

# electronics

radio, communication, industrial applications of electron tubes . . . engineering and manufacture



**JANUARY  
1936**

**Price  
50 Cents**

**McGRAW-HILL  
PUBLISHING  
COMPANY, INC.**

# BACK TO A GOOD OLD PRINCIPLE FOR A GOOD NEW YEAR

*A Frank Talk To Those in Radio Who Value  
Their Good Names as Much as We Value Ours*

**W**E BELIEVE there has been enough turning of wheels for the mere sake of turning them.

We believe that wear and tear on men, machinery and bank accounts is no substitute for profits.

. . . And we believe the time has now come for someone to speak out in a sincere effort to call a halt to a race which can end in nothing short of demoralization.

Certainly the price situation has reached serious proportions in radio within recent years. And it has hurt.

Manufacturers have been hurt as production and service problems have increased with the use of cheaper and still cheaper materials. Their parts suppliers have been hurt, for, when price wars start, even winners are apt to gain more damage than glory.

Distributors and dealers have suffered.

The consumer has been hurt, for he too has often received less in quality and trouble-free performance than he has a right to expect, considering the good names of the manufacturers involved.

The time has now come to face the facts.

The depression is over.

From a volume standpoint the radio business was good last year. It should be even better in 1936 and should be more profitable for the trade at large.

A real remedy calls for trade-wide cooperation in protecting a thing bigger than even the biggest of us, the integrity of the Radio Industry.

Naturally, we do not expect to remedy the price situation single-handed. But we CAN make a start—and that is what we propose to do.

Thus, our Policy now reverts back to its good old form:

At all times will Hugh H. Eby, Inc., consider quality and dependable service above price.

We will give our customers what they have every right to expect.

We will maintain a skilled engineering staff.

We will have a production organization geared for high quality even under the forced draft of sudden seasonal demands.

We will provide an engineering-sales-service to meet every need.

We will give every reasonable price advantage made possible by a well-equipped, modern plant.

In return, we shall ask for recognition of our heavy investment in plant and equipment and in carrying on worthwhile development work.

We shall expect the safeguarding of our designs, blueprints and samples.

We shall feel entitled to discuss frankly with the set manufacturer the limits of the allotted cost he can consider in the set or sets being planned.

We shall look for reasonable cooperation in anticipating and planning production schedules.

And, above all, we shall expect and insist on whatever price may be necessary to insure true Eby quality plus a fair profit to ourselves.

We believe there are many who will welcome such a policy, honestly presented and honestly followed through.

By April 1st a complete line of new and redesigned Eby parts will be presented for your careful consideration.

For twenty-four years we have been conscious of the value of our good name and the wisdom of preserving it.

Under stress of changing business conditions one learns, unlearns and relearns. Perhaps we have only relearned that a good name can never be taken for granted, lest you find it taken from you somewhere in the market place.

You must guard it, and actively sustain it.

Henceforth, that is our policy.

HUGH H. EBY, *President*

**HUGH H.**



**EBY, Inc.**

TIP JACKS    BINDING POSTS    WAVE CHANGE SWITCHES    MOULDED SOCKETS    MALE & FEMALE PLUGS    TAP SWITCHES  
ELECTRIC EYES    LOW LOSS SOCKETS    A-C SWITCHES    RADIO DIALS & KNOBS    TERMINAL STRIPS    SENSITIVE RELAYS

January 1936 — ELECTRONICS

# ELECTRONICS

radio communication and industrial applications of electron tubes . . . design, engineering, manufacture

HOWARD EHRLICH  
Vice-President

KEITH HENNEY  
Editor

DONALD G. FINK  
Associate Editor

H. W. MATEER  
Manager

## CONTENTS

January 1936

COVER—ANTENNA COUPLING INDUCTORS WITH ELECTROSTATIC SHIELD—RCA 50 KW. BROADCAST TRANSMITTER	
FRONTISPIECE—CONVEYORS FOR RADIO RECEIVERS IN PHILCO PLANT	6
1935 . . . IN REVIEW	7
Manufacturers report 1935 sale of 5-million radio receivers; communication arts advance economically and technically, industry looks with more favor on tubes, now they are made in metal	
THE ELECTRON TELESCOPE	10
A new photoelectric device makes use of electron optics to recreate and magnify optical images of large area, using infra-red, visible, or ultra-violet light	
A TUBE-CONTROLLED MOTOR, By PAUL B. KING, JR.	14
Impulses supplied by a synchronous motor (or alternator) are amplified and used to control the torque and speed	
GRAPHICAL HARMONIC ANALYSIS, By J. A. HUTCHESON	16
A method of computing the harmonic content of waves commonly present in amplifiers and modulators, by means of graphical construction	
HIGH FIDELITY ON 41 MEGACYCLES, By R. J. KINGSLEY	19
A report of the operation of W8XH, the ultra-high frequency high-fidelity broadcast transmitter in Buffalo, which enjoys a wide and regular audience	
BROADCAST TRANSMITTER CONSTRUCTION, By JOHN P. TAYLOR	26
New methods, mechanical and electrical, used in modern transmitting equipment for broadcast stations	
A NEW SOLAR RADIO DISTURBANCE, By J. H. DELLINGER	25
High frequency transmissions are affected by a cosmic disturbance of short duration every 54 days, the cause of which has recently been investigated	
R-f TRANSITION LOSSES, By HAROLD A. WHEELER	26
R-f IMPEDANCE-MATCHING NETWORKS, By RALPH P. GLOVER	29
Two charts, the first for evaluating the loss in r-f circuits due to impedance mismatch, the second for the design of matching networks to minimize the loss thus incurred	
OUTPUT TRANSFORMER RESPONSE, By F. E. TERMAN and R. E. INGEBRETSEN	30
Methods of computing the frequency characteristic of output transformers in audio service in terms of leakage inductance, turns-ratio, and the primary and secondary resistances.	

## DEPARTMENTS

CROSSTALK	5	THE ELECTRON ART	42
ELECTRONICS REFERENCE SHEETS	27	MANUFACTURING REVIEW	50
VIEWS AND REVIEWS	33	PATENTS REVIEW	56
TUBES AT WORK	36	INDEX TO ADVERTISERS	70

VOLUME 9 . . . NUMBER 1

Contents Copyright, 1936, by McGraw-Hill Publishing Company, Inc.

ELECTRONICS, January, 1936, Vol. 9, No. 1. Published monthly, price 50c. a copy. Subscription rates—United States, \$5.00 a year. Latin America, \$5.00 a year. Canada, \$5.00 a year. All other countries, \$6.00 a year or 24 shillings. Entered as second-class matter April 4, 1930, at Post Office at New York, N. Y., under the Act of March 3rd, 1879. Printed in U. S. A. Printed by The Schweinler Press, N. Y.

Branch Offices: 520 North Michigan Ave., Chicago; 883 Mission St., San Francisco; Aldwych House, Aldwych, London, W. C. 2; Washington; Philadelphia; Cleveland; Detroit; St. Louis; Boston; Atlanta, Ga.

**McGRAW-HILL PUBLISHING COMPANY, INC.**

330 West 42d Street, New York, N. Y.

JAMES H. MCGRAW, JR.  
Chairman

MALCOLM MUIR  
President

JAMES H. MCGRAW  
Honorary Chairman

HOWARD EHRLICH  
Vice-President

B. R. PUTNAM  
Treasurer

D. C. MCGRAW  
Secretary

Cable Address: MCGRAWHILL, New York. Member A.B.P. Member A.B.C.

**STANDARDIZE *your* SETS**  
*with the* **NEW TYPE**  
**STACKPOLE**

**INSULATED RESISTORS**

*One size for all requirements*  
*1/2 watt or less*

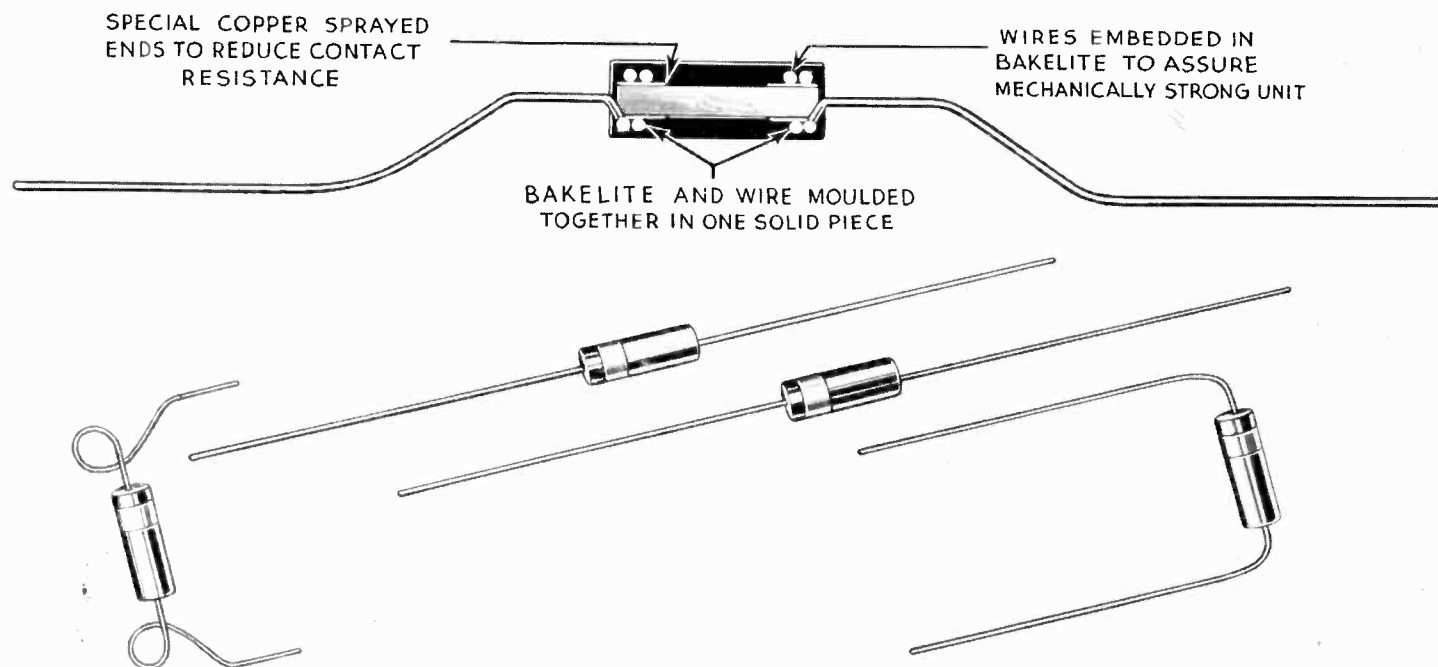

"No need to complicate purchasing—inspection, and manufacturing procedure with more than one resistor for loads of  $1/2$  watt or less—size of this new Stackpole  $1/2$  watt resistor only  $5/8 \times 13/64$ " . . . lead wires come straight out of the ends . . . fit into any wiring system anyplace . . . mechanically strong—insulation will not chip . . . resistors are fully encased and perfectly sealed against humidity or other influences.

Simplify your stock of resistors with Stackpole—the standard of quality and uniformity. Write for samples today—see for yourself the economical advantages of standardizing your sets with the new Stackpole insulated resistors."

**STACKPOLE CARBON COMPANY**  
**ST. MARYS, PA.**

# TUNE IN ON THE LATEST IMPROVED DESIGN IN SWITCHES AND CONTROLS BY STACKPOLE

## A TYPE FOR EVERY REQUIREMENT



Exterior view of the Stackpole Toggle switch with the end of the toggle showing at the top edge. May be equipped with plain type or extruded eye terminals as illustrated.



Interior view of the Stackpole Midget Switch in the closed position replete with all the advantages of a larger sized line switch.



Exterior view of the Midget Switch equipped with plain type terminals.



Type "P" Control with metal cover removed showing addition of friction clutch to standard tap type control.



Internal construction of the Midget Control showing design of contact carrying mechanism.



View showing internal construction of standard type "P" Control.



Showing addition of bell mouth sleeve construction to shaft.



Complete assembly of the Stackpole Midget Control with switch.



Side view of Rotary Switch mounted with bushing and shaft.

You asked for it—now here it is—the new Stackpole Midget Control for Auto Radios with all the known advantages of the larger sized controls . . . 100 per cent accurate and just the "ticket" in the new Auto Radios where space is at a premium. The Stackpole Midget Control is also ideal for the modern household receivers as the line switch carries approval of the Underwriters Laboratories.

As you will note above, each terminal of the switch has two contacts, insuring positive control and the lowest possible contact drop. You have a choice of several different types as illustrated including the newly developed Rotary Switch. Check the types you are particularly interested in and we shall be glad to send samples together with detailed data on the complete Stackpole line.

# STACKPOLE CARBON COMPANY

## ST. MARYS, PA.

# The GOOD JOB continues...

The mere fact that over 5,000,000 Yaxley All-Wave Switches are now in use is a fair indication of the satisfactory service that Yaxley All-Wave Switches are giving in actual service.

Leadership in precision engineering has made it possible for Yaxley to contribute materially to more rapid progress in all-wave receiver development.

In the past, Yaxley engineering research has

been outstanding in solving the knottiest problems. Each succeeding Yaxley All-Wave Switch design has established higher standards of performance.

In 1936, Yaxley will continue the good job, anticipating all improved circuit requirements and making possible advances in all-wave receivers far beyond any performance yet given. The Industry's disposition to consult continuously with the Yaxley engineering staff is bearing fruit.

## YAXLEY MANUFACTURING DIVISION

of P. R. Mallory & Co., Inc.

INDIANAPOLIS, INDIANA

Cable Address—PELMALLO



# ELECTRONICS

JANUARY  
1936

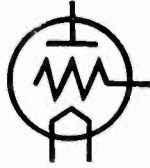

KEITH HENNEY  
Editor

## Crosstalk

► **SPECTRUM CHARTS . . .** Twice *Electronics* has published a chart of the ether spectrum, the audible frequencies, and the photoelectric spectrum in four colors. These charts have been distributed not only to the circulation of the paper but to several thousand others who saw or heard of it somewhere. These charts are to be found framed and hung on the walls of many engineers, executives, and others in all parts of the world and in all manner of industrial or learned professions.

These charts have been out of stock for six months, and still requests come by mail and phone. Ralph Langley suggests that a nominal charge (say 25 cents) could be made for this chart and that sufficient people would want them, perhaps in bulk, to make the reprinting from completely new plates (to take care of recent developments) not too expensive. The Editors would be delighted to hear from readers who have ideas on this subject.

► **ON 41 MC . . .** In this issue is a brief report of the new high-frequency broadcast transmitter installed by WBEN at Buffalo (see *Electronics*, April, 1935, for a description of the pioneer efforts in this direction by WBEN). Now it is understood that a half-dozen newspaper owners of broadcast stations have purchased similar equipment as adjuncts to their regular broadcast service. Of even greater ultimate importance is the fact that at least one of these 100-watt high-fidelity sets has been sold to a company that never owned a station—and does this not indicate that a whole new realm of local broadcasting might be opened up?

Receivers good to 60 mc. will improve this market for local coverage high-fidelity transmitters.

► **MAGIC DOORS . . .** In 1930 Mr. Horace H. Raymond sold his company, The Stanley Works, the crazy idea of developing door openers operated by phototubes. Since then this single com-

pany has installed equipment of this sort in restaurants, office buildings, garages, railroad stations, saloons (for exit purposes) and countless other places where an automatic Stanley Magic Door performed a natural service. Mr. Raymond wrote a report on this activity for this, the Review Issue of *Electronics*, but it is too good to hide in such a place. Instead it will have a space in February more fitting to its importance to the electronics art.

► **WITH THANKS . . .** The flood of letters continues from readers commenting favorably upon the increased contents of *Electronics*, its new appearance, its longer articles, its larger illustrations, its better paper. And in response to our request, we have the kicks, too. An engineer objects to the style of illustration given Mr. Weeden's skit on the control room operator's troubles. On the other hand a non-technical executive of a broadcast chain took the trouble to point out that he was enticed into reading this article because it did not look too technical for him to understand, and that as a result he learned much of the problems connected with putting a program on the air. We can't keep these non-engineers from reading *Electronics*; if the engineers have any advice on this score it will be appreciated.

There are still engineers who feel that any old kind of paper, any kind of printing or illustration, so long as it is legible, is all right for technical material. We have commented many times upon the attitude by which electronics engineers considered themselves, usually as members of the hired-help staff. We believe this attitude (of not liking a paper made good to look at, easy to read), dates from the days when technical colleges turned out cracker-jack engineers in a given profession but dumb at all others, ignorant of history, art, music, literature, or beauty. We believe the more recent graduates have a larger horizon, in spite of their kicking and screaming at

having to take some of the cultural courses now made compulsory.

And while we don't hold any briefs for ourselves as fancy editors, we believe that a good-looking paper will teach, subtly perhaps, the engineers' bosses a bit more about their professional work than a stodgy publication that must frighten away all but the hardest-boiled engineers.

► **P.S. . . .** The above material was written a month ago and was not published in December because of lack of space. Now we feel as we did then—fortified somewhat by the unofficial audit of *Electronics* circulation showing a 25 per cent increase in circulation during the past six months, to the highest figure the net paid has ever reached (approximately 8,000).

Shall we grant the fading depression and the better economic condition among engineers a small portion of the credit for this rapid increase in circulation or is there something to this new *Electronics*?

► **THANKS TO THE BEAM . . .** Anyone who has arrived at the Newark airport on a thick day when the ground cannot be seen for the last 50 or 100 miles or until a few hundred feet (or less) of the ground cannot help but marvel at the beams on which the pilots ride their craft. In the *Saturday Evening Post* for November 9, 1935, Richard Thruelsen rhapsodizes over the Chicago to Newark TWA route and in the *New Yorker*, November 30, Morris Markey expresses much the same feeling. Both articles are designed for popular consumption by well known writers but are worth the time of a blasé radio or aviation engineer. They cannot help but lend the impression that American air travel is made as safe as it is largely through the medium of electronics. On this score, Morris Markey points out that from June, 1934, to June, 1935, transport airplanes hauled 590,139 passengers with a total loss of 9 passengers.



## Nine Thousand Radio Chasses a Day

Overhead conveyors carrying completed chassis to the test room in the Philco plant where 40 percent of the 1935 U. S. production of radio receivers was made



# 1935 ..... In Review

Radio receiver manufacturers enjoy banner production year, tube plants struggle with metal envelopes, communication improves technically and economically, electron tubes increase their service to industry

**A** YEAR in which five million radio receivers were sold cannot escape being a success; such was 1935. Contributing to this pleasant fact were the better economic condition of the average citizen and the improved technique. Broadcasting stations, too, benefited to the extent of increased income from advertising, some of which was put back into new station equipment. At the same time that the communication portion of electronics noted signs of better conditions, the industrial section took greater advantage of the versatility and practical usefulness of the electron tube. More installations of non-communication tube applications were made, and, as in radio, new technical advances were accomplished.

In the realm of general radio communication, the mobile services were improved with better direction finding stations and equipment. The sensitivity and selectivity of the radio compass were improved during the year, a new phase indicating system was developed which gets around the 180° ambiguity existing heretofore; orders were issued which will compel certain passenger liners to carry complete public address systems and cause other vessels to be fitted out with automatic alarm equipment which will either make unnecessary a radio operator or make more certain that aid can be summoned in case of trouble at sea.

Facsimile equipment for transmitting weather maps, or news, has been built and will be installed on several ships as an experiment. In addition the ultra high frequency circuit between New York and Philadelphia neared the day when trials will be made. After these tests, RCA Communications plans to cover the nation with a radio network. Other advances in the realm of ra-

dio point-to-point service include multiplex between New York and San Francisco, the addition of numerous new international radio telephone circuits and other new code circuits. On ultra high frequencies there has been much activity and installations have been made between Barcelona and the Balearic Islands, across the English Channel, between England and Ireland, between Norway and islands off the coast, and a 50-mile, 200 Mc. circuit in the Hawaiian Islands has been put in service. In this country an unattended circuit has been installed by the Bell System at Green Harbor, Massachusetts.

Pan American Airways has added to its stations in Alaska and installed a complete network over the Pacific Ocean in preparation for regular flight service between this country and China.

Police radio equipment continues to be installed at rather high speed. There are now nearly 400 cities which boast radio service belonging to the police department. Many of the new installations have been in the experimental bands below 10 meters. For this service standard equipment is now available for use in the 30 to 42 Mc. bands in powers from 15 to 150 watts. Work on still higher power has continued and no doubt these more powerful stations (Newark is a good example of higher power) will continue to be in-

stalled where conditions demand. Some of the new receivers designed for police car service employ crystal control of the heterodyne oscillator. Present equipment bears little resemblance to the amateurish radios used in the early days of police radio.

Much work has been done to solve the problem of automobile ignition noise resulting in better reception on the broadcast band (about one million auto radios were installed during 1935) and on the police or other high frequency bands. One receiver employs both the superheterodyne and superregenerative principles. It follows advances in home receiver design in having excellent a.v.c. and a "squelch" circuit to get rid of carrier-off noise.

A transceiver of 1-watt power operating on 300 Mc. (1 meter) was developed by General Electric and has been used over a line-of-sight distance of 20 miles or over 1 mile in a residential district. Engineers in the G.E. Laboratory designed a signal-to-noise ratio meter to be used in the 30 to 42 Mc. bands which has proved to be most useful in making field surveys in anticipation of police radio installations.

Public interest in short-wave reception continued at a high level during the year, making it possible to get out of the home and into scrap many of the receivers which have grown antiquated. Sale of high

# 1936 ..... A bright picture is promised for improved entertainment in the home by sight and sound, better profits are in sight for manufacturers, better wages are indicated for engineers

priced receivers is most encouraging. Several thousand sets which approached the thousand-dollar unit price were sold during the year. Metal-tube sets undoubtedly stirred public interest and created sales opportunities.

While it's true that some improvement in tone fidelity and range were accomplished during the year, one cannot gloss over the fact that the best of today's receivers are still pretty dead at 5000 cycles. Band wideners became rather widely used in 1935 and improved the high frequency end of the audible scale somewhat but it must be regarded as unfortunate that the upper limit is not 6000 to 7000 cycles rather than 4000. It seems that the selectivity problem has been tackled and solved much better than the problem of how to get this selectivity without ruining the upper register. Radio is still radio to the engineers, salesmen, and listener—not a musical instrument.

The high point in broadcasting during the year was probably the

*T. S. McCaleb, Harvard, designs ultra-high frequency burglar alarm; detects any motion whatever in a given space*

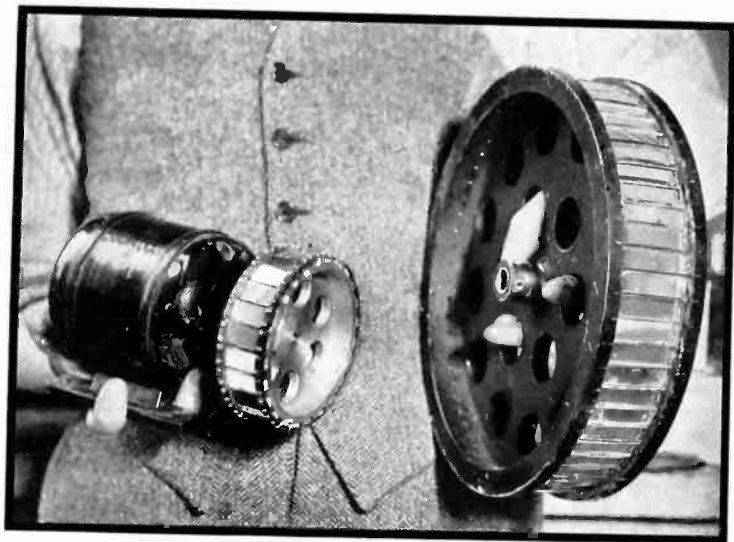
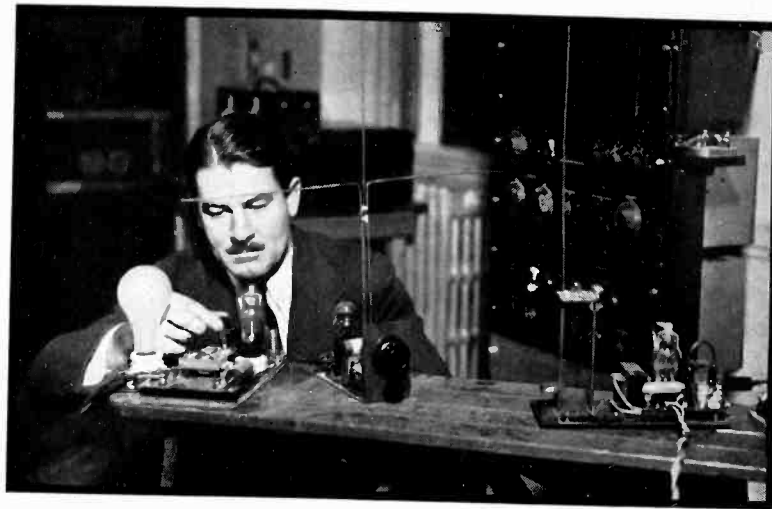
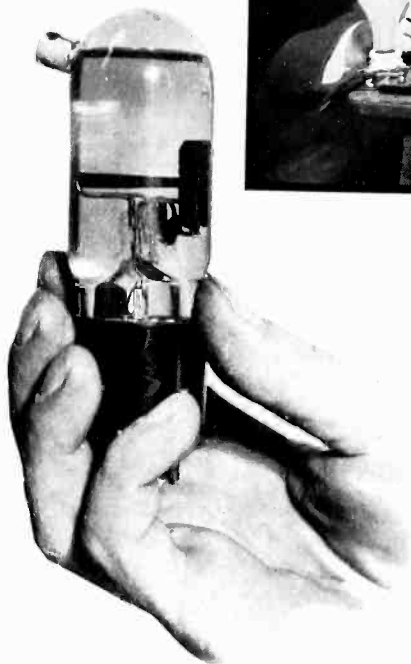

*Kerr cell and mirror drums of W. H. Peck by which 60- and 180-line mechanical scanning is accomplished*

stratosphere flight of the Explorer II details of which were carried to a world-wide audience.

During the year an electronic musical instrument was shown by Hammond Clock company, an instrument that attracted considerable attention from all but the radio people, who scoffed, as usual. It is now stated that more than a hundred of these instruments are being made per month, that deliveries are about 6 weeks after orders, and that the lowest price per unit is something over \$1000. Thus the radio manufacturers who scoffed may have passed up a cool million-dollar market.

At Christmas time a powerful public address system was installed at Fort Wayne by the Electro-Acoustic products company, a Magnavox subsidiary. This system was made up of a battery of large speakers which were fed with 450 watts of audio frequency power. Thus the town of Fort Wayne was covered with Christmas carols and chimes through phonograph records and by speech.

A reviewer cannot approach any estimate of the immediate possibilities of television without certain misgivings. If he is pessimistic he is likely to be confounded within a short time by an actual demonstra-

tion; if he is optimistic, he runs the risk of exciting the radio trade with false fears that the radio receiver business is about to be ruined.

The truth is that considerable progress has been made in television during the year. All forces are now engaged in a rather gigantic struggle to bring this final (?) prodigy from the laboratory and into the home. And it must be stated at once that not all the research is being done in large laboratories. There is a tremendous amount of serious work going on here and there in the belief that a workable system of sight and sound broadcasting can be developed and sold.

The ideal system, no doubt, is one which delivers a large, bright, well defined picture, probably in color, with low cost. This seems a lot to shoot for; but no one can say it is impossible, or that such a development might not come from unexpected quarters at any time within the next year or so. Prophets, without great knowledge of what the men in the laboratories are doing, bandy dates about with scant regard for facts. Thus 1940 has been mentioned—just as 1935 was mentioned 5 years ago.

The new year will see an ambitious test of cathode ray, ultra-high frequency television in New York. A new transmitter is being installed in the Empire State building, receivers are being built and will be installed at many points in the metropolitan district; broadcasting systems are experimenting with programs from the television viewpoint, endeavoring to answer in advance of need the question of "how shall we handle this program when television comes?" And as for mechanical systems, it would be extremely dangerous to state that they have been

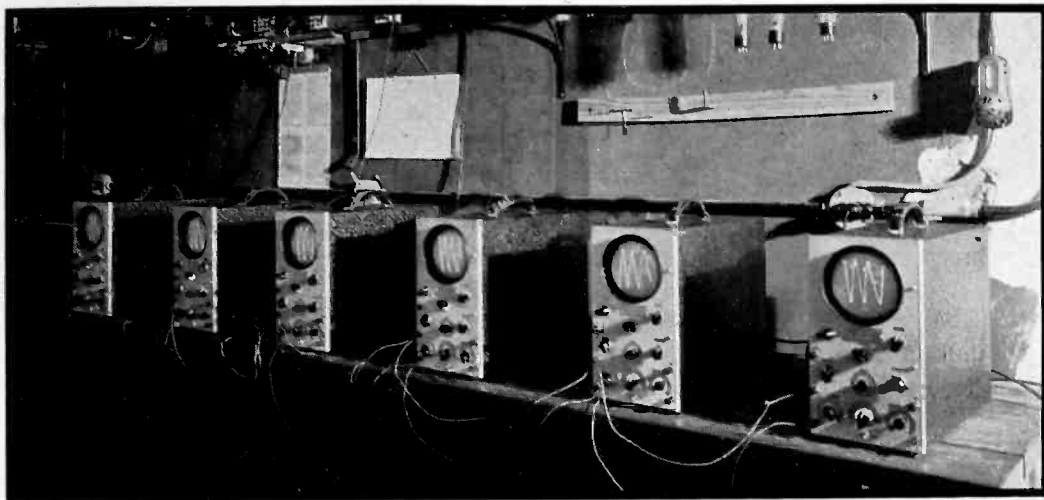

*Cathode ray tubes enjoyed wider sale in 1935. Here DuMont tubes are going through a portion of 75 tests before being shipped*

*Smooth flowing contours mark the recent automobile radio equipment. This Arvin control is molded of Durez*

cast aside completely in favor of electron stream devices. As a summary, this reviewer feels that the television outlook is most hopeful, that ultimately there will be most excellent receivers in the home, and perhaps in the theater.

Non-communication uses of vacuum tubes of all sorts continue to grow both as to numbers of units or installations sold and as to new applications. While the large companies making electrical equipment are awaiting the day when high powered, conversion equipment finds a market, such as for direct current power transmission, frequency changing, etc., they are not inactive in promulgating the use of tube apparatus for low power control and other uses.

From the industrial standpoint, introduction of the metal envelope vacuum tube of the two-element and of the controlled rectifier types should have a stimulating effect since the old prejudice against glass tubes can no longer be advanced against the use of tubes in industrial plants. These metal tubes are now available in several types, among them a 30-ampere half-wave mercury vapor rectifier, a similar tube in the 1.25 ampere size and a Thyatron carrying 6.4 amperes. This is a shield-grid type of tube. The metal tube was made possible by development of tube-controlled welding apparatus which saw wide sale during the last half of the year to the manufacturers of metal receiving tubes.

Mercury pool tubes of the immersed igniter and Ignitron types are now available in large size to handle peak currents of the order of 5000 amperes.

The year has seen more inquiry of the editors of *Electronics* as to the opportunities existing in the de-

velopment and sale of electronic equipment by people who know nothing, or very little, about the matter. In general these potential electronic manufacturers are in doubt whether to tackle the whole field or to search out and cultivate a few applications of wide potential market. A good example of the latter group is The Stanley Works which has made a considerable success of phototube controlled door opening equipment.

First application of the "feedback" circuit in illumination control by the tube-reactor system was made during the year at Omar's Dome, a restaurant in Los Angeles. Here tubes are used to control manually the decorative scheme of the large room both as to color and intensity. Table fixtures and the balcony spotlights are controlled. Five circuits in all are controlled by four electron-tube panels each of which is under the control of an operator at a central position in the room from which the effect can be observed. Two buttons are provided at this remote point, one of which dims the lights until released and the other increases their intensity. They actually govern the direction of rotation of a small electric motor which changes the position of an iron core solenoid

[Please turn to page 33]

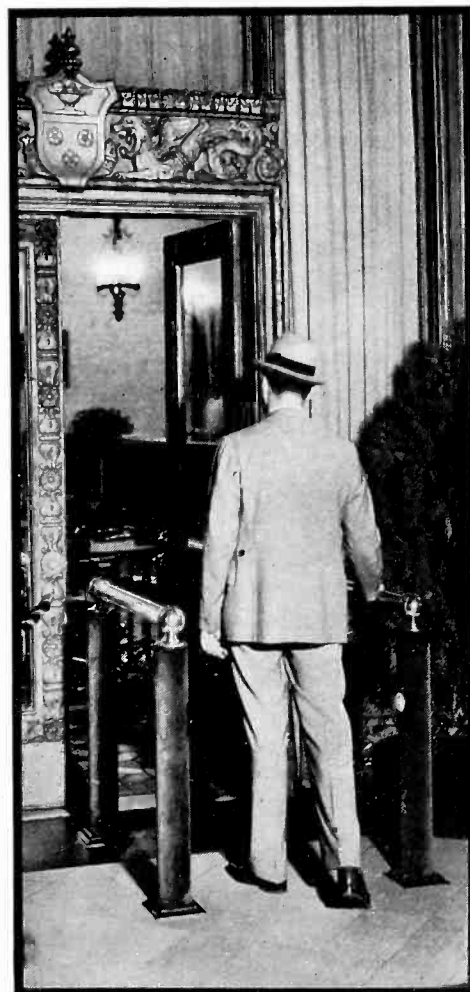

*Door opening provides a useful outlet for phototube apparatus, as this installation at the Roosevelt Hotel, New Orleans, by The Stanley Works shows*

# The Electron Telescope

A new application of electron optics is revealed at the annual meeting of the American Association for the Advancement of Science by Doctors Zworykin and Morton. Infra-red light made visible directly in new device

**E**LECTRON optics was advanced one step nearer the full stature of its sister-science, the optics of light, on January second when Doctors V. K. Zworykin and G. A. Morton of RCA Victor announced and demonstrated their newly developed electron telescope. This device, the latest application of the principles first used in the cathode ray tube, has several unique applications such as translating infra-red light directly into visible light without the necessity of any intervening photographic process. The model of the telescope shown was particularly remarkable in that the images produced in it were entirely free from the spherical aberration which usually distorts pictures produced by electronic means. This freedom from distor-

tion is made possible by the use of a specially curved photoelectric surface, one of the outstanding contributions to the practice of electron optics made during the past year.

As the authors pointed out, the origins of electron optics are older than the discovery of the electron itself; the earliest workers with cathode rays found that a solid object would cast a shadow when placed in a beam of rapidly moving electrons and that the electron beam resembled light beams in that respect. Later investigators established the fact that electron beams could be bent by refraction and diffraction (see *Electronics*, September 1935, page 24) in much the same way as light is affected by lenses and sharp edges; and it was these discoveries which led to the wave-theory of the

electron which is now occupying so much attention.

The evident analogy between light rays and electron beams led to such terms as "electron lenses," and "electron images." The design of electron lenses capable of bending electron beams likewise has many geometrical features in common with the design of glass lenses. For the same reason that the ordinary glass lens has spherical surfaces, it was found that electric fields having a spherical character (that is, fields possessing radial symmetry) were of greatest practical value in focussing electron beams.

The analogy between the electron lens and the glass lens can be carried through mathematically. The focal length  $f$  of a glass lens ( $f$  is the distance from the lens at which

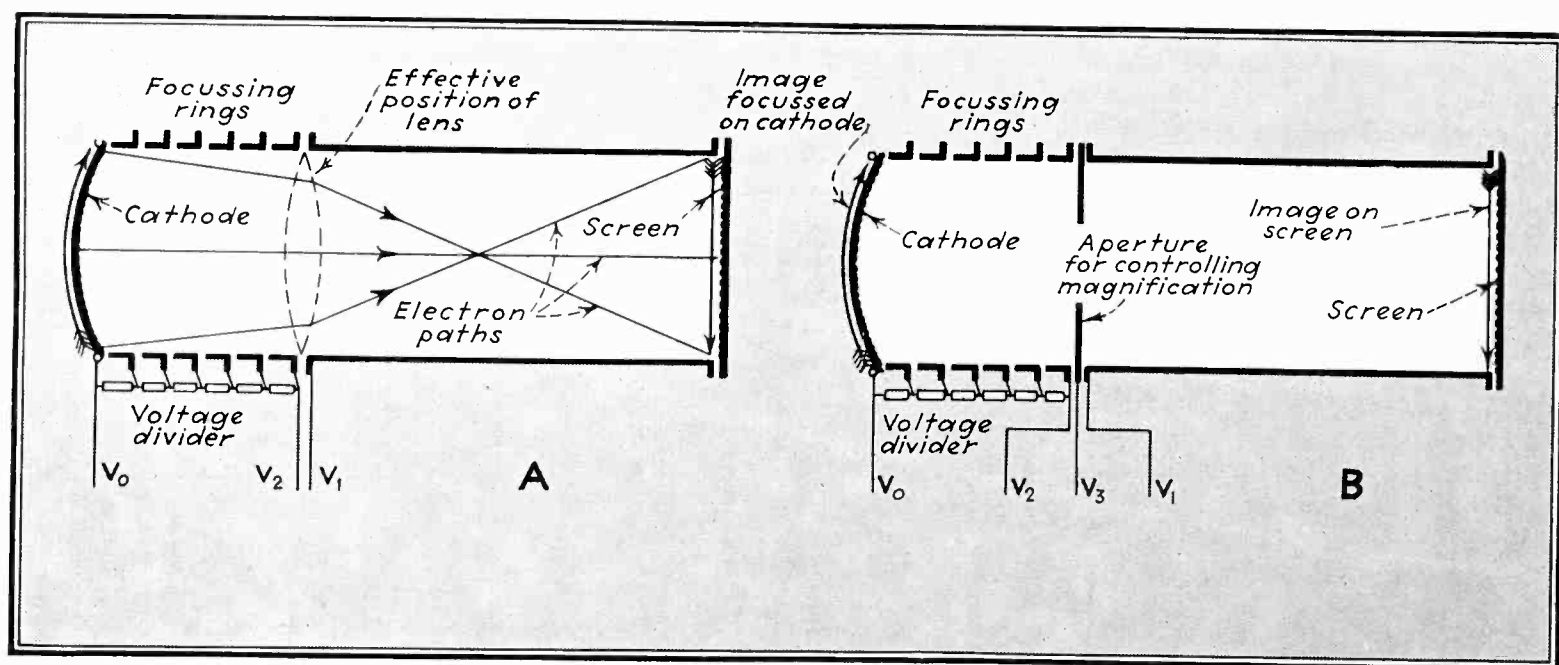

*Construction of the electron telescope. As shown in A, the optical image (the arrow) is focussed on the transparent photoelectric cathode. Electrons thus produced take the paths shown, and upon hitting the Willemite screen, recreate the image in an inverted position. The electron lens consists of the two cylinders, the left of which is broken up into a series of rings to aid correct focussing. A glass lens acting on light rays in the same way would have the position shown in dotted lines. At B is shown a model containing an aperture by which the magnification can be controlled electrically. By increasing the potential  $V_3$  with respect to  $V_2$  the magnification can be increased*



Doctors Zworykin and Morton in the Electronic Research Laboratory where the new device was developed, photographed by the Editor on a recent visit to Camden. Dr. Morton holds a typical telescope tube

a beam of parallel rays is brought to focus at a point) can be given by:

$$f = \frac{4K}{\mu_2 - \mu_1}$$

where  $K$  is a constant depending on the lens dimensions and  $\mu_2$  and  $\mu_1$  are the indices of refraction of the glass and of the air. Likewise the focal length of a charged aperture (a form of electron lens) is given by:

$$f = \frac{4V}{E_2 - E_1}$$

where  $V$  is the velocity of the electron whose path is being bent, and  $E_2$  and  $E_1$  are the electrostatic fields on either side of the aperture. Thus by the proper choice of dimensions and fields, the electron lens is capable of bringing a beam of electrons to focus in the same way that a glass lens acts on a light beam. Furthermore either positive or negative lens action (converging or diverging) may be produced.

#### Applications of Electron Lenses

At present the most important application of electron lens action is that used in the cathode ray tube, i.e. in the production of the beam of electrons as they leave the activated cathode surface and in focussing the electrons in a small spot on the fluorescent screen. The smallness of the spot is particularly important in television work, where it is the absolute limitation of the

definition of the picture produced. Another application of great promise is the electron microscope. These instruments use electron lenses dependent usually on both electrostatic and magnetic action. They have been very successful in certain applications where light cannot be used in the examination of small objects. The electron micro-

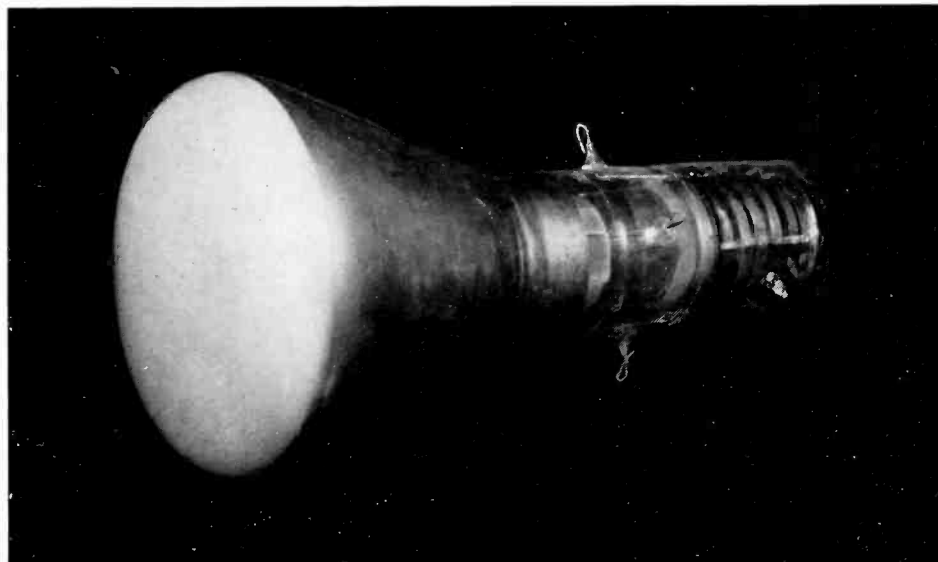

The type of tube demonstrated at St. Louis, with an enlarged fluorescent screen producing pictures six to eight inches in diameter

scope in fact promises to be the ultimate tool in this field, since the resolution theoretically possible with an electron beam is several times greater than that possible with light, making it possible to distinguish points separated by a much smaller distance.

In the course of the investigations carried out by Doctors Zworykin and Morton, they developed an instrument capable of producing an electron image of a large object, whereas the electron microscope and cathode ray tubes are concerned with very small emitting surfaces. The instrument was built with several requirements in mind: a large area of object and image, freedom from distortion, small circle of confusion, large lens aperture, and a small (one-half to three times) degree of magnification. Because the instrument can be focussed on a large scene, in much the same way as with an ordinary terrestrial telescope, it has received the name "electron telescope." Actually it is more closely an "electron copying camera," as will be seen from the nature of its applications.

#### The Electron Telescope

The electron telescope consists of an evacuated tube inside which are the following elements (see diagrammatic illustration on page 10): a semi-transparent photoelectric cathode on which the optical image may be focussed by means of a suitable glass lens and a series of

focussing anodes (the lens) for directing the electron stream from the cathode toward the fluorescent screen at the opposite end of the tube. The image thus produced on the Willemite screen reproduces the image focussed on the transparent cathode, and the degree of

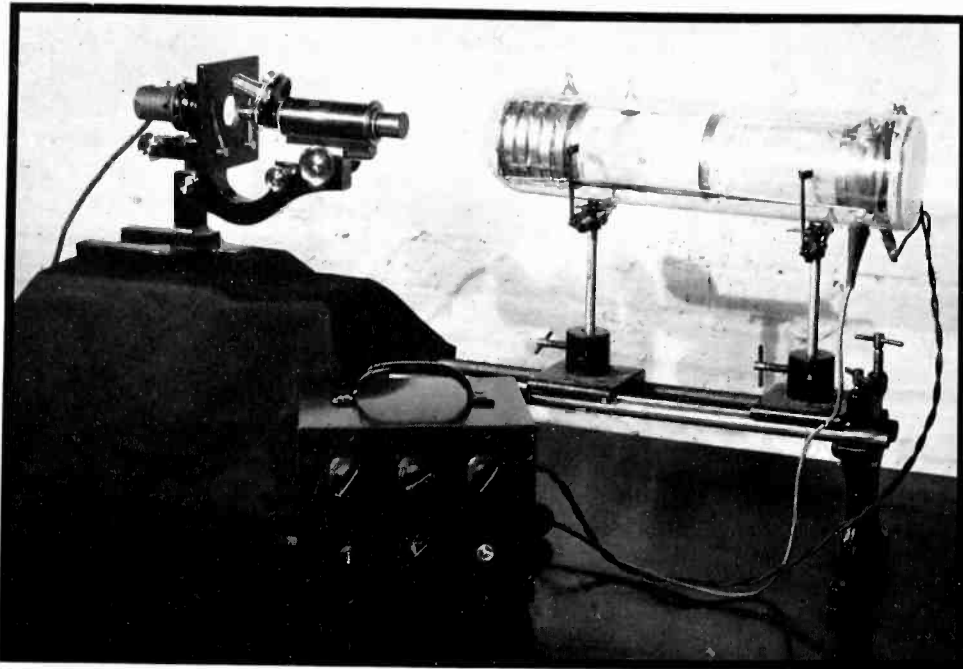

*The tube used to view images cast by a microscope on the photoelectric cathode. The motion of microscopic animals may be viewed in infra-red light by means of this arrangement*

*Below, the image produced on the fluorescent screen by the microscope set-up, about one-half actual size*

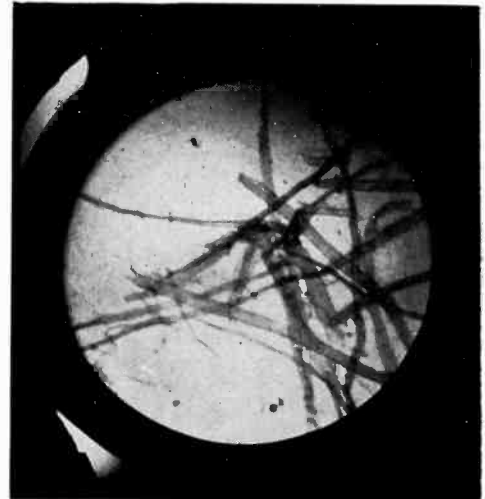

magnification can be controlled within the available limits by changing the relative potentials on the focussing anodes and aperture. Since the photoelectric surface of the cathode can be made sensitive to infra-red, visible, and ultra-violet light, the image visible on the screen is formed regardless of what kind of light is used on the cathode, and for this reason the device is a very efficient converter of both infra-red and ultra-violet light to the visible spectrum.

#### *Details of the Design*

In constructing an optical instrument, the ability to focus the image by changing the relative position of the lenses in the system is of course of prime importance. In building electronic devices, changing the position of the cylinders and apertures which form the lens system is extremely difficult (though not impossible) once the tube has been evacuated and sealed off. A system of fixed focus is shown in the right hand figure of the diagram (page 10); to build such a tube so that it will exhibit perfect focus when completed is almost impossible. The solution to this difficulty is to devise some means of changing the focus electrically, that is, by changing the potential applied to one or more of the electrodes. This change will change the configuration of the lines of force acting on the electrons.

When so changing the curvature

of the equipotential surfaces (or the lines of electrostatic force at right angles to them) to change the focus, it is important not to change the field next to the cathode at the same time. This was prevented by using six separate cylinders for the first half of the lens, as shown in the diagram, with a difference of

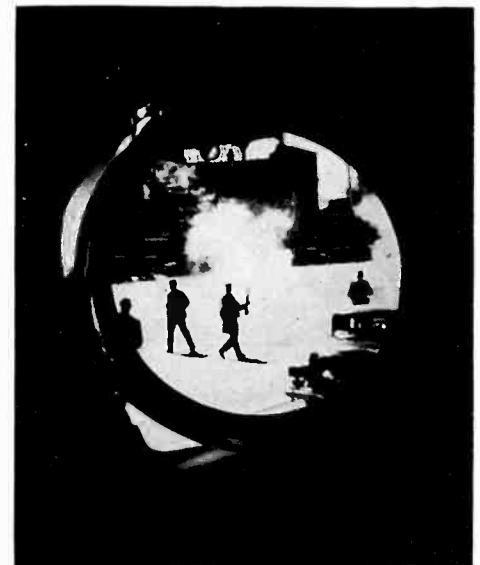
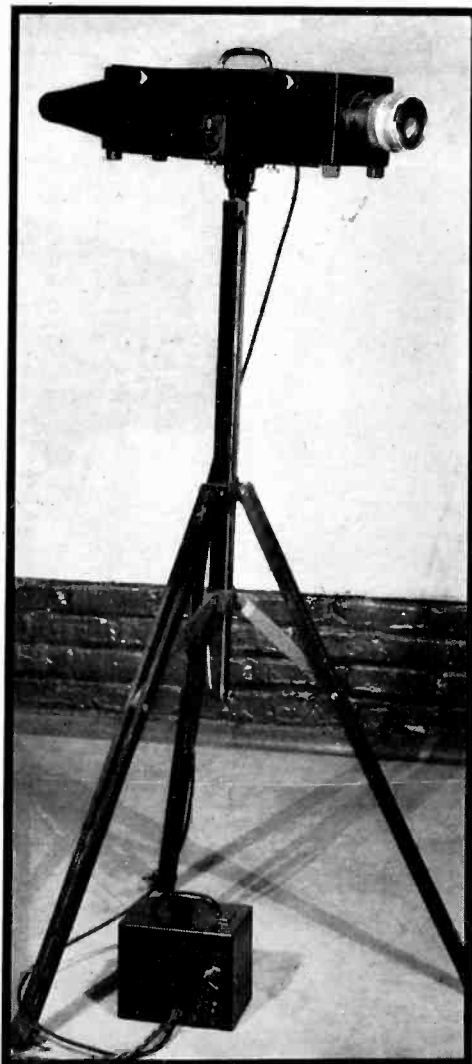

*Above, the image produced when the cathode was illuminated with a news-reel motion picture*

*At left, the tube set up as a terrestrial telescope, with a glass lens for focussing the scene on the cathode. This device can see in the dark if ultra-violet or infra-red light is used*

potential between each. The potential gradient along the cylinder thus formed prevents changing the field close to the cathode. Such tubes were capable of producing acceptable images provided the area used on the cathode was small. If the image formed on the cathode

is large, the "pin cushion" distortion shown in the photographs of the rectangular grid (below) is produced.

The cause of this aberration is primarily the changing curvature of the field with distance away from the cathode. By altering conditions at the cathode surface, either geometrically or by changing the field, the distortion can be corrected. Changing the field is possible but much less practical than the method finally adopted by the authors, which was the use of a curved, spherically shaped cathode surface, as shown in the diagrams. Because of the nature of the distortion, the cathode surface is curved concave toward the image. The radius of the spherical surface is equal to the distance from the cathode surface itself to the electron lens proper. When the shaped cathode is used, the "pin-cushion" distortion is reduced to a negligible amount, as shown in the illustrations.

The complete tube, as shown, contains a voltage divider within the tube which distributes the potentials in the proper relation to each ring of the lens.

#### *The Use of Apertures in the Tube*

If the electron lens is used in conjunction with a single aperture (diagram B page 10) the magnification is not given by the same law as with the lens alone. Instead, depending upon the position of the aperture with respect to the two sides of the lens, the magnification becomes greater or less than that

available without the aperture; as a result, tubes of otherwise identical construction can be made to have a wide variety of possible magnifications by changing the effective position of the aperture. Changing the potential applied to the aperture with respect to the potentials on the two sides of the lens will change its effective position so that the degree of magnification can be varied electrically between the limits available. The pin-cushion distortion can be corrected by means of the spherical cathode, over almost the entire range of magnification.

#### *Formation of the Cathode*

The cathode used is a semi-transparent cesium-oxide-silver layer on sputtered platinum, and is produced as follows: The curved glass or quartz plate is first sputtered lightly with platinum which acts as an inert conducting base. A layer of silver is then deposited by evaporation, and after baking, the plate is mounted in the tube. After exhausting the tube, the silver is oxidized by electric discharge in oxygen, and then cesium vapor is admitted, which reacts with the silver oxide. This process is very similar to that used in making cesium photocells.

#### *Applications of the Telescope*

The applications of the tube are shown in the illustrations, i.e. as a copying camera both of still and motion pictures, with infra-red, visible, or ultra-violet light. The tube may

be mounted for use with the infra-red microscope as shown. This application is of particular value as it permits examination of live and moving specimens under infra-red light, which has heretofore been possible only through the use of motion picture photography.

Other applications of the tube are smoke and haze penetration by the use of infra-red filters. Also, in connection with the infra-red camera used in long distance photography, the tube may be used to obtain a better idea of what will be recorded on the film. The telescope may be used for signalling, for alarm systems and the like.

At the presentation of the paper in St. Louis, Dr. Zworykin showed pictures formed by focussing the output of a motion picture projector onto the cathode surface through a red filter. The fidelity of reproduction was remarkably good, better in fact than the illustrations printed here would indicate. The large tube produced pictures approximately six inches in diameter.

Since the tube consumes a very small current (photoelectric and leakage currents) the power supply, even though it must provide voltages of the order of several thousand, can be very compact, as shown in the illustrations. The entire device can be fed directly from a 110 volt, 60 cycle line.

The editors are indebted to the authors of the paper and to Dr. Henry B. Ward, Permanent Secretary of the A.A.A.S., for permission to publish the information contained in this article.

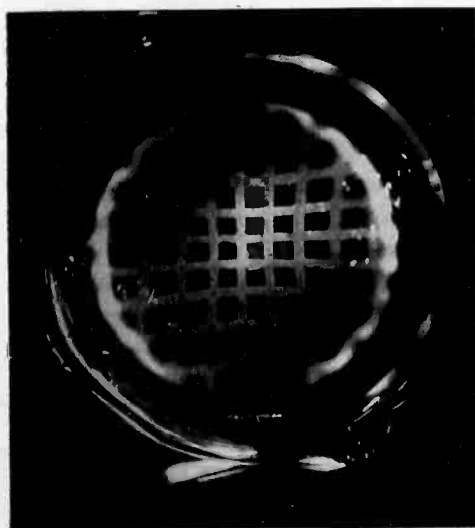

*"Pin-cushion" distortion which results when a flat surfaced cathode is used with an image of a grid*

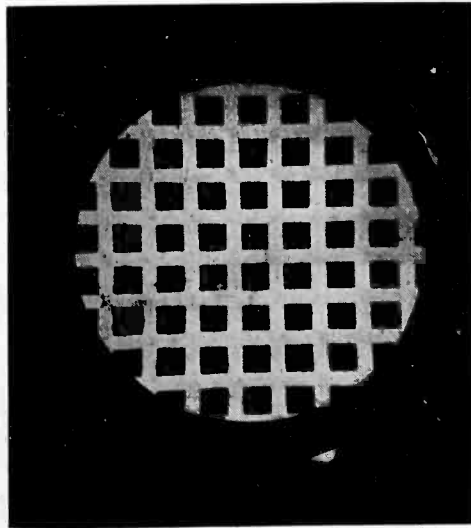

*The corrected image of the grid made possible by the use of a spherically shaped cathode surface*



*Two favorite television subjects as they appear when reproduced by the telescope tube*

# A Tube-controlled Motor

A synchronous motor with electronic connection between field coils forms a mechanically-coupled variable-frequency oscillator of interesting uses

**D**URING the past several years the number of uses for small synchronous motors has greatly increased. These motors, ordinarily, are of the tone wheel type, that is to say, a notched rotor which revolves in a pulsating magnetic field. Unless the device has some special means of self-starting, it must be brought to synchronous speed by hand. When once started, operation is quite stable if the power supplied is constant and the frequency does not vary. This, in many cases, is a decided advantage. However, there are times when the supplied power must vary (line voltage fluctuation, decrease in tube emission, etc.) without affecting the frequency. In this case it might be a serious handicap if the motor were to "fall out" or stop.

The device described overcomes this difficulty with the added advantage of supplying much more power for a given control voltage.

The original apparatus consisted of a 1,000-cycle motor similar to the type used in frequency standards. There were three field coils, two of which were used as driving coils, and one alternator or control coil. These are hereafter referred to as plate and grid coils, respectively. The grid coil was so arranged that it might be swung through a small angle about the rotor.

The combination of the grid coil and rotor forms an inductor type alternator, so that as the rotor is spun a pulsating current of a frequency equal to the number of poles passing the pole piece of the coil per second is produced. This current passes through the primary of a transformer and the resulting secondary voltage is applied to the grid of a vacuum tube. The amplified voltage is then applied to the plate coils, the combination of which, with the rotor, constitutes a simple synchronous motor. When (a) the power supplied by the tube

By PAUL B. KING, JR.

*Cruft Laboratory  
Harvard University*

is enough to overcome the friction losses of the rotor and (b) the phasing of the grid and plate coils is correct, the motor will run, increasing in speed until the losses are equal to the power supplied. Since the speed of the machine is always synchronous with the generated frequency, the words speed and frequency will hereafter be interchangeable.

When the above situation is analyzed, it will be seen that the device is actually a type of oscillator in which a rotating mechanism is used to secure feedback and control the frequency. The angular position of the grid coil with respect to the plate coil determines the phase of the voltage fed back, which in turn

determines the torque. In this device, when the phase relation shifts through a critical value, the direction of rotation is reversed, while in an ordinary oscillator, oscillations would cease until the phase is shifted 180° further. Since a free wheel has no definite period of rotation, and since none of the circuits have been made sharply resonant, the speed, up to the cutoff of the amplifier, is a function of the power supplied.

However, the frequency may be quite accurately controlled by several means, such as (1) tuning the grid or plate circuits, (2) inserting an electro-mechanical resonator in the circuit, (3) introducing a control frequency from an external source, (4) employing a mechanical governor on the rotor. Little need be said about the first and last of these methods, as they operate exactly as would be expected.

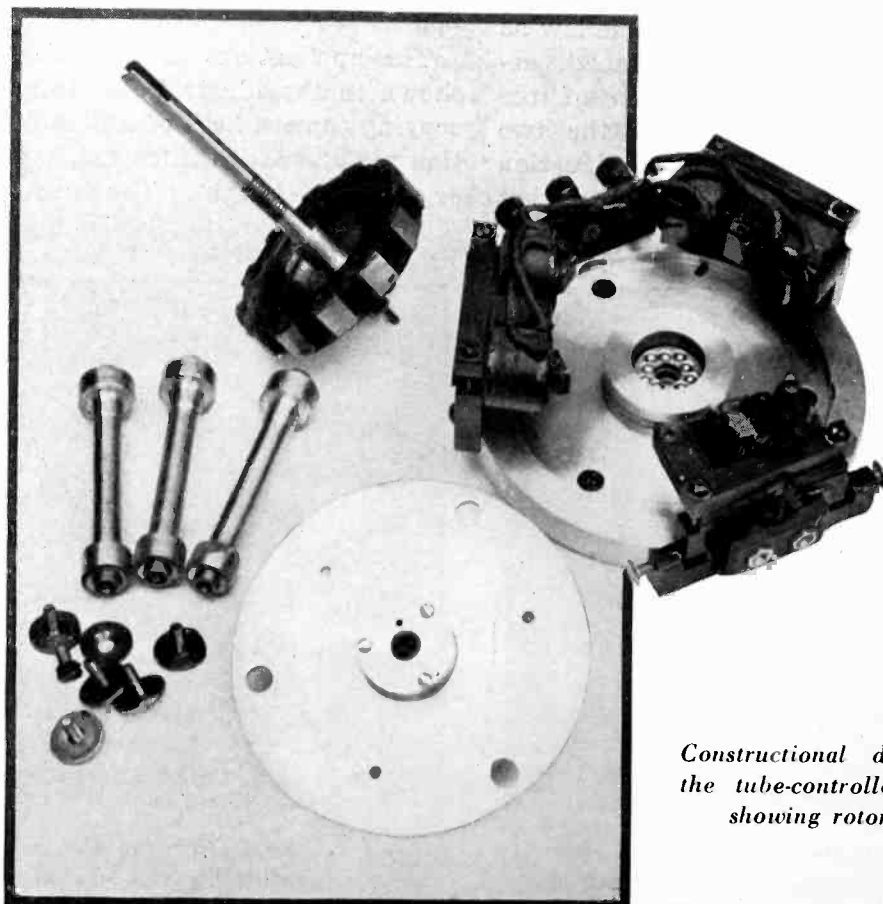

*Constructional details of the tube-controlled motor showing rotor, etc.*



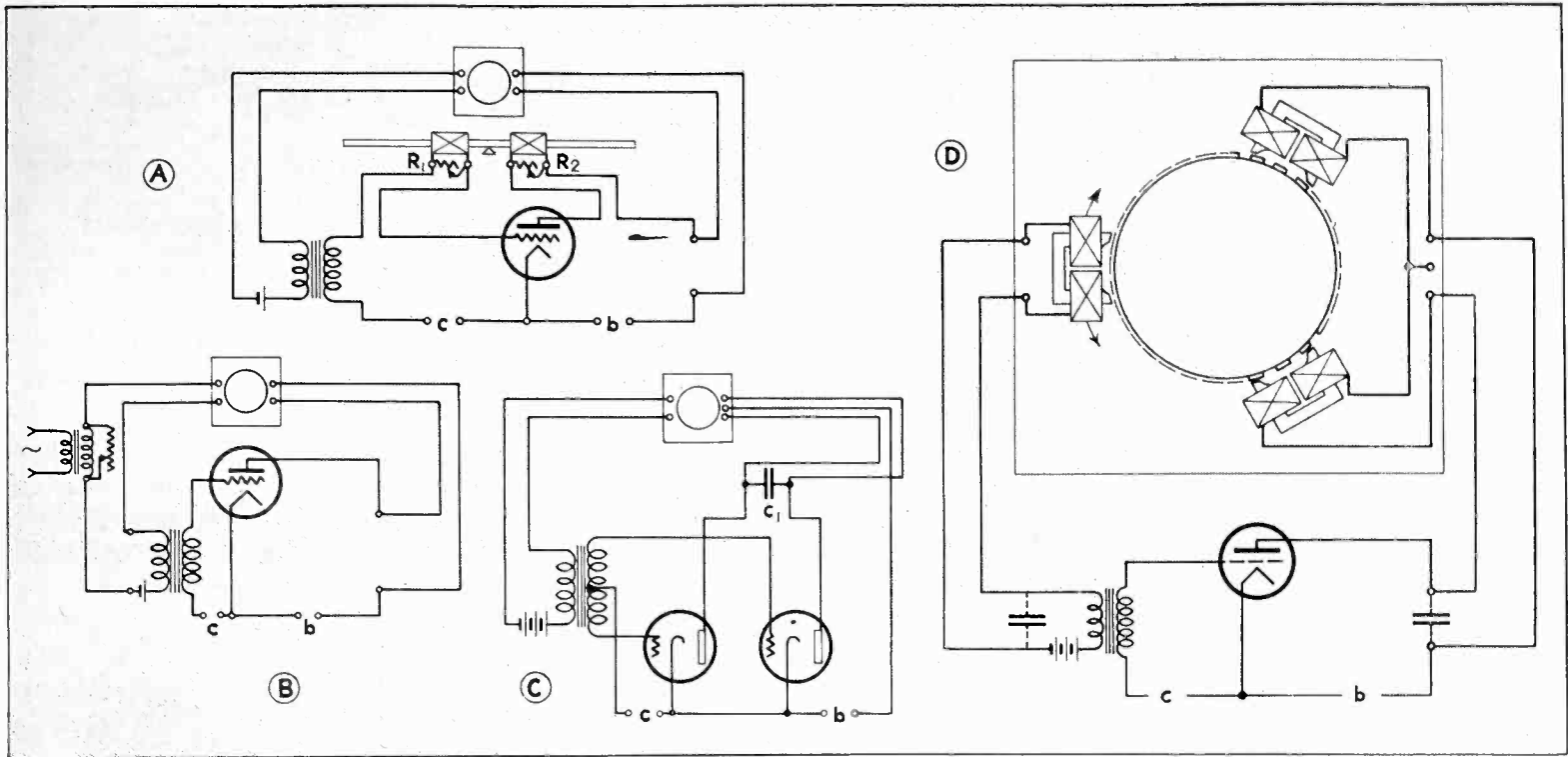

Methods of control. A—Magnetostriction

B—External control;  
C—Thyatron

D—Tuned circuit type  
of control

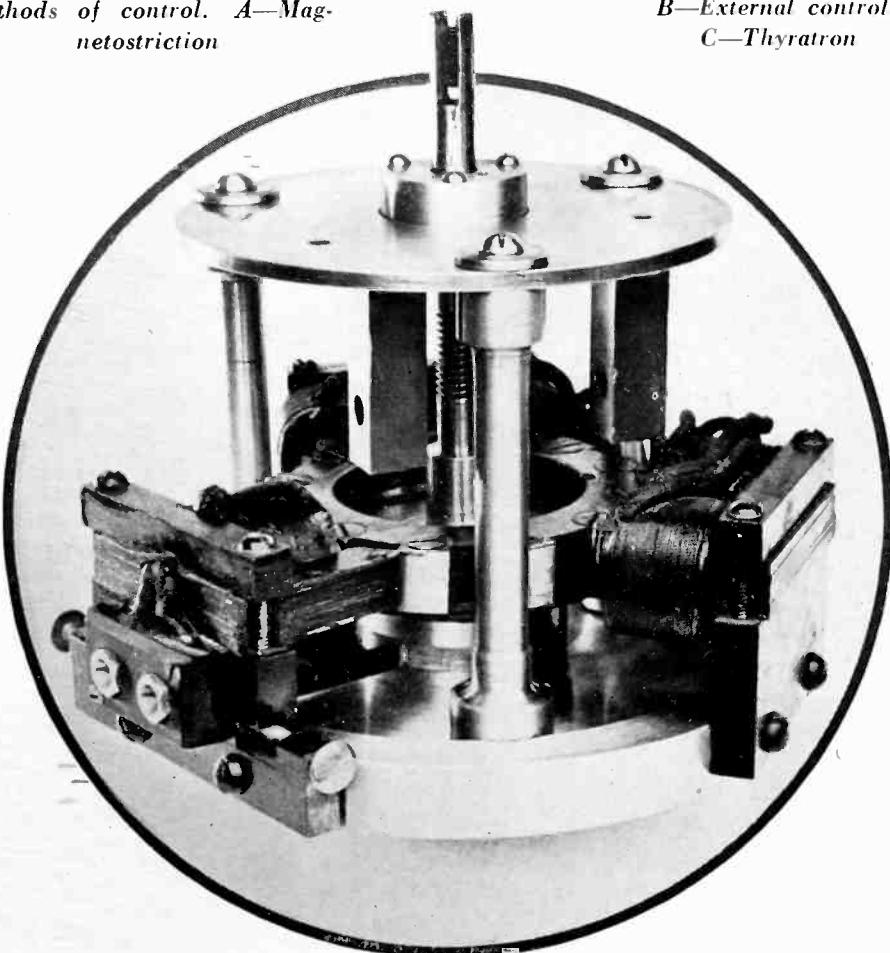

Complete assembly of the mechanically-coupled alternator, synchronous motor of controlled speed

A tuning fork or magnetostriction rod may be connected as shown. The grid and plate coils are connected to promote oscillation.  $R_1$  and  $R_2$  may be decreased until oscillation just stops. Now if the rotor is started and the grid coil properly phased, the speed will increase until the frequency is synchronous with the natural frequency of the resonator

and will fall into synchronism. If the rotor speed is still further increased, by hand, it will immediately fall back into synchronism. The damping effect of  $R_1$  and  $R_2$  seems to have little effect on the stability of operation. With this system and the addition of temperature control, a one-tube primary standard of frequency is possible.

If a control frequency from an external source is introduced, the stabilizing effect and adjustment for operation is much the same as for the mechanical resonator. In operation all the power necessary to run the motor and associated apparatus is supplied by the vacuum tube, while the only function of the control voltage is to control the speed. Adjustments can be made so that the control voltage may undergo a change of more than five to one without causing the motor to drop out of step.

A circuit is shown in which a pair of thyatrons or grid glow tubes are used to supply the driving power. It is actually an inverter circuit in which the controlling frequency is supplied by the grid coil. In operation this circuit has the advantage of large power and good speed regulation over a wide range of frequency. In this case the speed may be controlled by adjusting the tank condenser  $C_1$ . Of course, stabilization may be also secured from an external source as in the vacuum tube device.

The author believes that the device here described may be used to advantage, in some cases, over the simple synchronous motor. As an oscillator there may be found many interesting applications. One interesting characteristic is that it cannot jump from one frequency to another due to rotor inertia.

# Graphical Harmonic Analysis

Method applicable to waves of the type where there are present sine components of odd harmonics and cosine components of even harmonics; as for amplifiers or modulators

By J. A. HUTCHESON

Radio Division  
Westinghouse Electric &  
Manufacturing Co.  
Chicopee Falls, Mass.

WITH the advent of high fidelity transmission and reception apparatus, more and more attention is being given to the accurate determination of the harmonic output of amplifying systems. In the past, graphical methods of pre-determining second and third harmonics introduced by an amplifier tube have been used with satisfactory results. However, at this time it has become necessary for the engineer to know not only the second and third harmonic amplitudes but also the amplitude of higher order harmonics. One method<sup>1</sup> has been previously presented which applies to calculation of harmonics in waves of the type which possess only sine components of odd harmonics such as a perfectly balanced push pull amplifier. It is the purpose of this paper to present a general method applicable to waves of the type wherever there are present sine components of odd harmonics and cosine components of even harmonics. This covers the field wherein the dynamic operating characteristic of the device can be represented by a curved line such as a class A amplifier operating into a pure resistance load, a class B radio frequency amplifier, a class C plate modulated radio frequency amplifier, screen or suppressor grid modulated amplifiers and so forth. The data presented in this paper will allow calculation of all harmonics up to the eighth. The method to be described, however, is accurate and if carried further will result in accurate determination of as many harmonics as are desired. It is felt that the data presented in this paper are sufficient to meet the majority of the needs of the designers of present day apparatus.

It is apparent that a periodic wave resulting from a dynamic characteristic such as is shown in Fig. 2 possesses one type of sym-

metry, namely that if the wave were folded on a line passing through the peak both halves would coincide. This is the type of wave which satisfies the condition that an ordinate  $f(x)$  is identical with the ordinate  $f(\pi-x)$  provided that the origin  $x=0$  is so chosen that if three equal ordinates  $a, b,$  and  $c,$  are taken, then the distance (along the abscissa) from  $a$  to  $b$  is equal to the distance from  $b$  to  $c.$  (See Fig. 1). It has been shown<sup>2</sup> that when this condition is satisfied the wave possesses only sine component terms of odd harmonics and cosine component terms of even harmonics.

The departure of the dynamic characteristic from a straight line is due to the harmonic components in the wave. If a straight line is drawn from one end of the dynamic characteristic to the other end, the harmonic content can be accurately

determined by a measurement at specified points of the ordinate difference between the straight line and the dynamic characteristic. To determine the proper points at which the ordinate differences should be measured curves shown in Fig. 3 were plotted. The abscissa for all curves is  $x = \sin \omega t.$  The separate curves are obtained from the following equations:

$$\begin{aligned} 3a) \quad I_2 &= I_{o_2} \cos 2 \omega t \\ &= I_{o_2} (1 - 2 \sin^2 \omega t) \\ \text{as } x &= \sin \omega t \\ I_2 &= I_{o_2} (1 - 2x^2), \end{aligned}$$

Similarly,

$$\begin{aligned} 3b) \quad I_3 &= I_{o_3} (3x - 4x^3) \\ 3c) \quad I_4 &= I_{o_4} (8(1 - x^2)^2 - \\ &\quad 8(1 - x) + 1) \\ 3d) \quad I_5 &= I_{o_5} (5x - 20x^3 + 16x^5) \\ 3e) \quad I_6 &= I_{o_6} (32(1 - x^2)^3 - \\ &\quad 48(1 - x^2)^2 + 18(1 - x^2) - 1) \\ 3f) \quad I_7 &= I_{o_7} (7x - 56x^3 + \\ &\quad 112x^5 - 64x^7) \end{aligned}$$

<sup>1</sup>I. E. Mouromtseff and H. N. Kozanowski  
Proc. IRE Vol. 22 page 1090, Sept. 1934.  
<sup>2</sup>M. G. Malti—Electric Circuit Analysis  
Chap. XIII Page 168.

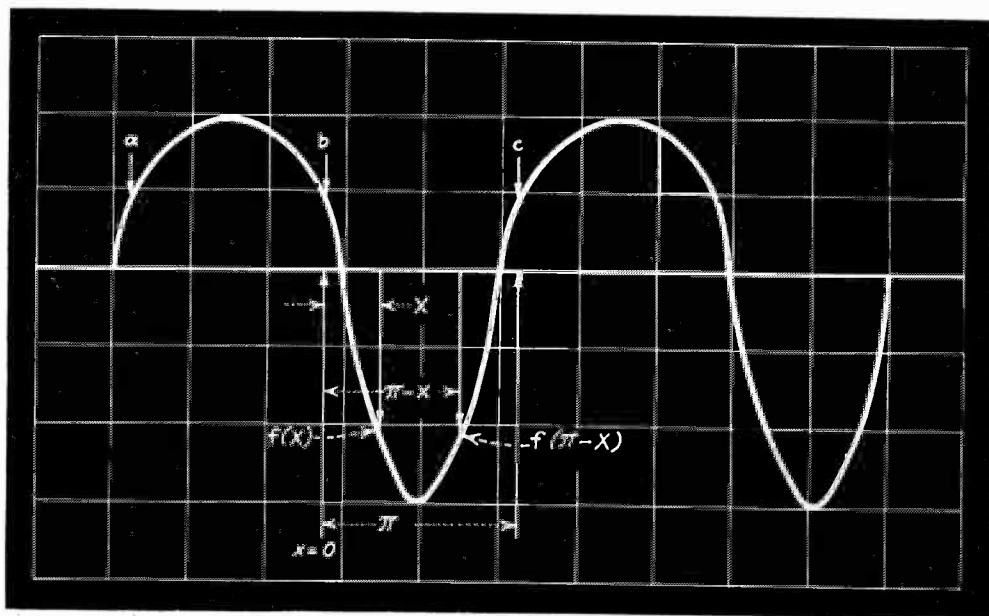

Fig. 1. Periodic wave which results from the dynamic characteristic shown opposite. This form possesses symmetry about a vertical axis through the maximum point

These curves show how the amplitude of the individual harmonics varies during the half-cycle variation of the fundamental wave from its trough to its peak. Now as we have connected the ends of the dynamic characteristics with a straight line, the same straight line must connect the ends of the individual curves for each harmonic. Therefore, the distance at any point ( $x$ ) between the dynamic characteristic and the straight line joining its ends must be the sum of the distances between the curves for the individual harmonics and the straight line joining their ends at the same point  $x$ , provided, of course, the dynamic characteristic represents a wave having no harmonics of higher order than the seventh in this case. Thus, by setting up as many simultaneous equations as there are harmonics to consider we can solve for the value of each harmonic in terms of the ordinate differences between the dynamic characteristic and the straight line joining its ends.

By the inspection of Fig. 3 we can see that the problem is considerably simplified by the choice of points at which the ordinates are measured. Thus at the point  $x = -0.707$  the curve for the seventh harmonic passes through the straight line joining the ends of the curve, and the equation is as follows. Calling the ordinate difference measured at  $x = -0.707$ ,  $a$ , the equation for  $a$  is:

$$a = I_{o_2} - 1.414 I_{o_3} - I_{o_4} + 1.414 I_{o_5} + I_{o_6}$$

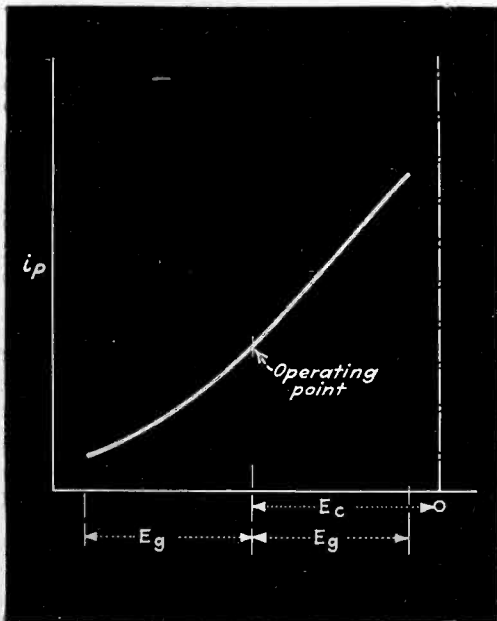

Fig. 2. Dynamic characteristic used in producing Fig. 1.

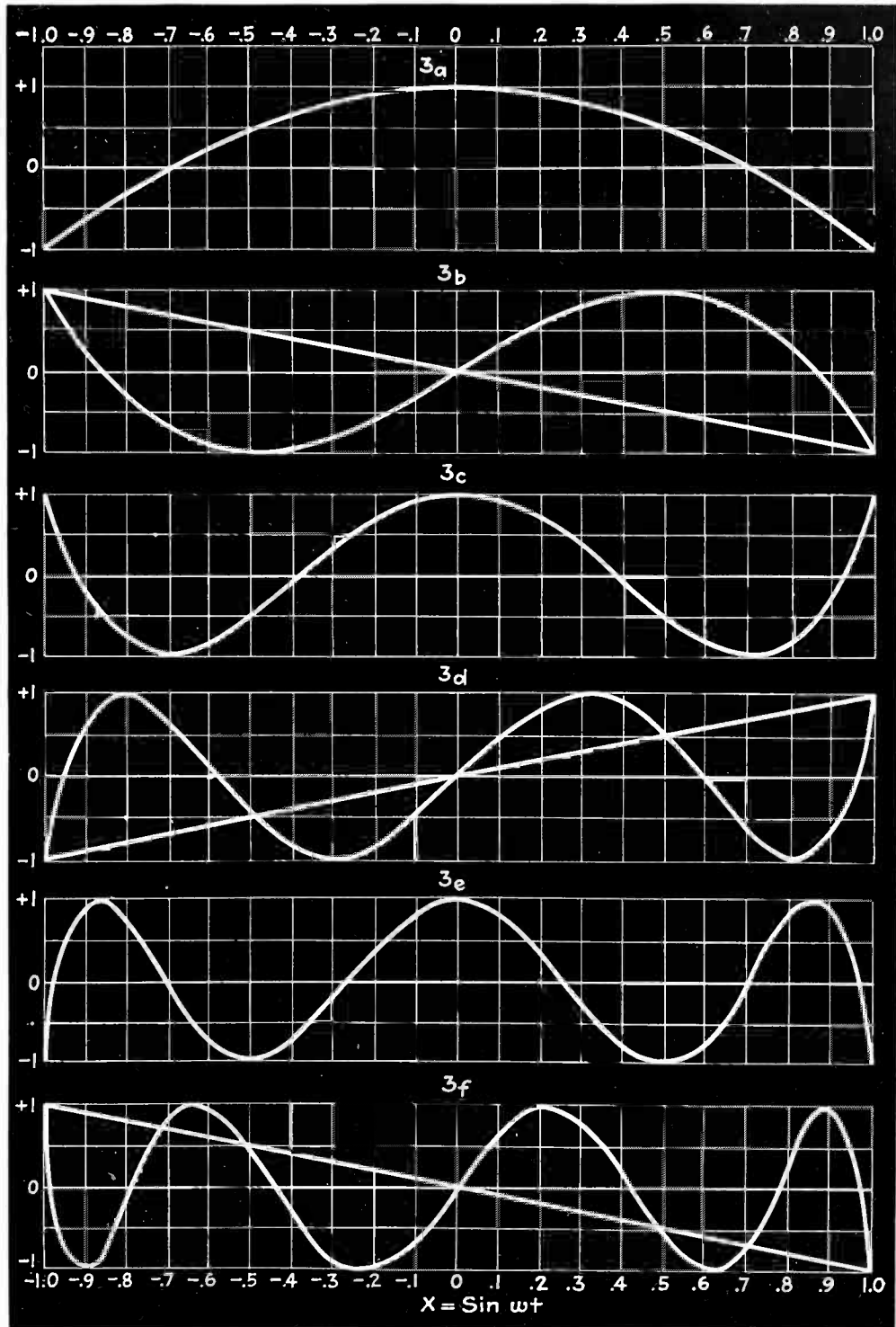

Fig. 3. Curves used in showing how the amplitude of each individual harmonic varies during a half-cycle of the fundamental, plotted from the equations given in text

Similarly calling  $b$  the ordinate difference measured at  $x = -0.5$ ,  $c$  the ordinate difference at  $x = 0$ ,  $d$  the ordinate difference at  $x = +0.5$ ,  $f$  the ordinate difference at  $x = +0.707$  and  $g$  the ordinate difference at  $x = +0.3$  the following equations are obtained.

$$\begin{aligned} b &= 1.5I_{o_2} - 1.5I_{o_3} - 1.5I_{o_4} \\ c &= 2I_{o_2} + 2I_{o_6} \\ d &= 1.5I_{o_2} + 1.5I_{o_3} - 1.5I_{o_4} \\ f &= I_{o_2} + 1.414 I_{o_3} - I_{o_4} - 1.414 I_{o_5} + I_{o_6} \\ g &= 1.82 I_{o_2} + 1.092 I_{o_3} \\ &\quad - 0.6552 I_{o_4} + 0.699 I_{o_5} \\ &\quad + 0.751 I_{o_6} + 1.146 I_{o_7} \end{aligned}$$

Solving these equations to find the harmonic current amplitude in terms

of the ordinate differences  $a$ ,  $b$ ,  $c$ ,  $d$ ,  $f$ , and  $g$  we find that:

$$\begin{aligned} I_{o_2} &= \frac{1}{3} (d+b) + \frac{1}{4} (c-f-a) \\ I_{o_3} &= \frac{1}{3} (d-b) \\ I_{o_4} &= \frac{1}{4} (c-f-a) \\ I_{o_5} &= \frac{1}{3} (d-b) + \frac{a-f}{2.828} \end{aligned}$$

$$\begin{aligned} I_{o_6} &= \frac{c}{2} - I_{o_2} \\ I_{o_7} &= \frac{g - 1.82I_{o_2} - 1.092I_{o_3} + 0.6552I_{o_4} - 0.699I_{o_5} - 0.751I_{o_6}}{1.146} \end{aligned}$$

It is apparent from inspection of the curves of Fig. 3 that the relation between the amplitude of the fundamental  $I_{o_1}$  and the ordinate distance between the extremities of the

dynamic characteristic is affected only by the odd harmonic components. For example if we suppose that we had a fundamental amplitude of 100 units and added to it a second harmonic having an amplitude of 10 units we can see from 3a that the second harmonic component is negative in sign at both ends of the curve. The peak amplitude of our complex wave would be  $100 - 10 = 90$  units and the minimum point at the trough of the wave would be  $-100 - 10 = -110$  units. The ordinate distance between the peak and the trough is  $90 + 110 = 200$  which is the same as that for the fundamental component alone. The same reasoning applies to the other even harmonics. However, suppose we added 10 units of third harmonic instead of second harmonic. We see from curve 3b that the third harmonic is negative in sign at the point corresponding to the peak of the fundamental and positive in sign at the point corresponding to the trough. The peak amplitude of the complex wave would be  $100 - 10 = 90$  units and the minimum point at the trough of the wave would be  $-100 + 10 = -90$ . In this case the ordinate distance between the peak and the trough is  $90 + 90 = 180$  units. Therefore, we see that,

as the relation between the ordinate distance between the ends of the dynamic characteristic is affected by only odd harmonics, we can express the fundamental amplitude  $I_{o_1}$  in terms of the peak to trough amplitude of the complex wave  $I_a$ , as follows:

$$I_{o_1} = \frac{I_a}{2} + I_{o_3} - I_{o_5} + I_{o_7}$$

With the above expression for the fundamental amplitude together with the expressions for harmonic components it is possible to analyze a non-linear dynamic characteristic for the resultant harmonic components expressed directly in amperes (or volts as the case may be) or in percentage of the fundamental.

The expressions derived are correct in sign when distance measured from a point on the straight line to a corresponding point on the dynamic characteristic which is below the straight line is called negative. In other words, always measure from the straight line and when measuring downward call the distance negative in sign and when measuring upward call the distance positive in sign. The resultant sign of some of the harmonic amplitudes will almost always be negative. This

merely means that the harmonic is shifted  $180^\circ$  in phase which naturally affects the resultant wave form but has no effect on the harmonic content. For example it makes no difference in the relation of the harmonic to the fundamental whether the equation for the complex wave is:

$$y = 100 \sin x + 10 \cos 2x + 5 \sin 3x$$

or

$$y = 100 \sin x - 10 \cos 2x + 5 \sin 3x$$

although it has a large effect on the wave shape. It is interesting sometime to solve for the harmonic components of a wave, then recombine them and check the wave shape, which is obtained against the original wave shape.

A practical example will best serve to illustrate the application of the foregoing. Figure 4 is the dynamic characteristic of a type 2A3 class A amplifier tube operating at 250 volts plate with 43.5 volts of bias into a load resistance of 2,500 ohms. Assuming the peak grid voltage swing to equal the applied bias the points at which the ordinate differences between the straight line and the dynamic characteristic are to be measured are determined as follows. With the operating point at  $e_g = -43.5$ , point *a* is found to be  $-43.5 - (0.707 \times 43.5) = -74.2$  volts. Similarly point *b* is at  $-43.5 - (0.5 \times 43.5) = -65.2$  volts. Point *c* is the operating or zero point and is  $-43.5$  volts. Point *d* is at  $-43.5 + (0.5 \times 43.5) = -21.75$  volts.

Point *f* is at  $-43.5 + (0.707 \times 43.5) = -12.8$  volts.

Point *g* is at  $-43.5 + (0.3 \times 43.5) = -30.45$  volts.

The ordinate differences in milliamperes are found to be:

Point	Ordinate difference
<i>a</i>	-5.1
<i>b</i>	-7.0
<i>c</i>	-6.5
<i>d</i>	-3.9
<i>f</i>	-2.5
<i>g</i>	-5.1

Substitution of the above values gives the peak values of the harmonic currents to be:

$I_{o_2} =$	-3.35
$I_{o_3} =$	-1.03
$I_{o_4} =$	-0.28
$I_{o_5} =$	-0.11
$I_{o_6} =$	-0.1
$I_{o_7} =$	-0.09

The maximum and minimum in-

[Continued on page 34]

Fig. 4. Dynamic characteristic of a 2A3 operating as a Class A amplifier

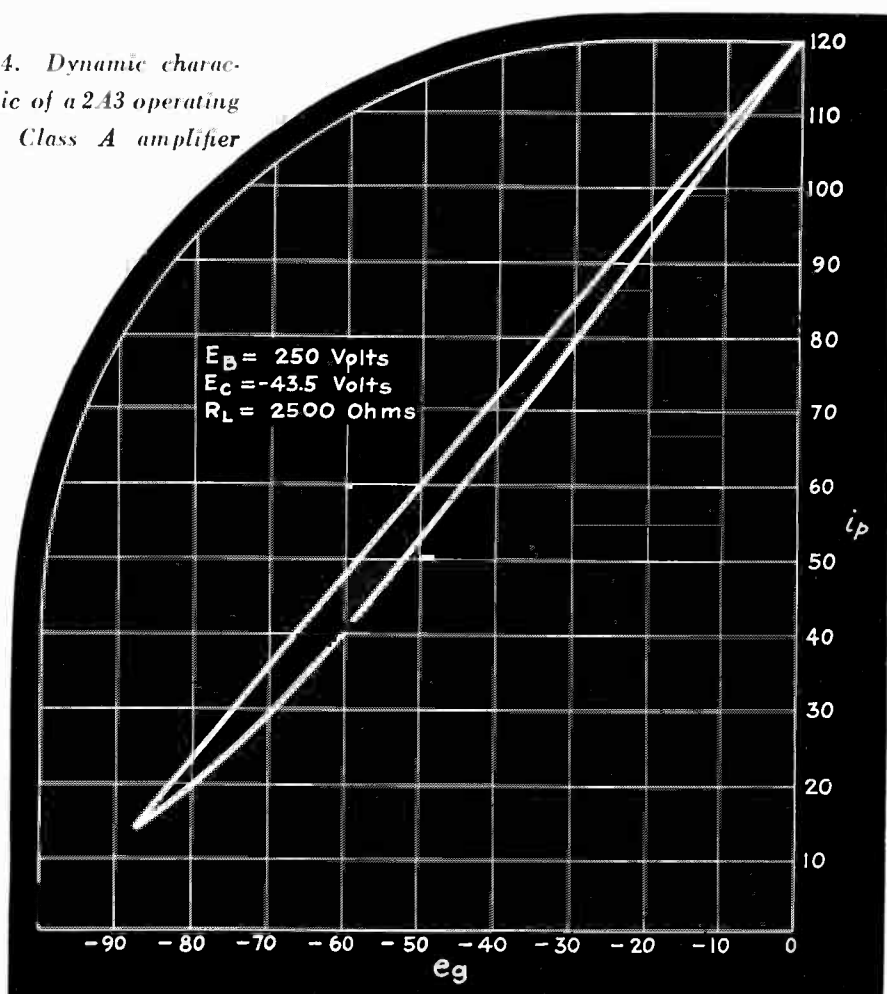

# New 41-Mc. W8XH

Does the high-fidelity, high-frequency WBEN transmitter presage a new broadcast service?

By R. J. KINGSLEY

*Technical Supervisor  
WBEN, Buffalo*

**R**ADIO has suffered from three major reception troubles: static, fading and weak signals. Thanks to the ingenuity of radio design engineers these troubles have been largely overcome.

In these modern times we are, however, afflicted with another source of interference, namely interstation interference between broadcast stations on the overcrowded 550-1500 kilocycle band, which limits the frequency range of all stations in this band. The listening public is demanding more faithful reproduction over the musical range and under the present operating conditions, this is limited to about eight thousand cycles. Actually only 5000 cycles can be transmitted without causing interference in adjacent channels.

The solution to some of these problems may lie in utilization of the ultra high frequency bands for broadcasting purposes. The present experiments, such as W8XH is carrying on, should produce information which will determine just how useful these frequencies may be. These experiments also may indicate whether they can be utilized in the present broadcast band, as well as to define some of the limits their use will set up in their respective fields.

Station WBEN has pioneered in ultra short wave broadcasting and was the first station to go on the air with regularly scheduled musical programs. On March 18th, 1934, general experimental station W8XH went on the air on a frequency of 51,400 kc. and a power of 50 watts. Later the operating frequency was changed to 41,000 kc. and today the Buffalo area has many listeners to the W8XH programs on this frequency.

The interest which this station

has aroused all over the country is attested by the thousands of inquiries received from interested persons in the Buffalo area who wish to receive the programs and from broadcast station executives who are wise enough to recognize the possibilities of the ultra high frequencies for broadcast purposes.

At the time of writing, the installation work is just about completed on a new transmitter and antenna system which will broadcast programs of the highest possible fidelity on a frequency of 41,000 kc. The transmitter was especially built for the job by the RCA Manufacturing Company at their Camden, N. J. plant. It has an output power of 100 watts and is capable of full 100 per cent high level modulation. The transmitter is crystal controlled and operates through three frequency doubling stages to its operating frequency. An intermediate stage and modulated power amplifier complete the line-up. Preliminary tests have shown the transmitter to be very stable in operation.

The antenna system was designed by Dr. G. H. Brown, of the RCA Victor Company, and is known as a Turnstile antenna array. The polarization is horizontal. The antenna is erected on a self-supporting steel pole, 70 feet high, located on the roof of the Hotel Statler. The total height above street level is 350 feet.

In the design of the transmitter, special attention was given to the matter of audio-frequency response with the result that the transmitter itself is flat within two decibers from 30 to 17,000 cycles.

While field strength measurements are yet to be taken on the new transmitter, past measurements and listener reports indicate that very good broadcast reception will be obtained up to a distance of between 25 and thirty miles. Thus, it can be readily seen that a broadcast station operating on the ultra high fre-

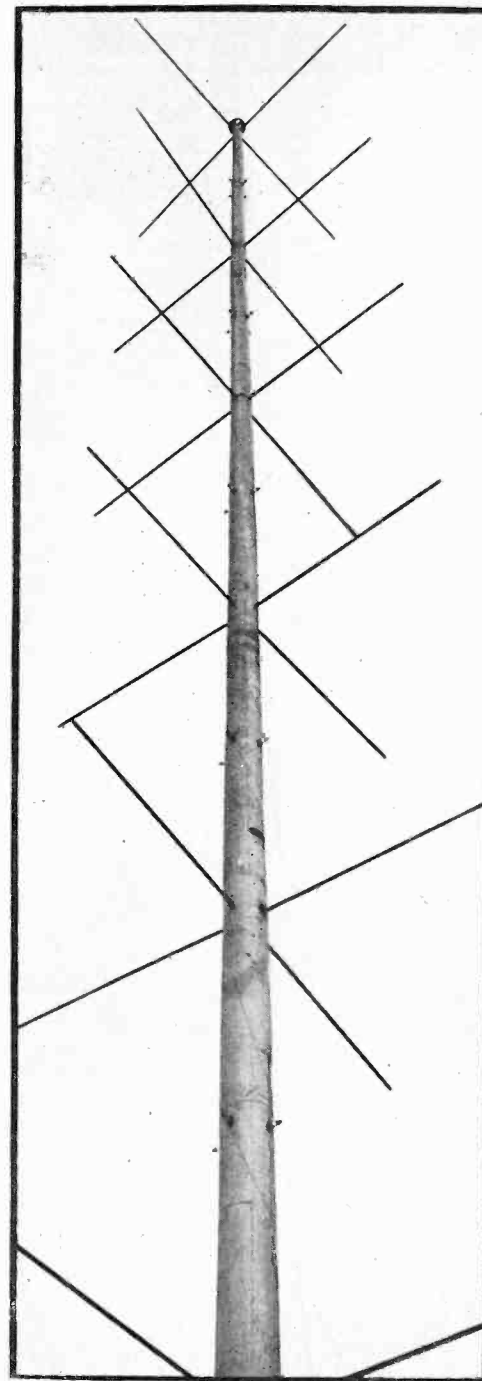

"Turnstile" antenna array at W8XH

quencies has as good coverage as the night-time coverage obtained by most one thousand watt regional stations operating in the 550-1500 kilocycle band, and this with considerable less power output. It also appears that receiver manufacturers are recognizing the importance of extending the receiving range of receivers into the ultra high region. There are now a number of sets on the market which will do this and more are soon expected to follow.

WBEN is indebted to Dr. G. H. Brown, and Mr. T. A. Smith of the RCA Manufacturing Company and to Mr. L. C. F. Horle, its consulting engineer, for the assistance which they have rendered in the development of this project.

# Broadcast Transmitter Features

New constructional designs advance ease of adjustment, accessibility of tube and components for service and replacement, save space, and, above all, follow the element of showmanship demanded by the broadcaster

By JOHN P. TAYLOR

transmitter development—are thus of special interest and importance not only in the broadcasting industry, but also in the allied communication fields.

In the field of constructional design especially the changes evinced are not just improvements of degree but in most instances completely new innovations—some of them destined to revolutionize old ideas of transmitter construction. Not only are the advances pronounced but their promise of further development is greater, and, therefore, of importance as an indication of future trends. Moreover, the increased reliability and convenience which they emphasize are advantages closer to the everyday work of the average

broadcasting engineer or operator.

Most striking of the features common to all of the new transmitters is the cabinet-style construction. This method of assembly has been used for several years in low-power transmitters, and has been found so advantageous and popular that it has now been adopted for all powers up to 5 kw. Primarily it is made possible by the elimination of the front panel as a determining factor in the mechanical assembly, accomplished largely by the use of flexible couplings between variable components and their associated panel controls. Such an arrangement makes it possible to group all tuning controls on small centralized panels, thus leaving the greater part of the front available for doors. These large doors—secured by instantly-released catches—provide

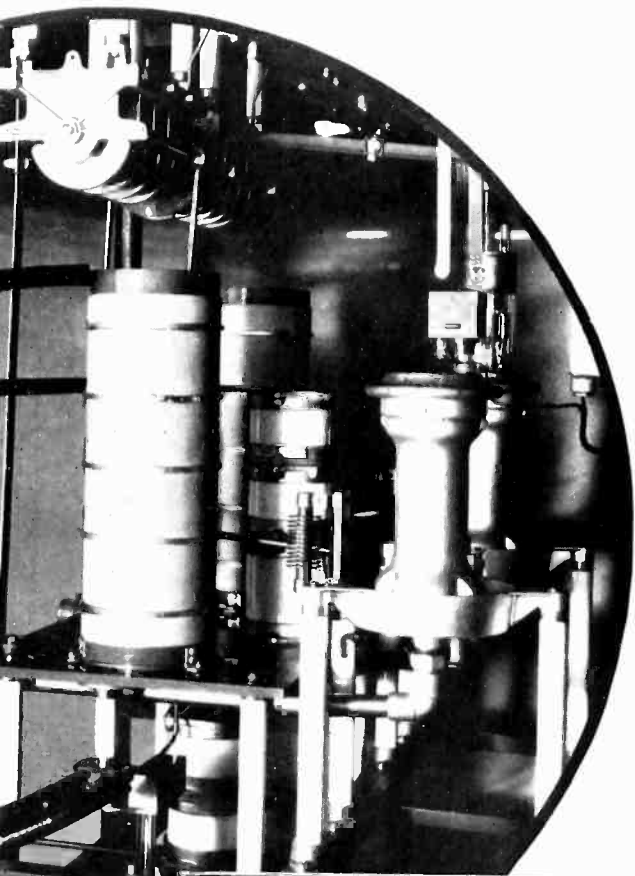

Tube unit for 5 kw amplifier. Cleancut, well designed construction

Power amplifier and output circuit—tuning control (at top) operated by key prevents inadvertent detuning

Small sized antenna units to replace unwieldy and separately-mounted components, and remove necessity of antenna tuning house

**B**ROADCAST transmitter development—almost at a standstill during early depression years, and limited to three or four new low-power designs in 1933 and 1934—has notably quickened in pace during recent months. The large manufacturers, in step with increased daytime-power grants to regional stations, have recently announced new five kilowatt models. And with the Federal Communications Commission known to be considering a general upping of broadcast powers, new fifty and five hundred kilowatt models are anticipated.

These new transmitters definitely mark a new step in transmitter advance. Their general characteristics—as an indication of the trend in

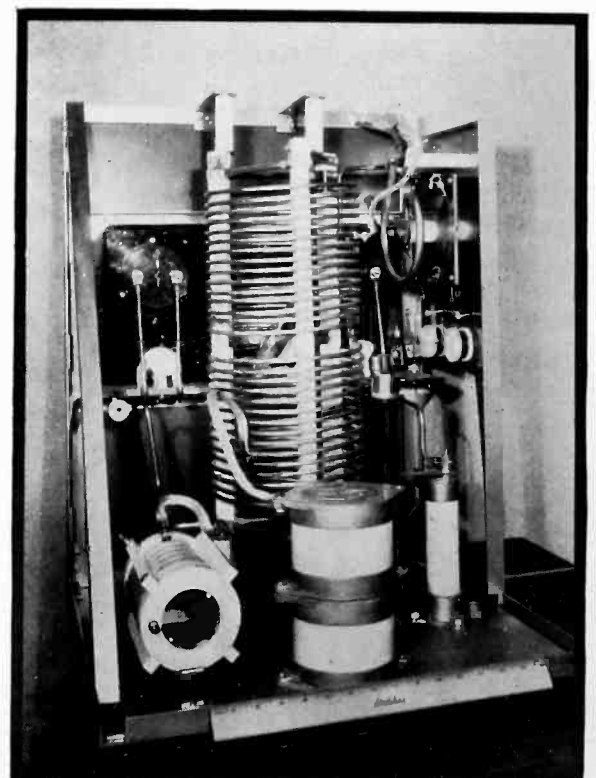

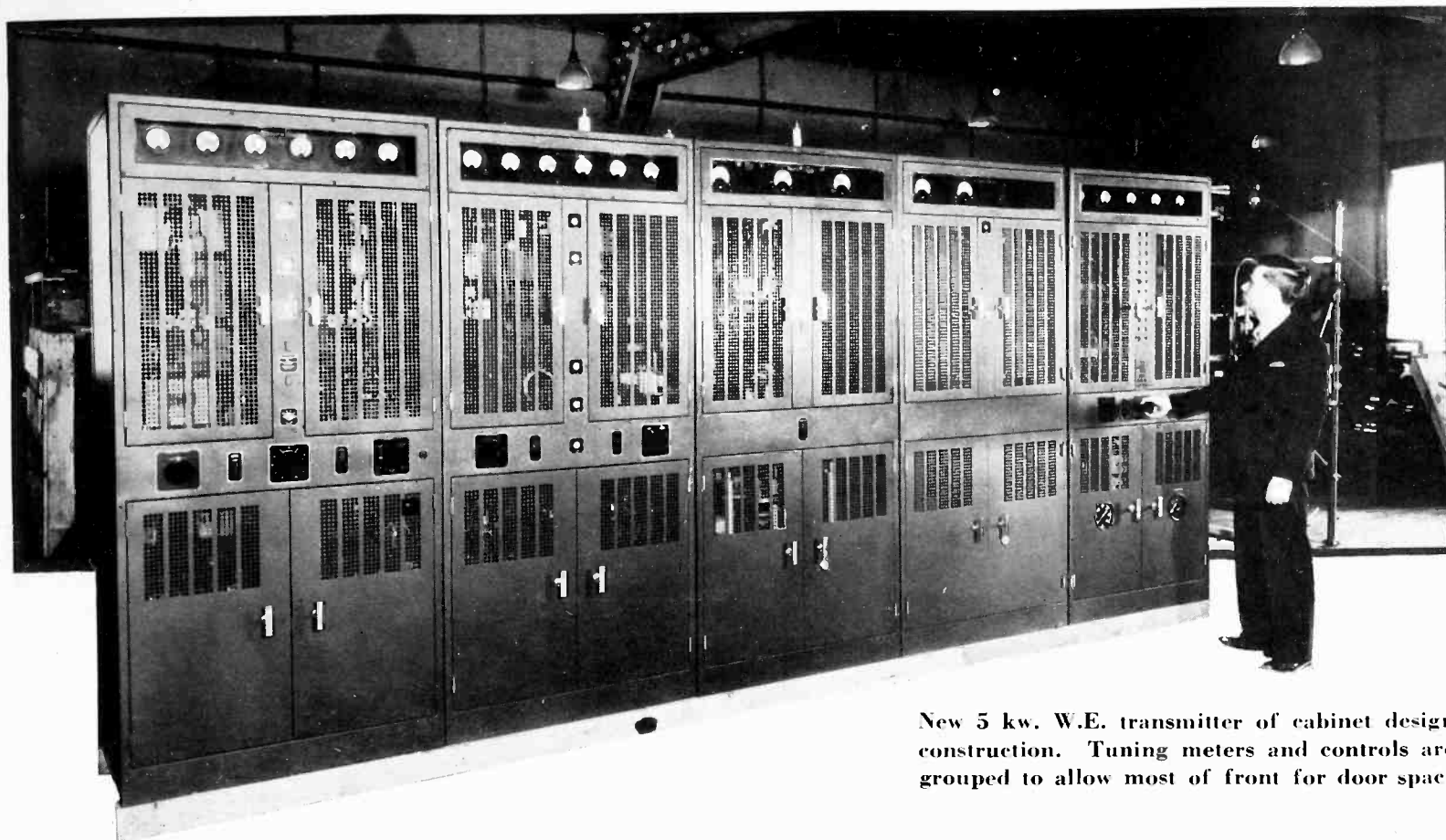

New 5 kw. W.E. transmitter of cabinet design construction. Tuning meters and controls are grouped to allow most of front for door space

easy access to tubes, relays, circuit breakers and all components which may require inspection with an obvious increase in accessibility over older models, in which side panels—secured by literally dozens of thumb screws—had to be removed. More-

over, this front-of-the-panel access has advantages in the placing of the transmitter. For instance, it allows the various units to be placed side by side and quite close to the rear wall of the room. Or they can be built into the wall, a type of installation

which is becoming quite popular now.

The new cabinet-style units have also had an important effect in lending impetus to the trend toward improved appearance. The centralized controls, replacing the former hodgepodge of irregularly placed and awkward-looking dials, result in a vast advance in this respect. Meters, similarly, have been grouped, the common arrangement being to mount them on forward-sloping illuminated panels at the top of the cabinet. In one instance, at least, the idea has been carried out to the point of using the new square-type meters. The pleasing effect of these centralized metering and control panels has been accentuated by proportioning them, as well as the doors, grill work, and the like, along lines of dynamic symmetry. Finally, designers have abandoned the old flat black in favor of pleasing and practical shades of lighter colors. The element of the show business in broadcasting makes this matter of appearance more important than in other communication fields.

Capacitor assembly of low-powered amplifier showing improved mechanical construction of the new transmitters

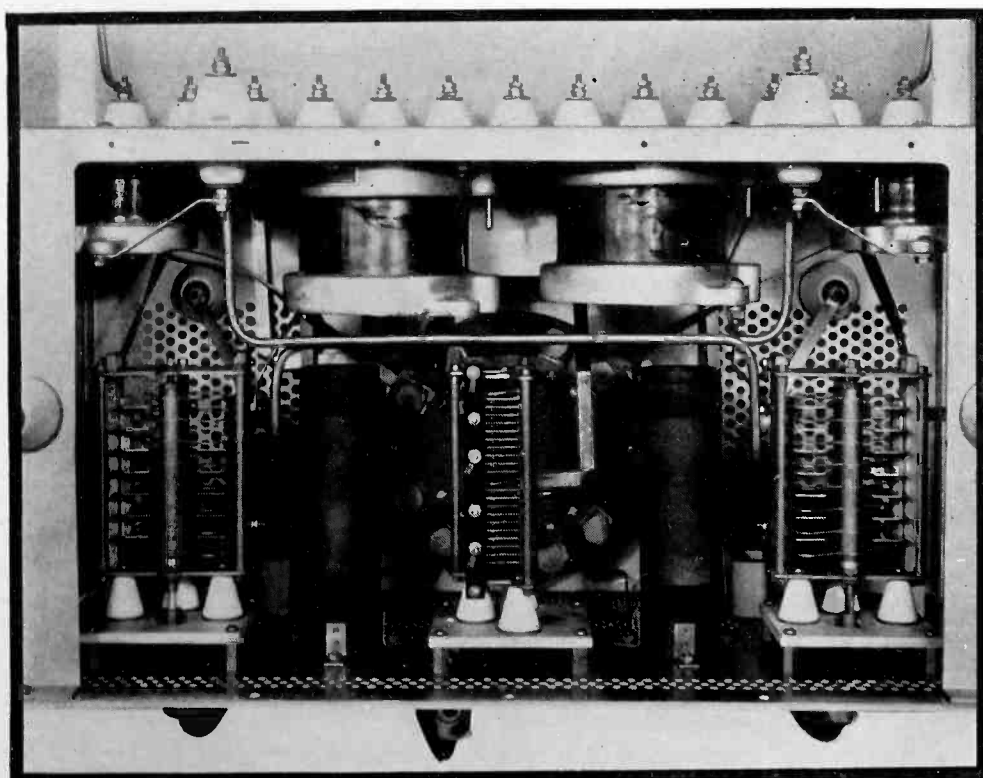

#### *Self-contained Units*

The cabinet-type construction of these transmitters has not been limited to appearance. The tendency is to make each cabinet an integral

RCA 5 kw transmitter built up from low-power units. This unit in turn may excite a higher-powered transmitter

Speech input amplifier of modern design, showing simplicity and beauty

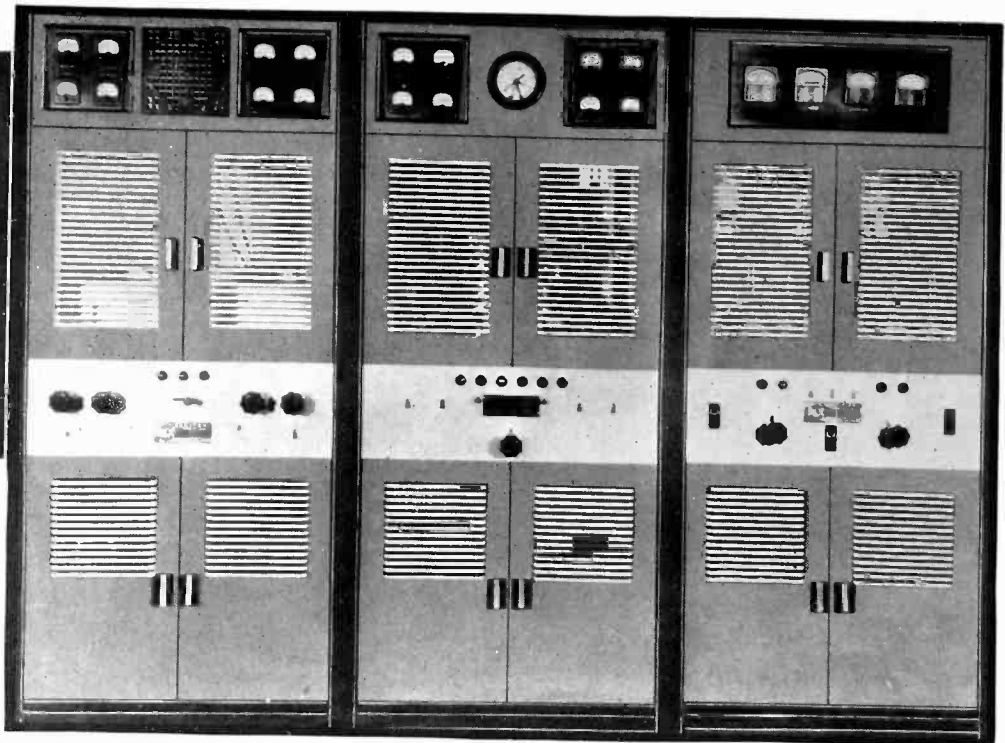

1 kw. there are no parts whatsoever external to the main units. In the 5-kw. transmitters it has not been possible to accomplish this completely, but even here the number of external units has been sharply reduced. In one of the 5-kw. transmitters the plate transformer, blower-pumps unit and line switch are the only components external to the main units. This self-contained type of construction greatly simplifies installation and reduces installation costs. Moreover, equipment is more easily and more completely tested in the factory, and the assurance of obtaining factory performance in the field is greatly increased.

#### *New R-F Construction*

The features of these new transmitters so far mentioned have been those which are outwardly evident. Equally important constructional changes are apparent in interior assemblies. Although the r-f circuits, for instance differ but little electrically they show quite radical changes in mechanical design. They indicate a growing realization that, "all that is radio is not electrical." Under this heading, for instance, comes the complete elimination of the use of wood for support or insulation. Metal, mycalex, isolantite and other ceramic materials are now used exclusively, and some of the new r-f constructions achieved with these materials are quite remarkable. The use of flexible tuning shafts has

lent much incentive to these new constructional designs, for variable components, no longer restricted by rigid panel-couplings, can now be located without regard to front panel lay-out. Not only are connections shortened and circuit construction simplified, but a considerable saving of space is made possible, since individual shielding of stages is now easily accomplished with small shield boxes. Still other advances in r-f circuit construction result from the use of newly developed components. In oscillator design, for example, low-temperature-coefficient crystals make possible greatly simplified temperature-control systems. Similarly, in higher-power units the use of pressure condensers which reduce space requirements has led to completely new designs.

#### *Built-up Antenna Units*

In the antenna coupling and tuning systems there are changes similar to those in the r-f stages, plus certain others intended to reduce the amount of harmonic radiation.

The addition of static shields, harmonic filters and other suppressive devices, together with the necessity of better balance in output circuits has resulted in new and improved mechanical design of the output-coupling systems employed. Another constructional change intended to improve performance is provision for use of a concentric transmission line to the antenna. In

unit. Thus each is an exciter, amplifier, rectifier, tuning, or control unit, complete in itself. Moreover, the units have been carefully planned so that power increases will require little or no change in the units previously installed. But even more important from the constructional viewpoint is the tendency to make these units as nearly self-contained as possible. In the low-power units this has been accomplished to the fullest degree, and for powers up to



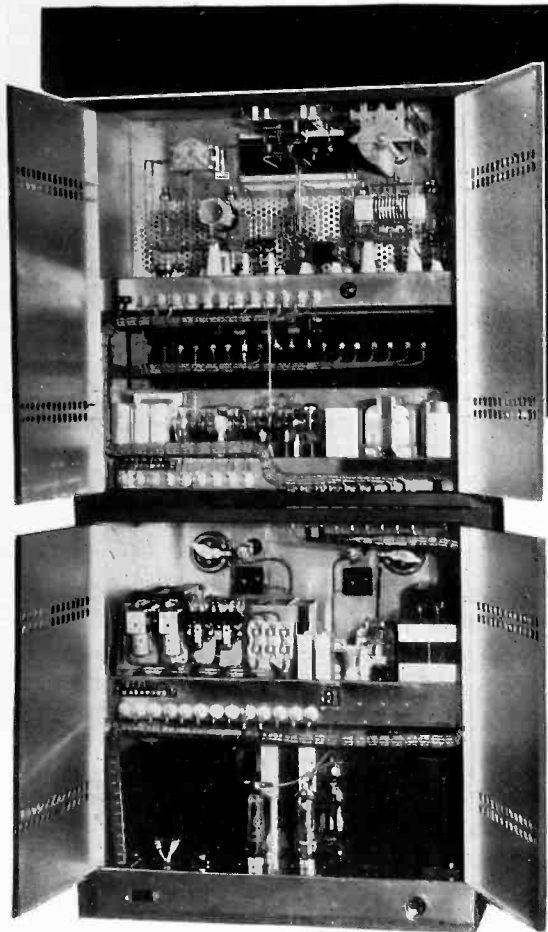

Collins 1 kw transmitter for amateur, government, police or other high frequency channel, music-frequency modulated

Interior of new exciter unit. Note small crystal-control unit, individually shielded R-f stages, self-contained power supply

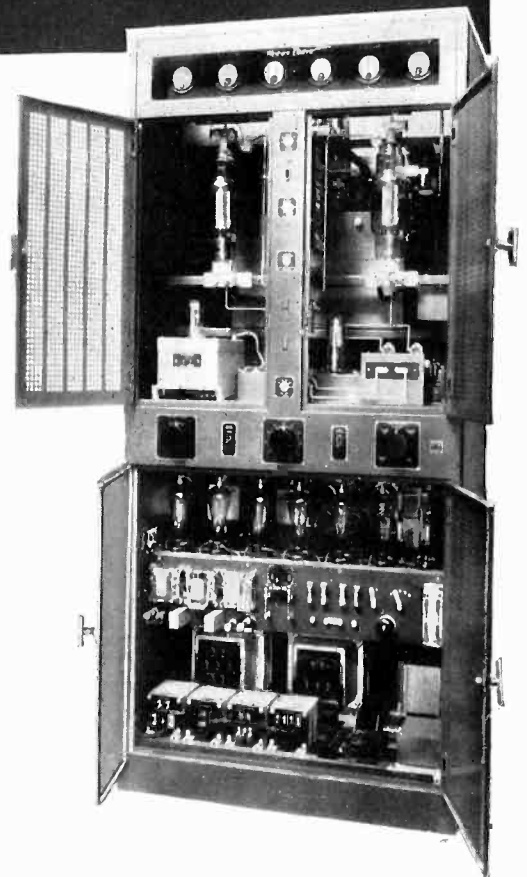

the antenna coupling unit itself, similar constructional changes have been made and, to simplify and cheapen installation, these units have been mounted in steel boxes which can be mounted on a pole, thus eliminating the necessity for building an antenna tuning house.

#### *Fewer Rotating Machines*

Reduction in the number of rotating machines is one of the most

definite recent trends. In early 5-kw. designs five or six units were nearly always used, and more in some cases particularly where duplicates of some of the machines were considered necessary. In recent years rectifiers have completely replaced motor-generators as a plate supply source. The new transmitters go a step further in that they eliminate all bias machines. In one transmitter a.c. is used on all filaments and the hum balanced out in the input. The blower-pump motor is the only rotating machine used with this transmitter. In another transmitter shown only two small machines—for filament and rectifier air-blower — are used. Even the latter is a very considerable reduction over the number of machines always used before. It would appear that the day is not far distant when high-power transmitters will have no moving parts and will be almost as easily installed as a broadcast receiver.

Simplification of the power supply sources is also apparent in the rectifiers. For powers up to 1 kw. these are now built into the transmitter units, and, in the case of the rectifiers for the higher power transmitters, are units in themselves. The tendency appears to be to mount the filter condensers and chokes, the voltage regulator and other units of the rectifier as integral parts of the main rectifier assembly, thus reducing the number of separately mounted parts simplifying and cheapening the installation. Another marked tendency is the use of a larger number of small rectifier tubes in place of a few larger tubes. Six and twelve tubes are used on the 5-kw. transmitters in place of three as formerly. The small tubes provide a cheaper tube line-up and, being less critical as to ambient temperatures, can be more simply mounted. Time-off due to rectifier tube failures is likely to be less than before, due to the fact that all of the

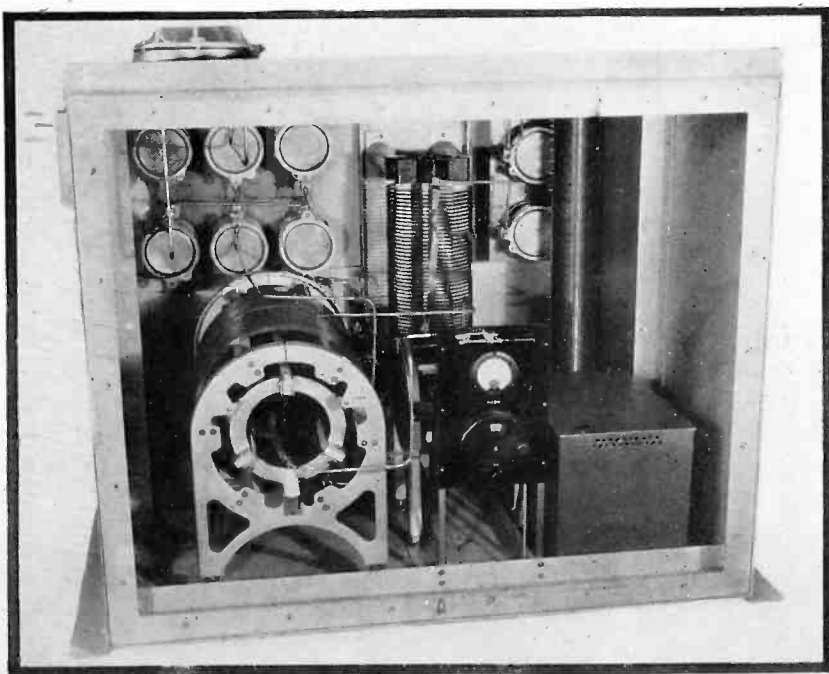

Antenna coupling and tuning equipment in weatherproof box for pole mounting. Box in lower corner contains monitoring rectifier

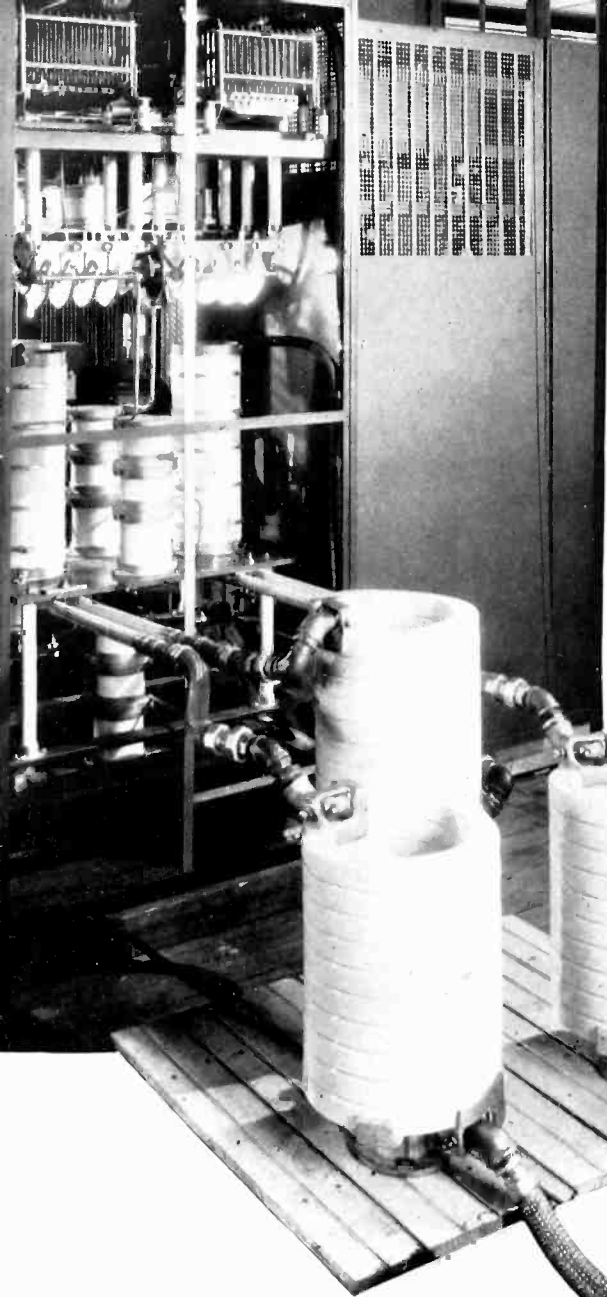

are now centralized in location. In both RCA and WE transmitters practically all of the essential elements of control are centralized in easily-reached positions just inside one pair of the front doors. Conforming to new ideas of safety requirements additional precautionary devices have also been incorporated. The tendency is to provide a mechanical system to parallel and supplement the electrical interlock system. One such device is a gravity-operated switch which short circuits the high voltage supply in case of any failure of the interlock circuit. Another is a mechanical

Porcelain reels and fittings replacing rubber hose formerly used to isolate tube jackets

external piping by flexible metal hose or lead pipe with standard fittings being used at all connections. Thus are eliminated the impurities which formerly got into the water from the rubber, recurring leakage at hose connections and the constant danger of breakdowns difficult to repair in a hurry. To long-suffering engineers, who have often thought their struggles with these difficulties would never end, this will be the greatest boon of all. Moreover, having removed one of the primary causes of water impurity, the other, viz., electrolysis with consequent scale formation, has also been practically eliminated by making the remainder of the water-cooling circuit entirely non-ferrous. This has been accomplished by using copper instead of iron storage tanks, bronze water pumps, and copper pipe for all intermediate connections. The cooling systems thereby formed can use distilled water, since leakage is small and replacement seldom required.

new rectifier designs feature individual arcbreak (reverse-current) indicators for each tube, thereby providing practically instantaneous location of tube failure.

#### *Automatic Control Circuits*

The control systems of a transmitter lie in a quasi-defined field between electrical and mechanical design. However, no discussion of the constructional features of the new broadcast transmitters would be complete without some reference to control changes leading to more-automatic operation, increased convenience, and greater safety. They increase, rather than decrease, the complexity, however. For example, more relays are provided so that the necessary delays between application of all voltages are automatically timed and sequenced. More meters and indicating lights are provided to locate more easily sources of failure. These indicating lights as well as relays, circuit breakers and the like

Tank and output coupling circuit of 5 kw amplifier of metal, mycalex, isolantite construction

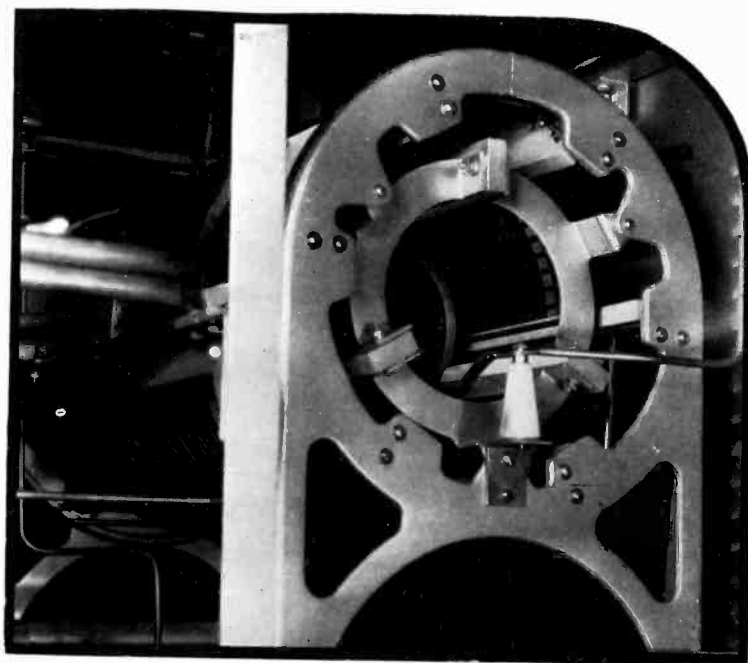

coupling arrangement which shorts the high voltage supply when the door leading into the rectifier compartment or room is opened.

Another of the design advances incorporated in these new broadcast transmitters is the improvement in the water-cooling systems. Most outstanding is the substitution of porcelain reels for the rubber hose reels formerly used to isolate the tube cooling jackets. These are connected with the tube jackets and the

Finally, the leakage meters, flow interlocks and temperature indicators (always likely breakdown points) are of new types greatly improved mechanically as well as electrically. The overall result of these numerous improvements in the water-cooling system is an extraordinary increase in reliability. Added to similar accomplishments at other points this guarantees that cost of time lost, replacements and servicing will be only a fraction of that with older models.

# A New Solar Radio Disturbance

Every 54 days, approximately, high-frequency transmission is violently affected for a comparatively short period. Dr. Dellinger points out the possible cause of this newly-discovered phenomenon

UNIQUE vagaries of high-frequency radio transmission occurred during the past year at approximately 54-day intervals. The phenomenon is a wiping out of radio signals above a certain frequency. The evidence indicates that in each case it occurred over the entire illuminated half of the globe. In most of the cases it was a sudden disappearance of high-frequency long-distance radio signals for several minutes, the complete process of fading out and reappearing occupying but 15 minutes. In one case it was a lowering of the upper frequency limit for a whole day, but not to such low values of frequency. In none of the cases was transmission at the ordinary broadcast frequencies affected.

In June I received a letter from Dr. R. Jouaust, Secretary of the

By J. H. DELLINGER  
Chief, Radio Section.  
National Bureau of Standards

French National Committee of the International Scientific Radio Union, transmitting the following statement from Mr. Garnier, of the Compagnie Radio-France: "I wish to inform you that a general fading was observed at Villecresnes on all our short wave receptions on May 12, 1935, from 1157 to 1215 GMT. The fading came suddenly; reception disappeared in three minutes and then reappeared slowly after a few minutes, resuming its former value at the time indicated above." Dr. Jouaust inquired whether a similar phenomenon was observed in the United States. Upon inquiry, I learned from Mr. L. Espenschied that transatlantic

high-frequency radio telephone reception had entirely faded out at the New Jersey receiving station of the A.T. and T. Co., from 1156 to 1214 GMT on May 12. I also learned from Mr. H. H. Beverage that all signals from Europe and South America had similarly disappeared at the Riverhead, N. Y., receiving station of RCA Communications Inc., from 1200 to 1215 GMT on May 12. Nothing of this kind occurred at the Pacific coast receiving station of the two companies.

I subsequently received reports, through the courtesy of the gentlemen mentioned, of a similar fadeout that had occurred on March 20 at 0150 to 0205 GMT, and of one that occurred on July 6 at 1409 to 1425 GMT. The engineer in charge of the RCA Riverhead station reported that the July 6 fadeout "was so sudden and unexpected it was at first believed that a voltage break had occurred" in the station.

The startling agreement as to the time at which each fadeout occurred at widely separated points invited careful study. I found that on each occasion the fadeout occurred simultaneously at all reported points on the half of the globe which was illuminated by the sun, and did not occur at any of the reported points on the dark half. I also noted that the times were separated by approximately 53 and 55 days. This is twice the recurrence period of terrestrial magnetic disturbances and twice the time of rotation of one portion of the surface of the sun. I therefore suggested to my correspondents that special watch be maintained for a repetition of the occurrence during August 28 to 30. It put in its appearance August 30 at 2320 to 2335 GMT, the fadeout not being so complete but being again limited to the illuminated side of the globe.

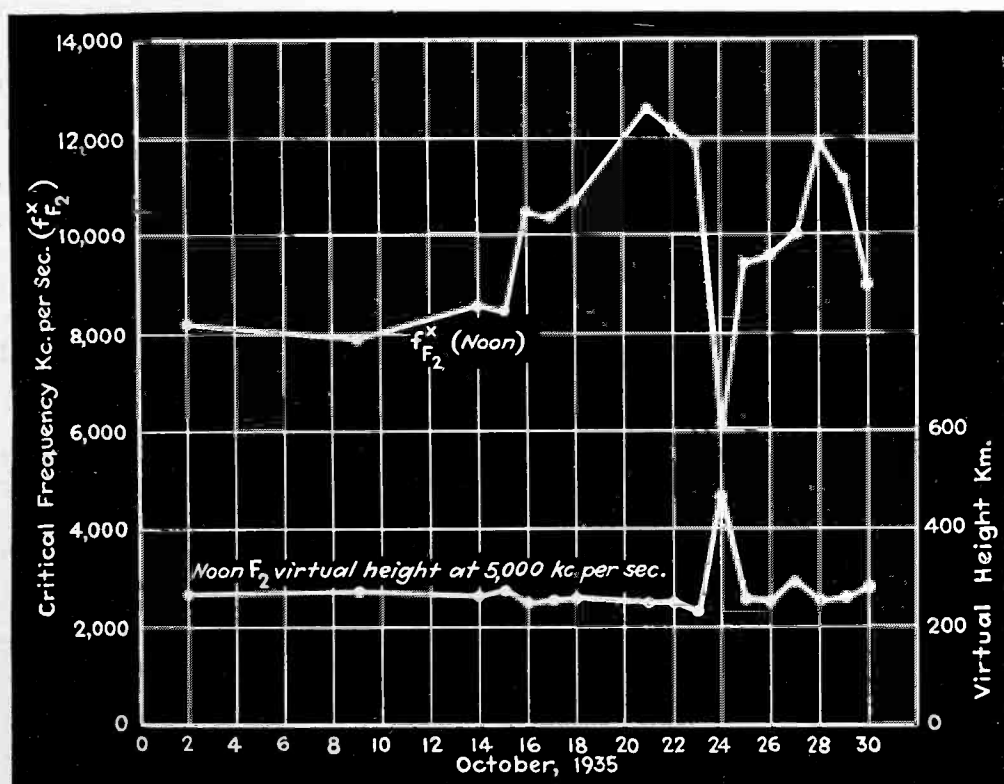

Striking data on the 54-day fading effect

[Continued on page 34]

# R-f Transition Losses

R-f losses due to impedance mis-matching may be evaluated by the graphical method presented here; the design of a matching network, for minimizing the loss thus incurred, may be developed using the charts on the next following page.

**I**N the design of transmission lines, filters, amplifiers and other communication networks, there is always the problem of matching impedances at the junction of sending and receiving circuits. The maximum power transfer occurs when the two circuits have equal resistance and zero (or equal and opposite) reactance. Any departure from this condition is said to cause a transition loss relative to the maximum power transfer. This article presents formulas and a simple chart for determining the transition loss at the junction of two impedances, caused by the mismatching of resistance and the presence of reactance.

Table I gives the meaning of two parameters,  $U$  and  $V$ , as applied to the mismatching of two impedances, one of which is a pure resistance. See Diagrams A and B in the chart opposite. The real component of

By HAROLD A. WHEELER  
Hazeltine Corporation  
Bayside, N. Y.

the impedance ratio is  $U$  and the imaginary component is  $V$ . Perfect matching is indicated when  $U = 1$  and  $V = 0$ . Otherwise the power transfer is less than the maximum, in the ratio

$$\frac{1}{A} = \frac{4U}{(1+U)^2 + V^2} \quad (1)$$

This power ratio is a loss preferably expressed in decibels.

Any given value of the power loss can be caused by various combinations of  $U$  and  $V$ . All such combinations form a curve on the  $U, V$  plane, one curve for every value of  $A$ . The family of curves is represented by the above equation, which may be rewritten

$$[U - (2A - 1)]^2 + V^2 = (2A - 1)^2 - 1 \quad (2)$$

For each value of  $A$ , this equation represents a circle whose center is at the point

$$U = (2A - 1), \quad V = 0 \quad (3)$$

and whose radius is

$$\sqrt{(2A - 1)^2 - 1} \quad (4)$$

The maximum and minimum values of  $U$  are

$$(2A - 1) \pm \sqrt{(2A - 1)^2 - 1} \quad (5)$$

The maximum value of  $V$  is equal to the radius (4).

The phase angle  $\phi$  of the reactive impedance is also defined in Table I. For each value of  $A$ , this angle has a maximum value determined by the relations

$$U^2 + V^2 = 1; \quad \cos \phi = \frac{1}{2A - 1} \quad (6)$$

The latter expression is also the minimum value of the power factor of the reactive impedance, for a given value of the power loss.

The above values have been used in drawing the chart on the opposite page. Each circle is drawn about  $U$  (center) with a radius of  $V$  (max.).

The chart shows graphically the relations between the transition loss and the circuit parameters. The following relations appear from the chart and the above formulas.

(a) The product of  $U$  (max.) and  $U$  (min.) is unity, so that these values are mutually reciprocal.

(b) Any straight line through the origin represents a certain phase angle of the reactive impedance. Such a line intersects any given circle (if at all) at two points whose distances from the origin are mutually reciprocal. Since the distance from the origin to a point is the absolute value of the corresponding impedance ratio, interchanging the impedances does not affect the loss.

[Continued on page 46]

Table I

The table below defines the parameters  $U$  and  $V$  when a pure resistance is matched with an impedance. The loss in db. caused by the mismatch can be found by locating the point on the chart corresponding to  $U$  and  $V$  in the particular case under consideration.

	Case I	Case II	Case III	Case IV
$U \pm jV =$	$\frac{Z}{R_0}$	$\frac{R_0}{Z}$	$\frac{Y}{G_0}$	$\frac{G_0}{Y}$
$U =$	$\frac{R}{R_0}$	$\frac{R}{R_0}$	$\frac{G}{G_0}$	$\frac{G}{G_0}$
$\pm V =$	$\frac{X}{R_0}$	$\frac{X}{R_0}$	$\frac{B}{G_0}$	$\frac{B}{G_0}$
$\pm \tan \phi =$	$\frac{X}{R}$	$\frac{X}{R}$	$\frac{B}{G}$	$\frac{B}{G}$

NOTE: Case I and II refer to the diagram A in the chart on the opposite page. Case III and IV refer to diagram B.

# Transition Loss Chart

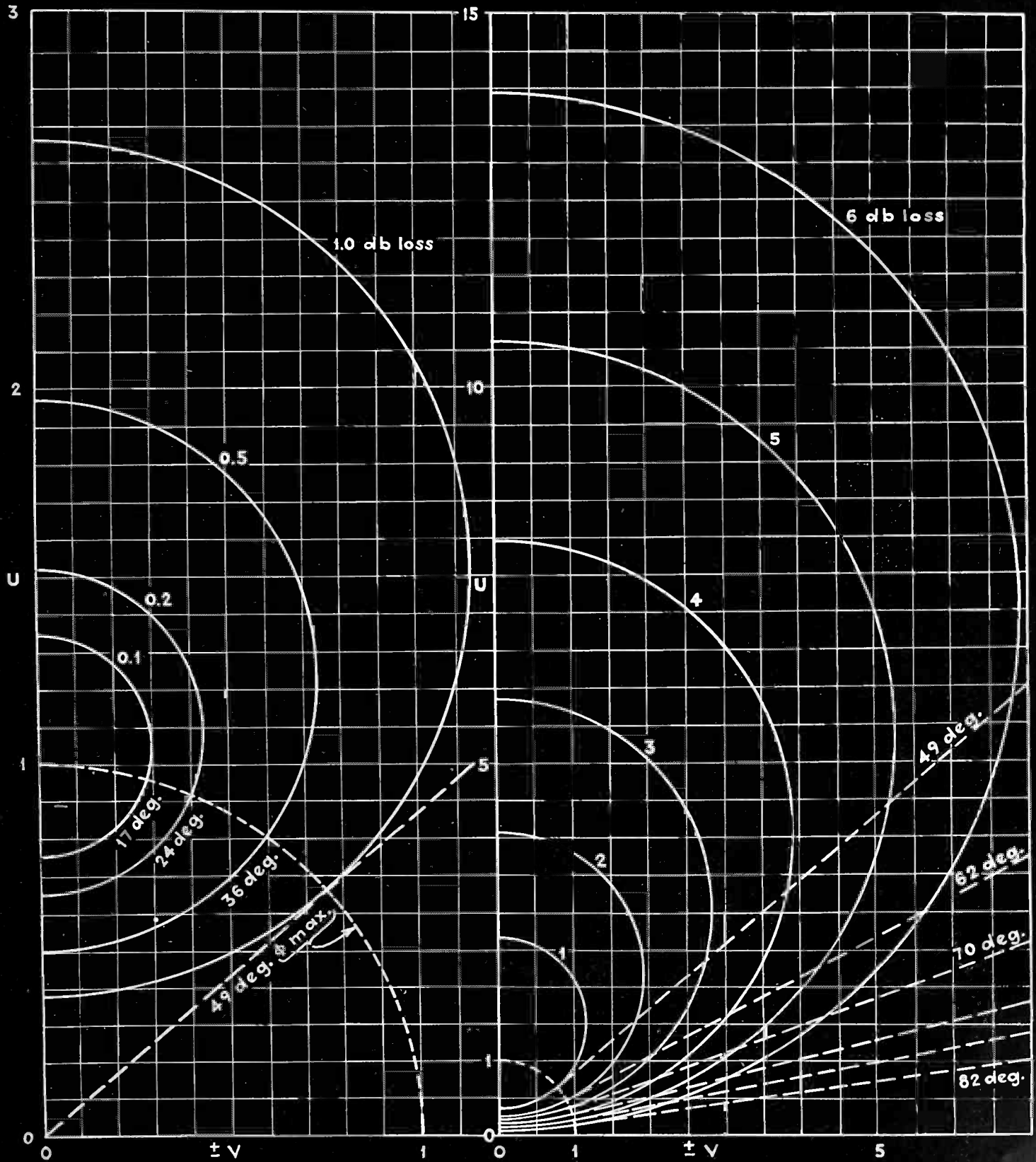
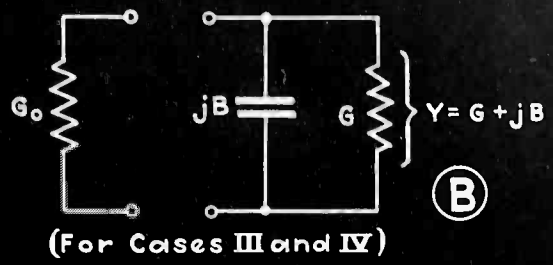
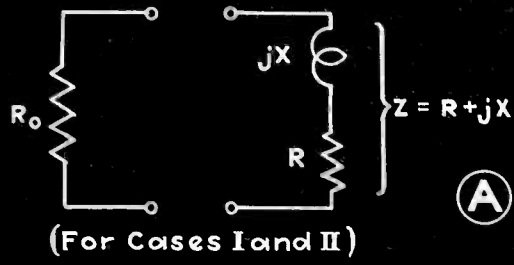

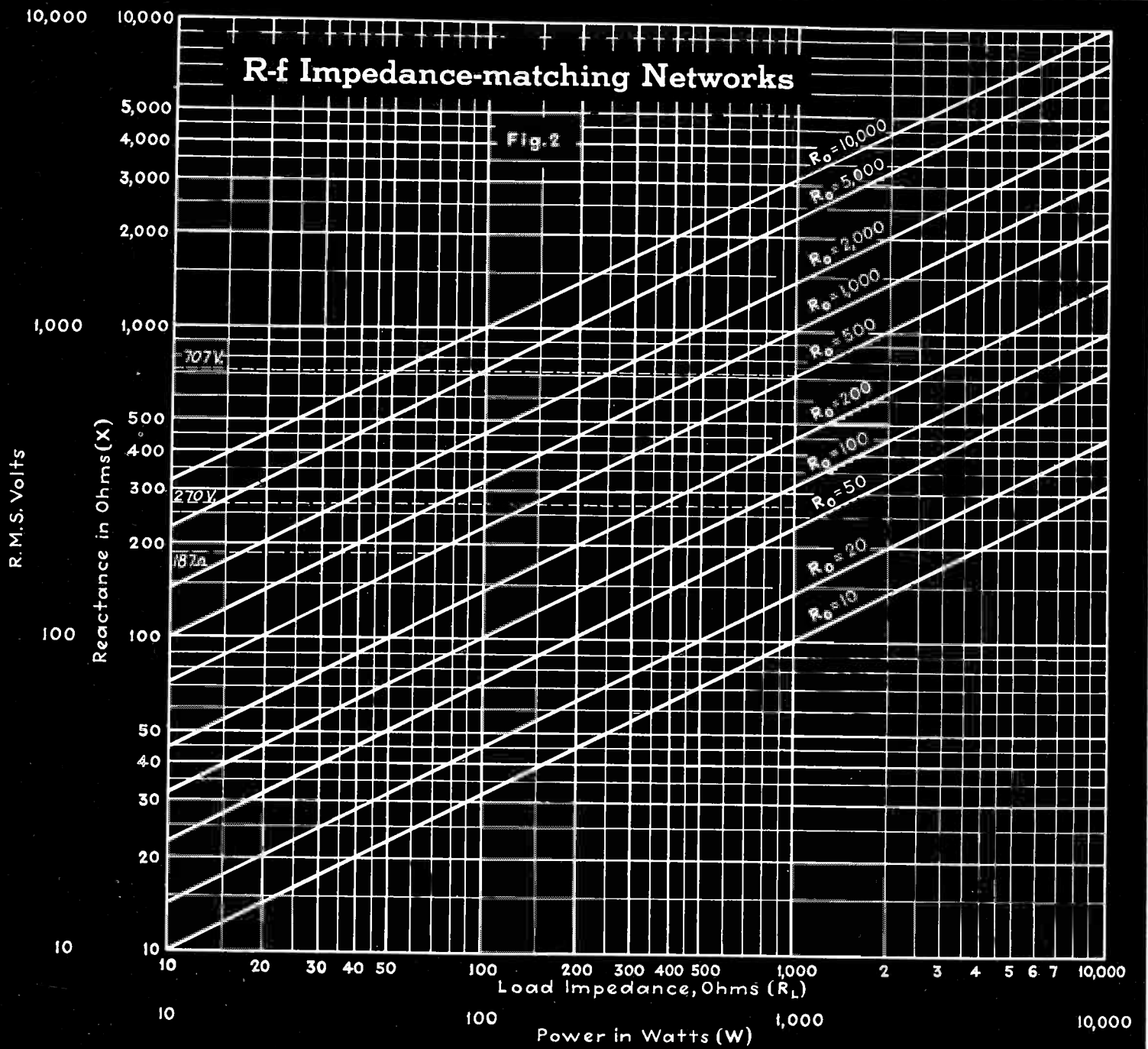

#### Summary of Formulae

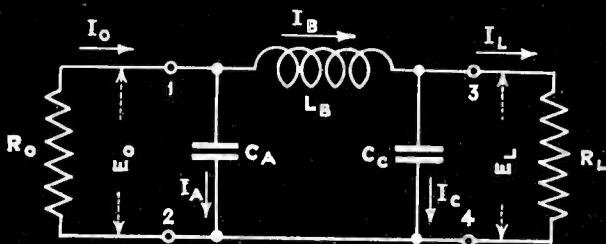

Fig. 1

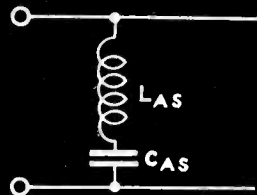

Fig. 3

$$L_{AS} = K_1 L_B$$

$$C_{AS} = K_2 C_A$$

TABLE 1

Harmonic	$K_1$	$K_2$
2nd	0.333	0.75
3rd	0.125	0.889

$$K_1 = \frac{1}{1-N^2} \quad K_2 = \frac{1-N^2}{N^2}$$

Where N is the order of the harmonic (2 for 2nd, 3 for 3rd etc.)

- ①  $X = \sqrt{R_o R_L}$  (Fig. 2) then compute;  
 $C_A = C_C = \frac{1}{\omega X}$  farads;  $L_B = \frac{X}{\omega}$  henries  
 Where  $\omega = 2\pi f$ ;  $f$  = carrier frequency
  - ②  $E_o = \sqrt{R_o W}$  &  $E_L = \sqrt{R_L W}$  where  $W$  = network input in watts (Fig. 2)
  - ③  $I_A = \frac{E_o}{X}$ ;  $I_C = \frac{E_L}{X}$  r.m.s. amperes (compute) (For carrier peak values, multiply  $E$  &  $I$  by 1.414)  
 (For 100 per cent mod. peak values, multiply  $E$  &  $I$  by 2.828)  
 $I_B = \sqrt{I_A^2 + I_C^2}$  (compute)
- $$I_B = \sqrt{I_L^2 + I_C^2}$$

$$I_L = I_A; I_o = I_C$$
- ④ For very high harmonic attenuation, replace  $C_A$  or  $C_C$  or both by series inductance and capacity, resonant at the harmonic, but presenting a capacitive reactance of  $X$  ohms at carrier frequency as shown in Fig. 3

# R-f Impedance-matching Networks

Data for the design of pi-section networks used in matching transmitters to antennas and in similar problems by which the losses treated in Mr. Wheeler's chart may be minimized

**T**HE problem of efficiently connecting two circuits of different impedances arises frequently in r-f transmission design. At radio frequencies the impedance match can be accomplished with high efficiency by means of a network of inductive and capacitive elements.

Everitt has pointed out that the pi-section low-pass network is preferable in most cases because of its harmonic reducing properties, and that the most efficient design is obtained by making the network a symmetrical structure which is the equivalent of a quarter-wave line.

Such a network is shown in Fig. 1 on the opposite page. It consists of an inductance in series with the line and shunt condensers at input and output. The inductor is preferably adjustable by means of a clip or taps. The input and output condensers should be variable over a range above and below the computed value to take care of normal terminal impedance variations and to allow exact adjustment under operating conditions. In practical design problems, it is obviously important to determine the network voltages.

## Example

Design a network to couple a 500-ohm transmitter output to a 70-ohm concentric transmission line. The power is 1,000 watts at 1,000 kc.

(1) **Determine the network branch reactances.** For the quarter-wave type all three branches have numerically the same reactance. In Fig. 2, the intersection of a 70-ohm load with a 500-ohm source gives a reactance of 187 ohms.

(2) **Compute the inductance and capacitance necessary to give this reactance at carrier frequency.**

$$L_B = \frac{X}{\omega} = \frac{187}{2\pi \times 1 \times 10^6} = 29.8 \mu h,$$

$$C_A = C_C = \frac{1}{\omega X} = \frac{1}{2\pi \times 1 \times 10^6 \times 187} = 852 \mu\mu f.$$

By **RALPH P. GLOVER**

*Chief Engineer  
Shure Brothers Company  
Chicago*

It is good practice to make  $L_B$  about 25% larger than the computed value, say 35 microhenries, and adjust to the exact value required by means of a short-circuiting clip. The shunt condenser elements should have an available total capacity of approximately 1,000 micromicrofarads each.

(3) **Determine the current and voltage ratings of the condensers and the current in the inductive branch.**

The impedance looking into the input terminals of the network under working conditions is a resistance of 500 ohms. For a power of 1,000 watts the corresponding R.M.S. voltage is obtained from Fig. 2 at the intersection of the line for 500 ohms. Thus  $E_0 = 707$  volts, R.M.S. Assuming 100% efficiency (approached in well-designed networks at moderate frequencies)  $E_L$  is similarly determined from Fig. 2 by interpolation as 270 volts R.M.S. for an impedance of 70 ohms.

$$I_A = \frac{E_0}{X} = \frac{707}{187} = 3.78 \text{ amp. R.M.S.}$$

$$I_C = \frac{E_L}{X} = \frac{270}{187} = 1.42 \text{ amp. R.M.S.}$$

$$I_B = \sqrt{I_A^2 + I_C^2} = 4.04 \text{ amp. R.M.S.}$$

It is important to remember that the voltages and currents given above are R.M.S. carrier values; components with adequate safety factors for peak modulation conditions should be selected.

(4) **Design of high harmonic-attenuation shunt branch.** Suppose it is desired to produce very high attenuation at the second harmonic without altering the properties of

the network at carrier frequency. We can replace  $C_A$  by a series combination resonating at second harmonic but presenting a net capacitive reactance of  $X$  ohms for carrier frequency. Referring to Fig. 3 and the table for  $K_1$  and  $K_2$ .

$$L_{AS} = K_1 L_B = 0.333 \times 29.8 = 9.93 \mu h$$

$$C_{AS} = K_2 C_A = 0.75 \times 852 = 639 \mu\mu f.$$

The carrier component of current through the composite branch is the same as that already computed for the simple shunt condenser case. The carrier component voltage across  $C_{AS}$  is therefore:

$$E_C = I_A X_{CS} = \frac{I_A}{\omega C_{AS}}$$

$$= \frac{3.78}{6.28 \times 1 \times 10^6 \times 639 \times 10^{-12}}$$

$$= 943 \text{ Volts R.M.S.}$$

It is usually sufficient to base the design on carrier frequency conditions and allow a generous factor of safety (for peak conditions) in determining the ratings of components.

If it is desired to make the network balanced to ground, this may readily be accomplished by dividing  $L_B$  into two equal inductors and inserting one inductor in each side of the line.

The possibilities of short and open circuit conditions should be considered and appropriate protective measures adopted where required.

It has been assumed that both generator and load impedances are pure resistances, a condition closely approached in many practical problems. Where the terminating impedances involved have reactive components, these components can often be neutralized by inserting series reactance of opposite sign.

When the network is used for coupling an electronic amplifier to its load the network is designed exactly as indicated in the chart, except that  $R_0$  is taken as the impedance required for proper loading of the amplifier output.

# Output Transformer Response

Leakage inductance is the important frequency-determining factor. When this, as well as the turn-ratio and the primary and secondary resistances are known, the frequency characteristic may be calculated

**T**HE frequency range of an ordinary Class A power amplifier depends primarily upon the primary and leakage inductances of the transformer. The typical frequency response curve of such a transformer is characterized by a falling off at low frequencies because of the shunting effect of the primary inductance, and a falling off at high frequencies because of the voltage consumed by the leakage inductance. It is the purpose of this paper to show how the frequency response can be accurately predicted by calculation, and to discuss the factors controlling the frequency range.

## Equivalent Circuits

For purposes of calculation, the output stage can be represented by the equivalent circuits shown in Fig. 2. The actual circuit is shown at (a), while practical equivalent circuits in which the tube has been replaced by a generator acting in series with a plate resistance are shown at (b) and (c). Figures 2(d), 2(e), and 2(f) give modifications of (c) that apply to limited frequency ranges. In these equivalent circuits it will be noted that the transformer is taken into account by the primary inductance  $L_p$ , the leakage inductances  $L_1$  and  $L_2$ , the primary and secondary copper resistances, and a transformation ratio  $n$ . Distributed capacities have been omitted because they are associated with low resistances and therefore have negligible effect at audio frequencies. Core loss has likewise been neglected because with normal transformer proportions it has little effect on the frequency response. Since the plate resistance of the tube and the primary resistance of the transformer are in series they can be conveniently lumped together to form an effective plate resistance  $R_p'$ . Likewise, the load and trans-

By **F. E. TERMAN**  
and **R. E. INGEBRETSEN**  
*Stanford University*  
*Stanford, California*

former secondary resistance can be lumped to form an effective load resistance  $R_L'$ .

A push-pull output stage has the equivalent circuit shown in Fig. 1. The result is seen to be the same as Fig. 2(b) except that the plate resistance is now twice that of a single tube. A separate analysis for the push-pull case, therefore, is not needed.

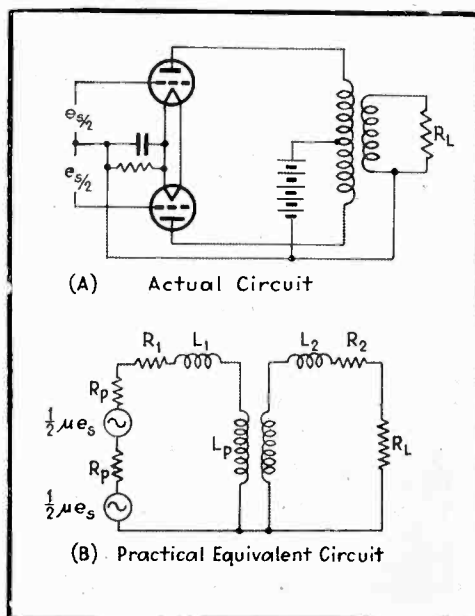

Fig. 1—Circuits for push-pull amplifier. Note the correspondence between Fig. 1 (b) and Fig. 2 (b)

The equivalent circuit of Fig. 2(c) can be further simplified if one considers only a limited frequency range. Thus Fig. 2(d) applies at low frequencies, where the leakage inductance has negligible reactance, while Fig. 2(f) can be used at high frequencies where the reactance of the primary inductance has negligible shunting effect. Between these extremes the frequency is low enough for the leakage in-

ductance to have very little effect, and yet high enough so that the shunting action of the primary inductance can be neglected, resulting in the equivalent circuit of Fig. 2(e).

## Calculation of Frequency Response

The simplified equivalent circuits of Figs. 2(d), 2(e), and 2(f) are the basis for analyzing the frequency response characteristics of output transformers. Considering first the middle range of frequencies, the output voltage to be expected is given by the equation below the circuit of Fig. 2(e). Passing now to low frequencies and Fig. 2(d), a little manipulation of the equations representing the voltage and current relations of this circuit shows that the response at low frequencies is the output in the middle range of frequencies multiplied by the factor  $1/\sqrt{1 + (R/X)^2}$ , where  $R$  is the resistance formed by the effective plate and load resistance,  $R_p'$  and  $R_L'$ , in parallel, and  $X$  is the reactance of the primary inductance. The factor  $1/\sqrt{1 + (R/X)^2}$  is plotted in Fig. 4(a), which can be used to determine the way in which the response falls off at low frequencies. It is to be noted that the output voltage falls off to 70.7 per cent of its maximum (i.e. is 3 db down), when the frequency is such that the reactance of the primary inductance exactly equals the resistance formed by the effective plate resistance  $R_p'$  in parallel with the effective load resistance  $R_L'$ .

Solution of the voltage and current relations of Fig. 2(f) shows that the output voltage at high frequencies is equal to the output at the middle range of frequencies multiplied by the factor  $1/\sqrt{1 + (X'/R')^2}$ , where  $X'$  is the reactance of the leakage inductance and  $R'$  is the sum  $(R_p' + R_L')$  of effective plate and plate load resistances. The factor



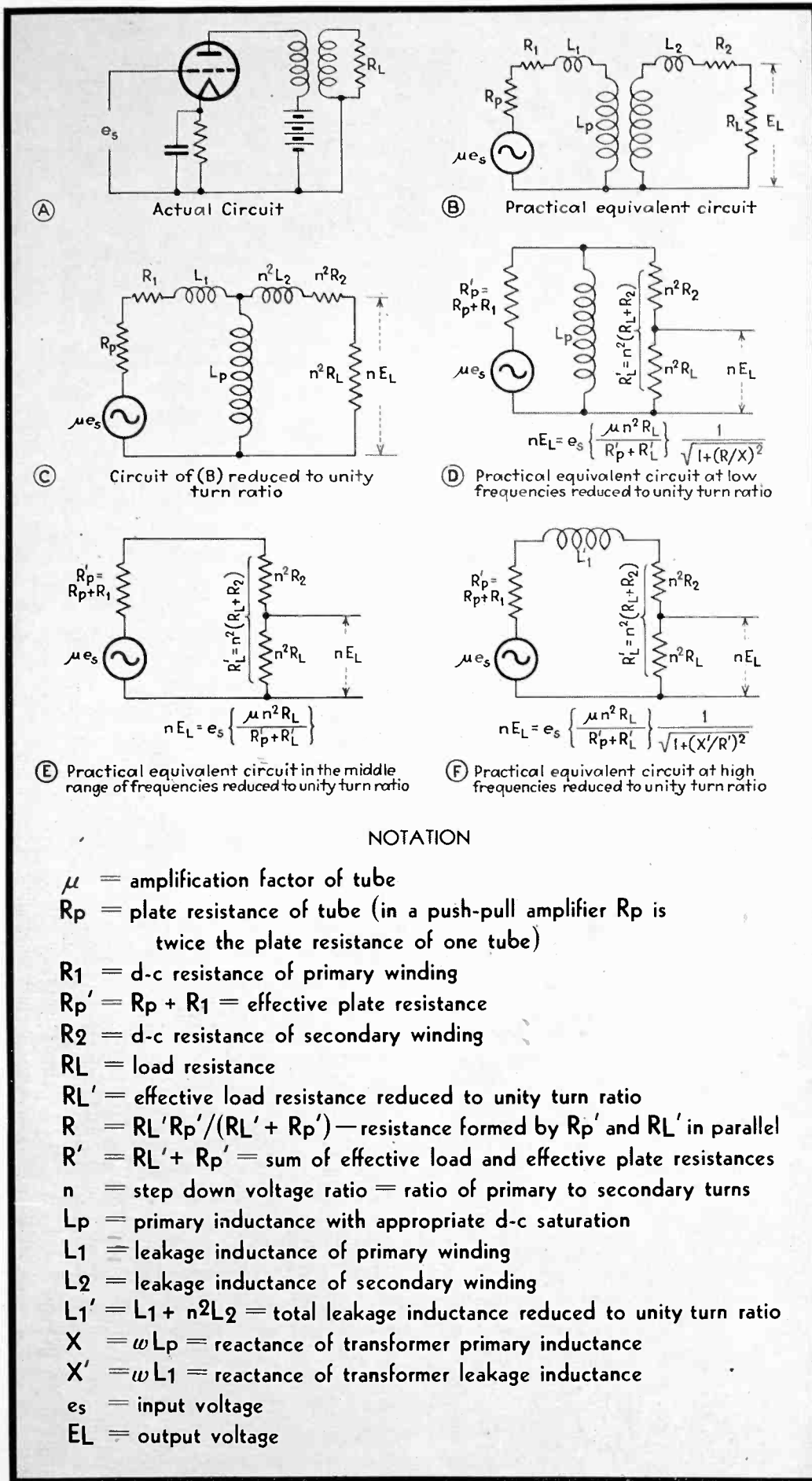

NOTATION

- $\mu$  = amplification factor of tube
- $R_p$  = plate resistance of tube (in a push-pull amplifier  $R_p$  is twice the plate resistance of one tube)
- $R_1$  = d-c resistance of primary winding
- $R_p' = R_p + R_1$  = effective plate resistance
- $R_2$  = d-c resistance of secondary winding
- $R_L$  = load resistance
- $R_L'$  = effective load resistance reduced to unity turn ratio
- $R = R_L' R_p' / (R_L' + R_p')$  — resistance formed by  $R_p'$  and  $R_L'$  in parallel
- $R' = R_L' + R_p'$  = sum of effective load and effective plate resistances
- $n$  = step down voltage ratio = ratio of primary to secondary turns
- $L_p$  = primary inductance with appropriate d-c saturation
- $L_1$  = leakage inductance of primary winding
- $L_2$  = leakage inductance of secondary winding
- $L_1' = L_1 + n^2 L_2$  = total leakage inductance reduced to unity turn ratio
- $X = \omega L_p$  = reactance of transformer primary inductance
- $X' = \omega L_1$  = reactance of transformer leakage inductance
- $e_s$  = input voltage
- $E_L$  = output voltage

Fig. 2—Actual and equivalent circuits of class A power amplifier; equations for calculating amplification

calculate the frequency response characteristic of a Class A power-output stage. Results obtained in this way are correct within a few per cent with ordinary transformers, as a typical comparison between calculated and experimental results will show. It is consequently not necessary actually to set up a complete power amplifier to obtain the frequency-response curve. All that is necessary is to measure the d-c resistance of both transformer windings, determine the primary and leakage inductances, and obtain the turn ratio (or voltage ratio). With this information an accurate frequency response curve is easily calculated for any plate and load resistance.

The turn ratio is normally given by the manufacturer, while the d-c resistance of the windings can be determined using any of the common methods. The leakage inductance reduced to unity turn ratio is the inductance measured across the primary terminals of the transformer with the secondary terminals short circuited. This is most readily obtained by means of an ordinary bridge at 1,000 cycles. The primary inductance is the inductance across the primary terminals with the secondary terminals open, and must be measured with the same d-c current in the winding as can be expected under normal operating conditions.<sup>1</sup>

Importance of the Leakage Coefficient

Examination of the factors controlling the frequency range of the transformer show that what is wanted is a high primary and a low leakage inductance. The ratio  $L_1'/L_p$  can be defined as the leakage coefficient of the transformer, and determines the ratio of the maximum to minimum frequency that can be covered with a given ratio of load to plate resistance. All transformers having the same leakage coefficient will cover the same number of octaves irrespective of the plate resistance with which they are to work.

$1/\sqrt{1 + (X'/R)^2}$  is plotted in Fig. 4(b), which can be used to determine the way in which the response falls off at high frequencies. It will be observed that the output voltage at high frequencies falls off to 70.7 per cent of its value in the middle range of frequencies (down 3 db) when the

frequency is such that reactance of the leakage inductance is exactly equal to the resistance formed by the equivalent plate resistance  $R_p'$  and equivalent load resistance  $R_L'$  in series.

The above working rules and Fig. 3 make it a simple matter to cal-

Fig. 3—Factors showing how amplification falls off at low and high frequencies

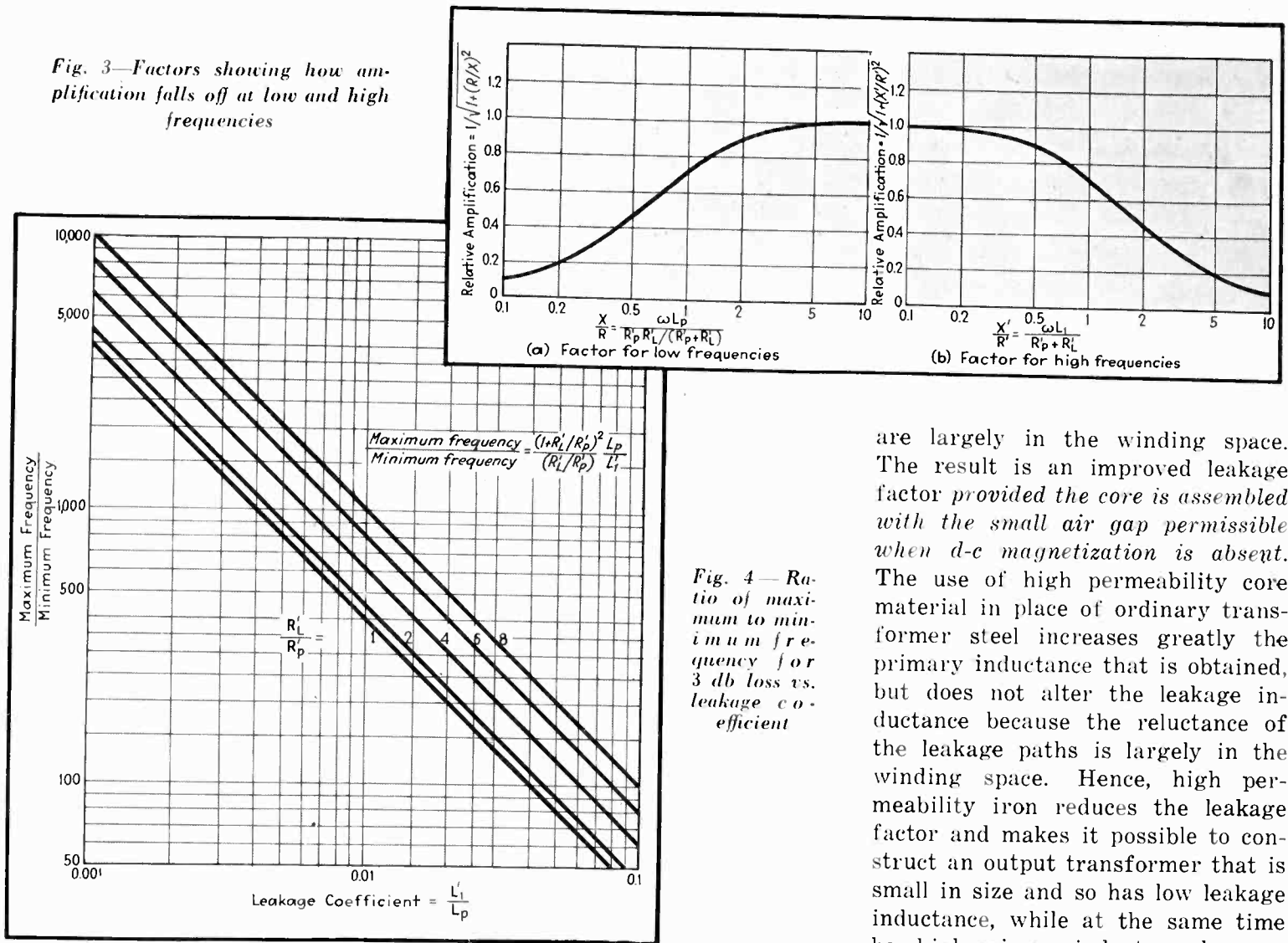

Fig. 4—Ratio of maximum to minimum frequency for 3 db loss vs. leakage coefficient

provided only that the ratio of the effective load resistance  $R_L'$  to effective plate resistance  $R_p'$  is kept constant. The quantitative relationship between the frequency range for not more than 3 db drop, and the leakage coefficient is shown in Fig. 4 for different ratios of  $R_L'/R_p'$ . It is to be noted that, although the maximum output is obtained when the ratio  $R_L'/R_p'$  equals 2, the frequency range is increased by using higher load resistances. This comes about because the higher load resistance extends the high frequency response more than it reduces the low frequency response.

The leakage coefficient depends primarily upon the transformer proportions and design rather than upon the size of the transformer. Large transformers tend to have high primary inductance and hence good response at the low frequencies, but at the same time fall down sooner at the high frequencies because of increased leakage inductance. Small transformers normally tend to have poorer low frequency response be-

cause of the low primary inductance, but give excellent response at high frequencies because of the low leakage inductance that results with the same leakage coefficient.

The principal means available for reducing the leakage coefficient are:

1. Interleaving primary and secondary windings and properly proportioning the winding space.
2. Elimination of d-c magnetization in the core by the use of push-pull or shunt-feed arrangements.
3. The use of core material having high permeability. By intermingling primary and secondary windings it is possible to reduce greatly the amount of flux that can encircle one winding without linking both, and so lower the leakage reactance. Properly proportioning the winding space to make the leakage paths long also works in the same direction. Elimination of d-c magnetization in the core makes it possible to use a very small air gap in the core. This increases the primary inductance but does not affect the leakage inductance because the flux paths

are largely in the winding space. The result is an improved leakage factor provided the core is assembled with the small air gap permissible when d-c magnetization is absent. The use of high permeability core material in place of ordinary transformer steel increases greatly the primary inductance that is obtained, but does not alter the leakage inductance because the reluctance of the leakage paths is largely in the winding space. Hence, high permeability iron reduces the leakage factor and makes it possible to construct an output transformer that is small in size and so has low leakage inductance, while at the same time has high primary inductance because of the core permeability.

To summarize, it is seen that the important constants of an output transformer are the primary and leakage inductances. When these quantities, together with the turn ratio and primary and secondary d-c resistances are known, the frequency response characteristic of the output transformer can be readily calculated with high accuracy using the equivalent circuits of Fig. 2 and the curves of Fig. 3. The number of octaves which a transformer can cover is determined by the ratio of leakage inductance to primary inductance, and is increased somewhat by making the load resistance considerably higher than twice the plate resistance (See Fig. 4). The leakage coefficient of a transformer can be reduced by interleaving the primary and secondary windings, by properly proportioning the winding space, by the use of push-pull and shunt-feed circuits to eliminate d-c magnetization, and finally by the use of alloy cores of high permeability.

<sup>1</sup>The Hay bridge is particularly suitable for such measurements. See F. E. Terman, "Measurements in Radio Engineering," page 53.

inductor, thus varying the impedance of the inductor. The varying voltage drop across this inductance is fed to an electron tube panel where it controls the amount of rectified current passed by grid-controlled rectifiers. This current changes the degree of saturation of a d-c winding on a transformer, the a-c windings of which are connected in series with the a-c line and the lights to be regulated.

In addition to the Thyratrons used in this circuit there are mercury vapor rectifiers and high vacuum rectifiers. The gaseous rectifier permits current to flow during the interval between pulses supplied by the controlled rectifier. The high vacuum rectifier is in the "feedback" circuit where it electrically compares the voltage on the lamps with the voltage from the inductor and acts on the grid circuit of the Thyatron to hold the lamp voltage constant for any one setting of the inductor core. The object is to prevent changes in the lamp load from affecting the lamp-circuit voltage. The feed-back circuit responds only to the magnitude of the voltage and not to the phase. For this reason the inductor may be connected to a single phase while the lamp load may be distributed over three phases with obvious advantages.

The volume of electrical manufacturing business in 1935 kept pace with the increase in 1934 over the previous year. This amounted to about 30 percent, and was accompanied by the largest consumption of power by the home that had ever been recorded. It is felt that this increased use of power must ultimately lead to increased generating capacity of the public utilities with the distinct possibility that this will provide the opportunity of trying some of the tube-operated power apparatus for generation, transmission, or conversion of power. Research has already shown that metal tubes can successfully handle as much power as 3000 kw. for rectification and inversion of d.c. to a.c. Furthermore it seems not unlikely that two of these installations could be operated in series to supply 6000 kw. at 30,000 volts.

### Making a Living in Radio

By ZEH BOUCK. *McGraw-Hill Book Company, Inc., New York City, 1935.* (222 pages, 25 illustrations; price \$2.)

THIS BOOK is based on the experience of a man thoroughly familiar with the radio field. Mr. Bouck, being an old-timer, is inclined to view the field in a somewhat pessimistic fashion, but this arises primarily from his anxiety to warn the reader against dreams of becoming rich and famous over night. The competitive nature of the several branches of radio, including radio servicing, operating, engineering, broadcasting, and writing, is made clear. The book does not consist entirely of warnings, however, but contains a wealth of constructive information that any man intending to enter radio work may well find necessary. This reviewer particularly appreciates Chapter IX on "Radio Writing" in which the rules for preparation of technical copy are outlined. A thorough understanding of this chapter on the part of authors would be a great boon to editors. The appendices give a complete bibliography in the field in addition to the addresses of organizations which specialize in placing radio operators, together with

a list of companies specializing in the manufacture of electrically transcribed programs. In short, the book makes clear that radio is not the happy hunting ground that it was ten years ago, so far as making money is concerned, but that there are many worth-while jobs available to those qualified for them. For those who wish to enter radio work on this basis, the book is a valuable guide.—D. G. F.

### Fundamentals of Radio Second Edition.

By R. R. RAMSEY, *author and publisher, Bloomington, Ind., 1935.* (425 pages, 438 figures. Price, \$3.50.)

SIX YEARS AGO Professor Ramsey's first edition appeared. All who read *Electronics* know the rapid changes in the art which have made necessary a new edition. Here the author includes a new chapter on Multi-electrode tubes, has rewritten the chapter on coupling to give a more direct application to the usual radio circuits, he has endeavored to make clear to the "average sophomore" the meaning of vector potential, he has added valuable lists of problems and questions to test the student's knowledge.

### FACSIMILE PROVIDES PRIVATE COMMUNICATION

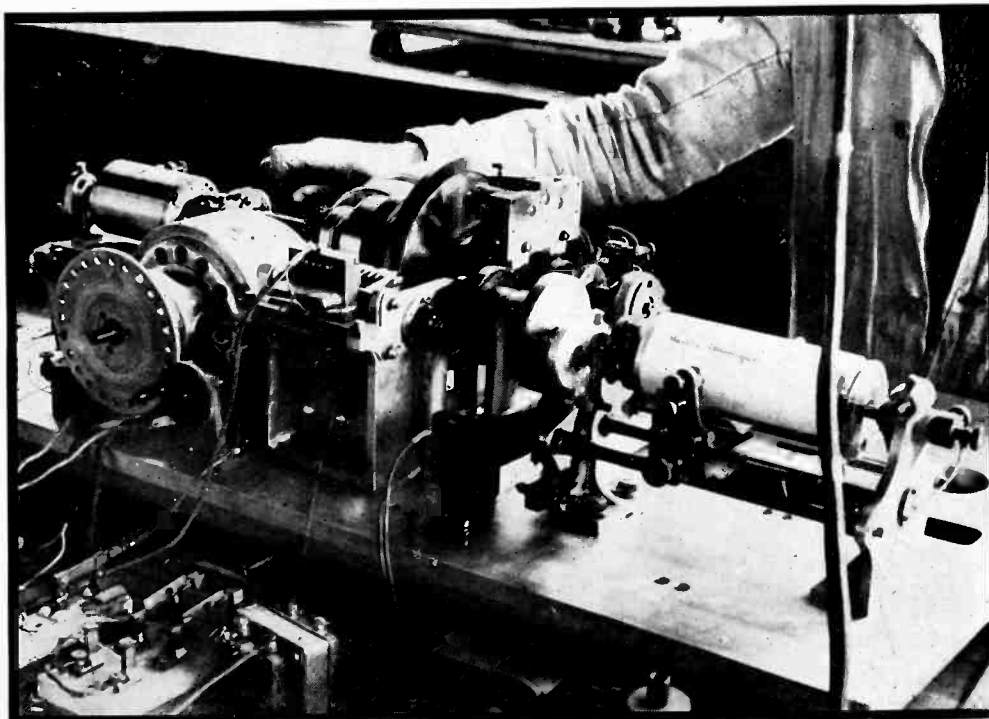

Developed to provide spy-proof communication in the event of war, a radio facsimile machine has been invented by the French inventor Belin. Translation of the facsimile message can be performed only when the original scanning and progression rates are known

# New Solar Phenomenon

[Continued from page 25]

I then published a suggestion that observers, not only in radio but in related sciences such as terrestrial magnetism and solar activity, be on the watch for special phenomena during October 21 to 25. Such phenomena appeared on October 24, under interesting circumstances which seem to shed new light on the relations of solar, radio, and terrestrial magnetic phenomena. On Oct. 10 there had begun a great increase in sunspot activity, accompanied by a general improvement in radio transmission on the higher frequencies. Amateurs and others found that they received excellent daytime signals on much higher frequencies than usual. By October 21 to 23 the upper limit of frequency had reached the highest value ever observed by the National Bureau of Standards. Then, for a single day, October 24, this was completely reversed. The upper limit of frequency on this one day dropped to half its value on the preceding days, and on October 25 and succeeding days returned to the high previous values. This was accompanied also by a remarkable change in the virtual height of the  $F_2$  layer of the ionosphere; this height shot up to 460 km. on October 24 from a height of about 250 km. on the preceding and following days. These changes were the most pronounced ever observed by the Bureau. On October 24 also a world-wide magnetic storm occurred.

Magnetic disturbances, sunspot activity, and poor high-frequency radio transmission have hitherto been considered to go together in general, but with many puzzling exceptions. The present results may help to unscramble the relation, and the following hypothesis is offered. High-frequency radio transmission improves as general sunspot activity increases (probably because of increased ultraviolet radiation), but some particular, relatively sudden eruptions on the sun have the reverse effect (impairing high-frequency radio transmission on the illuminated side of the globe) and also give rise to terrestrial magnetic disturbances.

It appears that the relation between the sudden solar and radio disturbances is a simple one. The widespread daytime radio effect is approximately synchronous with the solar eruption, depending directly on the changed ionization produced in the ionosphere by the solar emanation. The magnetic disturbance, however, is a derived effect resulting from the currents flowing in the ionosphere as the charges therein redistribute themselves, and it would be difficult to identify cause and effect.

Such identification is possible however for the radio disturbances, and has in fact been found. In response to a request from the National Bureau of Standards a report by Mr. R. S. Richardson of optical observations of the sun was received from Mt. Wilson Observatory. This report indicates that the spectrohelioscope showed sudden marked changes in form and intensity of a hydrogen flocculus within a few minutes of the time of each of the radio fadeouts of July 6 and Aug. 30, and also showed a similar phenomenon on Oct. 24. (No observations were made at the times of the March and May fadeouts). Mr. Richardson's report says the Aug. 30 and Oct. 24 eruptions were unusual. Data are not available as to whether widespread radio fadeouts occurred at the times of other notable solar flocculi eruptions.

The synchronous radio fadeouts and visible solar eruptions, lasting only a few minutes, appear to be some sort of climax of a process occurring over a period of hours. The Oct. 24 radio observations revealed the disturbed condition over such a longer period rather than the climactic sudden type of fadeout. It should be noted, by the way, that the direct correlation of solar and radio effects with which we are here concerned are daytime phenomena, i.e., on the side of the globe illuminated by the sun. Night-time radio phenomena are far more variable.

It is by no means proved, but it may be that solar eruptions (visible or not) are the usual cause of wide-

spread daytime impairment of high-frequency radio transmission, and also of at least some terrestrial magnetic disturbances. Even if only a small proportion of the effective eruptions should have a visible stage, certainly further study of such visible effects, and comparison with radio transmission results and ionosphere data, will be of value in elucidating the mysteries of magnetic disturbances and other effects closely related to events on or in the sun.

## Graphical Analysis

[Continued from page 18]

stantaneous plate currents were 119 and 14 milliamperes respectively.  $I_a$  therefore is  $119 - 14 = 105$ . The peak value of fundamental current therefore is  $I_{o_1} = \frac{105}{2} + 1.03 - 0.11 - 0.09 = 53.33$  milliamperes.

The percentage of harmonics then is:

Harmonic	Percentage
2nd	6.28
3rd	1.93
4th	0.53
5th	0.21
6th	0.19
7th	0.17

These values are typical of a tube of this type operating at full output into a resistance load. The output obtained is easily determined from the fundamental current times the load resistance. In the above case the RMS fundamental current is  $0.707 \times 53.33 = 37.65$  ma. The output is  $(0.03765)^2 \times 2,500 = 3.55$  watts. This value is in excellent agreement with the published value of 3.5 watts.

In general the use of the above method will give results sufficiently accurate for all design purposes. While extending the calculations to include harmonics of higher order than the seventh will tend to improve the accuracy of calculations for all harmonics, it is felt that for the majority of cases it would merely cause unnecessary trouble and delay in the analysis of the problem.

# More

## FOR THE RADIO MANUFACTURE FARM RADIO CHARGING GENERATOR

**A NEW LOW COST  
GENERATOR FOR  
LIGHTS AND RADIO**  
*Sold Only to  
Manufacturers*

*that really works!*

The PIONEER gas engine driven generator features: Push button starting. (Also provided with manual starter.) 150 watts output either 6, 12, 32 or 110 volt DC. Maximum mechanical power:  $\frac{3}{4}$  horsepower. Four cycle ball-bearing gas engine. Generator and gas engine directly connected in one unit. No coupling connections. Extra pulley operates mechanical appliances. generator can be disconnected or used to charge battery simultaneously. No voltage fluctuation. Gas engine and generator both efficiently air-cooled. Unit supplied with ammeter, cutout and muffler. Operates 15 hours on one gallon of gasoline. Motors for operating washing machines, pumps, and other farm appliances can be driven electrically from this generator. Generator is designed and built in the PIONEER plant particularly for this purpose—not an assemblage of units intended for some other use.



### AIR-FLO CHARGER

If you are not familiar with the superior qualities of the PIONEER wind charger, write or wire for sample unit. Provides 6 volts and 5 amperes direct current. Operates at a remarkably low wind velocity.

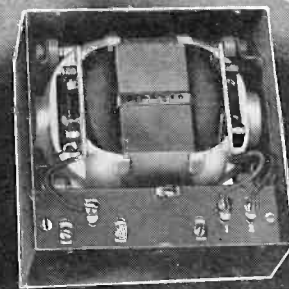

### GEN-E-MOTOR

Pioneer Gen-E-Motor Model complete with built-in filter unit is available to provide plate supply for farm radio receivers. Superiority over the vibrator type of plate voltage supply is unquestioned for a steady plate voltage without ripple. Send for a sample to your specifications.

**466 W. Superior St., Chicago**  
**CABLE ADDRESS: SIMONTRICE, NEW YORK**

# PIONEER GEN-E-MOTOR CORP.

### MAIL THIS COUPON

Pioneer Gen-E-Motor Corp.,  
466 W. Superior Street, Chicago, U.S.A.

RUSH sample PIONEER 6-volt Gas-Engine Generator

Company .....

Address .....

By .....

# TUBES AT WORK

**A** CATHODE-RAY tube with a memory, a bucking-circuit for color measurement, a diode welder-watcher, and a sub-surface prospecting system are among this month's crop of new tube applications

## Cathode Ray Recorder "Remembers" by Means of Fluorescence Delay

AN UNUSUAL TYPE of cathode-ray oscillograph recorder which records not only a current or voltage impulse but also the current or voltage which preceded the impulse was announced by Dr. A. W. Hull, General Electric Research Laboratory before the National Academy of Science at the University of Virginia. The instrument, which was developed for use in the study of lightning flashes, makes use of the fact that the fluorescent screen of a cathode ray tube will retain the image produced upon it for a fraction of a second after the cathode beam has

been removed. A picture of the screen is "triggered" by the lightning impulse. The picture thus records not only the position of the beam at the instant the camera shutter is opened, but also the path it has traveled for a few hundredths of a second preceding that time. In this sense the cathode ray tube is capable of storing up information or "remembering" for as long as the fluorescent screen is capable of retaining the image placed upon it.

In the study of lightning impulses it is necessary to have a camera with an extremely short reaction time, that is, a camera capable of recording the impulse before it has dissipated itself, within a few millionths of a second. Actually a camera with a negative reaction time, that is one

recording circuit immediately before the impulse occurred.

The device may be permanently connected and will record without attention, except that the film in the camera must be moved after each exposure is taken. Since the image on the cathode-ray screen is continually erasing itself, the only images which appear on the film are those immediately preceding, during, and immediately after the impulse occurs. The time lag of the fluorescent material is about 1/25 of a second. The device has been used in the General Electric Laboratories in Schenectady for studying the occurrence of discharges and faults in power rectifiers and inverters.

• • •

## Photoelectric Color Measuring Device Used for Process Control

THE USE OF COLOR measurements for controlling the various industrial processes, such as sugar refining, oil refining, heat treatment and the like, has been seriously handicapped because of the relative insensitivity of the eye to slight changes in color. A photoelectric device known as a "compensating colorimeter" has been devised for measuring the color of liquids or any transparent or translucent material.

The device consists of two self-generating photoelectric cells which are connected in a potentiometer circuit so that the voltage generated by one cell bucks the voltage generated by the other. Consequently when the illumination on each cell is the same the net voltage is zero, as indicated by a galvanometer. By placing the sample whose color is to be determined in front of one of the cells, and by placing a standard solution in front of the other, the relative transmission efficiency of the two materials can be evaluated directly by determining the difference in voltage produced by the two cells. The potentiometer knob is turned until the galvanometer returns to zero. At this position the potentiometer knob indicates either the voltage difference or the color in terms of a standard scale.

The device may be used directly for determining the transmission of light to various substances, or it may be used to determine the color of substances in terms of transmission efficiency. For this latter type of work three colored filters of standard characteristics are used. These filters are interposed between the sample and the cell and between the standard and the cell to determine the percentage of different colors contained by the sample

At right, the screen of a cathode ray tube which "remembered" the two waves which had already occurred when the camera shutter opened. Below, Doctor A. W. Hull with the pre-recording oscillograph

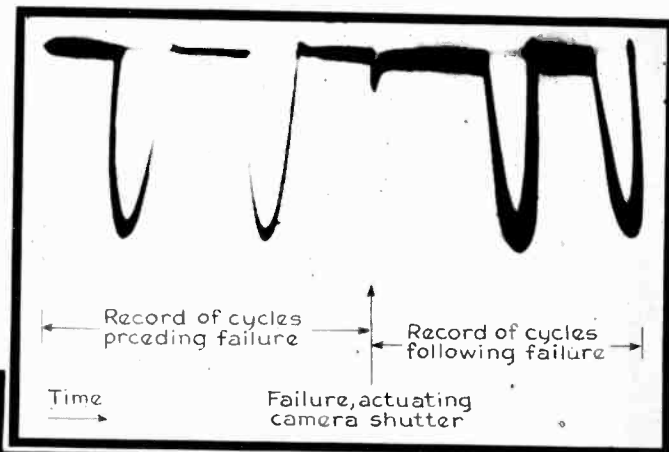

capable of commencing recording just before the lightning flash occurs, would be desirable. The device described by Dr. Hull accomplishes this seemingly impossible result in the following manner:

The pre-recording oscillograph, as it is called, consists of an ordinary cathode ray oscillograph tube having a fluorescent screen specially constructed to have an appreciable time lag. The tube is surmounted by a light proof chamber and a small camera having a fast lens. The shutter of the camera is controlled magnetically from a thyatron whose grid is excited by the lightning impulse. When the lightning voltage appears the camera shutter is opened, thus exposing the film to the image formed on the screen. This image consists of the form of the lightning impulse, and in addition the still-visible image produced by the re-



*In* 1936

**ERIE** *Insulated* **RESISTORS**

*The outstanding resistor development  
of 1935*

**WILL CONTINUE TO BE**

**THE CHOICE OF LEADING**

**RADIO MANUFACTURERS**

**WHERE QUALITY IS GIVEN**

**FIRST CONSIDERATION**

**ERIE INSULATED RESISTORS ARE AVAILABLE IN PRODUCTION QUANTITIES  
IN  $\frac{1}{4}$  AND  $\frac{1}{2}$  WATT SIZES.**

**ERIE RESISTOR CORPORATION**

**ERIE, PA.**

**Factories in ERIE, PA. - TORONTO, CANADA - LONDON, ENG.**

in terms of the red, violet, and yellow portions of the spectrum. This is a standard procedure known as the trichromatic analysis.

Since the instrument is entirely self-contained (except the indicating galvanometer) and a.c. operated it may be applied to a variety of industrial problems without special accessory apparatus. In sugar analysis, for example, the sugar sample is placed between the illumination source and one cell, while between the source and the other cell is placed a container filled with water. The relative transmission both to white light and to various monochromatic sources may then be determined directly in terms of the transmission through the water.

• • •

### Monitoring a Welder With Mathematics

IN THE MANUFACTURE of metal tubes, where such currents as high as 75,000 amperes are used, the welding machines must be adjusted so that the total heat energy developed in the weld during the welding cycle has the correct value. In the RCA Radiotron Division plant this quantity is measured by means of an ingenious circuit designed by Mr. F. H. Shepard.

An air-cored toroidal coil is slipped over one of the welding electrodes where it induces a voltage from the field of the welding current. Because

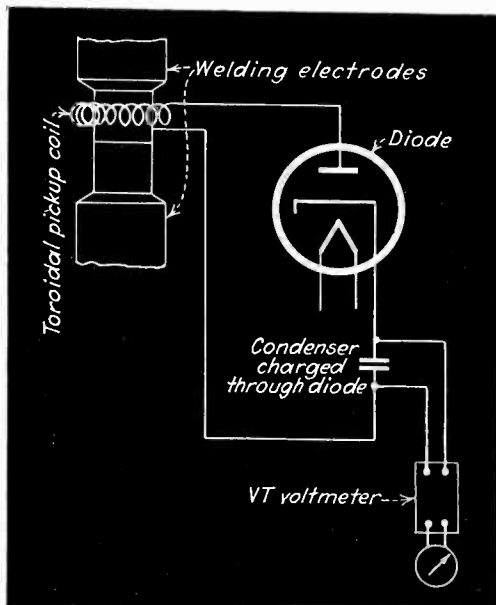

Circuit of the welding monitor

the welding current is a train of sine waves, the coil voltage is sinusoidal and is proportional to the welding current. A small part of the coil voltage, about 0.1 volt, is applied to a diode in series with a condenser. Since the diode characteristic for this small voltage has the form of the square law, the current flowing into the condenser is proportional to the square of the coil voltage and hence proportional to the square of the welding current. The condenser stores up the charge flowing into it, and thus builds up a voltage which is closely proportional to the diode current integrated over the welding period. The condenser voltage is not large enough to disturb appreciably

the proportionality of the diode current to the square of the coil voltage, and hence the voltage attained by the condenser is proportional to

$$\int_0^T i^2 dt$$

where  $i$  is the instantaneous value, and  $T$  the duration, of the welding current. It will be seen that this integral can be taken as a measure of the total heat

energy of the weld  $\left( \int_0^T i^2 r dt \right)$  if it is

assumed that  $r$ , the resistance of the weld, always varies in the same manner during the welding period. On the basis of this assumption, which is approximately correct, the condenser voltage is read on a vacuum-tube voltmeter as a measure of the total welding heat.

This measurement is particularly helpful when a welding machine is first being put into operation. There are two adjustments to be made on the machine, one controlling the peak amperage of the welding current and the other the duration of the welding current. These adjustments are made so that the total heat energy of the machine's weld has the same value as that of other machines turning out satisfactory work.

• • •

### New Optical Crystals to Aid Atomic Research

A NEW PROCESS of producing artificial lithium fluoride crystals suitable for optical use has been announced by Professor Donald C. Stockbarger of the Department of Physics at M.I.T. Because lithium fluoride is extremely transparent to light both in the ultra-violet and infra-red region, its use in optical instruments, notably in spectrometers and other instruments used in electronic research, is of considerable importance. Lithium fluoride crystals have a transmission range far wider than that of any other optical material, including fused quartz, optical glass and rock salt. In addition the material refracts light of different colors far more equally than does any other known substance.

The process of growing crystals of this substance consists in the production of lithium fluoride salt in highly pure form by a synthetic process and in growing the crystals in an electric furnace whose temperature is precisely controlled. The powdered salt is placed in an accurately shaped platinum crucible with a conical bottom. At the apex of this bottom a seed crystal is planted and from this the growth continues until the entire body of the substance has become uniformly crystallized. Optically perfect crystals as large as 3 in. in diameter have been produced by Professor Stockbarger.

### RECORDER ENGRAVES EVIDENCE ON CELLULOID



A new device for recording conversation and other evidence secretly by means of a diamond stylus engraving on celluloid film. The recording may be played back immediately without processing



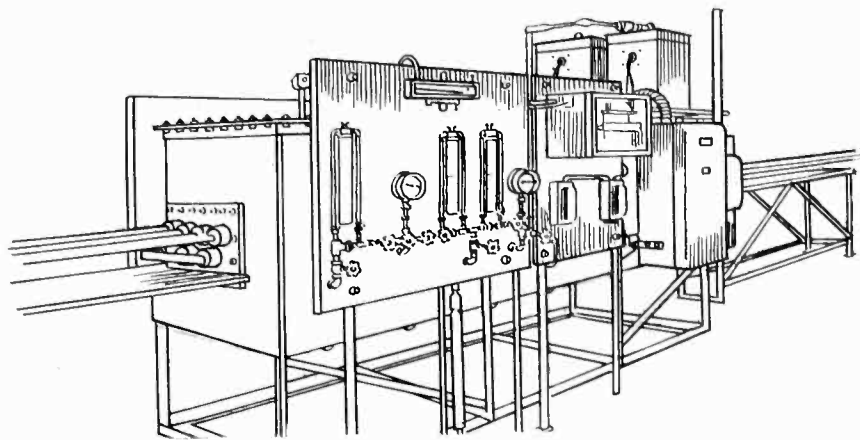

## AS SURE AS CAN BE---

*We are on the way to more business*

A year ago, after being in production 3 months, we employed 45 men. At our 1935 peak we employed 190 men on three 8-hour shifts.

We made money and paid dividends on November 15, 1935, to our stockholders for the full period from November 30, 1934, the date of incorporation, to the dividend payment date.

We feel that a business that cannot pay for the hire of dollars is not properly conducted. We all pay for hire of labor. Why not for dollars?

This company does not pay large salaries to executives; dollars and wages come first. Only then has management a right to be heard.

### SUPERIOR TUBE COMPANY

Norristown, Pa.

*(TWENTY-FIVE MILES FROM PHILADELPHIA)*

MANUFACTURERS OF

FINE SEAMLESS TUBING

IN SMALL SIZES

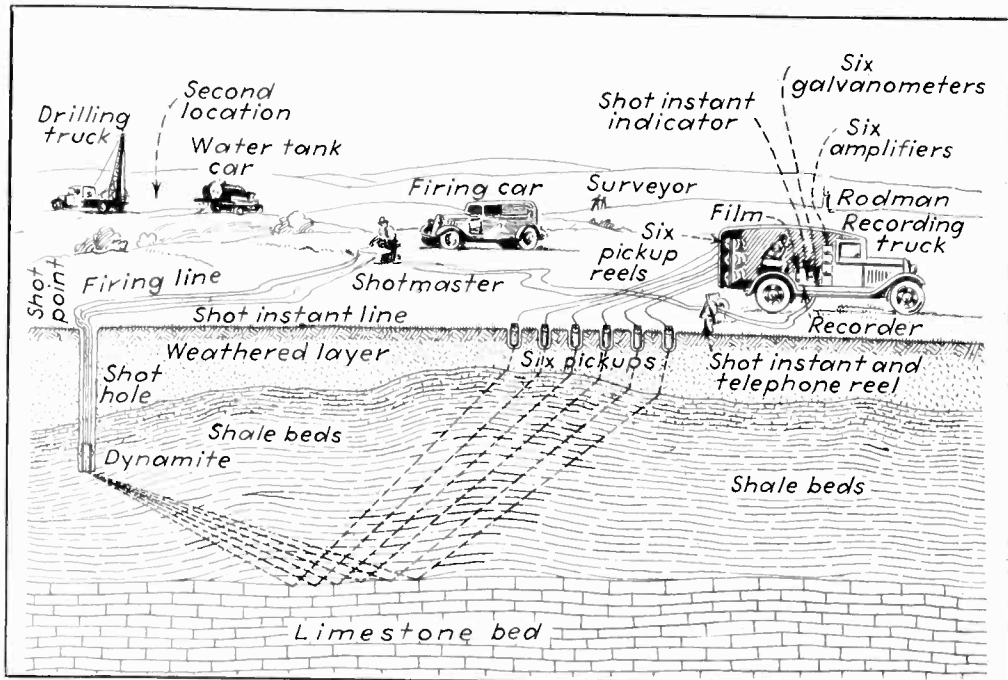

Complete layout of the Askania seismic prospecting apparatus described below. An oscillograph record of the "sound-wave" sent through the earth by a dynamite explosion reveals the features of the hidden sub-surface geology

### Seismic Prospecting Method Uses Electronic Recorders

SEISMIC PROSPECTING, an important method of geophysical exploration which reveals the presence of valuable oils and mineral deposits, is now carried out with the aid of electronic amplifiers which record earth tremors caused by the explosion of a charge of dynamite. As shown in the illustration, the method consists in burying a charge of dynamite below the surface of the area which is being explored. The dynamite is exploded electrically, and the impulse or shock thereby given to the earth travels downward until it hits a reflecting layer. At this layer the seismic wave is reflected back toward the surface where its presence is recorded by six vibration detectors, that is, specially constructed instruments which convert the mechanical vibration of the ground surface into electrical impulses. These impulses are amplified in conventional recorder amplifiers and applied to individual galvanometers of a magnetic type oscillograph. The vibration experienced by each vibration detector is thus recorded on a moving strip of photographic paper. On the same strip of paper are also recorded the electrical impulse which detonated the dynamite blast and a series of timing marks equally spaced at intervals of 1/100th of a second.

If the time of travel of the seismic wave through the earth is known it is possible to calculate the depth of the reflecting layer simply by measuring the time between the blast and the arrival of the shock at the vibration recorders. The seismic wave may be regarded as a sound wave traveling through the earth's surface, and the

arrival of the reflected wave as an echo.

Six separate seismographs (vibration pick-ups) are used in order to identify surely the reflected waves from the other disturbances which are produced by the blast. This is possible because the refracted and directly transmitted surface waves and sound waves in the air arrive at the six recorders from a more or less horizontal direction whereas the reflected wave arrives in a nearly vertical direction. The reflected waves therefore show almost exact time coincidence on the oscillograph record, whereas the other waves are spread out over a greater time.

It is of course necessary to know the velocity of the wave through the earth's surface, but when this is known the accuracy in determining the depth of the reflecting layer may be as good as 1/10 of one per cent under favorable conditions. The reflecting layer does not necessarily indicate the presence of minerals or other valuable sub-surface deposits, but it does indicate a distinct discontinuity in geology of the region, which is of prime importance in the geologic study of any prospecting survey.

### Photocell Detector to be Used with New 200-in. Telescope Mirror

ACCORDING TO Dr. George E. Hale, chairman of the Palomar Observatory council, the new 200-inch mirror for the reflecting telescope to be installed atop Mount Palomar will be used in conjunction with a photocell detector for registering the presence of extremely faint illumination. The photocell amplifier, constructed by Dr. Albert E. Whitford of the University of Wis-

consin, has been used in the Mount Wilson observatory with remarkable results. The device is capable of registering the presence of a candle at a distance of seven miles without the use of a telescope. With the telescope at Mount Wilson, which has a 100-in. reflector, the candle would be detectable at a distance of 3,000 miles, assuming no absorption in the atmosphere beyond the first mile.

• • •

### Utility Service Crews Using Ultra-High Frequency Radio

ACCORDING TO *Electrical World*, tests have been made by a western public utility company using ultra-high frequency transceiver equipment between the service crews who patrol wire lines and other transmission equipment, and the dispatchers of the system who direct their work. Since much of this work must be done during lightning storms, the freedom of the frequencies between five and ten meters from atmospheric disturbances makes them particularly suited to this type of service. The tests indicated that such equipment may be highly useful for use in controlling and dispatching work. Further tests, in which the dispatcher transmitter will feed an aerial on top of a 265 ft. smoke-stack, are being planned.

### NOBEL LAUREATES



Frederick Joliot and his wife, Irene Joliot Curie, winners of the Nobel prize in chemistry, for their synthesis of radioactive elements (See *Electronics*, November 1935, page 7.)

# Advanced Styling with Bakelite Molded

TODAY'S TREND in Radio Cabinet Styling is definitely toward simplicity in both form and line—toward designs which will look well anywhere. For the production of these modern cabinets, particularly in large sizes, Bakelite Molded is proving both economical and practical.

Forming large hollow shapes with Bakelite Molded in deep cavity molds has proved to be completely successful with numerous dissimilar designs. The excellent example featured here measures 17"x21"x7" overall, and others even larger are being produced in quantity.

From a manufacturing standpoint forming these large size cabinets of Bakelite Molded affords as many advantages and economies as with smaller sizes. Absolute uniformity of dimension is assured; accurately positioned lugs and bosses may be molded in, thereby simplifying assembly; the permanently lustrous finish is acquired in the mold, and



no staining or polishing operations are necessary. A number of attractive colors of Bakelite Materials are available from which to select.

We urge Radio manufacturers and designers to investigate the excellent opportunities offered by Bakelite Molded for producing exceptionally attractive Cabinets in the larger sizes, and to consult us about them. We also invite you to

write for our informative booklet 13M "Bakelite Molded".

★

*This unusual Radio Cabinet is formed throughout of Bakelite Molded. Cabinet and doors are black and trimmings are ivory white. Exhibited at a recent radio show it won the popular vote for beautiful design and was appropriately nicknamed the "Radio in Evening Dress".*

BAKELITE CORPORATION, 247 Park Avenue, New York, N. Y. . . . . 43 East Ohio Street, Chicago, Ill.  
BAKELITE CORPORATION OF CANADA, LIMITED, 163 Dufferin Street, Toronto, Ontario, Canada

## BAKELITE

The registered trade marks shown above distinguish materials manufactured by Bakelite Corporation. Under the capital "B" is the numerical sign for infinity, or unlimited quantity. It symbolizes the infinite number of present and future uses of Bakelite Corporation's products.

### THE MATERIAL OF A THOUSAND USES

ELECTRONICS — January 1936

41

# THE ELECTRON ART

**D**EVELOPMENTS reported recently in the technical press include a new magnetic alloy, unusual uses of glow-lamps as circuit elements in radio receivers, and a graphical method of studying a.v.c. circuits

## Alnico—New Magnetic Material

NEWSPAPERS RECENTLY CARRIED the story about some fifty industrialists on tour of the large research laboratories who saw a new magnetic material at Schenectady where General Electric research engineers described the history and the merits of this new alloy. Originally developed as a heat-resistant alloy which resists scaling and deterioration at high temperatures, Professor T. Mishima of the Imperial University at Tokyo discovered that it had most interesting magnetic qualities.

This new alloy is cast and finished to shape by grinding. It will support 60 times its own weight when properly designed. It is made up of iron, aluminum, nickel and cobalt. It has higher coercive force and lower residual induction than other magnetic materials. The maximum available

energy is higher and occurs at a lower flux density and a higher demagnetizing force. Alnico magnets may, therefore, be of smaller volume. They will be less subject to demagnetization by stray fields. An a-c field of 500 ampere turns per inch caused the magnetism to decrease only 10 per cent in a one-minute application and further exposure produced no further loss in flux lines.

Alnico magnets are less subject to demagnetization by heat or by mechanical vibration. They require stronger magnetizing force to magnetize them completely, a force of at least 2,000 oersteds (4040 ampere turns per inch) is recommended. The specific gravity is 6.9, the alloy is non-corrosive and is brittle.

Considerable data may be secured on the subject by reading U. S. Patent 1,968 569 to W. E. Ruder of the General Electric Company.

## Bibliography on Oscillation

THE RECENT NUMBER 2 OF VOLUME 5 of the *Report of Radio Research in Japan* brings an article (pp. 40-68) by Rensuke Usui on the non-linear theory of electric oscillators which discusses many examples of these types of oscillators amplifying von der Pol's result (I.R.E. 22:1501, 1934); a second article (pp. 69-78) by Kinjiro Okabe of the Department of Physics, Osaka University, describes the production of

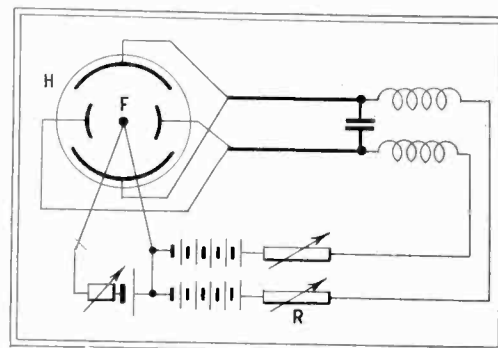

*Magnetron oscillator. Lines of force perpendicular to plane of the paper*

ultra-short wave oscillations with double-anode magnetrons, i.e., magnetrons with two pairs of split plates; besides wave-lengths given by  $13,000/H$  (Gauss), a second system of waves given by about  $8,000/H$  is produced.

Tatuo Hayasi from the same university contributes two articles, one on a new amplitude modulation system for magnetron oscillators (pp. 89-104) and another (pp. 105-113) on new electron oscillations outside the inner grid dynatron oscillating electrode, their wave lengths, about 100 cm, being not only quite independent of that of the main oscillator but also comparatively constant for wide changes in electrode voltages.

• • •

## Discharge Tubes in Radio Sets

### *Volume Control*

[W. HEINZE and W. POHLE, P. MIRAM] The glow-lamp in which the discharge is restricted to the negative glow is a suitable means for indicating the position in which a radio receiver is tuned to the incoming wave. The surface covered by the glow, or, when the cathode is in the form of a wire, the length of the glow, is proportional to the current. In the discharge tubes used the cathode is a thin rod, two or three inches long, which becomes covered to the tip with the glow when the current reaches 2 ma. A ring-shaped positive electrode surrounds the lower part of the cathode, and an auxiliary electrode at the foot of the

## NEW GEIGER COUNTER FOR COSMIC RAY STUDY

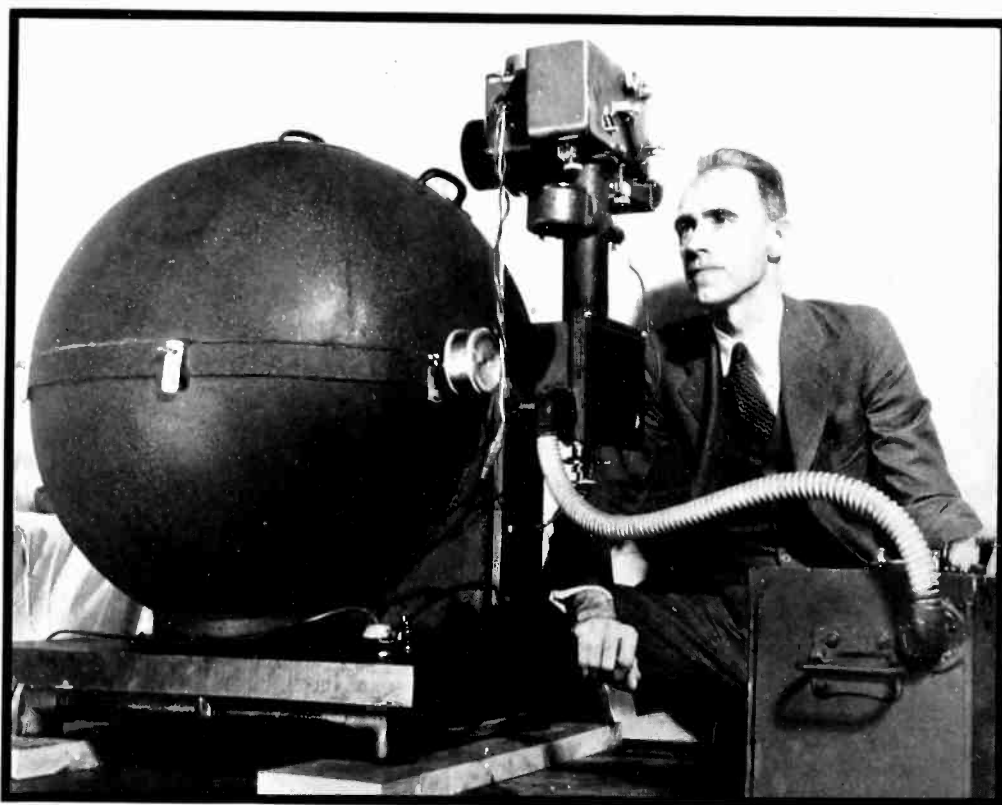

*Professor R. D. Bennett of M. I. T. with one of seven new cosmic ray intensity meters to be installed throughout the world. An automatic camera records variations in the intensity of the cosmic bombardment, which are registered in argon gas maintained at 750 pounds pressure. The instrument, battery operated, will record for one year without attention*

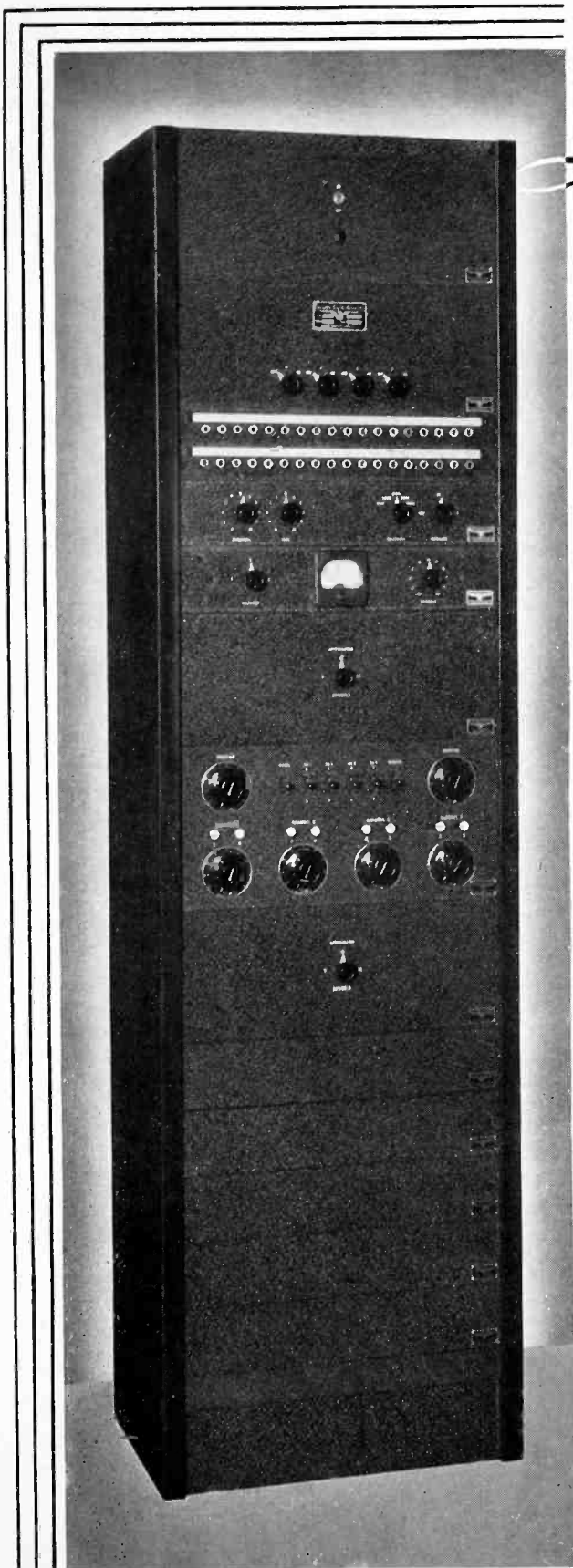

★ Well proportioned cabinets, pleasing in style, with symmetrically placed controls, blend attractively with modern studio appointments.

# Increased Flexibility

## FOR ★ ★ ★ ★ ★ SMALL OR LARGE STUDIO INSTALLATION

The COLLINS type 12E Speech Input Assembly, because of its flexible circuit design, is easily adapted to the individual requirements of large or small broadcast stations.

The following features of the 12E are an indication of the careful engineering found throughout the entire Series 12 Speech Input Equipment: Completely independent program and monitor circuits . . . . All units may be isolated or eliminated completely from the circuit by means of jacks . . . . Loud speakers in control room and studios are controlled automatically by microphone control switches . . . . Control operator may "talk back" into rehearsal studio without interrupting program on the air from another studio . . . . Improved type of high-speed volume level indicator used . . . . All important controls are grouped on one panel which may be removed from rack and located on control operators' desk . . . . The 12E may be used to feed transmitter directly or to feed program line to transmitter . . . . Standardized construction of units allows equipment to be enlarged, instead of replaced, as the demands of the station increase.

The careful attention which has been given to these and other details of design in the 12E, permit a flexibility of operation never before attained in a factory assembled speech input system.

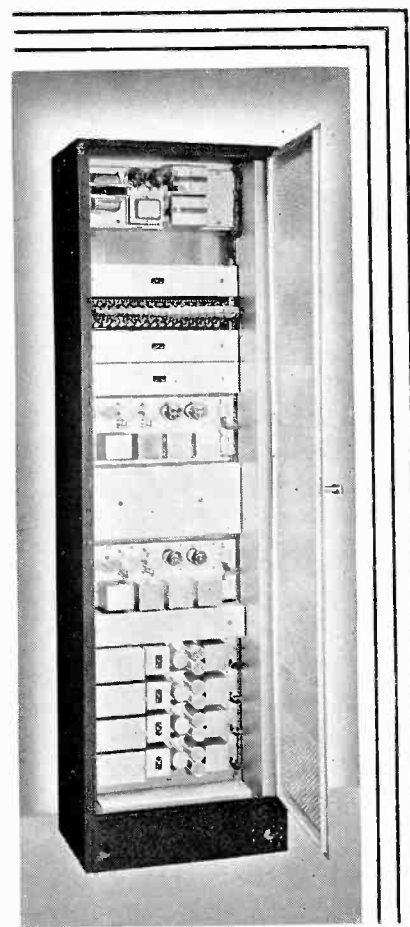

★ The clean cut appearance of the interior emphasizes the dependable performance and sturdy construction.

# COLLINS RADIO COMPANY

CEDAR RAPIDS, IOWA



NEW YORK, 11 West Forty-Second Street

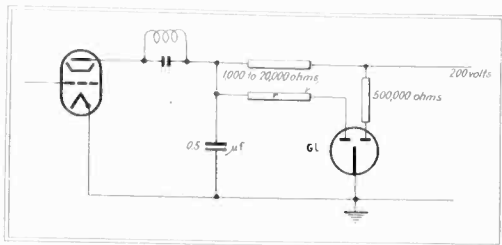

Negative glow indicating tuning

cathode. A weak discharge is maintained between the auxiliary electrode, and the main electrode; with uncoated electrodes the starting potential is about 190 volts, the operating potential 160 volts.

In the set the main discharge together with a series resistance  $r$  is placed in parallel with a resistor inserted in the lead from the plate of the detector or a.v.c. tube. The resistance  $r$  is so chosen that when the set delivers maximum undistorted power the cathode is completely covered with the negative glow. This current is of course equal to the fraction obtained by dividing the potential drop  $V$  across the lamp and its series resistance minus the operating potential  $v$  of the lamp by the series resistance, that is  $i = (V - v) : r$ . If the resistance  $R$

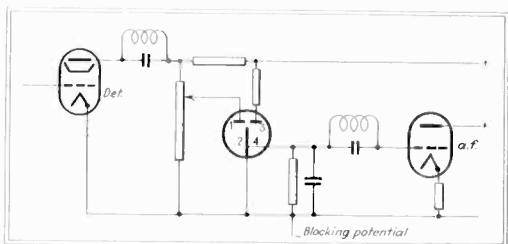

Negative glow with silent tuning

in the plate circuit is such that when the set is being tuned, the voltage drop across the resistance varies by 30 volts, or from 200 to 170 volts at one end, then the resistance to be placed in series with the lamp must be about 20,000 ohms to produce full coverage at resonance with 2 ma. current. The discharge has its greatest length when the steady plate current has reached its smallest value. The auxiliary discharge is about 0.3 ma.; it is in series with a resistance of  $\frac{1}{2}$  meg.

By inserting a fourth electrode in the top of the tube so that it extends part way down the cathode, the glow discharge tube may be made to switch the audio stage in and out. As the current and the length of the glow increase there comes a stage where the fringe of the negative glow touches the fourth electrode, and charges this electrode to nearly the same potential, about 160 volts below that of the plate of the tube. In one arrangement the fourth electrode, or probe, is connected to the screen of the following tube kept at ground potential by being shunted with a 5 or 10 meg. resistor and blocking the plate current until the probe is touched by the discharge. The current to the probe and therefore the screen current must be kept smaller

than 0.2 ma. to prevent the discharge from becoming self sustaining. Another way is to apply a strong bias to the control grid of the next tube. When the glow progresses to the tip of the probe, the grid is practically short-circuited to ground and allows the current to pass; its strength is controlled by the drop in the grid bias resistor. The resistance of the cathode-to-probe space varies, however, with the current

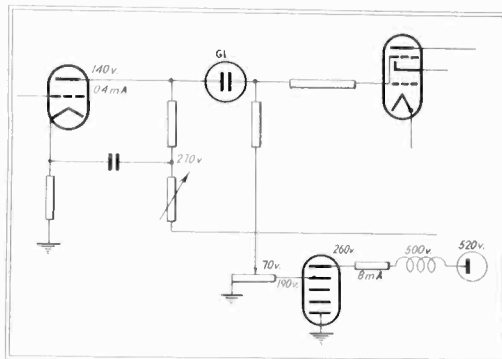

Glow discharge as coupling element in a-f amplifier

through the discharge tube, producing changes of the grid voltage, and the method should only be used with tubes having a low amplification factor; with other tubes it is necessary to place a rectifier between probe and cathode.

#### Audio Amplification

Discharge tubes with the negative glow only may be used to advantage instead of the coupling condenser in resistance coupled a-f amplifiers. The lowest current insuring a steady discharge, about 0.05 ma., is chosen for

operating the tube to get a resistance of a few megohms and a nearly straight current against voltage line. If a.c. is superimposed, the additional resistance introduced is practically zero so that all the frequencies are transmitted to about the same extent without any loss of the lower notes. —*E. T. Z.* 56 (No. 33): 917-920, 1935. *Funkt. Mon.* No. 10: 373-376, 1935.

#### A.V.C. Doubler

[PAUL MANDEL] Whatever the circuit used, the purpose of a.v.c. is to maintain the output at practically the same level regardless of signal strength; the aim is achieved by varying the grid bias of at least one tube and thus changing its amplification in accordance with the output voltage. Let  $e_1$  be the voltage applied to the first grid,  $e_2$  the amplified voltage in the same tube,  $e_3$  the voltage after three stages of amplification. In the simplest case the amplification by one tube is equal to  $e_2 = e_1 GR$ , or when several, (for instance, three) stages, are used,  $e_4 = e_1 G^3 R^3$ , when  $G$  is the mutual conductance and  $R$  the internal resistance, supposed to be much larger than the load.  $G$  depends on the grid bias  $e$ , which in turn depends on the output  $e_2$  or  $e_3$ , of the amplifier. In case of a three stage r-f amplifier followed by a diode, applying the rectified voltage directly to the grid of the first tube and giving almost perfect rectification,  $e \doteq 0.84 e_1$ . If a series of measurements on r-f tubes of a certain type shows that on the average  $\log G = -3 - 0.2 e$ , and  $R = 100,000$ ,



#### GLIDER TRANSCEIVERS

In the recent All-Union Glider Meet held in Crimea, pilots testing new glider models kept in contact with the ground by ultra-short-wave radio

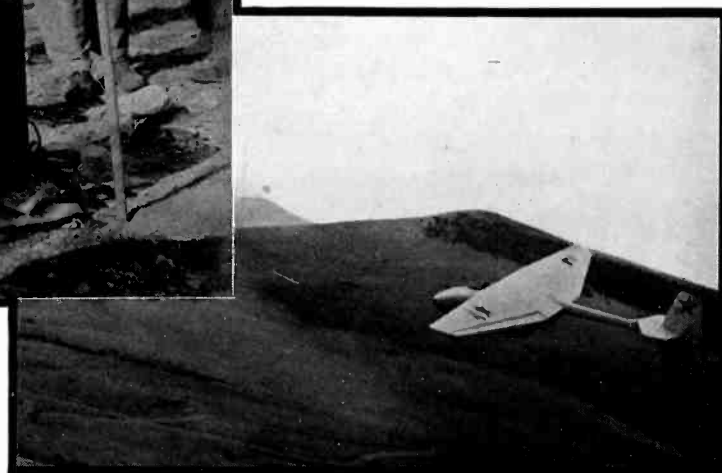

# AN ASSEMBLY MODERNIZATION

*that Costs Industry Nothing*



*Countless opportunities* for economies and improvements . . . without added expense or radical changes . . . are being uncovered by design engineers and shop executives with the aid of a **PARKER-KALON ASSEMBLY ENGINEER**

Throughout the metal working industries it is conceded that one of the most important modern aids to production speed and economy is Parker-Kalon Hardened Self-tapping Screws. So much simpler to use than other fastening devices . . . and affording greater holding power in most cases . . . these unique Screws solve many assembly problems. Hundreds of metal and molded products are being made better and more economically as a result. Numberless jobs are done in less time, with less labor and trouble.

There are many concerns, though, who are missing the advantages this outstanding assembly modernization could give them. And, thousands who now employ it to a degree could benefit further by applying it to other assemblies still being made by more difficult and costly methods. So this invitation to use Parker-Kalon's Assembly Engineering Service is important to *every* manufacturer.

PARKER-KALON CORPORATION • 198 VARICK STREET • NEW YORK

Through this Service any plant may obtain the cooperation of an Engineer who by reason of years of practical experience and a broad knowledge of assembly methods is a specialist in his field. He sells nothing. His sole function is to work with interested engineers and shop executives in searching-out all opportunities for cost reduction, design simplification and product improvement that might be attained through Hardened Self-tapping Screws. In seven out of ten cases such searches lead to worthwhile benefits, without investment or radical changes of any kind.

*What Opportunities exist in your Assembly Work?*

Certainly it will pay to find out whether you are making the fullest use of this assembly modernization that has worked production miracles on hundreds of products from artificial limbs to airplanes. Your request will bring a Parker-Kalon Assembly Engineer to you, without cost or obligation.

**PARKER-KALON** *Modern* **FASTENING DEVICES**



TYPE "Z"



HEX HEAD

A Type for Every Kind of Assembly



TYPE "A"



TYPE "U"

it follows that

$$\log e_1 = \log e_0 + 0.6 e - 6$$

or

$$\log e_1 = \log e_0 + 0.5 e_n - 6$$

a relation which represents the result obtained with automatic volume control; with  $e_1$  in microvolts and  $e_0$  in volts

$$e_1 = 0.9 \quad 10 \quad 20 \quad 80,000 \quad 10^6 \mu V$$

$$e_0 = 0.25 \quad 1.6 \quad 2.0 \quad 8.0 \quad 10 \text{ volts}$$

that is, when the input voltage varies in the ratio 1:1,000,000 the output voltage varies only from 0.25 to 10.

In the general case the characteristic curves of the tubes are more complicated, and though they may be expressed in a power series, graphical methods give a more immediate picture of the control mechanics. First the voltage amplification,  $A$ , is plotted as a function of the grid bias  $e$  using logarithmic scales; then, in the same system of coordinates but with an appropriate scale for  $e$ , the output voltage  $e_2$  is plotted as a function of the grid bias produced by the a.v.c. circuit. Starting with an arbitrary value of  $e_2$  on the ordinate, a parallel is drawn to the  $e$ -axis; it cuts the  $e_2$  curve in a certain point; a parallel to the ordinates drawn through this point leads to the value  $a$  on the amplification curve. On the prolongation of the  $e$ -axis toward the right, the distance  $a$  is plotted to the left from the point chosen as  $e_1 = 1$ ; the point obtained corresponds to  $e_2$ , and a perpendicular at  $a$  is drawn to intersect with the parallel through  $e_2$ . By repeating the construction for several points, the curve  $e_2 = Ae_1$  is obtained; it represents the results obtained with

a.v.c. The scales for  $e_1$  and  $A$  must be identical.

In the ideal case the curve obtained would be a horizontal line; to approach this condition the control must be extended to several tubes, or a separate a.v.c. tube must be added, both measures tending to increase the slope of the curves  $A$  and  $e$  plotted to logarithmic scales. The method may be extended to include control of a-f amplifications by means of  $e_1$  or  $e$ . If the a-f amplifier is to produce a constant voltage, its amplification must be so adjusted that it is inversely pro-

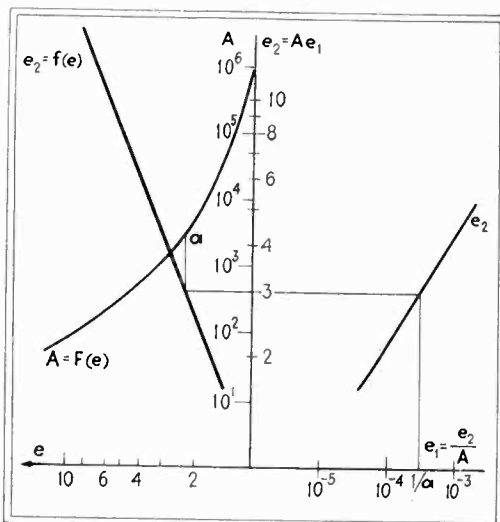

Graphical method of studying a.v.c.

portional to the input voltage  $e_1$ , or inversely proportional to  $e$ .—*Onde el.* 14 No. 164: 531-539, 1935.

## TYPEWRITER TUNER

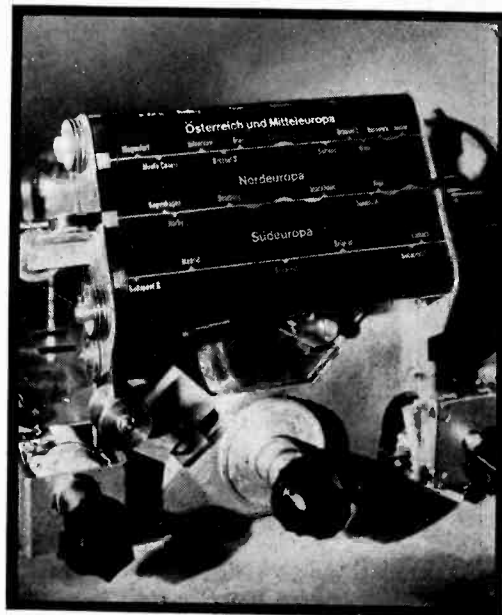

A German tuning control whose scale moves like the paper in a typewriter. The station settings are printed on an endless strip of celluloid which moves with the band-change switches

## R-f Transition Losses

[Continued from page 26]

(c) For any given phase angle, the loss is a minimum when the absolute value of the impedance ratio is unity. For a phase angle of  $49^\circ$ , the minimum loss is one decibel.

Let it be required to determine the transition loss between two impedances, in general, either or both of which may be reactive. The two impedances are represented as

$$Z_1 = R_1 + jX_1; \quad Z_2 = R_2 + jX_2 \quad (7)$$

The net reactance is

$$X = X_1 + X_2 \quad (8)$$

The values of two parameters  $U$  and  $V$  are then determined by either one of the following alternative representations,

$$U = \frac{R_2}{R_1}; \quad \pm V = \frac{X}{R_1} = \frac{X_1 + X_2}{R_1} \quad (9)$$

$$U = \frac{R_1}{R_2}; \quad \pm V = \frac{X}{R_2} = \frac{X_1 + X_2}{R_2} \quad (10)$$

The chart is readable more accurately when the relation is used which gives the greater value of  $U$ .

The transition loss chart was shown in the presentation of "The Design of Doublet Antenna Systems" by the same author, on November 20, 1935, at the Rochester Fall Meeting of the I. R. E.

## UNATTENDED WEATHER REPORTER IN ARCTIC ZONE

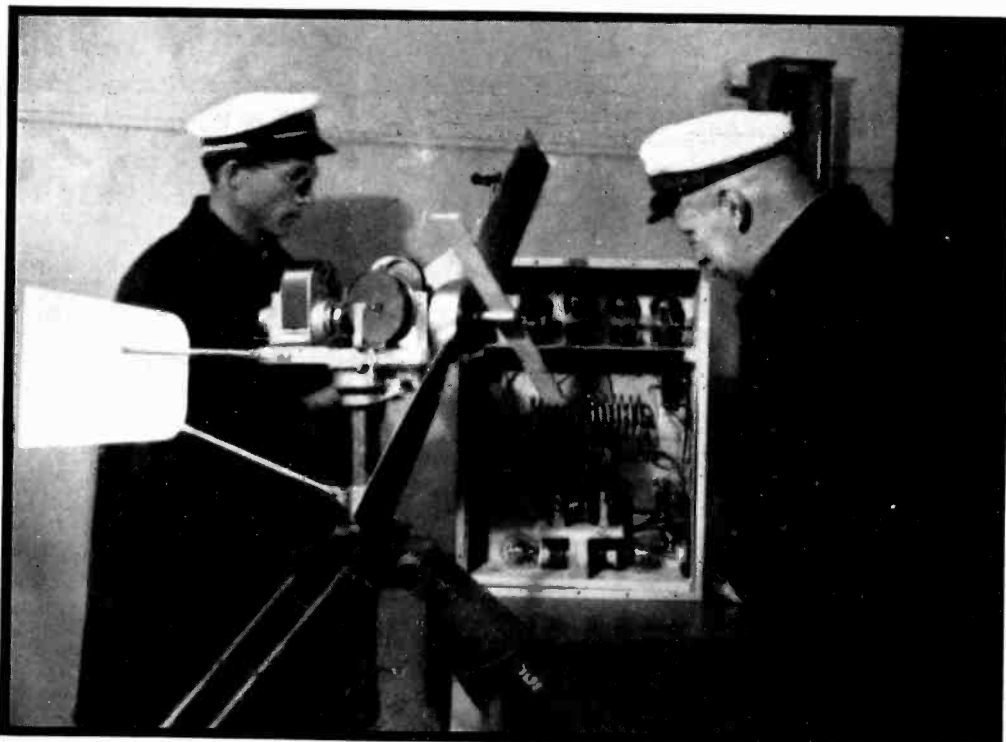

The Arctic Institute of Russia has installed this automatic transmitter in Franz Joseph Land where it transmits wind velocity and other weather data directly to the Central Meteorological Institute in Leningrad



# VARIABLE CONDENSERS ... are no better than their INSULATION!

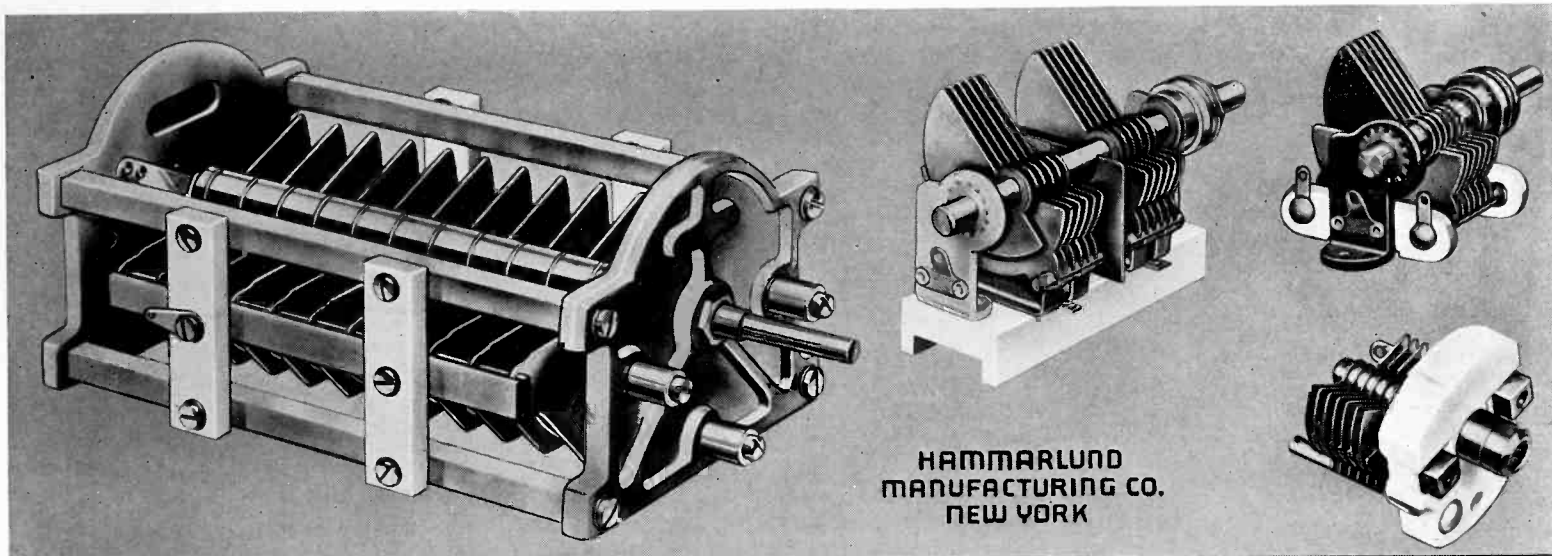

HAMMARLUND  
MANUFACTURING CO.  
NEW YORK

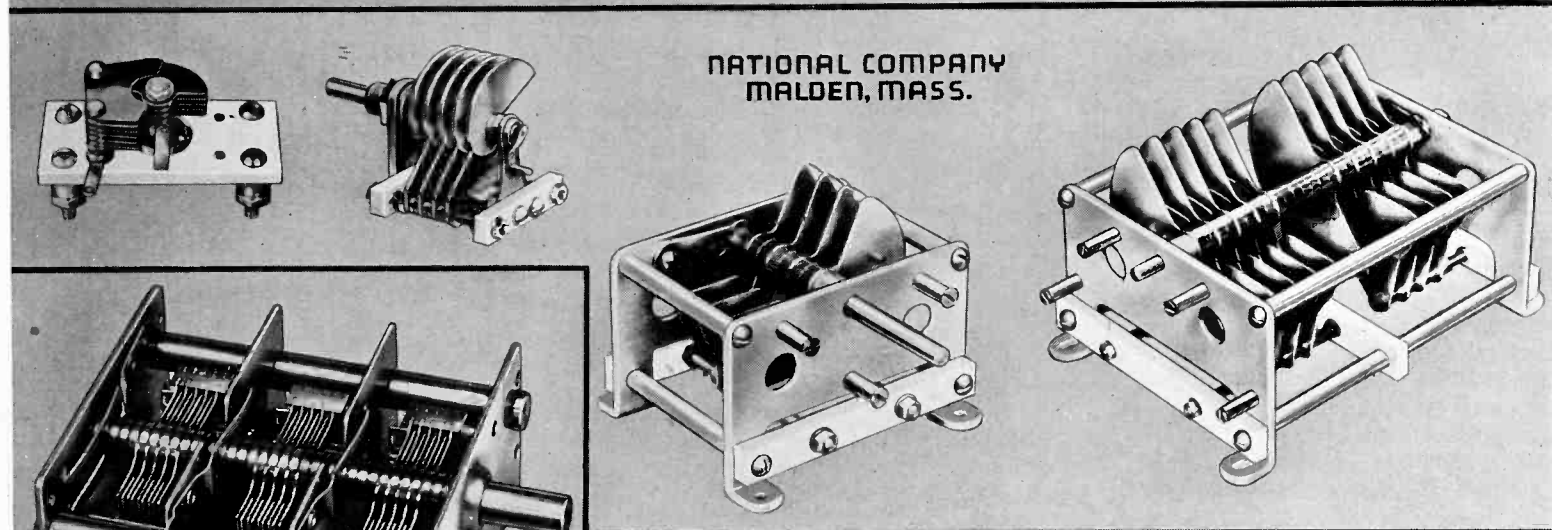

NATIONAL COMPANY  
MALDEN, MASS.

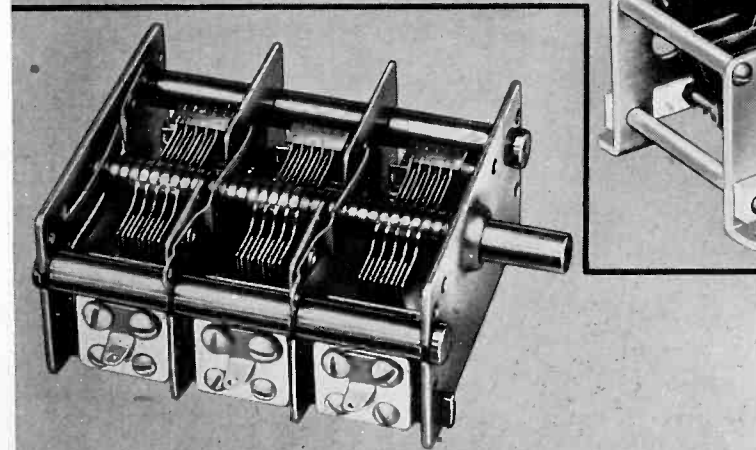

RADIO CONDENSER CO.  
CAMDEN, N.J.

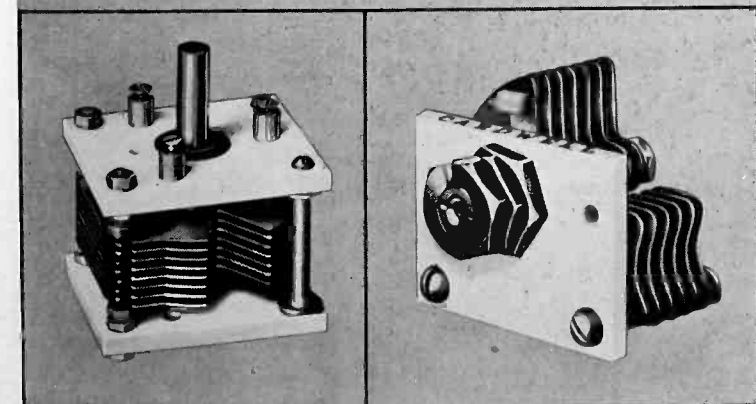

GENERAL RADIO CO.  
CAMBRIDGE, MASS.

THE CARDWELL MFG. CORP.  
BROOKLYN, N.Y.

Recognizing this most important fact, these and many other manufacturers choose ISOLANTITE for insulating their quality products.

Insist on Condensers insulated with ISOLANTITE for maximum stability and dependability in your equipment.

Isolantite Inc., 233 Broadway, New York, N. Y. Factory at Belleville, N. J.

**Isolantite**  
**CERAMIC INSULATORS**

## Reception With Short Antennas

[E. SIEGEL, Professor at the University of Prague] Provision can be made either for adjusting the antenna circuit by means of a variable inductance  $L_1$  in series with the coupling coil (partial resonance  $P$ ) or for adjusting the secondary capacitance (partial resonance  $S$ ). When the voltage produced at the grid of the first screen

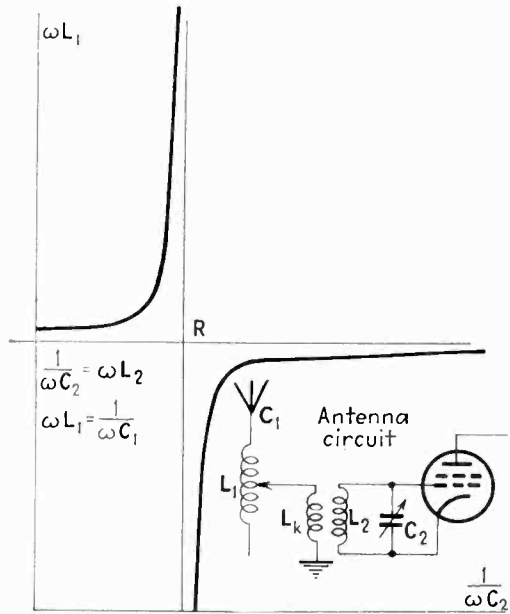

grid tube is represented by a vertical line of length  $E_2$  for each pair of values  $\omega L_1$  and  $1/\omega C_2$ , (where  $\omega = 6.28$  times frequency and  $\omega L$  and  $1/\omega C_2$  are plotted in a horizontal system of coordinates), the points obtained form two mountain ridges, each one with a sharp bend at a nearly right angle near the highest points. The first ridge starts with a relatively low altitude near the point  $1/\omega C_2 = \text{zero}$  and  $\omega L_1 = 1/\omega C_1$ , and runs parallel to the  $1/\omega C_2$  axis (or X-axis), but when it approaches the point  $R$  at which  $1/\omega C_2 = \omega L_2$ , it makes a sharp bend and runs for the rest of its course parallel to the  $\omega L_1$  (or Y-axis) towards larger and larger values of  $\omega L_1$ . For larger values of  $1/\omega C_2$ , on the other hand, the second ridge runs also parallel to the  $\omega L_1$  axis but from the opposite direction, near the point  $R$  for which  $1/\omega C_2 = \omega L_2$  and  $\omega L_1 = 1/\omega C_1$  (resonance) it turns and runs for the rest of its course parallel to the  $1/\omega C_2$  axis toward large and larger values of  $1/\omega C_2$ . The two ridges are connected by a saddle in the center of which lies the point  $R$  for which the antenna as well as the grid circuit are tuned to the incoming wave of angular velocity  $\omega$ . In practice the antenna circuit is left untuned,  $\omega L_1$  being much smaller than  $1/\omega C_1$ .

A perpendicular plane parallel to the  $1/\omega C_2$  axis (and corresponding to partial resonance  $S$ ) or parallel to the  $\omega L_1$  axis (partially resonance  $P$ ) cuts

one ridge at a time along a curve having the shape of an inverted  $V$ . The highest points of the ridges trace a hyperbola when projected upon the horizontal plane, the peaks lying not far from the point  $R$ .

While giving higher voltages at the grid of the first tube, this region has the disadvantage that tuning is not very sharp since a perpendicular plane parallel to  $1/\omega C_2$  either cuts the saddle or runs nearly parallel to one of the ridges. Better tuning can be obtained as a rule for small values of  $\omega L_1$ , that is without attempting to adjust the antenna circuit since perpendicular plane, which cuts the ridges along a curve representing the changes in  $1/\omega C_2$  is then nearly at a right angle to the ridge. Tests with an antenna 12 m. long receiving a 470-m. wave ( $\omega = 4 \times 10^6$ ) and a 249-m. wave ( $\omega = 7.57 \times 10^6$ ) prove this point. (Capacitance of the antenna about 85  $\mu\text{f}$ .)

A different system of ridges is obtained for each incoming frequency. It may be shown that when using an antenna which can be tuned to the incoming wave, the larger values of  $\omega L_1$  and the correspondingly smaller values of the coupling factor  $k^2 = M^2/L_1L_2$  increases the chances that two stations interfere in the receiver. The use of variable antenna circuits offers therefore practically no advantages.—*H. jr. Tech. El. Ak.* 45 (No. 6): 198-204. 1935.

## Details of British Television Systems Announced

THE TABLE BELOW describing the technical features of the two major television systems now being developed in Great Britain for public use is repeated from the *Wireless World*, Vol. 37, No. 14, page 371.

	Baird.	Marconi-E.M.I.
Number of frames per picture	1	2
per second	25	50
Number of lines per picture	240	495
per frame	240	202.5
per second	6,000	10,125
Picture ratio	4:3	5:4
Number of lines in each frame for	12	3-4
black edging	8	7-4
picture	220	192.5
Proportion of each line devoted to	8%	10%
synchronising	2%	5%
black edging	90%	85%
picture	166.666	98.765
whole line	13.333	9.876
Total time in micro-seconds of	3.333	4.983
black edging	150.0	83.95
picture portion	40	20
synchronising	2	0.2963
portion	—	0.5926
black edging	1.333	0.6914
portion	36.666	0.3951
picture portion	27.5.1	19.0123
Ratio of black edging to picture, i.e. stroke to fly-back of time-base line	45.1	48.1.1
Range of modulation depth for black to white in picture	40—100%	30—100%
Tolerance during programme	$\pm 2.5\%$	$\pm 3\%$
Additional day to day tolerance	—	$\pm 3\%$
Range of modulation depth for synchronising	0—40%	0—30%

THE RADIO CORPORATION of America announced that the net income of this organization for the first nine months of 1935 was \$2,801,000, an increase of more than 25 per cent over the corresponding period of 1934.

## WEATHER DATA RADIOED FROM 17,000 FEET



A radio meteorograph of the Blue Hill Observatory, Harvard University, is carried aloft 17,000 feet each day by Pilot A. V. Marsh and his assistant R. De Gregorio. The instrument radios the barometric pressure, temperature and humidity automatically to the observatory below



# LABORATORY TEST REPORT

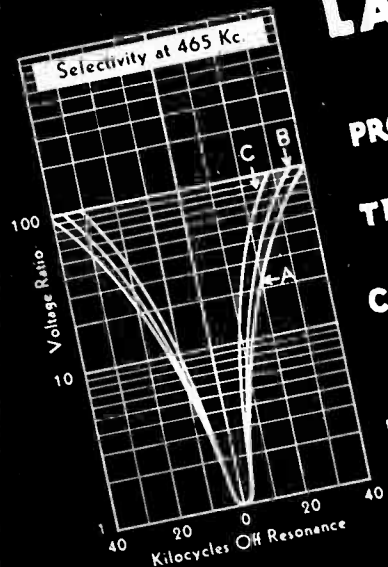

**PRODUCT:** Aladdin Polyiron Coils

**TEST:** Effect of shield size on gain and selectivity

**COILS:** Type C-465 kc with the following shields:-  
 A-1 1/8"sq x 2 1/2" Shield  
 B-1 3/8"sq x 3 1/2"  
 C-2"sq x 4"

<b>Gain</b>	<b>Band-width at 10x</b>
53	24 kc
65	21 kc
72	18 kc

**RESULTS:**  
 (measured between 6A7 and 6D6 tubes)

## Use the i-f transformer shield which best suits your chassis design—Use Aladdin Polyiron Core Coils which give you the best performance

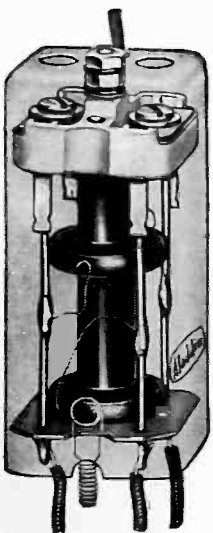

Type C  
Size 1 1/8" x 2 1/2"

The superior characteristics of Aladdin Polyiron core i-f coils improve the performance of any modern receiver design. Improved performance means increased sales and profits for '36.

The keen competition of modern radio retailing forces consideration of every detail which will improve the performance and appearance of a radio chassis.

You can't honestly ignore the advantages of Aladdin Polyiron coils in your designs.

*Demonstration of a type C Aladdin transformer in cathode ray comparison test with a large air core i-f transformer at optimum gain adjustments exhibited before the Rochester I. R. E. convention, November 26. In the double exposure photograph, the higher oscillograph curve is that of the small Aladdin transformer at the left; the lower curve, that of the large air core unit at the right.*

Aladdin Polyiron core coils are available for antenna, radio frequency, and intermediate frequency transformer applications in auto, home, and communication receivers. Special couplers are designed for band expansion in one or two steps.

Send for Polyiron Data Sheet 1135 for latest complete list of stock coils and their characteristics. Full engineering cooperation is available to recognized manufacturers who wish to improve existing designs with Aladdin Polyiron core coils.

**Aladdin Radio Industries, Inc.**  
 466 W. Superior St., Chicago, Ill.  
 Licensee of Johnson Laboratories, Inc.

These devices are manufactured under one or more of the following patents: 1887380, 1978599, 1982690, 1940228, 1978600, 1997453, 1978568, 1982689, 2005203, 2002500, 2018626. Other patents pending.

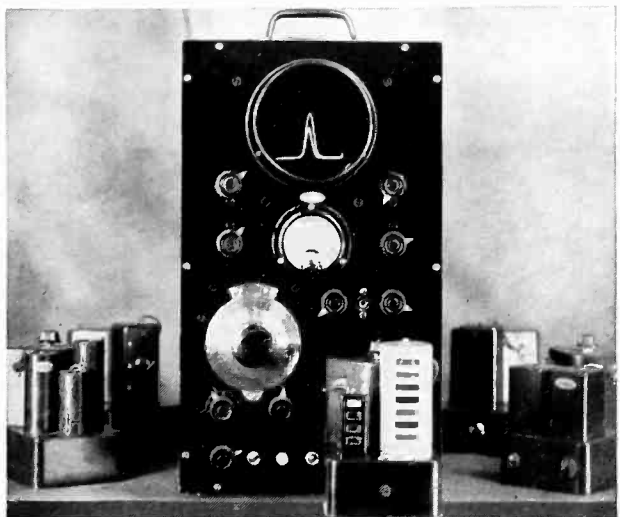

# Aladdin

# MANUFACTURING REVIEW

## Names in the News

♦ Walter E. Holland has resigned as an officer and director of Philco after eighteen years of active service with that organization. Mr. Holland's radio career included such positions as chief



engineer of the Edison Storage Battery Company, director of the Engineering Division of the R.M.A. and as Philco's radio director since Philco has been engaged in radio. Mr. Holland is taking this step because of poor health and will spend the winter on his recently acquired ranch at Paul Spur, Arizona.

♦ Carrington H. Stone, export sales engineer of electronic equipment was recently elected chairman of the Mid-West Section of the Society of Motion Picture Engineers and member of the board of governors of the parent society.

♦ Don Bartlett has recently been appointed to an executive position on the production staff of Erpi Picture Consultants, 250 West 57th St., New York, N. Y.

♦ W. C. Stevens has been appointed vice-president in charge of engineering for Cutler-Hammer, Inc., Milwaukee, Wisconsin. Mr. Stevens has been with this organization 30 years, devoting



most of his time to engineering work and serving in the capacity of chief engineer for the past several years.

♦ Frank Zambrino has returned as Chicago Manager of Radio Transcription Company of America, after an absence of six months in San Diego, California. Ben Crose returned to Hollywood as Coast Manager; Lindsay MacHarrie returned to his post as production Manager.

• • •

## New Products

### Tubes

**New Raytheon types.** From Raytheon Production Corporation, 30 East 42nd Street, N. Y. City, comes a description of three new metal tubes all with octal bases: 6X5, 25A6 and 25Z6. The 6X5, a full wave high vacuum rectifier, has a maximum plate voltage of 350 and a peak inverse voltage of 1,250 volts. This tube, developed primarily for use



in automobile receivers, is  $3\frac{1}{8}$  inches long and  $1\frac{1}{8}$  inches in diameter. Type 25A6, for use as a Class A amplifier, with a plate voltage of 180 volts has a power output of 2.75 watts; grid voltage —20; amplification factor 96; mutual conductance 2,400 micromhos; plate current 40 ma. Type 25Z6, for use as a rectifier in power supply applications where a transformer is not employed, has a plate voltage of 125 volts; d-c load current of 85 ma. and a peak plate current of 500 ma. per plate. Overall length  $3\frac{1}{8}$  inches; diameter  $1\frac{1}{8}$  inches.

**Ultra-high frequency triodes.** Ampere Electronic Products, Inc. 79 Washington Street, Brooklyn, New York, announce two new tubes suitable for high frequency work. Model HF 300, when used as a Class C oscillator or power amplifier at a frequency of 60 megacycles, is described by the manufacturers as having the following characteristics: Plate dissipation 200 watts; plate voltage, 3,000 volts a.c., 2,200 volts d.c.; plate current 275 ma.;

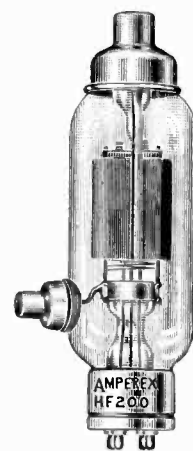

power output, 400 to 600 watts. Overall length  $10\frac{1}{8}$  inches; diameter 3 inches. Model HF 200, somewhat smaller in size, has a plate dissipation of 150 watts; plate voltage 2,500 volts a.c., 2,000 volts d.c.; plate current 200 ma.; power output, 250 to 350 watts. Overall length  $9\frac{1}{2}$  inches; diameter  $2\frac{3}{8}$  inches.

**Triodes.** Eitel-McCullough, Inc., San Bruno, California, announces two additions to their tube line. Eimac 50T, a 50 watt tube, has the following characteristics: Plate current .125 amperes; amplification factor 12; maximum plate voltage 3,000 volts; maximum plate dissipation 75 watts; maximum grid current .030 amperes; overall height  $7\frac{1}{2}$  inches; maximum diameter  $3\frac{1}{8}$  inches. Type 150T, a medium powered radiation cooled triode. Plate current .200 amperes; amplification factor 13; maximum plate voltage 3,000 volts; maximum plate dissipation 150 watts; maximum grid current .050 amperes; overall height 10 inches and maximum diameter  $3\frac{1}{8}$  inches.

**New RCA Metal types.** RCA Manufacturing Company announce three new all-metal, octal-base, radio tubes, designated as RCA-6Q7, RCA-25A6 and RCA-25Z6. Type 6Q7, a duplex-diode high-mu triode, has a maximum plate voltage of 250 volts; amplification factor 70; plate resistance 58,000 ohms; mutual conductance 1,200 micromhos. Type 25A6, a power amplifier pentode, has a maximum plate voltage of 180 volts; amplification factor 95; mutual conductance 2,400 micromhos, power output 2.75 watts. This tube is  $3\frac{1}{8}$  inches long and has a diameter of  $1\frac{1}{8}$  inches. Type 25Z6, a high-vacuum rectifier-doubler, as a voltage doubler has a maximum plate voltage of 125 volts, a 500 ma. peak plate current and a d-c output current of 85 ma. In half-wave rectifier service, these characteristics are the same, and the two units may be used separately or in parallel.

# NEW FORMICA TUBING



**-that Machines  
Easier! . . . .**

**In the new YRT tube Formica has produced a base for inductances which has many advantages over any tube previously offered, especially for mass production . . . This tube punches much better, threads better and works better than any Formica tubing previously available . . . It is the equivalent electrically of the previous YRT tubing, but mechanically it is 30 per cent more flexible . . . Ask for samples of this modern tube.**

**THE FORMICA INSULATION COMPANY**  
4638 Spring Grove Avenue, Cincinnati, Ohio

**FORMICA**

**250 watt tube.** United Type 304A, triode, completely mounted on two channel members to insure constant maintenance of electrical characteristics. Amplification factor 25. Filament voltage 11. Plate current 0.125 amperes. Mutual conductance 4,000  $\mu$ mhos. Class B carrier output 100 watts. Plate dissipation 250 watts. Class C maximum output 350 watts. Maximum length  $14\frac{3}{8}$  inches; maximum diameter  $4\frac{1}{8}$  inches. United Electronics Company, Newark, New Jersey.

**R-f amplifiers.** Hygrade - Sylvania Corporation announces two new r-f amplifiers, types 1A4 and 1B4. Type 1A4, similar to the older type 34, has an amplification factor of 525; plate resistance 750,000 ohms; mutual conductance at -15 volts grid bias, 15; output capacity, 11.0 mmf.; type 1B4, with substantially the same circuit application as type 32, has an amplification factor of 650; plate resistance 1,000,000 ohms; output capacity, 11.0 mmf. This company also announces the type 10 tube, with a low-loss base for amateur work, and the type 6E5, primarily for use as a visible tuning indicator of the electron-ray type.

• • •

## Assemblies

**Angle Switching.** By the use of inductive generators on motor shafts, grid-glow tubes and high speed relays in the field closing circuit, Westinghouse has overcome the difficulty arising from the time required for the usual relays and contactors to function in starting up synchronous motors. This angle switching device was supplied for four hundred hp. 225 r.p.m. 199 volt three-phase, 60-cycle 100 per cent pf. synchronous motors used for air conditioning the new Kansas City Auditorium.

**Welding Timers.** A new line of timers, developed by the Welding Timer Corporation, Chrysler Building, New York City. No. 1, for 30 and 50 amperes, one unit; No. 2, for 75 and 150 amperes, one unit; No. 3, for 250 amperes, made in two units.

**Electronic Gage.** A semi-automatic gage for manual operation on materials up to and including one inch in diameter; has a sensitivity of 0.000002 in., and can be set to within 0.00001 in. It employs three lights on the top of the gage, operated by three "inspector" vacuum-tube relays. Objects can be sorted into three classes, for example, if piston pins were being checked the tolerance would be as follows: All under 1.0000", undersize; all 1.0000" and under 1.0001", first good size, first station, one light; all between 1.0001" and 1.0002", second good sorting, second station, two lights; all over 1.0002", oversize, third station, three lights. Works on 110 volts a.c., 50 or 60 cycles. U. S. Patents 1980816 and 1963554, other patents pending. Devel-

oped by Electronic Inspection Laboratories, 942 Prospect Avenue, Cleveland.

**Switch.** A cam lever switch for use in circuits where the break-down requirements do not exceed 2,500 volts. The overall dimensions of the type

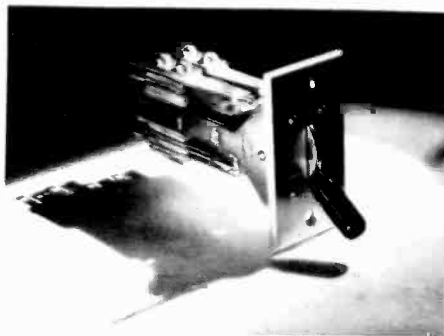

illustrated, A-20291-A, are  $2\frac{1}{2}$  inches wide,  $5\frac{1}{2}$  inches long from handle to end of contacts, and  $1\frac{1}{4}$  inches thick. The Gamewell Co., Newton, Mass.

**Communication Receiver.** Hammarlund "Super Pro" a 16-tube superheterodyne designed primarily for amateur, experimental and broadcast reception. Frequency range from 20 mc. to 540 kc. with direct dial calibration throughout. List price is \$330, with quartz crystal filter \$360. Manufactured by the Hammarlund Mfg. Co., 424 W. 33rd St., New York City.

• • •

## Sound Equipment

**Recording Disk.** The Presto Recording Corp., 139 W. 19th St., New York, announces the Green Seal Disc, a non-breakable acetate coated aluminum disk of extremely hard surface. 6,500 cycles lateral recording, 9,000 vertical recording. Provided with three center holes to prevent slippage during cutting.

**Pickup.** Audak Company, 500 Fifth Avenue, New York City, announces a compact pickup, Model No. 100, for use

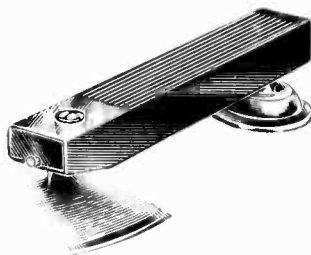

in portable and midget combinations. It is exceptionally flat in construction, and light in weight.

**Amplifiers.** A new high gain amplifier, model SH3, with a minimum of components. It has a gain of 73 d.b. when driven from a 500 ohm source; either 2.5 volt or 6.3 volt filament tubes may be used interchangeably; has an output impedance matching any load of 20,000 ohms or higher; frequency response plus or minus  $\frac{1}{4}$  d.b. from 25 to 9,000 cycles. The amplifier measures 3 x 9 x 9 and can be mounted in any position including rack mounting. Bruno Laboratories, 20 W. 22d St., New York City.

**Loudspeaker system:** The Shearer Two-way Sound System, designed at the Metro-Goldwyn-Mayer Studio, consisting of four 15 inch dynamic speakers, Lansing No. 15X29, mounted behind an exponential horn terminated with a flat baffle, for covering frequencies up to 300 cps, and 2 moving coil speakers, Lansing model 284, for covering frequencies from 300 cps up. The high frequency units operate into a multi-cellular exponential horn. Suitable for use in small and medium size motion picture theaters. Also a smaller unit (not illustrated) for use in small projection rooms, consisting of one 15X29 and one 199-HE Lansing speakers for low and high frequencies,



respectively. Manufactured by the Lansing Manufacturing Co., 6920 McKinley Avenue, Los Angeles, California.

**Recorder.** The Universal Microphone Co., of Inglewood, California, has completed an improved model of their No. 12 recorder, in which the recording head from the professional recorder is a part of the assembly. It is of the four-pole, double coil, center pivot type operating on the push-pull principle. The cutter is  $\frac{1}{2}$  in. thick, 1 in. wide and 3 in. long. The turntables are heat treated and lathe-turned and the guide arm for the lead screw is hinged overhead to permit ease of handling. Tension screws are provided to permit the adjustment of weight on the stylus.

• • •

## Parts and Materials

**Ceramic - Dielectric Condensers.** A new dielectric material known as Cro-lite dielectric has been developed by the Henry L. Crowley Co., of West Orange, N. J. Dielectric constants of from 50 to 170 are reported for this material. Samples subjected to voltages of 1,200 d.c. and 440 a.c., produce no leakage. Has high voltage break-down.

**Plastics.** From General Plastics, Inc., North Tonawanda, New York, an announcement of the use of Durez as housing for a new milliammeter of the Hickock Electrical Instrument Company, and as the body of the new Arvin auto radio control.



This Tube served  
Minneapolis Police  
for  
**46,428**  
**HOURS**

*Howard O. Kelly—Supervisor of Minneapolis Police Radio Stations KGPB and KGPR—holds veteran 251A in front of Western Electric transmitter where it served more than 5 years.*

May 30, 1930, this Western Electric tube joined the Minneapolis Police. 24 hours a day, 7 days a week its filament was lighted. In May 1935 it was removed temporarily—returned to its socket. November 18, 1935, it was finally retired. ☐ During all its 46,428 hours' service, no readjustment of the Western Electric transmitter was needed to compensate for falling off emission—nor did the grid bias have to be juggled. The tube was doing a 100% job all the time! ☐ That shows the quality and long life that Western Electric builds into tubes.

## *Western Electric*

*Distributed by GRAYBAR Electric Co. In Canada: Northern Electric Co., Ltd.*

**RADIO TELEPHONE BROADCASTING EQUIPMENT**

**ELECTRONICS — January 1936**

**Speaker.** A new permanent magnet electro-dynamic speaker, in 6, 8, 10 and 12 inch sizes, of which the 12 inch model is shown in the illustration. This speaker is compact, and is available in several models suggested for use in battery operated radio receivers, and public address systems. Manufac-

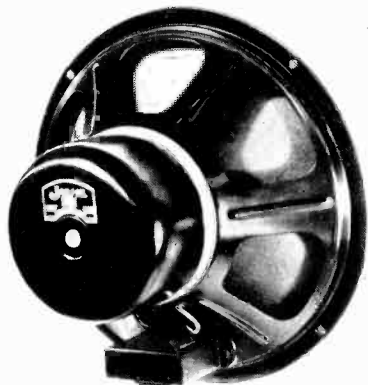

tured by Jensen Radio Manufacturing Company, 6601 S. Laramie Avenue, Chicago, Illinois.

**Meter.** A compact meter, Type No. 573, made in all popular d-c ranges as a milliammeter, ammeter and voltmeter; sensitivity, 75 m.v. in the 1 m.a. range; molded case; 4 1/4 inches square;



mounts through a 2 1/4 inch panel hole. Manufactured by the Hoyt Electrical Instrument Works, 755 Boylston Street, Boston, Massachusetts.

**Insulator.** The new wafer insulator to be used on the 6A8, 6L7 or 6K7 Raytheon tube, has been developed by the engineers of that organization in their laboratory at Newton, Massachusetts. Raytheon reports that this material has the mechanical strength of the strongest material previously used but much lower losses at the high frequencies.

**Resistor.** A high-resistance carbon brush, designed to act as a "cushion" to absorb interference waves on short-wave sets used in cars where the coil and distributor are combined in a single unit, and a high resistance cannot be placed in the wiring circuit between distributor and the coil. Type 1-RS, manufactured by the Ohio Carbon Company, 12508 Berea Road, Lakewood, Ohio.

## Anti-noise Equipment

**Suppressor.** A new device perfected by the engineers of the Consolidated Wire & Associated Corporations, Chicago, Illinois, for the elimination of auto radio noise. This "filtron Robotrol" operates on the phase-inverter principle of setting up a counter disturbance of adjustable intensity to balance out the ignition interference, but not impairing the motor efficiency. List price \$2.50.

**Anti-Noise Device.** A device for eliminating noise on ultra-high frequency radio receivers consisting of a neon tube which short circuits the audio amplifier when no carrier is being received. Manufactured by the Western Electric Co., 195 Broadway, New York City.

**Shortwave Antenna.** A tuned short-wave antenna claimed to provide four times the signal strength as the best existing doublet system. A special tuning unit covers the range from 1,700 to 33,000 kc., and thus making the antenna resonate throughout this band. List price \$14.75. Manufactured by McMurdo Silver, 3354 N. Paulina St., Chicago, Ill.

**Component Analyzer.** An analyzer for testing the components of a radio receiver, coils, condensers, resistors, manufactured by the Triumph Manufacturing Co., 4017 West Lake Street, Chicago, Ill. Net price \$19.95. Ranges: resistance 5 to 2,000,000 ohms; capacity 50 micromicrofarads to 20 mfd.—inductance 50 microhenries to 20 millihenries.

**Noise Filters.** A series of noise reducing filters for use on supply lines rated to carry 5 amp. a.c. or d.c., list prices 40 cents to \$1.50. Manufactured by the Continental Carbon, Inc., 13900 Lorain Ave., Cleveland, Ohio.

**Noise Analyzer.** An analyzer used to determine what values of condensers or chokes are needed to eliminate r-f



noise from small appliance motors, oil burners, etc. Manufactured by the Sprague Products Co., North Adams, Mass.

## Industry Notes

♦ **Astatic Microphone Company** has moved to a new factory at 830 Market St., Youngstown, Ohio. The new headquarters are designed to accommodate the offices and the plant, which combined, utilize about four times as much floor space as previously occupied by this organization.

♦ **Audio Productions, Inc.**, has recently completed the installation of new optical printing equipment in its studio headquarters at 56th Street and 10th Avenue, New York City. This apparatus, designed by the Akeley Camera Company, is to be under the direction of Alex Gansell, in charge of trick photography and optical printing.

• • •

## Literature

♦ **Magnetic Materials Practice.** Loose-leaf bulletin "Magnetic Core Materials Practice" issued by the Allegheny Steel Company, Breckenridge, Pennsylvania.

♦ **Condensers and Resistors.** A new catalog, bringing the entire Aerovox line of condensers and resistors up to date. Aerovox Corporation, 70 Washington Street, Brooklyn, N. Y.

♦ **Microphones.** A condensed catalog of the most important items in their line, published by the Shure Brothers Company, 215 W. Huron Street, Chicago, Illinois.

♦ **Condensers.** Catalog No. 7-S, issued by Solar Manufacturing Corporation 599 Broadway, N. Y. City, includes descriptions of their entire condenser line.

♦ **Quartz Crystals.** A sixteen page catalog describing quartz crystals, holders and ovens for transmitters, single signal filters and standard frequency bars, issued by the Bliley Electric Company, 201 Union Station Building, Erie, Pennsylvania.

♦ **Electrical Instruments.** Electrical Measuring Instruments, for research, teaching and testing, is described as "Broadside E," by the Leeds & Northrup Company, 4901 Stenton Avenue, Philadelphia, Pennsylvania.

♦ **Ceramic Insulation.** Bulletin No. 34 describing electrical and mechanical uses of ceramic products of the American Lava Corporation, Chattanooga, Tennessee.

♦ **Transformers.** Amer.-Tran. News, Vol. 1, No. 1. American Transformer Company's new house organ, which, they advise, will be published at more or less regular intervals.



# GOAT RADIO TUBE PARTS INC

A DIVISION OF THE FRED GOAT COMPANY • INC • Established 1893



- The largest manufacturer of Tube Shields.
- The largest independent manufacturer of parts for glass and metal radio tubes.
- This position was attained not by accident, but by supplying parts of the highest quality at very reasonable prices, and through many years of prompt and reliable service to the industry.
- Goat also manufactures parts for power and cathode ray tubes, and for special tubes of all descriptions.



314 Dean St., Brooklyn, N. Y.

## ENAMELITZ

Reduce manufacturing costs on I.F. and R.F. coils through the use of Enamelitz—"Litz" wire without a fabric covering.

Three Fold Savings—

1. Cost of wire
2. More coils per pound of wire
3. Less space—Greater safety

Sample and Technical Bulletin on Request.

Other Acme Wire Co. Products

Magnet Wire (all insulations)

Coils, Magnet Wire Wound

Varnished Insulations

(Cambric, paper, silk, tape)

Parvolt Condensers

(Filter, By-pass, Power Factor Correction)

Aerial Wire

(Stranded and Solid—Bare or Enameled)

For over 25 Years, suppliers to the largest radio and electrical manufacturers.

**THE ACME WIRE CO.**

New Haven, Conn.



## Metal-Clad CONDENSERS



Metal - case paper condensers . . . all types, sizes, capacities, voltages, combinations.

Oil-impregnated oil-filled units for transmitting and heavy-duty functions.

Heavy-duty mica units in metal cases.

Metal-can dry and wet electrolytics . . . the greatest variety for all needs.

Maximum mechanical and climatic protection. Also greatest eye appeal. Whether wax-filled or oil-filled paper, dry or wet electrolytics, or heavy-duty mica, AEROVOX metal-cased condensers denote your bid for longest, most economical and best service, in those better grade radio sets and electronic assemblies.

**DATA** New 1936 Catalog, together with sample copy of monthly Research Worker, sent on request. Submit your condenser and resistor problems for engineering collaboration and quotations.

**AEROVOX**  
CORPORATION

75 Washington St. Brooklyn, N. Y.

# PATENTS REVIEW

**P**ATENTS indicate trends. Next year's radio circuits, applications of electron tubes for non-communication purposes, new tube types, new materials, may be discovered by following United States and British inventions.

## Radio Circuits

**Altimeter.** Electrical waves are radiated from an antenna on an aircraft and are caused to produce reflection of the waves from the earth's surface. The change in the characteristics of the received wave from the transmitted wave is a function of the distance above ground. Stuart Ballantine, RCA. No. 2,020,347.

**Modulation system.** This patent filed Oct. 25, 1920, 44 claims to R. A. Heising, Western Electric Co., Inc., relates

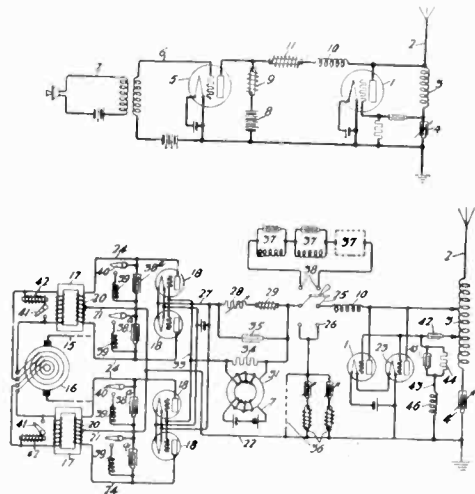

to constant-current method of amplitude modulation. No. 2,018,401.

**Recording method.** A device for obtaining sound from printed impressions on paper of light fluctuations. Morris Grossman, New York, N. Y. No. 2,006,890.

**Volume level control.** In a sound control system, method of controlling sound waves for maintaining the volume level of the amplified pulsations substantially constant, comprising a recorder for receiving and recording the amplified constant volume electrical pulsations, etc. Ferguson Hall, Schenandoah, Iowa. No. 2,004,893.

**Glow discharge circuit.** Method of transforming signals of constant amplitude and variable frequency into signals of variable amplitude comprising an electrode inside the tube and one outside, these electrodes forming a condenser across which signals are impressed. Fritz Schröter, Radio Patents Corp., New York. No. 2,004,587.

**Automatic volume control.** The following patents relate to the general subject of automatic volume control. Re-issue 19,744 to H. A. Wheeler, Hazeltine Corp; 2,012,421, E. T. Dickey, RCA; 2,018,982, Charles Travis, RCA; 2,019,173, K. A. Chittick, RCA; 2,019,243 and 2,010,253 to L. E. Barton, RCA; and 2,020,363 to V. D. Landon, RCA.

**Short wave systems.** No. 2,017,126 to F. H. Kroger on an ultra-short wave relaying communication system. No.

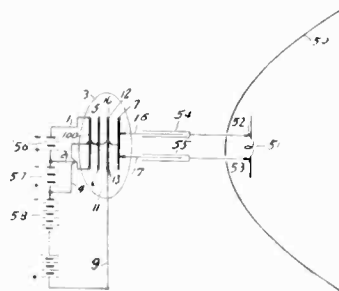

2,020,310 to Ross Gunn, Chevy Chase, Md., on ultra-high frequency generator of the Barkhausen-Kurz type.

**Tone control.** Method of suppressing

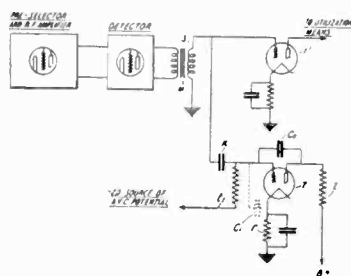

background noises in a radio receiver. J. Yolles, RCA. No. 2,017,270.

**Oscillator.** Short-wave system of the long-line type. C. W. Hansell, RCA. No. 2,017,093.

**Coupling system.** A high frequency system adapted to operate over several frequency ranges, comprising a transformer having at least two secondary coils of different inductance adapted to be coupled to a load circuit, a switch for removing one of the coils from the circuit, etc. N. P. Case, Hazeltine Corp. No. 2,018,545.

**Tone control.** Method of operating a tone control with the sensitivity control of a receiver simultaneously. H. K. Johnson, Hazeltine Corp. No. 2,018,526.

**Phase modulation.** A system for receiving and demodulating oscillations

modulated in phase and in amplitude. M. G. Crosby, RCA. No. 2,019,446.

**Phase detector.** A phase-rotation detector and frequency regulator. George Usselman, RCA. No. 2,018,820.

**A-c d-c system.** Method for obtaining alternating potential of predetermined

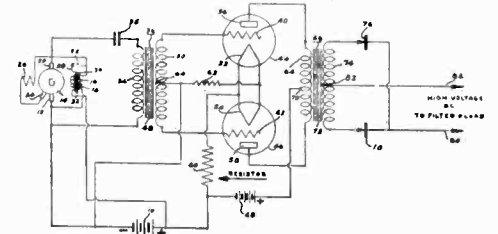

value from a direct current source having a different potential value with a tube means of breaking up the d-c to form an alternating current. F. T. Brewer, General Motors Corp. No. 2,018,483.

**Remote control.** Method of tuning a radio circuit by means of a motor controlled by thyatron tubes. G. L. Beers, RCA. No. 2,020,275.

**Universal-type receiver.** A circuit of the series filament type. R. P. Wuerfel,

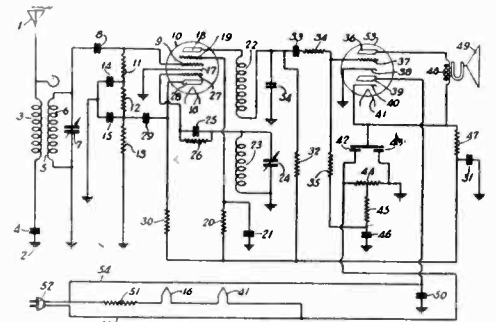

International Research Corp. No. 2,017,085.

## Electron Tube Applications

**Processing apparatus.** Apparatus for testing and classifying condensers, means for subjecting the condensers to a voltage breakdown, an insulation resistance and capacity test, and means

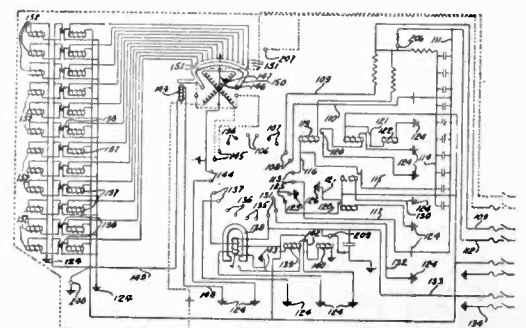

for sorting the condensers according to predetermined limits. C. A. Purdy, Western Electric Co. 37 claims. No. 2,016,455.

# A ray focusing anode material



Aquadag\* Brand colloidal graphite (in water) is now a standard coating on various cathode ray tubes. In its use as a ray focusing anode material, this product has the following four advantages:

1. It is easy to apply.
2. It is economical to use.
3. It adheres equally well to all types of glass.
4. It reduces light reflection because of the dark, matte surface formed on the glass.

Technical Bulletin No. 191B giving detailed information is available gratis on request.

\*Reg. U. S. Pat. Off.

REG. U.S. **dag** PAT. OFF.

COLLOIDAL PRODUCTS

**ACHESON**  
COLLOIDS CORPORATION  
FOUNDED [1908] AS ACHESON OILDAG COMPANY  
PORT HURON • MICHIGAN

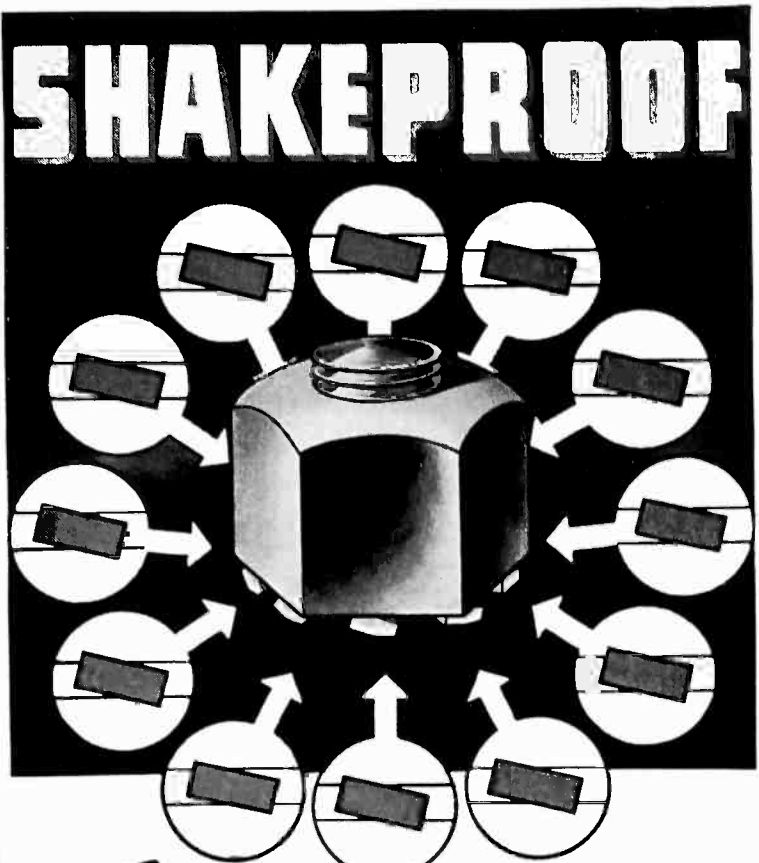

## Locked tight- ALL THE WAY 'ROUND!

If you are anxious to protect the performance of your product from the damaging action of vibration, you should seriously consider using Shakeproof Lock Washers under every nut and screw. This multiple locking washer provides a positive force against any backward movement of the nut which keeps each connection absolutely tight. Each twisted tooth bites into both nut and work surfaces and, as vibration increases, the teeth bite in deeper. Test this modern lock washer on your own product—see its action with your own eyes—send for free testing samples today!

SEND FOR YOUR FREE COPY OF THIS  
**NEW CATALOG**

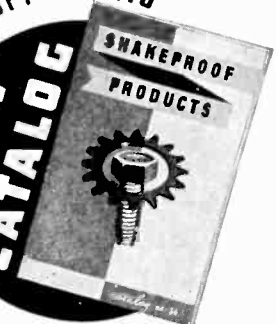

## SHAKEPROOF Lock Washer Company

Distributors of Shakeproof Products  
Manufactured by Illinois Tool Works

2539 N. Keeler Ave.

Chicago, Ill.

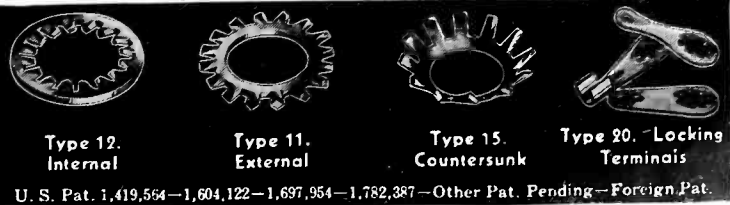

U. S. Pat. 1,419,564—1,604,122—1,697,954—1,782,387—Other Pat. Pending—Foreign Pat.

**Color comparator.** A photo-electric device with light source, comparison material, etc. C. G. Stone and Abraham Edelman, New York, N. Y. No. 2,020,281.

**Distance measuring.** An echo method for measuring distance or depths. R. L. Williams, Submarine Signal Co., No. 2,015,702.

**Color Comparator.** For comparing color and shade characteristics of several specimens, by means of a pair of balanced light-sensitive tubes. C. E. Hays, Pawtucket, Rhode Island, No. 2,015,675.

**Photo-electric system.** Describing the "Petoscope" (see Oct., 1935, *Electronics*) in which photo-sensitive elements are placed behind screens which are divided into transparent opaque portions, so that any motion in front of these screens produces an unbalanced photo-cell output. A. S. Fitz Gerald, Wynnewood, Pa., 27 claims. No. 2,016,036.

**Metals testing.** A portable device for determining the characteristics of a metal piece by comparison with a metal piece of known characteristics, utilizing the cathode ray tube. H. T. Hallowell, Standard Pressed Steel Co., Jenkintown, Pa. No. 2,010,189.

**Position control.** A machine for reproducing on a work blank the contour of a pattern surface for controlling the energization by means of reactance variations. 34 claims, D. J. Stewart and Howard C. Colman, Rockford, Ill., No. 2,013,676.

**Surge responsive device.** Controlling the conductivity of a tube in accordance with the rate of change of a quantity, by actuating a voltage inducing means in response to the rate of change of quantity. F. C. Lindvall, G. E. Co. No. 2,009,114.

**Synchronizing apparatus.** Electron tube method of synchronizing two sources of alternating current. H. T. Seeley, G. E. Co. No. 2,009,097.

**Phase indicator.** Indicating apparatus comprising a gas filled electric discharge type to indicate small phase differences of interconnected systems. D. D. Knowles, WE&M Co. No. 2,018,268.

**Picture transmission.** A scanning system involving a source of light, a scanning disc, etc. J. W. Dalton, London. No. 2,005,130.

**Regenerative system.** Apparatus for photographically recording sound vibrations, comprising a pair of cooperating shutters arranged in advance of the light source, moving toward and away from each other. Bernard Kwartin. No. 2,005,425.

## Oscillating Circuits

**Dynatron.** No. 2,011,290 to P. O. Farnham, and No. 2,011,291 to N. M. Rust, both to RCA.

**Cathode ray tube oscillator.** C. B. Terry, RCA. No. 2,011,920.

**Positive grid oscillator.** Waldemar Ilberg, Telefunken. No. 2,015,523.

**Multi-grid oscillator.** A crystal control circuit. J. K. Clapp, General Radio Co. No. 2,012,497.

**Short wave detector.** H. S. Polin, Port Washington, N. Y. No. 2,011,299.

**Glow tube oscillator.** J. J. Numans, RCA. No. 2,010,881.

**Constant amplitude oscillator.** W. Kautter, Siemens & Halske. No. 2,014,136.

**Electron coupled oscillator.** J. B. Dow, RCA. No. 2,008,690.

**Constant frequency oscillator.** I. F. Byrnes, RCA. No. 2,007,637.

**Long line oscillator.** G. E. Pray, RCA. No. 2,009,069.

**High frequency oscillator.** Circuit in which the anode has dimensions related to the wavelength desired. G. L. Usselman. No. 2,009,368. RCA.

**Generator.** C. W. Hansell, RCA. No. 2,009,369.

**Constant frequency oscillator.** E. L. Koch, Chicago, Ill. No. 2,003,371.

**Positive grid ultra high-frequency oscillator.** N. E. Lindenblad, RCA. No. 2,011,943.

**Magnetic field oscillator.** Werner Weihe, Telefunken. No. 2,013,773.

**Ultra short wave circuit.** A receiver. R. W. George, RCA. No. 2,011,942.

## Patent Suits

1,403,475 (a), H. D. Arnold; 1,403,932, R. H. Wilson; 1,507,016, L. de Forest; 1,507,017, same; 1,702,833, W. S. Lemmon; 1,811,095, H. J. Round; Re. 18,579, Ballantine & Hull; Re. 18,916, J. G. Aceves; 1,618,017, F. Lowenstein; D. C., N. D. Ill., E. Div., Doc. 14254, *Radio Corp. of America et al. v. Arlab Mfg. Co. et al.* Patents held valid and infringed; injunction granted April 15, 1935.

1,403,475 (b) H. D. Arnold; 1,403,932, R. H. Wilson; 1,618,017, F. Lowenstein; 1,702,833, W. S. Lemmon; 1,811,095, H. J. Round; Re. 18,579, Ballantine & Hull; Re. 18,916, J. G. Aceves, D. C., N. D. Ill., E. Div., Doc. 14260, *Radio Corp. of America et al. v. A. Bloomfield*

(*Standard Radio Products Co.*). Patents held valid and infringed; injunction granted April 15, 1935.

1,403,475 (c), H. D. Arnold; 1,403,932, R. H. Wilson; 1,618,017, F. Lowenstein; 1,702,833, W. S. Lemmon; 1,811,095, H. J. Round, D. C., N. D. Ill., E. Div., Doc. 14262, *Radio Corp. of America et al. v. Universal Radio Mfg. Co., Inc. et al.* Decree pro confesso holding patents valid and infringed; injunction granted April 15, 1935.

1,403,475 (d) H. D. Arnold; 1,403,932, R. H. Wilson; 1,618,017, F. Lowenstein; 1,702,833, W. S. Lemmon; 1,811,095, H. J. Round; Re. 18,579, Ballantine & Hull, D. C., N. D. Ill., E. Div., Doc. 14264, *Radio Corp. of America et al. v. D. Krechman et al.* Decree pro confesso holding patents valid and infringed; injunction granted April 15, 1935.

1,507,016, L. de Forest; 1,507,017, same, appeal filed Sept. 16, 1935, C.C.A., Ind. Cir., Doc. *RCA v. F. A. Andrea et al.*

1,251,377, A. W. Hull; 1,297,188, I. Langmuir; 1,573,374, P. A. Chamberlain; 1,707,617, 1,795,214, E. W. Kellogg; 1,894,197, Rice & Kellogg; 1,728,879, same, D. C., N. D. Ill., E. Div., Doc. 14255, *Radio Corp. of America et al. v. Arlab Mfg. Co. et al.* Default decree holding patents valid and infringed; injunction granted Apr. 25, 1935. Doc. 14261, *Radio Corp. of America et al. v. A. Bloomfield (Standard Radio Products Co.)* Decree pro confesso holding patents valid and infringed; injunction granted Apr. 15, 1935. Doc. 14263, *Radio Corp. of America et al. v. Universal Radio Mfg. Co., Inc., et al.* Decree as above. Doc. 14265, *Radio Corp. of America et al. v. D. Krechman et al.* Decree as above.

1,356,763, R. V. Hartley; 1,403,475, H. D. Arnold; 1,520,994, same; 1,403,932, R. H. Wilson; 1,465,332, L. de Forest; 1,507,016, same; 1,507,017, same; 1,936,162, R. A. Heising, filed Aug. 8, 1935, D. C., S. D. Calif. (Los Angeles), Doc. E. 742, *Radio Corp. of America et al. v. Globe Wireless Ltd. et al.*

1,403,475 (a), H. D. Arnold; 1,403,932, R. H. Wilson; 1,507,016, L. de Forest; 1,507,017, same; 1,618,017, F. Lowenstein; 1,702,833, W. S. Lemmon; 1,811,095, H. J. Round; Re. 18,579, Ballantine & Hull, D. C., N. D. Calif. (San Francisco), Doc. E 3897-L, *Radio Corp. of America et al. v. Kahn Dept. Stores, Inc.* Patents held valid and infringed Aug. 5, 1935.

1,403,475 (b), H. D. Arnold; 1,403,932, R. H. Wilson; 1,507,016, L. de Forest; 1,507,017, same; 1,702,833, W. S. Lemmon; Re. 18,579, Ballantine & Hull, D. C., N. D. Calif. (San Francisco), Doc. E 3894-S, *Radio Corp. of America et al. v. C. Silverman.* Patents held valid and infringed Aug. 7, 1935.

1,403,475 (c), H. D. Arnold; 1,403,932, R. H. Wilson; 1,507,016, L. de Forest; 1,507,017, same 1,811,095, H. J. Round; Re. 18,579, Ballantine & Hull, D. C., N. D. Calif. (San Francisco). E 3893-L, *Radio Corp. of America et al. v. Schwabacher-Frey Co.* Patents held valid and infringed Aug. 7, 1935.



## UNIVERSAL TUBE BRIDGE

*For Measurements of*

Amplification Constant  
Mutual Conductance  
Plate Resistance

Of Any Receiving and low-power Transmitting Tube

THESE parameters are measured independently and are selected by a three-position switch. Balance is obtained by adjusting a three-decade attenuator and a variable condenser. At balance, the quantity being measured is read directly to three significant figures. Both positive and negative values of coefficients may be measured.

Appropriate tube sockets for 4, 5, 6, and 7 prong tubes are incorporated in the instrument. Sockets for additional tubes are provided in an external adapter, and terminals for connection to any type of tube are conveniently located on the panel.

A double-range a-c and d-c filament voltmeter and an a-c heater power supply are incorporated in the instrument.

Type 561-C Vacuum Tube Bridge . . . \$375.00

*Write for Circular P-82-E2 for Detailed Information*

**General Radio Company**  
Cambridge Massachusetts



THESE Ward Leonard Controlled Rectifiers, without moving parts, offer a most economical means of providing direct current from alternating current supply. They operate with little electrical and no mechanical loss. They require no maintenance. Here is the device you have been looking for to operate your DC equipment from AC cur-

rent where voltage control is a factor. Send for particulars.

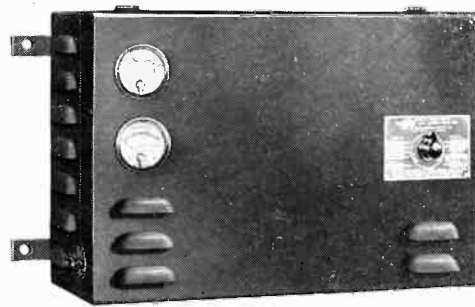

CONTROLLED RECTIFIERS for communication, laboratory and similar uses requiring a constant DC voltage with varying loads.



SEND FOR DESCRIPTIVE BULLETIN Bulletin 8601 describes the Ward Leonard Controlled Rectifier, gives efficiencies and other technical data. Send for a copy.

## WARD LEONARD RELAYS - RESISTORS - RHEOSTATS

WARD LEONARD ELECTRIC CO.  
32 South Street, Mount Vernon, N. Y.

Please send me your bulletin No. 8601.

Name .....

Company .....

Street .....

City and State .....

# British Patents

## Radio Circuits

**Q-a-v-c system.** Method for suppression of noise and undesired signals when tuning from one preselected transmission channel to another by disabling the receiver which is automatically restored to normal transmission only when the tuning means is set

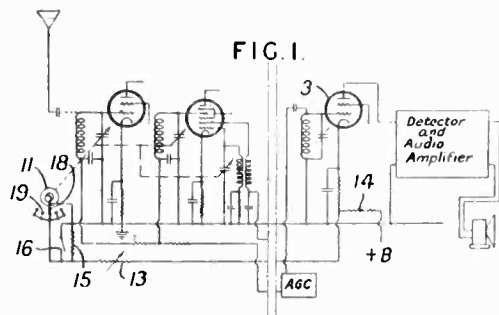

to position corresponding to the carrier frequencies of the desired channels. R. F. L., Inc. No. 431,702.

**Improving selectivity.** A modulated carrier receiver includes two carrier frequency channels of different selectivity, one of which operates to change the selectivity of the receiver as a whole as a function of the incoming signal strength. Marconi Co. No. 431,755.

**Noise suppression.** Positive grid bias is applied through an associated inductance to a carrier frequency tube in a receiver provided with A.V.C., to obtain interchannel noise suppression. C. R. L. Barrett. No. 432,135.

**Oscillator.** A tube oscillator has its frequency maintained constant by the use of a tube having a high filament emission, which is reduced to the current required for the production of oscillations by provision of a grid adjacent to the cathode and held at a negative fixed voltage. P. D. Tyers, Herts, England. No. 432,426.

**Distortion prevention.** A low frequency amplifier, particularly of the mains-driven type, where the resistance of the input circuit causes a shift in grid-bias potential when grid current flows, the grid potentiometer is shunted by a neon lamp or auxiliary tube designed to maintain the biasing-potential constant. J. J. Numans, The Hague, Holland. No. 432,618.

**High frequency detector.** Method of increasing the efficiency of a tube detector for short-wavelength detection, below 10 meters particularly, by means of a grid-leak or choke of the order of  $10^4$  ohms in connection with a positive bias of 5 volts. The object is to increase the speed of the electron stream inside the tube. M. von Ardenne. No. 432,728.

**Iron core circuits.** To facilitate the ganging of high-frequency circuits comprising inductances with ferromagnetic cores, the polarizing effect of the d-c component of the tube anode current is eliminated by superimposing the effect of an equal current of opposite sense so that the polarization of the core is zero. One method is to use high frequency stages in push-pull. Another is to provide the high frequency transformers with a third winding fed with current from some part of the high-tension supply circuit. Marconi Co., No. 427,114.

**A.v.c. system.** The signal is rectified and the d-c component of the voltage produced is amplified and applied to effect the gain control through a second rectifier, the first rectifier being also the signal demodulator and biased to effect inter-channel noise suppression, while the second rectifier is biased to delay the application of the control potential until the signal reaches a predetermined amplitude. L. E. Barton, Marconi Co., No. 427,629. See also No. 427,650 to C. Travis, Marconi Co.

**High frequency circuit.** Method of supplying voltages for the grid and plate of an ultra-short-wave oscillator or detector of the vibrating electron type which are derived from a potentiometer across the supply source in such a manner that variations in sup-

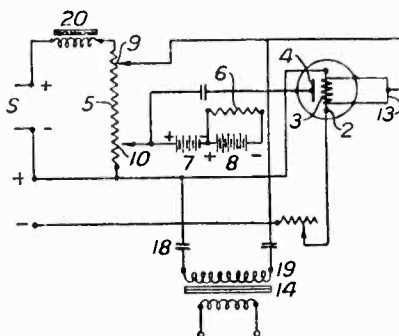

ply voltage do not affect the frequency of oscillation, but affect the output linearly. Standard Telephones. No. 432,781.

**Position determination.** The position of a moving craft is determined relatively to one or more fixed radio beacons by measuring the apparent change in the frequency of the received wave, due to the Doppler effect, on a cathode-ray-tube indicator mounted on the craft. Explorator, Switzerland. No. 432,790.

**A.V.C. circuit.** In a receiver in which a carrier frequency tube feeds a demodulator which is rendered inoperative for signals of below a predetermined amplitude by a potential derived from a subsequent low frequency amplifier whose impedance is dependent

on a signal-supplied muting diode, voltage for A.V.C. is derived from the cathode circuit of said carrier frequency tube. E. K. Cole. No. 433,164.

**Remote tuning.** The tuning capacity is reflected into a transmission line. Majestic Electric Co., No. 425,594.

**Automatic tuning.** A motor driving scheme with automatic means to stop or disconnect the motor on reception of a carrier exceeding a predetermined strength. L. H. Brown, London, No. 425,626.

**Short-wave oscillator.** A magnetron with its oscillatory circuit coupled to the receiving aerial, with an auxiliary self-modulating circuit whereby the oscillator may be employed for modulated transmission or for super-regenerative reception. Compagnie Generale de Telegraphie Sans Fil. No. 433,427.

**Directive signalling.** The field characteristic of a fixed aerial system is automatically modified or conditioned so as to maintain the principal lobe always directed upon a given station in spite of permanent or periodic changes in the direction of the signal wave-front. The desired result is secured by electrically or mechanically maintaining a predetermined relation between the phases of the aerial voltages before they are fed to the receiver. Standard Telephones. No. 433,843.

**Oscillator circuit.** Preventing load variations from affecting the frequency of a tube oscillator feeding an amplifier in which a magnetic coupling is used in the oscillator and capacity coupling for coupling the oscillator to the amplifier. Lorenz. No. 433,924.

**Ultra short wave circuit.** The carrier-wave from a Barkhausen-Kurz generator is modulated at constant frequency by a relaxation-oscillation circuit, comprising a glow-discharge tube and a tuned circuit in series with a condenser. Telefunken. No. 434,326. See also No. 434,638 to Pintsch Akt., Ger-

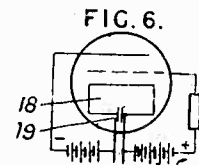
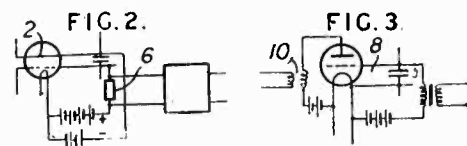

many, on means for increasing the rectifying efficiency and amplification factor of a Barkhausen-Kurz tube.

**A.V.C. circuit.** Delayed A.V.C. voltages are derived from the grid current of a detector-amplifier tube in which no grid current flows until the applied signal exceeds a certain value. J. A. Robinson, Bronx, N. Y. No. 434,299.

# Smooth Control—

with the

## AmerTran Voltage Regulator

The  
Patented  
Transformer  
Commutator  
Type

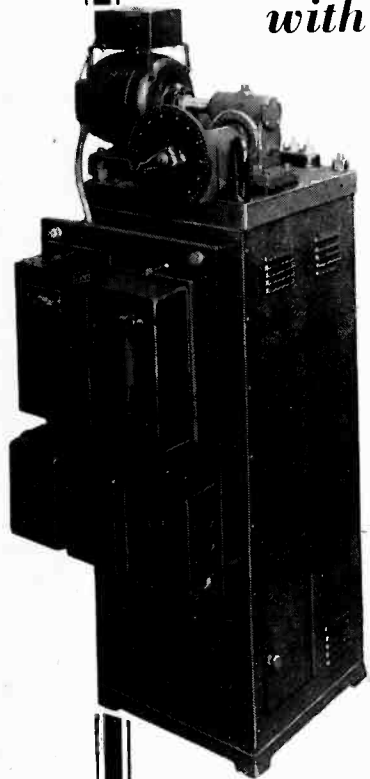

**T**HE AmerTran Voltage Regulator is ideally suited to broadcast station requirements. It may be used to permit reduction of power without interrupting the program and as a feeder regulator to maintain the line voltage at the desired value. Hand-operated, motor-operated, and fully-automatic types are available in sizes from 0.25 to 200 Kva. capacity.

The transformer-commutator regulator is an exclusive AmerTran development. It equals a transformer in efficiency and the induction regulator in smoothness of control. It has no effect upon power factor, does not distort the wave, and has low exciting current. Types can be furnished for use on single- or three-phase circuits and for 100% regulation of the secondary voltage, if required.

We welcome the opportunity of sending information on all types of regulators and transformers used in broadcasting.



### TRANSFORMERS

Manufactured Since 1901 by—  
AMERICAN TRANSFORMER COMPANY  
172 Emmet St. Newark, N. J.



ACCURACY  
GUARANTEED  
WITHIN 2%

PRECISION  
WITHOUT  
EXTRAVAGANCE

MODEL 223 D.C.

### O-1 MILLIAMMETER

Dimensions, body  $2\frac{1}{8}$ " diam.; Flange  $2\frac{5}{16}$ "; Body depth  $1\frac{1}{4}$ ". Metal Case clamp-on type.

Here is shown a 2" instrument—just one of Triplet's large line of instruments. Made in Bakelite and metal cases. D.C. instrument is the moving coil type, A.C. is an outstanding design movable iron repulsion type. Accuracy guaranteed within 2%.

### TRIPLETT MANUFACTURES

a complete line of all sizes and styles electrical measuring instruments for radio, electrical and general industrial purposes both standard and custom built. See them at your jobbers. If you have an electrical instrument problem write to TRIPLETT.

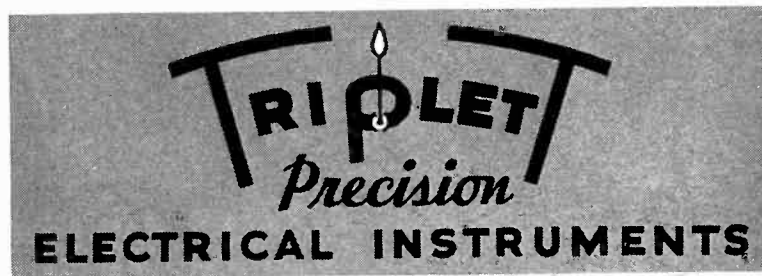

### MAIL THIS COUPON!

TRIPLETT ELECTRICAL INSTRUMENT COMPANY  
231 Harmon Drive, Bluffton, Ohio

Please send me your new 1936 Catalogue

Name .....

Address .....

City ..... State .....

## Tube Applications

**Inspection circuits.** To detect the presence of foreign bodies on the bottoms of transparent vessels, a light-sensitive cell receives light passing through the bottom of the vessel and an apertured screen moving relatively thereto, the aperture being small compared with the area of the cell. N. P. Stoate. No. 425,602.

**Telemetering system.** Signalling impulses are produced by a photocell. The tube is enclosed in a casing having a slot of less width than that of the slots of the interrupting disc so that square-fronted light impulses are transmitted to the tube. G.E. Co. No. 426,144.

**Interval timer.** Current impulses of accurately timed short periods are obtained in a circuit by employing one or more grid-controlled rectifier tubes energized from an a-c source and each having a bias potential on the grid, which is removed to permit it to conduct for the required periods by the charging current of a condenser flowing through a resistance of predetermined value. British Thomson-Houston Co. No. 426,201.

**Automatic voting machine.** The voters are provided with keys or other selectable means which determine the amount of electric energy supplied to a meter furnished with means for adjusting the scale to bring the reading equivalent to all voters registering their votes to 100. Consequently when the question is put and those in favor vote, the instrument will give the result as a percentage. Projectors direct energy at the audience, the individuals of which are provided with hand reflectors by means of which they may influence light-sensitive cells, thermocouples, etc., mounted at the foci of the parabolic mirror and connected by wire with an amplifier and with a meter disposed in a projector to throw the results upon a screen. If infra-red rays are used, the individuals are provided with discs black on one side and covered with gold or bronze on the other. N. M. Hopkins, 111 E. 10th St., New York, N. Y. No. 427,400.

**Motion detector.** A gaseous discharge tube has a voltage on the grid induced on it by an electrostatic field which suppresses the discharge. The resistance leak is connected between the grid and the main electrode, preferably the cathode. On the approach of an object to be detected, the field is distorted and the discharge is initiated. H. J. Spanner, New York, N. Y. No. 427,785.

**Directive signalling.** In a device for automatically steering an airplane or other craft in such a way as to offset the effective wind drift and follow the shortest path to a radio beacon, a non-

linear resistance is used to produce a current indicative of the position of the directive frame aerial. British Thomson-Houston Co. No. 428,212.

**Exposure meter.** Method of varying the amount of light admitted to a light-sensitive cell forming part of a photographic exposure meter. O. Riszdorfer, Budapest. No. 428,776.

**Altimeter.** An airplane approaching a landing field along a radio guide line is given an indication of its height and distance by two vertical beams of different wavelengths, or differently modulated, which affect glow lamps in the plate circuit of a radio receiver carried on the plane. Telefunken. No. 429,001.

**Vehicle lighting system.** Parking lights are switched on automatically when daylight illumination falls below a certain value by a photocell of the current generating type operating a switch associated with a relay. Weston Electrical Instrument Corp. No. 430,864.

## Radio Circuits

**High-frequency transmission.** Signals are transmitted, preferably on micro-waves, by using a body of ionized gas situated in a magnetic field to vary the plane of polarization of the emitted wave. I. Wolff and E. G. Linder, Marconi Co. No. 433,842.

**Automatic tuning system.** A receiver in which the tuning is effected automatically by the incoming signal. Tuning control is rendered inoperative when the receiver is tuned to a broadcast carrier wave, whether modulated or not, and remains inoperative until the control is initiated by an operator. A. W. Stapleton. No. 433,298.

**Wide-band amplifier.** Use of discharge tubes having a magnetic field parallel with the cathode, the output electrode of one stage being directly connected to the input of the stage succeeding. C. W. Hansell. No. 433,346.

**High-frequency transmission line.** This patent relates to low-loss couplings between transmission lines carrying ultra high-frequency currents. They are of two types, the closed line comprising two concentric conductors and an open line comprising two strip or wire conductors, the juncture being surrounded by a cylindrical screen to prevent local radiation. No. 433,681.

**Interstage circuit.** Circuit for muting grid for interchannel noise suppression, fading an amplifier from one audio frequency source to another, or for automatic tone control to reduce the amplification of the higher audio frequency when receiving weak signals. C. Travis, Marconi Co. No. 433,837.

## Television

**Cathode ray transmitter.** The intensity of the cathode ray is varied to yield carrier frequency, synchronizing signals, and control of the average brightness of the picture. Marconi Co. No. 426,672.

**Scanning system.** When the two sets of electric oscillations applied for deflecting the cathode ray in directions at right angles are each of constant amplitude, the ray scans a keystone-shaped area in a plane perpendicular to an axis defining the mean direction of the ray and so a rectangular area on a screen inclined to this axis, with the object of avoiding distortion of the picture due to the inclination of the screen. A. W. Vance, Marconi Co. No. 427,113.

## Patent Suits

1,271,529, M. C. Hopkins, Acoustic device, D. C. Pa. (Philadelphia), Doc. 5751, *Lektophone Corp. v. Sears, Roebuck & Co.* Dismissed Sept. 20, 1935.

1,769,851, I. Nachumsohn, Radio apparatus, D. C., N. D. Ill., E. Div., Doc. 14078, *I. Nachumsohn v. The Crosley Distributing Corp.* Dismissed without prejudice June 17, 1935.

1,756,000, J. M. Miller, Piezo-electric oscillation generator, C. C. A., 3d Cir., Doc. 5581, *J. M. Miller v. National Broadcasting Co.* Decree affirmed Sept. 25, 1935.

1,789,949, A. Georgiev, Electrolytic cell, D. C., S. D. N. Y., Doc. E 59/174, *Aerovox Wireless Corp. v. Mayo Laboratories, Inc.* Dismissed for lack of prosecution (notice Oct. 8, 1935).

1,297,188, I. Langmuir, System for amplifying variable currents, filed Oct. 17, 1935, D. C., E. D. N. Y., Doc. E 7780, *General Electric Co. v. A. Levine et al.*

1,405,523, M. C. Latour, Audion or lamp relay or amplifying apparatus, D. C., S. D. N. Y., Doc. E 72 386, *Latour Corp. v. L. Lang (Lang Radio Co.)*. Consent order of discontinuance without prejudice (notice Oct. 28, 1935).

## Adjudicated Patents

(C. C. A. N. Y.) Hazeltine patent, No. 1,648,808, for wave signaling system, claim 19 *Held* invalid. *Hazeltine Corporation v. Sears, Roebuck & Co.*, 79 F (2d) 238.

(C. C. A. N. Y.) Hazeltine patent, No. 1,755,114, for unicontrol signaling system, claims 12, 14, 16, 17, 19, 23, and 24 *Held* invalid, but in any event were not infringed. *Id.*

(C. C. A. N. Y.) Hazeltine patent, No. 1,755,115, for variable condenser, claims 1, 2, 3, 8, and 9 *Held* invalid, but in any event were not infringed. *Id.*

(C. C. A. N. Y.) Wheeler patent, No. 1,879,863, for volume control, claims 1, 5, 6, and 10 *Held* invalid. *Hazeltine Corporation v. Abrams*, 79 F. (2d) 329.



A better  
**GETTER**  
because of the  
**EXPERIENCE**  
behind it

The kind of experience offered by King Laboratories is based on specialization in research and development on just one product—the vacuum tube "GETTER."

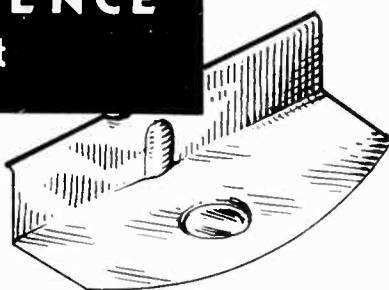

The perfection of BAREX Embedded Getters has been achieved through performance in service involving millions of vacuum tubes. Complete vaporization without splash—minimum shrinkage, and increased production of superior quality vacuum tubes, can be depended on to reduce tube costs.

Leading manufacturers are now using our new BAREX Embedded Getter designed especially for the metal tube—a Getter developed after months of research and backed by our specialized experience.

**KING LABORATORIES, Inc.**  
205 ONEIDA STREET  
SYRACUSE . . . NEW YORK

*The NEW*  
**BAREX Embedded GETTER**

*Two Accurate RCA Test Instruments*  
**AT A PRICE YOU CAN PAY**

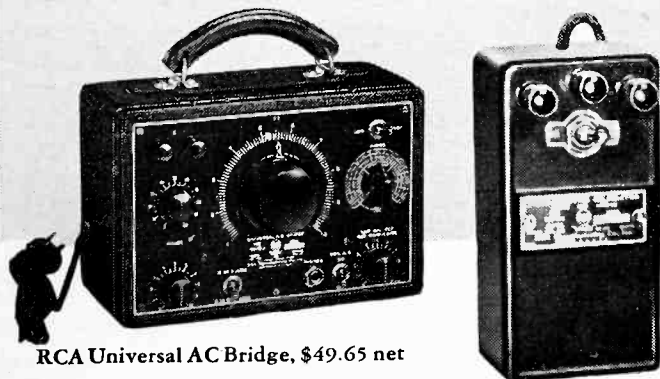

RCA Universal AC Bridge, \$49.65 net

RCA Piezo-Electric Calibrator, \$29.95 net

RCA AC Bridge offers quick and accurate measurement of inductance (100 microhenries to 10 henries); capacity (10 micro-microfarads to 10 microfarads); and resistance, (1 ohm to 1 megohm) at 1,000 c. p. s. Accuracy is 5% overall at full scale. Price includes tubes, standards, power supply, everything except headphones used as null indicator.

Crystal Calibrator checks frequencies from 100 to 50,000 kc. with an accuracy of 2 parts in 1,000,000. Crystal included has modes at 100 and 1000 kc.

Write RCA Parts Division for complete descriptions of these remarkably accurate though low-priced instruments.



**RCA Manufacturing Co., Inc.**  
Camden, N. J. A subsidiary of the  
RADIO CORPORATION OF AMERICA

**AN OUTSTANDING  
COMBINATION . . .**

[1]

Type 148  
Cathode Ray  
Oscillograph



List Price with 3" tube—\$94.50  
List Price with 5" tube—\$106.50

This instrument features a *basically new sweep* which allows waves from 10 to 500,000 cycles to be observed with improved linearity and exceptionally fast return trace.

Another feature, contributing to outstanding performance is an *Improved Synchronizing Circuit* permitting locking sweep with fractions as well as multiples of wave.

In addition, a *Cascade Amplifier* is offered which gives 1 inch deflection with a .2 volt signal—a *Single Knob* controls all switching—a *Patented Calibrated Scale* with 5 inch DuMont cathode ray tube—and the unit is *completely A. C. operated.*

[2]

The NEW  
MODEL 150  
SIMPLIFIED  
ELECTRONIC  
SWITCH



List Price—complete with tubes—\$42.50

lograph or any other commercial Oscillograph—vastly increases the value of the Oscillograph.

It permits simultaneous observation of any two voltages or current phenomena—can be used to inspect and compare wave form or phase of two voltages or currents from different parts of the same circuit—compare waveform of a standard wave with any other wave—can be applied to a timing wave in conjunction with the wave under observation—and for many other useful applications.

Unit is self-contained and operates from 110-120 volt 60 cycle circuit. Controls are provided for adjusting gain of amplifiers for varying the speed of switching.

Frequency Range 10-500,000 cycles per second.

Gain of Amplifier in Audio Frequencies—40.

Power consumption—30 watts.

*Write for complete data on these  
two outstanding instruments.*

**ALLEN B. DUMONT  
LABORATORIES, INC.**

UPPER MONTCLAIR

NEW JERSEY

# Measurement techniques and measurement equipment

for the problems encountered by the radio engineer

Here is a full engineering discussion of measurements in radio engineering, combining the service to the reader of selecting those methods that are most to be recommended for all practical reasons, with that of giving complete information needed to understand the equipment and techniques of applying these methods.



Just published

## Measurements in Radio Engineering

by **FREDERICK EMMONS TERMAN**  
Associate Professor of Electrical Engineering, Stanford University  
400 pages, 6 x 9, 208 illustrations, \$4.00

**T**HIS book provides a comprehensive engineering discussion of the measuring problems commonly encountered by radio engineers. The method of treatment, the practical approach, the completeness of the book make it particularly adaptable to the needs of practicing engineers. The book, while complete in itself, is in a sense a complement to the author's Radio Engineering, supplementing the general principles presented in that volume with a treatment, on the same engineering level, of measuring methods and measuring apparatus.

### Important Features

- gives considerable attention to the principles involved in design and construction of laboratory equipment, to facilitate its construction by experimenter where commercial apparatus is expensive or unavailable.
- emphasizes methods which experience has shown to be the most practical, require the minimum of equipment, and are least likely of error.

**Contents:** 1. Voltage, Current, and Power. 2. Circuit Constants at Low Frequencies. 3. Circuit Constants at Radio Frequencies. 4. Resistance, Inductance, and Capacity Devices. 5. Measurement of Frequency. 6. Wave Form and Phase. 7. Vacuum-tube Characteristics. 8. Audio-frequency Amplification. 9. Receiver Measurement. 10. Oscillator, Power-Amplifier, and Modulation Measurements. 11. Measurements on Radio Waves, Antennas, and Transmission Lines. 12. Laboratory Oscillators. 13. Cathode-ray Tubes. 14. Miscellaneous.

Examine this new book for 10 days

### McGraw-Hill ON-APPROVAL COUPON

McGraw-Hill Book Co., 330 W. 42d St., N. Y. C.  
Send me Terman—Measurements in Radio Engineering for 10 days' examination, on approval. In 10 days I will pay \$4.00 plus a few cents for postage and delivery, or return book postpaid. (We pay postage on orders accompanied by remittance.)

Name .....

Address .....

City and State .....

Position .....

Company ..... L. 1-36  
(Books sent on approval in U. S. and Canada only.)

## PROCTOR Piezo Reproducer

### High Fidelity Records Require a Modern, Wide Range, High Fidelity Pickup

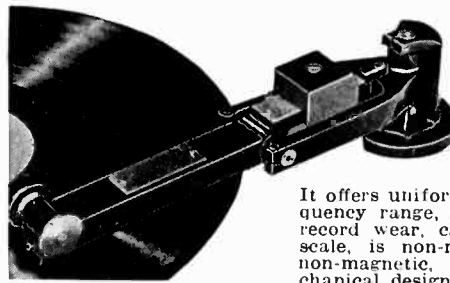

Leading Broadcasting Stations and Sound Studios are today making every link in their wide range equipment complete—by installing the Proctor Pickup.

It offers uniform response, extended frequency range, high and low, minimum record wear, calibrated needle pressure scale, is non-resonant, freely damped, non-magnetic, and unequalled in mechanical design and construction. Reasonably priced. Write for Bulletin E-2

B. A. Proctor Co., Inc., 17 West 60th St., New York, N. Y.  
Designers and Manufacturers of Sound and Recording Equipment.

## DYNAMIC (MOVING COIL) MICROPHONES

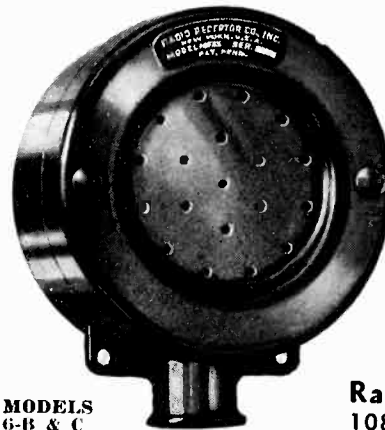

The high sensitivity of these microphones reduces amplifier cost, parasitic and tube noises.

MODEL 6-A—especially designed for studio broadcasting and recording work.

MODEL 6-B—for remote pickup and public address work.

MODEL 6-C—for amateur use and low-priced public address equipment.

List price \$30.00 and up. Send for complete descriptive literature and ask us to quote on your requirements.

MODELS 6-B & C

Radio Receptor Co. Inc.  
108 7th Ave., N. Y. C., U.S.A.

## GOOD SOLDER

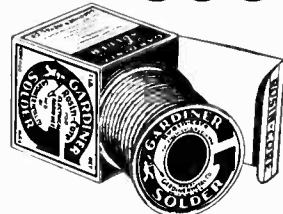

assures satisfactory results—spending valuable time and labor with inferior solder is poor economy.

Gardiner Rosin-Core Solder is made only of the best materials with the most exacting care and is always of uniform high quality. Even the most inexperienced help can do better and neater soldering with Gardiner Solder.

Made in various alloys and core sizes and in gauges as small as 1/32 of an inch.

And due to modern production methods Gardiner Solder actually costs less than even ordinary solder.

Available in 1, 5 and 20-lb. spools.

We will be glad to submit samples to your specifications.



4834 So. Campbell Ave., Chicago, Ill.

## A TRIAL WILL CONVINC YOU

30 Years' Experience  
Insures Dependability

We Manufacture

PERMANENT MAGNETS TOOLS and DIES  
METAL STAMPINGS LAMINATIONS

## THOMAS & SKINNER STEEL PRODUCTS CO.

23d St. at Alford

Indianapolis, Ind.

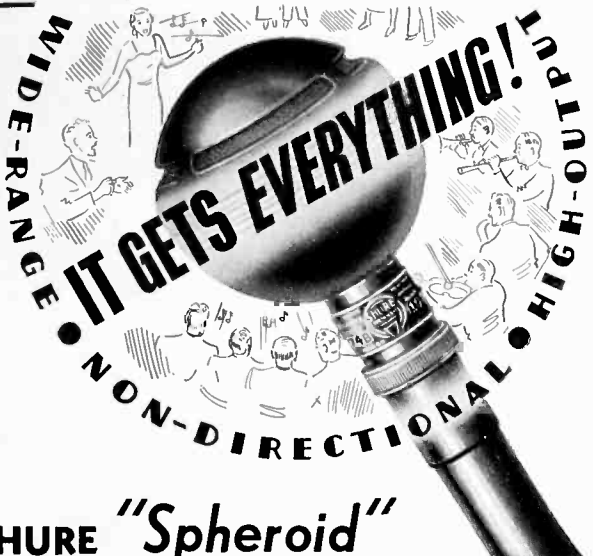

**SHURE "Spheroid"  
CRYSTAL MICROPHONE**

MODEL  
74B

• You won't be worried by the artist who "won't stay put" . . . or the chorus that can't be grouped compactly . . . or a hundred-and-one other troublesome pick-up problems . . . if you have a SHURE Model 74B "Spheroid." This "all-around" crystal microphone provides high-quality non-directional wide-range reproduction from every angle . . . and it lists at only \$37.50. Write today for Bulletin 134M!

*Licensed under patents of the Brush Development Company. Shure patents pending.*

**SHURE MICROPHONES**  
SHURE BROTHERS • MICROPHONE HEADQUARTERS  
215 WEST HURON STREET • CHICAGO, U. S. A.

<b>TUNGSTEN</b> ROD, SHEET, WIRE AND RIBBON SPECIAL SHAPES FORMED PARTS HEATER WIRE HOOK WIRE TUNGSTEN MOLY ALLOYS FOR LAMPS	<b>MOLYBDENUM</b> ROD, SHEET, WIRE AND RIBBON SPECIAL SHAPES FORMED PARTS GRID WIRE HOOK WIRE MOLY TUNGSTEN ALLOYS AND	<b>KULGRID</b> GRIDS (Round and Flat) KULGRID "C" TUNGSTEN WELDS RADIO TUBES
---	---	---

**CALLITE PRODUCTS COMPANY**  
540 39th STREET UNION CITY, N. J.

**ELECTRONICS**  
circulation hits new high

Preliminary figures indicate average total distribution for

First 6 months of 1935 . . . . . 7165  
Last 6 months of 1935 . . . . . 8328

—an increase of 16.2% which boosts ELECTRONICS circulation to a new high record.

**ELECTRONICS**  
A McGraw-Hill Publication

330 West 42nd St. New York, N. Y.



**GREEN  
SEAL**

*Look for the name . . .*

**P R E S T O**

*The Disc Acclaimed by  
Engineers Everywhere*

*And the reason that sound engineers are acclaiming this remarkable disc, is very simple:*

Its extremely pliable super-sensitive surface, is answering a need that has long been felt in the sound reproduction field. In combining versatility in operation, with mechanical strength, Presto engineers have produced a disc that is more than "just as good."

*Get the details immediately—or better still write for a sample and convince yourself.*

**RECORDING EQUIPMENT IN ITS  
MOST CONVENIENT FORM**



**PRESTO INSTANTANEOUS RECORDER**

The Presto Instantaneous Recorder—long recognized by the field for its compactness—handy portability and utility and constant high fidelity characteristics has achieved new heights during 1935.

Specified as standard studio equipment by the leading broadcast stations, and transcription laboratories.

EVERYTHING FOR RECORDING FROM A NEEDLE TO A COMPLETE STUDIO INSTALLATION

*Consult with our engineering department regarding your recording difficulties. Descriptive literature available upon request.*

ALL PRESTO EQUIPMENT UNCONDITIONALLY GUARANTEED.

California Distributor: Norman B. Neely, 1656 North Serrano St., Los Angeles, Calif.

**PRESTO**  
RECORDING CORPORATION  
139 West 19th Street, New York, N. Y.

Now—a high-powered—

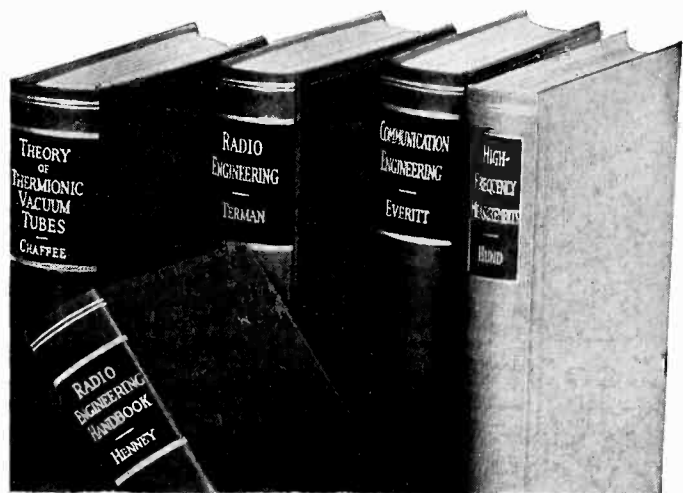

## Radio Engineering Library

- especially selected by radio specialists of McGraw-Hill publications
- to give most complete, dependable coverage of facts needed by all whose fields are grounded on radio fundamentals
- available at a special price and terms.

THESE books cover circuit phenomena, tube theory, networks, measurements, and other subjects—give specialized treatment of all fields of practical design and application. They are books of recognized position in the literature—books you will refer to and be referred to often. If you are practical designer, researcher or engineer in any field based on radio, you want these books for the help they give in hundreds of problems throughout the whole field of radio engineering.

**5 volumes, 2981 pages, 2000 illustrations**

1. Everitt's COMMUNICATION ENGINEERING
2. Terman's RADIO ENGINEERING
3. Chaffee's THEORY OF THERMIONIC VACUUM TUBES
4. Hund's HIGH-FREQUENCY MEASUREMENTS
5. Henney's RADIO ENGINEERING HANDBOOK

*Special low price and easy terms*

Bought singly, the five volumes comprising this library would cost you \$26.00. Under this offer you save \$2.50 and in addition have the privilege of paying in easy installments beginning with \$2.50, 10 days after receipt of the books, and \$3.00 monthly thereafter. Already these books are recognized as standard works that you are bound to require sooner or later. Take advantage of these convenient terms to add them to your library now.

**ON-APPROVAL COUPON**

McGraw-Hill Book Company, Inc.  
330 West 42d Street, New York, N. Y.

Send the Radio Engineering Library (5 volumes) for 10 days' examination on approval. In 10 days I will send \$2.50, plus few cents postage, and \$3.00 monthly until \$23.50 has been paid, or return books postpaid. (We pay postage on orders accompanied by remittance of first installment.)

Signed .....

Address .....

City and State .....

Official Position .....

Name of Company .....

(Books sent on approval in U. S. and Canada only.) L. 1-36

# Candohms

ARMoured WIRE WOUND RESISTORS  
OVER ELEVEN  
MILLION IN USE

MAY WE SAMPLE  
AND QUOTE?

**MUTER**

**THE MUTER COMPANY**  
1255 SO. MICHIGAN AVE., CHICAGO

**HOYT  
METERS**

FOR  
PRODUCTION  
JIGS

ACCURATE  
RELIABLE  
INEXPENSIVE

**BURTON-ROGERS**  
755 BOYLSTON ST.  
BOSTON, MASS.

SALES DIVISION OF HOYT  
ELECTRICAL INST. WORKS

# ARISTON Speakers

Our aim is to make a quality speaker of careful design and manufacture, whose performance is the best. A sample made to your specifications is available upon request.

**ARISTON MFG. CORP.,**  
4049-59 DIVERSEY AVE., CHICAGO, ILL.

## HI-POWER FOR PORTABLE SOUND EQUIPMENT

The Carter GENEMOTOR supplies the most reliable and economical "B" Power for Class A or B Amplifiers from a 6 or 12 volt battery. Output up to 500 volts. Sturdy — Compact — Quiet in operation — Requires no oiling — Guaranteed. Also can be supplied for A.C. output.

Write for Circular  
**CARTER MOTOR CO.**  
365 W. Superior St., Chicago

# The "Q" METER

TYPE 100-A

... for high speed, accurate measurement of COILS, CONDENSERS, RESISTORS and other COMPONENTS at radio frequencies.



The "Q" Meter is in wide and constant use by most of the leading manufacturers of receivers, coils, condensers, vacuum tubes, etc. Price \$445.00 F.O.B. Boonton, N. J.

This modern high speed instrument furnishes the means of measuring and designing efficient coils, condensers, and other components over a wide range of radio frequencies.

Every engineer wants one of these completely contained instrument for measuring "Q"; every progressive radio manufacturer needs the Q-Meter to reduce production costs to a point where he can successfully meet competition.

Write for full details and specifications of this outstanding contribution to the field of radio frequency measuring equipment. Send for 4-page bulletin giving complete information.



BOONTON RADIO CORPORATION  
Boonton, New Jersey

## ELECTRICAL INSULATION



... Varnished Cloth, Tapes, Silks and Papers



... Plates, Segments, Rings, Tapes, Tubes, Washers



... Laminated Bakelite Fabricated Parts, Sheets, Rods and Tubes



... Untreated Papers, Linen and Silk Tapes, Varnishes, Fibre, Spaghetti Tubing, Cotton Sleaving, etc.

RAW MICA, Uncut blocks, or cut to size.

MICA SHAPES

200 Varick Street, New York; 542 So. Dearborn Street, Chicago; 1276 W. 3rd St., Cleveland. Branches at: Birmingham, Boston, Cincinnati, Los Angeles, San Francisco, Seattle, Montreal, Toronto.

**MICA INSULATOR CO.**

New

## REMLER AP3-18

MODERNIZES REMOTE PICK-UPS



- High Gain
- High Fidelity
- Compact
- Portable
- No Batteries
- Attractive
- Moderate Price

High gain Remote Amplifier and Power Supply, designed for use with three Dynamic, Velocity or Inductor microphones and also in a type for operation with the above in combination with condenser microphones. Compact, high fidelity system incorporating refinements ordinarily associated with studio equipment. Three channel input with individual attenuators and master gain control. Feeds two broadcast loops simultaneously. 50 or 200 ohm input units connected by 6' cable and lock-type plugs. AC or battery operation. Overall gain 95 DB. Tubes 2-77; 1-79; 1-6A6 and 1-80. Used and endorsed by leading broadcast stations. Write for catalogue sheets. List price \$365.00.

REMLER COMPANY, Ltd.

2101 Bryant Street

San Francisco, Calif.

**REMLER—THE RADIO FIRM AS OLD AS RADIO**

# 25 TIME-TESTED TRANSMITTING TUBES



Type		Price
303A	*130 Watts	\$15.00
304A	*350 "	97.50
310	* 25 "	5.75
311	*130 "	17.50
311C	*130 "	17.50
312D	*250 "	75.00
361A	*130 "	17.50
376A	*130 "	17.50
930	* 40 "	8.75
930B	* 60 "	10.00
938	*130 "	18.00
941	* 25 "	5.75
942	Audio	5.75
945	Audio	17.50
949	*500 Watts	160.00
951	*1250 "	350.00
952	*165 "	16.40
911CH	*150 "	19.50
317C	Vacuum Rectifier	20.00
966	Mercury Rectifier	2.25
966A	" "	5.00
972	" "	15.00
972A	" "	16.50
967	" "	14.00
973	" "	25.00

\*Nominal RF Power Output.

Consult your Dealer or write direct to—

## UNITED ELECTRONICS CO.

42 SPRING ST., NEWARK, N.J.



Diamond Vulcanized Fibre is a hard, tough, pliable insulating material made in sheets, rods, tubes and parts fabricated to specifications. It combines exceptionally high electrical insulating properties with great mechanical strength—and is economical. Let us send you a copy of the Diamond Vulcanized Fibre catalog, which tells of thousands of applications in every industry.

CONTINENTAL-DIAMOND FIBRE CO., Newark, Delaware

# DIAMOND FIBRE

**GUTHMAN Coils**

Guthman Coils are dependable, guaranteed to be exactly according to specifications, within the tolerances you demand. Let us submit samples and quote on your requirements. Prices are extremely favorable.

**EDWIN I. GUTHMAN and CO., Inc.**  
1036 West Van Buren St., CHICAGO, ILLINOIS

... offers you a specialized service on

**NEACO**

- NEACO Electrical Cords with Rubber Plugs
- Rubber and Shielded Lead-Ins
- Harnesses of All Types
- Push Backs

Specialization on the production of all types of cord assemblies and harnesses to insure you a prompt and economical source of supply for this type of material.

A dependable service used by leading manufacturers. You can use "NEACO" specialization to your profit. Send samples or detailed specifications, and we will do the rest.

**GENERAL INSULATED WIRE CORP.**  
Division National Electric Appliance Corp.  
Gordon Avenue Providence, R. I.

**BIDDLE SPECIALTIES**

- "MEGGER" Insulation Testers and Ohmmeters
- "MEGGER" Capacitance Meter
- "FRAHM" Frequency Meters
- "JAGABI" Rheostats
- "PIEZON" Oils, Greases and Waxes for High Vacuum Work

**"JAGABI" RHEOSTATS**

FOR fine adjustment and control of electric current, these devices have performed—for many years—an outstanding service in the manufacture and use of electronic tubes, and in general laboratory and experimental work. Four sizes; 76 different ratings; numerous special types.

Write for descriptive Catalog 1370-E.

**JAMES G. BIDDLE CO.**  
ELECTRICAL AND SCIENTIFIC INSTRUMENTS  
1211-13 ARCH STREET · PHILADELPHIA · PENNSYLVANIA

## YOU NEED THIS INSTRUMENT

The Acme Voltrol is a full range manual voltage regulator providing complete control over primary voltage in a stepless range from 0 to 130 volts. Accurate 1/2 volt adjustments. Every laboratory needs Voltrol. Write for free bulletin 136.



**THE ACME ELECTRIC & MFG. CO.**

1447 Hamilton Ave., Cleveland, Ohio

Another **TRIUMPH** Masterpiece

# MODEL 800 OSCILLOGRAPH

## Sensational Appearance—Performance and Price

We are pleased to announce the Model 800 Oscillograph, a new member of the famous TRIUMPH family of original electrical testing equipment. Once more TRIUMPH has scored in both design and workmanship, offering the first Oscillograph equipped with all controls, connections and the Cathode-Ray Screen on the top deck of the instrument.

It has always been a source of pride to the TRIUMPH COMPANY that their instruments are designed to best fit the operating requirements of the user. The Model 800 Oscillograph again proves our thoroughness in developing electrical testing equipment.

Manufacturers are constantly finding new uses for the Oscillograph, and the Model 800 fits your need of an accurate, compact and easily operated testing device. Radio technicians, electrical manufacturers, radio manufacturers and precision manufacturers will find the Oscillograph an ideal precision testing instrument and the Model 800 the finest made.

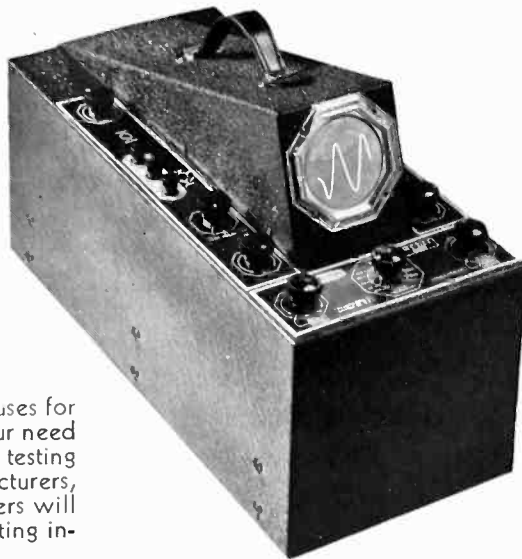

### FEATURES

- Perfect Locking
- Perfect Linearity
- Widest Sweep Range
- Horizontal and Vertical Amplification
- Visual Wave Demonstration Without Additional Apparatus
- Unlimited Laboratory and Industrial Uses
- Ideally Suited for Photographic Analysis
- Graduated Reference Scale
- Power Cut-Off-Safety Switch
- Top-deck Controls and Wide Angle View

Don't overlook this marvelous new testing instrument. The price is as much a revelation as the design.

**\$79.50**

Net complete only

THE WORLD'S MOST ORIGINAL  
AND PROGRESSIVE TESTING  
EQUIPMENT MANUFACTURERS.

TRIUMPH MFG. CO.  
4017 W. LAKE STREET  
CHICAGO, ILLINOIS

TRIUMPH MANUFACTURING COMPANY  
4017 W. Lake St., Chicago, Ill.

Please send me without obligation complete brochure on the Model 800 Oscillograph.

Name .....

Street .....

City .....

State .....

## PROFESSIONAL SERVICES

### BLILEY ELECTRIC CO.

*Designers—Manufacturers*

Quartz Crystals for standard or special radio frequency applications.

Inquiries Invited.

240 Union Station Bldg.  
Erie, Penna.

### ELECTRICAL TESTING LABORATORIES

*Characteristics and Life Tests of Vacuum Tubes*  
Tests of photo cells, glow lamps, crater lamps.  
Tests of electronic and optical devices.

80th Street and East End Avenue  
New York, N. Y.

Phone: Butterfield 8-2600

### HUDSON BROS. MFG. CO., Inc.

539-41 42nd St., Union City, N. J.

Designers and consultants for experimental glass apparatus, pyrex and soft glass.

Aspirator Pumps	Ground Joints
Graded Seals	Stop-Cock Grease
Stop-Cocks Pyrex and Soft Glass	McLeod Gauges
	Traps of all types.

Glass Apparatus Made to Blue Print Specifications.  
Tel. Palisade 6-2940

### VAPOR LAMP LABORATORIES

148 West 23d Str., N. Y. City

Designers and Consultants on

Special Glow, Fluorescent and Discharge tubes and lamps for Electronic and Advertising field.  
Special hot and cold cathodes for low voltage Neon and other gases.

High Vacuum work and Equipment, Cathode Sputtering, Glass Blowing, etc.  
Phone Chelsea 2-5648 and 9690.

# FLASH!

THE Turner Company announces a new series of popular priced Crystal Microphones. Each model has a specific field of application and is well suited to commercial and industrial service. Bulletins available on models illustrated, also six other new types. All models are listed at \$22.50.



Model 38  
Single Crystal



Model 17  
Non-directional



Model 24  
Hi-Fidelity

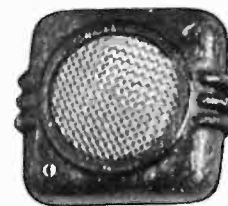

Model 83  
Lapel Type

THE TURNER COMPANY  
CEDAR RAPIDS, IA,

Licensed under patents of the Brush Development Co.





# SEARCHLIGHT SECTION

Continued from opposite page

## RADIO AND RADIO TUBE MANUFACTURERS

# DON'T MISS THIS

Opportunity to save money on your requirements for equipment.  
We still have some exceptional values to offer in the following:

### Radio Tube Equipment

24 head Exhaust Units,  
Vacuum Pumps, Bombardiers,  
Sealing, Basing, Branding,  
Hot Cut Flare and Stem Machines,  
Tubulating and Cutting Machines,  
Furnaces, Filament Coating,  
Seasoning and Testing Equipment,  
Tube Manufacturing Materials.

### Radio Manufacturing Equipment

Punch Presses, Dicing Machines,  
Drill Presses, Tapping Machines,  
Coil and Condenser Winders  
Wax Impregnating and Dryers  
Drying Ovens, Furnaces, etc.,  
Wood Working Machinery,  
Production Testing Equipment,  
Meters, Laboratory Equipment, etc.

*Detailed Descriptions and Prices Furnished Upon Request*

## GRIGSBY-GRUNOW COMPANY, INC.

in liquidation by order of the United States District Court

FRANK M. McKEY, Trustee

5801 Dickens Ave.

Phone, Berkshire 7500

CHICAGO, ILL., U.S.A.

Cable Address—Grigaut

### EQUIPMENT

Air Blowers  
Vacuum Pumps  
Aspirators  
Gas Boosters  
Spot Welders  
Gas Burners  
Accessories

NEW—RECONDITIONED  
for making  
ELECTRONIC TUBES, RADIO  
TUBES, INCANDESCENT  
LAMPS, NEON SIGNS  
Special machines for cutting  
hard glass.

Flare  
Stem  
Winding  
Sealing  
Exhaust  
Basing  
Machines

EISLER ENGINEERING CO.  
751 So. 13th St., Newark, N. J.

All types of High Grade New and  
Used Equipment for the manu-  
facture of Electron Tubes.

Lowest prices on the market.

AMERICAN ELECTRICAL SALES CO.  
65 East 8th St., New York, N. Y.  
Cable Address "AMELSACOMP-NEW YORK"

### HIGH GRADE NEW AND USED ELECTRON TUBE EQUIPMENT

Write for Bulletin Showing Savings  
From 20 to 80%

KAHLE ENGINEERING CORPORATION  
Specialists in Equipment and Methods for the  
Manufacture of Neon Tubes, Radio Tubes, Incan-  
descent Lamps, Photo Cells, X-ray Tubes, etc.  
941 DeMott St., North Bergen, N. J.

## POLICY

We take Pride in our Fairplay  
Method, in dealings with our Cus-  
tomers—this Policy has Secured, to  
us, a steady Trade and Won, for  
us, many new Friends.

YOU cannot go wrong in using  
our Reconditioning Service on  
Transmitting Tubes, as we Guar-  
antee Service and Satisfaction.

National Radio Tube Co., Inc.,  
3420 18th St., San Francisco, Calif.

### DEPENDABLE

New and Used

### ELECTRONIC TUBE EQUIPMENT

A complete line of equipment for the manufacture of  
Radio Tubes, Neon Tubes, Incandescent Lamps, etc.  
Write for Bulletin showing savings from 25 to 75%

EISLER ELECTRIC CORP.  
534-39th Street, Union City, N. J.

## "SEARCHLIGHT" Opportunity Advertising

—to help you get  
what you want.

—to help you sell  
what you no longer need.

Take advantage of it—For Every Business Want

"Think SEARCHLIGHT First"



**Type J Bradleyometer**  
When furnished without a line switch, the unit is known as the Type J Bradleyometer. Practically any resistance gradation can be provided.



# The **Type J Bradleyometer** for metal tube circuits

**TYPE JS** Bradleyometers are equipped with quick-acting, positive contact, shielded line switches. The switch is actuated by an arm insulated from the control shaft.

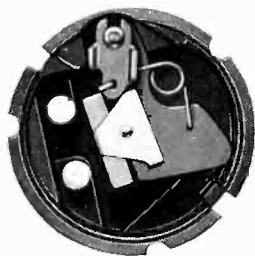

The increasing demand for compact designs, resulting from the development of metal tubes, has made Type J Bradleyometers the first choice of radio engineers charged with the responsibility of creating compact receivers with maximum reliability.

The Type J Bradleyometer is so different from ordinary volume controls that every radio engineer should be familiar with its construction. The resistor is a solid molded ring—not a film-type unit. The resistor material

is varied in different parts of the ring to fit any specific resistance-rotation curve.

After it is made, the resistor cannot change. Severe service cannot alter its performance; long wear does not deteriorate it. High humidity has no effect on Bradleyometer Types J and JS; they remain permanently quiet.

These volume controls built to R. M. A. standards are only 1/16 in. in diameter. They are available with or without a built-in line switch.



Note the small size of the Type JS Bradleyometer. Its extreme compactness makes it the ideal volume control for modern radio receivers.

Allen-Bradley Company  
110 W. Greenfield Ave., Milwaukee, Wis.

**ALLEN-BRADLEY RADIO RESISTORS  
RADIO CONTROLS**

Here is your

# Reliable Source of Supply for Auto Radio Remote Control

## Flexible Shafts

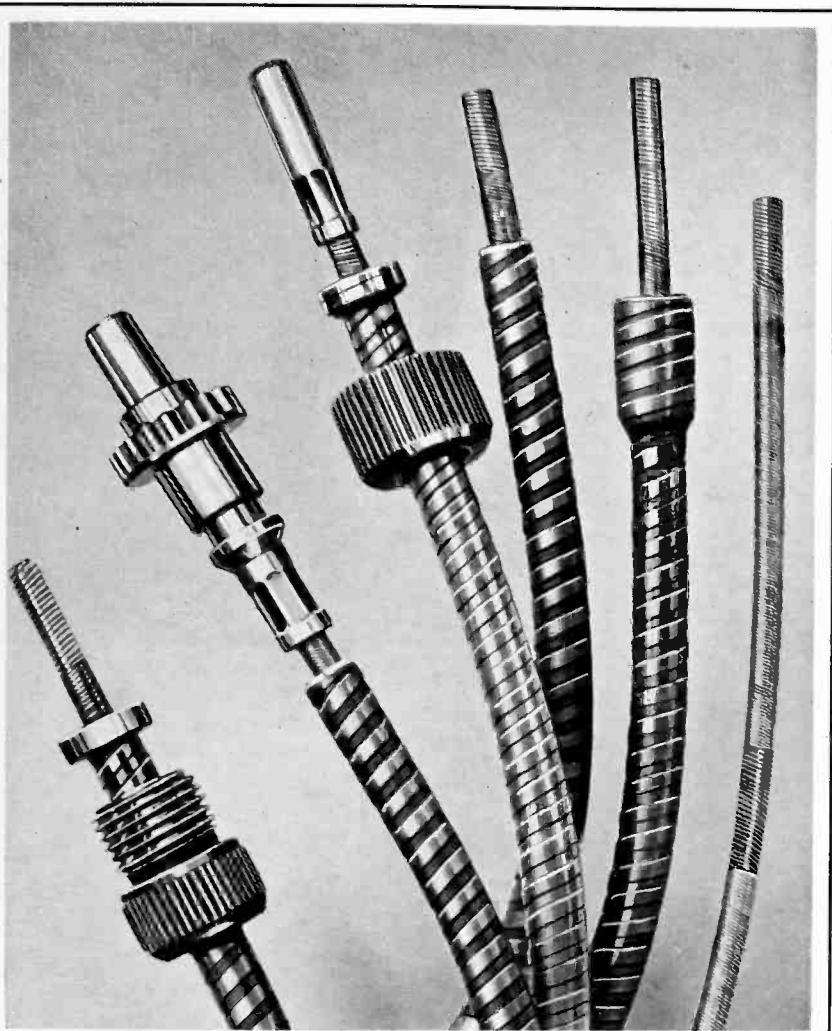

Shown above from left to right, actual size:

1. Shafting ends swaged accurately square for square hole, collet, or set-screw attachment; Casing with integral formed flange and male nut.
2. Conventional die-cast geared end fitting on shaft; Casing with plain end.
3. Conventional machined end fitting swaged on shaft; Casing with integral formed flange and female nut. We are prepared to make machined ends to specifications.
4. Shafting with regular square swaged end ready for attachment of end fitting; Casing with plain end.
5. Shafting with ends octagonally swaged for easy calibration of control unit, condenser or volume control; Casing with integral enlarged end.
6. Shafting with one or more intermediate square swages for cutting to length in the field.

●  
**S. S. WHITE** not only offers flexible shafts and casings specially developed for auto radio application, but also has the facilities, the organization and the resources to meet all demands for these shafts and casings—and without sacrificing quality.

With **S. S. WHITE** as your source of supply you are protected against interruptions to production when your demand is at its peak. Use **S. S. WHITE** Shafts and Casings and be sure of *deliveries to specification and to schedule.*

●  
**WRITE**

**FOR SAMPLE CARDS**

**SAMPLE CARD No. 1**—On this 8½"x11" card are mounted actual samples of the .150" diameter shaft and its companion casing. Details and dimensions are printed on the card.

**SAMPLE CARD No. 2**—Contains samples and dimensions of the .130" diameter shaft and its companion casing.

*These cards will be sent free, to anyone actually concerned with the design of auto or airplane radios, who makes the request on his business letterhead.*

**The S. S. WHITE Dental Mfg. Co. INDUSTRIAL DIVISION**

10 East 40th St., Room 2310E, New York, N. Y.

*Now offered to Set Manufacturers*

# 3 NEW RCA

## *All-Metal Tubes*

Set manufacturers now have available three additional types of RCA All-Metal Tubes. These include a duplex-diode triode, a power amplifier pentode, and a rectifier doubler—all of particular interest to engineers designing "transformerless" receivers. Of these, the 6Q7 also is well-suited for receiver designs employing a 6.3-volt heater supply. Technical information on these new tubes sent on request.



**DUPLEX-DIODE HIGH-MU TRIODE**—Heater Current 0.3 ampere. Triode Amplification Factor 70.



**POWER AMPLIFIER PENTODE**—Heater Current 0.3 ampere. Power Output at 18 volts 2.75 watts.



**RECTIFIER DOUBLER**—Heater Current 0.3 ampere. D-C Output Current 85 milliamperes.



# *Radio Tubes*

RCA MANUFACTURING CO., Inc., RCA Radiotron Division, Harrison, N. J.  
A subsidiary of the Radio Corporation of America