

electronics

electron tubes—their radio, audio,
visio and industrial applications

radio
sound pictures
telephony
broadcasting
telegraphy
carrier systems
beam transmission
photo-electric cells
facsimile
amplifiers
phonographs
measurements
receivers
therapeutics
television
counting, grading
musical instruments
traffic control
metering
machine control
electric recording
analysis
aviation
metallurgy
beacons, compasses
automatic processing
crime detection
geophysics

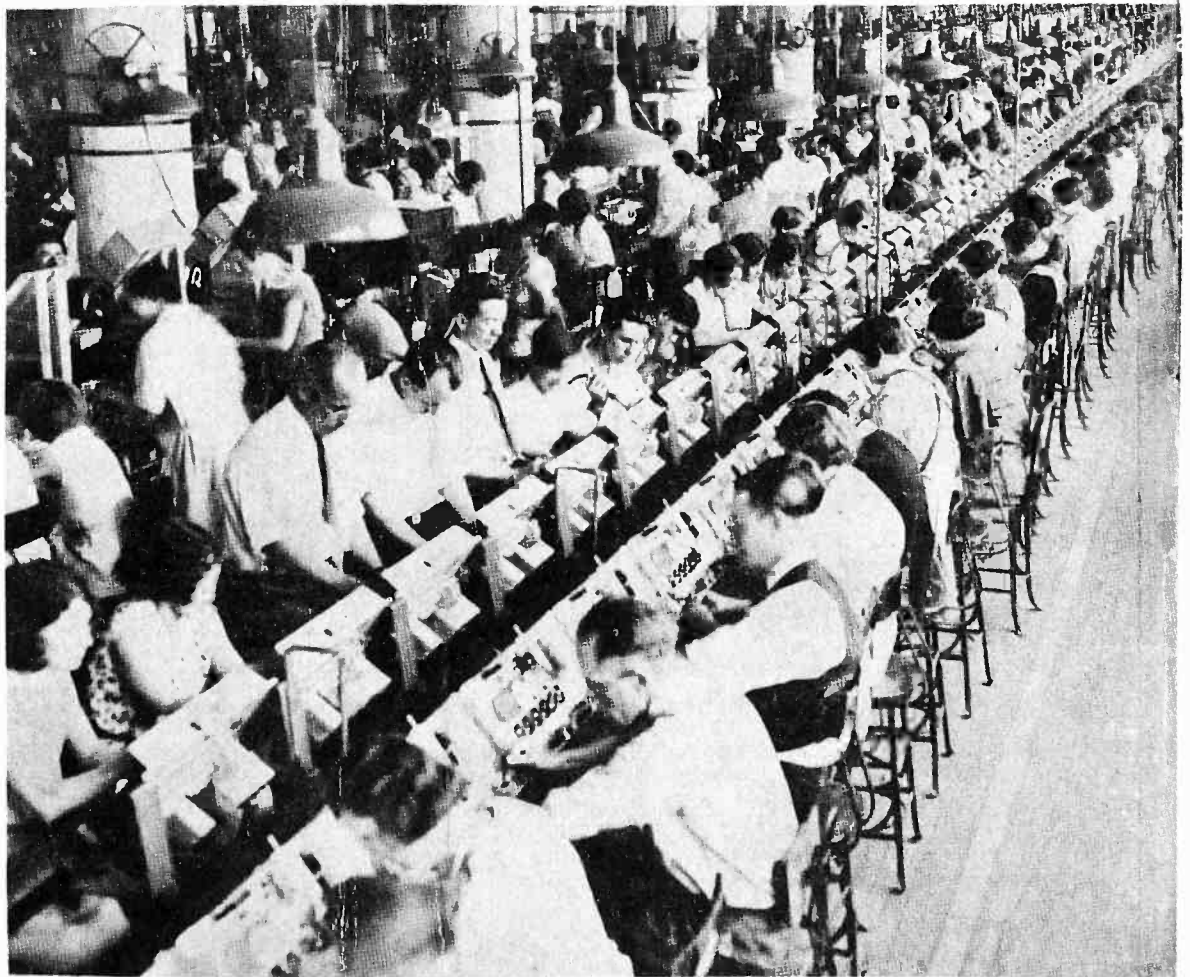

Keeping production lines busy in 1931

Page 412

The acoustics of sound-picture screens

Page 420

Uniform-gain radio-frequency amplifiers

Page 414

A MCGRAW-HILL PUBLICATION

Price 35 Cents

DECEMBER, 1930



electronics

M. E. HERRING
Publishing Director



M. CLEMENTS
Sales Manager

Contents for DECEMBER, 1930

Copyright, 1930, by McGraw-Hill Publishing Company, Inc.

The march of the electronic arts	409
Broadcast-station power and 1931 radio-set sales ..	412
BY O. H. CALDWELL	
Analysis of uniform r.f. amplification	414
BY EDWIN A. UEHLING	
A dual-frequency audio source for general laboratory use	417
BY G. F. LAMPKIN	
Phototube voltage supervisor	418
BY W. P. KOEHEL	
Acoustic and light characteristics of sound screens ..	420
BY BARTON KREUZER	
The importance of phase control in synchronizing ..	423
BY C. W. HORN	
Voice number calls from dial phones	424
BY PAUL FINDLEY	
Simplified method of measuring broadcast harmonics	425
BY E. C. MILLER	
Output transformer design—Part II	427
BY R. C. HITCHCOCK and W. O. OSBON	
Electronic musical instruments	435
Electrical transcriptions for broadcasting	438

DEPARTMENTS

New books on electronic subjects	426
High lights on electronic devices in industry	430
Editorials	432
Letters to the editor	434
News of the electron industries	439
Review of electronic literature here and abroad	440
New products	443
Patents	445
Index to Volume I (April-December, 1930)	446

McGRAW-HILL PUBLISHING COMPANY INC., Tenth Ave. at 36th St., New York, N. Y.

Cable Address: "Machinist, N. Y."

McGRAW, Chairman of the Board
McGRAW, President
McGRAW, Jr., Vice-Pres. and Treas.
McGRAW, Vice-President

MASON BRITTON, Vice-President
EDGAR KOBAK, Vice-President
HAROLD W. MCGRAW, Vice-President
H. C. PARMELEE, Editorial Director
C. H. THOMPSON, Secretary

NEW YORK District Office, 285 Madison Ave.
WASHINGTON, National Press Building
CHICAGO, 520 North Michigan Ave.
PHILADELPHIA, 1600 Arch Street
CLEVELAND, Guardian Building
ST. LOUIS, Bell Telephone Building

SAN FRANCISCO, 883 Mission Street
BOSTON, 1427 Statler Bldg.
GREENVILLE, S. C., 1301 Woodside Bldg.
DETROIT, 2-257 General Motors Bldg.
LOS ANGELES, 632 Chamber of Com. Bldg.
LONDON, 6 Bouverie St., London, E. C. 4

electronics

A MCGRAW-HILL PUBLICATION

New York, December, 1930



O. H. CALDWELL

Editor

FRANKLIN S. IRBY, Ph. D.

Associate Editor

KEITH HENNEY, M.A.

Associate Editor

The march of the electronic arts

Producers to spend \$250,000,000 in 1931

Expected to be one of the boom years in picture production, the advent of sound pictures is expected for 1931, by leading executives of the industry. Adolph Zukor, of Paramount Pictures Corporation has announced that his studios would produce approximately 55 or 60 feature pictures in Hollywood and 5 to 20 features in many of his New York Studios under an estimated budget of \$25,000,000.

Metro-Goldwyn-Mayer Studios are planning for approximately 50 feature pictures and also additional foreign pictures.

Warner Brothers, including First National, has announced plans for over 50 feature pictures making the largest production program undertaken by the industry.

United Artists and Universal Pictures are planning the production of 20 feature pictures necessitating a budget of \$10,000,000. Fox Film Corporation has announced a program calling for upwards of 50 feature pictures. Radio Pictures has planned for more features, while Pathe, Vitaphone and others are also planning production schedules.

Radio quotas to be set by Federal Radio Commission

Following an outcry in Congress over the present division of radio broadcasting facilities among the states, the members of the Federal Radio Commission with the exception of Commissioner H. A. Lafount have advanced plans for meeting the state quota of stations imposed by the Davis Broadcasting amendment.

The Davis amendment prescribes an

equal division of wavelengths, power and hours of operation among the five zones into which the country is divided for radio administrative purposes and then a division among the states within those zones in proportion to their populations.



BEAM MICROPHONE



Developed by RKO Studios, Hollywood, this parabolic reflector with microphone placed at the focus is used for long distance pick-up in recording sound pictures

U. S. Supreme Court holds film producers in trust

Ten of the largest motion picture producers in the country and 32 film-distributing boards handling 98 per cent of motion picture film output in this country, were held guilty of violating the Sherman anti-trust law in two decisions handed down November 24, by the United States Supreme Court.

The producers and distributors involved in the two cases before the Court included: Metro-Goldwyn-Mayer Distributing Corp.; Paramount-Famous-Lasky Corp.; Universal Film Exchanges, Inc.; United Artists' Corp.; F-O-B Pictures Corp.; Fox Film Corp.; Pathe Exchange, Inc.; Vitaphone, Inc.; Educational Film Exchanges, Inc., and First National Pictures, Inc.

Justice McReynolds, in referring to the standard exhibitors contract, stated: "Certainly it is unusual, and we think—directly tends to destroy the kind of competition to which the public has long looked for protection. Ten producers and distributors of films controlling 60 per cent of the business agreed to contract with exhibitors only according to a standard form and then combined through thirty-two local film boards of trade with other distributors, who with themselves control 98 per cent of the entire business.

"In order to establish violation of the Sherman Act it is not necessary to show that the challenged arrangement suppresses all competition between the parties or that the parties themselves are discontented with the arrangement. The interest of the public in the preservation of competition is the primary consideration. The prohibitions of the statute cannot be evaded by good motives."

Paramount startles industry with new 65 mm. equipment

Dr. N. M. LaPorte of the Paramount Publix Corporation, unveiled for the first time, to the New York Chapter of the Society of Motion Picture Engineers, on December 5, the new 65-mm. camera and projection equipment about which there has been so much secrecy for months. All of the equipment shown was developed and manufactured abroad. The projector is an Ernemann unit built in Germany and is of most unusual design. The projection head is a multiple type accommodating either 35 mm. or 65 mm. film. The aperture opening used for the wide-film shown is 23 x 41 mm. making a picture ratio of 1 to 1.78. The lenses for the projector and camera were designed by Carl Zeiss, Jena.

The new wide-film camera, which was built by DeBrie Etablissement, Paris, is also of unique design. It is built on a pedestal provided with an electric motor for propulsion; the camera unit can be steered about the set with a control lever similar to handling a motor car. The camera may be raised or lowered by motor power on the pedestal shaft. The camera is provided with a 230 degree shutter opening. Several reels made with this new wide film equipment were shown.

A new form of optical printer also built by DeBrie for Paramount and used in making reduction prints from 65 mm. to any width was exhibited.

EAVESDROPPING OF NO VALUE HERE

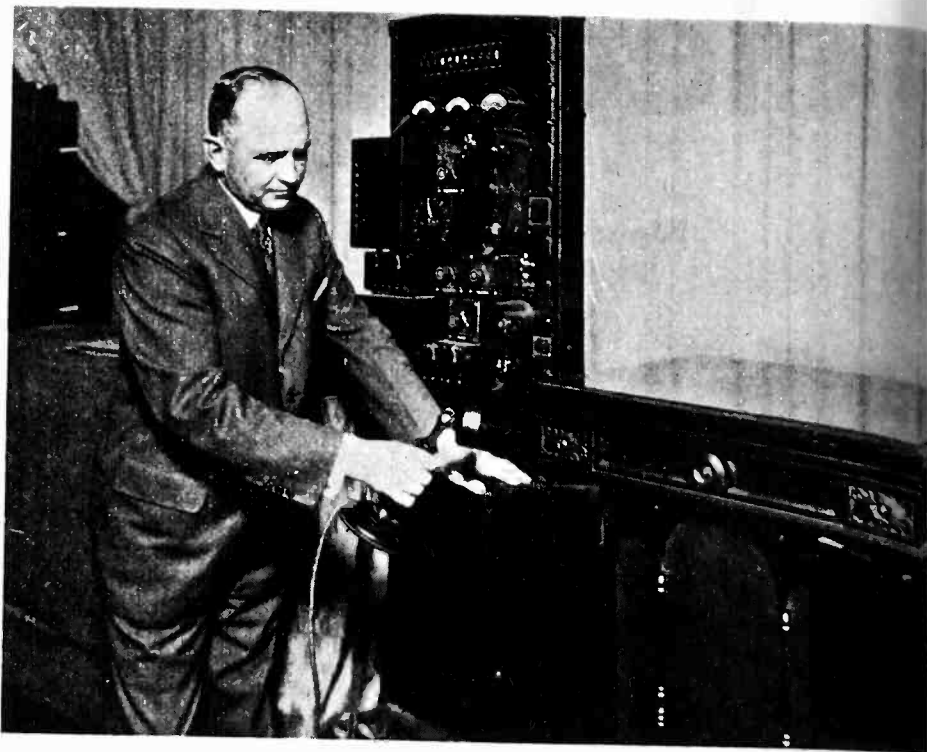

Sergius P. Grace of the Bell Laboratories is shown demonstrating apparatus used for scrambling speech, making possible secret transatlantic radio telephone conversations

◆ ◆ ◆

Films showing Paramount's new color system were presented. These films were made by a three-color additive process and the definition and lighting values were most excellent indicat-

ing great progress in color photography. Dr. LaPorte pointed out that a film equipment shown was adapted to any standard width that might be agreed upon by the industry.

◆ ◆ ◆

◆

TO CHEER HARVARD'S CRIMSON TEAM

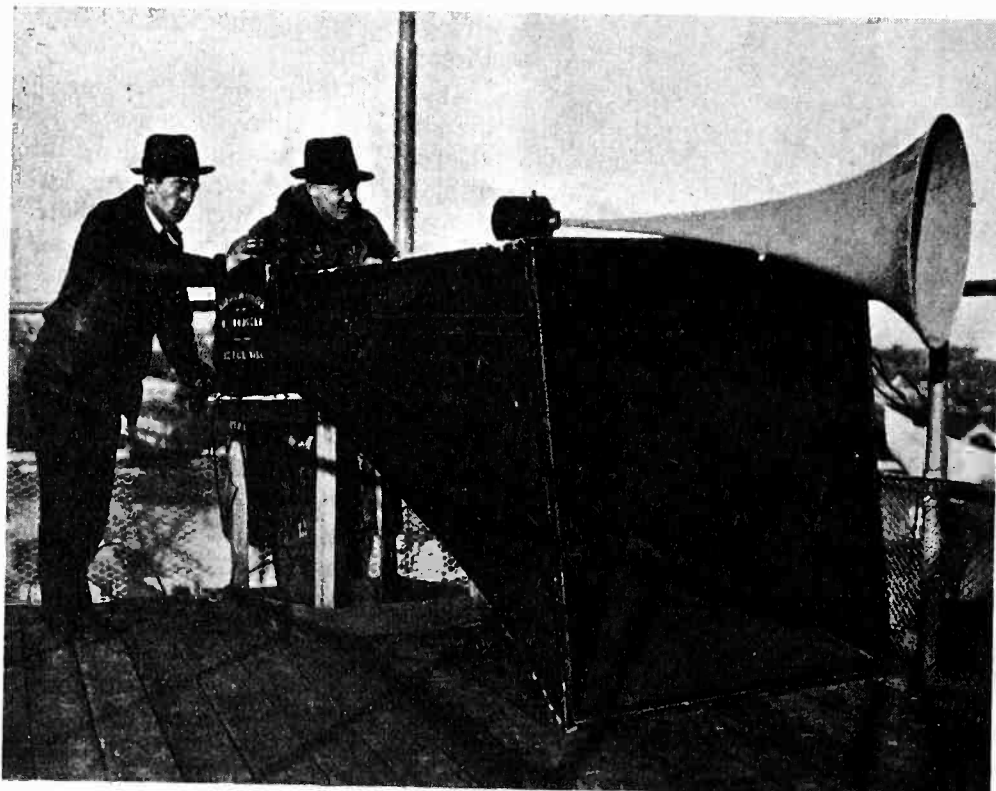

This loud-speaker unit, said to be one of the largest in use, has been installed at the football stadium at Harvard, Cambridge, Mass. Announcements made from it can be heard with clarity over the entire field

Amplifier business growing

A lusty growing infant of the family is the amplifier manufacturing branch. Amplifiers in theaters, auditoriums, public parks, ball rooms, way stations and similar places are becoming so widely used that manufacturing of amplifiers is one of the rapidly growing developments in radio. To meet the needs of amplifier manufacturers the Radio Manufacturers Association has approved new standards to be afforded to the amplifier market headed by A. C. Kleckner of Webster Electric Company, Racine, Wis., chairman. There has been approved a recommendation by Chairman Kleckner to form a special amplifier section of the Standards Committee of the RMA Engineering Division. The amplifier section will develop standardized ratings for power amplifiers and also cooperate with the National Board of Fire Underwriters in drawing up a satisfactory set of standards covering amplifiers. Exporting in amplifiers and traffic, state legislative and other interests of amplifier manufacturers also will be developed by respective RMA committees.

"Business" will be keynote of 1931 RMA trade show

Annual convention and trade show of the Radio Manufacturers Association in 1931 will be held in some middle city and during the first or second week in June, under a decision made November 18, at a meeting of the board of directors at the Cleveland. Business, without doubt, will be the keynote of the 1931 gathering of the radio industry, which is the largest industry assemblage in the United States and which drew over 100,000 persons to Atlantic City. The date of a meeting place for the next meeting was deferred temporarily by the RMA directors. There is keen competition for the 1931 trade show between the cities of St. Louis, Pittsburgh, Chicago and Detroit, and one of these four cities soon will be definitely chosen. The RMA Board plans to hold its 1931 convention and trade show on a roof and along simplified, direct lines, with the least possible expense to exhibitors and trade visitors. There will be reduced railroad rates to the convention city and no increases in hotel rates.

Assurance exhibition of new and current radio merchandise in the 1931 RMA board of directors has adopted a new rule which will require exhibitors to show their new or improved receiving sets and other radio lines. This will prevent recurrence of the conditions in the last show. A new rule for the trade show will permit exhibition, not in the show rooms, of demonstration rooms of exhibits of associated radio products and manufacturers in addition to receiving sets, etc.

Forecast predicts early recovery

Mr. F. Gifford, President of the American Telephone and Telegraph Company, speaking to members of the Essex Club in Salem, Mass., on November 22, said: "As sure as I am standing, this depression will soon end and we are about to enter a period of recovery, the like of which no one has ever seen before; a new era of big business working for the benefit of its social obligations; and development in industry to work out the problems of distributing what is produced on the basis that we have a way to go around." Gifford stated it was inevitable that business through science would lead toward an industrial and social order which would be gained by the selection of the best and cheapest service consistent with financial

LABORATORY ON WHEELS

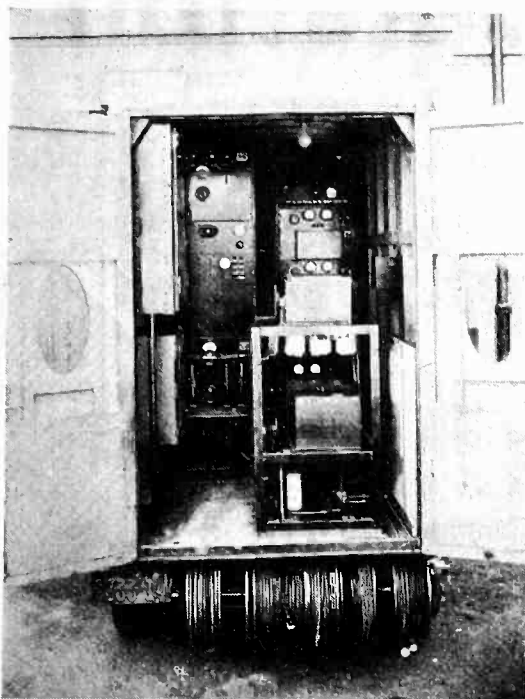

This motor truck is equipped with complete acoustical measuring equipment for making analysis of theaters and auditoriums. Designed by Warner Bros. Studio, Brooklyn, N. Y.

Radio interference

A plan for cooperation between radio manufacturers to reduce the interference troubles of the radio public has been adopted by the Radio Manufacturers Association. The association's board of directors, meeting November 18, at Cleveland, approved the program presented by H. B. Richmond of the Gen-

eral Radio Company, Cambridge, Mass., chairman of the RMA engineering division, to enlist the cooperation of manufacturers on interference work. This will be carried on through a special interference section of the engineering division and later it is planned to enlarge the interference service for the owners of radio receiving sets by the establishment of a separate bureau in the RMA for such interference work, under the direction of competent engineers.

Short-wave channels made available to film industry

The Federal Radio Commission, on November 26, set aside three continental short-wave channels for the use of motion picture producers. Frequencies of 1552 and 1556 kilocycles, hitherto reserved for ship stations, have been made available for temporary use in connection with the production of motion pictures. Power on these frequencies is limited to 250 watts. A third channel, on 1554 kilocycles, was set aside for radio-telephone contact.

The purpose of these channels is to provide facilities for communication between parties "on location" with the main studios. This will provide the necessary means of communication to location parties in desert areas, shipboard, etc., where no other means of communication are available. Such facilities will speed up production of talkies and shorten the period of maintaining parties on location.

CROOKS AND GANGSTERS BEWARE

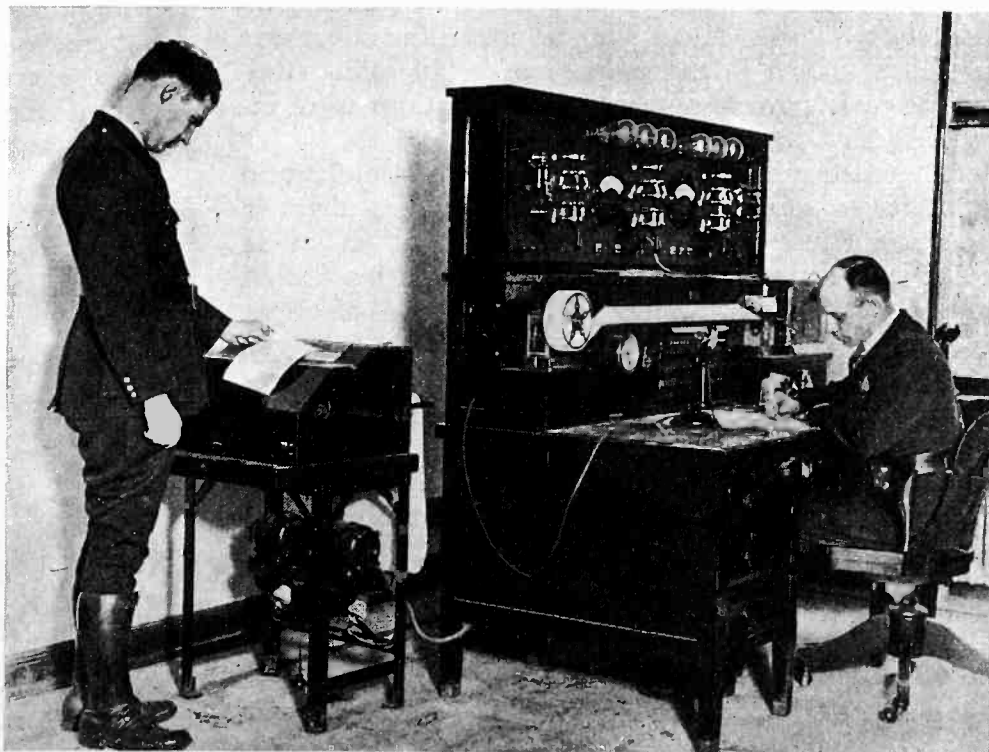

View of teletype machine over which alarms are sent simultaneously to all precincts by the police department of Dearborn, Michigan. This equipment, with radio on police cars, will not make the criminal's lot any easier

Broadcast-station POWER

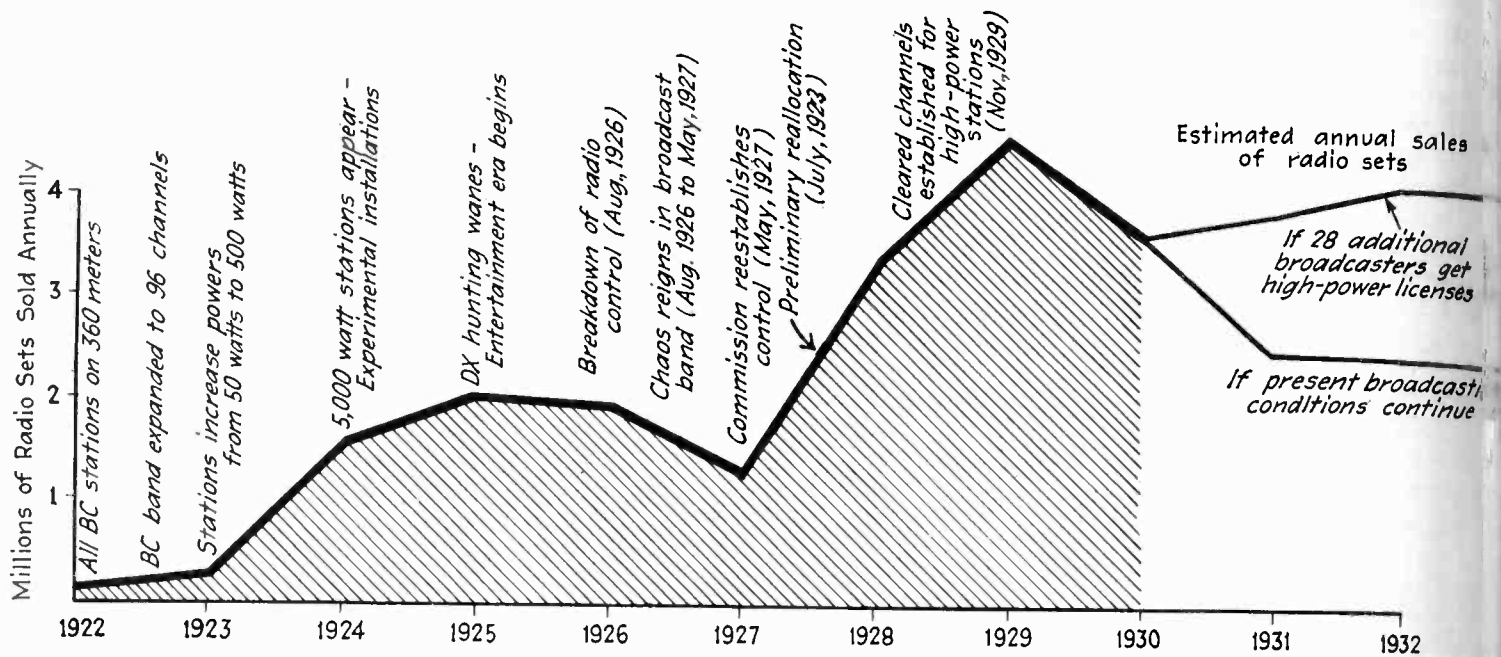

Annual sales of radio-receiving sets, 1922 to 1930, showing influence of broadcasting conditions on public's purchases

By O. H. CALDWELL

Editor *Electronics*, Former Federal Radio Commissioner

IN FEW other places in industry or business is there such a close relationship as exists between the quality of broadcasting service supplied to the public, and the public's response in the form of the purchase of radio sets. Radio-receiver sales in any territory depend upon the technical and program character of the broadcast service received, as can be shown by repeated examples when tracing the history of broadcasting to date.

In 1926, when the radio law broke down and radio broadcasting relapsed into a state of chaos, the effect was immediately shown in the collapse of retail radio sales. Again, as early powers of broadcasting stations were increased, radio sales mounted upwards.

Better broadcasting is thus an effective stimulant to radio-set sales. One cannot sell radios unless there is broadcasting; just as one cannot grow a garden unless there is sunshine. Obvious as this relationship would seem to be, there has yet been a surprising lack of attention given to the broadcasting situation by those whose business investments most depend upon it. Executives of radio manufacturing companies too often have felt or shown little interest in this vital service, which is the very life blood of their continued radio business activity.

Within the last two weeks, representatives of *Electronics* have interviewed radio leaders who have

We must open up new territories for receiver selling, if 1931 and 1932 volumes are to repeat past levels. Higher powers for existing stations will do it.

responsibility for producing and selling a large part of the country's radio sets.

These men all seem to expect a contraction in sales volume during 1931 and 1932. They say "saturation" is now so far advanced that we cannot have a 4-million-set year.

But is this the inexorable picture facing us?

Let us look at the real facts of the situation from the broader angles of the radio art.

In those parts of the United States where good broadcasting service (that is, high signal strength) is being had, it is true that saturation of receiving sets is now approaching a fair degree of intensity,—for the radio sets sold during recent years have been introduced into these regions.

But there are still vast populated regions of the country where broadcasting is pitifully poor,—where the extent of the broadcasting receivable is a single program, available only during night hours in a

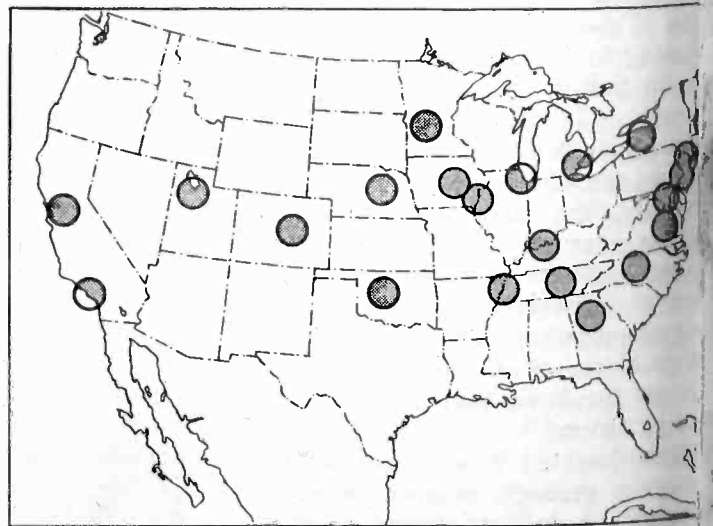

Present "fair-quality" service areas of the 28 broadcasting stations (chiefly 5 kw.) which are now asking the Radio Commission for 50 kw. licenses

and 1931 radio-set SALES

Such broadcasting service of course cannot pro-
lio sales.

per cent of the nation's population live seventy-
es or more from broadcasting stations furnishing
nt regular satisfactory programs. In these
served territories, where only one or two
s are received, each spoiled by static, few radio-
urally, are yet in use. But these populated areas
eat opportunities for future radio-set sales, as
a demonstrated each time an increase in power
en granted to the broadcaster serving such a

olution of the radio industry's problem, therefore,
existing broadcasting stations to increase their
to reach these now sterile sections. At this
28 leading independent broadcasters from all
the country are in Washington applying to in-
their powers to 50 kw., being willing to spend
each to improve their service ranges—the very
that all the listeners, the farmers, and the radio
returers and dealers most want them to do.

the Radio Commission, operating against the
is of all engineering opinion, holds back against
necessary and inevitable action,—on account of
pressure from its Senate masters (who do not
comprehend high power as an improved service to
and farm population).

Independent broadcasters in majority

only many radio manufacturers and other industry
are on record as favoring high-power. For their
preservation, however, the present emergency
that they go emphatically further, entering the
igorously in the interest of the whole radio
air. This matter of high power is not a question
ing the so-called "radio trust" stations. The 28
eters applying are chiefly *independent*, far-seeing
liberated concerns,—newspapers, educational in-
stitutions, department stores, business houses, etc., from
all parts of the country, independent of any radio-trust
ownership or control whatever.

HIGHER POWERS FOR STATIONS ON CLEARED CHANNELS WILL—

**Bring clear, strong signals to millions now
poorly served**

Open up vast new territories for receiver sales

**Improve summer reception everywhere, ironing
out summer slump and extending production-
period of radio factories**

Usher in \$100,000,000 of waiting receiver sales

**Open up \$10,000,000 business in broadcasting
apparatus**

Restore employment to 100,000 radio workers

The moral influence of the radio industry and trade,
exerted through its representatives in Congress will speed
Commission action on high power immeasurably by
interpreting the situation to the Senators in its true terms
of high power as a service to the rural population.

The direct effect would be to put good clear strong
broadcasting into all the now unsaturated territories,
and so immediately to stimulate sales of receiving, as has
been repeatedly demonstrated locally where broadcast
stations have increased their powers.

With radio manufacturing volume next year other-
wise facing saturation, prompt action in getting
high-power broadcasting is the one remaining funda-
mental factor which can restore radio sales to their past
happy situation of 3 and 4-million-set years.

Thus upon the prompt action of the Radio Commis-
sion in granting high-power licenses, there now await
\$10,000,000 in broadcast station sales; \$100,000,000 in
receiving set sales; the future prosperity of the radio
industry, and the employment of a hundred thousand
radio workers.

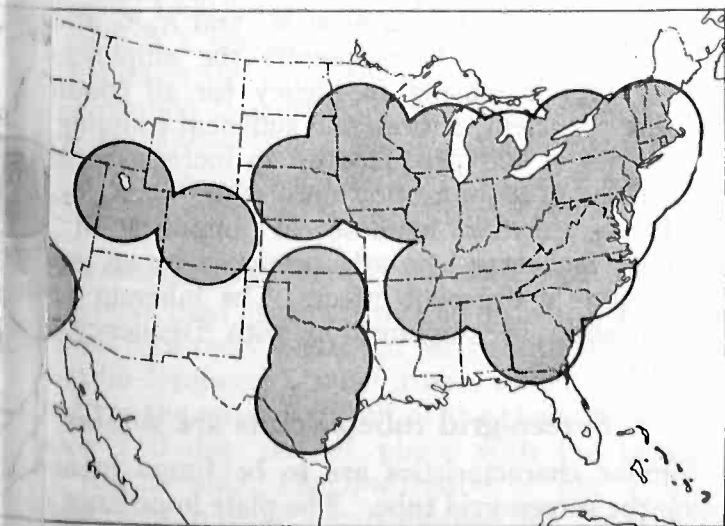

"air-quality" service areas of the 50-kw. broadcast
stations of U. S. as they would appear if applications
now before Commission were granted

Broadcasting stations applying for 50 kw.

WHAM	Rochester, N. Y.	Stromberg Carlson Telephone Mfg. Co.
WOR	Newark, N. J.	Bamberger's Department Store
WBZ	Springfield, Mass.	Westinghouse Elec. & Mfg. Co.
WBAL	Baltimore, Md.	Consolidated Gas & Elec. Co.
WHAS	Louisville, Ky.	Courier Journal
WCAU	Philadelphia, Pa.	Universal Broadcasting Co.
WWJ	Detroit, Mich.	Detroit Evening News
WRVA	Richmond, Va.	Larus Bros. & Co.
WJR	Detroit, Mich.	The Goodwill Station, Inc.
WBT	Charlotte, N. C.	Queen City Broadcasting Co.
WSM	Nashville, Tenn.	National Life Insurance Co.
WSB	Atlanta, Ga.	Atlanta Journal
KVOO	Tulsa, Okla.	Southwestern Sales Corp.
WREC	Nashville, Tenn.	WREC, Inc.
WMC	Memphis, Tenn.	Commercial Appeal
KFAB	Lincoln, Nebr.	Buick Auto Company
WCCO	Minneapolis, Minn.	Washburn-Crosby Mills
WTMJ	Milwaukee, Wis.	Milwaukee Journal
WCN	Chicago, Ill.	Chicago Tribune
WMAQ	Chicago, Ill.	Chicago Daily News
WCFL	Chicago, Ill.	American Federation of Labor
WBBM	Chicago, Ill.	Atlas Brothers
WHO	Des Moines, Iowa	Bankers Life Ins. Co.
WOC	Davenport, Iowa	Palmer School of Chiropractic
KGO	San Francisco, Cal.	General Electric Company
KOA	Denver, Colo.	General Electric Company
KSL	Salt Lake City, Utah	Mormon Church
KPO	San Francisco, Calif.	San Francisco Chronicle
KHJ	Los Angeles, Calif.	Don Lee, Automobiles

Analysis of uniform r.f. amplification

By EDWIN A. UEHLING

AMONG the principal aims of all research in the field of radio-frequency is the development of an amplifier capable of high sensitivity and selectivity; and capable, moreover, of maintaining these characteristics with a high degree of uniformity over the entire broadcast range. Inasmuch as this is a range of three to one in frequency, and of nine to one in the variable parameter of the amplifier, this aim toward which development has proceeded will constitute no mean accomplishment when achieved. Progress has been so persistent during the years of the history of radio engi-

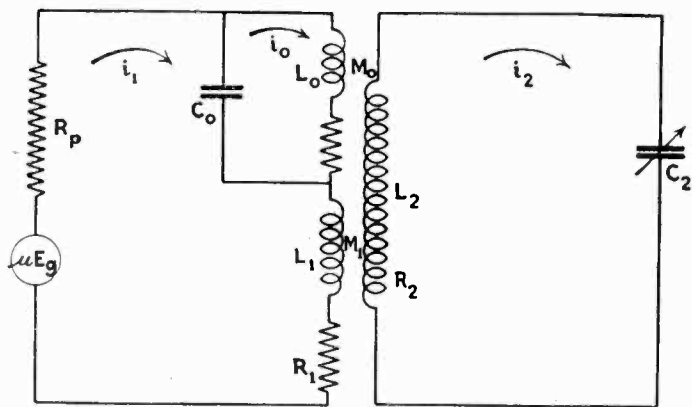

Fig. 1—Circuit suggested for effecting uniformity of amplification

neering that one might say the goal in question has been very nearly reached.

Uniformity of selectivity and uniformity of sensitivity are separate problems and are usually treated as such, though, of course, they are related in many particulars, and a complete treatment of one cannot be carried out without due consideration of the other. Nevertheless, it is our purpose at this time to consider exclusively the problem of uniform amplification. The methods to be described have been used frequently, and may find a more or less universal application in the future. However, an adequate description of the theory of uniform amplification is lacking, and in view of the

importance of the subject, such a description may have considerable value to many engaged in certain lines of research.

Non-uniformity is inherent

We will ascertain the nature of non-uniform amplification before discussing the means of controlling it. The current in the tuned circuit of a transformer-coupled stage of radio-frequency amplification is given by the equation

$$I_2 = \frac{\mu E_g \omega M}{\omega^2 M^2 + R_p R_2}$$

where μ is the amplification factor of the tube, the impressed signal voltage on the grid of the pre-tube, ωM is the mutual impedance, R_p is the plate resistance of the tube, and R_2 is the tuned circuit impedance. As the frequency is varied all factors in the equation except ω and R_2 are constant. Rewriting the equation to give the amplification directly, we have

$$\text{Amplification} = \frac{\mu M L \omega^2}{\omega^2 M^2 + R_p R_2}$$

The extent to which the amplification will vary with frequency will depend on the value of the term $R_p R_2$ as compared with $\omega^2 M^2$, and on the amount of variation in R_2 with frequency. But in order to realize the maximum possible amplification at any frequency $\omega^2 M^2$ should be equal to $R_p R_2$ at that frequency. In general this condition is difficult to achieve because of practical considerations. One permits himself to feel fortunate if he can make the term $\omega^2 M^2$ equal or nearly equal to the term $R_p R_2$ at the highest frequency of the broadcast range. Having established this condition he has given to the amplifier the highest possible amplification at all frequencies attainable under the circumstances for which the amplifier is designed. The characteristic, however, will be anything but uniform. If optimum conditions can be established at only one frequency, the amplification frequency curve must necessarily reflect this condition.

A first derivative of the equation with respect to ω may be taken, considering R_2 in this equation as one of the variables. If R_2 is considered to vary directly with frequency, the derivative of the equation will be of the form

$$\frac{K'}{(\omega M^2 + K'')^2}$$

where K' and K'' are positive constants. The derivative is therefore positive for all frequencies less than the relative values of $\omega^2 M^2$ and $R_p R_2$ at a particular frequency. Consequently the amplification increases with increasing frequency for all conditions of coupling: deficient, critical, and sufficient coupling. An increase in ωM produced by an increase in M produces an increase in amplification until $\omega^2 M^2 = R_p R_2$, after which no further increase in amplification can be obtained, an increase in ωM produced by an increase in ω has quite a different effect. The inherent nature of the variation in amplification with frequency is thus obvious.

Screen-grid tube circuits are similar

Similar characteristics are to be found in amplifiers using the screen-grid tube. The plate impedance of such tubes is so high that conditions seldom exist under which it is possible to realize the optimum amplification characteristics. The square of the mutual impedance between circuits is by means of a transformer

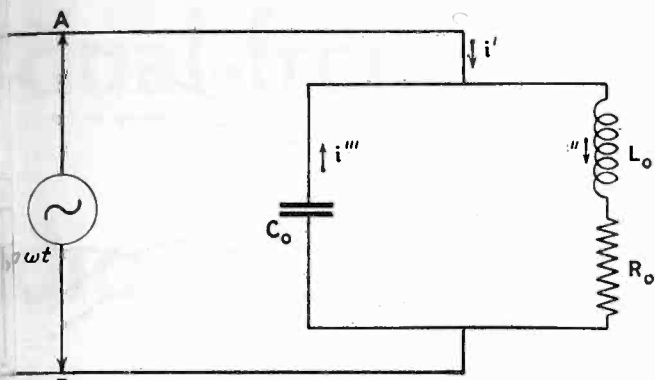

Fig. 2—Circuit used for solution of the problem of uniform amplification

ally but a small fraction of the product of the circuit and plate resistances. For this reason a approximation to the amplification obtained is given the product of the mutual conductance of the tube the load resistance. If the coupling from one tube another is by means of a tuned impedance the load impedance is given by $\frac{\omega^2 L^2}{R_2}$. The amplification is then

proportional to this term. Since R_2 seldom varies at a higher rate than the first power of the frequency at lower frequencies, and at only a slightly higher rate at higher frequencies, this term can be considered to vary approximately as the first power of the frequency. Accordingly the amplification when screen-grid tubes are used varies at even a greater rate than when other tubes are used. The variation for a single stage may be almost two to one over the broadcast range, and for a two-stage amplifier the value of the variation will be the square and the cube of this value respectively. These causes of variation in amplification, which are inherent in the amplifier, cannot be eliminated by any forward application of amplifier principles. Therefore when an amplifier is to be used over a wide range of frequencies something more than a simple transformer is required. Means, which are not a part of the transformer design as such, must be employed which will provide a certain amount of uniformity in the amplifier characteristic at various frequencies. It is these methods which will be discussed at this time.

In applying the amplification equation we observe that the symbol denoting the mutual inductance of the amplifier appears in the numerator. A method of introducing uniformity in amplification suggests itself immediately. The mutual inductance can be made to vary in some particular fashion a partial or complete compensation for the variations in the equation may be obtained. Obviously this method is worthy of investigation. We will defer the investigation has been made that a partial application of the method has been used many times in the past, usually unknown to the research engineer.

Introducing uniformity of amplification

The method used is characterized principally by the inclusion of a tuned circuit in series with the primary of a radio-frequency transformer which is coupled inductively to the secondary coil of the transformer with the coupling 180 deg. out of phase with the principal current flowing to this coil. The illustration of Fig. 1 shows the arrangement in detail. It is evident that the effective mutual inductance between primary and secondary is a function of the frequency. The rate and sign of the variation is obvious, and a solution of the circuit equations is necessary. This solution will yield the design informa-

tion required, and will increase considerably the ease with which the desired results may be obtained.

A study of Fig. 1 shows that the arrangement consists essentially of three circuits and three sets of mutual impedances. Using the notation of this figure we write down the circuit equations

$$\begin{aligned} \left[R_0 + L_0 \frac{d}{dt} \right] i_0 + \left[R_0 + R_1 + R_2 + L_0 \frac{d}{dt} + L_1 \frac{d}{dt} \right] i_1 + \left[M_0 \frac{d}{dt} - M_1 \frac{d}{dt} \right] i_2 &= \mu E_0 e^{j\omega t} \\ \left[R_0 + L_0 \frac{d}{dt} + \frac{1}{C_0} \int dt \right] i_0 + \left[R_0 + L_0 \frac{d}{dt} \right] i_1 + M_0 \frac{d}{dt} i_2 &= 0 \\ M_0 \frac{d}{dt} i_0 + \left[M_0 \frac{d}{dt} - M_1 \frac{d}{dt} \right] i_1 + \left[R_1 + L_1 \frac{d}{dt} + \frac{1}{C_1} \int dt \right] i_2 &= 0 \end{aligned}$$

The solution for i_2 due to E_0 is not sufficiently simple to be used with facility, and accordingly another method of solving these equations will be used. The problem is unlike ordinary three-circuit problems in that not only does a mutual impedance exist between the first and second, and the second and the third circuits, but also between the first and third circuits.

We will obtain an approximate solution of these equations in the following manner. Assume an alternating e.m.f. $E_0 \sin \omega t$ impressed between the points A and B of Fig. 2. A current i' will flow in the principal circuit having the value

$$i' = \frac{E_0 \sin \omega t}{j\omega L_0 + R_0} \frac{1}{1 - \omega^2 L_0 C_0 + j\omega R_0 C_0}$$

In the inductive branch of the parallel circuit there will be a current

$$i'' = \frac{E_0 \sin \omega t}{j\omega L_0 + R_0}$$

and in the capacity branch

$$i''' = j\omega C_0 E_0 \sin \omega t$$

We are interested in the ratio of i'' and i'

$$\frac{i''}{i'} = \frac{1}{1 - \omega^2 L_0 C_0 + j\omega R_0 C_0}$$

This ratio is a function of the frequency, and as a consequence the tuned circuit $L_0 C_0 R_0$ located with reference to the principal circuits as shown in Fig. 1 may be considered simply as an arrangement for obtaining a variation of the current in a mutual impedance ωM_0 according to a predetermined manner. But a current varying as a function of the frequency in a fixed circuit parameter can be replaced by a fixed current in a variable circuit parameter. Therefore in place of M_0 we may consider a mutual inductance of the value

$$M' = \frac{M_0}{1 - \omega^2 L_0 C_0 + j\omega R_0 C_0}$$

Since this mutual inductance is of the opposite sign to the inductance M_1 the total effective mutual inductance in the circuit connecting the currents i_1 and i_2 is

$$M = M_1 - M' = M_1 - \frac{M_0}{1 - \omega^2 L_0 C_0 + j\omega R_0 C_0}$$

Now if the frequency at which the amplifier is used is always below the frequency for which

$$\omega^2 = \frac{1}{L_0 C_0}$$

the value of M , the effective mutual inductance, will decrease with increasing frequency. The values of L_0 and C_0 can be so chosen that this condition for ω is fulfilled throughout the operating range. Also, the rate

at which variation with frequency will take place will depend on the product of the values of L_o and C_o . A proper choice of M_1, M_o , and the product $L_o C_o$ will give to M any desired value at any frequency in the broadcast range as well as the desired change in this value with change in frequency.

For a single effective mutual inductance M , the amplification has been found to be equal to

$$\text{Amplification} = \frac{\mu \omega^2 M L}{\omega^2 M^2 + R_p R_2}$$

In deriving this equation all impedances in the primary circuit with the exception of R_p have been neglected. Therefore we may use for the value of M in the amplification equation the effective value

$$M_1 = \frac{M_o}{1 - \omega^2 L_o C_o + j \omega R_o C_o}$$

only on the supposition that the impedance of the tuned circuit $L_o C_o R_o$ is small compared with R_p . This is not a serious limitation. In selecting values for L_o and C_o , it will in general be found advisable to place the resonant frequency of this combination of circuit elements well out of the broadcast range. Consequently the impedance is small compared with the value of the resistance R_p .

We are now ready to see how the equations for amplification and for effective mutual inductance may be used together. We have seen that the value of the amplification increases with increasing frequency. We may wish to know now the condition under which the amplification will decrease with decreasing M . The derivative with respect to M of the amplification equation is positive when

$$R_p R'_2 / \omega_o > \omega M^2$$

and negative when

$$R_p R'_2 / \omega_o < \omega M^2$$

where R_2 is considered to vary directly as the frequency, but has the value R'_2 at the lowest frequency $\frac{\omega_o}{2\pi}$ of the broadcast band. Therefore the amplification decreases with decreasing M throughout the broadcast band if at every frequency in this range

$$R_p R_2 > \omega^2 M^2$$

This condition is nearly always satisfied. In amplifiers using the screen grid tube this condition is not only satisfied, but the value of $R_p R_2$ is so large compared with $\omega^2 M^2$ that the amplification varies very nearly inversely as the coupling.

We are now ready to determine the approximate values of M_1 and M_o for an amplifier using the screen grid tubes. If in the tuned circuit in the series with the primary coil $\omega^2 L_o C_o \ll 1$ for the highest frequency of the broadcast band, a simplification in the equation for the effective mutual inductance of the circuit may be introduced and the equation written as follows:

$$M = M_1 - \frac{M_o}{1 - \omega^2 L_o C_o}$$

We will now determine the values of M_1 and M_o to be used in a particular amplifier. Experience tells us the value of the ratio of the amplification at the highest broadcast frequency to that at the lowest frequency in a particular amplifier. Let this ratio be denoted by k . Now introducing the circuit modification of Fig. 1 we will require a change in the effective mutual inductance over this range of frequencies which expressed as a ratio may also be denoted by the symbol k . It should be remembered that this simple procedure is possible only

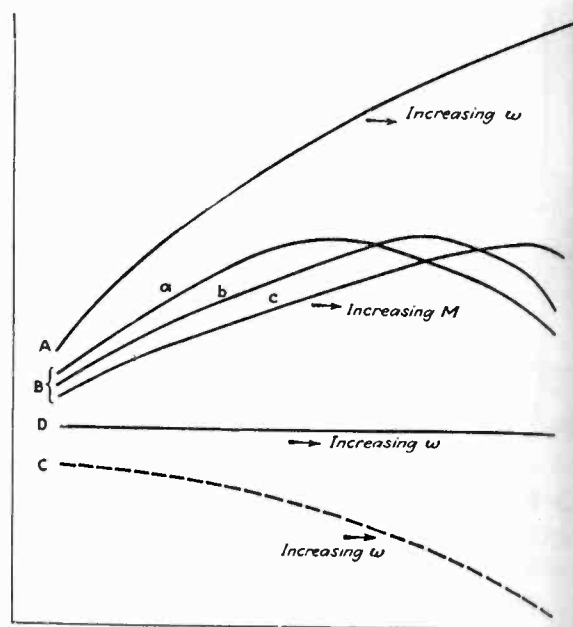

Fig. 3—Curve A—Variation in amplification with frequency

Curve B—Amplification as a function of M for values of $R_p R_2$, increasing in the order a, b, c

Curve C—Required variation in M needed to approximate ideal Curve D

in the case of the screen grid tube. For all other the change required in M will differ considerably the value k . Since the ratio of the effective mutual inductances at the highest and lowest frequencies is to k , we have

$$\frac{M_1 - \frac{M_o}{1 - \omega_1^2 L_o C_o}}{M_1 - \frac{M_o}{1 - \omega_2^2 L_o C_o}} = k$$

where ω_2 corresponds to the highest frequency and to the lowest frequency. L_o and C_o are chosen on basis that $\omega_2^2 L_o C_o < 1$. M_1 is chosen generally as largest possible mutual inductance obtainable. This condition then gives the required value of M_o .

When other than screen grid tubes are used the of M_o is selected with slightly greater difficulty. easiest method is perhaps one of selecting a set of values; determining from this set a value of M at a highest frequency and another value for the lowest frequency; and then substituting these values of M in amplification equation, determining a value of the amplification at two different frequencies. In making substitution different values of R_2 must be used for different frequencies. This process may be carried until a set of values for M_1, M_o, C_o and L_o are found that give a constant value for the amplification.

These equations will probably simplify to some extent the work of designing radio-frequency amplifiers with uniform amplification characteristics. They are directly applicable to amplifiers using the screen grid tube as a consequence they are especially valuable at this time when the use of the screen grid tube is almost universal in radio-frequency amplifiers. Similar results may be obtained directly in the laboratory by experiment, but a small amount of computation using these equations greatly facilitate the work. One might add, furthermore that these equations and the methods by which the circuit of Fig. 1 has been solved give an interpretation of the functioning of this circuit, which, if a more rigorous method of solution had been used, might have been considerably more difficult, or practically impossible.

dual-frequency

radio source

general

laboratory use

C. F. LAMPKIN

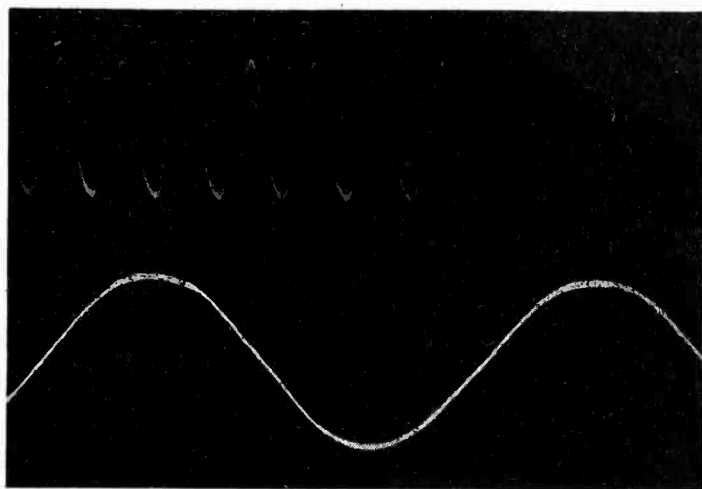

Comparison of the wave form with a 60-cycle timing wave of the 415-cycle output

of use include those when bridge measurements are necessary; when sensitivity and selectivity tests on radio receivers are made; when tone modulation is needed on radio transmitters; or when various transmission networks—amplifiers, filters, long lines—are to be studied.

The schematic circuit of the unit is drawn in the figure

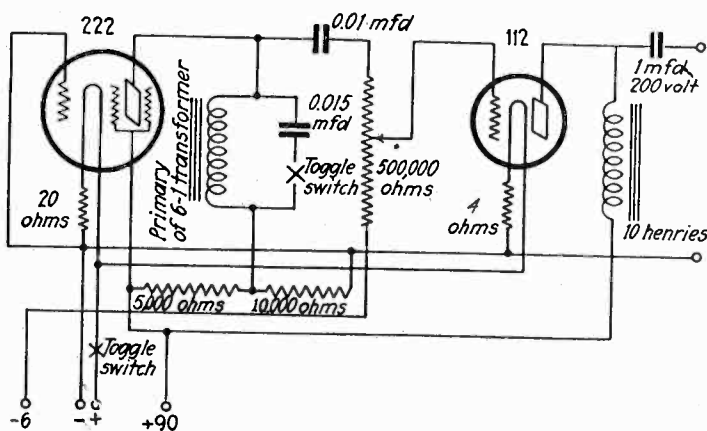

Circuit diagram of audio oscillator of the dynatron type

The UX-222 screen is used as a dynatron oscillator because of the simplicity of the circuit, the ease of oscillation at audio frequency, and the purity of wave form. Two resistors are used to place the correct plate voltage on the UX-222, and thus eliminate one battery tap and connection. The oscillator feeds through a voltage-controlling potentiometer to the output tube. The latter is used to isolate the dynatron from the load. A choke and condenser filter keeps the d.c. from the output.

The operating voltages shown are for a 222 and a 112 tube. A 171-A may be used for the output tube if a higher voltage is desired, since there is ample input from the oscillator. The new 2-volt 230-series tubes would be excellent for enhancing portability of battery supply.

Using the constants and apparatus as above, the two frequencies are approximately 415 and 1060 cycles. The 1060-cycle note increases 4 per cent with filament voltage change of 4.5 to 5.5 volts; and decreases 20 per cent with a 90 to 112-volt plate-voltage change. With 90 volts plate the output voltage range on a 13,000-ohm load is from overload on the 112, or about 30 volts peak, down to around 15 millivolts. Lower output can be obtained by using a potentiometer on the output. Higher output calls for a 171-A-type tube. The wave form of the 415-cycle output is shown in figure, accompanied by a 60-cycle timing wave. The film was taken with 22.2 volts r.m.s. across the primary of a stepdown transformer working into the oscillograph vibrator.

Continuously variable source of audio frequency
desired, a beat-frequency oscillator is a most
portable instrument. There are other times, however,
when a single audio frequency is needed, and a beat-
frequency oscillator is either too bulky or too expensive.
In such times a dynatron oscillator of the sort de-
scribed below is adequate. It has been designed to be
compact; to give a wide range of output voltages;
to give one frequency near the center of the musical
range and another near the center of the voice range;
to be nearly independent of the nature of the load; and
to give a sinusoidal wave form.
In times when a single-frequency audio source is

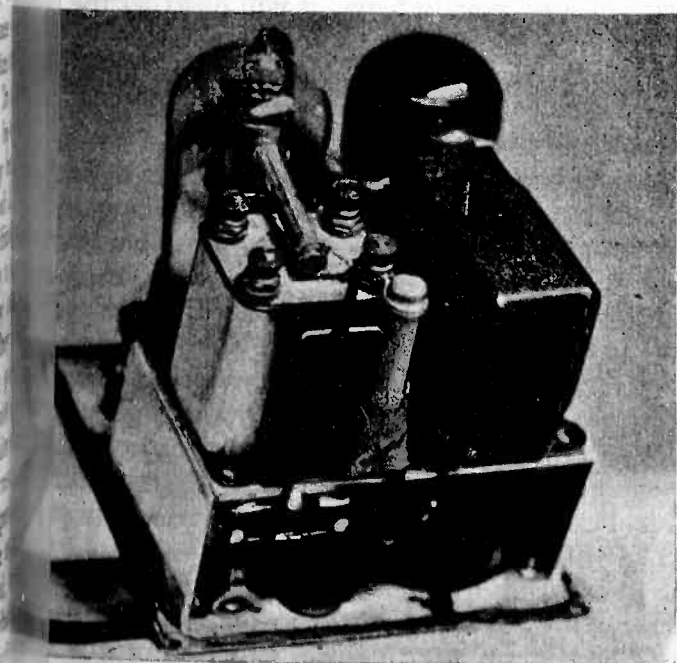

The oscillator is very compact; it is contained in a box five inches square

Phototube voltage supervisor

An aid to tube production

By W. P. KOECHEL*

EACH of the 40 test tables in the radio tube factory of the Ken-Rad Corporation, Owensboro, Ky., was until recently equipped with individual batteries, voltage controls, and voltmeters. Under these conditions, requiring constant attention and maintenance, it was extremely difficult to keep the test tables in such a condition that those tables testing similar apparatus would check each other consistently. To meet this problem, an automatic master voltage control has been developed which depends upon the simple action of a phototube. There are 17 different voltages in constant use for the grid, plate, and filament voltages of the tubes under test. These voltages now originate from a central bank of storage batteries, from which the desired voltages are tapped and carried to separate receptacles in the test tables.

The voltages are all adjusted and controlled from a central control panel, thus eliminating the voltmeters and

IN A tube manufacturing plant the problem of supplying correct and uniform voltages to the test positions is important. An ingenious solution is to apply a phototube to monitor these voltages and to give warning when abnormalities occur. The method can undoubtedly be applied to any production problem where movements of a current meter needle indicate a proper or improper condition.

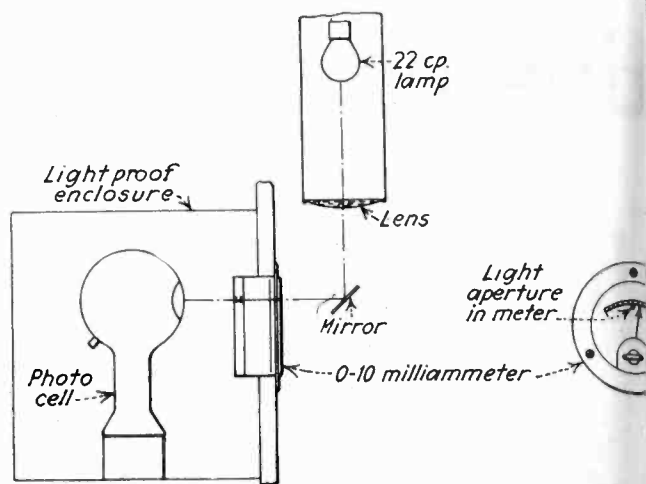

Arrangement of phototube and meter

voltage controls on the individual test sets. In that the 17 independent voltage settings at the control panel may be properly supervised, an ingenious automatic alarm system was devised whereby an alarm, both visual and audible, is given whenever voltage supply is higher or lower than its specified value. The accuracy of this scheme is such that an indication of one per cent above or below normal will give immediate alarm. This is accomplished as shown in the accompanying illustrations by the use of a phototube in conjunction with a master monitoring meter and a commutating device by which this monitoring meter is successively connected to each of the voltage circuits being supervised.

The master monitoring meter is an 0-10 milliammeter arranged by means of proper series resistors to read exactly 5 ma. whenever it is connected to any voltage for supervision providing that circuit is adjusted to normal voltage. At exactly the 5 ma. point on the scale of this meter a small hole is drilled through the dial and another hole exactly in line with it is drilled in the front of the meter. Over the front of the meter, suspended in a bracket, is a tubular case containing a 22 candlepower lamp and a suitable lens for focusing the light through the means of a mirror, on the aperture.

If the pointer of this master monitoring meter indicates any value other than 5 ma., the focused ray of light from the lamp will pass through the aperture on the scale and impinge on the phototube. However, when the pointer indicates exactly 5 ma., it will obstruct the path of the ray of light and the phototube will be "dark."

This phototube is connected to the input of a vacuum tube amplifier in such a manner that the action of the lamp on the cell will increase the negative bias on the amplifier tube and reduce the plate current to a negligible amount. In the plate circuit of the amplifier tube is a relay which is continuously energized as long as the phototube is in a "dark" condition. The operation of the phototube causes this relay to drop to the non-operative condition, thus energizing a second relay which in turn operates a pilot light and gong. This second relay also acts to connect the motor driving the commutating device. In addition, there are a number of small pilot lights, each voltage circuit being supervised. These small lights indicate which particular circuit is indicating an abnormal voltage.

The monitoring meter is connected in proper series with each circuit for about three seconds in every minute. The commutating device, mounted on the

*Engineer in charge of Test Department, the Ken-Rad Corporation, Owensboro, Ky.

control panel, consists of three of 20 contacts each, with three rotating arms. Two of these contacts make the connections to monitoring meters, while the other operates the alarm signals. The circuit is so arranged that the phototube alarm feature, the motor stops at that point and causes the pilot light to stay lit until the trouble is corrected. In order to prevent the motor from coasting beyond the commutator point after the current is cut off, an electric brake scheme is utilized, in which 110 v. a.c. is applied to the motor instant that the 110 volts a.c. is cut. This acts as a very effective and silent brake, and the rate at which the motor decelerates can readily be controlled by the applied d.c. voltage.

The accompanying diagram shows the apparatus connections.

In this master control system, the voltage values are adjusted manually at the control panel. As each circuit is supervised once every 80 seconds, it is

almost impossible for an abnormal voltage condition to persist. When the alarm is sounded, the faulty voltage is manually reset to its proper value.

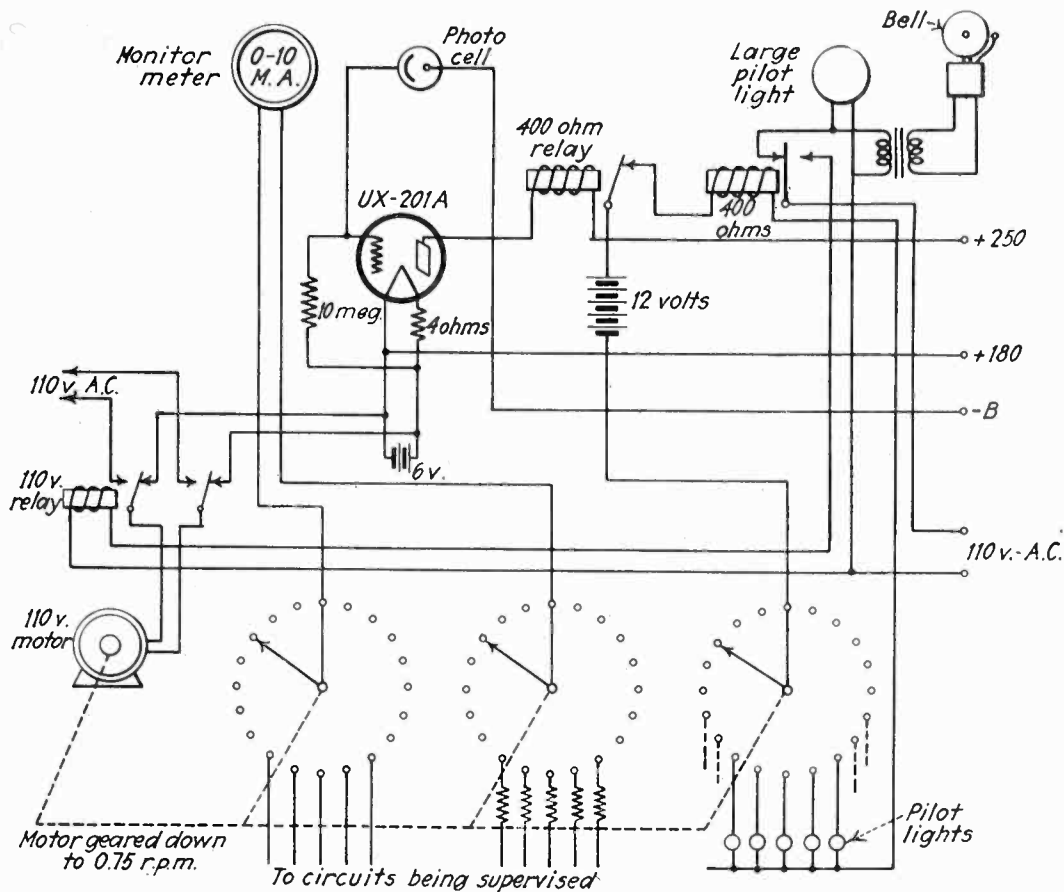

ELECTRONIC RECORDING OF HIGH-SPEED PROJECTILES

Applications of the photo-electric vacuum tube have been used in the testing of government equipment; in ways that may be of civilian and industrial uses. A photo cell, in one instance, serves as a powerful amplifier to obtain an accurate record of the time of flight of aircraft projectiles. The apparatus is so arranged that a spark causes a perforation in a paper which is carried on the slow-motion Aberdeen chronograph. When the gun is fired, the muzzle flash causes the pen to jump, and the burst of light from the projectile at a remote point of the trajectory causes the second spark. This apparatus has functioned satisfactorily in firing but with less certainty at any time, because of the great accuracy required.

A photo-electric cell has also been used in the measurement of velocity of projectiles. The apparatus is so constructed that when the projectile passes through a reduction in the light which is recorded by the cell is recorded by an amplifier on an oscillograph instrument. This method of measuring velocities is especially suitable for the measurement of the velocity of guns at angles of elevation too

great for convenient use of the solenoid chronograph.

To obtain a record of the impact of inert bombs on the ground in connection with ballistic data and also to record the delay of bomb fuses, a very sensitive apparatus based on vacuum-tube oscillations has been made. The ground shock from the impact of bombs, slight as it is, causes a change in the distance between two metal plates, whose capacity forms part of the oscillating circuit. This apparatus has been found sensitive enough to record

the impact of 17-lb. bombs on rather soft ground at a distance of 1,200 feet from the apparatus. The impact of heavier bombs can be recorded with certainty at a distance of a mile or more from the station.

For testing small arms a closed range for the purpose of obtaining a series of spark photographs at different points along the trajectory of a given bullet and of measuring the retardation by photo-electric cells has been constructed and is now being equipped at the Aberdeen proving ground.

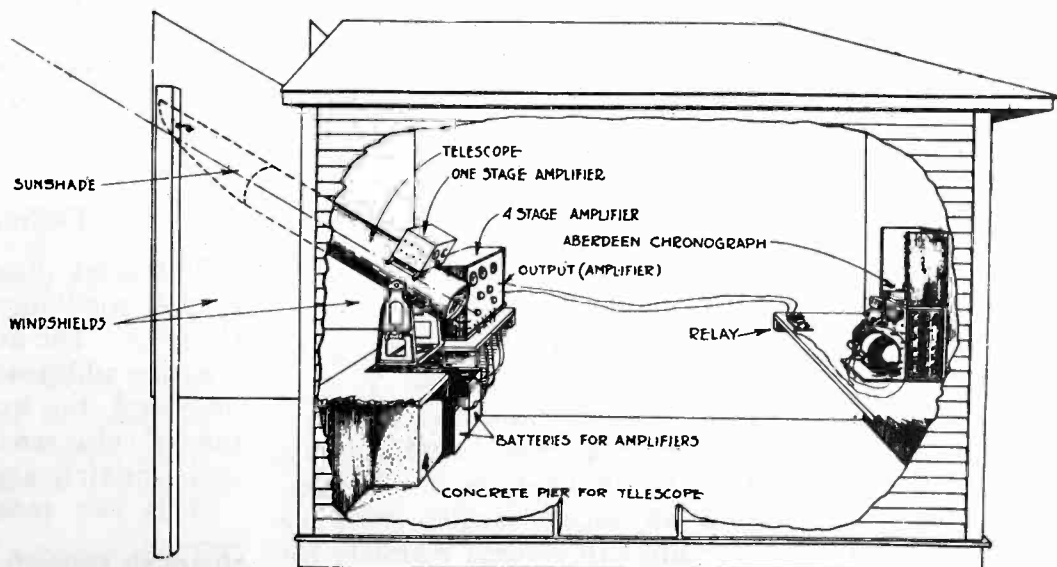

Acoustic and light characteristics of sound screens

By BARTON KREUZER*

DUE to the advent of sound motion pictures the choice of picture screens for theater use has become increasingly important. The factors governing the choice of a screen are several. They may be divided into two general classes, i.e., the merit of the screen judged by its technical performance, and its serviceability.

Under the latter class, such points must be considered as: the type, weight, and strength of the material, its inflammability, whether it collects dust easily and is difficult to clean, whether it will fade, crack or discolor and the amount of handling it will stand. The last point is of especial importance with beaded and mesh screens. All of the factors in this class may be tested both without a great deal of technical knowledge or equipment.

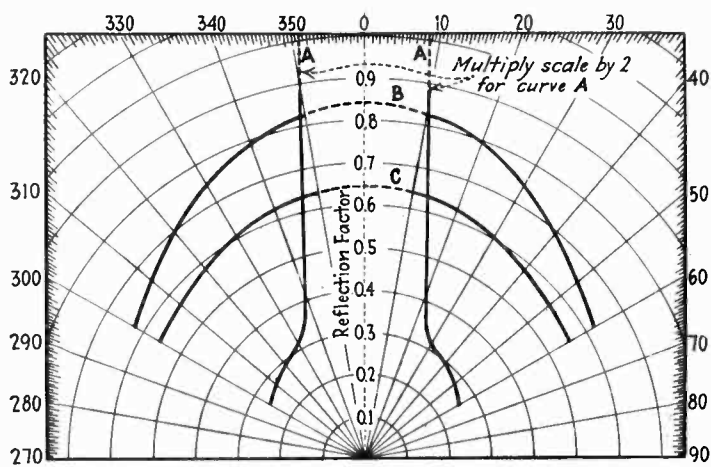

Fig. 1—Typical brightness curves for different screens. Note rapid “fadeout” of the beaded screen shown by curve A

The merit of a sound screen from a technical viewpoint is based on two characteristics. These are the “brightness” characteristic and the “acoustic transmission” characteristic of the screen. The “brightness” characteristic of a screen may be defined as the intensity of illumination of the screen plotted for various angles from the illuminating beam. There are two general methods for

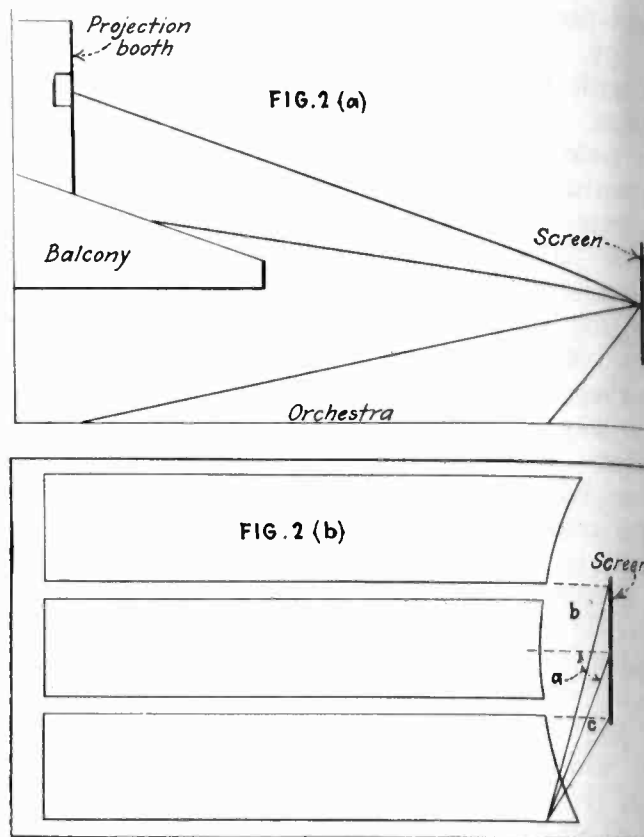

Fig. 2 (a), (b) Limiting projection and viewing angles in a theater. These angles determine the best screen from its light characteristics

obtaining the “brightness” curve for a screen. The first of these is by the use of some photometric comparing instrument, such as an illuminometer, where the observer is called upon to match two brightnesses. The second method is by the use of a photoelectric

Methods for obtaining light intensities

The photoelectric cell can be used in two ways. In one method it can be used “statically” to measure brightness at various angles of a normally incident beam. With a large resistance in the circuit the cell can be adjusted for linearity over a fair range of intensities and can be employed to vary the bias on a vacuum voltmeter.

In the second method if a rotating wheel cut is used to cause sinusoidal variations in the light intensity placed in the path of the incident light beam, a lower intensity source may be used, as a quite ordinary audio frequency amplifier will amplify the photoelectric cell output to the point where meter reading is convenient. This is much more convenient than the d.c. amplifier necessary with the same illumination for the “static” method. A greater linear intensity range is also available with the dynamic method since it may be polarized through a transformer eliminating any appreciable change of anode potential with incident intensity.

Difficulties in using photo-cells

The chief disadvantage of the illuminometer is the possibility of error introduced by the observer. The disadvantages of the photoelectric method are: the additional equipment, the greater light intensity necessary, the lack of uniformity of cell sensitivity, the cell color sensitivity characteristic which may vary quite unfairly against certain screens.

This last reason is important because in the

*Research engineer, RCA-Photophone, Inc.

the brightness of a screen is judged by the eye, the color sensitivity of which is a broad peak in the yellow portion of the spectrum with less response in the violet and red ends of the spectrum. Practically all of the present photoelectric cells, whether they merely possess a peak in the blue region, or whether they are yellow sensitive do not match the color sensitivity of the eye. Because of this a screen may be unduly bright at either end of the spectrum may be unduly dim at either end of the spectrum by accepting its rating from a photoelectric cell because the eye bases its judgment chiefly on the yellow region in which only very slight absorption occurs.

a visual (photometric) instrument method where the eye may have difficulty matching intensities of different color characteristics, yet, a small amount of experience will enable the observer to obtain accurate results by adjusting the instrument to secure a reading of the line of demarcation between the surface illuminated by the working standard and the image of the surface under test.

Another method the procedure is to cast a spot of light on the screen, free from color or filament image, and incident normally both horizontally and vertically. Measurements are then made of the brightness as close to the center as possible and progressively away from the center in a circle.

Obtaining typical brightness curves

The curves in Fig. 1 have been obtained with an audiometer in this manner and later checked with the photoelectric cell method. In some cases it may be desirable to take characteristics with the light beam at an angle other than normal, but usually the results of such measurements can be predicted from the normal curves.

The curves are plotted in polar form and are in terms of reflection factor.

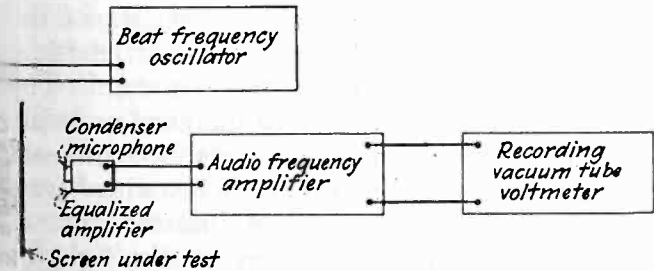

3—Set-up of sound measuring equipment for determining acoustic qualities of screens

“Reflection factor.” The use of a reflection factor provides a more intelligent understanding of a screen’s properties and makes direct comparisons of the reflection factor for a perfectly diffusing material with unity. Where curves rise above unity the screen is not paradoxical for a spherical distribution of sound is considered and at certain angles these surfaces may use light poorly and verge on direct totally reflecting surfaces. Conversion to a reflection factor is accomplished by taking readings on a standard spherical test plate whose reflection factor was

observed curves for representative screens are shown in Fig. 1. No actual points are shown to within 10 deg. from the normal because of the difficulty encountered when the test equipment is used with the light beam source.

Curve A shows the characteristics of a typical beaded

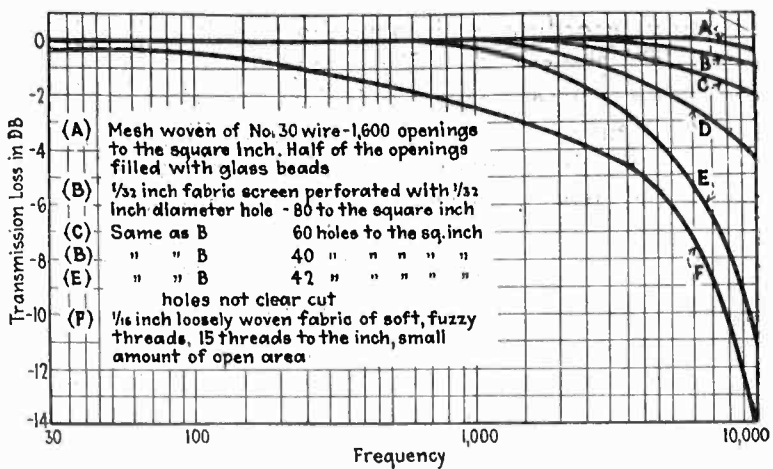

Fig. 4—Typical sound transmission curves showing losses in decibels for different types of screens

screen. Note the high value for the first few degrees and the rapid “fadeout” making it suitable for use only in a narrow theater where no patron will be at a very great angle from the normal. This type is preferred for a house with a large balcony since the point of maximum brightness always lies along the incident beam whether it be normal or inclined. With the light coming from a projection booth above the balcony this insures good screen illumination for the balcony seats. This type of reflection is due to the spherical globules used as “beads.”

Curve B shows the characteristics of a reflecting type screen. Note its greater uniformity over large angles and its freedom from “fadeout.” This makes it quite suitable for use in large, wide, theaters. With this type a maxima is observed along the incident beam with a slight, secondary maxima at the angle of reflection (an angle from the normal equal to the angle of incidence) due to a slight mirror effect.

The type of curve obtained from a diffusing screen does not differ appreciably from that of curve B except that when the light is not thrown on normally the slight maximum point occurs along the incident beam without any secondary maxima. It more closely approaches a perfect diffusing surface.

Curve C has been obtained from a special type of “beaded” screen. Here the “beads” are glass cylinders whose height is about equal to their diameter. These disks are embedded in the screen material and give a very uniform “brightness” characteristic although with reduced efficiency.

Figs. 2 (a) and (b) show the angles to be considered in choosing the right screen for a theater. In Fig. 2 (a) (vertical cross-section) the angles to be considered are obvious, but in Fig. 2 (b) (horizontal or plan view) the angle (a) not only of the furthest seat with the center of the screen must be considered, but also the angles (b) and (c) that opposite sides of the screen subtend at that seat. Care must be exercised not only to prevent distortion and “fadeout” due to the large possible difference between angles “b” and “c” but also to prevent fatigue to the eye due to great differences in the apparent intensity of illumination at these points.

Measuring acoustic characteristics of screens

The “sound transmission characteristic” of a screen is the variation with frequency of the sound transmitted through the screen. To obtain these characteristics response curves were taken on standard theater loudspeakers with a beat frequency oscillator, using sound

measuring recording equipment, both with and without a screen being present. By careful selection of an acoustically treated room and the use of many check curves, the effects of reverberation, standing waves, and "stray" reflections were successfully minimized. The screen when placed in front of the loudspeaker was put in exactly the same position as it would be in a theater installation. This meant that the screen was sufficiently removed from the speaker mouth to prevent any reaction upon the speaker which might alter its response and lead to incorrect measurements. It will be noted that the curves obtained in this manner were quite regular and smooth.

The schematic diagram of the sound measuring equipment is shown in Fig. 3. The beat frequency oscillator has a logarithmic variation of frequency from 30 to 10,000 cycles with uniform rotation of its dial. Its output is fed to the stage type loudspeaker, consisting of an electro-dynamic cone unit, and a directional baffle. In front of this is the screen under test. The sound pressure is converted by the condenser microphone into electrical energy and amplified in an associated amplifier which is equalized to correct for the frequency characteristic of the microphone. After further amplification the output is fed to a vacuum tube voltmeter. A drum carrying logarithmic frequency paper is geared to the beat frequency oscillator. As the frequency is varied this drum revolves and an ink trace is left by a pen connected by linkwork with a pointer pivoted over the output meter of the voltmeter. By means of a handle attached to this system the observer is able to make the pointer follow the variations of the meter and leave a trace on the drum proportional to the speaker response at any point over the frequency range.

The relatively linear vacuum tube voltmeter (any slight non-linearity is corrected in the mechanical system) is obtained by using a UX-864 with $E_p = 45$ volts, $E_g = -3.0$ volts, making the output meter insensitive

▼ ELECTRONIC MUSIC IN THE SPOTLIGHT

THE musicians in a symphony orchestra, the performers in a popular band, and the musical artist in the home, have suddenly found a strange and startling novelty—the electrical musical instrument. Into the realm of music, where for so many centuries instrumental progress has been largely along conventional and time-honored lines, the electron suddenly comes to the middle of the stage and waits for the spotlight of public interest which soon will blaze upon it.

—DR. A. N. GOLDSMITH

by shunting it down and using a large input. This may even drive the grid positive. Linearity is achieved for individual tubes by the variation of a series resistor of from 5,000 to 20,000 ohms. With a former input this may not be necessary.

Types of sound screens available

Fig. 4 shows the sound transmission characteristics of several screens. These curves show the decibels for different screens under test. In general screens are 100 per cent efficient for the lower frequencies and then gradually fall off. This is comparable to the situation in an electrical transmission system where a series element which reduces the current flow 30 per cent at 5,000 cycles may not cause any decrease below 500 or 1,000 cycles that can be measured by conventional instruments.

Curve *A* in Fig. 4 shows the transmission for a screen with a "mesh" backing. This is ideal for sound measurements but unfortunately it is one of the beaded screens whose characteristic is of the type shown by curve *D* in Fig. 1. This naturally limits its use. Curve *B*, *C* show the characteristic of well-perforated screens with satisfactory brightness qualities. These are very good screens.

Curve *E* shows the characteristic of a poorly perforated screen. The holes in this screen were not cut.

Curve *F* shows the absorption in a woven screen due to the use of soft "fuzzy" thread. Lint from the thread blocks the openings in the material and causes dissipation of the sound.

The electrical analogue of the usual sound screen can be considered as an inductance of very slight resistance placed in series with a transmission network. The values of the inductance and resistance are a function of the dimensions of the holes in the screen and their density. The values of inductance and resistance increase as the holes become tube-like, i.e., as their length approaches or becomes greater than their diameter. This is due, of course, to the thickness of screen material or small holes. The value of resistance may also be increased in the presence of poorly perforated holes with "frayed" edges or holes clogged with lint or dust to cause dissipation. The effect of the perforations on the light quality of screens is approximately linear, i.e., with 10 per cent of the screen area occupied by perforations the reflection factor at any angle is reduced to approximately 90 per cent of its value for an unperforated like surface.

The effect on sound transmission is different, however. This same percentage of holes may transmit as much as 80 per cent of the sound at 5,000 cycles.

Although a slightly lowered reflection factor can be overcome usually by greater light from the projection booth the perforations introduce an intangible effect on the picture because of the "greying" of the screen surface. This is due, very often, not only to the screens themselves but also to the view of the darker material forming their side walls, which the audience may unconsciously perceive.

It is obvious that good screens require the highest technical skill in design. To be quite ideal a screen should have a high reflection factor reasonably constant over large angles, be free from diffraction and scattering, reflect light, and transmit sound satisfactorily up to 10,000 cycles, as well as be sufficiently rugged to withstand theater use.

importance of phase control in synchronizing

C. W. HORN*

SYNCHRONIZATION of two or more broadcasting stations transmitting the same program involves the solution of two important problems, that of keeping stations on the same carrier frequency, and that of keeping them at some constant phase difference with respect to each other. While it has been recognized that carrier frequencies must be identical and must be kept so, it is only recently that the importance of phase difference was discovered. This phase difference need not be zero, it can, as a matter of fact, be anything so long as it is unvarying, or at least varies at a constant rate.

For a number of years, WBZ and WBZA have been "neutralized," i.e., they have been on the same carrier frequency and have transmitted the same program simultaneously with each other without noticeable interference to each other. Here, however, conditions were such as to be generally experienced. Ordinarily any two stations operating on approximately or even exactly the same frequency created an area between the stations in which considerable distortion was evidenced. This distortion was due to the fact that the ground waves of the two stations at times opposed each other, thus giving a resultant strength of signal which was very low; while at other times they might aid each other by being in phase, thus creating a stronger signal.

The WBZ installation

In the WBZ-WBZA area, however, there were special favorable conditions operating in the region between the two transmitters, in which listeners would not experience "mush" where neither station can be heard, and so nothing was lost so far as they were concerned. At the same time, neither station is able to transmit its carrier over the barrier which exists.

Experiments have been conducted for a number of years to determine the feasibility of synchronizing low-powered stations as WEA, WGY, and WJZ. On a number of occasions these stations were kept together transmitting the same program under the same technical conditions as exist at WBZ and WBZA, i.e., frequency synchronization. Peculiar re-

*Engineer, National Broadcasting Company, Inc.

sults were at once apparent which made it evident that maintenance of the same carrier frequency was not sufficient no matter how exactly it was performed.

For example, within the service area of WEA, bad interference was experienced from the other two stations when all were transmitting identical programs on the same carrier. It was evident that the carrier waves of the other stations were destroying the program emanating from the local station, WEA.

When, however, the stations were maintained not only at the same frequency but in a fixed phase relation, several important and encouraging events transpired. No longer was the program coming to local listeners from WEA disturbed; the mush area disappeared, and those listeners in this area experienced an increase in local field strength. Apparently when one of the stations was fading out, another, or both of the others might be fading in. It was certain that the average field strength was no worse and nearly always better—some of the fading hollows had been filled in.

Neutralized point of interference

At various places out in this area, usually characterized by "mush," the ground waves of two stations may create what might be termed a "neutralized point" if they meet head on and are 180 degrees out of phase. Theoretically, no field strength exists at this point but fortunately such a "neutralized point" is sharply defined, and of only a few meters extent. Therefore, any ordinary antenna will cover an area greater in extent, and thus will receive sufficient energy. Experience indicates that so long as the phase displacement of the synchronized carriers is constant or varies very slowly, the listener will be better off than if the stations were not synchronized. Depending upon location and distances, the listener will benefit by a better average field strength, because it is unlikely that all of the synchronized stations would fade out at the same moment—even in this contingency, reception would be in no way worse than if only a single station were transmitting the program on that particular frequency.

Thus far we have looked only at the technical problem and the results of experiments carried out with the cooperation of the National Broadcasting Company, the Radio Corporation of America, and the American Telephone and Telegraph Company. The difficulty of putting into practical operation any number of synchronized stations, whether to cover sections of the country or the whole country, is one that must be studied carefully in each individual case, for it involves many factors, including wave allocations and more particularly, highly important economic considerations.

▼

THIS statement by the engineer who for years has been studying and advocating "synchronizing," tells how the dream of all broadcasting engineers has at last been achieved.

▲

Voice number calls from dial phones

By PAUL B. FINDLEY*

FUNDAMENTAL research in the fields of electronics and thermionics has long been conducted by Bell Telephone Laboratories and has resulted in such devices as the telephone repeaters which make possible long-distance telephony. A recent and extremely interesting development in this field is the "call announcer," which transforms into speech the pulses produced when you dial a telephone number.

The necessity for apparatus of this nature is a result of the present transition period from manual to dial operation of telephones. If you were to dial the number of a telephone connected with a manual exchange, you would cause a series of pulses to pass over the wires to an operator in that exchange. These pulses, however, are absolutely unintelligible to the operator, and there must be present some means of translating them into a signal which she will understand and which will give her sufficient information to set up the desired connection.

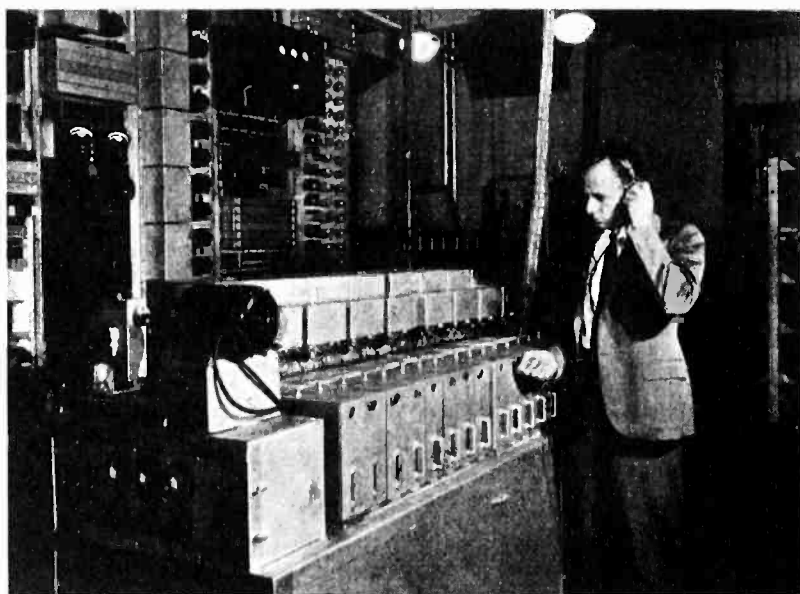

The "call announcer" in use. Below the motor-driven sound-film units can be seen the associated amplifiers. At the left are operating meters and controls

When this problem first arose, it was solved by use of "call-indicators" in which the pulses from telephones caused certain numbers and letters to be played before the operator. There were limitations in the use of this apparatus, however, and it became necessary to develop supplementary apparatus. Due to the work of the Laboratories on sound-picture systems, the use of the available considerable sound-picture apparatus, investigation was therefore made of the possibility of translating dial pulses into speech.

The result of this work was the call-announcer, as finally developed, consists of eight drums. One of these is a spare and the other seven carry on their edges fourteen strips of film, on each of which is recorded one of the ten digits or one of the four letters, J, M, R, W. These drums are mounted on a common shaft and driven by a small motor. In front of each film is a small lamp which is focussed on the film and behind the film and within the drum is a photo cell of the type developed for sound pictures.

For any apparatus designed for use in the telephone system, length of life is very important. For the call-announcer makes it possible to clamp the short strips of film to the drums, thereby eliminating the friction and wear of the sprockets and gates, which is unavoidable in showing sound pictures. Under the conditions in which the call-announcer is used, film need be replaced more than once a year.

Long life of tube and film elements

The question of replacements also arose in connection with the lamp and photoelectric cell, which, as in a sound-picture projector, have a life of about 100 days. In a call-announcer, due to their continuous use, these elements would have to be replaced too frequently for economical operation, and a departure from sound-picture operating technique has therefore been made for the purpose of decreasing the necessary number of replacements. This departure consists in operating the lamp at a lower illumination level, thus obtaining a longer life for lamp and cell. As a result, the average life of these elements in a call-announcer under normal conditions is about 200 days.

Due to the lower illumination level of the lamp, however, the current from the lamp is of much lower intensity than in sound picture practice. For this reason a three-stage amplifier is associated with each of the fourteen systems, and is located immediately beneath the drums. On passing through these amplifiers, the current is raised about fifty decibels and fed into telephone repeaters which act as final amplifiers.

When a subscriber dials a number, the number is recorded on relays in the sending mechanism, which remains stored until the operator who is to complete the call is free to do so. She then pushes a button which operates relays in which the number is stored, actuates other relays and cuts in the proper films in the correct sequence to announce to the operator at the manual board the number which has been dialed.

Development work on this machine has been completed and numerous tests have been made of its performance. It is expected that a number of these machines will be placed in service before the end of the year.

*Bell Telephone Laboratories, 463 West St., New York

Simplified method of

measuring

broadcast

harmonics

E. C. MILLER*

of producing cross-talk and heterodyne interference with distance stations whose signals are of comparable magnitude. Such interference is of course caused by harmonics of stations operating in the channels between 550 kilocycles and 750 kilocycles, and 1,100 and 1,500

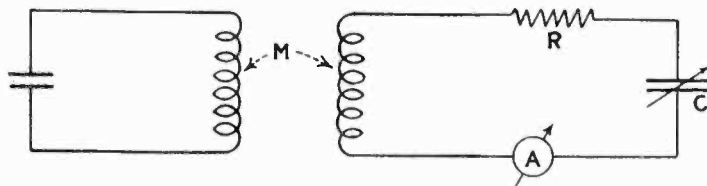

Fig. 1—Wavemeter circuit for harmonic measurement of broadcast stations

kilocycles. However it is also well to consider the reduction of the second harmonic of the latter group. The third and succeeding harmonics of broadcast transmitters may, due to their successively weaker generation be neglected. Notwithstanding the high percentage of modulation usually obtained in present transmitters, the trend toward powers of the order of 50 and 100 kw. presents a serious problem in the adequate reduction of harmonics. Probably for powers of this magnitude a reduction of the second harmonic to 0.01 per cent is essential, but for the average transmitter a value of 0.05 per cent is sufficient. It is the purpose of this article to describe a simple method of measuring harmonic percentages in a transmitter or r.f. oscillator.

Determination of harmonic output

While the determination of harmonic percentages of broadcast transmitters is probably best effected by the use of field strength measurements at a distance from them, such equipment and facilities are not always available, so that the subject is likely in some instances to be neglected.

An ordinary selective wavemeter may be employed for the detection. A knowledge of its constants permits the calculation of the percentage of the harmonic current to that of the fundamental in the tank and antenna circuits of the transmitter or in the tuned plate circuit of an r.f. oscillator. A wavemeter coupled as shown in Fig. 1 to an r.f. generating circuit containing harmonics will reveal a current versus frequency characteristic as shown in Fig. 2. The current curve of gradual slope is that due to the fundamental, while the current humps are produced by the various harmonics, whose numbers are multiples of the fundamental frequency. The fundamental current in the wavemeter is with sufficient accuracy the mean of the two cut-off currents, while the harmonic current in the wavemeter is the difference between the maximum current at the harmonic, and the fundamental current. The numerical ratio obtained directly by these measurements is not the actual ratio of fundamental to harmonic existing in the primary, or generating circuit, but by taking into account the coupling and tuning conditions the ratio of primary or generating currents of harmonic and fundamental frequencies is equivalent to the ratio of secondary or wavemeter currents of fundamental and harmonic frequencies, and from this ratio the percentage of harmonic to fundamental may be readily determined.

Considering the case of inductively coupled circuits

*Assistant engineer, Buffalo Broadcasting Corporation.

A BROADCASTING station to be as effective as possible must transmit into the ether as much power as possible on its fundamental carrier frequency and as little as possible on any of the harmonics of this frequency. In considering this radiation of harmonics from a broadcast transmitter, cognizance must be taken of their relative strength. A five kilowatt transmitter will produce a field strength of 100,000 microvolts per foot at a distance of from four to five miles over flat unobstructed terrain. If the harmonic percentage radiated is one per cent, a field strength of 200 microvolts per foot is laid down for the harmonic at the same distance. In many sections of the country, signals of this magnitude are the maximum available.

In an area of about three miles of such a station, a strong harmonic signal can be expected to harass the listener. At night these intensity ranges are greatly increased, causing comparatively strong signals capable

Calculation of Harmonic Percentage

POWER AMPLIFIER TANK

—Wavemeter Currents—									
Low-Freq. Cut-Off, ma.	High-Freq. Cut-Off, ma.	I' ma.	Max. Cur. ma.	I'n ma.	Rn Ohms	$n(n^2-1)$	ωL Ohms	$\frac{I_n}{I}$	Per Cent Harmonic $100 \times \frac{I_n}{I}$
48	46	47	86	39	15.5	6.	629.	.0033	.33

ANTENNA CIRCUIT

—Wavemeter Currents—									
Low-Freq. Cut-Off, ma.	High-Freq. Cut-Off, ma.	I' ma.	Max. Cur. ma.	I'n ma.	Rn Ohms	$n(n^2-1)$	ωL Ohms	$\frac{I_n}{I}$	Per Cent Harmonic $100 \times \frac{I_n}{I}$
74	72	73	103	30	15.5	6.	629.	.00168	.168

as in Fig. 1 it is found that when the secondary circuit resonates at the harmonic:

$$I' = \frac{I\omega M}{\left(\omega L - \frac{1}{\omega C}\right)} \quad (1)$$

and

$$I'_n = \frac{I_n\omega_n M}{R_n} \quad (2)$$

where I' and I'_n = secondary currents of fundamental and harmonic frequency respectively.

n = harmonic number.

M = mutual inductance between primary and secondary.

R_n = secondary or wavemeter resistance at harmonic n .

Taking the ratio of these expressions and solving for the primary current ratio:

$$\frac{I_n}{I'} = \frac{I'_n}{I'} \times \frac{\omega}{\omega_n} \times \frac{R_n}{\left(\omega L - \frac{1}{\omega C}\right)} \quad (3)$$

When the secondary is tuned to the harmonic, $\omega_n L = \frac{1}{\omega_n C}$. Remembering that $\omega_n = n\omega$, eq. (3) reduces to

$$\frac{I_n}{I'} = \frac{I'_n}{I'} \times \frac{R_n}{\omega L} \times \frac{1}{n(n^2 - 1)} \quad (4)$$

The measurements and calculations may readily be tabulated on a form similar to that given in the table. The figures given are actual measurements on a 1,000-watt transmitter operating on 550 kc. before steps were taken to reduce the harmonics. The measurements were taken in the power amplifier tank and in the antenna circuit.

It must not be forgotten that if the indicating meter

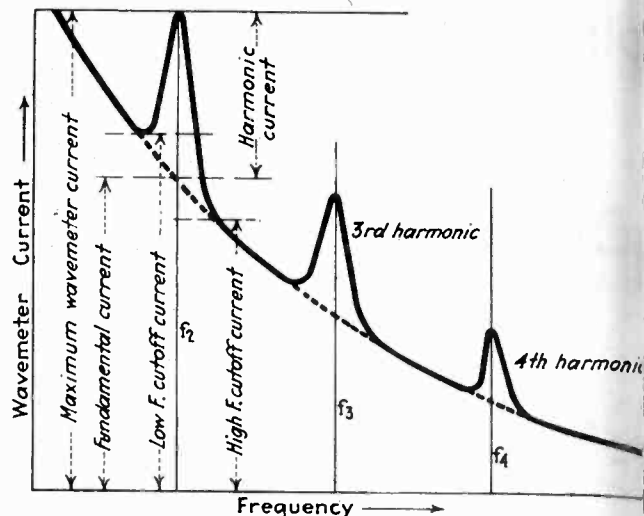

Fig. 2—Current-frequency response of wavemeter to transmitted wave

is a current-squared instrument, the square root readings ratio is to be substituted for I'_n/I' in eq. (4). It is to be noted that the wavemeter should be fixed coupling with respect to the primary for all measurements at any one harmonic, but may be moved close to the secondary for measurements at other harmonics if necessary to obtain sufficient meter deflections. The measurement of harmonics by means of the above method has been used on several broadcast transmitters and oscillators, and has been found convenient in determining the effective harmonic suppression schemes.



NEW BOOKS ON ELECTRONIC SUBJECTS

Recording sound for motion pictures

Comprising 25 special papers covering the fundamentals of sound recording. McGraw-Hill Book Company. Profusely illustrated. Price \$4. Published this Autumn.

THIS VOLUME represents the combined papers of 25 leading authorities in the sound picture industry. It is the outgrowth of a special course on fundamentals of sound recording and technique as given under the supervision of the Academy of Motion Picture Arts and Sciences, Hollywood, Calif. The contents include an introduction by William C. De Mille, president of the academy, and 25 chapters covering the following general subjects: Sound recording equipment, the film record, studio acoustics and technique; and sound reproduction.

The appendix includes a very complete glossary of technical terms which answer every possible question covering the technique of motion pictures. The glossary alone is a small dictionary, and worth the price of the book. All chapters are profusely illustrated, with circuit diagrams and photographs of

special sound equipment.

"Recording Sound for Motion Pictures" should be the official reference and instruction book in the library of all technicians in the various branches of motion picture production, projectionists, exhibitors and engineers in the electrical and related professions.



An introduction to the study of wave mechanics

By Louis De Broglie, D.Sc., Paris, translated by H. T. Flint, D.Sc.; E. P. Dutton & Co., New York. 246 pages. Price \$4.25.

THIS VOLUME SHOULD clarify in the mind of the advanced student of physics the various theories proposed in explanation of the newer puzzles of wave mechanics. Price De Broglie, winner of the Nobel prize for Physics in 1929, has outlined the mathematical development of most of these theories and has indicated at what points the conceptions are no longer satisfactory. He discusses clearly and in sufficient detail the theory of Jacobi, the conceptions underlying wave mechanics, the equa-

tions of propagation of the wave associated with a particle, the principle of interference, the diffraction of particles by crystals and the scattering of charged particles by a fixed charge. The theory of Bohr and Heisenberg on the propagation of waves, the stationary states of atoms, the quantization of motion from the point of view of wave mechanics, the meaning of wave mechanics, the meaning of waves of quantized systems, etc.

The author appears to favor the interpretation of Bohr and Heisenberg. He holds that the wave does not represent a physical phenomenon taking place in a region of space; rather it is a symbolic representation of our knowledge about the particle. In conclusion, he says: "The physical interpretation of the new mechanics remains an extremely difficult question. However, one great fact is now well established; this is that for matter and radiation the dualism of waves and particles must be admitted, and the distribution of the particles can only be foreseen by the theory of waves. Unfortunately, the true nature of the two mechanisms is still a mystery."

Output

Transformer

Design—Part II

D. C. HITCHCOCK
W. O. OSBON*

THE first part of this article (November 1930 *Electronics*) the general aspect of transformer design was discussed, the mathematics of transformer design was given and the general groundwork laid for design which is discussed in this article.

Fig. 1 is an alignment chart giving the relationship between f_o , R_p , and L_p based upon the ratio $\omega L_p/R_p = 1$ discussed in Part I. Let us now consider a typical case where the primary must carry steady plate current usually does. Under this condition the design of transformer is a simple matter since a direct method has been developed by C. R. Hanna for calculating coils and transformers which carry direct current. Design curves shown in Fig. 2 for 4 per cent silicon steel and for hipernik (50 per cent nickel and 50 per cent iron), respectively, are taken from his paper.¹ In the curves the notation is as follows:

- L_p Inductance of coil in henries.
- I Direct current in amperes.
- V Volume of iron core in cm.³
- N Number of turns.
- l Mean length of magnetic circuit in cm.
- a Length of air gap in magnetic circuit in cm.

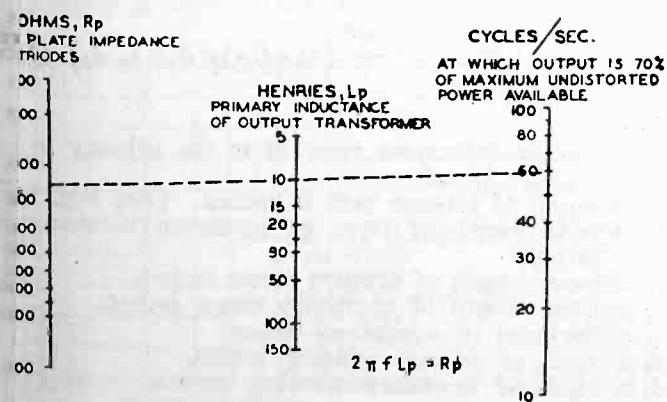

Fig. 1—Alignment chart for determining primary inductance

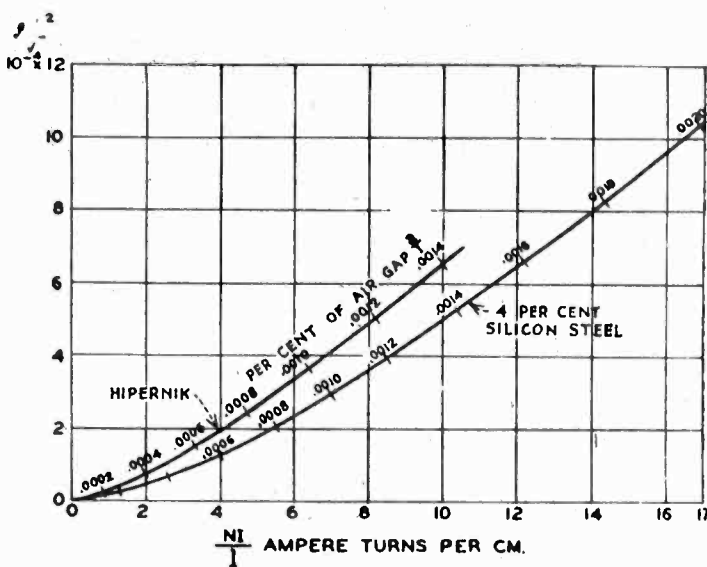

Fig. 2—Design curves for 4 per cent silicon steel and for hipernik

The value of the inductance is determined as outlined in Part I and the amount of the direct current is known when the output tube is decided upon, so that the quantity $\frac{LI^2}{V}$ can be found for an assumed value of core volume. The corresponding values of ampere turns per centimeter, NI/l , and per cent air gap, $\frac{a}{l}$, are read from

the curve for the particular kind of iron being used. The required length of air gap to be inserted in the magnetic circuit and the number of turns are then readily determined. It may be that in order to get the required number of turns in the window of the core selected, the size of wire will have to be so small as to make the resistance of the winding excessive. If this is the case, either the volume of the core must be increased by stacking the punchings higher or punchings with a larger window must be used. If the volume or mean length of core are changed, it will be necessary to go through the calculations for N and a again.

When the transformer is to work out of a push-pull stage, it is customary to assume 10 per cent unbalance in the plate currents of the two tubes. For example, with a UX-250 push-pull stage, a difference in plate current of 0.0055 amperes would be assumed for the two tubes. This current flows through only half of the winding, which is equivalent to 0.0027 amperes through the total winding. The value of current to be used in calculating the number of turns is, therefore, 0.0027 amperes.

Several writers^{2,3} have worked out design curves similar to Mr. Hanna's for other kinds of core material.

In the arrangement using a combination of output choke and transformer, there is no direct current in the transformer primary. The calculation of a coil under such conditions is not as easy a matter as one might think. The formula for the inductance is simple enough, being merely—

$$L = \frac{0.4\pi N^2 A \mu}{l}$$

The question which arises is, of course, the value to use for the permeability μ . The permeability is affected by a number of factors, such as the magnitude of the

*Research Department, Westinghouse Electric & Manufacturing Company.

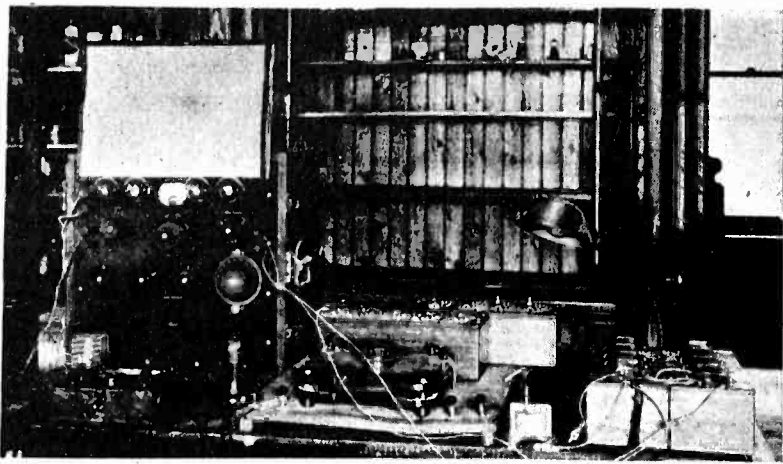

Transformer testing equipment used by author

signal current flowing through the winding, the amount of handling and bending the iron has received, and its previous magnetic history. A fourth important factor is that unless the core is made up of ring punchings instead of E or L punchings with lap joints, there will always be a small air gap in the magnetic circuit which will affect the apparent permeability of the iron. None of these factors are definite, so that the permeability and hence the inductance, are also indefinite quantities.

These factors also affect the permeability in a transformer which is carrying direct current, but where an

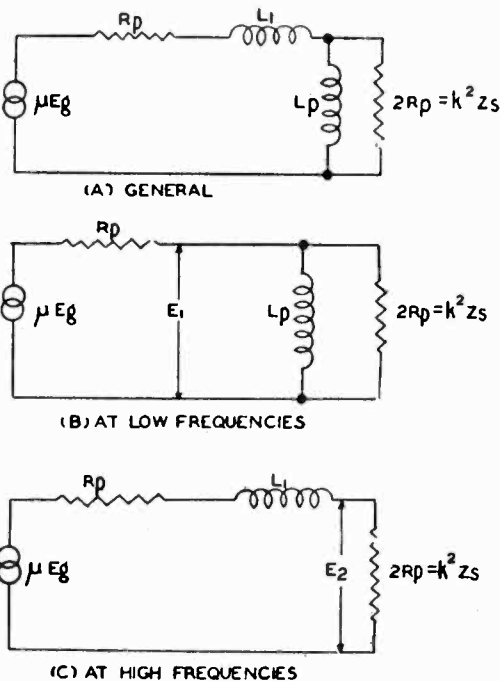

Fig. 3—Equivalent circuit of output stage

appreciable gap is purposely inserted in the magnetic circuit, and where there is a relatively large and definite value of steady magnetization, the effect is not nearly so pronounced.

It has been the experience of the writers that, under conditions ordinarily met with in practice, the inductance of a transformer primary when it is carrying a small amount of direct current does not differ greatly from the inductance when there is no direct current. Under conditions where the difference is appreciable it is always to the advantage of the coil without direct current. A paper by Prof. H. M. Turner⁴ presents some excellent data confirming these statements.

In view of the above it has been customary with the authors, when designing transformers which do not carry

direct current, to assume that there is a small amount of direct current flowing through the winding. The procedure is then the same as has already been outlined. For ordinary output transformers a current of 3 to 5 milliamperes is suitable.

Effect of leakage inductance

At high frequencies ωL_p becomes large compared to $9R_p$, so that the equivalent circuit of Fig. 3-A reduces to that shown in Fig. 3-C. The voltage drop across the load at high frequencies is—

$$E_2 = \frac{2R_p \mu E_g}{3R_p + j\omega L_1} = \frac{2R_p \mu E_g}{\sqrt{9R_p^2 + (\omega L_1)^2}} \dots (1)$$

At low frequencies $(\omega L_1)^2$ becomes negligible compared to $9R_p^2$, and E_2 attains its maximum value, $E_m = 2/3 \mu E_g$. The voltage across the load expressed as percentage of the maximum is, therefore—

$$\frac{E_2}{E_m} = \frac{1}{\sqrt{1 + \frac{1}{9} \left\{ \frac{\omega L_1}{R_p} \right\}^2}} \dots (2)$$

Here again the power is proportional to the square of the voltage, so that the percentage of maximum undistorted power delivered to the load is given by—

$$\frac{P_2}{P_m} = \left\{ \frac{E_2}{E_m} \right\}^2 = \frac{1}{1 + \frac{1}{9} \left\{ \frac{\omega L_1}{R_p} \right\}^2} \dots (3)$$

Formulas (2) and (3) are represented graphically by Curves 1 and 2 of Fig. 4 respectively.

Fig. 5 shows the calculated curves for two typical output transformers. Transformer No. 1 was for a push-pull circuit and its leakage inductance was 0.152 henry. Its response is quite satisfactory. Transformer No. 2 was for a single tube and its leakage inductance was 0.288 henries. The low R_p out of which it works at the high value of L_1 combine to make its response at high frequencies very poor. On the other hand, this poor response may have been intentional, for this particular transformer is used with a loud speaker which has prominent peak in its response at high frequencies.

Leakage inductance

Fig. 6 shows a section through a typical output transformer. E. G. Reed in his book, "Essentials of Transformer Practice,"⁵ has developed an approximate formula for the leakage reactance of a transformer which when modified to suit our needs, takes the form—

$$L_1 = 1.05 \times 10^{-6} \frac{N^2}{l} (3lgG + l_p d_1 + l_s d_2) \dots (4)$$

where:

- L_1 = leakage inductance referred to the primary in henries
- N = primary turns.
- l = length of leakage path in inches. (See Fig. 5).
- l_p = mean length of layer of insulation between windings in inches.
- l_p = mean length of primary turns, inches.
- l_s = mean length of secondary turns, inches.
- g = thickness of insulation, inches.
- d_1 = depth of primary winding, inches.
- d_2 = depth of secondary winding, inches.

It will be noted that the terms $l_p g$, $l_p d_1$ and $l_s d_2$ are respectively the cross-sectional areas in a plane perpendicular to the magnetic flux.

to the coil axis of the in-
 the primary winding and
 secondary winding. Values
 average inductance calculated
 is formula agree satisfac-
 with actual measured

value of this formula lies
 usefulness in checking a
 former design to see if its
 frequency response will be
 satisfactory. If the designer of
 former No. 2 in Fig. 5 had
 the formula, he would have
 said that this leakage induc-
 was high and could have
 steps to lower it, had he
 it desirable. Assuming
 thickness of insulation
 ed, there are two ways he

heave done this. First he could have split one of
 windings into two sections and interleaved the other
 between them. Or, he could have reduced the
 of primary turns and then compensate the de-
 primary inductance by using a larger core.
 example, from Fig. 4 we see that to get 70 per
 the maximum power requires that $\omega L_1/R_p = 2$.
 re satisfied with 70 per cent at 5,000 cycles, the
 inductance may be no more than—

$$L_1 = \frac{2 \times 1,800}{6.28 \times 5,000} = 0.115 \text{ henries.}$$

n 4 shows that L_1 varies as the square of the
 of turns, so that in order to reduce L_1 from
 0.115 henries it is necessary to decrease the

of turns by a factor $\sqrt{\frac{0.288}{0.115}} = 1.58$. The
 inductance is reduced in the same ratio as the
 inductance, and the primary inductance varies
 the first power of the core area, so that it is
 y to increase the core area by $(1.58)^2$ or 2.5
 n order to retain the same value of primary
 inductance.

information presented in the foregoing para-
 although specifically applicable to the output
 former, may also be applied to other forms of
 devices. For instance, the same considerations
 ratio and primary inductance apply as well to the
 of an output choke as to a transformer. If the
 not tapped, however, it is an auto-transformer of
 ratio, so that its primary and secondary windings
 identical and occupy the same space. There is then,
 leakage flux between the two windings and the leak-
 inductance is zero. In the case of the tapped choke

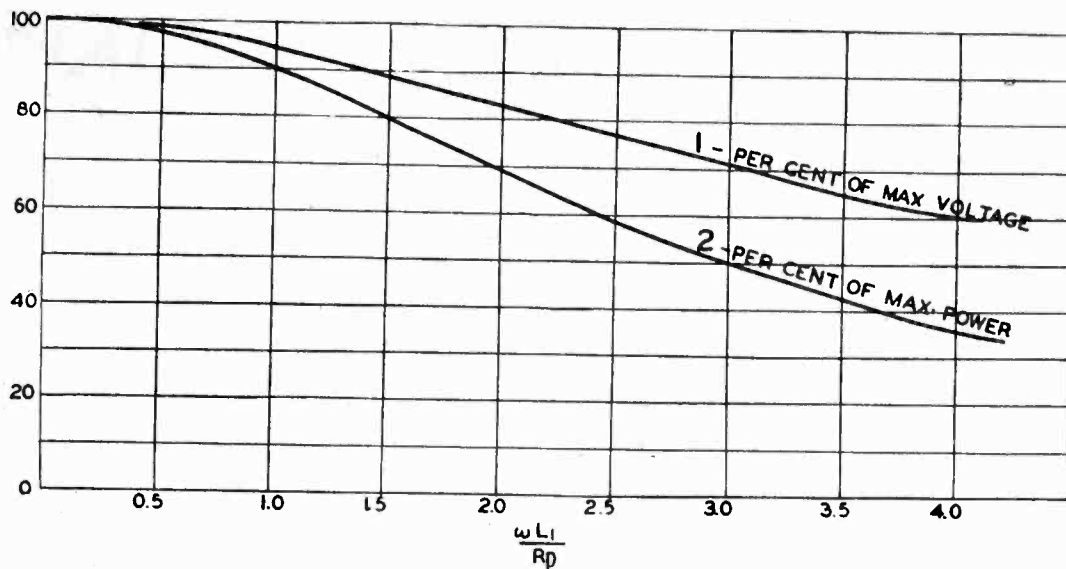

Fig. 4—Effect of leakage reactance of an output transformer

there will be a leakage flux between the primary and secondary, but the formula for calculating the leakage inductance given above will not apply in this case.

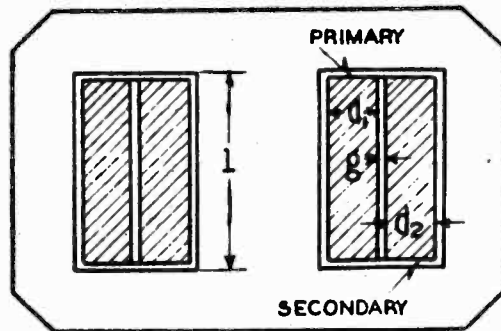

Fig. 6—Section through typical output transformer

Another formula must be developed using the same method as was used in the text referred to previously.⁵

When an output choke and condenser are used in combination with a transformer, the inductance of the choke, with the plate current flowing through it, should be at least as great as the primary inductance. The blocking condenser in such a circuit must be large enough so that its reactance at the lowest frequency it is desired to reproduce is low compared to the primary equivalent of the loud speaker impedance.

This type of output circuit has a very distinct advantage over the one using an output transformer alone. It is generally used with a single output tube where the direct plate current is considerable. By shunting this plate current through the choke coil, the number of primary turns necessary to give a suitable value of primary inductance is considerably lower than it would be if the relatively large plate current were required to flow through the primary winding. Since the leakage inductance is directly proportional to the square of the primary turns, this will result in an appreciable reduction in the effect of the leakage reactance.

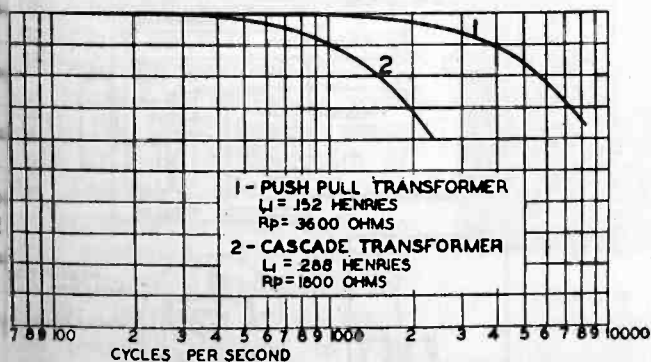

Fig. 5—Effect of leakage inductance on power output for two typical transformers

¹C. R. Hanna, "The Design of Reactances and Transformers Which Carry Direct Current," *Jour. A.I.E.E.*, 46, 108; Feb., 1927.

²A. A. Symonds, "Loop Permeability in Iron and the Optimum Air Gap in an Iron-Core Choke with D.C. Excitation," *Experimental Wireless and the Wireless Engineer*, vol. 485, September, 1928.

³D. E. Replogle, "Notes on the Design of Iron-Core Reactances Which Carry Direct Currents," *QST*, XII, 23; April, 1928. Also "Additional Notes on Iron-Core Reactances," *QST*, XII, 46; August, 1928.

⁴H. M. Turner, "Inductance as Affected by the Initial Magnetic State, Air Gap, and Superposed Currents," *Proceedings I.R.E.*, Vol. 17, No. 10, October, 1929.

⁵E. G. Reed, "Essentials of Transformer Practice," Second Edition, pp. 117-120; D. Van Nostrand, Inc., 1927.

HIGH LIGHTS ON ELECTRONICS

Electric eye separates chemicals

Many chemical analyses, basic processes in every industry, depend upon the detection of color changes. The more elementary among these are the shade variations of "indicators" used to show whether a solution is alkaline or acid or when these two chemical conditions neutralize each other.

"As we all know," says Walter Krahl, chief engineer with the Arcturus Radio Tube Company, Newark, N. J., "the sensitivity of the human eye to color changes varies with the individual. Some of us are color blind. Such persons are unable to discriminate among delicate color changes. To a mild case of color blindness, pink and yellow appear the same color, and so do blue and green. A bad case of color blindness sees photographically—that is, everything appears like a photograph, in varying shades of black and white. Many people are color blind without knowing it, and often hold down positions where a certain degree of color discrimination is desirable or even necessary.

"An artificial eye however, employing the photo-electric cell, can be designed that is sensitive to color changes the normal eye cannot detect. Automatic mixing machinery can be designed for industrial chemical plants, in which the flow of different chemicals will be automatically stopped when an acid or alkaline neutralization

is achieved, the neutral point being instantly noted by the photo-electric cell, and the associated apparatus made to control or stop the addition of the neutralizing agent."

"In the final analysis," concludes Mr. Krahl, "this may mean anything from a cheaper toothpaste to a better soap!"

Unique animated chart controlled by photo-cells

Photo-electric cells control a striking demonstration of the effect of voltage changes upon the wattage, candle power, and cost of electric lamps in an ingenious animated chart on exhibition at the Westinghouse Lighting Institute in Grand Central Palace, New York City. The animated chart consists of five illuminated columns, under the headings of voltage, wattage, candle power, total cost, and cost per candle power. Ordinates are in percentage of normal. As the height of the column headed percentage of normal voltage is increased above the 100 per cent mark, all the columns of light are lengthened but in varying proportions to correspond with the actual variation in these factors with the voltage. The height of these columns is controlled merely by placing the hand between a light source and one of two photo-electric units located at the side of the chart.

The movement of each of the columns is accomplished by an individual shutter which moves before a vertical row of ten-watt lamps in a box behind each column. The shutters are operated by cams of different sizes on a common cam shaft rotated through reduction gears by a small electric motor. The action of the photo-cells is merely to

start, reverse, or stop the motor in a simple and striking way. This is accomplished as shown in the accompanying circuit diagram.

In two of the columns a portion of the column length is colored to give additional information. The colored portion of these columns is produced by inserting colored translucent material in the shutter mechanism. In the "watts" column the red represents watts due to losses in the wiring, and in the "cost" column a red and a blue portion represents the fixed charge and the cost of lamp renewals. Colored films or screens are associated with the shutters but driven by separate cams and gears at their own speed.

This chart was designed by C. Merrill of the National Lamp Work for the N.E.L.A. Lamp Committee. It was first exhibited in the Lamp Committee's booth at the last N.E.L.A. convention at San Francisco, its purpose being to demonstrate the effect of age variations in industrial lighting.

Ultraviolet light shows up check raiser's changes

The treatment of check paper with aesculin, a white powder obtained from the bark of the horsechestnut tree, makes it possible for the bank teller to detect with ease erasures and changes which otherwise might escape notice.

Aesculin fluoresces, or glows, when placed under ultraviolet light. Erasures on paper treated with this substance would show up as a dark spot on an otherwise luminous surface. A patent on the process has just been granted to Dr. D. Julian Block.

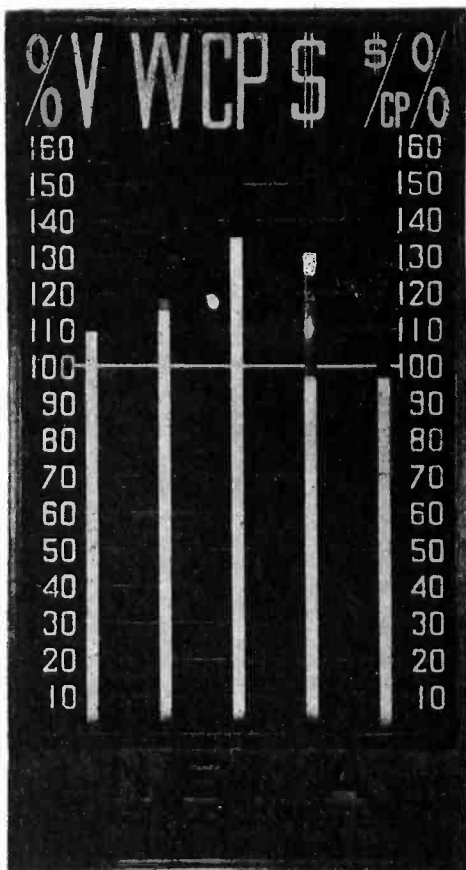

The moving columns on this chart bear fixed relations to each other, and their movement for various "lamp-voltage" values is controlled up or down by intercepting with the hand, one of two photo-cells, through the circuits at right.

Such mechanism has, of course, many other applications in industry.

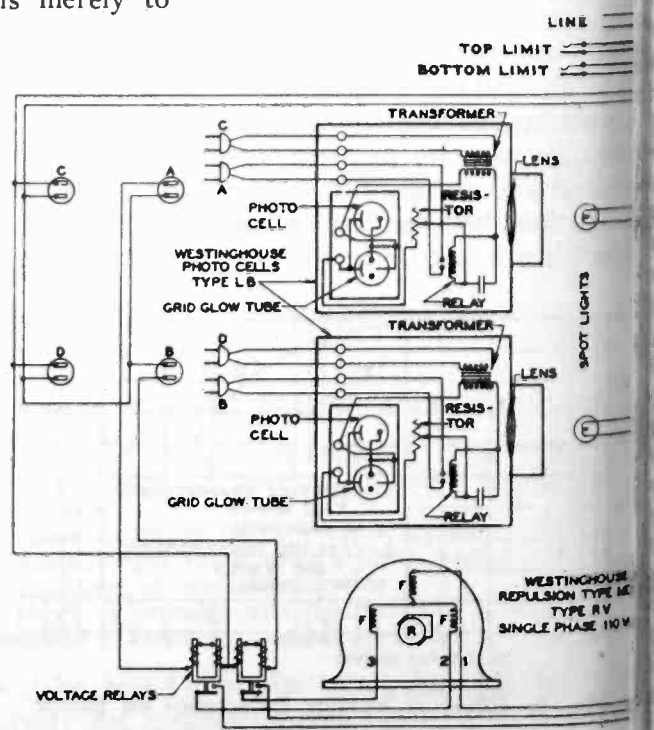

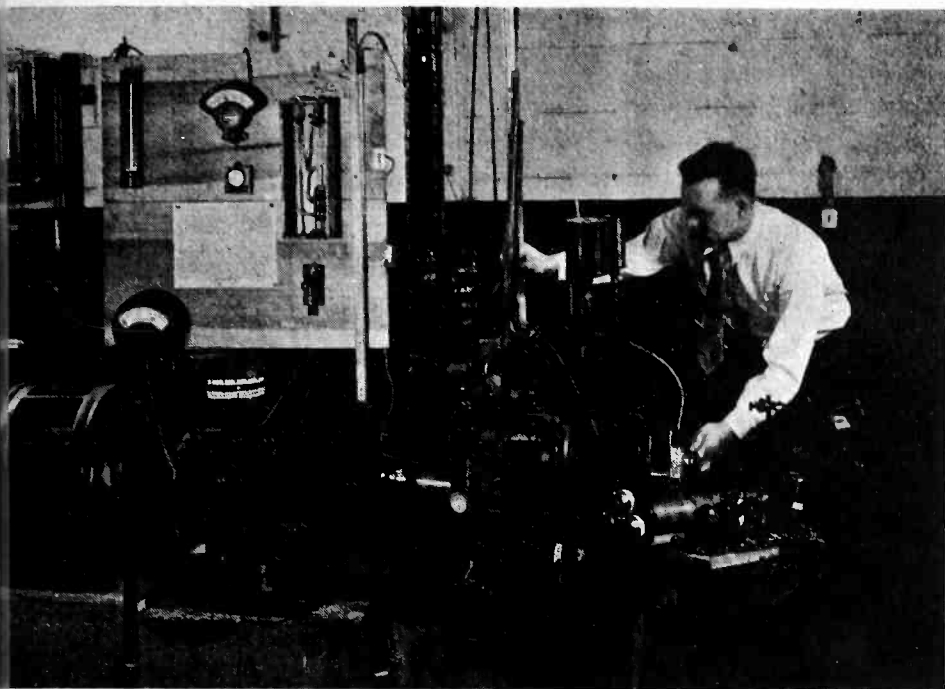

Normal engine noises are screened out by "high pass" filters, allowing only the knock, which has a frequency of 3,000 cycles per second, to pass through the vacuum tubes

✦ ✦ ✦

Tube device controls gasoline "knocks"

Electronic science has entered a new field and is now controlling anti-knock qualities in gasoline.

Microphone and vacuum tubes, magnifying sounds a hundred-fold, have been combined with other delicate instruments to form an electrical ear to detect the faintest whisper of a knock and yet to remain deaf to other engine noises!

The apparatus, sensitive to sounds far beyond the range of the human ear, was developed by scientists of the Atlantic Refining Company, according to Dr. T. G. Delbridge, head of the company's research laboratories. It was designed in the course of research leading to a new type of gasoline, perfected after years of study and an expenditure of more than a half million dollars. Necessity for the device arose when scientists were able to find none capable of interpreting engine noises, or delicate enough for their purpose.

In operation, the "mike" is suspended from coiled springs near the engine testing the gasoline. Sounds that could not be heard by man are picked up by the microphone, and the rest of the apparatus then selects and magnifies the knock and registers the sound intensity.

✦ ✦ ✦

shaft is kept singing by an electric device and the tone which it emits is compared with that from a similar wire stretched to a known degree. Any twist of the shaft is thus measured.

CAN COMPARE WIDELY SEPARATED COLOR SAMPLES

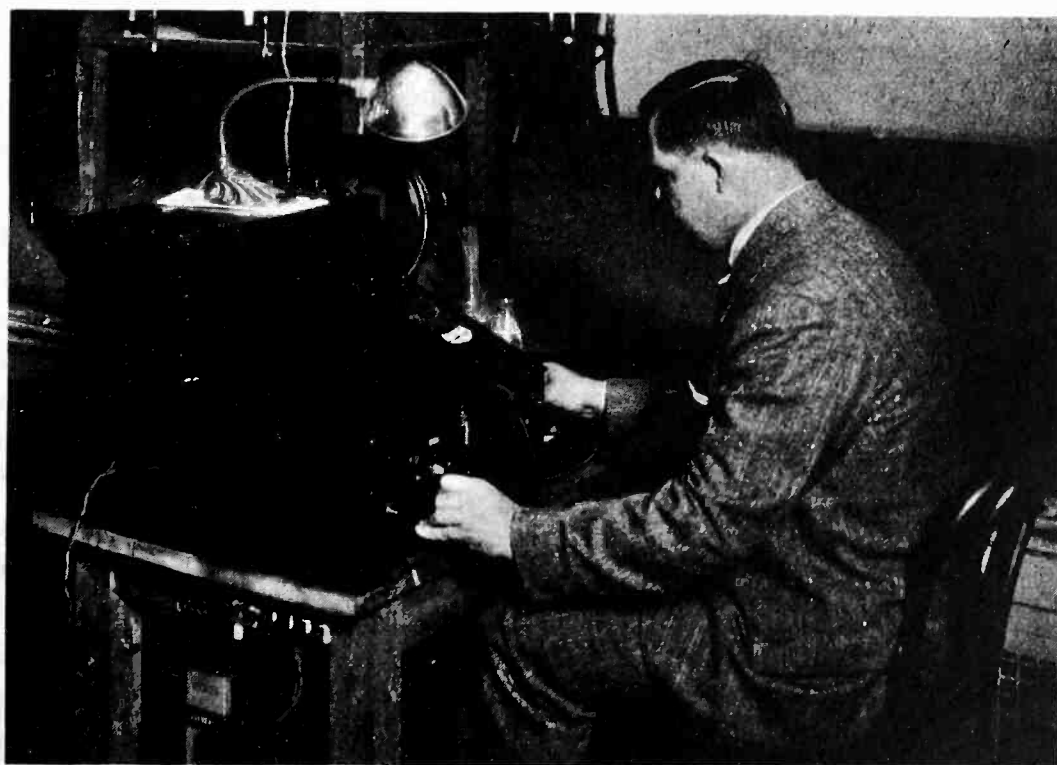

The new color comparator designed by Dr. H. H. Sheldon of New York University, New York City, enables dyes to compare tints with an accuracy impossible to the eye. Used under the artificial light of winter afternoons, when the peak of textile manufacture comes, it greatly increases the productive hours of the dye-room. Samples compared can be in different rooms

ing wire

sure twist of shaft

piano wire used to measure twist which the great engines of an liner give to the great steel forms the propeller shaft is a application of the science of elec- perfected recently in Germany in first practical test on the the steamship *Bremen*.

metal ever is absolutely rigid. of the great propeller shafts of ut liners are made amply strong the gigantic horsepower of the et without twisting apart, such w twist a small fraction of an er their load of engines and Engineers need to measure such accurately, not only to detect any ed weakness of the metal which ke trouble later on but also to ove designs and specifications e shafts and engines. In the h of measuring this tiny, o too small to be seen while the otating, a piece of steel piano etched between projections on rs clamped to the shaft some t. If the shaft between these vists by even a hundredth of the distance between the two is increases a trifle and the e is stretched. This changes of the musical tone which the es out, just as a piano tuner the tone of a string in that nt by stretching it more or less. le piano wire fastened to the

electronics

McGraw-Hill Publishing Company, Inc.
Tenth Avenue at 36th Street
New York City

O. H. CALDWELL, *Editor*

Volume 1 — DECEMBER, 1930 — Number 9

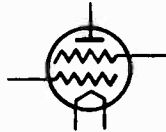

The press, radio and sound-pictures to the rescue

THE three greatest forces available for overcoming the present economic depression in the shortest time comprise the press, radio and sound pictures. Through these agencies every person in this country can be informed daily and even hourly of improvements in trade progress. It is interesting to note that two of these mediums are basically electronic. Past depressions did not have their assistance for the come-back. The electron tube has already served mankind well—it stands ready today to carry the glad tidings of progress to the four corners of the globe.

Such forces alone cannot cure the business ills of the nation but they are already alleviating the pain by the entertainment offered the public. Motion-picture producers are planning record expenditures for 1931. Radio broadcasters stand ready to spend millions if granted high power. And, in indication of the optimism of the press, the McGraw-Hill Company has contracted for a new \$7,000,000 building now being erected.



The bottle-neck

“**M**USIC put on the air,” says Leopold Stokowski, conductor of the Philadelphia Symphony Orchestra, “is compressed until it is out of shape, because radio can carry only a certain amount of energy.”

The celebrated conductor whose orchestra is

heard via radio through the courtesy of is partly correct and partly not. A full orchestra has an output range of volume of about one million to one (60 db). Telephone line connecting pick-up with transmitter can handle about 30 db. Here is a two-to-one compression in volume before the radio program really started.

When the pianissimo passages of the orchestra threaten to be lost in line noise, the pick-up operator must artificially increase the sound when the fortissimo passages threaten to talk into adjacent wire circuits, the operator reduce these peaks of power which give the rendition.

The radio is not at fault; it is the wire. No amount of engineering to eliminate frequency distortion at transmitter or receiver can eliminate amplitude compression. No satisfactory method of combating this inherent distortion has been put into practice.



Electronics—a wide field

RADIO engineers frequently claim that their profession calls for a greater knowledge of physics and chemistry than that of the electrical engineer.

It is probable that the electronic engineer of the future will be even better equipped. The application of a photo cell to industry demands more than a knowledge of electron emission. It is a field so deep and, to most engineers, closed as the quantum theory, and realms of physics and chemistry quite often hurried through by their way to the brighter—and more important—fields of communication or power.

Optics plus photo cells have made possible the recording of sound on motion picture film. The future of vision awaits some optical, mechanical, or electrical genius who will get around the scanning problem.

All new industries attract to them the best equipped consultants who are willing to apply their knowledge at the expense of the clients. It is to be hoped that the industry built up around the adaptation of photo cells to vacuum tubes to other services than radio sound pictures will be in the hands of engineers with the widest possible training and experience.

Leading up the fireman!

enterprising team of dealers and service-men in a middle western city have applied tubes and associated apparatus in an interesting manner. In this city a number of out-of-town departments are in communication over wires with a central bureau. At this central bureau someone is always on duty. To get the apparatus into action the central bureau is connected to the other offices.

The new system consisted in putting a microphone at the chief's desk, a power amplifier and speaker in each station house. Now the chief talks to all the stations at once and in such tones that in the middle of the night, the firemen can get their orders on their way down every pole from the sleeping room.

The latest those districts equipped with loud speakers instead of the older system got under way arrived at the fire sooner than the others equipped.



Sound-movies for the deaf

LEADING authority of the American Acoustical Society tells us that approximately 10 per cent of our population or 12,000,000 people in the United States, suffer from deafness in one degree or another. With the change-over from silent to sound moving pictures thousands of such people have been cut off

from the one form of entertainment they enjoyed most.

Means are now available to equip theaters with individual ear phones so that such persons can still enjoy the movies with the addition of sound. Usually from 20 to 50 seats equipped with ear phones, depending upon the size of the theater, would take care of this 10 per cent. The return to the theater management in a short time would pay for such equipment, besides building up good will in the community.



"Electronic knife" third great advance in brain surgery

THE application of electro-surgery to surgery of the brain and nervous system marks the third great advance that has been made in the field of neuro-surgery, according to Dr. Ernest Sachs, of St. Louis, speaking before the American College of Surgeons at Philadelphia, last month.

By means of the "radio knife" brain tumors that were formerly considered inoperable can now be dealt with, and other types of brain tumors can be removed more safely than before.

The technique of the method takes time to learn, but Dr. Sachs prophesied that more and more will be accomplished with it in the future as surgeons become increasingly familiar with it and learn to realize its possibilities.



Cumulative index of 1930 issues of Electronics, see page 446

ELECTRONICS points with some pride to pages 446, 448 and 450 of this issue where an index of its first nine issues (Volume I) will be found. A perusal of this summary of editorial material will make clear to the curious reader the *raison d'être* of *Electronics*—to bring to the engineers who design and manufacturers who build electronic apparatus (radio, sound pictures, industrial applications of tubes as well as electronic tubes themselves) the advances in their art and the news of their industry.

Such an index in a new art like electronics provides a unique and invaluable history of pioneer work, a fascinating disclosure of the wide application of electronic tubes to industrial problems, and a source of technical and manufacturing information on specific subjects.

LETTERS TO THE EDITORS

E-lectron-ics—the wedding of the sciences!

Editor, ELECTRONICS:

I was very much interested in your recent editorial regarding the typography of *Electronics*, entitled "That little 'e'; its big significance."

Electron comes from a Greek word which is usually translated "amber." If the first "e" is omitted, we have the Greek word "lectron," which means "bed." In the plural the word means "marriage bed." So that first little "e" is rather significant.

I always make it a point in my classes that the word electron be always pronounced "e-lectron," so as not to offend classical students and purists. I think that the point is rather well taken.

WALTER J. SEELEY,
*Professor of Electrical Engineering,
Duke University, Durham, N. C.*

An astronomer comments on the photo-cell

Editor, ELECTRONICS:

The photo-electric cell has not been very widely used in astronomy, partly due to its erratic nature. For about fifteen years, however, a photo-electric cell photometer has been used with success by Professor Joel Stebbins of the Washburn Observatory, Madison, Wis. Photo-electric photometers are also used in Babelsberg Observatory, Berlin, and three or four others have been made for different observatories. One has just been made by Stebbins for the Yerkes Observatory.

But nearly always photo-cells are unsuccessful because of "dark currents," instability of the cells, and too great

sensitiveness for the irregularities of our atmosphere. Stebbins has used his instrument to get some of the most accurate light curves of variable stars there are on record, but it has taken a lifetime of technical work to develop the photometer and use it with moderate success.

We keep saying to ourselves that some day the photo-electric photometer will be simple and practical.

HARLOW SHAPLEY,
*Harvard College Observatory,
Cambridge, Mass.*

Blind in need of 600 radio sets

Editor, ELECTRONICS:

The American Foundation for the Blind has, during the past two or three years, distributed several thousand completely equipped radios throughout the country to needy blind people who had not the means to secure these for themselves.

We have on file hundreds of letters, telling of the great boon that this has conferred upon them, and of the inestimable blessing that these radios have brought to their lives, otherwise spent in monotonous darkness.

Mr. Powel Crosley some time ago was good enough to donate to us one thousand sets for this purpose—Mr. Atwater Kent kindly sold us at a nominal price two hundred and fifty obsolete models, which we also distributed among our needy blind friends throughout the country.

We now have applications from approximately six hundred more needy blind people, to whom a radio would be a gift from Heaven, but who are unable to procure such sets.

I am wondering whether you possibly help us enlist the interest of some manufacturer or manufacturer who might have a quantity of models that they would be willing to let us have for this purpose—or sell us at a nominal price; they should not be an expensive type, in the cheapest kind would do, so long as they are efficient.

Mr. William Ziegler, Jr., and I personally will donate most of the money to cover the above expense, if the models are not available as a gift.

M. C. MIGEL,
*President American Foundation
for the Blind,
125 E. 46th St., New York*

Chicago's future "Hall of Electronics"

Editor, ELECTRONICS:

I want to express my appreciation for your recent news item concerning the Hall of Electronics in the new Museum of Science and Industry, now being completed in Jackson Park, Chicago.

We are setting aside several thousand square feet for the development of electron theory and the engineering and industrial applications of the electron tube.

This was the idea of your magazine and you deserve the fullest credit. I think we shall be the first museum in the world which will pay adequate attention to the subject of electronics in this manner.

WALDEMAR KAEMPPFER
*Director, Museum of Science
and Industry
300 West Adams St., Chicago*

Albert Coates expects new art in microphone technique

Albert Coates, noted English conductor, guest-leader of New York's Summer symphonic concerts at Lewisohn Stadium, who studied science at Liverpool University under Sir Oliver Lodge, believes that radio's microphone picks up sound waves like a person who listens with only one ear. Mr. Coates declares that he is convinced, notwithstanding the perfection claimed for present-day broadcasting, that music sent over the radio or reproduced from

phonograph records a few years hence will be vastly superior—more nearly like the original sound—than engineers are able to produce at present. He believes that this will evolve through advances in the art of microphone technique, which will create a new era in music appreciation.

As a motion picture is given the effect of depth through a system of twin exposures and projections of a scene, the broadcasters will learn to use microphones in a way to give the effect of natural sound, which is now largely lacking in many presentations, Mr. Coates said.

Higher altitudes better reception

The higher the altitude the better the radio reception conditions become. Federal Radio Commissioner L. A. LaFount, who draws this conclusion from his own recent experience dialing 32 stations on a portable receiver at an elevation of 11,200 feet during a recent tour of the Mountain region. Radio, Mr. LaFount adds, is a godsend to the ranchers, rangers and sheepherders of the mountains.

ELECTRONIC MUSICAL INSTRUMENTS

By combining fundamentals and overtones, electronic musical instruments make possible new timbres and qualities never before heard. Examples of such instruments are the electronic organ of M. Coupleaux of Paris, France (shown at the right), and the new keyboard form of the American theremin (illustrated below). See also *Electronics* for September, 1930, page 272

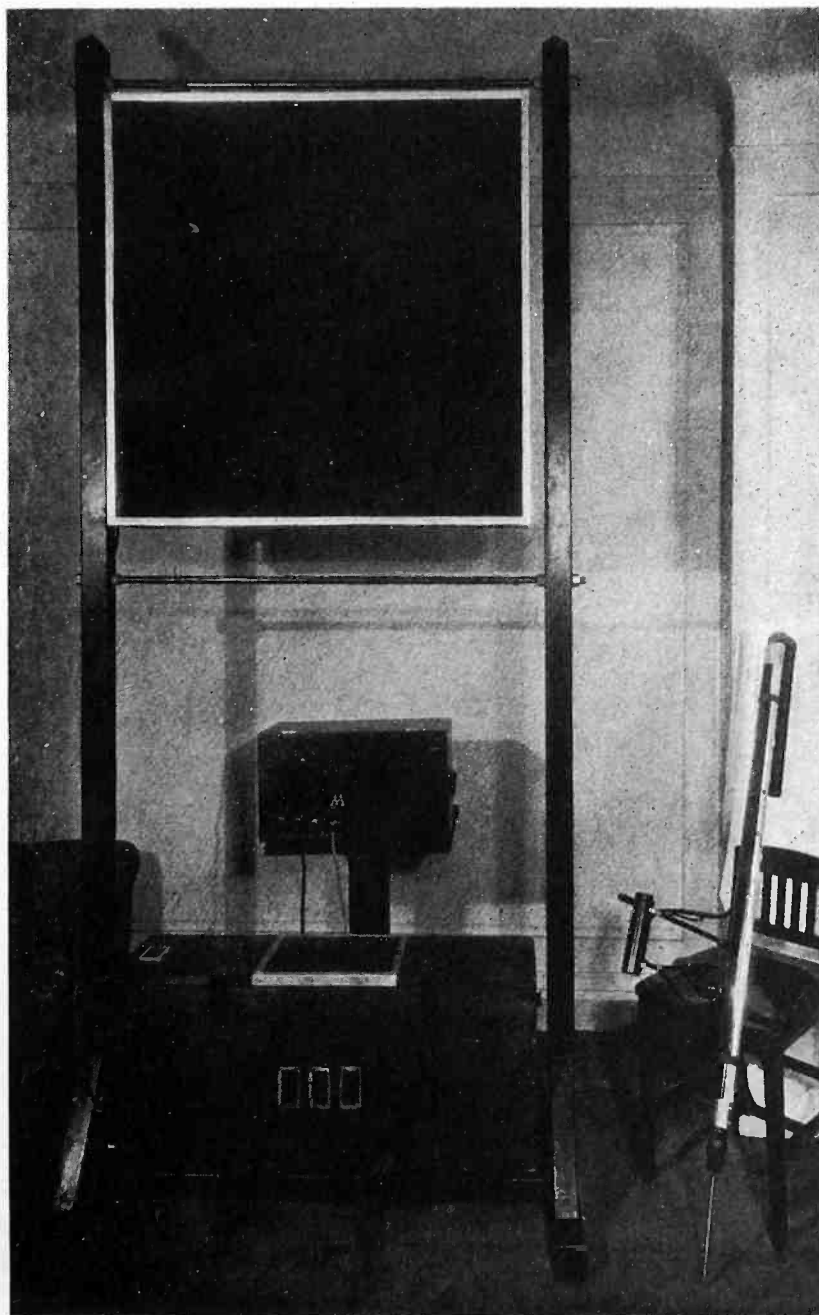
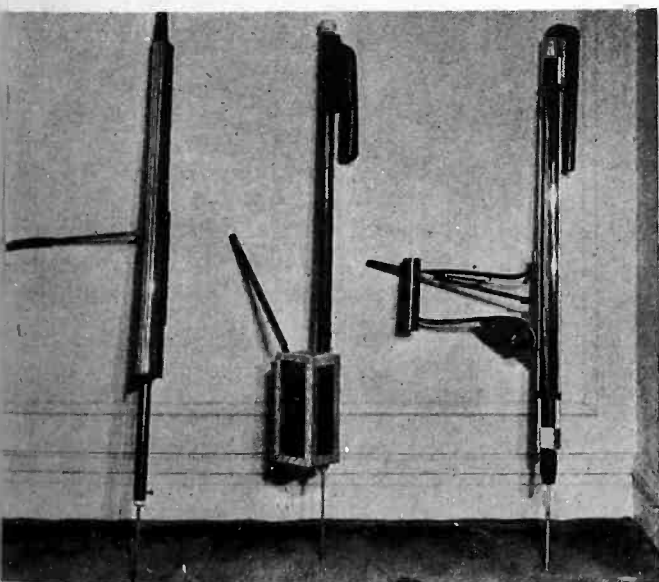

To accommodate musicians familiar with stringed instruments, these new forms of antenna control for the theremin have been developed, both with separate pick-up and with attached loudspeaker and amplifiers

Electrical transcriptions for broadcasting

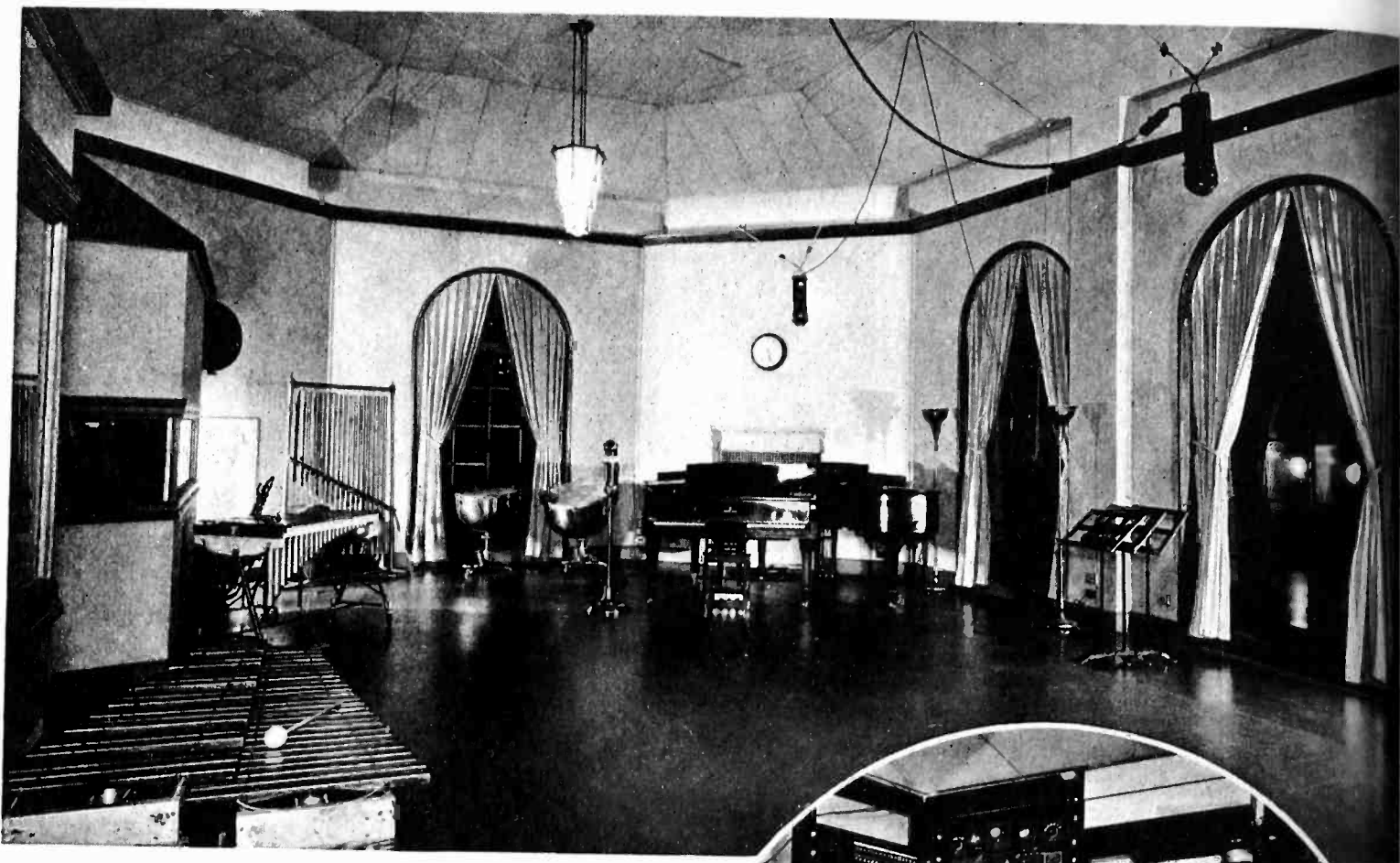

View of the main recording studio of the Judson Radio Program Corporation, New York City. Here electrical-recorded phonograph records used in broadcasting stations are made

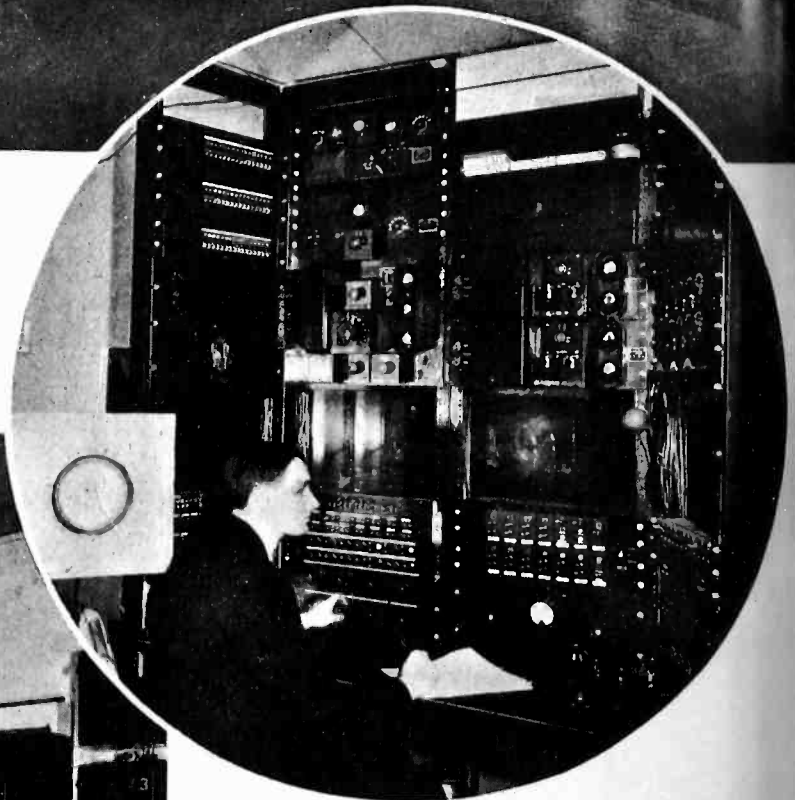

The monitoring room of the studio (above) where proper balancing of the various microphones and correct volume is maintained in recording



One of the disk recording machines (left) where an electrically-operated sapphire stylus transfers the sound vibrations from the amplifiers to the wax record. The suction tube seen leading from the ceiling is provided to remove the wax thread which is cut by the sapphire knife

NEWS

THE ELECTRON INDUSTRIES



W RMA directors

directors elected unanimously to the RMA board at its meeting, December 18, in Cleveland, Ohio, were J. F. Farny of the All-American Radio Corporation, North Tonawanda, N. Y., and A. S. Wells of the Tully Company, Chicago, Ill. Farny and Wells were elected to fill vacancies created by the resignations of Lester Tully of Springfield, Ohio, formerly of the United Reproducers Corp., and J. H. Tully of Chicago, formerly of the Tully-Tully Company, both of whom are not now actively identified with the radio industry. Messrs. Noble and Wells served for several years in various capacities in the RMA. Mr. Wells was formerly chairman of the RMA's Merchandising Committee, and Tully its treasurer. The new directors are prominent and active in the radio manufacturing.



Vacuum Products & Co., Inc., 100 Ogden Ave., Chicago, Ill., has reorganized with the following directors: A. F. Maitland, president, J. H. Taylor, chief engineer and vice-president, and W. M. Craig, secretary, treasurer and sales manager. Mr. Taylor was formerly connected with the engineering staff of the United Air Corporation of Chicago. Mr. Taylor has been associated with the tube industry for a number of years. The company is specializing in making heavy-duty, 250, 281, 866, 845-B, and 845-C tubes; in custom building of tubes and the designing of tube sockets. The general superintendent of the company is Mr. W. W. Dwyer who has had 15 years' experience in the tube industry and was formerly with the Tully Electric Company.



Upcoming meetings

American Physical Society—Annual meeting, Cleveland, Ohio, December 30-31, 1930.
Acoustical Society of America—Los Angeles, Calif., December 12-13, 1930.
American Association for the Advancement of Science—Cleveland, Ohio, December 29-Jan. 3, inclusive.
American Institute of Electrical Engineers—Winter Convention, New York City, January 19-23, 1931.

McMurdo Silver, president of Silver-Marshall, Inc., has just returned from the East where he addressed dealer meetings at Newark, New York City and Boston. He reports that public acceptance of superheterodynes has been greater than the most optimistic expectations.

Standard Transformer Corporation, 852 Blackhawk St., Chicago, Ill., has announced the appointment of Everett E. Gramer as Chief Engineer. Mr. Gramer is widely known among the users of transformers and is considered an authority on transformer design and production. He was formerly active and instrumental in the success of the Transformer Corporation of America during the period in which it made transformers exclusively. The Standard Transformer Corporation also announces the addition of approximately 5,000 square feet as added production space. This was necessitated by the substantial volume of business the company was obligated to produce.

The Ward Leonard Electric Company, Mount Vernon, N. Y., announces the appointment of R. C. James as sales representative in the Seattle district.



JOHN W. MILLION, JR.



John W. Million, recently appointed chief engineer Audiola Radio Company, Chicago, Ill. He was formerly with the Brunswick-Balke-Collender Company in the same capacity and later research engineer with the Utah Radio Products Company

Mr. James' organization will be located at 2321 Second Avenue, Seattle, Washington.

W. R. G. Baker, formerly with the General Electric Company at Schenectady, N. Y., has assumed charge of manufacturing activities of the RCA-Victor Company at Camden, N. J., according to an announcement of the RCA-Victor company.

Mr. Baker, who was vice-president in charge of engineering at this plant, will have the added responsibility of production scheduling and manufacturing at the Victor company. Mr. Baker succeeds Alfred Weiland who was in charge of manufacturing for the old Victor Talking Machine Company and who continued in this capacity when the company was taken over by the Radio Corporation of America.

The Magnavox Company, with general offices at 155 East Ohio Street, Chicago, Ill., announces the opening of a factory branch in Sydney, New South Wales, Australia. The opening of this branch has been warranted by the increased demands for Magnavox dynamic speakers in Australia and New Zealand, and will now place the company in much better position to render immediate delivery to its manufacturing and distributing trade in this territory. The factory is in actual operation, fabricating, assembling and marketing speakers throughout this territory. The name of the operating company is—Magnavox (Australia) Limited, and is under the management of Mr. Don T. Hinchey, who has been associated with The Magnavox Company for many years in building up the loud speaker division of the radio industry in the Australian markets.

White Engineering Corporation, 32nd and Arch Sts., Philadelphia, Pa., appoints Walter H. Kelly sales director. Mr. Kelly is well known from his many years' association with the radio industry. He has represented Brunswick, Lyric, Crosley and Sonora, and is well recognized among the dealers and jobbers of the eastern seaboard. Mr. Kelly brings to the White Engineering Corporation, in addition to his radio experience, a long background of general sales experience.

Westinghouse General Catalog, 1931-1932, comprised of 1352 pages presenting descriptions and illustrations of apparatus representative of the myriad of products manufactured and sold by the Westinghouse Electric and Manufacturing Company, of East Pittsburgh, Pa., has been announced recently by that company.

The Newark Wire Cloth Company, 351 Verona Ave., Newark, N. J., manufacturers of wire cloth for all industrial purposes, announces that it is now manufacturing wire cloth of stainless steel. This cloth is made in all meshes, widths and lengths, and will be made as fine as 200x200 (40,000 openings per square inch) provided quantity orders will warrant.

Mr. Harry Kalker, sales manager of the International Resistance Company, manufacturers of Durham metallized resistors recently paid a visit to the Pacific Coast using Air-rail T-A-T route. Mr. Kalker visited his company's many accounts who are at present busy with the manufacture of mantel-type receivers. The International Resistance Company reports running close to peak production in order to fill the increased demand for metallized resistors.

REVIEW OF ELECTRONIC LITERATURE HERE AND ABROAD

Electricity, ether and quanta

[F. PRUNIER] After having again derived Maxwell's equations as the most general equations of the movements of the ether, the author deduces certain properties of the ether. He then shows how these properties permit giving it certain electric, magnetic and gravitational characteristics. He is thus led to introduce into the theory of these phenomena some new types of waves and vibrations. These types of waves are precisely those which correspond to the famous Schrödinger equations. The author's conclusion is that wave-mechanics is not essentially different from the classical-mechanics, but that it can appear as a division of the latter just as in previous publications he has shown that the dynamics of relativity may be considered as a division of classical dynamics.—*Revue General d'Electricité*, October, 1930.

A simplified modulation circuit

[WEICHAFT AND LANGEWIESCHE] Communication from the Postal Department laboratories. With the grid modulation normal in German Broadcasting stations the insulation of the modulator tube filament supply is difficult and the capacity to ground troublesome. It is suggested that this can be overcome by using radio-frequency current for this filament and experiments have shown that results are entirely satisfactory. A further refinement is to obtain in a similar manner the necessary polarizing voltage for the modulator tube grid, by inserting in the same circuit the filament of a rectifier tube and feeding its plate

with a radio-frequency voltage picked up by a coil coupled to the inductance L. (See circuit diagram below.)—*E.N.T.*, Berlin, October, 1930.

Electrical properties of soil at radio frequencies

[J. A. RATCLIFF AND F. W. G. WHITE] In the transmission of wireless waves over long distances the character of the earth may play a very prominent part. The effect of the earth has been determined from attenuation measurements and from measurements on the tilt of the wave front. The results are normally expressed in terms of the dielectric constant and the conductivity of the soil. The authors show that there is no sound basis for assuming *a priori* that these constants are independent of the frequency. By laboratory tests on samples of earth from two widely different locations and using two different methods of measurement, one a cathode-ray oscillographic method and the other a resonant method, they show that between one and ten million cycles the dielectric constant may show a four to one ratio, having smaller values at the high frequencies. The conductivity characteristic is a saddle-backed affair with a minimum at some intermediate frequency and showing only about a 25 per cent variation. The conclusion is reached that the only satisfactory way of measuring these quantities is to measure them for ground *in situ* and at the frequency required, either by the tilt method or by means of attenuation curves.—*Philosophical Magazine*, October, 1930.

Triode generator and amplifier

[L. B. TURNER AND L. A. MEAD] It is common usage to state that the ideal efficiency of a linear oscillator amplifier is 50 per cent. This, however, presumes that it is possible for the voltage to drop to zero and also that no grid current flows. By confining the swing of plate potential to the portion of the lumped characteristic so adjusting coupling and voltage that the grid potential never becomes negative these authors show, both theoretically and experimentally, that the maximum output is obtained when the resistance is twice the plate resistance and that the maximum efficiency attained for very large values of resistance and small outputs, is 2 cent. In the experimental work harmonics are measured in the plate current by means of a calibrated amplifier if these harmonics are translated in terms of plate potential it is shown that the most prominent harmonic (the second) was less than one thousandth of the fundamental.—*Cambridge Philosophical Society*, October, 1930.

Three-tube local receiver with the new "flat" tubes

[UNSIGNED] Of interest as being the first published description of a receiver developed independently of the other manufacturers (in this case in the "Funk" laboratory) using the new capacity controlled "grid-less" tubes (page 346, October, *Electronics*). Particularly mentioned are the existence of somewhat more hum than with the normal indirectly heated tube, and the extreme critical nature of the regeneration setting.—*Funk*, Berlin, November, 1930.

The differential condenser loudspeaker

[SCHWANDT.] Details of the new differential condenser loudspeaker in which the membrane is negatively polarized and rests between two positively polarized (1,000 volt) gratings, the secondary of the transformer being connected to the two latter. Curves are given and a claim of tenfold sensitivity as compared with the dynamic loudspeaker is made.—*Radio B.f.f.A.*, Stuttgart, October, 1930.

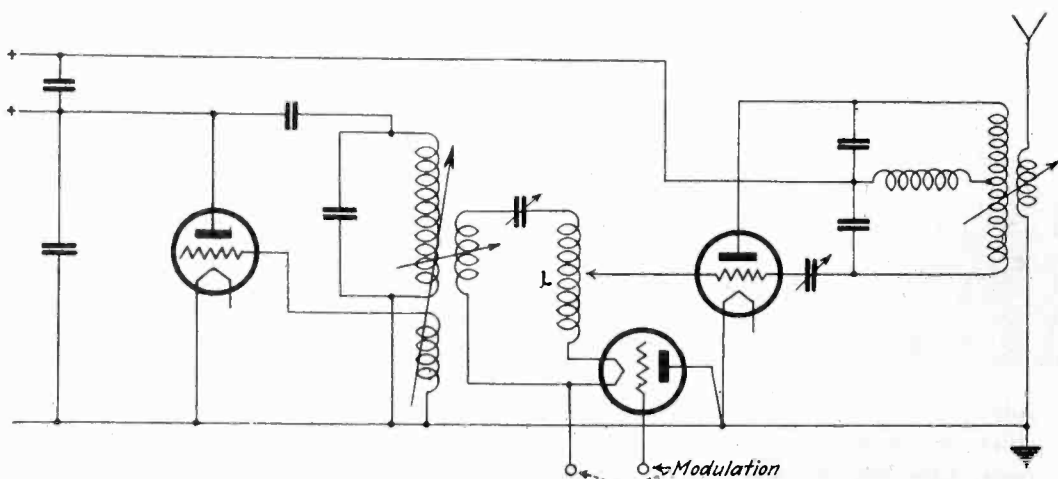

Modulation circuit in which r.f. current is supplied to the filament to avoid ground capacity. Similarly a rectifier filament is fed with r.f. to supply grid voltages (Weichart and Langewiesche)

The theory of amplifiers

[WATERWORTH.] Technical literature is replete with solutions of the usual type of wave filter, consisting of several similar sections. Here we present an analysis of a new type of filter in which each section is separated from the next by a thermionic tube. In other words, the problems of amplification and filtering are combined as in the simple receiver.

Starting with a simple series-resonant circuit to be used in a low-pass filter, it is shown that the voltage across the condenser is equal to the input vol-

multiplied by the factor $\frac{1}{\sqrt{1+X^2}}$

where X is the ratio of operating frequency to cutoff (resonant) frequency, and m is the constants of the circuit are related. Generalizing this result shows that $F = (1+X^2)^{-\frac{1}{2}}$ and m is a factor which increases with the number of sections used in the filter. The constants which must be satisfied in the design of one or two element filters are derived. From this simple theory the author expands to include (a) multi-section amplifiers, (b) band-pass filters, (c) band-stop filters and (d) high-pass filters. For each class a design is included which shows the values of the constants to employ in the filter using any given tube.—*Experimental Wireless, October, 1930.*

★

Measurement of small currents

[S. V. RAGHAVA RAO AND H. E. ...] Increasing use of photo-electric cells has made the measurement of small currents a matter of prime importance. The circuit normally used for measuring small currents from a photo-cell or other source is one in which the cell and its attendant battery are connected so as to charge the grid of a thermionic tube either positively or negatively and the resulting change in plate current is measured on a galvanometer balanced with respect to the grid current. Experiments showed that different types of tubes show widely different sensitivities. Even the very best vacuum tubes show some reverse current or "back lash" and this is of extreme importance in such measurements. When the cathode (or anode) of the photo-electric cell is connected directly to the grid of the thermionic tube the grid current is due to the photo-electric current. The change in plate current then depends on the variation from "free-grid" potential ($\phi = 0$) to the potential which permits this current to pass and the mutual conductance of the tube. Since the back lash is partially due to leakage

caused by the anode voltage it is desirable to reduce the latter provided the mutual conductance is not decreased more by this same change.

The conclusions arrived at are: The main requirements in a valve to give high magnification of small direct currents are: extremely good insulating of the grid (a conducting factor being low filament temperature) high mutual conductance and low impedance and anode voltages much lower than normal. (See *Electronics, September, p. 290*).—*Experimental Wireless, October, 1930.*

★

Some interesting television problems

[NOACK] Brief discussions of recent developments: Kirschstein's experiments showing that gas-filled photo-cells are not independent of frequency when high polarizing voltages are applied; Okolic-sanyi's experiments tending towards greater clearness of image; the Zworykin system using the Braun tube—it is stated that this system has not come up to expectations and seems to be making little progress; the colored television systems of Aronheim (twelve colored rotating filters) and of Andersén (three such filters); synchronization problems in general and Korn's suggestion of a central radio station emitting nothing but a synchronizing frequency for the whole continent.—*Radio B. F. j. A., Leipzig, November, 1930.*

General new tendencies in loud-speaker construction

[NESPEN] A general survey of recent German products—more especially the Isophon 4-pole, 4-watt; Pyreia 8-pole; Wufa Giant 60-pole; recent dynamic loud-speakers with permanent magnets; and the Vogt electrostatic in its latest form.—*Funk Magazin, Berlin, November, 1930.*

★

The screen-grid tube as detector

[KAPLAN] Article specially for the short-wave telegraph amateur. Normal regenerative coupling is used but control of the regeneration is by variation of the screen-grid voltage, a variable series resistance of 50,000 ohms being inserted in this lead (with a large parallel condenser to reduce noise in operating). Claims of greatly increased sensitivity and easy operation (no change in frequency with change of regeneration) are made.—*Funk, Berlin, October 31, 1930.*

★

Detection of ore-masses by radio

[VINOGRADOW] Simple description of a system using a small transmitter on 6,000 meters wave-length with a loop antenna capable of rotation about a vertical axis and a receiver with a loop antenna capable of rotation about both horizontal and vertical axes.—*Science et le Vie, Paris, November, 1930.*

★ ★ ★

GERMANY'S "NBC"

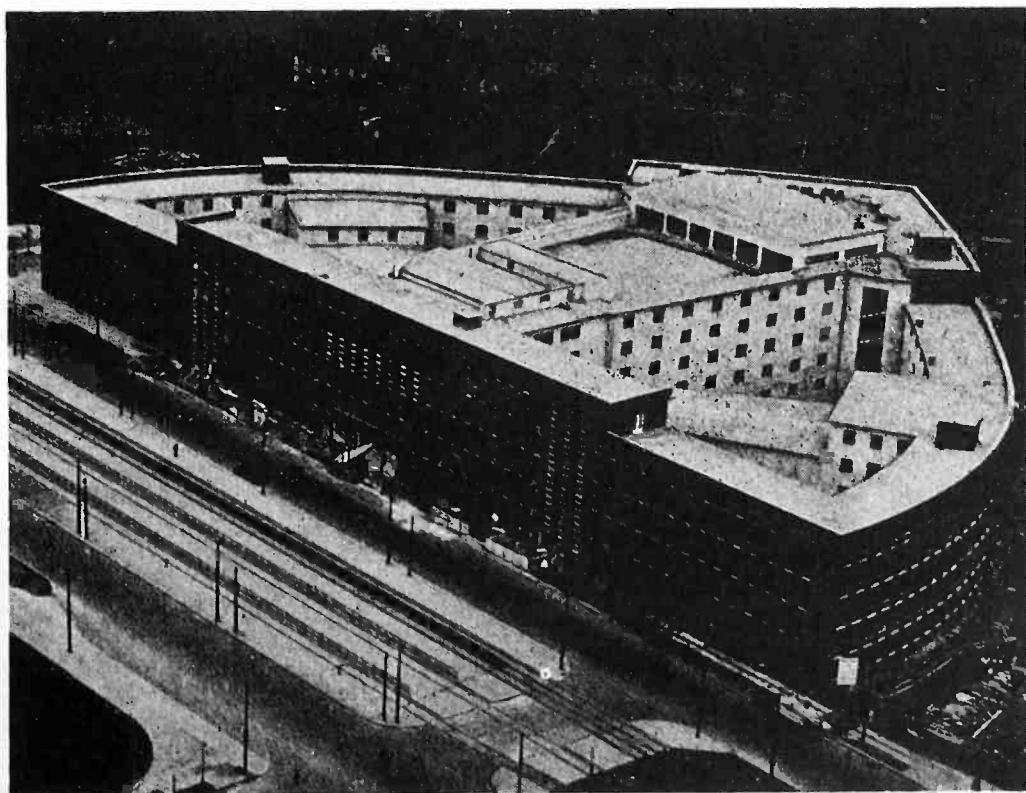

The new radio center at Berlin was dedicated December 1. Broadcasting studios, a museum, research laboratories and the general offices of the commission are combined in one building in the German capital

Producing sinusoidal i.f. currents; their measurement

[J. G. BEDFORD AND H. JOSEPHS] Where a very wide range of output voltage and constancy of frequency are desirable, particularly at low frequencies, say from 5 to 100 cycles per second, thermionic valve methods of generation are at a disadvantage. The alternative solution adopted here is to provide a square topped wave with negligible transit time, filter this and measure the output frequency by means of a modified Maxwell's Commutator Bridge. The square topped wave is derived from a motor driven Baudot distributor; the filter consists of six 6-henry coils and a total of 40 mfd. capacitance. Oscillograms are included showing the wave form obtained at various frequencies.—*P.O.E.E. Journal*, October, 1930

Logarithmic tube-characteristics

[FACAL] It is suggested that the normal characteristic curves may with advantage be replaced by curves of R_p/E_p , "Durchgriff"/ E_p (or μ/E_p since the "Durchgriff" is 100 divided by μ), and mutual conductance/ E_p , in which curves the values of E_p are plotted linearly but those of R_p , "Durchgriff" and mutual conductance logarithmically. It thus becomes possible, if the E_p scale is the same in all cases, to read complex characteristics such as the "Güte" (μ multiplied by mutual conductance) directly, and a permanent check on the correctness of the curves is given by the fact that the three ordinates for R_p , "Durchgriff" and mutual conductance respectively for any given value of E_p must total 1 (since the product of these three quantities is unity). Methods of obtaining the curves directly are given: or they can be calculated from the usual curves.—*Funk Magazin*, Berlin, November, 1930.

The use of discharge tubes in electric circuits

[RICHARD RUEDY.] This paper discusses first the voltage-current curve of a typical glow discharge through gas at a low pressure. The greater part of the article then describes the many types of devices that have been developed to utilize the characteristics of this curve. These are discussed as follows:

1. The use of such tubes as voltage reducers, voltage regulators, and rectifiers.
2. Mathematical analysis of gas-incandescent cathode rectifiers.
3. The use of discharge tubes as relays.

4. Their use and analysis as glow tube buzzers in self-interrupting circuits.

5. The uses of gas-filled photoelectric tubes, particularly in the measure-ment of very small illuminations.

6. The discharge tube as a light source for neon lights and talking pictures.

A table is included which gives the characteristics of both the older and the more recent types of gas-filled photoelectric tubes. Dr. Ruedy in this paper has given a valuable summary of some of the many uses of glow discharge tubes.—*Journal of the Franklin Institute*, November, 1930.

Amplifying tubes with photoelectric emission

[VON ARDENNE] Such tubes, in which the cathodes emit electrons under the influence of light and not of heat as in the case of the normal tube, these electrons being attracted by an anode and the flow controlled by a grid in the usual way, can be used with high coupling resistances only (5 to 10 Megohms) on account of the high internal resistance. Audio frequency voltage amplifications of 10 to 30 per stage can thus be obtained.—*Z.f.Hf.T.*, Leipzig, October, 1930.

Compensated v.t. voltmeter with balanced bridge output

[W. G. HAYMAN] Due to its high input impedance the anode-bend type of rectifier is often preferred for use in measurements where the measured circuit must suffer a minimum disturbance. The question of the best output circuit to use brings up several interesting problems in regard to safety, sensitivity and stability. The author reviews the published literature in regard to this subject and then describes a "push-pull" or balanced bridge circuit in which one tube is used as a dummy to balance out the galvanometer current when the signal voltage is zero.—*Experimental Wireless*, October, 1930.

New giant loud-speaker

[NEUMANN.] Details of the new type in which a very great increase of sensitivity has been attained, chiefly by the increase of the magnetic field to 20,000 gauss, this having been made possible by a new arrangement of the coils relative to the poles and by improved materials. Loads up to 800 watts can be handled and approximately 25% is radiated as sound energy, giving easily-understandable speech at 500 meters distance.—*Siemens Zeitschrift*, Berlin, October, 1930.

Modern receivers

[Lz] Continuation of the ser-riptions of modern German-ial products (see previous- The Schaub, Owin and Pollux- described, with photographs and- diagrams. All are fully elect- have one screen-grid radio-f- tube regenerative detector, ;- resistance-capacity coupled a- quency stages. Prices range f- to \$90 approximately.—*Radio- Leipzig*, November, 1930.

On the operation of externally-controlled tu

[VON ARDENNE.] Interesting r-ments on the new flat Telefunk- with external "grid" (these- previous months). In the case- high-vacuum tube, the effective- ity between the active part of- ternal element and the space-ch- the glass within is of the o- 1 micromicrofarad, bridged by ;- ance (the leakage-resistance- glass) of about 10,000 megohm- "gas" in the soft type of the- mercury vapor. Curves of the- "grid volts—anode current" ty- obtainable in the normal manne- got by the use of the oscillogra- from these the amplification fac- about 25) and plate resistance- 400,000 ohms) were calculate- actual voltage amplification ;- coupling resistance of 1 to 3 m- is about 20, and with 70,000- about 15. Very little distorti- curred with "grid" voltages of- practically none with 1 volt. ;- pacity between anode and cathod- 3 to 4 micromicrofarads, betwe- element and anode or cathode- 6 to 7 micromicrofarads. Micro- effects are relatively small. D- ments are suggested: firstly- direction of increased ampli- factor by a reduction in the size- anode; and secondly by the us- second grid around the anode- tween anode and cathode (corre- ing to the screen-grid tube).—*Berlin*, October 3, 1930.

The multistage valve am

[A. C. BARTLETT] The autho- siders the multistage amplifier fr- point of view of recurrent netwo- commonly applied to transmissio- The effective voltage in the pla- cuit of the tube is replaced by- stant current generator $G_m V_i$, G_m is the mutual conductance- the input voltage. The ratio of- voltage to input voltage, and- ratios, are obtained in terms of- perbolic functions of the circuit- meters.—*Philosophical Magazine*,- ber, 1930.

★ NEW PRODUCTS

THE MANUFACTURERS OFFER

Amplifier unit for table mounting

AMPLIFIER DESIGNED for operation on 110-volt 60 cycle a.c. has been announced by Ferranti, Inc., 130 West 42nd St., New York City. The unit is Model 250 D-3 Amplifier, is designed for table use. It can also be used for 245 tubes and for rack mounting. This amplifier has a gain of 20 and the manufacturers claim a frequency response within $2\frac{1}{2}$ db. from 100 to 8,000 cycles. The principal

A 110-volt vacuum tube

DESIGNED TO OPERATE from the 110-volt lighting circuit, either direct or alternating current, a tube developed by the Leston Corporation of America, 26 W. 17th St., New York City, has been announced. This tube is of the heater type and because of the excellent filament emission has a very high mutual conductance. Contrasted with a 112-type of tube, which it is designed to replace, the "Lestron" 110-volt tube has a mutual conductance of over 2,000 micromhos compared to 1,600 for the 112-type under the same conditions, i.e., 135 volts on the plate and 9 on the grid. The manufacturers expect a life of 3,000 hours, the tungsten filament operating at the comparatively low temperature of 1400° C. — *Electronics, December, 1930.*

D.C. circuit tester.

COMBINED IN ONE UNIT, a compact, portable instrument, accurate within 2 per cent, is the Model 563 d.c. circuit tester announced by the Weston Electrical Instrument Corporation, Newark, N. J. It consists of a Weston Model 301 meter, $3\frac{1}{4}$ inch diameter having two resistance ranges — 5,000 and 50,000 ohms — mounted in a black Bakelite case. It contains a toggle switch for



16 mm. sound movie equipment

FOR HOME, BUSINESS OR SCHOOL use, a new type of 16 mm. sound equipment has been announced by Victor Animatograph Corporation, Davenport, Iowa. This unit consists of the newly designed

range selection; a self-contained 1.5 volt flashlight cell; a leather strap carrying handle and a pair of 30-inch leads with test prods. This unit is particularly useful for checking resistance values and continuity of circuits during the process of manufacture and for service and installation work on many types of electrical apparatus such as: Telephone apparatus and circuits, radio transmitting and receiving sets, small electric motors, transformers, etc. List price, \$21. — *Electronics, December, 1930.*

characteristics of this unit are: three transformer coupling; an output of 1 watt; low operating temperature; type transformers and chokes electrolytic condensers, eliminating hum; input and output impedance as desired; and low hum freedom from distortion and reproduction over a wide range of frequencies and music is claimed. — *Electronics, December, 1930.*

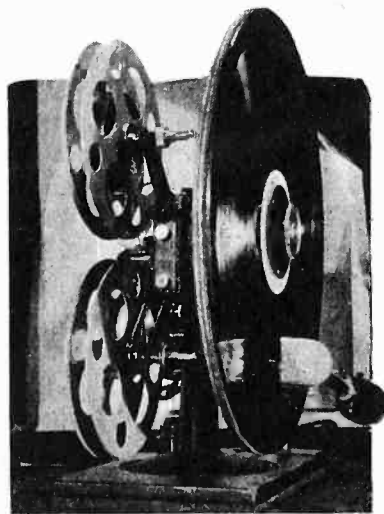

Victor Model-5 Projector and No. 33 "Animatophone," assembled in one unit in which the turntable becomes an intimate part of the projector mechanism to insure perfect synchronism. A new feature of the "Animatophone" is the vertical mounting of the record instead of the usual horizontal mounting. Two models of amplifier speakers are offered for use with the "Animatophone." Amplifiers and speakers are compactly assembled in a carrying case, the No. 245 being about the size of the projector case and the No. 250 about half again larger. — *Electronics, December, 1930.*

Phonograph turntable motor

MODEL "G" TURNTABLE MOTOR, as brought out by the L. S. Gordon Company, 1800 Montrose Ave., Chicago, Ill., is equipped with Spanish felt gears to

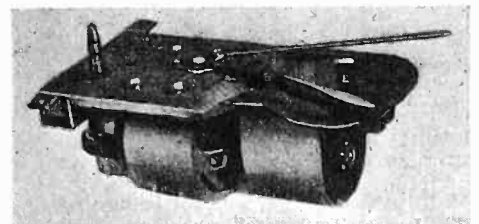

assure silence in operation. It is also equipped with automatic stop control. This equipment can be installed easily and the manufacturers claim a quick starting torque and long life. List price, \$30. — *Electronics, December, 1930.*

Dynamic automobile speaker

DESIGNED ESPECIALLY FOR operating with portable radio sets, is the Junior Model 10-B speaker, announced by the Radio Products Company, 1737 Michigan Ave., Chicago, Ill. It consists of a No. 510 six-volt battery dynamic unit, built into an oxidized metal grille mounted in an octagon $8\frac{1}{2}$ " wide and $4\frac{1}{2}$ " thick. The metal grille is silk lined, making the speaker dust-proof. The octagon and compact size permits installation in a very limited space. It is supplied with convenient mounting brackets and a 5-foot cord. Operating current is one ampere. List price, \$12. Radio Products Company, which is a division of Utah Radio Products Company, at the same address, has re-announced a 1931 catalog covering radio components, copy of which can be obtained by writing to the company direct. — *Electronics, December,*

Lead-in-weld for tubes

THE AMERICAN ELECTRO METAL CORPORATION, 65 Madison Ave., New York City is introducing a new "Elmet" product a lead-in-weld for use in radio tube and incandescent lamps. An addition to their plant in Lewiston, Maine, has just been completed, where the newest type machinery for the manufacture of these welds has been installed. These welds are claimed to be of the highest obtainable quality. The American Electro Metal Corporation is prepared to serve the trade with these welds in the same efficient manner as with their well-established moly wire.—*Electronics, December, 1930.*

Voltage compensator

A VOLTAGE COMPENSATOR which delivers regulated voltage to a.c. radio receivers and many other applications of vacuum tubes and relays, has been announced by the Sola Corporation, 2525 Clybourn Ave., Chicago, Ill. This compensator is designed to maintain the incoming line voltage within narrow limits and

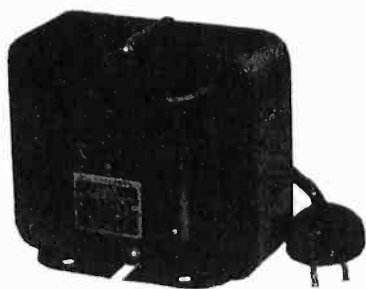

it is claimed to lengthen the life of vacuum tubes, because of operation of the voltages within safety limits; protection of condensers from early breakdown, and elimination of trouble from the power compact. This unit has the following characteristics: capacity, 100 watts; input—95 to 135 volts—output 0.90 amperes at 110 volts. It is designed for operation on 60 cycles a.c. only, and weighs 7½ lbs. This unit is also applicable to furnishing regulated voltage for film printing lamps, synchronous sound equipment, relay applications, and signalling devices. List price, \$8.—*Electronics, December, 1930.*

Photo-electric cell bulletin

AN INTERESTING BULLETIN describing the various types of photo-electric cells manufactured by the National Carbon Company, 30 East 42nd St., New York City, has been issued by this company. This bulletin gives a brief description of the types of vacuum and gas cells, and characteristic curves of the Eveready Raytheon Type Photocells. It also gives an analysis of the photo-electric cell as a circuit element and suggestions regarding proper operation, when using

these cells. Typical photo-electric cell circuits are shown to enable one to use these cells in different applications.—*Electronics, December, 1930.*

Gang type metallized resistors

WHERE COMPACTNESS and simplicity are prime requisites, the gang type metallized resistor unit is particularly applicable. The International Resistance Company, 2006 Chestnut St., Philadelphia, Pa., has designed a new unit for small console or "mantelpiece" receivers. The unit comprises the necessary num-

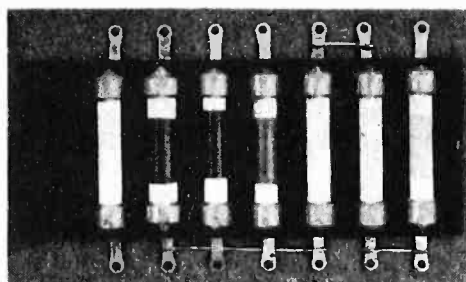

ber and values of standardized metallized resistors mounted on a strip by means of lead tips passing through holes in the strip and crimped on soldering lugs on the reverse side, making for ready wiring. The resistors may be supplied in practically any resistance value and in a wide range of current-handling capacities to meet the requirements of all types of receivers.—*Electronics, December, 1930.*

Transformer winding machine

A SPACE WINDING MACHINE, designed primarily for winding radio frequency transformers, has recently been developed by the Meissner Manufacturing Company, 522 South Clinton St., Chicago, Ill. In the Model 30 machine, the turns of wire are accurately spaced by the spacing arm producing a uniform distributed capacity practically eliminat-

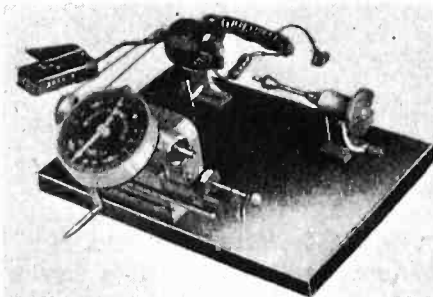

ing difficulty in matching. Various sizes of wire ranging from No. 20 to 38 inclusive can be wound and accurately spaced on this machine. The transverse mechanism, operating in any direction can be set to any desired length up to approximately six inches. The revolution counter combined with this mechanism permits operation at high speed and counts accurately from one to 10,000 turns.—*Electronics, December, 1930.*

Automatic record changing unit

AN INTERESTING AUTOMATIC record changing unit, has been announced by the White Research Laboratories, 33rd and Arch Sts., Philadelphia. The standard production models be made in a Queen Anne wall for the jobbing trade and will contain the automatic record unit, without amplifier, equipped to be plugged into the regular radio set. There will be a portable unit for installation of sound equipment, and a standard change for the radio manufacturer to install



combination sets. On this unit records are stacked in a pile on the table. It will hold up to 12 records all makes. Ten and twelve inch records can be mixed in the pile and handled automatically by this machine. Motors are provided to prevent records slipping under the tone arm thus assuring good reproduction.—*Electronics, December, 1930.*

Screen-grid tube for midget sets

A SCREEN-GRID TUBE designed especially for midget sets, to provide as much gain as possible, has been announced by the DeForest Radio Company, Passaic, N. J. It is reported that this new type of tube has been checked in a number of midget sets it has been found that the sensitivity of the average midget set can be doubled by using the new type tubes. For example, if a set has a sensitivity of 10 microvolts per meter, with the screen-grid tubes, the sensitivity can be increased to 20 microvolts per meter with the new type tubes. Although the new type tubes were essentially designed for use in midget sets, they are interchangeable with the standard tubes and can be re-employed in any of the present-day radio sets for the purpose of doubling the sensitivity. The DeForest Company is prepared to supply the new type screen-grid tubes at the same price as the standard type.—*Electronics, December, 1930.*

PATENTS

IN THE FIELD OF ELECTRONICS

A list of patents (up to Dec. 9) granted by the United States Patent Office, chosen by the editors of *Electronics* for their interest to workers in the fields of the radio, visio, audio and industrial applications of the vacuum tube

Electronics Applications

Frequency meter. Across a device of constant frequency characteristic is to be connected a coil and condenser in series. Each of these reactances is the reactance of a vacuum tube in whose plate circuit is the winding of a differential transformer. When either the capacity or the inductance of the device changes, the transformer relay operates to bring the circuit back to normal. An indicator on the scale reactance indicates what change has occurred in the circuit. W. J. Schimpf, Berlin, Germany, assigned to G. E. Company. No. 1,780,919.

Viscosimeter. A tube in which the liquid flows has wound about it inductances to the grid and plate circuit of two vacuum tubes. Variations in viscosity are indicated by the device. E. M. Symmes, assigned to Hercules Powder Co., Wilmington, Del. No. 1,780,952.

Explosion recorder. Apparatus using vacuum tubes to record the time of arrival of mechanical vibrations, involves translating these vibrations into electrical impulses, combining them with other impulses of higher frequencies, and recording the resultant combination. Frank Rieber, San Francisco, Calif. No. 1,780,567.

Frequency regulating system. An oscillation generator has coupled to it a constant frequency heterodyne which produces a beat frequency. This beat frequency is rectified and is used to maintain a constant relationship between the heterodyne frequency and the generator frequency. Henri Chireix, Paris, France. No. 1,782,807.

Sound receiver. A method in which the dielectric constant varies with certain vapors which in turn are varied by sound waves. A. B. Peterson, Fredericksburg, Denmark. No. 1,783,138.

Sound reproducing apparatus. Transformer connects a loud speaker to a vacuum tube amplifier. A second loud speaker is connected to the amplifier between the amplifier and the mentioned transformer. A. T. Bradshaw and M. J. DeForest, assigned to United Research Corporation, Long Island City, N. Y. No. 1,780,899.

Railway traffic control. An a.c. current is put on the track of a railway. Coupled to the tracks is a vacuum tube circuit so that the current flowing in one track neutralizes the current of the vacuum tube device induced from the other track. E. W. Bauman, assigned to Union Switch & Signal Co. No. 1,780,737.

Electrical testing system. Determining the relative values of two waves by comparing one with the magnitude of a given wave, and comparing the other with a given wave having a magnitude bearing a known relation to the first wave. A null method is used. Edmond Bruce, assigned to Bell Telephone Laboratories, Inc. No. 1,781,363.

Communication

Telegraph signal receiver. Stray frequency currents and dot frequency currents are filtered out from the incoming signal current. The remainder of the incoming signal is combined with a locally-generated signal of dot frequency and predetermined shape, whose frequency depends upon the dot frequency of the incoming signal. August Jipp, Berlin, assigned to Siemens & Halske. No. 1,782,524.

Radio amplifier. Tuned radio-frequency amplifier in which the effective input impedance of each coupling transformer at resonance is so adjusted that the ultimate amplification of all stages is substantially constant. W. A. MacDonald, assigned to Hazeltine Corp. No. 1,781,759.

Radio receiver. A method of trapping an induced charge upon one of the electrodes of an electron device. Oscillations to be detected and amplified are conveyed through the electrode having this induced charge. M. J. Rittenhouse and O. V. Maurer, Cleveland, Ohio. No. 1,781,861.

Radio-frequency amplifier. An amplifier known to radio engineers as the "Loftin White Circuit" in which the response of the amplifier can be pre-determined and adjusted to any desired characteristics whether flat over a frequency range or otherwise. F. W. White, assigned to RCA. No. 1,780,611.

Current regenerative radio circuit. Tuned radio frequency stage in which an impedance is in series with the low potential end of the input tuned circuit and the filament of the tube. Octavius Knight, Westfield, N. J. No. 1,782,993.

Carrier current communication. A system of communication whereby stations on different lines, although operating at different frequencies, can be interconnected. F. W. Frink, assigned to G. E. Company. No. 1,783,037.

Radio-frequency amplifier. Combination of an antenna and a loop to the input of a radio frequency amplifier. H. H. Snow and W. T. Loughlin, assigned to Radio Frequency Laboratories, Inc. No. 1,780,987.

Radio transmitter. A means of coupling one oscillator to another by radiation from an antenna system. W. M. Brower, assigned to Federal Telegraph Co. No. 1,780,167.

Train communication system. A system of communicating by modulated high frequency signals between a mobile body and a fixed station, and a method of changing the transfer efficiency between the transmitter and the moving body, to provide a substantially constant transmission equivalent. J. W. Horton, assigned to Bell Telephone Laboratories, Inc. No. 1,780,921.

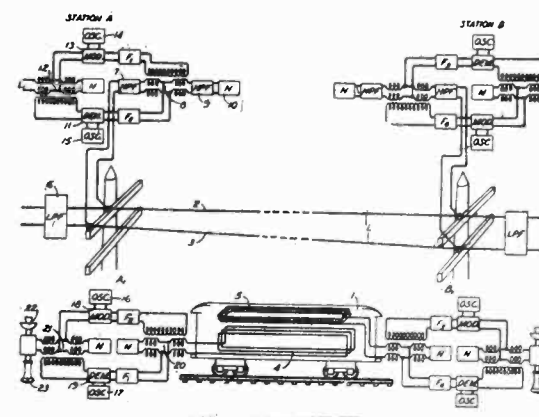

Signal control system. Two oscillatory circuits tuned to different frequencies. G. W. Cattell, assigned to Federal Telegraph Co. No. 1,779,585.

Untuned radio system. An untuned detection circuit and means whereby the effect of variable tuning is obtained by positively-controlled generation. L. W. Chubb, assigned to Westinghouse E. & M. Co. No. 1,781,268.

[Continued on page 450]

PATENTS—

[Continued from page 445]

Electronic Apparatus

Oscillograph. A cathode ray oscillograph. Otto Ackerman, assigned to Westinghouse E. & M. Co. No. 1,779,794.

Rectifier. A full wave rectifier of the type having a large anode surface and small cathode surfaces. Jacques Risler, Paris, assigned to Risler Corp. of America, Kansas City, Mo. No. 1,780,504.

Vacuum tube. Apparently a tube in which the grid is replaced by a coil of wire wound on magnetic material. E. E. Blackman, assigned to Cleveland Redfield, Ogden, Utah. No. 1,780,698.

Television

A television transmitting system, including a Kerr cell, etc. E. F. W. Alexander and Ray D. Kell, assigned to G. E. Co. No. 1,783,031.

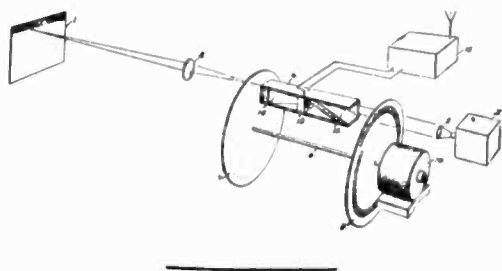

Generation, Detection, Etc.

Oscillation generator. A Piezo-electric device capable of vibrating simultaneously in several modes at different frequencies. E. I. Green, assigned to A. T. & T. Co. No. 1,780,229.

Double-wave rectifier. A system employing two vacuum tubes for rectifying a.c. C. B. Bartley and V. H. Dake, Pittsburgh, Pa. No. 1,782,228.

Linear detector. A resistance is inserted in the cathode lead to which the grid is attached, so that the volt-ampere rectifier characteristic of the device is substantially rectilinear. G. E. Spitzer, assigned to G. E. Company. No. 1,783,059.

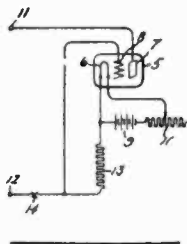

Piezo oscillator. A means for manually adjusting the air gap between one conductive plate and the surface of the piezo crystals, as well as a means for indicating the distance between them. Russell F. Ohl, assigned to A. T. & T. Co. No. 1,783,130.

Piezo crystal device. Method of indicating intensity of high frequency oscillations by reflecting light upon mirror near piezo crystal. Vibrations of quartz cause movements of mirror when the light is reflected upon a screen. Alexander Meissner, assigned to Gesellschaft für Drahtlose Telegraphie, Berlin, Germany. No. 1,783,297.