

electronics

electron tubes—their radio, audio,
visio and industrial applications

radio
sound pictures
telephony
broadcasting
telegraphy
carrier systems
beam transmission
photo-electric cells
facsimile
amplifiers
phonographs
measurements
receivers
therapeutics
television
counting, grading
musical instruments
traffic control
metering
machine control
electric recording
analysis
aviation
metallurgy
beacons, compasses
automatic processing
crime detection
geophysics

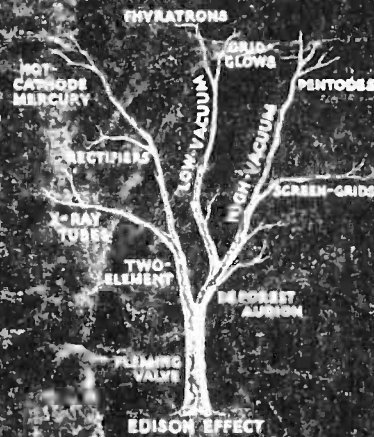
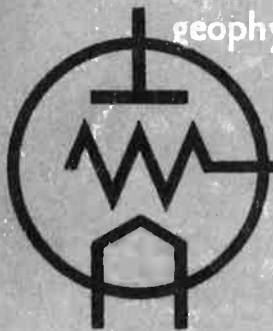

The family tree of the thermionic tubes

+

Developments in wide-film sound pictures

+

Organizing a competent engineering staff

+

Measuring distortion in amplifier systems

A MCGRAW-HILL PUBLICATION

MAY 1930



electronics

M. E. HERRING
Publishing Director

M. CLEMENTS
Sales Manager

Contents for May, 1930

Copyright, 1930, by McGraw-Hill Publishing Company, Inc.

The march of the electronic arts.....	59
Electron tubes play important rôles in fields of four national conventions this month.....	60
Building an engineering organization..... By W. R. G. BAKER	62
Latest developments in wide-film pictures..... By E. I. SPONABLE	65
Producing artificial fevers..... By C. M. CARPENTER and A. B. PAGE	68
Vacuum-tube oscillator used for continuously recording wire diameter..... By C. W. LOEBER	70
Development of insulating materials..... By ROBERT KRUSE	72
Industrial uses of the photo-cell..... By J. V. BREISKY	74
The family tree of the thermionic tubes.....	77
Power and distortion.....	78
Measuring harmonic distortion in tube circuits..... By D. F. SCHMIT and J. M. STINCHFIELD	79
Antenna coupling systems as applied to radio receivers..... By JESSE MARSTEN	82
Power control thru grid-regulated heavy-current tubes..... By O. W. PIKE	85
Hazards from induced emfs.....	88
It counts, it alarms, it controls.....	95
Two-way television.....	100

DEPARTMENTS

New books on electronic subjects.....	89
Editorials.....	90
Review of electronic literature here and abroad.....	92
News and convention programs.....	101
New products.....	102
Patents.....	104

McGRAW-HILL PUBLISHING COMPANY INC., Tenth Ave. at 36th St., New York, N. Y.

Cable Address: "Machinist, N. Y."

McGRAW, Chairman of the Board
MUIR, President
McGRAW, JR., Vice-Pres. and Treas.
J. MURPHY, Vice-President
C. H. THOMPSON, Secretary

MASON BRITTON, Vice-President
EDGAR KOBAK, Vice-President
HAROLD W. MCGRAW, Vice-President
E. C. FARMELER, Editorial Director

NEW YORK District Office, 235 Madison Ave.
WASHINGTON, National Press Building
CHICAGO, 520 North Michigan Ave.
PHILADELPHIA, 1600 Arch Street
CLEVELAND, Guardian Building
ST. LOUIS, Bell Telephone Building

SAN FRANCISCO, 883 Mission Street
BOSTON, 1427 Statler Bldg.
GREENVILLE, S. C., 1301 Woodside Bldg.
DETROIT, 2-257 General Motors Bldg.
LOS ANGELES, 632 Chamber of Com. Bldg.
LONDON, 6 Boulevard St., London, E. C. 4



electronics

A MCGRAW-HILL PUBLICATION

New York, May, 1930



O. H. CALDWELL
Editor

FRANKLIN S. IRBY, Ph. D.
Associate Editor

KEITH HENNEY, M.A.
Associate Editor

LEE DEFOREST, Ph.D.
Consulting Editor

The march of the electronic arts

Wave radio telephone service now spans the continents of North and South America. This new regular commercial service was inaugurated early in April in conversations between President Hoover and the presidents of Argentina, Uruguay and Chile.

Remote control of airplanes by radio was demonstrated on an unprecedented scale during the month, when an entire squadron of British bombing planes was directed 400 miles. The pilots aboard kept in touch, while the automatic equipment was actuated from ground stations.

Facsimile reproduction of an entire newspaper page was transmitted from San Francisco to Schenectady, N. Y., April 3, in three hours of its issue from the wire. Dr. E. W. F. Alexanderson's transmitter was used, operating on 17.3 megacycles.

Artificial synthesis of heavy atoms from lighter ones, was demonstrated at Savannah, Ga., April 9, before the American Chemical Society. Dr. W. D. Harkins of Chicago University showed photographs of helium building up into neon.

Electrons as wave-motions rather than as particles, was argued by Dr. C. J. G. Bosch before the American Philosophical Society at Philadelphia, April 10. The electron's properties are shown in experiment to be dual, declared Dr. Bosson, satisfying both definitions.

Motion pictures of surgical operations are being demonstrated to students at the Medical Center, New York City. Motion pictures have the advantage of giving intimate close-ups, with the great personalities of the day acting as lecturers, giving every student a front seat at the lecture.

Diathermic heating of the brain tissue by high-frequency fields, is being experimented with by Dr. Paul F. Schilder of Vienna. Such internal heating, it is reported, apparently stimulates brain activity and speeds up nervous and motor reactions.

Building-up of matter out of energy, with the incidental propagation of very short-waves, was declared by Dr. R. A. Millikan, at New York, April 9, to be now going on out in the cold recesses of the universe. This is evidenced by the cosmic rays received on earth, from unknown sources in interstellar space.

A 50-kw. broadcaster at Rome, American-built and just opened, is now the largest transmitter in all Europe. "Radio-Roma" is its designation, and its 100-per-cent modulation, brings it up to 100 to 200 kw. during peaks of transmission.

Reorganization of the Radio Corporation, facilitating its new functions as a holding company for its many subsidiaries, was announced, subject to stockholders' vote on May 6. General Electric will own 40 per cent of RCA stock, and Westinghouse 13 per cent, giving them, jointly, control.

X-ray and electronic tests of steel welds were demonstrated at Lehigh University, Bethlehem, Pa. The X-ray method reveals hidden faults visually; the second plan utilizes amplifiers and loud-speakers which report strains by characteristic sounds when the weld is struck.

Interlocking aircraft communication systems between Canada and the United States were recommended at Washington conference, April 11. Aircraft beacon services of North America should be co-ordinated declared Dr. C. B. Jolliffe, U. S., and Commander C. P. Edwards, Canada.

The Fox Film interests are completing plans for refinancing with \$100,000,000 of new capital. Harley L. Clarke, president of General Theatres Equipment, Inc., and Utilities Power and Light Corporation, purchased the controlling interest from William Fox for \$18,000,000.

A full orchestra of electrical instruments presented its premiere recital of "ether-wave music" at Carnegie Hall, New York City, April 25, under the direction of Prof. Leon Theremin. Its elaborate program included Brahms, Wagner, Liszt, Beethoven and Handel, and demonstrated many new timbres and acoustic qualities.

Warner Brothers within the past two weeks have made a tie-up with the Kuchenmeister group. (Sprekfilm of Amsterdam, Tobis of Germany, Associated Sound Film Industries, Ltd., of London, Tobis of France) by purchase of substantial interests in the patents and licenses of these groups.

Brunswick-Balke-Collender Company has just passed to the control of Warner Brothers. The assets of the former company, including the plants, structures and good will of the Bremer-Tully Manufacturing Company, radiograms; Farland Manufacturing Company, loud-speakers and Brunswick Radio Corporation are included in this deal.

Radio aided astronomers in photographing the eclipse of the sun visible on the west coast of the United States, April 28, by carrying time and control signals from Mare Island Navy Yard to airplane and ground observation stations.

Patents of Lowell and Dunmore for operation of radio receivers from alternating current are now claimed by the Government to be public property, since the inventors were U. S. Bureau of Standards employees. The suit involves patents said to be worth twenty million dollars.

. . . Electron tubes play four national conventions

Association leaders send greetings to the engineers of the electronic

Electronics and the motion-picture engineer

THE application of the photo-electric cell and the three-electrode vacuum tube to the recording and reproducing of sound represented a very important landmark in the progress of the motion-picture art. Many years previously sound had been recorded on wax and synchronized with the motion picture, but the quality of the resulting sound was comparatively poor.

The introduction of the vacuum tube made possible the amplification of the extremely feeble electrical currents generated by the microphone which, in turn, are translated into (1) modulated mechanical energy for recording on wax or (2) modulated light energy for recording photographically. In a similar manner the light energy falling on the photo cell from the photographic sound record is miraculously translated into electrical energy, amplified by the vacuum tube, and again converted into sound energy by suitable means.

The photo cell and its ally, the vacuum tube, are also being applied successfully in the measurement of illumination levels in the studio and theater and the measurement of the density of photographic images, and are destined to receive numerous other future applications.

The electrical manufacturer and the new uses of the vacuum tube

WITH but few exceptions—and most of those the companies whose association has been intimate from the inception—the electrical manufacturer has little realization of the enormous possibilities of the art of electronics. But it is being borne in upon him that a tool of almost limitless application is approaching availability, and he is beginning to watch keenly.

The use of amplified current in combination with the photo-electric cell interests, but leaves the impression of being apart from and not generally applicable to the materials and processes which he employs. But the device for detecting the presence of flaws in steel rails is another thing. That strikes home, and as realization comes—together with understanding of the simplicity of the principles involved and the relative sturdiness of the devices themselves—the applications which will result should surpass any present anticipation.

By J. I. CRABTREE

*President Society of Motion-Picture Engineers,
Research Laboratory,
Eastman Kodak Company*



The counterpart of the photo cell—the flashing lamp—is already in practical use for sound recording by the Fox Movietone process. The chief drawback of this type of light valve lies in the low intensity of its radiation, but further research will undoubtedly produce a lamp having the required brilliance. The cathode ray tube also appears promising as a means of solving the television problem while the thyatron will undoubtedly prove to be a valuable tool in the motion-picture field.

The successful motion picture engineer of the future must keep himself thoroughly informed with progress in the field of electronics. In the Journal of the Society of Motion Picture Engineers it is impossible to cover this specialized field adequately and I feel that *Electronics* will be welcomed by every motion-picture engineer.

By
A. W. BERRESFORD

*Managing Director, National
Electrical Manufacturers Association,
Past President, A.I.E.E.,
American Engineering Council*



There could be no more timely service to the electrical manufacturer than to bring forcibly to his attention by both example and precept the present state of the art.

It is not new. Ten years ago its possibilities in the control of electrical energy in commercial volume were forecast and it has been developing slowly but substantially throughout the period. One hesitates to prophesy the uses which the inventor-designer will find for this new agency as realization of its versatility grows within him. Certainly the subject is one in which the electrical manufacturer is much interested.

Important roles in fields of this month . . .

and trace effects of the electron tube in their own industries

Electronic phenomena

Open new doors to electro-chemistry

AS long as metallurgy was primarily dependent upon the analytical chemist, progress was slow, and results and conclusions were often contradictory. Two samples of steel would have the identical chemical composition and yet, mechanically, the two samples were together different in behavior and properties. It was the introduction of high-powered microscopes to metallurgy that made it possible to place the alloy steels on a sound foundation. Metallurgists with the aid of a microscope could control their processes to a nicety, and results could be reproduced at will.

As long as the electrochemist was solely dependent upon heats of formation as the basis of his theory and prognostication, advance was slow and uncertain. With the discovery and interpretation of the basic phenomena of the vacuum or electron tube, the electrochemistry of

By
DR. COLIN G. FINK
*Executive Secretary,
American Electrochemical Society,
Professor of Electrochemistry,
Columbia University*



gases took on a new and brighter aspect. Reaction phenomena that could not be accounted for on a purely thermal basis were now readily interpreted on the new electrical basis. We have but just discovered in the field of electrochem-

istry of gases a trail which will undoubtedly lead to heights of vast scientific and industrial importance. Reactions are being brought about at room temperature which, under the old thermal interpretation, would require temperatures of several hundred to a thousand degrees. Electrically activated nitrogen is no longer inert.

Acoustic engineers credit recent

marked progress to electronic tools

THE importance of the electronic tube as a tool for acoustic measurements, is well recognized by the members of the Acoustical Society of America.

In fact, the large advances made in technical acoustics during the past fifteen years have been largely due to the new tools furnished the acoustic engineer involving electronic tubes.

Before the invention of the vacuum tube, quantitative measurements of sound intensities were very difficult because the quantities involved were so small. Microphones are now available which will transform such sounds into an electrical form with scarcely any distortion. This electrical form can be amplified to almost any extent by means of the vacuum-tube amplifier and its magnitude can be measured by the well-known rectifier. Because of these new tools, acoustic measurement is now reduced to an exact science.

Besides their new uses in the many applications of

acoustic measurements, electronic devices are used as electro-optic converters, especially in connection with the recording and reproducing of sound. Oscillators and amplifiers used in connection with electro-acoustic converters furnish combinations for producing sounds which can be controlled in pitch, intensity, and quality. No doubt in the near future developments will result in

such combinations being used as musical instruments.

By
HARVEY FLETCHER, Ph.D.
*President, Acoustical Society of America,
Director of Acoustical Research,
Bell Telephone Laboratories*



Conventions and meetings during May. For program features, see page 101.

Society of Motion-Picture Engineers,
Wardman Park Hotel, Washington, D. C.,
May 5 to 8.

Institute of Radio Engineers, Engineer-
ing Societies Building, New York City,
May 7, 7:30 p.m.

American Institute of Electrical Engineers,
(District meeting) Springfield, Mass., May
7 to 10.

Acoustical Society of America, Westing-
house Institute, Grand Central Palace,
New York City, May 9 and 10.

Radio Club of America, Columbia Uni-
versity, New York City, May 14, 8 p.m.

National Electrical Manufacturers Asso-
ciation, Hot Springs, Va., May 18 to 23.

American Electrochemical Society, St.
Louis, Mo., May 29 to 31.

Building an engineering organization

The selection and assignment of engineers in a large staff working on electronic problems

By W. R. G. BAKER

Vice-president in Charge of Engineering,
RCA-Victor Company, Camden, N. J.



IN those types of manufacturing which depend upon technical developments, the personnel problems of management assume major importance. The problem of handling the factory operators is much the same as in other industries, but the technical organization, forming the backbone of the business, requires more serious consideration. For this reason special methods must be employed to handle this phase of the problem effectively.

It has been said that industry is made up of persons working with things, and that the products of industry are skilled persons and useful things. In the electronic fields, the skill is largely technical. Since no profit can be shown on the human output, care must be taken to conserve the technical skill, develop it in every way possible, and accumulate it as one of the most valuable assets of the company.

A corporation's fourth asset

The invested capital of a company is usually shown under three general headings: (1) land and buildings; (2) machinery and equipment; (3) inventory, raw and in process. Not one of these items is capable of paying dividends without the guidance of the fourth asset, *the Organization*. New factories are frequently built almost overnight; machines can be purchased on short notice, and materials are seldom lacking. Even factory operators can be obtained with little difficulty, but without the

technical skill of the engineers and manufacturing executives to direct their efforts, the product might actually be of less value than the original raw material itself. Last but not least, a skilled organization cannot be purchased in the open market ready made, but must be carefully trained to meet particular requirements.

It has been estimated that the cost of training an average factory operator varies from \$50 to \$200, pending upon the degree of skill required. The training period is usually one to ten weeks. The technical organization requires at least one or two years training and probably costs \$2,000 to \$10,000 per man, again depending upon the skill or executive ability required.

Looking at the matter another way, each engineer must contribute sufficient technical skill to more than justify his salary, since he performs no manual labor. His salary is thus one portion of the net earnings of the company for his technical ability. The other portion appears as profit. Therefore, it is conservative to capitalize the salary allowance at not less than 6 per cent, indicating that a \$3,000 man represents an investment of \$50,000, a \$6,000 man \$100,000 invested, etc. Of course, the individual usually responsible for the major part of this investment is accumulating it in the form of early training, school and college work, etc., but nevertheless, when this accumulated ability is placed at the disposal of a manufacturing company in consideration of a salary, is it not reasonable to include this investment, in some way, among the assets of the company?

Personnel turnover

Considering this question from the viewpoint of personnel turnover, many companies could better afford a flood of fire causing a net loss of \$100,000 than to lose the services of one well-trained "profit engineer" at a salary of \$6,000 a year; yet the latter would not appear on the books as a loss. It might appear later as an unaccountable decrease in net profits, and too many such losses in the same period may even cause a failure. If the organization is not shown as an asset, reports would not indicate the true cause.

Scientific management has accomplished wonders in the elimination of waste in industry. There is still much to be done, however, in the field of economic waste due to personnel turnover. The causes of this turnover may be summarized briefly in the three general reasons why employees leave:

- (1) voluntary, because of (a) work, (b) pay, (c) personal reasons;
- (2) involuntary, laid off for (a) business or seasonal fluctuations, (b) discipline, (c) retirement;
- (3) involuntary, discharged on account of (a) unfitness for work (b) personal character.

Changes that improve the organization

A study of the personnel records often brings to light surprising facts regarding the causes of turnover. It is safe to say that two reasons out of the eight (work and pay) will account for the majority of the engineering turnover, and these with fluctuations (2a) account for the factory labor difficulties. The dissatisfaction with the work is usually lack of opportunity ahead, or indefinite plans of promotion. The rapid growth of the industry has been largely responsible for the competitive offer to trained men in positions of responsibility, and the best men are not immune.

Of course, a limited turnover is healthful, particularly if the men obtain positions of responsibility with the

side. Continued contact with such men provides an inside perspective or viewpoint of the organization and its products. The vacancies created by these changes, together with normal expansion, provide openings for new men, and tend to keep the organization young in spirit. With the engineering organization often forming so large a part of the assets of a business, the conservation and development of this organization must be planned in advance, with the same care as any production undertaking.

The old definition of an engineer credited him with the utilization of the materials and forces of nature for the uses of man. In industry he must go farther, producing and maintaining profits by introducing new and improved utilities to meet and anticipate demands. It is not sufficient to *produce*, but to *produce at a profit*; not enough to *utilize* forces, but to use them *economically*; not alone to *supply* the needs of mankind, but to *create* and stimulate *new needs*, in turn supplying them, at a profit. Thus, the engineer has three major functions: research, application, and production, all measured by a common standard—the net profit.

Requirements of an engineering staff

There are several requirements for a strong and flexible engineering organization, which must be considered in detail. The proper delegation of responsibility and authority is of prime importance. Responsibility without authority is of little value, and authority without responsibility is usually a mistake. The two must go hand in hand for efficient work.

Responsibility is not an inherent quality, and must be developed gradually to obtain best results. Too much at one time will either "make or break" a man, it is true, but the risk of spoiling a man's future by an unearned failure must be considered. The development of this quality may be entirely independent of his regular work, consisting of outside trips or special work to be completed without assistance, in a specified time. Self-confidence can be developed by similar methods, having the man prepare papers for publication, or give lectures or talks before groups of his fellows, for example. It is surprising how few engineers are able to express themselves from the platform.

The selection and training of assistants is also important. Every man in a position of responsibility should have an assistant who is well acquainted with at least the routine items of the work. If possible each man should hold three jobs at one time: first, as advisor to the man who succeeded him on his last assignment; second, his present assignment; and third, as understudy for the position he will next occupy. In this first position he is a teacher of his previous duties; in the second he is in charge of his present work and teacher to the man who will next occupy that position; and in the third he is learning the fundamentals of his next assignment. With well-planned lines of promotion of this kind, even an epidemic has small chance to interfere with progress.

Dangers of over-organization

Sometimes there is a tendency toward over-organization—having too many men for the authority and responsibility available. This is often the result of hiring too mediocre men to do one job, rather than pay one good man what the job is worth; it is not economy, either in payroll or space required. It certainly does not improve departmental efficiency, morale, or standards of ability. Furthermore, both of the mediocre men are

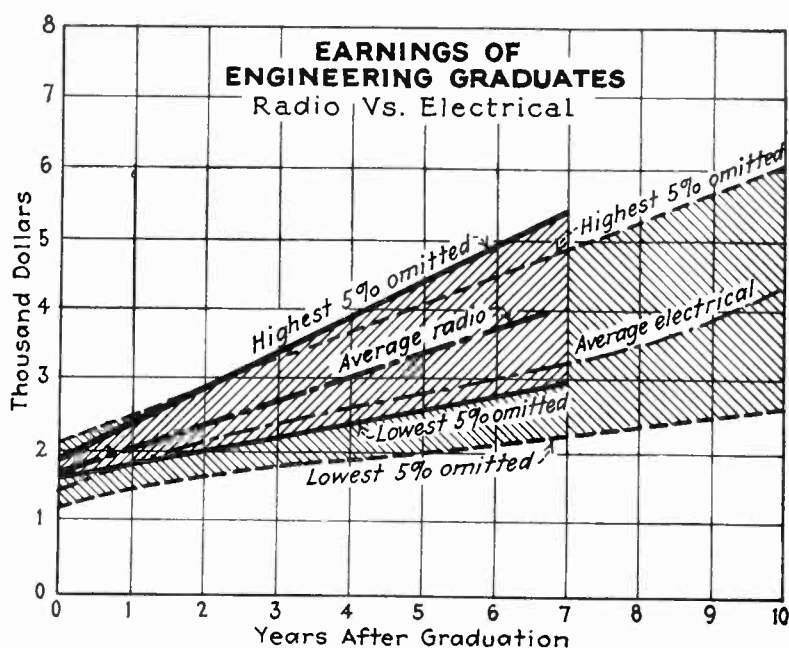

doubtless discontented with the job and the salary, thus accounting for increased turnover.

However, the other extreme must also be avoided. The smaller number of high-grade men must not be so overloaded with work, particularly routine details and reports, that they have no time to *think constructively* about the work in general. It is the ability to *think* and continually improve that makes this class of men the better investment.

The question of salaries depends somewhat upon the relation between the supply and demand, and upon prevailing rates in other branches of the electrical industry. To maintain an organization of high calibre without excessive turnover, salaries must be above average.

The Society for the Promotion of Engineering Education recently compiled a rather complete analysis of the earnings of engineering graduates, in all branches of the profession. Since the data obtained for the electrical graduates conform very closely with the average for all engineers, it may be used for purposes of comparison. It must be remembered, however, that conditions vary slightly from year to year, and 1926 data is not directly comparable with that of 1930, nor is 1930 indicative of 1935. However, for a rough comparison, corresponding data has been tabulated for a large group of engineering graduates employed in radio, and the comparison is shown in the diagram. Assuming that these data are typical of the radio industry, it is evident why many of the higher-class graduates are interested in linking their futures with that of radio.

Value of the bonus

For the junior executives and group heads the financial return for time and effort invested should be composed of two portions. The major portion should be a salary, increased at periodic intervals. The balance may be in the form of a bonus, payable annually or semi-annually. This bonus should not be in any way proportional to the salary, but should depend upon the contribution of the individual to the profit and advancement of the department, and upon the net profits of the company for the period it covers. In this way many of the men become partners in the business venture and guardians of the profit.

In any case, the salary should be ample to attract and hold the best men. It should be limited by ability rather than by length of service or other arbitrary standards. This tends to develop a good morale and a feeling that

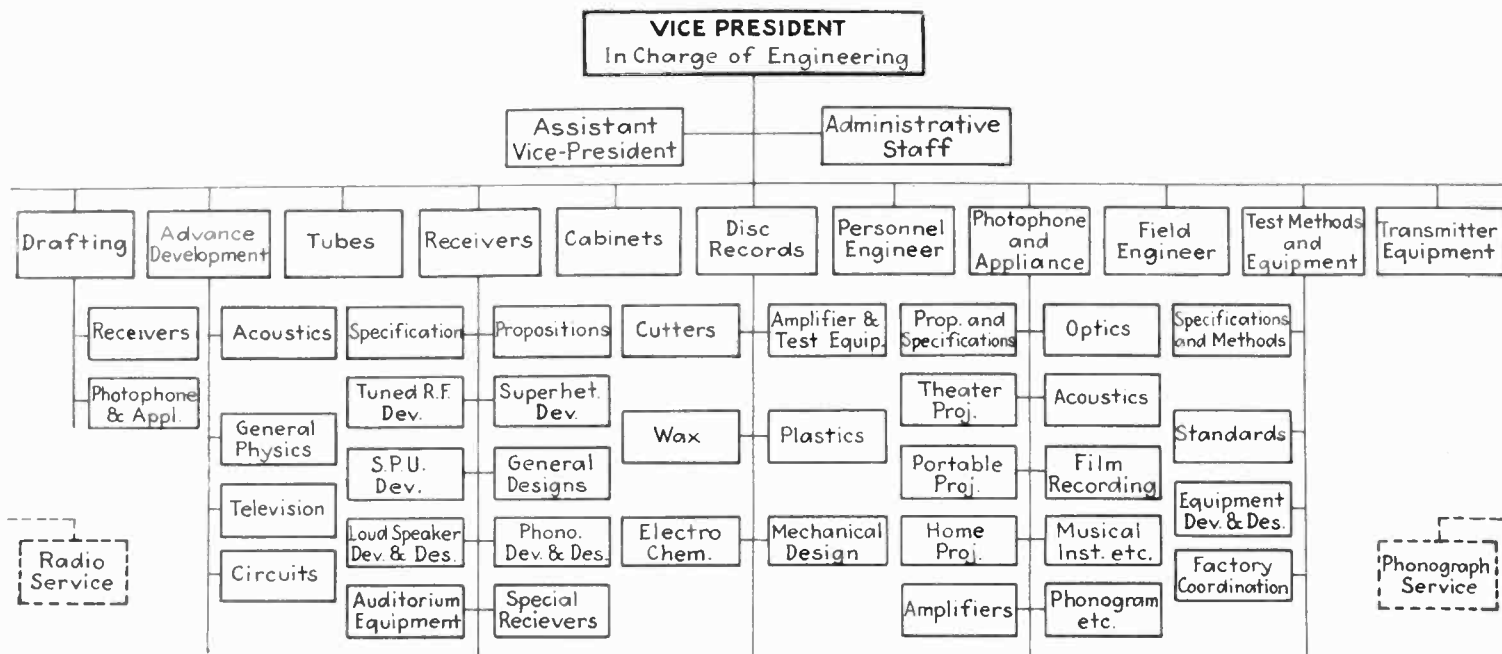

the organization is humanly considerate and willing to pay for further effort.

However, these efforts must be expended along proper lines, with a minimum of duplications. Each individual must have a clear conception of his responsibilities, the extent and limits of the work to be done, and the results desired.

Of course, no one type of organization will fit all conditions. Much depends upon the policy of the company and its attitude toward the industry. One class strives to add to the total knowledge of the art, as a partial return for net profits derived from it, with a view toward continuing the profits, and broadening the field. This class requires a relatively large engineering and research organization, headed by executives with foresight and patience.

Research credited with 20 per cent of profits

Another class, sometimes called "parasitic" organizations, strives to obtain the maximum profit from the art, considering the present with no regard for future progress. This class requires no research and engineering group, but a large force of high-pressure salesmen. Examples of both classes have been found in the automobile history. Hundreds of small manufacturing organizations of the latter class have had their day and are now but memories. The survivors are almost without exception in the former class. In the electrical industry, for example, one of the largest research laboratories was credited last year as being responsible for 20 per cent of the company's profits, on devices unknown or unimportant ten years ago.

There is, of course, a third alternative for the manufacturer who prefers not to engage in research and engineering work. He may utilize the facilities of independent laboratories and consulting engineering organizations. A relatively large number of such organizations usually exist in the early stages of a new industry, before requirements become stabilized.

In addition to research engineers who have specialized in physics, chemistry, and mathematics, radio requires several other types. In receiver development work, for example, electrical engineers specialize in circuits, and have only a secondary interest in the mechanical construction of a device. On the other hand, the receiver design section is primarily interested in the mechanical construction and manufacturing cost. The development engineers strive to get the utmost in operation, and the

design group to obtain this degree of operation at a minimum cost.

After a device is in production another group periodically reviews and analyzes the costs and profits, suggesting improvements in both. This group must deal with the factory engineers, who are responsible for manufacturing facilities, materials, methods and processes, and must also have a broad perspective of the other elements of cost, such as overhead, development expense, distribution, etc. Other engineers contribute their efforts to the sales, service, and legal problems. Directing all of these activities are executive engineers, who must be able to correlate the various phases of the problem, including the human phase.

Radio thus requires at least seven types of engineers all with different viewpoints. No one man could perform all of these functions effectively, yet the graduate who nearest meets the need of industry today is a combination business-engineer and research scientist, capable of charting a safe course into the unknown, and then navigating it profitably. However, this combination is extremely rare, and industry must utilize the desired qualities as they normally occur—divided among three or four different types of individuals—by getting them to work as one man under the leadership of the executive or "organizer" type. To cooperate effectively, each type must be acquainted at least with the viewpoints and problems of the others, and the preliminary training should be arranged with this in view.

To supply the additional personnel for all of these engineering functions, a group of technical graduates is selected each year. Many of the applications come in by mail, from all parts of the United States. Others are obtained by personal interviews at some of the large colleges and technical schools.

In selecting men, many things must be considered besides scholastic ability and character. One factor, often overlooked, is practical experience, usually indicated by vacation work. Theory is no substitute for practice, and a few months of summer work along the right lines, regardless of pay, are invaluable to a student. Foresight and purpose are measured by choice of summer work.

Another consideration is the portion of college expenses earned by the student. A good man who devotes half his time to making expenses will not obtain grades that reflect his true ability. If standing is high under these conditions the man is especially valuable.

[Continued on page 110]

Latest developments in wide-film pictures

By E. I. SPONABLE

Formerly Chief Engineer and Technical Director
of Fox-Case Corporation

THE motion-picture industry, and those connected therewith, having received and partially assimilated the revolutionary jolt caused by the advent of sound, have evidenced during the past year certain apprehensions regarding a new terror in the form of wide film.

Stories and rumors concerning stereoscopic pictures, natural sound, television for theatres, and pictures of tremendous size, have been so prevalent and confusing that even technicians begin to wonder if they know what it is all about. Many in this generation have seen the motion picture grow from the child of the nickelodeon days to the industrial giant of the present. During this time, even with the addition of sound, nothing radical has been undertaken in reference to the system as a whole. This does not mean that improvements have not been made. On the contrary, much excellent work has been done in perfecting and refining the mechanics of the art, including panchromatic and super-sensitive films, fast lenses, improved cameras, processing machines, high intensity projection lamps, better screens, and many others. Wide-film silent pictures are actually not a new development. In fact, they are practically as old as the motion picture itself.

In the accompanying views are shown two specimens of these earlier wide films. There are many others such as Henderson, Spoor, Biograph and Widescope. To justify those who began the development of wide-film sound pictures,

let it be said that the original problem was definite, and resulted from the logical growth of the industry. It is now being solved in the same orderly manner as was originally contemplated.

Limiting factors in picture size

Certain factors indicated a need for such a development. The sound track cutting off 13 per cent of the space originally used for pictures has changed the original picture frame of three by four proportion, resulting in a square shaped picture that is neither pleasing nor artistic. The quality of the present 35 mm. pictures fails perceptibly when projected with the magnification now used in the larger theatres. The loss of definition particularly in the long shots of color pictures due to low resolving power of the film becomes more apparent with increased magnification. These factors, together with many other deficiencies caused certain producers to believe that the time was at hand to modify the system as a whole to meet the present and future requirements of the studio and theatre. This, then, is the reason for the development of wide film. It was not with the intent of producing chaos in the industry, nor with a thought of replacing immediately the present standard 35 mm. system; but rather with the idea of being able to reproduce picture and sound of a quality commensurate

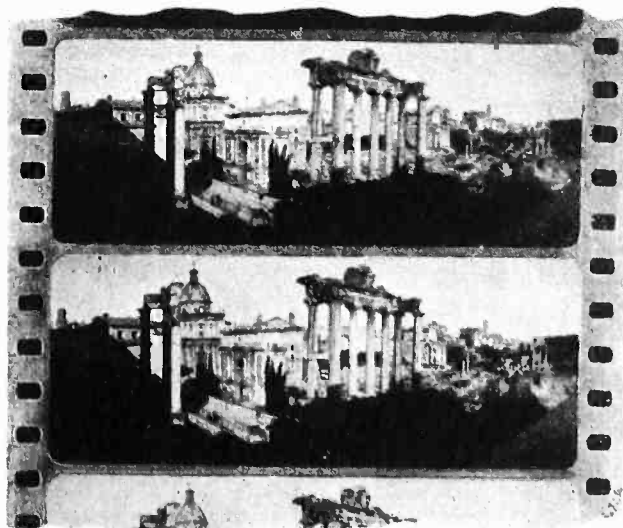
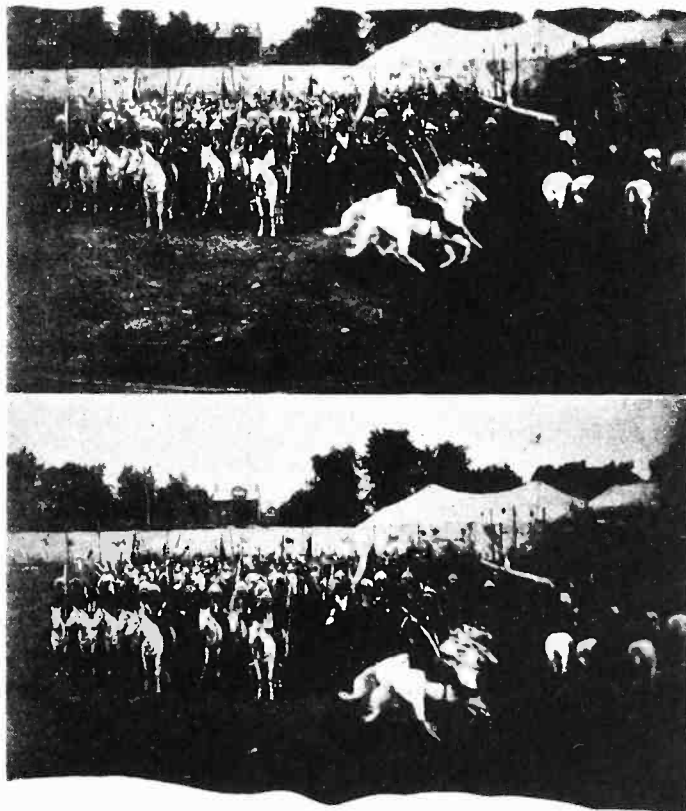

Gripper system film 75 mm. made about 1900. This film was used in a projector that had no sprocket teeth.

Italian film (Alberini print 68 mm.) made in 1914. Ratio picture width to height 2.48.

Comparison of Dimensions and Characteristics of the Principal Wide Films

	Picture Frame, Ratio Width to Height	Sprocket Holes per Frame	Sound Track Width, Mils	Perforation Pitch, In.	Projection Speed, In. Feet per Minute	Present Signal Range Above Ground Noise	Maximum Reproducing Frequency in Cycles with 1-Mil Slit
Standard 35-mm. film.....	1.17	4	100	0.187	90	25 db.	9,000
Grandeur 70-mm. film.....	2.00	4	240	0.234	112.3	34.5-70 db.	11,250
Proposed 65-mm. film.....	2.00	5	250	0.187	112.2	34.5-70 db.	11,250
Suggested compromise 67.5-mm. film.	1.90	5	230	0.187	112.2	34.5-70 db.	11,250

Note: A full symphony orchestra has a sound signal range in power of about 1,000,000 to 1 (60 db.) Present broadcast transmission and reception handle a range of about 10,000 to 1 (40 db). Improved sound technique will increase the sound power peak from approximately 300 times the ground noise to a level much more natural.

Present broadcasting facilities permit transmission of audio frequencies as high as 5000 cycles; but most receivers have poor fidelity to these high tones. Thus in the theatre, reproduction from the wider sound track will have an additional advantage from the standpoint of frequency transmission over present broadcast reception.

with the lavishness and luxury of the modern picture playhouse.

In connection with the picture a very extensive survey was made of existing large theatres, noting the size and shape of the prosceniums; the possible height a picture can be displayed without being cut off by the balconies and mezzanines; and the distance from the front row seats to the probable location of the screen. It was found that the average possible picture height was about 21 feet. Knowing this, and deciding arbitrarily upon the maximum amount of graininess of the film allowable from the front row seats, it was comparatively easy to determine a suitable size and shape of picture on the film itself. Thus, by more than a coincidence, at least three independent investigators representing three of the larg-

est producers found a satisfactory picture size to be 23x46 millimeters. If the overhang of the balconies in many theatres did not limit the height of the picture, a ratio of width to height of something less than 2.0 might have been chosen and might be more pleasing from an æsthetic standpoint. However, this condition together with the desirability in many instances of showing panoramic scenes led to the size set forth as a fair compromise. It is always possible to decrease this ratio either by masking, or by effective composition if conditions warrant.

Sound recording technique

In the case of the sound track the present 100 mil width permits, under average processing conditions, a signal volume range of about 25 db above the ground noise level of the film. This range can be materially increased by adding to the width of the sound band. Optical and other practical limitations, however, limit the choice of a new sound track to 250 mils. This will permit a scanning aperture of 23 mils as compared to 80 mils on standard film. The resulting signal range will be increased approximately 9.5 decibels.

Through more recent developments in the technique of film processing and handling, it is now certain that with this new width of sound band a signal volume range even up to 70 db. above the surface noise can be attained. This means that all normal sound conditions, including the pipe organ and the symphony orchestra, will be recorded and reproduced with their true quality and shading, thus eliminating the necessity of volume control required at the present time. This together with an increase in linear film speed of from 90 feet per minute to 112.3 feet per minute produces a very noticeable increase in the quality of reproduced sound. Higher frequencies are reproduced with less dis-

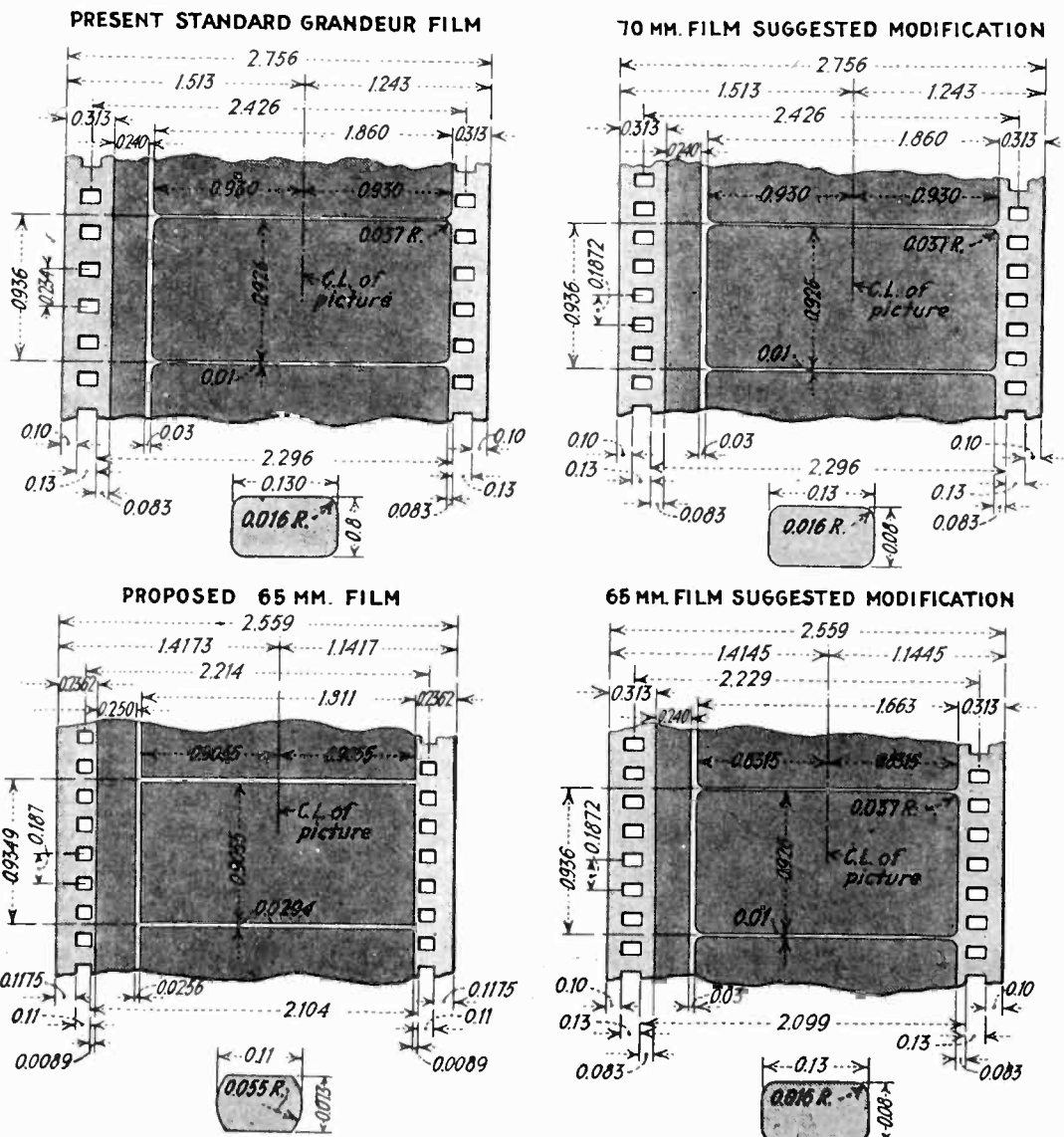

ortion and surface noise is practically eliminated.

Under present recording conditions the average effective recording slit width is 1 mil; this limits the maximum recording frequency to 9,000 cycles. However, with the increase in the linear film speed to 112.3 feet per minute the maximum recording frequency will be extended approximately 50 per cent. This will also insure better integration in the upper register of the audible frequencies.

Standardization for the new films

Although the principal projecting companies are in substantial agreement on the size of picture and width of sound track, there is still a difference in the proposed overall width of the film. One company has commercially exploited a film 70 mm. wide with four perforations to the frame. Other companies have developed a film 65 millimeters wide with five perforations per frame. These two types

of film are shown in the accompanying sketches. The design of the perforations in both cases has been made to allow for normal film shrinkage and proper size of sprocket teeth. It is quite certain that both sizes of film are practical from an operating standpoint, but two different sizes in practice would obviously be ruinous to the industry. Efforts are now being made by the engineers of the companies concerned to effect an agreement or compromise in the final film size.

Certain compromises have been proposed in order to bring all producers into agreement on a standard wide film. One of these proposals calls for a film of 67.5 mm. width with a sound track of 230 mils width. The picture frame dimensions for the latter would be 44.7 by 35.5 millimeters. Five sprocket holes per frame would be used which is the same number as in the proposed 70 mm. film.

In the standard 35 mm. projector the present length between the center of the picture frame and sound gate is 14½ inches. In the proposed wide films this distance is reduced to 11¼ inches. This allows the sound attachment to be included in the projection head, which with the present apparatus is not possible. This will also reduce the "hangover" of the sound in the present projection heads which are equipped with separate sound attachments.

The use of 70 mm. film in double system studio work requires new sound recording machines. These have been designed to use split film stock with perforations on one side only. A recording speed of 112.3 feet per minute is used. With 65 mm. film having a perforation pitch of .187 in., which is the same pitch as standard 35 mm. film, it is possible to use standard recording machines provided they are speeded up to 112.3 feet per minute.

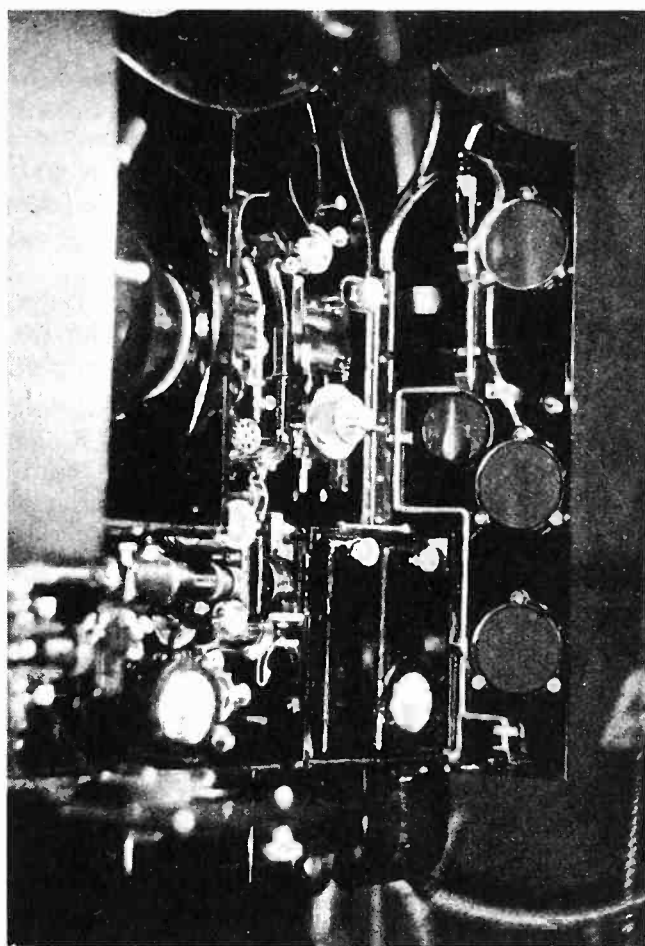

Projection head of new Grandeur projector as installed in the Roxy Theatre, N. Y. Note sound attachment combined with projection head

space is available if a band is required to effect some manner of electrical control of sound distribution.

Thus, in developing wide film, an attempt has been made to give the motion picture industry the wherewithal to make pictures of a truly imposing character. It will not make production easier or prove a cure-all for careless film processing. With proper technique it should be possible to produce pictures of a most pleasing sense of depth and perspective, but they will not be stereoscopic. It should give the scenarists and directors a chance for greater expression, and result in pictures in the theaters of a scope, beauty and realism hitherto unknown.

▼

Mr. Sponable is an outstanding figure in motion picture engineering. He has had ten years experience on the problems related to light and sound with the Case Research Laboratories. Together with Mr. Theodore Case, he was responsible for the development of the Movietone system of sound recording. His most recent work has been in the development of wide films. The first "Grandeur" film shown with sound synchronization was made under his supervision.

—The Editors.

▲

Producing artificial fevers

By short radio waves having frequencies of ten million cycles per second

By C. M. CARPENTER and A. B. PAGE

THE value of heat as a physical means of alleviating and curing disease has been emphasized constantly throughout the history of medicine. However, the significance of fever and its relation to the course of an infectious disease or to the healing of trauma has been debated often. It was believed that a rise in body temperature was only a sign of disease, as in pain, and, to establish the comfort of a patient, must be dissipated. Nevertheless, evidence has been accumulated during the last few years to show that a fever, disregarding hyperpyrexia of central origin, may be a phenomenon valuable to the diseased animal body, and is a defensive mechanism for the body.

Combinations of certain diseases occurring in the same individual—for example, an acute febrile disease with a chronic afebrile malady—sometimes results in an improvement or a cure of the latter. Such observations played an important role in Wagner von Jauregg's development of the malaria treatment for paresis. Because of his success, the study of the value of fever in an infectious disease syndrome is engaging the attention of many investigators. That the heat associated with the febrile phenomenon, due to the injection of a protein, is

[From a paper presented at the American Physical
Therapy Association convention at Boston, April 18]

the factor that is responsible for the beneficial results suggested by the favorable results obtained in the treatment of neurosyphilis by heat alone.

The present methods that are used to establish fever in man are unsatisfactory in one respect or another. The injection of foreign proteins is hazardous. The use of plasmodium malariae or spirochaetes for the treatment of general paresis often fails because of the danger concerned with the administration of a living virus, or because of a failure to infect immune individuals.

Since the observation of Dr. W. R. Whitney, director of the Research Laboratories of the General Electric Company, that there is an elevation of the body temperature of men working in the field of a short-wave radio transmitter, considerable experimental work has been undertaken to adapt this energy for producing artificial fevers. Hosmer has reported these heating effects on salt solutions of various concentrations and on small laboratory animals.

Internal tissues are directly heated most rapidly

It was determined that this is a method for producing in animals any degree of fever at will, without the introduction of foreign substances. The heat is produced directly within the animal body, as occurs in the course of a fever due to an infectious disease. This constitutes a method for internal heating in which the heat is generated in the organs of the body as rapidly as in the boiler walls, but because of the greater heat loss at the periphery the temperature of the internal tissues rises more rapidly.

During the last two years special types of apparatus have been designed by the Research Laboratories before mentioned and used experimentally in an endeavor to cause a fever in man rapidly, without great discomfort to the patient and to a degree high enough to be of value. The equipment used in our experiments has been constructed on the same principle as a short-wave radio transmitter, with the exception that the energy is concentrated between two condenser plates instead of being directed from an aerial.

The heater consists of a vacuum-tube oscillator and full-wave rectifier that supplies the high voltage for the oscillator. The high-frequency oscillator is composed of two 500-watt radiotrons operating at a frequency

▼

Body temperatures as high as 106 deg. Fahr. have been developed without discomfort to the patient.

Such artificial fevers offer wide possibilities in the treatment of diseases, since such temperatures (1) make the body environment less favorable for the multiplication of a virus, and (2) speed up the body chemical processes that make for immunity and defense against infection.

▲

from 10,000 to 14,000 kilocycles, the output of which is concentrated between two plates. The rectifier is an immersed transformer having a 7,000-volt secondary and feeding two half-wave, hot-cathode, mercury-vapor tubes. In conjunction with filter system this unit furnishes the 3,000-volt direct-current supply for the oscillator. An auto-transformer is connected on the primary circuit of the high-voltage transformer to provide plate-voltage regulation.

The condenser plates are of aluminum, 28 in. by 18 in. by $\frac{1}{8}$ in., and are covered with hard rubber plates 30 in. by 20 in. by $\frac{1}{4}$ in. to prevent arcing, should the patient attendant come in contact with the plates. In this field of undamped waves between the plates there is a rapid alternation of 3,000 volts drop of potential. We have obtained our greatest heating from the use of a meter wave that oscillated 10,000,000 times per second between the plates. We have used wave lengths of 6, 8 and 18 meters, but they have not heated the body so effectively with the oscillator described.

Arrangement of the patient

The patient is suspended on interlaced cotton tapes stretched across a wooden frame 76 in. by 28 in. made of two-by-six timbers. The under-surface of the frame is covered with celotex $\frac{1}{2}$ inch thick, forming an air chamber beneath the body. A celotex cover of similar thickness, 8 inches high and one foot shorter than the frame, is fitted over it so that the head of the patient projects through an opening at one end. Thus there is formed a fairly tight air-chamber around the body as it lies on the tapes. The patient rests on his back and the plates are placed at each side of the celotex box so that radio waves oscillate through the body from one side to the other. The plate distance can be varied, but as a rule it has been kept at 30 inches. Two small hair dryers as suggested by Dr. Thomas Ordway are placed in openings in the foot, one above and one below, to circulate hot air around the body. These decrease heat loss and equalize the humidity throughout the enclosed atmosphere.

By applying the plates in this manner and by enclosing the body, it is heated rapidly without causing great discomfort to the patient. We have raised the normal normal temperature of 99.6 degrees F. to 104 degrees F., and 105 degrees F., in from 60 to 80 minutes. In one instance a temperature of 106.5 degrees F. was recorded. Other temperatures may be obtained easily with the apparatus employed, but, because of our limited experience, we have proceeded cautiously. When the desired temperature is reached, it may be maintained in several ways: First, by decreasing the voltage; second, by increasing plate distance; third, by employing only the hair blowers.

Theories explaining heat production

Although we are able to produce successfully artificial fevers with the radio waves as described, we realize that the equipment used and the method for applying this form of energy to heat the body can be greatly improved, and this is rapidly being done. Various theories explaining the rise of temperature of the body when exposed to short radio waves have been discussed by Carpenter and Boak¹ in another report. We believe that the development of heat is due to the resistance of the body to the induction of current between the surfaces adjacent to the opposed plates. At each alternation of polarity of the waves the corresponding polarities are induced upon the

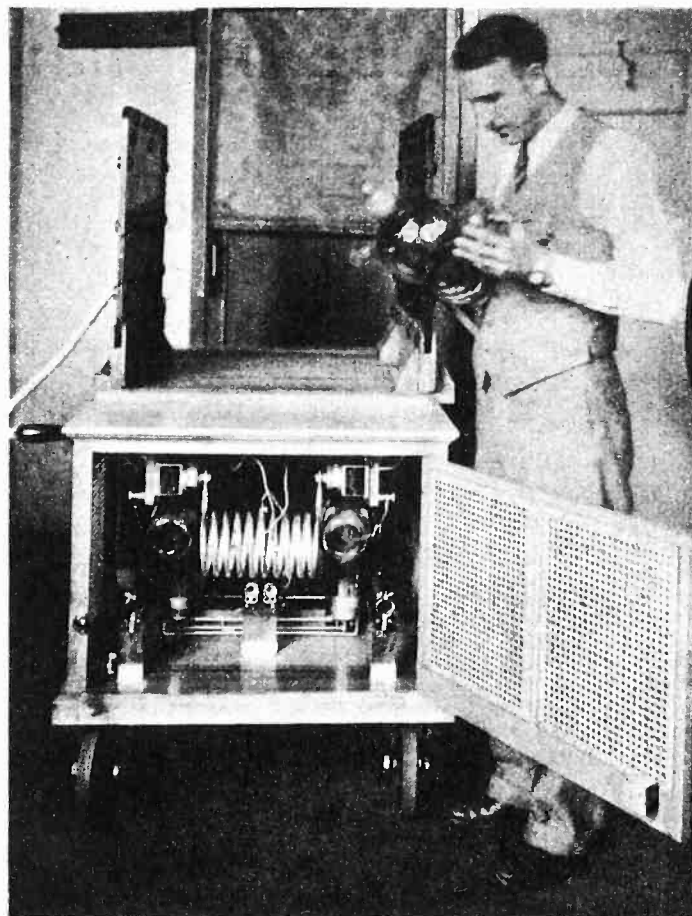

An end-view of the portable therapeutic heater showing the high-frequency tubes in place. Above the table-top are seen the two vertical condenser plates between which the patient is placed

adjacent boundaries of the interposed body, and current is conducted through the material for a brief interval. The heating of solutions similar to the blood serum is dependent directly upon their electrical resistance. It has been shown that dilute solutions of different salts when of the same electrical resistance exhibit practically identical heating effects.

The use of therapeutic fevers is still in the experimental stage but they have great possibilities if our conception of the significance of a febrile reaction is correct. We have studied the effect of fevers produced by short radio waves on various laboratory animals and on 25 patients, and thus far we have failed to observe any objectionable effect unless extremely high temperatures are maintained for long periods. We have proceeded, of course, with caution and followed closely the variations in body temperature, blood pressure, the pulse and respiration. The use of such a method demands conservatism and sound judgment because of the comparatively short time it has been studied. However, we are of the opinion that because of the practicality of this method of heating, it may be of value not only to the clinician but to the physiologist, the biochemist, and the bacteriologist.

Studies of infectious diseases in laboratory animals that will be reported elsewhere lead us to believe that two desirable effects are obtained by raising the body temperature. First, the increased heat within the body makes a less favorable environment for the multiplication of a virus. Second, the heat increases the rate of those chemical processes concerned with the development of immunity and with the general defense mechanism of the body against infectious agents.

¹Carpenter and Boak, to be published in American Journal of Syphilis.

Vacuum-tube oscillator used for continuously Recording wire diameter

By C. W. LOEBER

THE operation of this apparatus for measuring wire diameter depends upon the well-known principle that small changes in the capacitance of a vacuum-tube oscillatory circuit produce changes in the frequency of the oscillator. Two vacuum-tube oscillators are used, one having a fixed frequency and the other having its frequency varied by changes in the thickness of the wire being measured. An audible beat-note is thus produced, the change in pitch of which will be a direct function of the change in wire thickness. The output of the oscillators passes to suitable amplifiers whose input is bridged by a resonant circuit. The latter is so adjusted that the voltage drop across the grid of

To accurately and rapidly determine the variations in thickness of wire, especially over great lengths, becomes a serious problem in the manufacture or use of wire. Uniformity in the diameter of such wire as tungsten and nickel has assumed great importance since the advent of mass production of radio tubes, for quality of these finished products is largely a matter of filament life. Using the apparatus here described it is possible to make a continuous record of the variation in thickness of any length of wire.

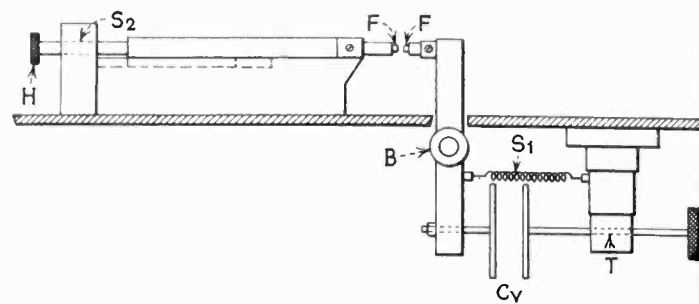

Fig. 1—Mechanical arrangement of the apparatus for measuring and recording the wire diameter.

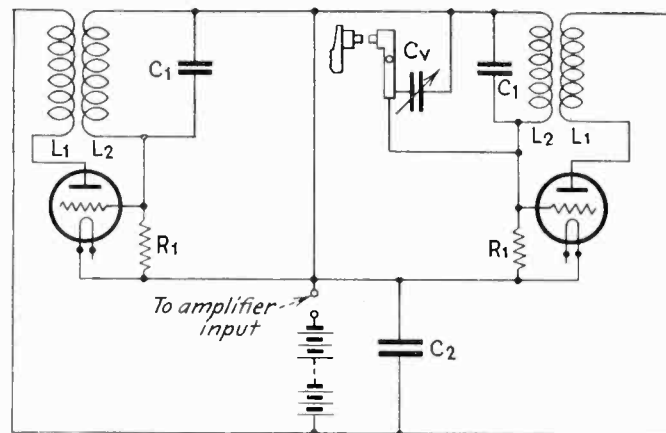

Fig. 2—Circuit diagram of the two oscillators. The beat frequency between them is amplified and used to operate a recording meter

the first amplifier bears a linear relationship to the frequency variations of the beat-note. A recording milliammeter is used in the plate circuit of the amplifier. The apparatus was developed by W. W. Loebe and J. Samson of the Physical Laboratory of the Osram Company of London, England.

The mechanical arrangement of the apparatus is shown in the accompanying drawing, Fig. 1. The wire is passed through two "feelers" (*FF*), one of which is stationary while the other is movable and carries one plate of a variable air-dielectric condenser C_v which forms part of the oscillatory circuit. By means of a micro-meter screw at *T*, the capacitance of the variable condenser is changed. A light spring S_1 governs the tension on the wire being measured. Spacing between the "feelers" is varied by a second micrometer screw, which moves the fixed "feeler" horizontally. This adjustment is used to calibrate the instrument and the micrometer head may be marked to read directly in millimeters. In order to prevent wearing of the surfaces of the "feelers," these are made of a suitably hard substance such as diamond. Minimum friction on the bearing of the movable member is essential to accurate recording.

Shielding of mechanism

The equipment is carefully shielded to prevent the effects of external electrostatic and electromagnetic fields. An additional precaution, that of thermally insulating the apparatus to prevent changes in circuit constants caused by changes in temperature, must be taken where great accuracy is required. This may be accomplished by building the apparatus of materials having a low coefficient of thermal expansion.

The wavelength of the oscillators is determined

beat-note requirements of the resonant circuit. Individual measuring requirements will vary. The choice of wavelength is governed by the size of the variable condenser, the spacing of the condenser plates, the design of the resonant circuit, and the anticipated variations in wire diameter. For example: If the variable condenser has a spacing between its plates of $\frac{1}{10}$ mm. which is changed by 10^{-5} mm. due to a proportional change in wire diameter, the condenser capacitance is increased or decreased by 0.01%, corresponding to a change in frequency of 0.005%. If the mean oscillator frequency is 10,000 kc., the beat frequency is changed by 500 cycles per second. If the mean beat frequency is adjusted to 900 cycles per second, a decrease of 500 cycles per second will lower the note by about one octave. It is therefore necessary to choose wavelengths which will give beat frequencies falling on the essentially

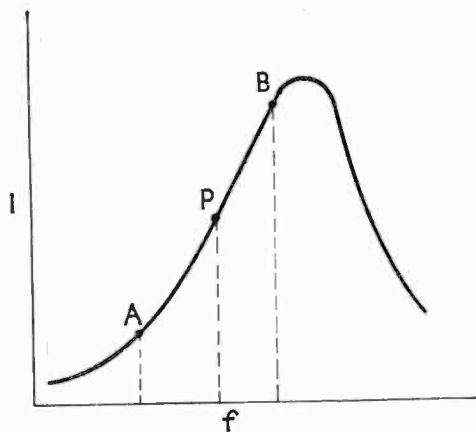

Fig. 3—The section A-B shows the part of the response curve over which the system operates

straight portion of the frequency response curve of the resonant circuit.

If the resonant circuit is designed so that its frequency response is similar to that shown in the curve and the mean beat frequency is adjusted to lie at the point P, the range over which the apparatus will give accurate results is determined by the length and slope of the straight portion, A-B, of the curve. Fairly high resistance will be needed in the circuit in order to obtain a curve which has a constant slope nearly equal to unity. In Fig. 2, C_1 , C_1 are condensers which control the wavelengths of the oscillators. L_1 and L_2 are the respective plate and grid coils, while C_2 is the output by-pass condenser. Grid bias may be obtained from a battery through the resistors R_1 , R_1 . Choice of tubes will depend upon the range of the recording milliammeter. In order that no distortion may take place in the audio frequency amplifiers, it is essential that the transformers have flat frequency response curves from about 100 cycles to 3,000 cycles per second, and all vacuum tubes must be operated on the straight portion of their characteristic curves. The latter requirement may be successfully met by operating the tubes conservatively from the standpoint of peak currents and voltages.

Method of calibration

With a space between the "feelers" equal to the diameter of the wire, the apparatus is adjusted so that the pen of the milliammeter rests in the center of the graph sheet. By means of the micrometer screw S_2 (Fig. 1) the air gap between the "feelers" is then

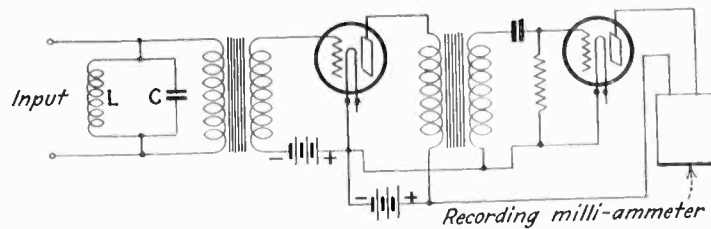

Fig. 4—Two-stage amplifier which finally records the variation in wire diameter

increased by 10^{-2} mm. Assuming that the milliammeter mechanism is in operation, the pen will trace a line to the right or left of the graph sheet. The spacing between the "feelers" is then reduced by 10^{-4} mm. This will give another straight line on the graph sheet closer to the zero position. Still further decreasing the air gap by 10^{-2} mm. will bring the pen on the other side of its zero position on the graph. Fig. 5 illustrates clearly how this calibration appears on the graph sheet. It will be necessary to calibrate the instrument for each different diameter of wire.

It has been shown above that this apparatus is capable of measuring differences in wire diameters of the order of 10^{-5} mm. However, such a degree of sensitivity can only be obtained by observing the precautions mentioned in an earlier paragraph. Nevertheless, by merely shielding the apparatus from external fields it is entirely possible to obtain a sensitivity of the order of 10^{-4} mm. Loebe and Samson, in their early experiments, used an oscillator frequency of 1,000 kc. The air space of their variable condenser ranged between 0.5 and 1 mm. Their beat-note had an average frequency of 1,000 cycles per second. A change of diameter of 10^{-4} mm. gave a reading of 0.8 mm. on the graph. The linear speed of the wire was 2 to 3 cm. per second, while the speed of the graph sheet was one-third of the wire speed. Thus every centimeter on the graph sheet represented 3 cm. of wire length.

Measuring and recording cross-sections

In order to check the apparatus, a piece of wire was measured four consecutive times and the graphs compared. It was found that these were practically congruent, showing that the results obtained at any time may be readily reproduced.

Cross-sections of wire may be rapidly measured with this apparatus. A specimen of wire is placed between the "feelers" and rotated through 360 deg. Graphs made of such measurements furnish another check upon the accuracy since the readings from 0 deg. to 180 deg. must equal those obtained from 180 deg. to 360 deg. with the exception that they will lie on the opposite side of the zero line on the graph. It will, of course, be necessary to make measurements of each specimen of wire individually.

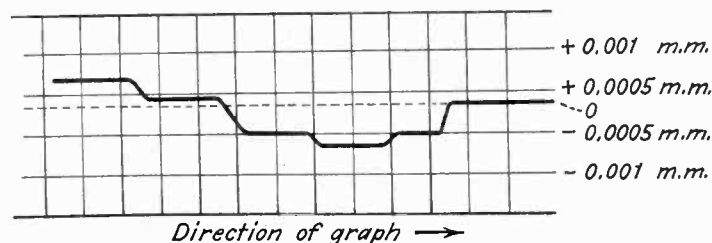

Fig. 5—The graphic record of the wire diameter secured when the instrument is calibrated.

Development of insulating materials

By ROBERT KRUSE

WIDER distribution of high-powered broadcasting stations, the advent of high-sensitivity receivers, and the desire for more selectivity, have all forced upon radio engineers the problem of designing tuning circuits with a minimum of resistance. Attention has been directed at the form-factor of coils, and the size of wire and shield, and now research has been directed at the form upon which the coil is wound.

In this article, the research that led to a new insulator, of specified properties, is described. The purpose was to find an insulating material which would make possible coils with less resistance than usual, and therefore, tuned circuits with greater selectivity. The work was carried out at the Radio Frequency Laboratories, Inc., by Dr.

▼

There is a general feeling among engineers not actively engaged in designing radio receivers, that such design consists in juggling circuits alone, and that the component parts have not changed appreciably for a long time. This, however, is not the case. Sooner or later every individual unit or raw material that goes into a radio receiver comes under the microscope of the technician, and is revamped, and brought up to date. Research never ceases.

▲

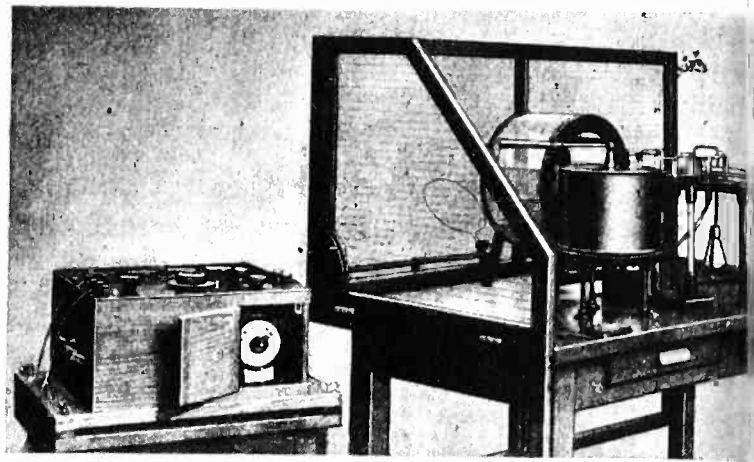

Laboratory apparatus for measuring losses and dielectric constant of insulators.

L. M. Hull and H. A. Snow, at the instance of the Boonton Rubber Manufacturing Company.

Moulding compositions in general consist of a fill and a binder. In the case of the common phenolic compositions the binder is the raw phenolic-derivitive resin which undergoes a chemical change when heated and compressed in the mould, and may therefore be spoken of as a reactive binder. Investigation of the various phenolic resins has shown that they may be produced to yield pure resin-moulded products with a power factor as low as 1 per cent, which is to say a phase-angle of about 34 seconds. The use of such moulded parts of the pure resin alone is not economical for a number of reasons, especially if any machining of the finished part is necessary. Therefore, the desired low-loss composition should contain a filler of some kind which will yield good mechanical properties while not destroying the requisite electrical ones.

The proper filler must not only avoid extreme hardness and granularity but must also avoid participation in undesired chemical reactions.

Experiments with series of test compositions

A long series of test compositions was prepared and tested as to power factor and mechanical properties. Since the immediate purpose was to produce a material for radio use, the more promising compositions were given "R" numbers, and as the 29th of these selected compositions proved desirable, the result of the tests now appears under the commercial designation of R-29.

This composition uses mica as the non-reacting filler, raw silk as a fibrous ingredient to increase the toughness of the material and small percentages of fluxes and hardening agents, the proportions of all these various materials to the binder changing with the mechanical and heat requirements. The "flux" just referred to may be the natural wax of the silk itself, although other waxes are sometimes used.

The use of silk, rather than cotton, asbestos or wood fibre is due to the relative power factor of these materials. This is shown clearly in the accompanying curves. This chart also shows that the resin itself is of great importance since the same asbestos filler, of which 20 per cent could be used in the special resin without raising the power factor above 1.8 per cent will produce a composition having a power factor of 7.5 per cent when the resin is of an ordinary quality. Although some samples of asbestos show up rather well as to power factor they do not contribute as much strength as does silk. Wood-fibre also ranks somewhat low in

regard. When a composition is wanted which is somewhat cheaper than the one containing silk it is usual to employ carefully chosen, well-dried cotton. Both the silk and the cotton are usually cut into short lengths to permit better mixing and to improve the appearance of the product.

Method of measurement

The power factor measurements were made in the familiar manner of using a sample of the material as a condenser plate and measuring the resistance of this condenser. The power factor may be derived easily from this resistance since the frequency and capacity are known. The test sample was a disk $7\frac{1}{2}$ in. in diameter having a raised rim and an even thickness across the portion inside the rim. The sample was floated on mercury in a glass dish and more mercury was poured on the specimen, being retained by the rim. The contact was very intimate, assuring that the condenser so produced had only the test material as its dielectric. Referring to the picture of the entire set-up; r.f. power from the oscillator in the case at the left of the table is led through a shielded line to the single-turn coil seen behind the static-screen of the table. The r.f. field of this coil is coupled through the static-screen to the inductance coil on the table and thence through a thermocouple to a highly insulated switching mechanism which permits the closing of the circuit through either the test specimen or through a high-grade quartz-insulated variable condenser.

The procedure is to switch to the test piece, set the oscillator at the resonant frequency, and adjust the coupling to secure a convenient current as shown by a galvanometer connected to the thermocouple. The test piece is then switched out and the calibrated air condenser substituted. When it is adjusted for resonance the capacity of the test piece may be read from the condenser calibration. Next the current is reduced to the same value as that found with the test piece by starting small straight-wire resistance links of negligible inductance. The resistance required to reduce the current to the former value is obviously equal to the difference in resistance between the test condenser and the air condenser. Usually the resistance of the air condenser can be neglected and one may say that the test condenser has a resistance equal to the inserted series resistor. Contact uncertainties are avoided by a scheme which keeps the total number of contacts the same at all times, all contacts being between mercury and amalgamated copper to insure low resistance.

The power factor, dielectric constant, and phase angle will all be calculated rapidly since the capacity and resistance of the test condenser are now known and the frequency may be determined easily by the frequency meter. When other frequencies are considered the inductance in the tuned circuit is changed, and the oscillator is adjusted accordingly.

Electrical and mechanical properties

Some of the electrical constants of the material are given. In general the power factor is in the vicinity of 1 per cent as compared with 2.7 to 7 per cent for the more usual phenolic compositions. The puncture strength of such a composition may be made equal to or more than that of compositions containing wood flour and other normal fillers. The high-frequency puncture strength especially may be made materially better since this de-

[Continued on page 110]

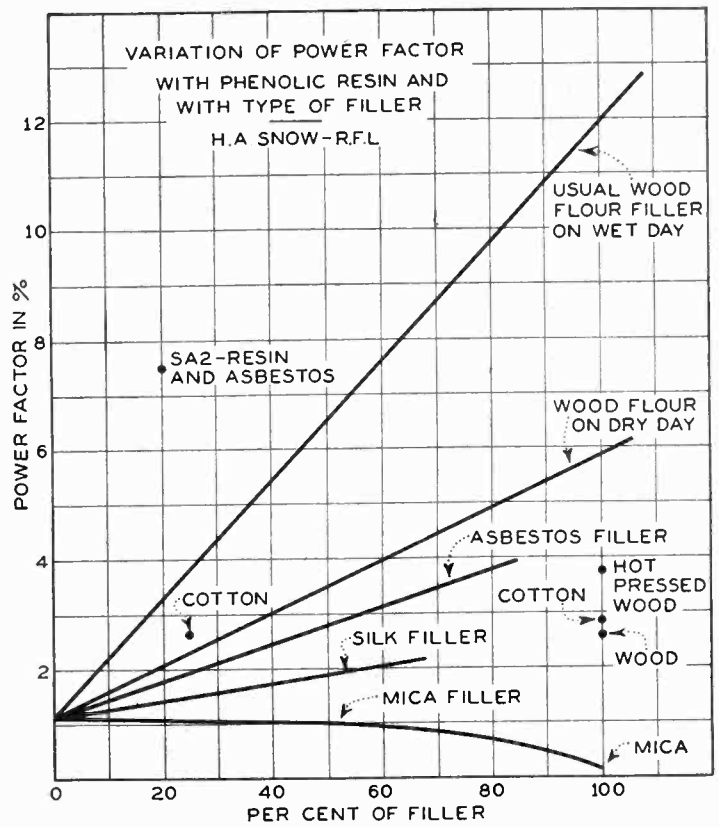

The low-loss resin was used in all the above compositions except the point marked "SA2."

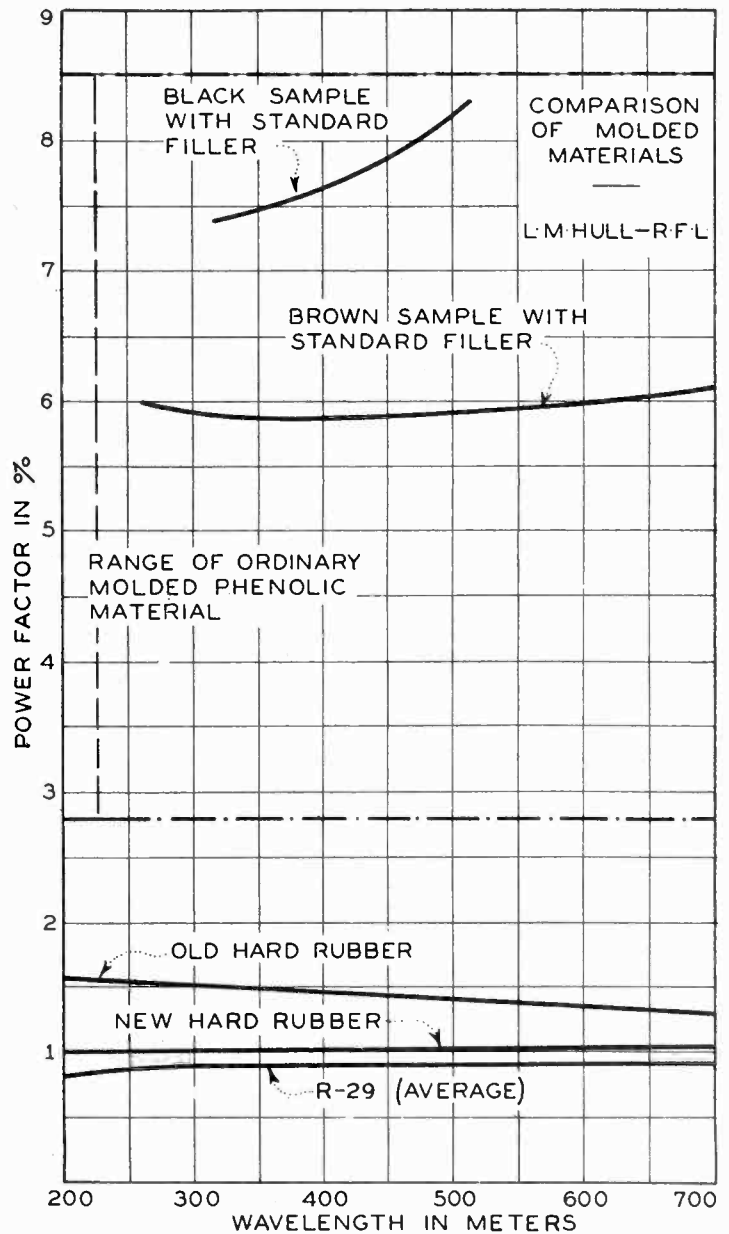

Comparison of power factor of various molded materials. A good insulator has a low power factor.

Industrial uses of the photo cell

By J. V. BREISKY

IF AN industrial expert should tabulate all the operations now partly dependent upon visual judgment, but otherwise mechanical and routine in performance, he would be able to give a fairly comprehensive view of the place photo-electric applications will hold in the future. Mechanisms are replacing human labor wherever it is possible, in order to reduce expense, waste, and loss of time. Moreover, for purely mechanical tasks human labor is imperfectly suited, because it is "only human" for attention to stray, for hands and eyes to suffer fatigue, and for differences in individuals to be responsible for differences in output.

Not only do machines relieve men from unduly arduous labor, but they perform their tasks with flawless regularity. Many routine operations are now dependent upon human labor only because so far no mechanical means have been devised to perform the task satisfactorily.

Of vital interest to the industrial world are those inventions which apply not only to a specific problem but which are based on a principle which makes them applicable to a group of problems. Such an invention is the photo-electric cell. It has been a privilege for those engi-

Mr. Breisky, the author of this article, is in charge of photo-electric cell applications in the supply engineering department of the Westinghouse Electric & Manufacturing Company, East Pittsburgh, Pa.

neers who first sought practical applications for a new device to assist in the solving of many troublesome problems in widely separated fields. Its initial use, an indispensable factor in television and talking motion pictures, is sufficiently well known not to be discussed here. Although it is only within recent years that the photo cell has been developed to its present stage of workaday efficiency, industry has already made use of many instruments now complete for certain applications. The photo-electric smoke recorder, for example, has a specific piece of work to do, and is an established piece of equipment. Other apparatus, such as the light relay and photo-cell amplifier units, are applicable to many types of work, and are being used wherever it is found that they supplement or replace present methods advantageously. As engineers become more familiar with the possibilities of photo-electricity they will be enabled to simplify many present operations and to reduce losses caused by the variable human factor.

A mechanical "sense of sight"

What the versatile photo-electric cell is able to do is of interest to everyone looking for better methods of getting work done. Machines have long been performing superhuman tasks in response to mechanical impulses. The new thing which the photo cell contributes is the automatic response of machines to variations in light. It is almost as if "the mechanical man" had developed a sense of sight. What the hitherto irreplaceable human eye is actually able to do when one analyzes its functions—apart from the intelligence which interprets optical impressions—is mainly to note variation in light and shade, color, size and shape. This, the photo cell is also able to do, and like the eye with its optical nerve, it is equipped to send an impulse which reports what it sees.

In studying the applicability of the photo cell in relation to any particular problem, it is necessary to understand the action of the cell itself and of the method by which the impulse is amplified. Figuratively speaking to put the "electric eye" to work the engineer must give his apparatus "intelligence" to analyze or interpret what it sees. For example, in one application the photo cell is trained upon packages, in order to cause those to be thrown aside where a label is missing. No very complex adjustment was necessary to enable the photo cell here to replace human eyesight for inspecting the countless specimens produced daily. But naturally, for every special operation certain requirements are slightly different. However, when once a clear understanding is

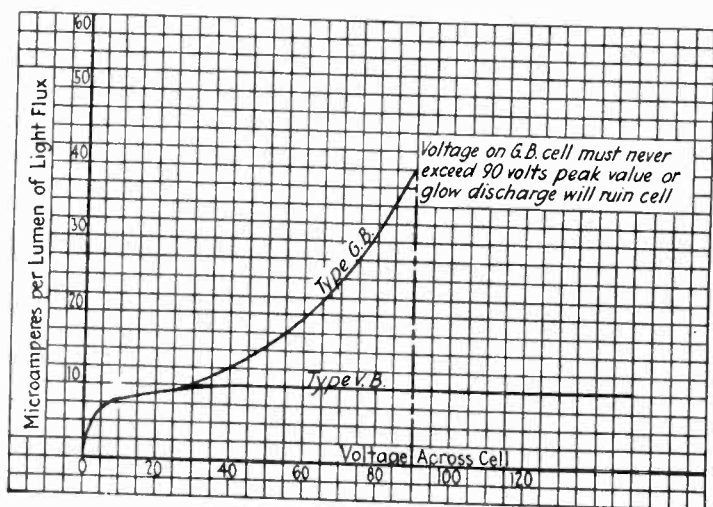

Fig. 1—Photo-cell output in terms of voltage applied

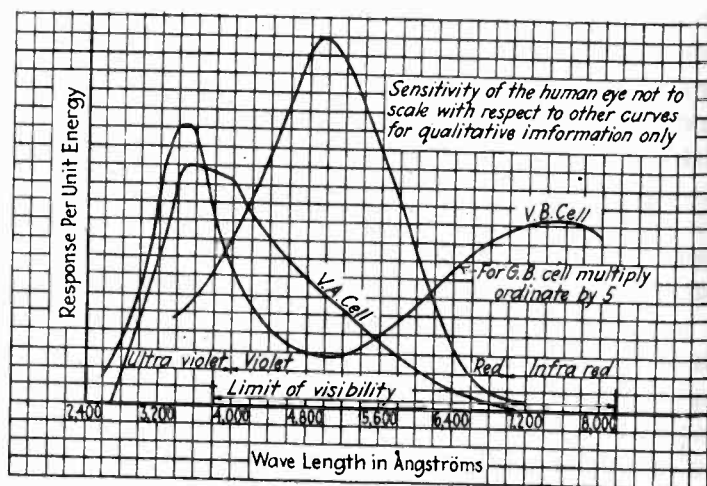

Fig. 2—Color sensitivity of cell compared with eye

of such devices as are described herein, further applications can readily be made by the use of ingenuity. A full explanation of the operation of the photo cell given in the April issue of *Electronics*, (pages 16-29).¹ It goes without saying that by now the photo cell is a practical and inexpensive device, with a very long factory record for length of life. There are two standard types of cells: a vacuum type cell, and a gas-filled cell.

Types of photo-electric cells

The vacuum-type VB cell gives constant output at varying voltages, and should be used for most applications. The gas-filled type GB cell gives increased output with an increase in voltage and is recommended when sensitivity is the chief consideration, not constancy.

Fig. 1 shows typical curves of cell output as a function of applied voltage at one lumen of light flux. For small quantities of light, the current is proportional to weight. The cells will respond to light frequency as well as standard frequencies.

Photo-electric cells used for grading or matching colors usually require a suitable color filter in conjunction with the light source so that the percentage change in cell response may be a maximum following a change in color. A special vacuum cell type VA, is available having a response more closely corresponding in hue to the human eye, but with only one-fifteenth the sensitivity of the VB cell. Fig. 2 shows color sensitivities of the VA, VB, and GB cells.

The two standard type VB and GB cells are alike in mechanical construction. The photo cells are mounted on a standard four-prong base and consist of a cathode and an anode. Although four prongs are applied, only two are connected—namely anode and cathode prongs. The anode plate is coated with caesium and the light-sensitive material.

It will be most helpful here, perhaps, to describe first the methods by which impulses from the photo cell are amplified; and second, actual complete apparatus employing photo cells, and some of their applications. Since the current of a photo-electric cell is but a

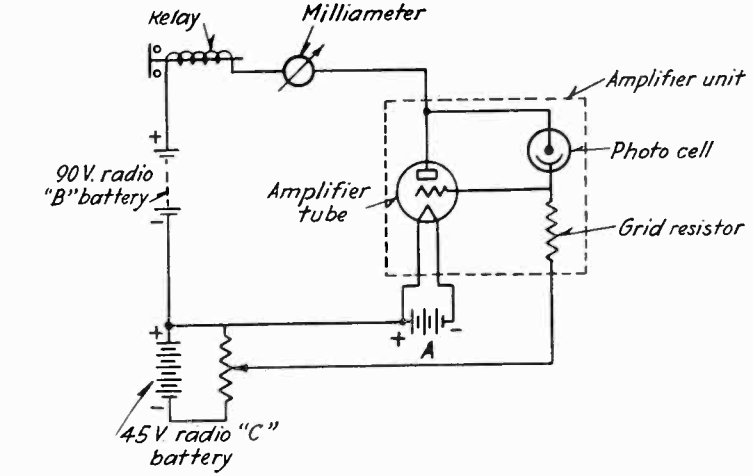

Fig. 3a—Amplifier circuit for direct-current use

few microamperes, it is too small to operate a relay without amplification. In most applications two types of devices or modifications of these are suitable for this use, according to the class of work required of the cell. Where continuous indications or records of certain light effects on the cell are required, the thermionic amplifier is best used, as this has an output directly proportional to the light falling on the cell, thus a continuous graphic record can be obtained. In other photo-electric devices it is desired to cause an operation to be performed only when a beam of light is partially or completely interrupted, as in counting. Here a glow discharge device of the grid controlled type operates as a relaying tube, since when a specific point is reached in the amount of light falling on the cell, current flows or stops flowing through the glow tube, setting auxiliary apparatus into operation.

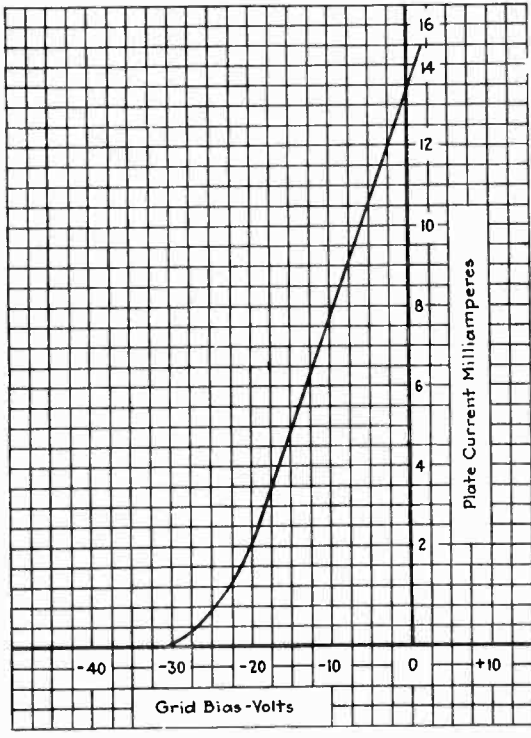

Fig. 3b—Characteristics of tube shown in Fig. 3a

Fig. 3a shows a diagram of a typical photo-amplifier tube circuit, intended for d.c. operation, except that the amplifier tube filament may be heated by a.c. The operation of such a circuit can best be understood by also referring to the amplifier tube characteristics as shown in Fig. 3b.

Assuming the photo cell is dark (infinite resistance), it can be seen that the grid will be at a negative potential with respect to the filament, as determined solely by the potentiometer adjustment and the value of the "C" battery. If the photo cell is illuminated, a current will flow under the influence of the B and C battery through the relay and through the photo cell, and will return to the negative terminal of the C battery after passing through the grid resistor across which as a result will exist a difference of potential. The polarity of this voltage drop over the grid resistor will be such as to tend to cause the grid to become more positive with respect to the filament. In other words, the effective negative bias will have been reduced. From Fig. 3b it can be seen that this reduction in negative bias voltage will result in the flow of more plate current, and as a result the relay in the plate circuit will be energized.

Assuming an initial bias voltage of 25 volts and assuming a 50 megohm grid resistor in use, it is seen from Fig. 3b that upon illuminating the photo cell slightly, if

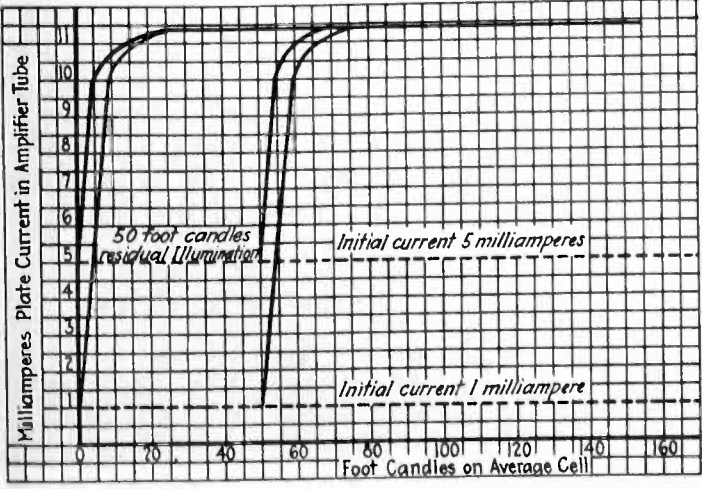

Fig. 4—Current flow for various intensities

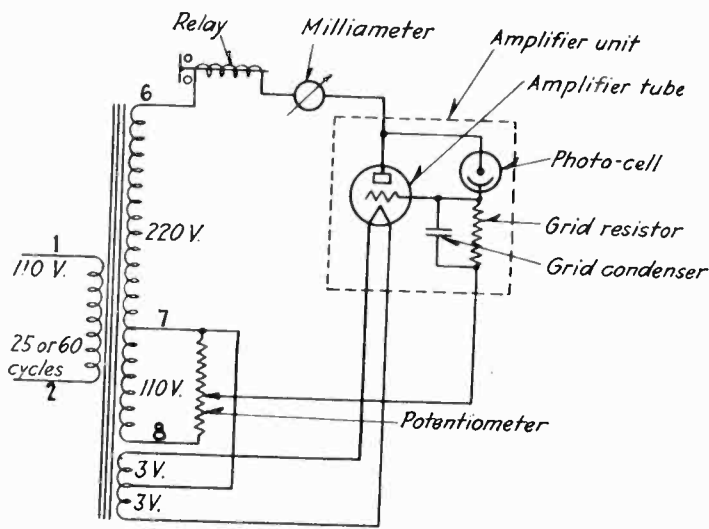

Fig. 5—Amplifier operated directly from a.c.

0.3 micro-amperes should flow, the voltage drop over the grid resistor would rise from 0 to 15 volts, which subtracted from the negative grid bias leaves 10 volts, and the plate current would rise from 1 milliamperes to 8 milliamperes. From the typical curve in Fig. 4 it is seen that an illumination intensity of about 7.5 foot candles should produce this result.

By some minor changes in the circuit, the plate current can be made to decrease with an increase in light, which will be found desirable for some applications.

The d.c. circuit is the most sensitive obtainable. However, because of the fact that both the photo-electric cell as well as the amplifier tube are rectifiers, it is possible to operate them from alternating current directly. In this circuit the amplifier current will also be proportional to the illumination on the photo cell, but the sensitivity is smaller than that of the d.c. circuit. A typical circuit is shown in Fig. 5.

Photo-cell and grid-glow tube

This circuit is mainly intended for a.c. operation. The current output is either zero or a definite value depending on the illumination on the cell. A grid-glow tube is used as the amplifier instead of a thermionic amplifier tube such as is used in the other circuits. This circuit should be applied chiefly where most of the light is interrupted quickly. It is the most simple circuit obtainable. The grid-glow tube is a three-element neon-gas-filled

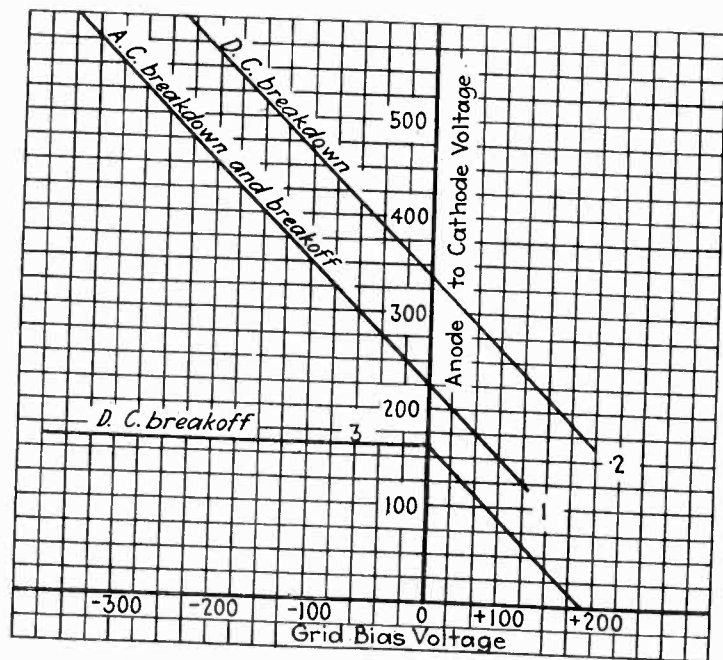

Fig. 6—Static characteristics of grid-glow on a.c.

tube, consisting of cathode, anode, and grid, mounted on a standard four-prong base.

This tube, developed by D. D. Knowles² of the General Electric Research laboratories, operates on a unique principle. When the grid is free, a high positive charge is built up which blocks the flow of electrons between the cathode and the anode. However, when a conducting path from the grid to the anode drains the charge away from the grid and permits current to flow, producing the orange glow from which the tube derives its name. The conducting path may be a condenser or a resistor.

The conducting path between the grid and the anode needs but a small current-carrying capacity—a non-ohmic characteristic when a photo-electric cell is to be the grid conductor. Therefore, the grid-glow tube is an ideal amplifying device for the "electric eye."

Fig. 6 shows the static characteristics of the grid-glow tube when used on alternating current. It may be seen that in the circuit shown in Fig. 7, the photo-electric cell and the condenser act as a potentiometer on the a.c. supply in such a way that when the photo cell is illuminated, the grid is essentially at cathode potential, whereas when the photo cell is unilluminated, the grid of the grid-glow tube approaches anode potential. In this manner

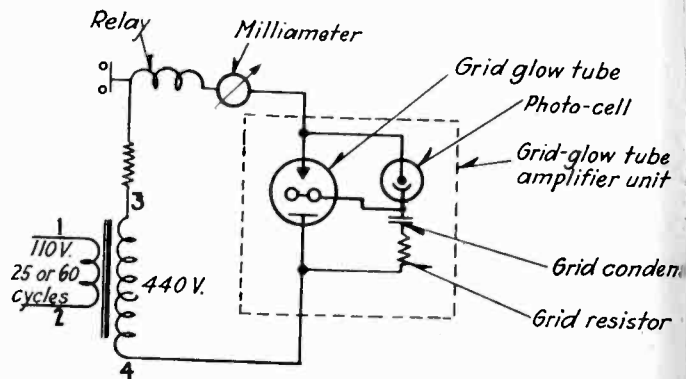

Fig. 7—Potentiometer circuit used with grid-glow.

By combining the characteristics of the photo cell and the grid-glow tube, it is possible to cause the grid-glow tube to pass current or not pass current, depending upon the value of illumination on the photo cell. The resulting characteristic of the combination of photo cell and grid-glow tube is shown in another diagram.

The d.c. photo cell-amplifier tube circuit shown in Fig. 3a responds very quickly to changes in illumination. The time lag is generally of the order of 0.001 to 0.01 seconds. This figure is for the plate current in the amplifier tube. When a relay is used, an additional time lag enters, depending on the speed with which the relay armature picks up and closes its contacts.

The a.c. photo cell amplifier tube circuit shown in Fig. 5 as well as the photo cell-grid glow tube circuit shown in Fig. 7 have a greater time lag inherent in the unit itself, since it is necessary for the voltage wave to reach the proper half of the cycle before any plate current can flow.

[To be concluded in Electronics for June]

¹Also refer to: "Photo-electric Cells," by E. H. Vedder, *Electronics Journal*, March, 1930, page 152, and "Photo-electric and Cathode Discharge Devices and Their Applications to Industry," by J. Breisky and E. O. Erickson, abridgment in *A.I.E.E. Journal*, August, 1929, page 118. (For unabridged article refer to *A.I.E.E. Journal*, August, 1928, page 146).

²"The Theory of the Grid Glow Tube," D. D. Knowles, *The Electronics Journal*, February, 1930, page 116.

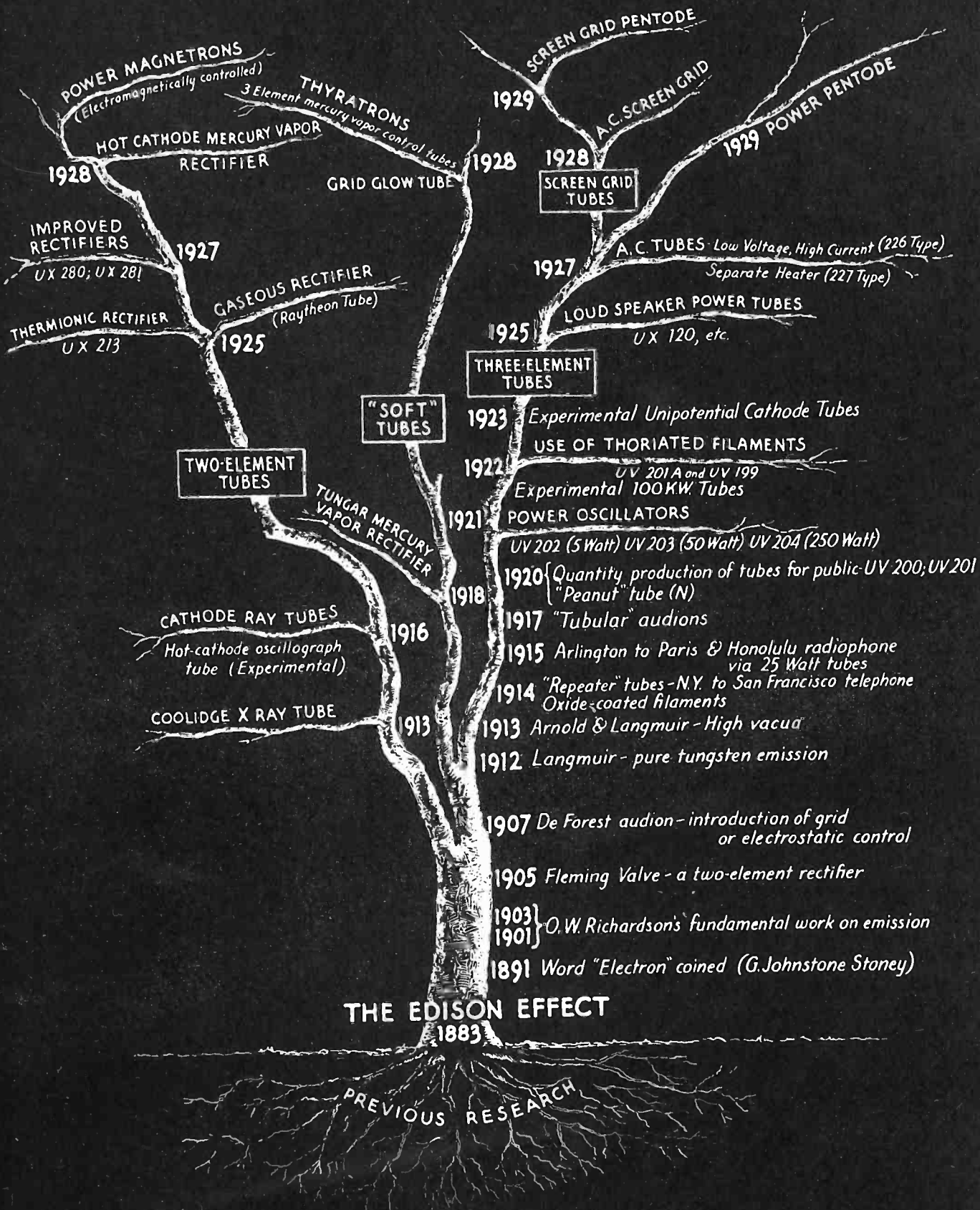

The family tree of the thermionic tubes

POWER and DISTORTION

Single tube vs push-pull tubes

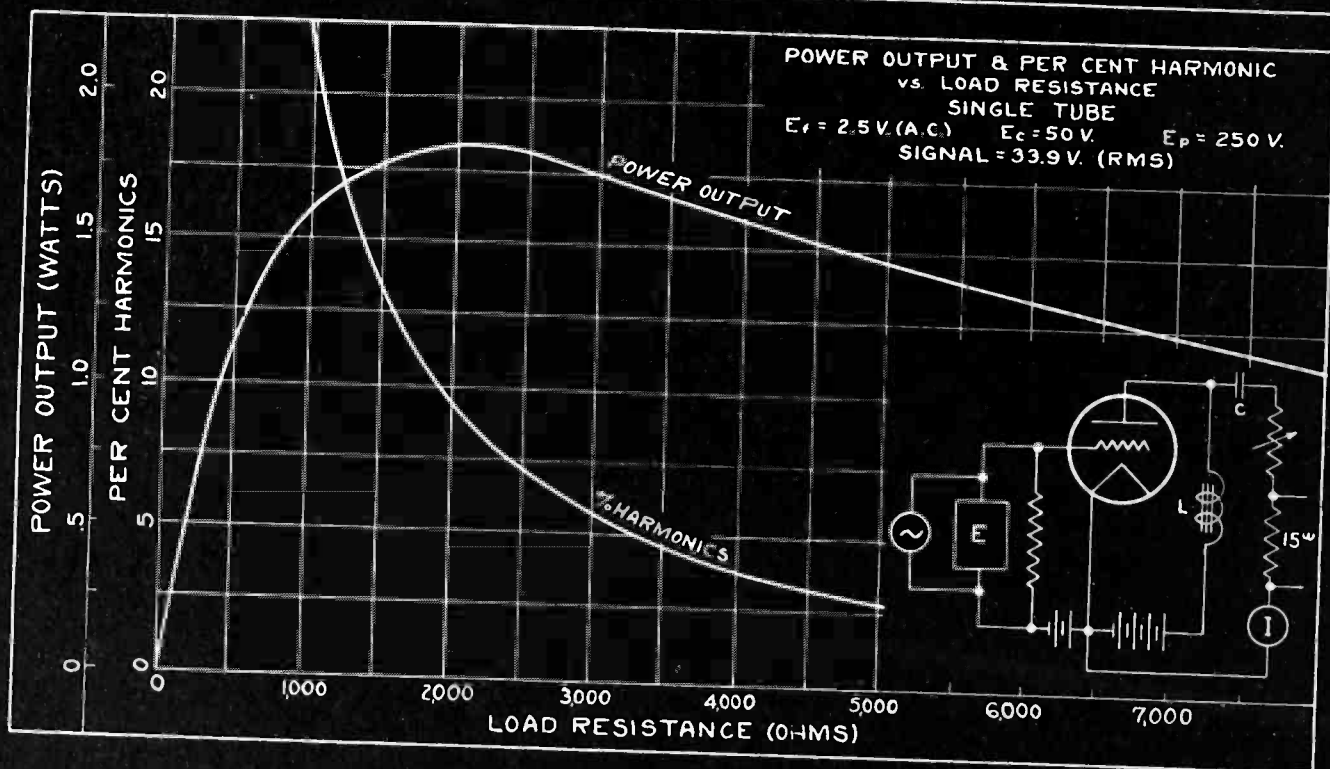
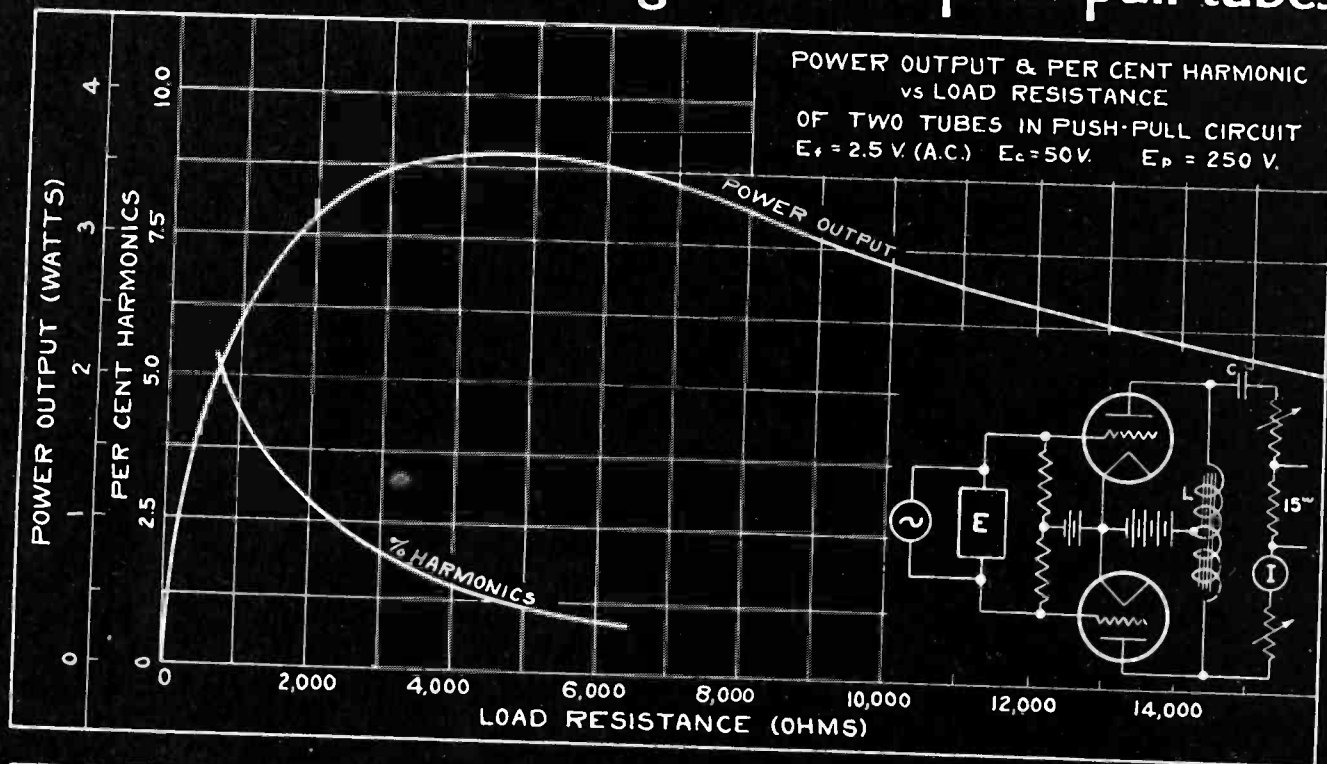

These curves demonstrate the superiority of two tubes in push-pull compared to a single tube, not only from the standpoint of increased power output but from the greater freedom from harmonics; i. e. greater fidelity. The output is double that obtainable from a single tube provided the proper load is used, and the distortion with the load giving the greatest power output is roughly one-sixth that of a single tube

Measuring Harmonic Distortion

in tube circuits

by D. F. SCHMIT and
M. STINCHFIELD

Cunningham, Inc.

AN ALTERNATING current which is not a pure sine wave is equivalent to two or more pure frequencies. If these frequencies are simple multiples (2 times, 3 times, etc.) of the fundamental, they are called harmonics. If a pure sine or cosine wave signal is connected to the grid of a vacuum tube and if the output a.c. plate current is not a pure sine wave, then distortion of the signal has occurred. This distorted waveform of the a.c. plate current is equivalent to a sine wave of the fundamental (signal) frequency and a series of sine waves which are two, three, four, etc. times the fundamental frequency. These are the second, third, fourth, etc. harmonic distortion components. In the study of tube design and application, waveform analysis and total harmonic distortion measurements are important, and the purpose of this discussion is to describe a complete test procedure which makes the measurement of distortion a comparatively simple procedure.

In general the distorted a.c. waveform may be represented by a Fourier's Series, thus:

$$E_t = E \sin \theta + E_2 \sin \theta_2 + E_3 \sin \theta_3 + \dots + E_n \sin \theta_n + \dots$$

Where,

- E_t = the voltage of the distorted a.c. plate current.
 - E = the amplitude of the fundamental (signal) frequency.
 - E_2 = the amplitude of the second harmonic.
 - E_n = the amplitude of the n^{th} harmonic.
 - $\theta_n = 2\pi$ times the n^{th} harmonic frequency times the time plus its phase angle $= 2\pi f n t + \phi_n$.
- Where E , E_2 and E_n are peak values

The percentage of any one harmonic is usually given as the ratio of the amplitude of the harmonic to the fundamental expressed as a per cent. It is also equal to the ratio of the r.m.s. of the harmonic to the r.m.s.

of the fundamental. When two or more harmonics are compared with the fundamental the per cent of the total harmonics is usually defined as the ratio of the r.m.s. of all the harmonics to the r.m.s. of the fundamental.

From equation (1) the per cent second harmonic will be,

$$(2) \quad H_2 = \left(\frac{E_2}{E} \right) \times 100 \text{ per cent}$$

The per cent total harmonics will be,

$$(3) \quad H = \sqrt{\frac{E_2^2 + E_3^2 + \dots}{E^2}}$$

where the E 's may be either r.m.s. values or peak values.

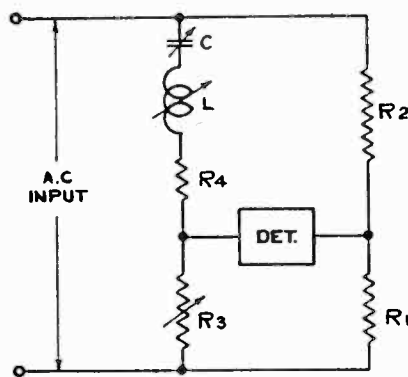

Fig. 1—Resonance type of bridge used for harmonic measurement

A method which has been found convenient for measuring the total harmonic content of an alternating current was described by I. Wolff in the Jour. Optical Soc. of America, Vol. 15, p. 163, Sept. 1927, entitled, "The A.C. Bridge as a Harmonic Analyzer." It has been used also by others and was described by G. Belfils in the Rev. Gen. d'Elec., April 3, 1926, and by C. Chiodi in L'Electrotecnica, Vol. 15, p. 166, March 5, 1928.

The circuit of an a.c. bridge is shown in Fig. 1. It is similar to a Wheatstone bridge except for the inductance and capacity in one arm. A resistance balance can be obtained on this bridge for the one frequency at which the reactances are equal. At all other frequencies the bridge will be unbalanced as indicated on the detector—which may be a tube amplifier and meter. The amplifier has a high input impedance so that no current flows in this branch. (This is the only difference between Wolff's and Belfil's circuit.)

In operation the bridge is balanced with L , C , and R_3 for a minimum reading on the detector, the values of L and C corresponding approximately to resonance at the fundamental frequency. The residual voltage across the detector due to the frequencies for which the bridge is unbalanced will be mainly the voltage across R_1 since the voltage across R_3 will be small. Accurately the volt-

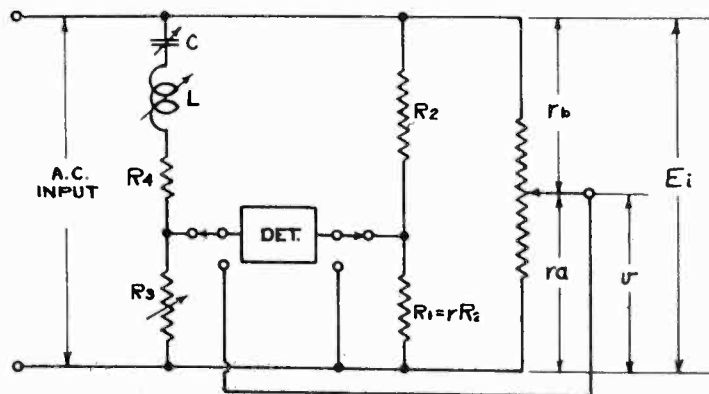

Fig. 2—Addition of a backtone potentiometer to the bridge circuit

age across the detector is the difference between these, or
 (4)
$$v = (E_{R_1} - E_{R_2})$$

where

v = the voltage across the detector when V volts of a single frequency f are applied to the input.

E_{R_1} = the voltage across R_1

E_{R_2} = the voltage across R_2

Suppose the bridge is balanced for the fundamental frequency. If a voltage V of any other frequency is applied to the input, the voltage across the detector (derived from equation (4), see Wolff's article) is found to be,

$$(5) \quad v = V \left(\frac{r}{r+1} \right) \left[\frac{1}{\sqrt{1 + \left[\frac{R_4 (r+1)}{\omega_1 L_1 \left(n - \frac{1}{n} \right)} \right]^2}} \right]$$

where,

v = the voltage across the detector due to the n^{th} harmonic

V = the n^{th} harmonic a.c. input voltage to the bridge

r = the bridge ratio (R_1/R_2)

$n = 2$ for the second harmonic, 3 for the third, etc.

$\omega_1 = 2\pi$ times the fundamental frequency

L_1 = henries inductance required to balance out the fundamental frequency.

R_4 = the resistance in the LC arm, usually the a.c. resistance of the inductance.

Equation (5) shows that if the term in brackets is close to unity, the voltage across R_3 is negligible and the voltage across the detector is equal to that across R_1 . The ratio of the harmonic voltage across R_1 , to the harmonic voltage in the input ($R_1 + R_2$) will be,

$$(6) \quad \frac{v}{V} = \frac{R_1}{R_1 + R_2}$$

or replacing, $R_1 = r R_2$.

$$(7) \quad \frac{v}{V} = \frac{r R_2}{r R_2 + R_2} = \frac{r}{r+1}$$

$$(8) \quad v = V \left(\frac{r}{r+1} \right)$$

which is equation (5) when the bracket term is unity.

When the ratio of inductance (L_1) to resistance (R_4) is chosen so that $\omega_1 L_1/R_4$ is equal to 5, and the bridge ratio $r = R_1/R_2 = \frac{1}{2}$, the term in brackets of equation 5 is equal to 0.98 for the second harmonic and 0.995 for the third harmonic. For all higher harmonics, and for inductance values or frequencies which make $\omega_1 L_1/R_4$

greater than 5 this bracket term will be nearer unity and the equation (8) will be sufficiently accurate for engineering purposes.

It then remains merely to measure the voltage (r.m.s. of all the harmonics across the detector) and total r.m.s. harmonic voltage in the input (V) which

known from the equation $V = v \left(\frac{r+1}{r} \right)$.

If the total input voltage, that is, the r.m.s. of fundamental and harmonics is E_i , and E is the r.m.s. of fundamental part, the relation between these is:

$$(9) \quad E_i^2 = E^2 + V^2 \text{ or, } E_i = \sqrt{E^2 + V^2}$$

The per cent total harmonics (H) is then,

$$(10) \quad H = \frac{V}{E} \times 100 \text{ per cent}$$

If the detector consists of a tube amplifier, which has negligible frequency discrimination, and has a meter on the output, the meter readings will be proportional to the r.m.s. voltage applied to the detector. The detector input is then switched from the bridge back to a known r.m.s. value, the reading can be readily interpreted in r.m.s. volts. Note that the meter need not be a pure single frequency waveform meter. True r.m.s. indications are shown on the detector.

Referring to Fig. 2 the backtone potentiometer can be connected across the a.c. input to the bridge. The detector is then switched to the backtone potentiometer for the same detector reading as shown with the bridge. The backtone is then at voltage v while the total voltage across the backtone potentiometer is E_i .

Their ratio is from equations (8) and (9)

$$(11) \quad \frac{v}{E_i} = \frac{V \left(\frac{r}{r+1} \right)}{\sqrt{E^2 + V^2}} = H \frac{\left(\frac{r}{r+1} \right)}{\sqrt{1 + H^2}} = \frac{r_a}{r_a + r_b}$$

Solving for H where $r = \frac{1}{2}$ and $(r_a + r_b) = 3,000$ ohms

$$(12) \quad H = \frac{r_a}{1,000} \left[\frac{1}{\sqrt{1 - \left(\frac{r_a}{1,000} \right)^2}} \right] \times 100\%$$

$$(13) \quad H = \left(\frac{r_a}{10} \right) K \text{ in per cent}$$

where K is a correction factor to be applied when distortion is of the order of 10 per cent and above. The per cent harmonic distortion is indicated by a reading of a dial on a decade box without knowledge of input or output voltage.

The arrangement described below in the diagram shown in Fig. 3 have been used to study total harmonic distortion of tubes and amplifiers where the individual components were not of interest. The amplifier employs two CX-340 high- μ tubes in a resistance coupled circuit having a flat characteristic from 30 to 3,000 cycles. The thermal meter which is slow in operation and requires a power tube in the last amplifier stage has been replaced with an r.m.s. tube voltmeter. This tube voltmeter employs a CX-322 tube with 45 volts on the plate, 22.5 volts on the screen-grid, 3.0 volts negative bias on the control grid, and the filament voltage adjusted to give square law response. This is usually about 2.8 volts. The steady

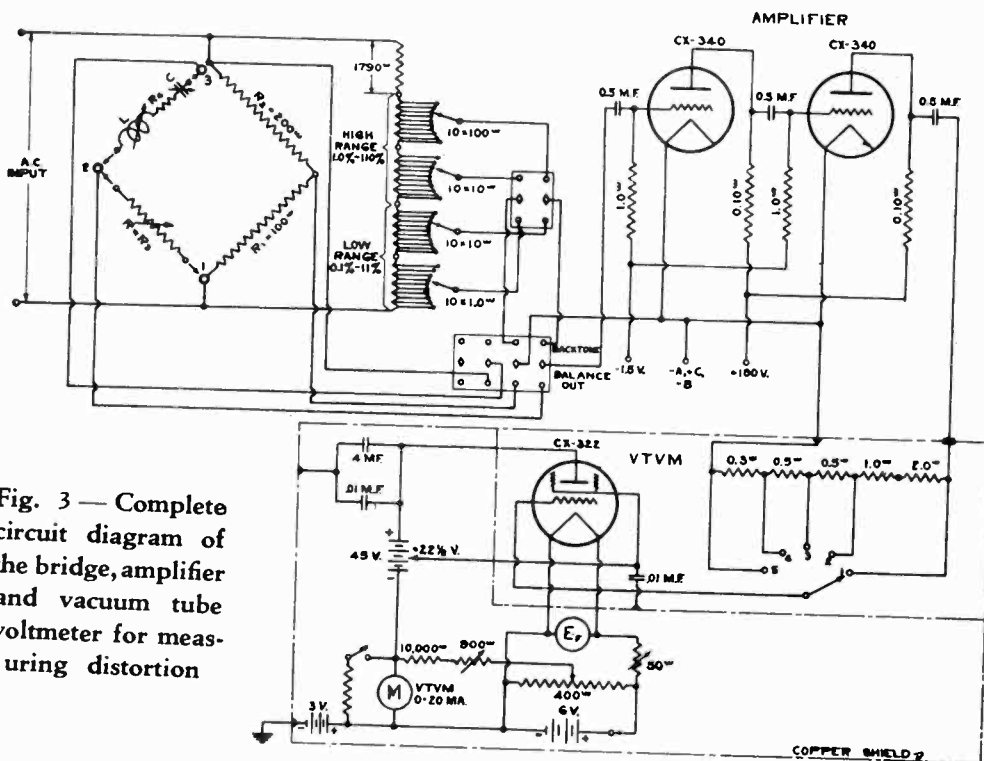

Fig. 3 — Complete circuit diagram of the bridge, amplifier and vacuum tube voltmeter for measuring distortion

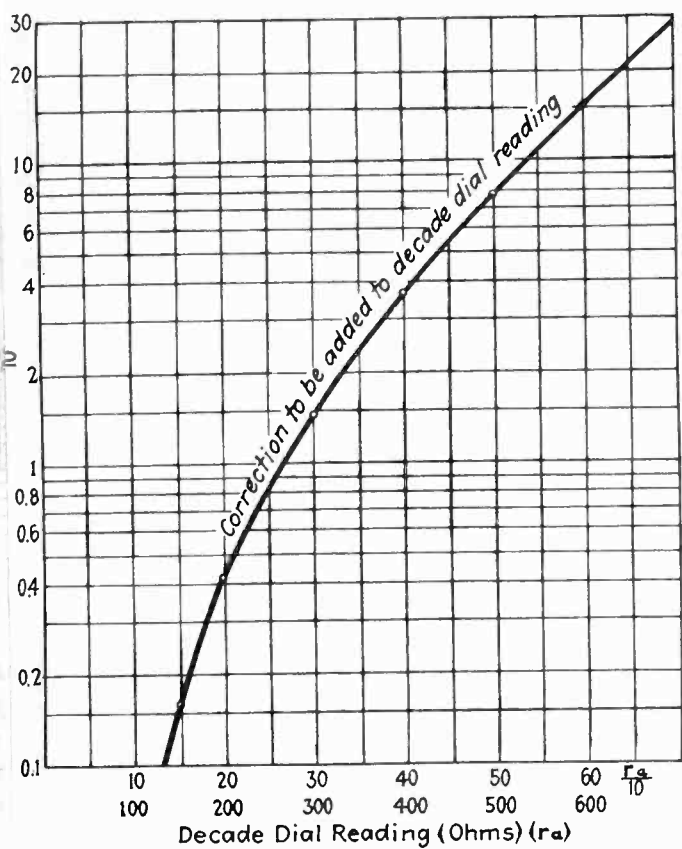

Fig. 4—Graph of correction to be added to dial readings

component of the plate current is balanced out of meter M with a potentiometer connection to the battery. The meter M is a 20 microampere voltmeter, which gives a full scale deflection on a voltage of less than 1.0 volt r.m.s. The input of the tube meter is connected through a tapped potentiometer which may consist of several high grade resistors totaling one or more megohms so that the input resistance remains constantly high. The values shown were chosen so that the range is doubled at each tap, with a maximum range of approximately 15.0 volts. With this maximum the amplifier will not be overloaded if the meter indicates full scale. The last tap shorts the input to the voltmeter. It is found convenient to protect the meter and permit zero balance adjustment.

The input resistance to the bridge is 300 ohms ($R_1 + R_2$) and 3,000 ohms ($r_a + r_b$) in parallel, or 273 ohms. In the backtone position this is constant. For the bridge in the balance position the variable resistors $R_3 + R_4$ are in parallel with the input for the fundamental frequency. For the other frequencies the input resistance remains close to 273 ohms. This will cause the input voltage of the fundamental frequency to drop when the bridge is balanced. The harmonic voltage will not be changed however. If the voltage generated at the source remains constant this will not introduce an error since the fundamental is merely balanced out and not used in the bridge in the balance position and will return to its normal value when it is returned to the backtone position.

When the bridge is connected in the plate circuit of a tube it becomes part of the plate load resistance. If the bridge is then balanced for the fundamental frequency, the 273 ohm bridge resistance will be reduced for the fundamental frequency due to the parallel resistance ($R_3 + R_4$). If the resistors R_3 and R_4 are fairly large (and the bridge constitutes only a small part of the plate load on the tube the error will be negligible. If switching the bridge from backtone to balance position causes an appreciable change in the load on the tube, the percentage of harmonics generated, in this case, would

change. This would require a readjustment of the load. If sufficient a.c. plate current is available a low resistance shunt on the input to the bridge will be effective. If a constant resistance attenuator is available it will usually eliminate any readjusting of the load and is a convenient control on the input current to the bridge.

With the arrangement shown in Fig. 3 harmonic percentages as low as one per cent can be read with two milliamperes current to the bridge. For higher percentages of harmonics the current may be about this value or may be less.

The backtone consists of two decade boxes having two dials, and a 1,790-ohm resistor. One decade box has units and ten ohm steps, the other ten and one hundred ohm steps. Dividing the dial reading by ten, one box reads 0.1 to 11.0 per cent harmonics in 0.1 per cent steps. The other box reads 1.0 to 110 which usually must be corrected for the high percentages of harmonics. The correction curve is shown in Fig. 4. When the dial reads 10.0 the correct reading is 10.05 per cent so that the correction is less than $\frac{1}{2}$ of one per cent for readings below ten per cent. For convenience and accuracy in applying the curve, Fig. 4 has been so calculated that the correction is an addition to $r_a/10$ rather than a multiplication.

Method of application

To illustrate the method of using the circuit arrangement of Fig. 3 the following example is given. In the chart facing the first page of this article the power output and per cent total harmonics from a power amplifier tube are shown. The audio frequency input to the tube was 33.9 volts r.m.s. of 400 cycles. The choke L and condenser C were large enough so that practically the entire a.c. output passed through the load resistance consisting of two decade boxes arranged to give the required load and to shunt part of the current across the harmonic analyzer. The thermal meter I was 30 ohms. The analyzer was shunted with 15 ohms. The balance of the load consists of 1,456 ohms to give the required total 1,500 ohm load. The meter indicated 34.2 milliamperes. The capacity C connected to the harmonic analyzer was 0.10 mfd. The tuning was done with a variometer about 1.6 henries being required. With the bridge key (see Fig. 3) in the balance-out position the variometer and the resistor R_3 were carefully adjusted until a minimum reading was shown on the vacuum tube voltmeter. The bridge key was then moved to the backtone position and the per cent harmonic dials adjusted to bring the vacuum tube voltmeter reading to the same value. The low range dial was found insufficient, so the range key was switched to the high position and the high range dial adjusted for the required vacuum tube voltmeter reading. The reading on these dials was 130 or roughly 13.0 per cent. The correction curve (Fig. 4) shows that this reading should be increased 0.1 per cent to give the true reading 13.1 per cent. The correction here is less than can be read on the smallest dial and was neglected. The power output was calculated as $I^2R = (0.0342^2 \times 1,500) = 1.76$ watts. The harmonics were less than 5.0 per cent when the load was increased to 4,000 ohms. The results of measurements on two tubes in pushpull are shown in the second diagram on the opening chart. The signal input voltage was increased to twice that used in the other case and the load was connected from plate to plate of the tubes. The per cent total harmonics was found to be about 1.4 per cent with a 4,000 ohm load. The load resistance was decreased to 730 ohms before the harmonics reached 5.0 per cent.

Antenna coupling systems

as applied to radio receivers

By JESSE MARSTEN

THE ANTENNA coupling unit is a single impedance or a network of impedances which couples the antenna of a receiving set to the grid of the first radio-frequency tube. Its primary function is to transmit to the grid of the first radio-frequency tube the signal which is developed in the antenna.

The design of this unit must be considered with relation to the performance of the receiver as a whole. The major factors to be taken into consideration in its design may be enumerated as follows:

1. *Selectivity.* Owing to the great number of broadcasting stations and the increase of power the selectivity problem has become more and more severe, particularly at the higher frequencies. It is highly desirable, therefore, that, if possible, the antenna coupling unit contribute a certain degree of selection. This relieves the burden imposed on the rest of the receiver of supplying the requisite selectivity. In fact, with very high gain receivers, this consideration is imperative on account of the appearance of a new difficulty.

In this article, Mr. Marsten, a radio engineer of some thirteen years standing, discusses a problem which at first sight seems very simple, that of connecting a radio receiver to the antenna system which has its existence in a sea of ether waves. Various methods have been used; the author discusses nearly all of them.

—The Editors.

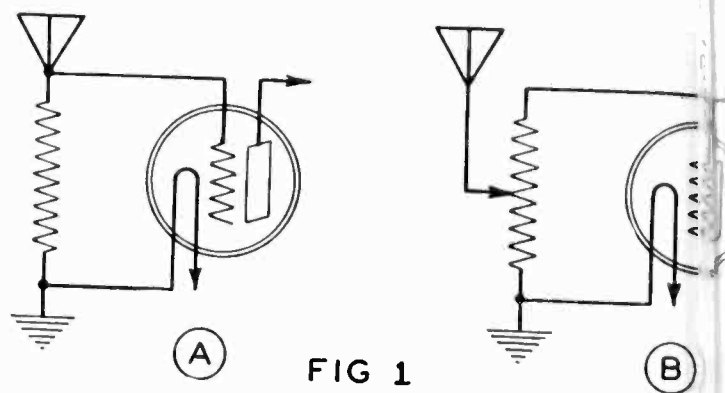

FIG. 1

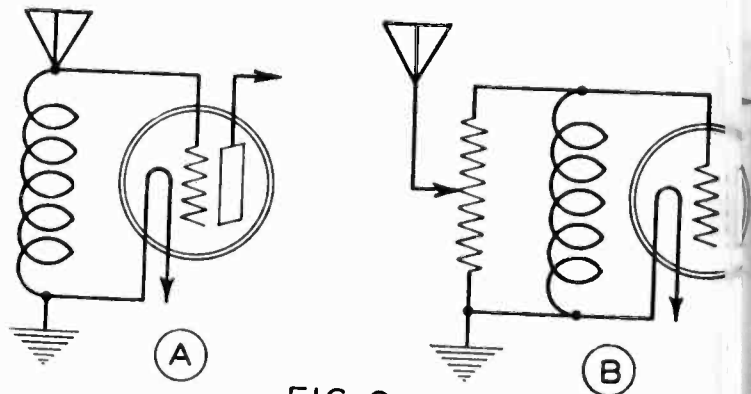

FIG. 2.

Well known methods of connecting antenna systems to a radio receiver.

2. *Elimination of cross-talk.* This phenomenon becomes more evident with increases in the radio-frequency gain of receivers. It is a form of interference which a station may be tuned-in on one or more carriers other than its own, or its harmonic frequency, in contradistinction to the more usual form of interference resulting from mere broadness of tuning, where the signals of carriers on adjacent channels overlap. It generally occurs when receiving in the proximity of a powerful local station which delivers extremely high signal strengths at the receiver. If this interfering local signal reaches the grid of the first radio-frequency tube at a sufficiently high level it is amplified in the usual manner but at the same time partial rectification takes place. This rectified signal in the plate circuit of the first radio-frequency tube modulates the carrier to which the receiver is tuned, thus producing the cross-talk. From the nature of this interference it is seen to be independent of the frequency separation of the interfering and interfered stations (although it may be much worse at the second harmonic of the interfering station) and of the amount of signal selection occurring after the first radio-frequency tube. The only way to reduce this type of interference is to prevent this interfering signal from reaching the grid of the first r.f. tube. This calls for a certain amount of selection in the antenna coupling system.

3. *Sensitivity.* Depending upon its design, the antenna device may or may not contribute a step-up in received signal voltage. It is desirable, of course, that it should, in view of the trend towards high-gain receivers.

4. *Uniform sensitivity.* In view of the desirability of securing substantially uniform gain over the broadcast band, the design of the antenna coupling device should be such that its gain curve should be the reciprocal of that of the radio-frequency amplifier.

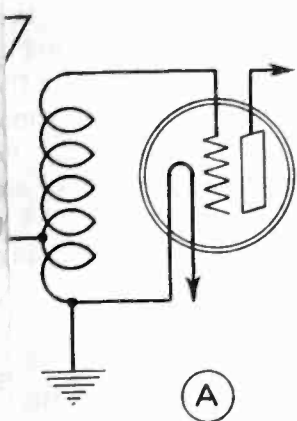

FIG. 3.

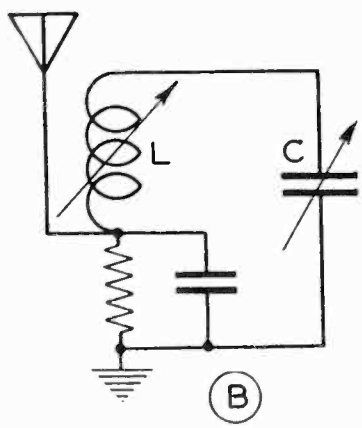

FIG. 4.

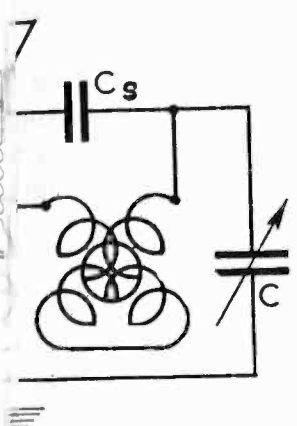

FIG. 5.

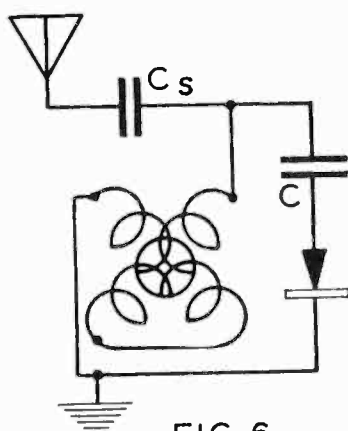

FIG. 6.

More complicated methods of transferring voltages from an antenna to the first circuit of a radio receiver.

Practical elimination of antenna capacity reaction. In unicontrol receivers it is essential that the antenna condenser, or condenser coupled to the antenna, track in the others. Due to the coupling between the antenna and the first tuned stage there will be a capacity or inductance reflected from the antenna into the first stage. It is essential that this reflected capacity or inductance be substantially constant over the frequency band, and it is desirable that it be substantially constant for different sizes of antennas.

Aperiodic systems

One of the simplest means of avoiding the unicontrol problem of antenna circuit tracking consists in the use of an aperiodic system in the antenna. There being no tuned circuit in the antenna or coupled to it, the antenna effect disappears. Three primary means of coupling the antenna to the first r.f. tube have been employed commercially. These are (1) resistance coupling; (2) choke coil coupling; (3) auto-transformer coupling. Combinations of these may also be used, as for example, choke and resistance coupling.

This aperiodic antenna coupling was employed to some extent in battery-operated unicontrol receivers, but became more popular with the advent of the a.c.-operated receiver because the 226-type tube in radio-frequency circuits presented a difficult problem in the control of volume, and the use of a variable resistance in the antenna presented one solution—though far from satisfactory.

All that can be said for this type of antenna coupling is that it meets the unicontrol problem. It contributes nothing to the selectivity of the receiver. It accepts all

signals at all frequencies and results in very severe crosstalk. The resistance coupling contributes no voltage gain to the receiver. The choke coil coupling and auto-transformer may contribute some voltage gain if the inductance of the choke tunes the antenna capacity to some frequency in the broadcast band. The amplification thus secured is confined, however, to a narrow band of frequencies around the resonant frequency. At all other frequencies the gain is practically nil. Also the frequency at which some gain is obtained due to resonance will vary with different antennas.

A further objection arises when the volume control of the set is used in conjunction with this type of antenna coupling unit as in Figs. (1a) and (2a), namely the noise-signal ratio for powerful signals becomes too great. This is particularly prominent in high-gain receivers with good high-frequency response. With this system of volume control the loud speaker signal intensity is adjusted by varying the attenuation of incoming signal between the antenna and the first r.f. tube. The amplification of the receiver is maintained at its maximum level. Any noises inherent in the receiver such as tube noises and circuit element noises, are therefore amplified to the maximum capability of the receiver at all times. These noises modulate the incoming signal. This noise level is a fixed quantity for any set. The weaker the desired signal, the greater the noise-signal ratio. For very powerful signals in the antenna, it is essential to attenuate them considerably for reasonable loud speaker level by means of this antenna volume control. Hence the noise becomes very conspicuous, and all the more so as the loud speaker level is lowered. This effect is more pronounced at a given loud speaker level on powerful locals than on weak distant signals, because in the latter case atmospheric noises mask the receiver noise effect. With other types of volume controls which act after the first tube to reduce r.f. amplification this effect is not so bad, first because we start out with a high signal level instead of a low one, and secondly because the amplification of the receiver is reduced for lower speaker levels.

From every point of view, therefore, the aperiodic type of antenna coupling unit is undesirable.

Separately tuned antenna stages

Coupling systems in which the antenna tuning is separately controlled sidetrack the unicontrol problem by eliminating the antenna capacity reaction on the first tuned circuit. However, experience has shown that there is no serious public reaction against the use of an antenna tuning adjustment, especially if it gives satisfactory results.

Fig. 4 represents a system which is a true vernier control. The antenna is connected across an impedance in the ground side of the tuned circuit L. C. The variable condenser is one section of the gang tuning condenser in the set. The effect of the antenna capacity in the tuning of this circuit is practically negligible no matter what the antenna capacity is. The inductance L, therefore, need be designed only to give vernier control, and a variable range of about 10 or 20 per cent in nominal inductance is sufficient. This is obtained by the motion of a copper sleeve in and out of the field of the coil. The resistance is used to complete the circuit for biasing the first r.f. tube.

In the system represented by Fig. 5 the inductance must have a much greater range because the antenna

TABLE I

Selectivity characteristics of several coupling systems showing effect of loading

Antenna System	Band Width at $\frac{1}{2}$ Amplitude			
	at 1200 kc.	at 500 kc.		
Fig. 4	45 kc.	23 kc.		
Fig. 5	90 kc.	30 kc.		
Fig. 6	68 kc.	24 kc.		
Tightly Coupled Transformer	}	}		
Low Imped. Primary Fig. 7			92 kc.	12 kc.
Loosely Coupled Transformer			}	}
Low Imped. Primary Fig. 7.	42 kc.	12 kc.		

TABLE II

Selectivity characteristics of loosely coupled transformer with variable primary

Primary Turns	Band Width at $\frac{1}{2}$ Amplitude		Transformer Data
	At 1200 kc.	At 550 kc.	
10½	12 kc.	38 kc.	Form—1¼" O.D. Secondary—100 Turns No. 28 Enamel Close Wound Primary wound at Low Potential End. .010" spacing between Primary and Secondary.
7½	12 kc.	35 kc.	
4½	12 kc.	32 kc.	
2½	12 kc.	42 kc.	

capacity is in shunt with the whole tuned circuit (through the series antenna capacity C_s) and therefore raises the initial capacity of the circuit considerably. Thus the usual 9:1 range of capacity ordinarily secured with a variable condenser no longer obtains, and may be as low as 3 or 4 to 1. The inductance must, therefore, supply the necessary additional variation to enable a 3 to 1 range in frequency to be secured. Secondly, because different sizes of antenna capacities have to be handled in practice, it is necessary that the combined range in the variable tuning elements be much greater than the usual 9:1 range. A variometer having as high a ratio of maximum to minimum inductance consistent with securing the proper inductance values is needed. By designing the stator and rotor so that very tight coupling is secured, it is possible to secure a range of approximately 6:1 in inductance. In this particular case the range is 35 to 175 microhenries.

In Fig. 6 all of the tuning from 1500 kc. to about 900 kc. is accomplished by the inductance L. At 900 kc. a fixed mica condenser is automatically shunted across L and the inductance L again is the variable tuning element up to 550 kc. The antenna coupling is made very loose by making the antenna series condenser C_s very small, about 100 micro-microfarads, so that the effect of antenna capacity variation is reduced. L and C are so chosen that for all antennas met with in practice tuning over the entire broadcast band is easily accomplished with the inductance L. This, again, must be a variometer with as large a ratio of maximum to minimum inductance as possible. In practice this ran from 65 to 375 microhenries.

The voltage step-up of the system is shown in the accompanying curves. The abrupt change in the gain curve for Fig. 6 system occurs at the point where the L C ratio system changes radically when the shunt condenser C is thrown across the tuning variometer.

The selectivity data in Table I shows the effect of antenna loading. In the system of Fig. 4 the loading

of the antenna on the tuned circuit plays a part due to its position in the circuit. The other systems have the antenna loading in shunt with the circuit through a coupling condenser. Broader results, the values of the band width depending on the size of the antenna coupling condenser, a small condenser, as in Fig. 6, having the advantage. These systems give practical relief from cross-talk during modulation.

Transformer coupling

There are two types of antenna transformers in one having a high-impedance primary and the other a low-impedance primary. Both these transformers properly designed give good selectivity characteristics, gain, and practical freedom from cross-talk. They meet satisfactorily the problem of antenna stage tuning for unicontrol sets.

The transformer employing the high-impedance primary was described by W. A. MacDonald in August 1929, RADIO BROADCAST and the gain characteristics are given. The primary of this transformer has a high

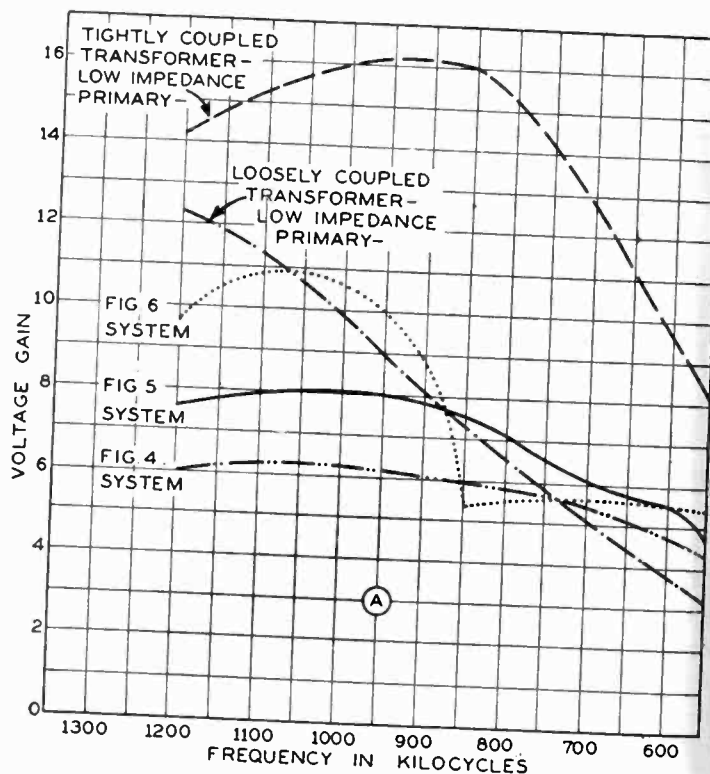

Fig. 7—Effect of using transformers of various characteristics as coupling devices is shown above

inductance, of the order of 400-700 microhenries. It tunes the antenna capacity to a low frequency just outside the broadcast band. Long-wave gain due to resonance is therefore high in comparison to the short-wave gain. Very loose coupling of the order of 10 per cent is employed. Antenna reaction reduces the effective secondary inductance, but, owing to the very loose coupling employed, this is of small magnitude, and easily compensated. The gain of this system decreases with increasing frequency, but it tends to straighten out the over-all gain curve of sets employing conventional type r.f. interstage transformers.

The antenna transformer with low-impedance primary, was the most widely used system in battery set especially two-and three-control sets. The primary consisted, generally, of about 6 to 20 turns (depending upon

[Continued on page 108]

Power control thru grid-regulated heavy-current tubes

O. W. PIKE

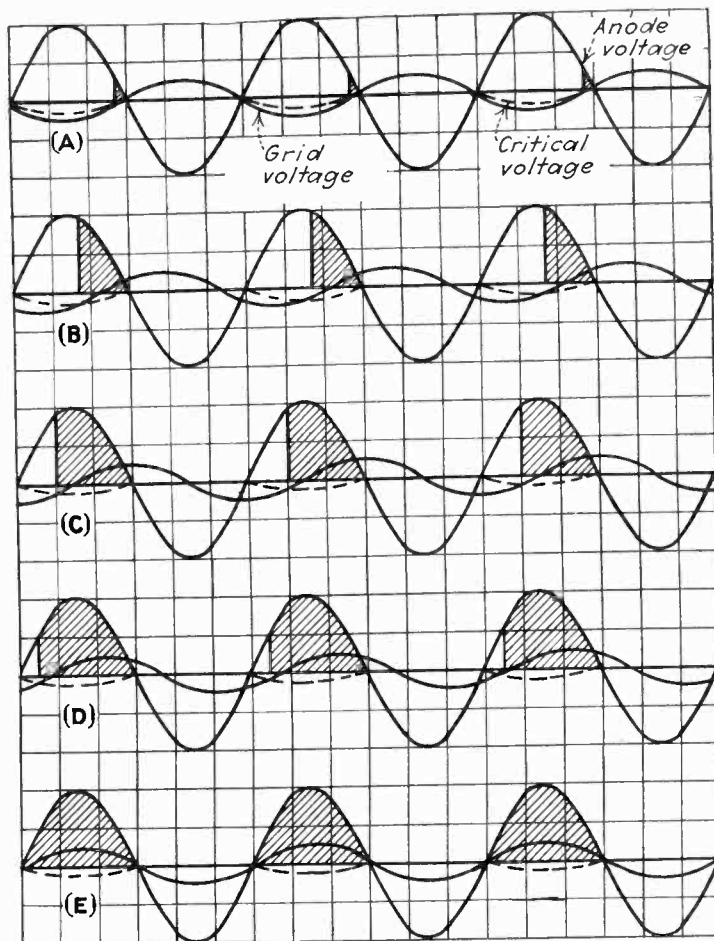

Control of thyatron plate current by variations in the grid voltage.

WITH the increased use of electron tubes, especially for non-radio purposes, there has been an increased need for a design which would handle higher currents. The high space-charge voltage drop of the usual high-vacuum tube results in a large internal-power loss which has hitherto prevented these tubes from carrying the high currents desired. This article describes a new type of electron tube, called the thyatron, which minimizes this limitation and also utilizes new cathodes of high efficiency for the production of the high emission that is required.

For the past two years there have been available hot-cathode mercury-vapor rectifier tubes. These tubes differ from the pool-type mercury rectifiers in that their current-carrying capacity is due to electron emission from a hot cathode, the same as in high-vacuum rectifier tubes. They are an improvement over the high-vacuum recti-

fiers, however, in that they contain a small amount of mercury. The vapor resulting from this mercury becomes ionized and neutralizes the space-charge electrons, resulting in a constant voltage drop of only about 15 volts when the tube is carrying current in the forward direction. The mercury vapor pressure, however, is so low that the plate can withstand high voltages when negative. The result is an almost ideal rectifying valve.

A development of hot-cathode rectifiers

The thyatron is a development from this form of rectifying tube, and incorporates in addition a control electrode. Inasmuch as the method of control is quite different from that in the usual three-electrode tube, we shall describe it in detail. For a given plate voltage there is a particular grid voltage at which ionization will just occur, thus allowing the tube to draw current. Let us consider this as the "trigger" point. The actual grid voltage at the "trigger" point may either be positive or negative, depending upon the particular tube design. If, however, the grid voltage is more negative than the "trigger" point, no discharge will be set up. As soon as the grid potential passes the "trigger" point, ionization occurs and the tube draws current. Unlike a vacuum tube, however, once this discharge starts the grid potential has no appreciable effect on the anode current, control being restored to the grid only when the discharge ceases long enough for deionization of the mercury vapor to occur.

The reason for this is clear. In the simple rectifying tube we mentioned the fact that the positive ions neutralize the space charge. In the thyatron they also tend to neutralize the charge on the negative grid as well as the space charge. The result is that in most cases a prohibitive current would have to be supplied to the grid before it could regain control with plate current flowing. In order to allow the grid to act the plate voltage must be

Wide interest has been manifested in this new type of electrostatically controlled mercury and gas-filled tubes for use in control and power circuits. These tubes have been designated as "thyatrons," from the Greek word *thyra* meaning *door*, and this term has been adopted as the trade name by the General Electric Company in whose Schenectady research laboratories they were developed.

reduced to practically zero for a long enough period for the mercury vapor to deionize.

If an a.-c. voltage is applied to the plate, the grid has an opportunity of regaining control once each cycle and can delay the start of the arc for as long a period during the cycle as the grid voltage is sufficiently negative. Therefore, if the grid as well as the plate is supplied with an alternating current, the phase relation between the grid and plate voltages determines the amount of current passing through the tube. The result, then, is a control valve which in itself has little resistance and hence low internal loss. The illustration shows the wave shapes obtained by a shift in phase between the grid and plate. Example *a* shows the wave forms with the tube in an almost non-conductive condition, while *e* illustrates rectification throughout the entire half wave. The other diagrams show several intermediate stages of grid control.

In addition to the phase-shift method of thyatron control it is possible to obtain a partial control by a variation in the magnitude of either direct or alternating grid voltage, and of course it is possible to obtain an on and off action with either d.-c. or a.-c. provided the anode voltage is alternating. In general, the phase-shift method

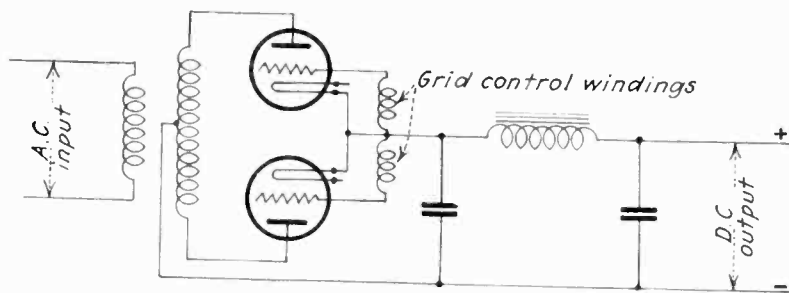

Controlled rectifier and filter circuit, single phase. Polyphase circuits are employed with larger thyatrons.

is the most satisfactory in that it almost entirely eliminates the effect of variation of tube characteristics with temperature and the effect of variation in grid currents. It should, therefore, be used even where it is necessary to obtain it by inductance and resistance. The on and off control presents no difficulties, although it is necessary to supply ample grid voltage from a sufficiently low-impedance source.

New cathode design

There has been considerable advance during the past year in the design of cathodes for these tubes. While there are a variety of different designs, the general trend has been toward a unipotential surface heated by a separate non-emitting filament. This surface is inclosed in heat reflecting shields in order to reduce the wattage necessary for heating. The result is that cathode efficiencies have been increased until now it is possible to obtain, in the more recent designs, useful electron emissions greatly in excess of an ampere for every watt of cathode heating power. At present there appears to be no fundamental limitation on the possible size of cathodes. Development samples have been built which will give an instantaneous current of several thousand amperes. Cathodes may take the form of an (1) open filament, (2) indirectly heated cathode, (3) shielded filament, (4) coiled filament. The choice of these designs for any given tube depends upon the service required. For instance, the first-named is the quickest heating, while the second is the most efficient.

There are two general methods of thyatron operation

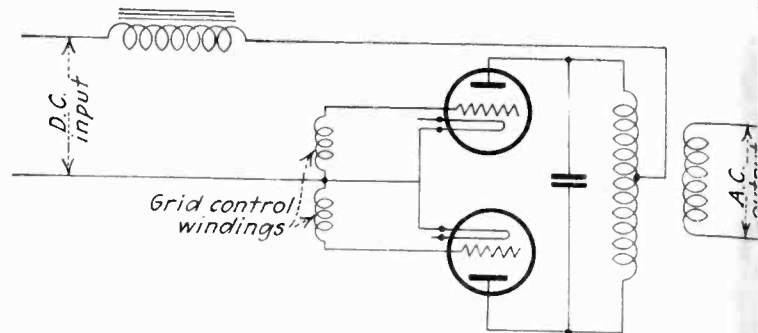

Single-phase inverter employing two thyatron tubes. Such a circuit and tubes will convert direct current into alternating current.

with regard to control characteristics, and the general design of the tubes depends upon this characteristic.

The first is known as the negative control type. This is, the grid voltage necessary to just prevent ionization is negative for all but the very lowest anode voltage. This characteristic is very desirable where the tube is to be used for relay purposes, because the grid power required is very small and therefore the power amplification of the tube is very large. It can be seen that this type of tube is a very useful tool in that it not only rectifies alternating current, but allows a control of the amount of current rectified with the expenditure of a negligible amount of power.

The second class is known as the positive grid type and in this case a positive grid voltage is required to start the tube except for the very highest plate voltages. This type of tube is used for control purposes where it is wished to have a tube remain normally off and pass current only with the application of an appreciable amount of grid power. Its greatest use, however, is found in power circuits, and the requirements of these circuits impose a number of additional design considerations on the tube. The most important of these is the time required for the tube to deionize at the end of a cycle. In many power circuits only a few microseconds are allowed for this action and this necessitates particular design features. With this type of tube appreciable power is required for driving the grid and the grid structure must be designed to accommodate this power.

An example of the improvement of the thyatron over

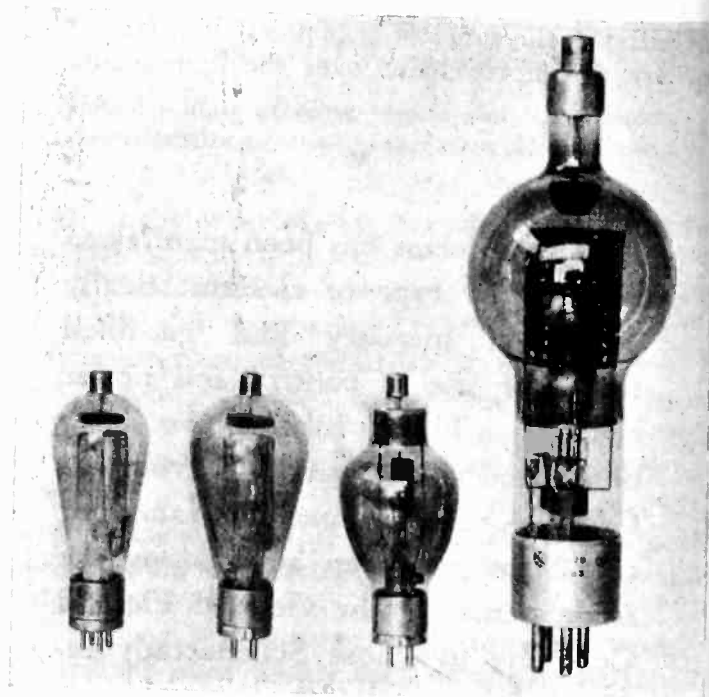

A series of thyatrons, from a small tube handling a plate power of five kilowatts, to a large tube which will control 100 kilowatts.

high vacuum type of tube in the control field of
ce can best be illustrated in comparing a typical
a high vacuum tube with a similar thyatron. These
tubes are of about the same size and are of approx-
ely the same cost. Also, the amount of grid power
red is about the same in each case. The vacuum
will handle approximately 0.75 ampere, while the
atron has a comparable rating of 2.5 amperes.

Of course, the thyatron has a higher cathode wattage,
it would not be possible to utilize the larger cathode
of the vacuum tube due to the space charge drop. In
other words, the current carrying capacity of the new
tube has been increased some 30-fold over that possible
in vacuum tubes of the same size and cost.

Fundamental circuits

There are a few fundamental circuits upon which
the applications of thyratrons are based. We have
previously indicated the controlled rectifier. This should be
considered as the fundamental means of changing con-
stant potential alternating current to variable potential
alternating current. In addition to its many control appli-
cations the thyatron is applicable to power circuits where
large current is required from an alternating-current
source. With the larger thyratrons polyphase circuits are
commonly employed in order to minimize the amount of
inductance required for smoothing and to attain the usual
advantages of such circuits. A single-phase controlled
rectifier circuit is shown.

Another fundamental application principle is the in-
verter. This changes direct current to alternating current
and may be either separately-excited or self-excited, de-
pending upon the source of power applied to the grids.
There are several types of inverters, but the general
principles are similar. In every case d.-c. voltage is
applied to the plate of the tubes and the grid is supplied
with the frequency it is desired to obtain, or else from
a circuit tuned to this frequency. In this respect an
amplifier may also be considered as a thyatron amplifier
oscillator. The function of the tubes is to com-
mute, or in other words, perform a switching opera-
tion. In all inverters some form of power storage is
necessary in order to supply power during the commu-
tation period. This may be in the form of static con-
densers, or a power system with leading power factor,
or a rotating apparatus.

The fundamental action is simple and may be illus-
trated by the accompanying diagram. The anodes of
the tubes are positive. Assume that the grid of the
upper tube is positive. Current will flow from the posi-
tive d.-c. source through the transformer to the negative
output line by way of this tube. The grid of the lower
tube is negative and allows no current to pass. The

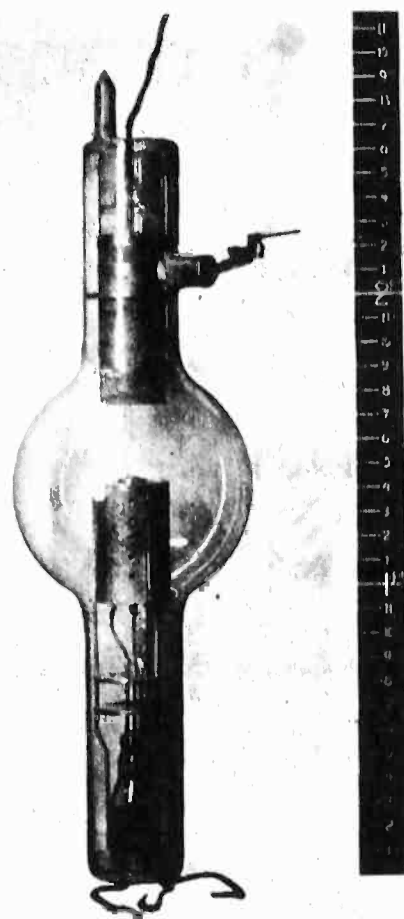

A thyatron with a peak current rating of
several hundred amperes.

condenser is charged with the potential drop across the
output transformer due to the current flow in the upper
half of the winding, the upper terminal becoming nega-
tive and the lower positive. Toward the end of the cycle
the grids exchange polarity. This has no direct effect
on the current flow through the first tube, but allows
current flow through the second, which in effect con-
nects the lower side of the condenser to the negative
lead. This places a negative voltage of short duration
on the upper plate allowing the upper grid to regain
control. As this action continues voltage is generated in
the output winding. As with the controlled rectifier the
usual power applications would be polyphase.

A number of types of thyatron tubes have been devel-
oped. These range in peak current capacity from 1.0 to
75.0 amperes and in voltage from 1,000 to 20,000.
Different tubes are designed to meet various require-
ments, such as short heating time for the cathode, low
cathode power, short deionization time, etc. Tubes of
various power ratings are now being manufactured and
thyratrons capable of handling considerable power are
under development.



The cathedral builders of the past — and the electronic designers of the present

Just as every medieval cathedral had a soul—a part of the soul of its
designer and of the souls of the pious men who built it—so every modern
machine has a soul; it is a part of the soul of its inventor and of the patient
souls of the men who developed it.

Prof. MICHAEL I. PUPIN,

Hazards from induced emfs

Metal structures

in high-frequency fields

develop unexpected voltages

RADIO or high-frequency currents may create unexpected hazards in metal buildings, garages, steel ceilings and other metallic structures, as well as on shipboard, according to investigations which have recently been concluded by government experts. The Naval Research Laboratories at Washington, in cooperation with the U. S. Navy ships, have determined that under certain conditions fire and explosive hazards may be introduced by the use on shipboard of high-frequency radio transmitters.

It has been common knowledge for some time that currents of considerable magnitude are induced in conductors placed in the vicinity of an energized antenna, especially when their electrical length is such as to approach resonance with the antenna. Also, that high potentials are induced in large metallic bodies when insulated from the ground and placed in a strong field under an antenna. The first case is illustrated by the high currents induced in standing rigging aboard ship if not broken up by insulators, while the second case is in the strong spark drawn from an automobile, parked under an energized antenna. High frequencies will naturally cause the greatest danger as there are more conductors on board ship likely to be of the right electrical length to produce resonance with the different high frequencies in use.

Dangers on navy ships

The greatest danger on shipboard may arise from a resonant condition set up between the transmitting frequency and a conductor placed in the proximity of explosives and inflammables. On board a Navy ship some of the serious conditions are:

(a) The danger of premature firing of exposed broadside guns caused by the resonance between the transmitter and the firing leads of the gun. This can occur only after the breach is closed and the firing circuit completed to the firing lock.

(b) Resonance set up between the transmitter and a gasoline filling hose may result in a spark setting off the gas vapor usually present.

(c) Danger of setting off primers on airplane wing tip flares when resonance occurs between the transmitter and the wiring lead to the primers.

The danger from condition (a) may be corrected by placing a small choke coil in series with the firing lead and electrode, with a 0.06 microfarad mica condenser connected from a point between the pick-up wire and the choke to ground. This modification made it impossible to fire the primers under extreme test conditions. Merchant vessels, especially oil tankers, might well consider the hazards caused by high frequencies if used during fueling operations. In conducting the tests aboard Navy ships, the Research Laboratory intentionally exaggerated the conditions while under certain normal conditions concentrated electric fields due to poor antenna arrangement may result in a dangerous accident. These tests indicated that the use of ground strips are not always effective when the lengths of such paths to ground are comparable to quarter wave lengths. In the test conducted on one ship, it was found that the muzzle of a 14 inch gun in one turret was quite hot electrically when an antenna close by was excited at 16,000 kilocycles by a one-kilowatt transmitter. The distance between the trunnions of the gun and its muzzle was approximately three-fourths of a wave length. At intermediate and lower frequencies the muzzle was effectively grounded.

Big guns as antennae

The length of guns aboard ship are now comparable to quarter wave lengths or multiples of quarter wave lengths. This introduces the possibility of producing standing electric waves by excitation from a nearby high frequency antenna. The existing conditions are shown more clearly in the accompanying figure. In this case

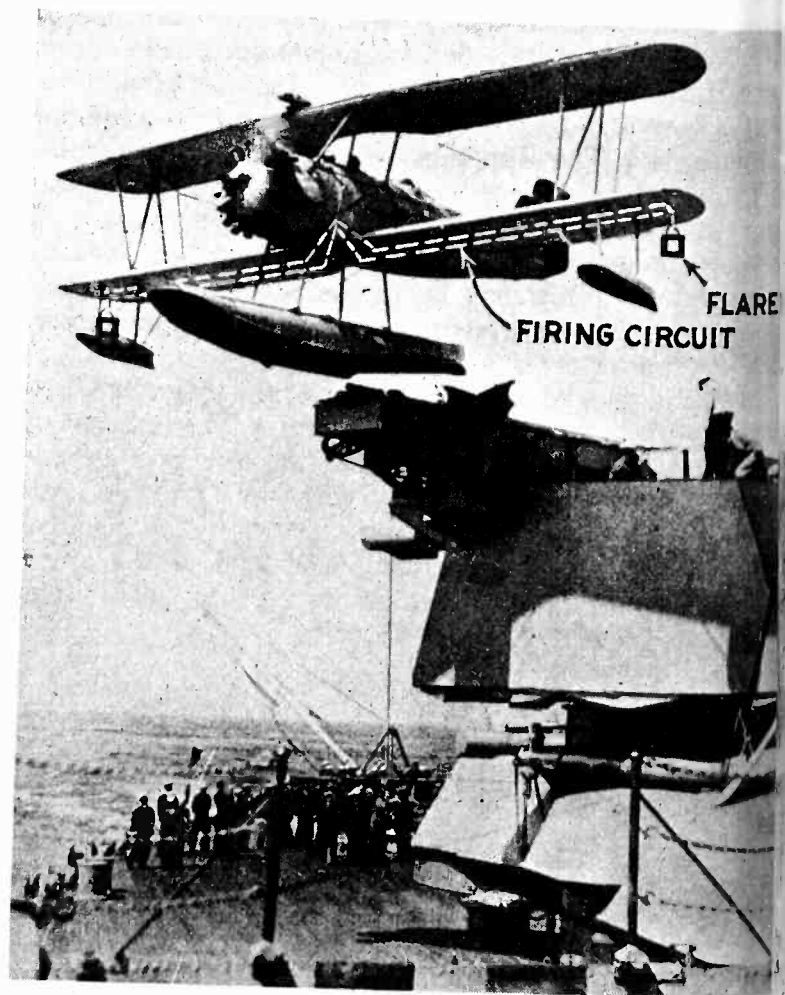

A Vought-Corsair seaplane being catapulted from the turret of a battleship. A tracing of the firing circuit for the wing-tip flares is shown

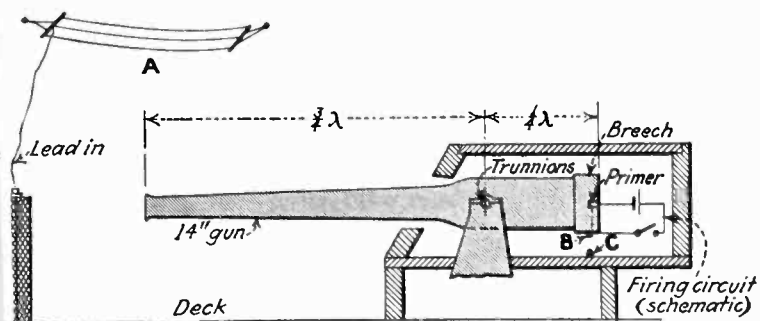

Simplified sketch of battleship turret showing conditions for producing standing electric waves in the gun by excitation from a nearby antenna

length of a 45 calibre 14 inch gun is a full wave length for certain high frequencies, the trunnions are approximately one-quarter of a wave length from the breech and three-quarters of a wave length from the muzzle end. With the muzzle end of the gun exposed to the high-frequency field, it is possible to set up electrical oscillations with the result that low but readily measurable voltages can be detected at the breech of the gun. This condition can exist even though the rear part of the gun is shielded from the electric field of the antenna by the turret.

By setting up the worst conditions it was found possible to light an 18 or 24 volt lamp by connecting it between the breech (B) and turret (C). Voltages as high as 1,000 volts were set up under the right conditions. It was also found possible to explode a primer in the breech

by utilizing the energy picked up by the gun and induced in the firing circuit with a special tuned circuit arrangement. Another hazard exists in setting off primers on airplane wing-tip flares when such aircraft are exposed to the field of a high-frequency antenna. This condition exists when the flare circuits are in resonance with the antenna circuit. It was found possible to light airplane running lights because of a similar condition. The airplane pictured shows the wiring leads to the flare wing-tips. This circuit when in a high-frequency field is capable of picking up an induced current sufficient to set off the flares.

Some figures on clearances

The above experimental tests showed that the radiating portion of high-frequency antennas should be located as far as possible from objects whose electrical lengths are such that resonance effects may be set up. The radiating portion of the antenna should be placed at least 50 ft. from any possible resonant object, when an antenna output of 500 watts is used on frequencies in excess of 10,000 kilocycles. In case the output is increased, the distance should be increased and for less output, it may be decreased. It has also been recommended that two-wire feed lines should be employed for all antennas which will be operated at 10,000 kilocycles or above or where it is not practical to maintain the lead-in spacing equal to that specified above for the radiating portion. Planes designed for use on board ship should have all electric wiring shielded and this shielding should be bonded where practical.



NEW BOOKS ON ELECTRONIC SUBJECTS

Elements of electricity

By Anthony Zeleny, Ph.D., New York, McGraw-Hill Book Co., Inc. 27 pages. Price \$3.

THIS TEXT BOOK by the professor of physics of the University of Minnesota, a unique method of presentation is followed, which while departing widely from customary concepts, nevertheless shows closely present views concerning electric current. The best explanation of the method used is found in Professor Zeleny's own words: "All the major phenomena are explained in terms of physical concepts which are reducible to two basic phenomena. This explanation is made possible by taking the point of view that electric fields have inertia, interpenetrate freely, and are inseparable from their elemental charges. Superposed fields are then construed to exist as independent fields, even though they neutralize one another's action on electric charges. It follows that an un-

charged body is surrounded by both a negative electric field, which is the resultant of the superposed elemental fields of all its electrons, and an equal opposite positive field due to the fields of all its protons. It also follows that when electrons are in motion within or with a conductor, each electron is surrounded by a magnetic field which is inseparably associated with the moving elemental electric field. A magnetic field is therefore regarded as an aspect of a moving electric field. From this point of view a large number of the most important phenomena, such as induction and the production of electro-magnetic waves, which usually are only inadequately described, are readily explained in a satisfactory manner. Since clearness of exposition is materially improved by referring to the direction of electron flow rather than to the conventional direction of the current, all explanation are made in terms of the flow, and arrows in the figures are drawn to represent the direction of the flow."

Electron physics

By J. Barton Hoag, Ph.D. New York; D. Van Nostrand Company, Inc. 208 pages. Illustrated. Price \$3.

THE UNDERLYING PURPOSE in this work is to present by text and by experiment the evidence for many of the concepts of modern physics. It is the outgrowth of a course given at the University of Chicago for many years, called "Radioactivity and Discharge through Gases," a laboratory course in the experiments which have brought the modern scientist such phenomena as X rays, the photoelectric effect, the three element vacuum tube—and hence radio, sound movies, and the field of electronics in general.

The book is well indexed, contains experiments that the student can perform, such as the well known oil-drop experiment of Millikan, and a series of problems on electronic subjects. The pages are clearly illustrated.

electronics

McGraw-Hill Publishing Company, Inc.
Tenth Avenue at 36th Street
New York City

O. H. CALDWELL, *Editor*

Volume 1 — MAY, 1930 — Number 2



Don't limit broadcasting power

AT LAST the iniquitous Davis Act, assigning broadcasting facilities proportionally to state populations, appears to be in way of repeal and revision. Even Senator Dill who was the principal advocate of this unsound and destructive legislation of 1928, has deserted his former protégé since he discovered that its practical application cut broadcasting facilities in his own state of Washington by 50 per cent.

He now proposes as law a new rule-of-thumb combination, by which states will be awarded broadcasting facilities on a basis of 25 per cent proportional to their "equal states' rights," 25 per cent proportional to their areas, and 50 per cent proportional to their respective populations.

In so far as this new plan departs from the population proportionality and the limit on power it is an improvement. But any plan which attempts to set up a strict mathematical formula for the assignment of usable power, is bound to cause needless trouble to broadcasting and indefensible waste of the nation's broadcasting facilities.

Only "clear" or exclusive channels can render service to the largest public.

On clear channels, there is no conceivable sense in setting up broadcasting power limits—proportional to population, area, or anything else. The only sound principle is to allow *all possible power* on each such clear channel, to enable the surrounding public to be served as well as possible.

Only in this way can true proportionality of broadcasting opportunity be secured, with maximum service to the public. The radio and electrical industries must see to it that the next radio amendment avoids the wasteful inefficiency of the Davis-Dill amendment of 1928.

Standardization of the new "wide films"

THE question of whether the new wide film are to be 70 mm., 65 mm., or a compromise somewhere in between, should be settled by the motion picture industry in the near future. The standardization committee of the Society of Motion Picture Engineers should be given every support by the executives of the producing companies. No group is better qualified to answer the engineering and economic problems involved.

The success which this industry is reaping today is due to the standard and universally adopted 35 mm. film which permits films made in Hollywood to be shown in Hindustan. The national barrier that American films now cross, should cause some consideration of the new standard width to be adopted. It is quite clear that 35 mm. films will be used for some time to come. However, in order that progressive development of the equipment for making the new wide film may receive the necessary impetus, it is obvious there should be an early agreement on the new standard width.



High-frequency hazards

AS THE applications of vacuum tubes and circuits increase, the presence of high frequencies around metal structures is bound to develop some unexpected hazards which must be carefully guarded against.

In the presence of high-frequency electrostatic or electro magnetic fields, ordinary metal objects and housings may have set up in them emfs which can give rise to dangerous currents. Metal garages, steel walls and roofs, steel ceilings, copper gutters, ship's hulls, automobiles, and airplanes may thus unexpectedly become carriers of considerable voltages or currents, the discharge of which may occur through inflammables and do serious damage.

The safe guarding of metal structures against induced high-frequency currents is a problem for the engineer to consider at the outset. So mysterious and incomprehensible are the manifestations of high-frequency effects to the ordinary layman, that ignorant attempts at prevention may do more harm than good, and actually multiply hazards.

Whenever metal structures exist around high-frequency circuits involving any power, fugitive waves and currents are likely to be set up. They must be watched for and guarded against. The designer's responsibility does not end with his circuits and equipment. He must scrutinize every metal conductor within inductive range and see that it is rendered safe and harmless.



Wanted, another Nipkow

THE limits of the present available systems of television are apparently being rapidly reached. From now on, it would appear, search must be made in new directions. Any system of television depending upon the successive point-by-point transmission of the image is bound to be subjected to all the present fundamental limitations, and such point-by-point systems involve tremendous high frequencies. This means the channel width for either wire or radio transmission must be excessive (necessitating hundreds of kilocycles) or else the picture must lack in detail.

The basic theory of all our present systems of television dates back to Nipkow's work in the mid-nineteenth century. Even with all the refinements developed since by patient research, its possibilities now seem to have been about exhausted. We must look for new principles of transmission. We must start building on new foundations, if we are to extend, over distances, anything approaching the quality of the marvelous multi-linear linkage between eye and brain.



Do side-bands exist?

FROM time to time doubts as to the physical existence of side-bands in radio transmission arise in the minds of those who have no ready means of actually detecting them by means of properly tuned devices. But such doubts are dismissed in private and an engineer who values his reputation will not raise such questions before a general audience.

In a recent issue of *Nature*, a scientific periodical, a scientist whose name has been connected

with the electronic industry for two generations says that side-bands are the result of mathematics, and that they really do not exist. He says in effect that two television stations could operate on closely adjacent channels without interference.

This will be disconcerting news to telephone engineers who have spent years in designing and building filters to suppress not only an occasional side-band but often the carrier as well. In such cases, is anything transmitted? Experience gives an affirmative answer. Our British scientist says no.

If modulation takes place in a given circuit and the output of that circuit is amplified, less power will be required if only one side-band is transmitted than if the entire product of modulation is amplified, viz, carrier and two side-bands. Surely no scientist no matter how much he may wish otherwise will state that the figments of a mathematician's imagination will work a watt hour meter.



Custom-built tubes for measurements

IN a great power system, a vacuum tube controls a time-clock network and thereby controls the frequency of the system. But the engineer in charge complains that vacuum tubes differ so much in their constants that when the tube finally wears out and is replaced, the system must be re-balanced to get accuracy of time again.

Last month, in these pages, the chief engineer of a company building measuring equipment said of the tube: "Due to its variability and the consequent impossibility of relying upon a single calibration it is necessary to employ methods in which the vacuum tube may be calibrated as it is used."

Is there not a challenge in these complaints? Is it not possible that a series of tubes, hand-made if necessary and expensive, could be sold for measurement and control purposes, tubes whose characteristics would duplicate each other, that would have long life, and would be readily obtainable? Could not some tube company build up a nice business for itself by "custom-building" vacuum tubes for use in laboratories and other places where constancy, uniformity, and reliability would be in demand?

REVIEW OF ELECTRONIC LITERATURE HERE AND ABROAD

Trans-oceanic telephone service short-wave equipment

[A. A. OSWALD] The application of short-wave radio transmission to trans-oceanic telephone circuits is developing apparatus and stations designed distinctively to meet the needs of these services. This paper describes from the radio point of view the important technical features and developments incorporated in the new transmitting and receiving stations of the American Telephone and Telegraph Company, located respectively at Lawrenceville and Netcong, N. J., and it outlines some of the radio problems encountered in the station design. A brief description of the transmitting equipment and antennas at Lawrenceville is given. One of the methods of obtaining a sharply directive characteristic is to arrange a large number of radiating elements in a vertical plane array, spacing them at suitable distances and interconnecting them in such a manner that the current in all the radiating members are in phase. This method is employed at Lawrenceville and depends upon the manner in which standing waves are formed on the conductors. At the receiving end the radio wave is collected by means of a directional antenna array whose prime function is to improve the ratio between the desired signals and unwanted noise or other interference.

This is done in two ways: viz., (1) by increasing the total signal energy delivered to the receiver and (2) by discriminating against waves whose directions of arrival differ from the chosen ones. Since, under many conditions, the direction of arrival of static and other disturbances including unwanted radio signals are random, it is obvious that sharp directive discrimination aids very materially in excluding them from the receiver.—*Journal A.I.E.E.*, April, 1930.

Radio stations at Algeria and Strasbourg

[MICHAEL ADAM] This article contains a detailed description of two new French stations, one at Algiers in North Africa and one at Strasbourg in Alsace-Lorraine. The purpose of these stations is frankly political. The North African Station is already in operation and the Alsace-Lorraine Station will be before the end of 1930.—*Revue Générale d'Electricité*, March 8, 1930.

Recent progress in atomic physics

[L. G. CARPENTER] This article is a résumé of recent experimental and theoretical advances in the field of atomic physics. The author outlines De Broglie's concept of the electron as the basis of the new wave mechanics and its experimental confirmation by G. P. Thompson in Scotland and Davisson and Germer here; he mentions Einstein's "Unitary Theory of Gravitational and Electrical Fields"; he shows how Sommerfeld, using de Broglie's concept of the wavelength of electrons has been able to successfully explain the relation between thermal and electrical conductivity and several related phenomena. The emission of electrons from cold metals is given some consideration as is

Thousand-cycle frequency standards

[L. ARMITAGE] For a long time ordinary tuning forks were considered satisfactory secondary standards of frequency, and were used for adjusting vacuum tube oscillators. The process was simply to strike the fork and then to adjust the frequency of the oscillator until the beat note, produced by the combination of the frequencies of the fork and the oscillator, could no longer be detected by the operator. The overall accuracy of this method limited by the accuracy of the fork and the personal error of the operator is about 2.5 cycles in 1,000.

Later, a resonance type of frequency meter was introduced as a secondary standard. It is limited in accuracy only by the precision with which the values of its circuit constants may be determined. Frequencies from 100 to 50,000 cycles may be measured to one part in 1,000 with this type of meter. During the past few years the accuracy requirement of secondary standards of frequency have become more rigorous. The higher requirements are due largely to closer limits in the testing specifications of

the change of resistance of metals subjected to intense magnetic fields. The article concludes with a section devoted to Millikan's experiments on cosmic rays and the theoretical explanation of their origin.—*World Post*, London, March, 1930.

Micro-cinematigraph for 16-mm. camera

[HEINZ EISENBERGER] Description of method of mounting commercial home motion-picture camera (16 mm.) in use in connection with microscope lens system for making motion pictures of biological and scientific experiments. By slow timing of photographs, successive growth can be illustrated.—*Science*, March 7, 1930.

such apparatus as coils and filters, the measurement of whose constants and frequency of the testing current must be known.

Accurate knowledge of frequency is also important when measurements are made with the resonance type of bridge. Recently a vacuum tube oscillator has been developed by the laboratories for use as a secondary standard of frequency. This standard oscillator is designed to produce a frequency of high stability. The frequency of the oscillator is 1,000 cycles. Its frequency control unit is assembled in a compartment insulated by means of an air chamber, so as to be unaffected by rapid changes in low temperatures. The tuned circuit of the oscillator is compensated for temperature changes by the use of two types of condensers, having temperature coefficients of opposite sign.—*Bell Laboratories Record*, April, 1930.

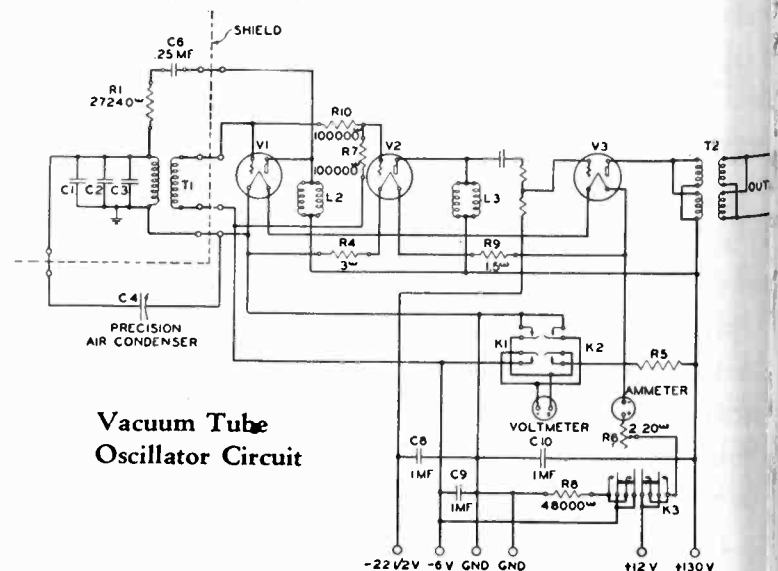

Vacuum Tube Oscillator Circuit

The work of Louis de Broglie

[DAUVELLIER] M. Louis de Broglie in 1929 awarded the Nobel Physics Prize for his theory of wave mechanics as a substitute for the classical mechanics. The author, a colleague of Louis de Broglie's, gives us a concise description of the work which led up to the new concept, an outline of the wave mechanics, and an interpretation of the significance of this concept in the physical world. It is worthy of note that the experimental verification of this new theory has been applied by American scientists; by Thomson and Germer of the Bell Telephone Laboratories, who demonstrated the wave-nature of electrons and by Chester Davis of the University of Chicago who demonstrated the wave-nature of neutrons.

The ideas which M. Louis de Broglie forth re-established harmony in the world of physics with regard to the exchange of energy between matter and radiation. From the wave viewpoint Planck had established the notion of quanta and Einstein had definitely localized the energy in corpuscles. Now Louis de Broglie, working from the analogy to the undulatory, had endowed electrons which are protons and electrons with a wave motion of a new sort. His mission is to pilot these grains through high fields of force.

In the words of Arthur Holley Compton, himself a recipient of the Nobel Physics Prize, "this, the most important contribution of the 20th century physics, is that the physical world can be reduced to three kinds of particles—protons, electrons and photons—and that each of these particles have also the characteristics of waves."—*Revue Générale d'Electricité*, March 22, 1930.

Working along a beam of light

[D. BROWNE] The modulation of a light beam and its reconversion to electrical oscillations of acoustic frequency are the two essential features of a light coding and reproducing system. In the system described in this article the modulated currents from the microphone pickup are used to modulate the light intensity of a glow lamp. Either neon, argon or helium gas-filled tubes may be used but in this particular system the neon tube is preferred since the modulated light waves are used to energize a photographic film so that a permanent record of the speech may be obtained. The light from the helium lamp has a higher actinic value than that from the neon tube. The light beam so modulated, passes through a system of lenses and is focused onto a photographic film. After development, the amount of blackening corresponds to the sounds picked up by

the microphone. If this film is subjected to a steady beam of light this beam is modulated in accordance with the original signal waves and this modulated beam falling upon a photoelectric cell produces variations on the electric current output which being amplified and sent through loud-speakers reproduce the original signal.—*Wireless World*, March 5, 1930.

Laboratory B-voltage supply

[FREDERICK BEDELL and JACKSON G. KUHN] Various B-eliminators now on the market, while adequate for their intended use with radio receiving sets, are inadequate for more varied purposes. The laboratory B-voltage eliminator

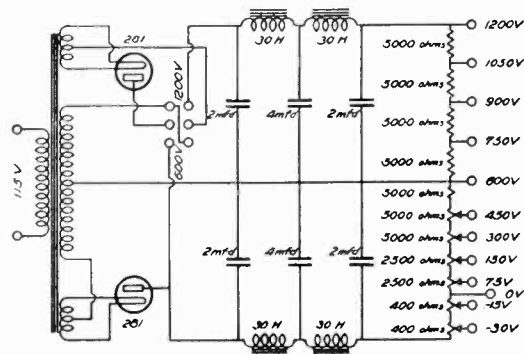

described is relatively free of ripples usually present in radio B-eliminators. The wiring diagram of this eliminator is shown in the accompanying view.—*Review of Scientific Instruments*, April, 1930.

Thermionic emission of oxide cathodes

[A. L. REUMAN and R. MURGOCI] The following observations were made:

(1) The electrical conductivity, c , of a "formed" alkaline earth oxide varies with the temperature T according to a law of the form $c = \alpha \epsilon^{-\beta/T}$ where α and β are constants.

(2) During the process of forming, both the thermionic emission and the electrical conductivity grow similarly, and after its completion both are "poisoned" similarly by exposure of the oxide to

(a) oxygen (b) a discharge in carbon monoxide, and

(c) a discharge in hydrogen.

Complete recovery of the formed condition by reforming is possible only a few times in succession after poisoning by (a) and (b) but any number of times after poisoning by (c).

(3) At current densities comparable with those in the coatings of oxide cathodes from which saturated thermionic space current is being taken, the current conducted through an oxide powder between two electrodes, embedded therein, saturates.

On the basis of these observations,

together with the results of related work by other investigators, the following theory of the action of oxide cathode is formulated:

1. The coating conducts the space current, which, of necessity, passes through it, electrolytically. Practically only the metallic ions are mobile, the oxygen ions playing no part in the electrolysis.

2. The whole surface of each crystal of oxide of a formed cathode is covered with a mobile monatomic layer of alkaline earth metal. The passage of space current is accompanied by a continual circulation of this metal which diffuses outward along the surfaces of the crystals and inward through the crystals in the form of electrolytic ions.

3. At the usual operating temperatures of oxide cathodes the average life of alkaline earth metal particles on the emitting surface is of the order of 10^{-3} seconds and the rate of flow of the metal over the surface of an idealized independent of circulation.

4. The coating is probably in very imperfect contact with the core metal so that the space current passes from core metal to coating mainly in the form of thermionically emitted electrons. Sufficiently copious electron emission of the core metal at the low temperatures of operation of these cathodes would be made possible by a continuation of its surface with adsorbed barium or with barium and oxygen.

Explanations are suggested for

(1) the eventual life failure of oxide cathodes;

(2) the observed phenomena relating to poisoning;

(3) the considerable variation in the published values of the thermionic constants of oxide cathodes.—*Philosophical Magazine*, London, March, 1930.

Stabilized oscilloscope using cathode ray

[FREDERICK BEDELL and JACKSON G. KUHN] One stage of amplification is included in the stabilizing circuits of the Bedell-Reich oscilloscope, which comprises a cathode-ray tube with linear time-axis for observation of periodically varying quantities. It extends the frequency range of the instrument and permits stabilization without disturbance to the circuit under test. Although not primarily intended for use beyond the audio range, the instrument has in this way been stabilized above 100,000 cycles. Curves are given showing the use of the instrument for the study of non-electrical quantities (as sound and light) as well as of electrical quantities (as in the study of modulation and rectification).

The freedom from inertia of the cathode beam and the fact that no appreciable amount of energy is required to deflect it, makes possible the use of this

type of instrument, in cases where an instrument with moving parts possessing mass could not be used. The linearity of the time-axis is highly important. Some interesting photographs are included which show the modulation of a 50,000-cycle wave, also the wave form of a 107,000-cycle oscillator. The linear time-scale is obtained by impressing upon one pair of plates of the cathode-ray tube a saw-toothed wave of controllable frequency, obtained from a neon oscillator, consisting of a condenser periodically charged at a uniform rate through a saturated thermionic tube and automatically discharged through a neon lamp when a definite breakdown voltage is reached. The oscilloscope makes it possible to observe the effect produced by changing experimental conditions while they occur. For permanent records, the curves when stabilized may be photographed, either by direct contact prints or by means of a camera.—*Review of Scientific Instruments*, April, 1930.

♦

"Grandeur" wide-film system

[R. H. McCULLOUGH] The writer gives a brief description of the Grandeur projectors installed in the Fox-Carthy Circle Theater in Los Angeles. Photographs of the new wide-film projectors are shown. The projection angle at this theater is 23 degrees. It was found necessary to install special glass prisms in front of each lens so as to eliminate any vertical distortion. The prisms are adjustable so that objects may be adjusted in height to eliminate such distortion. The addition of extra reproducing horns was found necessary because of greater screen width and an adjustment of the horns was necessary to insure proper illusion with respect to natural sound from the screen personnel. Large-screen installations should be made as close to the stage floor as possible to enhance the illusion of a stage presentation.—*Motion-Picture Projectionist*, April, 1930.

♦

Our eyes and the movies

[DONALD A. LAIRD, PH.D.] An outline of the physical, physiological and psychological principles on which the satisfactory vision of moving pictures is based. High screen intensities are necessary to overcome flicker. Utilizing too large a visual angle will produce a sense of flicker, owing to the greater sensitiveness of the outlying edges of the human retina. Animals do not "see" movies as do humans, their eyes apparently lacking the photochemical elements which cause persistency of vision or fusing of successive pictures.—*Scientific American*, March, 1930.

Filaments in hydrogen— electronic collisions

[H. COPAUX] Hydrogen may be activated by heat, as Langmuir discovered in 1912. The heat lost by a filament of tungsten in such gases as argon, nitrogen, mercury vapor, and hydrogen, is dissipated by radiation, convection, and conduction. For argon, nitrogen, and mercury vapor the loss by conduction and convection, that is, the difference between the total loss and the loss by radiation, measured in vacuum, is proportional to the 1.9th power of the absolute temperature, up to the highest temperatures supportable by the filament. For hydrogen, however, from 1,500° to about 2,300° C. the loss of heat by convection and conduction is proportional to the fifth power of the temperature, because of the consumption of energy in the dissociation of H₂ into 2H. The product of this dissociation is active, reducing, with change of color, such oxides as those of molybdenum and tungsten in a cool part of the tube. The other method of activating hydrogen is by the action of the electrical discharge upon the rarefied gas. This does not last more than a second, however. It is not at all certain that the active hydrogen is composed entirely of atoms.

It has been shown within the last few months that hydrogen, subjected to collisions with electrons, begins to reduce copper oxide in the cold as soon as the accelerating potential applied to the electrons reaches 11.4 volts. The study of the spectrum shows that the first degree of resonance of the molecule H₂ is situated at 11.6 volts. It may be that metastable molecular hydrogen is present in the active hydrogen, as is the case in nitrogen.—*Chimie et Industrie*, Paris, February, 1930.

♦

Film foundation of Harvard University

There has been established at Cambridge a university film foundation by the aid of a gift made last fall by Mr. John D. Rockefeller, Jr. The Foundation is able to make completely both silent and talking films in its plant. A soundproof studio has been installed, and in connection with it, a complete sound-on-film recording equipment, loaned to them by the R.C.A. Photophone. A well-equipped laboratory has been built for developing and printing the film, both standard width and 16-millimeter size. The Foundation has a staff of twenty persons and includes specialists such as sound engineers, projectionists and laboratory men. The Foundation is about to start making a photographic record of eminent professors and personalities connected with the university. It is planned not only

to record the professors speaking also to show them illustrating the experiments and making demonstration of scientific material.—*Science*, 1930.

♦

Two-way airplane radio communication

[G. E. EVERETT] A description of a radio set developed for the Transcontinental Air Line is given by the writer, also a discussion of the faults existing in previous sets. The new set consists of a single unit installed on a remote panel hung on a shock-absorber at the rear of the fuselage. The transmitter itself weighs only 29 lb., and with installation and operation accessories involved for remote control, it weighs 85 lb. Fuses have been used to protect all the circuits, and a five-point irreversible plug makes all the necessary connections to the transmitter and ground. The entire set may be removed and another installed within three minutes.—*Aviation*, April 12, 1930.

♦

Progress of sound films in France

[P. HEMARDINQUER] A description of the Gaumont system of sound-picture projection, with illustrations and details of the reproducing apparatus. The mechanism follows in general the principles of construction of American projectors, although somewhat more elaborate in mechanical arrangement.—*La Nature*, Paris, March 15, 1930.

♦

Architectural acoustics of auditoriums

The usual acoustical defects of auditoriums are echo, dead spots, and reverberation. Reverberation (including echo, which is a particular kind of reverberation) is a serious defect since prolongation of one sound such as a musical note or spoken syllable, may interfere with the next sound, produce hopeless confusion. A certain amount of reverberation is however desirable. A table of acceptable limits of reverberation time for rooms of different volumes, and formulas for calculating reverberation time are given. Values are likewise given for the sound absorption powers of different materials as compared with an open window which constitutes an almost perfect absorber.

Practical general directions for designing an auditorium are included. Copies of this circular (No. 380) may be obtained from the Superintendent of Documents, Government Printing Office, Washington, D. C., at 5 cents each.

counts, alarms, controls

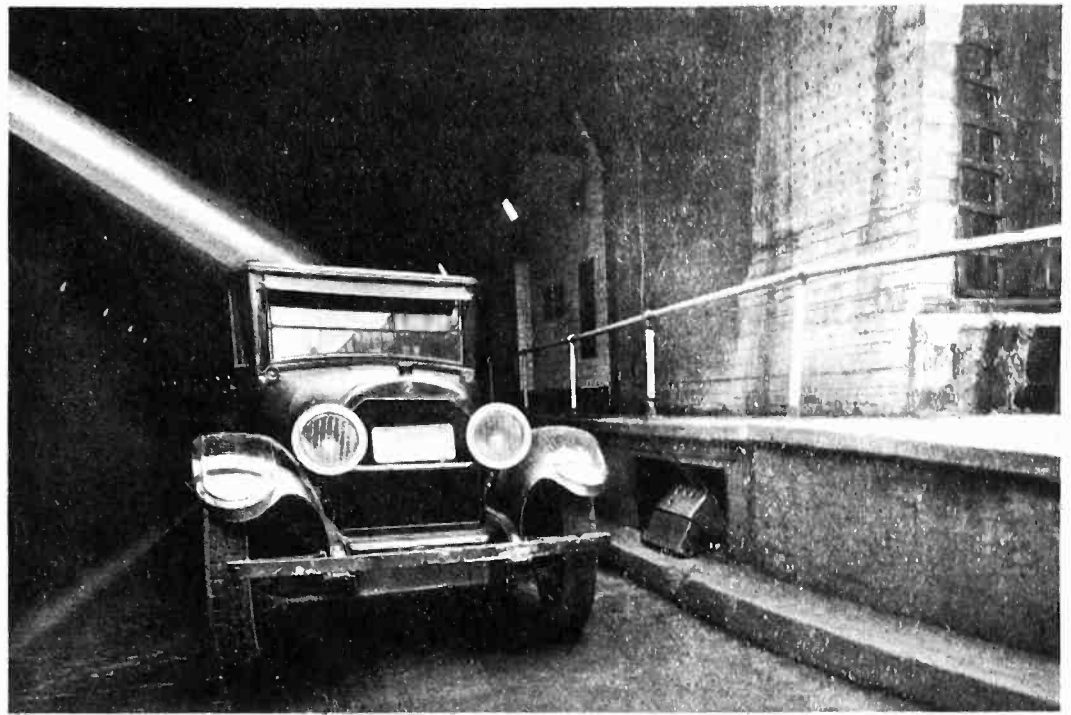

ABOVE—Is shown the method of counting automobile traffic passing through the Holland Tunnel at New York. The car intercepts a light-beam directed into a photo-cell.

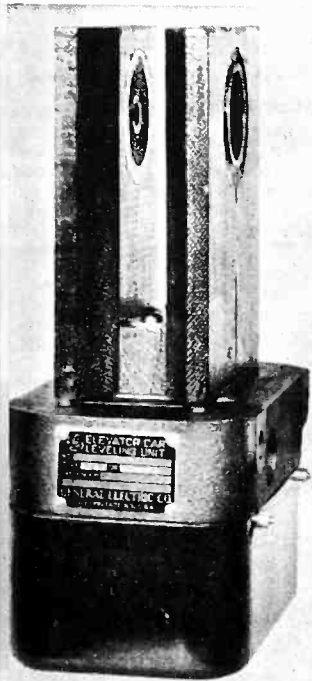

ABOVE—The active part of the elevator-levelling control unit which brings the car quickly to a stop flush with the floor. Vacuum tubes form the heart of this device. Such self-leveling equipments are used on all the new button-controlled elevators in big city buildings.

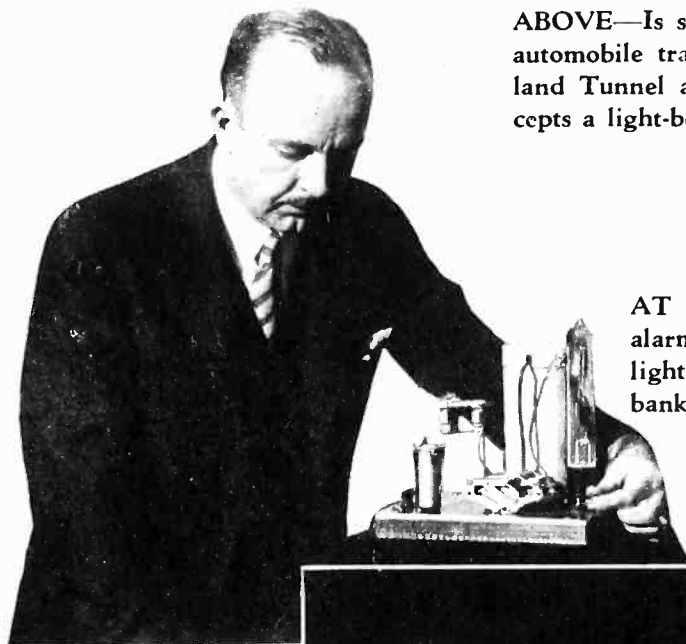

AT LEFT—A photo-cell burglar alarm, sensitive only to ultra-violet light. It is used for guarding safes, bank vaults, etc.

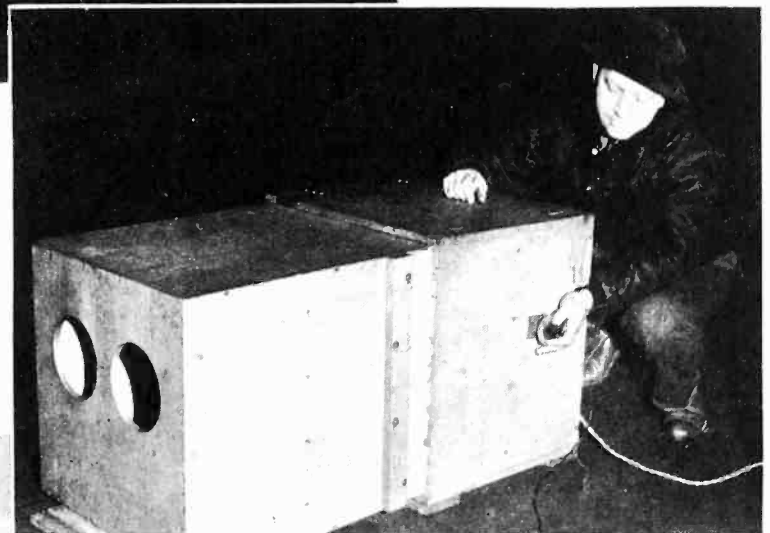

AT RIGHT — A gas detector. The gas is less transparent to infra-red rays than is air. Hence when gas is present, an alarm rings.

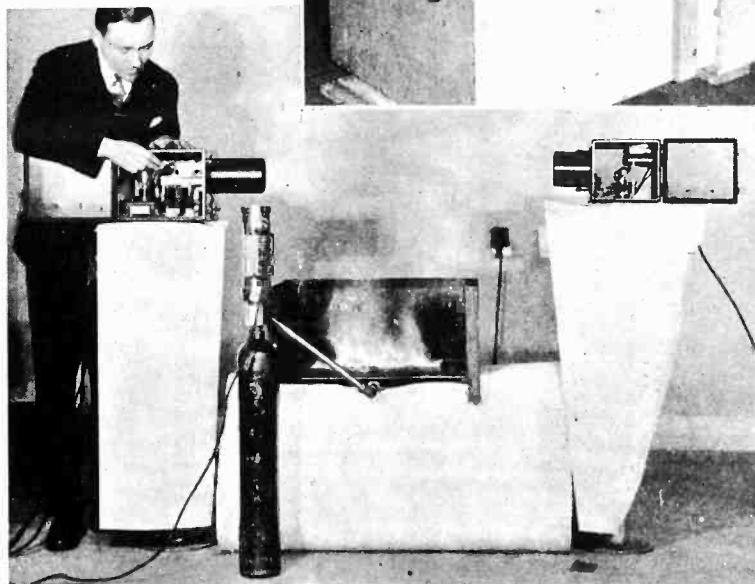

AT RIGHT—The photo-electric system as an automatic fire alarm and extinguisher. When an inflammable liquid is ignited in the pan, the smoke it produces intercepts the light-beam falling on a photo-cell. This causes an amplifier circuit to open the valve of a tank of carbon-dioxide, which drowns out the fire.

A few
of the
tube's
many
uses

Two-way television

enabling both parties to a telephone conversation to see each other as they talk

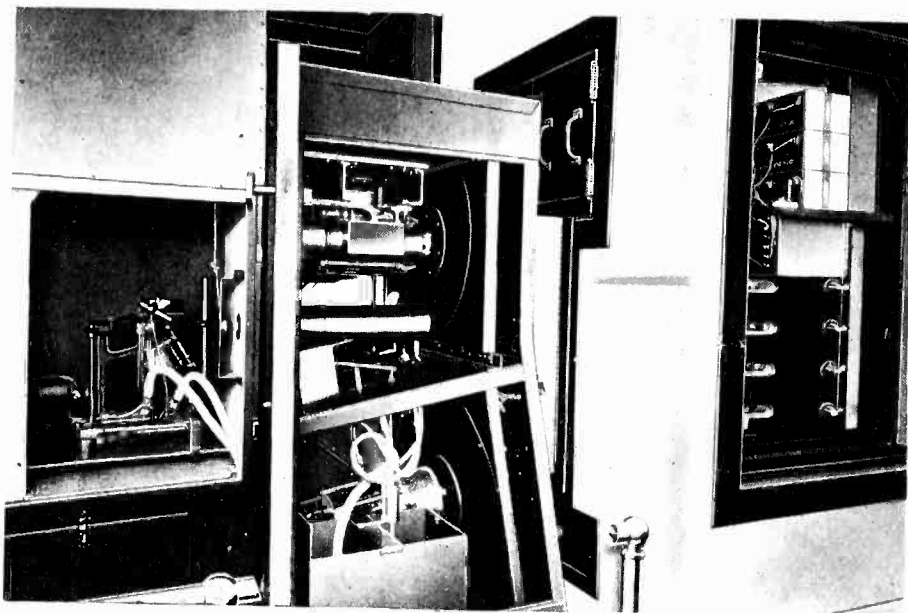
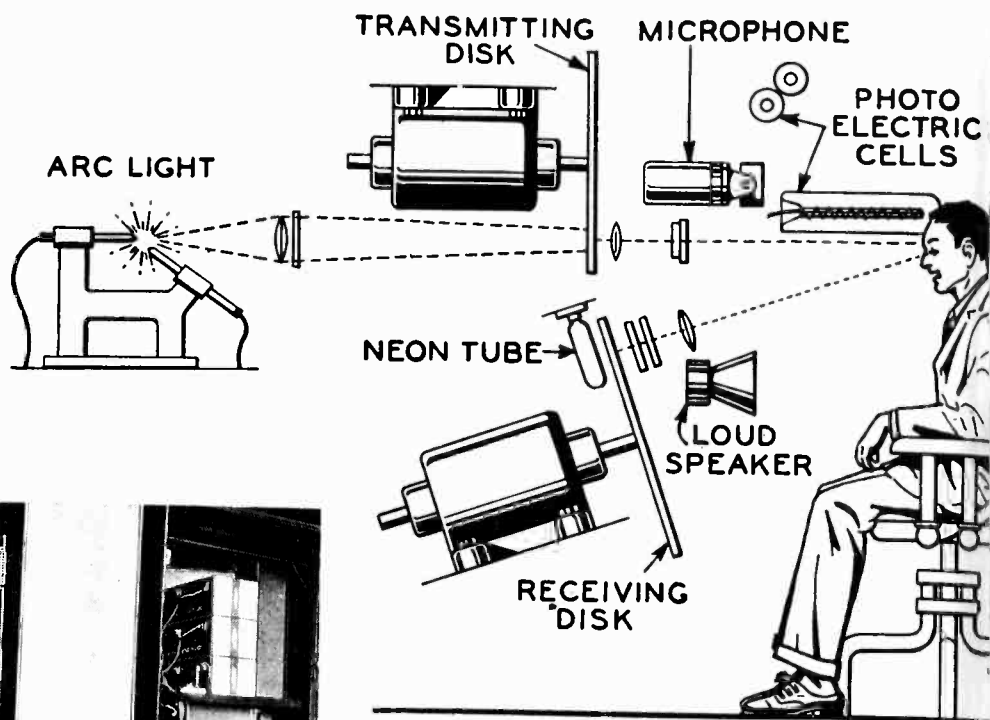

Above is shown the working equipment in diagrammatic form, and at the left is a photograph of the actual apparatus correspondingly arranged. The booth in which the "television-user" sits, is seen through the window.



At right — W. S. Gifford, president, A. T. & T. (sitting), and Dr. H. E. Ives, one of the engineers largely responsible for the Bell television apparatus shown on this page.

One of the water-cooled neon tubes. When in operation, the central square glows with a pinkish light.

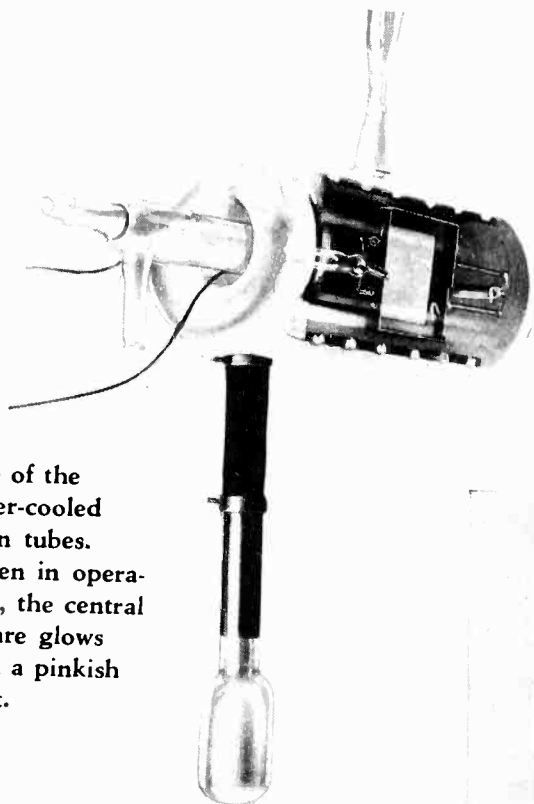

At right — the interior of a television booth. The party at the other end of the wire is "seen" in the small rectangle. Around the sides are the light-sensitive photo cells which transmit the local image.

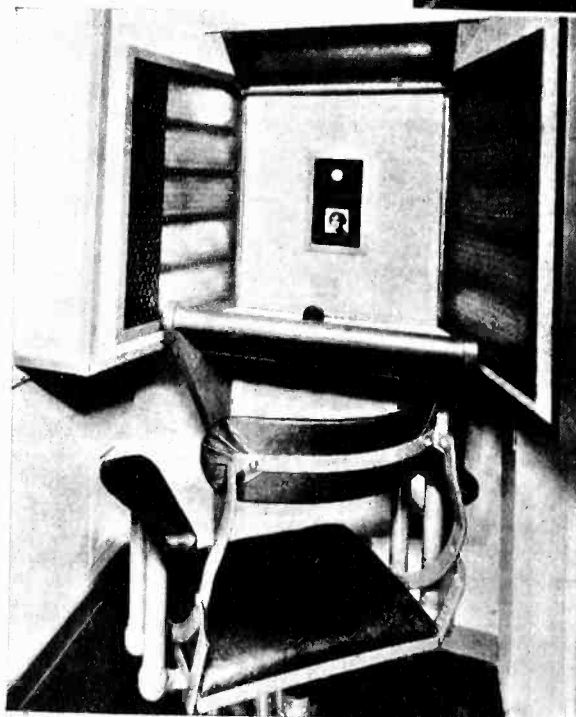

Among the improvements which have made two-way television possible are: The increase in sensitivity of the newest photo-cells, which have three times the former response. These cells employ a central anode and use potassium sensitized with sulphur. The voltage on the cell runs from 60 to 100. The glow tubes have a gas pressure of 12 mm. of mercury. A Sperry arc furnishes the light for the scanning beam. Vacuum tubes are used to keep the scanning-disk motors in synchronism.

NEWS OF THE ELECTRONIC FIELD



**tion Picture Engineers
Washington, May 5-8**

OLLOWING are papers of especial electronic interest, to be presented at the convention of the Society of Motion Picture Engineers, May 5-8, at Wardman Park Hotel, Washington,

MONDAY, MAY 5

Address by President J. I. Crabtree, Eastman Kodak Company; "Recent and Future Changes in the Motion Picture Industry," by Franklin S. Irby, Associate Editor, *Electronics*, N. Y.; "Home Radio Movies and the Cathode Ray Tube," by V. Zworykin, Radio-Victor Corporation, Camden, N. J.; "A Silhouette Studio," by C. F. Jenkinson, Washington, D. C.; "Medical Motion Pictures in Color," by H. B. Tuttle, Eastman Kodak Company, Rochester, N. Y.

TUESDAY, MAY 6

"Loud-Speakers and Theater Sound Reproduction," by T. Malter, R. C. A. Photophone Inc., New York; "Factors Governing the Use of Sound Reproducing Equipment in Theaters," by W. J. Sette, Electrical Research Products, Inc., New York; "Sound-Recording and Acoustics," by A. S. Ringel, RCA-Victor Corporation, Camden, N. J.; "Sound Reproduction—Disc vs. Film," by H. Evans, Warner Bros. Eastern Studios, New York, N. Y.; "Acoustical Characteristics of Loud Screens," by H. F. Hopkins, Bell Telephone Laboratories, Inc., New York; "New Recorder for Variable Area Recording," by E. W. Kellogg, Radio Victor Corporation, Camden, N. J.; "Phonofilm," by J. Hopan, General Talking Pictures, New York; "Acoustic Principles of Recording and Reproduction of Speech and Music," a feature film by Harvey Fletcher; "Galvanometers for Variable Area Recording," by G. L. Dimmick, Radio Victor Corporation, Camden, N. J.; "A Type of Acoustic Apparatus in Sound Recording," by R. L. Mason, Bell Telephone Laboratories, Inc., New York; "The Becquerel Effect and Its Application to Talking Picture Systems," by Joseph Miehling, Universal Sound System, Philadelphia, Pa.; "An Experimental Study of the Reverberation Characteristics of a Small Room," by C. F. Eyring, Bell Telephone Laboratories, Inc., New York; "Apparatus for the Analysis of Photographic Sound Records," by O. Sandvik, Kodak Research Laboratories, Rochester, N. Y.; "Photographic Treatment of Variable Area Sound Films," by J. A. Maurer, R. C. A. Photophone, Inc., New York; "The Measurement of Density in Variable Area Sound Films," by C. Tuttle and J. W. McFarlane, Kodak Research Laboratories, Rochester, N. Y.; "A New Microphone Boom," by E. C. Fordson, Mole-Richardson, Inc., Hollywood, Cal.

WEDNESDAY, MAY 7

"Television System," by C. F. Jenkins, Washington, D. C.; "Aeo Light Recording," by Robert Nicholson, New York; "Some Engineering Problems Affecting Sound Quality," by J. Crabtree, Bell Telephone Laboratories, Inc., New York.

THURSDAY, MAY 8

"Approved Synchronizing Apparatus for Sound Films with Disc Records," by Wm. H. Bristol, Wm. H. Bristol Talking Pictures Corporation, Waterbury, Conn.; "New Power Amplifier System," by L. Hopson, Wm. H. Bristol Talking Pictures Corporation, Waterbury, Conn.; "The Measurement of Light Valve Resonance," by O. Ceccarini, Metro-Goldwyn-Mayer Studios, Culvert City, Calif.; "Talking Pictures—the Great Internationalist," by Wm. B. Franklin, West Coast Theaters, Incorporated, Los Angeles, Calif.

**Electrical Engineers at
Springfield, Mass., May 7-10**

AMONG the papers of special interest to *Electronics'* readers to be presented at the New England district convention of the A.I.E.E. May 7 to 10, are the following:

WEDNESDAY, MAY 7

Morning

"New Portable Oscillograph," C. M. Hathaway; "Self-Compensating Temperature Indicator," I. F. Kinnard and H. T. Faus; "Generator Speed and Retardation During Loss Measurements," O. E. Charlton and W. D. Ketchum; "M.I.T. Network Analyzer," H. L. Hazen, M. F. Gardner and O. R. Schurig; "Phase Difference in an Air Condenser," W. B. Kouwenhoven and C. L. Lemon.

Afternoon

"Research and Design with the Field as a Laboratory," F. A. Andrews and C. L. Stroup; "1928 Lighting Experience on American G. & E. Lines," Philip Spron; "Arcing Grounds and Neutral Impedance," J. E. Clem.

THURSDAY, MAY 8

Morning and Afternoon

"Transient Currents in Transformers," H. M. Turner; "Effect of Transient Voltage on Power Transformer Design," K. K. Paluff; "Reduction of Eddy Current Losses," J. M. Lyons; "Transformer Ratio and Differential Leakage of Distributed Windings," R. E. Hellmund and C. G. Veinott.

FRIDAY, MAY 9

Morning

"Co-operative Courses," K. L. Wildes, M.I.T.; "Ship-To-Shore Telephone Service," L. Espenschied and W. Wilson; "Relations of Measurements on Rubber Cable," C. L. Kasson.

**Acoustical Society at
New York, May 9 and 10**

THE third annual meeting of the Acoustical Society of America will be held in the auditorium of the Westinghouse Lighting Institute, Grand Central Palace, New York City, May 9 and 10. Following are the papers scheduled:

FRIDAY, MAY 9

Morning—Symposium on Noise

"New York City's Noise Abatement Commission," Dr. Shirley Wynne, Health Commissioner; "Results of Noise Surveys," "Noise Out-of-Doors," Rogers H. Galt, Bell Telephone Laboratories; "Noise in Buildings," Rexford S. Tucker, American Telephone and Telegraph Co.; "Noise Reduction," John Parkinson, Johns-Manville Corp.; "Objective Measurement of Machinery Noises," F. A. Firestone, University of Michigan; "Elimination of Noise in Machinery," Arthur L. Kimball, General Electric Co.

Afternoon

"Concatenated Cone Speaker," A. V. Bedford, Research Laboratory, General Electric Co.; "Binaural Localization of Pure Tones," E. R. Wightman and F. A. Firestone, University of Michigan; "High-Scale Acoustic Phenomena," R. B. Bourne, The Maxim Silencer Company, Hartford, Conn.; "New Instruments in the Iowa Laboratory for the Psychology of Music," C. E. Seashore, University of Iowa; "The Reverberation Time Bridge," Harry F. Olson and Barton Kreuzer, R. C. A. Photophone, Inc., New York; "The Octave Interval," Wilmer T. Bartholomew, Peabody Conservatory of Music, Baltimore, Md.; "Teaching Control of the Human Voice," Louis Simmons, 210 Fifth Ave., New York.

SATURDAY, MAY 10

Morning—Symposium on Loud Speakers

"Theory of the Electrostatic Loud Speaker," C. R. Hanna, Westinghouse Electric & Mfg. Co.; "Theory of the Horn Type Loud Speaker," C. R. Hanna; "Radiation of Sound from Loud Speakers," Irving Wolff, RCA-Victor Co., Inc., Camden, N. J., and Louis Malter, RCA Photophone, New York; "Loud-Speaker Sound-Pressure Measurements," Edward W. Kellogg, RCA-Victor Co., Inc., Camden, N. J.; "An Efficient Loud Speaker at the Higher Frequencies," L. G. Bostwick, Bell Telephone Laboratories.

**Coming Meetings,
Institute of Radio Engineers**

AT the New York City meeting of the Institute of Radio Engineers to be held Wednesday evening, May 7, at the Engineering Societies Building, O. H. Caldwell, editor of *ELECTRONICS*, will speak on "Radio's Contributions to Modern Civilization."

The June meeting of the New York Section, I.R.E., will be held at Atlantic City during the annual Radio Trade Show.

The annual convention of the Institute of Radio Engineers will be held at the King Edward Hotel, Toronto, Canada, August 18 to 21. Six hundred delegates are expected to attend this first international gathering.

**Radio Week at
Atlantic City, June 2 to 7**

IN connection with the annual Radio Trade Show and Radio Manufacturers' Association convention to be held at Atlantic City during the week of June 2, there will be meetings of other radio organizations.

The Institute of Radio Engineers will hold engineering sessions at 10 a.m. and 2 p.m. on Tuesday, June 3.

The Radio Manufacturers Association will meet on Wednesday and Thursday, and R.M.A. Committees will assemble on other days of the week.

The Radio Wholesaler's Association will meet on Wednesday morning. The directors of the National Association of Broadcasters will convene the same day.

★ NEW PRODUCTS

THE MANUFACTURERS OFF

Portable direct-reading circuit tester

THE Roller-Smith Company of Bethlehem, Pa., has marketed a portable, direct-reading circuit tester shown in the accompanying illustration. The instrument can be used to ascertain if there is an electrical circuit existing between conductors applied to the terminals of the instrument and also the resistance in ohms of the circuit under

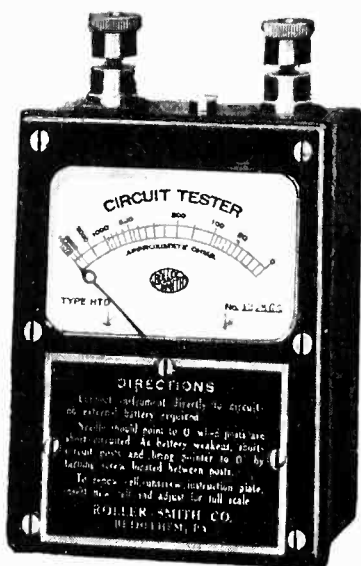

test. The instrument measures $4\frac{1}{2}$ " x 3" x $1\frac{1}{2}$ " and weighs only 19 ounces, making it a convenient pocket size. The manufacturers recommend it particularly for use by wiremen, repair men, and on coil and other electrical installation work which necessitates identification and checking of various circuits. These testers may be obtained for 10,000, 100,000 or 200,000 ohms. No. 3009 S Type HTD circuit tester, 10,000 ohms is listed at \$21.—*Electronics, May, 1930.*

Photo-electric relay unit

THE G-M Laboratories, Inc., Grace and Ravenswood Avenue, Chicago, Ill., have announced a new sensitive relay for use in conjunction with photo-electric cells. The relay embodies a one-stage amplifier, using a standard UX 199 type tube. This unit can be used for conversion of photo-electric reactions into electrical impulses, thus permitting the operation of auxiliary apparatus.—*Electronics, May, 1930.*

This section is prepared by the editors of *Electronics* purely as a service to readers. Its aim is to present announcements of all new products, devices and materials of interest in the field of the paper. All items are published solely as news, and without any charge or any advertising consideration whatsoever.

Tube Checker

A NEW and simplified tube checker for a.c. tubes has just been perfected by the Jefferson Electric Company, 1500 S. Laflin St., Chicago, Ill. With this tester it is possible to know if the plate and grid are shorted, the plate is open, and the filament is open or shorted. It has six sockets, one each for the 226, 227, 224, 247, 171A and 280 type tubes; a milliammeter; a push button; and the connection for testing screen-grid tubes. The net price to the dealer is \$13.50.—*Electronics, May, 1930.*

Electrolytic condenser

THE Sprague Specialties Company of Quincy, Mass., has announced an electrolytic condenser of entirely novel construction. It has a one-piece anode made entirely of aluminum. Some of its other features are: no welded joints, a protected vent, a pressure seal, and a shield which precludes possibility of

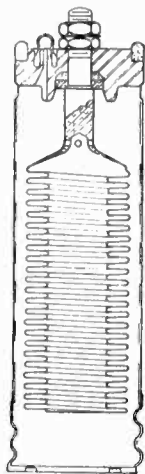

short circuit. This type of condenser lays claim to increased life, less leakage and better shelf characteristics. Leakage current is guaranteed not to exceed $\frac{1}{10}$ milliamperes per mfd. at 350 volts after 5 minutes. Another feature is the mounting arrangement which is of the screw type.—*Electronics, May, 1930.*

Photo-electric cell and amplifier unit

THE Westinghouse Electric & Manufacturing Company, East Pittsburgh, Pa., has placed on the market a photo-electric cell with an amplifier which is now sold as a unit. The amplifier shown in the illustration, consists of a die-cast aluminum box in which are mounted the necessary coupling device



The top, which is a Micarta panel, is provided with two four-prong bases for mounting the photo-electric cell and amplifier tube. All of the wiring is concealed, connections being made by binding posts on the top panel. The unit is dust-proof and moisture-proof. The short connections in the unit permit possible a very high speed response between .0001 and .001 seconds. In some applications, complete apparatus has been developed and can be supplied as a unit; but for most applications where no standard apparatus is available, the photo-electric cell with amplifier is sold as a unit to be applied by the customer. Price complete tubes, \$60.—*Electronics, May, 1930.*

Portable amplifier

THE Operadio Manufacturing Company of St. Charles, Ill., who have specialized in public address equipment for indoor use, has recently produced an amplifier designed for this type of service. It is a portable model and is entirely self contained, capable of driving either standard electrodynamic speakers, or two of the large bowel speakers, a recent development of the same company. The complete unit contains a microphone with extension cord; a control panel; and electric phonograph, as well as the line amplifier. A key switch is provided which permits the operator to shift from voice to music instantly. A compartment is provided for the storage of the microphone, and power supply cord.—*Electronics, May, 1930.*

Electrodynamic speaker

DEFORD Radio Corporation, 3200 Carroll Ave., Chicago, Ill., has announced eight new models of dynamic speakers for 1930. Universal transformers are used with tapped connections, permitting connections to sets having various outputs. Direct connections can be made to two No. 250, 124 or 171-A tubes in push-pull and sockets arranged for use with a magnetic speaker.—*Electronics, May, 1930.*

Air column horn

THE Macy Manufacturing Corporation, 1449 39th St., Brooklyn, N. Y., manufactures exponential type horns of various sizes. The accompanying view shows Model S-120, which has a depth of 36 inches and an air column 10 feet in length. This horn is designed primarily for use in theatres, large auditoriums, churches, rinks, etc. It is

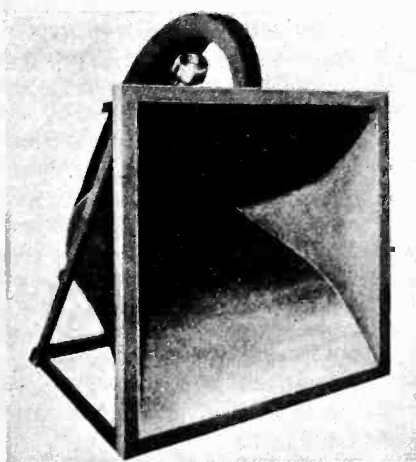

Equipped with Macy electric dynamic receiver units GAC-1 for interiors or unit GAC-2 for exterior use. Price complete, including one receiver \$250.—*Electronics, May, 1930.*

Water-cooled 5-kw. audion

THE DeForest Radio Company, Passaic, N. J., is the manufacturer of the 5-kw. audion shown in the accompanying view. This tube is designed for use as an oscillator on frequencies below 3,000 kilocycles, or as a radio-frequency amplifier on even higher frequencies. It may also be used as a modulator, by using several in parallel, to modulate a radio-frequency power amplifier. One of the principal features of the audion 520-B is the water jacket



construction. The jacket is an integral part of the tube itself, the water-cooling installation calling only for the attaching of two lengths of hose to the water inlet and outlet.—*Electronics, May, 1930.*

Multiple coil winding machine

THE Acme Electric & Manufacturing Company, 1444 Hamilton Ave., Cleveland, Ohio, has obtained exclusive rights to manufacture and sell these machines. The multiple coil winding machine has a capacity of from 6 to 12 coil windings at a single operation, winding sizes of wire from No. 26 to No. 42. The winding of sizes of wire above No. 36 is difficult, and very few winding machines are capable of handling the fine sizes, especially when several coils are wound at the same time. At the end of the layer, through a cam mechanism, together with a mercury switch, the glassine paper is automatically inserted in the winding, and the machine winds another layer over this paper and then the operation continues.—*Electronics, May, 1930.*

Electrolytic condensers

THE Aerovox Wireless Corporation, 70 Washington St., Brooklyn, N. Y., has recently announced a new dry type electrolytic condenser. This condenser

is dry, is very compact for a given capacity and voltage rating and has a maximum peak voltage rating of 500 volts, making it suitable for use in connection with 245 type power amplifiers.—*Electronics, May, 1930.*

Precision wire-wound resistors

INTERNATIONAL Resistance Company, 2006 Chestnut St., Philadelphia, Pa., has recently announced a new line of resistors. These resistors are non-inductively wire-wound to provide for an accurate and stable resistor to be used as a voltmeter or milliammeter mul-



tiplier for laboratory use or wherever non-inductive resistors wound to accuracies of $\frac{1}{2}$ of 1 per cent or 1 per cent are required. The resistors are made in all values of from 500 ohms to $\frac{1}{2}$ megohm in the size shown, and can be provided in values even higher with slightly larger winding forms.—*Electronics, May, 1930.*

D.C. converter for neon signs

THE Motorless D.C. Neon Sign Co., 180 East 123rd St., New York City, has recently placed on the market a direct-



current high-voltage transformer for luminous-tube sign operation. This device employs standard-26 vacuum tubes in place of a mechanical vibrator. It is designed for d.c. districts but will operate on a.c. though in this case the brilliancy of the luminous tubes is one-half. The manufacturers claim no interference with radio sets when using the device. Price of the complete set with three De Forest tubes \$15.00.—*Electronics, May, 1930.*

PATENTS

IN THE FIELD OF ELECTRONICS

A list of patents (up to April 15) granted by the United States Patent Office, chosen by the editors of *Electronics* for their interest to workers in the fields of the radio, visio, audio and industrial applications of the vacuum tube

Acoustic Devices

Loud speaker. A resonant body actuated by several electromagnets arranged in a square about it. George Maehren, assigned to Rocco Elio and Francis H. Davis. No. 1,751,284.

Deaf aid. An electrical arrangement enabling deaf persons to hear conversation, etc., composed of acoustic filters to attenuate the lower frequencies and a receiver which selects the high frequencies and discriminates against low frequencies. Bernardt Langenbeck, Leipzig, Germany, and Helmut Sell, Berlin, Germany, assigned to Siemens and Halske, Berlin. No. 1,750,960.

Acoustic wave filter. A means for converting non-acoustic energy into acoustic energy in the form of a standing wave having several components. Several energy-dissipating means are situated in the system at the proper places and of the proper character to dissipate energy other than the desired component of the standing wave. Included in the device is a method for re-converting the non-dissipated acoustic energy into non-acoustic energy. Harvey C. Hayes, Washington, D. C. No. 1,751,035.

Sound transmitter. Combination of a diaphragm, a rigid member, a conical member containing ground-up resistance material and a number of superimposed interconnected angular leaves between the rigid member and a conical member for damping purposes. Earl Wensley, assigned to Western Electric Company. No. 1,752,515.

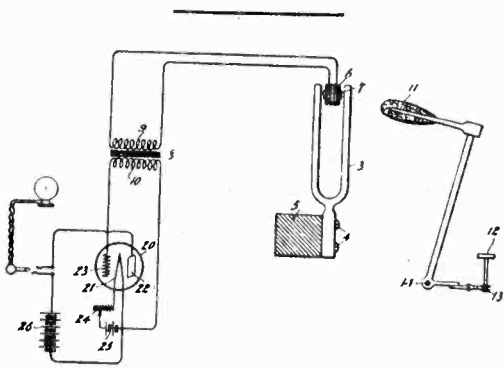

Sound generator. Vibrating tuning fork varies the reluctance of a magnetic circuit which in turn controls the grid circuit of an amplifying vacuum tube. Max. Schumm, Port Jefferson, N. Y. No. 1,753,069.

Acoustic signaling. Consists in repeatedly exciting a sound generator by individual sound impulses that succeed one another at intervals of less than one third of a second. Heinrich Kuchenmeister, Berlin, Germany. No. 1,752,185.

Electrostatic loud speaker. Comprising a fixed prism and vibrating coverings over the external faces of the prism. Georg Seibt, Berlin-Schoneberg, Germany. No. 1,753,137.

Loud speaker. Several intersecting sound amplifying horns each resonant to a different portion of the audible frequency range and actuated by separate movements. John Preston Minton, and Abraham S. Ringel, Brooklyn, N. Y., assigned to Radio Corporation of America. No. 1,750,900.

Phonograph records. A phonograph record having an extension projecting inwardly from the innermost groove to cause the stylus to move inwardly and an independent outwardly directed inner groove to engage the stylus and move it outwardly. Isadore E. Neft, Los Angeles, Calif. No. 1,751,166.

Loud speaker. Two cone-shaped fabric diaphragms joined together at the apex of the cone, and two frames to hold the fabric. The reproducing unit is attached to the apex. Edward Freund, Long Beach, N. Y. No. 1,752,981.

Loud speaker. Loud-speaking telephone apparently of the balanced armature type. This patent was filed July 3, 1922, and has 23 claims. A. A. Thomas, New York, N. Y. No. 1,753,812.

Radio Circuits

Signaling system. A method consisting in transmitting waves having a band of frequency components and dividing this band into several short spans which overlap each other. These short bands are modulated on several carrier waves of different frequencies, one corresponding to each sub-band so as to produce a plurality of five bands within practically the same frequency limits as were occupied by these sub-bands before modulation. These sub-bands are separate from each other in the frequency spectrum and are transmitted simultaneously. Ralph K. Potter, New York, N. Y., assigned to A. T. & T. Co. No. 1,750,688.

Short-wave system. Short wave antenna consisting of several rods separated from the earth and tuned to the frequency of the transmitter. All the rods being in the same plane are separated by the same angular distance and a hot wire anemeter is at the point of junction. These rods are not conductively coupled to the transmitting system. Russell F. Ohl, assigned to A. T. & T. Company. No. 1,753,715.

Receiving circuit. Another interesting member of the large family of Wheatstone bridge arrangements of vacuum tube circuits. Byron B. Minium, assigned to Story & Clark Radio Corporation. No. 1,751,706.

Transmitting circuit. An oscillator, amplifier, harmonic generator, and final amplifier which is coupled to antenna. The method involves supplying a vacuum tube with oscillations modulating currents and causing tubes to produce oscillations of a frequency which is a multiple of the frequency of the supplied oscillation. The produced oscillations are modulated the supplied wave. John F. Farrington assigned to Western Electric Co., Inc. No. 1,751,271.

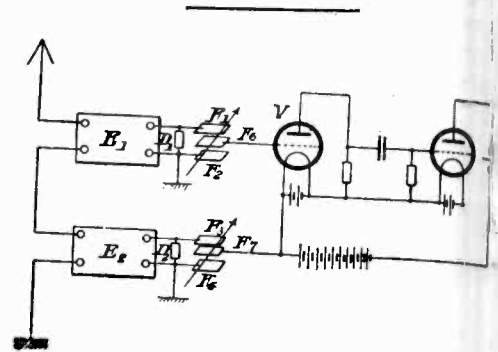

Receiving circuit. In the diagram above E_1 is tuned to the desired signal but E_2 is tuned somewhat away from the desired signal. E_1 , therefore, receives not only the desired wave, but also any disturbances that may exist, while the second circuit receives the disturbance only. The two disturbances are balanced against each other and do not appear in the output while the desired signal appears in the output. Siegmund Loew assigned to R.C.A. No. 1,751,588.

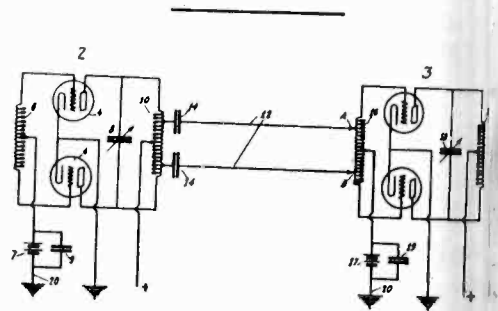

Coupling system. In the circuit shown, 2 and 3 are amplifier circuits which are coupled together by the transmission lines between them. To reduce the interaction between the circuits and to improve the accessibility of the several stages the transmission line has considerable length and is so tapped onto the output of the one circuit and the input of the other that the impedance between the coupling equals the characteristic impedance of the line. Clarence W. Hansell. Assigned to R.C.A. No. 1,751,996.

Signaling system. Several receiving systems of the double-detector type in which quartz crystals or other piezoelectric substances control the frequency generated by the oscillators. Russell S. Ohl, assigned to A. T. & T. Company. No. 1,753,444, No. 1,753,445 and No. 1,753,446.

Interference-reducing system. Voltages are induced in the antenna of a receiving system which are equal and opposite to those induced there from a magneto on an internal combustion engine. W. A. Loth, assigned to Societe Industrielle des Procèdes, W. A. Loth Paris. No. 1,753,610.

frequency changer. Two tubes in a push-pull Meissner circuit, designed to modulate the high frequency with a low frequency voltage. Charles V. Logwood, Jersey City, N. J., assigned to De Forest Radio Telephone and Telegraph Company. No. 1,751,485.

interference reducers and suppressors. Several patents assigned to the A.T.&T. Company are described in the following patents: 1,752,303; 1,752,325; 1,752,326; 1,752,330; 1,752,344; 1,752,360; 1,752,342. Patentees are Leo A. Kelley, Elmwood, N. Y.; David B. Branson, River Edge, N. J.; Robert H. Clapp, Ramsey, N. J.; Newton Monk, New York; Vaughn Corp., River Edge, N. J.; Herman A. Ridgewood, N. J.; Frank A. Leibel, N. J. The methods in general involve balancing a signal plus interference against interference alone, either in the electrical circuit or in the mechanical output circuit (relay.)

Wave filter. A net work composed of inductances and capacities across the lines and equivalent to a more complicated network composed of three filter sections of the series shunt type. Timothy E. Shea, assigned to Western Electric Company, No. 1,752,579.

Transmission network. A wave filter adapted to transmit electrically a pre-determined broad band of frequencies. In this particular patent, a method is provided for neutralizing the effect of stray capacity on the circuit. Timothy E. Shea, Hartford, N. J., assigned to Western Electric Company, No. 1,752,461.

Gas-discharge communication. Sound transmitting apparatus composed of a sealed container having a sound opening, hot cathode and anode arranged to produce ionization of the gas. A thermionic current is discharged through the tube, and audio signals are impressed on its discharge for modulation purposes. Samuel Ruben, assigned to Ruben Products Company, No. 1,752,811.

Sound ranging system. A submarine sound ranging system comprising vacuum tube repeaters, artificial lines and recovery apparatus. George R. Lum, assigned to Western Electric Co. No. 1,753,346.

Photometer. A gas-filled cell; pair of electrodes in this cell and a means of producing an initial ionization of the gas. Apparently the voltage put upon the cell causes ionization and the extent of the ionized column is used as an indication of the voltages involved. Robert E. Bragg, assigned to Bell Telephone Laboratories, Inc. No. 1,753,330.

Scanning system. Reflecting and scanning apparatus including several rectangular units arranged side by side. Clarence B. Gardner, Los Angeles, Cal. No. 1,753,697.

Signaling system. A facsimile or telegraph transmitting system in which a carrier wave is modulated with a number of other frequencies representative of the portions of symbols adjacent to another in a message to be transmitted. Vladimir K. Zworykin, assigned to Westinghouse E. & M. Co. No. 1,753,961.

Circuit Devices

Rectifiers. A series of rectifiers operating on the dry surface contact principle. One of the rectifiers is composed of magnesium and an element formed in an alloy of the metals copper, and compounded with a chemical ele-

ment from the sixth periodic group. Samuel Ruben, assigned to Ruben Rectifier Corporation. No. 1,751,359, No. 1,751,363, No. 1,751,460.

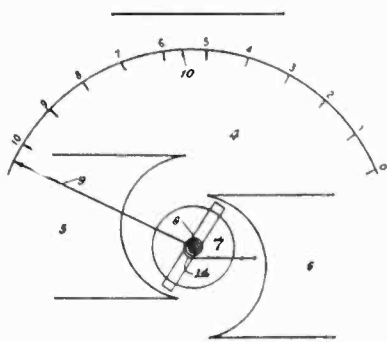

Meter. A meter having a scale reading in transmission units which are logarithmic functions of the current to be measured. The scale is made uniform by so positioning the coil with respect to the pole pieces and so shaping the latter that the pointer will move to a uniform distance at any part of the scale in response to a change in current corresponding to one transmission unit. Fred H. Best, assigned to A. T. & T. Company. No. 1,753,230.

Resistor for electrical measuring instruments. A vacuum tube used as a resistance for a measuring meter. A movable cylinder surrounding the cathode for screening it against the anode can be shifted by means of an external magnet. Werner Esbe, assigned to Siemens - Schuckertwerke Gesellschaft, Mit Veschrakter Haftung, Berlin, Germany. No. 1,754,152.

Vacuum-tube rectifier. An incandescent cathode rectifier for medium voltages having two anodes which are screened from each other by a glass or other non-conductor, each having a protected portion between the anodes and the base. Bruno Donath, Berlin, Germany. No. 1,754,012.

Process and Manufacturing

Glass machinery. Method and apparatus for producing tubular glass, etc. Leonard Souvier, Toledo, Ohio, assigned to Owens-Illinois Glass Company. No. 1,750,971; No. 1,750,972; and No. 1,750,973.

Getter. A mixture of a phosphorus compound and a reducing agent which vaporizes upon heating the mixer to clear up residual gases. Ernest A. Lederer, assigned to Westinghouse Lamp Company. No. 1,752,747.

Leakage preventer. Vacuum tube containing an alkali metal current conductor sealed into the tube and the coating of an inorganic salt containing oxygen on the interior surface of the envelope between the current conductors. Ernest A. Lederer, assigned to Westinghouse Lamp Company. No. 1,752,748.

Transformer-coil process. Process for the manufacture of coils comprising a fibre absorbent core tube, and a coil of wire thereon. Prior to winding the core it is treated with a liquid having the characteristic when solidified of being impervious to hot impregnating liquids. Marshall Barnum, New Haven, Conn., assigned to the Acme Wire Company. No. 1,751,971.

Radio inductance. A tubular coil machined to a pre-determined diameter, with a number of apertures at one end

and at least one aperture at the other end for the conductors. Robert C. DaCosta, assigned to Atwater Kent Manufacturing Company. No. 1,751,854.

Variable coupling device. Mechanical method of varying coupling between primary and secondary of a radio frequency transformer. Lloyd A. Hammarlund, Rockville Center, N. Y., assigned to Hammarlund Manufacturing Co. No. 1,753,182.

Vacuum-tube wire. Composite metal, comprising an alkaline metal with a magnesium coating, the alkaline metal being more readily oxidizable than the magnesium, and both metals being capable of acting as "getters." William Andrew Ruggles, assigned to the General Electric Company. No. 1,752,813.

Purifying rare gases. Method of purifying rare gases by passing an electric discharge through the gases which are in a proper container. Richard E. Miesse, assigned to New Process Metals Corporation, Newark, N. J. No. 1,753,298.

Inductance system. Method of connecting water supply to a transmitter inductance for cooling purposes. Louis A. Gebhard, assigned to Wired Radio, Inc. No. 1,753,408.

Electrolytic condenser. The well-known electrolytic condenser. Samuel T. Woodhull, assigned to the Amrad Corporation. No. 1,753,912.

Vacuum tube. Apparently a construction patent defining methods and position of placing the various elements to attain rigidity. Ernest Yeoman Robinson, assigned to Metropolitan-Vickers Electrical Company, Great Britain. No. 1,754,120.

Vacuum Tubes

Vacuum tube. A tube comprising an evacuated container, a conductor through the container comprising several parallel elements about the conductor, and an anode in the form of a revolutes about the cathode and a means whereby a current different in value from the current may be supplied to the conductor. Wm. E. Powell, assigned to General Electric Co. No. 1,751,418.

Cathode-ray oscillograph. Cathode ray tube, provided with a screen at one end, having a curved surface whose curvature is such that at least one plane intersection thereof will lie in a straight line. Ralph Bown, Maplewood, N. J., assigned to A. T. & T. No. 1,750,661.

Control apparatus. A combination of an electrical circuit and an electron-discharge device with anode and cathode heating circuit. A method is provided for disconnecting the heating circuits and maintaining them disconnected for a predetermined interval of time. Adolf Waltemath, Oberschoneweide, Germany, assigned to General Electric Company. No. 1,751,374.

Vacuum tube. A tube in which the pulsations in the filament voltage can be balanced out by means of a direct current connected between the mid point of the filament and the mid point of a high resistance connected across the two filament terminals. Charles F. W. Bates, Cleveland Heights, Ohio. No. 1,753,260.

Relay system. A relay connected to a glow tube arranged to transmit current only at a voltage exceeding that of the supply system. Franz Hirt, Berlin, Germany, assigned to G. E. Co., No. 1,751,330.

Signaling system. In the plate circuit of a vacuum tube are two inductances connected in series acting as a primary

PATENTS—

of a transformer. The secondary of the transformer is connected to a succeeding vacuum tube and has several sections so connected to the primary that a second voltage is built upon the grid of the tube in phase. Anatol Gollos, Chicago, No. 1,751,081.

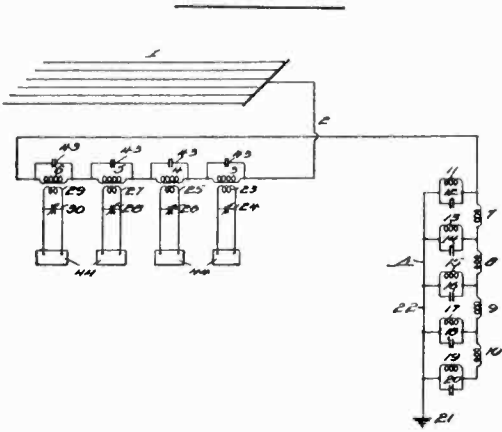

Radio receiving system. Multiplex radio receiving system consisting of an antenna in series with a number of tuned circuits. A number of receivers each tuned to a frequency corresponding to one of the tuned circuits in series with the antenna picks up the desired signal whence it is detected and amplified. Louis Cohen, assigned to Federal Telegraph Company. No. 1,753,308.

Projection and Recording

Recording apparatus. A method of modulating a light beam and reflecting it onto a photographic film. Roscoe Royal, Chicago, Ill. No. 1,750,863.

Photographic apparatus. A method of producing distorted pictures of an object by placing a refractive distorting element in front of the lens of a camera. George W. Ford, Brighton, England, assigned to H. G. Ponting, London, England. No. 1,750,883.

Color photography. An optical method for producing color pictures consisting of a mirror partly light impervious and lenses arranged so that two paths are provided for the light to reach a film. One path receives the rays reflected from the mirror while the other path receives the rays transmitted through the mirror. After transmission through the optical system, the rays are turned into parallel halves, registering with the two halves of a film. Karl Martin and Paul Pietee, Rathenow, Germany. No. 1,752,680.

Color film. Multi-color picture-positive having four component images in two half pictures, supporting layers, etc. John Edward Thornton, assigned to John Owden O'Brien, Manchester, England. No. 1,753,140.

Projector. A combined prismatic and cylindrical lens designed to shift de-centered images so that they will be projected on the center of the screen and then spread to cover the entire screen. Andrew J. Timoney, assigned to Harold Williams & Gus Durkin. No. 1,753,222.

Sound-recording system. The sound vibrations after being amplified by a vacuum tube amplifier, are passed to the

coils of two electromagnetic devices in series. These devices actuate diaphragms which in turn control a light shutter and thereby affect the quantity of light flowing from a light cell onto a moving film. Freeman H. Owens. No. 1,753,530.

Power and Oscillatory Circuits

Oscillatory circuit. An inductance consisting of wire wound on a core of nickel iron, so constructed as to reduce any current losses to a low value is in series with a circuit tuned to the desired signals of a given strength. When the signal strength increases beyond this value the inductance of the nickel iron core coil changes to such an extent that the circuit is no longer resonant. Alexander Meissner, Berlin, Germany. No. 1,751,592.

Electric-discharge producer. A device for producing a current of constant intensity at pre-determined small duration having a range of less than one one-hundredth-thousandth second to several seconds duration. Two condensers are connected in series and a battery is across the remaining terminals. Across each condenser is a resistance. A method is provided for suddenly producing in the circuit a voltage having a predetermined value and decreasing afterwards according to an exponential law to a second pre-determined value. These voltages are impressed upon the grid circuit of a vacuum tube whose plate current falls to zero during the exponential decrease of voltage. The plate potential of the first vacuum tube is impressed upon the second vacuum tube. Leon Nicolas Brillouin, Paris, France. No. 1,752,228.

Power-converting apparatus. Two electric valves, a capacity and charging circuit, including one of the tubes and a capacity discharging circuit including the other vacuum tube. An alternating-current circuit is common to the charging and discharging circuits and a means is provided for successively changing the conductivities of said tubes. Alan S. Fitzgerald, Schenectady, N. Y., assigned to General Electric Company. No. 1,752,247.

Power-converting apparatus. Two vacuum tubes and an oscillatory circuit including inductances and capacitances connected in series with one another, and provided with opposed terminals. A direct current circuit is connected between these opposed terminals through one of the tubes and through a means of subjecting the other vacuum tube successively to the resultant difference between the inductive and capacitive voltage drops of the oscillatory circuit and to the resultant sum of the voltage drops. Camil A. Sabbah, assigned to General Electric Company. No. 1,752,205.

Oscillation producer. A static transformer, a rectifier, a discharging air core transformer, a condenser and a method for increasing and decreasing the electromotive force from the rectifier in a rhythmical fashion. Julienne Beaumont and W. H. Blum. No. 1,752,632.

Tube Applications

Picture-transmission system. Light sources are arranged in spiral formation about a scanning disk. The disk is rotated in synchronism with a similar disk at the transmitting station. The

received signals are connected to corresponding light on the receiving disk by means of a commutator arrangement. The lights on the receiving are permanently biased by means of a battery to eliminate the effect of the periodic flashing of these lights. Fred Schroeder, Berlin, Germany. No. 1,751,606.

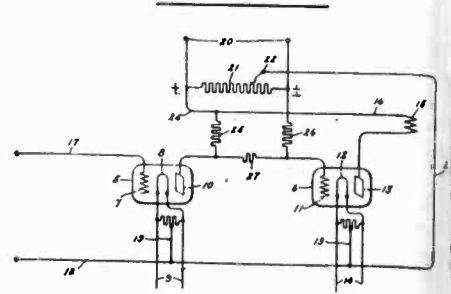

Amplifier. A direct coupled amplifier comprising two tubes and a resistor network between the grid and plate. A potentiometer with variable tap connected to the filament of the tube ensures the proper voltage relation between the grid of the second tube and the plate of the first. Paul C. Gardiner, assigned to The Gardiner Company, No. 1,752,8

Movement and position detector. System by which a moving object can have its position and movement determined at a distant point. At the observing station, a frequency is generated; between the fixed and moving stations other frequencies are transmitted whose phase bears some relation to the frequency generated at the observing station. The phase of the frequency generated at the observing station compared with the phase of a frequency which has been shifted in phase by transmission. By changing the effective phase of one of the waves with respect to the other, a measurable instantaneous change of direction is noted and thereby data are obtained from which the distance between the fixed station and the moving object may be determined. By making similar observations from another fixed station, the absolute position of the moving object may be computed. Estill Green, East Orange, N. J., assigned to A. T. & T. Co. No. 1,750,668.

Picture transmission. A method of transmitting a picture having several shades by selecting the respective shades transmitting code signals for these shades and causing a record to be made of the shades as determined by the code signals. Ernst F. W. Alexanderson, assigned to General Electric Company. No. 1,752,876.

Amplifier. Circuit composed of several three-element vacuum tubes and a vacuum tube rectifier and low pass filter. The amplifier tubes are apparently connected in what is popularly known to-day as a direct-coupled circuit. Harry Nyquist, Milburn, N. J. Assigned to A. T. & T. Company. No. 1,751,527.

Transmission apparatus. Apparatus for locating the direction of a source of sound composed of a pair of sound detectors and a pair of transmitting devices connected by a pair of transmission lines. One of the transmission lines is varied to compensate differences in time of arrival of a sound wave at the sound detectors. Also a means for indicating the direction of the source of sound. Frances A. Hubbard, assigned to Western Electric Company, No. 1,752,528.

Antenna Coupling Systems

(Continued from page 84)

type of transformer employed). The coupling coefficient was as high as 40 per cent and it was necessary to resort to very tight coupling in the antenna stage in order to get better transfer of signal voltage at long waves. This tight coupling, however, was very unsatisfactory at short waves. In the first place, the capacity coupled from the antenna circuit into the secondary was so great that it was not always possible to tune the first stage down to 1500 kilocycles. In the second place, the loading due to the antenna, and the dielectric loss between the primary and secondary were both increased, resulting in very poor selectivity characteristics for the antenna stage. It was, therefore, necessary either to reduce the coupling by reducing the primary turns by means of a tap on the primary, or to shorten the antenna electrically by the use of an antenna series condenser. The use of a single antenna connection was therefore not satisfactory over the entire frequency band.

The performance of the tightly coupled antenna transformer with low primary impedance is shown by the voltage gain curve, Fig. 7, and band widths in the Appendix and Table I. The transformer consists of 78 turns of No. 30 enamelled wire space wound on a $2\frac{1}{4}$ in. tube with a primary of 18 turns of No. 30 enamelled wire space wound, and .010 in. spacing between it and secondary. The gain starts falling above 1000 kilocycles due to antenna loading and dielectric loss in the transformer. Below 1000 kc. the gain falls due to a reduction in voltage transfer with falling frequency.

While the gain in this type of transformer is satisfactory, its selectivity characteristics at short waves are not. A band width of 92 kc. at 1200 kc. is very poor, and is due to antenna loading and excessive dielectric loss resulting from too tight coupling. The coupling also prohibits the use of this system in a unicontrol set.

The loosely coupled transformer with low-impedance primary overcomes the disadvantages enumerated above. By reducing the coupling to about 10 per cent the antenna loading is made less and loading and dielectric loss are reduced to a point where they are not objectionable. The performance of such a transformer is shown in the

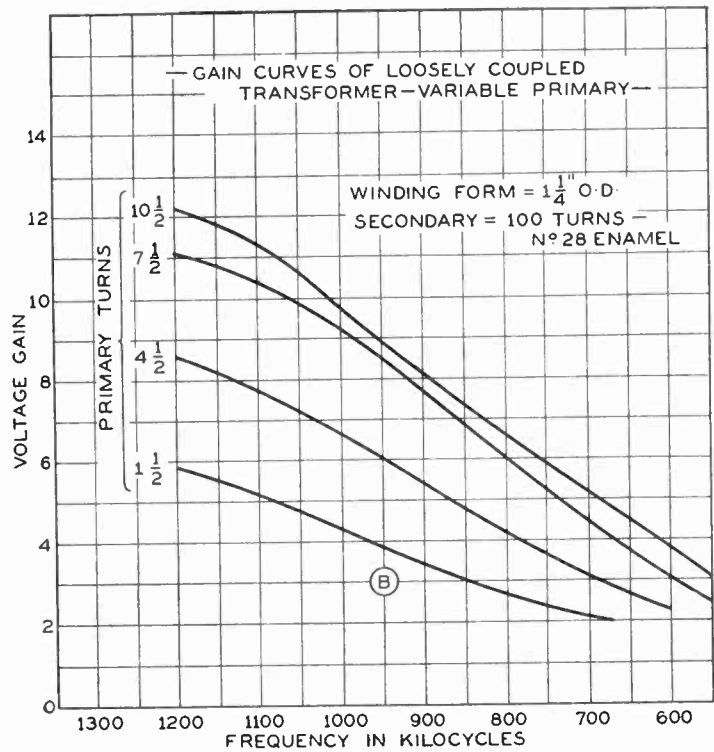

Fig. 8—Relation between frequency, voltage gain, and primary turns is shown in the above curves.

appropriate curve of Fig. 8. This transformer consists of 100 turns of No. 28 enamelled wire close wound on a $1\frac{1}{4}$ in. tube, with a primary of 10 turns of No. 28 enamelled wire close wound and spaced .010 in. above secondary. Due to the very loose coupling the long-wave gain has dropped considerably. It is therefore necessary to employ interstage r.f. transformers having high long-wave gain in order to equalize the over-all gain curve. The selectivity characteristic at 1200 kc. is 42 kilocycles, which is a satisfactory figure. The curves in Fig. 8 show what happens as the coupling is still further reduced. The long-wave gain is reduced considerably as is to be expected. Table II shows the improvement effected in selectivity with this reduced coupling. It is possible to utilize this loose coupling and still obtain uniform gain over the frequency band by the use of interstage transformers in which the short and long-wave gain are independently controlled, in this way securing all of the advantages of a very loosely coupled antenna circuit for unicontrol sets.



Adjudication of the oscillating-tube patents

Editor ELECTRONICS:

We have been interested in the first issue of ELECTRONICS and wish to congratulate your organization on the very good job that has been done on this paper. We believe that this magazine will answer very well in keeping engineers interested in "electronics" in line with new developments. In the April issue, however, in an article by Mr. S. M. Kintner, we would like to call your attention to the statement by him, which follows:

"E. H. Armstrong discovered the feed-back circuits and proved that the audions could be made to generate oscillating currents of nearly any desired frequencies. The Armstrong discovery stimulated a new interest in the audion which was at once recognized as offering the best opportunity for getting continuous-wave generators to displace the old damped-wave types for radio sending stations."

The final decision in the controversy between the Westinghouse Electric &

Mfg. Co., owners of the Armstrong applications, and the DeForest Radio Company, owners of the DeForest oscillating audion patents was given by the Supreme Court of the United States on October 29, 1928. This decision stated that the DeForest patents, 1,507,016 and 1,507,017 were held to be valid and the Armstrong interfering patent was wiped out. These two particular patents cover any form of oscillating circuit.

ALLEN B. DUMONT,
Chief Engineer, DeForest Radio Co.



Building an engineering organization

[Continued from page 64]

for he has developed the "work-habit" that many men lose in four years of care-free college life.

Unexplained gaps in a man's employment record are usually worthy of investigation, particularly if the applicant has been out of college several years.

For commercial or other work requiring outside contacts, personal appearance is often considered important, as the customer must depend upon first impressions. For laboratory work, particularly research, appearance is of secondary importance, although untidy dress by no means indicates an abstract thinker.

In addition to electrical engineering graduates, physicists and chemists are required for research and development work; mechanical engineering graduates for design and factory problems, and business administration students for commercial, general office, and legal work. All of these students go through the same general training course, spending the first year on six assignments of two months each, in several different sections of the engineering department, to obtain a broad foundation and perspective for their future work. The second year is divided into two assignments in the general type of work for which the student is best fitted, after which a

permanent assignment is made. During the first three years students attend regular classes and lectures, during working hours, and after the first year may enroll in approved courses, leading to an additional degree, at one of the nearby colleges.

To assist students in choosing the work for which they are best fitted, an advisor is assigned to every six or eight men. He is also able to advise them on other matters, and help them get acclimated to their new environment.

As the organization expands or a new problem occurs, an additional section is formed, headed by the best man available in the organization. Vacancies and additional requirements are filled from the junior engineers and from the student course. Ability, initiative, character, and personality all have more weight than length of service in considering a man for promotion, and many positions of considerable responsibility are now held by young men, with only a few years' service. While the engineering organization is made up of several functional divisions, the personnel of all divisions is considered when a vacancy occurs. It is, therefore, necessary for a man to be well informed in several related fields, and to maintain a broad, cooperative viewpoint.

[An additional article by Mr. Baker on engineering personnel management will follow in the June issue of *Electronics*.]

Development of insulation materials

[Continued from page 73]

depends to a considerable degree on the hysteresis and leakage losses both of which are lower than for the usual compositions.

The mechanical strength of these materials varies somewhat with the changes mentioned above but is in general very high in compression, somewhat less than that of standard compositions in tension and bending, and materially lower in shock. The last must be allowed for when designing parts which are to endure violent treatment. The mechanical strength may be increased by alteration of the proportions of the flaked mica filler and the fibrous filler (silk or cotton), without greatly damaging the electrical quality of the material.

The performance in moulding is normal. The usual moulds may be used in the usual presses. Intricate parts have been moulded without incident, inserts behave as usual, and details such as threads on coil-forms or lettering on the piece come-up as usual. Dimensions may be held as closely as with standard compositions.

The dielectric constant is about 5.9 and remains fixed with time. The power factor does not stay constant but for a time decreases slowly.

R-29 can be shaped readily by either wet or dry grinding and takes a good surface under such working. When machined with cutting tools there is some tendency toward chipping unless a light cut is taken. It may be drilled readily and cleanly, and most of the forms used in radio may therefore be produced readily and with entirely satisfactory surface. The color is that of ochre, some variation of shade being possible through alterations of composition and heat treatment during moulding.

A tuned circuit may be improved materially by the use of such an insulation. This can best be shown by examples.

If a tube of the 199 type were to be operated with a

coil shunted by 90 micromicrofarads of tuning capacity we would find results about as follows by merely changing the material of the tube base:

	Normal Bakelite	R-29
Capacity of tube base	1.6 mmfd.	1.1
Equivalent series R in tuned ckt.	5 ohms.	1.5 ohms.

The resistance of the accompanying coil, which was of good design as to form of coil and spool, was about 15 per cent lower when using the R-29 form at 300 meters and about 25 per cent lower when using it at 200 meters.

The tuning condenser is a less promising point of attack. In some of the older designs, using insulating end-plates, the radio-frequency resistance was reduced as much as 10 or 12 ohms by replacing other compositions by the low-loss material. In the newer designs less insulation is used, and it is placed more carefully. As a result the reduction to be expected is frequently not over an ohm.

In typical cases the reduction of equivalent series resistance for the tuned circuit as a whole, for modern tubes and construction, may be expected to fall in the vicinity of 5 to 15 ohms if normal insulations can be replaced by a low-loss material. The value of such an improvement must be judged for each case and a general statement cannot be made.

The requirements of a transmitter are basically the same as those of a receiver but are more severe because of the higher electrical field intensity and necessity for greater mechanical strength. Transmitter construction is such that the insulating members are not necessarily mouldings but may be manufactured conveniently from sheet, rod, and tube.

A molded material with such a combination filler as has been described is applicable to transmitting practice, where "low loss" is equally appreciated.