

Electronics World

MAY, 1971
60 CENTS

NEW SATELLITES TO SERVE MAN
KNOW YOUR ELECTRONIC CHEMICALS
MULTICHANNEL TAPING FOR CLASSICAL RECORDINGS
HI-FI TESTS — Scott 387 Receiver & Sony TA-1144 Amplifier

RECOMMENDED TV ANTENNAS

For Your Particular Area



NOW you can measure resistors accurately

IN CIRCUIT!

in solid state devices



FE20 HI-LO
with hi-voltage probe and large
six-inch meter \$129.50



FE21 HI-LO
with 4 1/2-inch
meter \$99.50

WITH THE NEW HI-LO FIELD EFFECT MULTIMETERS

USES ONLY .08 VOLTS TO POWER OHMMETER TO PREVENT TRANSISTORS FROM CONDUCTING AND UPSETTING READINGS

Look at these extra features to see why the Hi-Lo meter belongs on your want list:

- Unbelievable specifications of 15 megohm input impedance on DC and 12 megohms on AC
- Laboratory accuracy of 1.5 percent on DC and 3 percent on AC
- 9 DC voltage ranges from as low as .1 volts full scale to 1000 volts
- 3 hi-voltage ranges of 3 KV, 10 KV and 30 KV
- 9 DC zero center ranges from .05 volts to 500 volts . . . a must for delicate transistor bias measurements
- 7 resistance ranges from 1000 ohms full scale to 1000 megohms
- 9 DC current ranges from 100 microamps to 1 amp
- Automatic built-in battery test . . . never a worry about rundown batteries, just push the switches under the meter and read.
- Standard .6 amp fuse to protect the ohms and milliamps scales if voltage or overload is accidentally applied. No more need to return the meter to factory for repair . . . just replace the fuse.
- Special probe with 100K isolation resistor in probe to prevent AC pickup or to prevent loading oscillator circuits. Leave in normal position for most tests.

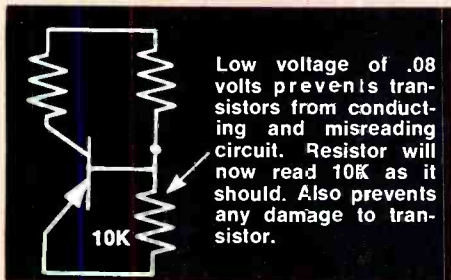

Here is why you should have both Hi and Lo battery voltages for correct in-circuit resistance measurements in solid state circuits:

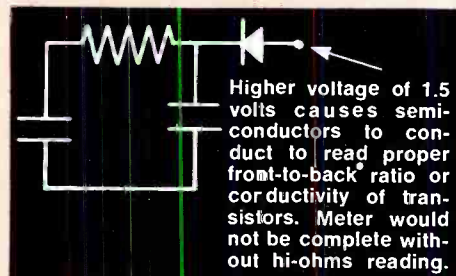

SENCORE INC. 3200 Sencore Drive • Sioux Falls, South Dakota 57107

Another introductory offer to new members of the ELECTRONICS AND CONTROL ENGINEERS' BOOK CLUB

	389/608 PRINCIPLES OF DATA COMMUNICATION by Lucky, Salz and Weldon Pub. price, \$14.50 Club price, \$11.60		347/506 ELECTRONIC DIGITAL TECHNIQUES by P. M. Kinter Pub. price, \$12.50 Club price, \$10.65
	070/636 PROGRAMMER'S GUIDE TO THE IBM SYSTEM/360 by J. H. Bradley Pub. price, \$13.50 Club price, \$11.50		635/099 ELECTRONIC AND RADIO ENGINEERING, 4/e by F. W. Terman Pub. price, \$19.50 Club price, \$16.55
	404/437 SOURCEBOOK OF ELECTRONIC CIRCUITS by J. Markus Pub. price, \$19.75 Club price, \$14.75		313/059 HANDBOOK OF SEMI-CONDUCTOR ELECTRONICS, 3/e by P. Hunter Pub. price, \$27.50 Club price, \$21.50
	259/607 COMMUNICATION SYSTEM ENGINEERING HANDBOOK by D. H. Hamsher Pub. price, \$29.50 Club price, \$22.50		092/32X DIGITAL COMPUTER PRINCIPLES, 2/e by Staff, Technical Training, Burroughs Corp. Pub. price, \$9.95 Club price, \$8.45
	637/377 TRANSISTOR CIRCUIT DESIGN by the Engineering Staff of Texas Instruments, Inc. Pub. price, \$17.50 Club price, \$13.95		124/035 HANDBOOK OF PHYSICS, 2/e by Condon and Odishaw Pub. price, \$34.75 Club price, \$14.95
			494/754 ENGINEERING MANUAL, 2/e by R. H. Perry Pub. price, \$12.50 Club price, \$9.95
			423/814 PULSE, DIGITAL AND SWITCHING WAVEFORMS by Millman and Taub Pub. price, \$18.00 Club price, \$15.30
			570/426 THE NEW ELECTRONICS by B. Shore Pub. price, \$10.00 Club price, \$8.50
			209/731 STANDARD HANDBOOK FOR ELECTRICAL ENGINEERS, 10/e by Fink and Carroll Pub. price, \$32.50 Club price, \$24.95

ANY ONE
of these great professional books
for only \$ **1.00**
VALUES FROM \$9.95 to \$34.75
Special \$1.00 bonus book comes to you with your first club selection

Save time and money by joining the Electronics and Control Engineers' Book Club

HERE is a professional club designed specifically to meet your day-to-day engineering needs by providing practical books in your field on a regular basis at below publisher prices.

How the Club operates: Basic to the Club's service is its publication, the *Electronics and Control Engineers' Book Club Bulletin*, which brings you news of books in your field. Sent to members without cost, it announces and describes in detail the Club's featured book of the month as well as alternate selections which are available at special members' prices.

When you want to examine the Club's feature of the month, you do nothing. The book will be mailed to you as a regular part of your Club service. If you prefer one of the alternate selections—or if you want no book at all for that month—you notify the Club by returning the convenient card enclosed with each *Bulletin*.

As a Club member, you agree only to the purchase of four books over a two-year period. Considering the many books published annually in your field, there will surely be at least four that you would want to own anyway. By joining the Club, you save both money and the trouble of searching for the best books.

MAIL THIS COUPON TODAY

ELECTRONICS AND CONTROL ENGINEERS' BOOK CLUB
582 Princeton Road, Hightstown, N.J. 08520

Please enroll me as a member of the Electronics and Control Engineers' Book Club and send me the two books indicated below. I am to receive the bonus for just \$1.00, and my first selection at the special Club price shown. These books are to be shipped on approval, and I may return them both without cost or further obligation. If I decide to keep the books, I agree to purchase as few as four books during the next two years at special Club prices (at least 15% below list).

Write Code No. of
bonus book
here

Write Code No. of
first selection
here

Name _____

Address _____

City _____

State _____ Zip _____

E 33160

Better attention getter.

When the tea kettle sounds off, you know it.

But the Sonalert® electronic audible signal is even louder. In fact, it blasts out a penetrating 80 db with 14 milliamps of current.

And its solid-state design is compact enough to go anywhere . . . 1½" long, 1¼ ounces light: production machines, computers, appliances, alarm systems. Even as a reminder on cars.

There are models for just about any use: 6 to 250 volts, ac and dc; -20 to 65°C standard temperature . . . wider range available; fixed, pulsating or warbling tone.

Write for our free use and circuit idea booklet (Sound Folder 9-406), it'll help you make a lot of noise. Mallory Distributor Products Co., a division of P. R. Mallory & Co. Inc., Indianapolis, Indiana 46206.

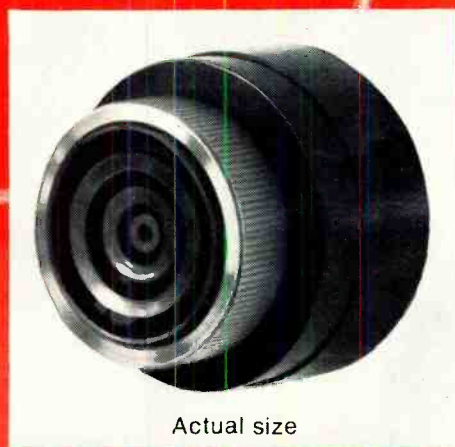

Actual size

MALLORY

MALLORY DISTRIBUTOR PRODUCTS COMPANY

a division of P. R. MALLORY & CO. INC.
Box 1658, Indianapolis, Indiana 46206; Telephone: 317-636-5333

Batteries • Capacitors • Controls • CRIME ALERT® • DURATAPE® Recorders • Resistors • Semiconductors **SONALERT®** Switches • Timers

Electronics World

MAY 1971

VOL. 85, NO. 5

Contents

Electronics World



THIS MONTH'S COVER shows three of the all-channel TV antennas that are discussed in our article "How to Select a TV Antenna." At the top left is Winegard's new outdoor/indoor Sensar antenna, one model of which has a built-in antenna preamp. The large antenna at the center of the cover is Channel Master's Color Crossfire Model 3661 for all-channel fringe-area use. At the bottom right is RCA's Permacolor Model 4BG36, also an all-channel fringe-area antenna. For operating principles and design details on these and other TV antennas, refer to article on page 30.



Publisher

LAWRENCE SPORN

Editor

WM. A. STOCKLIN

Technical Editor

MILTON S. SNITZER

Managing Editor

PRISCILLA B. HOEFER

Contributing Editors

WALTER H. BUCHSBAUM

Prof. ARTHUR H. SEIDMAN

FOREST H. BELT

Art Editor

RICHARD MOSS

Technical Illustrator

J. A. GOLANEK

Advertising Manager

JOSEPH E. HALLORAN

Advertising Service Manager

MARGARET DANIELLO

Associate Publisher

STANLEY NEUFELD

Group Vice President

Electronics & Photographic

FURMAN H. HEBB

May, 1971

27 ERTS—Satellites to Serve Man

The new Earth Resources Technology Satellites, to be launched next year, will help scientists map the earth, catalogue water resources, survey vegetation, to detect water and air pollution, and acquire oceanographic data.

30 Recent Developments in Electronics

32 How to Select a TV Antenna *Forest H. Belt*

There are some real design improvements in the new antennas. Here's what's available to help you pick the best antenna for your particular area. A complete listing of the recommended antennas from 15 manufacturers is included.

33 Recommended Antennas for Various Signal Areas

36 Relaxation Oscillators—Old and New *R.D. Clement & R.L. Starliper*

38 Using Silicon Diode Rectifiers as Power Resistors *John T. Bailey*

39 Spray Chemicals for Servicing *John Frye*

Here are the chemicals that are available to make servicing easier. Included is information on what they do, who makes them, how they are used, precautions.

43 Classical Recording Techniques *Fred Catero*

44 All Those Electronics Chemicals *James Robert Squires*

45 Signal Averaging Techniques *Sidney L. Silver*

When weak signals are buried in noise that can't be filtered out, these methods allow us to recover these signals. The techniques are used in biomedical work, vibration studies for oil exploration, and investigating signals from outer space.

50 Rationale of Troubleshooting *John Frye*

54 Precision Square-Wave Audio Generator *Roy A. Walton*

78 Dynamic Dwell/Tachometer *Jon Colt*

7 EW Lab Tested

Scott 387 AM/Stereo-FM Receiver
Sony TA-1144 Integrated Stereo Amplifier

9 Reader Service Page

76 Test Equipment Product Report

Heath IB-101 Frequency Counter

MONTHLY FEATURES

4 Coming Next Month

20 Letters

13 News Highlights

60 Books

81 New Products & Literature

Copyright © 1971 by Ziff-Davis Publishing Company. All rights reserved

ALWAYS INSIST

ON

CQC*

*CONTROLLED
QUALITY
CRYSTALS

for your Communications

THE

"ON-CHANNEL"

CRYSTALS by

CRYSTEK

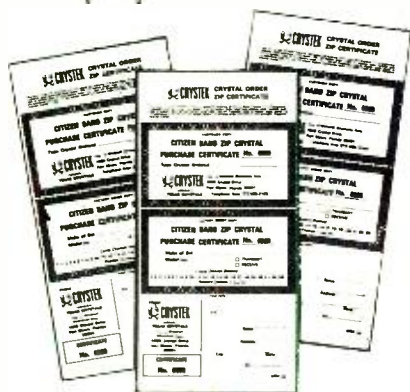

NOW YOU CAN

ZIP-ORDER

THE CQC CRYSTALS YOU WANT

Your electronics dealer has new, fast, direct-factory ZIP-Order Purchase Certificates to enable you to get CRYSTEK CB, Monitor or Amateur Controlled Quality Crystals mailed direct to you promptly. Ask about them.

CRYSTEK
formerly

TEXAS CRYSTALS

Div. Whitehall Electronics Corp.

1000 Crystal Drive Fort Myers, Florida 33901
4117 W. Jefferson Blvd. Los Angeles, California 90016
CIRCLE NO. 57 ON READER SERVICE PAGE

Coming Next Month

Special Feature Article



HIRSCH-HOUCK

LAB TESTS

AUTOMATIC TURNTABLES

If you're looking for just the right turntable for your hi-fi setup, you can't afford to miss Julian Hirsch's findings and comments on currently available models—their technical characteristics and special features. A representative selection of models from BSR, Dual, Garrard, Miracord, Perpetuum-Ebner are included in this important roundup.

Solder & Soldering Tools

The advent of printed circuits, integrated circuits, and all types of semiconductor devices in consumer equipment has changed the way technicians handle repairs. No longer is a high-wattage, chisel-point iron and standard solder the answer to all cases of parts replacement. The newer components call for new equipment and solder formulations and John Frye has the complete story for you in this important and comprehensive article. Don't miss it!

CMOS Logic: Low-Powered & Versatile

Complementary metal-oxide semiconductor IC's, in which both "n" channel and "p" channel MOSFET's are fabricated on a single die, offer new ways of obtaining very-low-power digital circuits. Joseph Wujek discusses units available from RCA, Motorola, Ragen, and Solid-State Scientific.

TV Product-Service Technician

A vocational profile of the "technician's technician" and the man behind a manufacturer's service notes and techniques. Every new chassis receives a "serviceability" check from an experienced technician who helps iron out servicing "bugs" before sets are shipped and sold to consumers. When the set shows up on your service bench—you'll know how to tackle it.

All these and many more interesting and informative articles will be yours in the **June** issue of **ELECTRONICS WORLD** on sale **May 20th**

ZIFF-DAVIS PUBLISHING COMPANY

William Ziff, President
W. Bradford Briggs, Executive Vice President
Hershel B. Sarbin, Senior Vice President and Secretary
Stanley R. Greenfield, Senior Vice President
Philip Sine, Financial Vice President and Treasurer
Walter S. Mills, Jr., Vice President, Circulation
Phillip T. Heffernan, Vice President, Marketing
Frank Pomerantz, Vice President, Creative Services
Arthur W. Butzw, Vice President, Production
Edward D. Muhlfeld, Vice President, Aviation Division
Irwin Robinson, Vice President, Travel Division
George Morrissey, Vice President
Sydney H. Rogers, Vice President

Editorial and Executive Offices
One Park Avenue
New York, New York 10018
212 679-7200

NEW YORK OFFICE
212 679-7200
Joseph E. Halloran, Adv. Mgr.

MIDWESTERN OFFICE
307 North Michigan Avenue
Chicago, Illinois 60601 312 726-0892
George B. Mannion, Jr.

WESTERN OFFICE
9025 Wilshire Boulevard
Beverly Hills, California 90211
213 875-7100
Tokyo 497-1930/6821
Western Advertising Manager, Bud Denn

JAPAN: James Yagi, Oji Palace Aoyama
6-25, Minami Aoyama, 6-Chome, Minato-ku
Tokyo 497-1930/6821

CIRCULATION OFFICE
P.O. Box 1093, Flushing, N.Y. 11352



Member
Audit Bureau of
Circulations

Radio & TV News • Radio News • Radio-Electronic Engineering Trademarks Reg. U.S. Pat. Off.

SUBSCRIPTION SERVICE: Forms 3579 and all subscription correspondence should be addressed to Electronics World, Circulation Department, P.O. Box 1093, Flushing, N.Y. 11352. Please allow at least six weeks for change of address, as well as new—enclosing if possible an address label from a recent issue.
EDITORIAL CONTRIBUTIONS must be accompanied by return postage and will be handled with reasonable care, however publisher assumes no responsibility for return or safety of art work, photographs, or manuscripts.
ELECTRONICS WORLD (May, 1971, Vol. 85, No. 5.) Published monthly at One Park Avenue, New York, New York 10018, by Ziff-Davis Publishing Company—also the publishers of Airline Management and Marketing Including American Aviation, Boeing, Business & Commercial Aviation, Car and Driver, Cycle, Flying, Modern Bride, Popular Electronics, Popular Photography, Skiing, Skiing Area News, Skiing Trade News, Stereo Review, and Travel Weekly. One year subscription rate for U.S., U.S. Possessions, and Canada, \$7.00; all other countries, \$8.00. Second class postage paid at New York, N.Y. and at additional mailing offices. Authorized as second class mail by the Post Office Department, Ottawa, Canada and for payment of postage in cash.

ELECTRONICS WORLD

There is no substitute for training on real electronic equipment.

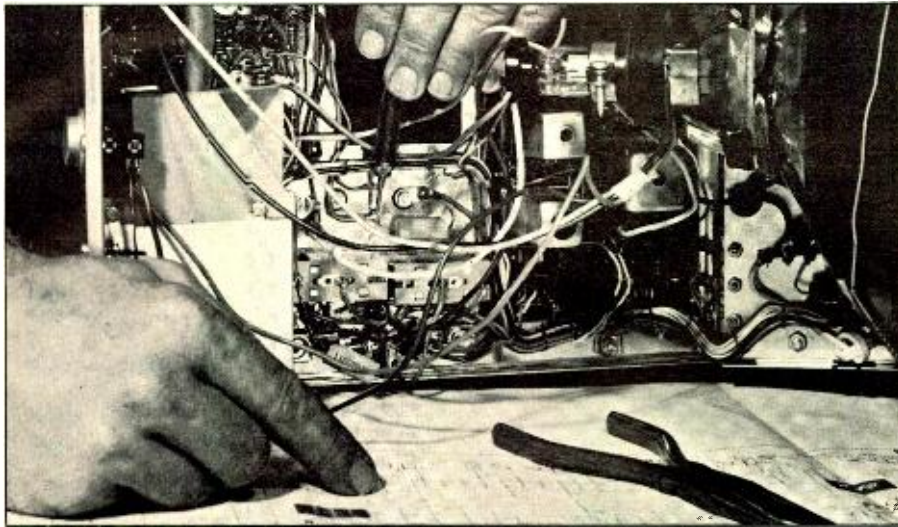

It's just as easy to train on the type of equipment technicians actually use and service.

And it's a lot more practical. Take TV Servicing, for instance.

You'll have it all over the man whose only experience has been on a TV receiver designed strictly for training purposes.

NTS Project-Method courses in Electronics combine the latest, professional equipment with easy-to-grasp lessons, texts and manuals. You build your equipment a stage at a time, and then use the equipment on projects that duplicate actual servicing problems.

It's like getting on-the-job experience at home.

Here's just some of the equipment you get to keep, and what you will learn. You'll get all the details when you receive the NTS full-color catalog.



NTS COLOR AND B&W T.V. SERVICING

You receive a color TV with many unique features, including built-in self-servicing equipment so you can make all normal test operations. You also build an AM-SW radio, solid-state radio, F.E.T. Volt-Ohmmeter, and electronic tube tester. You learn trouble-shooting, hi-fi, multiplex systems, stereo and color TV servicing.

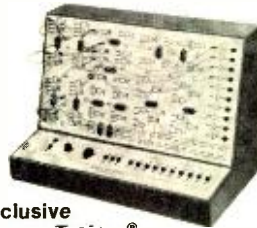

Exclusive Compu-Trainer®

NTS ELECTRONIC & COMPUTER TECHNOLOGY

One of the 10 important kits included is this remarkable Compu-Trainer®—an NTS exclusive. It's a fully operational computer logic trainer—loaded with integrated circuits. It introduces you quickly to the how, what, and why of computers. You also receive a F.E.T. Volt-Ohmmeter and a 5" wide band oscilloscope.

5 watt AM transmitter receiver



NTS ELECTRONICS COMMUNICATIONS AND F.C.C.

Two exciting courses in the big-paying fields of transmitting and receiving. Either one qualifies you for your FCC First Class Radio-Telephone License. NTS assures you will pass this FCC exam within 6 months after successfully completing your course—or your tuition is refunded. You receive 14 kits to build an amateur phone 6 meter VHF transmitter plus NTS' exclusive 6 transistor solid-state radio and a fully transistorized volt-ohmmeter.

5" Oscilloscope



NTS INDUSTRIAL & AUTOMATION ELECTRONICS

Let NTS put you into the age of electronic controls. Systems automation is rapidly becoming the emphasis of modern industry. NTS training equipment includes a 5" wide band oscilloscope. You also get the new exclusive NTS Electro-Lab—a complete workshop. Build five industrial controls to regulate motor speed temperatures, pressure, liquid level and much more.

Solid-state B&W TV 74 sq. in. picture (cabinet included)



The B&W TV receiver features the latest in solid-state circuitry, making your TV training the most modern, most advanced available.

Mail coupon today for free, full-color catalog that details every training program we offer.

No obligation. No salesman will call.



Please rush Free Color Catalog and Sample Lesson, plus information on course checked below. No obligation. No salesman will call.

National Technical Schools

4000 S. Figueroa St., Los Angeles, Calif. 90037

- | | |
|--|--|
| <input type="checkbox"/> Master Course in Color TV Servicing | <input type="checkbox"/> Practical Radio Servicing |
| <input type="checkbox"/> Color TV Servicing (For advanced Technicians) | <input type="checkbox"/> FCC License Course |
| <input type="checkbox"/> Master Course in B&W TV & Radio Servicing | <input type="checkbox"/> Master Course in Electronics Technology |
| <input type="checkbox"/> Master Course in Electronics Communications | <input type="checkbox"/> Industrial and Automation Electronics |
| | <input type="checkbox"/> Computer Electronics |
| | <input type="checkbox"/> Basic Electronics |

Dept. 240-051

Name _____ Age _____

Address _____

City _____ State _____ Zip _____

- Check if interested in Veteran Training under new G.I. Bill. Check if interested only in Classroom Training at Los Angeles.

CLASSROOM TRAINING AT LOS ANGELES

You can take classroom training at Los Angeles in sunny Southern California. NTS occupies a city block with over a million dollars in facilities devoted exclusively to technical training. Check box in coupon.

APPROVED FOR VETERANS

Accredited Member: National Association of Trade & Technical Schools; National Home Study Council.

NATIONAL TECHNICAL SCHOOLS

World-wide training since 1905

4000 S. Figueroa St., Los Angeles, Calif. 90037

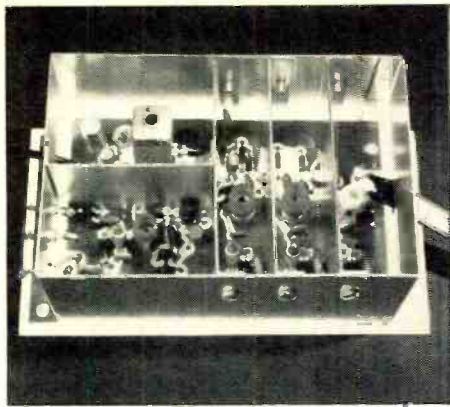

It's the only receiver with the Varitronik™ FM tuner—with 4 FET's and balanced Varicap tuning for lower distortion and for higher sensitivity. By using 4 FET's instead of ordinary bi-polar transistors, cross modulation problems are virtually eliminated. And by using 4 double Varicaps instead of a conventional mechanical tuning capacitor, a better balanced circuit performance is achieved with perfect linear tracking. The 725A's FM tuner also uses a combination of Butterworth and crystal filters for better selectivity and stereo separation. And, it features an advanced muting circuit with full muting at 2.5 μ V for quiet tuning without loss of stations. Specifically, here's how the new Altec 725A receiver performs. Harmonic distortion is a low 0.3%, IHF sensitivity is 1.8 μ V and capture ratio is 1.3 dB.

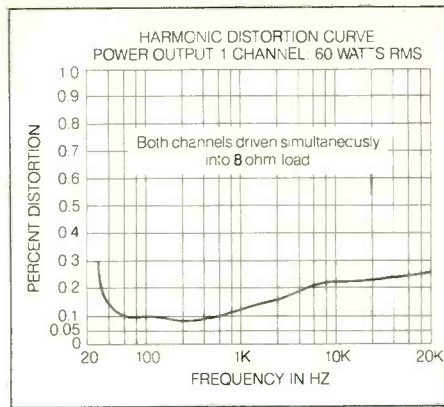

Altec's new 725A AM/FM stereo receiver gives you 60/60 watts of RMS continuous power. The 60 watts of power per channel you hear with the new Altec 725A receiver is not IHF music power at 4 ohms for just an instant. It's not music power (plus or minus 1 dB) either. And it's not peak power, or EIA power or any other rating. Instead, it's 60 watts of RMS continuous power per channel with both channels driven simultaneously at 8 ohms from 30 to 20,000 Hz—rated in the same manner used exclusively by the professional audio field and by quality testing labs. With this much power you hear clean, accurate sounds at all frequencies from even the lowest efficiency speakers. And you always have enough power in reserve to hear that extra-low bass.

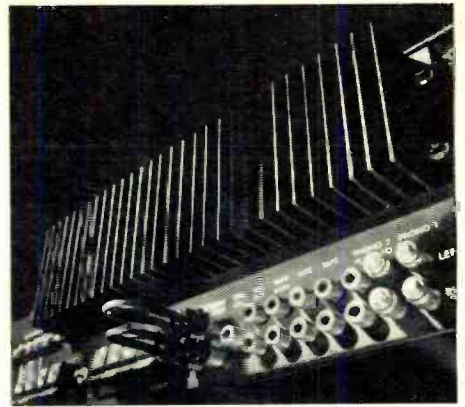

And it includes many extra features to make it the most versatile receiver on the market. The new Altec 725A receiver includes a long list of standard features like 2 separate tuning meters, spring-loaded speaker terminals, and 100 percent modular construction. In addition, it includes these "extras" for more versatility and convenience.

- Pushbutton controls for stereo reverse, mono L & R, low and high filter.
- Indicator lights on all functions — AM, FM, phono 1 & phono 2, tape, auxiliary, tape monitor and FM stereo.
- Tape recorder input & output on front panel.
- A heavy-duty fluted aluminum heat sink.
- Accessory jacks for the Altec Acoustavoicette Stereo Equalizer.

Altec's new 725A AM/FM stereo receiver sells for \$699.00. It's built a little better than anything else you can buy. Hear it at your Altec dealers. Or, write for a new, complete 25-page catalog: Altec Lansing, 1515 S. Manchester Ave., Anaheim, CA 92803.

Built a little better.



A QUALITY COMPANY OF LTV LING ALTEC, INC.

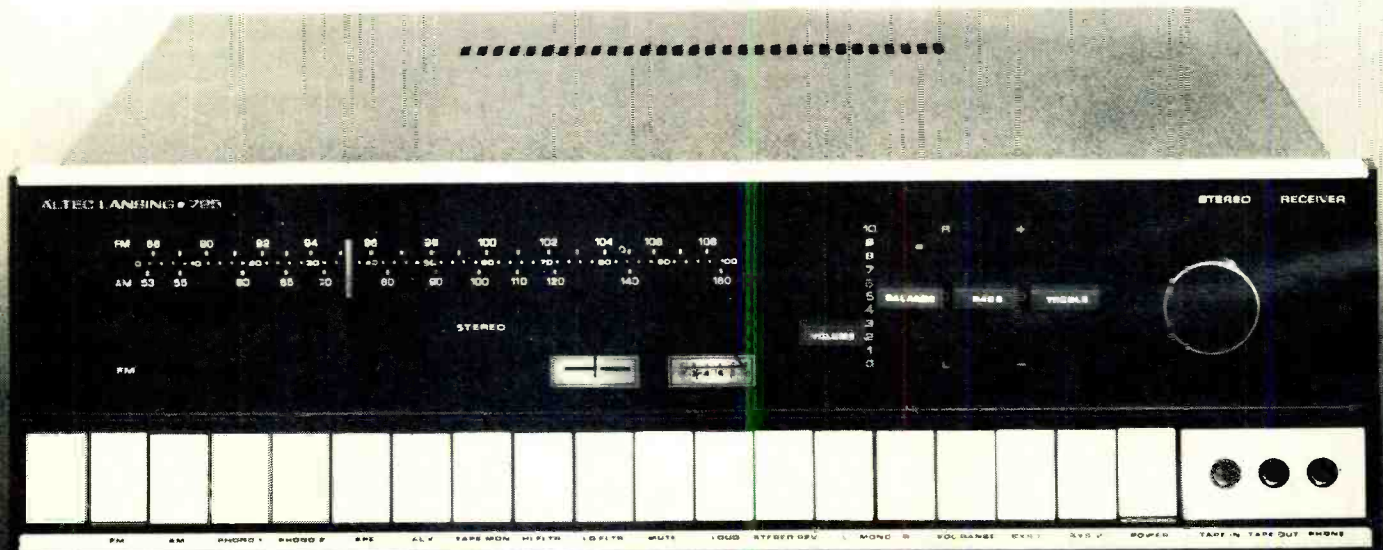

Altec's new 725A receiver. It's built a little better.

CIRCLE NO. 50 ON READER SERVICE PAGE

HI-FI PRODUCT REPORT

EW LAB TESTED

by Hirsch-Houck Labs

Scott 387 AM/Stereo-FM Receiver
For copy of manufacturer's brochure,
circle No. 1 on Reader Service Page.



THE new Scott 387 AM/stereo-FM receiver is rated at 55 watts per channel continuous output into 8-ohm loads. This is one of the most powerful amplifiers ever offered in an integrated receiver, backed up by an electronic short-circuit protection system. The FM-tuner section employs IC's in its i.f. and multiplex sections, plus a six-pole crystal filter that provides excellent selectivity as well as permanent FM alignment. Correct FM tuning is indicated by the lighting up of the word "Perfectune" next to the large, multi-color slide-rule dial (which blacks out when the receiver is off). The IC differential amplifier that operates the Perfectune lamp senses the correct tuning point more accurately than is normally possible with a zero-center tuning meter. An illuminated signal-strength meter helps in orienting an FM antenna and serves as an AM tuning indicator. The AM i.f. amplifier also uses an IC and has a fixed filter, rather than an i.f. transformer—two rather unusual features.

High-reliability wire-wrap connections are used throughout, and all the active circuits are on eight plug-in printed-circuit boards. Authorized Scott service centers can rapidly substitute a correctly operating board for a defective one, should the need arise. This is the basis for the "Modutron" service policy—free parts and labor for two years and a nominal exchange cost of \$10 per module at any later time.

The front panel has a full array of controls, including separate concentric bass and treble controls for the two chan-

Scott 387 AM/Stereo-FM Receiver Sony TA-1144 Integrated Stereo Amplifier

nels, plus loudness and balance controls. In addition to FM, AM, phono, and a high-level Extra input, the 387 has rear-panel jacks that will accept a pair of dynamic microphones. A pair of front-panel tape-in and tape-out jacks parallel those in the rear. A row of push-on, push-off buttons controls the two sets of speaker outputs, FM interstation-noise muting, high-cut filter, mono/stereo mode, tape monitoring, and loudness compensation. There is also a front-panel stereo headphone jack. In the rear, besides all the expected inputs and outputs (including the usual 300-ohm antenna terminals), there is a jack intended for a 75-ohm low-impedance coaxial cable. There is also a two-position phono sensitivity switch.

The receiver measures 17½ × 15 × 5½ inches, including knobs and the AM rod antenna. It is supplied with a black metal cover, and weighs 26½ pounds. The recently downward revised price is \$399.95.

Laboratory Measurements

The audio amplifiers delivered 67 watts per channel at the clipping point (both channels driven) into 8-ohm loads with a 1000-Hz test signal. Into 4 ohms, the output was 100 watts per channel, and into 16 ohms it was 39.5 watts. The harmonic distortion at 1000 Hz was below 0.1 percent from 1 to 60 watts and under 0.25 percent from 0.1 watt to 65 watts. The IM distortion was well below 0.5 percent from 0.1 watt to 65 watts. At the rated 55-watt output, the distortion was under 0.5 percent from 25 to 20,000 Hz, and less than 0.2 percent over most of that range. At lower power levels, the distortion was slightly less.

At frequencies below 1000 Hz, our measurements were affected by 120-Hz power-supply ripple, which increased (but remained inaudible) at higher power levels. (Above 1000 Hz, a filter in our distortion analyzer was able to remove these components, permitting an accurate distortion measurement.) The actual harmonic distortion at lower frequencies was typically a small fraction of the measured values, but could not readily be isolated from the ripple, which, it should be repeated, remained inaudible throughout.

The tone controls and loudness compensation had conventional characteristics. The high-cut filter introduced a 6-dB/octave slope beginning at 2000 Hz, which effectively

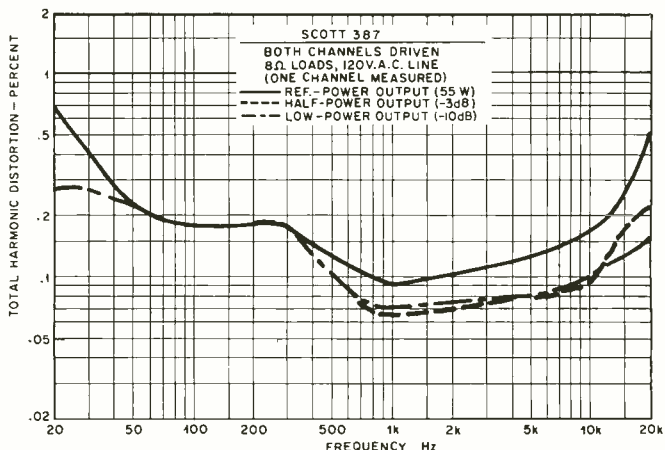
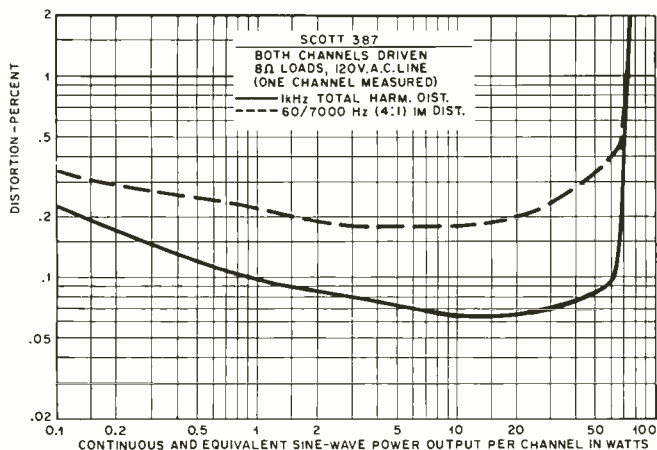

gave FM and phono programs an "AM" quality. At the phono input, 1.5 or 3 millivolts (depending on the setting of the phono-sensitivity switch) was needed for 10 watts output. Since the corresponding overload levels were 29 and 58 millivolts, the receiver can handle the output of any modern phono cartridge without overload distortion. The noise was 70 dB below 10 watts on the high-level Extra input, and 68 dB below 10 watts on high-gain phono input.

FM usable sensitivity (IHF) was 2 microvolts, with limiting complete at 4 microvolts. FM distortion was 0.62 percent at full signal. The ultimate quieting was 70 dB below full modulation, and the AM rejection was 66 dB. The image rejection was 60 dB. All these figures essentially met or surpassed Scott's excellent specifications. FM stereo separation was very uniform over a wide frequency range: about 30 dB from 100 to 3000 Hz, and better than 20 dB from 30 to 15,000 Hz. A highly effective low-pass filter in the multiplex outputs removed 18-kHz and higher frequency signal components while maintaining FM frequency response within ± 0.5 dB from 30 to 15,000 Hz. The Perfectune indication exactly corresponded to correct tuning for minimum distortion and optimum stereo separation. The FM interstation-noise muting was excellent, operating with a slight, positive "click," but without noise bursts.

Use Tests

Although most of the design features of the 387 can be found in other receivers, and one would not expect any obvious audible advantages from most of them, in this case the total effect seemed to exceed the sum of its parts. Everything felt right and worked right, from the noncritical tuning, aided by the Perfectune indicator (which we judge to be a real convenience rather than a mere gimmick), to the transparently clean sound from FM or other program source at any listening level we could tolerate.

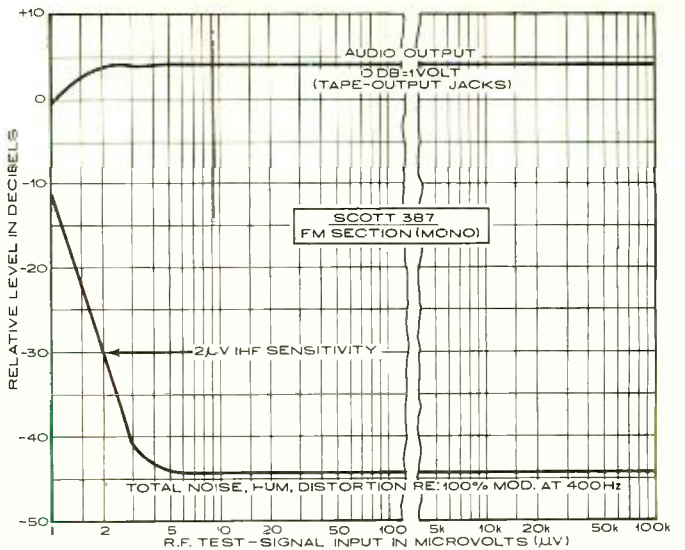

The unit delivered distortion-free FM reception from signals too weak to move its meter, yet most of the forty-odd stations we picked up on a single sweep of the dial drove the meter pointer nearly to the top of the scale. The AM performance was adequate, with pleasant sound quality and no whistles or "birdies," but it did not approach the tonal quality available on FM.

It is really quite difficult to single out any one aspect of the receiver's performance for special mention. It did a thoroughly fine job in all respects, which suggests that the combination of many small improvements can lead to a genuinely outstanding final product. Most users will probably never be aware of the design effort that has gone into the Scott 387, but the results speak for themselves. ▲

Sony TA-1144 Integrated Stereo Amplifier

For copy of manufacturer's brochure, circle No. 2 on Reader Service Page.

THE new Sony TA-1144 integrated stereo amplifier differs from the company's previous models in styling and in much of its circuitry. The pale gold satin finish used on other Sony components has been replaced by a two-tone panel, whose silver-colored satin finish contrasts with its charcoal-gray borders and center section.

In its control flexibility and over-all caliber of performance, the TA-1144 closely resembled the company's much more expensive TA-1120A. A large volume-control knob dominates the center section of the panel, flanked by the two bass tone-control levers on the left and the two treble tone-control levers on the right. Each channel has its own

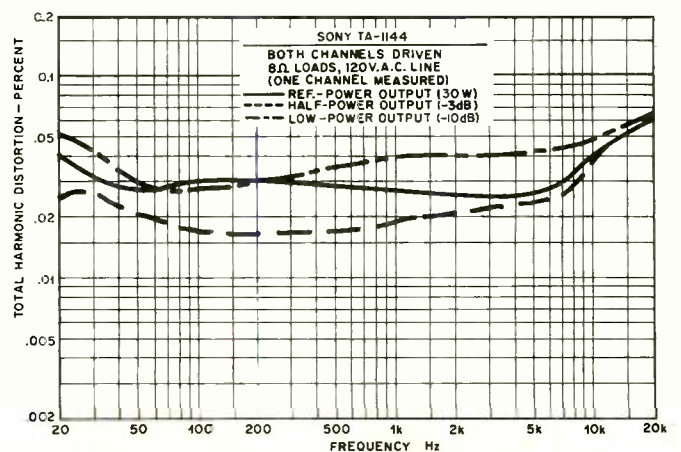
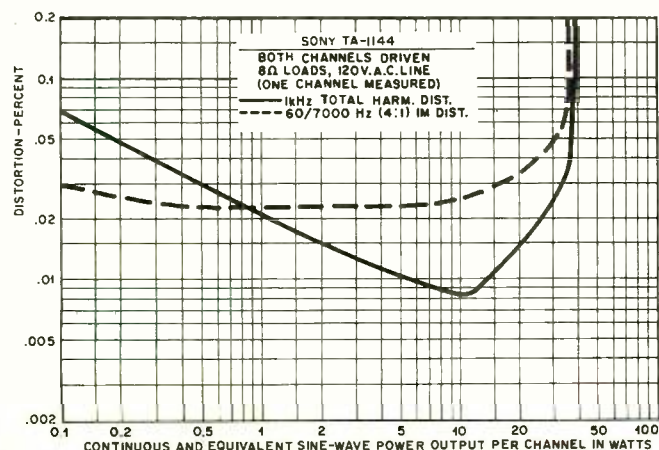
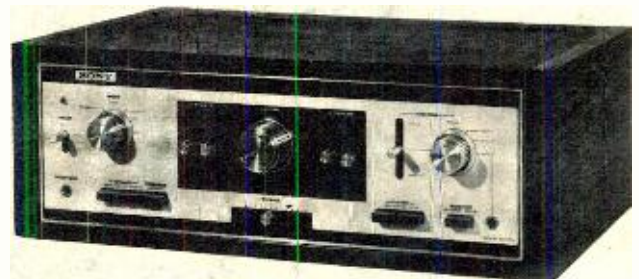

Electronics World

READER SERVICE PAGE

FREE INFORMATION SERVICE!

Here's an easy and convenient way for and to get additional information about products advertised or mentioned editorially (if it has a "Reader Service Number") in this issue. Just follow the directions below . . . and the material will be sent to you promptly free of charge.

1 On coupon below, circle the number(s) that correspond(s) to the key number(s) at the bottom or next to the advertisement or editorial mention that is of interest to you. (Key numbers for advertised products also appear in the Advertisers' Index.) Print or type your name and address on the lines indicated.

2 Cut out the coupon and mail it to:
Electronics World,
P.O. Box 7842,
Philadelphia, Pa.
19101

NOTE:

If you want to write to the editors of ELECTRONICS WORLD about an article on any subject that does not have a key number, write to ELECTRONICS WORLD, One Park Avenue, New York, N.Y. 10016. Inquiries concerning circulation and subscriptions should be sent to ELECTRONICS WORLD, P.O. Box 1093, Flushing, N.Y. 11352

Electronics World Void 60 days after date of issue 571
P.O. Box 7842
Philadelphia, Pa. 19101

1	2	3	4	5	6	7	8	9	10	11	12	13	14	15	16	17	18	19	20	21	22	23	24	25
26	27	28	29	30	31	32	33	34	35	36	37	38	39	40	41	42	43	44	45	46	47	48	49	50
51	52	53	54	55	56	57	58	59	60	61	62	63	64	65	66	67	68	69	70	71	72	73	74	75
76	77	78	79	80	81	82	83	84	85	86	87	88	89	90	91	92	93	94	95	96	97	98	99	100
101	102	103	104	105	106	107	108	109	110	111	112	113	114	115	116	117	118	119	120	121	122	123	124	125
126	127	128	129	130	131	132	133	134	135	136	137	138	139	140	141	142	143	144	145	146	147	148	149	150

Name (Print Clearly) _____ Title _____
Company Name _____
Address _____
City _____ State _____ Zip Code _____
na

Electronics World Void 60 days after date of issue 571
P.O. Box 7842
Philadelphia, Pa. 19101

1	2	3	4	5	6	7	8	9	10	11	12	13	14	15	16	17	18	19	20	21	22	23	24	25
26	27	28	29	30	31	32	33	34	35	36	37	38	39	40	41	42	43	44	45	46	47	48	49	50
51	52	53	54	55	56	57	58	59	60	61	62	63	64	65	66	67	68	69	70	71	72	73	74	75
76	77	78	79	80	81	82	83	84	85	86	87	88	89	90	91	92	93	94	95	96	97	98	99	100
101	102	103	104	105	106	107	108	109	110	111	112	113	114	115	116	117	118	119	120	121	122	123	124	125
126	127	128	129	130	131	132	133	134	135	136	137	138	139	140	141	142	143	144	145	146	147	148	149	150

Name (Print Clearly) _____ Title _____
Company Name _____
Address _____
City _____ State _____ Zip Code _____
nb

STUDIO MONITOR AMPLIFIERS

by

Crown

D40



compact

delivers 40w RMS/channel at 4 Ω
takes 1 3/4" rack space, weighs 8 1/2 lbs.
IM distortion less than 0.3% from
1/10w to 30w at 8 Ω
S/N 100dB below 30w output
price - \$229 rack mount

D150



universal

delivers 150w RMS both channels 8 Ω
IM distortion less than 0.1% from
1/10w to 75w at 8 Ω
S/N 100dB below 75w output
takes 5 1/4" rack space, weighs 20 lbs.
price - \$429 rack mount

DC 300



power

delivers 300w RMS/channel at 4 Ω
IM distortion less than 0.1% from
1/10w to 150w at 8 Ω
S/N 100dB below 150w output at 8 Ω
Lab Standard performance and
reliability
price - \$685 rack mount

All Crown amplifiers are warranted 3 years for parts and labor. They are 100% American-made to professional quality standards. All are fully protected against shorts, mismatch and open circuits. Construction is industrial grade for years of continuous operation.

Crown®

BOX 1000, ELKHART, INDIANA 46514, U.S.A.
CIRCLE NO. 56 ON READER SERVICE PAGE

10

tone controls. They are vertically oriented sliders, with light but positive detents, offering five boost and five cut positions, a center flat setting.

The input selector is the dual type used on many other of the company's audio components and receivers. A three-position vertical lever switch selects Tuner or Phono 1 in its top and bottom positions; in the center, the input source is selected by the knob to the right of the lever switch. It has a second Phono position, two high-level Aux inputs whose jacks are in the rear of the amplifier, and a third Aux input through a front-panel stereo headphone jack. This method of input selection is very convenient to use, since the three most commonly used program sources can be controlled by the three-position lever switch.

To the left of the center panel section is the Mode selector, with provisions for normal and reversed-channel stereo, mono, or either channel input played through both outputs. At the far left of the panel are the pilot light and stereo headphone jack.

Beneath the volume control is the balance control, a horizontal slider potentiometer. Six push-button switches along the bottom of the panel control the two speaker outputs, loudness compensation, high- and low-cut filters, and tape-monitoring functions.

In the rear of the TA-1144, in addition to all the usual input and output jacks, there is a DIN connector for making a single cable connection to a suitably equipped tape recorder (most Japanese and European recorders are so equipped). The preamplifier outputs and power amplifier inputs are brought out to separate jacks, with internal bridging between them. A slide switch in the rear breaks this connection so that the preamplifier outputs can be fed to an external electronic crossover system, equalizer, or similar accessory, and its outputs returned to drive the power amplifiers of the TA-1144.

The amplifier is conservatively rated at 30 watts per channel. We found that it delivered 41 watts per channel to 8-ohm loads at the clipping point, with both channels driven at 1000 Hz. Into 4-ohm load impedances, the output was slightly less (38.5 watts), and into 16 ohms output was 25.5 W.

The amplifier uses direct-coupled complementary-symmetry output stages with no output blocking capacitors to limit low-frequency response or speaker damping. Apparently this new amplifier design has other benefits, since we found the distortion of the TA-1144 so low that most conventional distortion analyzers would be unable to measure it. At 1000 Hz, the harmonic distortion was below the noise level at 0.1 watt and did not exceed 0.07% up

to about 36-watts output. Between 1.2 watts and 25 watts the distortion was less than 0.02% and reached a minimum of 0.0086% at 10 watts. IM distortion was very low, under 0.03% from 0.1 to 15 watts, reaching only 0.05% at rated 30-watts output.

Unlike many other amplifiers, the TA-1144 maintains this kind of performance over the full audio-frequency range. At full rated power, or any lower power, the harmonic distortion was under 0.06% from 20 Hz to 20 kHz.

The amplifier could be driven to 10-watts output by a signal of 54 millivolts (Aux) or 0.44 millivolt (Phono). The noise was 72 dB and 68 dB below 10 watts on the two inputs and, needless to say, was quite inaudible. The phono inputs had a very high dynamic range, with 100-millivolts input required to overload them. The preamplifier output (at the rear jacks) did not clip until 9 volts was reached, and the power amplifier required less than 1 volt for full output. In other words, the preamplifier section of the TA-1144 cannot limit its performance in any way. Its output impedance was fairly low, also—a shunt capacitance of 600 pF reduced the 20 kHz output by only 1 dB.

The amplifier frequency response was flat within ± 0.5 dB from 20 Hz to 20 KHz. The filters had cut-off frequencies of 60 Hz and 6 kHz with 6 dB/octave slopes. The RIAA equalization was accurate within ± 0.75 dB from 30 Hz to 15 kHz.

The tone-control characteristics were unusual, and very effective. The first few steps of the bass control affected only frequencies below 100 Hz, with the inflection point moving up to 200 Hz and 300 Hz on the two highest steps. The common deficiencies of most speakers at the lower frequencies can be effectively equalized with this control, without paying the price of lower mid-range "boom."

The treble controls had a very different characteristic, with a "shelved" response affecting all frequencies above about 2 or 3 kHz equally, except at the extremes of the control where the response was sloped like that of most tone controls.

A comparison is inevitable between the TA-1144 and Sony's top-of-the-line amplifier, the TA-1120A, if only because they share so many features and have exceptional performance characteristics. The TA-1144 has about 40 to 50% less power than the TA-1120A, with comparable distortion levels and almost identical control functions. Since it sells for less than half the price of the TA-1120A, it is clearly a real bargain for anyone who wants state-of-the-art performance in a moderately priced integrated amplifier. The Sony TA-1144 integrated stereo amplifier sells for \$219.50. ▲

ELECTRONICS WORLD

FINCO

70 SERIES
COLOR
SPECTRUM
TV ANTENNAS

NO VHF VHF STRONG VHF MODERATE VHF WEAK VHF VERY WEAK

All Prices Subject to Change	70-V11 \$26.95	70-V17 \$39.95	70-V14 \$34.95	70-V20 \$49.95	70-V35 \$94.95	70-V28 \$74.95
------------------------------	-------------------	-------------------	-------------------	-------------------	-------------------	-------------------

CS-U1 \$12.05	70-12A \$39.95	70-18A \$56.95	70-23A \$73.95	70-23A \$73.95
------------------	-------------------	-------------------	-------------------	-------------------

CS-U2 \$18.35	70-12B \$44.95	70-18B \$62.95	70-23B \$80.95	70-29B \$100.00
------------------	-------------------	-------------------	-------------------	--------------------

CS-U3 \$26.40	70-18B \$62.95	70-18B \$62.95	70-23B \$80.95	70-29B \$100.00
------------------	-------------------	-------------------	-------------------	--------------------

Select the antenna for your area from this chart

The set choice is yours...
the antenna choice is **FINCO**

Send for free Catalog. 20-556

NAME _____

ADDRESS _____

CITY _____ STATE _____ ZIP _____



THE FINNEY COMPANY
34 West Interstate St., Dept.
Bedford, Ohio 44146

NOTE: Each model above is also available with 75 ohm coaxial cable downlead and compact behind-the-set balun-splitter to match antenna system to proper set terminals.

With Sylvania's 3 lines of color tubes, you can meet it. Customers' wallets come in different sizes. Thick, thin and in-between.

With Sylvania's 3 complete families of replacement color picture tubes, you can be sure of having the right-priced tube for each one.

At the top end of the line, you've got the *color bright 85[®]XR*, the tube with our brightest phosphors and X-ray inhibiting glass.

And in the middle, you have the *color bright 85[®]RE*. This is the tube that brought color TV out of the dark ages. Its bright rare-earth phosphors still

make it *the* tube to watch.

For economy, there is the *color screen 85* family of replacement tubes. But, economy doesn't mean cheap construction. You can still give your customer features like Sylvania's Sharp-Spot electron gun and a rare-earth phosphor screen without breaking his budget.

When you sell Sylvania, you're selling from the broadest line in the industry. You'll have the tube to match the set.

And a price to match the wallet.

SYLVANIA
GENERAL TELEPHONE & ELECTRONICS
CIRCLE NO. 85 ON READER SERVICE PAGE

Every man has his price.





NEWS HIGHLIGHTS

Engineering Salaries Up Along With Unemployment

The salaries of engineers who are still employed increased by almost 5% annually between 1968 and 1970. The increase was apparent at all levels of experience, in all areas of employment, and at all degree levels. The results are almost exactly what would have been anticipated in the absence of the current economic slump, but, of course, since there are fewer engineers employed, the total salaries paid is down considerably. Half of the 230,000 engineering graduates surveyed by Engineers Joint Council earned more and half earned less than the median of \$15,550. One-tenth of the engineers had salaries higher than \$22,750.

Enrollments in the nation's engineering colleges were lower this year in practically all classes, presaging a smaller number of graduates in 1971. The greatest drop was in part-time doctoral candidates. No doubt enrollments will continue to fall in the next few years unless the nation can find more ways to use the technical skills of the engineer.

A final note on the unemployment situation is that the U.S. Dept. of Labor has deleted all areas of engineering, including electronic and electrical, from the list of occupations for which preferences in immigration are granted because of U.S. manpower shortages. This means that would-be engineering immigrants must now present evidence of a U.S. job before being issued a visa.

Yes, It Was a Tough Year for Consumer Electronics

Now that the final year-end figures are in from the Electronic Industries Association on domestic-label distributor sales to dealers of TV sets, radios, and phonos, we can see how bad the last year's slump really was. For 1970, color-TV set sales were down 12.7% compared to 1969, black-and-white TV set sales were down 8.6%. Home radio sales were down 17.8%, while auto radios were down 19.6%. Portable and table phonos were down 18.7%, and console phonos were down 20%. At this time, we haven't seen figures on the imports as yet. One bright note however is that year-end sales were beginning to inch up, so that we are hopeful that 1971 should be a slightly better year for consumer electronics.

The Quiet Revolution in Communications Satellites

Without too much fanfare a new generation of commercial communications satellites has been successfully launched. By the time this column appears, the first in a series of eight Intelsat 4 satellites should be in service over the Atlantic. The new satellite is able to transmit as many as 9000 simultaneous transoceanic telephone messages. The first Early Bird satellite in 1965 could only handle 240 while the present Intelsat 3 handles only 1200 phone calls. Intelsat 4 can also carry up to 12 simultaneous color telecasts, or a mixture of TV, telephone, and data channels. The \$13.5-million spacecraft was launched by NASA for Comsat and its 76 partner nations. The consortium paid \$16-million to NASA for the successful launch. Two more Intelsat 4 launchings are scheduled for later this year.

Quote of the Month

Addressing the Poor Richard Club as the recipient of its 1971 Gold Medal award for distinguished service to the fields of information and communications, RCA Chairman and President Robert W. Sarnoff said: "Let us not confuse this ground swell of popular concern with the perennial clamor of those few malcontents who always seek the Holy Grail at a discount, with optional extras. Current consumer unrest is rooted in both real and imagined offenses in the form of overstated claims, poor service, inflated charges, and neglected consumer needs."

TV Blackout in New York

At about 7:15 p.m. on February 7th, a lot of New Yorkers who had been watching TV started looking up the phone numbers of their local TV technicians. Others began checking their antennas or looking into their TV front-ends. What happened was that all New York City's local TV stations (and many FM stations) suddenly went off the air due to a power failure in the Empire State Building, where all the transmitters and antennas are located. The local utility company, *Con Edison*, had been just barely keeping up with the

demand for electricity by cutting its output voltage by 5 to 8% when things got too tight. It turned out that a big circuit-breaker relay had "exploded" open (a workman said), cutting off a high-voltage distribution transformer that was supplying parts of the mid-town area.

The problem was solved at about 10:30 p.m. when power began to be restored and the TV stations started coming back on the air. Full power was restored before midnight. The utility company could not guarantee that the same thing wouldn't happen again, especially when demand for electricity will be even greater in the summer. Most people learned about the blackout over their transistor radios, since AM broadcasters were not affected. Manhattan's cable-TV systems also continued to operate during the partial blackout.

Noise Pollution in the Kitchen

A just-completed study of "The Auditory Environment in the Home" showed that our homes are noisier than we think. For example, sound-pressure levels measured in kitchens for such appliances as range-vent fans, blenders, dishwashers, mixers, knife sharpeners, and garbage disposers, were up in the 70-90-dB range. According to the report, the annoyance threshold for intermittent sounds is between 75 and 85 dB at which level involuntary nervous responses begin to narrow the arteries, raise blood pressure, and reduce supply of blood to the heart.

Investigators strongly urged manufacturers of household appliances to design equipment whose noise level does not exceed 65 dB. We know a number of housewives who would be willing to pay a little more for their kitchen helpers if they weren't so noisy. The study was conducted by the Environmental Design Department of the University of Wisconsin under the sponsorship of stereo-headphone manufacturer *Koss Electronics*. Perhaps the housewife should wear a set of headphones while working in the kitchen.

Early Warning Fire Detector Uses Atomic Energy

A tiny bit of radioactive americium is being used in an early warning fire detector that can set off an alarm long before there are visible flames or even smoke. Early products of combustion, which are entirely invisible, are all that are needed. The detector, manufactured by *Pyrotronics Inc.* (Cedar Knolls, N. J.), consists of an ionization chamber with two electrodes to which a voltage is applied. Normally the radioactive material emits *alpha* particles which ionize the air between the electrodes and cause a small current to flow. When tiny invisible, micron-sized particles of combustion products enter the chamber, the ions are slowed down and current flow is reduced. This drop in current (effectively an increase in resistance and resultant voltage drop) is used to trigger a special cold-cathode gas tube which then actuates a relay to sound an alarm. In a recent demonstration we saw, overheated resistors and power wiring set off the alarm in a matter of seconds long before there was any evidence of a fire.

Upcoming Electronics Shows

Moving to one of the warmer sections of the country is the National Electronics Week (NEW) show for electronics manufacturers who sell through parts distributors, as well as dealers and reps. The show will be held on June 3-5 at the Americana Hotel in Bal Harbour, Florida. Space has been assigned to 152 companies who will occupy 175 booths and 37 conference suites.

The fifth annual Consumer Electronics Show, where manufacturers will introduce their new consumer electronics lines of TV's, radios, and hi-fi equipment to the nation's retailers, will be open to the trade on June 27-30. Location is the new McCormick Place in Chicago. Over 250 exhibitors are expected to show their wares.

Electronic Flashes

GTE filed with the FCC proposal for a domestic satellite communications system. The company would build four earth stations interconnected by a satellite 22,300 miles over equator. Eight microwave radio channels would be leased, providing total capacity of 10,560 voice-grade circuits or eight TV circuits. . . . The U.S. computer industry will achieve a 17-percent growth in total revenue when all the 1970 figures are in, according to *International Data Corp.*, a computer-industry research firm. Percentages of 1970 shipments are estimated as: *IBM* 65.4%, *Honeywell* (inc. *GE*) 8.9%, *Burroughs* 6.4%, *Univac* (*Sperry Rand*) 5.3%, *National Cash Register* 4.3%, *RCA* 3.3%, *Control Data* 3.0%, *Digital Equipment* 1.4%, and *Xerox* 0.8%. . . . Sales of recorded stereo tapes will continue to grow at a faster rate than phonograph record sales and will make up a third of all U.S. recorded music sales in 1971, according to *Amplex*. . . . A survey from Fordham University says that by the time the average student graduates from high school he will have spent 15,000 hours at home watching TV, yet he will have been in school only 10,800 hours. ▲

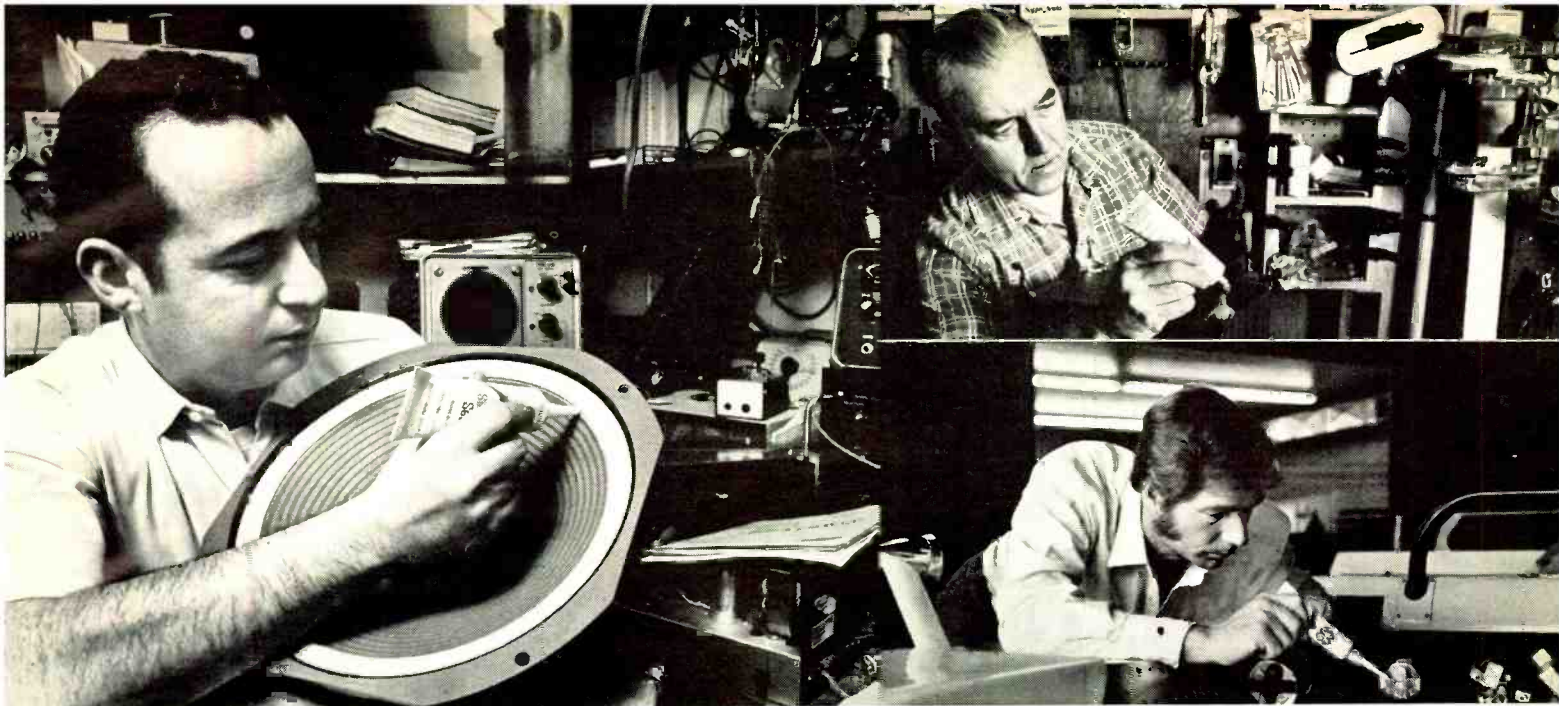

Larry Steckler
Editor
Radio-Electronics

Wayne C. Leckey (Top)
Home and Shop Editor
Popular Mechanics

Jim Hall
Designer of the
Chaparral 2J, world's
most advanced racing car

Match wits with the experts and win a \$1000 shopping spree.

Three top pros challenge you to come up with an imaginative use for General Electric Silicone Seal or Silicone Lubricant. Something they may not have thought of.

Using the seal, electronics expert Larry Steckler repaired a speaker cone, and sealed an antenna lead-in feedthrough and outdoor antenna terminals. With the lube, he sprayed telescoping auto and TV antennas, a record changer mechanism and slide, and an antenna rotator.

With the sealant, home-and-shop expert Wayne C. Leckey dabbed rubber "feet" onto a trinket chest, sealed a rain gutter and caulked a bathtub. With the lube, he sprayed a fishing reel, some stuck drawers and all of his tools.

On his Chaparral 2J, Jim Hall used Silicone Seal to make formed-in-place gaskets, to seal all electrical connections, and as an adhesive to hold components to the body. Then he spray-lubed the throttle linkage, suspension ball joints, wheel lugs and battery terminals.

Now here's what you can do: send in another use for either product, different from those mentioned above, and enter our sweepstakes. (To win, all you *must* do is fill in your name and address and the name and address of the store where you saw GE Silicone Seal and GE Silicone Lubricant on display.)

Grand Prize: \$1000 worth of anything from your favorite store carrying GE Silicone Seal and GE Silicone Lubricant. Next 100 prizes: \$25 worth each. Next 1000 prizes: one-year subscriptions (or renewals) to the magazines from which you clip your official entry blank.

GE Silicone Seal: The most reliable adhesive/sealant/insulator/moisture-proofer/instant rubber. Guaranteed for 10 years. Ignores temperatures from -60°F . to 500°F . Won't harden, soften, crack or shrink. Ever. Dab it on, overnight it becomes a strong, flexible, permanent rubber. In white, black, clear and metallic. In 3-oz. tubes and 12-oz. cartridges.

GE Silicone Lubricant: The slipperiest stuff in a can. Longest wearing, strongest moisture resister, best corrosion fighter. Age, water and temperature (-70°F to 400°F) can't hurt it. *First lube of its kind that can be painted over.* Really works on just about everything, even aluminum. (Not recommended for TV tuners.) In 6-oz. aerosol cans.

OFFICIAL RULES—NO PURCHASE REQUIRED

- (1) On Official Entry Blank or plain piece of 3"x5" paper, print your name, address, zip code and the name and address of your favorite store carrying GE Silicone Seal and GE Silicone Lubricant. Include suggestions for new or different uses for either product, and name of magazine in which you saw this ad.
- (2) Enter often, but mail entries separately to: MATCH WITS, P.O. Box 250, Murray Hill Station, New York, N.Y. 10016. Entries must be postmarked by July 5, 1971 and received by July 12, 1971.
- (3) Winners selected in random drawings by an independent judging organization. Decisions final. All prizes awarded. Only one to a family.
- (4) BONUS PRIZE: If you win the Grand Prize and your entry includes a new or different use, you receive a Bonus Prize of \$100.
- (5) Any resident of the U.S. is eligible except employees and their families of General Electric Company Silicone Products Dept. and its agencies. Void where prohibited. Subject to all federal, state and local laws and regulations.

OFFICIAL ENTRY BLANK

MATCH WITS

P.O. Box 250, Murray Hill Station
New York, N.Y. 10016

Here's what I did with (check one) GE Silicone Seal
or GE Silicone Lubricant:

(attach extra sheet of paper for additional uses)

Name _____

Address _____

City _____ State _____ Zip _____

Name and address of my favorite store carrying GE
Silicone Seal and GE Silicone Lubricant _____



GENERAL  ELECTRIC

CIRCLE NO. 67 ON READER SERVICE PAGE

NOW train at home with NRI to be a Computer or Digital Technician—no other program is so complete in digital logic, computer operation and programming.

ANOTHER



FIRST

Your own digital computer included at no extra cost

This may very well be the most unique educational aid ever developed for home training—a *real* digital computer you build yourself and use to learn organization, operation, trouble shooting and programming.

This remarkable training aid performs the same functions as bigger commercial computers. One of ten training kits you receive in the new NRI Complete Computer Electronics course.



NRI FIRSTS make learning Electronics fast and fascinating—give you priceless confidence

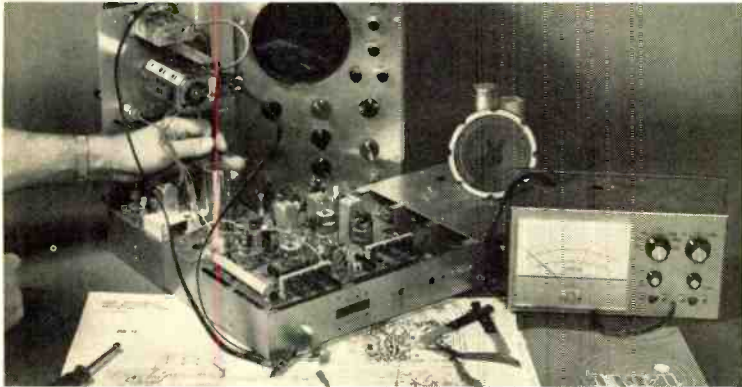

FIRST to give you Color TV training equipment engineered specifically for education—built to fit NRI instructional material, *not* a do-it-yourself hobby kit. The end product is a superb Color TV receiver that will give you and your family years of pleasure. You “open up and explore” the functions of each color circuit as you build.

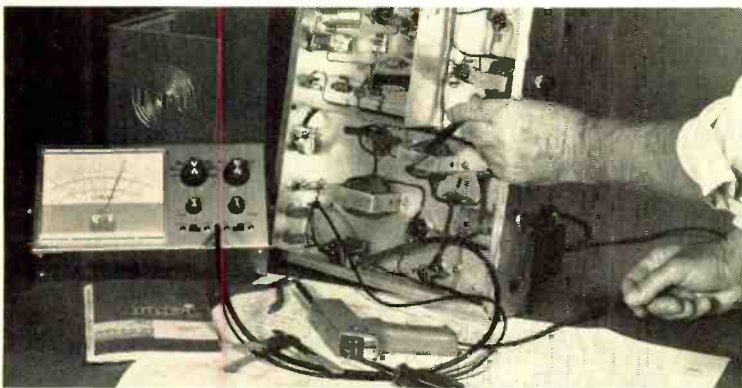

FIRST to give you true-to-life experiences as a Communications Technician. Every fascinating step you take in NRI Communications training, including circuit analysis of your own 25-watt, phone/cw transmitter, is engineered to help you prove theory and later apply it on the job. Studio equipment operation and trouble shooting become a matter of easily remembered logic.



FIRST to give you completely specialized training kits engineered for business, industrial and military Electronics Technology. Shown is your own training center in solid-state motor control and analog computer servo-mechanisms. Telemetering circuits, solid-state multivibrators and the latest types of integrated circuits are included in your course.

There is so much to tell you about this latest “first” in home training from NRI, you must fill in and mail the postage-free card today to get the full story of the Complete Computer Electronics course and the amazing digital computer you build and use as you learn.

Planned from the start to include specially designed training equipment in the pioneering NRI tradition, this exceptional new course succeeds in combining kits with NRI “bite-sized” texts to give you an easy-to-understand educational package. But, unlike other home training, this is not a general electronics course. Lessons have been specifically written to stress computer repair. You perform a hundred experiments, you build hundreds of circuits. Included are over 50 modern, dual-in-line TTL integrated circuits you use in the construction of your computer. You use professional test equipment. In addition to your digital computer, you build and use your own solid-state voltohmmeter and oscilloscope. Because you work with your hands as well as your head, your training is as much *fun* as it is education.

Train with the leader—NRI

As it has in other fields of home-study Electronics training, NRI has taken the leadership in computer training because the “Computer Age” continues to leap ahead. Qualified men are urgently needed, not only as digital technicians and field service representatives, but also for work on data acquisition systems in such fascinating fields as telemetry, meteorology and pollution control. Office equipment and test instruments also demand the skills of the digital technician. Like other NRI courses, this exciting new program can give you the priceless confidence you seek to walk into a technician’s job and know just what to do and how to do it. Mail the postage-free card for the FREE NRI Catalog. No obligation. No salesman will call. NATIONAL RADIO INSTITUTE, Washington, D.C. 20016.

GET FACTS ABOUT GI BILL

If you have served since January 31, 1955, or are in service now, check GI line on postage-free card or in coupon.

If postcard has been used, mail this coupon



NATIONAL RADIO INSTITUTE

Washington, D.C. 20016

2-051

Please send me your FREE NRI CATALOG with details about new Complete Computer Electronics training.

Name _____ Age _____

Address _____

City _____ State _____ Zip _____

Check here for facts on GI Bill

ACCREDITED MEMBER NATIONAL HOME STUDY COUNCIL



another
great new
idea

reversible ratchet handles

for
Xcelite
"99" tools

These two unique plastic (UL) handles extend the usefulness of all Xcelite Series "99" tools, make welcome additions to any "99" set.

Both regular (99-1R) and Tee (99-4R) types accept more than 60 individually available nutdriver, screwdriver, and special purpose snap-in blades to speed and simplify assembly and service work.

Fully enclosed ratchet mechanism is built to highest socket wrench quality standards. Recessed reversing shift operates at the flick of a thumb. Patented spring chuck holds blades firmly.

*nationwide availability
through local distributors*

REQUEST BULLETIN N670

Made in U.S.A.



XCELITE, INC., 12 Bank St., Orchard Park, N. Y. 14127
In Canada contact Charles W. Pointon, Ltd.

CIRCLE NO 89 ON READER SERVICE PAGE

LETTERS

DIRECT VS REVERBERANT SOUND

To the Editors:

Mr. Blum's letter (January, 1971) about "inaccuracies" in the articles by Don Davis and myself on directional vs nondirectional loudspeakers requires a brief comment in return. He correctly points out my logical inconsistency in stating that a large sound source can be distinguished from a small one, "all other factors being equal." I should have written "all factors other than distribution patterns being equal," as the remainder of the paragraph makes clear.

In his other two objections, Mr. Blum seems to confuse binaural with stereophonic reproduction. If a listener stays in one spot with his head in a clamp, then "30 or 40" channels obviously are not required to replicate the original sound field; two will do quite nicely. My guess of 30 or 40 channels is based on personal experience plus some of Dr. Harry F. Olson's published papers. I don't know where Mr. Blum's "generally agreed to be less than 10" comes from. And my observation that exactly the same sound everywhere in the room cannot be stereo seems to me self-evident!

As to Mr. Blum's final question, the answer strongly suggested by the two articles is that to some listeners and in some listening rooms, directional loudspeakers sound more like the original performance, whereas to other listeners (including me) in other rooms, diffuse-source speakers come closer to the original.

G. L. AUGSPURGER
Los Angeles, Cal.

To the Editors:

I note with interest a letter to the editor from Gerald D. Blum in your January, 1971 issue with regard to reverberant sound. There is a growing amount of attention to this subject; however, one needs to tread carefully in reaching conclusions without taking the time to investigate its vast complexities.

I am sending you a brochure containing an abstract of my doctoral dissertation which should be quite relevant to the prevailing discussion. Sound directionality and perception are investigated from the standpoint of timbre. It is a psycho-acoustical study

with musical applications, but approaches some aspects of speaker design and musical-instrument design. There is also a valuable bibliography included in the study.

The complete dissertation is available from *University Microfilms*, Ann Arbor, Mich. Directions for obtaining a copy appear in "Dissertation Abstracts." As my study was completed in August, 1970, it should be in their newest edition.

DR. JAMES A. EBBETS
San Bruno, Cal.

Dr. Ebbets is currently music teacher at Burlingame Intermediate School in Burlingame, Cal., and lecturer in music at San Francisco State College. His dissertation is entitled "The Influence of Azimuth on Timbre Discrimination: Reported Perceptions and Implications for Musicians."—Editors

* * *

JAPANESE SERVICE DATA

To the Editors:

Just a note concerning the assistance given (or not given) by different companies. I recently wrote *Realtone Electronics Corporation* for a schematic of its "Globepacer" transistor radio (11 bands, Model TR-2663). Within a week I had received an envelope containing two complete service manuals at no charge. Perhaps, as someone implied in a recent issue of your magazine, the Japan-based companies do take better care of their customers than most of our domestic companies.

SHELBY ENNIS
Birch Run, Mich.

* * *

ENGINEERING CRISIS

To the Editors:

Congratulations to Mr. Kenneth Pogran of MIT for his letter on the engineering crisis published in one of your recent issues. I work in that "defense and aerospace" world he mentions and have done so for 14 years.

Let me extend Mr. Pogran's comments:

(1) The overspecialized engineer is virtually useless in solving either industry or social problems.

(2) At the same time, a thorough grounding in applied as well as basic science is essential.

(3) Give me a "good head" with horse-sense and a background in busi-

ELECTRONICS WORLD

ness, marketing and communications in preference to the *Phi Beta Kappa* "pure" engineer every time.

(4) A good mix of arts and sciences is a workable compromise.

(5) Most of all, I'll take the innovative thinker with guts.

In defense of "industry recruiters," guys like me raise hell with them for bringing in the rosy-cheeked slipstick artist full of engineering philosophy instead of reasonably mature men with "growth" on their minds. I refer to the kind of growth that we learn from our lives rather than our classrooms.

To stem any potential accusations of anti-academique, I'm not. My company sends young men with potential back to schools like MIT after they've gotten their feet wet.

DON BROUGHTON
Bellevue, Wisc.

In view of the current high unemployment of engineers and technicians in our defense and aerospace industries, companies are taking a harder look at the qualities of men they do hire.—Editors

* * *

C-D IGNITION SYSTEM

To the Editors:

The article on the "Improved Capacitive-Discharge Ignition System" on page 78 of *ELECTRONICS WORLD* for February, 1971 is excellent.

However, the transformer marked "6.3 V, 1.2 A" is what type or make? Is this a 12-volt center-tapped primary, 400-volt secondary, or what? A parts list would help solve the question.

J. F. VOELKER
Easton, Pa. 18042

The transformer in question is a conventional step-down (120 V a.c. to 6.3 V a.c.) filament transformer with a center tap at 3.15 V a.c. For the sake of voltage amplification, it is run backwards. The insulation-voltage rating on the 400-V side must be at least 400 V, obviously. However, we have yet to see one which did not have at least this rating.—Editors

* * *

SPECIAL SECTIONS AVAILABLE

For those of our readers who might be interested in the "Special Sections" we have published in the past, eight of the more recent ones (since 1967) are still available in limited quantities:

"Computer Memories" October, 1970
"Linear IC's" July, 1970
"Solid-State Diodes" July, 1969
"Filters" April, 1969
"Cables & Connectors" October, 1968
"Linear IC's" July, 1968
"Power Supplies" April, 1968
"Relays" April, 1967

Send 25¢ for each to *ELECTRONICS WORLD* Editorial Dept., One Park Ave., New York, N. Y. 10016. ▲

May, 1971

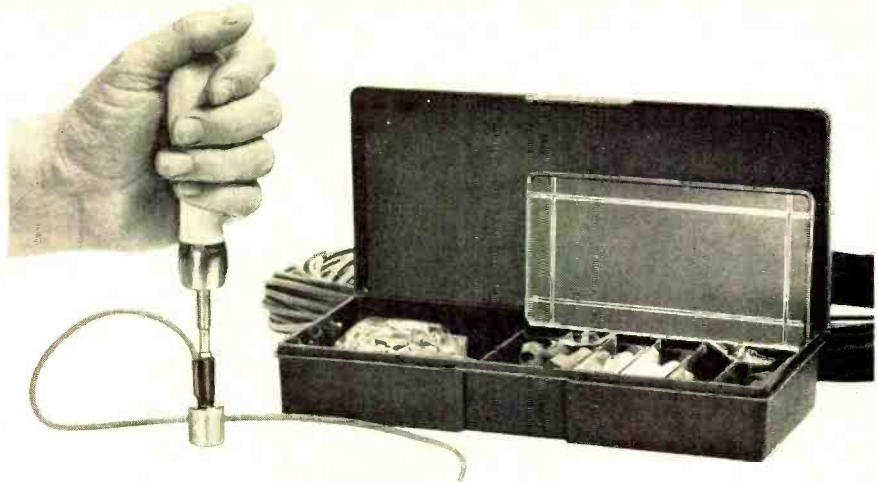

Make and repair your own patchcord stacking plugs in seconds. Any color, any length for 40% less cost.

These new kits contain everything you need to custom assemble and/or replace damaged molded stacking patchcord plugs: 60 metal banana or .080 standard tip metal plugs, 60 housings, 10 in each of the six standard colors. An assembly tool and fixture for fast, easy assembly. Use with standard 0.144" wire (not included in kit). To assemble, simply feed stripped end of wire through cross-hole metal contact. Insert contact and wire into housing. Place in fixture and snap contact into place.

Convenience and flexibility, plus savings of at least 40% over molded stacking patchcord plugs.

E. F. Johnson Company, Waseca, Minnesota 56093

Please send me complete information on your new stacking patchcord kits.



Name _____ Firm _____
Address _____
City _____ State _____ Zip _____

E. F. JOHNSON COMPANY

CIRCLE NO. 74 ON READER SERVICE PAGE

The Experts Guide! Stereo Review's 1971 TAPE RECORDER ANNUAL



Your own personal expert on tape recorders and tapes.

Here's THE guide to getting the best use and pleasure from your tape recorder! What's available—and how to choose what's best for you. WHAT TO BUY: reel-to-reel recorders, 4 and 8 track cartridges, players, cassettes; HOW TO USE IT: taping off the air, tape editing, using test tapes; TAPE TACTICS: tape recorder maintenance, replacing your tape heads, using an oscilloscope—PLUS—a complete Directory of Manufacturers • Glossary of Tape Recorder Terminology • fact-filled Tape Recorder Directory covering—Video tape recorders • Recorders, players, transports • Combination "Music Center" Machines • Raw tape • Tape accessories • Microphones—PLUS a round-up of the best pre-recorded tapes of the year!

This is the Annual you'll want to have, and save... and refer to again and again, all year.

Ziff-Davis Service Division, Dept. TRA
595 Broadway, New York, N. Y. 10012

Please send my copy of the 1971 TAPE RECORDER ANNUAL as checked below: EW-571

\$1.35 enclosed, plus 35¢ for shipping and handling. Send me the regular edition. (\$2.50 for orders outside the U.S.A.)

I am enclosing \$3.50. Please send me, postpaid, the Leatherflex-covered Deluxe Edition. (\$4.50 for orders outside U.S.A.) (Please allow 3 additional weeks for delivery of the Deluxe Edition.)

print name _____
address _____
city _____
state _____ zip _____

— PAYMENT MUST BE ENCLOSED WITH ORDER —

SAVE \$240.00!



New low price on Lampkin Type 107A

DIGITAL FREQUENCY METER / SYNTHESIZER / SIGNAL GENERATOR

A money-making, time-saving, all-purpose instrument for mobile-radio maintenance.

— PLUS —

Numerous applications in educational, aerospace, industrial laboratories; in AM, FM, and TV broadcast engineering; in commercial frequency-measuring services, and many others.

PRICE \$2150.00

Write, wire, or phone — NOW!

Name _____
Address _____
City _____ State _____ Zip _____

LAMPKIN LABORATORIES, INC.
MFM Div., Bradenton, Fla. 33505

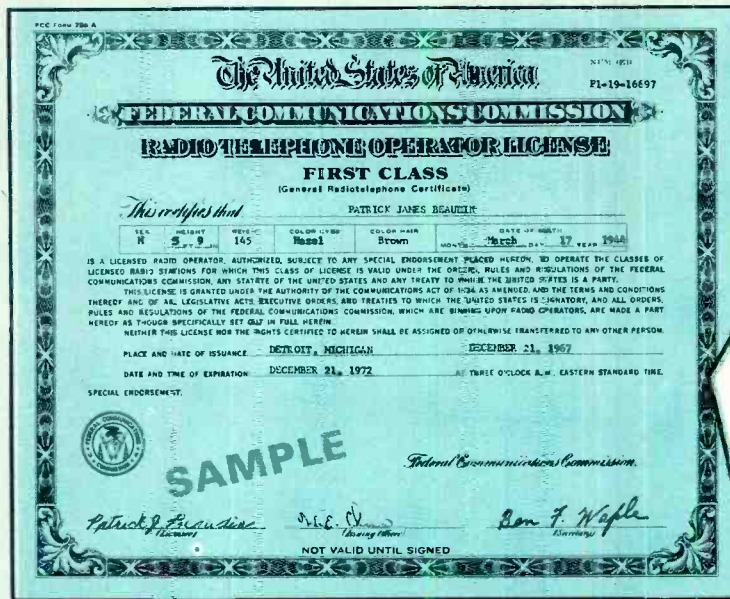

Better than
9 out of 10
CIE grads w
their "ticket"
the very first
time they try

(NATIONAL AVERAGE
IS ONLY 1 OUT OF 3)

Cleveland Institute of Electronics
MONEY-BACK
WARRANTY
of success in obtaining a
Government FCC License

The Cleveland Institute of Electronics hereby warrants that upon completion of the Electronics Technology, (with or without Lab), Broadcast Engineering, or First-Class FCC License course, you will be able to pass the FCC examination for a First Class Commercial Radio Telephone License (with Radar Endorsement);

OR upon completion of the Electronic Communications course you will be able to pass the FCC examination for a Second Class Commercial Radio Telephone License;

AND in the event that you are unable to pass the FCC test for the course you select, on the very first try, you will receive a FULL REFUND of all tuition payments.

This warranty is valid for the original completion time allowed for the course selected.

G. O. Allen
 Dr. G. O. Allen
 President

You can earn more money if you get an FCC License

...and here's our famous CIE warranty that you will get your license if you study with us at home

NOT SATISFIED with your present income? The most practical thing you can do about it is "bone up" on your electronics, pass the FCC exam, and get your Government license.

The demand for licensed men is enormous. Ten years ago there were about 100,000 licensed communications stations, including those for police and fire departments, airlines, the merchant marine, pipelines, telephone companies, taxicabs, railroads, trucking firms, delivery services, and so on.

Today there are over a million such stations on the air, and the number is growing constantly. And according to Federal law, no one is permitted to operate or service such equipment without a Commercial FCC License or without being under the direct supervision of a licensed operator.

This has resulted in a gold mine of new business for licensed service technicians. A typical mobile radio service contract pays an average of about \$100 a month. It's possible for one trained technician to maintain eight to ten such mobile systems. Some men cover as many as fifteen systems, each with perhaps a dozen units.

Coming Impact of UHF

This demand for licensed operators and service technicians will be boosted again in the next 5 years by the mushrooming of UHF television. To the 500 or so VHF television stations now in operation, several times that many UHF stations may be added by the licensing of UHF channels and the sale of 10 million all-channel sets per year.

Opportunities in Plants

And there are other exciting opportunities in aerospace industries, electronics manufacturers, telephone companies, and plants operated by electronic automation. Inside industrial plants like these, it's the licensed technician who is always considered first for promotion and in-plant training programs. The reason is simple. Passing the Federal government's FCC exam and getting your license is widely accepted proof that you know the fundamentals of electronics.

So why doesn't everybody who "tinkers" with electronic components get an FCC License and start cleaning up?

The answer: it's not that simple. The government's licensing exam is tough. In fact, an average of two out of every three men who take the FCC exam fail.

There is one way, however, of being pretty certain that you will pass the FCC exam. And that is to take one of the FCC home study courses offered by the Cleveland Institute of Electronics.

CIE courses are so effective that better than 9 out of every 10 CIE-trained graduates who take the exam pass it. That's why we can afford to back our courses with the iron-clad Warranty shown on the facing page: you get your FCC License or your money back.

There's a reason for this remarkable record. From the beginning, CIE has specialized in electronics courses designed for home study. We have developed techniques that make learning at home easy, even if you've had trouble studying before.

In a Class by Yourself

Your CIE instructor gives his undivided personal attention to the lessons and questions you send in. It's like being the only student in his "class." He not only grades your work, he analyzes it. Even your correct answers can reveal misunderstandings he will help you clear up. And he mails back his corrections and comments the same day he receives your assignment, so you can read his notations while everything is still fresh in your mind.

It Really Works

Our files are crammed with success stories of men whose CIE training has gained them their FCC "tickets" and admission to a higher income bracket.

Mark Newland of Santa Maria, Calif., boosted his earnings by \$120 a month after getting his FCC License. He says: "Of 11 different correspondence courses I've taken, CIE's was the best prepared, most interesting, and easiest to understand."

Once he could show his FCC License, CIE graduate Calvin Smith of Salinas, California, landed the mobile phone job he'd been after for over a year.

Mail Card for Two Free Books

Want to know more? The postpaid reply card bound-in here will bring you free copies of our school catalog describing opportunities in electronics, our teaching methods, and our courses, together with our special booklet, "How to Get a Commercial FCC License." If card has been removed, just mail the coupon at right.

THESE CIE MEN PASSED THE FCC LICENSE EXAM... NOW THEY ARE EARNING MORE MONEY

From Tugboat to Television

"When I started my CIE electronics training, I was working in the engine room of a tugboat. Before finishing, I passed my First Class FCC License exam and landed a job as a Broadcast Engineer at KDFM-TV in Beaumont. I was able to work, complete my CIE course and get two raises... all in the first year of my new career in broadcasting. The course was interesting and well written."—Richard L. Kihn, Anahuac, Texas.



New Job with 40% More Pay

"CIE has taken me from a dull low-pay job with little chance for advancement to one with challenge and a good future. I'm now an Engineering Specialist with National Radio Company, Inc. testing prototype equipment. CIE training gave me the electronics technology I needed to pass the exam for First Class FCC License. I'm already earning 40% more than I could without my CIE training."—Joseph E. Pery, Cambridge, Mass.



NEW REVISED G.I. BILL BENEFITS: All CIE courses are approved for full tuition reimbursement under new G.I. Bill. If you served on active duty since January 31, 1955, OR are in service now, check box on reply card or coupon for G.I. Bill information.

Cleveland Institute of Electronics
1776 East 17th Street, Cleveland, O. 44114

Please send me without cost or obligation:

Your illustrated 44-page book, "How To Succeed in Electronics."

Your book on, "How To Get a Commercial FCC License."

I am especially interested in:

- | | |
|---|--|
| <input type="checkbox"/> Electronics Technology | <input type="checkbox"/> Electronic Communications |
| <input type="checkbox"/> Broadcast Engineering | <input type="checkbox"/> Industrial Electronics |
| <input type="checkbox"/> First Class FCC License | <input type="checkbox"/> Electronics Engineering |
| <input type="checkbox"/> Electronics Technology with Laboratory | |

Name _____
(PLEASE PRINT)

Address _____

City _____

State _____ Zip _____ Age _____

Veterans & Servicemen: check here for latest G.I. Bill information. EW-89

2 NEW CIE CAREER COURSES

- ELECTRONICS TECHNOLOGY with LABORATORY** . . . teaches you the fundamentals. With a 161-piece laboratory you apply the principles you learn by analyzing and trouble-shooting electronics equipment.
- ELECTRONICS ENGINEERING** . . . Covers steady-state and transient network theory, solid state physics and circuitry, pulse techniques, computer logic and mathematics through calculus. A college-level course for men already working in Electronics.

CIE Cleveland Institute of Electronics
1776 East 17th Street, Cleveland, Ohio 44114

Accredited Member
National Home Study Council



The ruggedized Color Crossfire stays home
while other antennas hit the town!

No matter how stormy Winter nights get, you won't find the new Color Crossfire on the streets the morning after!

Channel Master has ruggedized this world famous powerhouse with 30% stronger rear elements that stand up to heavy wind, snow and ice loading...and still deliver the colorful message that's made the Crossfire series the nation's number one.

And we've added a rugged, all aluminum one-piece harness that can't rust or wrench out of shape to cause shorting...yet keeps all elements working in perfect harmony.

And preassembled hardware for a faster and easier rugged installation.

So now, while everybody else is sitting up wondering where their antennas are in a storm, you can relax. That Color Crossfire you installed is right where it should be... delivering outstanding color and black and white reception through the worst of it!

The new ruggedized Color Crossfire
and Color Crossfire-82 from **CHANNEL MASTER**





ERTS— Satellites to Serve Man

This new breed of satellite, to be launched early next year, will provide scientists with a tool to measure and manage the natural resources upon which mankind depends for his existence.

SOME time next year, the National Aeronautics and Space Administration will launch a satellite that will herald a new era in the practical utilization of aerospace technology. From the vantage point of a space orbit, the craft—called the Earth Resources Technology Satellite, or ERTS—will provide scientists with a powerful new tool with which to measure and manage the natural resources upon which mankind depends for his existence. ERTS and its successors may provide capabilities to:

- Map the entire earth within a year or less
- Catalogue water resources
- Survey crops, forests, and other vegetation, revealing their vigor
- Detect water and air pollution and trace their sources
- Identify soil and rock types and collect data on their moisture content
- Acquire scientific oceanographic data and help commercial fishermen to find the most productive fishing grounds
- Find promising sources of minerals

These objectives, although ambitious, already have a basis in fact even though the first ERTS will not fly until 1972. Experiments conducted from aircraft and during manned space flights, as well as research and development programs in laboratories across the country, have



A picture, originally in color, taken during an Apollo mission shows current patterns and effluent discharge from Albermarle and Pamlico Sounds located along the North Carolina coastline.

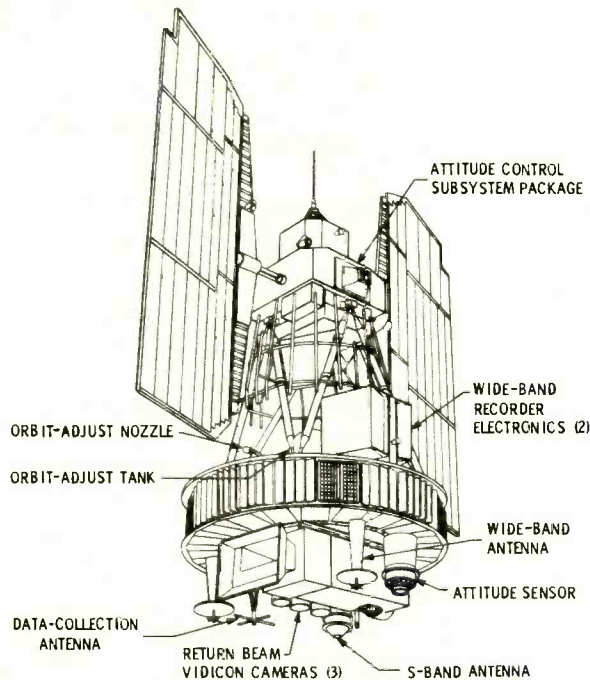

Some of the important components in the ERTS satellite.

demonstrated the efficacy of using earth-orbiting platforms to acquire data on the globe's natural resources.

Although it has been under study by both NASA and private industry for some time, the initial ERTS is just beginning to take shape. It will bear a close resemblance to the Nimbus experimental meteorological satellite which is being adapted by its builder, *General Electric*, for the earth resources mission. This approach is consonant with the philosophy evolved for ERTS by NASA's Goddard Space Flight Center during initial studies of the program. At that time, the planners concluded that it would be best to modify an existing spacecraft design rather than develop an entirely new satellite.

The primary sensors to be carried by each of the first two satellites in the series, ERTS A and B, will be three *RCA* return-beam vidicon TV cameras and a *Hughes* multispectral radiometric scanner. The satellite also will have a data

collection/relay system and a pair of wide-band recorders to store data from TV cameras and scanner. The sensors will be aimed at earth continuously since ERTS will make one revolution per orbit as it flies a 565-mile-high polar path synchronized with the sun's movement.

The return-beam vidicon cameras will be the highest resolution TV cameras ever flown in space. They will employ 4200 horizontal scanning lines as contrasted with about 1000 lines for the previous highest resolution space TV and 525 lines for commercial TV in the United States. The three cameras will view the same 100-by-100 mile ground area. However, each will image the scene in a different portion of the light spectrum: one in green (0.47-0.61 micron), a second in red (0.59-0.71 micron), and a third in the near-infrared (0.68-0.89 micron) region.

The multispectral scanner will view a 100-mile swath with the vertical component of the image being provided by the satellite's motion. It will employ bands close to those of the TV—0.5-0.6, 0.6-0.7, and 0.7-0.8 micron—plus an additional channel that goes farther into the infrared region at 0.8-1.2 microns. In addition, the ERTS B scanner will have a fifth band still farther into the infrared region, covering 10.4-12.6 microns.

The "slicing" of the light spectrum into separate spectral bands will be the key to the satellite's data-producing capabilities. The separate images, after receipt and processing on the ground, can be combined into one special view in which ground features are more pronounced than in conventional photography. The individual separations also will be valuable in themselves since certain earth resources information is revealed best in specific spectral bands. Surface water is best seen in the near-infrared band, while the green band is useful for seeing through water to survey shoaling in the near-coastal regions.

Photography of the earth from space using spectral bands similar to those slated for ERTS A and B has been accomplished during the Apollo program. During the Apollo 9 mission, the astronauts mounted film cameras in a spacecraft window and photographed the ground below. The resulting data was used to verify the bands selected for ERTS.

In addition to its TV and scanner, the satellite will carry a system for receiving, storing, and then transmitting to ground stations data from a wide variety of ground-based sensors, such as stream-flow gages or soil-moisture monitors. The spacecraft thus can serve as a communications link to a host of widely scattered remote sensors.

Ground stations at Greenbelt, Maryland, Corpus Christi, Texas, and Fairbanks, Alaska, will put a receiving site within range of the satellite any time it is over the United States or its adjacent coastal areas. When the spacecraft is out of range of a station, data from the TV and scanner will be stored on a new wide-band recorder under development by *RCA*.

The recorder is taking aim on a new standard of reliability and long life in space. It will be designed to operate for 1000 hours, or about three times as long as any previous similar system. The recorders (two will be carried in each satellite for redundancy) will record TV-camera signals from d.c. to 4 MHz and 15 megabit-per-second digital data from the scanner. However, while it can record data from both, the recorder cannot accept inputs from the TV and scanner simultaneously; it must record from one or the other.

The output of ERTS, therefore, will be high-resolution images in various segments of the light spectrum plus the data it will receive and relay from the ground-based remote sensors. Analyzed on the ground with the aid of computers and other interpretive techniques, the satellite is expected to give scientists their first opportunity to take a comprehensive, up-to-date look at the condition of the entire earth—and do it repetitively on a timely basis since the satellite will cover any given 100-by-100 mile area each 17-18 days.

Benefits from the Satellite

One of the first and surest beneficiaries of ERTS will be cartography. Because it is taken from so high above the earth, the data in a satellite picture is orthographic. Subjects within the scene maintain their proper spatial relationships so the image need not be subjected to elaborate and expensive processing to remove distortions, as is required with photographs taken from aircraft. A satellite photograph, therefore, becomes an "instant map." Also, everything pertinent is shown at the scale for which the taking cameras are configured so no one must decide what to include or exclude as is the case with maps drawn by draftsmen. The presentation is objective.

Another, and enormous, cartographic advantage stems from the satellite's speed and sun-synchronous orbit. It will always view the ground below at the same sun angle and therefore lighting of the scene will be uniform. Aircraft, on the other hand, are constantly subjected to changing sun angles over even just a few hours of aerial mapping. The result is non-uniform lighting in the separate photographs that are mosaiced to form an aerial map. The shadowing causes ground features which are, in fact, identical to appear different in the map. However, ERTS will view a large ground area under the same lighting so that features that are identical will appear identical and features that are different will appear to be different.

Thus, cartographers will be able to create maps superior to anything obtainable from aircraft. And, since the satellite will cover the entire earth every 18 days, even accounting for times of cloud cover, engineers estimate that the data needed to create an aerial map of the entire world will be on hand in less than a year. The data can then be updated to chart dynamic events—the change in size of a lake, for example—thanks to the 18-day repetitive coverage.

Another area looking to ERTS for major benefits is agriculture. The detection of differences in spectral signatures—the individual characteristics of vegetation in reflecting, absorbing, emitting, or scattering light—may permit scientists to use satellite images to distinguish between species of vegetation and between healthy and diseased plants.

The implication of these capabilities is enormous. Blight in crops or grazing land could be spotted in time for it to be checked before major damage occurs. Crop yields could be predicted more accurately. Soils could be mapped quickly (it will be 1998 before soil mapping of the entire United States is complete using current methods). Forests could be catalogued according to tree type. Comprehensive land-use maps, more accurate and timely than anything now possible, could be compiled. In fact, the potential of an earth-orbiting satellite to benefit farming and agricultural-related activities is virtually limitless.

Similarly, oceanography and commercial fishing are eagerly awaiting data. The Apollo 9 multispectral photographs proved that it is possible to chart currents that affect the movement of fish. In fact, the Apollo 9 pictures were used to forecast the shrimp population in the Gulf of Mexico just off Texas, one of the world's richest fisheries. In the same way, photographs of the Gulf of Aden in the Middle East, taken from Gemini spacecraft, have shown the areas heavily inhabited by tuna.

ERTS is also expected to produce such oceanographic data as color of the sea, surface texture, surface temperatures, slope of the ocean surface, and the magnitude of tide-producing lunar forces—all important since scientists now know far less about the moving surface of the sea than they do about the earth's land areas.

Data on inland water resources also will be acquired by the satellite. Hydrologists will seek to apply ERTS technology in four basic areas: study of the hydrological cycle, map-

ping the extent and thickness of snow and ice fields, surveying coastal hydrological features and large inland lakes, and the communication of data gathered by ground-based hydrological sensors.

The growing concern over ecology and the increasing problem of pollution have also stirred major interest in the potential of remote sensing by satellite to help detect and pinpoint pollution and its sources. Already, lower-resolution cameras in weather satellites have shown the discharge of

(Continued on page 67)

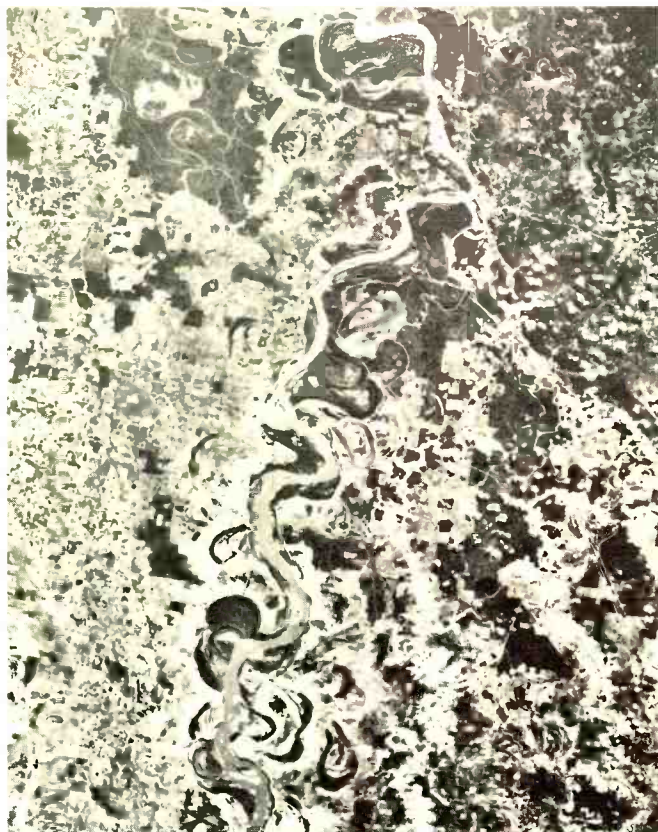

An infrared photo of the Mississippi River and the surrounding area taken from Apollo 9 spacecraft. Scientists can analyze such pictures for land use, water distribution, and vegetation.

An infrared picture, originally in color, taken from Apollo 9 command module in earth orbit defines cropping patterns in the Imperial Valley of California near the Salton Sea (black body at upper left). ERTS will produce similar data of entire U.S.





Recent Developments in Electronics

Communications for Trapped Miners. (Top left) A coal mine rescue and survival system, consisting of breathing apparatus, a mobile shelter, a large fixed shelter, a communications/location subsystem, and a rescue subsystem, is being developed for the Bureau of Mines by Westinghouse. The communications subsystem uses both seismic and electromagnetic techniques. The surface seismic equipment can "hear" trapped individual miners hitting the walls, floor, or rails in the mine and can determine their location. The electromagnetic communications equipment, which operates in the very low frequency range, sends voice signals down through the earth to receivers in the mine. Although voice communications from the mine to the surface will not be possible because the battery-power consumption would be prohibitive, transmitters in the mine shelters or barricade areas will be capable of sending coded signals to the surface. Individual miners would be equipped with small receivers, shown in the photo, mounted on their lamp-battery cases. After a mine accident, a miner would open the sealed receiver, withdraw an earphone, and listen for instructions.

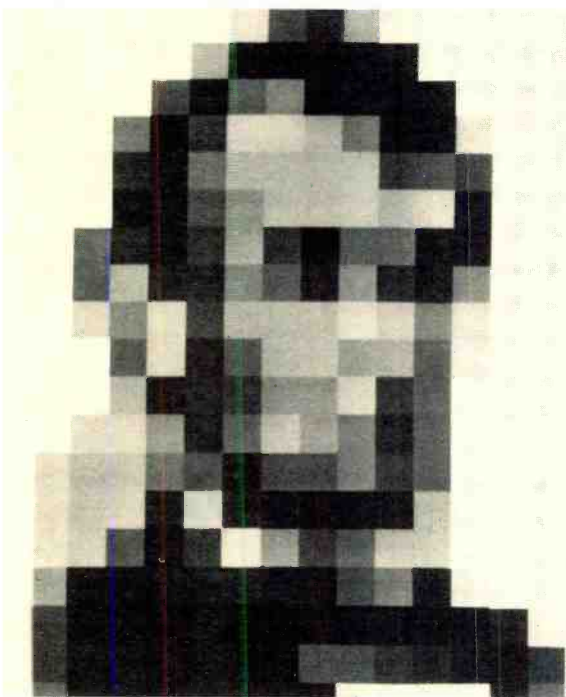

Cubism by Computer. (Center) This is a picture of a well-known face that has been digitized by a computer. It's part of a study at Bell Laboratories to learn the least amount of visual information a picture needs in order to be still recognizable. The picture is divided into about 200 squares, with each square rendered in an even tone from one of sixteen intensities of gray. Studies of the information content of a picture may be useful in designing future video-telephone systems and for devising techniques for computer storage of pictures. (If you still don't recognize the portrait, try looking at it from a distance, or while you're squinting, or with your eyeglasses removed.)



Color Video Tape Recorder-Player. (Below left) A new color video tape recorder-player is to be introduced next fall by Emerson TV. The format used is that employed by Avco's Cartrivision. In addition to receiving both color and black-and-white telecasts, the new unit will be able to record directly from on-the-air TV programs, video record live from a black-and-white or color camera, and play pre-recorded and homemade cartridge tapes. The cameras for home-movie making will be available as optional equipment. Blank cartridges suitable for recording on the unit will have a playing time of from 15 minutes to two hours and will vary in price according to length. Pre-recorded cartridges will be available to the consumer from several sources, including appliance dealers. They will cover new and old movies, instructional films, sports and travel events, and specialized films featuring individual artists and performers. They will be priced according to content and running time. The recorder-player will be marketed through Emerson and DuMont dealers. Pricing has not been determined as yet.

Rainbow Laser. (Top right) The beam from a newly developed laser is split into multi-colored rays and caught in the palm of researcher Dr. Karl G. Hernqvist. The device, a helium-selenium laser, can produce up to 24 different laser beams in every color of the rainbow. Demonstrated recently for the first time, the laser can be used in optical experiments, for investigation of materials, or as an alignment tool for surveying or laying pipelines. Research on the unit was done at RCA Laboratories.



Silicon Crystals Grown by Computer. (Center) Computers have been teamed with crystal-growing furnaces to produce single-crystal silicon ingots, such as the one shown at the left in the photo. Such ingots, 2 1/4 inches and larger in diameter, are sliced and polished to form the silicon wafers which are then processed to produce monolithic logic and memory IC chips. The chips are then packaged to form computer circuitry. The computer-aided technique uses an IBM 1800 data acquisition and control system to monitor key process parameters, such as silicon melt temperature, crystal lift and rotation speeds, and crucible lift and rotation speeds.

Pocket Calculator Uses Single IC. (Below left) The hand-held calculator shown can add, subtract, multiply, and divide and is small enough to slip into a coat pocket or a lady's handbag. Light-emitting diodes are used in the display. The complete logic for the calculator is on a single LSI (large scale integration) circuit that has been custom-made by Mostek Corp. (affiliate of Sprague Electric). The tiny chip, about the size of three grains of rice, contains the equivalent of over 2100 transistors, over 360 logic gates, and 160 flip-flops. The chip is mounted in a considerably larger ceramic package measuring about 0.6-in wide by 2-in long in order to accommodate all the interconnecting leads. Display units, their drivers, a keyboard, and the battery power-supply circuits complete the unit. The calculator is made by Nippon Calculating Machine Co. (sales affiliate is Basicom Corp.) and will sell for just under \$400.

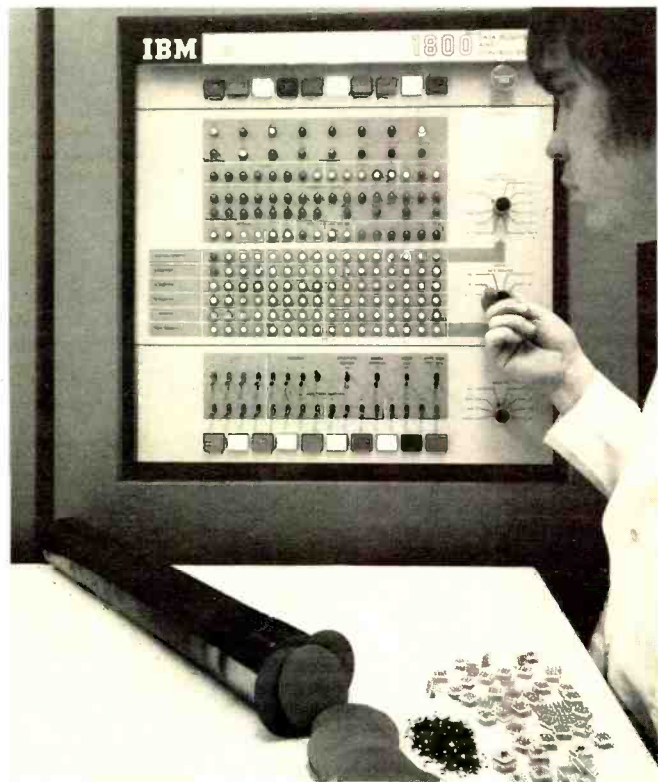

Night-Viewer Scope. (Below right) A hand-held viewing device which allows police and security personnel to detect man-sized objects more than one-third mile away under moonlight conditions is shown. Resembling a small telescope, the unit uses image intensification to amplify up to 45,000 times the light that is invisible to the unaided human eye. When the scene is illuminated by a bright light, such as a sudden flash, an automatic brightness control adjusts the scope to maintain a clear picture and protect the intensifier tube. The three-pound unit, which operates up to 50 hours on two "A"-sized batteries, was designed by GTE Sylvania. Price of scope is \$3945.



How to Select a TV ANTENNA

By FOREST H. BELT/Contributing Editor

Some of the new antennas just have new names, but others have real design improvements. Here's what is available to help you choose the best antenna for your particular area. Complete listing of recommended antennas is included.

SNOW-FREE television pictures, with all colors in place, are the stakes in the antenna game. Sometimes the game is played with numbers, like how many decibels of gain one antenna has over another. Or the ammunition may include technical-sounding phrases like "front-to-back ratio," "side lobes," or some such. Boxes may display a number of very enticing catch-labels; such as, "Color Spectrum," "Magic Color," "Color Guard," "Color Tuned," "Color Brite," "Sensar," and so on.

But whatever the words or numbers, the crucial question is, "Does this antenna give a good color or black-and-white picture where I live?" You figure the topography around you, the distance and power of the stations, and how high you can mount the antenna. Then you choose.

The full-page table with this article is a general guide. If there are no u.h.f. stations, you don't need an all-channel model. If u.h.f. is the only kind of TV you get, you won't need an antenna for v.h.f. too. Of course, if there's distant

v.h.f. to be picked up by a very sensitive antenna mounted high, you might want to consider an all-channel model. Or, a v.h.f. or u.h.f. station might be coming to town soon.

Table 1 gives an idea of mileages. If terrain is hilly, consider the next greater distance grouping; it'll take a more sensitive antenna model to pull signals "over the hills." It's the same if you live between two mileage categories; again pick the more sensitive antenna. Beyond the mileages shown, even the best antenna is likely to produce only a snowy picture unless mounted extremely high or the terrain is very smooth.

As for which brand, you'll have to choose for yourself. The big chart lists the model each major manufacturer recommends for each category. Prices are not always a reliable guide to what's "better." Ask your antenna distributor to let you see the antenna. Judge solidity of construction, ease of assembling and erecting, and weatherproofing, along with price, directional quality, and gain (sensitivity).

Fig. 1. Winegard-developed u.h.f. antenna section. It fits in front of v.h.f. antennas made by other manufacturers as well.

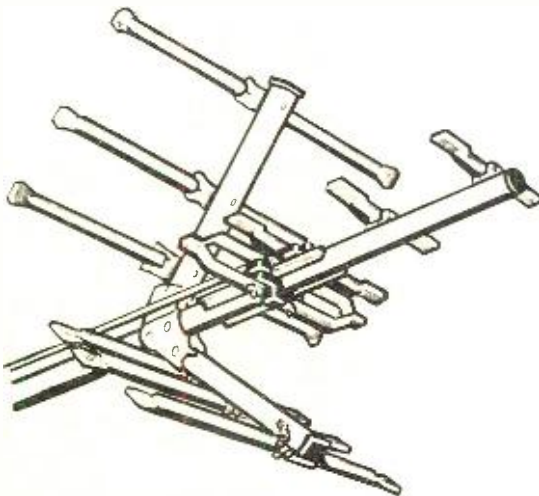

	V.H.F.	U.H.F.
Local Signal	0 to 20 miles	0 to 15 miles
Medium Signal	20 to 50 miles	15 to 30 miles
Fringe Signal	50 to 100 miles	30 to 70 miles

Table 1. Approximate distances from transmitting antenna for local, medium, and fringe signals (see full-page chart).

Table (right) shows antennas recommended by various antenna manufacturers for different signal areas. All antennas are outdoor types. Each manufacturer has been limited to a single choice; in many cases, there are other antennas in company's line with somewhat different gains and directivities. Most of the antennas are general-purpose types where no special installation or interference problems exist. For approximate mileage distances for local, medium, and fringe signals, refer to Table 1. It is frequently possible to combine a v.h.f. antenna with a separate u.h.f. antenna using a splitter and/or stacking bars. Such arrangements have not been listed. Most of these antennas, although mainly designed for color or black-and-white-reception, can also be used for FM reception too.

Recommended Antennas for Various Signal Areas

MANUFACTURER	V.H.F. ONLY			U.H.F. ONLY			V.H.F. LOCAL SIGNAL			V.H.F.-U.H.F. COMBINATIONS			V.H.F. FRINGE SIGNAL		
	Local Signal	Medium Signal	Fringe Signal	Local Signal	Medium Signal	Fringe Signal	U.H.F. Local Signal	U.H.F. Medium Signal	U.H.F. Fringe Signal	U.H.F. Local Signal	U.H.F. Medium Signal	U.H.F. Fringe Signal	U.H.F. Local Signal	U.H.F. Medium Signal	U.H.F. Fringe Signal
Antenna Corp. of America	AC505 \$9.95	AC511 \$23.95	AC525 \$62.95	AC320 \$7.95	AC310 \$14.95	AC315 \$16.95	AC711 \$10.88	AC712 \$25.50	AC720 \$39.95	AC710 \$20.95	AC717 \$29.95	AC725 \$49.95	AC7210 \$39.95	AC725 \$49.95	AC730 \$64.95
Antennacraft	CS-500 \$12.95	CS-800 \$39.95	CS-1000 \$69.95	Y-11G \$9.95	Y-20G \$14.95	Y-28G \$19.95	Big Shot 8 \$9.95	CDX-650 \$24.95	CDX-750 \$34.95	CDX-750 \$34.95	CDX-850 \$44.95	CDX-1050 \$69.95	CDX-1050 \$69.95	CDX-1050 \$69.95	CDX-1050 \$69.95
Blonder-Tongue Labs	0610 \$21.95	0611 \$29.95	0613 \$44.95	3518 \$8.46	0511 \$14.95	0512 \$23.95	0711 \$29.95	0711 \$29.95	0712 \$47.95	0713 \$47.95	0713 \$47.95	0714 \$61.95	0718 \$61.95	0718 \$61.95	0719 \$71.95
Channel Master	3615A \$18.75	3612A \$50.75	1210B \$84.95	4305 \$10.25	4304 \$16.50	4310 \$25.65	3624 \$9.95	3626 \$22.75	1262B \$32.95	3665A \$35.50	1252B \$53.10	1251B \$60.30	3662A \$75.50	3661A \$89.50	1211B \$99.95
Finney	CS-V5 \$21.30	70-V17 \$39.95	70-V28 \$74.95	CS-U1 \$12.05	CS-U2 \$18.35	CS-U3 \$26.40	CS-A1 \$23.50	CS-A2 \$28.50	CS-A3 \$37.15	70-18A \$56.95	70-18B \$62.95	CS-C3 \$72.35	70-23A \$73.95	70-23B \$80.95	70-29B \$100.00
Gavin Instruments	1011 \$31.50	1019 \$49.95	1026 \$65.95	CR-5 \$7.75	CR-5 \$7.75	CR-10 \$11.95	1106 \$20.95	1113 \$32.95	1122 \$55.50	1110 \$25.50	1118 \$41.50	1122 \$55.50	1118 \$41.50	1122 \$55.50	1134 \$76.90
GC Electronics	32-706 \$16.52	32-709 \$24.84	32-719 \$41.49	32-8965 \$3.75	32-8978 \$7.91	32-8978 \$7.91	32-906 \$8.78	32-507 \$16.52	32-511 \$24.84	32-511 \$24.84	32-519 \$41.49	32-519 \$41.49	32-519 \$41.49	32-524 \$59.94	32-524 \$59.94
Jerrold Electronics	VIP-301 \$17.95	VIP-303 \$34.95	VIP-306 \$63.50	PAU-450 \$11.25	PAU-700 \$16.50	PAU-900 \$27.50	VU-931 \$24.25	VU-932 \$32.75	PXB-48 \$31.95	VU-932 \$32.75	VU-933 \$44.50	PXB-65 \$50.95	VU-934 \$55.50	VU-934 \$55.50	VU-935 \$69.95
JFD Electronics	LPV-6L \$25.55	LPV-11L \$46.70	LPV-17L \$69.05	LPV-CTC15 \$17.50	LPV-CTC21 \$23.55	LPV-CTC39 \$40.10	LPV-CTC110 \$21.70	LPV-CTC220 \$28.55	LPV-CTC323 \$36.20	LPV-VU60 \$36.20	LPV-CTC426 \$48.65	LPV-CTC532 \$61.15	LPV-VU180 \$85.50	LPV-CTC1639 \$73.00	LPV-CTC1747 \$85.50
Kay-Townes	CP-5G \$11.84	CP-15G \$30.20	CP-36G \$82.75	C-1G \$11.15	UHF-4BT \$6.03	PRO-51UG \$50.25	CPG-9G \$15.25	CPG-12G \$20.25	CT-24G \$35.40	GA-520G \$40.87	GA-310G \$55.32	GA-210G \$66.72	GA-520G \$40.87	CT-34G \$56.40	CT-42G \$68.60
Lance Industries	LC-880 \$20.30	LC-881 \$29.90	LC-884 \$59.80	KW4S \$7.95	LU-820 \$13.65	LU-840 \$34.35	LC-30 \$17.20	LC-80 \$19.05	LC-81 \$27.65	LC-37 \$23.00	LC-82 \$32.00	LC-83 \$58.25	LC-38 \$34.95	LC-39 \$54.95	LC-119 \$62.40
RCA Parts & Access.	3BG09 \$17.30	3BG17 \$35.95	3BG27 \$66.95	2BG04 \$4.85	2BG09 \$12.25	2BG17 \$16.25	4BG10 \$16.45	4BG13 \$21.95	Separate*	4BG15 \$26.40	4BG20 \$31.95	4BG30 \$53.25	Separate*	4BG23 \$42.50	4BG36 \$68.95
RMS Electronics	STP-7 \$14.45	STP-11 \$20.95	STP-28 \$56.95	COR-1 \$8.95	U-9 \$9.95	U-15 \$19.95	DYN-33US \$19.95	DYN-54US \$29.95	DYN-118US \$44.95	DYN-54US \$29.95	DYN-66US \$34.95	DYN-118US \$44.95	DYN-88US \$44.95	DYN-118US \$44.95	CB-34 \$59.95
Wiregard	SR-10 \$34.88	SR-20 \$49.88	CW-2000 \$100.00	U-965 \$18.75	U-975 \$25.95	U-995 \$38.50	SR-10 \$34.88	SR-20 \$49.88	SC-82 \$54.10	SR-20 \$49.88	SR-20 \$49.88	SC-82 \$54.10	CW-96 \$58.95	CW-98 \$74.50	CW-1000 \$100.00
Zenith Sales	973-83 \$21.50	973-85 \$44.50	973-87 \$69.50	973-101 \$8.95	973-8 \$14.95	973-10 \$31.95	973-89 \$24.50	973-90 \$32.95	973-91 \$36.95	973-92 \$54.50	973-92 \$54.50	973-92 \$54.50	973-93 \$65.95	973-93 \$65.95	973-94 \$89.95

*Separate u.h.f., v.h.f. antennas recommended.

Note: Prices are suggested list, not firm selling prices; they also vary with locality.

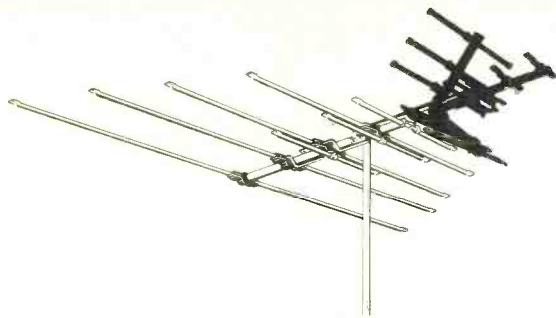

Fig. 2. "Impedance correlators" (short elements under dipoles) are a feature of this Antenna Corporation of America model. The u.h.f. section in front is shown solid in the illustration.

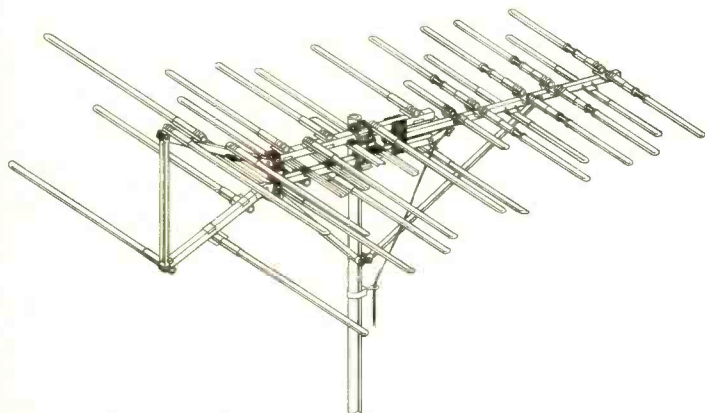

Fig. 3. Finco antenna features delta reflector, transposed feeder bars, and directors that use insulating gaps shown.

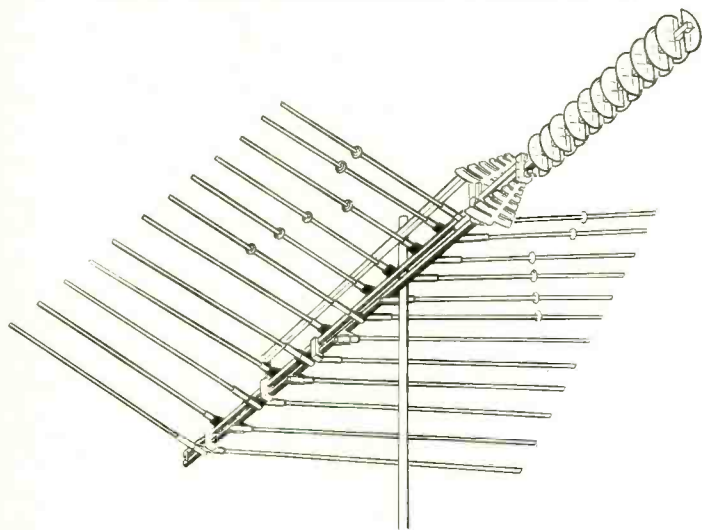
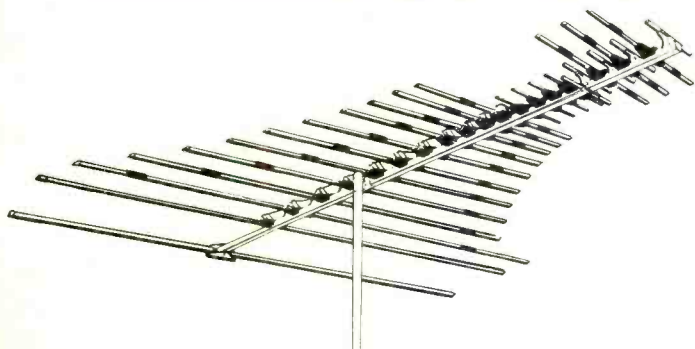

Fig. 4. A distinctive feature of JFD log-periodic antenna is the set of half-disc reflectors for high u.h.f. gain.

Fig. 5. Lengths of the elements in this GC Audiotex antenna follow exponential formula, said to give good broadbanding.



Some manufacturers explained their designs to us. The shapes of these high-gain monsters, however odd they may appear, are not the least bit accidental. The reasoning behind some of them may interest you.

U and V Together

For example, *Winegard* has a patented u.h.f. design (Fig. 1) using what are called "tetrapole collector elements." Only one element is driven—the folded dipole that appears to wrap around the boom. Lead-in fastens at the bottom. You'd expect the folded dipole to be solid across the top, but it's not. It has a center gap, just like at the bottom. Of course, that gap has to be closed electrically for the dipole to present a 300-ohm impedance at the lead-in block on the bottom. A pair of phasing bars (you can only see one in the illustration) are connected at the top. They run parallel to the boom. They are just the right length at u.h.f. to present a zero impedance—effectively a short circuit—across the tap on top of the dipole.

Why bother, you ask? At v.h.f., the phasing bars and the u.h.f. dipole have no resonance. The 300-ohm v.h.f. antenna feeds directly to the phasing bars. They and the u.h.f. dipole are mere coupling lines to the lead-in block. The lead-in sees 300 ohms for either antenna.

The u.h.f. part of one *Antenna Corp. of America* model uses this *Winegard* design. Behind it, the v.h.f. sections look simple (Fig. 2). There are two dipole driven elements (nearest the mast), two reflectors (back end), and one straight director. The V-shaped array that is a corner reflector for u.h.f. is also a director for v.h.f.

Elements with this straight design work in two modes. Their entire lengths resonate at a half-wavelength for low-band v.h.f. For high-band v.h.f. they divide into thirds and resonate at three half-wavelengths.

That high-band "breakup" can be uneven and upset impedance at the take-off point in the center. The result could be serious dips and lobes in the response of the antenna. To counteract that, short elements are added just beneath the longer driven dipoles. They're called "impedance correlators," and they smooth out response of the array. An even 300 ohms for all channels is presented to the lead-in.

Shaping and Spacing the Elements

The *Finco* (*Finney Co.*) antenna in Fig. 3 has several design features of special interest. One is a patented formula the company calls its "frequency-dependent principle" (FDP). The object is to raise the gain of the antenna as frequency goes up to compensate for natural losses in the TV spectrum. Shorter (higher-frequency) elements toward the front are spaced farther apart along the boom.

Feed-centers of the dipoles are transposed, a practice that narrows the front lobe of the antenna response. The second special feature is how they're transposed. Instead of the driven dipoles being straight across and separated at the center, these are staggered along two electrically separate booms. One half of any given dipole is on one boom, the other half on the other. The effect is electrical transposition along the length of the booms. One boom then goes to one side of the lead-in terminal block, and the other boom to the other side.

A third feature is called the "delta reflector." It purports to give better front-to-back ratio than plain reflector bars. The stagger principle of mounting element halves continues in the *delta*, as you can see. The *delta* connects electrically to the back ends of the double boom. The result is a closed resonant loop that is said to smooth response across the v.h.f. band.

The fourth noteworthy design factor in this model is in the director elements up front. To aid in breakup into three half-wave elements, so high-band "cells" form along the driven elements, the directors are divided by insulators. The technique, used by other manufacturers too, helps im-

prove high-band performance of this particular antenna.

Gavin Industries' antennas use what is called "yagi spacing" for elements; they're all the same distance apart. Lengths vary across the low v.h.f. band, for a broadband effect. As usual, the elements operate in thirds for high-band v.h.f.

Yagi-type antennas can produce undesirable side lobes at high-band frequencies, which also detract from gain. The rear two reflectors on *Gavin* antennas are swept a bit forward to eliminate side lobes. This also narrows and strengthens the front lobe. Directors are short, to bring high-band gain up to match low-band.

Log-Periodic Antennas

The log-periodic principle for antenna elements was pioneered by *JFD Electronics*. The design formula expresses a logarithmic relationship between velocity of television signals and the size and spacing of elements. One result is better gain as frequency goes higher, and with smooth impedance coupling.

An all-channel version is pictured in Fig. 4. The v.h.f. section uses some techniques already described. The twin-boom method of terminating the driven elements is one; it transposes without criss-crossing wires. Breaking up the front elements with insulators has already been described. But the insulators in *JFD* models are capacitive, "tuning" the dipoles for efficient capture of high-band signals. Other manufacturers use "bat-wing" tuning stubs which are mounted at an angle from the antenna elements for this same purpose.

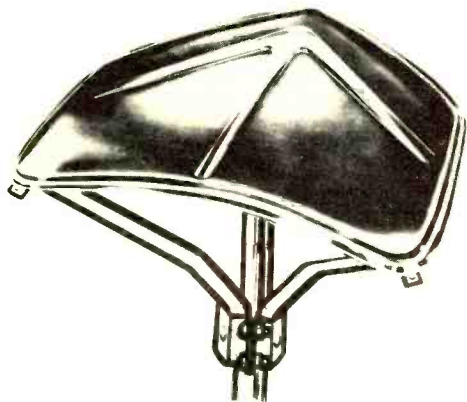

After this article was written, we learned that *JFD Electronics* was just getting ready to introduce a very unusual all-channel outdoor-indoor antenna called "Stellar 2001." We don't have too many technical details as yet, but here are some things we have been able to find out about it. The antenna consists of a multi-element linear dipole array with built-in v.h.f. solid-state amplifier that is said to provide enough signal to drive two to four receivers. The antenna and amp are enclosed in a sealed weatherproof fiber-glass housing. The assembly is very compact, measuring only about 34" x 28" x 4" thick. Coax output from the built-in amplifier, whose circuitry is etched from a single sheet of copper that may also be used for the antenna elements, is fed to an associated power supply/2-set coupler. A pair of 300-ohm outputs are then connected to two TV receivers. The manufacturer claims a range of up to 70 miles for the new antenna, depending on signal strength.

Interestingly, the antenna can either be mast-mounted or it can be mounted directly using the three small mounting brackets supplied. With these brackets, the antenna is placed several inches above the roof, above the attic floor, below the attic rafters, or even below the ceiling of a room.—Editor

Look at that unique u.h.f. array up front. There are two driven sections, each stamped out of one metal plate. Spacing and lengths of these elements are log-periodic, in the u.h.f. band. The wedge shape, tapering together at the high-frequency ends, purportedly improves capture of u.h.f. signals.

The half-discs are u.h.f. directors. They're very broadband. *JFD* calculates they deliver twice the gain of linear directors.

A line of antennas from *GC Electronics*, marketed under the *Audiotex* brandname, is partly log-periodic. An all-channel version appears in Fig. 5. Note the curved pattern outlined by the lengths of the elements. This is one application of the logarithmic design formula. According to designers, this special tapering improves the broadband response of the antenna.

These dipoles are broken up by insulators, too, but not into thirds. The short outer stubs make parts of the driven elements parasitic for some of the other elements. Gain and smoothness of response over the bands is the purpose. The dipole-to-dipole wiring harness, which is hard to see in the illustration, is a standard transposed type; it has small insulated copper wire instead of the usual heavy bare aluminum wire.

It's also noteworthy that the u.h.f. array is sandwiched between the main v.h.f. array and some high-band directors at the extreme front. The directors are also broken up by insulators into parasitic elements for the u.h.f. band. This is another case of multiple use of elements for higher gain

(Continued on page 70)

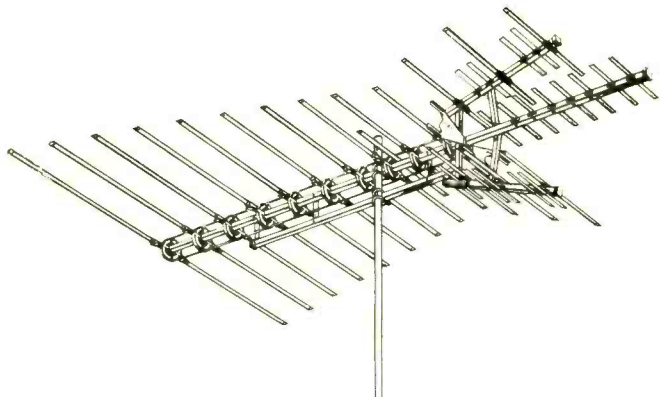
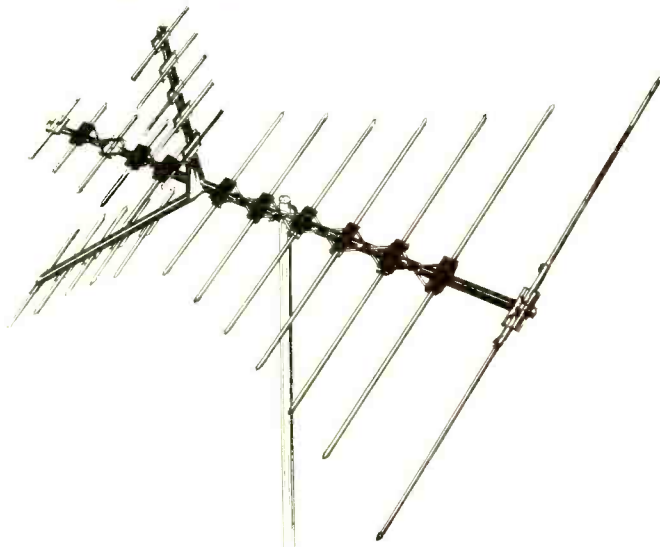

Fig. 6. You can recognize this Jerrold antenna by the circular insulators. Wires inside form transposing harness.

Fig. 7. The u.h.f. portion of the *RMS Electronics* antenna is miniature version of v.h.f. plus use of corner reflector.





Relaxation Oscillators

—Old and New

By R. D. CLEMENT and R. L. STARLIPER
Western Electric

A collection of tried and tested circuits using various types of solid-state switches that can be employed for pulse generation.

THE relaxation oscillator is one of the most basic types of pulse-generating circuits in use today. This kind of oscillator circuit may be designed around almost any type of non-linear switching component. In most relaxation-oscillator circuits, the switching component is used to quickly discharge a capacitor into a low-impedance load. The particular type of switching component used determines the output pulse characteristics and frequency of operation.

During the past several years, many new switching components have appeared on the market which make a variety of relaxation oscillator circuits feasible. This article describes a number of such oscillator circuits using different components.

Neon Lamps and 4-Layer Diodes

The basic relaxation oscillator of the past consisted of a resistor, capacitor, and neon lamp connected as shown in Fig. 1A. When power is applied to this circuit, C1 charges through R1 and R2 until the firing voltage of the neon lamp is reached. When this occurs, the gas within the lamp ionizes, causing it to switch to a low-impedance state. This causes C1 to discharge through the neon lamp until the voltage across it will no longer maintain ionization. The discharge of C1 produces an output pulse across R_L each time the lamp fires. The values selected for R1, R2, and C1 control the frequency of operation of the oscillator circuit. The value of C1 must be large enough to provide adequate energy to the neon lamp to sustain oscillation. If the value of C1 is reduced below 4000 pF, the circuit will not oscillate.

Due to the ionization and de-ionization time of the gas

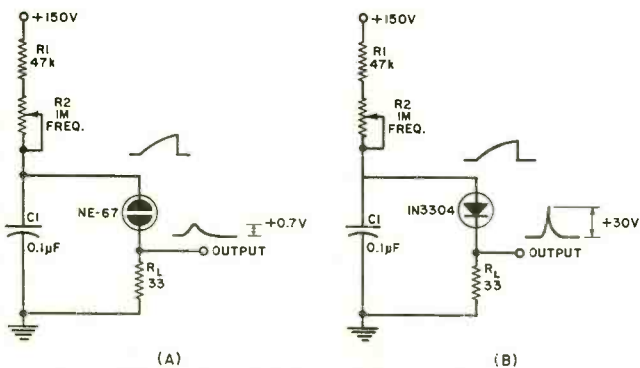

Fig. 1. (A) Neon lamp, (B) 4-layer diode relaxation oscillators.

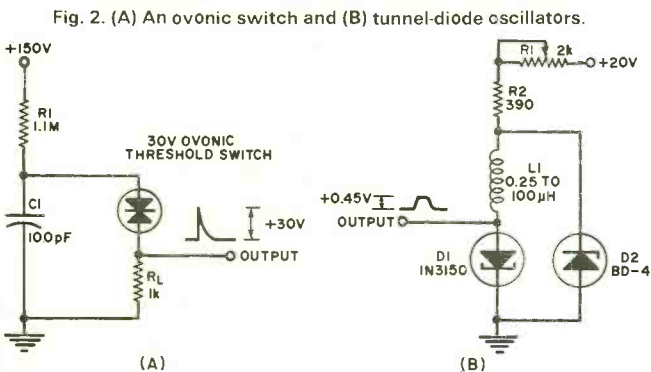

Fig. 2. (A) An ovonic switch and (B) tunnel-diode oscillators.

within the neon lamp, the pulse characteristics of this circuit are poor. With the component values shown in Fig. 1A, the output pulse across R_L has an amplitude of +0.7 volt, a width of 50 μ s, and a rise time of 20 μ s. With a value of 4000 pF for C_1 , the circuit would oscillate at a maximum frequency of 1 kHz.

The pulse characteristics of the circuit can be improved by replacing the neon lamp with a 4-layer diode, as shown in Fig. 1B.

The circuit of Fig. 1B operates on the same principle as that of Fig. 1A. However, the switching time (50 ns max.) and "on" resistance (5 ohms max.) of the 4-layer diode shown improves circuit operation considerably. The output pulse measured across R_L has an amplitude of +30 volts, width of 2 μ s, and a rise time of 30 ns. The amplitude of this pulse may be increased by connecting several 4-layer diodes in series, thereby increasing the effective firing voltage. If three 1N3304 diodes are connected in series, the output pulse amplitude across R_L will be about 90 volts.

Positive and negative pulses can be generated simultaneously by adding another load resistor in series with C_1 . These pulses have the same characteristics except the amplitudes are reduced to one-half their original value. Frequencies up to 500 kHz may be obtained with the circuit of Fig. 1B if C_1 is reduced to 100 pF.

Ovonic Switches and Tunnel Diodes

The circuit shown in Fig. 2A is essentially the same as that shown in Fig. 1B except the 4-layer diode has been replaced by a 30-volt ovonic threshold switch. This device will switch much faster than a 4-layer diode, producing a 30-volt output pulse with less than 8-ns rise time across R_L . Since the ovonic threshold switch is a bilateral device, the polarity of the supply voltage may be changed, resulting in a negative output pulse across R_L . The characteristics of the ovonic threshold switch are similar to the *Motorola* MPT32 3-layer diode except for switching time.

The relaxation oscillator circuit shown in Fig. 2B consists mainly of tunnel diode D_1 , backward diode D_2 , and charging inductor L_1 . When power is applied to this circuit, current through D_1 increases according to the R_1, R_2, L_1 time constant until its peak current is reached. When this occurs, D_1 switches to its high-voltage state, producing an output pulse as shown in Fig. 2B. Backward diode D_2 is used to bias D_1 in its negative resistance region so as to return the circuit to its low-voltage state. The cycle is then repeated.

The operating frequency of this oscillator is controlled by the value of L_1 and the output pulse width by R_1 . With a 0.25- μ H coil for L_1 , the circuit operates at 10 MHz.

Crystals, UJT's and SCR's

One of the problems that exists in relaxation oscillators is frequency instability, which is due mainly to power-supply variations and component drift. If one discrete frequency is desired, the instability may be minimized by adding a crystal in the RC circuit, as shown in Fig. 3A.

This circuit is a basic unijunction relaxation oscillator in which the charging capacitor has been replaced by a crystal. The operating frequency of this circuit is $99,925 \pm 1$ Hz with a 100-kHz crystal and $999,663 \pm 1$ Hz with a 1-MHz crystal. The output signal at B_2 of the unijunction transistor is a 2-V (p-p) distorted sine wave, as shown in the diagram.

A relaxation oscillator using an SCR as the switching component may be constructed as shown in Fig. 3B. In this circuit the R_1 - C_1 time constant is made small to insure that sufficient anode voltage is available to the SCR when the gate is turned on. As the anode voltage increases, C_2 charges through R_2, R_3 , and R_4 until enough energy is supplied to the gate to turn the SCR on. When the SCR conducts, C_1 discharges through SCR_1 and L_1 . The sudden discharge of C_1 through L_1 creates a back-e.m.f. which momentarily reverse-biases the SCR, thereby returning it to its

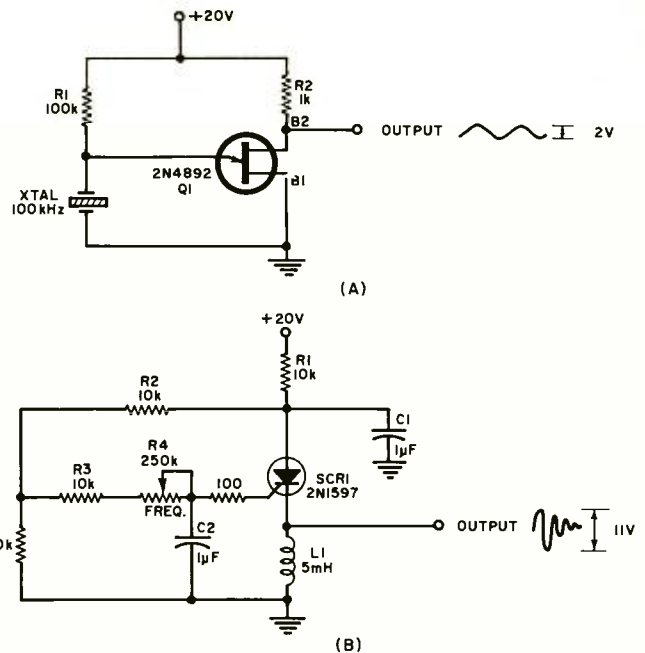

Fig. 3. (A) Crystal-UJT and (B) SCR relaxation oscillators.

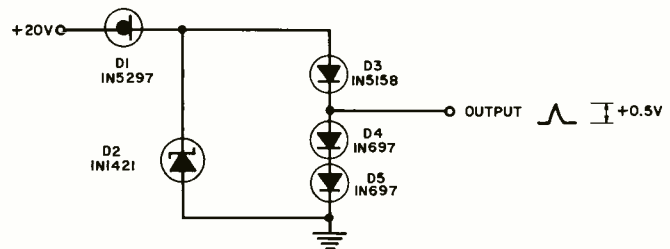

Fig. 4. A relaxation oscillator that employs all diodes.

high-impedance state. The cycle is then repeated at a frequency determined by the value of R_4 . The output signal taken across L_1 is an 11-V (p-p), 150- μ s damped sine wave as shown. With the component values given, the circuit will oscillate with a supply voltage between +5 and +35 volts.

All-Diode Oscillator

The relaxation oscillator shown in Fig. 4 is unique in that it was constructed using diodes only. When power is applied to this circuit, the junction capacitance of zener diode D_2 is charged with a constant current (1 mA) from field-effect diode D_1 . D_2 continues to charge until the forward break-over voltage of 4-layer diode D_3 is reached. When this occurs, D_3 fires, discharging D_2 and producing a small pulse across conventional diodes D_4 and D_5 . The operating frequency of the circuit shown is approximately 40 kHz with power-supply variations from 10 to 35 volts.

This discussion of relaxation oscillators has centered around the generation of positive and negative pulses with different amplitudes, rise times, and frequencies. Most of the oscillator circuits described can also be used to generate different types of ramp functions. For example, with the circuit of Fig. 1B, an RC ramp appears across C_1 at the operating frequency of the oscillator. If resistors R_1 and R_2 in this circuit are replaced by a field-effect diode, as used in the circuit of Fig. 4, the ramp generated will be linear. If a field-effect diode is used in conjunction with a variable-capacitance diode in Fig. 1B, the waveform generated is an exponentially increasing function since the charging capacitance changes with voltage.

Another useful feature of the circuits shown in Figs. 1B, 2B, 3B, and 4 is that if all diodes are reversed and the polarity of the power supply is reversed, the waveforms generated will be of opposite polarity to those shown. ▲

Using Silicon Diode Rectifiers as Power Resistors

By JOHN T. BAILEY

Two simple rules for designing and servicing circuits in which diodes are used to drop voltages for series filament strings.

THERE is an increasing number of TV sets using a silicon diode rectifier instead of a power resistor to drop the voltage applied to the series-heater string to the required value. This diode application should not be confused with a similar application where the diode is in the circuit to supply a lower value standby current and is switched out of the circuit to provide essentially no warm-up delay. This article is devoted to the former voltage-dropping diode application. One may be surprised to learn of the problems encountered in designing and servicing such a simple circuit.

Fig. 1A shows a typical 150-mA heater-string circuit for a phono amplifier using a resistor to drop the line voltage to the value required for the sum of the individual heater voltages. Old timers will recall early a.c.-d.c. amplifiers and radios in which the dropping resistor was built into the line cord in order to keep heat dissipation out of the cabinet. They will also recall worried customers who thought their sets had a short because the line cord would run quite hot. And then a few do-it-yourself set owners were known to

have cut off part of the line cord because it was too long for their needs. These perplexed souls couldn't understand how shortening a line cord could possibly affect the set's operation. Well, those days are gone forever. Line-dropping resistors, if needed, are now much smaller, dissipate less heat, and are mounted inside the sets. But in certain applications, a diode should be used instead of a dropping resistor because it costs less, is smaller, and runs cooler (passes either negative or positive half of input waveform, not both).

Design

Fig. 1B shows the same heater string but with the resistor replaced by a diode. One obvious question at this point is what happened to the 34-volt difference between the line voltage and the heater string? Where is it accounted for in the simple series circuit? The answer is that the diode passes only the positive or negative portion of the sine wave applied to the circuit. Which portion depends on whether it is connected as shown for a negative output or reversed for a positive output as shown for a negative output or reversed for a positive output. As for heating the string, it makes little difference which way it is connected but there is a slight preference for the negative output connection. According to one major tube manufacturer, with the heaters negative with respect to cathodes at or near ground potential, the heater will not pick up electron emission from other parts of the tube.

Now it may be asked why isn't the voltage that is fed to the heater string just one-half of the line voltage since the diode passes one-half of the sine waveform? The answer is that, for heating purposes, we must deal in terms of r.m.s. (effective) currents. Regardless of the waveform, we must design the circuit for an r.m.s. current equal to whatever the current rating of the string. With the type tubes indicated in Figs. 1A and 1B, the tube handbook rating is 150 mA. Current ratings are understood to be r.m.s. values because heating effect is based on r.m.s. currents. Tube heaters are resistive. An r.m.s. voltage applied to a heater string will cause an r.m.s. current to flow. Therefore, we want to know what is the r.m.s. voltage output of the diode and why it is not one-half of the voltage applied to the diode by the line voltage.

Fig. 2A shows the waveform of a half-wave rectifier when the load is resistive. Disregarding the small drop across the rectifier, the peak value of the output waveform below the zero reference is equal to the peak value of the input waveform. Electrical engineering handbooks will show (see

(Continued on page 72)

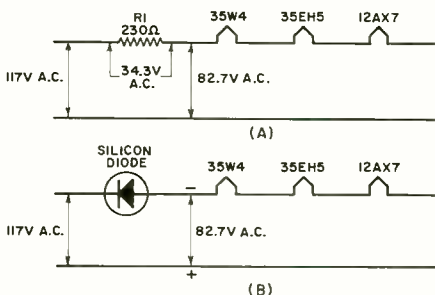

Fig. 1. Typical a.c.-d.c. phono-amplifier heater string circuit using (A) a dropping resistor and (B) a diode replacement for dropping input line voltage to obtain the value required for the sum of the individual heater voltages.

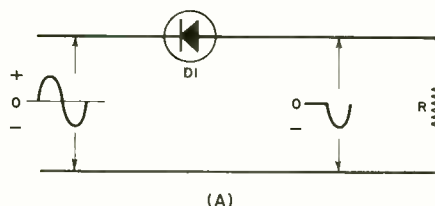
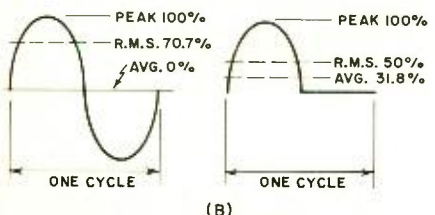

Fig. 2. (A) Input and output waveforms of a half-wave rectifier with resistive load and (B) relationship of r.m.s. and average values to peak values between one cycle of sine wave and the half-wave rectified voltage across resistive load.



Spray Chemicals for Servicing

By JOHN FRYE

Chemicals handle a wide range of electronic servicing problems—from quick cooling for checking intermittents to making TV tuners, switches, and controls perform more reliably. Here are the chemicals that are available, what they do, who makes them, how they are used, and precautions to observe.

EARLY physicists recognized a mysterious affinity between chemistry and electricity. Zinc and carbon plates immersed in a dilute sulphuric-acid solution created a battery and caused an electric current to flow through a wire connecting the plates. On the other hand, if two platinum conductors were placed in the same solution and connected to a battery, hydrogen gas formed at one electrode and oxygen at the other in a 2:1 ratio, the H_2O of the solution being decomposed by electrolysis into its chemical elements. With the discovery of the electron theory the truly intimate relationship between the two fields was revealed.

Today electronics relies heavily and unabashedly on chemistry at all levels from research through manufacturing to service. This article will, of necessity, restrict itself to a small segment of this immense field: aerosol chemicals designed to aid the electronics technician. Even with this restricted focus, the treatment cannot hope to be exhaustive; but we will try to give an idea of representative chemicals that are available, who makes them, why they were developed, how they are used, and what precautions should be observed with them.

Aerosol-type service aids can be arbitrarily divided into *cleaners*, *lubricants*, *insulating coatings*, and *DPRmiscellaneous*. Each of these four categories can again be arbitrarily divided and subdivided. We say "arbitrarily" because many spray products, as you will see, are designed to do two, three, or even four jobs, while others are highly specialized.

Deadly carbon tetrachloride was probably the first service chemical used lavishly in all innocence by technicians to clean contacts. It was an excellent degreaser, but it left naked con-

tact riding on naked contact, and they soon failed. What was needed was a general-purpose non-toxic chemical that would (1) dissolve and wash away grease, oxidation, and corrosion from the contacts; (2) evaporate completely leaving no residue; (3) coat the contacts with a long-lasting protective lubricant; and (4) be easy to apply to difficult-to-reach contacts. Many manufacturers have come up with just such chemicals, and they have solved (4) by placing them in aerosol spray cans. Ideally, the contact cleaner has low surface tension for good wetting and penetration into tiny crevices and high density to give the spray weight for dislodging and washing away crud. Also, hopefully, it is non-explosive and non-flammable—but don't depend on this; read the instructions!

Spray Contact Cleaners

General-purpose contact cleaners are used on all kinds of switch and relay contacts plus the contacts of all sorts of plug-in devices, including tubes. Application depends somewhat on the type of contact. With sliding contacts, such as rotary and slide switches, tuning-capacitor wipers, or plug-in devices, the spray is directed at the contacts, usually through the small plastic tube furnished with the spray. After waiting a few seconds for the chemical to soften the oxidation, work the switch or tuning capacitor or insert and remove the plug-in device several times so the softened corrosion will be wiped away by the sliding action and the protective lubricant will be evenly distributed over the cleaned contacts. Where wiping action is less pronounced, as in relay contacts, it may help to insert a piece of notepaper between the wetted contacts and hold them pressed against the paper while



it is slid back and forth to wipe away the dirt; then spray the contacts again.

Here's a partial list of general-purpose contact cleaners together with their manufacturers: *Chemtronics* Contact Kleen, *CRC CO* Contact Cleaner, *Crown Switch & Contact Cleaner*, *DCMC* Electronic Switch Cleaner & Lubricant, *Electronic Chemical Corp. (ECC)* EC-44, *Injectorall* Electrical Contact Cleaner, *GC Electronics* Relay-Kleen, Action, and JIF; *LPS Research Labs* Instant Contact Cleaner, *Miller-Stephenson Chemical Co.* MS-230 Contact Re-Nu, *Quietrole* Spray-Pack Lubri-Cleaner and Silitron, *RCA* SC106 Deluxe Relay and Contact Cleaner, *Sprayon* Electrical Contact Cleaner, *Trans Atlantic Electronics* Electrolube 2A, 2A-X, and 2GA-X; and *Workman Electronics* Super Wissh Contact Cleaner.

Some chemical manufacturers felt another type of cleaner was needed for specific use on all types of variable-resistance controls. Aerosol sprays permit introducing the cleaner without dismantling the control. The spray can be introduced through crevices where the lugs emerge from the case or through small openings produced by stamping a rotation stop in the cover. Poor contact occurs more often between the rotor and the connecting lug than between the rotor shoe and the resistance element; so cleaner is needed especially at the sliding contact near the shaft.

Workman markets a clever tool, called Gozinta, to take care of this and to permit cleaning the control from the front without pulling the chassis. It consists of a tapered plastic tube threaded at the large end to screw onto the shaft collar of the control. The small end inserts into the aerosol-cleaner outlet, and pressure forces the cleaner around the shaft into the control. In all cases, after the

cleaner is sprayed into the control the shaft should be turned back and forth through full rotation several times. If this does not clear up erratic operation, the resistance element is probably worn and the control will have to be replaced.

Manufacturers and their products specifically recommended for cleaning controls are: *Chemtronics* Contact Kleen, *ECC* No Noise Volume Control & Contact Restorer, *Injectorall* Hi-Fi Control Cleaner, *GC* Spray-Pack and Silitron, *RCA* SC101 Heavy Duty Control Cleaner & Lubricant, and *Workman* Lubrite.

When TV tuners came into use, they presented special problems with regard to contact cleaning. Not only were there lots of contacts carrying a wide variety of currents ranging all the way from d.c. to minute amounts of v.h.f. and u.h.f. radio frequencies, but in close proximity to these contacts were associated tuned circuits easily detuned by the presence of any foreign substance—including contact cleaner—in their fields.

Wide-ranging attempts to satisfy critical TV-tuner cleaning requirements result in a large number of products hard to catalogue, for each manufacturer has a somewhat different idea. One approach is to design a combination degreaser-cleaner in which the solvent cleans the contacts and evaporates, leaving a lubricant coating to protect the contacts. Other manufacturers feel no one product can do both cleaning and lubricating jobs properly; so they manufacture one evaporating lubricant-free cleaner to wash off accumulated grime and a second heavier lubricator-polisher to protect cleaned contacts. Other manufacturers make a tuner cleaner specifically for color-TV sets and still another for nuvistor/transistor tuners.

Since we are still talking about cleaners, we shall here discuss these TV-tuner cleaners: the degreaser-cleaners, color-TV tuner cleaners, and nuvistor/transistor-tuner cleaners. When we get around to talking about spray lubricants, we shall discuss the lubricator-polisher types of tuner cleaners. Remember, though, tuner cleaners do not always fit neatly into such categorizing. One-shot degreaser cleaners may also contain a lubricant; a color-TV tuner cleaner can safely be used on black-and-white sets; etc.

In applying any kind of aerosol tuner cleaner, it is well to keep these points in mind: (1) one-shot products with more lubricant usually protect better but detune more; (2) silicone lubricants last longer than petroleum lubricants; (3) avoid spraying any capacitive device, especially a neutralizing capacitor, or any coil; (4) don't drench the tuner with cleaner, confine the spray as nearly as possible to the contacts; (5) a better job can usually be done by removing the tuner and taking off the shield cover so contacts can be sprayed with greater force and precision; and (6) always follow the manufacturer's instructions.

Here are representative TV-tuner degreaser-cleaners and their manufacturers: *Castle TV Tuner Service* Muck Off, *Channel Master* Tuner Cleaner and Tuner Wash, *ECC* Super Bath Spray, *Injectorall* Spray-Clean and Economy Cleaner, *Krylon* No. 1333 Tuner Cleaner, *Quietrole* Mark II, *Tech Spray* Blue Stuff, and *Workman* Miracle Bath.

Higher picture-tube voltages in color sets cause more dirt to precipitate in their tuners. Critical tuning in color tuners can be seriously changed by the presence of lubricant in the wrong places. Such considerations have led to the marketing of sprays the manufacturers particularly recommend for cleaning color-TV tuners: *Channel Master* Chroma Foam, *Chemtronics* Color Lube, *GC* Color Magic Spray-Lube, *Injectorall* Super 100, *RCA* SC100 Deluxe Color Tuner Cleaner Lubricant, and *Workman* Color Tuner Toner.

Small neutralizing capacitors in nuvistor and transistorized tuners are particularly sensitive to the presence of some cleaners in their electrostatic fields. At least two manufacturers have produced tuner cleaners said to be safe



The most common use is to clean and lubricate TV tuner contacts.

Chemicals are also used to clean the heads in tape machines.



with these sets: *Chemtronics* Tun-O-Lube 800 Transistor Tuner Cleaner and *GC* Nuvi-Tran Tuner Cleaner.

Spray chemicals are used to clean other things than contacts. For example, efficiency of record and playback tape heads of audio and video recorders are seriously impaired by the build-up of material lost from the tape that holds the tape away from the heads and partially short-circuits the magnetic fields of the gaps. The residue also collects on the capstan, pinch-roller, and tape guides and interferes with the proper transport of the tape past the heads. Several manufacturers market aerosol cleaners to wash away this material: *Channel Master* Tape Head Cleaner, *Chemtronics* THC-6, *ECC* Tape-Reco Head Cleaner, *Injectorall* Clear Sound, *GC* Audio-Video Magnetic Tape Head Cleaner, *Miller-Stephenson* MS-200 Magnetic Tape Head Cleaner, *RCA* SC107 Deluxe Audio/Video Tape and Head Cleaner, and *Workman* 8 Heads Tape Head Cleaner.

Grease and other material collecting on dial-drive, tape recorder, and other belts encountered by the technician cause these belts to slip. Sprays to clean this material off the belts are made by: *Crown* Non-Slip Drive Belt Cleaner, *Krylon* No. 1330 Belt Dressing, and *Sprayon* No. 607 Belt Dressing.

Solder flux can be removed from where it is not wanted by *Crown's* Flux Remover, *Miller-Stephenson's* MS-190/MS-190HD Flux Removers, and *Sprayon's* Freon TMC Cleaner.

Rust and corrosion are always a problem in TV antennas and towers as well as automotive installations, so several manufacturers have come up with products that we group together as rust removers, rust inhibitors, and penetrating oil. These sprays are excellent to loosen rusted nuts or frozen yokes or other seized unions of two pieces that should move freely and to keep rust and corrosion from returning. Examples include: *Chemtronics* Chem-Oil, *CRC* 2-26, *Crown* Penetrating Cleaning Oil, Rust Inhibitor, and Formula 101; *Krylon* Let-Go No. 1332, *LPS* #1, #2, and #3; *Miller-Stephenson* MS-150 En-Rust, *C. H. Mitchell Co.* 12/34 Miracle Formula, and *Sprayon* Penetrol, PDRP, Anti-Rust Spray, and Penetrating Oil No. 203.

Occasionally the technician needs a really heavy-duty cleaner to remove sludge from an antenna rotating motor, an over-oiled phono motor, etc. He will find same in *CRC's* Lectra-Clean and *Krylon's* Electric Motor Cleaner.

An allied problem is the need to remove moisture from motor windings or to pull the water out of a transistor radio that has been dropped in the lake. The need is met by *LPS's* #2 or #3 and by *Sprayon's* Quik-Dri Demoisturant No. 2004.

Finally, after the technician has done all this cleaning, he is likely to need a little cleaning himself, and he has not been forgotten. An aerosol can of *CRC's* Electrical Antiseptic Hand Cleaner or *Crown's* Foaming Hand Cleaner in his tool-box will allow him to lay immaculate hands on that blonde TV cabinet.

So much for the "cleaners." As we warned you, many of them do lots more than clean, but their essential role is that of a burlesque queen—to take things off. Now we turn to the spray products whose basic purpose is to lubricate.

Spray Lubricants

First, let's return to the unfinished business of the TV tuners that were cleaned and not lubricated or to those in which we feel we need to place a polishing lubricant to keep the contacts bright. In applying these, great care should be used to direct the spray only at the contacts and not to over-spray. Examples include: *Castle* Intimate Contact, *Chemtronics* Tun-O-Brite and Tun-O-Foam, *ECC* Super-Lube, *Injectorall* Blue Lube, *GC* Magic Vista, and *Workman* Foamy White Lubrite. Note some of these clean as well as polish and lubricate the contacts. They are grouped here because their makers emphasize lubrication.

As long as mechanical parts are designed to rotate and slide together, the technician will need a light lubricating oil to facilitate this action. He needs such an oil especially for use with record players, tape recorders, remote-control motors, switch-latching mechanisms, and detent mechanisms. Several manufacturers package such a lubricant in spray cans for putting the oil into hard-to-reach areas: *Chemtronics* Chem-Oil, *GC* Pressurized Lubricating Oil,

Q & A on Sprays

Editor's Note: While we were gathering material for this article, we found the following interesting and informative questions and answers on aerosol spray chemicals in a catalogue put out by Sprayon Products, Inc. We'd like to share them with our readers.

What Makes It Spray? About half the contents is liquid gas in solution with the product (A). At 70°F, there is a pressure of about 35-38 pounds per square inch. So when the push-button valve is depressed, the head pressure from the vaporized gas in the can forces out the product, liquid-gas solution. The gas vaporizes instantly in the free air—in a sense, explosively atomizing the particles of the products which are deposited as a smooth film.

How Long Can It Be Stored? Aerosol products were relatively new in 1948, but samples held since then have worked successfully. The can is hermetically sealed, and not much can happen to it. Perhaps over a period of many years, the valve and can gasketing material might break down, but the gas has no effect on the product.

What About Clogging? A properly formulated product-gas solution should yield a package practically free of what used to be the No. 1 complaint—clogging. Paint products will dry and harden, and unless certain simple precautions are taken, heavy pigmented enamels—not lacquers—may tend to block the small pinhole openings in the valve. If the can is merely inverted after use, the valve released, and a jet of clear gas passed through the valve, the valve will be self-cleaned and will always operate free of trouble (B). If this precaution is neglected, pull off plastic valve head, clean it and valve core.

Can You Use All of It? There is more than enough gas to spray the entire contents. Sometimes, however, one unacquainted with the "insides" will try to use the can in the wrong position (C). Obviously only clear gas will come out. Merely turn the plastic valve head a half turn, and the plastic tube will then dip into the solution and the last drop will be as uniform as the first. The gas has the unique property of liquefying at low pressure, and only enough gas will vaporize inside the can to maintain a constant head pressure.

How Should It Be Stored? Remember that gas pressure increases at a rapid rate as the temperature increases. All aerosol products are tested at 130°F temperatures (ICC Regulations), but they should not be exposed to temperatures over 120°F. Also, use caution in disposing of empty cans. They should never be incinerated or thrown in a rubbish fire. There is still residual gas that might burst the can. Do not puncture the can or you will have an "unwieldy" stream of paint, or whatever the product might be, on your hands.

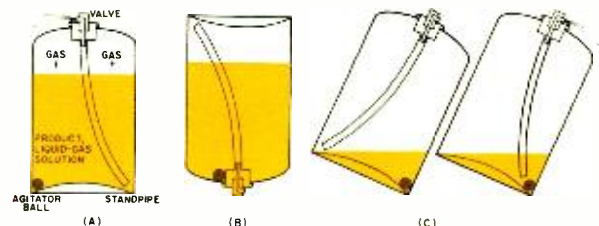



Many companies have a complete line of chemicals for servicing.

RCA SC105 Deluxe Multi Purpose Lubricant, and *Workman* Spray Oil.

When a lubricant is needed that will not run, gum, or form residues; that forms a protective seal against water or corrosion; that preserves and lubricates rubber, wood, and even aluminum; and that will not contaminate surfaces to prevent later painting, a silicone lubricant is indicated. This spray lubricant keeps antenna rotors and turntables turning smoothly, protects connections from moisture and corrosion, prevents doors and locks of the service truck from freezing, and even keeps the zipper on your service jacket working smoothly! Such lubricants are: *Crown* Silicone Lubricant and Slix-it, *General Electric* Silicone Lubricant, *Krylon* All-Purpose Silicone Spray and Heavy Duty Silicone Lubricant, and *3M* Spray Silicone. Finally, if you pull a lot of coax through conduit while installing TV-distribution sys-

(Continued on page 72)

A listing of manufacturers and the spray-chemical products that they make.

MANUFACTURERS

Castle Television Tuner Service, Inc. C,M 5710 N. Western Ave., Chicago, Ill. 60645	Krylon Dept., Borden Chemical Inc. C,G,I,J,O,Q,U 350 Madison Ave., New York, N.Y. 10017
Channel Master Div., Avnet, Inc. C,D,F,T Ellenville, N.Y. 12428	LPS Research Labs, Inc. A,I,K 2050 Cotner Ave., Los Angeles, Calif. 90025
Chemtronics A,B,D,E,F,I,M,N,Q,R,T 1260 Ralph Ave., Brooklyn, N.Y. 11236	Merix Chemical Co. S 2234 E. 75th St., Chicago, Ill. 60649
CRC Chemicals A,J,L,Q Div. C.J. Webb, Inc. Dresher, Pa. 19025	Miller-Stephenson Chemical Co. Inc. A,F,H,I,S,T Route 7, Danbury, Conn. 06813
Crown Industrial Prods. Co. A,G,H,I,L,O,Q,S,T,U 100 Stateline Rd., Hebron, Ill. 60034	C.H. Mitchell Co., Electronic Tools Div. I 18531 Ventura Blvd., Tarzana, Calif. 91356
DCMC International Inc. A,Q,S,U 239 Great Neck Rd., Great Neck, N.Y. 11021	Quietrole Co. A,C Box 2607, Station A, 395 St. John St., Spartanburg, S.C.
Electronic Chemical Corp. (ECC) A,B,C,F,M,T 813 Communipaw Ave., Jersey City, N.J. 07304	RCA Parts and Accessories A,B,D,F,N,Q,R,S,T 2000 Clements Bridge Rd., Deptford, N.J. 08096
Emerson & Cuming Inc. Q,V Dielectric Materials Div., Canton, Mass. 02021	Sprayon Prods. Inc. A,G,H,I,K,Q,S,T 26300 Fargo Ave., Bedford Heights, Ohio 44146
Epoxy Products Co., Div. Allied Prods. Corp. V 166 Chapel St., New Haven, Conn. 06513	Tech Spray C Amarillo, Texas
GC Electronics, Div. Hydrometals Inc. A,B,D,E,F,M,N,Q,R,T 400 S. Wyman St., Rockford, Ill. 61101	Tempil Div., Big 3 Industries Inc. W Hamilton Blvd., So. Plainfield, N.J. 07080
General Electric Co., Silicone Prods. Dept. O Mechanicsville Rd., Waterford, N.Y. 11218	Trans Atlantic Electronics Inc. A 55 Bloomingdale Rd., Hicksville, N.Y. 11801
Holub Industries Inc. P Sycamore, Ill. 60178	3M Co., Adhesives, Coatings & Sealers O,U 3M Center, St. Paul, Minn. 55101
Injectorall Electronics Corp. A,B,C,D,F,M,Q,R,S,T 4 North Rd., Great Neck, N.Y. 11024	Workman Electronic Prods. Inc. A,B,C,D,F,M,N Box 3828, Sarasota, Fla. 33578

KEY TO PRODUCTS

CLEANERS

- A. General-purpose contact cleaner
- B. Control cleaner
- C. TV tuner degreaser/cleaner
- D. Color-TV cleaner
- E. Nuvistor/transistor tuner cleaner
- F. Tape-head cleaner
- G. Non-slip belt cleaner
- H. Flux remover
- I. Rust remover. inhibitor. penetrating oil

- J. Heavy-duty cleaner
- K. Moisture remover
- L. Hand cleaner

LUBRICANTS

- M. TV tuner polisher-lubricant
- N. Light lubricating oil
- O. Silicone coating
- P. Wire-pulling lubricant

INSULATORS

- Q. Insulating spray. protective coating
- R. High-voltage spray
- S. Anti-static spray

MISCELLANEOUS

- T. Cooling spray
- U. Adhesive spray
- V. Conductive coating
- W. Temperature-indicating spray



The author, shown adjusting knobs of control console during mix-down session, does complete engineering, dubbing, mixing and sound effects for records made and published by the Filmore Corporation. For all recording assignments he uses multichannel recorders, including Ampex's MM-1000-8 and -16.

Classical Recording Techniques

By FRED CATERO/Chief Engineer, Filmore Corp.

Present methods of recording classical material often do not have the quality of live performances achieved by jazz/rock recordings.

Greater use of multichannel recording techniques may be the answer.

TRADITIONALLY, classical music represents one of the highest forms of musical expression. Its combination of sounds, emotion, and complexity of composition make years of preparation and study mandatory for its execution, or even its appreciation. The harmonic spectrum of classical music is the basis for many of the other musical forms which have evolved during the past four centuries. Although other types of music have enthusiastic adherents, by world-wide consensus, the audience for classical music is the largest and most enduring.

Recently, it has become increasingly clear that, in some respects, the classical music world is lagging behind jazz/rock. The fault lies not with the quality of classical music performances, which remain consistently high, but in the way they are being recorded.

The classical music tradition has also proved a hindrance to its progress. The proliferation of taped music makes classical recordings of all types available to a whole new audience. However, current methods of recording classical tapes do not always provide the live-performance quality such listeners have been used to with their jazz/rock recordings. One reason is that jazz and rock are being recorded using multichannel techniques, while classical discs are not.

Multichannel recording of jazz/rock allows pure sounds to be captured, original sounds to be enhanced, and errors to be corrected. These advantages are obvious when comparing classical and jazz/rock recordings with their live

performances. The jazz/rock (multichannel) recording can faithfully recreate, and frequently enhance, the live performance whereas a classical recording invariably falls short of a true "concert-hall" effect.

A brief review of classical recording methods will pinpoint just where multichannel techniques could be used to improve such recordings.

The objectives of the classical recording engineer differ from those of the jazz/rock engineer. The latter wants to separate instruments while recording so that sound effects, corrections, and various sound impressions can be added later. On the other hand, the classical engineer tries to record the orchestral performance as faithfully as possible. While both want a fine product, the classical engineer is not permitted the technical flexibility which multichannel recorders offer the jazz/rock engineer.

Unlike the jazz/rock engineer, the classical engineer has very few cues to watch for in controlling volume. The volume, which could be accurately measured by instruments, is the province of the conductor. The instruments for a classical recording are as traditionally positioned as the keys of a typewriter, so it is the conductor who ultimately controls the volume. Thus, the engineer is left to record sounds as they are played.

The number of tracks used in classical recording makes it virtually impossible to recreate a true "concert-hall" effect. Classical recordings have been made with 3- and 4-track

(Continued on page 66)

All Those Electronic Chemicals

BY JAMES ROBERT SQUIRES

A lighthearted look at those modern wonder chemicals that pamper our electronic gear.

ANY list will include more than fifty assorted chemicals used by the electronics industry, the TV technician, the lab engineer, or the experimenter. They make his work easier, smoother, cleaner, brighter, stickier, duller, scratch-proof, more oily or free from oil or rust or flux or glue or—it goes on forever.

We now have chemicals to get us into and out of just about any mess we might imagine. The secret, of course, is knowing which chemicals to use for what mess. The parts-supply houses offer page after page of these chemicals with others available on special request from both these houses and other companies. Methods of dispensing chemicals range from the old-fashioned tube and bottle to misty, sometimes drippy sprays, to the little lab where you are required to mix the final brew yourself such as with some of the epoxy-resin cements. One company even allows you to mix the chemicals in a tube.

Our electronic systems are the most squeezed at, brushed on, rubbed in, sprayed over, and embedded around the world. It is a frustrating, confusing chemical world at best. The sophisticated user of today's electronic chemicals never considers putting something on his circuit without something else close at hand to just as quickly remove the same stuff.

Paints, for example, in old-fashioned cans and used with a brush are still available but these are losing popularity to the aerosol spray enamels, crackle finishes, and a whole slew of others too numerous to mention. Just press a button and beautiful colors appear to decorate any surface.

Among the most fascinating of the chemicals are the specials. One in this category is *General Cement's* "Zero Mist," which is sprayed on the warm operating electronic circuit. The mist cools the component, thus locating circuit malfunctions quickly. It can isolate cold-solder joints, oxidized junctions, and open components such as resistors. You can spray on blackboard surfaces, dulling coatings or mirror surfaces, lubricating oils and compounds, or in another container find a non-slip aerosol coating. There are chemicals to prevent corona and electrical noise in carbon controls, to put out fires, and to frost your cocktail glasses or your window glass as the need develops.

There are unique cleaners that have been developed in an attempt to match the chemical to the special need. There are motor cleaners, tuner cleaners, non-detuning cleaners, lubricating cleaners, non-lubricating cleaners, and wiping-contact cleaners. You can also find rust and degrease cleaners and, last but not least, there is a hand cleaner to wash away residue of all those other cleaners from your hands.

Burstein Applebee offers a "Super Frost Test" for thermal intermittent components similar to *Zero Mist*. *B.A.* states that it can also be used to cool martini glasses for a party. So, you see, the chemical guys aren't really all establishment. There is a scratch-removing compound that is claimed to remove cigarette burns as well as many other genre of scratches from polished plastic surfaces. So, no matter what your thing—drink or smoke—the chemical guys are in there pitching.

We now have a tool dip that gives any of your tool handles a bright, tough, insulating plastic coating that resists acids, alkalies, and petroleum derivatives such as gasoline.

Sealant cements are available that have a lifetime of ten years or more. *General Electric's* "Silicone Seal," for example, remains pliable for years and will bond to such tricky surfaces as ceramics, fabrics, glass, and masonry.

Spray-on techniques have even progressed to power sprays. *Allied Radio* now offers a "Jet-Pak" spray outfit that is powered by a gas cartridge and enables you to spray any liquid that is fluid enough to pass through the spray's nozzle. I wonder how a very dry martini would go down if it were sprayed one swallow at a time into the recipient's mouth? Seems that martinis might take on the acceptable aura of a mouth spray and could then be enjoyed even en route to work if that's your way.

It is at this point that the toughest job of all confronts us as we attempt to match the proper chemical to the electronic component with an eye to what we can expect the chemical to do for us. This isn't as easy as it sounds, considering that certain solvents we might pick will, say, dissolve plastics (acetone dissolves most commercial plastics) and other parts of valuable components. Certain other paints will never dry under some conditions, leaving the surface a gooey mess. Many of the modern electro-chemicals must be used with adequate ventilation to avoid inhaling poisonous fumes.

There are times when the judicious use of chemicals will make an inexpensive component perform like one of the best. There is the inexpensive switch whose contacts can be immersed in a silicone lubricant. This acts as a contact cleaner as well as preventing further corrosive effects. Thus, by the use of chemicals, you have greatly improved the reliability of the switch as well as its useful life span.

The future of spray chemicals is indeed bright. Someday, possibly, you'll be able to spray a circuit to your own exact specifications using a series of templates and a proper collection of aerosol cans filled with such goodies as sprays for 5-watt resistors, 0.05- μ F capacitors, 20-mil copper wiring, fuse wiring, and on and on. ▲

Signal Averaging Techniques

By SIDNEY L. SILVER

When low-level repetitive signals are buried in noise that can't be filtered out, these methods pinpoint the signals. Biomedical electronics, vibration studies for oil exploration, investigating signals from outer space, analyzing the molecules of materials are some of the many applications.

In the physical and biophysical sciences, it is often necessary to observe repetitive waveforms whose parameters are obscured by noise. The noise sources may include interference from nearby equipment, power-line pickup, system ground loops, and random noise. These disturbing elements set a fundamental limit on the ultimate sensitivity, or resolution, which defines the minimum detectable signal increment that can be handled by a precision instrument. In principle, where the signal of interest and the noise occupy a different portion of the frequency spectrum, conventional filtering techniques are entirely satisfactory.

Random noise, however, includes all extraneous interference such as the effect produced by thermal fluctuations, and by statistical variations due to the quantized nature of the physical phenomena being measured. Since this type of noise is generally distributed over a wide range of frequencies, selective filtering is useless because no matter where the passband is located on the frequency scale, some of the noise will always pass through the system. This presents a difficult problem in spectral analysis, namely that of isolating and extracting a usable output signal when the input level is extremely small in comparison with the incoherent background noise level of the measurement system.

To overcome this problem, a powerful technique known as signal averaging, or signal recovery, is being employed to pull desired signals out of non-filterable noise. This technique is a form of spectrum accumulation which makes use of the redundant information inherent in repetitive waveforms. A basic requirement for signal averaging is that a time reference signal be made available which bears a fixed relationship to the desired signal, but not to the noise. This may be accomplished by using a synchronizing pulse (usually derived from the physical parameter being measured) to identify each repetition of the waveform segment to be examined. Thus, by time-locking the repetitive component to the system trigger, it is possible to extract a coherent pattern, even if the spurious noise is much greater in magnitude than the signal of interest. The over-all result is a substantial improvement in system sensitivity, dynamic range, resolution, and accuracy.

Signal-averaging equipment has found wide application

in biomedical electronics in which the analysis, diagnosis, and monitoring of physiological phenomena is accomplished by the measurement of bioelectrically transduced

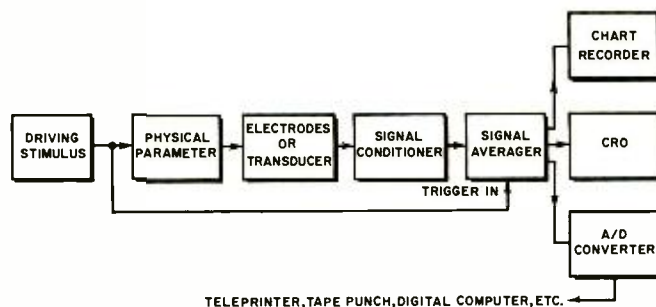
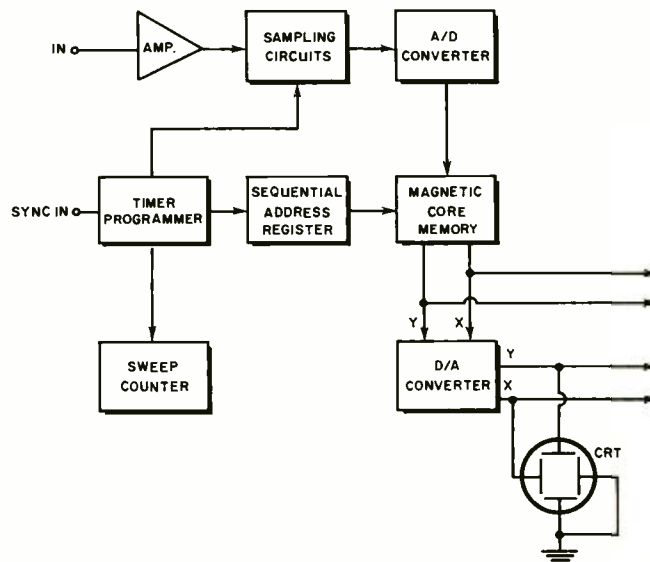

Fig. 1. Block diagram of typical measurement setup using signal averaging to optimize the signal-to-noise ratio.

Fig. 2. Diagram showing basic elements of a digital averager.



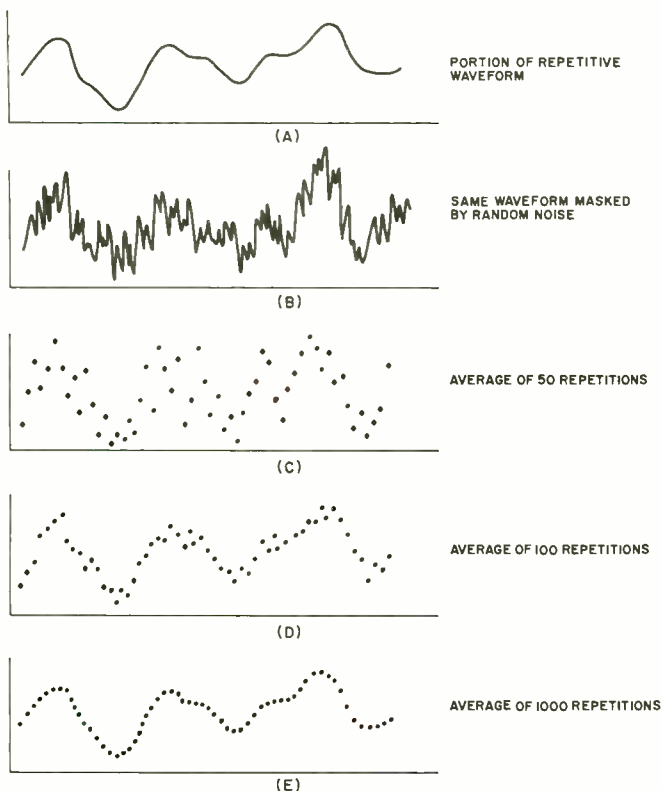

Fig. 3. Graphs A through E demonstrate that signal recovery by digital averaging produces gradual signal-to-noise improvement.

potentials. Using evoked response techniques, the cause-and-effect relationship between various stimuli and the particular responses can be determined, even in cases where the signals of interest are concealed in a blanket of spontaneous noise. Signal recovery enables the researcher or clinician to study in detail the reaction of a muscle to a nerve impulse, the events relating to the cardiac cycle, and the response of the brain to such stimuli as sound, light, and touch. In all of these electrophysiological measurements, the small electrical impulses associated with each phenomenon can easily be separated from the inherently noisy environment. Moreover, by interfacing a signal averager with a computer, it is possible to analyze large amounts of medical data from clinical records to determine the statistical influence or significance of various parameters. These results can be used to measure the effects of specific treatments and to develop improved diagnostic procedures.

In analytical instrumentation, the averaging process is particularly useful in many types of spectroscopy for determining the chemical composition of liquid, solid, and gaseous material. Some of these fields include spectrophotometry in the infrared, visible, and ultraviolet ranges, nuclear magnetic resonance, fluorescence analysis, and x-ray diffraction spectrometry. In each of these application areas, there is a scanning process in which a sample specimen under investigation is subjected to a varying magnetic or electric field. Generally there is absorption of energy by the sample, and since different samples have distinct patterns, or spectra, the elements or compounds contained within the specimen can thus be identified. These characteristic patterns are formed by detecting the energy absorbed and plotting it as a function of the values of the field which created the absorption. Here signal averaging of the detected signal is often required when working with sample specimens whose spectra are difficult to obtain because of very small quantity or extremely high dilution.

Other applications where signal recovery has proven valuable are molecular beam analysis, pulsed ultrasonic flaw detection, vibration studies in seismic exploration of oil,

transient-response analysis, and the investigation of pulsar signals from outer space. In effect, the averaging technique enhances the signal-to-noise ratio in many measurements where extensive random noise interferes with the recovery of repetitive waveshapes, and which require sophisticated signal processing to sift useful information from the raw data.

Principles of Operation

Fig. 1 shows a typical measurement setup which incorporates signal averaging to optimize the signal-to-noise ratio. Here the pickup may consist of an electrode array for biomedical phenomena or a suitable transducer for converting the physical quantity into corresponding electrical signals. The signal conditioner provides a variable bandwidth characteristic and includes a low-noise, high-gain differential amplifier to supply sufficient drive for the signal averager. To obtain the required sync pulse, it is possible to use a recurrent peak of the repetitive signal as a reference trigger, provided it occurs prior to the spectral region of interest. In this case, an external driving stimulus excites the system in order to evoke a response from the physical parameter. Another way to create the scanning process is to derive a sync pulse from a contact closure at the start of the scan by pulsing the physical quantity with a mechanical chopper. During the signal-averaging process, the clearly defined output signal is continuously available for observation on a monitoring scope, or read out on demand or by programmed command on a chart recorder.

Signal recovery can be accomplished with either analog or digital circuitry. In the digital averager shown in Fig. 2, the input signal (which is often a composite of signal plus noise) is sampled or sliced into small segments at equally spaced intervals, and the resulting information stored in a 1000-word magnetic-core memory. The sync pulse provides an indication to the sampling circuits when to initiate the scanning cycle. As the signal repeats itself, a new sample of the composite waveform is taken and added to the original information, thus building up the data samples in each memory channel. After a sufficient number of repetitions, the voltage level of the desired signal in each channel will be proportional to the average value for that particular segment of the signal waveform (Fig. 3).

In this process, the signal of interest is reinforced at an algebraic rate while the random noise (not being synchronous with the trigger) is added at an r.m.s. rate. In effect, the signal portion of the input waveform is a constant for any sampling point, so that its contribution to the stored sum is multiplied by the number of repetitions. By contrast, the noise, which makes both positive and negative amplitude excursions at any sampling point, varies in proportion to the square root of the data samples taken. As an example, after 10,000 repetitions of the waveform, the signal is 10,000 times stronger, while the noise is $\sqrt{10,000}$, or 100 times greater. Thus, the signal-to-noise voltage ratio is 100 to 1, or an improvement of 40 dB. In practice, any continued enhancement of the signal-to-noise ratio (up to a maximum of 60 dB) depends upon the instrumentation limit of the measuring system and the stability of the input signal itself. Provision is made for calibrating and stabilizing the output signal, so that the waveform amplitude remains effectively constant as the noise component diminishes about the desired signal level.

Stimulus-Evoked Response Measurements

Almost all physiological functions of the human body are accompanied by bioelectrical changes, the measurement of which provides an effective means for studying the condition of various organs. In these measurements, an array of biopotential electrodes acts as the interface between the living tissue and electronic instrumentation. These probes detect the minute impulses produced by electrochemical

reactions within the body and transform them into analogous electrical form. However, due to ambient noise originating in the measurement system, as well as within the biological system, the low-level signals of interest tend to be swamped out, thus making it virtually impossible to perform many useful electrophysiological measurements without some form of signal recovery.

Fig. 4 shows an automatic measuring system in which signal averaging is used to process electrical signals produced by various external sensory stimuli. Here a selective stimulus, e.g., light flash, audio tone burst, or tactile stimulator, is applied repeatedly to the subject being tested, in order to evoke a response potential and also to initiate operation of the averaging circuits. Using the appropriate sensor for a particular analysis, this instrumentation system can be employed in many areas of biomedical data acquisition, such as electroencephalography (EEG) for studying evoked response signals from various portions of the brain, audiometry for testing hearing acuity, electrocardiography (ECG) for investigating the series of complex electrical changes repeated at every heart beat, electromyography (EMG) for time averaging of nerve impulses along portions of the muscles, and electroretinography (ERG) for measuring the electrical activity of the retina following light absorption.

The heart of the measurement system is a logic device, or programmer, which controls the automatic function of various components so that they operate in proper time sequence. In preparing for a run, or analysis sweep, a number of processing parameters are preselected, such as the desired stimulus characteristics (i.e., frequency, presentation rate, duration, and rise and fall times), analysis time, and the desired roll-off characteristics of the driver amplifier. During the run, the two-channel chart recorder displays the raw output of the driver amplifier in one of its channels, and the averaged responses processed by the signal averager on the other channel.

Initially, the raw signals are recorded at a very low chart speed so that any spurious noise pulses generated by variations in contact potential (due to displacement of the electrodes) can readily be observed. The low chart speed is also convenient for monitoring the gradual build-up of the stimulus-evoked signals with time. After a predetermined number of responses have been accumulated, the recorder drive is automatically speeded up to provide an expanded, detailed trace of the actual processed signals used for the analysis. Usually the chart recorder is equipped with a pair of event markers, one of which is activated by the sync pulse to record the beginning and duration of each stimulus, and the other to manually record an identifying mark at any time during the measurement. The interpretation of the recorded signals involves a technique of pattern recognition where the measured parameters of the waveforms are compared with those associated with normal and pathological subjects, so that a diagnosis can be made.

In a typical EEG analysis, a number of surface electrodes are attached to the subject's head, one of the electrodes being connected to the system ground. Here the repetitive flash of a xenon-filled strobe lamp is used to evoke an optical response from the brain, the stimulus also serving as the trigger mechanism to start the analysis sweep. As a result, rhythmic variations are picked up by the sensors, the changes representing the positive and negative charges that shift throughout the brain. These transduced signals are quite low in amplitude and frequency, ranging from 10 to 100 μV at 1 to 100 Hz. After a sufficient number of stimuli have been applied, all non-repetitive variations of the signal due to unrelated brain activity tend to be suppressed, so that a clean averaged response is retrieved at the output.

In the example shown in Fig. 5C, the average response (shown as an analog plot) taken over analysis time t_a indicates that the primary response of the raw EEG waveform

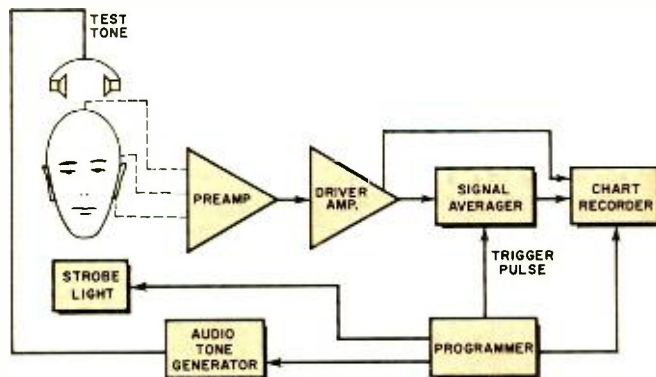

Fig. 4. Block diagram showing an automatic biomedical instrumentation system for stimulus-evoked response measurements.

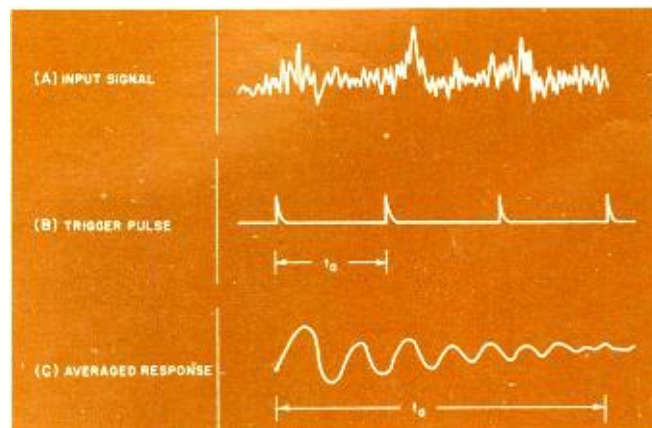

Fig. 5. Graphs demonstrating signal averaging of EEG signal. The raw input data (A) uses a trigger pulse (B) to produce an averaged evoked response (C) of analysis time t_a .

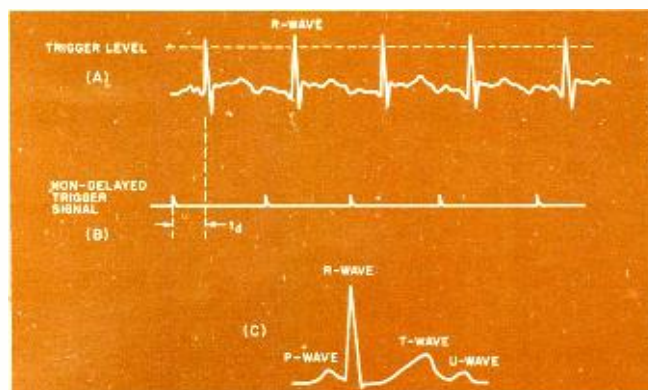
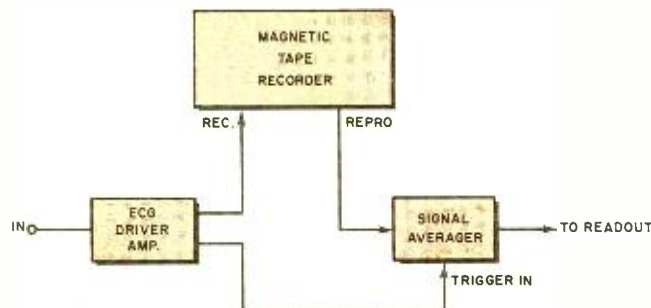

Fig. 6. Signal recovery technique in which amplified ECG signal (A) is delayed in relation to trigger pulse (B) derived from the R-wave. The smoothed averaged response (C) is shown after 100 sweeps. Letters are standard medical notations associated with different events of cardiac cycle.

Fig. 7. Block diagram showing how magnetic tape recorder is used to introduce a fixed time delay during an ECG analysis.



(Fig. 5A) contains signal components that are very much like repetitive bursts of damped sine waves. These variations are referred to as *alpha* waves (normally about 10 Hz) and represent the dominant rhythm of the brain's cortex when the subject is in a relaxed state with the eyes closed. In this case, the relatively smooth *alpha* rhythm of the averaged response serves as a good indication of a normally functioning brain. Signal recovery enables the diagnostician to observe any secondary or tertiary responses overriding, or even blocking, the *alpha* waves, in order to find any characteristic pattern associated with various types of brain disorders. By pairing the electrode leads in various combinations through a selector switch, any abnormal activity of the brain can then be localized. Another important application of the EEG is the detection of toxic states, such as in the diagnosis of barbiturate intoxication.

Using the same EEG probes, the instrumentation system can also be employed to measure the hearing ability and determine the auditory threshold of a subject. Here the primary electrode is attached to the post-auricular area of the head, the other to the vortex, and the ground electrode to the ear lobe. The stimulus consists of a series of audible tones of varying pitch, duration, and intensity; and these are fed repeatedly to the subject *via* headphones or a loudspeaker. The resulting evoked brainwave response is lifted from the dense background noise by signal recovery, and subsequently written out for evaluation. Since the subject is not required to respond voluntarily to the auditory stimulus, this technique is ideal for testing infants and noncooperating adults.

To perform an ECG analysis, a number of surface electrodes are placed on the limbs of the body to detect the electrical potentials emanating from the heart. Normally, when a measurement is taken with the subject at rest, the raw ECG waveform is quite clean, but when he is exercising, the heart signals are obscured by high-amplitude spikes generated by the muscles (other than the heart) in the vicinity of the electrodes. In this case, signal averaging is necessary to retrieve not only the slowly varying signals but also the stationary ones. As indicated in Fig. 6A, the transduced signals consist of a series of complex repetitive waveforms (in the millivolt range) in which a recurrent peak, known as the R-wave, appears as the most prominent point of any heart cycle. The R-wave is produced by contractions

of the ventricles of the heart and provides a naturally occurring reference point for triggering the signal averager. However, it cannot be used directly to synchronize the successive heart cycles because the interval between peaks varies from one heart beat to another.

To offset this problem, a fixed time delay is established between each R-wave in order to average the complete cardiac cycle from precisely the same reference point each time. The time-delay interval is pre-set so that the heart cycle is initially scanned at the base line preceding the onset of the P-wave, this wave representing the contractions of the auricles of the heart. Fig. 6C shows an expanded trace of the cardiac cycle in which the extraneous background noise is effectively eliminated after 100 sweeps of the signal averager.

A convenient method of implementing the delay time is given in Fig. 7. Here the amplified ECG signal is simultaneously fed to a magnetic tape-recording system and the trigger circuit of the signal averager. The delayed signal is obtained because of the physical separation of the record and reproduce heads. Clearly the time delay (typically 0.2 second) is directly proportional to the distance between the heads and inversely proportional to the speed of the tape.

Pulsed Nuclear Magnetic Resonance

In many types of liquid, solid, and gaseous materials, the nuclei of certain atoms have properties similar to small magnets. Hence, they are capable of absorbing r.f. energy at specific (resonant) frequencies when these substances are subjected to a magnetic field. This phenomenon, known as nuclear magnetic resonance (NMR), provides valuable data on the molecular structure of complex mixtures and compounds, as determined by certain characteristic patterns displayed on the readout device. These spectra, which often appear as very sharp resonant lines, would be rather difficult to interpret precisely without the aid of signal recovery, since any random fluctuations in the measurement system would tend to blur the finely separated lines. With signal averaging, many rapid scans of full spectra could be accumulated to resolve the narrow spectral peaks from the extraneous background noise.

In the pulsed NMR system shown in Fig. 8, the sample specimen to be analyzed is placed within a pickup coil positioned between the poles of a permanent magnet. A driving (transmitter) coil, also contained in the magnetic field gap, is connected to a source of r.f. energy and pulsed by an electronic switch to provide a reference signal for the signal averager. Simultaneously, the magnetic field of the sweep coils is varied continuously (from zero to about 14 kilogauss) and swept through the condition of resonance. To minimize direct coupling from the drive (r.f.) generator, the pickup coil is oriented so that its field is perpendicular to the magnetic fields of the drive and sweep coils.

As the nuclei of the sample specimen come under the influence of the swept magnetic field, they respond by "precessing," or wobbling around the direction of the field. This phenomenon is somewhat analogous to the gyroscopic action of a spinning top. When the drive frequency of the r.f. generator is tuned so that it is equal to the frequencies of precession, the two oscillating systems are brought into resonance with each other, and the nuclei "flip" over, thereby absorbing power from the driving field. For a given drive frequency, different nuclei absorb energy at different points on the magnetic field sweep depending upon their nuclear properties. This absorption is large enough to induce a series of voltages across the pickup coil, which are amplified and detected by the receiver and presented on a chart recorder as a function of the applied field. The resultant NMR spectrum has a unique spectral position in which the number of peaks, amplitude range, and relative location of the peaks with respect to one another, yield a de-

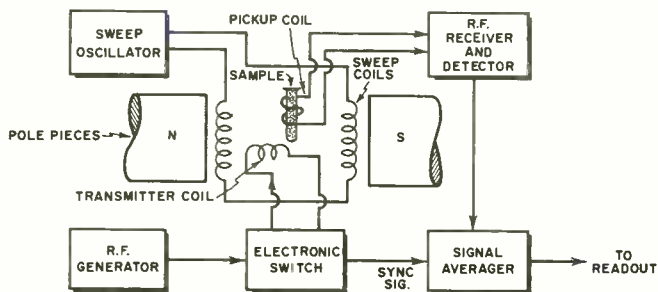
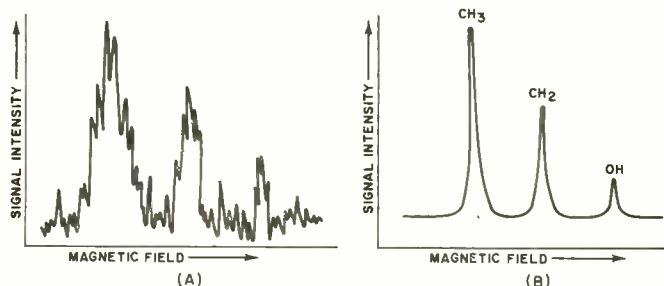

Fig. 8. Block diagram of nuclear magnetic resonance spectrometer.

Fig. 9. Comparison of NMR spectra of ethyl alcohol ($\text{CH}_3\text{CH}_2\text{OH}$) at 40 MHz. In (A) the resonant peaks are immersed in random noise before signal averaging. In (B) the characteristic pattern is clearly defined by averaging over 100 repetitions of the test.



(Continued on page 53)

Important New SAMS Books

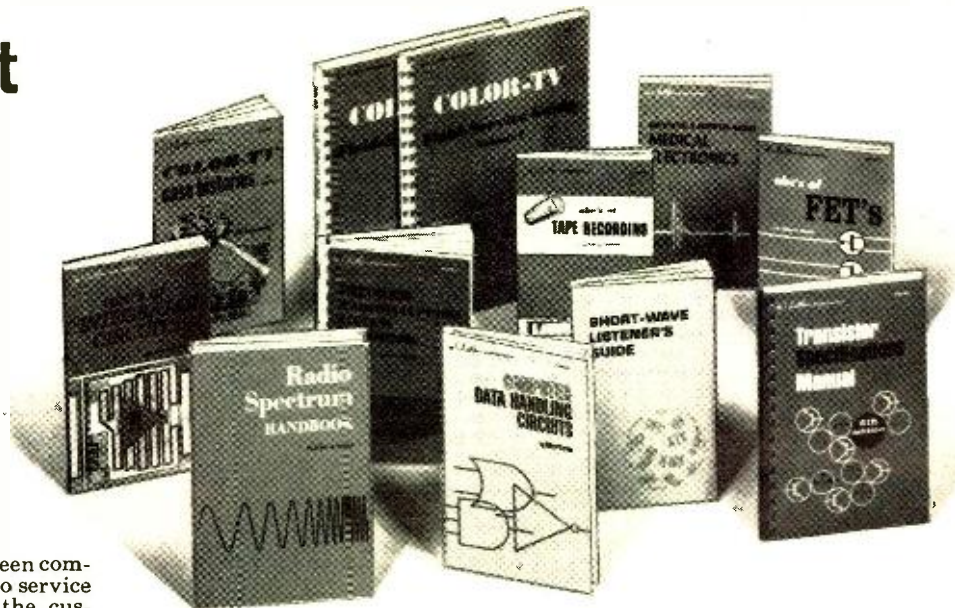

Color-TV Field-Service Guides

These invaluable guides have been compiled to enable the technician to service color-TV more efficiently in the customer's home. Charts provide chassis layouts showing type, function, and location of all tubes and/or transistors used in a particular chassis, ratings and locations of fuses and circuit breakers, location of service controls and adjustments, etc. Specific field-adjustment procedures are shown on page opposite chassis layout. Index provides instant reference to the proper chart for any particular TV chassis. Each volume contains 80 diagrams covering over 3,000 chassis.

Volume 1. Order 20796, only . . . \$4.95
Volume 2. Order 20807, only . . . \$4.95

Questions and Answers About Medical Electronics

by EDWARD J. BUKSTEIN Anyone familiar with basic electronic circuits will find this a fascinating and readily understandable book emphasizing the applications of electronic equipment in clinical and research medicine, general principles of equipment operation, special features of the equipment, and the related medical terminology.

Order 20816, only . . . \$2.95

ABC's of Integrated Circuits

by RUFUS P. TURNER. This basic introduction to the integrated circuit (IC) will be welcomed by hobbyists, experimenters, and students who have some familiarity with semiconductors. Describes the fundamentals of the IC, and its applications in amplifiers, oscillators, control circuits, communications, test equipment, and computers.

Order 20823, only . . . \$2.95

Transistor Specifications Manual. 4th Ed.

by THE HOWARD W. SAMS ENGINEERING STAFF. Lists the electrical and physical parameters (along with the manufacturers) of virtually all of the transistor types now in use. Also includes frequency, gain, and leakage parameters, as well as a special section on rf power transistors. Comb-bound.

Order 20788, only . . . \$4.50

ABC's of FET's

by RUFUS P. TURNER. Clearly explains the theory and describes the operating principles of FET's (field-effect transistors), special semiconductor devices with unique qualities. Describes FET circuit design and typical applications in a number of practical circuits.

Order 20789, only . . . \$2.95

Computer Data Handling Circuits

by ALFRED CORBIN. This book offers the beginner a valuable introductory course in practical digital data circuit analysis. Makes understandable the semiconductors and circuitry used in digital equipment. Explains digital data logic and the associated mathematics. Analyzes the basic logic circuits and their functional blocks, as well as digital display devices. Invaluable for anyone desiring to be conversant in the operational theory of data handling circuits.

Order 20808, only . . . \$4.50

Color-TV Case Histories

by JACK DARR. Case histories not only provide the TV technician with solutions to troubles he is likely to encounter, but enable him to compare his troubleshooting methods with those of others. Each of these case histories of troubles actually happened. The symptoms are given for each trouble, along with the method used to locate it.

Order 20809, only . . . \$3.50

Radio Spectrum Handbook

by JAMES M. MOORE. This book fills the "information gap" about the many types of radiocommunication which exist apart from radio and TV. Each chapter covers a given frequency-allocation range; a table provides an overall summary of the uses of all frequencies in that range, followed by text describing the individual radio services available. Includes information on receivers available for the various frequency bands described. Hardbound.

Order 20772, only . . . \$7.95

First-Class Radiotelephone License Handbook. Third Edition

by EDWARD M. NOLL. Completely updated to cover all the new material included in the recently revised FCC Study Guide. Book sections include: Theory and discussion of all phases of broadcasting; all the questions (and the answers) included in the FCC Study Guide; three simulated FCC examinations; appendices containing the most relevant FCC Rules and Regulations. This book will not only help you acquire your license, but will also serve as a textbook for broadcast engineering training.

Order 20804, only . . . \$6.50

Short-Wave Listener's Guide. 4th Ed.

by H. CHARLES WOODRUFF. Completely revised and enlarged to include the most recent changes in SW broadcasting schedules. Lists world-wide short-wave stations by country, city, call letters, frequency, power, and transmission time. Includes Voice of America and Radio Free Europe stations, and stations operating behind the Iron Curtain. With conversion chart and handy log.

Order 20798, only . . . \$2.95

ABC's of Tape Recording. 3rd Ed.

by NORMAN CROWHURST. Newly revised and updated edition of this popular handbook. Explains how tape recorders work (transport mechanisms, heads, controls, etc.), how to choose the best recorder for your needs, and how to use it most effectively for both entertainment and practical purposes. Includes tips on recording quality and recorder care.

Order 20805, only . . . \$2.95

HOWARD W. SAMS & CO., INC.

Order from your Electronic Parts Distributor,
or mail to Howard W. Sams & Co., Inc., Dept. EW-051
4300 W. 62nd St., Indianapolis, Ind. 46268

20796 20808

20807 20809

Send books checked at right. \$_____enclosed

20772 20789

Send FREE 1971 Sams Book Catalog

20816 20804

Name _____

PLEASE PRINT

20823 20798

Address _____

20788 20805

City _____

State _____

Zip _____



Rationale of Troubleshooting

Knowing just what takes place during a diagnostic process is a help in becoming a better technician.

By **John Frye**

ASCREECH of brakes followed by a solid "wump" that could only mean a car crash interrupted the peaceful quiet of Mac's Service Shop. Matilda, Mac, and Barney all ran out the front door and saw two cars had collided directly in front of the shop. One of the occupants had been thrown from his car and was lying in the street with a thin trickle of blood issuing from his nostrils. As they watched, a passing motorist braked his car to a stop right in the middle of the street and hurried to the side of the injured man. He carried a small black bag, and Barney noticed the caduceus of a doctor on his license plate.

The doctor, kneeling on the pavement, took a stethoscope from his bag, and listened to the chest of the unconscious man. Next he lifted both eyelids with his thumbs and peered at the pupils. Finally he felt cautiously around the man's skull. By this time the pulsating sound of an approaching ambulance could be heard. The doctor glanced up and picked Mac's face out of the ring about him. "Mac," he said, "would you park my car for me? I think I had better go in the ambulance with this man to the hospital."

Mac nodded agreement. The ambulance arrived, and the doctor supervised the careful placing of the injured man onto the stretcher and into the ambulance and took a seat beside the patient; then they were off with the siren going "wow-wow-wow-wow," but, on the doctor's orders, the ambulance was driven slowly.

Matilda and Barney were still discussing the accident when Mac came back from parking the doctor's car.

"Well," Mac offered, "if the poor devil had to get hurt, he certainly picked the right spot and time. Doctor Wilson has the reputation of being as good a brain surgeon and diagnostician as there is in the Midwest."

"He certainly seemed to know what he was doing," Barney agreed. "Every movement he made was fast but sure. I kept thinking about all the knowledge that had to be stored in his head, ready for instant recall, to enable him to know exactly what to look for."

"I've thought the same thing about you and Mac when I watched you troubleshooting a TV receiver," Matilda confessed.

"I'm glad to hear you testify!" Barney exclaimed. "Lately I've been doing a lot of thinking about what really goes on in the head of a radio and TV technician when he is troubleshooting a set, and I keep being reminded that his troubleshooting and a medical diagnosis are almost identical."

"Oh, oh! I smell a lecture coming on," Mac said resignedly, perching himself on a corner of Matilda's desk. "But go ahead; get it out of your system."

"Okay, since you insist so eagerly," Barney replied. "Cybernetics is the key to understanding the diagnostic or troubleshooting process. Think of the brain as being a computer. The first need is to stock the basic knowledge memory bank. The doctor does this by an intense study of human anatomy in the broadest meaning of that word, covering everything from gross anatomy down to cellular respiration. What he secures from books is reinforced by what he sees with a microscope and learns in the dissecting room.

"In the same way the would-be technician must store his memory bank with a thorough and accurate knowledge of basic electrical and electronic theory. He must know how an electron behaves under the influence of chemical action, static electrical charges, and magnetic fields. He must grasp the different behaviors of direct and alternating currents. He must know the functioning of batteries, generators, capacitors, inductances, resistances, transformers, silicon diodes, zener diodes, transistors, integrated circuits, all kinds of tubes from simple diodes to a three-gun color tube, and a host of other components too numerous to mention. Finally, he must understand the interaction of these components when they are combined in a circuit.

"This knowledge must be both thorough and accurate, for it will color everything of a technical nature he takes into his mind from this point on. Somehow, some way, he must really understand basic theory. The form in which he acquires this knowledge will depend on the individual. Some men find it easy to think in abstract terms about unseen electrical behavior; others need the help of analogies. There is nothing wrong with the latter as long as it is kept in mind that no analogy is perfect and should not be forced. For example, comparing electrical current to the flow of water helps understand many direct-current behaviors, but the analogy breaks down when you think about inductance and transformer action. The important thing is that you understand clearly, on your own terms, what takes place inside every component of an electrical circuit."

"You are right about the importance of getting your basic concept of electrical theory correct," Mac chimed in. "The computer people wrap up this idea in their coined word 'gigo.' That stands for 'garbage in; garbage out.' In other words, if incorrect information is fed into the computer, you are going to get incorrect information out. If the technician allows fallacious and fuzzy ideas about basic electronic theory to be stored in his mind, no amount of theory is going to correct for this because he will be interpreting everything he sees in terms of his mistaken ideas about how the circuit works."

"Right!" Barney agreed. "Once you've grasped what constitutes normal performance you are ready to consider abnormal performance. The doctor calls this *disease*, and a great deal of his education is spent learning how to recognize the difference between health as manifested in a wide range of individuals and actual disease in those individuals."

"The technician, too, must learn all the things that can go wrong with the components of his electronic circuits. Not only must he learn how these components can fail; he must also learn the tests necessary to prove that a component is incapable of proper function."

"All of this information I consider as being stored in the basic memory bank. When this bank is adequately stocked—I hasten to add 'for the time being' because a good technician is going to be adding to and expanding his fund of basic knowledge all his life—it is time to start stocking the experience memory bank. Truthfully, it's difficult to draw a sharp line between what a person learns as theory



Why do you always use RCA SK Replacement Devices?

Will I need a large inventory?

What's another reason?

Are you saying RCA is the only source for reliable solid-state replacements?

Seriously, is the SK Replacement Guide that great?

I'm sold! How can I go wrong with RCA SK's?

Because SK's are specifically designed and engineered for replacement use in home-entertainment equipment. RCA doesn't make SK types unless they're needed in the field and serve the professional.

Not at all. Only 67 types cover a broad range of replacements in TV, hi-fi, and other entertainment equipment. It's the shortest line of product with the broadest range of replacement applications. That's just one of the reasons I like it.

Quality — it's assured! SK's are tested with the finest dynamic testing equipment, operated by the same personnel who test other RCA power, signal, and IC devices. They're even tested again at the factory warehouse before shipment.

No. But SK's are top quality, and the SK Replacement Guide is a truly reliable source for cross-reference information. RCA only cross references types where there is engineering assurance that the SK will do the job as well as, or better than, the original.

Better! It includes technical information on the line, plus a "Quick Selection Chart" which is unique in the industry. Now I can choose the proper SK replacement for almost every type made.

You can't. No one can!

RCA

RCA | Electronic Components | Harrison, N.J. 07029

The Most Spectacular Sound Exhibition of STEREO FIDELITY Ever Available on one Disc.

Stereo Review **STEREO DEMONSTRATION RECORD**

A stunning series of demonstrations, each designed to show off one or more aspects of musical sound and its stereo reproduction.



This record is the result of two years of intensive research in the sound libraries of Deutsche Grammophon Gesellschaft, Connoisseur Society, Westminster Recording Company and Cambridge Records Incorporated. The Editors of Stereo Review have selected and edited those excerpts that best demonstrate each of the many aspects of the stereo reproduction of music. The record offers you a greater variety of sound than has ever before been included on a single disc.

It is a series of independent demonstrations, each designed to show off one or more aspects of musical sound and its reproduction. Entirely music, the Record has been edited to provide self-sufficient capsule presentations of an enormous variety of music arranged in a contrasting and pleasing order. It includes all the basic musical and acoustical sounds that you hear when you listen to records, isolated and pointed up to give you a basis for future critical listening.

WIDE RANGE OF DEMONSTRATIONS

- Techniques of Separation & Multiple Sound Sources • Acoustic Depth • Ambiance of Concert Hall • Sharp Contrasts of Dynamics • Crescendo & Diminuendo • Very High & Very Low Pitched Musical Sounds • Polyphony (2 or more melodies at once) With Both Similar & Contrasting Instruments • Tonal Qualities of Wind, String & Percussion Instruments • Sounds of Ancient Instruments • Sounds of Oriental Instruments • Sound of Singing Voice, Both Classically Trained and Untrained • Plus a Large Sampling of Finger Snapping, Hand Clapping, Foot Stamping & Other Musical & Percussive Sounds.

13 SUPERB SELECTIONS

STRAUSS: Festive Prelude, Op. 61 (excerpt) DGG
DEBUSSY: Feux d'artifice (excerpt). Connoisseur Society
BEETHOVEN: Wellington's Victory (Battle Symphony) (excerpt from the first movement) Westminster Records.
MASSAINO: Canzona XXXV à 16 (complete) DGG Archive
CORRETTE: Concerto Comique Op. 8, No. 6, "Le Plaisir des Dames" (third movement) Connoisseur Society
KHAN: Raga Chandranandan (excerpt) Connoisseur Society
RODRIGO: Concert—Serenade for Harp and Orchestra (excerpt from the first movement) DGG
MANITAS DE PLATA: Gypsy Rhumba (complete) Conn. Soc.
MARCELLO: (arr. King): Psalm XVII "The Heavens are Telling" (complete) Connoisseur Society
PRÆTORIUS: Terpsichore: La Bourrée XXXII (complete) DGG Archive
BERG: Wozzeck (excerpt from Act III) DGG
BARTOK: Sonata for two pianos and Percussion (excerpt from the first movement) Cambridge Records.
BEETHOVEN: Wellington's Victory (Battle Victory) (excerpt from the last movement) Westminster.

AVAILABLE IN YOUR CHOICE OF 33½ RPM OR 45 RPM

The Stereo Demonstration Record is processed and pressed on a newly developed, improved vinyl. It is permanently anti-static, repels dust and dirt and promotes longer stylus wear. The use of this material is conducive to low surface noise and contributes to the production of full dynamics and frequency range. The record continually looks new, sounds new and wears longer.

FREE Descriptive Booklet Enclosed includes discussion of the selections on the record, plus a complete description of each selection and the purpose behind its demonstration.

RECORDS • Ziff-Davis Service Division
 595 Broadway • New York, N.Y. 10012

Please send me _____ Stereo Review Stereo Demonstration Record Albums at \$5.98 each, postpaid. My check (or money order) for \$_____ is enclosed. Check One: 33½ rpm 45 rpm (outside U.S.A. please send \$8.00 per album ordered.) New York State residents please add local sales tax.

Print Name _____
 Address _____
 City _____ EW-571
 State _____ Zip _____

PAYMENT MUST BE ENCLOSED WITH ORDER

and what he learns from experience because experience is actually a learning process and is bound to sharpen the knowledge of theory. For our purposes, however, we shall separate them arbitrarily. Experience is additional knowledge gained from performing the work for which the study was done. In the doctor's case, this is acquired first as an intern; but he adds to it with every patient he treats after he hangs out his shingle.

"In the beginning the technician must apply his basic theory to problem solving because that is all he has to work with. He uses his senses to collect symptoms; he studies the circuit to see what possible component failures could produce those symptoms; and finally he evolves a theory as to what is wrong. This theory is checked by making measurements or substituting components. All diagnosis or troubleshooting is actually a matching process. You try to match the observed symptoms to a hypothetical dysfunction of the mechanism you are studying. The more accurately you observe and the more careful you are about the exact congruency of the symptoms and the hypothetical case, the more likely it is that your diagnosis will be correct.

"Unfortunately it is not always that easy. Identical symptoms can be produced by several combinations of troubles. Without experience, you have no choice but to eliminate these possibilities one by one with measurements, tests, or substitutions until you hit on the right one. After you have stocked your memory bank of experience, however, you need not follow such a haphazard procedure. Experience will have shown you some of the possibilities are much more likely to be present than others, and you will be able to check them out in the order of probability. This is a great time saver and aid to efficiency, but it does contain a trap; if experience has shown that nineteen times out of twenty a particular component failure produces a set of symptoms, you're prone to think this is *always* the case and change out the suspected component without verifying that it is causing the trouble. Anyone who ever changed a metal-can filter capacitor on a printed-circuit board, only to discover the hum was caused by a filament-to-heater short in a tube knows what I mean."

"I know," Mac nodded his head. "You're saying troubleshooting is a three-legged stool standing on (1) knowledge of theory, (2) observation of symptoms, and (3) experience. Which of these legs do you consider the most important?"

"Wish you hadn't asked," Barney admitted. "I've kicked that around a lot in my own mind without coming up with a good answer. Theory is very im-

portant because of its versatility and because it makes experience much more meaningful. I think of electronic theory as being a kind of adjustable wrench that will turn many different nuts. It is just as true and applicable if you're working on a radio, a color-TV set, a tape recorder, or a garage-door opener. And when you have a good grasp of theory to interpret what you observe, your experience is far more fruitful. The Why always enriches the How.

"But anyone who has ever watched a brand-new EE trying to repair a color set also knows that theory alone is not enough—at least when time is a factor. Experience provides the technician with a thousand shortcuts, it ranks the possibilities presented by pure theory so that 'sage experience the short process guides,' as Joel Barlow put it.

"But theory and experience are both locked in the memory banks of our computer, or brain, and can only work on information presented to it from without. That's why the observation of symptoms is so important. We're back to your 'gigo,' for the input to the computer is what is observed by the senses directly or through the medium of instrument readings. If a technician is not keenly observant and constantly alert to the presence of obscure but pertinent symptoms, the performance of his 'computer' is badly crippled. S-o-o-o-o, I wish you'd withdraw your question. I don't see how a good troubleshooter can possibly stand on any two of those three legs you mentioned."

"Question withdrawn," Mac said. "Really I was trying to trap you. If you had said any one was unimportant, I was ready to give you a stiff argument. While I hesitate to say so, knowing how conceited you are, I enjoyed your little discussion. I'm always glad to see a man trying to understand how his mind works. Now let's go back into the service department and demonstrate how efficiently our troubleshooting computers work, shall we?"

"If you insist," Barney grumbled. "There are always some mundane souls who aren't happy unless they are able to make a carrier pigeon out of a golden eagle!" ▲



"Yes, but I think you could have shown just as much detail at a smaller scale."

Signal Averaging Techniques (Continued from page 48)

tailed pattern, or "fingerprint" of the molecular environment.

Fig. 9 illustrates an example of NMR spectrometry in which a very weak concentration of an unknown liquid is applied to the measurement system. Before signal recovery is employed (Fig. 9A), the characteristic resonance peaks which would normally identify the substance, are hidden by spontaneous noise in the system. After 100 sweeps of the signal averager, the spectral lines emerge as three distinct peaks of different amplitudes (Fig. 9B), each peak corresponding to the frequency of resonant absorption. The amount of energy absorbed in the areas enclosed by the resonant peaks are observed to be in ratios of 3:2:1, which are proportional to the number of hydrogen protons in each molecular group. Thus, according to the magnetic resonance spectrum, the liquid under test is identifiable as ethyl alcohol (ethanol), whose chemical structure is designated as $\text{CH}_3\text{CH}_2\text{OH}$.

Pulsed NMR measurements can also provide useful information regarding the relative strength of molecular components in a wide variety of substances. For example, the moisture content in such materials as wood, plastics, and minerals can be determined by separating the narrow resonant peaks of the water molecules from the comparatively broad peaks which characterize solid material. Similarly, the presence of oil molecules, which also exhibit sharp spectral lines, can be detected accurately in various mixtures. In other applications, pulsed NMR techniques are used in geophysical prospecting to determine the magnetic field of various ores and rock samples, and also in making precise measurements of the earth's magnetism. ▲



"If this bill is for amateur equipment, I'd hate to think what professional equipment would cost!"

*the tape that
turned the
cassette
into a
high-fidelity
medium*

TDK

Until TDK developed gamma ferric oxide, cassette recorders were fine for taping lectures, conferences, verbal memos and family fun—but not for serious high fidelity.



TDK SUPER DYNAMIC (SD) TAPE



The new magnetic oxide used in TDK Super Dynamic tape distinctly differs from standard formulations in such important properties as coercive force, hysteresis-loop squareness, average particle length (only 0.4 micron) and particle width/length ratio. These add up to meaningful performance differences: response capability from 30 to 20,000 Hz, drastically reduced background hiss, higher output level, decreased distortion and expanded dynamic range. In response alone, there's about 4 to 10 db more output in the region above 10,000 Hz—and this is immediately evident on any cassette recorder, including older types not designed for high performance. There's a difference in clarity and crispness you can hear.

Available in C60SD and C90SD lengths.

TDK ELECTRONICS CORP.
LONG ISLAND CITY, NEW YORK 11103

CIRCLE NO. 86 ON READER SERVICE PAGE

OUR STORE
AT YOUR DOOR



Fill in coupon for a **FREE** One Year Subscription to **OLSON ELECTRONICS** Fantastic Value Packed Catalog — Unheard of **LOW, LOW PRICES** on Brand Name Speakers, Changers, Tubes, Tools, Stereo Amps, Tuners, CB, HI-FI's, and thousands of other Electronic Values. Credit plan available.

NAME _____
ADDRESS _____
CITY _____ STATE _____
GIVE ZIP CODE _____

If you have a friend interested in electronics send his name and address for a **FREE** subscription also.

OLSON ELECTRONICS
Dept. EQ 260 S. Forge Street
Akron, Ohio 44308

CIRCLE NO. 80 ON READER SERVICE PAGE

**Build this pipelike
Schober Recital Organ
for only
* \$1850!**



*Includes finished walnut console. (Only \$1446 if you build your own console.) Amplifier, speaker system, optional accessories extra.

You couldn't touch an organ like this in a store for less than \$4,000—and there never has been an electronic instrument with this vast variety of genuine pipe-organ voices that you can add to and change any time you like! If you've dreamed of the sound of a large pipe organ in your own home, if you're looking for an organ for your church, you'll be more thrilled and happy with a Schober Recital Organ than you could possibly imagine—kit or no kit.

You can learn to play it—and a full-size, full-facility instrument is easier to learn on than any cut-down "home" model. And you can build it, from Schober Kits, world famous for ease of assembly without the slightest knowledge of electronics or music, for design and parts quality from the ground up, and—above all—for the highest praise from musicians everywhere.

Send right now for the full-color Schober catalog, containing specifications of all five Schober Organ models, beginning at \$499.50. No charge, no obligation. If you like music, you owe yourself a Schober Organ!

The *Schober* Organ Corp., Dept. RN-89
43 West 61st Street, New York, N.Y. 10023

Please send me Schober Organ Catalog and free 7-inch "sample" record.
 Enclosed please find \$1.00 for 12-inch L.P. record of Schober Organ music.

NAME _____
ADDRESS _____
CITY _____ STATE _____ ZIP _____

CIRCLE NO. 83 ON READER SERVICE PAGE

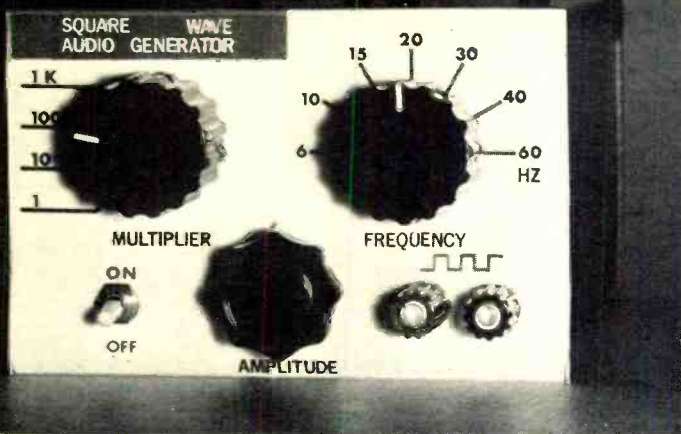

Two switches are used to select the square-wave frequency desired from a low 6 Hz all the way up to 60 kHz.

Precision Square-Wave Audio Generator

By ROY A. WALTON

Inexpensive, accurate generator which will supply continuously variable output up to 1 V into an impedance as low as 8 ohms.

A SQUARE-WAVE generator is a highly versatile instrument and is useful in many tests from amplifier analysis to finding the length of a roll of coaxial cable. One that is known to be accurate has even more uses, such as serving to calibrate an oscilloscope time base or checking frequency-measuring devices.

The main drawback of a precision generator is the high cost. This article will detail the construction and calibration of a high-precision square-wave generator that cost the author less than \$25.00 to build.

The specifications are as follows: frequency over the audio spectrum is 1% accurate, the range is 6 Hz to 60 kHz in four multiplied steps of seven increments (6, 10, 15, 20, 30, 40, and 60 Hz times 1, 10, 100, and 1000), and a common-emitter output stage will supply a continuously variable voltage of 1-volt peak-to-peak maximum to as little as an 8-ohm input.

Circuit Operation

Q1 (Fig. 1) is a UJT operating as a relaxation oscillator with S1 choosing the resistance through which the timing capacitor, selected by S2, is charged. This RC network determines frequency of the oscillator whose output is a sawtooth waveform coupled by C8 to the buffer, Q2. R9 sets the operating point of Q1 and acts as a master-oscillator adjustment for the entire frequency range. It may be used to offset effects of temperature extremes or weak batteries.

With cover removed, here is what the generator looks like.

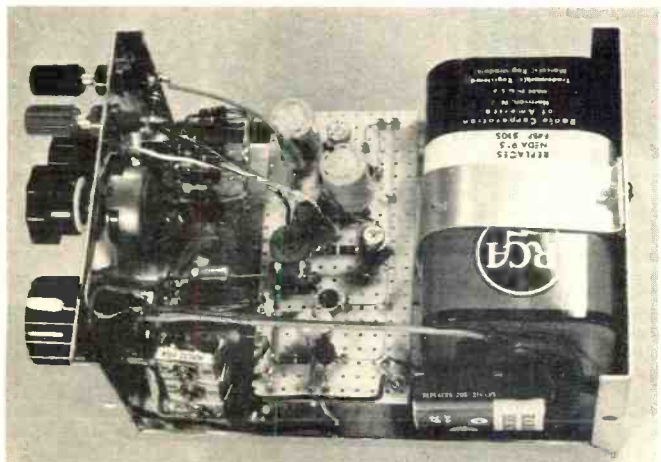

IC1 is a JK flip-flop operating in the divide-by-two mode and is triggered by Q2. R13 is located in the inverted output lead of the IC and is used to adjust a feedback voltage that prevents spurious counts.

Q3 is a common-emitter stage with R14 controlling the output amplitude. This configuration allows the signal to be fed to fairly low impedance inputs as well as the high impedances usually encountered.

It should be noted that V_1 is 6 volts positive with respect to ground. This is to aid in preventing adjacent-capacitance effect as is the chassis ground of negative battery terminals.

The only part of the design that might be considered difficult is obtaining the correct values for R2 through R7. These are the resistors in the frequency switch and must be accurate almost to the ohm. This high accuracy is fairly easy to obtain by "trimming" the resistors; that is, a bundle of resistors is made up by paralleling two or more common values to come up with the exact value needed. These resistive values are found by using the generator in a partially completed state, the 60-Hz power-line frequency, and an oscilloscope. The procedure will be detailed later.

It is recommended that component placement closely approximate that of the prototype, as shown in the photographs. The following parts are mounted on the circuit board: R8, R10, R11, R12, R13, R15, R16, C8, C9, C10, Q1, Q2, Q3, and IC1. S1 (Frequency), S2 (Multiplier), S3 (On-Off), and R14 (Amplitude) are mounted on the front panel. R9 was mounted on the cabinet top in the prototype and adjusted through an access hole. This control provides a semi-permanent adjustment and should be located so adjustments can be made without opening the cabinet. All components should be mounted and soldered except R2 through R7.

Calibration and Alignment

Couple the generator output directly to an oscilloscope vertical input. Set the generator controls to S1 60, S2 X1, R9 midrange, R13 midrange, and R14 to maximum. The scope display should be a square wave. Connect a 60-Hz power-line source to the scope horizontal input and use this as the sweep. The display will be a rotating rectangular figure and R9 should be adjusted so that the figure is stationary. This setup should be returned to frequently during calibration to correct for any possible drift in the instrument frequency. Return the scope to internal sweep and adjust the sweep controls for exactly 12 cycles of the generator's 60-Hz waveform.

Resistor R_2 will be a bundle of resistors referred to as R_{2a} , R_{2b} , etc. Choose R_{2a} to have a slightly higher value than R_2 (see Table 1) and tack-solder it to its position (40 Hz) on S_1 . When R_2 is correctly trimmed the display will be exactly 8 cycles. If more than 8 cycles are displayed, R_2 is low in value or if fewer than 8 cycles are displayed, R_2 is high. If 8 cycles cannot be produced by a single resistor, R_{2a} is chosen for a display of slightly less than this amount and trimmed with higher value resistors until the correct display is obtained. This is done by soldering R_{2a} in the circuit and manually bridging it with other resistors until the right display is observed. If the correct display is still unobtainable, R_{2b} is chosen to give as close to the right display as possible yet still yielding less than 8 cycles. R_{2b} is soldered in the circuit and R_{2c} is found using the same method, as is R_{2d} if necessary. (The prototype never required more than four resistors to a bundle.)

This calibration should be checked against the 60-Hz power-line frequency on the scope horizontal input as was the 60-Hz square wave. In this instance a complex figure will be observed that, ideally, will be stationary, although if it is rotating slowly it is acceptable. If the figure on the oscilloscope is rotating rapidly, the R_2 bundle needs additional trimming.

It is helpful to swab the resistors and switch lugs with alcohol after soldering as the resistance changes temporarily with heat and can shift the frequency of the oscillator.

This same procedure is used to calibrate the remainder of the resistors on S_1 . Maintain the scope internal sweep to show 12 cycles of the 60-Hz output. This should be checked frequently and readjusted to compensate for any drift in the scope. The correct displays are as follows: 40, 8 cycles; 30, 6 cycles; 20, 4 cycles; 15, 3 cycles; and 10, 2 cycles. To calibrate the 6-Hz position of S_1 the scope must be reset to display 10 cycles of the 60-Hz generator output and R_7 trimmed to produce a 1-cycle display. Adjust R_{13} for a stable output of the 6-Hz display. Unless the scope used is d.c.-coupled, distortion will be evident at the low-frequency settings of the generator.

The last step is to calibrate the multiplier capacitors. This is done in a similar fashion to the frequency switch except that the main capacitors must merely be brought into the range of the trimmers. Adjust the scope for a display of one cycle of the generator 60-Hz output. Set S_2 to X10 and adjust C_2 for 10 cycles of display. If this is not within the range of C_2 , C_3 must be trimmed as were the S_1 resistors until it is. (The more capacitance the fewer cycles displayed.) The final adjustment of C_2 should be made, with the cabinet closed, using a non-conducting alignment tool. This should be done while observing the figure produced by the 60-Hz line frequency on the scope horizontal input. Adjust C_2 for a stationary figure. (The shape of the figures used is of no importance in this alignment, only the lack of rotation.)

The remaining two ranges of this switch are calibrated in the same manner by setting the scope for a display of 1 cycle of the previously calibrated range and adjusting the following range for 10 cycles of display. Since the

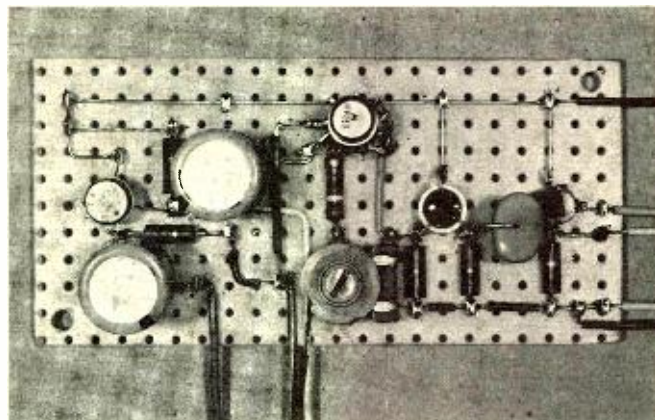

Closeup of circuit board showing transistors and the IC.

frequencies overlap, the same frequency may be observed on two different settings of the multiplier switch.

This generator is quite stable and the accuracy will remain within 1% under normal operating conditions. If temperature extremes or weak batteries are encountered, R_9 can be used to compensate for them. The generator should be checked periodically by feeding its 60-Hz X1 output to the scope vertical input and the power-line frequency to the scope horizontal input and adjusting R_9 for a stationary rectangular display. ▲

Fig. 1. The schematic shows the unijunction relaxation oscillator feeding a buffer amplifier whose output is divided by 2 in an integrated circuit. The output stage provides the isolation. All parts are standard and available.

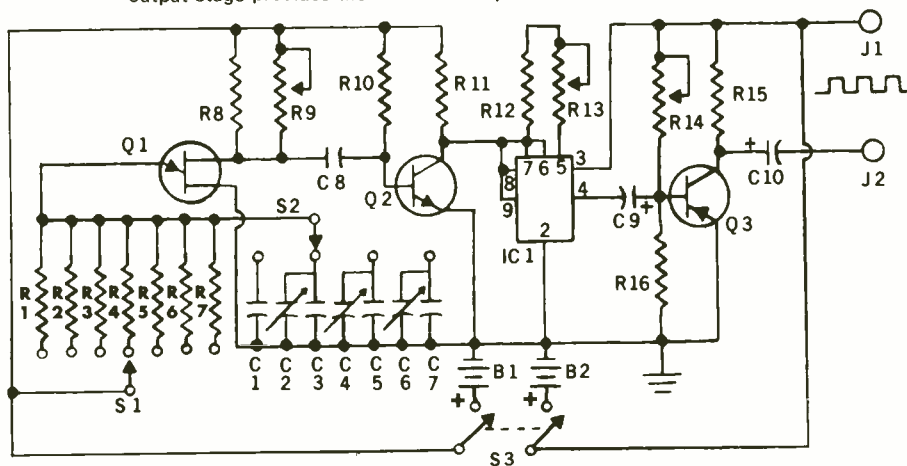

IC1—JK flip-flop (HEP 558)

*Resistors R_2 through R_7 were from the parts box or selected from 1/2-W resistor "grab bag."

Table 1. Values of resistors used for R_1 through R_7 , respectively.

MEASURED RESISTANCE	RESISTORS USED (in order of insertion)
R_1 (4.8k)	4.7k
R_2 (7.2k)	8.2k, 15k, 220k, 820k
R_3 (9.7k)	10k, 100k
R_4 (12k)	15k, 330k, 1.5M
R_5 (19k)	20k, 580k, 6.8M
R_6 (28k)	30k, 680k, 1.5M
R_7 (48k)	47k

It should be noted that the resistors used were from a "grab-bag" and many had no tolerance band. This is the reason that calculated resistance for the ones actually used may not be the same as the measured resistance.

If You Were the BOSS and Had to CUT BACK, **WOULD YOU FIRE YOU?**

If you were the boss, how would you choose who to let go?

1. You'd probably fire the man who never completed his electronics education. This man may have a solid foundation, but he *quit learning* before he went far enough.
2. You'd probably fire the man who is only a "tinkerer" because his electronics education went *far* enough but *not deep* enough. A specialist must really understand before he can really perform.
3. You'd probably fire the man who has been in electronics for many years but has *not kept up to date* in this rapidly changing industry. Nothing becomes obsolete so quickly as the man who does not study.

Who Will YOUR Boss Fire When He Has To Cut Back? **DON'T BE THE MAN TO GET THE AXE!**

Investigate *now* the Grantham college-level program in electronics engineering, offered (by correspondence) to working technicians while they remain on their jobs. Grantham lessons place heavy stress on fundamental concepts of logic and mathematics (taught so you can understand them), and build from there in a systematic manner, covering physics, circuits, and systems. The lessons are easy to understand because they are carefully written, with step-by-step explanations and consistent review and regrouping of ideas.

Now is the time, not only to protect yourself from unemployment, but also *to prepare yourself for the greater demand in engineering* which is sure to come. You can't become an engineer in a few short weeks; it takes many months. You can be upgrading yourself in your present job while the economy is "slow", and then *be ready to move into engineering* when the national economy gets going again. Yes, now is the time to prepare, so that *you* will be ready to take advantage of opportunity when it presents itself.

Upgrading in your career begins when you begin studying the very first lessons of the Grantham ASEE Degree program in Electronics Engineering. You may very well move up *from* electronics technician *to* electronics *engineering* technician upon completion of the first 100 lessons (out of a total of 400 in the entire program). Upon completion of the program and receiving your ASEE Degree, you are then ready to work as an *electronics engineer*.

Accreditation and G.I. Bill Approval

Grantham School of Engineering is *accredited* by the Accrediting Commission of the National Home Study, is *approved* under the G.I. Bill, and is *authorized* under the laws of the State of California to grant academic degrees.

Not For Beginners

The Grantham educational program in electronics engineering is *not for beginners*. Every point is explained just as carefully as if you were a beginner, but this program is designed, written, and taught *for and to* experienced technicians; beginners are not accepted for enrollment. As a technician, you already know the "hardware" side of electronics, and you can upgrade from technician to engineering technician, and then to engineer, while you continue your employment in electronics.

Grantham School of Engineering

• Established in 1951 •

1505 N. Western Ave.
Hollywood, Calif. 90027

Telephone:
(213) 469-7878



For complete details, mail postcard or coupon.



ELECTRONICS TECHNICIANS:

If you really want
to go places in this
Age of Electronics...

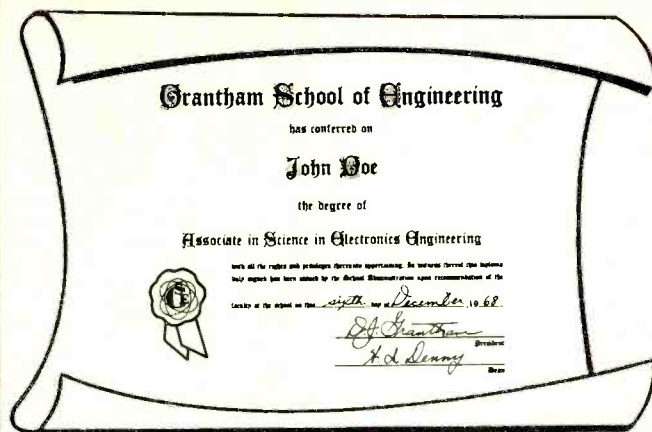

EARN YOUR DEGREE

AND GET INTO ELECTRONICS ENGINEERING!

Advance beyond the technician level. Become an engineer. If you are a high school graduate and have a good aptitude for electronics and mathematics, you can earn the Degree of Associate in Science in Electronics Engineering

MOSTLY BY STUDYING AT HOME

while you remain on your present job. Grantham School of Engineering (GSE) offers a home-study program, followed by a two-week class, for the ASEE Degree. This degree is accredited by the Accrediting Commission of the National Home Study Council.

In this college-level program (presented at the same level as resident-college engineering courses), the lessons have been prepared especially for *home study*. They have been written, revised, added-to, revised, expanded, revised, re-oriented, revised, etc., over a period of many years, by home-study experts in the teaching of engineering, with the one objective of providing a *better way* for technicians to learn engineering.

This *accredited* ASEE Degree program includes a review of basic electronic circuits and systems, a thorough coverage of applied engineering mathematics (including algebra, trigonometry, and calculus), classical and modern physics, technical writing, computer science, electrical networks, and semiconductor circuit analysis and design.

We award the *associate* rather than the bachelor's degree because our educational program covers only engineering and engineering-related subjects and does not cover general subjects such as English, History, Foreign Languages, etc. Notice, however, that the ASEE is a degree in *engineering* rather than the usual junior-college kind of associate degree.

We Teach Better Because We Specialize

The main purpose of the GSE educational program is to *upgrade* electronics technicians to the *engineering level*. Therefore, as a GSE student, you are not, for example,

studying math with accounting students or studying physics with medical students. Instead, all of the lessons covering all subjects are written for students just like yourself — for electronics technicians upgrading to the engineering level. This method allows electronics engineering examples and applications to be tied in with the study of all subjects in the curriculum.

Since all of our students have backgrounds similar to yours and the same professional objective as yours, we can teach all of the required subjects more directly to the point — the way they should be taught (for maximum advantage) specifically to electronics technicians who are upgrading to the engineering level — not generalized to the extent that they apply equally well to a dozen different professions! So *our way* of teaching electronics engineering is more applicable to *your need*.

— G.I. Bill Approved —

For complete details, mail postcard or coupon.

Grantham School of Engineering EW-5-71
1505 N. Western Ave., Hollywood, Calif. 90027

Gentlemen:

I have been in electronics for _____ years. I am interested in the Grantham degree program in Electronics Engineering. Please send me your free bulletin.

Name _____ Age _____

Address _____

City _____ State _____ Zip _____

from Alpha to Omni

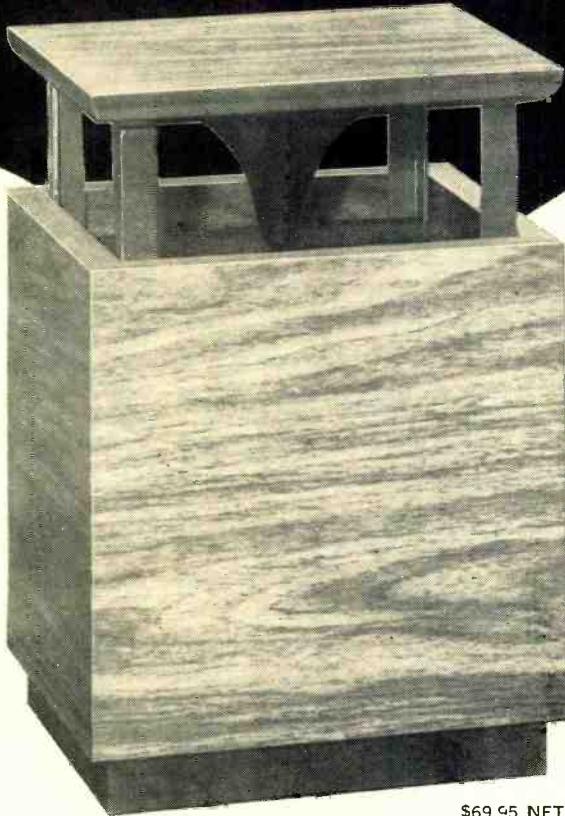

\$69.95 NET

OM-1 OMNI SPEAKER SYSTEM. We've been in it from the beginning... at point ALPHA in time. Our engineers took audible sounds—electronically produced, and made them clear, high fidelity tones. We participated in the design and engineering of speakers to create the world's finest stereophonic sound reproduction. Now, we have reached OMNI... OM-1 OMNI SPEAKER SYSTEM produces sound uniformly for any part of the room. It is "omni-directional," (radiates 360 degrees). This new concept radiates both direct and reflected sound deftly, creating a real depth sensation. You can place this OMNI speaker anywhere from the middle of the room to a corner bookshelf. The UTAH Omni Speaker is a wonderful new way to enjoy music.

sound all around

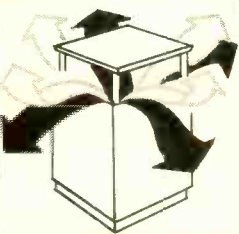

SPECIFICATIONS

Woofer; 8" diameter, cloth roll suspension, $1\frac{3}{4}$ pound magnet structure, 1" voice coil. Tweeter; 3" diameter, co-axially mounted, Alnico V magnet. Crossover frequency; 4,500 Hz. Cabinet; $9\frac{3}{4} \times 9\frac{3}{4} \times 14\frac{1}{2}$ " high, durable laminated walnut finish. Power; 30 watts peak, (15 watts program). Response, 35/18,500 Hz. Impedance, 8 ohms. Shipping weight, 15 pounds.

utah

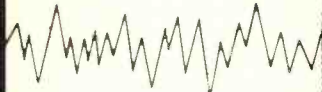

HUNTINGTON, INDIANA 46750
CIRCLE NO. 87 ON READER SERVICE PAGE

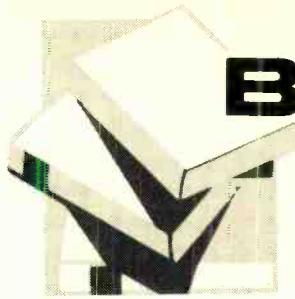

BOOKS

"ENGINEERING MATHEMATICS HANDBOOK" by Jan J. Tuma. Published by *McGraw-Hill Book Company*, New York. 326 pages. Price \$9.95.

If this isn't the "last word" in mathematical handbooks, it comes very close. It contains virtually every definition, theorem, formula, and table that an engineer (or engineering student) needs in his work—all presented in a unique and easy-to-understand format.

The material is divided into five major sections covering algebra, plane and solid geometry, trig, analytic geometry, and elementary functions in six chapters; differential calculus, infinite series, integral calculus, vectors, complex variables, Fourier Series, and special functions in six chapters; ordinary and partial differential equations and related topics in three chapters; numerical methods, probability, and statics in three chapters; and finally a single chapter which consists of over 720 cases of indefinite integrals and their solutions indexed in 80 tables.

Finally, four appendices carry important tables, conversion tables, a glossary of symbols, and references and bibliography. Two-color printing is used throughout the book to highlight the most significant features of the pinpointed text and/or illustration.

* * *

"AN INTRODUCTION TO ELECTRONICS" by Dennis F. Shaw. Published by *American Elsevier Publishing Co., Inc.* 52 Vanderbilt Ave., New York 10017. 383 pages. Price \$9.00

This volume, an updated second edition of a 1962 work, is designed for students working toward a degree in physics and covers the fundamentals of both circuit theory and electronic devices.

The first eight chapters cover circuit theory while the balance of the book takes up the physical properties of electronic devices with emphasis on the role of electrons and holes in conduction processes.

Since the author is University Lecturer in Physics at Oxford University in England, his mathematical approach is geared to the background of his students—first and second year men working toward degrees in pure and applied physics. Those with the requisite mathematical background will find this text useful and timely.

* * *

"ELECTRONICS FOR THE AMATEUR" by Louis M. Dezettel, W5REZ. Published by *Editors and Engineers, Ltd.* Indianapolis, Ind. 46268. 265 pages. Price \$7.95.

This handy book contains most of the information that the prospective ham will need to pass the theory portion of his license examination. Rather than having to cull through a number of different sources to find answers to amateur-oriented questions, the author has assembled the basic material in eleven information-packed chapters.

Both beginners and advanced hams will find this book worthwhile. While the presentation is at a basic level at the beginning of each chapter, the author steps up the level and the complexity of his treatment as the discussion progresses. Two excellent chapters on antennas and one each on reception and transmission should prove especially helpful. Lavishly illustrated and written in easy-to-understand

ELECTRONICS WORLD

form, this book plus the requisite knowledge of code and the Rules and Regulations should see the reader through the licensing exams.

* * *

"QUESTIONS & ANSWERS ABOUT MEDICAL ELECTRONICS" by Edward J. Bukstein. Published by *Howard W. Sams & Co., Inc.*, Indianapolis. 95 pages. Price \$2.95. Soft cover.

The growing field of medical electronics has generated a need for technicians to check and service the various devices now being used routinely in hospitals and doctors' offices. While the "Q&A" treatment of the subject by the author is at a rather elementary level, it does give the technician thinking about entering this field an overview of the types of equipment used and for what medical purpose.

A basic understanding of how oscillators, amplifiers, and power supplies work will be useful since the author has concentrated on applications and general principles of operation rather than the nuts-and-bolts of the circuits that are used.

The text is well illustrated. The material is divided into twelve parts and covers specific areas of instrumentation. A glossary of medical and medical-instrument terminology is a useful addition.

* * *

"PRACTICAL ELECTRONIC SERVICING TECHNIQUES" by Larry Allen. Published by *Tab Books*, Blue Ridge Summit, Pa. 17214. 255 pages. Price \$7.95.

Emphasis here is on the "practical" aspects of servicing with the author plumping for analysis rather than random and undirected action. He demonstrates how a top-notch technician saves time and effort by using his senses and drawing deductions regarding the probable fault from such primary analyses. The entire technique breaks down into three easy steps: inspection, isolation, and pinpointing.

The writing is informal but no-nonsense and the text material is elaborately illustrated to demonstrate the author's service techniques.

* * *

"TESTS-ANSWERS FOR FCC FIRST AND SECOND CLASS COMMERCIAL LICENSE" by Warren G. Weagant. Published by *Command Productions*, P.O. Box 26348, San Francisco, Calif. 94126. 54 pages. Price \$9.95. Soft cover, spiral bound.

This is a revised and updated study manual for holders of Third Class tickets wanting to sit for Second and First Class Radiotelephone exams. Before starting on a home-study program the author has provided a "self-study ability test" by means of which the student can determine whether or not he has the requisite mathematical background and suitable study habits to tackle such a project.

All of the material included in the manual is based on actual FCC exam questions and, in addition, the author has provided study tips, testing information, a bibliography, and answers to the various test questions.

* * *

"COLLECTED BASIC CIRCUITS" by D.I.P. Stretton & A. W. Hartley. Published by *Howard W. Sams & Co., Inc.*, Indianapolis, Ind. 171 pages. Price \$4.95. Soft cover.

The authors have assembled a wide variety of circuits using thermionic tubes and semiconductors in this compact handbook to help engineers and technicians find the right circuit for a specific job.

Information on over 250 circuits is included, along with a schematic of each circuit, its most important characteristics, and details of its operation. Circuit types covered include amplifiers, clippers and limiters, oscillators, multivibrators, pulse generators, trigger circuits, counters, and digital, logic, and gate circuits. Other chapters detail sweep generators, detectors, regulators, modulators, choppers and switches, power supplies, and miscellaneous circuits. A comprehensive index permits quick location of specific circuits. ▲

NEW AND ONLY FROM EICO-THE INDUSTRY'S LOWEST-PRICED PROFESSIONAL FET-TVM.

- ADVANCED SOLID STATE DESIGN
- BATTERY-POWERED

New Model 239
\$39.95
KIT
\$59.95 Wired



Use the new 239 on your bench or in the field. Checks semiconductor and vacuum tube circuits. 11 Megohm DC input impedance. Reads AC rms and DC voltages in seven 10db steps from 1 to 1000 volts on large 4½" meter. Measures and reads peak-to-peak AC to 2800 volts. Check resistance from 0.2Ω to 1000 MΩ on seven ranges. Includes exclusive time-saving Uniprobe.

2 NEW DE-LUXE FET-TVM's

Includes all purpose DC/AC ohms Uniprobe.

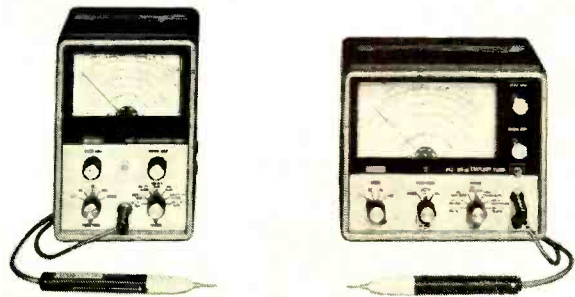

EICO 240 Solid-State FET-TVM. \$59.95 kit, \$79.95 wired. AC or battery operated. 7 ranges each + and - DC volts, peak-to-peak AC volts, ohms. 10 turn zero adjust pot. 4-1/2" 200 μA meter. response to 2 MHz (to 250 MHz with optional r-f probe).

EICO 242 Solid-State FET-TVOM. \$69.95 kit, \$94.50 wired. As 240 plus 7 ranges each AC/DC milliammeter, 1 ma to 1A: very low voltage ohmmeter. 10 turn ohms and zero adjust pots. Large 6-1/2", 200 μA meter.

Write for '71 catalog of 200 EICO Top Buys in test equipment, stereo, color organs, science project kits, environmental lighting.



EICO, 283 Malta St., Brooklyn, N.Y. 11207. (212) 949-1100.

10 Reasons why RCA Home Training is your best investment for a rewarding career in electronics:

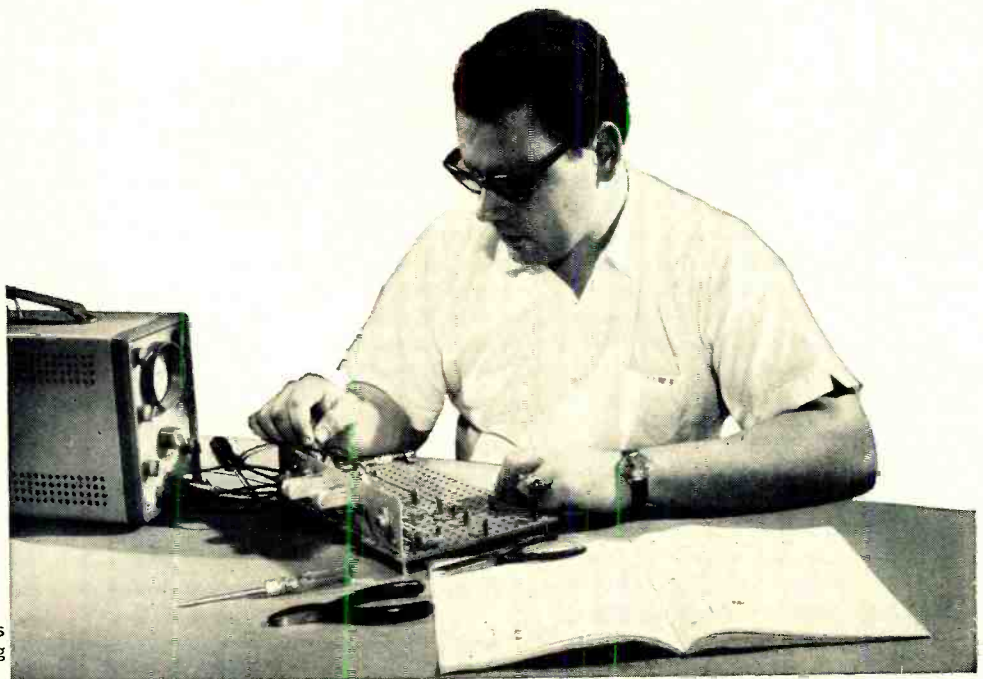

Performing transistor experiments on programmed breadboard—using oscilloscope.

1 LEADER IN ELECTRONICS TRAINING

When you think of electronics, you immediately think of RCA... a name that stands for dependability, integrity, and pioneering scientific advances. For over half a century, RCA Institutes, Inc., a subsidiary of RCA, has been a leader in technical training.

2 RCA AUTOTEXT TEACHES ELECTRONICS FASTER, EASIER, ALMOST AUTOMATICALLY

Whether you are a beginner or refresher, AUTOTEXT, RCA Institutes' own method of programmed Home Training will help you learn electronics more quickly and with less effort, even if you've had trouble with conventional learning methods in the past.

3 WELL PAID JOBS ARE OPEN TO MEN SKILLED IN ELECTRONICS

RCA Institutes is doing something positive to help men with an interest in electronics to qualify for rewarding jobs in this fascinating field. There are challenging new fields that need electronics technicians... new careers such as computers, automation, television, space electronics where the work is interesting and earnings are greater.

4 WIDE CHOICE OF CAREER PROGRAMS

Start today on the electronics career of your choice. On the attached card is a list of "Career Programs", each of which starts with the amazing AUTOTEXT method of programmed instruction. Look the list over, pick the one best suited to you and check it off on the card.

5 SPECIALIZED ADVANCED TRAINING

For those already working in electronics or with previous training, RCA Institutes offers advanced courses. You can start on a higher level without wasting time on work you already know.

6 PERSONAL SUPERVISION THROUGHOUT

All during your program of homestudy, your training is supervised by RCA Institutes experts who become personally involved in your efforts and help you over any "rough spots" that may develop.

7 HANDS-ON TRAINING

To give practical application to your studies, a variety of valuable RCA Institutes engineered kits are included in your program. You get over 250 projects and experiments and as many as 22 kits in some programs. Each kit is complete in itself. You never have to take apart one piece to build another. They're yours to keep and use on the job.

8 FCC LICENSE TRAINING—MONEY BACK AGREEMENT

Take RCA's Communications Career program—or enter with advanced standing and prepare immediately for your 1st, 2nd, or 3rd class FCC Radio Telephone License examinations. RCA Institutes money-back agreement assures you of your money back if you fail to pass the FCC examination taken within 6 months after completing the course.

9 CONVENIENT PAYMENT PLANS

You get a selection of low-cost tuition plans. And, we are an eligible insti-

tution under the Federally Insured Student Loan Program.

10 RCA INSTITUTES IS FULLY ACCREDITED

RCA Institutes is an accredited member of the National Home Study Council. Licensed by N. Y. State—courses of study and instructional facilities are approved by the State Education Department.

VETERANS: TRAIN UNDER NEW GI BILL

SEND ATTACHED POSTAGE PAID CARD TODAY! FREE DESCRIPTIVE BOOK YOURS WITHOUT OBLIGATION!

If reply card is detached, send this coupon today.

RCA INSTITUTES, INC.
DEPT. 240-005-1
320 W. 31 ST.
NEW YORK, N. Y. 10001

Please send me FREE illustrated career catalog. I understand that I am under no obligation.

Name _____

Address _____

City _____

State _____ ZIP _____

Age _____

Veterans: Check here

RCA

Construction of Multimeter.



May, 1971

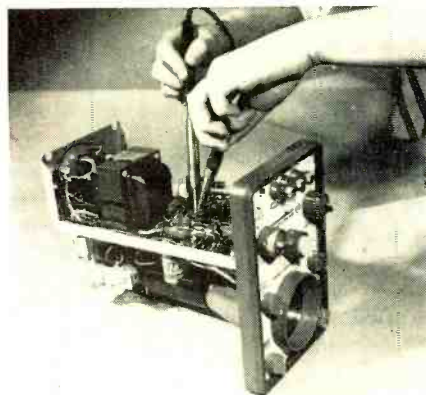

Construction of Oscilloscope.

Temperature experiment with transistors.

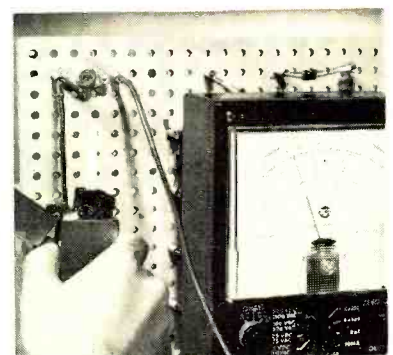

65

Punch clean, true holes in seconds.

A Greenlee chassis punch is the quickest way yet to cut round, square, key, D, or double-D holes in 16-gauge metal, hard rubber, plastics, epoxy, etc. Available at radio and electronics parts dealers. Or write for Catalog E-730 to: Greenlee Tool Co., 1764 Columbia Ave., Rockford, Ill. 61101.

GREENLEE TOOL CO

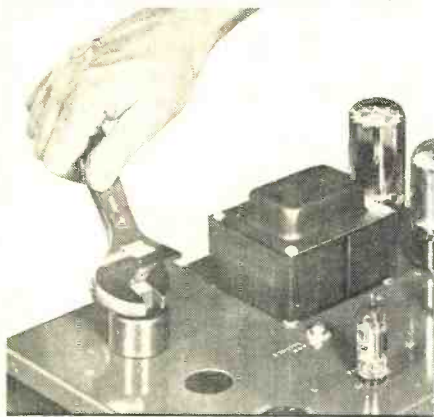

EX-CELL-O CORPORATION

CIRCLE NO. 70 ON READER SERVICE PAGE

MINIATURE AC BRIDGE

Transistorized — 9V battery operated — accurate, easy to use for resistance, inductance, capacitance.

ONLY \$65

ELECTRONIC TOOLS DIVISION
C. H. MITCHELL CO.

14614 Raymer St. / Van Nuys, CA 91405

CIRCLE NO. 79 ON READER SERVICE PAGE

**Cooperate With The
Zip Code Program
of The Post Office
Department
Use Zip Code
In All Addresses**

GET INTO ELECTRONICS



V.T.I. training leads to success as technicians, field engineers, specialists in communications, guided missiles, computers, radar and automation. Basic & advanced courses in theory & laboratory. Electronic Engineering Technology and Electronic Technology curricula both available. Assoc. degree in 29 mos. B. S. also obtainable. G.I. approved. Graduates in all branches of electronics with major companies. Start September, February. Dorms. campus. High school graduate or equivalent. Write for catalog.

VALPARAISO TECHNICAL INSTITUTE
Dept. RD, Valparaiso, Indiana 46383

CIRCLE NO. 88 ON READER SERVICE PAGE

Classical Recording (Continued from page 43)

recorders since 3-track mastering began in the late 1940's. The 3-track concept is the one used most frequently with one track left, one center, and one right.

Such recorders give the engineer a practical limit of four inputs per channel. In most cases, this means that he has 12 or, at most, 16 microphones with which to cover up to 150 instruments, a chorus, sound effects, audience noises, etc. In most symphony orchestras, the four basic instrumental sections (strings, woodwinds, brass, and percussion) may involve 80 or more people who are miked (two microphones spaced every 15 feet) not for isolation/separation but for "fullness" of sound. To gain this effect, instrumentalists are sometimes added or the volume is increased.

Quite a bit of leakage results from using 12 to 16 loosely positioned microphones recording section-by-section instead of by instrument type or specific instrument. With this technique, much specific audio information is lost in the general tonal leakage. Isolation screens are seldom used—except for a vocalist being swamped by the orchestra or for bringing forward the delicate sounds of the harpsichord, etc.

Responsibility for volume balance and tonal control is usually divided among the recording director, the conductor, and the instrumentalists. At studio rehearsals, just prior to taping the actual recording, the orchestra will make two or three takes. The director, score in hand, will carefully follow the movement, note corrections to be made, and advise the conductor. The conductor then assumes responsibility for recording the movement properly. While the performance is in progress, the conductor must correct any errors (and prevent their repetition), and achieve a mix suitable for the final master tape. This process could be handled more efficiently and easily electronically. The orchestra—it goes without saying—is expected to perform flawlessly, but this is not always the case.

Meanwhile the engineer's involvement has consisted of setting up and balancing microphones. He does a minimum amount of mixing, only that which is crucial to the final two-track stereo master.

The final master may have tonal or instrumental errors or sound-effect deficiencies—the singer may be inaudible, a cue may be missed, a cymbal may have entered too soon, or the acoustics of the concert hall or studio may be too live or too dead. These are mishaps which could ruin an otherwise commendable performance.

Because of re-takes, many classical recordings can be extremely costly to make yet not give an accurate representation of the original performance. Classical recordings also represent a great waste of the technical capabilities of the engineer and fail to take advantage of the sophisticated recording equipment available to him.

The application of multichannel recording (8 or 16 tracks) would eliminate most, if not all, the problems involved in making classical recordings. It would be legitimate to use three tracks for the stereo effect (left, center, right), one or two tracks for soloists, one track for the chorus, one track for sound effects, one or two tracks for instrument isolation, one track for director/conductor instructions and editing purposes, and one additional track for instrumental corrections. This means using at least an 8-track recorder which could provide audio information as well as volume and mix control not previously available to the conductor, director, or engineer once the initial take was over.

With the multichannel recorder, such common situations as a great orchestral performance but poor voice reproduction, poor instrumental balance, timing errors in rhythm or sound effects, or a singer out of balance, could be eliminated from the recording.

Multichannel recorders could eliminate costly repeats during a final taping session—something that often occurs when a singer's voice cracks, a violin string breaks, or a music stand gets knocked over. By using 8- and 16-track recorders with selective synchronization, a performer can listen to the playback of one track while recording on another, so a part that was ruined during the final taping can be redone without having to reassemble the orchestra and repeat the performance.

Here are a few worthwhile tips: Record by instrument type and objective; isolate each section, allowing one or more tracks as needed to achieve the proper effect with no leakage; pre-mix and balance, putting different instruments on different tracks so that correct emphasis can be placed on a desired instrument or sound effect during the final mix-down; use roughly 15 to 25 microphones and mike close-to to achieve a pure sound without having woodwinds or strings drowned out by the brass or percussion sections. This sound can be greatly enhanced by the skillful addition of reverberation, equalization, compression sound limiting, panning, and various other effects. Multichannel recording would not detract from the "feel" of the recorded performance as heard by those listening to a disc or tape, but it would insure that everything that should be heard on the disc will be audible. ▲

ERTS—Satellites to Serve Man (Continued from page 29)

effluent into the ocean from rivers and streams. More advanced earth resources satellites may be equipped with such instruments as spectrometers not only to spot air pollution, but also to analyze it qualitatively. In short, with its frequent coverage of the earth on a broad regional scale, ERTS will give pollution controllers a new way to look at both air and water pollution.

Oil and mineral exploration will also benefit from the broad coverage of the new satellites. Ground features normally associated with "finds" can be surveyed quickly by the satellite to narrow the areas of exploration, thus increasing yields and reducing cost of finding the resources. The same spectrometers used to monitor air pollution could enable future satellites to pinpoint certain gases, such as iodine, which frequently hang in invisible clouds over potential oil and mineral sources.

As numerous as they now appear, areas of application will no doubt expand even further once the data begins to flow in from the satellite. For example, after analyzing photographs taken from the Gemini and Apollo spacecraft, geographers feel they can chart population growth in major urban areas using the satellite pictures. ERTS thus may provide a means of taking an interim census from space.

Present plans for ERTS call for the first spacecraft to be launched in the first half of 1972 with a goal of one year's operation. At the end of this year, ERTS B will be sent into orbit to provide another year of experimental coverage. An ERTS C and D, which would carry relatively simple film photography systems, with the film being returned *via* a special re-entry vehicle, is under consideration.

Beyond the present experimental satellites, there are a host of possibilities. If ERTS A and B live up to expectations, an operational version could follow quickly. There could also be a number of special-purpose spacecraft, each configured to perform specific functions. For example, spacecraft zeroing in on oceanography could be outfitted with specialized instrumentation such as radar scatterometers.

In all cases, there will be broad participation in the program not only by non-NASA government agencies, such as the Departments of Interior and Agriculture, but also by private industry and universities as well. For example, some 25 to 30 companies—chiefly in mining and petroleum—have shown an interest in the program and may become users of the satellite data.

The satellite may very well acquire an international flavor. Although no formal policy has yet been expounded, President Nixon told the United Nations last year that data from earth resources satellites would be "open to the world community." ▲

A model of the vidicon TV camera, three of which will be carried aboard each satellite. Using 4200 horizontal scanning lines, this will be the highest resolution TV system ever flown in space.

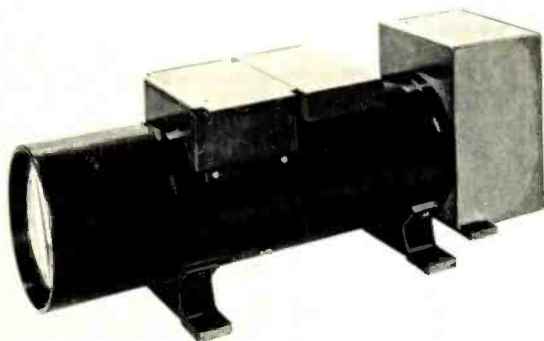

May, 1971

YOU PAY LESS

For top performance with ELECTRO POWER SUPPLIES

Whatever your power supply needs are . . . you'll be better off buying Electro. Every model is engineered to deliver the superior performance you want, yet all are priced to create outstanding values you'll be hard pressed to duplicate. For complete details write today.



**RUGGED
High-Current
NFB-NFBR
SERIES
0-32 Volts DC
Up to 15 Amps DC
Continuously Variable**

High current power supplies designed to deliver up to 480 watts of well filtered DC power. Exceptionally reliable, they feature silicon rectifiers for higher efficiency, less than 0.75% ripple at top load, a fast acting circuit breaker in the output circuit, excellent load regulation, special chokes, condensers and Pi-type filters, and two meters with 0-50VDC output voltage—0-25ADC output current.

**EXTRA
Hi-Power
PS-1000 Series
1000 Watts
Continuously Variable
Well filtered for Low Ripple**



For continuous heavy-duty. Continuously variable output. 0-32 VDC for loads to 30 amps. Ripple: less than 0.75% at max. current. Filter circuit uses chokes and capacitors. Variable autoformer for smooth control. Bridge-type silicon rectifiers. Also available in an 0-55 VDC at 20 amps. model.



**HIGH-CURRENT
PS-50, PS-30
12 Volts
ADJUSTABLE
Low Ripple at Max. Current**

These new general purpose power supplies are heavy duty adjustable 12-volt units for servicing auto, aircraft and marine communications equipment. Useful in industrial and educational labs, thermo-electric cooling power source, etc. Maximum ripple is 1% at maximum current. Output voltage adjustment is 8-position tap switch. PS-50 delivers up to 50 amps. continuously; PS-30 rated up to 30 amps.

Sold through leading Electronic Distributors



ELECTRO®

ELECTRO PRODUCTS LABORATORIES, INC.
6125 WEST HOWARD STREET, CHICAGO, ILLINOIS 60648
312-647-8744/FAX: JMD/CABLE ELECTROLAB

CIRCLE NO. 65 ON READER SERVICE PAGE

67



23" GR-370



25" GR-371MX



20" GR-270

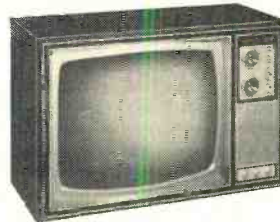

18" GR-269



14" GR-169

There's a Heathkit® solid-state color TV to fit every size and budget need. Think about it.

Consider the choice. Heath offers five different solid-state color TV's in easy-to-assemble kit form, from the portable 14" GR-169 to the largest screen in the industry, the 25" GR-371MX. All offer Heath's famous modular plug-in circuit board design that makes assembly easier. Only two tubes (picture and high voltage rectifier). And Heathkit color TV's are the only sets available at any price that can be serviced by the owner, without special test

equipment or years of training. The famous Heath manual, combined with the special volt-ohm meter supplied, enables you to perform every adjustment required. And each set includes the No-charge 90-day Warranty Service on solid-state modules and 2 year picture tube warranty. Here's the rundown on the Heath series of solid-state color TV's. Think them over, you'll find one just right for your own size and budget requirements.

25" GR-371MX . . . the top of the Heath color TV line. Compare this list of **standard** features on the 371MX . . . there isn't another set available that offers all these extras at no extra cost. Giant 25" Matrix picture tube delivers the biggest, brightest color picture you'll ever see . . . 315 sq. in. And pictures don't wrap around the sides as before. Specially formulated etched-glass face plate cuts out glare, increases contrast without reducing brightness. Automatic Fine Tuning delivers perfectly tuned picture and sound with a push of a button. "Instant On" circuitry provides sound instantly, picture in seconds. Exclusive Heath MOSFET VHF tuner gives superior reception, even under marginal conditions. VHF Power Tuning is built-in . . . a push of a button lets you scan thru all VHF and one preselected UHF channel. High resolution circuitry improves picture clarity and adjustable video peaking lets you select the degree of sharpness you desire. Adjustable tone control . . . adjustable noise limiting and gated AGC . . . hi-fi sound output . . . 75 & 300 ohm VHF antenna inputs . . . Automatic Chroma Control — all standard. Plus three luxurious optional cabinets to choose from: Mediterranean, Early American or Contemporary. Plenty of reasons to order your new GR-371MX now.

Kit GR-371MX, (less cabinet), 125 lbs. **\$579.95***

23" GR-370. Actually the GR-371MX with a smaller picture tube. Features a premium quality bonded face, etched-glass 23" screen . . . 295 sq. in. of viewing enjoyment. Includes the same standard

high performance features as the 371MX above, except the Matrix picture tube is a low cost option.

Kit GR-370 (less cabinet) 127 lbs. **\$539.95***

Kit GR-370MX, as above with Matrix picture tube **\$549.95***

20" GR-270. In reality, the feature-packed GR-371MX with standard 20" bonded-face, etched-glass picture tube providing 227 sq. in. of colorful TV viewing. See the GR-371MX above for all the other standard features. Easily your best buy in a medium size solid-state color TV, and ideal screen size for smaller living rooms.

Kit GR-270 (less cabinet), 114 lbs. **\$489.95***

18" GR-269 . . . the Heathkit "compact" color TV. Has the same highly sophisticated modular solid-state circuitry as the GR-371MX, but modified to accept the popular 180 sq. in. color picture tube. Features AFT, "Instant On", 3-stage IF, MOSFET VHF tuner, switch-controlled degaussing . . . all standard.

Kit GR-269, (less cabinet), 100 lbs. **\$399.95***

14" GR-169 delivers console performance with portable convenience. Here's the GR-371MX modular circuitry modified slightly to accept a 14" diagonal picture tube. Features MOSFET VHF tuner, 3-stage IF, switch-controlled degaussing, complete up-front secondary controls, built-in VHF & UHF antennas. Handsome portable cabinet included.

Kit GR-169, 69 lbs. **\$349.95***



TO-101 Legato Theater Organ

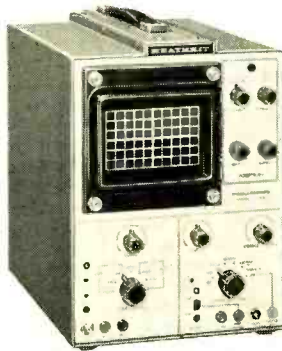

IO-102 5" Scope



IB-101 Frequency Counter

GD-29
Microwave
Oven

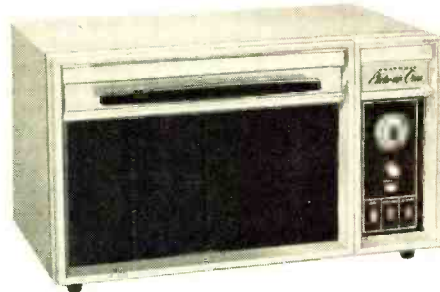

And here are a few of the more than 300 other Heathkit thoughts for the budget minded:

New Heathkit "Legato" 25-pedal Theater Organ. Now you can save hundreds of dollars by building this versatile instrument yourself. All solid-state design. Features 15 manual voices, 4 pedal voices. 25-note heel & toe pedal board, range 16' & 8' CO to C3. Two 44-note keyboards; accompaniment range 8', F1 to C5. Solo manual 16', 8', 4', 2', F1 to C7. Color-Glo key lights have you playing like a pro in minutes. Two solid-state amplifiers deliver 200 watts peak power . . . one amp for the rotating 2-speed Leslie, one for the two 12" main speakers. Tape record/playback jack on amp. Bandbox & Playmate accessories available. Bench included.

Kit TO-101, 299 lbs. \$1495*

New Heathkit Microwave Oven . . . tomorrow's cooking revolution here today in easy-to-build kit form. Exclusive patent pending Heath double door interlock prevents oven from being turned on if door is open. Cooks meals in minutes, not hours . . . eliminates dirty pots & pans by cooking on paper, glass, china. Low profile design fits nearly anywhere. 120 V operation.

Kit GD-29, 97 lbs. \$399.95*

New Heathkit 5" Solid-State Scope . . . ideal for all general lab

& shop applications. Wide 5 MHz response, 80 nanosecond rise time and 30 mV/cm sensitivity make the IO-102 a truly high performance, low cost scope. Convenient switch-selected AC or DC coupling. Frequency-compensated 3-position attenuator. FET input provides high input Z (1 megohm) to minimize circuit loading. Recurrent, automatic sync type sweep provides 5 ranges from 10 Hz to 500 kHz with vernier. External horizontal and sync inputs. One volt P-P output. New flat face 5" CRT with removable 6x10 cm ruled graticule. Zener-regulated power supplies give excellent display stability. 120/240 VAC operation. Choose easy to assemble kit or factory-wired version.

Kit IO-102, 29 lbs. \$119.95*

Assembled IOW-102, 29 lbs. \$179.95*

Assembled PKW-101, 1 megohm probe, 1 lb. \$ 19.95*

New Heathkit Solid-State Frequency Counter . . . delivers highly accurate measurement from 1 Hz to over 15 MHz. All IC circuitry for top performance. Automatic trigger level for wide range input without adjustment. Hz/kHz ranges & overrange give 8-digit capability. 1 megohm input Z.

Kit IB-101, 7 lbs. \$199.95*

See these and 300 other Heathkit suggestions at one of the following Heathkit Electronic Centers:

CALIFORNIA: Anaheim, 92805, 330 E. Ball Road; El Cerrito, 94530, 6000 Potrero Avenue; La Mesa, 92041, 8363 Center Drive; Los Angeles, 90007, 2309 S. Flower St.; Redwood City, 94063, 2001 Middlefield Rd.; Woodland Hills, 91364, 22504 Ventura Blvd.; **COLORADO:** Denver, 80212, 5940 W. 38th Ave.; **GEORGIA:** Atlanta, 30305, 5285 Roswell Road; **ILLINOIS:** Chicago, 60645, 3462-66 W. Devon Ave.; Downers Grove, 60515, 224 Ogden Ave.; **MARYLAND:** Rockville, 20852, 5542 Nicholson Lane; **MASSACHUSETTS:** Wellesley, 02181, 165 Worcester St.; **MICHIGAN:** Detroit 48219, 18645 W. Eight Mile Rd.; **MINNESOTA:** Hopkins, 55343, 101 Shady Oak Rd.; **MISSOURI:** St. Louis, 63123, 9296 Gravois Ave.; **NEW JERSEY:** Fair Lawn, 07410, 35-07 Broadway (Rte. 4); **NEW YORK:** Jericho, L.I., 11753, 15 Jericho Turnpike; New York, 10036, 35 W. 45th Street; **OHIO:** Cleveland, 44129, 5444 Pearl Rd.; Woodlawn, 45215, 10133 Springfield Pike; **PENNSYLVANIA:** Philadelphia, 19149, 6318 Roosevelt Blvd.; Pittsburgh, 15235, 3482 William Penn Hwy.; **TEXAS:** Dallas, 75201, 2715 Ross Avenue; Houston, 77027, 3705 Westheimer; **WASHINGTON:** Seattle, 98121, 2221 Third Ave.; **WISCONSIN:** Milwaukee, 53216, 5215 W. Fond du Lac

Retail Heathkit Electronic Center prices slightly higher to cover shipping, local stock, consultation and demonstration facilities. Local service also available whether you purchase locally or by factory mail order.



HEATH COMPANY, Dept. 15-5
Benton Harbor, Michigan 49022 a Schlumberger company

Enclosed is \$ _____, plus shipping

Please send model (s) _____

Please send FREE Heathkit Catalog.

Name _____

Address _____

City _____ State _____ Zip _____

Prices & specifications subject to change without notice.

*Mail order prices; F.O.B. factory. CL-410

ELECTRONIC TECHNICIANS!

Raise your professional standing and prepare for promotion! Win your diploma in

ENGINEERING MATHEMATICS

from the Indiana Home Study Institute

We are proud to announce two great new courses in Engineering Mathematics for the electronic industry.

These unusual courses are the result of many years of study and thought by the President of Indiana Home Study, who has personally lectured in the classroom to thousands of men, from all walks of life, on mathematics, and electrical and electronic engineering.

You will have to see the lessons to appreciate them!

NOW you can master engineering mathematics and actually enjoy doing it!

WE ARE THIS SURE: you sign no contracts—you order your lessons on a money-back guarantee.

In plain language, if you aren't satisfied you don't pay, and there are no strings attached.

Write today for more information and your outline of courses.

You have nothing to lose, and everything to gain!

The INDIANA HOME STUDY INSTITUTE

Dept. EW-5, P.O. Box 1189, Panama City, Fla. 32401

CIRCLE NO. 73 ON READER SERVICE PAGE

DON'T SETTLE FOR A HIT AND MISS IGNITION SYSTEM



Install a JUDSON ELECTRONIC MAGNETO

It offers the combined advantages of both the standard transistorized and capacitive discharge systems in one simplified patented circuit. Provides better performance, a smoother running engine and keeps your car in tune. Installed in twenty minutes.

Write Today for Literature

JUDSON
RESEARCH & MFG. CO.
CONSHOHOCKEN, PA. 19428

CIRCLE NO. 75 ON READER SERVICE PAGE

Selecting a TV Antenna

(Continued from page 35)

and for a smoother over-all response.

Multiple Features

For a collection of unique features, consider the new "VU-Finder" from *Jerrold Electronics Corp.* Fig. 6 illustrates one model of this high-gain all-channel antenna.

The elements are spaced evenly, yagi-style. Their lengths taper linearly toward the front. Transposed wiring is used, but it's through disc-shaped insulators with imbedded conductors. This trick lets two straight wires harness together the active elements. All the dipoles along the main boom are driven, for high gain. But shorter elements act as directors for longer ones and longer ones act as reflectors for the shorter ones.

Up front, you can see a couple of short parasitic elements that help break up the long elements for high-band v.h.f. signals. But even more effective are the parasitic elements that appear to be part of the u.h.f. array. They, too, are for high-band v.h.f.

The only driven u.h.f. element is the specially shaped bow-tie you see in the middle of the u.h.f. array. Its shape is a patented design developed by *Jerrold*. It's called an extended-resonance u.h.f. dipole. The projections at each corner are angle-aluminum, and the bow-tie itself is not flat—it's molded with half-cylinder depressions toward the sides.

The very shortest parasitic elements arrayed on the two angled booms form a corner reflector that improves u.h.f. sensitivity. The high-band v.h.f. elements contribute to u.h.f. gain, too; they "break-up" into thirds for u.h.f. Finally, to raise u.h.f. gain even more and to concentrate forward directivity, there's a boomful of parasitic u.h.f. elements at the very front of the antenna.

You'll recognize some design characteristics of the *RMS Electronics'* antenna in Fig. 7. The chief difference is that its driven u.h.f. array is practically a miniature replica of its v.h.f. array—even to the transposed element-phasing harness. There's a corner reflector for u.h.f., and one director; the v.h.f. array has only one reflector, and it's linear. The sketch shows a suburban model; higher-gain models have more u.h.f. directors and more v.h.f. reflectors.

Another feature is the coupling bracket between the v.h.f. and u.h.f. sections; it's jointed. You can point the u.h.f. antenna as much as 45 degrees to one side, in case the u.h.f. stations are not in the same direction as v.h.f.

Indoor/Outdoor Types

One of the most unusual new anten-

nas is the *Winegard* Sensar (shown at top left of cover). There's only one driven element. It's a big flat dipole. Each half of the dipole is about 2½ feet long and 6 inches wide, stamped out of flat aluminum. A slot is punched right down the middle of each flat plate, for most of its length. The tips are turned downward, giving the whole thing a wing-like appearance.

The center ends of the dipole halves fit into a molded plastic housing. In the more sensitive model, a transistor amplifier boosts the signal several dB before feeding it into the 75-ohm coaxial downlead. (Power for the amp comes up the lead from a power supply/2-set 300-ohm coupler; a small lamp on the plastic housing lights when power is applied.)

The Sensar is for indoor or outdoor use. *Winegard* claims an operating radius of 40 miles or more when driving two receivers, if the amplified version is used. If ghosts are a severe problem, the Sensar can't do much about them—particularly if they're off the

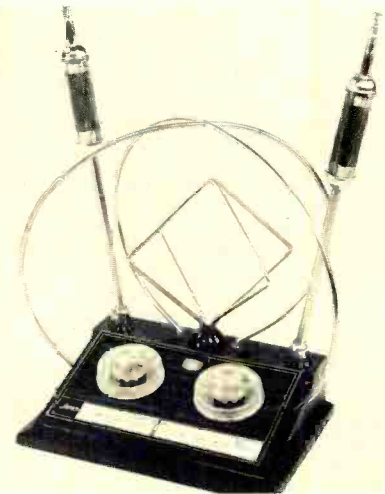
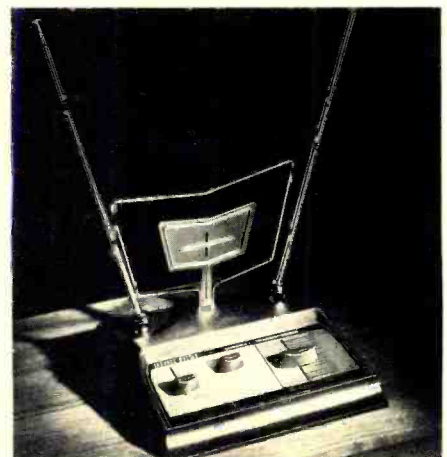

Fig. 8. One dial on this JFD indoor antenna switches the elements to rid picture of ghosts; the other dial is employed for over-all tuning purposes.

Fig. 9. Channel Master's indoor model has powered transistor amplifier. Knobs are for reducing ghosts and interference, and performing tuning.



ELECTRONICS WORLD

back end. It's an all-channel antenna, but u.h.f. performance of our sample was not as good as for v.h.f. Small size makes it a natural for attic or suburban rooftop installation, and a special bracket mounts it conveniently on the side of a camping trailer or pickup-truck camper.

There are also a multiplicity of indoor antennas. Indoor antennas have progressed far beyond the old "rabbit-ear" days. The simplest have telescoping dipoles for v.h.f. and a circular loop for u.h.f. That's okay for 10-15 miles from the station. Careful orientation takes care of most ghosts.

Yet there are some fancy indoor units. *Gavin* has a model with two u.h.f. loops, one slightly smaller to cover the higher u.h.f. channels. Some models have a "tuning" knob. The television viewer uses it to adjust the dipoles electrically for the exact channel.

JFD Electronics makes the complex indoor antenna shown in Fig. 8. One knob switches elements for various ghost conditions. The telescoping dipoles have loading coils, so they resonate for low-band v.h.f. at less cumbersome lengths. Another knob tunes inductive-capacitive circuits inside the base.

Channel Master has an amplified indoor antenna (Fig. 9) called the "Chroma I." It has telescoping dipoles for v.h.f. The u.h.f. antenna is a trapezoid-shaped wire loop, inside of which is a small metal plate of the same shape. Its v.h.f. transistor amplifier feeds a 75-ohm coaxial cable. The u.h.f./v.h.f. splitter converts impedance to 300 ohms at the receiver end of the cable. The base has three controls to rotate u.h.f. antenna, switch from u.h.f. to v.h.f., and tune an antenna-matching circuit for best performance and minimum nearby-station interference at other frequencies. ▲

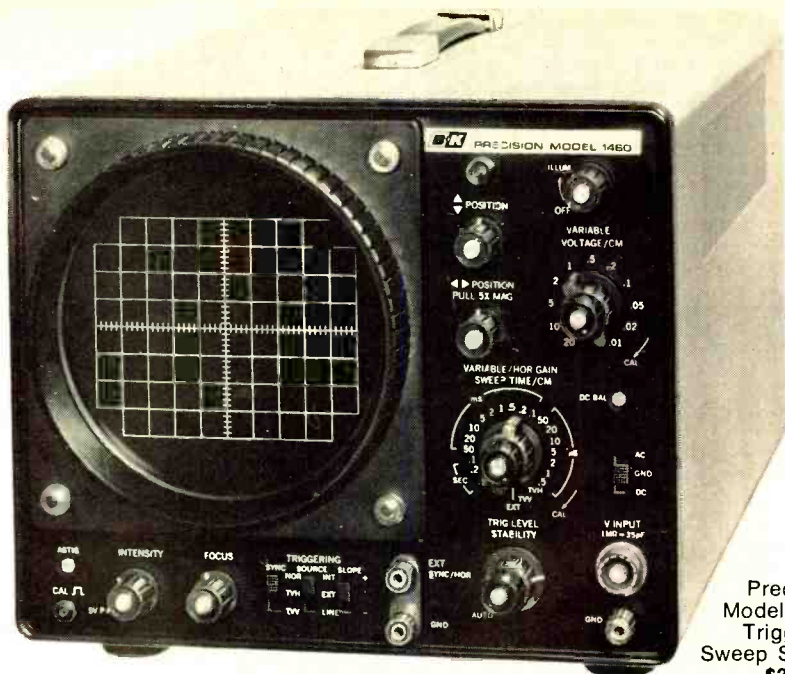

B&K Precision Model 1460 Triggered Sweep Scope \$389.95

B & K Precision's new 1460 Triggered Sweep Scope... The one that's been worth waiting for.

You won't believe how easy it is to sync TV-V and TV-H signals until you've actually tried it.

Trouble shooting complex TV circuits takes enough time without having to fiddle with dials and controls to adjust to the proper wave form.

That's why the new B&K Triggered Sweep Scope features the TV-H and TV-V positions. These are the two new positions you've always needed for quick one-knob selection of horizontal or vertical TV signals. Exclusive sync separator circuit. No complicated and time-consuming adjustments... just flick a single knob.

Fully automatic triggered sweep lets you view the entire complex TV signal or any part of it. Including the VITS (vertical interval test signal).

And the "back porch" of the horizontal sync pulse, with color burst information. All locked in rock steady.

All solid state with 6 FETS. Runs coolest. Vertical sensitivity (10mV/cm) and writing speed of 0.1 microsecond/cm (using 5X multiplier). Features usually found in expensive lab scopes. Complete with direct/10 to 1 probe. 19 sweep speeds and 11 voltage calibrated ranges, DC to 10 MHz.

Pinpoint your problems quickly and accurately with the new 1460 Triggered Sweep Scope. The only thing you'll have to adjust to is having more time on your hands. Ask your distributor or write for our free catalog.

There is a difference in test equipment—ours works!



Product of DYNASCAN CORPORATION
1801 W. Belle Plaine / Chicago, Illinois 60613
CIRCLE NO. 52 ON READER SERVICE PAGE

ABOUT YOUR SUBSCRIPTION

Your subscription to *ELECTRONICS WORLD* is maintained on one of the world's most modern, efficient computer systems, and if you're like 99% of our subscribers, you'll never have any reason to complain about your subscription service.

We have found that when complaints do arise, the majority of them occur because people have written their names or addresses differently at different times. For example, if your subscription were listed under "William Jones, Cedar Lane, Middletown, Arizona," and you were to renew it as "Bill Jones, Cedar Lane, Middletown, Arizona," our computer would think that two separate subscriptions were involved, and it would start sending

you two copies of *ELECTRONICS WORLD* each month. Other examples of combinations of names that would confuse the computer would include: John Henry Smith and Henry Smith; and Mrs. Joseph Jones and Mary Jones. Minor differences in addresses can also lead to difficulties. For example, to the computer, 100 Second St. is not the same as 100 2nd St.

So, please, when you write us about your subscription, be sure to enclose the mailing label from the cover of the magazine—or else copy your name and address exactly as they appear on the mailing label. This will greatly reduce any chance of error, and we will be able to service your request much more quickly.



"Yes, but this electronic heart is different—it's adjustable."

**Announcing the
NEW STANDARD
in Stereo Testing!**

The All-New Model SR12 STEREO TEST RECORD



**The most complete...
most sophisticated...
most versatile Test Disc
available today...**

For Just \$5.98!

Who needs the New Model SR12? You do. Whether you're an avid audiophile, a casual listener, or a professional technician... the new MODEL SR12 will be the most important disc in your entire collection. MODEL SR12 has been produced by Stereo Review Magazine for music lovers who want immediate answers to questions about the performance of their stereo systems and how to get the best possible sound reproduction. It is the most complete test record of its kind—containing the widest range of checks ever included on one test disc.

Make these important stereo checks BY EAR . . . (no test instruments required)

- Frequency response • Separation • Cartridge tracking • Channel balance • Hum and rumble • Flutter • Cartridge and Speaker Phasing • Anti-Skating Adjustment • "Gun Shot Test" for Stereo Spread • Multi-purpose Musician's "A" • Equal-tempered Chromatic Octave • Guitar-tuning Tones.

Attention professionals: For the ultimate in stereo testing, 7 critical TEST EQUIPMENT checks . . .

- 1,000-Hz square waves to test transient and high-frequency response of phono pickups.
 - 500 to 20,000 Hz frequency-response sweep.
 - Sine-wave tone-bursts to test transient response of pickup.
 - Intermodulation test using simultaneous 400-Hz and 4,000-Hz signals.
 - Intermodulation sweep to show distortion caused by excessive resonances in tone arm and cartridge.
 - 1,000-Hz reference tones to determine groove velocity.
 - 3,000-Hz tone for flutter and speed tests.
- Sample waveforms—illustrating both accurate and faulty responses are provided in the Instruction Manual for comparison with the patterns appearing on your own oscilloscope screen.

FREE Instruction Manual Includes Detailed Instructions, Charts, Tables and Diagrams

**RECORDS • Ziff-Davis Service Division
595 Broadway • New York, N.Y. 10012**

Please send _____ SR12 Test Records at \$5.98 each, postpaid. My check (or money order) for \$_____ is enclosed. (outside U.S.A. please send \$8.00 per album ordered.) New York State residents please add local sales tax.

print name EW 5-71

address _____

city _____

state _____ zip _____

PAYMENT MUST BE ENCLOSED WITH ORDER

Spray Chemicals (Continued from page 42)

tems, *Holub Industries'* Hi-Green Wire Pulling Lubricant can make your job easier.

Spray Insulators

But now let's turn to sprays intended primarily to insulate and protect. These are sprayed on everything from outdoor antenna connections to printed circuits after making a repair. Most technicians are familiar with at least one of the following: *Chemtronics* Klear Spray, *CRC* Red Urethane Seal Coat, *Crown* Klear Kote, *DCMC* Vinyl Protective Coating Spray, *Emerson & Cuming* Eccospray AC-6, *Injectorall* Clear Spray Plastic Coating, *GC K27* Print-Kote Silicone Resin Lacquer, *Krylon* Crystal Clear Acrylic Spray Coatings, *RCA* SC104 Deluxe Acrylic Spray, and *Sprayon* No. 2000 Clear Acrylic.

High-voltage sprays, of course, are intended to prevent arcing and corona in components carrying the high voltage to the picture tube. A listing includes: *Chemtronics* No Arc High Voltage Insulator, *Injectorall* Hi-Volt Red Insulator Spray, *GC* Red-X TV Corona Dope, and *RCA* SC103 Deluxe Red Corona Spray.

Every technician knows how a static charge on a plastic or glass meter face, the safety barrier of a picture tube, or even records can be annoying. These products are intended to "insulate" such surfaces from static charges: *Crown* Anti-Static Spray, *Injectorall* Lens Kleen, *DCMC* 865 Anti-Static Spray, *Merix* No. 79 and 790L Anti-Static, *Miller-Stephenson* MS-166 En-Stat, *RCA* SC108 Deluxe Anti-Static Record Spray, and *Sprayon* No. 610 Anti-Static Spray.

Miscellaneous Sprays

At last we arrive at our final group: miscellaneous. The cooling spray is the most popular of this group. It is essentially a refrigerant gas that abruptly lowers the temperature of any object struck by the spray. The chief use is to locate thermal intermittents in electronic circuits. After a chassis is hot, the spray can be directed at each component or printed-circuit conductor in a suspected circuit, and the one resulting in a dramatic change in sound or picture when cooled is the culprit. A shot of the cooler will also protect transistors, germanium diodes, and other heat-sensitive devices from damage while their leads are being soldered. One enthusiastic manufacturer even insists his cooling spray is good for snake bites! He says the cooling action of the spray directed on the bite slows down the spread of the poison. Most

technicians we know rely on another liquid for snake bite.

At any rate, here are the manufacturers and their colorfully named products: *Channel Master* 50° Below, *Chemtronics* Frost Aid and Super Frost Aid, *Crown* Freeze-It, *ECC* Frigid-Air, *Injectorall* Chill-It, *GC* Super Freeze Mist and Extra Dry Super Freeze Mist, *Miller-Stephenson* Quik-Freeze, *RCA* SC102 Deluxe Circuit Chiller, and *Sprayon* Circuit Cooler.

Sometimes a technician wants to paste a label, instructions, or a diagram on a component or inside a cabinet. One of the following spray adhesives makes this easy. *Crown* General Purpose or Heavy Duty Pressure Sensitive Adhesives, *DCMC* Spray & Stick Adhesive, *Krylon* Pressure Sensitive Spray Adhesive, and *3M* Scotch-Grip Spray Adhesive 77-N.

Conductive coatings, as well as insulating coatings, come in aerosol cans. They consist of fine metallic particles, usually silver, and a lacquer-type binder. When sprayed on almost any surface a continuous metallic coating is produced that is used for transistor heat sinks, capacitor plates of printed circuits, making connections to non-solderable units, repairing PC conductors, and creating r.f. shielding. *Emerson & Cuming* manufactures Eccocoat CC-2 Highly Conductive Surface Coating while *Epoxy Products Co.* makes E-Kote 40 Silver Conductive Paint.

The last item we have space to mention is a temperature-indicating paint called Tempilaq manufactured by *Tempil*. This consists of materials of calibrated melting points suspended in an inert, volatile, non-flammable vehicle. Over 100 different temperature ratings from 100°F to 2500°F are available. A mark of Tempilaq is sprayed on a transformer, tube envelope, or transistor case whose temperature you wish to check. If the mark liquifies and remains glossy-transparent on cooling, you know the temperature rating of that particular Tempilaq has been exceeded. By employing several marks made with different temperature ratings, you can tell how hot the unit became.

Common-sense measures should be observed in using *all* chemical sprays. Always spray away from yourself and never toward the eyes. Don't breathe the fumes even if they are claimed to be non-toxic. Do not spray freezing chemicals on the skin or you may end up with frostbite. Keep aerosol cans away from excessive heat. Always double-check to be sure you have the right can before you push that button. A friend who sprayed the multi-bank band-change switch of an expensive communications receiver with what he thought was contact cleaner but was really acrylic spray wished he had! ▲

Diode Rectifiers

(Continued from page 38)

Fig. 2B) that the r.m.s. value of a sine-wave waveform is 70.7% of the peak value and the r.m.s. value of a half-wave rectified waveform is 50% of its peak value. Hence, the r.m.s. current flowing through *R* of Fig. 2A is 70.7% of the r.m.s. current that would flow if *D1* were not in the circuit. In other words, the r.m.s. voltage applied to the heaters is 70.7% of that applied to the diode. Again, referring to Fig. 1B, the voltage applied to the heater string is equal to 117 volts times 0.707, or about 83 volts. Actually, it will be a fraction of a volt less after allowing for a small drop across *D1*.

Incidentally, when designing for use of a diode, the heater-string current does not enter into the calculations. Merely select a diode with a current rating greater than the heater-string current by whatever safety factor is desired. A safety factor of two should be ample. The diode must also have an inverse voltage rating greater than the peak value of the input voltage multiplied by a safety factor. Good design practice calls for a small bypass capacitor across the diode as protection against line transients.

Servicing

So much for design. Now let's look at some puzzling conditions pertaining to servicing. If the voltage across the heater string of Fig. 1B is measured with a service meter, the reading may be anything from 117 volts to 0 volts depending on the type of meter used. With a d.c. v.o.m. it will be about 52 volts, which is considerably less than the 83 volts expected. This apparent discrepancy is because most service instruments respond to average values rather than r.m.s. values, but are calibrated in r.m.s. values. The best way to measure the voltage across a rectifier heater string is to use a suitable d.c. range of a v.o.m. and then multiply the reading by 1.57. This factor is the ratio of the r.m.s. value (50%) to the average value (31.8%) of a half-wave rectified waveform, relative to the peak value or $50/31.8 = 1.57$.

Now we have established two simple rules. First, in order to calculate the r.m.s. voltage applied to the heaters, multiply r.m.s. input voltage applied to diode by 0.707. Second, when measuring the r.m.s. voltage across a heater string, use a d.c. range of a v.o.m. and multiply the reading by 1.57.

Why not measure the heater-string voltage with an a.c. range of a v.o.m. or a v.t.v.m.? The a.c. circuitry of these instruments varies according to their manufacturer so multiplier values cannot be stated for all cases. They will all

read the same on a sine-wave voltage because the scales are calibrated to read r.m.s. values even though a v.o.m. responds to average values and the v.t.v.m. to peak values. To illustrate variations found in meter readings, here are some actual voltage readings taken across the heater string shown in Fig. 1B.

With a v.o.m. on the a.c. scale, the reading is 58 volts with a full-wave bridge circuit; 117 volts with a half-wave bridge circuit or 0 with the leads reversed. With the v.o.m. on the d.c. scale, the reading is 52 volts with a resistor in series with the meter.

Using a v.t.v.m. and a differential amplifier meter circuit, the reading is also 52 volts. With a shunt diode and the v.t.v.m. on the a.c. scale, the reading is 80 volts or 37 volts with the leads reversed.

An a.c.-d.c. dynamometer reads 82 volts.

Phono-amplifier heater strings have been used as illustrations because they are relatively simple. Actually TV sets are where rectified heater strings are finding widest application. Color-TV tube sets have so many tubes that, where series heaters are used, more than one string is often required. Such an arrangement, using a diode for one of the strings, is shown in Fig. 3. When tubes and transistors are combined in a (hybrid) set, the tubes are relatively few, hence a diode to reduce the voltage to the sum of the heaters of a few tubes is a convenient solution. Such a circuit is shown in Fig. 4. ▲

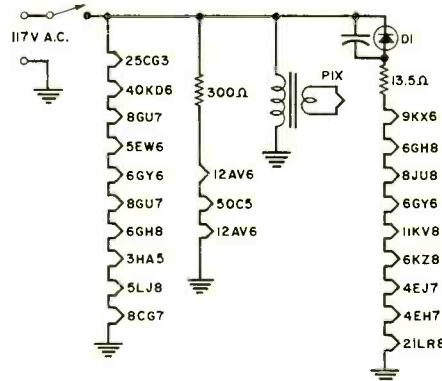
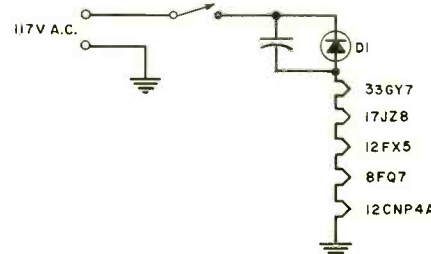

Fig. 3. Simplified heater string circuits in Silvertone color-TV chassis 528.72500. Note the variety of series heater string circuits that may be found in color-TV sets having a large complement of tubes.

Fig. 4. Simplified heater string circuit found in the RCA hybrid (tubes and transistors) 8 & W chassis KCS169X series.



\$150 FOR A \$600 TUNER?

The Dynaco tuner
you have been
waiting for ...
it does *everything*
a little bit better.

\$149.95 kit; \$249.95 assembled

CIRCLE NO. 61 ON READER SERVICE PAGE

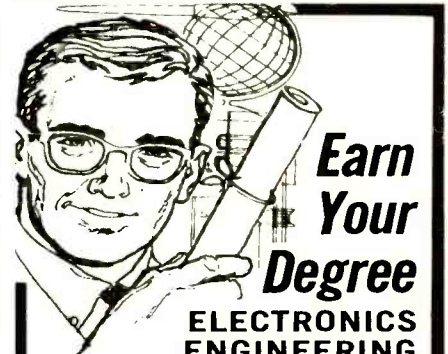

Earn Your Degree

ELECTRONICS ENGINEERING

through HOME STUDY

HIGHLY EFFECTIVE
HOME STUDY COURSES IN:
- Electronics Engineering Technology
- Electronics Engineering Mathematics

Earn your Associate in Science Degree in Electronics Engineering and upgrade your status and pay to the engineering level. Complete college level courses in Electronics Engineering. We're a forward looking school. Outstanding lesson material—thorough and easy to understand. Engineering taught on the basis of application and understanding rather than on the basis of memorization. Up to date in every respect. Acquire the knowledge and ability that means the difference between a low paying technician job and a high paying engineering position. Low tuition cost with low monthly payments. Free engineering placement service for our graduates. Write for free descriptive literature. Ask for bulletin #, no salesman will call on you.

COOK'S INSTITUTE
of Electronics Engineering
Forest Hill Road
P. O. Box 10634
Jackson, Miss. 39209
Established 1945
Formerly Cook's School of Electronics

CIRCLE NO. 55 ON READER SERVICE PAGE

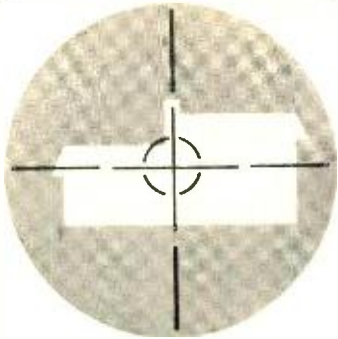

TONIGHT, YOUR
PROPERTY COULD BE
SOMEONE'S

Target

PROTECT IT WITH
DELTALERT!

Don't let unwanted visitors set their sights on your home or business. For total family and business safety get DeltAlert protection... before it's too late.

Enjoy new peace of mind with a reliable DeltAlert detection and alarm system. DeltAlert detects motion in 150 to 300 sq. ft. of critical space with a silent ultrasonic blanket... turning on lights automatically to drive away prowlers.

When the separate DeltaHorn is plugged into the DeltAlert unit, the intruder faces the additional obstacle of loud, ear-shattering noise. A built-in 20-second delay switch allows authorized persons to turn off the horn when entering the monitored area. The sturdy units, finished in handsome walnut veneer, are maintenance-free, economical and need no installation.

At home or work, proven economical security begins with DeltAlert alarm and detection protection.

DELTALERT
10 3/8" x 3 1/4" h x 3 1/4" d
\$69.95 ppd

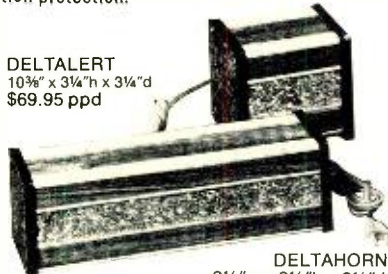

Made in U.S.A.

DELTAHORN
3 1/4" w x 3 1/4" h x 3 1/4" d
\$24.95 ppd

Order your DeltAlert Security System today!
Superior Products At Sensible Prices



DELTA PRODUCTS, INC.

P.O. Box 1147 EW Grand Junction, Colo. 81501
(303) 242-9000

Please send me literature immediately:
Enclosed is \$____. Ship ppd. Ship C.O.D.
Please send _____ DeltAlert(s) @ \$69.95 ppd.
Please send _____ DeltaHorn(s) @ \$24.95 ppd.

Name _____

Address _____

City/State _____ Zip _____

DP 70-26

TEST EQUIPMENT

Product Report

Heath IB-101 Frequency Counter

For copy of manufacturer's brochure, circle No. 3 on Reader Service Page.

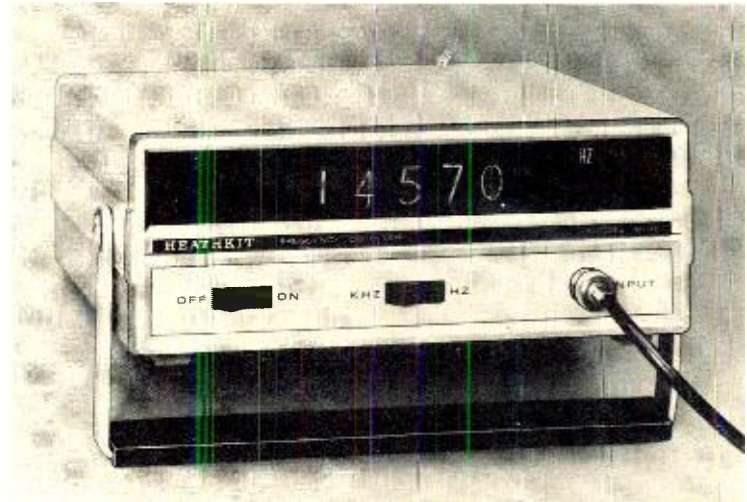

Editor's Note: The actual construction of the counter described below was extremely simple, requiring only about 5 1/2 hours to complete. Final tests and adjustments proceeded rather quickly without any problems. The final accuracy depends on the method used for calibration. If National Bureau of Standards radio station WWV is used as described in the text, an accuracy of 0.1 ppm (part per million) can be obtained. Using the zero-beat method described in the manual, a 1.0-ppm accuracy is obtainable.

There are many applications for a frequency counter of this type in electronics laboratories, for production testing, in servicing, and in schools. An application for the hobbyist or experimenter would be to tune electronic organs as well as other types of electronic musical instruments.

THE electronic frequency counter, one of the most versatile laboratory instruments, is rarely found on the bench of the service technician or experimenter, although both would find it useful. For years, counter prices

were typically from \$1000 to several times that amount (and the more sophisticated types are still priced in that range). However, the development of low-cost digital integrated circuits in recent years has made it possible to produce frequency counters to sell as low as \$350 to \$400, with some sacrifice in accuracy and versatility.

The new Heath IB-101 frequency counter offers the essential performance features of the lower-priced commercial instruments, with the accuracy and readout resolution associated with many instruments in the \$500 to \$700 range, and at a fraction of their price. The IB-101 is a compact unit, 8 1/4" wide x 3 3/8" high x 9" deep (plus a carrying handle which also serves as a tilt stand for bench use), weighs only 4 1/2 pounds, and draws 8 watts from the a.c. line. It has a five-digit readout on numerical-display tubes, with an over-range capability giving it 8-digit resolution. The rated frequency range of the IB-101 is from 1 Hz to 15 MHz, with an accuracy of ± 1 count, \pm the time-base accuracy.

Unlike most low-priced counters, the IB-101 uses a crystal-controlled time base, or clock, generated by a 1-MHz oscillator. The ultimate accuracy of its readout, at higher frequencies, is determined by the accuracy of the time-base frequency, which has an aging rate of less than 1 ppm (part per mil-

lion) per month after 30 days' operation, and a temperature coefficient of less than ± 0.2 ppm per degree C between 20 and 35 degrees C. The overall frequency variation is less than 0.002% from 0 to 50 degrees C.

The counter has two ranges, selected by a kHz-Hz rocker switch on its panel. An illuminated legend, next to the display tubes, indicates the selected range. When the frequency is too high to be displayed completely with five digits, an over-range light goes on.

The input impedance of the IB-101 is 1 M Ω , shunted by less than 20 pF. It is d.c.-coupled, requiring an external blocking capacitor if a d.c. component is present in the signal to be measured. Triggering is automatic, with a minimum required level of less than 100 millivolts from 1 Hz to 1 MHz, and 250 millivolts from 1 MHz to 15 MHz. The maximum permissible r.m.s. input voltage is 200 volts up to 1 kHz, derating to 5.6 volts at 15 MHz.

The gate time, during which the input frequency is counted, is 1 millisecond for the kHz range, and 1 second for the Hz range. After each counting period, the input flip-flop is inhibited and the accumulated count is transferred to buffer/storage circuits and displayed on the readout tubes. A total of two counting periods is required for a complete count/display cycle—2 seconds for the Hz range and 2 milliseconds for the kHz range. The display is steady and unblinking, changing only in accordance with the accumulated count of the preceding measurement period.

The counter can read frequencies with a resolution of ± 1 Hz over its full operating range. For example, if the reading on the kHz range is 14193, and it is desired to make a more accurate reading, switching to the Hz range might give a reading of 93274. The complete frequency reading, therefore, is 14193.274 kHz. Of course, the accuracy, and thus the significance of the last few digits, depends on how accurately the time-base frequency has been set. With reasonable care, the next-to-the-last digit could be significant, corresponding to an accuracy of better than 1 ppm.

The circuits of the IB-101 are almost entirely on one printed board, containing its 26 IC's and 8 transistors. Construction is straightforward and uncomplicated. If a frequency counter with an accuracy of 0.01 Hz is available, the time-base frequency can be adjusted until the IB-101 reading matches that of the other counter on a stable signal. Since many users of the IB-101 would not have access to such an accurate counter, or to a signal whose frequency is known to better than 1 ppm, *Heath* offers an alternate procedure. Harmonics of a 10-kHz flip-

flop in the IB-101 can be heterodyned against any AM broadcast station (all of which are on multiples of 10 kHz) by holding a small transistor radio near the IB-101 circuit board. The crystal oscillator frequency is then adjusted for a zero beat. This gives sufficient accuracy for most purposes—certainly as good as the 60-Hz power-line frequency used as a time base by many low-priced commercial counters.

A more accurate method, which we used, is to heterodyne harmonics of the 1-MHz crystal oscillator with the NBS station WWV, on 5, 10, or 15 MHz. A low-cost communications receiver, preferably with an "S"-meter, can be used for this. If a suitable receiver is not available, a cooperative ham friend should be able to assist with his receiver.

We used WWV's 10-MHz transmission, and were easily able to obtain a beat frequency of less than 1 Hz, as shown by the movement of the "S"-meter. This gives a time-base accuracy of 0.1 ppm, which is all that is warranted by the aging rate and temperature coefficient of the IB-101's crystal oscillator.

After all adjustments had been made, the triggering sensitivity of the IB-101 was less than 40 millivolts from 5 Hz to 5 MHz, increasing to 82 millivolts at 10 MHz and 165 millivolts at 15 MHz. The maximum frequency at which we could obtain reliable operation was 18.3 MHz, with a signal level of slightly over 0.5 volt. The maximum signal level we had available was 10 volts, up to 500 kHz, and triggering was reliable up to that point.

Compared to commercial counters selling for 2 to 3 times its price, the *Heath* IB-101 is generally more accurate (few of the lower-priced models use crystal time bases), but lacks the range of counting intervals offered by some instruments, or the ability to make period measurements. These are small sacrifices, indeed, when the overall performance, ease of use, frequency range, and accuracy of the IB-101 are considered.

The *Heath* IB-101 sells for \$199.95 in kit form. ▲



"He's a darn good engineer... his ideas are the same as mine."

HOTTER THAN EVER!

New Mark Ten B CD System With Exclusive VARI SPARK[®] Circuitry.

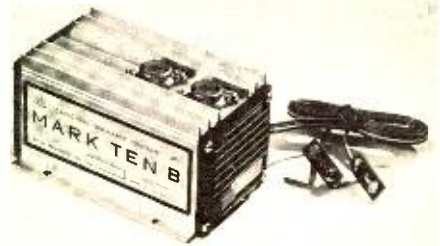

Delta, the world's oldest and largest manufacturer of Capacitive Discharge Ignition Systems, brings you the most dynamic improvement in ignition since the advent of the Kettering System.

By combining the new Vari Spark circuitry with the now famous Mark Ten system, Delta has formulated a new solid state ignition that drastically reduces combustion contaminants and restores power lost by the use of smog control devices. This completely sealed system, with handy switch for instant conversion, requires no rewiring—installs quickly. The Mark Ten B actually pays for itself in dollars saved.

Look At These Features:

- Eliminates 3 out of 4 tune-ups!
- Improves combustion, reducing contaminants.
- Installs in only 10 minutes.
- Instant starts in all weather.
- Dramatic increase in performance.
- Handy switch with redundant contacts for instant return to standard ignition.
- Two-piece housing with neoprene seals affording dust and moisture protection.
- Applicable to ANY 12-volt, negative-ground engine.

Mark Ten B Only **\$59⁹⁵** ppd.
(12v neg only)

Standard Mark Ten **\$44⁹⁵**

"Delta Products. One Of America's Finest Names In Electronics"

Order today! DP 70-25

 **DELTA PRODUCTS, INC.**
P.O. Box 1147 EW / Grand Junction, Colo. 81501
(303) 242-9000

Please send me literature immediately:

Enclosed is \$ _____ Ship ppd. Ship C.O.D.

Please send:

___ Mark Ten B @ \$59.95

___ Standard Mark Ten (Assembled) @ \$44.95

___ 6 Volt: Neg. Ground Only ___ Positive Ground

___ 12 Volt: Specify ___ Negative Ground

___ Standard Mark Ten (Deltakit[®]) @ \$29.95
(12 Volt Positive Or Negative Ground Only)

Car Year _____ Make _____

Name _____

Address _____

City/State _____ Zip _____

CIRCLE NO. 59 ON READER SERVICE PAGE



Dynamic Dwell/Tachometer

By JON COLT, P.E.

An in-car instrument using an IC and measuring circuit to check an engine's r/min and degrees of point closure.

THE best-known pesticide, D.D.T., works fine on insects, but when it comes to ridding your car of bugs, that's another problem. The electronic D.D.T. (dynamic dwell/tachometer) described here will not only help rid your car of most of the bugs which make it skip and miss, but will keep them from re-appearing.

Why a dynamic, or in-the-car, dwell meter? Well, it's generally acknowledged that the three best monitors of long-term car health are the oil-pressure gage, ammeter, and tachometer (which also tells you when to shift gears, if you're worried about that). All that's fine, but what about short-term health? It seems that a dwell meter is just about the only device going which gives a direct status indication of that part of the car which wears the fastest, is most prone

Fig. 1. The D.D.T.'s input circuit is used to change the (A) waveform found across most cars' points to (B) idealized, and (C) inverted idealized waveforms. Waveform is inverted to give increasing deflection for increasing dwell angle.

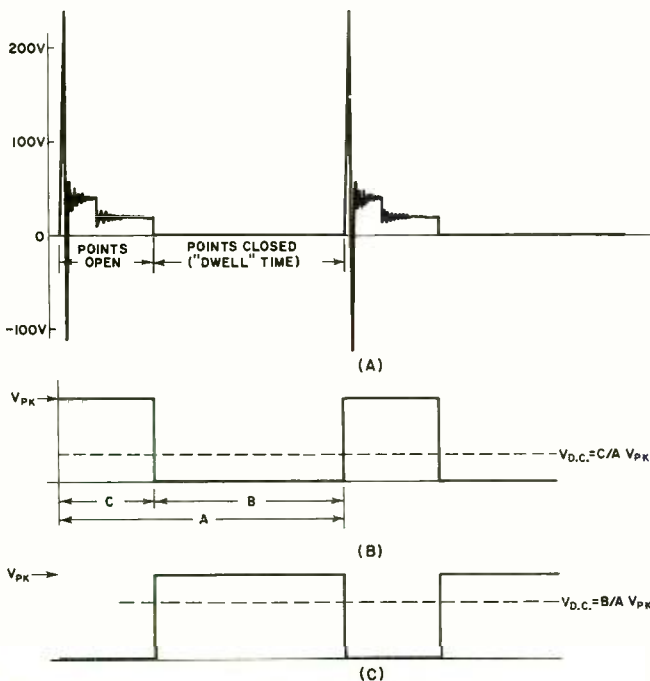

to fail, and upon which depends the operation of the entire car: the points.

Let's face it: your points—besides helping to light the fire in the combustion chamber—do nothing except wear out from the minute you crank up the engine after a brand-new tune-up job. An ever-present dwell meter would tell you when the points needed regapping to get some of that old zip back. Also, two of the most insidious bugs which creep into cars are due to the points, *i.e.*, point bounce and point float. These conditions are due to point-spring deficiencies and occur (usually) at higher engine speeds. They manifest themselves outwardly as a "skipping" or "missing" engine, and would show up on a dwell meter as a decrease in dwell angle (from the low-speed value). These bugs also come with new points at times, and that's what makes them so insidious. You will save more than the cost of the D.D.T. if, only once during your car's life, you prevent some motor jockey from needlessly overhauling your carburetor with the justification, "It *can't* be the ignition; you just got a new set of points and plugs."

With the D.D.T. you can, at the flip of a switch, monitor both engine speed and dwell angle, and do it for a lot less than the cost of a comparable, store-bought tachometer. You won't have to apologize for the unit's appearance, either. With a meter face similar to the one used by the author and a PC board layout, you should end up with the compact, very professional-looking device shown in the lead photo.

Design

The circuit design is relatively straightforward; so much so that you can use the techniques presented here to build a more specialized unit if you so desire. The design centers around changing the two parameters, r/min and dwell, to d.c. voltages which change linearly with respect to changes in r/min and dwell; then the selected d.c. voltage is read out on an appropriately calibrated voltmeter.

Since the waveform across a distributor's points can get pretty wild—as in Fig. 1A— $R1$, $D1$, and $C2$ (Fig. 2) serve to clean up this signal to present an "idealized" waveform to the D.D.T. (Fig. 1B).

It turns out that changing the dwell angle to a linearly related d.c. voltage is not much of a problem. Look again at Fig. 1B. Dwell angle is a measure of the ratio of the time

ELECTRONICS KNOW-HOW

20 electronics construction projects in the SPRING 1971 ELECTRONIC EXPERIMENTER'S HANDBOOK

All lab-tested by the Editors, with parts list, easy "How-To-Do-It, How-It-Works" instructions—many with actual size PC foil patterns!



BUILD THESE CHALLENGING PROJECTS! ■ Experimenter's Laser ■ Do-it-Yourself Laser Holography ■ Build Security 1 ■ Omni-Eight Speaker System ■ Build a D.C. Transformer ■ Microwaves for the Beginner ■ Build the Time Out ■ Ten-Watt PA Amplifier ■ Electronic Aquarium Heater ■ Build the VOXOR ■ Beginner's Signal Generator ■ The Thump-a-Thumpa Box ■ A Pair of Loaded Dice ■ Automatic Vehicle Burglar Alarm ■ Make Your Own Ion Chamber ■ Speaker Boxes That Are Something Else ■ The Waa-Waa ■ Portable Pulse Generator ■ One-Step Motion Detector ■ Build the "No-Fooling" Fence Alarm
PLUS THESE INFORMATIVE FEATURES: ■ Caution-Laser ■ Rally Round the Reflex ■ Engineering Level Opportunities for You ■ Strange Power of Air Ions

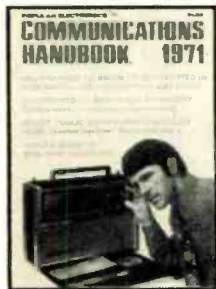

1971 COMMUNICATIONS HANDBOOK

tunes you in on everything you need to know about CB, SWL or HAM. Completely updated and revised. Also features Police and Fire Dispatcher Frequencies of 250 cities.

Here it is in one single package—the combined knowledge and experience of the top men in each field—Citizens Radio (CB), Shortwave Listening and Amateur Radio. Everything you need to know about getting licenses... equipment to buy and how to set it up... efficient operations... a whole bookful of up-to-the-minute data to make your listening hours more enjoyable! Fact-filled with time charts... station data... maps... country lists... awards... and much more. Photos galore.

Plus: BUYER'S GUIDE of CB and HAM RADIO GEAR. SPECIAL SECTION on LONG RANGE TV RECEPTION.

Deluxe Leatherflex-board editions are available. They make a handsome addition to your permanent library. Order your copies by checking the appropriate boxes on the coupon below! (Please allow three additional weeks for delivery.)

ZIFF-DAVIS SERVICE DIVISION—Dept. W
595 Broadway, New York, N.Y. 10012

Please send me the annuals I've checked below:

- 1971 ELECTRONIC EXPERIMENTER'S HANDBOOK—Spring, \$1.50
 Deluxe Edition, \$3.50
 1971 COMMUNICATIONS HANDBOOK, \$1.50
 Deluxe Edition, \$3.50

IN U.S.A., add 35c for postage and handling for each Regular Edition; Deluxe Editions are postpaid. OUTSIDE U.S.A., Regular Editions are \$2.50 each. Deluxe Editions are \$4.50 each, postpaid.

TOTAL ENCLOSED \$ _____ EW-5-71

print name _____

address _____

city _____

state _____ zip _____

PAYMENT MUST BE ENCLOSED WITH ORDER

Now, in an automobile, the repetition rate of the points' waveform is linearly related to r/min by the formula: $\text{pulses/second} = [(\text{no. of cylinders}) (r/\text{min})] / X$, where X equals 120 for 4-cycle engines and 60 for 2-cycle engines.

Table 1 lists the pulse rep rate and period of the points' waveform for the more popular 4-cycle auto engines, at various values of r/min . From the table and from our discussion, you can see that a one-shot must have a pulse width of less than 2.5 milliseconds to be usable on an 8-cylinder auto. Since this is a "universal" tachometer, this figure is what determines our design. The timing components, $R3$ and $C3$ (Fig. 2), were chosen to give an output pulse width of about 1.8 ms so the monostable will have adequate time to recover for the next input pulse. $I3$ and $I4$ —along with $R3$ and $C3$ —are connected to form the monostable proper. $I2$ is used to collector-trigger $I3$, while the input to $I2$ —the "idealized" points' waveform—is differentiated by $R2$ and $C1$. $D2$ serves to clip the negative-going spike which results from differentiating the negative-going edge of a square wave. The differentiating network (high-pass filter) is used to ensure that the input to the one-shot is always much shorter than the output pulse width.

This highlights another input/output constraint of conventional one-shots: the input pulse length cannot be longer than the output pulse—as would be the case at idle speed in our design, for example—because the input would tend to hold the output "on." In this case, there would no longer be independence between input and output.

$I5$ and $I6$ are used to "square up" the one-shot pulse and buffer the one-shot from its load; two are used to maintain proper polarity. As in the dwell portion, a diode is used to eliminate the error produced by the $I6$ output transistor's saturation voltage; and a potentiometer is used for calibration. The pot, $R4$, is used to calibrate the tach for 4-, 6-, or 8-cylinder use.

To see how the value of $R4$ was arrived at, let's take the case where $V_{D.C.}$ will be the highest: an 8-cylinder engine running at 6000 r/min . This calculation will yield the highest value of resistance which must be inserted in series with the meter to limit the current to 1 mA. Since the peak output voltage is approximately 3.6 volts, and the duty cycle is $1.8/2.5$, $V_{D.C.} = (1.8/2.5) 3.6$

$V = 2.6$ volts. Therefore $R_{CAL(\text{total})} = 2.6 V/1 \text{ mA} = 2600 \text{ ohms}$.

But since the meter and collector-load resistances contribute about 1000 ohms to the series string, R_{CAL} should be about 1600 ohms. The value chosen for R_{CAL} is a "cushion" against possible variations in any of the parameters we have been using to compute its value.

By the way, a 3.9-volt zener is specified for the D.D.T.'s power supply and we've been using 3.6 volts as the power-supply voltage throughout the article. This is because, at the current level set by $D4$'s current-limiting resistor ($R6$), the zener's voltage is about 3.6 volts. One other point: if you want to use the D.D.T. in a car with a 6-volt system, change $R6$ to 56 ohms, $1/2$ watt.

You can, of course, build the unit using almost any 1-mA meter and any construction technique. A PC board layout (as used by the author) is desirable because of the resulting compactness and using the specified meter—with the meter face shown here—will result in a highly professional-looking unit. The use of an IC socket for $IC1$ is strongly recommended.

The unit is dwell-calibrated as follows: with the engine running, attach the power and ground leads appropriately under the hood and adjust $R5$ for a full-scale reading. A small "6" (at full-scale) corresponds to full-scale dwell for 6-cylinder cars and a small "8" (at $3/4$ full-scale) is the "dwell set" point for 4- and 8-cylinder autos. Those with 4-cylinder jobs should remember to multiply all dwell readings by two.

Tachometer calibration can be carried out by the direct-comparison method, if you can get another, calibrated, tach. If you can't, the circuit of Fig. 5 can be used and results in an extremely accurate calibration. Here you're using the power line (60 Hz) as the pulse source, whereby 60 pulses/second gives the calibration points of 900 r/min (8-cyl., 4 cycle), 1200 r/min (6-cyl., 4 cycle), and 1800 r/min (4-cyl., 4 cycle). Adjust $R4$ accordingly.

One other point bears mention: the distributor is, ostensibly, grounded to the frame of the car through bonding straps (from the engine to the frame) or something similar. We've seen quite a few cars on which this "ground" left much to be desired. It might not be a bad idea to run two signal pickup wires to the distributor: a signal wire as in the schematic and a ground wire from the point where you ground the D.D.T. under the dash to a nice, solid ground near the distributor. ▲



NOTE: BECAUSE OF POTENTIAL HAZARDS INVOLVED IN USING 117V A.C. DIRECTLY FROM THE LINE, ENCLOSED CONSTRUCTION AND USE OF AN ISOLATION TRANSFORMER IS RECOMMENDED

Fig. 5. Circuit used to accurately calibrate tachometer.

NEW PRODUCTS & LITERATURE

For additional information on items identified by a code number, simply fill in coupon on Reader Service Page. In those cases where code numbers are not given, may we suggest you write direct to the manufacturer on business letterhead.

COMPONENTS • TOOLS • TEST EQUIPMENT • HI-FI • AUDIO • CB • COMMUNICATIONS

DUAL-BIAS TAPE DECK

The Model A-1230 stereo deck features three motors and incorporates such features as dual-bias position switch and a front-panel pause control. The dual-bias feature permits recording



with either low-noise or standard tapes. The deck is solenoid-operated for effortless operation, according to the company. The pause control allows fast start and stop in the record mode but does not introduce clicks. A unique feature allows the user to make a simple adjustment of the turntable height to allow for variations in reel dimensions and protect valuable tape.

The deck permits live monitoring, has a built-in microphone, and a line mixer. The three motors mean fewer mechanical parts for longer life and greater reliability. The capstan motor is a dual-speed hysteresis-synchronous type and speed changes are accomplished electrically. A newly developed equalization network uses a 3-stage direct-coupled amplifier for wider dynamic operating range.

A spec sheet on the Model A-1230 will be sent on request. Teac

Circle No. 4 on Reader Service Page

STEREO HEADPHONES

Two new stereo headphones, one the Mark III "Isophase electrostatic" and the other the "Dynaphase I, Model 5750," have just been introduced.

The unique feature of the Isophase system is a special protective circuit that prevents overloading of both the headphone and the listener's ears. Built into the system's polarizer, the overload relay automatically triggers when the power being fed to the headphones approaches the maximum listening level that is safe for the ear. A simple reset button reactivates the relay and allows the headset to operate again after the



May, 1971

power surge has passed or excessive power is reduced.

The headphones weigh only 15 ounces and have a frequency response of 20-20,000 Hz. The headphones have a dial-adjustable headband for maximum ease in adapting to all head sizes and shapes.

The "Dynaphase" unit has a frequency response of 30-18,000 Hz and a sensitivity of 95 dB at 1000 Hz for 1 mW. The phones come with a 10-foot coiled cord and have a nominal impedance of 12 ohms. Stanton

Circle No. 5 on Reader Service Page

MOBILE CB RADIO

The "Cobra 6" is an ultra-compact, push-button, 6-channel CB unit which features solid-state circuitry and switching, illuminated power/"S" meter, automatic noise limiting, squelch control, microphone, full 5-watt input, and external speaker jack.

Measuring only 1 3/4" x 6 1/4" x 7 3/4" and weighing 3 1/4 pounds, the unit covers the 26.965-27.255 MHz CB band and meets FCC type approval.

A 117-volt a.c. power pack is available, permitting the unit to be used as a base station. Dynascan

Circle No. 6 on Reader Service Page

BOOKSHELF SPEAKER

A bookshelf speaker system, the L100 Century, features a unique three-dimensional grille material that is acoustically more transparent

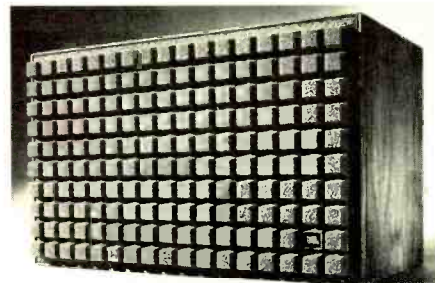

than cloth; a powerful long-excursion 12" woofer with 6-pound magnetic assembly and a free-air cone resonance of 27 Hz; a mid-range unit which operates from 2500 to 7500 Hz; and a direct radiator which takes over above 5 kHz and reaches full output above 7 kHz.

The crossover network permits full control of tonal balance by providing more than 9 dB of attenuation from laboratory standard for both mid-range and high-frequency reproducers. For ease of calibration, the controls are marked in dB of acoustic output and are located on the front of the cabinet under the grille. The enclosure is made from 3/4" and 1" stock, with lock-mitred and wood-welded joints, rigidly assembled to prevent resonance. The enclosure measures 24" x 14" x 13" deep.

The speaker will handle 50 watts continuous program material and nominal impedance is 8 ohms. JBL

Circle No. 7 on Reader Service Page

NEW STEREO-FM TUNER

The 433 "Digital Synthesizer" stereo-FM tuner uses a quartz crystal as a reference standard to provide a discrete series of scanning steps from center channel to center channel on any one of 100 channels available in the 88.1 to

107.9 MHz FM band. Visual frequency indication is provided by an accurate digital readout incorporating cold-cathode indicators, identical to those used in computer applications.

Station selection is by one of four methods: by inserting programmed cards into a special slot in the unit's front panel; by pushing a button for either automatic station scanning; automatic stereo station scanning; or manual channel selection. H.H. Scott

Circle No. 8 on Reader Service Page

DUAL-TRACE SCOPE

A dual-trace scope with a 25-MHz bandwidth, 10-mV sensitivity, and delaying sweep is now available as the D67. Other features include



a 3% measuring accuracy, a vertical signal delay line, and regulated power supplies. Bright displays are obtained by using 9-kV on the rectangular 5-inch CRT which has an 8 x 10 cm display area. Vertical trace drift is minimized by using FET inputs, reliability is improved through fully solid-state design, and servicing is made easier by placing all transistors in sockets.

The scope has an integral handle and weighs only 25 pounds, making it fully portable for field-servicing applications as well as bench use. Telequipment

Circle No. 9 on Reader Service Page

ALL-CHANNEL ANTENNAS

Two all-channel u.h.f./v.h.f./FM color antennas which will be marketed either alone or as a complete kit have been introduced as the Models CA-9 and CA-13.

The CA-9 is a nine-element antenna while the CA-13 is a thirteen-element antenna. As complete kits with a gold tripod installation mounting unit, the antennas carry the suffix "KT." All four versions are packed in full-color cartons which serve as a point-of-purchase display as well as a wrapping. Finney

Circle No. 10 on Reader Service Page

VIDEO TAPE RECORDER

A new 1/4" portable video tape recording system which provides instant playback of picture and sound and is ideally suited to the production of industrial/electronics training, sales presentation, and trade show audio-visual presentations is now available as the Model VT-100.

The unit weighs less than 20 pounds and is a completely self-contained, battery-operated recorder. All the operator has to do is aim the camera, adjust the focus, and shoot. The recorder instantly records the action and the sound while a built-in TV monitor shows the operator exactly what he is capturing on the video tape. The tapes can be played back instantly and can

also be edited or erased on the spot if reshooting is desired.

Technical specifications on the recorder, the camera, the video monitor, and the a.c. adapter/battery recharger are available on request. Akai America

Circle No. 11 on Reader Service Page

FREQUENCY COUNTER

A low-cost portable frequency counter with a range from 10 Hz to 500 MHz is being marketed as the Model 4058. It weighs only 8½

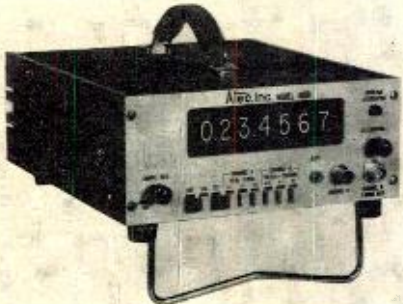

pounds and was designed primarily for fast and accurate frequency checks of transmitters and for field service.

With a 100-mV input sensitivity over the entire frequency range and an input impedance of 1 megohm from 10 Hz to 5 MHz and 50 ohms from 5 MHz to 500 MHz, the Model 4058 also includes display storage and a crystal-controlled time base with an accuracy of ± 4 parts in 10^7 .

The instrument measures 8½" wide \times 3½" high \times 12" d. Atec

Circle No. 12 on Reader Service Page

SMOKE SENSOR

A new early warning fire, smoke, and combustion products detector that can be used with existing fire-detection systems to provide better protection has been put on the market.

The unit features a normally open contact relay that will work on 24-volt or 120-volt power supplies most commonly used in fire-detection systems. It operates on a unique dual-gate circuit where both an ion chamber and a resistance bridge must agree that a fire exists before it will trigger. This eliminates annoying false alarms.

The functional design of the detector allows it to be ceiling mounted in offices, computer rooms, nursing homes, hospitals, factories, warehouses, and even horse barns—wherever early detection of fire is required. BRK Electronics

Circle No. 13 on Reader Service Page

PHOTOELECTRIC TACHS

A line of three models of "touchless" portable photoelectric tachometers has been recently introduced for the loadless speed reading of motors, engines, power tools, grinders, cutters, drives, presses, lathes, or any rotating or reciprocating movements.

These solid-state, hand-held, battery- or a.c.-operated units measure speed by pointing the photo-reflective probe at a rotating shaft and reading the r/min from a 4½" \times 4½" meter with knife-edge pointer and mirror-backed scale.

Model 891 has four ranges: 0-1000, 3000, 10,000, and 30,000 r/min; Model 909 has four ranges: 0-10,000, 30,000, 100,000, and 300,000 r/min.; while Model 912 (a.c.-operated) has the same ranges as the Model 891 battery unit.

Both units are available for panel mounting if desired. A carrying case is available as an optional extra for each model. Power Instruments

Circle No. 14 on Reader Service Page

DIGITAL COLOR GENERATORS

Two new IC digital color generators have been introduced as the deluxe Model 1246 and the standard Model 1243. Both models check convergence, color, linearity, size, and focus.

Rock-steady patterns are guaranteed through the use of flip-flop circuits for all counting func-

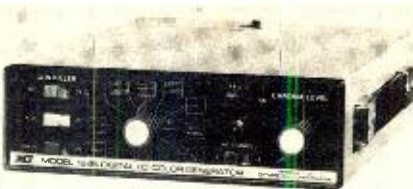

tions. The composite video signal, produced algebraically from the ultra-stable synthesized pulses, closely approximates TV broadcast standards. Precision crystals are used in both the master countdown and color oscillators. Dot and vertical line width are adjustable; all IC's and transistors are silicon; and the power supply is transformer-isolated and fully regulated for ripple-free constant voltages.

Specifications on these two new service instruments will be supplied upon request. B&K-Dynascan

Circle No. 15 on Reader Service Page

HEAT GUN

A new hot-air tool, the Princess Model 6955 heat gun, offers a unique combination of features and benefits to users of heat-shrinkable products, as well as in many other lab and industry applications, according to the company.

Its light weight of only 18 ounces permits firm, positive control where precise hot-air direction is required and also reduces operator fatigue. Air stream width at the nozzle is ⅜".



Two baffle reflectors, ¾" long and 1½" long, are included for solder sleeves and shrink-tubing applications.

The gun delivers an air-flow temperature at the nozzle of approximately 750° to 800°F in seconds. It is designed for either hand-held use or it may be placed on a table or workbench without the need for an auxiliary stand or holder. It is rated at 250 watts, 120 volts, a.c. only. Ungar

Circle No. 16 on Reader Service Page

TECHNICIANS' TOOL KIT

A new tool kit for electronics technicians and field engineers has been introduced as the JTK-16 "Detective" kit. Designed for professional use, the kit provides a complete set of tools in a compact package. Multi-purpose tools have been furnished wherever possible, providing broad versatility. Many essential "secondary" tools have also been included.

Each kit contains three regular screwdriver blades, three Phillips-type blades, a set of jeweler's screwdrivers, three nutdriver blades, an adjustable wrench, a 10-piece Allen-hex wrench set, and 10-piece Bristol-spline wrench set, utility-type pliers, long-nose side-cutting pliers, miniature side-cutting pliers, chain-nose pliers, a wire stripper, two multi-purpose handles, a knife, saw blade, 6" scale, miniature soldering iron, solder, solder aid, burnisher, alignment tool set, and a needle file. The kit can be supplied with or without a Simpson No. 355 v.o.m. Jensen Tools

Circle No. 17 on Reader Service Page

STEREO-FM TUNER

A solid-state stereo-FM tuner which features an FET front-end with four-section variable capacitor, a multi-section phase-linear i.f. filter, and integrated-circuit i.f. amplifiers has just

been added to the company's line of components.

According to the company, guaranteed distortion is less than 0.5% IM or THD on either mono or stereo. Other features include interstation hush for silent tuning, center-channel tuning meter, and automatic stereo switching with indicator light. Frequency response is 20-15,000 Hz ± 1 dB mono or stereo.

A data sheet giving full performance specs will be forwarded on request. Acoustic Research

Circle No. 18 on Reader Service Page

MEDIUM-CURRENT SUPPLIES

A complete line of medium-current d.c. power supplies, rated at 5 to 42 amperes is now ready for distribution. The new 3550 series is available in a broad range of voltage/current



combinations. It incorporates many state-of-the-art advancements, includes all-silicon circuitry, and offers a variety of optional features.

Specifications include 0.01% voltage regulation and 0.05% current regulation. Ripple is a maximum of 1.0 mV r.m.s. wideband and 10 mV peak narrowband. Eight-hour stability is 0.02%. Temperature coefficient is 100 ppm/°C from 0 to 50 degrees C. Input power may be either 90-125 V a.c. or 180-250 V a.c., 47-63 Hz. Alpha Scientific

Circle No. 19 on Reader Service Page

FIBER-OPTIC KIT

A deluxe plastic and glass fiber-optic kit has recently been added to the Archer line. Each of the optically perfect fibers may be cut or bent like wire to guide or "pipe" light around corners, up walls, etc.

The kit contains everything needed for creating optical displays such as light trees, fountains, waterfalls, and optical plaques. The unit can also be used for triggering light-sensitive devices such as photoelectric cells and infrared detectors. The kit contains over 1600 fibers and a 45-piece accessory kit. Allied Radio Shack

Circle No. 20 on Reader Service Page

AMPLIFIER & TUNER

A stereo amplifier, Model KA-5002, and an AM/stereo-FM tuner, Model KT-5000, have been introduced for those who prefer separate components.

The amplifier features direct-coupling with complementary-symmetry driver stage which prevents distortion between the amplifier and speaker. Other features include a low-level phono input (0.06 mV) for moving-coil type of low-level output cartridges; a phono-1 input impedance selector; terminals for two tape decks with tape monitor and dubbing switch for both; outputs for two sets of stereo speakers; inputs for two phonographs and two auxiliaries; preamplifier outputs for use with other power amplifier or multi-channel systems; plus 4-channel input/output terminals.



ELECTRONICS WORLD

IHF output is 150 watts at 4 ohms, 120 watts (r.m.s.) at 8 ohms.

The tuner features a two FET, 4-gang tuning capacitor front-end; two IC's and mechanical filter i.f. stages; an FM/AM signal-strength meter; and FM zero-center tuning meter with stereo indicator.

The units are housed in matching walnut cabinets with brushed aluminum front panels. Kenwood

Circle No. 21 on Reader Service Page

2-METER MOBILE RIG

A new low-cost v.h.f./FM 2-meter amateur mobile rig, the "Model A," has four channels and comes complete with two pair of crystals. This 6-watt unit is housed in an aluminum vinyl-clad enclosure with molded front panel. It measures 8½" wide × 2½" high × 11" deep. It comes with mounting cradle and press-to-talk microphone with coiled cord.

Frequency coverage is 144-148 MHz with 0.6-μV sensitivity or less for 20 dB quieting. Simpson Electronics

Circle No. 22 on Reader Service Page

SPEAKER SYSTEM

The ALX-2 speaker system incorporates an acoustic lens tweeter which the company claims provides high-end frequency response and wide dispersion to 20,000 Hz.

Each speaker enclosure contains an 8-inch high-compliance acoustic suspension woofer for bass tones, a 3½-inch sealed-housing tweeter, and a crossover network. Frequency response is 20-20,000 Hz. The system is rated at 8 ohms and will handle 30 watts (r.m.s.) of power.

The ALX-2 is designed to be used with any stereo system, including tape, phonograph, or

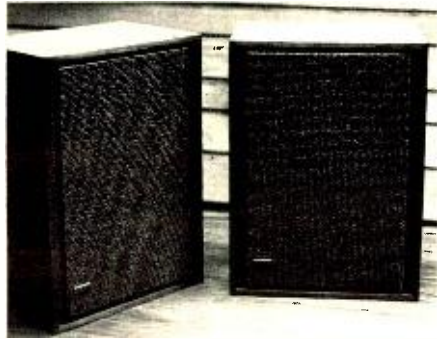

stereo-FM components. Each hand-rubbed walnut enclosure measures 13¾" wide × 19" high × 9¼" deep. The grille cloth is pebbled tweed of varying shades of brown to black. The speakers are sold in pairs. Ampex

Circle No. 23 on Reader Service Page

BATTERY-OPERATED SUPPLY

The BA6-1 battery-operated power supply features a highly regulated variable output with a self-contained nickel-cadmium battery capable of indefinite recharging. The instrument has a built-in charger and is designed so that an overnight charge will permit continuous full-load operation for 8 hours.

The instrument is suitable for field work involving digital logic and is especially useful for high-gain amplification applications such as strain-gage amplifiers where low noise is important.

The unit delivers a variable 0 to 6 volts at a maximum current of 100 mA and features regulation of 0.01%. Maximum noise is 25 μV r.m.s. and recovery time is better than 25 μs. Deltron

Circle No. 24 on Reader Service Page

SSB CB RADIO

A single-sideband, two-way radio operating in the Citizens Band has been introduced as the "Raycom IV."

In addition to the full range of 23 CB channels, the new set separates each channel into an upper and lower sideband to provide a total of

69 separate communications channels. Frequency synthesizing provides the multiple channels without the addition of extra crystals.

Fully solid-state, the set uses IC's for optimum reliability and dependability in marine service. Power drain from 12-volt lines is minimal. The radio measures 9" × 9" × 2⅝". Complete specifications will be supplied on request. Raytheon

Circle No. 25 on Reader Service Page

4-CHANNEL PLAYER

A new four-channel, 8-track stereo tape cartridge player is being marketed as the "Qaudio CH-702." The unit will also play standard two-channel (8-track) stereo tape cartridges.

The player is a complete home system, includ-



ing four channels of amplifications, with only the addition of four speakers required for immediate use. Housed in a walnut enclosure, the unit features a master volume control for all four channels plus a balance control for front and rear, left and right, and when four-channel material is being played, a rear balance control for matching rear-speaker output against the front channels. Four illuminated vu meters, one for each channel, facilitate adjustment. Toyo Radio

Circle No. 26 on Reader Service Page

PARAMETRIC POWER SUPPLY

A parametric d.c. laboratory power supply with positive protection against line transients, noise, and spikes, with over 100 dB noise attenuation to 1 MHz, is now being marketed as the Model PDC-16.

The unit incorporates one of the firm's Paramformers as the rectifier transformer, thus providing protection from line transients. It has a d.c. output of 0 to 16 volts at 0 to 4 amperes. Operating from a 105-125 V a.c., 60-Hz line, the unit exhibits regulation of ±0.005% and 500-μV ripple. Load-on/load-off response time is 5 μs.

Features include short-circuit protection, adjustable current limiting with automatic crossover to current regulation, remote sensing, and remote programming. Wanless

Circle No. 27 on Reader Service Page

PORTABLE OSCILLOSCOPE

A small, lightweight 10-MHz oscilloscope which can be powered from a.c., d.c., or internal rechargeable batteries has been introduced as the Type 324. The instrument is all solid-state and measures 10⅝" deep × 8½" wide × 4¼" high and weighs approximately 8 pounds including batteries.

Designed specifically for "on site" maintenance applications, the 10-MHz bandwidth is provided at a 10 mV/div deflection factor. For low signal-level applications, 2 mV/div deflection factor is provided with 8-MHz bandwidth. Sweep rates are 1 μs/div to 0.2 s/div. An ×5 sweep magnifier extends the fastest sweep rate to 0.2 μs/div.

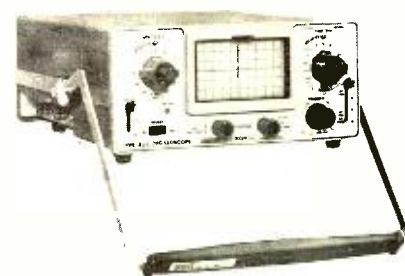

A single control knob provides automatic or manual level-sweep triggering, positive or negative slope. With no input, the automatic trigger mode provides a bright baseline reference at all sweep rates. The CRT uses a low-power, direct-heated cathode, providing a useful display 2 seconds after turn-on. A 6 × 10 div (¼-inch div) internal non-illuminated grid facilitates parallax-free measurements. Tektronix

Circle No. 28 on Reader Service Page

TIN-PLATING KIT

Materials and equipment for tin plating the copper patterns of etched-circuit boards by simple immersion are now available in a new kit, No. ITP-801. The chemical process deposits a thin coating of essentially pure tin on the copper surface, effectively preventing oxidation and greatly increasing solderability of the metal, according to the company.

The kit will process boards up to 7" × 10" in size and provides enough pre-mixed tin solution to plate patterns on approximately 25 square feet of etched boards. Also provided in the kit are a high-temperature glass tray, board-handling clamp, thermometer, and full instructions. Kepro

Circle No. 29 on Reader Service Page

P.A. AMPLIFIERS

A new series of four economy priced, solid-state public-address amplifiers has been introduced as the "C" series. Included are the C20, C35, C60, and C100, rated at 20, 35, 60, and 100 watts, respectively. All are designed for continuous operation at full output from -20°C to +50°C.

Advanced complementary transistor circuitry assures highest reliability of the power transistors, according to the company. The units are protected against circuit damage caused by accidental shorting or disconnecting of loudspeaker lines. Each control has red "Memory Markers" to aid in returning controls to previously determined levels.

The C100 (photo) has two high-impedance



microphone inputs, each with a volume control; two high-impedance, high-level auxiliary inputs with fader control; master volume control; bass and treble controls; and a power switch. All microphone inputs are equipped with filters to guard against RFI.

Complete specs on the C100 and other models in the line will be forwarded on request. Bogen

Circle No. 30 on Reader Service Page

HAND-HELD TRANSCEIVER

A hand-held, two-channel emergency u.h.f. transceiver which provides the ICAO standard emergency swept tone signal on 243.0 MHz and AM two-way voice communications on 243.0 and 282.8 MHz has been introduced as the Model ATR-150.

Built and tested for extreme environments, the new unit operates at temperatures to -30 degrees C and is impervious to saltwater immersion. It has a range of 100 miles and a minimum continuous-operation life of 30 hours. Features include built-in antenna, impact-resistant cast aluminum housing, magnesium-cell battery pack, and solid-state design. Communications Components

Circle No. 31 on Reader Service Page

LAB POWER SUPPLY

The new Model 9B is four instruments in one: three power supplies and a voltage-current meter. There are two 0-25 V d.c., 0-1 A supplies; one 0-10 V d.c., 0-5 A supply, with adjustable current limiting on all supplies. Each supply is



isolated and has overvoltage protection. Dual-range and parallel operation are possible.

The supply was designed with the user in mind, providing a bench-full of instruments in one small, convenient package. There is no need to disconnect leads or make provisions for external test points to perform current and voltage measurements.

The unit is designed for 105-125 volt, 47-440 Hz operation. Integrand Research

Circle No. 32 on Reader Service Page

RUGGEDIZED ANTENNAS

A new antenna series using solid aluminum ribbed harness, stronger rear elements, tubular boom braces, and preassembled hardware has been introduced as the newest version of the Color Crossfire line.

The long rear elements of the new antennas are $\frac{7}{16}$ " in diameter, compared with $\frac{3}{8}$ " for previous models, making the new elements 30% stronger and increasing their ability to stand up to heavy winds and ice loading. The 1" blue tubular boom braces keep the new antennas steady even in very high winds, according to the company. The mounting hardware, of new and ruggedized design, keeps the antennas from shifting on the mast.

The new Ruggedized Color Crossfire series includes thirteen models for applications from near suburban to deepest fringe areas. Channel Master

Circle No. 33 on Reader Service Page

SWEEP-SIGNAL GENERATOR

The new Model VS-60 sweep-signal generator covers the 5 to 1000 MHz range in one band. It can be swept up to its full width while having sufficient stability for narrow-band circuit testing, according to the manufacturer.

The instrument has provisions for both single-frequency and harmonic-type frequency mark-



ers with crystal accuracies of 0.005%. The unit also has provisions for accepting c.w. frequencies from external sources to provide additional marker capabilities.

The unit provides a full 10 mW of output power in both c.w. and sweep modes. It has a 0 to 3 dB vernier output control, a 0 to 10 dB in 1-dB step rotary attenuator, and a 0 to 60 dB in 10-dB step rotary attenuator.

Complete technical details, price, and delivery information will be supplied on request. Texscan

Circle No. 34 on Reader Service Page

MANUFACTURERS' LITERATURE

INFRARED SPECTROSCOPY

A 48-page handbook which details applications and techniques useful in infrared spectroscopy has just been published by Barnes Engineering Co., 30 Commerce Road, Stamford, Conn. 06902.

This new "Gold Book" includes performance characteristics, spectra, prices, and ordering information on a complete line of IR spectrophotometers cells, crystals, and accessories. Hundreds of items illustrated show advanced designs

in infrared sampling accessories including the new MicroMax and other ATR instruments, micro sampling devices, specular reflectance units, KBr die, GC fraction collector, pyrolyzer, beam condenser, attenuator, variable-temperature chamber, mull holders, liquid cells, etc.

Copies of Gold Book 1971-BE are available on letterhead request.

INDICATOR LIGHTS

A colorful, 20-page brochure, entitled "Spice of Life," has just been issued by Drake Manufacturing Company, 4626 N. Olcott Ave., Harwood Heights, Illinois 60656.

The publication describes and pictures an extensive line of midget (subminiature) indicator lights in easy-to-choose form. The brochure illustrates indicator lights housing midget screw, flanged, and bi-pin lamps for general-purpose, military, waterproof, RFI, and press-to-test requirements with a broad selection of lens caps and mounting styles.

Besides a regular index, there is a pictorial "product selection guide and product selector charts" to help the hurried engineer. For the engineer specifying indicator lights for the first time, there is a page containing basic information.

MICROWAVE POWER PRODUCTS

A new 24-page catalogue describing microwave power products is now available from the Electronic Tube Division, Sperry Rand Corp., Waldo Road, Gainesville, Florida 32601.

The revised brochure has been expanded to include an extensive line of c.w. TWT's with up to 400 watts of output power. A series of r.f. subsystems have also been added, including packaged TWT amplifiers, compact high-density power supplies, and packaged r.f. signal sources.

A letterhead request to the company will bring a copy of this catalogue.

INDICATOR/PILOT LIGHT DATA

Industrial Devices, Inc., 982 River Road, Edgewater, N.J. 07020 has just issued a 16-page, fully illustrated guide to indicator and pilot light selection combined with a cataloguing line of pilot lights.

The firm's neon pilot lights come in a broad range of styles, shapes, finishes, terminations, and lens colors. They are widely used in hi-fi equipment, electronic instrumentation, computers, display panels, and precision and electronic machinery. The incandescent and neon pilot lights are rugged and unaffected by vibration, shock, or voltage transients. They come equipped with current-limiting resistors and operate at low current levels of approximately 2 mA. They are designed for an average operating life of 10,000 hours.

STEREO HEADPHONES

The company's complete line of Stereohead equipment is displayed in a new 4-page, full-color brochure recently released. The publication illustrates and provides complete specifications for each of the six models. It also features the firm's new "Stereo Central" remote-control units which offer independent volume control for both left and right channels at locations remote from the original sound source.

A copy of "Enjoy Listening in a World of Your Own" is available on request. Sharpe

Circle No. 35 on Reader Service Page

POWER-SUPPLY DATA

A 32-page catalogue providing engineering and application data on an extensive line of highly regulated modular and laboratory power supplies is now ready for distribution. The publication includes complete specifications, mechanical drawings, features, electrical connection data, and accessory information for each series of supply.

A unique power-supply locator chart is provided so the user can decide which series of supply will best fit his needs. Models contained in

the catalogue range from small dual-output card types for operational amplifiers to large modular and systems units. The current price list is also included. Deltron

Circle No. 36 on Reader Service Page

ANTENNAS/ACCESSORIES

A 32-page catalogue, prepared with TV antenna installers and technicians in mind, has been issued covering an extensive line of TV and FM antennas and accessories.

Both indoor and outdoor antennas are included in the line along with rotators, u.h.f. converters, and all types of miscellaneous antenna hardware. For antenna mounting, masts, push-up towers, chimney mounts, tripod mounts, base mounts, wall and eave mounts are shown, along with aluminum, steel, and vinyl-clad guy wires. Lightning arresters and heavy aluminum ground wires are also listed. Channel Master

Circle No. 37 on Reader Service Page

COMPONENTS GUIDE

An updated, 10-page, two-color guide which provides quick reference information on components for power control and rectification has been issued.

Included in the guide is information on thyristors, triacs, rectifier and high-voltage stacks with ratings to meet almost every requirement from straightforward rectification to complex motor-speed control. All specifications are keyed to the outline drawings included in the guide. Mullard

Circle No. 38 on Reader Service Page

SERVICE TEST INSTRUMENTS

A four-page short-form catalogue which lists the firm's line of service test instrument is now available for distribution. It contains photographs, condensed specifications, and prices on tube testers, transistor testers, oscilloscopes, and signal generators.

These instruments are suitable for use in industrial, communications, laboratory, and service applications. Both bench-top and portable models are included. Hickok

Circle No. 39 on Reader Service Page

TTL IC HANDBOOK

A 128-page paperback handbook which describes its family of 54/74 transistor-transistor logic integrated circuits is now available from Signetics Corporation, 811 East Arquest Ave., Sunnyvale, California 94086.

The handbook begins with a two-page general section which discusses design considerations, electrical characteristics, absolute maximum ratings, package types, and ordering instructions. Section II features detailed electrical characteristics of the 54/74 series, and the third section covers the high-speed "H" series. Each product description includes the name and number of the device, the types of package, logic diagrams, schematics, recommended operating conditions, electrical characteristics, and switching characteristics. The final section provides parameter measurement information. ▲

PHOTO CREDITS

Page	Credit
7	H.H. Scott
8	Sony Corp. of America
27, 28 (center)	General Electric Co.
28 (top), 29	NASA
35, 70 (top)	JFD
40 (top)	Injectorall
40 (bottom)	Miller-Stephenson
41	Sprayon Products, Inc.
42, 70 (bottom)	Channel Master
43	Ampex Corporation
67	RCA Corp.
76	Heath Company

ELECTRONICS MARKET PLACE

COMMERCIAL RATE: For firms or individuals offering commercial products or services. \$1.00 per word (including name and address). Minimum order \$10.00. Payment must accompany copy except when ads are placed by accredited advertising agencies. Frequency discount: 5% for 6 months; 10% for 12 months paid in advance.

READER RATE: For individuals with a personal item to buy or sell. 65¢ per word (including name and address). No minimum! Payment must accompany copy.

GENERAL INFORMATION: First word in all ads set in bold caps at no extra charge. All copy subject to publisher's approval. Closing Date: 1st of the 2nd month preceding cover date (for example, March issue closes January 1st). Send order and remittance to: Hal Cymes, ELECTRONICS WORLD, One Park Avenue, New York, New York 10016.

FOR SALE

GOVERNMENT Surplus Receivers, Transmitters, Snooperscopes, Radios, Parts, Picture Catalog 25¢. Meshna, Nahant, Mass. 01908.

CONVERT any television to sensitive big-screen oscilloscope. Only minor changes required. No electronic experience necessary. Illustrated plans, \$2.00. Relco-A22, Box 10563, Houston, Texas 77018.

INVESTIGATORS, LATEST ELECTRONIC AIDS. FREE LITERATURE. CLIFTON, 11500-J NW 7th AVE., MIAMI, FLORIDA 33168.

SENCORE, B & K TEST EQUIPMENT UNBELIEVABLE PRICES. FREE CATALOG AND PRICE SHEET. FORDHAM RADIO, 265 EAST 149TH STREET, BRONX, N.Y. 10451.

ELECTRONIC PARTS, semiconductors, kits. Free Flyer. Large catalog, \$1.00 deposit. Bigelow Electronics, Bluffton, Ohio 45817.

BURGLAR ALARM SYSTEMS and accessories. Controls, bells, sirens, hardware, etc. OMNI GUARD radar intruder detection system, kit form or assembled. Write for free catalog. Microtech Associates, Inc., Box 10147, St. Petersburg, Florida 33733.

METERS Surplus, new, used, panel or portable. Send for list. Hanchett, Box 5577, Riverside, Calif. 92507.

ELECTRONIC COMPONENTS—Distributor prices. Free catalogue. Box 2581, El Cajon, California 92021.

ELECTRONIC Ignition. Various types. Information 10¢. Anderson Engineering, Epsom, N.H. 03239.

BACKGROUND MUSIC, continuous commercial-free. Solid-state MUSICON SCA ADAPTER plugs into any FM tuner, Receiver. Line powered. 5-year guarantee! Only \$39 postpaid. K-LAB, Box 572Z, South Norwalk, Conn. 06856.

NEW SEMICONDUCTOR LIGHT EMITTING DIODES. Bright red lights replace light bulbs. Typical life 100 years. Operate at 1.65 volts, 50 milliamps. Order 2 for \$2.98 NOW. Data sheet and instructions included. Monsanto Company, Hobby Section, 10131 Bubb Road, Cupertino, California 95014.

CONSTRUCTION PLANS: Laser ... \$2.00. 2-FM microphone transmitters ... \$1.00. FM telephone transmitter ... \$2.00. Sound telescope ... \$2.00. Space monitor-missile tracker ... \$2.00. Equipment and kits available. Howard, 20174 Ward, Detroit, Michigan 48235.

FREE ILLUSTRATED CATALOG!! covering wide range of low-cost stock business forms from 2-Way Radio to TV Service. Write today. Free catalog; samples, too. OELRICH PUBLICATIONS, 4040 N. Nashville East, Chicago, Illinois 60634.

EXCITING LISTENING: Police—Fire—Emergency calls on your broadcast radio, \$19.95 up. Also Crystals, receivers, Scanners, dualband. Salch Company, Woodboro 48, Texas 78393.

WOULD YOU SPEND 25¢ to save \$25.00 or more? Citizens Band, AM and SSB 2-way radios, USA and export models. Send 25¢ for catalog to: BAGGY'S RADIO, 6391 Westminster Avenue, Westminster, Ca. 92683. Dealer inquiries invited.

JAPAN HONG KONG DIRECTORY. World products information. \$1.00 today. Ippano Kaisha Ltd., Hillyard, Washington 99207.

TEKTRONIX, Hewlett Packard, General Radio, Gertsch, Kay, Polard, Lavoie, Beckman and many others. Scopes, Counters, Signal Generators, Recorders, Oscillators, Power Supplies, VTVMs, Ratio Transformers, Spectrum Analyzers. Call or Write GEM, P.O. Box 515, Irving, Texas 75060. 214-254-1531.

PRINTED CIRCUITS Quick. Free Estimates. Industrial Photo C-18, Oakhurst, N.J. 07755.

67KC SCA Adapter. Solid State, wired, tested. Operates on 9 to 30 volts. Use between FM tuner and Audio Amplifier. \$15.50. Postpaid USA with instructions, station list. Mark and Alan, P.O. Box 172, Chesterland, Ohio 44026.

NIXIES, Burroughs manufacture, \$4.00. Catalog 50¢. Dwight Patrick, 5885 E. 21st, Kansas City, Mo. 64126.

COLOR Organ Control, exclusive design. Free catalog. MECHANI-LAB, Box 284, South Euclid, Ohio 44121.

QUALITY reconditioned test equipment. All types. Reasonably priced. List available. Walters, 2697 Nickel, San Pablo, Calif. 94806.

EEG-Feedback phones. Relax, meditate rapidly. Literature: Inner Space, Box 319, Fairfax, CA. 94930.

SHIBADEN SV-700U video tape recorder, like new. 1007 West Mulberry, Denton, Texas 76201. (817) 387-9373.

EUROPE'S top quality electronic parts, ridiculous prices. Catalog 35¢. Electrovalve-America, Box 27A, Swarthmore, PA. 19081.

FLASHLAMP, \$2.98, Lasers, Photoflash, Beacons, Psychedelic Strobes; Plans, ZD 706, Box 3261, San Jose, California 95116.

ELECTRICAL MULTIMETERS—new, high quality, very reasonable. Request details. Newera, 4480 Broadview, Cleveland, Ohio 44109.

ORGAN OWNERS! Do your own thing! Save time and money. Tune your organ conveniently, accurately, inexpensively. Loss of tone quality and variation of pitch are easily and quickly corrected. Learn about our professional, economical tuning instrument. Write to: Musicon Electronics Co., Dept EW, Box 59, Fort Washington, PA. 19034.

FREE Electronics Catalog. Tremendous bargains. Edu-Kits, Department C-120E, Hewlett, New York 11557.

ELECTRONICS ENGINEERING AND INSTRUCTION

LEARN ELECTRONIC ORGAN SERVICING at home. All Makes including transistors. Experimental kit—troubleshooting. Accredited NHSC. Free Booklet. NILES BRYANT SCHOOL, 3631 Stockton, Dept. A, Sacramento, Calif. 95820.

ELECTRONICS! Associate degree—29 months. Technicians, field engineers, specialists in communications, missiles, computers, radar, automation. Start September, February. Valparaiso Technical Institute, Dept. N, Valparaiso, Indiana 46383.

RECTIFIERS & TRANSISTORS

Silicon Rectifiers

PIV	25	50	100	200	400	600	800	1000	1200
1A*	-.03	.04	.06	.08	.10	.14	.17	.22	
18A**	.09	.15	.19	.29	.39	—	—	—	—
20A	.23	—	—	.59	.75	1.13	1.35	1.73	2.10
40A	.38	—	—	1.35	1.80	2.25	2.70	3.15	3.60

*Tophat. Flangeless. **Pressfit. 3, 20, 40 Stud

Silicon Controlled Rectifiers

1500 PIV RECT.	PRV	25	50	100	200	400	600
1A*	—	—	—	.30	.55	.85	
STUD	7A	.11	.14	.20	.45	.90	1.20
1 AMP	18A**	.15	.23	.35	.60	1.10	1.40
25¢ EA.	20A	.18	.32	.45	.70	1.15	1.95

*Tophat **Pressfit. 7 & 30 Amp Stud

Germanium Power Transistors

150W-TO-3-7A	
2N456A—40V—25	2N 458A—80V—45
2N457A—60V—35	2N1021A—100V—60

Silicon Small Signal NPN, TO-5

2N696 7/\$1.00, 2N697 6/\$1.00, 2N699 5/\$1.00
2N3053 Silicon, NPN 3/\$1.00; 1N34A Diodes 100/\$2.98; 2N1142 Ger. Hi-Freq. Amplifier 3/\$1.00; Thermistor Beads, 5000 ohm or 1200 ohm—3/\$1.00; Varicaps—27, 47, or 100pf, 4V—\$1.25 ea.; P.C. Board 6" x 6" x 1/16" - 1 oz. Copper—2/98¢; Photo Cells, Herm. Glass, 5 Diff. for \$1.00; IN661 Silicon Switching 50/\$3.49—100/\$4.98; R.F. Coil Assort. 25/\$1.00, I.C. 10-5—15/\$1.00. Epoxy Diodes, 200 MA, 3000 Piv 49¢, 6000 98¢, IN658 Silicon Computer Diode—50/\$3.49—100/\$4.98; P.C. Connector 15 Contact 2/\$1.10.

ASSORTMENTS

Precision resistors film	50/\$1.00
Precision resistors wirewound	40/\$1.00
Ferric Chloride Etchant, 16 oz. bottle	.98
Relays 6 different types	6/\$1.00
Terminal lugs, assorted	200/\$1.00
Tie lugs, assorted	50/\$1.00
Push button switches, on-off, panel	6/\$1.00
Pots, 2-4 watt, different	10/\$1.00

Min. order \$3.00; send sufficient postage, average refunded; fully guaranteed; free catalog. 25% down on COD's.

GENERAL SALES CO.

254 E. Main St. (713) 265-2369
Clute, Tex. 77531

CIRCLE NO. 68 ON READER SERVICE PAGE

455 KC IF ASSEMBLY

Complete miniature 455kc IF amp assembly. 1.5 inches long, little over 1/2 inch square. Ready to use w/schem. Sim to Miller 8902 2.50

RF VACUUM SWITCH

Made for the ART-13 good for 100 watts RF, no doubt handles much more due to being underrated for the military. . . #71-17 3/2:00



NIXIE TUBES

Brand new BURROUGHS, 0-9 w/decimals. #B5441, with socket. List of \$8.40. #B5441 5.25

7400 SERIES IC GRAB BAG

Mix of 7400 series DIP, unmarked untested. Some schematics provided. 10 for 1.00
100 for 8.00
1000 for 60.00

70 AMP POWER SUPPLY KIT \$16.00

Runs on 115V 60 cycle. We include diagram, diodes, caps, resistors, transformer. Gives you a choice of 6V at 70 amps; 12V at 35 amps; 24V at 17 amps. Ship wgt. 30 lbs. #PK-1 16.00

TI SOLID STATE 3B28-866 REPLACEMENT

Brand new TI plug in solid state replacement for 3B28. Replaces 866. 9.00
2/17.00

Add Postage. New Catalog now out.

JOHN MESHNA JR.

19 ALLERTON ST., LYNN, MASS. 01904
P. O. BOX 62, E. LYNN, MASS. 01904

CIRCLE NO. 78 ON READER SERVICE PAGE

IMPOSSIBLE? BARGAINS IN SURPLUS ELECTRONICS AND OPTICS

SURPLUS TTL INTEGRATED CIRCUITS, BRAND NEW IN ORIGINAL MANUFACTURERS CARTONS

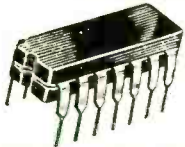

B & F has one of the worlds largest inventories of surplus integrated circuits. All are new, meeting all manufacturers original specifications, and in factory packaging. The low prices should speak for themselves. Manufactured

by Texas Instruments, National, Signetics or Philco, no choice. All packages are 14/16 lead silicone Dual In-Line Pak. Write for additional RTL and DTL lines not listed. Many other I. C. items in stock including nixies, 5 volt power supplies, indicators, logic breadboards.

- 7400 Quad 2-Input NAND Gate \$.50
- 7401 Quad 2-Input NAND Gate50
- 7402 Quad 2-Input NOR Gate50
- 7404 Hex Inverter50
- 7405 Open Collector Hex Inverter50
- 7408 Quad 2-Input AND Gate50
- 7410 Triple 3-Input NAND Gate50
- 7411 Triple 3-Input AND Gate50
- 7420 Dual 4-Input NAND Gate50
- 7421 Dual 4-Input AND Gate50
- 7430 8-Input NAND Gate50
- 7440 Dual 4-Input NAND Buffer50
- 7441 BCD To Decimal Decoder Driver 3.00
- 7450 Dual 2-Wide 2-Input Expandable A-O-I Gate50
- 7451 Dual 2-Wide 2-Input A-O-I Gate50
- 7453 4 Wide Expandable 2-Input A-O-I50
- 7454 4 Wide 2-Input A-O-I50
- 7460 Dual 4-Input Expander50
- 7470 J-K Flip-Flop 1.00
- 7472 J-K Master Slave Flip Flop 1.00
- 7473 Dual J-K Master Slave Flip-Flop 1.00
- 7474 Dual D Flip-Flop 1.00
- 7475 Quad Bistable Latch 1.75
- 7476 Dual J-K Master Slave Flip-Flop 1.00
- 7480 Full Adder 1.50
- 7490 Decade Counter 2.00
- 7491 8 Bit Shift Register 3.00
- 7492 Divide By 12 Counter 2.00
- 7493 4-Bit Binary Counter 2.00
- 8T01 NIXIE Decoder/Driver 3.00
- 8T04 Seven Segment Decoder/Driver 3.00
- 8162 Variable One-Shot 1.00
- 74192 Bidirectional Counter 3.00
- 74145 BCD to Decimal Decoder Lamp Driver 2.50

20% discount on orders for 100 or more integrated circuits. All I.C.'s postpaid, with FREE air mail on orders over \$50.00. We strive to ship I.C.'s by return mail. Free data sheets on all items.

- 1N4004 400 PIV 1 AMP DIODE 5/\$(1.00
- EPOXY F.W. BRIDGE RECTIFIER, 400 PIV 2 AMPS 1.00

DIODES BY THE FOOT

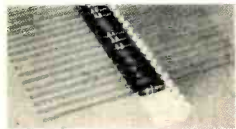

These diodes are packaged in rolls, for automatic machine insertion, spaced 0.2 inches apart so there are 60 to the foot. Buy a few feet of each type and keep them at your workbench, and you should have diodes handy all the time. Pull them from the strip as you need them. All at less than 10% of usual prices.

- Transistron SG2947 Silicon Planar 75 volts, 0.1 amps. 1 foot (60 diodes) \$2.00
- CBS 1N4148 Silicon Computer Diode. 1 foot (60 diodes) 3.00
- CBS 1N69 Germanium Diodes. Per foot (60 diodes) 1.50
- CBS Gold Bonded Germanium, ultra low forward drop, excellent for L.N.F. detectors. Per foot (60 diodes) 1.75
- Misc. Germanium Diodes. Per foot (60 diodes) 1.00

CIRCLE NO. 51 ON READER SERVICE PAGE



This mating connector is supplied with EACH card.

75% DISCOUNT, UNIVERSAL CIRCUIT CARDS

Large size cards, the easy inexpensive way to build, prototype, breadboard items. Epoxy-fiberglass material, 4 1/2" x 5 1/2". Complete with 46 contact gold plated mating connector, with built-in card guides. Original cost \$19.60 ea. Full instructions included.

- Circuit card and connector for 15 Dual-in-Line I.C.'s \$4.00
- Same as above, for 12 Flat-Pks 4.00
- Same as above, for 24 10 pin TO-5 I.C.'s 4.00
- Same as above, for 40 8 pin TO-5 I.C.'s 4.00
- Same as above, for Discrete Components 4.00



ROTARY THUMBWHEEL SWITCH

Brand new digital switch, available with output in straight decimal form, or specially coded BCD. Makes obsolete old style rotary switches.

- Thumbwheel Switch, per section, decimal (10 position) output \$4.25
- Same, BCD Output 4.25
- End Pieces50

OPERATIONAL AMPLIFIER SPECIALS

- 702 General Purpose Amplifier 1.00
- 709 OP Amplifier 1.00
- 711 Dual Comparator 1.75
- 741 OP Amplifier 1.25
- Sockets for 14-Pin DIP Integrated Circuits 3/1.00
- 2N3055 87.5 watt NPN Power Transistor 1.25
- VARIAC** - 2 1/2 ampere unit, brand new manufactured by GR or GE. Your workbench is not complete, unless you have one of these. Price \$4.75 + 1.25 postage

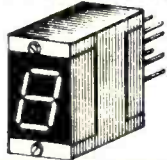

SEVEN SEGMENT READ-OUTS, WITH & WITHOUT COUNTER/DECODER/DRIVER UNITS.

This is a nice looking seven segment numerical readout. We are offering them with a kit including P.C. board, 7490 and

8T04 integrated circuits to build a decimal counter display unit, at an unheard of low price of \$9.75.

- Same unit with 74192 instead of 7490 I.C. for up/down counting. Used in preset counting, with encoders, etc. Price \$11.00
- Same unit, with 74192 and 7475 latch. With this arrangement you can display the last number read while making a new count (as in a frequency counter) so that you see a steady display instead of changing numbers. Price 13.00

See last months ad for low cost NIXIE and Incandescent readouts!

- 80 PAGE CATALOG . Free with any order or send \$0.25

ALL ITEMS POSTAGE PAID IN THE U.S.A.

Charges Welcome
BankAmericard - Mastercharge - \$10.00 min.

B. & F. ENTERPRISES

Phone: 617 532-2323
P.O. Box 44, Hathorne, Massachusetts 01937

\$1 PEP \$1
Dollar Sale
EACH PACKAGE
MONEY BACK GUARANTEE

1 AMP Silicon Rectifier Choice of Package Bullet-Glass-Min-Metal	1 AMP CLASS 50-100V 15/\$1.00
<input type="checkbox"/> 20-50V <input type="checkbox"/> 17-100V <input type="checkbox"/> 12-200V	<input type="checkbox"/> 5-800V <input type="checkbox"/> 2-100V <input type="checkbox"/> 3-1200V
3 AMP	2 AMP BULLETS
<input type="checkbox"/> 15-50V <input type="checkbox"/> 10-100V <input type="checkbox"/> 8-200V <input type="checkbox"/> 5-400V	<input type="checkbox"/> 4-600V <input type="checkbox"/> 3-800V <input type="checkbox"/> 2-1000V <input type="checkbox"/> 1-1200V
15 AMP TRIAC PRESET 5-50V 7/31.00	7 AMP SCR FLANGE PACKAGE 5-100V 10/51.00

CIRCUIT BOARD SPECIAL

A - Approximately 200 diodes - 7 transistors - over 50 resistors complete with board! - \$1.25
30 Amp. Stud. 24 V. 7 for \$1.00
Plastic low power transistors PNP No Test 25 for \$1.00

PRV	2 Amp	3 Amp	5 Amp	10 Amp
50V	1.25	1.35	1.50	1.70
100V	1.50	1.60	1.75	1.95
200V	1.75	1.85	2.00	2.20
400V	2.00	2.10	2.25	2.45
600V	2.50	2.60	2.75	2.95
800V	3.00	3.10	3.25	3.45

PRV	1 AMP	3 AMP	7 AMP
50	.20	.25	.30
100	.25	.30	.35
200	.40	.45	.50
300	.60	.70	.80
400	.75	.85	.95
500	1.00
600	1.30

PRV	1 AMP	3 AMP	6 AMP	10 AMP	15 AMP
100	.40	.50	.75	1.00	1.20
200	.65	.75	1.00	1.40	1.80
300	1.00	1.10	1.25	1.90	2.20
400	1.30	1.40	1.80	2.30	2.60
500	1.60	1.80	2.10	2.75	3.10

NO SALES TAX - WE PAY POSTAGE
OTHER PRODUCTS ON REQUEST
PARK ELECTRONIC PRODUCTS
P.O. Box 78, N. Salem, N.H. 03073
603-893-0276

CIRCLE NO. 81 ON READER SERVICE PAGE

Electronics World
SUBSCRIBER SERVICE

Please include an address label when writing about your subscription to help us serve you promptly. Write to: P.O. Box 1093, Flushing, N.Y. 11352

CHANGE OF ADDRESS: Please let us know you are moving at least six to eight weeks in advance. Affix magazine address label in space below and print new address in space provided. If you have a question about your subscription, attach address label to your letter.

TO SUBSCRIBE: Check these boxes: 5 years \$26
 3 years \$18 1 year \$7 New Renewal

SPECIFY: Payment enclosed - You get 1 extra issue per year as a BONUS! Bill me later.

AFFIX LABEL

If you have no label handy, print OLD address here.

name _____ please print
address _____
city _____ state _____ zip code 0365

name _____ please print
address _____
city _____ state _____ zip code _____

Add'l postage: \$1 per year outside U.S., its poss. & Can.

ATTENTION Electronic Technicians and Engineers! Upgrade your qualifications and ability. Highly effective College-Level home study course in "Technical Writing." Diploma awarded. Excellent employment opportunities with high pay. Interesting work. Write for revealing Free Descriptive Literature. Cook's Institute of Electronics Engineering, P.O. Box 10634, Jackson, Miss. 39209 (Established 1945).

WANT AN F.C.C. 1st CLASS LICENSE? WANT TO BECOME A DISC JOCKEY? REI has a school near you VA approved call toll free: 1-800-237-2251 or write REI, 1336 Main St., Sarasota, Florida 33577. Florida Residents call: (813) 955-6922.

LEARN DIGITAL LOGIC and integrated circuits. Free brochure. Performance Enterprises, Inc., 4706 NE 12th Ave., Fort Lauderdale, Fla. 33308.

MEMORIZE, STUDY: "1971 Tests-Answers" for FCC First and Second Class License. plus "Self-Study Ability Test." Proven! \$9.95. Satisfaction guaranteed. Command, Box 26348-P, San Francisco 94126.

DEGREE in Electronics Engineering earned mostly by correspondence. Free brochure. Dept. G-9, Grantham School of Engineering, 1505 N. Western Ave., Hollywood, California 90027.

TUBES

TUBES-Lowest prices. Foreign-American. Obsolete, receiving, special purpose, transmitting tubes. Send for tube, parts catalog. United Radio Company, 56-E Ferry St., Newark, N.J. 07105.

TUBES, SEMICONDUCTORS, ELECTRONIC EQUIPMENT & COMPONENTS. Quality merchandise only! Serving engineers, Purchasing Agents, TV/Hi-Fi Servicemen and Hams for 20 years. Write for Catalog or call 212-WA 5-7000. BARRY ELECTRONICS, 512 Broadway, New York, N.Y. 10012.

RECEIVING & INDUSTRIAL TUBES, TRANSISTORS, All Brands-Biggest Discounts. Technicians, Hobbyists, Experimenters-Request FREE Giant Catalog and SAVE! ZALYTRON, 469 Jericho Turnpike, Mineola, N.Y. 11501.

TUBES-36¢ each. Year guarantee. Tuner Cleaner \$1.00. Free catalog. Cornell, 4213-W University, San Diego, Calif. 92105.

INTEGRATED CIRCUITS / RECTIFIERS SEMICONDUCTORS / TRIACS

BCD COUNTER KIT

Consisting of:
1—PC board 12707
2—7476 IC's
2—Silicon diodes
1—Set of instructions
When assembled by enclosed instructions, this kit will count pulses from 0-9 in BCD. These boards can be connected in series to count as high as desired. Example, two boards will count to 99, three to 999 etc. \$6.95
ER900 TRIGGER DIODES. These bidirectional trigger diodes are one of the best and cheapest methods to trigger SCR's and triacs 4/\$1.00

TIS 43 GENERAL PURPOSE UNIUNCTIONS \$5.00

2N3819N Channel FET's 45

TRIACS

PRV	1A	10A	15A
100	.40	.70	1.00
200	.70	1.10	1.40
300	.90	1.35	1.80
400	1.10	1.60	2.20
500	1.50	2.00	2.60

LIGHT EMITTING DIODES (LED'S)

Infra red OR visible spectrum \$1.50 ea.
Photo detectors for each \$1.00

TTL IC SERIES (DIP)

7441 BCD Decimal Decoder	2.50
7474 Dual Flip Flop85
7475 Quad Bistable Latch	1.70
7476 Dual Mast-Slave JK FF	1.00
7490 Decade Counter	1.85
7492 Divide By Twelve	1.85
7493 4 Bit Binary Counter	1.85

Silicon Power Rectifiers

PRV	3A	30A	12A
100	.09	.30	.50
200	.16	.35	.80
400	.20	.45	1.20
600	.30	.70	1.50
800	.40	.85	1.80
1000	.55	1.10	2.20

Terms: FOB Cambridge, Mass. Send check or Money Order. Include Postage. Average Wt. per package 1 1/2 lb. No C.O.D.'s. Minimum Order \$3.00

NUMERICAL INDICATORS

0-9 TYPE 1801

12V D.C. operated, front panel mounted, 2 1/2" total height, 7/8" numbers \$5.50

Rated companies 30 days net

UNIVERSAL PC BOARD

12705, will hold 6DIP IC's and has extra pads for other components
Board & Mating Connector \$4.50

709C OPER AMP. \$1.00
SE 501 VIDEO AMP. 1.00

2N4303 P channel FET with a QMS of 2000 uohms \$.95
Controlled Avalanche or Epoxy Rectifiers 1 AMP.

100	.06
200	.07
400	.09
600	.11
800	.15
1000	.20

Silicon Control Rectifiers

PRV	3A	7A	20A	70A
50	.25	.28	.60	
100	.30	.38	.85	3.50
200	.50	.60	1.10	6.50
300	.60	.68	1.30	
400	.70	.75	1.50	9.50
500	.80	.85	1.70	
600	.90	1.20	1.90	11.00

Send for our Latest catalog featuring Transistors and Rectifiers; 325 Elm St., Cambridge, Mass.

OLID

Post Office Box 74B

TATE

Somerville, Mass. 02143

ALES

Tel. (617) 547-4005

CIRCLE NO. 84 ON READER SERVICE PAGE

GREGORY ELECTRONICS

Your Best Buys In

QUALITY USED
FM 2-WAY RADIO EQUIPMENT



RCA CMU15B

6/12 volts, 15 watts
450-470 M Hz

\$28.

Accessories available:
cables, control, head,
hand sets and speaker.

\$20.

We've Expanded . . .

We have expanded our warehouse to double its capacity. We can now stock a larger and more varied line of equipment. Should you be in our area (15 minutes from N.Y.C.) you are cordially invited in to browse. We now have the warehouse space to carry 15,000 pieces of used FM Mobile Communication Units.

Send for new '71 catalog



GREGORY ELECTRONICS CORPORATION

249 Route 46, Saddle Brook, N. J. 07662
Phone (201) 489-9000

CIRCLE NO. 71 ON READER SERVICE PAGE

FREE!

SPECIAL INTEREST RECORD CATALOG

Spectacular sound! Stereo testing!
Background music and sound effects!
Special Interest Records available
exclusively from Ziff-Davis.

Send for your free Record Catalog—
Ziff-Davis Publishing Co., Dept. 23,
One Park Ave., New York, N.Y. 10016.

WANTED

QUICKSILVER, Platinum, Silver, Gold. Ores Analyzed. Free Circular. Mercury Terminal, Norwood, Mass. 02062.

QUICK CASH . . . for Electronic Tubes, Semi-conductors, Equipment (Receivers, Transmitters, Scopes, Vacuum Variables, etc.) Send lists now! Write: BARRY ELECTRONICS, 512 Broadway, New York, N.Y. 10012 (212-WA 5-7000).

PAY \$10.00 for manual for Precise Development Corp. 300K Oscilloscope. Larry Brooks, 616 Cherry Lane, Pueblo, Colorado 81005.

WANTED—50 General Electric IN1692 Diodes. Dale Peter, Randolph, Kansas 66554.

DO-IT-YOURSELF

PROFESSIONAL ELECTRONICS PROJECTS—\$1.00 up. Catalog 25¢. PARKS, Box 25665A, Seattle, Wash. 98125.

PLANS & KITS

INTEGRATED CIRCUIT KITS—Free Catalog. FRAZER & ASSOCIATES, 3809 Surfwood Road, Malibu, California 90265.

TAPE AND RECORDERS

OLD Radio Programs on tape. 6 hours for \$8.00. Catalog 50¢. Don Maris, 1926 Cherokee, Norman, Okla. 73069.

STEREO TAPE TRANSPORT—7" reel—2 speeds—pause control—made for famous manufacturer—50 to 15,000 Hz—with rec/play and erase heads, without case. Send m.o. or check for \$19.50 to Stereo Center, 218 Columbia St., Utica, N.Y. 13502. \$2.50 for prepaid shipping and insurance.

STEREO TAPE RENTAL for particular people. Free catalog. Gold Coast Tape Library, Box 2262, Palm Village Station, Hialeah, Fla. 33012.

RENT 4-track open reel tapes—all major labels—3,000 different—free brochure. Stereo-Parti, 55 St. James Drive, Santa Rosa, California 95401.

BARGAIN MUSIC, Tape, Equipment Catalog 25¢. Saxitone, 1776 Columbia Road, Washington, D.C. 20009.

RECORDS

POPULAR organ albums factory direct. Concert Recording, Lynwood, Calif. 90262.

SPECIAL interest records available, produced by the editors of the world's leading special interest magazines. Send for free catalog. Record Catalog, EW, Ziff-Davis Publishing Company, One Park Ave., New York 10016.

May, 1971

HIGH FIDELITY

HI-FI EQUIPMENT—GET Our "ROCK BOTTOM" prices on NAME BRAND amplifiers—tuners—tape-recorders—speakers FRANCHISED—60 YEARS IN BUSINESS. Write for this month's specials—NOW! Rabson's 57th St., Inc., Dept 569, 119 W. 57th St., New York, N.Y. 10019.

LOW, LOW quotes: all components and recorders. Hi-Fi, Roslyn, Penn. 19001.

DIAMOND NEEDLES AND STEREO CARTRIDGES at low, low prices for Shure, Pickering, Stanton, Empire, Grado and ADC. Send for free catalog and price sheet. We will be happy to quote on any cartridge—Magnetic, Ceramic or Crystal. All merchandise brand new. LYLE CARTRIDGES, Dept. E, 365 Dahill Road, Brooklyn, New York 11218.

HI-FI components, tape recorders, sleep learning equipment, tapes. Unusual Values. Free catalog. Dressner, 1523 R Jericho Turnpike, New Hyde Park, N.Y. 11040.

AUTHORS' SERVICES

AUTHORS! Learn how to have your book published, promoted, distributed. FREE booklet "ZD," Vantage, 516 West 34th St., New York 10001.

PERSONALS

MAKE FRIENDS WORLDWIDE through international correspondence. Illustrated brochure free. Hermes, Berlin 11, Germany.

GOVERNMENT SURPLUS

JEEPS Typically From \$53.90 . . . Trucks from \$78.40 . . . Boats, Typewriters, Airplanes, Multimeters, Oscilloscopes, Transceivers, Electronics Equipment. Wide Variety, Condition. 100,000 Bid Bargains Direct From Government Nationwide. Complete Sales Directory and Surplus Catalog \$1.00 (Deductible First \$10.00 Order.) Surplus Service, Box 820-K, Holland, Michigan 49423.

MAGAZINES

OVER 2,000,000 Backdate magazines! Specify needs. Midtown, Box 917EW, Maywood, New Jersey 07607.

JAPAN PUBLICATIONS GUIDE business, pleasure, education. \$5.00. INTERCONTINENTAL, CPO 1717, Tokyo 100-91.

INTERNATIONAL Magic Magazine monthly. Tricks, dealers, news. Three month trial \$1.00. Genii, Box 36068-Z, Los Angeles, Calif. 90036.

U.S. GOV'T ELECTRONIC SURPLUS

Nationally Known - World Famous SURPLUS CENTER offers finest, most expensive, Government Surplus electronic units and components at a fraction of their original acquisition cost.

IBM COMPUTER POWER SUPPLY

(ITEM #22-934) - Expensive, regulated unit. Fine for college labs, research etc., service shops, etc. Pure DC over a wide range of voltages. DC output voltages 6, 12, 30, etc. Wide range of AC voltages available.



Finest transformers, filters, transistor load regulation system. Independent of line voltage fluctuations. Contains five separate rectifier systems. Unit is furnished without small "regulating card" which can be easily made or can be bypassed. Data and circuit diagrams furnished. 30" x 12" x 10". (12 lbs.)

Cost Gov't Over \$500.00 **\$24.95**

ONCE-IN-A-LIFETIME SPECIAL

BURGLAR-FIRE ALARM SYSTEM

(ITEM #1135-A) - Dual alarm system gives warning of fire or break-in. Operates on 115-VA. Control unit, 2-Kilohm flash fire, 2-mercury column, 3-door window detectors, alarm bell, 100 ft. wire, instructions. 8 1/2" x 2 1/2" x 3". (6 lbs.)



\$29.95

STANDARD DIAL TELEPHONE

(ITEM #715) - Standard, commercial telephone same as used throughout U.S.A. Attractive polished black. Like new condition. Use as extension phone in private systems or connect several phones together for local intercom system. Full instructions are furnished. Wt. 9 lbs.



Original Cost \$24.50 **\$7.49**

STEP-BY-STEP TELEPHONE SWITCH

(ITEM #7-906) - Amazing telephone selector switch. Great experimental item. When used with two-wire telephone dial will select any number from 0 to 100. Make intercom or private system. Use to turn on remote lights, start meters, etc. Complete with contact bank. 11 1/2" x 6 1/2" x 3". (16 lbs.) Cost Over \$90.00

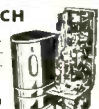

\$6.29

Telephone dial for use with above switch. Order as (Item #700)..... **\$1.97**

MAGNETIC DIGITAL COUNTER (12 to 18-VDC)

(ITEM #21-959) - Use to count electrically. Use to count number of times door is opened after business is closed, to show changing prices, laboratory uses, etc. Will count 1 for each pulse and will transfer 10th count to next unit. 9 1/2" x 1 1/2" x 1 1/2". Orig. Cost Over \$19.00 Each **\$1.99** Three For **\$4.99**



TYPICAL BUYS FROM OUR 1970 CATALOGS

- \$ 10.00 115-Volt DPDT Relays..... **\$1.69**
- \$101.00 Regulated Transformer, Wide Range..... **\$14.91**
- \$ 75.00 20-Relay Telephone Panel..... **\$4.39**
- \$250.00 Gyroscope, Twin Rotor, 24V..... **\$9.89**

AC PROGRAM TIMING CLOCK

(ITEM #158) - Zenith 115-VA AC unit. Use for program timing, work breaks, classes, etc. on radio, etc. Mfg. clips permit ON-OFF switching any time in 24-hour period. Also has "skip-ahead" feature. Can be multiple programmed. 15-amp. contacts. 8 1/2" x 6 1/2" x 4". (8 lbs.)



Cost Gov't Over \$30.00 **\$15.75**

SNAP AROUND VOLT-OHM-AMMETER

(ITEM #21-944) - Measures AC current without opening the line. Simply press handle and snap the probe around the conductor. Reads currents from .25 to 125-amps. Reads voltages to 500, reads ohms up to 500. Test motors, appliances, etc. Three current ranges, two voltage ranges. With case, test leads. 7 1/2" x 3" x 1 1/2".



\$36.90 Reg. Price \$39.95 (2 lbs.)

SPECIAL SALE

Correspondence Course In

ELECTRICAL ENGINEERING



\$8.79 Prepaid in U.S.A.
\$10.79 Outside U.S.A.

(ITEM #A180) - Obtain technical training at low cost! Lincoln Engineering School has suspended its Correspondence Courses because of rising costs. A limited number of Electrical Engineering Courses are available, but without the examination grading service. The course consists of 10 lesson books, each with associated exams and standard answers. High descriptive prize winning Home-Experimental laboratory bench furnished at no extra cost.

RUNNING TIME METER

(ITEM #2188) - Record number of operating hours of electric lights and electrical devices such as refrigerators, furnaces, etc. Records total hours, tenths and hundredths up to 9,999.99 hours. For 115-volt, 60-cycles. Size 4" x 3" x 2 1/2". Shipping weight 2 lbs. **\$4.39** Cost Over \$29.00



COMPUTER TRANSISTORS ON HEAT SINKS

IBM Computer Quality Units

(#22-928) - Unit consists of one 150-watt power transistor on heavy, ribbed, aluminum heat sink. Many experimental uses. (1 lb.) Cost Gov't Over \$10.00 **\$1.99**

(#22-915) - Unit consists of two 150-watt power transistors, 2 pots, several diodes, capacitors, resistors, etc. on heavy, ribbed aluminum heat sinks. Ideal for use as motor speed control. (4 lbs.) Cost Gov't Over \$35.00 **\$4.91**



ALL ITEMS SHIPPED F.O.B. LINCOLN, NEBR. Order Direct From Ad. Money Back Guarantee.

SURPLUS CENTER

DEPT. EW-051 LINCOLN, NEBR. 68501

HYPNOTISM

SLEEP Learning, Hypnotic Method. 92% effective. Details free. ASR Foundation, Box 7021 EW, HC Station, Lexington, Ky. 40502.

FREE Hypnotism, Self-Hypnosis, Sleep Learning. Catalog! Drawer H400, Ruidoso, N.M. 88345.

PHOTOGRAPHY-FILM, EQUIPMENT, SERVICES

SCIENCE Bargains-Request Free Giant Catalog "CJ"-148 pages-Astronomical Telescopes, Microscopes. Lenses, Binoculars, Kits, Parts, War Surplus bargains. Edmund Scientific Co., 300 Edscorp Bldg., Barrington, New Jersey 08007.

EMPLOYMENT INFORMATION

WORLDWIDE Electronic Employment opportunities for Technicians, Engineers. Latest report on best jobs now open, Salaries, qualifications, locations, where, how to apply-\$5.00. PRESTON-CLARKE PUBLICATIONS, Box 173C, Northport, N.Y. 11768.

EDUCATIONAL OPPORTUNITIES

LEARN WHILE ASLEEP. Hypnotize! Strange catalog free. Autosuggestion, Box 24-ZD, Olympia, Washington, 98501.

BUSINESS OPPORTUNITIES

FREE CATALOGS. Repair air conditioning, refrigeration. Tools, supplies, full instructions. Coolin, 2016 Canton, Dallas, Texas 75201.

I MADE \$40,000.00 YEAR by mailorder! Helped others make money! Start with \$10.00-Free proof. Torrey, Box 318-N, Ypsilanti, Mich. 48197.

MAKE BIG MONEY raising chinchillas, rabbits, guinea pigs for us. Catalog-25¢. Keeney Brothers, New Freedom, Pa. 17349.

WAREHOUSE-SPACE-REDUCTION SALE: (GIVEAWAY PRICES!)

LINE-VOLTAGE REGULATORS:

Sorensen & Superior Elect. Electronic Types, 0.1% Regulation, 3% Max. Harmonics:

- 500 VA, 95-130 v in. 110-120 v out 35.00
- 1000 VA ditto fob Utica N.Y. or Los Angeles 37.50
- 2000 VA ditto fob Los Angeles 67.50
- 2500 VA 0.01% regulation ditto, Los Angeles 99.50
- 2500 VA 0.1% regulation ditto, Los Angeles 89.50
- 3000 VA 0.1% ditto brand new, Utica, N.Y. 99.50
- 5000 VA 0.1% ditto checked OK, Los Angeles 149.50
- ditto 190-250 v to 220-240 v, Los Angeles ... 149.50

Electromechanical, 1%, No Distortion:

- 6000 VA Super. Electric, Utica or Los Angeles 49.50
- ditto General Radio =1570AL, Los Angeles... 57.50
- 15 KVA Superior Electric Los Angeles 195.00
- 27 1/2 KVA 1 Ph. 205-250 v to 220-240, Los Ang. 195.00
- 20 KVA 3 Ph. 185-255 v to 220-240, Los Ang. 195.00

MISCELLANEOUS BARGAINS:

General Radio #1610A: A complete Capacity-measuring system in a 43" high cabinet, sold for \$2090.00. Bridge, Oscill., Null Det., Filter, Guard ect. etc. Excellent condition guaranteed 195.00

Sorensen E-28-30: Regul. DC Pwr Sply 25-31 v. 0-30 amps, metered FOB Los Angeles 59.50

L & N #1554-A2: \$3200.00 Capacitance & Conductance Bridge Assembly, measures insulation etc. 195.00

AM/ASM-3: Complete new Test Set for AN/ASQ-8 Magnetometer, with books, fob San Diego 295.00

Gas Laser: Spectra Physics =110 with lens, less the simple power supply. With book 50.00

Nanosec Pulses 32 KV, 3 ma, Details: Ask! 60.00

Huist Test Set for AN/AQS-10 Sonar 27.50

Hughes #VTW-29 Stored Energy Welder Pwr 27.50

Raytheon =10A Stored Energy Welder Pwr Sply 27.50

Stoddart TS-587 (NMA-5) RFI Meter 15-400 Milz. needs repairs. Sold as-is, clean, w/book 97.50

TIC #431 Electronic Freq. Changer (or 1000 watt amplifier) Input 230 v 1 ph 60 Hz. Output adjustable 105-130 v. 330 to 3900 Hz. 1 ph 195.00

CML #33828 3 ph Electronic Freq. Converter, 1500 VA. Input 220 v 3 ph 60 Hz, output 115 v, 3 ph. 350 to 450 Hz; or use 500 VA any leg with no danger of unbalance; or 1000 VA any leg (3 KVA total) for any 10-second starting load 295.00

If you don't see it here, ask for it! Or ask for the KIND of material you want, like Oscilloscopes, Counters, VTVM's, etc. etc.

But don't ask for a general catalog. . . . we believe that is nonsense in surplus . . . we get new things in almost every day! WE ALSO BUY! So tell us what you have, condition, and your asking price.

R. E. GOODHEART CO. INC.

Box 1220-A, Beverly Hills, Calif. 90213
Phone: Area 213 272-5707.

CLASSIFIED ADVERTISING ORDER FORM

Please refer to heading on first page of this section for complete data concerning terms, frequency discounts, closing dates, etc.

1	2	3	4	5
6	7	8	9	10
11	12	13	14	15
16	17	18	19	20
21	22	23	24	25
26	27	28	29	30
31	32	33	34	35

Words @ .65 Reader Rate } = \$
@ \$1.00 Commercial Rate }

Insert _____ value(s) Total Enclosed \$ _____

NAME _____

ADDRESS _____

CITY _____ STATE _____ ZIP _____

SIGNATURE _____

WORD COUNT: Include name and address. Name of city (Des Moines) or of state (New York) counts as one word each. Zip Code numbers not counted. (Publisher reserves right to omit Zip Code if space does not permit.) Count each abbreviation, initial, single figure or group of figures or letters as a word. Symbols such as 35mm, COD, P.O., AC, etc., count as one word. Hyphenated words count as two words. EW-5-71

FREE BOOK "999 Successful Little-Known Businesses." Work home! Plymouth 445-Y, Brooklyn, N. Y. 11218.

\$200.00 DAILY In Your Mailbox! Your Opportunity To Do What Mailorder Experts Do. Free Details. Associates, Box 136-EW, Holland, Michigan 49423.

MAILORDER! Make big money working home. Free report reveals millionaire's trade secrets! Executive (1K5), 333 North Michigan, Chicago 60601.

CHINCHILLA income guaranteed. Terms: 25¢, bulletin \$1.00. Rainbow, Port Richey, Fla. 33568.

INVENTIONS WANTED

PATENT Searches including maximum speed, full airmail report and closest patent copies, \$6.00. Quality searches expertly administered. Complete secrecy guaranteed. Free Invention Protection forms and "Patent Information." Write Dept. 23, Washington Patent Office Search Bureau, 711 14th Street, N.W., Washington, D.C. 20005.

RUBBER STAMPS

RUBBER ADDRESS STAMPS \$2.00. SIGNATURE \$3.50. FREE CATALOG. JACKSON'S, BOX 443-G, FRANKLIN PARK, Ill. 60131.

CALL letters included! Pocket stamp, \$3. Brown's, 321 Price, Philadelphia, Pa. 19144.

MAGNETS

MAGNETS. All Types, Specials—20 disc magnets, or 2 stick magnets, or 10 small bar magnets, or 8 assorted magnets, \$1.00. Maryland Magnet Company, Box 192-E, Randallstown, Maryland 21133.

MUSICAL INSTRUMENTS

30% DISCOUNT name brand musical instruments. Free catalog. Freeport Music, 127-L Sunrise Hwy, Freeport, N.Y. 11520.

TREASURE FINDERS

FREE: Jetco Electronics free 24 page treasure finder catalog. Find metals, minerals, gold, silver, coins, and relics, Jetco, Box 132EW, Huntsville, Texas 77340.

MISCELLANEOUS

WINEMAKERS: Free illustrated catalog of yeasts, equipment: Semplex, Box 122-76, Minneapolis, Minn. 55412.

STOP BURGLARS THE EASY WAY! Affix authentic "Protected by Electronics Sentry Alarm" decals to auto windows, doors and windows of home, retail stores, vending machines, etc. Whether you have an alarm or not—thieves stay away! Only \$1.00 for each set of two. J. Ross, 80-34 Kent St., Jamaica, N.Y. 11432, Dept. EW.

MAIL ORDER OPPORTUNITIES WAITING FOR YOU!

Classified Advertisers find more outlets for their product and service advertising in Ziff-Davis Electronics Publications than in any other media.

Monthly publications: POPULAR ELECTRONICS, ELECTRONICS WORLD, STEREO REVIEW are each acknowledged leaders in their respective special interest areas. They offer mail order businessmen the opportunity to reach additional markets with Classified Advertising that is responded to regularly by an affluent audience of active electronics enthusiasts.

Prove to yourself the effectiveness of Classified Advertising in Ziff-Davis Electronics Publications. Write today for information, assistance or sample copies to:

Hal Cymes, Classified Advertising Manager
Ziff-Davis Publishing Company
One Park Avenue, New York, N. Y. 10016

May, 1971

It's The Biggest! It's The Most Popular PENNY SALE IN THE INDUSTRY!

ONE CENT

"EYE SEE" BONANZA BY POLY PAK

With Spec Sheets • Lowest Prices In U.S.A. • Brand New



Buy ONE at the special "Sale" price get the SECOND for only ONE CENT!

Type	Description	Each	2 for
SN7400N	Quad 2 Input NAND Gate	\$.88	\$0.89
SN7402N	Quad Input NOR Gate	.88	.89
SN7410N	Tripl 3 Input NAND Gate	.88	.89
SN7420N	Dual 4 Input NAND Gate	.88	.89
SN7430N	8 Input NAND Gate	.88	.89
SN7440N	Dual 1 Input NAND Buffer	.88	.89
SN7441N	BCD to Sixtic Driver	3.95	3.96
SN7460N	Dual 4 Input Expander	.88	.89
SN7473N	Dual J-K Flip Flop	1.19	1.20
SN7474N	Dual D Flip Flop	1.19	1.20
SN7475N	Quad Latch	2.95	2.96

SN7481N	16 Bit Memory	4.50	4.51
SN7490N	Decade Counter	4.50	4.51
SN7491N	8 Bit Shift Register	4.95	4.96
SN7492N	Divide By Twelve Counter	4.95	4.96
SN7493N	4 Bit Binary Counter	4.95	4.96

GENERAL ELECTRIC 3-WATT AUDIO AMP

Any 3 10% Discount!

\$3.95

• Lowest Prices • Brand New!

3 watts continuous 9 to 27 volt supply, 8 mV sensitivity, includes 11 circuits, for phono, tape recorders dictating, TV, FM, movie

LIGHT-EMITTING DIODES (LEDs) \$1.29

Any 2 10% Discount!

- Visible LED "Brite Red"
- Visible "Brite Red" Detector W/Spec Sheets
- Invisible "Infrared" Detector
- Invisible LED "Infrared"

TRIACS (THYRISTORS)

Any 3 10% Discount!

PRV	1A	3A	6A	15A	25A
50	.29	.35	.45	.55	.75
100	.35	.45	.59	.63	1.10
200	.45	.65	.85	.95	1.50
400	.95	1.25	1.50	1.75	2.50
600	1.25	1.50	1.95	2.15	2.95

LINEAR AMPLIFIERS

Any 3 — 10% Discount

702	Wide Band DC	\$.50	.88
709	Operational	.88	.88
710	H. Speed Diff.	.88	.88
723	V. Regulator	1.19	1.19
741	Freq. Comp. 709	1.50	1.50
2809	Dual 709	1.95	1.95
2747	Dual 741	2.98	2.98

10¢ Catalog on Fiber Optics, 'ICs', Semis, Parts
Terms: add postage. Rated: net 30, cod's 25%.
Phone Orders: Wakefield, Mass. (617) 245-3829
Retail: 211 Albion St., Wakefield, Mass.

POLY PAKS P.O. BOX 942 W LYNNFIELD, MASS 01940

CIRCLE NO. 129 ON READER SERVICE PAGE

PROGRAMMABLE UNIUNCTION TRANSISTOR (PUT)

STOCK NO. P4212 Similar to D13T1. Comes with 2 part magazine article reprint, loaded with application data. 1.45 ea. 4/5.00

INTEGRATED CIRCUITS

Series 74 TTL
Texas Instruments, Fairchild, National, ITT.

Dual in Line

Type	Function	Stock No.	Price
SN7404/9016	Hex Inverter	P3040	1.00
SN7410/9003	Triple 3 Input NAND gate	P3047	1.00
SN7441	BCD to Decimal Decoder/Driver	P3042	3.95
SN7442/9301	BCD to Decimal Decoder	P3043	3.25
SN7473/9020	Dual J-K Master Slave Flip Flop	P3052	1.25
SN7470	J-K Flip Flop	P3041	1.00
SN7475	4 Bit Bistable Latch	P3055	1.75
SN7490	Decade Counter	P3044	2.95
SN7492	Divide by 12 or 6	P3053	3.25
SN7493	4 Bit Binary Counter	P3045	3.50
SN7494	4 Bit Shift Register	P3046	3.50
SN7495/9300	4 Bit Right Shift-Left Shift Register	P3050	3.95

COMPUTER GRADE CAPACITORS

P2040	Sangamo or Pyramid 4 1/4" x 1 3/4"	
	4000 MFD 50 V	\$.65 ea. 5/\$3.00
P2049	3500 Mfd. 55 volt 4 1/4" x 1 3/4"	\$.65 ea. 5/\$3.00
P2062	40,000 Mfd. 10 volt 3" x 4 1/4" Brand new	\$1.25 ea. 6/\$7.00

HONEYWELL COMPUTER BOARD

Honeywell Boards 5 1/2" x 6". Loaded with late no. transistors, diodes, resistors and capacitors.
P9127 \$1.50 ea. 4/\$5.00

TRIACS

P4128 TRIACs 400 volt, 6 Amp.
Mounted on heat sink \$1.50 ea. 5/\$7.00

\$1.00 FREE WITH \$10.00 ORDER
MINIMUM ORDER \$3.00

Lots of other items—send for free flyer; all merchandise fully guaranteed. Please include postage; excess will be refunded.

DELTA ELECTRONICS CO.
BOX 1, LYNN, MASSACHUSETTS 01903
CIRCLE NO. 58 ON READER SERVICE PAGE

LIBERTY PAYS MORE! WILL BUY FOR CASH

- ALL TYPES:
- ★ ELECTRON TUBES
 - ★ SEMICONDUCTORS
 - ★ TEST EQUIPMENT
 - ★ Military Electronic Equipment
- WIRE—WRITE—PHONE COLLECT!
We pay freight on all purchases—

LIBERTY OFFERS MORE! PRESTEL FIELD STRENGTH METER

(Model 6T4G)

Only \$120.00

F.O.B. New York

- ★ Never Anything Like It!
 - ★ 1-Man Can Do A Better Job than 3 in the Same Time!
 - ★ A Gold-Mine for Antenna Installers!
- Calibrated from 40 to 230, and 470 to 860 in 4 Bands Megahertz, from 10 to 50,000 Microvolts. Nothing makes it easier to properly and speedily find the correct place to install TV, FM and Communication Antennas. You can measure and hear the signals with this 4 1/2 volt battery economically powered unit.

LIBERTY ELECTRONICS, Inc.
548 Broadway, New York, New York 10012
Phone (212) 925-6000

CIRCLE NO. 76 ON READER SERVICE PAGE

KEEP PACE WITH SPACE AGE! SEE MOON SHOTS—LANDINGS, SPACE FLIGHTS, CLOSE-UP!
AMAZING SCIENCE BUYS
 for FUN, STUDY or PROFIT

FREE GIANT CATALOG!

LOW COST TREASURE FINDER



Discover the fun and profit of treasure hunting inexpensively! Light as a feather (10 oz.) solid-state metal detector finds hidden coins, jewelry, precious minerals. Distinguishes minerals from metal objects. Great for school, beach, campground or backyard. Requires 9V transistor battery works with any common AM transistor radio thus eliminating costly extra circuitry, weight, dangling wires. Adjustable multi-purpose plastic handle reduces immediate area metal—adds to efficiency. No tuning needed.

Stock No. 71.395AK\$14.95 Ppd.

3-CHANNEL COLOR ORGAN BARGAIN!

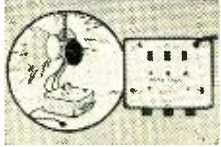

Create tremendous variety of unusual & beautiful lighting effects with this low-cost top-quality 1500-watt unit (500 W. per channel). Compare with others selling for twice the price. Has pilot light, plus individual sensitivity controls and channel indicator lights. Can operate 150-watt spot or 200 Christmas lights. Uses reg. house current—attaches to audio source w/RCA type phone plug. 5 1/4" x 6 3/4" x 2 1/4" lbs. Thermal setting plastic case, 6-ft. cord. Including complete instructions.

Stock No. 71.223AK\$44.50 Ppd.

LONG-WAVE BLACK LIGHT FIXTURE

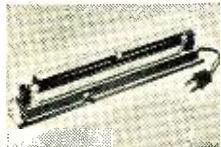

Extremely versatile, compactly designed, long wave (3200-4000 angstroms) black light (ultraviolet) fixture. Has 6-watt, 110-v lamp with built-in filter—eliminating shorter wave ultraviolet rays. Use to identify minerals, fungi, bacteria—check for surface flaws, oil and gas leakage—perfect for displays with fluorescent black paints, chalk, crayons, trace powder. Incl. adjustable aluminum reflector, push-pull switch, connecting plug. Mount vert., hor. or on corner. 10" L., 1 1/2" W., 1 1/2" H.

Stock No. 70.364AK\$12.50 Ppd.
 REPLACEMENT BULB
 Stock No. 60.124AK\$4.75 Ppd.

MIRRORED BALLS BOUNCE LIGHT



Yesterday's ballrooms echo in mirrored lights that ricochet to the beat of today's discotheque. Up to 1,000 mirrors, clear, handmade glass mirrors on each ball create fantastic lighting effects. Motorized—they cast reflections that blow the mind! Ideal for light shows, displays, restaurants, hotels and modern stores.

Stock No. 71.066AK (12" Diam.)\$30.00 Ppd.
 Stock No. 85.180AK (16" Diam.)\$75.00 FOB
 Stock No. 71.065AK (8" Diam.)\$17.50 Ppd.
 Stock No. 60.744AK (Ceiling Motor)\$12.50 Ppd.

BLACK-LIGHT MIGHTY MITES

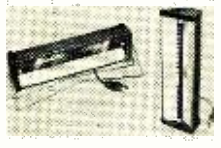

Relatively small (12") fixtures give surprisingly bright, blacklight. Mirror-finished reflector makes instant starting 8-watt, high-intensity bulb look like 40-watt. Up to 5,000 hours of safe, long-wave (3660A) blacklight to really turn-on parties, light & theatrical shows, psychedelic decors, holiday decorations. Shock-proof end-caps remove for safe, easy replacement of bulb and starter. Stands upright or horizontal. Alum. case.

Stock No. 71.274AK\$14.95 Ppd.
DELUXE OUTDOOR INDOOR MODEL
 Stock No. 71.299AK\$19.95 Ppd.

PSYCHEDELIC LIGHTING HANDBOOK



100 information packed pages! Fully explains latest in psychedelic lighting equipment, techniques, developments. Covers all facets of psychedelic light-show production including strobes, black lights, prisms, crystals, organic slides, mirrors, color organs, polarized color light, etc. Includes section, etc. Shows how to "psychedelize" parties, musical groups, shows or how to set up "electric trips" for private gatherings. 8 1/2" x 11" looseleaf paper punched for 3 ring binder.

Stock No. 9100AK\$3.00 Ppd.

MAIL COUPON FOR GIANT FREE CATALOG

148 PAGES—1000'S OF BARGAINS



Completely new 1971 edition. New items, categories, illustrations. Dozens of electrical and electromechanical parts, accessories. Enormous selection of Astronomical Telescopes, Microscopes, Binoculars, Magnifiers, Magnets, Lenses, Prisms. Many war surplus items for hobbyists, experimenters, workshop, factory. Mail coupon for catalog "AK".

EDMUND SCIENTIFIC CO.
 300 EDCORP BUILDING,
 BARRINGTON, N.J. 08007

NAME _____
 ADDRESS _____
 CITY _____
 STATE _____ ZIP _____

1st COMPLETE CRYSTAL SLIDE SET!

Five brilliantly colored crystal slides create dramatic effects. Fit 30mm slide projector. Add polarizing spinner—delicate, crystalline patterns appear to move, change colors. Sets contain 2 types of crystals: 4 Resorcinol Slides—brilliantly colored, wispy patterns; 1 Acetanilide Slide—jagged and rigid brown & purple patterns. 2" square. Glass-mounted. Sandwiched with Mylar® & polarizing material—less than 1/10" thick.



No. P-41.352AK\$10. Ppd.
 No. P-41.351AK\$10. Ppd.
MOTORIZED POLARIZED SPINNER KIT
 Stock No. 71.132AK\$12. Ppd.

50-150-300 POWER MICROSCOPE

Amazing Value—3 Achromatic Objective Lenses on Revolving turret. Color-corrected, cemented achromatic lenses in objectives give far superior results to single lenses usually found in this microscope price range. Results are worth the difference! Fine rack and pinion focusing. Imported.



Stock No. 70.008AK\$19.50 Ppd.
MOUNTED 500 POWER OBJECTIVE:
 Threaded achromatic lenses, 3mm F.L.
 Stock No. 30.197AK\$5.00 Ppd.

TUNE IN-AND TURN ON YOUR OWN

Psychedelic Light Show
 Take one book of sized conservative looking oiled walnut finished light box—with its built-in kicker, an indiv. controlled 3-channel color organ. Activate by attaching to hi-fi or stereo speaker. Plug in and switch on! Music fills the room and the prismatic screen leaps into pulsating life. Patterns are wild and wonderful, or soft and soothing—responding directly in time and intensity to music. Perfect home entertainment, little theater or combos. House current.



Stock No. 80.126AK (18"Wx12"Hx9"D) ..\$49.95 Ppd.

1st LOW COST XENON STROBE

Price breakthrough in bright, reliable electronic strobes. 50W/Second xenon tube. Variable flash rate—60 to 500 per minute. Long life—more than 1,000,000 flashes. Printed circuit board design. Safe, durable Bakelite case. Extensively mounted but plastic shield. 6 1/4x3 3/4x2 1/4. 14 oz. Perfect for psychedelic stop-action lighting effects for home light shows, parties, displays.



Stock No. 71.042AK\$24.95 Ppd.
BUILD IT-YOURSELF STROBE KIT
 Stock No. 71.343AK\$19.95 Ppd.

CHROMATIC "MACHINE-GUN" STROBE

Red, Green, Blue & White light barrage the eyeballs every 6 seconds with this low-cost mechanical strobe that can run continuously without fear of burning up. Densitating effects over 500 ft. sq. area. Created by rotating color wheel in front of 100W, 120v reflector floodlamp (incl.)—elements seem to flash on & off as colors fluctuate. Turns store windows, posters, parties into flashing, pulsating productions. Convection cooled. Walnut cabinet. Brass handle. Reg. house current.

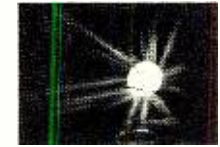

Stock No. 71.271AK (9 X 10 X 6 1/4") ..\$28.50 Ppd.

NEW Music Vision MINI-MODEL

Actually "see" music in dazzling action with compact, self-contained unit designed for portability. Produces fantastic patterns in beautiful color each individual note creating its own unique, twisting, radiating shape—each step dancing and prancing, whirling and swirling IN PERFECT TIME with the music. Features big patterns with low levels of sound at short projection distances. Perfect for window displays, rear proj. boxes, clubs, combos, parties. Stand or hang, 4 1/2 lbs. Uses reg. 110-120V. L-Pad needed for use w/big amplifiers.



Stock No. 81.124AK\$56.50 Ppd.
 Stock No. 41.140AK (L-PAD)\$ 2.00 Ppd.

BIG BARGAIN CORNER

Unique and fascinating low-cost items include pen to read/write in dark; world's highest flying inflatable kite; 125 decal stars that glow; challenging hand puzzle; weather instr. that shows wind dir., speed, temp. & records rainfall for week, month, year.



Nitewriter Pen, No. 1,928AK\$2.25 Ppd.
 Puffer Kite, No. 41,279AK\$2.25 Ppd.
 Stars That Glow, No. 9,298AK\$1.50 Ppd.
 Looney Loop Puzzle, No. 60,817AK\$2.00 Ppd.
 Weather Gauge, No. 50,259AK\$2.00 Ppd.

ELECTRONICS WORLD

May 1971

ADVERTISERS INDEX

R.S. No.	ADVERTISER	PAGE
50	Altec Lansing	6
51	B. & F. Enterprises	86
	CREI, Home Study Div., McGraw-Hill Book Co.	73, 74
53	Channel Master	26
54	Cleveland Institute of Electronics	22, 23, 24, 25
55	Cook's Institute of Electronic Engineering	75
56	Crown	10
57	Crystek	4
58	Delta Electronics Co.	89
59	Delta Products, Inc.	76, 77
61	Dynaco, Inc.	75
52	Dynascan Corp.	71
62	Edmund Scientific Co.	90
63	EICO Electronic Instrument Co., Inc.	61
64	Electronic & Control Engineers Book Club	1
65	Electro Products Labs	67
125	Electro-Voice, Inc.	4th Cover
66	Finney Company, The	11
67	GE Silicones Dept.	15
68	General Sales	85
	Goodheart, Co., R. E.	88
69	Grantham School of Engineering	56, 57, 58, 59
70	Greenlee Tool Co.	66
71	Gregory Electronics	87
72	Heath Co.	68, 69
73	Indiana Home Study	70
74	Johnson Company, E. F.	21
75	Judson Research & Mfg. Corp.	70
	Lampkin Laboratories, Inc.	21
76	Liberty Electronics, Inc.	89
77	Mallory & Co., Inc., P. R.	2
124	Memorex Recording Tape.....	3rd Cover
78	Meshna Jr., John	85
79	Mitchell Co., C. H.	66
	National Radio Institute. 16, 17, 18, 19 National Technical Schools	5
80	Olson Electronics	53
81	Park Electronic Products	86
129	Poly Paks	89
	RCA Electronic Components & Devices	51
	RCA Institutes, Inc.	62, 63, 64, 65
82	Sams & Co., Inc., Howard W.	49
83	Schober Organ Corp., The	53
123	Sencore	2nd Cover
84	Solid State Sales	87
	Surplus Center	88
85	Sylvania	12
86	TDK Electronics Corporation	53
87	Utah Electronics	60
88	Valparaiso Technical Institute	66
89	Xcelite, Inc.	20
	Classified Advertising	85, 86, 87, 88, 89

EDMUND SCIENTIFIC CO. 300 EDCORP BLDG. BARRINGTON, NEW JERSEY 08007
 ORDER BY STOCK NUMBER - SEND CHECK OR MONEY ORDER - MONEY-BACK GUARANTEE

How new Memorex Recording Tape shattered glass and why it will make your favorite music sound better.

To shatter glass with the human voice, a singer must reach and hold the pitch it takes to make a given glass vibrate. That pitch must then be projected with enough volume to vibrate the glass to its shatter point.

We figured if we could capture that precise pitch on our new Memorex Recording Tape and play it back at the same volume, we'd dramatically demonstrate the exactness with which our tape can reproduce music.

So that's exactly what we did.

Memorex has increased tape sensitivity, increased high-frequency response, and improved signal-to-noise ratio; so much, that now you can record your favorite music, then play it back the same way it sounded live.

You should hear us.

MEMOREX Recording Tape
Reproduction so true it can shatter glass.



Incidentally, our cassette tape also shatters glass.

© 1970 MEMOREX CORPORATION

New E-V Top Brass Microphones

with wider, smoother response
than any other Single-D cardioid
you've ever heard!



670V

Exciting development of pioneering laser holographic research.

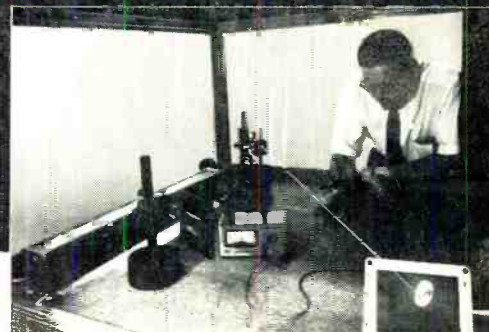

EY Inside the E-V microphone laboratories is a small, dark, quiet room. And in the room is a sophisticated holographic camera. Using newly developed techniques, E-V engineers can for the first time study microphone diaphragms under actual operating conditions. Movement as small as .000005" can be seen and precisely evaluated. And this unique facility has led to new insights into microphone behavior and specifically, a brilliant new microphone design. The Model 670.

Inside the 670

Let's take a look inside the 670 to see what makes it uniquely better than any other Single-D dynamic cardioid (including our own earlier designs). The big difference is the diaphragm itself... which functions closer to the theoretical ideal than any other yet measured. It starts with the familiar Acoustalloy® sheet, formed to provide compliance rings at the edge, but absolutely flat in the center. Bonded to the center is an odd dome, made of compressed polystyrene, that looks much like a squashed aspirin tablet.

This unusual construction adds high stiffness with optimum mass. High frequency

diaphragm breakup is eliminated. At 24" working distance the 670 has virtually ruler-flat response from 60 to 14,000 Hz.* This makes possible a host of benefits: a pure cardioid pattern with virtually no lobes, less chance of feedback or overloading of inputs at high levels (since peaks are gone), and — of course — superb sound plus excellent rejection of unwanted noise.

Rugged Internal Construction

The "head" of the Model 670 is built as a unit (and is actually field replaceable). The head is suspended within the case using a pneumatic shock absorber that soaks up impact noise while protecting the assembly. All resonators are built in for added stability and reduced sensitivity to shock. And the entire head is assembled without glue, so that structural integrity is maintained despite extremes of heat, humidity or mechanical shock. The case itself is machined from a solid bar of aluminum, then anodized in the Top Brass finish for lasting beauty.

In every detail the 670 is outstanding. For instance, you can easily change from Hi-Z to Lo-Z impedance without soldering. And the

professional connector insures minimum maintenance. Our pop and blast filter is unusually effective, a result of computer-aided research. Even the volume control on the Model 670V is unique. Designed for easy one-hand operation, yet placed to minimize accidental movement.

Light Weight, Low Cost

With all these features, you might expect a heavy microphone... and a big price tag. Good news: the Model 670 is half the weight of competitive Single-D microphones and is priced to please your pocketbook. Just \$76.50 list for the Model 670 with on-off switch and \$83.50 for the 670V with built-in volume control. Cable and stand mount is included. With standard phone plug add \$3.50 list. Carrying case \$3.50 list.

Find out for yourself the real benefits of E-V research. Choose the new E-V Model 670 or 670V Top Brass microphones. They're at your E-V sound equipment headquarters now.

*Of course as you move close, bass response is accentuated, a basic characteristic of all Single-D cardioid microphones.

ELECTRO-VOICE, INC., Dept. 512N,
629 Cecil Street, Buchanan, Michigan 49107

high fidelity systems and speakers • tuners, amplifiers, receivers • public address loudspeakers
• microphones • phono cartridges and styli • aerospace and defense electronics

CIRCLE NO. 125 ON READER SERVICE PAGE

Electro-Voice®

a GULTON subsidiary