

Electronics World

DECEMBER, 1969
60 CENTS

LSI—LARGE-SCALE INTEGRATION
EQUALIZATION CURVES FOR FM, TAPE & DISC RECORDING
LOUDSPEAKERS FOR PUBLIC-ADDRESS SYSTEMS
OMEGA—A V.L.F. RADIONAVIGATION SYSTEM

EW Lab Tests

STEREO COMPACTS



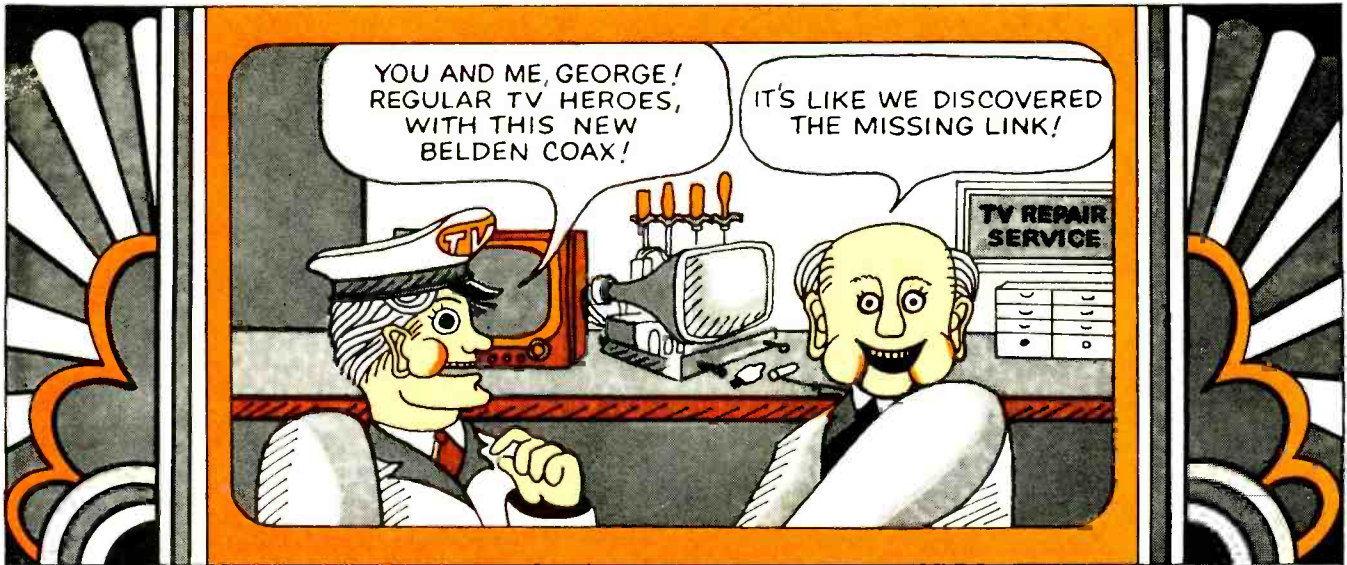

Jacket

Black all-weather PVC .030 nominal wall with a .242" nominal O.D.

Dielectric

Low loss cellular polyethylene, .180" nominal O.D.

Conductor

18 AWG solid, annealed, bare copper.

8228 BELDEN DUOFOIL

Drain Wires

4-28 AWG solid tinned copperweld conductors applied spirally and positioned uniformly around the circumference of the shield.

Shield

Belden DUOFOIL 100% shield is a polyester film with aluminum lamination on both outside surfaces.

THE MISSING LINK TO PERFECT VHF AND UHF COLOR AND B/W RECEPTION

BELDEN 8228 DUOFOIL®

75 OHM COAXIAL CABLE • 100% SHIELDED • 100% SWEEP TESTED

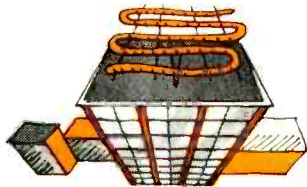

For MATV distribution systems, DUOFOIL is the finest coax yet. Its low loss, 100% shielding keeps B/W and color VHF and UHF signals pure. Apartment dwellers, hotel and motel tenants, etc.—even in congested areas—get sharp, clear reception. Its small diameter provides extra space savings in conduit installations.



Is CATV coming into your area? DUOFOIL is the perfect underground drop cable. Its exceptional flexibility and moisture resistance assures extra-long service life, and preserves the impedance values of the cable design.

LOW, LOW ATTENUATION

Nom. Attenuation per 100'	
mc	db
50	1.5
100	2.1
200	3.1
300	3.8
400	4.5
500	5.0
600	5.5
700	6.0
800	6.5
900	6.9

Available in 100, 500 and 1000 ft. spools. See your local Belden Distributor for full details or to order. For a copy of the reprint article, "Electronic Cable," write: Belden Corporation, P.O. Box 5070-A, Chicago, Illinois 60680.

Don't forget to ask them what else needs fixing?



8-5-8

CIRCLE NO. 150 ON READER SERVICE CARD

from Technician to ENGINEER

Advance beyond the technician level

Become an electronics engineer

In the Grantham electronics engineering program, you can earn the Degree of *Associate in Science in Electronics Engineering* (the ASEE) mostly by home study — and can continue in resident classes to earn your BSEE. In this program you can acquire an extensive knowledge of engineering, for greater prestige and better pay.

In America's race to the moon and outer space, *more and more* engineers are needed. By becoming an electronics engineer, you can move into the forefront of technology and engineering, and be an important part of this exciting age. You can help make things happen and be properly rewarded for doing so.

The demand for engineers continues to increase; electronics engineers are needed in the space program and in many other military and domestic projects. In a recent survey conducted by the Engineering Manpower Commission of the Engineers Joint Council, it was found that engineering employment in the electrical and electronics industries is expected to increase by 40% in ten years. The need for engineers is increasing faster than the population as a whole. The survey report indicates that in the next decade, employers expect to need almost *twice as many* new engineering graduates as are likely to be available.

If you have the desire to be an engineer, the determination to stick to your objective, and a reasonably good aptitude for mathematics and technology, the Grantham educational program can produce the wanted results for you. But make no mistake about it, to become an electronics engineer requires work. You must be willing to do that work; otherwise you can never reach your objective, regardless of what course of instruction you may choose.

Grantham School of Engineering

Specializing in Electronics since 1951

1505 N. Western Ave.
Hollywood, Calif. 90027

Telephone:
(213) 469-7878



December, 1969

CIRCLE NO. 130 ON READER SERVICE CARD

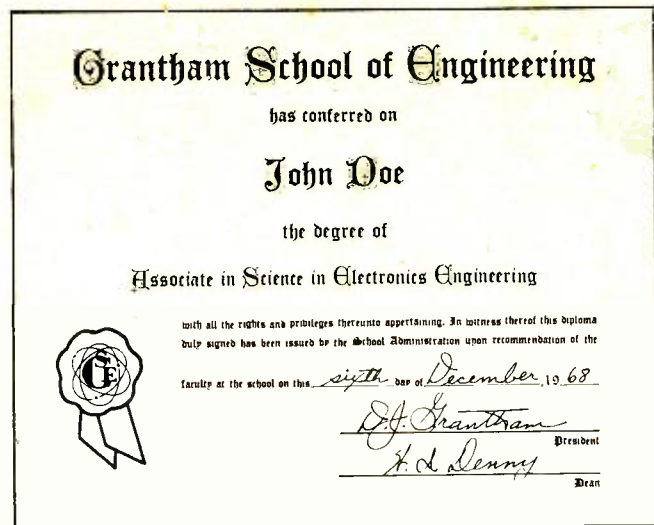

The Grantham *home study program* in electronics engineering consists of five "correspondence semesters" made up of a total of 370 lessons, followed by a two-week period of review and examination at the School. The prerequisite for enrollment in this program is high school graduation (or equivalent) and at least one year of experience as an electronics technician.

This *accredited* ASEE Degree program covers a review of basic electronic circuits and systems, applied engineering mathematics (including algebra, trigonometry, and calculus), classical and modern physics, technical writing, computer systems, electrical networks, and semiconductor circuit analysis and design. The ASEE Degree is awarded upon satisfactory completion of the 370 correspondence lessons and the final two-week residency at the School.

The Grantham educational program in electronics places heavy stress on fundamental concepts of logic and mathematics rather than on superficial manipulative skills. Since these fundamental ideas are largely unfamiliar to many electronics technicians, it is necessary to develop them in a systematic manner.

Accreditation and G.I. Bill Approval

Grantham School of Engineering is *accredited* by the Accrediting Commission of the National Home Study Council, *is approved* under the G.I. Bill, and *is authorized* under the laws of the State of California to grant academic degrees.

Grantham School of Engineering EW-12-69
1505 N. Western Ave., Hollywood, Calif. 90027

Please mail your free Bulletin, which explains how the Grantham educational program can prepare me for my Associate in Science Degree in Electronics Engineering.

Name _____ Age _____

Address _____

City _____ State _____ Zip _____

Our 1¼ oz. alarm will blast you with 80db of the most irritating noise in the world.

Nothing can drown out or cover up the persuasively piercing sound of the Mallory Sonalert®. It's made to be heard.

The light, compact Sonalert is of solid state design for maximum efficiency and reliability and requires as little as 3 milliamps current. No arcing. No RF noise. No mechanical wear.

Consider Sonalert for use with electronic equipment where voltage control is critical. Because the Sonalert generates no RF, there is no danger of its introducing extraneous and spurious signals into the system. Important not only for use



with computers, but with aircraft systems as well. Other uses include instrumentation, communications, medical electronics.

Sound intensity range is 68db @ 6VDC to 80db @ 28VDC. Sound frequency levels are 2900 hertz ± 500 Hz and 4500 hertz ± 500 Hz, depending on model.

For further information on the Mallory Sonalert, ask your Mallory Distributor for "idea folder" No. 9-406. Or write Mallory Distributor Products Company, a division of P. R. Mallory & Co. Inc., Indianapolis, Indiana 46206.

MALLORY

MALLORY DISTRIBUTOR PRODUCTS COMPANY

a division of P. R. MALLORY & CO. INC.
Box 1558, Indianapolis, Indiana 46206; Telephone: 317-636-5353

Batteries • Capacitors • Controls • Resistors • Semiconductors **Sonalert®** Switches • Timers • Vibrators • ICs



CIRCLE NO. 121 ON READER SERVICE CARD



THIS MONTH'S COVER illustrates some of the new stereo compacts that have become so popular these days. We had the Hirsch-Houck Labs run tests on eight of the new compacts and report on their results in our lead story this month. The unit at the left in our cover photograph is the Scott 2505. At the top right is the Sony HP-580. At the bottom right is the Benjamin 1050A. One loudspeaker from each of these compacts is also shown in the background. Complete details on these and other new stereo compacts are covered in our lead story Photo by Dirone-Denner.



Publisher
PHILLIP T. HEFFERNAN

Editor
WM. A. STOCKLIN

Technical Editor
MILTON S. SNITZER

Associate Editors
P. B. HOEFER
MURRAY SUNTAG

Contributing Editors
WALTER H. BUCHSBAUM
Prof. ARTHUR H. SEIDMAN
FOREST H. BELT

Art Editor
RICHARD MOSS

Technical Illustrator
J. A. GOLANEK

Advertising Manager
JOSEPH E. HALLORAN

Advertising Service Manager
ARDYS C. MORAN

Associate Publisher
LARRY SPORN

December, 1969

Electronics World

DECEMBER 1969 VOL. 82, No. 6

CONTENTS

- 27** **EW Lab Tests New Stereo Compacts** *Julian D. Hirsch*
Here are the results of our laboratory measurements on eight of the newest stereo compact systems. These represent the simplest way to get component-quality stereo.
- 31** **Color-TV Tape Player Uses Laser and Holograms** *Milton S. Snitzer*
- 32** **Recent Developments in Electronics**
- 34** **Electronic Type Composition** *Edward A. Lacy*
The author describes the new computer-driven CRT systems being used today by the print industry to keep pace with the information explosion and the continuously increasing costs.
- 37** **Large-Scale Integration** *David L. Heiserman*
Has the LSI era finally arrived? Here are some of the problems facing semiconductor manufacturers in going from IC to LSI and main features of LSI devices which are presently available to the electronics industry.
- 41** **Control of R.F. Interference** *James Hawk*
- 44** **Audio Equalization Curves Up-to-Date** *Thomas R. Haskett*
Complete descriptions of curves now used for FM broadcasting, disc recording, and tape recording—including latest standard for the new, popular tape cassette.
- 47** **Omega—a V. L. F. Radionavigation System** *Edward A. Lacy*
- 50** **Which P. A. Speaker Should You Use? (Part 3)** *Abraham B. Cohen*
- 74** **SCS Monostable Multivibrator** *Frank H. Tooker*
- 79** **"Beeping" a Sonalert** *Frank H. Tooker*
- 92** **Automatic Reset for Circuit Breaker** *Stanley W. Thomas*

6 **For the Record (Editorial)**

Four-Channel Stereo

12 **EW Lab Tested**

Ampex 715 Speaker System
Thorens TD-125 Turntable

56 **Technicians' Chance to Gripe** *John Frye*

64 **Test Equipment Product Report**

Heath IG-28 Color-Bar Generator
Sencore Model TF17 Transistor Tester
Leader Model LBO-53B Oscilloscope

MONTHLY FEATURES

- | | | | |
|-----------|---------------------------------|-----------|--------------------------------------|
| 4 | Coming Next Month | 23 | Radio & Television News |
| 16 | Letters From Our Readers | 84 | New Products & Literature |
| | 93 | | Book Reviews |

Electronics World: Published monthly by Ziff-Davis Publishing Company at One Park Avenue, New York, New York 10016. One year subscription \$7.00. Second Class Postage paid at New York, New York and at additional mailing offices. Subscription service and Forms 3579: Portland Place, Boulder, Colorado 80302.
Copyright © 1969 by Ziff-Davis Publishing Company. All rights reserved.

- ✓ Increase Engine Power
- ✓ Increase Gas Mileage
- ✓ Reduce Engine Maintenance
- ✓ Instant Starting in All Climates

Bay CAPACITIVE DISCHARGE IGNITION SYSTEM



Order Today!
ONLY

\$29.95

Completely wired, ready-to-install (not a kit)

- Easy installation (use original coil)
- Solid state reliability
- G-10 type spacecraft circuit board
- Distributor points last lifetime of car
- Spark plugs last 3 to 10 times longer
- No changes required on timing or dwell
- **EXCLUSIVE** built-in switch for instant change from CD unit to standard ignition system while engine is running (for tune-ups, testing)
- For 12-volt negative ground systems only
- 1-year written guarantee

DEALER / DISTRIBUTOR INQUIRIES INVITED!

Bay PRODUCTS, INC.

P.O. Box 9562, Houston, Texas 77011

Please send _____ Model SW100 Capacitive Discharge Ignition Systems @ \$29.95.
Enclosed is \$ _____ Ship ppd. Ship C.O.D.

Name _____

Address _____

City/State _____ Zip _____

CIRCLE NO. 142 ON READER SERVICE CARD

COMING NEXT MONTH

SPECIAL FEATURE ARTICLE:

TV: 20 YEARS FROM NOW

What will television be like in 1990? Will reception be via cable exclusively? How about direct reception from satellites? Will our children's schooling involve TV courses both at school and in the home? What about TV servicing? What will the sets be like? Will we rent them from the CATV company or buy outright? Answers to these questions and comments from industry leaders are featured in this important and timely survey.

ROOM EQUALIZATION FOR BEST HI-FI

A description of a unique equalizer system, using 24 band-rejection filters, to flatten out the acoustic response of a recording studio, concert hall, or even a home listening room. "Acousta-Voicing", as Altec Lansing calls it, "tunes" each speaker to the room where it is installed.

SPECTRUM CHART

This handy four-color chart tells you at a glance where every service is located in the electromagnetic spectrum. A fine reference guide for hams, CB-ers, service technicians, and engineers.

All these and many more interesting and informative articles will be yours in the January issue of *ELECTRONICS WORLD* . . . on sale December 18th.

RADIOLOGICAL SURVEY METERS

With a rising demand for nuclear instrumentation specialists, J. G. Ello of Argonne National Laboratories provides a complete description of such devices, outlines maintenance techniques for a typical survey meter, and explains how such survey meters operate.

TV-FM LEAD-IN: WHAT KIND TO USE?

This practical, down-to-earth article tells how to determine the right kind of lead-in for a specific installation, comparative costs for different lead-in types, and what performance to expect.

ZIFF-DAVIS PUBLISHING COMPANY

William Ziff
President

W. Bradford Briggs
Executive Vice President

Hershel B. Sarbin
Senior Vice President

Philip Sine
Financial Vice President

Walter S. Mills, Jr.
Vice President, Circulation

Stanley R. Greenfield
Vice President, Marketing

Phillip T. Heffernan
Vice President, Electronics Division

Frank Pomerantz
Vice President, Creative Services

Arthur W. Butzow
Vice President, Production

Edward D. Muhlfeld
Vice President, Aviation Division

Irwin Robinson
Vice President, Travel Division

Furman Hebb
Administrative Vice President

George Morrissey
Vice President

Sydney H. Rogers
Vice President

Editorial and Executive Offices
One Park Avenue
New York, New York 10016 212 679-7200

NEW YORK OFFICE 212 679-7200
Joseph E. Halloran, Adv. Mgr.
Michael E. Kelman

MIDWESTERN OFFICE
307 North Michigan Avenue
Chicago, Illinois 60601 312 726-0892
George B. Mannion, Jr.

WESTERN OFFICE
9025 Wilshire Boulevard
Beverly Hills, California 90211
213 Crestview 4-0265; Bradshaw 2-1161
Western Advertising Manager, Bud Dean

JAPAN: James Yagi, Ishikawa Mansion,
#4, Sakuragaoka Shibuya-ku, Tokyo 462-2911-3

CIRCULATION OFFICE
Portland Place, Boulder, Colorado 80302



Member
Audit Bureau of
Circulations

Radio & TV News • Radio News • Radio-Electronic Engineering Trademarks Reg. U.S. Pat. Off.
SUBSCRIPTION SERVICE: Forms 3579 and all subscription correspondence should be addressed to *Electronics World*, Circulation Department, Portland Place, Boulder, Colorado 80302. Please allow at least six weeks for change of address. Include your old address, as well as new—enclosing if possible an address label from a recent issue.

EDITORIAL CONTRIBUTIONS must be accompanied by return postage and will be handled with reasonable care; however publisher assumes no responsibility for return or safety of art work, photographs, or manuscripts.

ELECTRONICS WORLD (December, 1969, Vol. 82, No. 6). Published monthly at One Park Avenue, New York, New York 10016, by Ziff-Davis Publishing Company—also the publishers of *Airline Management* and *Marketing*, *Boating*, *Business & Commercial Aviation*, *Car and Driver*, *Cycle*, *Flying*, *Modern Bride*, *Popular Electronics*, *Popular Photography*, *Skiing*, *Skiing Area News*, *Skiing Trade News*, *Stereo Review*, and *Travel Weekly*. One year subscription rate for U.S., U.S. Possessions, and Canada, \$7.00; all other countries, \$8.00. Second Class postage paid at New York, N.Y. and at additional mailing offices. Authorized as second class mail by the Post Office Department, Ottawa, Canada and for payment of postage in cash.

ELECTRONICS WORLD

Special introductory offer to new members of the ELECTRONICS AND CONTROL ENGINEERS' BOOK CLUB

	#355 FIELD EFFECT TRANSISTORS by L. J. Sevin Pub. price, \$10.00 Club price, \$8.50		#737 TRANSISTOR CIRCUIT DESIGN by Texas Instruments Inc. Staff Pub. price, \$16.50 Club price, \$14.05
	#381 PULSE, DIGITAL, AND SWITCHING WAVEFORMS by J. Millman and H. Taub Pub. price, \$18.00 Club price, \$15.30		#371 SYSTEM ENGINEERING HANDBOOK edited by R. E. Machol Pub. price, \$29.50 Club price, \$25.00
	#290 ANTENNA ENGINEERING HANDBOOK by H. Jasik Pub. price, \$27.75 Club price, \$23.60		#978 TRANSFORMERS FOR ELECTRONIC CIRCUITS by N. R. Grossner Pub. price, \$14.00 Club price, \$11.90
	#1509 MATHEMATICS MANUAL by F. S. Merritt Pub. price, \$11.95 Club price, \$10.15		#955 ELECTRONIC TESTING by L. L. Farkas Pub. price, \$12.00 Club price, \$10.25
	#509 ELECTRONIC AND RADIO ENGINEERING by F. E. Terman Pub. price, \$19.50 Club price, \$16.55		#677 DATA TRANSMISSION by W. R. Bennett Pub. price, \$14.50 Club price, \$12.35
			#896 BASIC PULSE CIRCUITS by R. B. Blitzer Pub. price, \$8.50 Club price, \$7.25
			#530 PROJECT ENGINEERING by V. Hajek Pub. price, \$9.75 Club price, \$8.30
			#310 AUTOMATIC FEEDBACK CONTROL SYSTEMS by J. G. Truxal Pub. price, \$16.50 Club price, \$14.05
			#905 INTRODUCTION TO RADAR SYSTEMS by M. I. Skolnik Pub. price, \$14.50 Club price, \$12.35

ANY ONE
of these great professional books
for only **\$1.00**
VALUES FROM \$8.50 to \$29.50

Special \$1.00 bonus book comes to you with your first club selection

Save time and money by joining the Electronics and Control Engineers' Book Club

HERE is a professional club designed specifically to meet your day-to-day engineering needs by providing practical books in your field on a regular basis at below publisher prices.

How the Club operates: Basic to the Club's service is its publication, the *Electronics and Control Engineers' Book Club Bulletin*, which brings you news of books in your field. Sent to members without cost, it announces and describes in detail the Club's featured book of the month as well as alternate selections which are available at special members' prices.

When you want to examine the Club's feature of the month, you do nothing. The book will be mailed to you as a regular part of your Club service. If you prefer one of the alternate selections—or if you want no book at all for that month—you notify the Club by returning the convenient card enclosed with each *Bulletin*.

As a Club member, you agree only to the purchase of four books over a two-year period. Considering the many books published annually in your field, there will surely be at least four that you would want to own anyway. By joining the Club, you save both money and the trouble of searching for the best books.

MAIL THIS COUPON TODAY

ELECTRONICS AND CONTROL ENGINEERS' BOOK CLUB
330 W. 42 St., 18th Fl., N.Y., N.Y. 10036

Please enroll me as a member of the Electronics and Control Engineers' Book Club and send me the two books indicated below. I am to receive the bonus for just \$1.00, and my first selection at the special Club price shown. These books are to be shipped on approval, and I may return them both without cost or further obligation. If I decide to keep the books, I agree to purchase as few as four additional books during the next two years at special Club prices (approximately 15% below list).

Write Code No. of
bonus book
here

Write Code No. of
first selection
here

Name _____

Address _____

City _____

State _____ Zip _____

(Offer good in U.S. and Canada only.)

E-33123

SHORTAGE OF ELECTRICIANS ...YOUR BIG OPPORTUNITY!

Meet the demand! Get your start toward a terrific future, with big pay, as one of the trained electricians they're crying for—in industry, shops, home repair, your own business!

ICS has specialized in technical training for 80 years, has trained hundreds of thousands of men like you for better things in life. The place to start—ICS "Practical Electrician" training—or one of the other specialized courses listed in the coupon below. Courses that can open up a whole new world for you. Find out more. Send the coupon today!

ICS International Correspondence Schools
Division of Intertec

Mail to ICS, Scranton, Pa. 18515

I'd like to think about my future as an electrician. Send me details of your "Practical Electrician" course—and your free booklet, "How to Succeed," with its 30 pages of valuable job tips; and your sample text demonstrating the famous ICS method.

Name _____ Age _____
(Please print)

Address _____

City _____ State _____ Zip Code _____

Occupation _____ Employed by _____

Working Hours _____ AM to _____ PM E8747L

Check course you're most interested in:

<input type="checkbox"/> Practical Electrician	<input type="checkbox"/> Electrical Appliance Servicing
<input type="checkbox"/> Electrical Motor Repairman	<input type="checkbox"/> Electrical Home Maintenance
<input type="checkbox"/> Electrical Contractor	<input type="checkbox"/> Reading Electrical Blueprints
<input type="checkbox"/> Electrical Engineering	<input type="checkbox"/> TV Servicing

Approved for veterans
Accredited Member, Nat'l Home Study Council
CIRCLE NO. 127 ON READER SERVICE CARD

Enjoy Relaxing Background Music at Home with . . . NO COMMERCIALS!

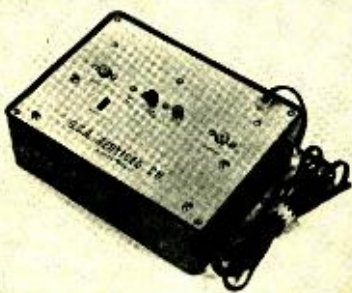

Size: 6 1/2 x 5 x 2 1/2

Our SCA-1 Decoder makes possible reception of this "private" musical programming, transmitted by nearly 400 FM stations around the country. YOUR FM tuner or receiver can recover this "hidden" music with the simple addition of an SCA-1.

Hook-up in minutes—full instructions supplied. SCA-1 is self-powered . . . uses all solid-state circuitry (FET's, IC's, NPN's). Works with any quality FM Tuner or receiver.

Send check or m.o. for either . . .

SCA-1 (Wired, ready to use) . . . \$64.50

SCA-1K (Kit, all needed parts) . . . \$49.95

Etched, drilled P.C. Board plus special IC plus full construction plans . . . \$12.50

One year parts guarantee
FREE National S.C.A. station list
supplied with every order.

SOLD FOR HOME USE ONLY

SCA Services Co.

Box 601 Port Washington, N.Y. 11050
CIRCLE NO. 107 ON READER SERVICE CARD



For the record

WM. A. STOCKLIN, EDITOR

FOUR-CHANNEL STEREO

WE have just returned from the Los Angeles Hi-Fi Show and, although attendance was not up to expectations and some exhibitors (at least those who were most vocal) were displeased, we think it was an excellent show. The only problem was attendance, and according to some, this may be the last IHF-sponsored show for the West Coast. To many others, though, the show was exciting. *Harman-Kardon* announced its new "Citation" line which will also be available in kit form. *Altec-Lansing* demonstrated its room sound equalizer system which we will cover in detail in our January, 1970 issue. *Dual* showed a new super-dehexe automatic changer. Electrostatic speakers and headphones were prevalent, too; *Koss* had several models of its new electrostatic headphones and *Infinity Systems, Inc.* (a newcomer, at least to us) displayed a wide line of electrostatic speakers. Another surprise to us, *Peploe, Inc.* displayed the *JansZen* electrostatic speaker systems which they recently took over from *Neshaminy*. New speakers were everywhere and we particularly noticed a trend toward the use of omnidirectional and reflected sound rather than direct sound, following the *Bose* principle.

Most exciting of all, though, was the introduction of "Quadrasonic Sound" or 4-channel stereo. There were 4-channel sound demonstrations by *Crown International*, *Bose*, *Telex*, *Acoustic Research*, and *Scott*. *Scott* even demonstrated a new 4-channel audio amplifier. Four-channel tape machines from *Crown* and *Telex* were seen in quite a few display rooms. Four-channel tapes, too, are now available. *Vanguard Records* has some on the market and *Columbia Records* has a few demonstration tapes but their future plans are not known.

Basically, the extra two channels are used to record reverberation in large auditoriums. When played back in a home environment, they add a spatial dimension. At present, the two additional speakers required are placed in the back of the listening room in the far corners, but we feel the industry will continue to experiment to determine the most effective positioning. Arguments will undoubtedly persist, too, as to whether or not the additional channels actually do add to home listening pleasure—or is 4-channel stereo just a gimmick to sell additional equipment?

Does it bring us closer to concert-hall realism—to reproduce an auditorium environment in a living room? This can never be attained and, if present trends continue, one will not be able to identify such a thing as an auditorium response. Today engineers are augmenting the reverberant effect of large auditoriums to what they think sounds best. Howard Souther of *Koss* put it quite well recently: "Toscanini once said he wished he had a thousand bass violins." He recognized that the actual sound produced by his orchestra in his day was not ideal. Today, the eight bass viols of a conventional symphony orchestra can be augmented electronically to produce the effect of hundreds. What should be ultimately con-

sidered is the over-all effect produced and the listener's personal enjoyment. Does 4-channel stereo add to your enjoyment or doesn't it?

Four-channel sound opens up new vistas. About a month ago *Acoustic Research* demonstrated 4-channel sound in the Boston area. Two stereo-FM stations were used, each transmitting two of the channels, and those in the area who had two stereo-FM receivers could receive the 4-channel transmissions. This was only a test, of course, and we feel it will be some time before single-station, 4-channel stereo will be common. We do know that several labs are developing 4-channel multiplex systems now, but it will take years for the industry to come to some agreement on any single system. It will also take time for field tests and the FCC will not be hasty in giving final approval.

The 4-channel disc may or may not be a long way off. We have heard that Peter Scheiber and his associate, Thomas Mowrey, of the *Audiodate Co.* of Rochester, have developed a method of producing a 4-channel disc. The principle involves producing a 2-track tape with the extra channels superimposed. This same 2-track (4-channel) tape can then be used to cut a disc, be transmitted over an FM station, or used directly with a conventional tape recorder. It is not a conventional multiplex system but a decoder is used to separate channels. Exact details are lacking at this time but we expect to have an opportunity of hearing a demonstration shortly. We should have more information for next month's issue. The system sounds promising but we would expect much more work will have to be done before it can be made available commercially.

So 4-channel tape is here today. It is interesting to note that back in our May, 1961 issue we published an article entitled "Four-Channel Stereo Adds Depth to Tapes" by John Hogan, then chief engineer of *Nortronics Co., Inc.* Today, in addition to demonstrations by *Acoustic Research*, it is *Nortronics* which has developed the 4-track head and *Viking* (now *Telex*) which has one of the original 4-channel tape systems. In 1961, we were all premature, but perhaps the time is now ripe for 4-channel stereo.

Getting back to the Los Angeles Hi-Fi Show, we wonder if there will be another West Coast show? Or, for that matter, will we ever have another New York show? Certainly, if the Institute of High Fidelity does not promote shows of this type, there will be other organizations or individuals who will sponsor them. The success of the Philadelphia and Washington hi-fi shows proves that it can be done without the Institute. We believe there is a need for these shows, and hope that those who are influential in making the decisions will do so from an unselfish point of view. Every effort should be made to promote the hi-fi component industry, and the past shows under the sponsorship of the *Institute of High Fidelity* have certainly reflected this attitude. ▲

CIRCLE NO. 132 ON READER SERVICE CARD →



Why an automatic turntable from Swindon, England has made it big in the States.

At the risk of seeming immodest, we've had a smashing success in the United States.

There are more Garrards being used in component stereo systems here than all other makes combined.

Even we find this a curious fact.

But the die was cast thirty-odd years ago.

Not parity, but superiority

H. V. Slade, then Managing Director of Garrard Limited, decreed, "We will sell a Garrard in the U.S. *only*



H.V. Slade (1889—1961)

when it is more advanced than any machine made there."

A commitment to, not parity, but absolute superiority.

Spurred by it, Garrard of England has been responsible for every major innovation in automatic turntables.

In the thirties, Garrard pioneered the principle of two-point record support. Still the safest known method of record handling. Oddly, still a Garrard exclusive.

In the forties, we introduced the aluminum tone arm. Today, widely used by makers of fine equipment.

By 1961, increasingly sensitive cartridges had led us to adapt a feature originally developed for professional turntables: the dynamically balanced tone arm, with a movable counter-

weight to neutralize the arm and an adjustment to add precisely the correct stylus tracking force.

In 1964, we added an anti-skating control, and patented the sliding weight design that makes it permanently accurate.

Then, in 1967, Garrard engineers perfected the Synchro-Lab motor, a revolutionary two-stage synchronous motor.

The induction portion supplies the power to reach playing speed instantly. The synchronous section then "locks in" to the 60-cycle frequency of the current to give unvarying speed despite variations in voltage.

"We're bloody flattered"

This year one of our competitors has introduced a copy of our Synchro-Lab motor on its most expensive model.

To quote Alan Say, our Head of Engineering, "We're bloody flattered.

"After all, being imitated is a rather good measure of how significant an innovation really is."

The new Garrard SL95B features still another development we expect will become an industry standard.

Garrard's viscous damped tone arm descent—originally offered to provide gentler, safer cueing—now operates in automatic cycle as well.

It seems only logical. Yet, for the

present at least, it is another Garrard exclusive.

Other 1970 Garrard refinements include a counterweight adjustment screw for balancing the tone arm to within a hundredth of a gram. A window scale on the tone arm for the stylus force gauge. And a larger, more precise version of our anti-skating control.

Un-innovating

At the same time, we've eliminated a feature we once pioneered. A bit of un-innovating, you might say.

Garrard's disappearing record platform is disappearing for good.

We've replaced it with a non-disappearing record platform. A larger, stronger support with an easy-to-grasp clip that fits surely over the stack.

A small thing, perhaps.

But another indication that H.V.'s commitment remains with us.

\$44.50 to \$129.50

Garrard standards do not vary with price. Only the degree of refinement possible for the money.

There are six Garrard component models from the SL95B automatic turntable (above) for \$129.50 to the 40B at \$44.50.

Your dealer can help you arrive at the optimum choice for your system.

Garrard

British Industries Co., a division of Avnet, Inc.



Learning electronics at home is faster, easier, more interesting with new achievement kit

GET A FASTER START IN THE COURSE YOU CHOOSE WITH NRI'S REMARKABLE ACHIEVEMENT KIT

When you enroll with NRI we deliver to your door everything you need to make a significant start in the Electronics field of your choice. This remarkable, new starter kit is worth many times the small down payment required to start your training. And it is only the start . . . only the first example of NRI's unique ability to apply 50 years of home-study experience to the challenges of this Electronics Age. Start your training this exciting, rewarding way. No other school has anything like it. What do you get? The NRI Achievement Kit includes: your first set of easy-to-understand "bite-size" texts; a rich, vinyl desk folder to hold your training material in orderly fashion; the valuable NRI Radio-TV Electronics Dictionary; important reference texts; classroom tools like pencils, a ball-point pen, an engineer's ruler; special printed sheets for your lesson answers—even a supply of pre-addressed envelopes and your first postage stamp.

Only NRI offers you this pioneering method of "3 Dimensional" home-study training in Electronics, TV-Radio . . . a remarkable teaching idea unlike anything you have ever encountered. Founded more than half a century ago—in the days of wireless—NRI pioneered the "learn-by-doing" method of home-study. Today, NRI is the oldest, largest home-study Electronics school. The NRI staff of more than 150 dedicated people has made course material entertaining and easy to grasp. NRI has simplified, organized and dramatized subject matter so that any ambitious man—regardless of his education—can effectively learn the Electronics course of his choice.

DISCOVER THE EXCITEMENT OF NRI TRAINING

Whatever your reason for wanting knowledge of Electronics, you'll find the NRI "3 Dimensional" method makes learning exciting, fast. You build, test, experiment, explore. Investigate NRI training plans, find out about the NRI Achievement Kit. Fill in and mail the postage-free card. No salesman will call. NATIONAL RADIO INSTITUTE, Electronics Division, Washington, D. C. 20016

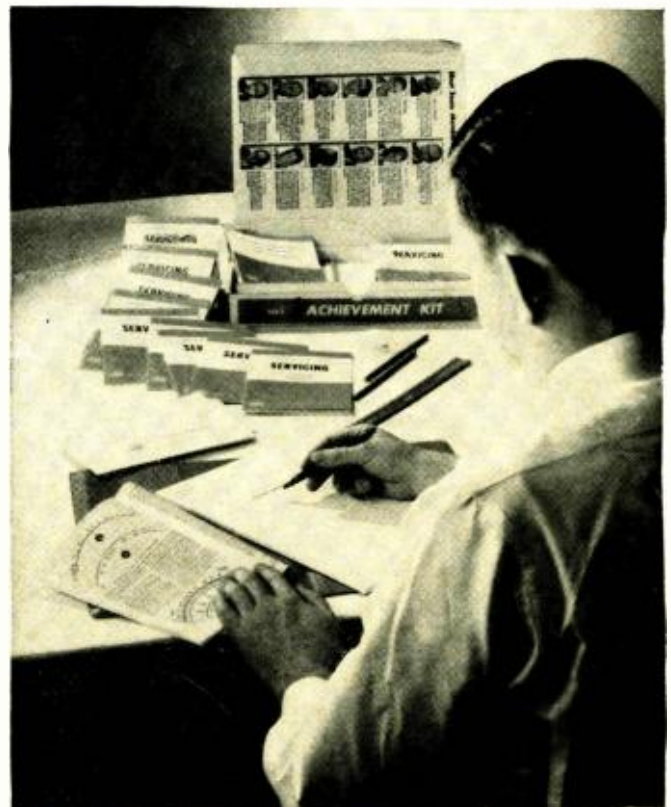

ELECTRONICS COMES ALIVE AS YOU LEARN BY DOING WITH CUSTOM TRAINING EQUIPMENT

Nothing is as effective as learning by doing. That's why NRI puts so much emphasis on equipment, and why NRI invites comparison with equipment offered by any other school, at any price. NRI pioneered and perfected the use of special training kits to aid learning at home. You get your hands on actual parts like resistors, capacitors, tubes, condensers, wire, transistors and diodes. You build, experiment, explore, discover. You start right out building your own professional vacuum tube voltmeter with which you learn to measure voltage and current. You learn how to mount and solder parts, how to read schematic diagrams. Then, you progress to other experimental equipment until you ultimately build a TV set, an actual transmitter or a functioning computer unit (depending on the course you select). It's the practical, easy way to learn at home—the priceless "third dimension" in NRI's exclusive Electronic TV-Radio training method.

SIMPLIFIED, WELL-ILLUSTRATED "BITE-SIZE" LESSON TEXTS PROGRAM YOUR TRAINING

Lesson texts are a necessary part of training, but only a part. NRI's "bite-size" texts are as simplified, direct and well-illustrated as half a century of teaching experience can make them. The amount of material in each text, the length and design, is precisely right for home-study. NRI texts are programmed with NRI training kits to make things you read come alive. As you learn, you'll experience all the excitement of original discovery. Texts and equipment vary with the course. Choose from major training programs in TV-Radio Servicing, Industrial Electronics and Complete Communications. Or select one of seven special courses to meet specific needs. Check the courses of most interest to you on the postage-free card and mail it today for your free catalog.

Available Under
**NEW
GI BILL**

If you served since
January 31, 1955, or
are in service, check GI
line in postage-free card.

custom training kits "bite-size" texts

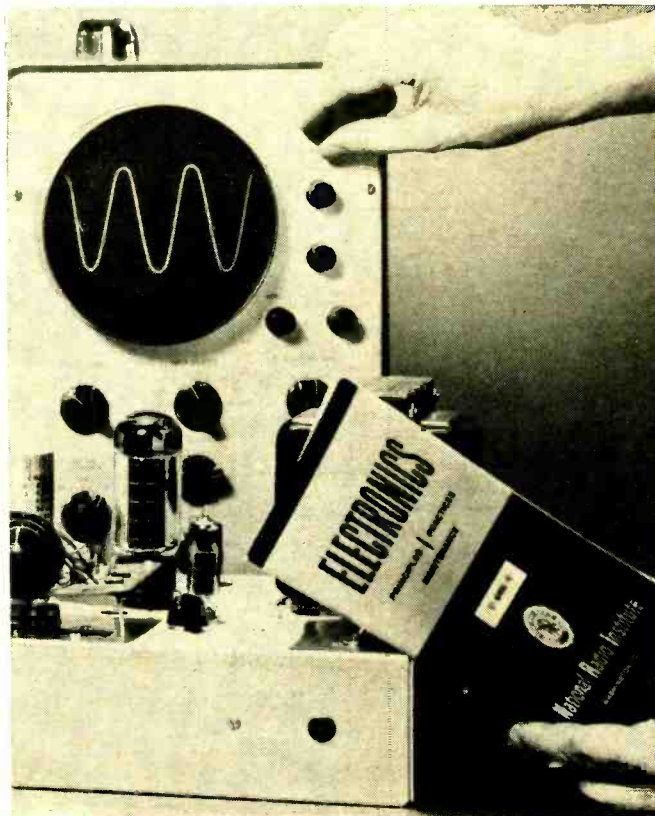

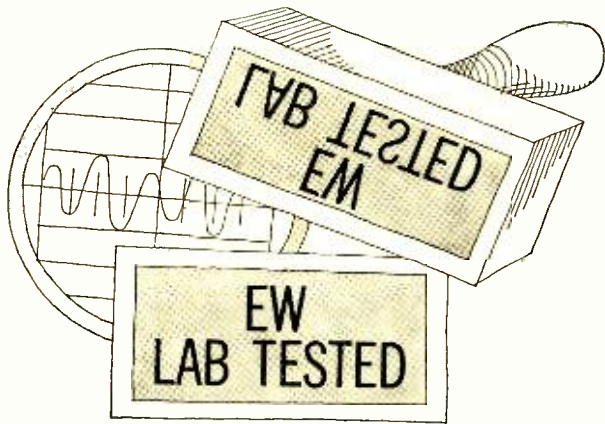

HI-FI PRODUCT REPORT

TESTED BY HIRSCH-HOUCK LABS

**Ampex 715 Speaker System
Thorens TD-125 Turntable**

Ampex 715 Speaker System

For copy of manufacturer's brochure, circle No. 22 on Reader Service Card.



LIKE most makes of tape recorders, Ampex machines are available with built-in playback amplifiers and sometimes with small integral or detachable monitor speakers. However, this manufacturer goes one step further toward providing a complete home-entertainment center based on the tape recorder with several separate speaker systems. These range from very small, modest systems to full-sized bookshelf models. The Model 715, which we tested for this report, could be classified as an intermediate-sized bookshelf system, measuring 19" wide by 13" high by 9½".

This is a two-way system, with two

small 6" woofers and a single 3½" cone tweeter. The woofers have very flexible cone suspensions and appear to be capable of a large linear excursion for their diameter. The enclosure is fully sealed and has an integral cable with a standard phone plug that mates with the external speaker jacks on Ampex and other makes of recorders. The system has the usual 8-ohm impedance. (According to the system's designer, mutual coupling between the two woofers increases the output between 200 and 600 Hz in order to give the system more "impact."—Editor)

The frequency response was measured with the speaker on a shelf at normal listening height, using eight microphones throughout the room. The response of all microphones was averaged to obtain a single curve. Harmonic distortion was measured at low frequencies with the microphone one foot in front of the enclosure, on its axis. Tone-burst response was measured at the same distance.

The frequency response of the Ampex 715 proved to be quite smooth and wide for a speaker of its size and price. It was within ±6 dB from 55 Hz to 15,000 Hz.

There was a peak of 5 dB at 12 kHz, a somewhat depressed but very flat response from 1 kHz to 10 kHz, and a few slight irregularities below 1 kHz.

Low-frequency harmonic distortion was under 5% down to 47 Hz, rising smoothly to 23% at 20 Hz. However, at that frequency the output was too low to be audible or useful. We would estimate the effective lower limit of the speaker's response to be between 50 and 60 Hz, no small achievement for a pair of 6" drivers. The transient response, as shown by the tone-burst tests, was generally excellent, except for one point at 3 kHz where there was ringing.

In listening tests, the speaker had a warm, rounded quality. It did not sound at all bright—in fact, the top highs were slightly muted—in spite of the 12-kHz peak which we measured. (The 12-kHz peak may have been the result of diffraction effects caused by the diameter of our measuring microphone.—Editor) Aurally, its balance was fine, with no undue emphasis on any part of the spectrum. It is a pleasant speaker to listen to, although it lacks the "sparkle" and solid lower bass which characterize many speakers sold for home use in component systems (usually at somewhat higher prices).

The attractive, yet simple styling of these speakers, ready to plug into an Ampex recorder and use, should make them popular with tape-recorder owners who want to hear more of their recorder's quality than the built-in speakers can provide.

The Ampex 715 sells for \$129.95 per pair. ▲

Thorens TD-125 Turntable

For copy of manufacturer's brochure, circle No. 23 on Reader Service Card.

THE TD-125 is the newest and most refined manual transcription phono turntable to come from Thorens, through their American distributor, Elpa Marketing Industries. It combines some novel design approaches with the fine craftsmanship which has always characterized Thorens products.

(Continued on page 68)

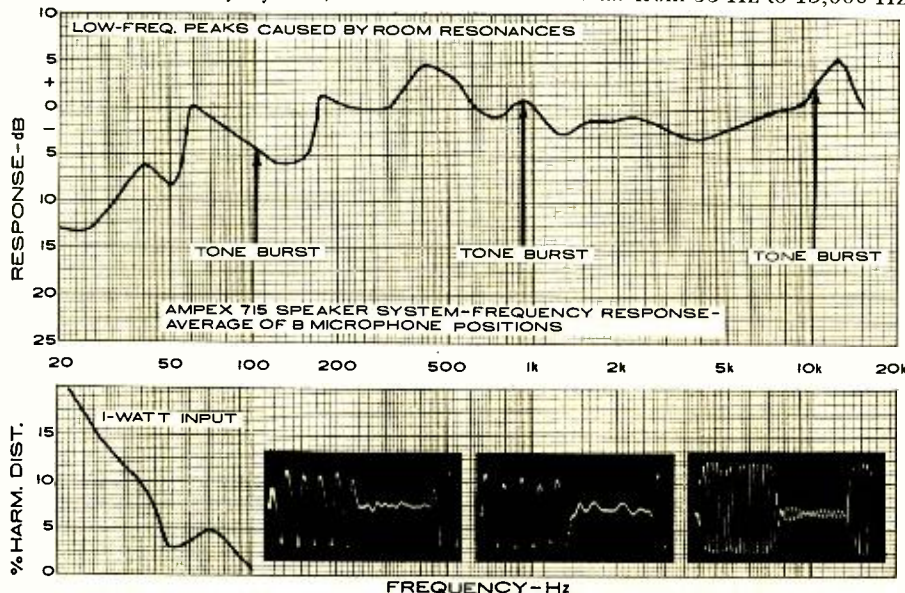

Go on a quality kick

You can afford it with these Outperformers

You give up nothing — except a high price — when you buy these quality performance Pioneer hi-fi units. Designed for the discriminating budget-minded buyer, they contain advanced engineering features and looks that put them in the class of much more expensive stereo components.

SA-500 INTEGRATED STEREO AMPLIFIER — The perfect starter unit for a stereo system, the all solid state SA-500 produces 44 watts of music power. Even at the highest crescendo, distortion is less than 0.5%. Four inputs plus outputs for speakers, tape recording, loudness contour and a headset jack make it tops in versatility. \$99.95

TX-500 AM-FM TUNER — All solid state, its multiplex circuitry provides wide channel separation with excellent frequency response. An FET front end, combined with years-ahead design, assures high sensitivity and superb image

rejection. Containing advanced features that place it on a par with more expensive units, it is priced at \$99.95.

SR-202 REVERBERATION AMPLIFIER — The most dramatic new component in years! No matter what your system is, the SR-202 adds dimension and greater realism to your stereo sound than you can realize. The SR-202 increases the natural quality of your recordings and tapes. Reverberation can be added to an audio amplifier using one or two tape recorders, a record player, or a tuner. In fact, a total of 15 equipment combinations are possible. \$95.00

These three Pioneer Outperformers are each housed in a handsome cabinet with brushed chrome facing and Brazilian rosewood end pieces. Hear them in action at your local Pioneer dealer.



PIONEER®

PIONEER ELECTRONICS U.S.A. CORPORATION, 140 Smith Street, Farmingdale, N.Y. 11735 • (516) 694-7720
West Coast: 1335 W. 134th St., Gardena, Calif. 90249 (213) 323-2374 & 321-1076 • Canada: S. H. Parker Co., Prov. Ontario
CIRCLE NO. 115 ON READER SERVICE CARD





DELTA will tell you *everything!* — Complete Specs including schematics!



MARK TEN[®] SCR

CAPACITIVE DISCHARGE IGNITION SYSTEM

Now discover for yourself the dramatic improvement in performance of your car, camper, jeep, truck, boat — any vehicle! Delta's remarkable electronic achievement saves on gas, promotes better acceleration, gives your car that zip you've always wanted. Find out why even Detroit has finally come around. In five years of proven reliability, Delta's Mark Ten has set new records of ignition benefits. No re-wiring! Works on literally any type of gasoline engine.

- ▲ Dramatic Increase in Performance and in Fast Acceleration
- ▲ Promotes More Complete Combustion
- ▲ Points and Plugs Last 3 to 10 Times Longer
- ▲ Up to 20% Mileage Increase (saves gas)

KIT FORM **\$29⁹⁵**
12V ONLY

ASSEMBLED **\$44⁹⁵**
ONLY **ppd.**

MODEL 3000 FET VOM

Delta now offers a compact, versatile, and extremely sensitive VOM which combines FETs and ICs for extreme accuracy. Compact (6½"W x 8"H x 3½"D), portable. Wt. 3¾ lbs.

IN KIT FORM: Feedback network with pre-selected components to eliminate all final calibration. Ready to use when assembled!

NEW DELTA FEATURES:

- ▲ Mirror scale 200 A D'Arsonval meter
- ▲ Integrated circuit (IC) operational amplifier for extreme accuracy
- ▲ FET input stage with current regulator
- ▲ Two stage transistor current regulator and Zener diode on OHMS for absolute stability and accuracy
- ▲ Voltage clippers for protection of input stage

- ▲ Fully temperature compensated for low low zero drift
- ▲ Ten turns ZERO and OHMS adjust potentiometers
- ▲ Epoxy glass circuit boards and metal case
- ▲ Enclosed switches
- ▲ Uses readily available type AA cells
- ▲ Uses standard test leads for maximum flexibility and ease of measurement
- ▲ 10 Megohms input impedance

ONLY **\$74⁹⁵**
ppd.

Only **\$59⁹⁵**
ppd.



COMPUTACH[®]

Delta, pioneers in CD ignition who produced the fabulous MARK TEN[®], now offer a precise computer-tachometer which obsoletes any type tachometer on the market today! You achieve unbelievable accuracy in RPM readings due to the advanced, solid-state electronic matched components used in the computer, coupled with the finest precision meter in the world. Works on all 2, 3, 4, and 6 cylinder 2 cycle and with 4-6-8 cylinder—4 cycle 12 volt engines.

- ▲ 0-8000 RPM range
- ▲ Perfect linearity — zero parallax
- ▲ Adjustable set pointer
- ▲ Wide angle needle sweep
- ▲ Translucent illuminated dial
- ▲ Chrome plated die-cast housing
- ▲ All-angle ball & socket mounting
- ▲ Use it with ANY ignition system
- ▲ Meter: 3½" dia. X 3¾" deep
- ▲ Calibration kit included, no test eqpt. needed.

*An exclusive computer-tachometer for precise RPM measurement in easy-to-build Kit form!

\$29⁹⁵
ppd.

KIT FORM ONLY

DP 9-B

DELTA: Please send me literature immediately.

I am enclosing \$_____ for items checked.

- Mark Ten SCR Kit Assembled
- Model 3000 FET VOM Kit Assembled
- Computach (Kit only)

Please ship immediately.

Name _____

Address _____

City/State _____ Zip _____

*My car is (Model) _____ (Year) _____

EW



DELTA PRODUCTS, INC.

P.O. BOX 1147 • GRAND JUNCTION, COLORADO 81501

TWO NEW BELL RINGERS FROM DELTA

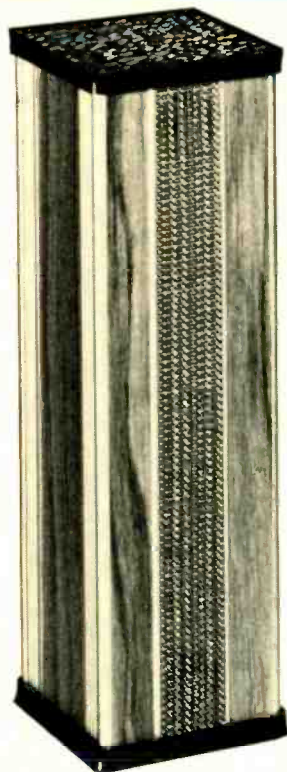

DELTALERT

Ultra Sonic Silent Sentry System

The all new economical-to-use DELTALERT, is more than a total motion detection and intrusion alert system. Use it as a convenience item to turn on lights, ring bells, alarms or monitor any area, indoors or out. Merely plug the system into any wall socket and plug the light, bell or alarm into the back of the unit. DELTALERT's Extra Feature variable sensitivity control and adjustable timing features provide you the most advanced sentry system on the market. Unit comes in handsome walnut finish, complete with 110-130V drop cord.

SPECIFICATIONS:

- ▲ Ultrasonic Frequency: 35 KHZ
- ▲ Area Coverage: 10-30 feet (depending on environmental conditions such as shape of area)
- ▲ Controls: On-Off Switch; Built in Timer; Variable Sensitivity Control
- ▲ Output: 110-130V at 1 Amp.
- ▲ Power Requirements: 110-130V, 60 HzAC

ONLY **\$59⁹⁵**
For Complete Unit, Ready to Use **ppd.**

HIGH VOLT ANALYST

Complete Auto Analyzer

Delta brings you a new concept in automotive tune-up — The High Volt Analyst. A unique and complete auto analyzer, it provides all the primary advantages of a scope and yet is completely portable.

SPECIFICATIONS:

- ▲ Accuracy — Tachometer $\pm 2\%$ of full scale (all ranges) • Dwell Meter $\pm 1\%$ (both ranges) • OHMS Scale $\pm 5\%$ • Low Voltage $\pm 2\%$ of full scale • High Voltage $\pm 5\%$ of full scale
- ▲ General — Fully protected meter circuit* • Size: 6½W x 8H x 3½D • Weight: 3¾ lbs.
- ▲ Ranges — DC Volts 0-15V, 15KV and 45KV • OHMS: 0-1 Meg. (10K center scale) • Dwell: 4, 6 and 8 cylinders • Tachometer: 0-1500 RPM, 6000 RPM

*Batteries (8 Type AA cells) included. Comes complete with standard lead set, a special probe, and high tension lead.

\$79⁹⁵ ppd.
Assembled

\$59⁹⁵ ppd.
kit form

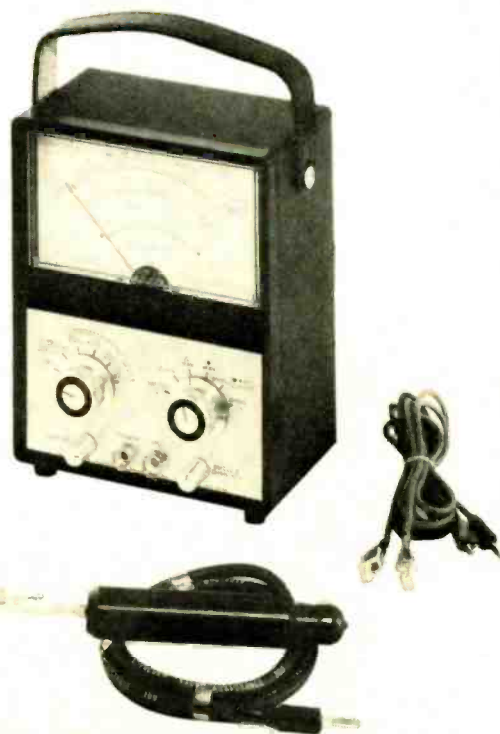

DELTA: Please send me literature immediately.

I am enclosing \$_____ for items checked.

- DELTALERT
- High Volt Analyst, Assembled
- High Volt Analyst, Kit form

Please ship immediately.

Name _____

Address _____

City/State _____ Zip _____



DELTA PRODUCTS, INC.

P.O. BOX 1147 • GRAND JUNCTION, COLORADO 81501

SAVE ON EVERYTHING IN ELECTRONICS!



Stereo hi-fi • Tape recorders & tape • Electronic & hobby kits • CB 2-way radios • Radios • Shortwave • Phonographs • Amateur gear • Automotive electronics • Tools & hardware • Tubes, transistors, parts, batteries, books and more! . . .

FREE 552-PAGE ALLIED 1970 CATALOG

Right off the press and crammed with values—our biggest catalog ever! Huge selections, low prices, fast service. Mail coupon below for your free copy. Hurry, while they last!

ALLIED RADIO, Dept. 532 Please
P.O. Box 4398, Chicago, Ill. 60680 Print

NAME First Middle Last

STREET ADDRESS or ROUTE & BOX NO.

CITY

STATE ZIP

CIRCLE NO. 147 ON READER SERVICE CARD

CONTROL CENTER Switches Speakers

ORDER BY MAIL

For Stereo Input Mixing Monitoring!

1st Time!



Alco Control Center allows your choice of up to 6 stereo speaker systems to be selected simultaneously. Push-on & push-off switches enable you to optionally select your choice of speaker pairs. Easy access rear panel connectors to match your particular system. No external power required; no impedance match problems. Useable with low or high impedance circuits. Leather-styled black metal with brushed aluminum trim. Size: 5 5/8" x 2 1/8" x 3 3/16". For home, professional use.

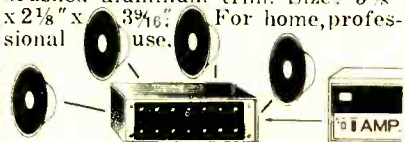

Model	No. Prs.	Connector Type	Each
CC4RCA	4	RCA	\$19.95
CC4PHM	4	Phone (Miniature)	21.95
CC4PHS	4	Phone (Standard)	22.95
CC6RCA	6	RCA	26.95
CC6PHM	6	Phone (Miniature)	28.95
CC6PHS	6	Phone (Standard)	29.95

CHOICE OF 6 MODELS

ALCO

Buy Direct: BOX 1348EW
LAWRENCE, MASS. 01842

We pay shipping when check accompanies order!

CIRCLE NO. 148 ON READER SERVICE CARD

LETTERS FROM OUR READERS



SOLID-STATE DIODES

To the Editors:

In the article "Silicon Junction Diodes" (page 35, special section on "Solid-State Diodes") in the July issue of *ELECTRONICS WORLD*, Author Seidman used a word which has been used by different people to mean different things. I would enjoy seeing a definition of the word "enhancement" as used on page 36 in the right-hand column. Just exactly what is an "enhancement layer?"

This word calls to mind another word which is loosely used and may indeed have a specific definition. I would like to see your definition of the word "enrichment" also.

GEORGE G. PINNEO
Mgr., Semiconductor Div.
Sensormatic Electronics Corp.
Hollywood, Fla.

We checked with Dr. J. Reynolds of Delco who used the term in question in our "Silicon Junction Diodes" article. Dr. Reynolds' definition of "enhancement layer" is a layer of richly doped material, like p+ or n+. The term "enrichment" means the same.—Editors

* * *

AUTOMATIC TINT CONTROL

To the Editors:

I wish to commend the author, Milton S. Snitzer, for his excellent article entitled "Automatic Tint Control for Color-TV" in the September issue. He did a fine job of introducing this new automatic control.

My opinion is that Magnavox has the only circuit that really works. However, some mention should have been made of Philco-Ford since they claim to have the same thing.

FRED J. DAMBECK, Chief Tech.
National Radio & TV Service
Milwaukee, Wis.

Washing out the color in the orange region will integrate TV performers toward a paper-sack color. The problems occur at transmitting stations where they could and should be automatically corrected. There is no way to do this at the receiver with present color-TV transmissions.

DARRELL MCKIBBIN
Sunnyvale, Cal.

Thanks to both Readers Dambeck and McKibbin for their comments. Regarding the Philco receivers, Reader Dambeck may be referring to the use of a varactor diode between the 3.58-MHz crystal and the input to the following stage to produce an automatic reactance control, removing the need for manual adjustment of the reactance coil in the automatic phase control circuit. This keeps the phase properly locked in with the transmitted signal, but does not actually perform a hue correction if there is a transmission phase error.

On the matter of the automatic tint control being actually a phase compressor, we did indicate in our article that a certain amount of color change would occur with this circuit in use and that is why Magnavox normally recommends only a partial correction for normal viewing. We probably would have felt just as Reader McKibbin does about the circuit had we not seen it in operation. The automatic tint control really does what it is supposed to do—and does it well. In spite of the fact that it "compresses the phase," the over-all result, when viewing the picture, is just what it is supposed to be; namely, the unpleasant changing of flesh tones when a commercial comes on, or when a color camera is changed, simply does not occur.—Editors

* * *

TRANSISTORIZED BATTERY CLOCK

To the Editors:

With everything going solid-state today, I guess I should not have been surprised to find transistors invading the battery-operated electric-clock field. I always thought that a battery-operated clock simply uses a flashlight battery to operate a 1 1/2-volt motor that drives the gear train and hands of the clock. But the other day I saw a battery-operated clock with a General Time Corp. movement with a transis-

To the Editors:

It is irritating to sort your way through semi-technical jargon and find that you are being hoodwinked. The article "Automatic Tint Control For Color-TV" in your September issue would be more honestly titled "Big Snow Job on Color Phase Compression." If phase compression is automatic tint control, then amplitude limiting is a.g.c. and bandpass filtering is a.f.c.

tor clearly visible. What's the transistor there for?

RAYMOND STONE
McKeesport, Pa.

Some such clocks do use a low-current 1½-volt motor, but the movement mentioned above does not. Instead, the balance wheel of the movement is driven directly by electromagnetic impulses controlled by a simple transistor switching circuit. Back-and-forth motion of the wheel is changed by means of an escapement lever into rotary motion of an indexing wheel which, in turn, drives the gears that move the hands. The balance wheel has two tiny magnets on it. When the wheel is in motion, the magnets pass across the turns of a small, adjacent pickup coil and induce a current pulse in the coil. The coil is in the base circuit of the transistor. The pulse switches the transistor on and this completes the circuit from the battery to a second coil, called a drive coil. This then electromagnetically pulses the balance wheel by acting on the tiny magnets. The wheel is then returned by its hairspring and the cycle is repeated as the magnets swing across the coils once more. The movement repeats or beats 300 times a minute just as in a conventional wristwatch. Accuracy should be good since the transistor is triggered on at exactly the proper instant to maintain balance wheel motion.

The battery should have a long life since current is required only in pulses rather than continuously as with a motor drive. Average current drain on the "C" cell used is about 350 microamperes so that a standard zinc-carbon cell should last 6 to 8 months. With a manganese alkaline cell, a useful life of 12 to 18 months should be obtained.—
Editors

* * *

EW FOR THE BLIND

To the Editors:

Our contact with the blind community indicates to us that many blind persons are unaware of the fact that ELECTRONICS WORLD is available to them on tape from Science For The Blind. It is read onto tape by volunteer readers with the publisher's permission and is intended solely for the use of the blind and physically handicapped.

We have sincerely appreciated the cooperation ELECTRONICS WORLD has given us with this project. We have included excerpts from it in our "Radio Digest," which is received by blind persons, and have had an enthusiastic response. We feel that this enthusiasm would be shared by a significant number of others if they knew about our service. Our thanks for your help.

(Mrs.) L. FULLER, Associate Director
Science For The Blind
221 Rock Hill Rd.
Bala-Cynwyd, Pa. 19004 ▲

December, 1969

For The Experimenter!

International EX Crystal & EX Kits

OSCILLATOR / RF MIXER / RF AMPLIFIER / POWER AMPLIFIER

Type EX Crystal

Available from 3,000 KHz to 60,000 KHz. Supplied only in HC 6/U holder. Calibration is $\pm .02\%$ when operated in International OX circuit or its equivalent. (Specify frequency)



\$3.95

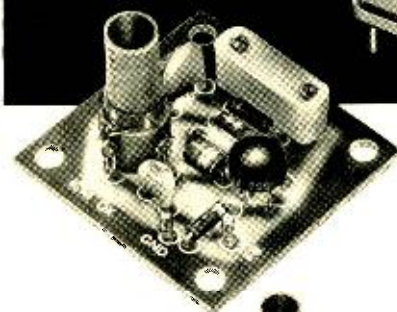

OX OSCILLATOR

Crystal controlled transistor type.
Lo Kit 3,000 to 19,999 KHz
Hi Kit 20,000 to 60,000 KHz
(Specify when ordering)

\$2.95

MXX-1 Transistor RF Mixer

\$3.50

A single tuned circuit intended for signal conversion in the 3 to 170 MHz range. Harmonics of the OX oscillator are used for injection in the 60 to 170 MHz range.
Lo Kit 3 to 20 MHz
Hi Kit 20 to 170 MHz
(Specify when ordering)

MXX-1



SAX-1 Transistor RF Amplifier

\$3.50

A small signal amplifier to drive MXX-1 mixer. Single tuned input and link output.
Lo Kit 3 to 20 MHz
Hi Kit 20 to 170 MHz
(Specify when ordering)

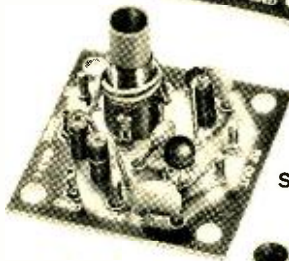

SAX-1

PAX-1 Transistor RF Power Amplifier

\$3.75

A single tuned output amplifier designed to follow the OX oscillator. Outputs up to 200 mw can be obtained depending on the frequency and voltage. Amplifier can be amplitude modulated for low power communication. Frequency range 3,000 to 30,000 KHz.

PAX-1



BAX-1 Broadband Amplifier

\$3.75

General purpose unit which may be used as a tuned or untuned amplifier in RF and audio applications 20 Hz to 150 MHz. Provides 6 to 30 db gain. Ideal for SWL, Experimenter or Amateur.

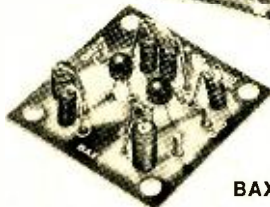

BAX-1

Write for complete catalog.



CRYSTAL MFG. CO., INC.
10 NO. LEE • OKLA. CITY, OKLA. 73102

CIRCLE NO. 126 ON READER SERVICE CARD

Can you solve these two basic problems in electronics?

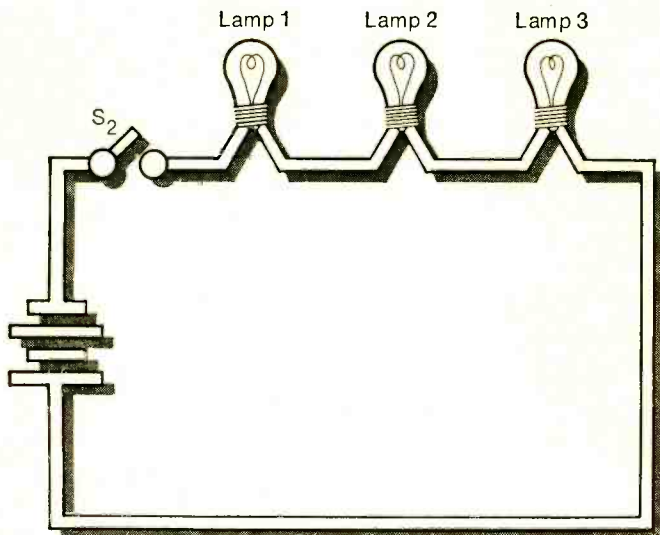

This one is relatively simple:

When Switch S_2 is closed, which lamp bulbs light up?

Note: If you had completed only the first lesson of any of the RCA Institutes Home Study programs, you could have solved this problem.

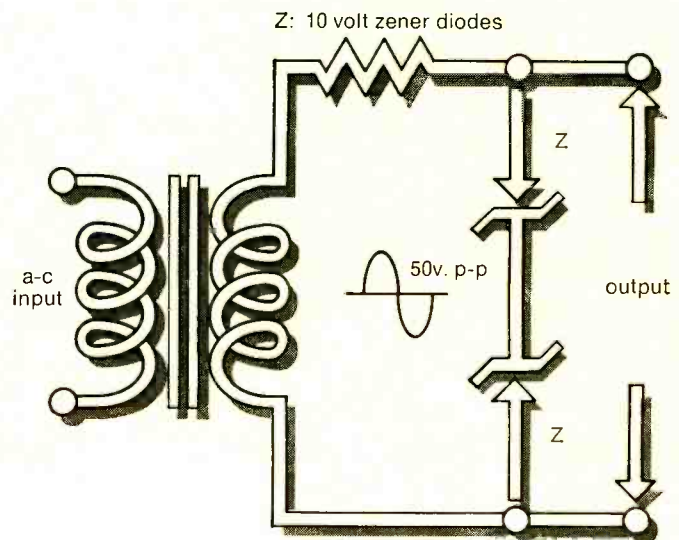

This one's a little more difficult:

What is the output voltage (p-p)?

Note: If you had completed the first lesson in the new courses in Solid State Electronics, you could have easily solved this problem.

These new courses include the latest findings and techniques in this field. *Information you must have if you are to service today's expanding multitude of solid state instruments and devices used in Television, Digital, and Communications Equipment.*

If you had completed an entire RCA Institutes Home Study Course in Semiconductor Electronics, Digital Electronics, or Solid State Electronics, you should now be qualified for a good paying position in the field you choose. Send for complete information. Take that first essential step now by mailing the attached card.

ANSWERS: Problem 1—they all light up
Problem 2—20 Volts (p-p)

RCA Institutes Autotext learning method makes problem-solving easier... gets you started faster towards a good-paying career in electronics

Are you just a beginner with an interest in electronics? Or, are you already making a living in electronics, and want to brush-up or expand your knowledge? In either case, RCA has the training you need. And Autotext, RCA Institutes' own method of Home Training will help you learn more quickly and with less effort.

Wide Range of Courses

Select from a wide range of courses. Pick the one that suits you best and check it off on the attached card. Courses are available for beginners and advanced technicians.

- Electronics Fundamentals
- Black & White Television Servicing
(Transistorized TV Kit Available)
- Color Television Servicing (Color TV Kit Available)
- FCC License Preparation
- Automatic Controls
- Automation Electronics
- Industrial Electronics
- Nuclear Instrumentation
- Electronics Drafting
- Computer Programming

Plus these new up-to-the-minute courses

- Semiconductor Electronics
- Digital Electronics
- Solid State Electronics
- Communications Electronics

Prepare for good paying positions in fields like these

- Television Servicing
- Telecommunications
- Mobile Communications
- CATV
- Broadcasting
- Marine Communications
- Nuclear Instrumentation
- Industrial Electronics
- Automation
- Computer Programming
- Solid State
- Electronics Drafting



Build and keep this valuable oscilloscope.

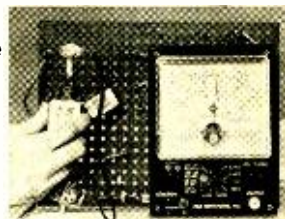

In the new program on Solid State Electronics you will study the effects of temperature and leakage characteristics of transistors.



Variety of Kits—Yours to Keep

A variety of RCA Institutes engineered kits are included in your program of study. Each kit is yours to keep when you've completed the course. Among the kits you construct and keep is a working signal generator, a multimeter, a fully transistorized breadboard superheterodyne AM receiver, and the all-important oscilloscope. These 4 kits are at no extra cost. Compare this selection with other home study schools.

Two Convenient Payment Plans

Pay for lessons as you order them. No contract obligating you to continue the course. Or, you can take advantage of RCA's convenient monthly payment plan. No interest charges!

Classroom Training Also Available

RCA Institutes operates one of the largest technical schools of its kind. Day and evening classes. No previous training is required. Preparatory courses are available. Classes start four times a year.

Job Placement Service, Too!

Companies like Bell Telephone Labs, GE, Honeywell, IBM, RCA, Westinghouse, Xerox, and major radio and TV networks have regularly employed graduates through RCA Institutes' own placement service.

All RCA Institutes courses and programs are approved for veterans under the new G.I. Bill.

Send Attached Postage Paid Card Today. Check Home Study or Classroom Training.

Accredited Member National Home Study Council.

IF REPLY CARD IS DETACHED, SEND THIS COUPON

RCA Institutes Inc.

Home Study Dept. EWD-9
320 West 31 Street
New York, N.Y. 10001

Please send me FREE illustrated career catalog.

Name _____ Age _____
(please print)

Address _____

City _____ State _____ Zip _____

We suspect that the new Dual 1219 will get a warm reception from the independent testing labs. For the same reasons that they welcomed earlier Duals.

With so many similar audio products, equipment reviewers appreciate innovations. And Dual has traditionally obliged them.

The 1219 continues this tradition in many ways.

One of the 1219's features that sets it apart from all other automatics is the Mode Selector that shifts the entire tonearm base down for the single-play mode and moves it up for the multiple-play mode. The tonearm is thus able to track at the ideal 15° stylus angle whether playing one record or the middle record of a stack. (Instead of tilting down on single records.)

Another "first" is the 1219's tonearm suspension which is a true four-point ring-in-ring gyroscopic gimbal. The tonearm pivots vertically from an inner concentric ring which, in turn, pivots

horizontally from a fixed outer ring. The tonearm is centered within these rings and pivots on four identical needle bearings.

The 1219's anti-skating system is also noticeably different. It provides a separately calibrated scale for each stylus type, conical or elliptical. (Elliptical styli create more skating force than do conical styli.)

Another touch of Dual precision is the tonearm counterbalance. As it is rotated, there's a click for every hundredth-gram. (Makes balancing easier and faster, especially when interchanging cartridges of different weights.)

Several other features of the 1219 might be mentioned. The effective tonearm length is 8-3/4", longest of all automatic arms. The 12-inch platter is dynamically balanced and weighs 7 pounds. The cue control is damped in both directions, so the tonearm moves with equal delicacy, and without bounce whether you're raising or lowering it. And the motor combines high starting

torque with the absolute constancy of synchronous speed.

Although we can anticipate all the above features and refinements being welcomed by the testing labs, we don't presume to predict how they might be evaluated in terms of performance. Which, after all, is what really counts.

But reviews of earlier Duals have included terms like "superior, uncompromised performance" and "one of the finest record playing mechanisms I have used."

Reviews like these aren't easy to top, but if any automatic turntable can do it, we believe the 1219 can. Even though its price of \$159.50 may cause the reviewers to set their standards correspondingly high.

Until the reviews are published, we can only suggest that you write for our descriptive literature, or see the 1219 yourself at your dealer. Then write your own review.

United Audio Products, Inc.,
120 So. Columbus Ave., Mount Vernon,
New York 10553. 

The Dual 1219 should give the testing labs something new to talk about.



Radio & Television **NEWS**

By FOREST H. BELT /Contributing Editor

Video Recordings at Home

There's a new flurry of excitement over playing prerecorded video at home. It was touched off by *RCA*. Its research and engineering division came up with a color-compatible recording system that uses a cartridge filled with very thin plastic tape. (See "Color-TV Tape Player Uses Laser and Holograms," page 31, this issue.)

Meanwhile, *Motorola* is trying to get an electronic video recording (EVR) machine ready for home use by early next year. The *CBS* system *Motorola* is using has film as its basis too, but processed differently. *Zenith* is working on something, but is hush-hush about it, so far.

The Japanese are digging for this market, too. The major VTR companies in Japan recently agreed on a standard format. Tape to be 1/2-inch wide; speed 7 1/2 inches per second; recording angle 3 degrees, 11 minutes using rotating heads; 1-mm sound track and 0.8-mm control track; resolution better than 240 lines.

Four-Channel Sound Comes on Strong

When we first told you about "surround" stereo (this column, September, 1969 issue), it was just being tried out. Since then, the idea has really caught on. Not only is tape being used as the medium, but station *WNYC-FM* in New York City is running tests to put all four channels on an FM carrier. The two front channels are broadcast in usual stereo-FM fashion. The left rear signal is amplitude-modulated on one SCA subcarrier (67 kHz) and the right rear signal goes on another (probably at 76 kHz). Both rear signals are limited in frequency content to 8 kHz—not really hi-fi, but apparently enough for the purpose, which is simulating reverberation.

There's even a disc-recording technique that can be used for four-channel stereo. Two channels are multiplexed together and put into one stereo channel in the same way stereo records are made now. The remaining two channels go into the other regular stereo channel. In playback, matrixing recovers the four channels.

One of the first major hi-fi makers to tool up for the new concept is *H. H. Scott*. Its Model 499 four-channel amplifier will be ready in another couple of months. *Vanguard Records* is producing six prerecorded tapes for the new system. The channel assignments by track number are: 1, left front; 3, right front; 2, left rear; 4, right rear. *Acoustic Research, Inc.* is demonstrating the system at listening rooms in New York and Cambridge, Mass.; *AR* is using a *Telex* deck with 4-track in-line heads. A production version may be ready by year's end as will a unit from *3M/Wollensak*. *Crown* and *Teac* have units that record and play back, but they sell for several hundred dollars. There's even talk of a four-channel cassette pretty soon.

Pay-TV is Okayed

The FCC came across with standards, finally, and opened the door to applicants for subscription-TV systems. First to file was *Zenith*, seeking official approval of its tried-and-proven Phonevision system. Here are the rules the FCC laid down: (1) There must already be four TV stations operating before a pay-TV station will be allowed in an area; (2) Only one pay-TV station per community; (3) Can't run a feature film that is more than 2 years old; (4) Can't carry sports events that were televised regularly within the preceding 2 years; (5) Must carry at least 28 hours of conventional programs each week; (6) Quality of transmission must equal that of regular stations; (7) No internal modifications can be made to subscriber's receiver.

At almost the same time, an Appeals Court ruled against the National Association of Theater Owners. That group was suing to keep the FCC from approving pay-TV.

Zenith spokesmen say that, with quick FCC approval of the Phonevision system, 1970 will see pay-TV systems in operation. About 80 markets are eligible. Then the marketplace will prove whether pay-TV catches on like CATV has or turns out to be a fad that dies away after a year or two.

Prices of Consumer Electronics Going Up

Hardest hit in this fall's price rises is color TV. The trend began late in September and by press time almost every manufacturer had announced increases. Most are under 3% if spread over an entire line, but

individual raises are more drastic. Some other products felt the push, too, but color got the worst of it. Yet, price hikes notwithstanding, home-entertainment equipment is still quite a good bargain; the Consumer Price Index still pegs electronic instruments below 90 (whereas the average for all commodities is 124).

Tapes Cost More, Too

Speaking of prices, those for cartridge tapes and cassettes have gone up sharply. Most major record companies have boosted them at least a dollar. That's a pretty big jump, percentagewise. A cartridge-tape owner already ties up several hundred dollars in even a small selection of cartridges. It's a shame when heavy demand pushes prices up like this. Mass production should create economies that hold prices down. Certainly production costs haven't taken a 20% jump while sales were doubling and tripling.

More and more cartridges are being sold through "clubs" similar to record clubs. A member buys a few tapes at the regular price and then gets a free one (usually from a list of not-very-popular releases). That saves some money, but not enough at the new prices.

Too Many Color Picture Tubes

The 1970 lines of color receivers have just about every size of screen you can imagine. Beginning with 9-inch (viewable diagonal), the CRT sizes go to 23-inch, omitting only 13-, 17-, and 21-inch.

But the parade isn't over. Now there are to be at least three more. The 19- and 21-inch slots will be filled with new square-cornered, flat-faced color tubes. (That'll make four 19-inch color CRT's: the regular 90-degree one; the 19R, formerly called 21-inch round; a square-corner 90-degree; and a soon-out 110-degree.) Also, there's promise of a true 25-inch version of the square, flat tube. *Toshiba* is bringing in a 16-inch 110-degree tube, and promising 12- and 19-inch versions.

The new tubes may not make it into the spring 1970 lines, but will be in the 1971 introductions next June. By then, there will likely be more 110-degree sizes, too. The number of different CRT's is getting almost as bad as with receiving-tube types.

Automatic Reversing for Cassettes

Michigan Magnetics of Vermontville, Michigan has a reversing system for cassettes. At the end of one stereo "side," the heads reposition so the reverse tracks play without the listener having to flip the cartridge over. The new system was shown at the Audio Engineering Society convention in New York in October. So far, no manufacturer has the system in a unit, but it seems a natural for auto stereo cassette machines.

Long-Range Plans for TV Shops

One common money-waster for TV service businesses is obsolete inventory. This may start getting worse in the next few months and years. Tubes are being rapidly replaced by transistors in home-electronics products. Any shop owner who doesn't analyze his tube inventory carefully every six months might soon be stuck with hundreds of dollars worth of tubes he'll never sell.

Start phasing out unnecessary tube stock by cutting down the number of slow-moving types on the shelf. Treat them like other slow-moving parts; order what you need instead of stocking them. A two-week supply of any tube is plenty; a one-week supply is more economical unless you get slow service from your parts distributor.

Flashes in the Big Picture

Officials of National Cable Television Association say 7500 CATV systems will serve 30 million homes by the end of 1970's; right now there are about 2300 systems serving 3.6 million homes. . . . *Matsushita Electric (Panasonic)* says its engineers have developed a new kind of phono cartridge; it's a resin block on which is deposited a thin film of piezoelectric germanium semiconductor material; tracking pressure is under 1½ grams. . . . Nearly 1 million color-TV sets will be sold this year in Europe—nearly six times the number sold there 2 years ago. . . . B. S. (Buz) Durant, popular and well-known chairman of *RCA Sales Corp.* has left the company; hasn't told his plans yet. . . . NCTA/NAB proposal (this column, August, 1969 issue) was torn apart by Justice Department, and called "protectionist"; Congress being forced into doing something about disagreement, and began hearings few weeks ago. . . . Electronic Industries Association reports \$4.8 billion in consumer electronics sales for 1969; predicts \$5 billion or more for 1970. ▲

Here's More Alarming News From The Alarmists!

Dialtronic Automatic Telephone Communicator Model DT-1000



Radarsentry Alarm announces a new powerful way to stop crime . . . "Dialtronic"

Radarsentry Alarm announces a new powerful way to fight crime. Imagine a security system that automatically and silently delivers any emergency message for which it is programmed. Dialtronic adds a new dimension to your security needs. Advanced concepts in technology and design bring you a new level of security. Providing unlimited application, the Dialtronic uses solid state circuitry to bring help immediately. Use it with existing alarm systems or any other sensing device. Dialtronic is the ideal personal protection for anyone who is vulnerable to intruders. Dialtronic will perform with never a lapse in security . . . You are assured of highly reliable protection.

Also used to protect premises while they are being occupied, the Radar Dialtronic gives push button protection to businesses and home owners alike. This system is triggered by a hidden push button or portable transmitter. Once set into action, it automatically dials the phone—delivering any pre-recorded message for which it is programmed without the would-be-thiefs' knowledge. In effect, the Dialtronic gives you a direct line to police, fire departments, in-plant security, key personnel . . . whoever you designate.

Dialtronic's built-in programmer lets you magnetically store "error free" messages on cassette type tape cartridges. Stored information is instantly available to notify proper officials, delivering correct message in each case.

Advantages of Dialtronic Telephone Communicator

- Eliminates costly leased telephone lines.
- Simultaneously stores up to ten separate messages on magnetic tape.
- Automatically dials the right people and delivers the correct message in each case.
- Battery operated (optional) Rechargeable "Nic/Cad" batteries with built-in charger.
- Converts existing local alarm to central station system. Easily and quickly installed.
- Silent "on premises hold up alarm with the ability to get the facts out" instantly.
- Can be used with optional wireless control.
- Home prowler alarm, fire alarm, emergency alarm for invalids. Can be programmed for any emergency.

The Crimebusters Want You! . . . Now!

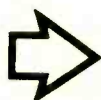

. . . To make the biggest profits of your career—filling ready-made demand for the dramatic new RADAR SENTRY ALARM systems. Get started NOW as dealer or distributor—step into five-figure income at once, with unlimited potential and wide-open opportunity to grow as you go! MAIL COUPON AT ONCE!

RADAR DEVICES MFG. CORP.
22003 Harper Avenue
St. Clair Shores, Michigan 48080

EW-129

- Send me the alarming details.
- Also send me booklet outlining available dealerships.

Name

Address

CityStateZip

Every minute is longer up there.

You can save as many as 20 or 30 of those long minutes when you put up one of our larger antennas, because they're pre-assembled. Our snap-joints take only seconds to lock in place.

Sylvania antennas are equipped with a double boom (for strength and rigidity).

All have strong, seamless, half-inch tubular elements (not rolled-over strips of aluminum).

All aluminum parts are gold-al-

dized inside and out (not sprayed, but dipped).

Even more care goes into the electronics.

We've peaked our antennas for flat response over the entire 6 MHz bandwidth of each TV channel. Flat response is absolutely necessary for good color reception. Otherwise, color rendition may be lost.

You also need high gain—that's obvious. But coupled with high directivity to knock out interference. Polar

patterns from our antennas show almost complete rejection of signals from the rear and sides.

We designed our antennas so you wouldn't have to (1) climb back up there or (2) fiddle around up there.

We know that the fiddler on the roof is just fiddling his own money away.

For more information on our line of antennas see your Sylvania distributor.

SYLVANIA
GENERAL TELEPHONE & ELECTRONICS



**Here's where we
can save you time.**



EW Lab Tests NEW STEREO COMPACTS

By JULIAN D. HIRSCH/Hirsch-Houck Laboratories

The results of our laboratory measurements on eight of the newest stereo compacts. These represent simplest way to get component-quality stereo hi-fi performance.

THE so-called "compact" high-fidelity system is a logical extension of the integrated receiver. Although the latter, combining tuner and amplifier in a single unit, simplified system planning and installation, the user was still faced with the task of selecting and installing a record player, cartridge, and speakers, whose characteristics had to be compatible with those of the other components.

Compact systems differ in many details, but all of them consist of a tuner/amplifier built into the base of an automatic record player. This space-saving design, made possible by cool-running solid-state circuits, allows the entire system (except for speakers) to occupy little more space than a record changer alone. The phono cartridge is supplied installed in the changer arm, with the correct balance and tracking force set by the manufacturer, which is an important convenience for the non-technical user.

Usually a pair of speakers fitted with phono connectors or integral cables is supplied with the system. The amplifier outputs are also usually through phono connectors, so that speaker phasing is automatically correct. Some compacts are supplied without speakers, in which case they have the usual screw-type terminals for speaker outputs.

Aside from the small size and ease of installation of a compact system, it is usually designed for maximum performance at a relatively low price. Most of the refinements to be found in separate components, or even most integrated receivers, are missing from the typical compact. For example, few offer a true tape-monitoring capability. All have a high-level (Aux) input, which can accept the playback output of a tape recorder, and tape-output jacks to drive the input of the recorder, independent of volume and tone control settings. Only a few, however, can monitor the playback from a three-head machine while making a recording.

The record changers in most compacts are relatively low-priced models from well-known manufacturers (principally *Carrard* and *BSR*). A few makes use more expensive changers, notably *Benjamin* with the *Miracord 620* (for which it

is the importer), and *Sony* with the *Dual 1210* changer.

The changers supplied with compacts are not designed for the very high compliance cartridges used in better component systems. Practically all compact systems are equipped with one of the *Pickering V-15* series cartridges, which track at forces from 3 to 4 grams. The two exceptions among the eight compacts tested for this report were *Benjamin*, who uses its own *Elac 244-17* cartridge, and *Heath*, who supplies the *Shure M44-7*. Both operate at 2.5 to 3 grams.

The amplifiers used in compact systems are relatively low-powered, compared to usual component-system standards. Although their power ratings seem impressive when expressed as "HIF power into 4 ohms," the fact remains that all the systems tested use 8-ohm speakers, to which they can deliver from 8 to 18 watts (continuous power) per channel, with both channels driven. There is one noteworthy exception, which will be described shortly.

These amplifiers and tuners correspond in design and performance to the budget-priced models in their makers' component lines. The amplifier low-frequency power is usually limited to about half as much power at 30 Hz as at 1000 Hz. This is not a particularly serious fault, since the speakers supplied with these systems rarely have any significant response to that frequency. In other respects, they are very good amplifiers, with typical distortions of one or two tenths of a percent at normal listening levels. All of them have headphone jacks, two pairs of speaker outputs, tone controls, and most have switchable loudness compensation. The speaker efficiencies are moderately high, so that comfortable volume levels are possible without distortion. The room-rattling volume to which audio buffs have become accustomed is not attainable with the typical compact system.

The tuners are generally of good quality, although they may not be as sensitive as good separate components. Most have HIF usable sensitivities of 3 to 4 microvolts, although some are appreciably more sensitive and these might be wise choices for outlying areas. Although all have tuning



Benjamin 1035



Bogen BC460

meters and automatic stereo switching, only two of the group tested have FM interstation muting. Most of the units have AM tuners, with the usual adequate but undistinguished sound which we have come to expect from such devices.

Many of the speakers supplied with compacts are standard models, available for use with any music system, except for having phono jacks instead of (or in addition to) screw or binding-post terminals. They range in quality and price from the budget class "under \$50" models to some very fine units selling for \$100 each. To a great extent, the sound of these systems is determined by their speakers, and this can be a rather subjective matter.

One of the units in this group might seem to be mis-cast as a "compact;" the *Marantz 25* is really an integrated stereo receiver, and a very good one at that. It comes without a record player or speakers, but has a removable walnut top which can be replaced by a pre-drilled motorboard (available from *Marantz*) for any *Garrard*, *Miracord*, or *Dual* changer. When thus equipped, it qualifies as a "compact," with the greatest power and lowest distortion, by far, of any of the models tested. Of course, in its complete form, with a pair of good speakers, it could easily cost in excess of \$650, placing it on top in this respect as well.

We tested the compacts in much the same way as we would treat separate components, except that some of the tests were somewhat abbreviated. (Fully testing eight tuners, amplifiers, record changers, cartridges, and speakers would be a formidable project indeed.) Since, in most cases, the phono inputs of the amplifiers were connected directly to the cartridge outputs, and were not accessible from the outside, we measured phono response by playing the *CBS STR-100* test record. In the case of the *Marantz 25*, we measured phono equalization from an electrical input signal. All amplifiers were terminated in 8-ohm loads, and were operated with both channels driven simultaneously. FM-tuner response and distortion were measured at the tape recorder outputs to eliminate any effect of the amplifier characteristics. The speakers were not lab-tested, but we made extensive A-B listening comparisons, using identical records and FM-radio programs for this purpose.

Heath AD-27



The individual equipment reports are presented below in alphabetical order and are summarized in the table. As with all our reports, all powers given are continuous sine-wave output per channel into 8 ohms, with both channels driven.

Benjamin 1035

The *Benjamin 1035* was one of the lowest powered models tested, delivering 9.6 watts per channel at 1000 Hz, and 2.9 watts at 30 Hz, with 2% distortion. At one watt, its distortion was a satisfactory 0.38%.

The FM-tuner sensitivity was 2.7 microvolts, and its distortion at full deviation was 1.2%. Stereo separation was very good (33.3 dB), and its frequency response was the flattest of any of the compacts at +0.5, -0.2 dB from 50 Hz to 15,000 Hz. An AM tuner is included.

The record player used an *Elac 244-17* cartridge in a *Miracord 620* changer. Its frequency response was better than average, +3, -2 dB from 40 Hz to 15,000 Hz. The rumble was low (-28 dB) and wow and flutter were averaged at 0.12% and 0.04%. Tracking force was 2.5 grams.

The speakers furnished were *EMI 55* two-way systems, with 8" woofers and 3" tweeters. They were the smallest of those tested, measuring 17" x 10 1/2" x 8 1/2".

The *Benjamin 1035* sells for \$350. This manufacturer also has a lower-power compact, the Model 1025, at \$300 and a higher-powered compact, the Model 1045, at \$450. Also, a model 1050A is available with larger speakers at \$600.

Bogen BC460

The *Bogen BC460* was the most powerful true compact in the group tested, delivering 18.7 watts per channel at 1000 Hz and 10.8 watts at 30 Hz, at 2% distortion. The distortion was a low 0.19% at 1 watt and 0.16% at 10 watts.

The FM-tuner sensitivity was 3.4 microvolts. Stereo separation was 38 dB, by far the best of the units tested. The FM frequency response was excellent, +0.8, -1.0 dB from 50 Hz to 15,000 Hz, and distortion was a moderate 1.6% at full deviation. There is an effective FM muting circuit and an AM tuner is included.

The record player is a *Garrard 3500*, with a *Pickering*



Marantz 25



Fisher 125

cartridge tracking at 2.5 grams. Frequency response was +2, -3 dB from 40 Hz to 15,000 Hz. Rumble was low at -29 dB, and wow and flutter were lower than average at 0.08% and 0.03%.

The BC460 has a tape-monitoring switch, and a unique compressor/expander circuit. Although we did not make any measurements on it, it seemed to do a fine job in both modes of operation, with no detectable distortion or other undesirable side effects. The BC460 uses horizontally oriented slide potentiometers for tone, balance, and volume controls. They operate smoothly and are easy to use.

Furnished with the BC460 are a pair of *Bogen* LS20 speaker systems. They measure 19" x 10" x 9", and contain an 8" woofer and a 3" tweeter. Optionally, the system may be had with the smaller LS10 speakers.

The *Bogen* BC460 sells for \$470. A lower-power version, Model BC420, is available at \$350.

Fisher 125

The *Fisher* 125 system delivered an output of 13 watts per channel at 1000 Hz, and 7.3 watts at 30 Hz, at 2% distortion. Its distortion was extremely low, measuring 0.06% at 1 watt and 0.08% at 10 watts.

The FM tuner was one of the most sensitive of the group at 2.3 microvolts, and had the lowest distortion (0.58%) at full deviation. The FM-stereo separation was better than average at 29.5 dB, and the FM frequency response was +2, -0 dB from 50 Hz to 15,000 Hz. An AM tuner is included.

The record player was a *BSR* 500 changer with a *Pickering* V-15/AC-1 cartridge tracking at 3 grams. Its response was +3.5, -1.0 dB from 40 Hz to 15,000 Hz. Rumble was fairly low at -27 dB. Wow and flutter, respectively 0.13% and 0.03%, were average. The *Fisher* 125 has an automatic phono shut-off feature, which switches off the entire unit when the last record is finished.

The speakers furnished with the *Fisher* 125 measure 20" x 10" x 7½" and contain an 8" woofer and 3" tweeter. The unit sells for \$330. The Model 120, at \$300, is identical except for the omission of the AM tuner. A version with a cassette recorder, Model 127, sells for \$450. A lower-powered

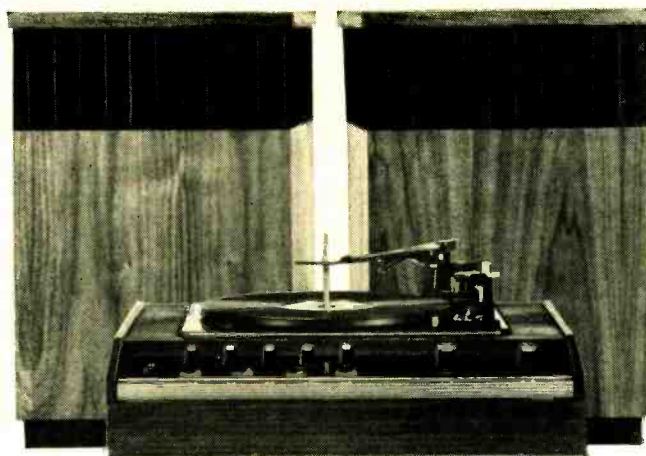

Harman-Kardon SC-2350

version, the Model 115, is available at \$270, while Model 135 with a pair of XP-60B speakers sells for \$400.

Harman-Kardon SC-2350

The *Harman-Kardon* SC-2350 is average in its power output, delivering 13 watts per channel at 1000 Hz and 7.9 watts at 30 Hz with 2% distortion. The distortion at lower levels was low, 0.20% at 1 watt and 0.16% at 10 watts.

The FM-tuner sensitivity was lowest of the units tested, at 4.5 microvolts. FM distortion was moderate at 1.8% with full deviation. Stereo separation was average at 27 dB, and frequency response was +2.7, -0.2 dB from 50 Hz to 15,000 Hz. The AM tuner has a separate tuning knob and dial.

The record player of the SC-2350 uses a *Garrard* 2025-TC, with a *Pickering* V-15/AC-1 tracking at 3.5 grams. Its frequency response was +7, -2 dB from 40 Hz to 15,000 Hz. Rumble was average at -26 dB, as were wow and flutter at 0.15% and 0.05%. There is an automatic shut-off which turns off the unit when the last record is finished.

Furnished with the *H-K* SC-2350 is a pair of HK50 omnidirectional speakers. These compact floor-standing two-way systems sell for \$100 each, and have the widest frequency response and best dispersion of any of the units tested.

The *Harman-Kardon* SC-2350 sells for \$400. This manufacturer has a large variety of compact systems at both higher and lower powers and with a variety of speaker systems. A version is also available with a cassette recorder. Prices for these various models range from \$200 to \$500.

Heath AD-27

The *Heath* AD-27, sold only in kit form, was the lowest priced unit in this group. Its power was average, 12.5 watts per channel at 1000 Hz and 11 watts at 30 Hz, with 2% distortion. Distortion was 0.13% at 1 watt and 0.19% at 10 watts.

The FM tuner (no AM provided) had a relatively low sensitivity of 4 microvolts, with 1% distortion at full deviation. Stereo separation was average at 28 dB, and the frequency response was +0, -3 dB from 50 Hz to 15,000 Hz.

The record player is a *BSR* 500A changer with a *Shure* M44-7 cartridge, tracking at 3 grams. Its frequency response



Scott 2505



Sony
HP-580

SUMMARY OF TEST RESULTS

Mfr., Model	Cont. Pwr. Out. per chan, 2% THD 1 kHz (W)	30Hz	THD @ 1 kHz 1W (%)	10 W (%)	FM Usable Sens. (μ V)	FM Dist. @ \pm 75 kHz (%)	FM Stereo Sep. @ 400 Hz (dB)	FM Freq. Response 50-15,000 Hz (\pm dB)	AM	FM Muting	Phono Freq. Res. 40-15,000 Hz (\pm dB)	Rumble (-dB)	Wow (%)	Flutter (%)	Track. Force (g)	Price (\$)
Benjamin 1035	9.6	2.9	0.38	—	2.7	1.2	33.3	+0.5, -0.2	yes	no	+3, -2	28	0.12	0.04	2.5	350
Bogen BC460	18.7	10.8	0.19	0.16	3.4	1.6	38	+0.8, -1	yes	yes	+2, -3	29	0.08	0.03	2.5	470 ¹
Fisher 125	13.0	7.3	0.06	0.08	2.3	0.58	29.5	+2, -0	yes	no	+3.5, -1	27	0.13	0.03	3.0	330
Harman-Kardon SC-2350	13.0	7.9	0.20	0.16	4.5	1.8	27	+2.7, -0.2	yes	no	+7, -2	26	0.15	0.05	3.5	400
Heath AD-27	12.5	11.0	0.13	0.19	4.0	1.0	28	+0, -3	no	no	+5.5, -1.5	24	0.13	0.03	3.0	250 ²
Marantz 25	35.5	31.0	0.05	0.02	3.6	0.58	26	+0.9, -1.8	yes	yes	+0, -1	—	—	—	—	329 ³
Scott 2505	7.8	4.5	0.13	—	2.1	0.85	24.2	+0, -3.7	no	no	+5, -2	20	0.07	0.03	4.0	360
Sony HP-580	16.8	8.4	0.21	0.12	3.8	0.9	24.1	+1.6, -3.9	yes	no	+5, -3	30	0.04	0.02	3.0	420

1. Compressor/expander ckt.; 2. In kit form, with lowest-priced speakers; 3. No speakers, no record changer.

was +5.5, -1.5 dB from 40 Hz to 15,000 Hz. The rumble of -24 dB was slightly higher than average, and wow and flutter were average at 0.13% and 0.03%. The AD-27 has an automatic shut-off, switching off the unit after the last record.

The *Heath AD-27* is supplied with an attractive walnut enclosure featuring a tambour door that slides into the back of the cabinet when opened. No speakers are furnished, but these are available at from \$35 each to \$50 each.

The *Heath AD-27* kit sells for \$180 without speakers. With the least expensive recommended speaker kits, total price comes to \$250.

Marantz 25

The *Marantz 25* had the most powerful and lowest distortion audio system of the group tested. It delivered 35.5 watts per channel at 1000 Hz and 31 watts at 30 Hz, with 2% distortion. At 1 watt the distortion was 0.05%, dropping to 0.02% at 10 watts. The RIAA phono equalization was within +0, -1 dB from 40 Hz to 15,000 Hz.

Although the FM tuner was not outstandingly sensitive (3.6 microvolts), it has very low distortion (0.58%). The FM-stereo separation was average at 26 dB, and the frequency response was +0.9, -1.8 dB from 50 Hz to 15,000 Hz.

The *Marantz 25* has interstation FM muting, tape monitoring, and a high filter. The walnut top cover may be cut out to accommodate any *Garrard*, *Miracord*, or *Dual* changer, using templates furnished, or a pre-cut board may be purchased from *Marantz* for \$10.

The *Marantz 25* sells for \$329. No speakers or record changers are supplied.

Scott 2505

The *Scott 2505* was the least powerful of the compacts tested, delivering 7.8 watts per channel at 1000 Hz and 4.5 watts at 30 Hz with 2% distortion. The distortion was a low 0.13% at 1 watt. The 2505 has a tape-monitoring switch.

Its FM tuner had the highest sensitivity (2.1 microvolts) of any of this group of compacts, with low distortion of 0.85% at full deviation. Stereo separation was slightly below the average at 24.2 dB, and its frequency response was +0, -3.7 dB from 50 Hz to 15,000 Hz.

The record player uses a *Garrard 715* changer with a *Pickering* cartridge, tracking at 4 grams. Its frequency response was +5, -2 dB from 40 Hz to 15,000 Hz. Rumble was above the average of the group at -20 dB. Wow and flutter were very low, only 0.07 and 0.03 percent respectively.

A pair of *Scott S-10* bookshelf speaker systems is included with the 2505. They are 3-way systems with a 10" woofer and a 3½" dual-cone mid-range/tweeter, and measure 23½" × 11¾" × 9". These speakers sell separately for \$90 each and are among the best over-all sounding of this group (their bass was the best, and the highs very nearly so).

The *Scott 2505* sells for \$360. It is available with smaller speakers (the S-14 or S-17) at lower cost, or with AM capability for \$20 more. The manufacturer also has two higher-power compacts with various speakers, the most expensive of which is the 2606-100 at \$500. A compact with a cassette recorder is also available without speakers as the Model 3610 at \$400.

Sony HP-580

Sony's HP-580 delivered 16.8 watts per channel at 1000 Hz with 2% distortion. At 30 Hz, the available power was 8.4 watts. At very high frequencies, the distortion at all power levels increased. The distortion at mid-frequencies was 0.21% at 1 watt and 0.12% at 10 watts.

FM-tuner sensitivity was 3.8 microvolts, with 0.9% distortion at full deviation. Stereo separation was the least of the group at 24.1 dB (still a perfectly satisfactory figure), and the frequency response was +1.6, -3.9 dB from 50 Hz to 15,000 Hz. An AM tuner is included.

The record player was the best of this group of compacts. It is a *Dual 1210* changer, with adjustable speeds, and the very low rumble of -33 dB. The wow and flutter were also the lowest of the units tested, respectively 0.04% and 0.02%. The cartridge was a *Pickering V-15/AT-3*, with an integral record brush, tracking at 3 grams. Phono frequency response was +5, -3 dB from 40 Hz to 15,000 Hz.

A pair of bookshelf speaker systems was supplied with the *Sony* HP-580. They are three-way systems, with an 8" woofer, 3" mid-range driver, and a 2" tweeter. The speaker systems, which measure 19¼" × 11¼" × 10¾", are exceptionally light at less than 13 pounds, and may be hung directly on the wall if desired.

In listening comparisons, the *Sony* speakers had less high-frequency output than the other speakers in this group, but had satisfactory bass response and good over-all balance.

The *Sony* HP-580 is housed in an exceptionally attractive walnut cabinet with a hinged wood and plastic cover. Its operating controls and panels are finished in the brushed satin gold style which is used on other *Sony* audio components.

The price of the *Sony* HP-580 (Continued on page 76)

COLOR-TV TAPE PLAYER Uses Laser and Holograms

By MILTON S. SNITZER / Technical Editor

RCA develops a \$400 tape player using \$10 plastic-film tape cartridges due for the consumer market in the early 1970's.

THE half-inch-wide clear plastic film that we saw reeling through the tape-transport mechanism of an experimental tape player at *RCA Labs* recently was producing good quality black-and-white and fair color pictures on a nearby color-TV set. The color pictures, in which the color information flickered somewhat and hues were not quite correct, were expected to be improved considerably before the players and tapes are to be introduced to the consumer market in 1972. The target price for the tape player is under \$400, while cartridges of tape, providing a half-hour color program, are expected to sell for about \$10. RCA refers to the system as "SelectaVision."

The tape, which was 2-mil-thick clear vinyl of the type used to wrap meats in supermarkets, was not coated in any way but appeared to be completely transparent. A close look at certain viewing angles showed a strip of laser-produced holograms, occupying about a third of the width of

Designer's model of the color-TV tape player with the tape cartridge protruding at top right. User will simply insert cartridge into slot, push a button, and a half-hour color show will appear on his color set. RCA plans to introduce a library of about 100 programs in about two years' time.



This reel-to-reel tape player, connected to a color-TV set, is the forerunner of a cartridge model scheduled for 1972.

the tape, embossed into the surface. When the beam from the tape player's built-in, very-low-power laser was directed through the tape, an optical image was produced. This image was picked up by a compact vidicon tube, also within the tape player, and was scanned by the vidicon's electron beam to produce a TV signal that was fed to the TV receiver's antenna terminals. Color information was also embossed in the same hologram by using two color subcarriers, one for the red and the other for the blue signal. The green signal is derived from the other two color signals when they are subtracted from the luminance or brightness information.

Why Use Holograms?

But why go to all the trouble of using holograms rather than regular optical images, as on a movie film, or magnetic recording on video tape? There are many reasons, but they all add up to lower cost and resistance to handling damage. The transparent vinyl tape is very inexpensive and the replication embossing process is very simple. In some respects it resembles the phono disc manufacturing process with its use of a nickel master and heat and pressure to produce the final recording.

A recording company should be able to replicate 2000 or more half-hour color cartridges at a price of between \$2 and \$3.

A hologram can be cut into smaller and smaller pieces, but each piece contains all the information needed to reconstruct the complete visual image. The only thing that is lost is picture resolution and contrast, but not over-all picture content. This feature makes the holograms scratch- and dust-proof and also means that the tape transport need not keep the images in accurate side-to-side alignment. At the demonstration we saw, a hairpin was used to punch holes in the tape and sandpaper was used to abrade its surface, and there was little or no effect on the TV picture in either case.

Since the light from the laser is moving in essentially parallel rays, the image need not be carefully focused and the pickup tube location is not at all critical. The pickup tube was moved back and forth several inches without affecting the TV picture.

With the particular type of hologram used, the image projected on the vidicon pickup tube simply fades in and out as the tape is moved through the laser beam, but the position of the image does not change. Therefore, there is no need for synchronization between the tape motion and the camera scanning rate. This permits a very (Continued on page 77)

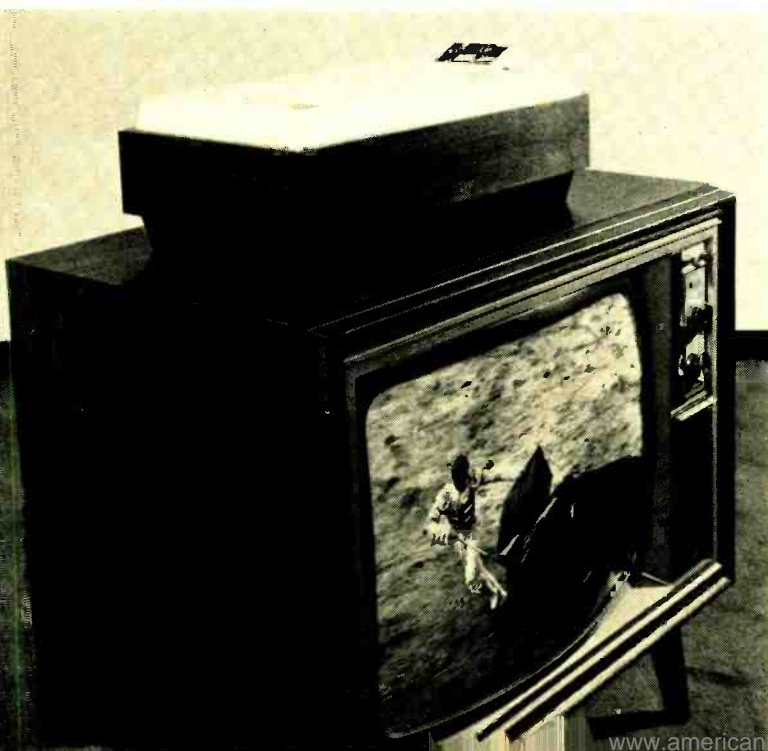



RECENT DEVELOPMENTS IN ELECTRONICS

Electron Beams Draw LSI Circuits. (Top left) The TV-like display monitor shows one of the masks that will be used to form a series of interconnected integrated circuits on the silicon wafer being held just above the monitor. Rather than being produced by a light beam, this mask was made by the beam of a scanning electron microscope (at left) that was fed by magnetic tapes prepared by a computer. By using tiny beams of electrons rather than the coarser beams of light, a greater number of circuits can be squeezed into a given area. This technique, developed by scientists of Westinghouse Electric Corp., can place some 4-million three-element electronic devices onto an area slightly larger than a postage stamp. The project could pave the way for the next generation of integrated circuits, using large-scale integration (LSI) where components of the circuits would be 100 times smaller than in present IC's.

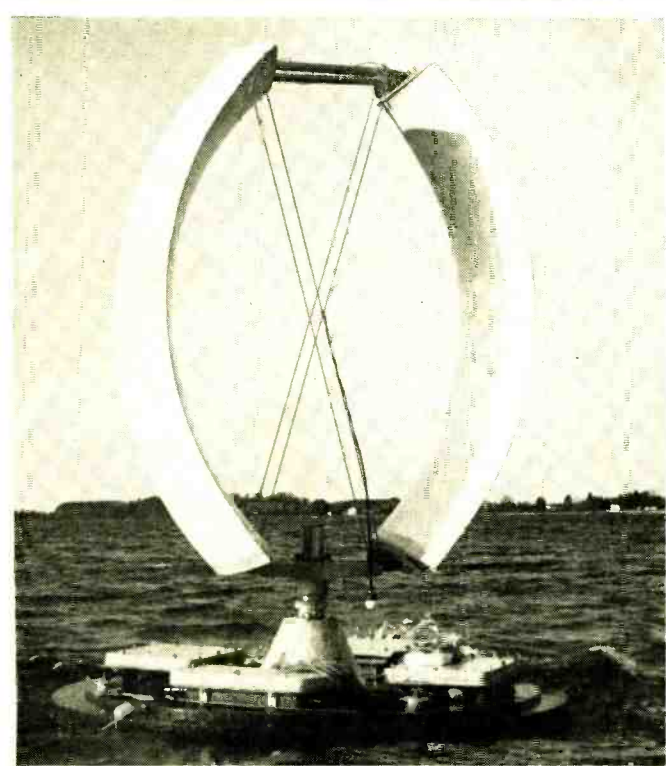

Radio-Controlled Robot Sailboat. (Center) This unique robot sailboat can navigate itself to any point on the world's seas to perform oceanographic, meteorological, or electronic-intelligence missions. The unmanned sailing craft is capable of remaining on station automatically for up to a year without a mooring. The buoy-like vessel, called SKAMP for Station Keeping and Mobile Platform, uses computer-based electronic navigation and a combination of movable air foils and rudders. Receiving information from a navigation system, such as provided by the Navy's navigation satellites, the vessel's electronics and servo system manipulates the air foils and rudders to guide it on course to its station. Once there, the vessel sails a tight back-and-forth course to remain within 0.2 nautical mile of its assigned true position. Since it is wind-driven by means of its rigid, foam-filled curved plastic sails, the vessel sails silently with no internal power required for propulsion. The RCA Astro-Electronics Div. has recently designed, built, and successfully sailed several prototypes. The present versions have a hull that is 9 ft in diameter and a sail height of just under 17 ft.



Copter Antenna for Satellite Communications. (Bottom left) This above-rotor helicopter communications antenna is to be used in the Defense Department's tactical communications satellite program currently under development. The super high frequency system is to be part of a world-wide network by which hundreds of small aircraft and ground units can be linked together by a single satellite. An experimental 1600-lb tactical communications satellite has already been successfully launched early this year as part of this program. In selecting the above-rotor location for the antenna, Bell Aerosystems' engineers expect to avoid the "chopping" effect which whirling rotor blades would have on transmitted or received signals. With this arrangement, special gyro stabilization and installation techniques are required to minimize vibration produced.

IR Thermometer Measures Plant Temperatures. (Top right) Using an infrared thermometer, Dr. David M. Gates, director of the Missouri Botanical Garden (St. Louis), is taking the temperature of an evergreen. The thermometer, a Barnes PRT-10, makes the measurement without physical contact that might damage or change the temperature of the plant. The instrument is merely pointed at the area whose temperature is to be measured. A spot $\frac{1}{2}$ -inch in diameter can be measured from a distance of 2 inches and variations as small as 0.2 degree C are easily detected at room temperature. Dr. Gates has been conducting a 3-year study of heat adaptation of plants and animals.



High-Powered Lasers for Industry. (Center) A new generation of compact, high-powered lasers is being developed for industrial use by Sylvania. The first unit is a 1000-watt carbon-dioxide continuous-wave laser that can generate a power density of 10 million watts per square inch, producing a temperature that is three times that of the surface of the sun. In the photo a cinder block has been heated instantly to incandescence when the laser beam was focused onto it. The laser equipment is about the size of a standard office desk and the manufacturer plans to market it at a price of approximately \$50,000.



Infrared Intrusion Detector. (Below left) Concealed behind the tiny lens built into what looks like an ordinary duplex receptacle is a gallium-arsenide light-emitting diode. The diode emits a narrow beam of infrared energy that is picked up by a detector concealed within another such receptacle located up to 75 feet away. When an intruder breaks the invisible beam, the receiver triggers an alarm. The system, called "Mini-Sentry," retails for about \$200 and operates for over a year on a 6-volt dry cell. The diode, made by Texas Instruments, was supplied to the manufacturer of the intrusion detector, Laser Systems Corporation, 313 North First St., Ann Arbor, Michigan.

Night-Vision Scope. (Below right) Another device to make life more difficult for criminals is this new, miniaturized night-vision scope. Similar to units that have been used by the Army in Vietnam, this commercially available device amplifies existing light more than ten thousand times. Using only the very faint, scattered nighttime light, such as from the stars or the moon, it is possible to see a man at up to about 850 feet or a vehicle at up to about 2000 feet. The night-vision scope, produced by Raytheon, uses an advanced image-intensifier tube.



Electronic Type Composition

By EDWARD A. LACY



Fig. 1. New electronic photocomposing unit, controlled by an IBM System/360 computer, can set a newspaper page in ten seconds and a full-length novel in approximately ten minutes.

Description of some of the computer-driven, electronic type-composition systems being used by an ever-increasing number of newspaper, magazine, and book publishers today in order to keep pace with the print explosion.

THESE days, electronic composition has nothing to do with music—it's the complicated process of using a computer-driven cathode-ray tube to compose type for newspapers, magazines, and books. With its phenomenal speed, it seems destined, at least in the larger printing shops,

to put the clanking, cumbersome typesetting machines out of business.

And not a moment too soon, for conventional typesetting machines are simply too slow and costly for today's print explosion. Whereas hot-metal type linecasting machines may take eight minutes to compose a typical page, RCA's 70/280 Videocomp, for example, can set the same page in 12 seconds. IBM's 2680 CRT printer (Fig. 1) can set graphic-quality type at speeds as high as 6000 characters per second; and it can compose a 300-page novel in less than 10 minutes.

Despite a price tag of \$250,000 to \$500,000, several electronic type-composition systems are already in use throughout the country. They are being used to set type for telephone and company directories, dictionaries, abstracts, indexes, and military documents.

The Government Printing Office, the country's largest printer, is using a Linotron 1010, built by *Mergenthaler-Linotype-CBS Laboratories*, to compose type for some of its annual workload of approximately 20 billion pages. Since most of the nation's printers are nowhere near as large as GPO, how soon they will adopt computer-driven CRT composition depends not only on bringing down the cost but on its acceptance by printing unions.

In recent years printers have been making use of electronics to control printing presses and binding machines and to control distribution, both in mailrooms and on shipping docks. In some instances they are using facsimile to send pageproofs over long distances by way of telephone lines and satellite. Just around the corner is newspaper editing on a CRT with a "light" pen instead of on paper with blue pencil. None of these applications, however, has had the dramatic impact of electronic typesetting.

In many businesses, conventional electric typewriters are

Fig. 2. Examples of text (A) produced from typewritten camera copy and (B) photocomposed from computer-generated magnetic tape, taken from "Electronic Composing Systems, a Guide for its Utilization," printed by Government Printing Office. In (B) readability is better while text bulk has been reduced 40%. (Examples have been considerably reduced in size.)

AD-419 819 Div. 2
OTS Price \$2.60

Sacramento Peak Observatory, Sunspot, N. Mex.
THE BRIGHTNESS OF FLOCCULI, MAGNETIC FIELDS AND MECHANISMS OF HEATING,
by V. E. Stepanov and N. N. Petrova, tr. by Alice B. Dunn. 1963, 25p.
SPO SRN43 Unclassified report

Trans. from Izvestiya Krimskoi Ast. Obs. XXI, pp. 152-179, 1959.

Descriptors: (*Solar atmosphere, Magnetic fields), Magnetic fields, Heating, Brightness, Rings, Time, Luminance, Propagation, Shock waves, Magnetohydrodynamics, Solar flares.

For fields with H less than 70 Gauss the brightness of flocculi increases in the mean with the increase in field strength. For fields with H greater than 70 Gauss the brightness of the flocculi decreases with increasing field strength. The study of the change of the form of flocculi and the magnetic field with time showed that the magnetic field influences the formation of flocculi. There are two mechanisms of flocculi formation. The first is connected with the development of rapid processes: flares and possibly sunspots. The second mechanism is also of an electromagnetic nature and is evidently connected with the absorption of the disturbances in the regions where the field strength carried by the wave is larger than the strength of the external field. The strength of the magnetohydrodynamic wave has been estimated. The difficulties met with by the explanation of the heating of flocculi as a result of the absorption of magnetohydrodynamic waves are enumerated. (Author)

(A)

AD-419 819 Div. 2
OTS Price \$2.60
SACRAMENTO PEAK OBSERVATORY,
THE BRIGHTNESS OF FLOCCULI, MAGNETIC FIELDS AND MECHANISMS OF HEATING,
by V. E. Stepanov and N. N. Petrova, tr. by Alice B. Dunn. 1963, 25p.
SPO SRN43 Unclassified report

Trans. from Izvestiya Krimskoi Ast. Obs. XXI, pp. 152-179, 1959.

Descriptors: (*Solar atmosphere, Magnetic fields), Magnetic fields, Heating, Brightness, Rings, Time, Luminance, Propagation, Shock waves, Magnetohydrodynamics, Solar flares.

For fields with H less than 70 Gauss the brightness of flocculi increases in the mean with the increase in field strength. In fields with H greater than 70 Gauss the brightness of the flocculi decreases with increasing field strength. The study of the change of the form of flocculi and the magnetic field with time showed that the magnetic field influences the formation of flocculi. There are two mechanisms of rapid processes: flares and possibly sunspots. The second mechanism is also of an electromagnetic nature and is evidently connected with the absorption of the disturbances in the regions where the field strength carried by the wave is larger than the strength of the external field. The strength of the magnetohydrodynamic wave has been estimated. The difficulties met with by the explanation of the heating of flocculi as a result of the absorption of magnetohydrodynamic waves are enumerated. (Author)

(B)

used to type reports, etc., directly onto paper offset-printing masters, such as Multilith, which are reproduced on photo-offset lithographic machines. In a variation of this technique, the typewritten copy is photographed; the line negatives are then "developed" on metal plates which are placed on the Multilith machines. Typically, such reports have fairly limited circulation and appearance is secondary to transfer of information, although the material must be legible and neat. No matter how good the printing is, it's all too obvious that the text has been composed on a typewriter. Hot-type line-casting machines such as Linotype (a tradename) are too expensive for such limited quantities and are rarely used for this purpose.

On the other hand, in newspapers, books, and magazines the reading public demands (perhaps subconsciously, if not overtly) top quality hot-type composition, which means justified copy and varieties of type sizes and styles. By "justified copy," we mean that the right margin of the printed column is as smooth and even as the left side. Justification is obtained by varying the spacing between words and, where necessary, breaking the last word at a syllable.

Linecasting machines can justify copy and provide numerous type faces and sizes. To increase the speed of these machines, printers have adopted punched-paper tape inputs. RCA began using this technique in the early 1960's by having a computer generate a paper tape loaded with instructions on justification and hyphenation as well as copy information.

Hyphenation of words can be a difficult process because of the inconsistencies in the English language. Thus, in practical systems, the computer will attempt to vary word spacing (within limits) in order to obtain justified copy before it will attempt to break the last word and use a hyphen.

One technique in computer-generated hyphenation is to use grammatical and logical rules for hyphenation and then check the word against an exceptions list stored in the computer. It's not 100 percent perfect, but neither is the human editor/operator.

Once this rather difficult computer routine for justification and hyphenation was worked out, the next step was to use computer-generated tapes to control electro-mechanical optical phototype composing machines. Finally, all-electronic type composition, using CRT's to form characters and then project them on film or short-run offset masters, was developed.

Linotron Model 1010

At the GPO, an IBM 360/50 computer is used to prepare the input magnetic tape for the Linotron. In the Linotron, characters placed on a glass plate grid are optically projected onto the face of a character-generator tube. The video signal for the selected character is sent to the display CRT where it is positioned according to the desired location on the output page. The image on the CRT is projected through lenses to photographic film and an entire page is composed before the film is advanced. The Model 1010 has a maximum image size of 48 x 63 picas (8" x 10½") and a speed (which varies with character size) of 620 characters per second for 10-point (normal book-size) type.

Before installation of the Linotron, the GPO, like numerous companies and organizations, had been using the output of a computer line printer as copy for the photo-offset printing process. While this was and is a fast method of preparing copy, each character in this type of printout takes the same amount of space, and vertical line spacing is fixed. Consequently, such composition is monotonous and seems strange to the reader, especially since most printed matter uses proportionally spaced type.

In the latter process, different letters take up different amounts of space in the line, some more, some less than monospace characters. On the average, however, proportional spacing and variable vertical-line spacing takes up to

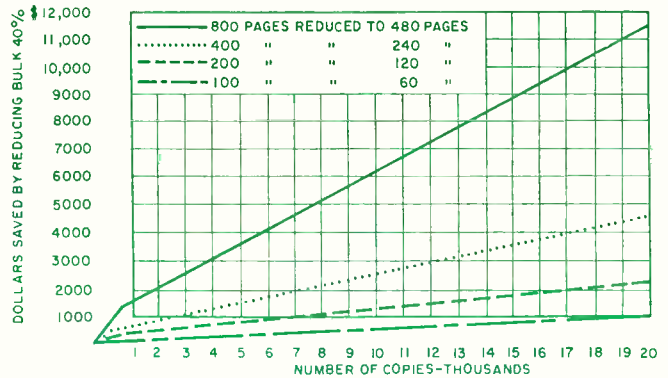

Fig. 3. Graph taken from "Electronic Composing System, a Guide for its Utilization," that shows the cost savings possible by reducing a publication's bulk by forty percent.

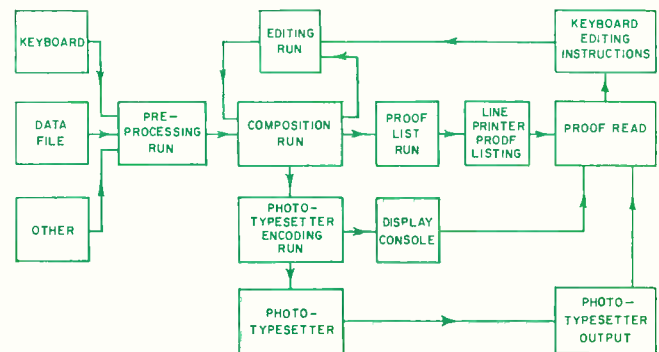

Fig. 4. Flow diagram of Fototronic-CRT typesetting system.

40 percent less page space than the same words printed with monospace characters, Fig. 2. But even with this saving, there is no feeling of crowding or eyestraining reduction; on the contrary, proportional spacing is much easier to read.

Linotron takes advantage of this technique in the following manner: A computer records its output on a magnetic tape instead of on paper with a line printer. This tape is then processed by an IBM 360 computer to create an input tape for the Linotron, which will compose the document with proportionally spaced characters. By cutting a number of pages from the document, considerable savings are possible, especially on "fat" printouts of many copies, as shown in Fig. 3.

RCA Videocomp

The RCA Videocomp 70/830 Series video composition system can produce fully made-up pages in four seconds; it has a peak character-writing speed of up to 6000 characters per second, depending on point size, line length, and type face. VideoFont type faces for the unit come in five size ranges, from 4 to 96 point. (In printing terminology, a point is approximately equal to 0.014 inch.) Line length can be up to 70 picas (6 picas = 1 inch).

An RCA Spectra 70 computer can be used to prepare the input tape for the Videocomp. Two magnetic tape drives can read industry-compatible 9-level tape at 800 bits per inch with a reading speed of up to 30,000 characters per second. The input information contains text, font, and command codes.

VideoFont patterns are stored in the core memory, which contains either 16,384; 32,768; or 65,536 bytes for storage of digitized font pattern information. Each font generally consists of 80 characters. Special letters and symbols, including mathematical symbols and foreign alphabets can also be stored. Through electronics, each character can be altered to form roman, oblique, extended, or condensed versions of the basic font.

In the logic and display section, analog and digital circuits generate the proper size character and position it on the

CRT. Characters are written on the CRT in an area 70 picas wide by 96 points high. For quality reproduction the characters are written with 1800 strokes per inch. For a fast look, just for proofreading, only 112.5 strokes per inch are used. The output of the Videocomp can be film, stabilization paper, or short-run offset plates.

Basic price for the unit is about \$300,000.

Intertype Fototronic

Intertype Company's (a division of Harris-Intertype Corp.) Fototronic-CRT typesetting system can generate 7-point type at a rate of 1000 to 1500 characters per second. Smaller type can be set considerably faster, larger type slower. Image width varies from 8½ to 16 inches, depending on the model. Type can be set in sizes from 4 to 24 point

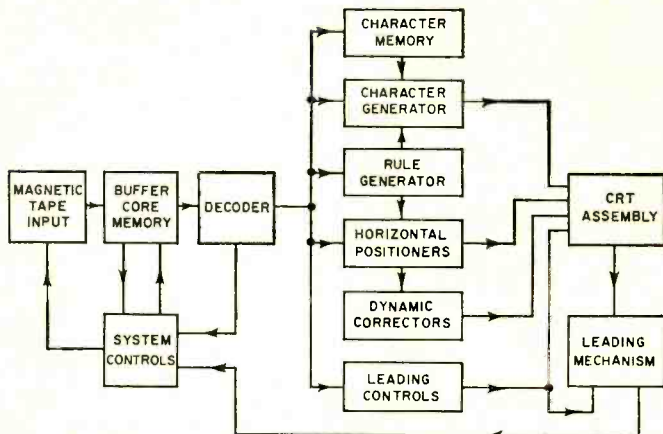

Fig. 5. Functional block diagram of the CRT phototypesetter.

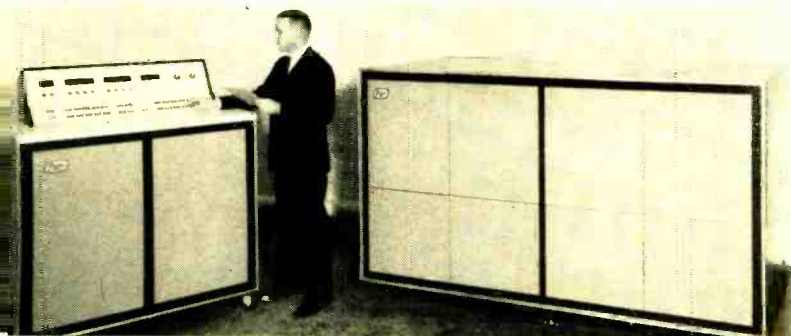
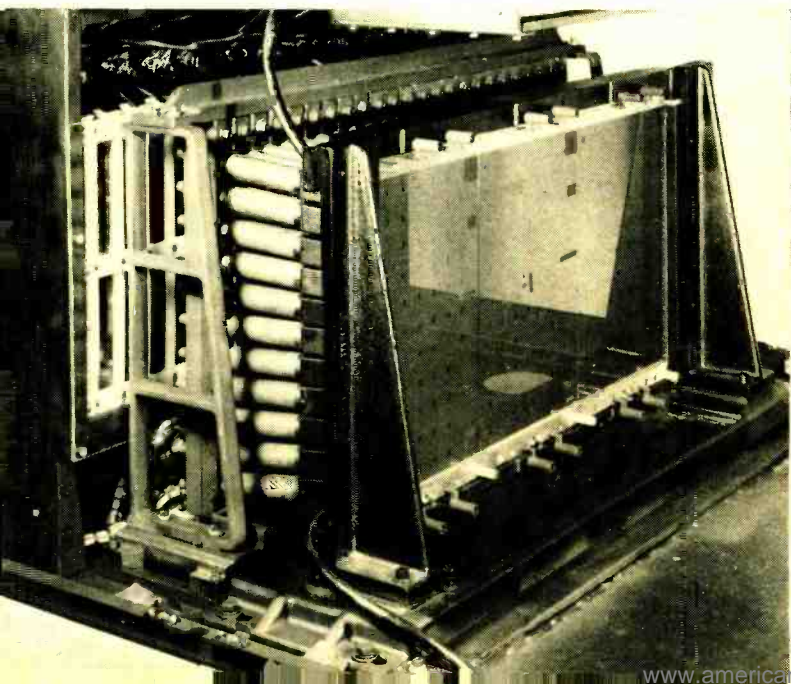

Fig. 6. Photon's ZIP 901 electronic type-composition system.

Fig. 7. Stationary glass grid for the ZIP 901 system that stores 264 alphanumeric characters as transparent images.



with a resolution up to 1000 lines per inch. A flow diagram of the Fototronic-CRT system is shown in Fig. 4 and a functional block diagram of the CRT phototypesetter in Fig. 5.

A 9-channel magnetic tape containing all copy and typesetting codes is the input to the Fototronic-CRT system. The standard model is compatible with all major computers. Data is recorded on the tape by the computer in blocks of 1024 nine-bit bytes, each representing an individual alphanumeric character of command. The tape is read and the data is stored in a buffer memory (Fig. 5) which has a continuous capacity of 1024 bytes, or codes. One code at a time is released by the buffer to the decoder, which interprets the code and sends it to the circuit it is meant to control.

A character or symbol is called up from the memory unit in digital form and forwarded to the CRT where it is projected onto film or paper. Characters in storage can be expanded, condensed, or slanted electronically to create additional type faces. Depending on the configuration, the Fototronic-CRT costs from \$300,000 to \$500,000.

IBM 2680 CRT Printer

The 2680 CRT printer is controlled by an IBM System 360 computer. Draft copy is fed into the computer on paper or magnetic tape, and the computer is then told the sizes (up to 18 point), styles, and formats of the type to use and is instructed to prepare the text. The finished text is composed on a CRT whose image is projected onto film. Purchase price is \$387,000.

Photon ZIP 901

Unlike the preceding systems, Photon's ZIP 901 (Fig. 6) does not use CRT's to form type characters. Instead, 264 alphanumeric characters are stored as negative (transparent) images on a stationary glass grid (Fig. 7). Each character has its own xenon flash which emits a 2-microsecond light burst through the grid to a laterally moving lens which delivers the character image to photo film or paper. The film or paper moves only for line spacing.

ZIP 901 produces 500 to 800 characters per second depending on line length and type font used. Line drawings and halftone photos can be imaged and positioned with ZIP's optional graphic insertion capability.

Cost of the basic unit is \$250,000, while Photon's 713 series Textmaster units, which are similar in some respects to the ZIP 901, costs from \$24,000 to \$63,500.

The 713's optical system consists of two photo-matrix strips mounted on a revolving drum. Xenon tube light flashes of 1.5 microseconds cast the character image. The beam passes through the photo matrix to one of eight lenses which projects the image in desired point size onto photo-sensitive film or paper. Model 713-40 has a speed of 60- to 70-newspaper lines of 30-character, 9-point type per minute. The unit decides for itself the right line breaks and inter-word spaces to justify copy without hyphens.

Photon has compiled the following cost comparison for its non-CRT electronically controlled photo-composition unit for setting a 12,000 word, 16-page, 8½ × 11 inch booklet, 19-pica column width, 10 point leaded 2 points, with occasional mix of matching italic and bold face plus 12-point and 18-point heads and subheads: \$0.74—straight keyboard line-casting equipment; \$0.37—by the 713-10 using same keyboard as with linecaster.

Wherever they have been tried, electronic type composition systems have been pressed into service. In 1967, the National Bureau of Standards sponsored a symposium on electronic composition in printing; when they distributed the proceedings of the convention, they attached this note:

"Although these proceedings deal with radically new printing techniques, they were produced by conventional methods because the limited NBS facilities to prepare machine-readable copy for photo-composition were fully committed to priority scientific programs." ▲

LARGE-SCALE INTEGRATION

By DAVID L. HEISERMAN

Is this the beginning of the LSI era? Here are some of the problems confronting semiconductor manufacturers in going to LSI, along with the main features of presently available LSI devices.

LARGE-scale integrated circuits (LSI's) are starting to find their way into the electronics industry, and by the end of 1970, LSI manufacturers expect to be making routine production runs of both standard and custom LSI circuits.

The transition from IC to LSI thinking has posed a number of problems not anticipated by most semiconductor laboratories and to solve these problems the semiconductor industry has had to resort to an almost total overhaul of its design, fabrication, and marketing methods. This article outlines the problems R&D labs faced, describes the solutions to some of the difficulties, and summarizes the main features of a number of the LSI devices available today.

What is MSI/LSI?

The terms "medium-scale integration" (MSI) and "LSI" refer to the relative number of active components inside one device. Generally speaking, an MSI circuit is made up of as many as 100 integrated components, while an LSI circuit is one having the equivalent of 100 or more transistors in a single package.

A large percentage of an IC chip area contains the metalization that intraconnects the integrated components. Therefore, to achieve the component densities required for MSI and LSI circuits, the intraconnecting metalization and oxide dielectric layers must be stacked (see Fig. 1) so that most of the chip area is available for integrated components.

The unique features of MSI and LSI circuits are high component densities and multiple metalization layers. To date, no authoritative definition of the precise differences among MSI, LSI, and ordinary IC's has been established. However, most manufacturers have adopted the arbitrary component-count rule-of-thumb described above, while others define their products in terms of the number of metalization layers; but it is likely the more popular component-count nomenclature will eventually win out.

In principle, there is so little difference between MSI and LSI devices that it is generally convenient to drop the term "MSI" and refer only to "IC" and "LSI" circuits. However, there can be no such convenient blending of terminology in the case of LSI and IC's because the differences between them are so vast that we are justified in talking about them as though they belong to two distinct technologies.

LSI—"Large-Scale Insanity"

A few years ago, LSI design labs faced two critical problems: making LSI work, and making it work economically. Today, the industry is well on its way to solving the fundamental problems of making workable circuits. *Motorola Semiconductor* recently announced a prototype "infinite array" that has a density of over 250,000 components per

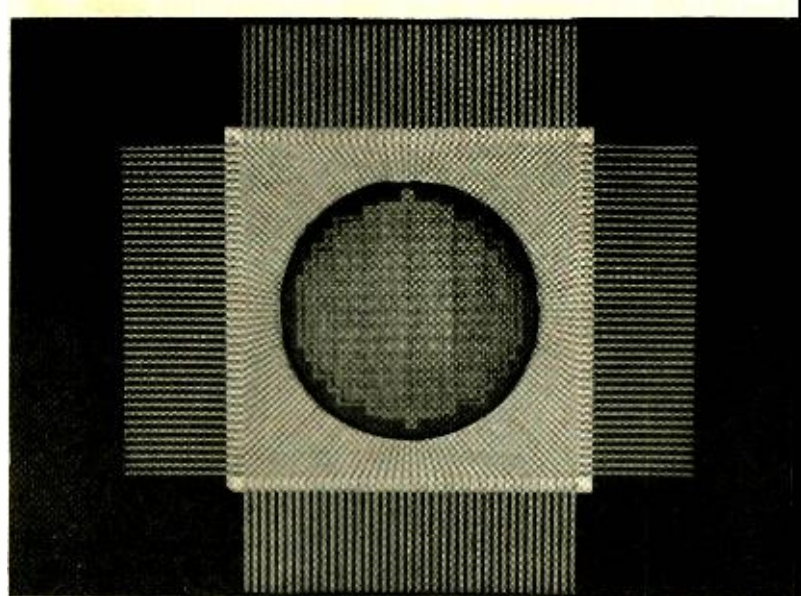

Texas Instruments' 156-pin flat-pack experimental LSI circuit.

square inch. Quoting from a *Motorola* publication, "Most everyone, today, can make large-scale integrated circuits. The problems are in making them at the right price."

About three years ago, discussions of the problems facing LSI R&D labs were not very encouraging. Many observers believed, for example, that the production yields of good LSI devices would be less than 0.5 percent. It appeared that the number of in/out terminals would be absurdly large and that the output power capability, operating voltage levels, and the quality of intracomponent isolation would severely limit component density. A satisfactory final-testing program was thought to be impossible because it would take 10^{16} years to completely test a 100-gate LSI at the rate of 10^8 tests per second while non-technical problems such as production lead times and unpredictable product delivery because of low yields seemed to make matters a hundred times worse. One of the principal reasons for using LSI was to reduce the total number of individual devices in an electronic system, thus LSI customers would be demanding smaller quantities of LSI packages—a situation that violates one basic rule of economics.

Such a pessimistic view of LSI technology was based primarily on extensions of ordinary integrated-circuit know-how. Today's LSI suppliers realize that standard IC thinking is inadequate for LSI from the first step of initial product design to customer delivery. LSI experts have had to completely revamp their ideas of how things can be designed, manufactured, tested, and sold. Many problems still exist, of course, but the first LSI computers are operating in the field, and the electronics industry is looking forward to 1970 as *the* year of the LSI.

Part of the reason for the twenty-year lag between the de-

Fig. 1. Intraconnecting metalization for MSI and LSI circuits. Metalization and insulation are stacked in layers so that most of the substrate area is available for integrated components.

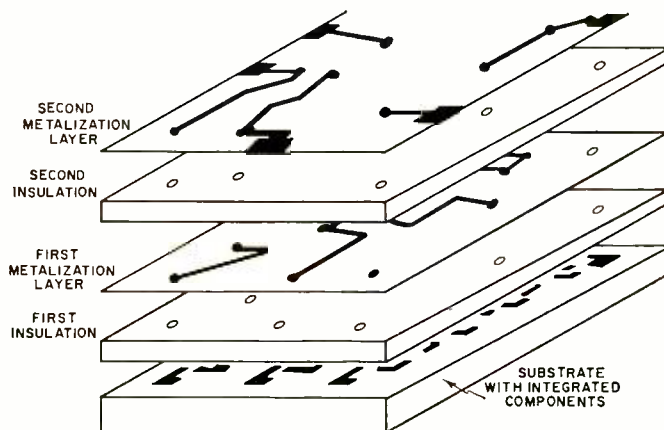

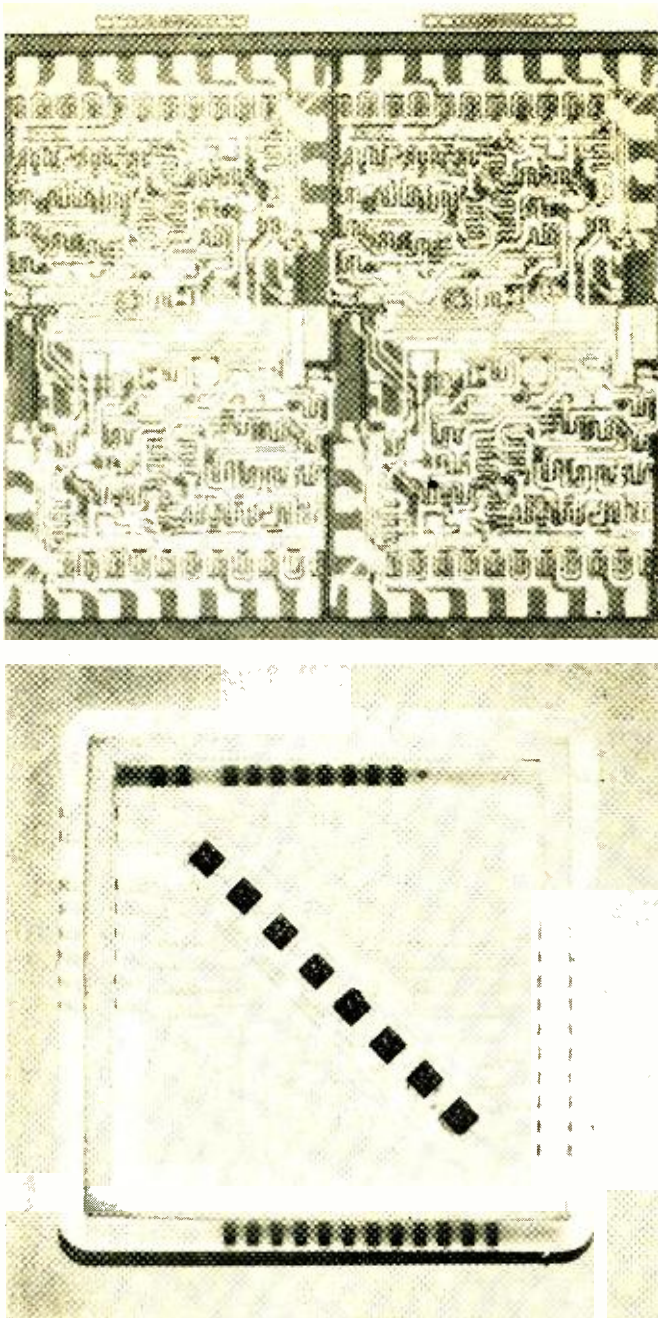

Fig. 2. (Top) Motorola's LSI 8-bit monolithic and (bottom) hybrid full adders. Monolithic LSI version has total of 448 components on 46 x 110 thousandths of an inch die. Hybrid version has eight individual logic chips on the ceramic substrate.

velopment of the transistor and the integrated circuit was because no one had found an inexpensive and reliable way of separating one transistor from another on the same chip. However, the problem was eliminated when the idea of bipolar isolation—isolating one component from another by a series of reverse-biased $p-n$ junctions—was conceived by IC researchers.

Problem-plagued LSI labs immediately thought of borrowing the bipolar-isolation technique for their own use. But, instead of isolating one active component from the others, the thin alternating p - and n -bipolar diffusions of LSI tend to behave like multiple-layer semiconductors. Thus, if a bipolar LSI is not laid out carefully, it is possible to set up SCR-like latch-ups between the so-called isolated components. To some extent, clever engineering and use of computer-aided design (CAD) can avoid such undesirable interactions, although in some cases even CAD has proven inadequate. Consequently, LSI labs are developing and marketing de-

VICES using an alternate isolation technique, known as MOS.

Metal-oxide-semiconductor technology has completely changed the electronic profile of transistors in recent years. Field-effect transistors are rapidly replacing bipolar transistors in many applications and are making it possible to use semiconductors in circuits that have always required the high-impedance characteristics of vacuum tubes.

Theoretically, MOS isolation is simple: merely place a thin layer of a metal-oxide insulation between the components. In practice, engineers have had too many bad experiences with MOSFET's to call the technique simple. Some of the problems with early MOS devices were due to small holes and bits of foreign matter in the oxide layers which led to voltage breakdowns, component instabilities, and low production yields. All of the bugs have not been worked out of the MOS technique as yet, but an increasing number of LSI laboratories are committing their R&D funds to perfecting MOS devices.

MOS improves component isolation and thus permits a 40- to 50-percent increase in component density. Therefore, it would be beneficial for a company tooling up for MOS-LSI isolation to produce LSI's having all MOS semiconductors on the chips—field-effect transistors rather than a junction type that is natural with bipolar isolation. Using MOS devices limits the speed of the device somewhat but increases the in/out impedances and makes it possible to interchange source and drain connections. The latter feature is especially useful when laying out intraconnecting metalization routings. MOS- and bipolar-LSI circuits have their own advantages and disadvantages, and it is not likely that one technique will ever "win out" over the other. LSI's of the future will be MOS, bipolar, and combinations of the two.

Today it is possible to place hundreds of components on a single silicon chip, and *General Instrument*, making use of this technique, will soon market a monolithic A/D-D/A converter LSI having 275 active MOS elements. In addition, present capabilities make it possible to tie together several simple monolithic chips to make one complex hybrid LSI package. To analyze the monolithic vs hybrid question, *Motorola Semiconductor* has produced two versions of an 8-bit adder. One version (Fig. 2, top), which is a true monolithic LSI system, has all eight adder circuits integrated on a single chip and uses multi-layer metalization to intraconnect the components. The hybrid version (Fig. 2, bottom) is made up of eight individual IC adder chips tied together by thin-film "printed-circuit" tracks.

Hybrid circuits offer several advantages over their monolithic counterparts. First, it is possible to inspect each chip before it is installed on the thin-film board, thus every LSI at the end of the assembly line is likely to be a good one. The second advantage of the hybrids is that they can be repaired when necessary, unlike a monolithic LSI circuit where losing one critical gate completely destroys its usefulness. The third and most outstanding advantage—lower cost for custom LSI devices—is obtained when a manufacturer can select several kinds of off-the-shelf IC "flip-chips," and interconnect them with thin-film tracks, rather than generating a complete set of masks and tooling up for a short monolithic production run. Finally, it is possible to market the individual flip-chips in raw form or package them as ordinary IC's.

However, LSI monolithics have one important advantage over the hybrid versions; it is less costly to make large quantities of monolithics because fewer individual production steps are involved. Because of the cost advantage, monolithic LSI circuits are beginning to dominate the LSI catalogues and we can expect all standard LSI circuits to take the monolithic form in the near future.

At a time when it is not uncommon to have a production yield of nearly 100 percent for medium-power discrete transistors, it is just as likely to have a less than 0.1 percent yield for LSI circuits fabricated by the usual "100 percent yield" technique. According to this technique, all components in an

LSI package have to be functional if the device is to be considered usable. Since it is unlikely that every gate on a 100-gate LSI chip will be within specifications, LSI laboratories have had to develop some alternate techniques.

One way to assure a 100 percent production yield is to use the hybrid-LSI approach outlined earlier since the less sophisticated chips that make up a hybrid-LSI circuit are relatively easy to manufacture with high yields. Hybrids are costly to manufacture and it is unlikely that the industry will be able to justify the added expense merely to obtain higher LSI yields.

The best solution to the LSI-yield problem appears to be a radically new idea called discretionary routing, which is a technique that recognizes the fact that at least 30 percent of the transistors on a monolithic LSI chip will be defective. Consequently, the engineer designs the substrate masks allowing for about 30 percent more transistors than the schematic calls for. As a result, when the substrate is completed, the probability that there will be enough good transistors to make the circuit perform its intended task is high and the only remaining problem is to find the defective transistors.

The functioning transistors are relatively easy to find using automated testing techniques that not only test the gates, but also informs a computer as to their location on the chip. The computer uses this information to generate the mask for the metalization layers, resulting in each LSI circuit having its own metalization layout.

LSI Compatibility

A reduction in the size of active components on the same chip would make it difficult to match the LSI input and output stages with external devices such as IC's and discrete transistors. Of course, although each tiny integrated component is compatible with every other component on the same chip, an LSI output transistor cannot begin to drive an external transistor having 100 times the chip area. If, on the other hand, all of the LSI transistors were made large enough to drive external discrete transistors, it would be impossible to place one hundred active devices on one small chip.

This problem is avoided by making the in/out LSI transistors large compared to the others on the chip. Fig. 3 shows how the hundreds of microscopic LSI elements, not communicating with external devices, can be clustered in the middle of the chip. Even if the LSI chip area is divided equally between the large in/out buffers and internal gates, it is still possible to have twenty or thirty buffers and several hundred internal gates.

The number of I/O terminals on the LSI package is also a problem. Fortunately, the number of leads required is determined more by the function of the LSI than by the complexity of the circuit. One of the tasks of CAD is to minimize the number of I/O terminals while increasing the operational complexity of the LSI device.

CAD or cut-and-try, the LSI engineer is still faced with other kinds of I/O lead problems. Broken connections between bonding pads and external leads have plagued semiconductor manufacturers for twenty-five years; the chances of a connection failing for monolithic LSI circuits having forty or fifty leads approaches even odds. Ultrasonic and laser-welding techniques will soon reduce this reliability problem to more manageable proportions in the near future.

LSI circuits with a large number of I/O leads also cause the instrument manufacturer some headaches. Printed-circuit board conductors connecting several LSI circuits together can take up much of the space saved by using LSI rather than IC's. Likewise, one package having dozens of leads increases the possibility of wiring errors and shorted external connections. The hope is that a new instrument fabrication technique, analogous to the printed-circuit process for transistors and IC's, will soon be available. However, until that day arrives, CAD and highly qualified assembly personnel will have to do this job.

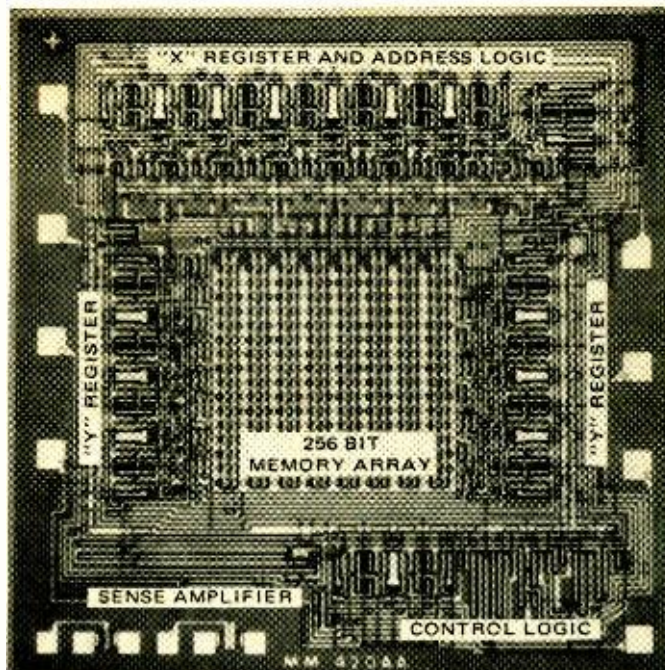

Fig. 3. National Semiconductor's 256-bit ROM. The relatively large, power-handling components are placed around the outside of the chip while the small, internally connected active LSI elements are clustered in the center of chip, as shown.

Off-the-Shelf Custom LSI

Part of the "insanity" in LSI is due to the fact that the number of different kinds of LSI circuits in demand just about equals the number of customers demanding them. LSI manufacturers are now selling a number of LSI devices designed for use in conventional digital systems. Customers who would like to use a small number of LSI circuits for a non-standard purpose would ordinarily have to pay \$20,000 or so for a run of purely custom LSI circuits. One way to offset this exorbitant cost is with the off-the-shelf custom approach.

The apparently contradictory terms "off-the-shelf" and "custom" apply aptly to a new concept in production and marketing that makes an almost limitless variety of LSI circuits available in small quantities and at a reasonable price. Using this approach, the LSI manufacturer stocks a large inventory of standard LSI gate arrays that have the second metalization layer missing (Fig. 4, top). A potential customer orders a design kit consisting of a schematic of the substrate and first metalization layer (Fig. 4, center) and a set of rules for laying out his own second metal layer. The customer then decides how he wants the standard cells intracommunicated, and sends the information back to the LSI manufacturer.

All the manufacturer has to do is make a mask for the second metalization, deposit this layer on the standard arrays drawn from stock, test them, and send them to the customer (Fig. 4, bottom). The enormous tooling costs are amortized over the manufacturer's entire stock and appear as a small portion of the final cost. Presently, there is a second metalization set-up charge of about \$600, but the LSI devices cost only about \$25 each after the initial charge.

It is still impractical to use only two or three LSI devices in one instrument, but the growing mini-computer business is a good example of an area where the off-the-shelf custom concept can pay off.

Standard Devices and Applications

Standard LSI products are usually those that are completely designed, fabricated, tested, packaged, and stocked by the manufacturer. The standard products available today are necessarily those LSI devices that stand the best chance of being sold in relatively large quantities. Initial production costs for such packages may run anywhere from \$10,000 to

\$25,000, depending upon the complexity of the system, the manufacturing techniques employed, and the amount of experience the manufacturer has had with LSI in the past. Although the engineering and production costs are amortized over the entire stock of usable LSI devices, the circuits generally cost the customer anywhere from \$50 to \$250 each.

Fairchild Semiconductor is one of the leaders in the LSI business today, so its breakdown of standard LSI devices, shown in Fig. 5, serves as an indication of what is available throughout the industry. The summary of devices and applications that follows is by no means complete, and does not include the names of all manufacturers and laboratories that have made valuable contributions to the LSI art. It does, however, show the state of the LSI industry today and for 1970.

Logic Building Blocks and Subsystems: The only difference between MSI/LSI logic building blocks and ordinary IC-logic circuits is the quantity of gates or flip-flops inside a package. Ten of the popular quad two-input *nand/nor* gates can be replaced by a single MSI chip having ten two-input logic gates, and five ordinary dual J-K flip-flops can be replaced by an LSI hybrid with five dual flip-flops connected together on the same ceramic base. LSI logic building blocks will also contain circuits to perform more than one kind of logic function. Such a package may contain several different types of logic gates, some flip-flops, and a small diode matrix. Part of the programming for these multi-function logic packages may be done on an external printed-circuit board.

Logic subsystems are complete functional digital units, such as up-down decade counters, accumulators, and full arithmetic units. An example of the latter subsystem is *Motorola's* bipolar dual full adder, the MC796, available in a 14-lead dual in-line plastic package selling for \$17.00. *General Instrument* has an MOS-LSI binary up-down counter that comes in a 24-lead flat pack that contains 160 MOS devices on a monolithic chip.

Shift Registers: The shift register packages make up one of the most popular lines of MSI/LSI devices available today. The *General Instrument* hybrid type MEM 3128-2 contains two MOS 128-bit dynamic shift registers, each on its own chip, and packaged in a 14-lead dual in-line case. Another example of an LSI shift-register system is *Fairchild's* 3300, an MOS monolithic register with a 25-bit capacity packaged in a 10-lead TO-100 case.

MOS Memory: The high-impedance, low-power-consumption characteristic of MOS devices makes them almost ideal data storage elements. The highest density LSI devices available are the MOS memories, and they are presently competing with the traditional ferrite-core memories for applications in instruments requiring only a limited or temporary data storage capability. As the LSI industry develops, the low cost of the small MOS memory units will make inexpensive computers available to small offices and businesses, and even the home.

Purely off-the-shelf MOS memories will have very small storage capacities during the first part of the 1970's. *General Instrument* is now marketing a 32-bit monolithic random-access memory that is made up of 32 storage flip-flops and comes in a 14-lead dual in-line package. The total memory capacity can be extended by using a number of the LSI packages.

Customers will have to specify the last metalization routing for the high capacity MOS/LSI memories coming in late 1969. *Fairchild* has announced a 4096-bit monolithic read-only memory and, according to the advance specifications, the customer will determine the (Continued on page 78)

Fig. 4. Approach used by MSI/LSI manufacturers to cut cost of MSI/LSI devices. (Top) *Motorola's* XC157 12-gate off-the-shelf custom MSI circuit shows basic substrate layout and first metalization layer. (Center) Schematic of XC157 sent to customer along with rules for laying out his own second metal layer. (Bottom) XC157 after customer's metalization layer has been made. Circuit is now four-channel clocked latch.

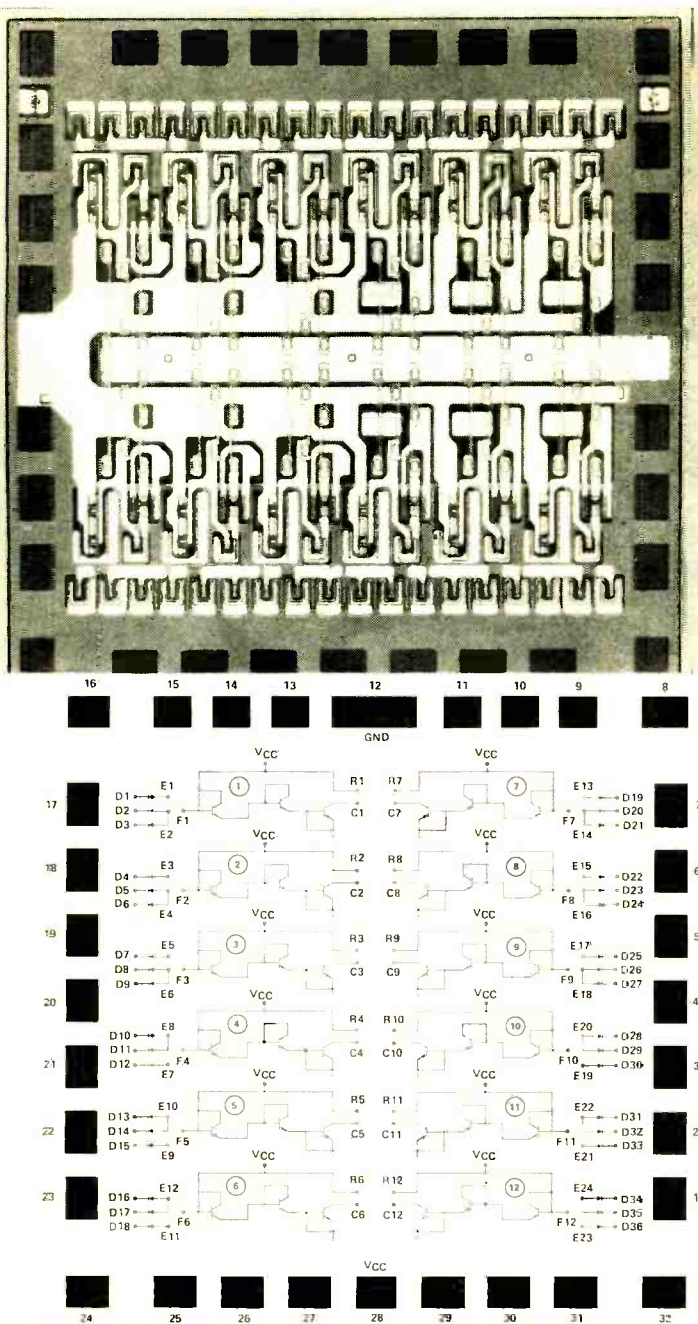

Control of R.F. Interference

By JAMES HAWK

Some common causes of RFI and effective techniques that may be used to alleviate or eliminate this ubiquitous problem are discussed.

EVERY radioman knows the meaning of QRM and QRN, the international Q signals used to describe radio-frequency interference (RFI) by man-made signals and static. In the time since these Q signals were devised, impressive advancements have been made in communications systems, as well as in the control of RFI.

The performance of a communications system may be described using a probability of successfully transmitting and receiving a given piece of information between two points, either by wire or by radiation, based upon a signal-to-noise ratio and the modulation pattern. The threshold of the system is usually stated as "what the probability is along with other conditions of operation." All communications systems have such a threshold, and RFI is important to the extent that the threshold is adversely affected.

The control of RFI involves three things: signal characteristics, signal paths, and the mechanisms of interference, that is, the signal, the path, and the mechanism.

Investigation of the signal issue involves such things as waveshapes, frequencies, repetition rates, signal timing, levels, and similar characteristics of the interfering signal, and is not considered difficult or complicated. However, investigation of the path and mechanism of the interference problem is sometimes difficult, time-consuming, and complicated.

Interference Paths

The interfering signal usually enters the unit being interfered with by means of a signal path (control lines, oscillator inputs, etc.), a common-ground impedance, or a power-supply voltage.

Coupling to the signal route of entry occurs by means of electromagnetic radiation, transformer coupling, capacitive coupling, or by means of circuit coupling to the signal wire itself from within another unit. Particularly difficult RFI problems are developed when combinations of these entry points and coupling paths exist. The conventional theories regarding radiation, transformer action, and capacitance are used in the evaluation of the means of coupling. A change in the physical distance between the coupling elements involved will usually provide sufficient diagnostic data.

The correction of problems associated with common grounds and common power-supply voltages can be difficult if consideration has not been given to these problems during the design phase of the equipment. This is especially true in the case of common-ground impedances that are frequently developed from chassis elements such as mount-

ing frames, racks, or drawers, which cannot be easily changed.

For some kinds of common-ground impedance problems, the RFI may become worse with the use of low-resistance ground straps. An example of this is shown in both Fig. 1, a pictorial presentation of how a common-ground impedance might be developed and Fig. 2, a schematic representation of the same situation. In Fig. 2, the voltage across R1 will be the sum of the battery voltage and the voltages across R3 and R4. The voltage developed across R4 is a function of the ground currents of both the radio and the ignition unit. Thus, the voltage across R1 will have a component which is a function of the current drawn by the ignition unit. The lower the value of R2, which is the resistance of the ignition unit ground path, the higher the interference voltage across R1. The interfering signal in this case would very likely take the form of ignition interference on AM reception, especially in areas of weak AM signals. If an electronic capacitor-discharge ignition system were being used, the interfering signal could include a harmonic of the d.c.-d.c. converter operating frequency.

In such interference cases, the correct thing is to separate the two ground paths completely, as shown in Fig. 3. Low-resistance ground straps are then helpful, as they reduce the I^2R losses of both R2 and R3. The same kind of problem can exist with signal-ground paths, as well as battery or power-supply ground paths.

The configuration shown in Fig. 3 (ground paths separated) still has the internal impedance of the battery in common, as well as the battery's hot terminal lead, either of which may give rise to an RFI problem. However, it's worth remembering that when everything possible has been done to reduce the RFI caused by the power-supply leads, or by the internal-source impedance of the battery or power supply, prohibitive interference may still exist as a consequence of a common-ground impedance path.

RFI problems, as a consequence of common power-supply voltages, are familiar problems and are usually dealt with by using decoupling networks and in-line filters. Even though power-supply leads only carry d.c. currents and voltages, they are also capable of carrying and transmitting a wide variety of interfering signals unless specific provisions, such as shielding and isolated routing, are taken to prevent them from doing so. Also, while the d.c. currents travel in one direction through the wires, the interfering signals may travel in either direction. Having one large power supply service many chassis should be avoided as it leads to a

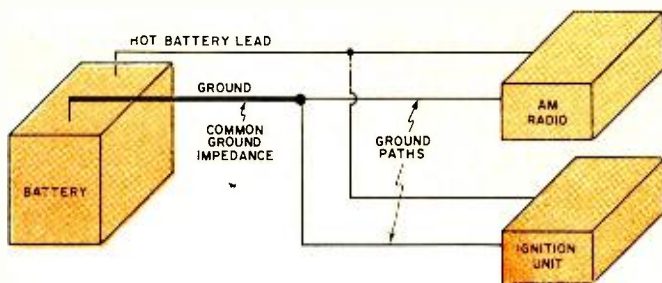

Fig. 1. Diagram showing how a common-ground impedance, a cause of RFI, develops between a car's AM radio and ignition.

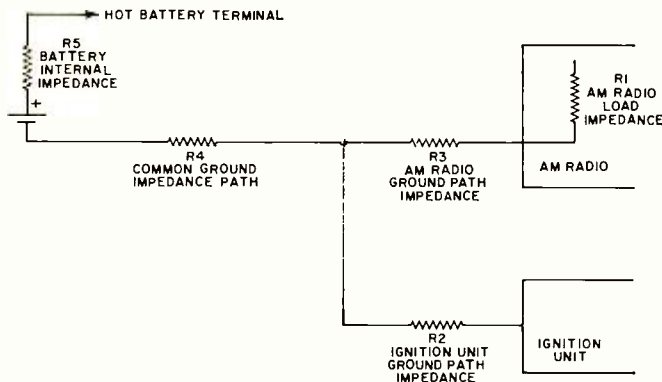

Fig. 2. Schematic of common-ground impedance path. The lower the value of R2 the higher interference voltage across R1.

variety of power-supply problems of which RFI is one. The internal impedance of a power supply can cause RFI in the same fashion as the common-ground impedance path, even though the power supply, because of electronic regulation, has a very low source impedance. This may be especially true when the power supply is used to provide energy for a d.c.-d.c. converter, as the switching times of the converter are fast and current demands large. In such cases, an in-line filter or a decoupling network should be used with power-supply leads that are between units susceptible to interference.

Thresholds

The effectiveness of most variations of the three most popular methods of modulation, AM, FM, and PM, is often-times expressed in terms of how the modulation intelligence is utilized after its removal from the r.f. carrier, the measurement of which is sometimes subjective. Consider, for example, the question of how much noise can be tolerated by a TV viewer while watching an old movie *versus* that which can be tolerated while watching an art show. Attempting to improve an RFI situation, using such criteria, can be frustrating and ineffective. It's better to relate the post-detection signal-to-noise ratio to the pre-detection signal-to-noise ratio using whatever threshold criterion is convenient, and then, while using the pre-detection signal-to-noise ratio as a standard, perform the testing and measuring at the lowest i.f. frequency. The lowest i.f. frequency is usually convenient in terms of test equipment and test techniques.

The most sensitive threshold point to use in determining just how much RFI energy is present is the point at which the noise power just equals the signal power within a known noise bandwidth and in a channel with linear gain. This point is found by first establishing the amount of noise power at the input of the receiver.

The noise power in a one-hertz bandwidth presented to the matched input of a receiver at room temperature is about -174 dBm, and for noise figures greater than 10 dB the amount of power may be increased by the amount of the noise figure with very little error. For noise figures less than 10 dB, increasing the amount of noise power by the noise figure will result in an error which will increase in

magnitude as the noise figure decreases. (See "Low-Noise Receiver Performance Measurements," *ELECTRONICS WORLD*, March 1969 issue.) To determine the amount of noise power in a known noise bandwidth, the noise power at the input is increased by the amount of noise bandwidth expressed in dB. For example, a receiver with a noise figure of 10 dB and a noise bandwidth of 100,000 Hz would have an input noise power of: -174 dBm -10 dB (receiver noise figure) -50 dB (100,000-Hz noise bandwidth expressed in dB) or -114 dBm per 100,000 Hz.

A signal generator connected to the input of the system would cause an r.m.s. meter to read 3 dB higher (3 dB = double the power) when its output was adjusted from zero to -114 dBm, because the signal power would then equal the noise power. This equal-power point is very sensitive to power-level changes in either noise or signal and is thus an excellent indicating point for observing changes in the RFI status.

Mechanisms

The mechanism of interference invariably depends upon the modulation scheme employed. Impulse noise has a much different effect upon a conventional AM system than it does upon an FM or PM system. A few strong noise pulses can seriously interfere with a digital-modulation pattern, and have negligible effect upon an FM/FM scheme. In addition to the variations among systems in terms of the RFI impact, there is the variation of interference effects upon different kinds of circuits. Circuits such as oscillators, mixers, amplifiers, limiters, modulators, demodulators, and switching elements, have their own RFI susceptibility pattern. Consequently, depending on the circuit, the RFI problem can be solved by modifying the circuit mechanism either by adding or subtracting gain, balancing a previously unbalanced demodulator, or placing the entire circuit in a separately shielded enclosure.

Control Techniques

The control of signal-ground impedances is sometimes accomplished by using a balanced-transmission system with an optional center-tap ground (Fig. 4). Most problems involving common-ground paths are avoided and, if tuned transformers are used, the system is then frequency-selective, which is an additional aid in avoiding RFI problems.

In addition to the grounding advantages, the balanced-

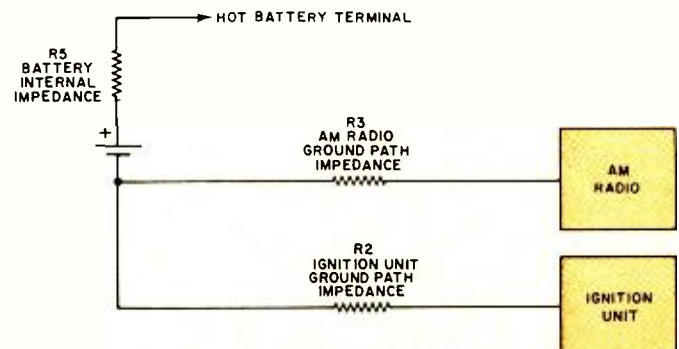
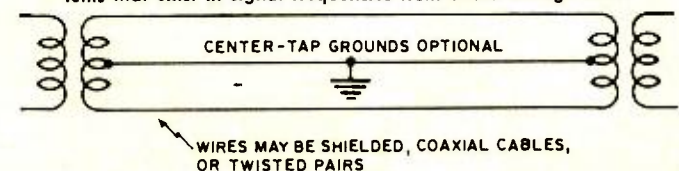

Fig. 3. Schematic showing common-ground impedance paths separated to reduce RFI. Battery's internal and hot-lead impedances are sources that may give rise to RFI problems.

Fig. 4. Balanced transmission system used to control signal-ground impedances. This system is used to reduce RFI problems that exist in signal frequencies from audio through u.h.f.



transmission system is a very poor performer as an antenna system, both for receiving and transmitting interfering signals. Received electromagnetic radiation will cause essentially equal and opposite currents to flow in the center-tapped windings, with a resulting small-current flow in the single-ended windings. Electromagnetic radiation, as a result of signal-current flow through the balanced lines, will be very small due to the negating effects of opposing signal currents. From an RFI viewpoint, the balanced system should be used for signal frequencies ranging from audio through u.h.f.

Coaxial lines which form an unbalanced-transmission system are sometimes grounded through a special coupling device which blocks d.c. and other low-frequency currents, while maintaining the integrity of the characteristic impedance of the coaxial line at the signal frequency. Such coupling devices are essentially capacitors that have been mechanically designed to be connected directly between a panel connector and the cable.

Various grounding schemes have been devised and incorporated into military and commercial specifications that handle the RFI problems effectively and directly. However, factors such as cost and schedule occasionally necessitate that the more effective specification requirements be ignored. In addition, in such cases, as when a single-point grounding concept cannot be implemented, the grounding schemes should be implemented to whatever extent possible.

A separate power-supply lead, shielded with inexpensive, high-capacitance-per-foot-rating shielded lead, should be provided for each service load. The shield should be grounded at both ends and, as often as possible in between, unless an over-all grounding scheme is being implemented and dictates to the contrary, or unless RFI tests result in a more effective grounding pattern being established. Another approach that is sometimes effectively employed, is to use an insulated shielded lead so as to be able to control the grounding points in between the two terminal ends.

Coaxial cables, used as part of a flat-transmission system, are very effective in terms of reducing RFI problems, since they become poor antennas when properly matched with their characteristic impedance. In particularly sensitive applications double-shielded cable may be used and sometimes, to minimize multiple reflections, it becomes important to terminate the cable in its characteristic impedance at both the source and load ends so as to maintain a flat line for signal currents flowing in either direction.

Connectors should be selected with RFI in mind. Flat-transmission systems should be used for all signal frequencies, video and above, and the connectors used should maintain the integrity of the coaxial impedance. Audio signals should be routed at an impedance level of 600 ohms, for a variety of reasons other than those solely associated with RFI problems, and be routed through ordinary connectors provided that the signal is not low and followed by high-gain phono, tape, or microphone outputs. In such cases, connectors which maintain the shielding integrity should be used.

The control of RFI is greatly enhanced if the various signal levels are standardized so as to avoid large differences in relative power levels; more than 20 dB or so. It's easier to avoid interference problems between two signals which are both 1 mW than between signals with relative-amplitude differences of 50 dB. A high-voltage signal should not be routed close to a high-impedance signal path.

In-line filters are often suggested as a solution to various RFI problems, particularly when the interfering signal enters the system through the primary channel. The filter itself usually has an insertion loss, sometimes as high as 20 dB, and its use therefore involves an adjustment of the gain constants of the channel. The chances of successfully making such an adjustment are greatly improved if the pos-

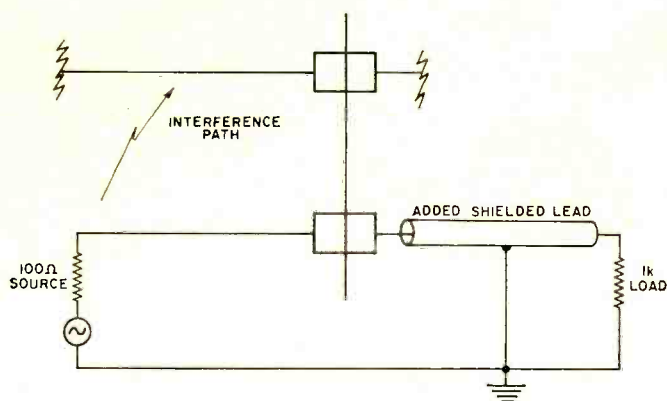

Fig. 5. An example illustrating where, by the addition of a shield to decrease RFI, the opposite effect actually occurs.

sibility of the need for such a filter is kept in mind while designing the gain assignments and the signal interfaces. In-line filters are generally useful in dealing with adjacent-channel interference.

The majority of RFI problems are caused by signal leads being coupled, even though the more difficult problems involve common-impedance paths. In solving RFI problems, most of the time is usually spent on changing signal routes, shield grounds, and connector arrangements.

The RFI problem, due to electromagnetic radiation, may sometimes be dealt with by considering the interference system as a transmitter, a transmitting antenna, a receiving antenna, and a receiver. Maximum power is delivered to the transmitting antenna when the source impedance of the transmitter is the conjugate match of the antenna impedance, and the same relationship is true for the receiving antenna and the receiver. In the case of an RFI problem it would be unusual if a match existed between a given antenna and its transmitter and receiver. Thus, a change in the impedance values is just as likely to improve impedance match as it is to make it more of a mismatch.

An improvement in the impedance match is likely to result in a degradation of the RFI situation. Consider, for example, the setup shown in Fig. 5 where the source impedance is 100 ohms and the load impedance is 1000 ohms. If a shield is installed on the right-hand section of the signal lead, as shown in the diagram, the load impedance as seen from the source will be lowered, causing more signal current to flow through the signal lead. More signal current will result in a higher level of radiation with an accompanying increase in interference. In this particular case the addition of a shield, in an effort to destroy the effectiveness of the signal wire as an RFI source, made the problem worse. The correct thing to do is to shield the entire length of the wire and, using a shielded connector, route the wire through the bulkhead. The shield may be grounded in several places. However, the addition of the shield and its grounding may give rise to common-impedance problems, indicating that the best grounding approach can be accomplished most easily by trial and error.

If a frequency difference exists between the interfering signals, much can be done to destroy energy transfer at the unwanted signal frequency. A frequency-selective filter consisting of a capacitor or an inductor, or both, in combination with a resistor, will give excellent results. A filter consisting of several poles may be used, depending upon the particular problem or application.

RFI problems are sometimes the most difficult aspect of equipment testing and operation, and the establishment of sensible threshold criteria may be the key to the problems' solution. ▲

(Editor's Note: Readers of this article will be interested in a special series of articles covering "Shielded Cables and Connectors" and "Filters" which appeared in our October 1968 and April 1969 issues, respectively.)

AUDIO EQUALIZATION CURVES UP-TO-DATE

By THOMAS R. HASKETT

Summary of curves now in use for FM broadcasting, disc recording, and tape recording—including the latest standard for the tape cassette.

In a high-fidelity audio amplifier, flat frequency response in every stage is the design ideal, so that the equipment does not add anything to the frequency relationships of the original sound. This principle is also followed in the design of most microphones and loudspeakers, for the same reason.

But when sound is processed through FM broadcast, disc recording, and tape recording, flat frequency response is not used in each stage throughout the system. Each system introduces noise, distortion, or loss at some frequencies which is not introduced at others. To overcome these difficulties, non-

linear frequency response is deliberately introduced near the system input. A complementary nonlinear response is then produced somewhere before the system output.

The over-all frequency response of FM, disc recording, and tape recording is made as flat as possible. Within the system, however, the frequency response is deliberately altered. This nonlinear response is known as *equalization*.

One thing common to all three systems: Most speech and music signals contain less energy at higher frequencies than lower. Thus the signal-to-noise ratio is inherently poorer at higher audio frequencies. For this reason, high-frequency boost—called *pre-emphasis*—is used near the system input in FM broadcasting, disc recording, and tape recording. As a complement, high-frequency attenuation—called *de-emphasis*—is then used near the system output.

FM-Broadcast Pre-emphasis

In the process of frequency modulation, the greater the amount of frequency deviation, the greater the amount of suppression of total system noise (provided only that signal amplitude is greater than noise). But the higher the modulating frequency, the less complete the suppression of noise. This is due to the lower modulation index produced by the higher audio modulating frequencies. Thus in an FM system not using pre-emphasis, both the modulation index and the signal-to-noise ratio are low at high audio frequencies. This noise consists—in the transmitter—of byproducts of the modulation method, and in the receiver of high-frequency impulse noise and possibly tube or transistor hiss.

In 1941 the FCC adopted a standard method of FM (and TV-sound) broadcast pre-emphasis. The system uses a 75- μ s RC network which produces the frequency response curve shown in Fig. 1. This pre-emphasis provides a boost starting at about 300 Hz, increasing to about 17 dB at 15,000 Hz.

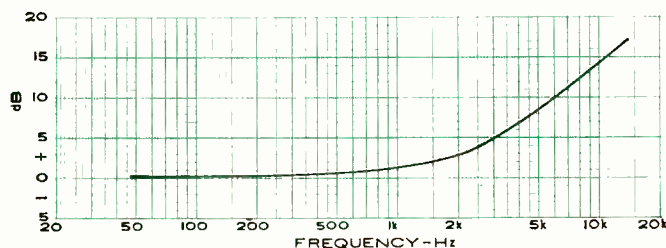
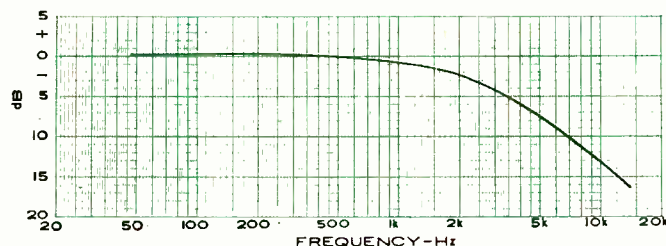

Fig. 1. Standard FM-transmitter 75- μ s pre-emphasis curve.

Fig. 2. The standard FM-receiver 75- μ s de-emphasis curve.



Thus noise suppression at higher audio frequencies is improved in the modulation system.

At the receiver, a complementary 75- μ s de-emphasis network is used which produces the attenuation curve of Fig. 2. A loss of about 17 dB occurs at 15,000 Hz. Over-all system response is then essentially flat.

In most program material, higher audio-frequency energy is relatively small, and pre-emphasis does not adversely affect the over-all audio balance. But in some program material the jingle of keys or the overtones of a violin produce high-amplitude, high-frequency signals. If the over-all gain of the system is not reduced, the high-frequency material overmodulates and causes distortion in the receiver, due to excessive frequency deviation. If the system gain is reduced to accommodate the high-frequency material, mid-range program audio suffers, as it is proportionately reduced.

To overcome this problem, many FM and TV stations use a frequency-sensitive limiter (e.g., CBS's FM Volumax, Fairchild's Conax, Gates' Top Level). Such a device reduces high-frequency gain when high-frequency audio exceeds a certain level.

Disc-Recording Equalization

The over-all frequency response of a disc recording and reproducing system is essentially flat, of course. But pre-equalization is used during recording, and complementary post-equalization during reproduction; each produces non-linear frequency response. There are two reasons for disc-recording equalization—low-frequency groove limitations and high-frequency noise.

For mechanical reasons, the velocity of the recording stylus is constant for constant input power. Since stylus displacement becomes excessively large at low frequencies, the danger of overcutting the record groove exists. To prevent this excessive displacement, low-frequency attenuation is used. Low-frequency roll-off therefore permits higher over-all recording level without groove overcutting.

It has been found that a disc recording and reproducing system has greater noise content at the higher audio frequencies than at the middle or lower frequencies. This noise—called *surface noise*—is due chiefly to minute irregularities in the recording medium. Since the average amplitude of high-frequency program material is low, it is possible to provide high-frequency pre-emphasis, thereby improving high-frequency signal-to-noise ratio.

At one time several types of disc equalization were used. In the early 1950's, however, RIAA (Record Industry Association of America) adopted a standard method, which was also adopted by NAB (National Association of Broadcasters) in 1964. The standard RIAA/NAB disc-recording pre-emphasis curve is shown in Fig. 3 as a solid line. There are three sections to the curve.

A. The low-frequency section is attenuated; this is known as the *constant-amplitude* area, as the amplitude of stylus displacement is limited to avoid groove overcutting.

B. The mid-frequency section has a *constant-velocity* characteristic, and has an amplitude which rises with frequency.

C. The high-frequency section employs pre-emphasis which increases with frequency, to overcome high-frequency noise inherent in the disc medium.

The dashed line in Fig. 3 represents the frequency response of the RIAA/NAB playback equalization system. Since it is exactly complementary to the recording equalization curve, it restores the over-all system response to an essentially flat curve.

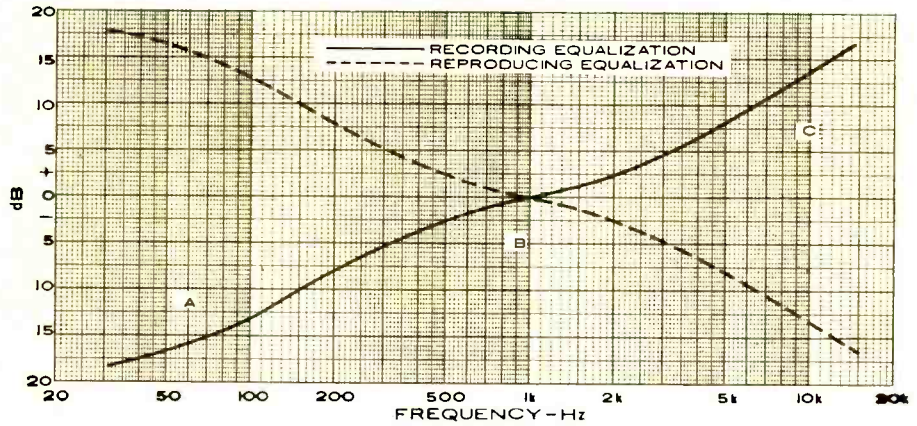

Fig. 3. Standard RIAA recording and playback equalization curves for discs.

Tape Equalization

In magnetic tape recording, equalization is needed for two reasons—low-frequency loss during playback and high-frequency loss during recording.

Fig. 4 shows the record-playback response curve of a typical tape recorder without equalization. The signal-output amplitude of a tape playback head increases with frequency at the rate of 6 dB per octave. This is so because a tape playback head is a velocity-sensitive device, which responds to the rate of change (frequency) for a constant flux (signal recorded on the tape). This phenomenon causes low-frequency response to fall below that at mid-frequencies.

In the recording process, high-frequency response is attenuated due to self-demagnetization and bias-erasure losses.

Thus tape equalization must consist of both low- and high-frequency boost. This equalization may be applied during

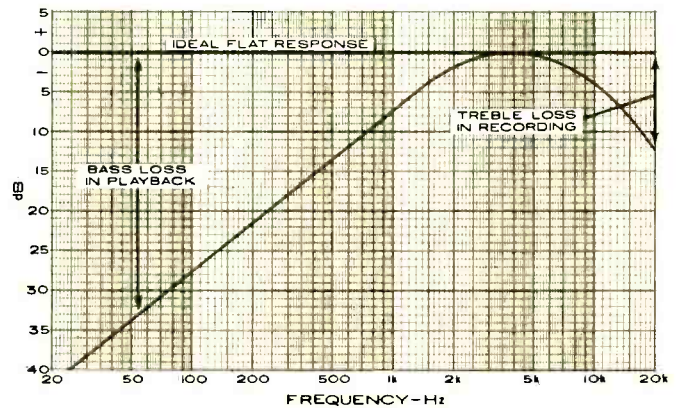
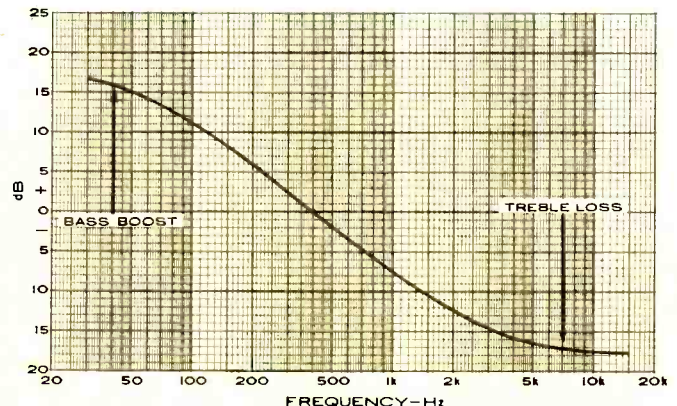

Fig. 4. Record-playback response of tape recorder without equalization shows wide departure from flat response.



Fig. 5. The RIAA playback characteristic for 7 1/2 in/s tape.



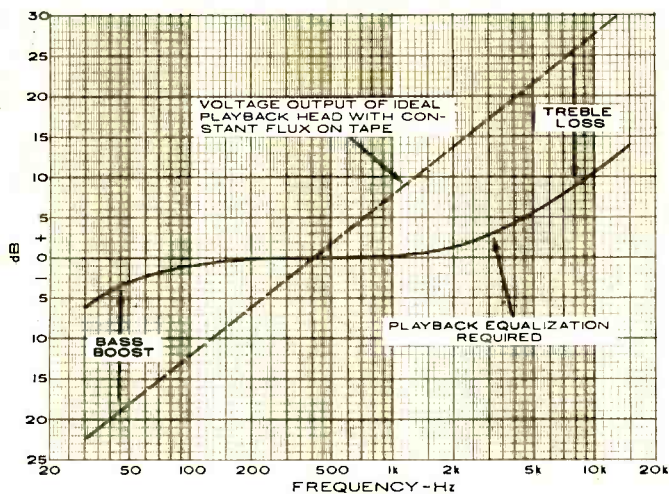

Fig. 6. New method of specifying tape equalization required.

either recording or playback, or both. The applicable criteria are flat response, minimum distortion, and maximum signal-to-noise ratio.

Current practice is to employ chiefly high-frequency (treble) boost during recording, and principally low-frequency (bass) boost during playback. Since typical audio program material contains low-level high-frequency signals, treble boost does not overload the tape, and provides maximum signal-to-noise ratio. Some bass boost is also employed during recording, but not enough bass boost to overload the tape.

During playback, bass boost is used to bring the over-all system response up to flat. No treble boost is necessary or desirable during playback, as this would emphasize tape noise.

The method of specifying and measuring tape equalization is not the same as that for FM broadcasting and disc recording. It is difficult to measure the recording characteristic of a tape system, since this means measuring the actual flux applied to the tape from the recording head. It is much easier to specify and measure the signal coming off the tape—that is, the playback characteristic.

Current standardization practice is to specify a playback characteristic which includes bass boost and treble loss. For example, Fig. 5 shows the RIAA playback characteristic for 7½ in/s tape. This curve specifies the response of the playback amplifier only, and does not include the head.

In practice, an audio generator is substituted for the playback head and the generator is used to feed a constant-amplitude signal at several frequencies throughout the audio range. The playback amplifier's frequency response is varied until the output conforms to Fig. 5.

Then the playback head is replaced in the circuit and the audio generator is connected to the input of the recording amplifier. The generator again is used to feed a constant-

amplitude signal at several frequencies throughout the audio range. The audio-generator output is recorded on the tape, and the tape played back. The recording equalization is then varied until the playback amplifier output is flat. Thus only the playback characteristic need be specified, provided that over-all record-playback response is also specified as flat. The recording characteristic is therefore whatever additional equalization is necessary to produce flat over-all response.

New Method of Specifying

The preceding method is no longer used because of one disadvantage; it presumes that the playback head is ideal and has no irregularities. Fig. 6 shows the new method of specifying the playback characteristics. Constant flux vs frequency is maintained in the playback head, and the straight dashed line indicates what the ideal response should be—voltage output rising with frequency at the rate of 6 dB per octave. The curved line indicates the actual playback-amplifier output, which includes bass boost and treble loss.

In practice, the playback system is aligned by using an accurately calibrated test tape, until the playback output conforms to Fig. 6. Recording equalization is then accomplished in the manner just described.

Since the new method includes both record and playback heads in the alignment procedure, tape compatibility among various machines is assured.

In FM broadcasting and disc recording, it is possible to use a single equalization curve because operating conditions do not change. Such is not the case in tape recording where various operating modes are used. There are four speeds (15, 7½, 3¾, and 1⅞ in/s), two tape widths (250 and 150 mils), and three configurations (reel-to-reel, endless-loop cartridge, and coplanar cartridge, or cassette) in common consumer usage. (Other speeds, widths, and configurations are employed in broadcast, recording-studio, and industrial applications.)

As tape-to-head speed is reduced, high-frequency losses increase. Thus an equalization curve for one speed would not be optimum for a lower speed. Accordingly, several curves are needed for the various speeds.

Through the years different equalization methods and curves have been used by various manufacturers and organizations. To assure compatibility of tapes recorded on one machine and played back on another, it is desirable that there be standard methods of equalization which everyone uses. Such equalization curves were adopted by RIAA and NAB in 1965 governing reel-to-reel machines, and by RIAA in 1968 governing cartridge machines.

Fig. 7 shows the three standard tape playback characteristic curves. Curve A is specified by the NAB for 15 and 7½ in/s, and by RIAA for 7½ in/s only. Curve B is specified by NAB for 3¾ and 1⅞ in/s, and by RIAA for 3¾ in/s only. Curve C is not used by NAB, and is specified by RIAA for 1⅞ in/s only. (This is also the curve specified by Philips for the 1⅞ in/s cassette—Editor) Curves A and B are specified by NAB for reel-to-reel machines only; other curves are specified for NAB cartridge machines. RIAA specifies the curves for speeds only, making no distinction among reel-to-reel, endless-loop cartridges, and coplanar cartridges (cassettes).

At various points in high-fidelity FM, disc, and tape systems, inherent difficulties make it necessary to purposely distort flat frequency response. Standard methods and amounts of equalization have been adopted by the responsible organizations in this country and abroad. These equalization curves now serve as reference for all concerned with recording or playback. ▲

Fig. 7. The standard equalization curves for the various tape speeds.

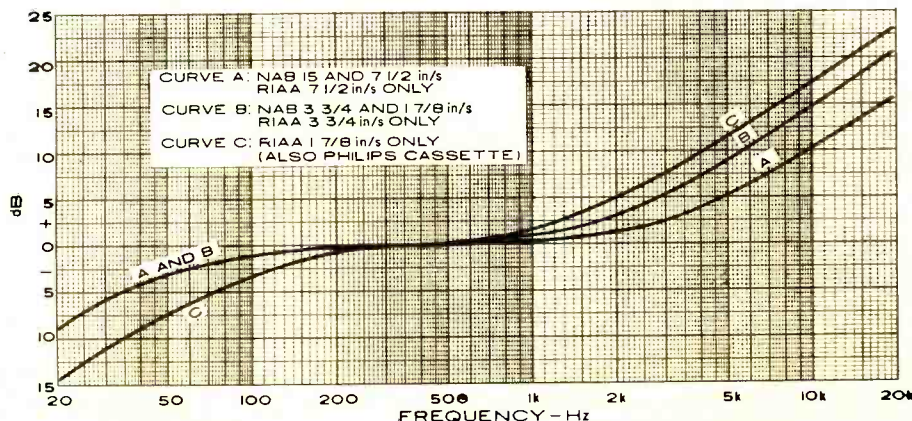

OMEGA— a V.L.F. Radionavigation System

By EDWARD A. LACY

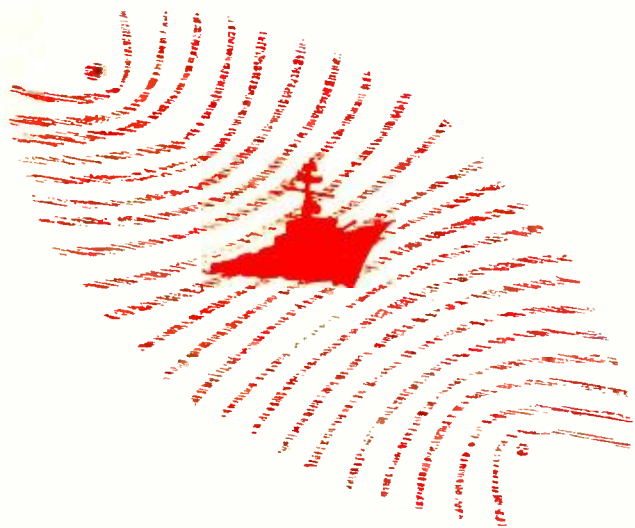

Loran's range is limited and inertial-guidance systems are too expensive. With this long-range navigation system, highly accurate position fixes are possible, during both night and day in all kinds of weather, on the oceans of the world.

WITH all the modern devices such as radar and loran aboard today's ocean-going ships, it is somewhat depressing to learn that such ships must revert to the non-electronic sextant for navigation, once they get a few hundred or a thousand miles from shore. Until recently, electronic navigation has had critical disadvantages: loran's range is quite limited and inertial navigation systems are too expensive. The sextant on the other hand is simple, but of course it can't be used in bad weather. And even when it can be used, its accuracy is nothing to brag about.

Now along comes the Omega long-range navigation system, operating at very low frequencies (10 to 14 kHz) and providing reliable navigation night and day, in all types of weather, to a root-mean-square accuracy of one mile in the daytime and two miles at night. (When the system becomes fully operational, and more information is obtained on v.l.f. signal propagation, even better accuracies may be obtained, according to some engineers.)

The system has already passed extensive tests aboard U. S. Navy ships and commercial ocean liners.

With four stations now in operation, the Omega system is now providing navigation coverage over much of the North Atlantic and eastern portions of the North Pacific. By 1972, hopefully, when the full system of eight shore-based stations becomes operational, all parts of the world will receive navigation signals from Omega. Omega will be available to military and civilian users, in all nations, whether on ships, aircraft, or submerged submarines.

And while an accuracy of only one mile may not seem significant to landlubbers, it's a marked improvement for ocean navigators. The *Northrop Corporation*, manufacturer of Omega equipment, points out that operating, labor, and insurance costs are significantly reduced by days saved at sea. Consequently, even fractional improvements in navigation accuracy on vast ocean stretches could save the world's maritime industry (more than 16,000 large ocean-going vessels) an estimated several billions over a 20-year period.

Omega is a direct descendant of the loran system, with some important differences as proposed by Professor J. A. Pierce of Cruft Laboratory, Harvard University. Pierce, who had played a major role in the development of loran during World War II, suggested to the Navy the use of very low frequencies and the use of phase-difference measurement techniques for navigation systems instead of time-difference measurement techniques, as in loran.

As a result of Pierce's proposals and his experiments in measuring phase delay at v.l.f. and establishing the phase stability of signals at v.l.f., the Navy began the development of the Radux navigation system, a 40-kHz system which was service tested in 1956. Radux worked well at ranges up to 2000 miles, and it showed the wisdom of using v.l.f. and phase-difference measurement techniques. But its accuracy of 3 to 5 miles was not sufficient and even greater range was desired. Thus, a refined Radux system—called Omega—was started in 1958 with test transmissions from Hawaii, at a much lower frequency: 10.2 kHz.

The shore-station equipment and the first experimental shipboard receiver for use in Omega were designed by the Naval Electronics Laboratory Center (NELC), San Diego, California, which acted as lead laboratory during other phases of the development. The Naval Research Laboratory, Washington, D. C., designed an aircraft Omega receiver and participated with NELC in evaluating the system.

The test transmission established the feasibility of Omega and in the early 1960's the Navy began encouraging industry to become involved in developing Omega equipment. In 1965 the Navy awarded a contract to the *Northrop Corporation* to design, develop, and build 10 receivers for shipboard test and evaluation. And in 1967 *Northrop* received a \$1.68-million contract to build 140 Omega receivers, now designated the AN/SRN-12, at an average cost of approximately \$11,000 per receiver.

Cost of Equipment

Costs of Omega receivers can go considerably higher than this—up to \$50,000 perhaps if features such as direct readout of latitude and longitude are added to the basic receiver. On the other hand, costs could be much lower for commercial gear (instead of military). While *Northrop* has not announced the price of its Omega I receiver, which is a commercial version of the AN/SRN-12, it should be much less expensive. The Omega I is built to the same reliability standards and design as the AN/SRN-12, but does not include a drawer of special test equipment as does the AN/SRN-12. Some industry estimates for commercial receivers are as low as \$1000 per set.

Whatever the cost, it may very well be worth it in improved traffic scheduling of ships, which in turn would give lower operating and dockside costs. *Northrop* estimates the total savings per Omega-equipped ship over a 10-year period to be from \$112,000 to \$225,000; when this cost is compared to an estimated \$17,500 for an Omega receiver over 10 years, they arrive at a net savings of \$94,500 to \$207,500.

Very-Low-Frequency Propagation

Because of the low attenuation of very-low-frequency radio signals, v.l.f. transmissions can be made over thousands of miles, using relatively low power. When up to full power,

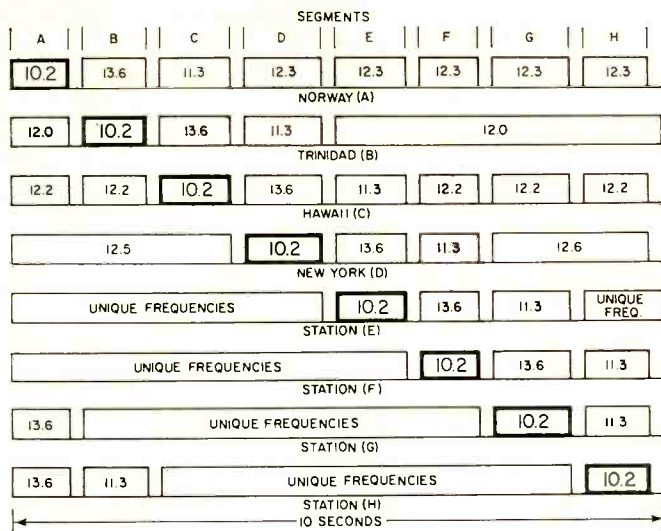

Fig. 1. Complete signal format. The 10.2, 11.3(33), and the 13.6-kHz segments constitute present system and are firm operational frequencies. Other frequencies are under test.

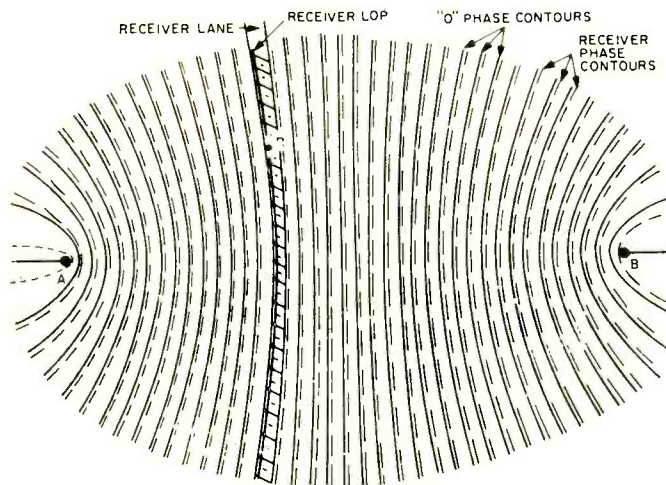

Fig. 2. Omega lane pattern produced by transmitters A, B.

each Omega station will have a range of about 5000 to 8000 miles. With such ranges, only eight stations will be needed to provide overlapping or redundant navigation coverage over the entire earth. (Loran would require hundreds of stations to give the same coverage.) In some areas it may be possible to receive all eight stations, but even in the worst locations, probably four or five of the stations will be received sufficiently well to allow a navigator to make accurate fixes.

Besides being long distance, v.l.f. propagation is reliable during all types of weather, day or night. More important from the Navy's point of view, v.l.f. signals can penetrate seawater to significant depths, so that reception is possible aboard submerged submarines, even under polar ice caps. According to the Navy Electronics Laboratory, radio signals at 100 kHz are attenuated by seawater at the rate of 3.5 dB per foot of water depth. But at 40 kHz this attenuation drops to 2.2 dB, and at 10 kHz it is only 1.1 dB. Thus, the same power that will penetrate 10 feet of seawater at 100 kHz will penetrate 32 feet at 10 kHz.

The Navy has long made use of such features in their fleet communications; however, the most important feature of v.l.f. from the standpoint of navigation is the fact that v.l.f. signals have extremely good phase stability over long distances. The small phase delays present can be predicted with good accuracy and can be made available to navigators.

One of these errors is the diurnal shift or effect: the effective height of the ionosphere is higher at night than dur-

ing the day, which results in a lower phase velocity of the Omega signals. If such errors are not compensated for, an error of several miles can result. However, tables of compensating factors have been published and are available through the U. S. Navy Oceanographic Office.

Within the v.l.f. region, 10.2 kHz was chosen as the main Omega frequency because at slightly higher frequencies (20 kHz) the phase perturbations are hard to predict and at lower frequencies the efficiency of transmission makes such frequencies uneconomical.

Antenna Sites

The Omega network presently has four stations: station A at Bratland, Norway; station B at Trinidad, West Indies; station C at Haiku, Hawaii; and station D at Forestport, New York. (Station D may be transferred to Minnesota.)

With these four stations, full-time service is now being provided over 20 million square miles of the Northern Hemisphere.

The four additional stations, which have been authorized by the Secretary of Defense, are needed somewhere in the areas of the Western Pacific, Tasmania Sea, Indian Ocean, and southern South America. The Navy hopes to find foreign partners to join the U. S. in completing the Omega system, rather than negotiating for permission to build and operate the U. S. stations on foreign soil. For after all, Omega is not exclusively for the military or for the U. S., but for use by all nations with ocean-going airliners and ships.

Worldwide coverage will be achieved when these additional four stations go on the air.

Strategic locations for the transmitters have been determined after much compromise: nice geometrical patterns for arranging the eight stations are complicated by three factors: (1) some of the best theoretical locations turn out to be in the ocean, (2) heavy attenuation rates for propagation paths across the Arctic and the Antarctica suggest avoiding such paths, and (3) transmission of signals in equatorial regions is better in some directions than others.

Another complication is the need for large hills or mountains for supporting the large antennas—from one to two miles long—at heights from 800 to possibly 2600 feet.

These antennas constitute a major part of the \$5 to \$7 million cost estimated for each station. Fortunately, the cost is held to a manageable level by the fact that the radiated power for an Omega station is only 10 kilowatts, a low value compared to other v.l.f. stations such as the Navy's Jim Creek facility.

Signal Format

Each of the eight stations will transmit signals on three main frequencies: 10.2, 11.333, and 13.6 kHz. Of these, 10.2 kHz is the frequency used for the fundamental measurement. The other two frequencies, as well as frequencies that are peculiar to one or a few of the stations, are used for other purposes, including lane resolution or identification, which will be discussed later.

As shown in Fig. 1, the stations transmit Omega signals on a time-sharing basis. During each 10-second interval, each station makes one transmission on 10.2 kHz, but no two transmissions coincide or interfere. Although not indicated in Fig. 1, these transmissions have different pulse lengths to help in station identification. Stations A and F are on for 0.9 second, B and H for 1.0 second, C and E for 1.1 seconds, and D and G for 1.2 seconds. After an 0.2-second delay between station transmissions to allow globe-circling signals to end, each station comes on in sequence. Atomic clocks are used to ensure that each transmission comes on at the proper time.

Pulse lengths are duplicated, but no two adjacent signals have the same pulse length. Consequently, station identification, an important procedure in Omega, is relatively simple.

The other frequencies—11.333 and 13.6 kHz—are transmitted in a similar time-sharing fashion, for purposes of lane identification. In addition, each station will transmit at a unique frequency for approximately 5 seconds in each 10-second time frame. Possible uses for these unique frequencies include time and frequency measurements.

Presently, the four operational stations are broadcasting the three basic frequencies and Station B (Trinidad) is transmitting on the unique frequency of 12.0 kHz.

Determining Position Fix

To obtain a position fix with Omega, the receiver must measure the phase relationships at the receiver between signals from at least three Omega stations. Since only one station transmits at a time on the basic frequency, the signals must be stored and compared indirectly. The phase difference between two stations, for example, Stations A and B, is measured and then indicated on digital counters or meters. While this difference indicates a line of position (LOP), the LOP could be any one of several LOP's since phase readings repeat at intervals of eight miles along a baseline connecting the two stations. These 8-mile intervals, called lanes (see Fig. 2), are determined by the half wavelength of the 10.2-kHz signals.

To be of any value, the LOP must be isolated to a particular lane. If the navigator can determine his position to within 4 miles, say by dead reckoning, he can then place the LOP on his Omega chart (otherwise he may pick the wrong LOP). However, he may not have to do this if he sets the counters in the Omega receiver at the start of a trip to the number of the lane (Omega lanes are numbered) at the starting point. During the journey, the receiver would then count the number of lanes passed through. Once an LOP has been obtained from Stations A and B, the navigator can use Station C in combination with either Station A or B to obtain another LOP. The intersection of the two LOP's then gives the position of the ship. A third LOP can be used to give confidence to the solutions (see Fig. 3).

By making use of two Omega frequencies—10.2 and 13.6 kHz—instead of one, the navigator can use Omega lanes that are 24 miles wide, that is, he can extend the points of ambiguity from 8 to 24 miles. With such a wide lane, the navigator only has to be within 12 miles of his estimated position in order to place the LOP in the proper lane. By using the third Omega frequency—11.333 kHz—as well, the navigator can have an Omega lane that is 72 miles wide, making it still easier to locate himself.

Three basic types of Omega receivers are available: single frequency, dual frequency, and triple frequency. Single-frequency sets, such as the AN/SRN-12, are satisfactory for use aboard ships when lane ambiguity is no problem. *Tracor Corp.* builds two versions of a dual-frequency receiver, one set that can be switched from one frequency to another, and a set that incorporates two separate receivers, each tuned to a different frequency. Triple-frequency sets are used aboard aircraft because aircraft can very quickly pass from one lane to another; accordingly, the maximum lane size must be used to avoid ambiguous readings.

AN/SRN-12 Receiver

The AN/SRN-12 receiver is a solid-state, single-frequency, phase-locked superheterodyne receiver with an i.f. of 102 Hz. It is used in conjunction with a 10-foot whip antenna. Four stations can be received simultaneously, giving six available LOP's of which any three can be displayed.

Receiver, controls, and digital displays are contained in the bottom one of two drawers, which slide out for maintenance. Graphic recorders and an oscilloscope are contained in the upper drawer.

A 5-digit display in the bottom drawer shows lane count in the first three digits and percent of lane a ship has traveled in the last two digits. When (Continued on page 69)

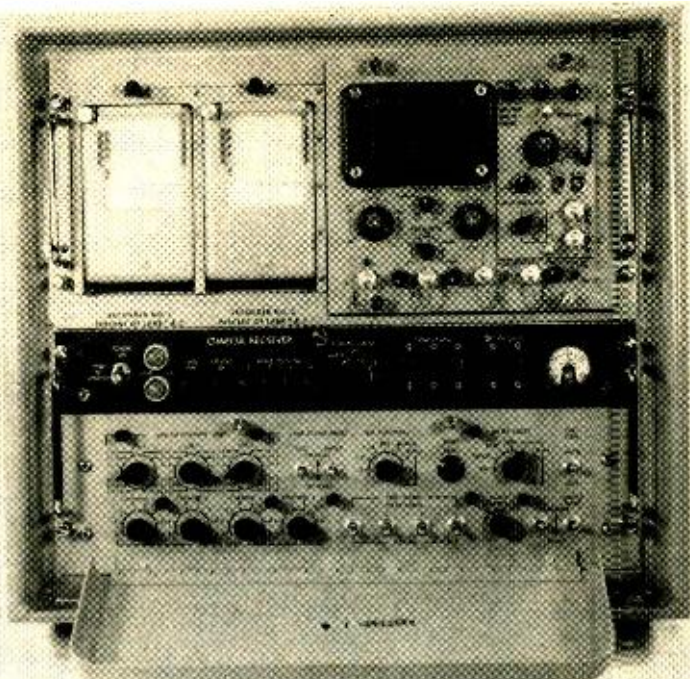

Complete Omega navigation equipment (AN/SRN-12) shown with front-panel cover down. Receiver section is at the bottom while the chart-recorders and scope readouts are at the top.

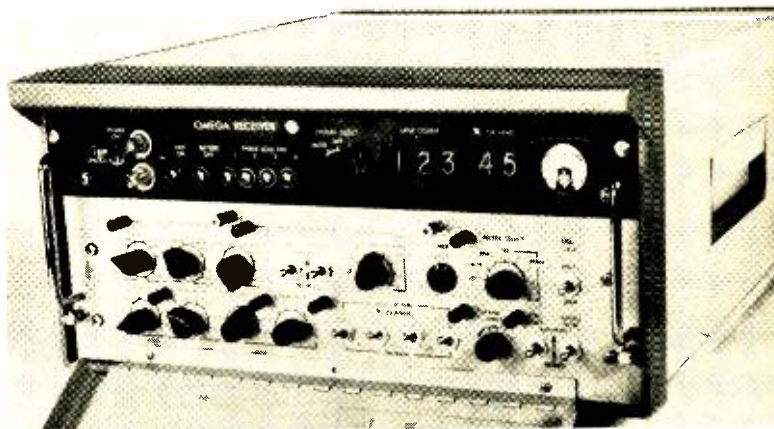

Close-up view of the Northrop Nortronics Omega I receiver.

Fig. 3. Position fix determined by three lines of position.

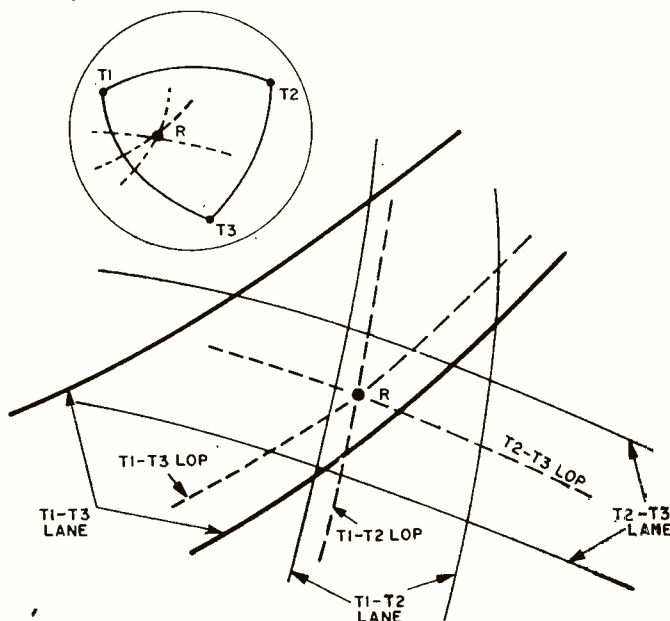

Which P. A. Speaker Should You Use?

By ABRAHAM B. COHEN, ISC/Telephonics
Division of Instrument Systems Corp.

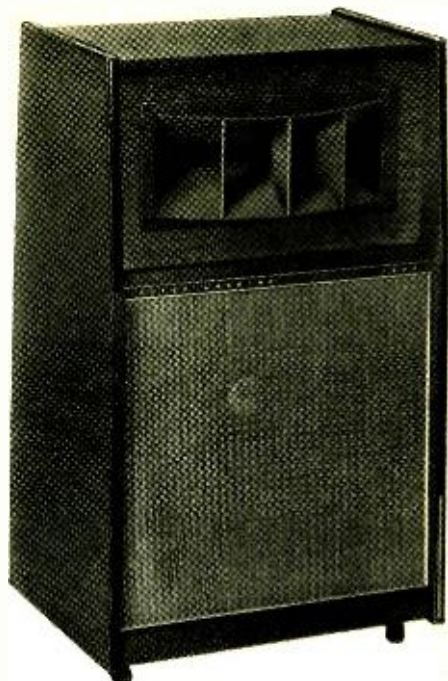

Fig. 1. An example of a direct-radiator cone enclosure with a sectoral high-frequency horn at the top for use in gyms or in small auditoriums. (Altec Lansing 1202A)

Part 3 of a series on modern p.a. sound-system practices describes speakers that are available, gives comparative characteristics, and includes much practical information on making best choice.

THE choice of loudspeakers for p.a. sound systems is determined by four factors: (1) the specific area to be covered by each speaker, (2) the acoustic properties of the area to be covered, (3) the propagation characteristics of the speaker, and (4) its efficiency.

A paging system intended to cover many different rooms of a manufacturing plant will obviously need as many speakers as there are rooms to be covered, with at least one speaker to a room, or more as the size of the room requires. On the other hand, an open-air concert shell or high-quality concert hall or theater may require only one master system placed over the center of the stage.

In a stockroom, where the area is broken up into aisles, storage shelves, bins, storage nooks and crannies and the like, the chances are that the area is generally free from disturbing reverberation. Hence, no special performance is required of the speaker other than it radiate enough sound so that people in the stockroom area can hear it comfortably. In a plant where there is a very noisy and large manufacturing area with cinderblock walls and high glass turreted roof, a network of small speakers placed near where the people paged are most likely to be found, such as at machines or foremen's stations, would be required. Here, the pattern from the individual loudspeakers should concentrate the radiated sound more directly toward the area to be covered, since sound dispersion into the high-ceilinged area might set up disturbing reverberation which could reduce the intelligibility of the message.

If the speaker is intended to reproduce a wide range of music, then the system would generally have to have the characteristics of a "hi-fi" system. If it were to be used for paging purposes, only a relatively narrow band of frequencies must be reproduced to get the message across.

Finally, the speaker selected will determine the amount of audio power necessary to drive the system; direct-radiator speakers having about one-fifth the electro-acoustic efficiency of horn-type reproducers.

Cone Speakers

The cone-type loudspeaker is generally used as a direct radiator. As direct radiators, they "sound out" directly into the area to be covered. As shown in Fig. 2, they may be mounted in simple small enclosures just large enough to accommodate the loudspeaker being used (usually no larger than an 8" unit), with just enough inner volume to give some semblance of bass reproduction. These are used mainly for low-level paging systems where frequencies below 250 Hz are unnecessary for speech-production and for background music where musical "sedation" rather than fidelity is the goal.

Often these cone speakers will be housed in baffles which are flush-mounted in the ceilings or walls. When mounted in walls, the back of the enclosure is often left open to allow the speaker to produce lower frequencies because the diaphragm is acoustically unclamped, making the enclosure appear larger. However, when mounted in the ceiling, the speaker is usually closed in by a rear box to prevent bits of plaster from falling into the back of the cone. In these small rear-enclosed ceiling mounts, the low frequencies are considerably attenuated. The enclosures need quite a bit of sound damping applied to their inner walls to minimize disturbing resonances within the enclosures.

Bi-directional baffles are often mounted in corridors or on walls, with sound coming out of the back as well as the front. This reduces the number of speakers required, however quality is sacrificed over and above the limited quality of the small enclosure itself. Since it is virtually open on both sides and is housed in a small enclosure, the cone is, for all practical purposes, unbaffled. This results in severe drop out of low frequencies. In addition, the high frequencies from the rear of the speaker are considerably attenuated with respect to the highs coming out of the front of the speaker. Yet despite these characteristics, bi-directional enclosures provide usable paging service and low-level background music in low-noise areas.

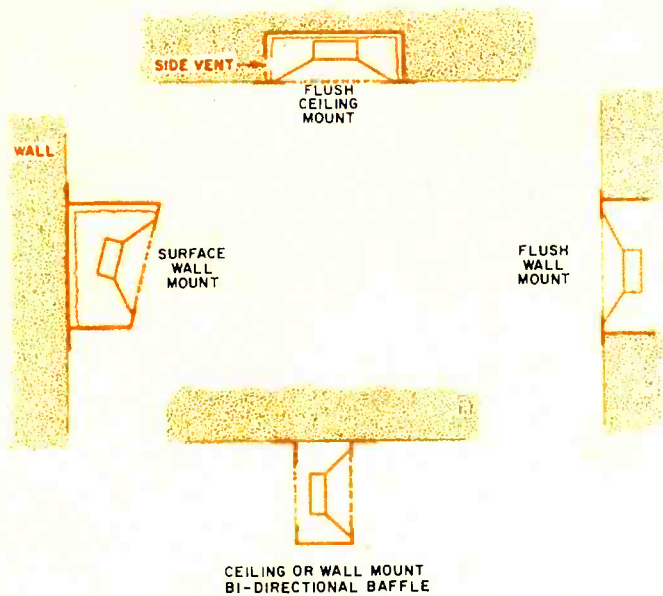

Fig. 2. Cone speakers for paging and utility purposes are housed in small compact metal or wood baffle enclosures.

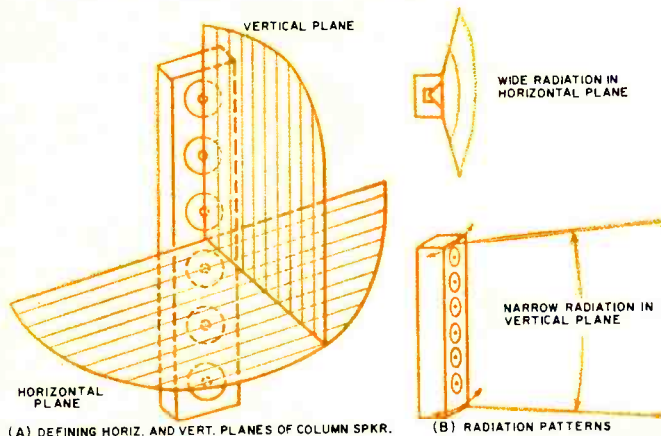

Fig. 3. The column speaker produces a wide-angle wedge of sound energy in horizontal plane at right angles to the column length. Sound wedge is narrow in vertical plane.

For a wider frequency range than that used for paging or background music, and where only moderate sound powers are required, the cone speaker may be mounted in a vented cabinet of the bass-reflex type, or in a sealed enclosure of the acoustic-suspension type. In both cases, the cone acts as a direct radiator, open and facing the audience. With a high-quality woofer, good low-frequency reproduction is possible. However, in almost all instances, a tweeter is a part of the enclosure system to augment the high frequencies of the main cone and to provide better dispersion of the highs.

With the reflex-type enclosure, the tweeter is generally a wide-angle horn to match the efficiency of the cone speak-

er, and may frequently consist of a multicellular or sectoral horn to ensure wide-angle coverage of the higher frequencies (Fig. 1). In the case of the sealed acoustic-suspension system, the enclosure invariably comes as a complete system with the built-in tweeter utilizing either one or two direct-radiator hard-shell dome-type structures to match the woofer efficiency. This tweeter system gives uniform high-frequency distribution rather than directional control of the radiation.

The power requirements of these two systems and the mode of deploying them are very different. Due to the much higher efficiency of the vented enclosure with its tweeter system, satisfactory coverage of an auditorium may be obtained by elevating two such systems on either side of the stage. In the case of the acoustic-suspension type, with its much lower efficiency, perhaps four or five of these enclosures would have to be strung along the footlight area to cover the auditorium. Also, more driving power will be required than for the vented type.

Column Speakers

The column speaker bridges the gap between the simple cone-radiator structure and the horn system. It will provide sharp directional control patterns but will also retain a good measure of cone-type quality not available from standard horns.

The column, as shown in Fig. 3, is a group of speakers mounted in an array, one above the other, and all facing the same direction. They are usually enclosed in one overall structure which is made as small as possible without deteriorating the bass response below that of which the speaker is capable. Regardless of the physical size of the column, the structure is designed to hold a minimum of four speakers, most frequently six, and not infrequently eight. The major function of the column array is to radiate most of the sound into a rather narrow wedge lying in a plane at right angles to the axis of the column itself, with the arc of coverage of this horizontal wedge often well over 120 degrees. Minimum sound is projected in the vertical direction into the area outside of this comparatively narrow horizontal wedge.

As illustrated in Fig. 4, it is possible to orient the speaker to throw the sound directly into the seating areas to be covered and to minimize the sound beamed at the upper hard-ceiling areas where the sound would otherwise bounce down to the audience with bothersome reverberation. It is surprising how a tilt of just 10 to 15 degrees from the vertical can focus the sound down on the area to be served and permit so little of it to get into the vertical plane.

Sound columns are not very efficient. The column is just a bit more efficient than the cone speaker in the column, but is not as efficient as a horn projector, power for power. However, putting aside the directional control advantage of columns, they have the secondary advantage of being able to handle as much more power than a single cone as there are cones in the array. Where one of the unit cones may be capable of handling 10 watts by itself, it will still take 10 watts in the column configuration, but the whole configura-

Fig. 4. Narrow vertical beam from column speaker system can be used to reduce generation of reverberant sound.

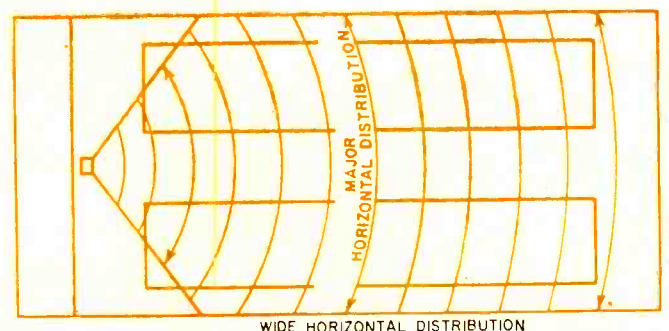
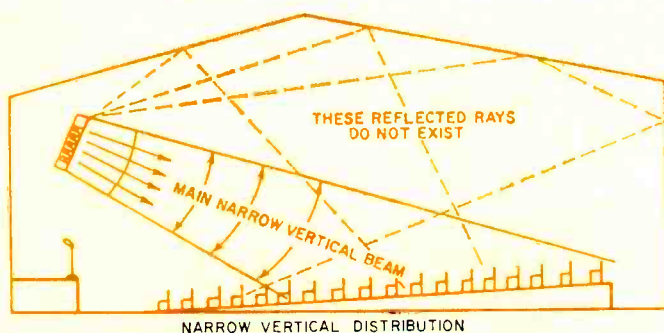

tion made up of perhaps six cones will now be able to take a total of 60 watts.

It is possible to design column speakers for large-area applications where the power-handling capacity may be on the order of 100 watts or more. There is great demand for this type of speaker not only in gymnasiums and large auditoriums, but even for small pop music gathering places where there is apparently no limit to the volume that people can tolerate irrespective of the resultant distortion. The fact that large amounts of power can be fed into the column and a band of frequencies that will cover the electronic instruments used by pop groups can be gotten out of it makes the column a very important system to the sound specialist. Fig. 5 is an example of a two-section break-away column with the top tweeter designed specifically for pop-music use.

In general, the larger the column, the better the low-frequency reproduction and the sharper the horizontal wedge of the sound distribution. Another rule-of-thumb in judging the sharpness of the horizontal pattern is the number of speakers in the column and the means of contouring the high-frequency response. The more speakers in the column, assuming them to be closely spaced, the flatter will be the horizontal wedge; eight radiators will produce a flatter horizontal wedge of sound than will a four-speaker column. When designing column speakers, an attempt is made to keep a constant ratio of radiated wavelength to the physical length of the column. Theory shows that if this condition can be maintained, then the wedge divergence will be uniform at all frequencies. It is obviously impossible to physically shorten the column as high frequencies (shorter wavelengths) are transmitted. The only feasible alternative is to make the column appear to be electro-acoustically shorter for the higher frequencies as they occur.

This automatic contouring is accomplished by one of the following three methods, or combinations of them, as in Fig. 6. (Left) The high-frequency capabilities of the two end speakers are reduced by either choosing their cone design so that they are not as inherently good high-frequency reproducers as the central radiators, or by removing any high-frequency elements, such as whizzers or tweeters from these end speakers. (Right) Electrical filters, such as crossover networks, may be used to prevent the high frequencies from getting into the end speakers. (Center) A separate line of tweeters located at the center of the column will make the tweeter column length to wavelength ratio at the high frequencies similar to that at middle and low frequencies. In some instances, the column itself is slightly arced to keep

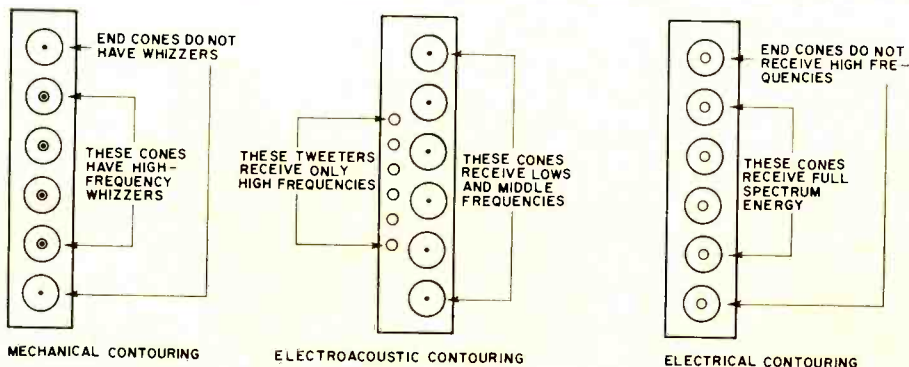

the highs from being dispersed vertically.

Horn Projectors

The horn-projector family will continue to be one of the sturdy building blocks of public-address sound systems. The reasons are not hard to understand. The ease of directing sound where it is desired by merely pointing the horn in that direction is readily apparent. The ability of the horn to produce sound that penetrates into very noisy areas is universally recognized. The economy of amplifier power it permits because of its high-efficiency characteristics is a matter of record. That they have time-proven reliability under the most adverse conditions of temperature, humidity, and precipitation is borne out by their use out-of-doors almost to the exclusion of other types.

Most high-efficiency horns used by the p.a. technician are of the re-entrant type. They can be recognized by a central member, resembling a long nose structure, as in Fig. 7. This member is one of three separate sections of the horn, folded around the other, for which the word "re-entrant" was coined.

Such horns, because of their design-controlled geometric expansion, have well-defined specifications, of which the

most important is the low-frequency cut-off point below which the horn theoretically will not transmit any acoustic energy. In this context, every horn is thus a simple high-pass filter. Looking at a group of horns, the larger the mouth of the horn and the longer the air column of the unfolded horn, the lower frequencies it will reproduce. One would expect that the larger horns would have a better sound-level output due to their improved acoustic loading on the driver unit energizing them and their better mouth-to-air impedance match. The table in Fig. 7 gives a general idea of the improvement in sound pressures that may be expected from typical horn sizes. A second rule-of-thumb is that the smaller the mouth of the horn, the wider its angle of sound dispersion. This characteristic stems from basic radiation theory that states that the smaller the radiator, the more it approaches a point source of energy and becomes a spherical radiator. As the radiator becomes larger, it deviates from the character of a point source and begins to develop directional characteristics. Hence, while a large horn mouth may produce better low frequencies and more sound power output, its upper frequency radiation becomes quite sharply beamed with the resultant loss of intelligible wide-angle sound projection.

A horn is a passive device; it does not produce power. The sound it transmits is the sound it receives from some other source of power, in this instance, the compression



Fig. 5. Break-away high-power handling sound column for portable pop-music use. Multi-horn tweeter on top of the column spreads high frequencies (Jensen Models LPC-152, HLV-40)

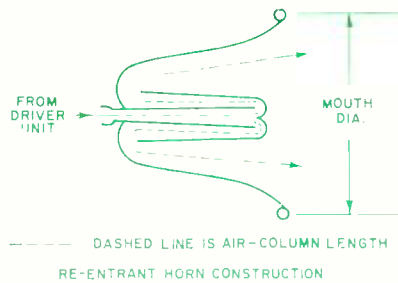

AIR-COLUMN LENGTH	MOUTH DIA.	CUT-OFF FREQUENCY	ANGULAR DISPERSION	RELATIVE ACOUSTIC GAIN
2 1/2" NOM	16" NOM	250Hz	95° NOM	REFERENCE
3 1/2"	21"	175Hz	85°	+ 1dB
4 1/2"	26"	120Hz	75°	+ 2dB
6 1/2"	32"	85Hz	65°	+ 4dB

Fig. 7. Construction and performance of re-entrant horns.

driver shown in Fig. 8A. The back of the unit is completely closed off from the outside air. The rear of the vibrating sound-producing diaphragm in the structure is thus under compression of the air trapped behind it. The front of the diaphragm, mounted in the acoustic head, delivers its acoustic energy into the narrow throat end of the horn which is coupled to the driver unit.

The driver unit has a powerful magnetic system which provides the initial source of power to cause a comparatively small diaphragm (usually about 2" in diameter) to be energetically vibrated as a result of the signal current to the voice coil immersed in the magnetic gap and attached to the diaphragm. This powerful magnetic drive (magnetomotive force) acting on the low mechanical impedance of the lightweight diaphragm, produces a very large amount of sound output.

The acoustic energy feeds into the throat of the horn and is allowed to expand at a controlled rate by the design flare of the horn until the sound power emerges from the horn mouth as in Fig. 8B. The horn is basically an acoustic transformer, as well as a high-pass filter. Its controlled expansion permits the high-intensity sound, originating at its throat, to gradually follow the horn expansion and to emerge from a large horn mouth area into the acoustic space in front of it. The large horn mouth thus provides an improved acoustic match to the air around it and accordingly "grabs hold of" that space in front and transfers its emerging power to it. This is the second high-efficiency step to take place in the process.

The high output of the compression driver, aided by the acoustic-matching properties of the horn, provides a combined efficiency of about 25% as compared to that of the cone system whose efficiency is seldom higher than 5%. Because compression-driven horns are very efficient doesn't necessarily mean that they are to be used only where large amounts of power are required. There are horn projectors rated as low as 5 watts input and there are some systems rated at 1800 watts input. The need determines the power requirement.

Paging & Talk-Back Horns

While the choice of a driver unit (or units on multiple-drive horns) is made on the basis of sound power required out of the horn, the horn in turn is chosen on the basis of the type of field coverage required and the frequency response needed for the application. The horn family is divided into three general categories: (1) paging and talk-back type; (2) high-power long-throw type; and (3) wide-angle dispersion type, covering both of the previous varieties.

Paging and talk-back horns are relatively small, ranging from 6" to 8" in horn-mouth diameter and about the same corresponding physical lengths (see Fig. 9A). They are easy

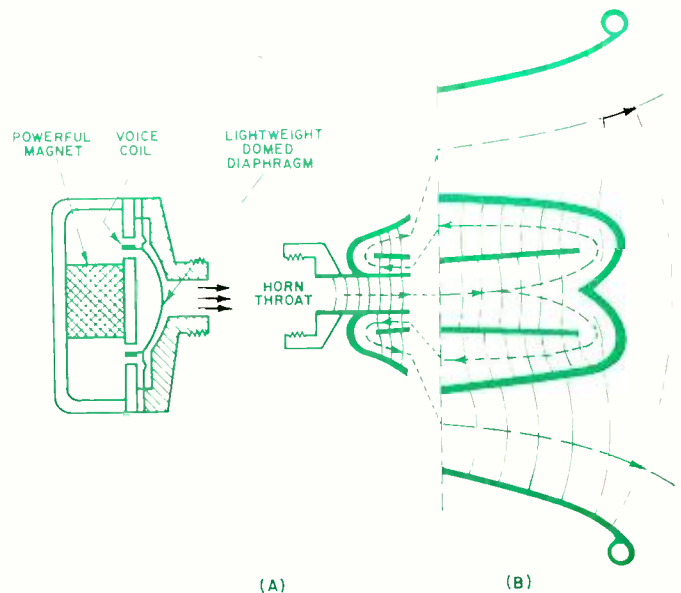
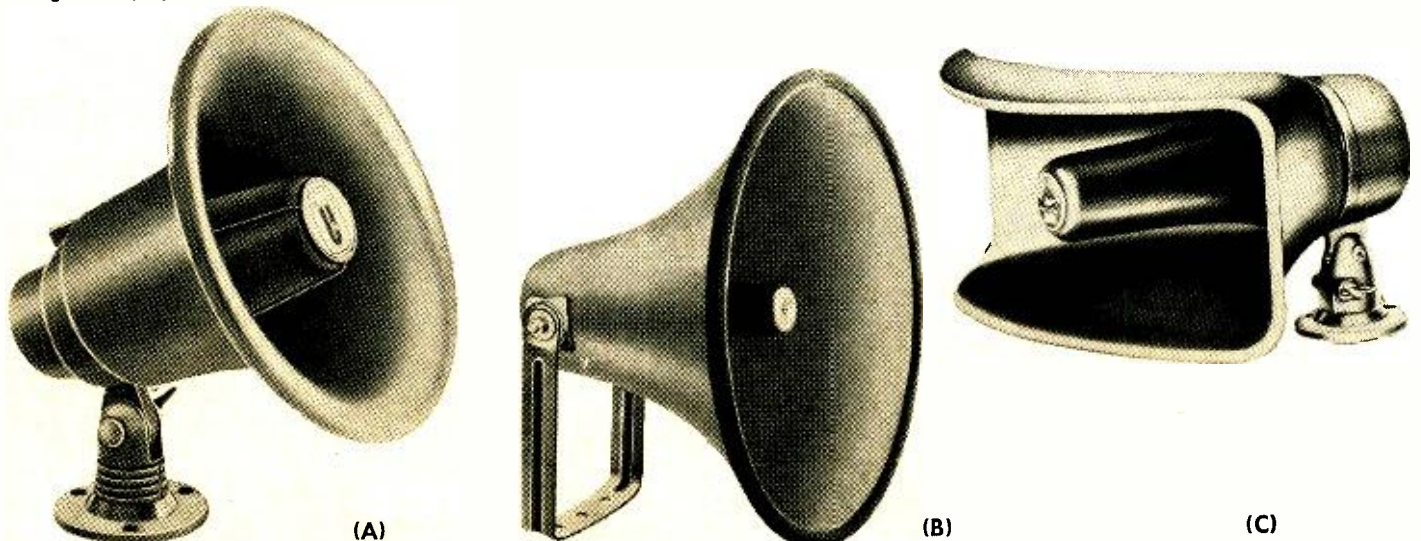

Fig. 8. The high sound output from efficiency compression driver and the good impedance match provided by the horn result in an over-all high efficiency of output.

Fig. 9. Various type of horns for p.a. use. (A, left) Paging and talk-back speaker with integral driver unit, University MIL-A; (B, center) long-throw projector with provision for screw-on driver unit, University GH; (C, right) contoured horn for wide-angle distribution (Atlas CJ-30B).



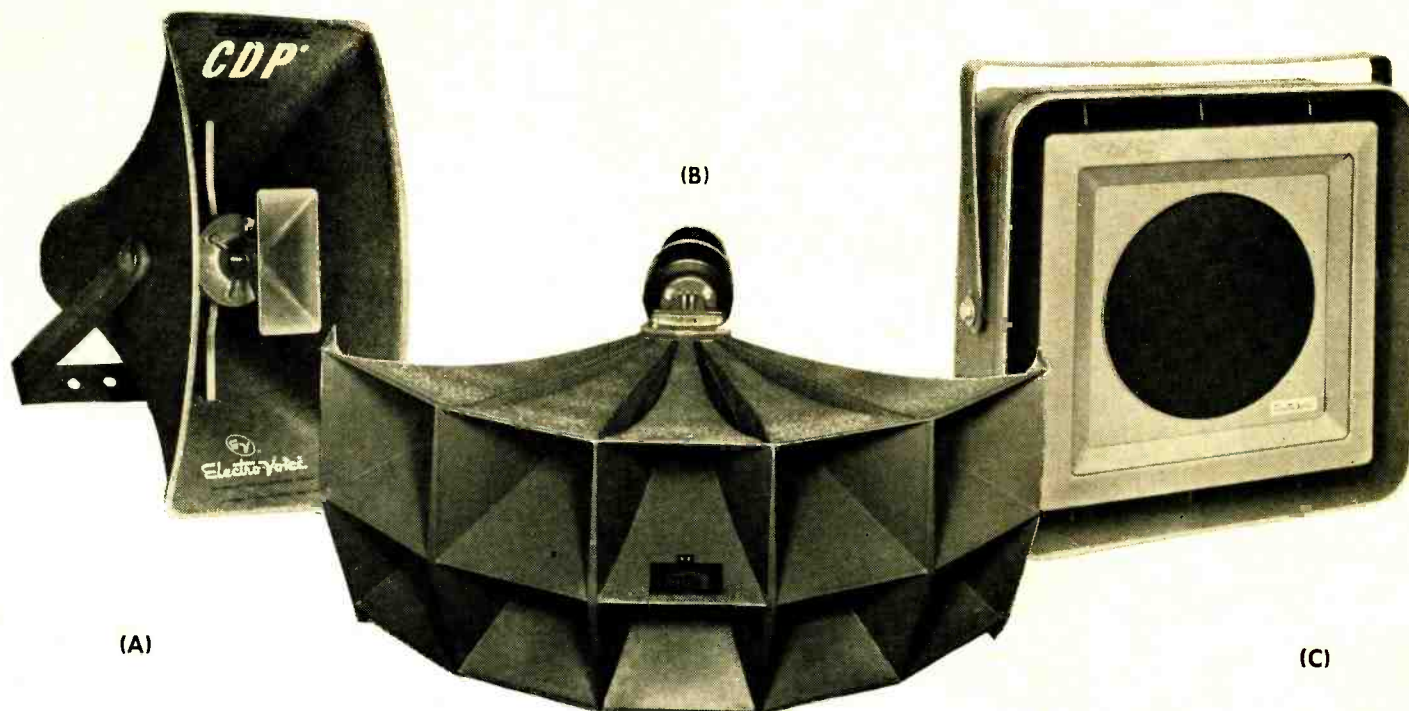

Fig. 10. Additional horns for p.a. use. (A, left) Horn tweeter in mouth of large horn provides wide-angle high-frequency distribution, Electro-Voice 848A; (B, center) 2 x 5 multicellular horn for wide-angle distribution, Altec 1003B; (C, right) rear horn-loaded outdoor speaker, Electro-Voice 1A.

to handle, being generally provided with some sort of a universal swivel mount. They may be conveniently affixed to walls, ceilings, ceiling cross beams, or any convenient abutment near the area to be covered.

Their response characteristics may start anywhere between 250 Hz for the 8" type to 500 Hz for the 6" size, and extend well beyond the upper limit of the speech spectrum. This brackets the band of approximately 250 to 5000 Hz. Articulation with these paging units is exceptionally high. They are placed close to the particular areas where the people to be paged are most likely to be found, and often are located close to or within an area where high noise generating equipment and its operating personnel are stationed.

Successful paging into these areas may be accomplished with moderately small amounts of power per speaker, usually about 5 watts, although such speakers are rated at and will handle as high as 20 watts for extreme conditions. Speakers of this sort may also be found on open-air platforms or in long-corridor systems, such as at airports and in subways where ambient noise may be quite high.

More even sound distribution may be obtained by spotting small speakers at short intervals down the corridor, rather than providing a single high-level source at one end of the corridor. The latter would merely introduce undesirable reverberation and extremely spotty and unevenly distributed sound.

Because the small speakers may be scattered over an area, they serve as high-efficiency microphones when incorporated in a sound system with intercom calling and listening facilities. One may speak quite a distance away from such a speaker and be understood back at the intercom-control station.

The high-power, long-throw horn system (Fig. 9B) is usually represented by the family whose acoustic column lengths may range from 2½ to 6½ feet and whose mouth diameters may be from 16 to 32 inches. The standard round horn of this group has a symmetrical distribution pattern of sound energy emerging from its mouth, beamed directly along its axis. Such patterns make it highly suitable for long-throw sound projection as far ahead and in front of the horn as possible, a sort of acoustic "spotlight" type of service. For

such application, it is wise *not* to spread the available energy out over a large area in such a manner that it will have to fight its way, under adverse conditions of air and humidity conditions, only to be lost at the listening area, but rather to beam it ahead for maximum usability.

In long-distance sound throws we cannot hope for real highs as they are absorbed by the air and buffeted about by wind currents. However, considering that we can get usable articulation from the middle frequencies, the symmetrical horn, with its normal beaming, provides excellent acoustic spotlighting of reasonably distant areas. Naturally, a cluster of such horns mounted at a common center can provide high-intensity spots of acoustic energy, one merging with the other to give wide-area coverage.

Focusing of the sound by the round horn may even be a useful adjunct to the horn designed for wide-angle throw (next up for discussion) where the listening audience may be in a park which has heavy outcroppings of "soft" foliage and other brush. The beaming round horn may transmit enough extra acoustic energy into that area to overcome any loss of the original wide-angle distribution at that point.

Contoured Horns

Using the same high-efficiency techniques as employed in the standard round horn, other shapes and modifications that produce wide-angle distribution of the sound pattern have been developed. These horns tend to "pancake" the sound pattern into those areas needing the sound energy and minimize the energy into those areas where it would be wasted or cause destructive interference. These problems are precisely the ones that the column speaker was designed to overcome; the horn, however, provides higher efficiency.

One method of obtaining this wide-angle dispersion is by reshaping the horn so that it will throw more sound in one direction than another (Fig. 9C). Another method of improving dispersion is by mounting a high-frequency horn in the center of the mouth of the larger horn (Fig. 10A). The smaller horn, operating as a p.a. tweeter, may be oriented for the direction in which the dispersion is desired. In this case, diffraction effects cause the beam to spread perpendicular to the larger dimension (*Continued on page 59*)

THE CALECTRO SUPERMARKET

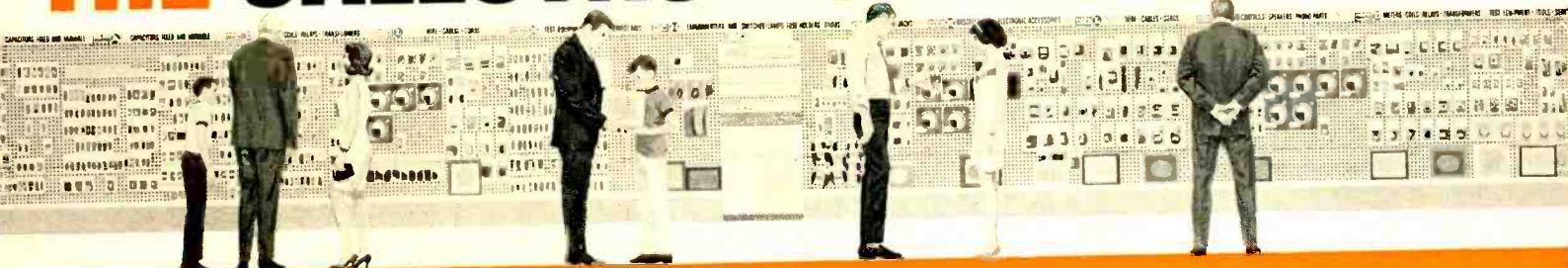

EVERYTHING IN ELECTRONICS!



VARIABLE BALANCE STEREO HEAD PHONE
 Unique "Sound Level" control on each earpiece permits adjustment. Frequency range: 20 to 20,000 + cps. 6 1/2' cord with stereo plug. Impedance 4 to 16 ohms.
 Cat. No. Q4-132 \$12.95 Net

MINIATURE LAMPS



Type PR2 - 2.5 volt - 0.50 amp -
 Cat. No. E2-430 - Pkg. of 2 \$.29 Net
 Type PR3 - 3.6 volt - 0.50 amp -
 Cat. No. E2-431 - Pkg. of 2 \$.29 Net



TAPE RECORDER MICROPHONE
 Outstanding performance on music and speech for the price. Low impedance matches late model solid state recorders. Removable desk stand; 4 1/2' cord with dual plugs that fit most models. Freq. Response: 100-8k Hz. Output: -77 dB. Impedance: 200 ohms
 Cat. No. Q4-146 \$4.95 Net

AUDIO ADAPTORS

"Y" Audio Adaptor has a phono pin jack on one end and dual phono pin plugs on the other.
 Cat. No. Q4-288 \$.99 Net

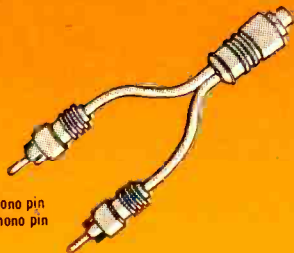

RESISTORS

Attractively packaged 2 per pack, showing values, color codes and formulas.

Type	Rating	Sizes Available	Price	Unit
Carbon 1/4 Watt	-10%	10 Ohm-	\$.19	Pkg. of 2
		10 Meg		
Carbon 1 Watt	-10%	10 Ohm-	.19	Ea.
		1 Meg		
Carbon 2 Watt	-10%	10 Ohm-	.25	Ea.
		100K		
Wire Wound	-10%	10 Ohm-	.36	Ea.
		15K		



HOBBYIST'S SOLDERING AND TOOL KIT

Diagonals, long nose pliers, soldering iron and solder, solder aid tool, heat-sink, and screwdriver. An ideal gift item.
 Cat. No. H3-378 \$7.95 Net.

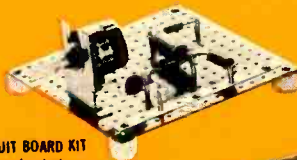

EXPERIMENTER'S CIRCUIT BOARD KIT

Contains a 3 3/4" x 4" perforated board, 15 terminals (No. J4-636) and 4 mounting feet w/screws. Build small circuits, hobby and science projects, etc.
 Cat. No. J4-660 \$.98 Net

STANDARD 1000 VOLT CAPACITOR

High quality, compact and reliable. Minimum capacity change with varying temperature. Rating: 1000 volts; tolerance: 20%.

Cat. No.	Description	Net	Unit
A1-060	220pF	\$.25	Pkg. of 2
A1-061	330pF	.25	Pkg. of 2
A1-062	470pF	.25	Pkg. of 2
A1-063	680pF	.25	Pkg. of 2
A1-064	0.001uF	.19	Ea.
A1-065	0.005uF	.19	Ea.
A1-066	0.01uF	.19	Ea.



The "GC Calectro Hobbyist Handbook" is available at your nearest Calectro Electronic Supermarket. One is located near you. WRITE TODAY and we'll rush you the name and address of your nearest Calectro Supermarket.



TWO STATION WIRELESS INTERCOM

Just plug into any electrical outlet. Completely portable. Expand system anytime with additional units. Two unit system complete in display pack.
 Cat. No. M4-110 \$34.95 Net

CALECTRO G-C ELECTRONICS

400 SO. WYMAN ST. ROCKFORD, ILLINOIS 61101



A DIVISION OF HYDROMETALS, INC.

CIRCLE NO. 133 ON READER SERVICE CARD



JOHN FRYE

An NEA committee is giving technicians a chance to tell TV manufacturers how to improve the serviceability of their sets.

TECHNICIANS' CHANCE TO GRIPE

BARNEY had been muttering to himself for a solid quarter of an hour as he worked on a clock radio. Finally Mac, his employer, said, "I wish you'd talk loud enough so I can hear what you're saying or quit growling. You're distracting my attention from this convergence job. You sound like Scrooge at his worst. That's not the old Jingle Bell spirit. What's eating you?"

"Aw it's the way this darling little clock radio is put together. All's wrong with it is that someone with pipe-wrench fingers has forced the clock control knob over the limit stop so the radio can't be turned off. However, to get the clock out to where I can work on the switch, I must first remove the chassis. Sounds simple, doesn't it? Well, just listen:

"To take off the back, I had to remove six Phillips-head wood screws. The superstructure of the chassis is held against the front by a long metal bracket screwed to the cabinet by four slotted screws. Two hex-head machine screws hold the chassis to this bracket. Because of space limitations, the bracket has to come loose from the cabinet and the chassis from the bracket to get the radio out. Four more hex-head metal screws of a different size hold the rear of the chassis to the case, and four more are used to fasten the front of the PC board to the cabinet. The clock leads are soldered to the chassis so both the chassis and the clock must come out together. The clock mechanism is held against the rear of the face by four push-on speed nuts that are heck to get off. Finally, the clock face is an integral part of the cabinet front; so I had to remove the plastic cover over the face and pull off all three clock hands before I could get the mechanism out the back.

"Just look: I have a whole bench full of tools to take that little radio out of the case, and I have been a half-hour doing it because I had to figure out the best procedure as I went along. The set is new enough that we don't have any service data on it, and there is no information on chassis removal printed on the bottom or back."

"Stop! You're breaking my heart!" Mac said mockingly, "but I know only too well what a job like that can do to a technician's blood pressure. However, I bring you tidings of great joy. Someone is finally doing something about this problem—at least as it applies to TV receivers. A serviceability committee of the National Electronic Associations has drawn up a check list of sixty-one questions they hope technicians will use on sets they think need improving and submit their findings to NEA at the national office at 7046 Doris Drive, Indianapolis, Indiana 46224. As these are received, they will be evaluated and full reports will be made to the manufacturer of that particular receiver to guide him in the development of his products."

"Well, it's about time," Barney growled. "I'm sick of TV sets in which replacing a channel indicator bulb is a major operation, sets without any provision whatever for 'in cabinet' servicing, sets that have no parking spaces on the chassis for subassemblies, sets that can't be set up on the bench for servicing without elaborate propping and consequent danger of causing damage to components."

"You're going to like this check list," Mac said. "Every

gripe you mentioned is covered by a question on the list. These questions are divided into two major categories: I. questions about the ease of servicing the set in the home, and II. questions probing into how easy the set is to service on the bench. Under I are questions about the difficulty of Back Removal and Installation, Product Identification, Service Control Accessibility and Identification, Accessibility for Service and Component Identification, and Chassis and Subassembly Removal and Handling. The questions under II pertain to the difficulty of preparing the set for service on the bench and the actual performance of that service."

"How about giving me some examples of questions from the check list," Barney suggested.

"Okay," Mac said, picking up a copy of the September issue of the *Electronic Service Dealer*. "Here are a few: Are antenna terminals separate from back? Is model number readily visible without removing back? Are service controls accessible through back, identified on back, and also identified on chassis when back is removed? Are dynamic convergence controls identified as to function and/or areas of screen affected? Are tubes properly identified on layout chart *without resorting to intermediate V numbers*? Do transistors plug in? Is more than one size tool required to remove chassis & subassemblies? Are there trick or unusual means of securing panels, covers, escutcheons, etc., which must be removed or released to remove or re-install a chassis or subassemblies? If so, are such means indicated and/or explained on label in cabinet? Are all components clearly identified on PC boards? There; that should be enough to give you an idea of the general nature of the questions on the check list."

"Yeah, and it sounds as though this might be one committee that really worked together and did a job. You remember that old joke about the giraffe looking as though he had been put together by a committee. But I can't help wondering just how much attention the manufacturers will pay to the complaints."

"The smart ones will pay plenty of attention, especially when a whole flock of complaints regarding a particular receiver are forwarded by the NEA. After all, the technician is very often consulted when the purchase of a new TV receiver is contemplated, and no technician is going to recommend a receiver that is unnecessarily difficult to service. I know you have heard me explain to a customer that the size of his bill is very definitely related to the difficulty of servicing his receiver, and I quite often take the time to show him what I am talking about. He may not have much savvy about electronics, but he can certainly understand that when you have to take out umpteen screws and practically dismantle the receiver to replace a channel indicator lamp, it is going to cost him."

"Why the heck don't manufacturers make their sets easy to service without being prodded into doing so?"

"Because, in all fairness, there are other factors to be considered, such as ease of assembly, cost, and appearance. These things are all easier to 'sell' than is ease of service. After all, it's poor sales psychology for the salesman to re-

Don't sell a color picture tube unless its been on a test ride.

Down at the bottom of the page, you have a major advance in space-age homeliness.

And a major advance in color tube testing as well.

That machine squatting down there is our beloved Iron Horse, the fully-automated, revolving carousel we use to test our color bright 85[®] tubes for emission, gas leakage, shorts, arcing and screen uniformity prior to shipment.

Now we don't intend to go into a song and dance on how total automation reduces testing error.

But we will tell you one thing.

Our Iron Horse test ride, combined with our life testing and 100% set testing, makes it almost impossible for you to get a defective color tube from us.

Which in turn makes it almost impossible for you to get chewed out by a customer.

Next time you need a color replacement tube, remember the great thing about the color bright 85. We don't send it to you till it's been around.

SYLVANIA
GENERAL TELEPHONE & ELECTRONICS

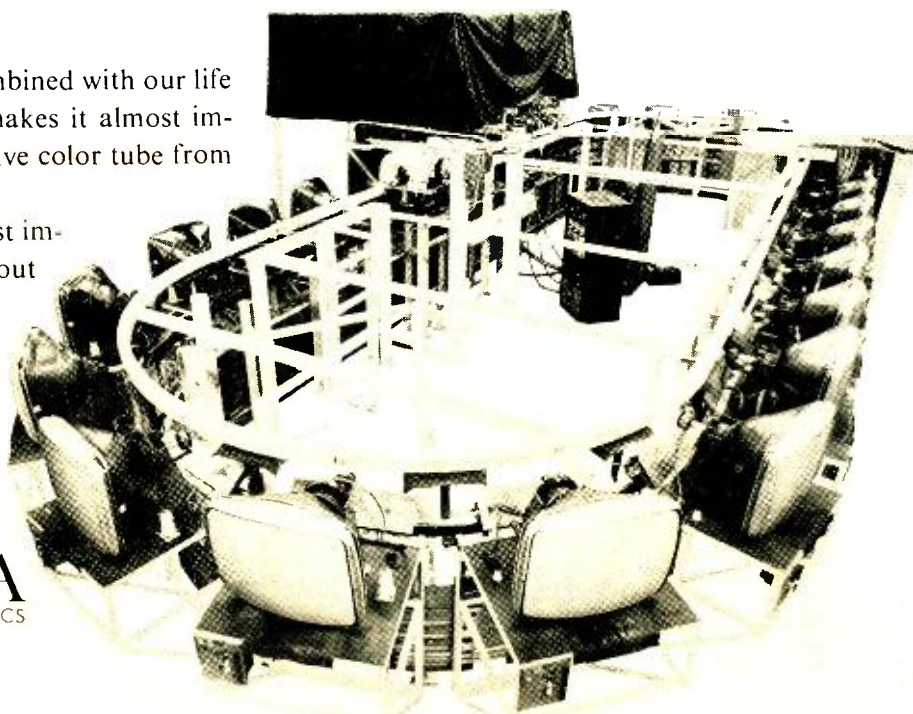

CIRCLE NO. 190 ON READER SERVICE CARD

**LAFAYETTE
RADIO ELECTRONICS**

FREE!

**1970 CATALOG NO. 700
JUST OFF THE PRESS!!
SEND FOR YOUR EXCITING COPY NOW!**



**LATEST
RELEASES!
BEST
BARGAINS!
496
Pages**

**YOUR 1st GUIDE TO
EVERYTHING IN
ELECTRONICS**

- ★ CITIZENS BAND 2-WAY RADIO
- ★ STEREO/Hi-Fi COMPONENTS
- ★ MUSICAL INSTRUMENTS AND AMPLIFIERS
- ★ PUBLIC ADDRESS
- ★ AMATEUR RADIO
- ★ TEST EQUIPMENT
- ★ PARTS
- ★ PORTABLE AND TABLE RADIOS
- ★ PHOTO EQUIPMENT
- ★ TOOLS BOOKS
- ★ AUTO ACCESSORIES
- ★ EDUCATIONAL AND OPTICAL
- ★ TV AND ANTENNAS

Mail the Coupon Today for your FREE 1970 Lafayette Catalog 700

LAFAYETTE Radio ELECTRONICS
Dept. 01129, P.O. Box 10
Syosset, L.I., N.Y. 11791

Please Send the FREE 1970 CATALOG 700 01129

Name _____

Address _____

City _____ State _____

Zip _____ (please include your Zip Code No.)

CIRCLE NO. 94 ON READER SERVICE CARD

GET INTO ELECTRONICS



V.T.I. training leads to success as technicians, field engineers, specialists in communications, guided missiles, computers, radar and automation. Basic & advanced courses in theory & laboratory. Electronic Engineering Technology and Electronic Technology curricula both available. Assoc. degree in bot. mos. B. S. also obtainable. G.I. approved. Graduates in all branches of electronics with major companies. Start September, February. Dorms, campus. High school graduate or equivalent. Write for catalog.

VALPARAISO TECHNICAL INSTITUTE
Dept. RO, Valparaiso, Indiana 46383

mind the prospective buyer that the shiny new TV set he is pushing will eventually need to be repaired."

"Yeah, and when you get right down to it, serviceability takes a back seat in the assembly of lots of things, including human beings," Barney offered. "In many ways it would be more convenient for the surgeon if we had our gall bladders, appendixes, and other organs that frequently give trouble hanging on the outside; but this arrangement wouldn't do much for Miss America when she is parading in her bikini."

"Leave it to you to think of that!" Mac exclaimed with a grin, "but you do have a point. We can't expect the manufacturer to place serviceability first in the characteristics he tries to build into his receivers. On the other hand, serviceability should be kept constantly in mind in designing the receiver; and, whenever possible, consistent with cost, performance, and appearance, the receiver should be built so that it will be easy to repair. In a surprising number of cases, a good engineer can come up with a design that makes no sacrifices in performance or appearance, adds very little to the cost, and yet produces a receiver that is easy to disassemble and service—but he has to be service-minded to do it. That's why I think there should be an experienced service technician on the design staff of every radio and TV receiver manufacturer with just as much say-so about final design as others on that staff."

"I just wish one thing," Barney interrupted, looking ruefully at the cluttered bench in front of him. "I wish the same thing were being done for radio receivers. Some of these little dingbats are harder to get into than a green coconut, and the average customer is not inclined to pay a large service bill on a 'simple little radio,' no matter how much sweat and time the technician has to put into it."

"What sort of general suggestions would you have for the radio manufacturers?" Mac quizzed.

"Remember you asked for it!" Barney warned. "I'd like to see disassembly instructions printed on a label pasted on the outside of the receiver indicating clearly what screws are to be removed for each operation. All screws used in holding the cabinet together and the chassis in the cabinet should, if possible, have the same kind of heads. A particular peeve of mine are those interlock arrangements where the male connectors are riveted to a flimsy, sagging circuit board and are supposed to slide into the female receptacle of the line cord at the same time the plastic case is sliding together. Unless everything is lined up perfectly, you can waste several frustrating minutes on that one."

"Don't forget the printed-circuit

boards where often-replaced units such as rectifiers and fusible resistors are hidden behind filter cans or in other hard-to-reach places," Mac suggested. "And if the design engineer wants to insure undying hatred of the technician, he can do so by using stiff, easily broken leads soldered to the chassis on one end and directly to the speaker connections, or to flimsy connectors, on the other. The speaker, of course, is mounted in the cabinet; so when you must remove the printed-circuit chassis for service, you are almost certain to break either the connecting wire or the chintzy connector that slides onto the speaker terminal. The same thing goes for control-clock leads."

"Speaking of those control clocks," Barney said, "let's not forget the guy who drives hard-to-work switches and mechanical linkages with spindly little brass shafts that are split on the end to take plastic push-on knobs. In a very short time the shafts are either broken off entirely or half of the split end is broken off so that the knob no longer will work. I've noticed about one clock radio in three that comes into the shop has one of these mutilated stubs sticking out of the clock face. The guy who designs those clocks should either make the mechanisms easier to operate or employ sturdier shafts that will do the job. I'm tired of having customers ask me to 'put on a new knob' when there's nothing there to put it on."

"Many of those check-list questions for TV sets also apply to radio receivers," Mac suggested. "I mean the ones about making sets easier to get into, using transistor sockets, identifying parts on the PC boards, and calling out test points on the boards. But let's be thankful that the NEA is finally doing something about the problem. If true communication can be established between the manufacturer and the service technician, not only will both of them benefit; so will the customer!" ▲

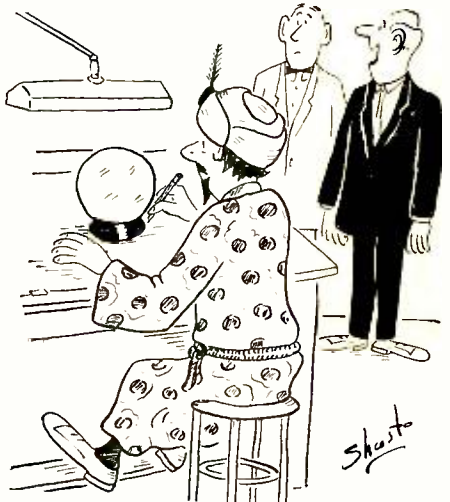

"Best checker we ever had—he can foresee fatigue factors, design deficiencies, contractor problems. . . ."

Which Speaker for P.A.?

(Continued from page 54)

of the mouth of the horns. A third method (Fig. 10B) uses an external multi-mouthed, or multicellular, horn to direct the high frequencies into those areas where the main radiator cannot project. For maximum horizontal dispersion of high frequencies, the horns in Figs. 9C, 10A, and 10B are mounted as shown in the photographs.

Because of the relative lack of low frequencies from horn projectors, they are not by themselves suitable for wide-range "hi-fi" p.a. systems, but are used frequently as the upper frequency elements of a system designed for concert work, especially in applications where distances are to be covered. The multicellular unit may be designated as a 2×5 unit or a 3×6 unit. This indicates how many rows of small horn are stacked one on top of the other, and how many small horns are in each row. The configuration of such a horn will determine the radiation pattern.

These horn clusters are rated for several cut-off frequencies, so that one has a choice of bandwidth and dispersion characteristics. In some well-designed systems there may be two clusters of horns, a mid-frequency and a high-frequency cluster, both working in conjunction with multiple high-efficiency cone radiators. The multiple low-frequency cones are housed in a bass-reflex enclosure large enough to reproduce very low frequencies cleanly and efficiently. In addition, the cones may be front-loaded with a short horn to raise the efficiency of the lower middle frequencies to be compatible with the efficiencies of the upper frequency clusters. Crossover networks are used and there is a choice of 6, 12, or 18 dB per octave roll-off. Systems such as these are found in theaters for high-quality sound-track reproduction, in large multi-use auditoriums, and for concerts in open shell areas.

We shall next take up the matter of the outdoor installations for patios, outdoor shopping areas and malls, sidewalk restaurants and esplanades, where good fidelity must be obtained from unobtrusive weatherproof speakers. The unit (Fig. 10C) frequently takes the form of either an 8" or 12" cone speaker whose diaphragm is treated with impregnating resins to make the paper stock water-resistant. The structure is that of a forward direct radiator, with the rear of the cone loaded by a short one-bend horn. This rear horn provides some acoustic loading on the back of the speaker so that the cone may radiate low frequencies consistent with the size of the structure. The second purpose of the horn is to protect the cone from rain or wind.

Because the horn is of limited length and since its mouth area is quite small, the low-frequency capability of the horn is limited, although quite adequate for the application. Accordingly the cone-speaker driver is of fairly high resonance, probably between 75 and 100 Hz for a typical patio unit. The front of the cone may be protected by water-impermeable cloth, protective screens, and metal grillework which may be decorative as well as protective. One can equate this type of speaker in terms of quality with the column speaker. In this case, however, the patio speaker is almost always omnidirectional, with no important horizontal or vertical advantage. The mouths of such speakers may range in size from approximately 10" across to 33½" with the choice, as in all p.a. work, determined by the area to be covered and the quality of performance desired. In the case of the larger models, the systems are usually woofer-tweeter combinations for maximum fidelity.

Any sound system must be approached on the basis of a system philosophy where the system consists not only of an amplifier, distribution system, and loudspeakers but, and most important, the audience to be reached. And to reach it successfully, the industry has designed and provided dozens of specialized loudspeakers for as many varied needs. ▲

Telex writes new specs on sensitivity and ruggedness in headphones.

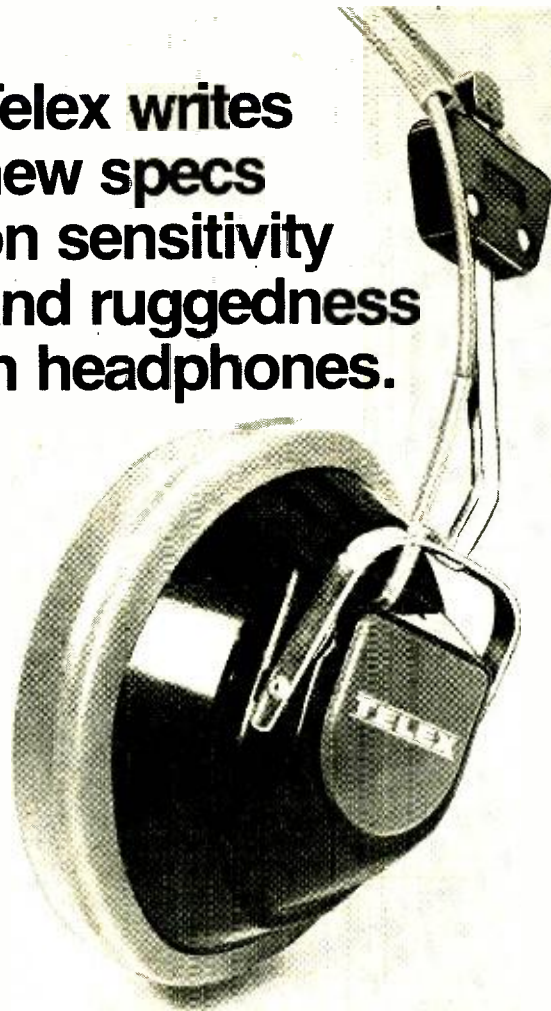

the Communicator Series

HIGH SENSITIVITY AND LOW OPERATING POWER. The new Communicator Series of headphones is designed around a dramatic new driver unit that requires only absolute minimal operating power. This added efficiency allows for a substantial increase in sensitivity without any increase in distortion, making the Communicator Series the most sensitive and versatile headphones available today.

RUGGED. CONSISTENT PERFORMANCE. Unlike the soft aluminum or paper cones in most of today's headphones, the Communicator's rugged new cone is made of special material that will provide peak performance without being affected by temperature or humidity. This means that you get consistent, high quality performance, day in and day out, under the most demanding communications conditions.

For more information on Telex's new Communicator headphones, contact your nearest Telex dealer or write.

PRODUCTS OF SOUND RESEARCH
TELEX[®]
COMMUNICATIONS DIVISION
9600 Aldrich Avenue South
Minneapolis, Minnesota 55420



CIRCLE NO. 98 ON READER SERVICE CARD

We pack your electronics course with kits to make your training fast. You'll enjoy every minute of it.

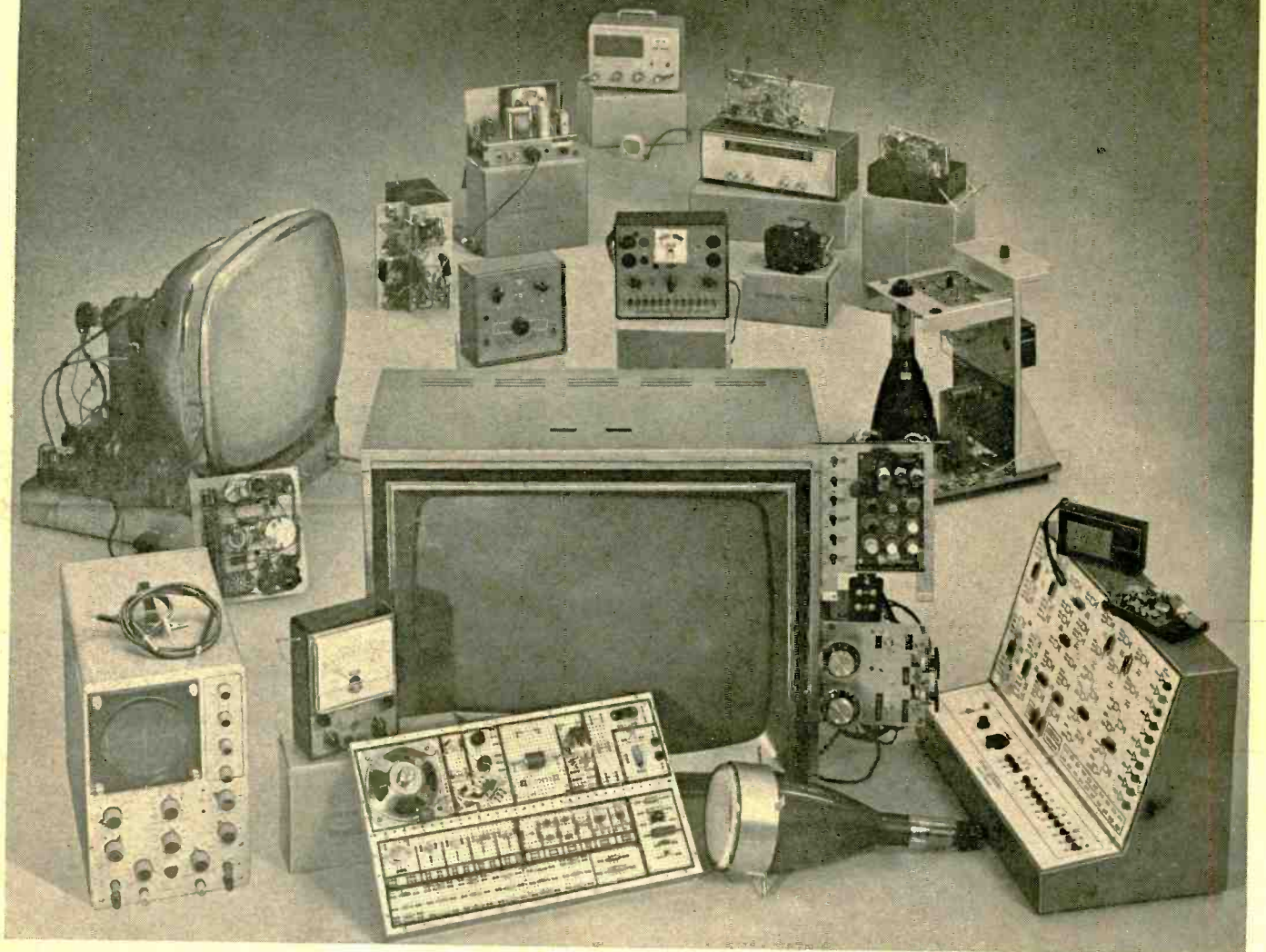

Your NTS success package

Choose a career in electronics: Computers. Color TV Servicing. Automation. Communications. Whatever the field, NTS has a complete home-study package to get you to the top *faster*. 10 thorough training courses. Each includes *everything* to give you the *working* knowledge required of successful technicians.

NTS Project-Method Training is the practical way to learn elec-

tronics. It's a proven combination of lessons and the best professional kit equipment available. NTS provides the *biggest selection of kits ever offered in home-study . . . all at no extra cost*. You'll construct these exciting kits to fully understand electronic circuits, components, and concepts. Our Project-Method lets you build skills by putting theory into practice . . . by working with your hands, as well as your head.

The NTS "learn and practice" approach makes training at home really easy. All it takes is a few hours a week . . . whether you're starting from scratch or in advanced courses. This is the all-inclusive success package that put thousands of men into the best paying jobs . . . or into their own business. If "just a living" isn't good enough for you, now is the time to get something better going for you!

NTS COMPUTER ELECTRONICS

This is the future. And it's happening now. The number of computers will *increase many times* in the next few years.



Exclusive new Compu-Trainer®

NTS offers a solid grounding in computer operation, wiring, data processing and programming. One of the 10 important kits included is our exclusive Compu-Trainer®. It's a fully operational computer logic trainer — loaded with integrated circuits — the first ever offered in home study. It introduces you quickly to how, what, when and why of computers . . . from theory to practical servicing techniques. This unit is capable of performing 50,000 operations per second. And it's sent at no extra cost.

NTS COLOR TV SERVICING

This is a broad, easily understood

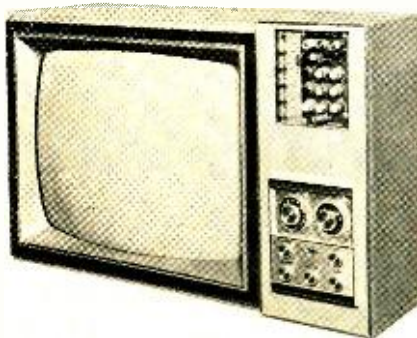

COLOR TV 295 SQ. IN. PICTURE

program designed to make you a complete home-entertainment service technician. Included, at no extra cost, is a color TV that has more features than any

set on the market. You also learn all about stereo, hi-fi, multiplex systems, and become a specialist in Color TV Servicing. Kits also include AM-SW radio, solid-state radio, field-effect transistor volt-ohmmeter, electronic tube tester.

NTS AUTOMATION/ INDUSTRIAL ELECTRONICS

You're trained in the "push-button" electronics that keep industry going and growing . . . from relay type controls to highly advanced systems essential to production. You receive 16 kits including a 5" wide band oscilloscope, and the new NTS electronics lab: a fascinating NTS exclusive experimental laboratory. A complete workshop which makes you familiar with solid-state, miniature, and integrated circuits.

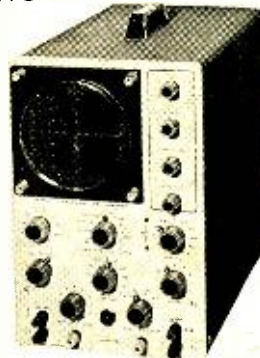

5"
Oscilloscope

NTS ELECTRONIC COMMUNICATIONS

The use of 2-way radio systems in private and commercial applications is skyrocketing. NTS prepares you for the big-money opportunities in the field of transmitting and receiving equipment. *Your tuition will be refunded in full if you cannot pass the FCC exam for a 1st Class Commercial Radio-Telephone License within*

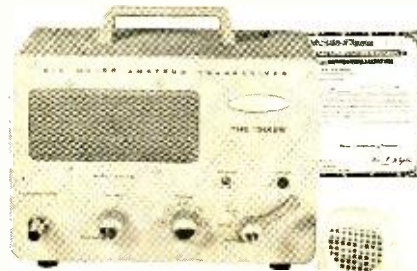

5 Watt AM Transmitter & Receiver

six months after successfully completing this course. You build valuable kits including Amateur-Phone 6 Meter VHF Transceiver, solid-state Radio, and a field-effect transistor volt-ohmmeter.

CLASSROOM TRAINING AT LOS ANGELES

You can take classroom training at Los Angeles in sunny Southern California. NTS occupies a city block with over a million dollars in facilities devoted exclusively to technical training. Check box in coupon.

NATIONAL TECHNICAL SCHOOLS

World-Wide Training Since 1905
4000 South Figueroa Street
Los Angeles, Calif. 90037, U.S.A.

APPROVED FOR VETERANS

Accredited Member: National Association of Trade and Technical Schools, National Home Study Council.

**TODAY, MAIL
COUPON
FOR FREE
COLOR
CATALOG
AND SAMPLE
LESSON.**

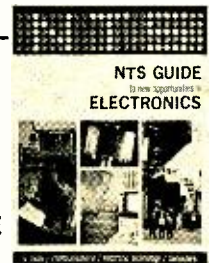

NATIONAL TECHNICAL SCHOOLS
4000 S. Figueroa St., Los Angeles, Calif. 90037

Please rush Free Color Catalog and Sample Lesson, plus information on field checked below. No obligation. No salesman will call.

- MASTER COURSE IN COLOR TV SERVICING
- COLOR TV SERVICING
- MASTER COURSE IN TV & RADIO SERVICING
- PRACTICAL TV & RADIO SERVICING
- MASTER COURSE IN ELECTRONIC COMMUNICATIONS
- FCC LICENSE COURSE
- MASTER COURSE IN ELECTRONICS TECHNOLOGY
- INDUSTRIAL AND AUTOMATION ELECTRONICS
- COMPUTER ELECTRONICS
- BASIC ELECTRONICS

Name _____ Age _____

Address _____

City _____ State _____ Zip _____

- Check if interested in Veteran Training under new G.I. Bill.
- Check if interested ONLY in Classroom Training at Los Angeles. Dept. 240-129

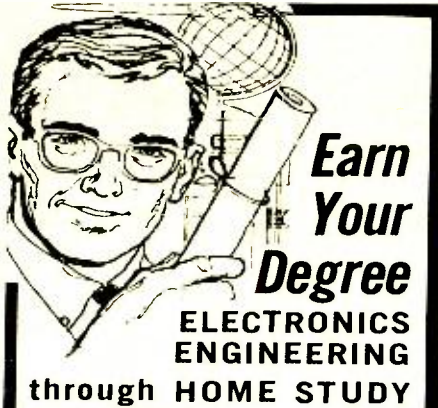

**Earn
Your
Degree**

**ELECTRONICS
ENGINEERING**

through HOME STUDY

**HIGHLY EFFECTIVE
HOME STUDY COURSES IN:**

- Electronics Engineering Technology
- Electronics Engineering Mathematics

Earn your Associate in Science Degree in Electronics Engineering and upgrade your status and pay to the engineering level. Complete college level courses in Electronics Engineering. We're a forward looking school. Outstanding lesson material—thorough and easy to understand. Engineering taught on the basis of application and understanding rather than on the basis of memorization. Up to date in every respect. Acquire the knowledge and ability that means the difference between a low paying technician job and a high paying engineering position. Low tuition cost with low monthly payments. Free engineering placement service for our graduates. Write for free descriptive literature. Ask for bulletin J, no salesman will call on you.

COOK'S INSTITUTE
of Electronics Engineering
Forest Hill Road
P. O. Box 10634
Jackson, Miss. 39209
Established 1945
Formerly Cook's School of Electronics

CIRCLE NO. 138 ON READER SERVICE CARD

NEED SOUND ADVICE?

Consult the all-new
1970 STEREO HI FI DIRECTORY

It's the most complete, most reliable guide to virtually every new component on the market. . . amplifiers•tuners•receivers•changers and turntables•home TV-tape recorders•tape machines•cartridge, cassette and reel-to-reel•speakers/cabinets•hi-fi systems•cartridge-arms—accessories•miscellaneous accessories.

You'll know what to look for, what to listen for, how to buy, what to pay— before you set foot in the store.

Your copy of the 1970 Stereo HiFi Directory is available now at your local newstand. It's only \$1.35. Or, if you prefer, send \$1.35 (plus 25c for shipping and handling) to Ziff-Davis Service Division, Dept. SD, 595 Broadway, New York, N.Y. 10012. We'll mail it to you promptly.

**TEST
EQUIPMENT
PRODUCT REPORT**

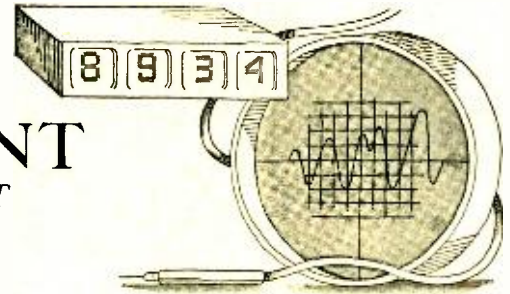

Heath IG-28 Color-Bar Generator

For copy of manufacturer's brochure, circle No. 24 on Reader Service Card.

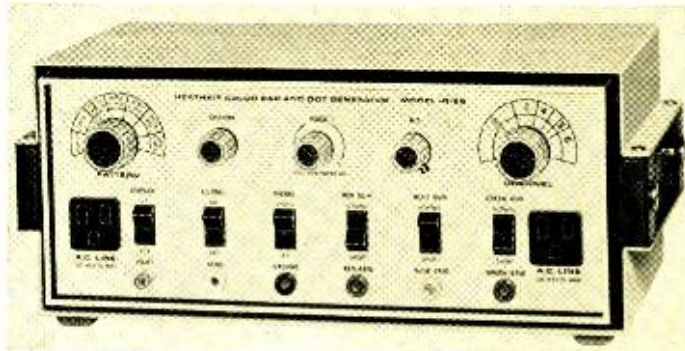

WHEN we first saw the prototype circuit designs for the new *Heath IG-28* color-bar generator some time ago, we knew that we were in for a really unique piece of test equipment. Rather than merely following the circuits of other color-bar generators on the market or the company's own vacuum-tube version, the engineers who designed this unit took two big steps forward. We have already seen a number of generators in which transistors are used as substitutes for vacuum tubes but with the same basic circuitry. With the IG-28, however, a second step was

taken and that is the use of integrated logic circuits in the frequency-divider chain. We know of only one other color-bar generator that uses IC's this way, and that is the *Conar Model 680*, described in our March, 1968 Test Equipment Product Report.

The IC's do away with the need to make adjustments and result in excellent accuracy, stability, and reliability. There are ten IC's used in all: both flip-flops and gates are employed (see block diagram). Along with the IC's, about a dozen transistors are used, mainly for the generator's various crystal-controlled

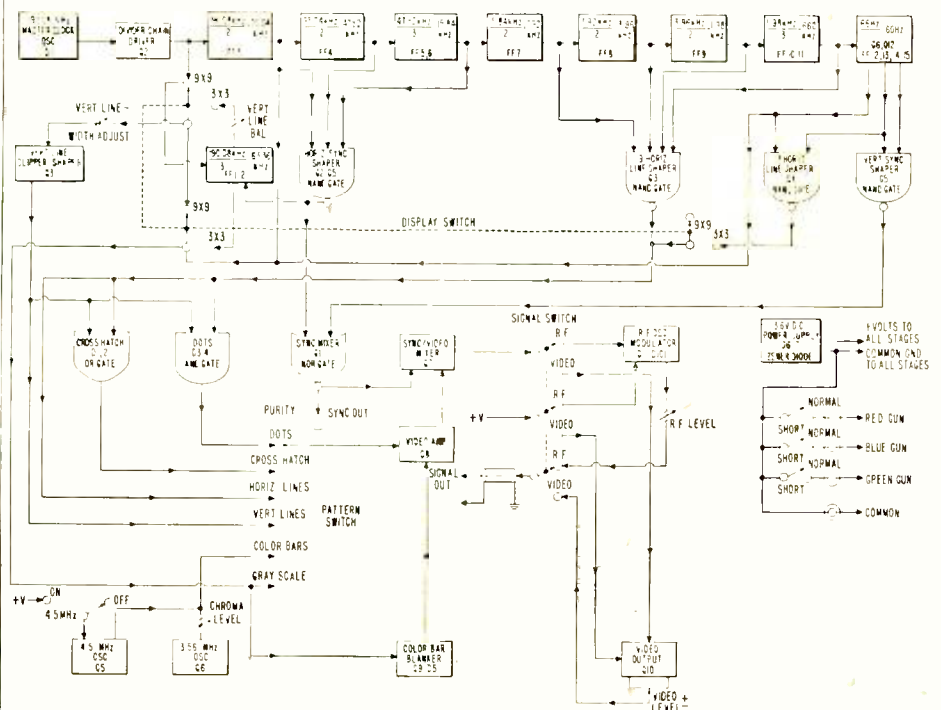



THE SOUND OF A DIFFERENT DRUM

Higher trackability in the "backbone" region of music

The grand structure of orchestral music relies heavily upon tympani, tuba, contrabass, bassoon, bass drum, and other low register instruments to form the solid foundation upon which the harmonies and melodic line are built. Unfortunately it is exceedingly difficult to track these passages when they are cut at high velocities. Even the Shure V-15 Type II, the world's highest trackability cartridge, required raising the tracking force when playing recordings containing this type of program material. We took this as a challenge and have prevailed. The top line of the graph at right shows the increased bass and mid-range trackability of the IMPROVED V-15 Type II. Practically speaking, it means you can reduce 1½ gram tracking force to 1 gram, or 1 gram force to ¾ gram for records with high velocity bass register material. No increase in price (\$67.50 net), but you will significantly extend record and stylus tip life.

NOTE: You can attain this superior bass and mid-range trackability with your present V-15 Type II by using the IMPROVED VN15E stylus at \$27.50. Look for the word Shure in red letters on the stylus grip.

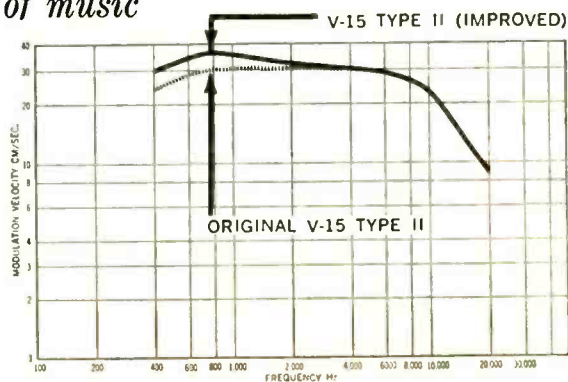

SHURE

V-15 TYPE II (IMPROVED)

SUPER TRACKABILITY PHONO CARTRIDGE

© 1969, Shure Brothers Inc., 222 Hartrey Ave., Evanston, Illinois 60204
CIRCLE NO. 103 ON READER SERVICE CARD

MR. SCA OPERATOR

NEED A RELIABLE SOURCE FOR HIGH QUALITY, LOW COST SCA RECEIVERS, OR SCA DEMODULATOR UNITS?

A new and proven sub-carrier demodulation scheme using old established principles is now practical due to recent component developments and mass production. The resultant reduction in cost is passed on to you.

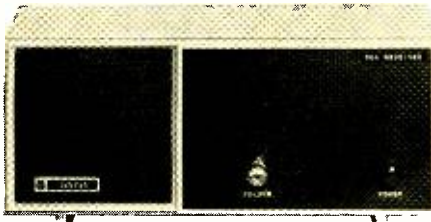

MODEL SCA-6137 SINGLE FREQUENCY FM RECEIVER. Size: 12" x 5½" x 4½". Price: \$69.95 (Quantity 1-9)

SCA-6137 FM Receiver Features:

- Range: 88 to 108 MHz • Frequency Field Adjustable • All Solid State Devices • RF Stage
- 3 IF Stages • Automatic Frequency Control
- Two 67 KHz Amplifier Stages • 67 KHz Ratio Detector • Adjustable Muting • Main/Sub-Carrier Switch • One Watt Audio Output • 4" Monitor Speaker • Provision for External Speaker • 117 Volt AC Operated.

Also available: SCA-3 sub-carrier demodulator IC Card with muting control. Size: 2½" x 3" x 5/8". Operates on 6 to 12 Volts DC at 6 ma. Available from stock. Price: \$39.95 (Quantity 1-9)

Quantity discounts and detailed specifications are available to SCA operators.

Send orders and inquiries to:

JanZac Company; P.O. Box 177;
Stamford, Conn. 06904

KenZac Company; P.O. Box 66251;
Houston, Texas 77006

CIRCLE NO. 124 ON READER SERVICE CARD

MOST ADVANCED IGNITION SYSTEM ON THE MARKET

JUDSON'S ELECTRONIC MAGNETO

Provides Better Performance. Reduces Fuel Consumption. Increases Plug and Point Life. Prevents High Speed Miss and Plug Fouling. You'll feel the difference right from the start.

The accepted standard in electronic ignition.

COSTS ONLY \$49.50

EASILY INSTALLED

Write Today For Free Literature

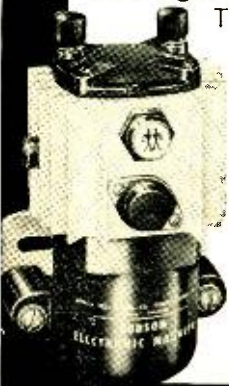

JUDSON
RESEARCH & MFG. CO.
CONSHOHOCKEN, PA. 19428

CIRCLE NO. 125 ON READER SERVICE CARD

oscillators and the higher-level stages.

No less than twelve patterns are produced by the generator. Six of these are the usual patterns, but in a 9 by 9 format; these are horizontal lines, vertical lines, cross hatch, dots, shading bars, and color bars. In addition, these same patterns are displayed in a useful 3 by 3 format. A clear raster is also available for adjusting the purity of a color set without upsetting its a.g.c.

Although the generator was designed primarily for color receivers, there are plenty of black-and-white sets we have seen whose pictures could be improved by a little more careful adjustment with the aid of the cross-hatch pattern of the generator.

An r.f. output is available from the generator for channels 2 through 6. An adjustable front-panel control permits the user to tune the generator to one of the blank channels in his area. A crystal-controlled 4.5-MHz sound carrier aids in fine tuning the generator to the exact

receiver frequency. Front-panel sync output along with variable plus and minus video output are also provided.

The usual gun-shorting switches are provided but there are also pin jacks for making connection to the grids of the color picture tube. A pair of 3-wire a.c. outlets on the front panel make it convenient to plug a color set into the generator during the set-up and convergence procedure.

A zener-regulated power supply is used for the generator, which is a.c.-line operated. A special copper-banded low-flux-leakage power transformer is employed to keep stray magnetic fields from disrupting the receiver under test.

The IG-28 is styled in beige and brown to match the rest of the new Heathkit instrument line. Kit assembly is facilitated by the use of two circuit boards and two pre-cut and stripped wiring harnesses. The kit version sells for \$79.95; a factory-wired unit is available at \$114.95. ▲

Sencore Model TF17 Transistor Tester

For copy of manufacturer's brochure, circle No. 25 on Reader Service Card.



EARLY transistor testers were one step behind some of the new solid-state equipment. This equipment frequently used among their complement of conventional transistors, the field-effect transistor. The early testers simply had no provision for testing these FET's. The test-equipment manufacturers soon caught up however, so that most of the new transistor testers are able to check this important semiconductor both in and out of the circuit.

The new Sencore TF17 is such an instrument. This is a portable unit that is designed to be used right on the job. It performs the same functions as the company's deluxe Model TF151, but is smaller, more compact, lighter in weight, and has a new, improved mechanical layout.

This versatile instrument checks regular transistors both in and out of the circuit for a.c. β , and out of the circuit for I_{CBO} leakage. By flipping the front-panel function switch, it can be made to check all FET's, including MOS, dual-gate, and the new enhancement types, both in and out of the circuit for gain, and out of the circuit for leakage. It also provides an increased current check for high-power transistors, and a special test is provided for critical r.f. transistors. Semiconductor diodes can also be checked with the tester.

The new instrument is housed in a vinyl-clad steel and brushed aluminum carrying case with lead compartment and removable cover. The instrument measures 9½-in high by 7¼-in wide by 3½-in deep and it weighs 7 lbs. Sencore's

ELECTRONICS WORLD

own special reference book, listing over 12,000 transistors and FET's with all information needed for testing them, is included. Price of the Model TF17 is \$109.50. ▲

Leader Model LBO-53B Oscilloscope

For copy of manufacturer's brochure, circle No. 26 on Reader Service Card.

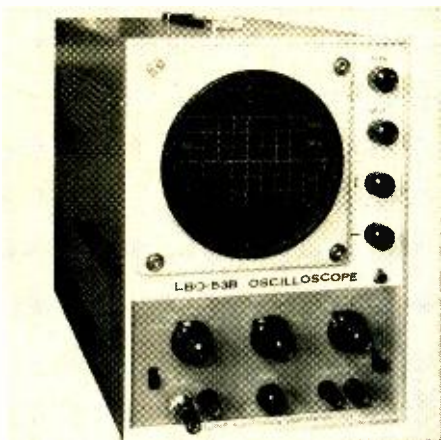

LEADER has a number of high-quality scopes which are being imported for TV and laboratory technicians and field-service engineers. The most recent one that we have seen is the LBO-53B, a wide-band, high-sensitivity instrument that is ideal for the service bench or for industrial uses. An interesting thing about this scope is that it is almost completely transistorized except for the push-pull output stages of the vertical and horizontal amplifiers. FET's are used in the input circuits for minimum loading on the circuit whose waveforms are being observed.

The vertical-amplifier bandwidth of the scope is from d.c. to 10 MHz at an input impedance of 1 megohm, while the deflection sensitivity is 10 mV (p-p) or better per centimeter. A four-step compensated attenuator is used at the vertical input. To make it convenient to check the amplitude of any waveform being observed, a calibration voltage is provided. This supplies 0.05 V (p-p) at the line frequency and is switched into the scope by merely operating the input-attenuator knob. When an input a.c. blocking capacitor is switched in, low-frequency response is maintained to within 3 dB down to about 2 Hz.

The sawtooth sweep generator employed in the scope uses automatic synchronization, so there are no sync adjustments to make. There are six sweep ranges providing sweeps from 1 Hz to 200 kHz. There is a special fixed sweep position for horizontal TV waveforms. A phasing control is used when the line frequency is employed as sweep. This is useful in getting non-overlapping sweep-alignment curves from a TV set. Direct input to the deflection plates is provided so that the TV technician can use the instrument as a vectorscope

the new SANSUI AU555



The AU555 by Sansui is an outstanding, professional control amplifier. 60 watts (IHF) of music power, bandwidth from 20 to 30,000 Hz and a distortion factor of less than 0.5% assure you of clean sound reproduction. The Sansui AU555 offers almost unlimited versatility with its pre- and main amplifier sections designed for independent usage, 2-adjustable speaker damping factors, 4-position speaker selector switch, 4-outputs and 7-inputs, and much, much more . . . At your franchised Sansui dealer. \$159.95.

sansui

SANSUI ELECTRONICS CORP. Woodside, New York, 11377 • Los Angeles, California, 90007
SANSUI Electric Co., Ltd., Tokyo, Japan • European Office Frankfurt a.M., West Germany
CIRCLE NO. 106 ON READER SERVICE CARD



Precision has led the field in quality and dependability for 25 years.

Greatest value in sound for every PA application

• Most trouble-free line in the industry, Precision offers a complete range of amplifiers in every power range including mobile, and a complete line of accessories. From the smallest office to large auditorium or industrial installations, Precision gives maximum flexibility and performance.

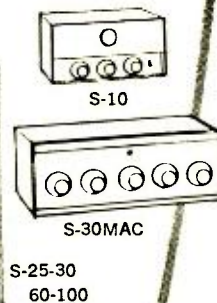

DIVISION OF PRECISION ELECTRONICS, INC.
9101 KING STREET, FRANKLIN PARK, ILLINOIS 60131

NAME _____
ADDRESS _____
CITY _____ STATE _____ ZIP _____



CIRCLE NO. 109 ON READER SERVICE CARD

Electronics World SUBSCRIBER SERVICE

Please include an address label when writing about your subscription to help us serve you promptly. Write to: Portland Place, Boulder, Colorado 80302

CHANGE OF ADDRESS:
Please let us know you are moving at least four to six weeks in advance. Affix magazine address label in space to the right and print new address below. If you have a question about your subscription, attach address label to your letter.

TO SUBSCRIBE:

Check boxes below.

- New Renewal
 5 years \$26
 3 years \$18
 1 year \$7

SPECIFY:

- Payment enclosed—
 You get 1 extra issue
 per year as a **BONUS!**
 Bill me later.

← AFFIX LABEL →

If you have no label handy, print OLD address here.

name _____ please print
 address _____
 city _____
 state _____ zip-code _____

Add'l postage: \$1 per year outside U.S., its Possessions & Canada.

name _____ please print 0294
 address _____
 city _____
 state _____ zip-code _____

ABOUT YOUR SUBSCRIPTION

Your subscription to **ELECTRONICS WORLD** is maintained on one of the world's most modern, efficient computer systems, and if you're like 99% of our subscribers, you'll never have any reason to complain about your subscription service.

We have found that when complaints do arise, the majority of them occur because people have written their names or addresses differently at different times. For example, if your subscription were listed under "William Jones, Cedar Lane, Middletown, Arizona," and you were to renew it as "Bill Jones, Cedar Lane, Middletown, Arizona," our computer would think that two separate subscriptions were involved, and it would start sending you two copies of **ELECTRONICS WORLD** each month. Other examples of combinations of names that would confuse the computer would include: John Henry Smith and Henry Smith; and Mrs. Joseph Jones and Mary Jones. Minor differences in addresses can also lead to difficulties. For example, to the computer, 100 Second St. is not the same as 100 2nd St.

So, please, when you write us about your subscription, be sure to enclose the mailing label from the cover of the magazine—or else copy your name and address exactly as they appear on the mailing label. This will greatly reduce any chance of error, and we will be able to service your request much more quickly.

when working on color-TV receivers.

The scope is fairly compact considering that it uses a 5-in CRT. It measures only about 10½-in high by 8-in wide by 16½-in deep, and it weighs about 24 lbs. The instrument is supplied with a low-capacitance probe, terminal adapter, and a vectorscope scale. Price of the LBO-53B is \$229. ▲

EW Lab Tests

(Continued from page 12)

The three-speed TD-125 has an 8-pound aluminum turntable platter mounted on a heavy plate, together with the tonearm. The entire assembly, weighing more than 15 pounds, is isolated from shock by being floated on soft isolators and is connected to the drive motor only through a rubber belt, which greatly reduces transmitted vibration. The arm-mounting board, which is removable, is available for 12- (normal) or 16-inch (transcription) arms, and is also available pre-drilled for the *Ortofon* 212 Series tonearms.

To keep motor speed variations at a minimum, the unit uses a 16-pole synchronous motor driven by a transistorized Wien-bridge oscillator and a 20-watt power amplifier (the motor actually requires about 5 watts). The oscillator frequency is adjustable from 20 to 55 Hz, corresponding to motor speeds of 125 to 350 r/min and turntable speeds of 16⅔ to 45 r/min. A three-position switch changes the turntable speed electronically by switching in two sets of capacitors. There is a vernier adjustment of 2 percent above and below each of the three speeds. An illuminated stroboscopic pattern, viewed through a window in the motorboard, simplifies exact speed adjustment. The TD-125 can be operated from 110- to 130-volt or 200- to 240-volt power lines, either 50 or 60 Hz. Although its speed is unaffected by line-frequency changes, the stroboscope is accurate only at 50 and 60 Hz.

The turntable is available by itself for custom installation, premounted on a base, or as a complete system on a base with an *Ortofon* RS-212 arm and *Ortofon* SL-15T cartridge. We tested the latter version. The measured rumble (unweighted) was -38 dB in both lateral and vertical planes and -43 dB with vertical rumble canceled out by paralleling the cartridge outputs. Since these figures are nearly identical to those we

have measured on two or three of the best turntables, we rather suspect that they are actually the residual rumble of our test records. *Thorens* claims about 10 dB less rumble than we measured, with unspecified test records. We used two test records, one made by *Acoustic Research* and the other by *Dataservice*, with identical results. Similarly, wow and flutter were as low as we have ever measured, which may also reflect the limitations of the *Dataservice* record. They were respectively 0.06 and 0.07 percent at 16⅔ r/min, 0.05 and 0.015 percent at 33⅓ r/min, and 0.07 and 0.02 percent at 45 r/min.

The speeds, which are easily adjusted to exact values, did not change detectably over a line voltage change from 85 to 140 volts, nor did they drift during extended use of the turntable. About 3 to 4 seconds were required for the turntable to come up to speed after switching on.

In its operation, the turntable was totally quiet, and its smoothly operating controls were a pleasure to use. Its isolated arm-platter mounting makes it relatively immune to physical shock and to acoustic feedback. As a matter of fact, we could operate it directly in front of a speaker with no difficulty.

The *Thorens* TD-125 is unquestionably one of the elite among record players. It would be hard to imagine a unit that performs better. This quality has its price, however. The basic turntable sells for \$185, and on a walnut base it is \$200. The complete unit, with arm and cartridge, is \$385, plus \$15 for a plastic dust cover. ▲

COMPUTERIZED STOCK TRADING

COMPUTERIZED trading in stocks has finally become a reality at Paine, Webber, Jackson & Curtis. The nationwide investment firm has started making markets via computer in some 80 Over-The Counter securities in which the firm deals as principal.

The system, called Computrade, was conceived by J. Peter Thompson of the broker's Secondary Market Division assisted by Robert Bell of the company's computerized communications technology department. Technical assistance on the project was provided by Control Data Corporation.

Computrade permits a Paine, Webber broker anywhere in the country to execute market orders instantaneously in stocks the firm positions. The computer automatically sends out a report confirming the execution. All trades are executed at a net price based on the bid or offer, plus or minus the equivalent NYSE commission.

The computer will automatically reject a second order for the stock at the bid price if the stock has been sold and, instead, provides a new quote. The order thus rejected is diverted to appropriate trading desk for manual processing.



Omega Navigation

(Continued from page 49)

this percentage passes through zero, the corresponding lane counter is advanced or set back, depending on direction of travel. When a ship starts off from a known geographical point, the position in terms of Omega lanes is manually set into the lane counters, but the counters are advanced automatically after that as the ship crosses lanes.

Typical time to obtain a fix is about one minute. In aircraft, a navigator cannot take 60 seconds to plot lines of position with an Omega set because his position could change 10 to 30 miles in that time. Therefore, a computer is used to calculate latitude and longitude and to make corrections based on information from other aircraft equipment, such as Doppler radar.

Block diagrams of the Omega receiver and the transmitting system are shown in Figs. 4 and 5.

Differential Omega

Much better accuracy may be obtained with a technique called "differential Omega." In this setup a ship can compare Omega position data with another ship nearby, provided the second ship is also equipped with an Omega receiver. Propagation disturbances, the principal causes of error in Omega, can then be cancelled and accuracies of approximately 600 feet become possible. In a variation of this technique, an Omega receiver is placed at a precisely located position on land. This station measures phase variations and then transmits propagation corrections to ships and aircraft within a limited area, typically on the order of 200 miles.

In addition to its use as a worldwide navigation system, Omega may soon be used for standard frequencies and times. The Naval Observatory cited Omega as an accredited DOD standard frequency source in 1967. Along with the Omega Navigation System Projects Office, the Naval Observatory is currently involved in tests to determine the feasibility of using Omega transmissions to distribute epoch time to an accuracy of plus or minus 1 microsecond. ▲

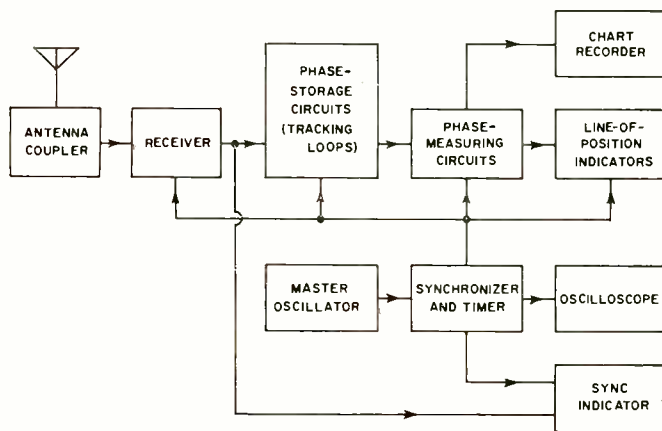
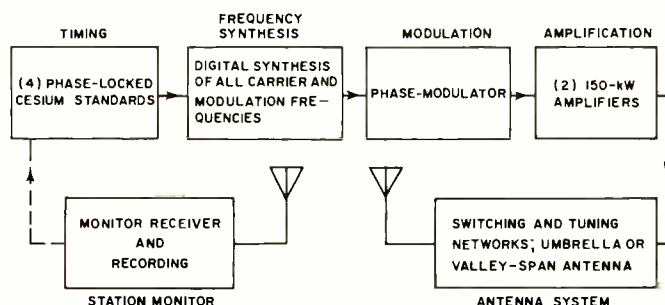

Fig. 4. Simplified block diagram of AN/SRN-12 Omega receiver.

Fig. 5. Transmitter block diagram showing timing system used.



Fast easy soldering is a gift from

Weller®

Give a Weller soldering tool for Christmas and you give a man the ability to make secure soldered connections quickly and easily. And because no other soldering tools match Weller for features and dependability, you know you're giving the best.

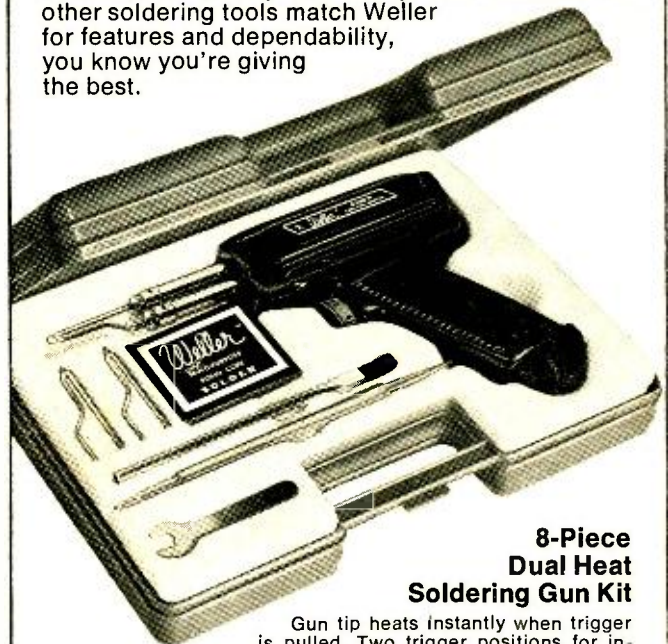

8-Piece Dual Heat Soldering Gun Kit

Gun tip heats instantly when trigger is pulled. Two trigger positions for instant switching to high 140 watt or low 100 watt heat. Built-in spotlight. Included: 3 soldering tips, tip wrench, flux brush, soldering aid, solder, plastic case. Model 8200PK. **\$995** list



New TEMPMATIC® Temperature Controlled Soldering Tool

Combines all the advantages of a fast heating soldering gun, a lightweight pencil iron and tip temperature control. Gives maximum component protection in the most delicate work situations. Yet it does heavy jobs like chassis soldering. Weighs only 7 ounces. Powerhead contains Weller's temperature control system. Model GT-7A has 700°F. $\frac{3}{16}$ " chisel point Powerhead. Model GT-6B has 600°F. conical $\frac{1}{16}$ " point Powerhead. Each tool—**\$1298** list



Weller MARKSMAN Soldering Iron Kit

Lightweight 25-watt iron outperforms all other irons of its size and price. Has replaceable tip, stainless steel barrel, cool handle. Included: 2 extra tips, soldering aid, solder. Model SP-23K. **\$444** list

WELLER ELECTRIC CORPORATION, EASTON, PA.
WORLD LEADER IN SOLDERING TOOLS
CIRCLE NO. 95 ON READER SERVICE CARD

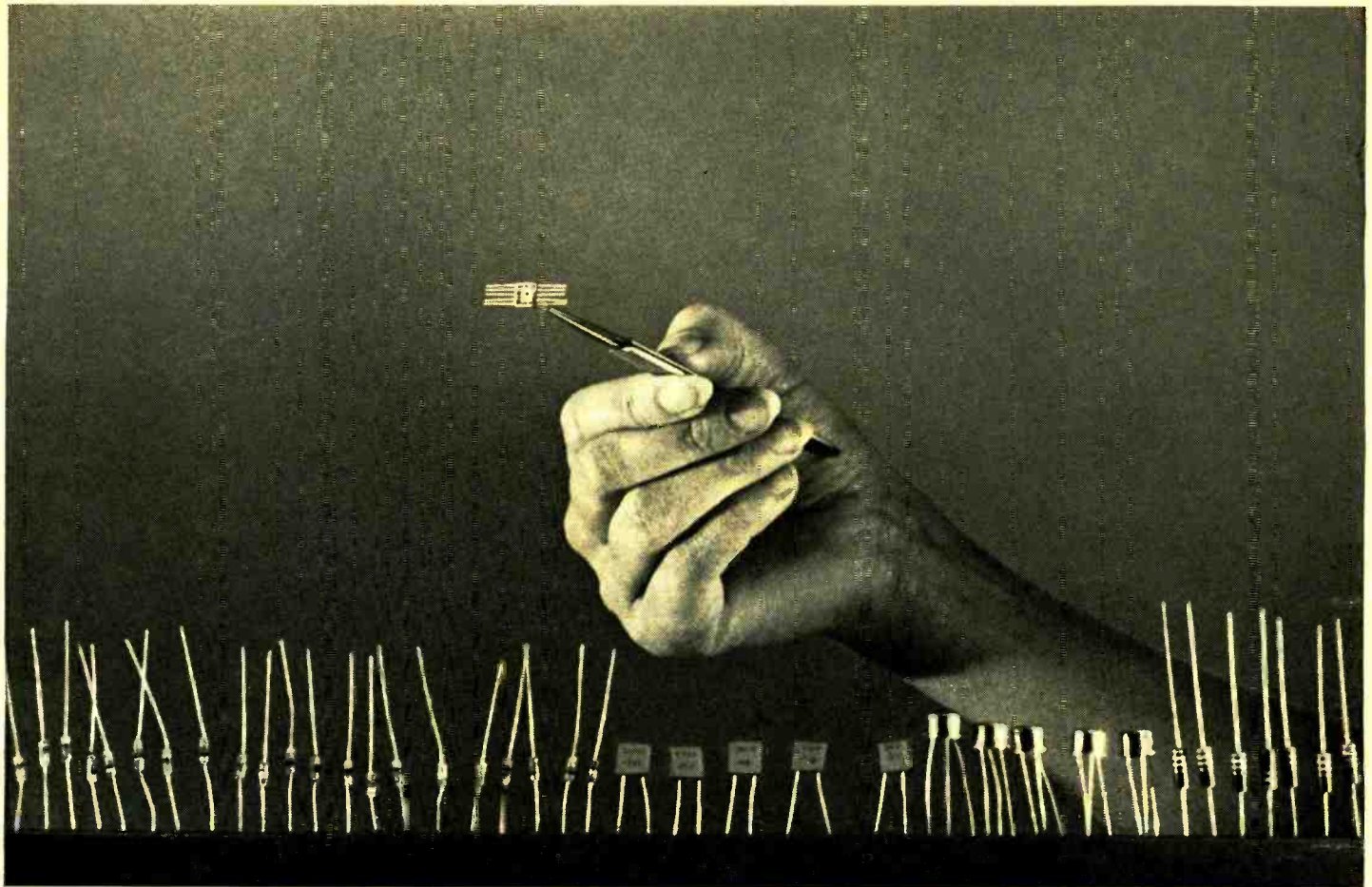

50 functions in a single chip. *The functions of 50 separate transistors, diodes, resistors and capacitors can now be performed by the tiny dot in the center of the integrated circuit held by the tweezers.*

The "Chip" ...will it make or break your future job?

THE DEVELOPMENT OF INTEGRATED CIRCUITRY is the dawn of a new age of electronic miracles. It means that many of today's job skills soon will be no longer needed. At the same time it opens the door to thousands of exciting new job opportunities for technicians solidly grounded in electronics fundamentals. Read here what you need to know to cash in on the gigantic coming boom, and how you can learn it right at home.

TINY ELECTRONIC "CHIPS," each no bigger than the head of a pin, are bringing about a fantastic new Industrial Revolution. The time is near at hand when "chips" may save your life, balance your checkbook, and land a man on the moon.

Chips may also put you out of a job...or into a better one.

"One thing is certain," said *The New York Times* recently. "Chips will unalterably change our lives and the lives of our children probably far beyond recognition."

A single chip or miniature integrated circuit can perform the function of 20 transistors, 18 resistors, and 2 capacitors.

Yet it is so small that a thimbleful can hold enough circuitry for a dozen computers or a thousand radios.

Miniature Miracles of Today and Tomorrow

Already, as a result, a two-way radio can now be fitted inside a signet ring. A complete hearing aid can be worn entirely inside the ear. There is a new desk-top computer, no bigger than a typewriter yet capable of 166,000 operations per second. And it is almost possible to put the entire circuitry of a color television set inside a man's wristwatch case.

And this is only the beginning!

Soon kitchen computers may keep the housewife's refrigerator stocked, her menus planned, and her calories counted.

Money may become obsolete. Instead you will simply carry an electronic charge account card. Your employer will credit your account after each week's work and merchants will charge each of your purchases against it.

When your telephone rings and nobody's home, your call will automatically be switched to the phone where you can be reached.

Doctors will be able to examine you internally by watching a TV screen while a pill-size camera passes through your digestive tract.

New Opportunities for Trained Men

What does all this mean to someone working in Electronics who never went beyond high school? It means the opportunity of a lifetime—if you take advantage of it.

It's true that the "chip" may make a lot of manual skills no longer necessary.

But at the same time the booming sales of articles and equipment using integrated circuitry has created a tremendous demand for trained electronics personnel to help design, manufacture, test, operate, and service all these marvels.

There simply aren't enough college-trained engineers to go around. So men with a high school education who have mastered the fundamentals of electronics theory are being begged to accept really interesting, high-pay jobs as engineering aides, junior engineers, and field engineers.

How To Get the Training You Need

You can get the up-to-date training in electronics fundamentals that you need through a carefully chosen home study course. In fact, some authorities feel that a home study course is the best way. "By its very nature," stated one electronics publication recently, "home study develops your ability to analyze and extract information as well as to strengthen your sense of responsibility and initiative." These are qualities every employer is always looking for.

If you do decide to advance your career through spare-time study at home, it makes sense to pick an electronics school that specializes in the home study method. Electronics is complicated enough without trying to learn it from lessons designed for the classroom instead of correspondence training.

The Cleveland Institute of Electronics has everything you're looking for. We teach only Electronics—no other subjects. And our courses are designed especially for home study. We have spent over 30 years perfecting techniques that make learning Electronics at home easy, even for those who previously had trouble studying.

Your instructor gives your assignments his undivided personal attention. He not only grades your work, he analyzes it. And he mails back his corrections and comments the same day he gets your lessons, so you read his notations while everything is still fresh in your mind.

Always Up-to-Date

Because of rapid developments in Electronics, CIE courses are constantly being revised. Students receive the most recent revised material as they progress through their courses. This year, for example, CIE students are receiving exclusive up-to-the-minute lessons in Microminiaturization, Logical Troubleshooting, Laser Theory and Application, Single Sideband Techniques, Pulse Theory and Application, and Boolean Algebra. For this reason CIE courses are invaluable not only to newcomers in Electronics but also for "old timers" who need a refresher course in current developments.

ENROLL UNDER NEW G.I. BILL

All CIE courses are available under the new G.I. Bill. If you served on active duty since January 31, 1955, or are in service now, check box on reply card for G.I. Bill information.

Tiny TV camera for space and military use is one of the miracles of integrated circuitry. This one weighs 27 ounces, uses a one-inch vidicon camera tube, and requires only four watts of power.

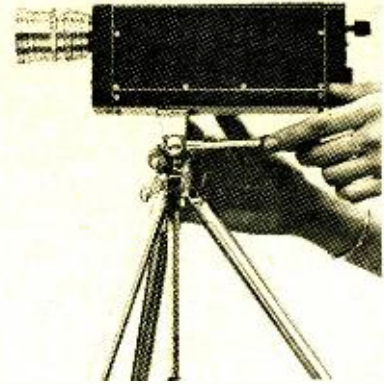

Get FCC License or Money Back

No matter what kind of job you want in Electronics, you ought to have your Government FCC License. It's accepted everywhere as proof of your education in Electronics. And no wonder—the Government licensing exam is tough. So tough, in fact, that without CIE training, two out of every three men who take the exam fail.

But better than 9 out of every 10 CIE graduates who take the exam pass it.

This has made it possible to back our FCC License courses with this famous Warranty: you *must* pass your FCC exam upon completion of the course or your tuition is refunded in full.

Mail Card for Two FREE Books

Want to know more? The postpaid reply card bound in here will bring you a FREE copy of our school catalog describing today's opportunities in Electronics, our teaching methods, and our courses, together with our special booklet on how to get a commercial FCC License. If card is missing, use the coupon below.

CIE Cleveland Institute of Electronics

1776 East 17th Street, Cleveland Ohio 44114

NEW COLLEGE-LEVEL COURSE IN ELECTRONICS ENGINEERING

for men with prior experience in Electronics. Covers steady-state and transient network theory, solid state physics and circuitry pulse techniques, computer logic and mathematics through calculus. A college-level course for men already working in Electronics.

Cleveland Institute of Electronics

1776 East 17th St., Cleveland, Ohio 44114

Please send me without cost or obligation:

1. Your 44-page book "How To Succeed In Electronics" describing the job opportunities in Electronics today, and how your courses can prepare me for them.
2. Your book on "How To Get A Commercial FCC License."

I am especially interested in:

- | | |
|--|--|
| <input type="checkbox"/> Electronics Technology | <input type="checkbox"/> Electronic Communications |
| <input type="checkbox"/> Broadcast Engineering | <input type="checkbox"/> Industrial Electronics and Automation |
| <input type="checkbox"/> First-Class FCC License | <input type="checkbox"/> Electronics Engineering |

Name _____ (please print)

Address _____

City _____

State _____ Zip _____ Age _____

Check here for G.I. Bill Information.

Accredited Member National Home Study Council
A Leader in Electronics Training... Since 1934

EW-68

Make the wiggly test.

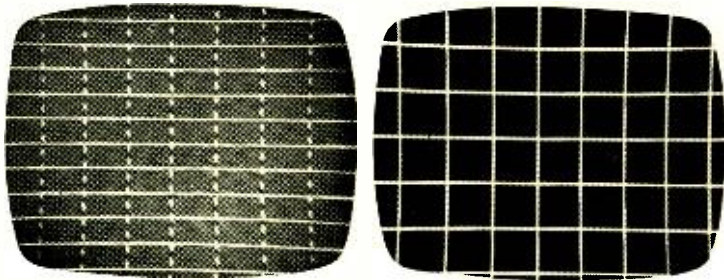

On the left, a pattern* produced by an ordinary color bar generator. On the right, the equivalent pattern* produced by Leader's LCG-388. Perfectly stable, the instant you turn the power on.

Flip the switch, and you can select from 15 patterns. Including the single dot, single cross, single horizontal and single vertical.

The magic is in Leader's binary counters and gates. Nobody else has them, and what a difference they make.

\$149.00, and you can make the wiggly test at your distributor's. For the one nearest you, just drop a line or call.

*As photographed.

Seeing is believing.



LEADER INSTRUMENTS CORP.

24-20 Jackson Avenue, Long Island City, N. Y. 11101/(212) 729-7411

CIRCLE NO. 123 ON READER SERVICE CARD

WANT A
MONEY
MAKER

3

SELL THE ALARM SYSTEM THAT GIVES YOU

3 ways to profit

1. a Radar Detection System
2. a Stress Sensor System
3. a Perimeter System

All in a Single Master Control



ONLY DETECTRON gives you all three sure-selling features — reliability...ease of installation...no maintenance — in an all-solid-state electronic security system utilizing the latest integrated computer circuitry. This means wider area coverage, more protection, greater dependability.

Unique DETECTRON system can be custom-tuned to any desired radius, it discriminates between random motion and continuous human movement, offers tested, proven reliability at a cost far below that of less-sophisticated alarm systems.

SAVE \$100 ON A NEW DEMO UNIT.

Attractively packaged self-contained demo unit literally sells itself. Regular production components actually cost \$455, you pay only \$350. Offer limited to 1 per dealer with a money-back guarantee (within 10 days) for your complete satisfaction. Write for additional information. Choice dealerships immediately available.

ELECTRONIC DETECTION CORP.
SAG HARBOR, LONG ISLAND, N.Y. 11963

Sales Office: 16 Church St. Greenwich, Conn. 06830 Call (203) 869-1311

CIRCLE NO. 135 ON READER SERVICE CARD



SCS

MONOSTABLE MULTIVIBRATOR

By FRANK H. TOOKER

Here is a simple monostable multivibrator with very low idling current that can be built with one semiconductor.

FOR low-frequency repetition rates, the monostable multivibrator circuit shown in the diagram offers certain advantages. For one thing, it uses only a single semiconductor: a silicon controlled switch. Secondly, its idling current is very low—on the order of 100 microamperes—hardly more than the current through voltage-divider resistors $R1$ and $R2$. Rise and fall times are good.

The SCS is off while the circuit idles. A positive-going spike pulse at the anode, delivered via capacitor $C1$, triggers it on. It remains on until the voltage build-up across capacitor $C2$ makes its cathode sufficiently positive to turn it off. Capacitor $C2$ then discharges through resistor $R4$, and the circuit idles until receipt of another trigger pulse turns it on again.

The output pulse is negative-going and has a rectangular waveform. With the value of $C2$ as shown in the diagram the duration of the output pulse in the prototype setup is about 10 milliseconds. For shorter duration—higher repetition rates—decrease the value of $C2$. The rating of electrolytics used for $C2$ need not be more than 3 V.

If, in an individual setup, the circuit is difficult to trigger, increase the value of resistor $R2$ one step. If it triggers too easily and is therefore too responsive to noise voltages—or if it breaks into oscillation as an astable multivibrator—decrease the value of $R2$ one step. Triggering of this circuit may also be accomplished by applying a positive-going spike pulse at the cathode-gate of the SCS. ▲

Schematic of SCS monostable multivibrator. Duration of output pulse depends on the value of capacitor $C2$ used.

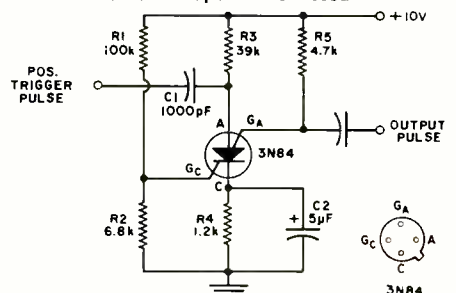

What can the works in a drawer mean to you?

The chance to do the job right on the first call

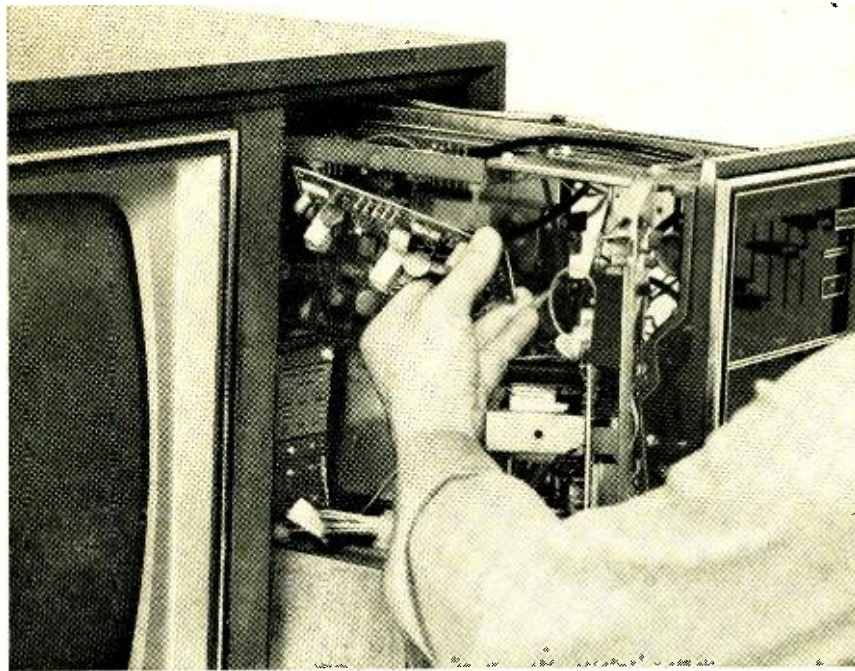

instead of
making call-back after call-back

We don't have to tell you how frustrating it is to replace a component in a color set and then be called back the next day or next week, because something else went wrong. You know how new components show up other weak spots hours or even days later. But all that your customer understands is that the set doesn't work right, and you get the blame. Quasar Color TV helps eliminate this problem. When a plug-in module is changed an entire circuit is replaced. What can the works in a drawer mean to you? A new respect for your professionalism by your customers.



All the reference materials you need to service Quasar Color TV are found in this panel caddy. If you feel you need additional information, call your distributor and he will set up training sessions.

Quasar[™] Color TV
with the works in a drawer
by MOTOROLA 

designed to help the professional be more professional

CIRCLE NO. 92 ON READER SERVICE CARD

NEW COAX WALL PLATES

For UHF/VHF
Color/B&W TV

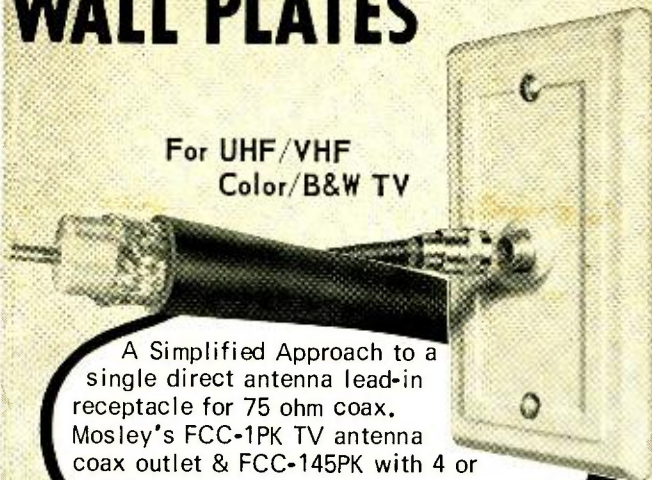

A Simplified Approach to a single direct antenna lead-in receptacle for 75 ohm coax. Mosley's FCC-1PK TV antenna coax outlet & FCC-145PK with 4 or 5 wire rotor cable outlet assures Top Performing UHF/VHF and FM-Stereo. Designed with improved solderless connections. New FCC-Series Wall Plates are installed quickly and easily in minutes.



Write Dept. 167 for FREE detailed brochure

Mosley Electronics, Inc. 4610 N. Lindbergh Blvd.,
Bridgeton Missouri 63042

CIRCLE NO. 119 ON READER SERVICE CARD

NEW! . . . from Lampkin Laboratories TYPE 107 DIGITAL FREQUENCY METER FAST - ACCURATE - PORTABLE



Designed to meet today's
mobile-radio service needs -

- ★ ONE PART PER MILLION ACCURACY!
- ★ ALL-CHANNEL COVERAGE - TO 500 MHZ
- ★ READ FREQUENCY DIRECT - NO CHARTS!
- ★ EASIER - MORE FLEXIBLE - FASTER!

\$2,390 F.O.B. Bradenton, Florida

For complete specifications - Mail coupon today

Name
Address
City State Zip

LAMPKIN LABORATORIES, INC.
MFM Div., Bradenton, Fla. 33505

EW Lab Tests Stereo Compacts (Continued from page 30)

is \$420. The company also has a lower-powered unit with smaller speakers, the HP-460, at \$320. Also the Model HP-550 is available with a *Carrard* changer at \$380.

Summary and Comments

The ultimate sound quality of any of these compact systems is determined largely by their speakers, as is true of any high-fidelity system. All of them sounded pleasant and were easy to listen to. Here in the New York Metropolitan area, all of them had adequate sensitivity for use with indoor folded-dipole antennas, but all could have benefited from a good external antenna. It would be difficult, perhaps impossible, to list them in any order of over-all quality, since none was perfect and none had any serious faults. In any case, personal preference and styling considerations would have a great role to play in one's choice of any of these systems.

However, there were clear distinctions in the sound of the various speakers, which could serve as a guide for anyone contemplating the purchase of a compact system. To our ears, the best highs, from the standpoint of extended response and dispersion came from the *Harman-Kardon* HK50 floor-standing omnidirectional speakers. A close second was the more conventional *Scott* S-10 speaker system which may be either floor or wall mounted. Next, in our judgment, came the *EMI (Benjamin)* and *Bogen* speakers, which were of comparable quality, although they sounded quite different from each other. The *Sony* speakers had noticeably less brilliance than any of the others.

In our listening room, the lowest frequencies seemed to be reproduced best in the *Scott* S-10, followed closely by the *Harman-Kardon* HK50. The *Bogen* and *Sony* speakers came next, with *EMI* (smallest of the group) slightly behind.

It was evident, and not at all surprising, that the over-all sound quality of the speakers correlated closely with their price. The lower-ranking speaker models sell in the \$50 to \$60 bracket, while the two best units are priced at \$90 and \$100 each.

All the control units were distinctively styled, and this factor certainly can influence one's choice. The *Heath* AD-27 with its tambour sliding door, and the *Sony* HP-580 with its attractively styled plastic and walnut hinged cover, are the least "electronic" in appearance. Plastic dust covers are available for most of the others, but would probably not hide their record players from view. The *Bogen* BC460 has a distinctive appearance, with its slide-type controls, and also has a unique electronic compressor/expander which really works. It is also the only one of the true compacts (excluding the *Marantz* 25) to offer FM muting.

The *Marantz* 25 is, of course, pretty much in a class by itself. It has all the control features one expects in a good integrated receiver, with the traditional *Marantz* low distortion, and is the only one of this group with sufficient power to drive the best low-efficiency speakers.

One instance where other than purely sonic considerations might determine one's choice would be in fringe-area reception, where the most sensitive FM tuner would be required. Most compacts are not as sensitive as a good component tuner or a receiver, but of the group tested, the *Benjamin*, *Fisher*, and *Scott* were appreciably more sensitive than the others, and should do a better job on weak signals.

It should also be mentioned that other compact systems are available with built-in cassette recorders, four- or eight-track tape players or recorders, or reel-to-reel tape recorders, instead of, or in addition to, a record player. In many cases, speakers are optional, so that the user has considerable latitude in assembling a system to suit his taste, while retaining the space-saving and installation convenience features of the compact format. ▲

Color-TV Tape Player

(Continued from page 31)

simple, inexpensive, but reliable playback mechanism that does not need a shutter or electronic sync circuits.

It is possible for tapes to be moved at any speed to achieve slow-motion effects, or to be stopped altogether to allow extended viewing of a single frame. In the demonstration we saw, a modified audio tape transport was used and a tape speed of 7½ in/s was employed.

No audio information was included in the demonstration tapes we saw. Commercial versions will contain one or two (possibly for stereo) audio tracks, also embossed on the plastic tape using laser-holographic techniques. The color-TV tapes are fully compatible and will be seen without color on conventional black-and-white sets. Note that the device described here is strictly a playback unit. It cannot be used to record your favorite TV program nor can it be tied in with a home TV camera. In order to have such facilities, a more conventional type of video tape recorder would have to be used which employs much more expensive, but reusable, video recording tape.

RCA has several patents pending involved in the SelectaVision process. They would like to see other manufacturers get into both the tape-cartridge and tape-player fields in order to supply products for what they consider to be a billion-dollar SelectaVision industry, which they expect to develop within ten years after the system's introduction. ▲



"Well, one consolation—you ought to be glad I'm designing a water system and not a sewer system."

NOW— CHECK ALL TRANSISTORS IN OR OUT OF CIRCUIT ...

Flick function switch to left to check all regular transistors.

Flick function switch to right to check any FET.

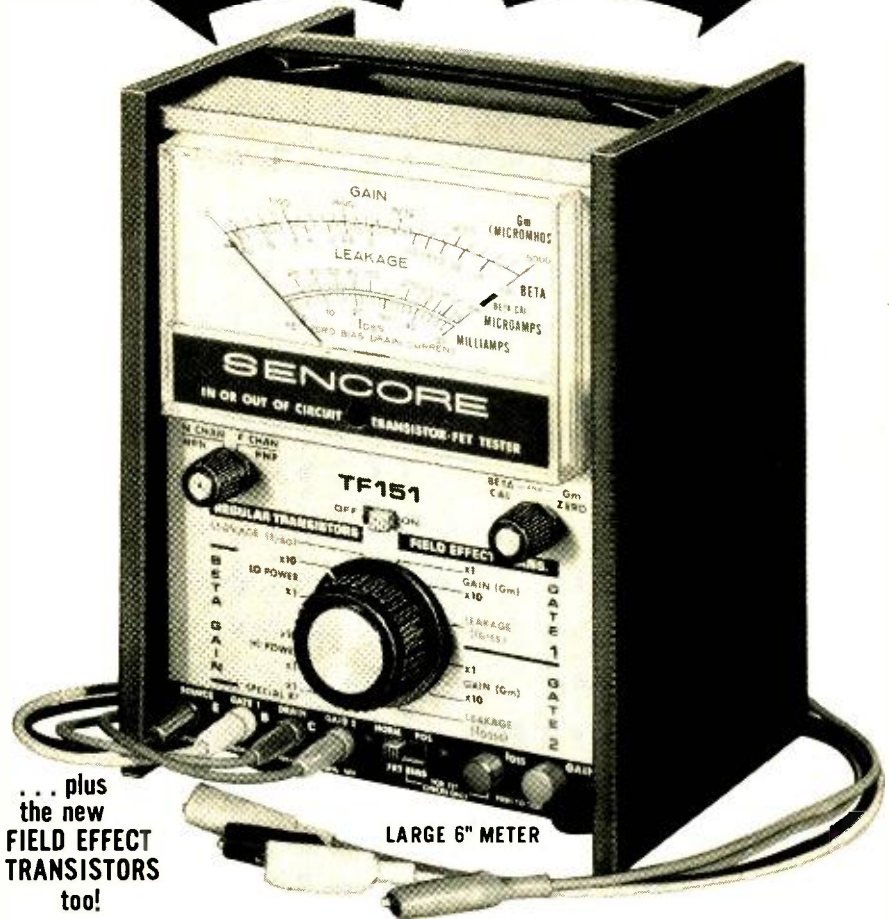

... plus the new FIELD EFFECT TRANSISTORS too!

LARGE 6" METER

You won't be stopped when you run into the new FETs that are wired into the latest hi-fi, newest TV receivers and nearly every other new device coming on the market. For the very first time, you can check them all, in or out of circuit. The TF151 works every time using tried and proven signal injection techniques. New, improved tests on special RF transistors and the latest high power transistors, mean that the TF151 is the only up-to-date transistor tester on the market. A new, exclusive setup book in rear compartment guides you to every test for over 12,000 transistors and FETs. The book is not needed for general service troubleshooting. Regular transistors are checked for beta gain and I_{cbo} leakage. FETs are checked for transconductance and I_{gss} leakage. **only \$129⁵⁰**

NEW SENCORE TF17 compact in and out of circuit transistor FET tester. Same as TF151 except in new Sencore Handi case and with 4-1/2" meter ... \$109.50

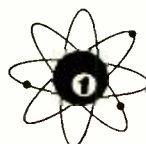

SENCORE

NO. 1 MANUFACTURER OF ELECTRONIC MAINTENANCE EQUIPMENT

426 SOUTH WESTGATE DRIVE, ADDISON, ILLINOIS 60101
CIRCLE NO. 104 ON READER SERVICE CARD

ActionLITE PUSHPINS LIGHT UP...

ACTUAL SIZE

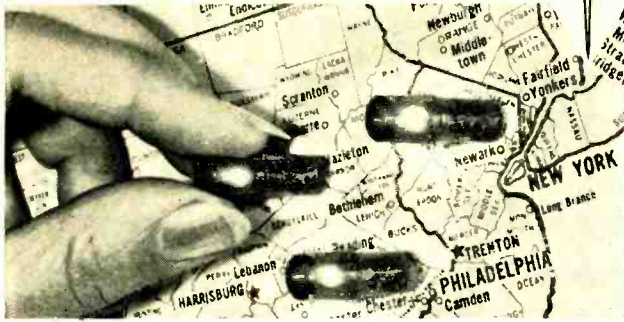

GET YOUR MESSAGE ACROSS IN A FLASH!

Versatile NEW visual display system features pushpins that light . . . even flash. Your overlays of sales maps, production charts etc. mount easily on special cork-board surface backed with conducting Plaston. (Board uses ordinary electric current.) Use ActionLITE pushpins to focus attention. The special surface is Magnetic too, to insure dramatic visual impact. ActionLITE pushpins and magnetic markers come in many sizes, shapes, colors. Boards range in size from 2'x3' to 4'x8'.

METHODS RESEARCH

200 WILLOW AVE.
STATEN ISLAND, N.Y. 10305
CIRCLE NO. 120 ON READER SERVICE CARD

It's yours
free



for the asking!

**GIANT 274 PAGE
1970
RADIO-TV
ELECTRONICS
CATALOG**

YOUR BUYING GUIDE FOR . . .
TV's, Radios, Recorders, Phonos, Amateur and CB equipment,
electronic parts, tubes and test equipment . . . featuring B-A's
famous big bargain packed section!

Write to:

BURSTEIN-APPLEBEE CO.,
DEPT. EW-L 3199 MERCIER ST.,
KANSAS CITY, MO. 64111

Name _____

Address _____

City _____

State _____

Zip Code _____



CIRCLE NO. 141 ON READER SERVICE CARD

Large-Scale Integration (Continued from page 40)

layout of one mask. Total power consumption will be less than 250 mW and the data access time will be about 1 microsecond.

Although the customer specifies the final programming of the LSI memories, they are not considered off-the-shelf custom devices in the same sense as the "standard custom" arrays. The latter devices can be programmed to perform a wide variety of different kinds of logic functions, but the memories will still be memories irrespective of the final programming layout.

Switches, Converters, and Display Arrays: This series of in/out LSI standard products rivals memories in internal circuit complexity and have by far the most complicated external pin arrangements of any LSI device. *General Instrument's* 16-channel multiplexer LSI-switch system contains an addressable counter, a decoder, and a 16-channel multiplexer all on one monolithic MOS chip and is housed in a 40-lead plug-in package measuring 0.9" x 0.7" x 0.03".

Fairchild Semiconductor will soon bring out a 10-bit digital-to-analog converter in a 36-pin dual in-line package. The MOS-monolithic subsystem contains serial/parallel data-input shift registers which will parallel load a set of holding registers upon receiving an external command. Digital-to-analog conversion of the holding register data can take place at the same time that new data is being fed into the input registers.

An example of a standard LSI display array is *Fairchild's* 3250 CRT numeric-character generator. Used in conjunction with a CRT, the device provides X- and Y-deflection information, video-blanking signals, and character-writing video information. This MOS subsystem can display up to 520 characters at a 60-Hz refresher rate and the input can be either serial or parallel fed with binary data. The entire subsystem is inside a 24-lead dual in-line package. *Fairchild* expects to use the LSI character generator in calculator readouts, cockpit displays, numerical control machine position readouts, and process control monitors.

LSI Instruments

In April 1969, *Texas Instruments* delivered the first LSI computer system to the U.S. Air Force. The system contains 34 LSI packages that replace 1735 IC's needed for an earlier version of the same system. The LSI packages are divided into 14 different kinds of circuits, fabricated from only two different wafers. One of the wafers contains 128 flip-flops and 646 *nand* gates on a 1½" monolithic chip while the other chip contains over 1000 flip-flop shift-register elements. The 14 different packages were made from two basic monolithic LSI chips by a programmable discretionary routing technique.

This LSI computer system represents a 10:1 reduction in the number of circuit interconnections and a 70:1 decrease in the number of circuit assembly operations.

If LSI circuits do indeed represent the last logical step in the evolution of semiconductor technology, it follows that future laboratory efforts will be devoted mainly to producing larger, more complex, and less costly LSI devices and systems. ▲

Fig. 5. Breakdown of Fairchild's line of standard LSI and MSI packages, which is typical of present-day LSI/MSI industry.

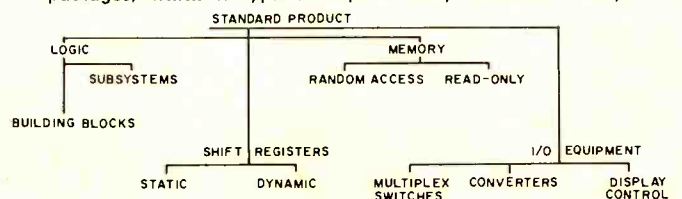

"BEEPING" a SONALERT

By FRANK H. TOOKER

Here is a free-running multivibrator that will make Sonalert's wail a better attention-getter.

WHILE the continuous piercing wail of a d.c. Sonalert is difficult to ignore, "beeping" the unit, *i.e.*, alternately turning it on and off at a rate of about 2 "beeps" per second, is often a better attention-getter. The circuit shown in the diagram accomplishes this with high efficiency. Current requirement for the entire setup is insignificantly more than that of the Sonalert alone. However, power requirement is less than that of the Sonalert alone, since, with this setup, the Sonalert is on only operating half the time.

The circuit uses a silicon controlled switch transistor (SCS) in an astable multivibrator or self-triggering configuration with a repetition rate of about 2 pps. The repetition rate of this circuit may be changed by changing the value of capacitor C1. Increasing the value of C1 decreases the repetition rate, and *vice versa*.

In an individual setup of the circuit, some improvement in performance may be realized by a slight adjustment in the value of resistors R1, R3, or both. Too large a change in these values, however, can prevent triggering of the circuit altogether.

In an application where, say, three Sonalerts are used to monitor three different situations, one can be wailed at the continuous rate, one at a slow "beeping" rate, and one at a more rapid rate, thereby permitting each unit to identify the situation it monitors. To obtain the slower "beeping" rate a 500- μ F capacitor can be used for C1. ▲

Schematic of Sonalert "beeping" circuit. Value of C1 controls beeping rate.

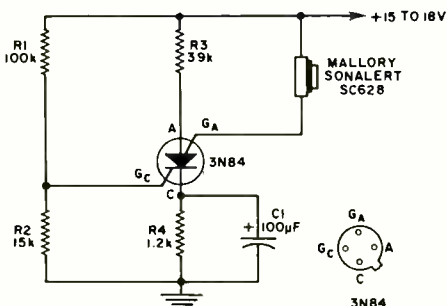

December, 1969

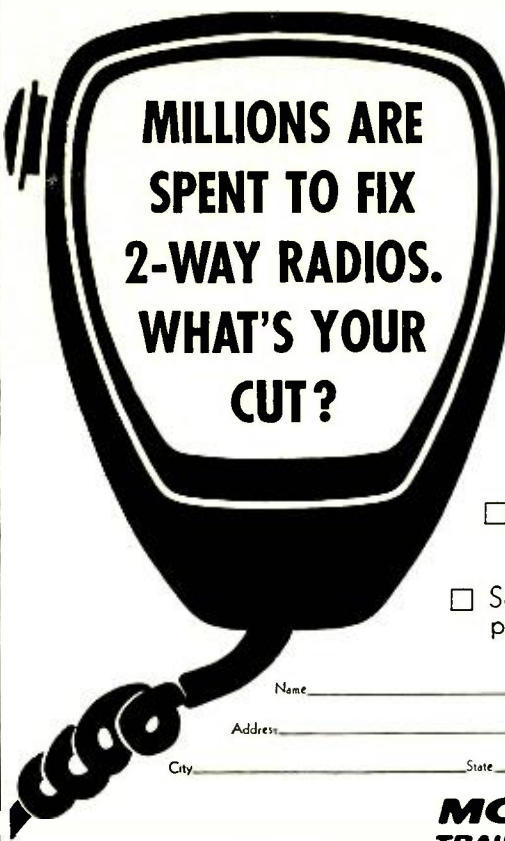

**MILLIONS ARE
SPENT TO FIX
2-WAY RADIOS.
WHAT'S YOUR
CUT?**

If you'd like to get into a top-paying job, maybe FM 2-way radio is for you. Each year, more and more businesses are buying 2-way. That means service. And service means money. We can train you to get in on the action. Our special home study course is the place to start. We teach you FM 2-way radio servicing, and prepare you for an FCC license.

Send me FREE Evaluation Examination

Send details on Home Study Course on FM 2-way radio servicing.

Send details on how you can prepare me for an FCC license.

Name _____ Occupation _____

Address _____

City _____ State _____ Zip _____

MOTOROLA
TRAINING INSTITUTE 

1301 Algonquin Road, Schaumburg, Ill. 60172

CIRCLE NO. 118 ON READER SERVICE CARD

Build this magnificent Schober Theatre Organ for only \$1730!*



You couldn't touch an organ like this in a store for less than \$3500—and there hasn't been a musical instrument with this vast variety of genuine Theatre Organ voices since the days of the silent movies! Haunting tibias, biting strings, blaring reeds—the whole A to Z gamut of real pipe sounds that make the simplest playing a thrilling experience and give the professional organist everything he needs. If you've dreamed of the grandeur of authentic big-organ sound in your own home, you won't find a more satisfying instrument anywhere—kit or no kit.

*Includes finished walnut console. Amplifier, speaker system, optional accessories extra. Only \$1256 if you build your own console.

The *Schober* Organ Corp., Dept. RN-72
43 West 61st Street, New York, N.Y. 10023

Please send me Schober Organ Catalog and free 7-inch "sample" record.

Enclosed please find \$1.00 for 12-inch L.P. record of Schober Organ music.

NAME _____

ADDRESS _____

CITY _____ STATE _____ ZIP _____

CIRCLE NO. 105 ON READER SERVICE CARD

You can learn to play it. And you can build it, from Schober Kits, world famous for ease of assembly without the slightest knowledge of electronics or music, for design and parts quality from the ground up, and—above all—for the highest praise from musicians everywhere.

Send right now for your copy of the full-color Schober catalog, containing specifications of the five Schober Organ models, beginning at \$499.50. No charge, no obligation—but lots of food for a healthy musical appetite!

**“Get more
education
or
get out of
electronics
...that’s my advice.”**



NEW!
Expanded
coverage of
solid state
electronics
including
integrated
circuits!



Ask any man who really knows the electronics industry.

Opportunities are few for men without advanced technical education. If you stay on that level, you'll never make much money. And you'll be among the first to go in a layoff.

But, if you supplement your experience with more education in electronics, you can become a specialist. You'll enjoy good income and excellent security. You won't have to worry about automation or advances in technology putting you out of a job.

How can you get the additional education you must have to protect your future—and the future of those who depend on you? Going back to school isn't easy for a man with a job and family obligations.

CREI Home Study Programs offer you a practical way to get more education without going back to school. You study at home, at your own pace, on your own schedule. And you study with the assurance that what you learn can be applied on the job immediately to make you worth more money to your employer.

You're eligible for a CREI Program if you work in electronics and have a high school education. Our FREE book gives complete information. Mail postpaid card for your copy. If card is detached, use coupon below or write: CREI, Dept. 1112H, 3224 Sixteenth Street, N.W., Washington, D.C. 20010.



**CREI, Home Study Division
McGraw-Hill Book Company
Dept. 1112-H, 3224 Sixteenth Street, N.W.
Washington, D.C. 20010**

Please send me FREE book describing CREI Programs. I am employed in electronics and have a high school education.

NAME _____ AGE _____

ADDRESS _____

CITY _____ STATE _____ ZIP CODE _____

EMPLOYED BY _____

TYPE OF PRESENT WORK _____ G.I. BILL

I am interested in

- Electronic Engineering Technology Computers
- Space Electronics Nuclear Engineering Technology
- NEW!** Digital Communications **NEW!** Industrial Automation

APPROVED FOR TRAINING UNDER NEW G.I. BILL

NEW PRODUCTS & LITERATURE

For additional information on items identified by a code number, simply fill in coupon on Reader Service Card. In those cases where code numbers are not given, may we suggest you write direct to the manufacturer.

COMPONENTS • TOOLS • TEST EQUIPMENT • HI-FI • AUDIO • CB • HAM • COMMUNICATIONS

DUAL-CHANNEL SCOPE

Dumont Oscilloscope Laboratories, Inc., 40 Fairfield Place, West Caldwell, N.J. 07006 has developed a new solid-state, high-frequency, high-performance dual-channel oscilloscope, the Model 1050.

Among the features, some of which are ex-

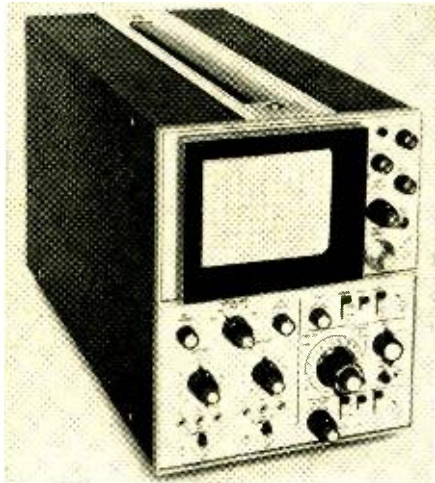

clusive, are a new triggering device which eliminates trace flicker, maintenance of signal synchronization irrespective of vertical positioning of either trace, and the elimination of the need to readjust trigger level control to maintain the desired reference level after trace positioning.

This lightweight and portable scope is designed to be used in a wide variety of applications in high-frequency digital circuit testing, analysis of low-level analog waveforms, measurement of fast single transient phenomena, among others. The unit is solid-state throughout with FET input amplifiers and micrologic switching circuits which provide quick warm-up time and extremely low trace drift.

A four-page data sheet providing complete information on the 1050 is available on letterhead request to the company.

CASSETTE/8-TRACK ADAPTER

The C/8 coordinator is designed to adapt tape cassette machines to 8-track stereo cartridge units for better sound reproduction. The unit permits cassette machines to be attached to any audio equipment which has a headphone jack, allowing the tapes to be played through hi-fi systems. Weltron

Circle No. 1 on Reader Service Card

CONTROL AMPLIFIER

The SCA-80 transistorized control amplifier is a single integrated package combining a power amplifier and preamplifier and has all the performance and flexibility of separate components, according to the company.



The amplifier is rated at 40 watts continuous r.m.s. power per channel across the entire audio spectrum with both channels driven simultaneously into 8 ohms. Harmonic distortion is under 1/2% and IM is under 1/10% at rated output, and distortion decreases as power is reduced.

The control section has complete facilities yet is simple to operate with a basic two-knob control action for those who do not require such features as loudness, filters, blending, remote speaker switching, and other subtle variations. A front-panel stereo headphone jack is always live and can be utilized with speakers either live or off.

Available in both kit and factory wired versions, the kit features factory assembled and in-circuit-tested PC boards for all critical circuitry. Assembly is estimated at 12 hours. Dynaco

Circle No. 2 on Reader Service Card

PHONE ANSWERING MACHINE

The Phone-Mate 700 is an automatic telephone answering machine for small business, home, and professional use. The unit answers the phone, delivers a pre-recorded outgoing message, records the caller's incoming message, and hangs up, ready for the next call.

The machine can also monitor and screen incoming calls. The user can hear who is calling without touching the phone and can "be out" if he doesn't wish to talk immediately or can pick up the phone and override the machine.

The all-transistor instrument features visible message reels which indicate whether or not calls have been received. It will accept and store 30 to 40 incoming messages with its self-contained circuitry or can be connected to an optional external cassette tape recorder which can be employed to store up to 135 incoming telephone messages. Tron-Tech

Circle No. 3 on Reader Service Card

NEW CB RADIO

An all-channel CB two-way radio for marine, mobile, or base-station operation is now available as the "Raycom III."

Using synthesis, the set is delivered factory tuned for immediate use on each of the 23 CB



channels. The completely solid-state circuitry reduces the size of the transceiver to a compact 2 1/2" x 6 1/2" x 9" deep. Current drain from 12-volt lines is 1.2 amps when transmitting. Instrumentation includes a transmit/receive relative strength meter, backlit channel selector switch, and a squelch control. Raytheon

Circle No. 4 on Reader Service Card

SILICON FOCUS RECTIFIER

Scientific Components, Inc., 350 Hurst Street, Linden, N.J. 07036 is now marketing the CLR 7 focus rectifier, a silicon device designed to replace selenium cartridge rectifiers for focus diode application in TV receivers.

Designed for operation in a 525-line, 30-frame TV system, the silicon rectifier is said to be com-

petitive in price with selenium rectifiers while capable of operating at higher temperatures. It has a maximum recurrent peak inverse voltage of 7000 volts and a maximum average forward rectified current of 5 mA at 65° C.

The unit can operate in temperatures up to 70 degrees C with a maximum storage temperature of 125 degrees C.

Full details are available on letterhead request direct to the company.

FM RECEIVER

The new KR-70 FM receiver combines a super-sensitive FM tuner and a 75-watt amplifier with terminals to accommodate record player, tape recorder, auxiliary, two pairs of stereo speakers, and center-channel output.

The tuner section, with two IC i.f. stages, two FET's, and 4-gang tuning capacitor, has an IHF

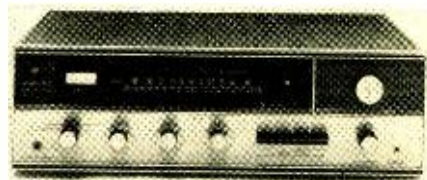

sensitivity of 1.9 μ V, harmonic distortion of less than 0.8%, and capture ratio of 2.5 dB. A luminous dial, tuning meter, and stereo-FM indicator add to ease of operation.

Keyboard controls regulate loudness, noise filter, tape monitor and mode while front-panel jacks provide convenient access for stereo headphones and dubbing tape record.

Amplifier frequency response and power bandwidth are 20-30,000 Hz. The receiver comes complete with cabinet. Kenwood

Circle No. 5 on Reader Service Card

250-WATT SPEAKER

An 18-inch, 250-watt electronic musical instrument speaker has been introduced as the Model SMI-285.

The new model features a 12 1/2 pound magnetic structure, using a highly efficient 3 3/4 pound DP-Alnico-5 magnet to provide the high power. A precision-wound 4-inch voice-coil is fabricated on a special high-power bobbin. The speaker also features a large aluminum dome, a laminated reinforced flexible-edge suspension, and rugged cast construction.

The speaker is designed for sound reinforcement, p.a., replacement applications, or for upgrading present equipment. Jensen

Circle No. 6 on Reader Service Card

REEL-TO-REEL RECORDER

The new Model 771X reel-to-reel recorder features a Cross Field head system, full stereo and mono record and play, 40 watts peak music power, and extended range speakers.

The recorder also provides facilities for sound-on-sound, has four speeds including 1 7/8 in/s, electrical switched hysteresis synchronous motor, two vu meters, and a four-digit push-button reset index counter. Roberts

Circle No. 7 on Reader Service Card

2-METER FM TRANSCEIVER

A two-meter FM transceiver designed to provide reliable local communications, is available as the Model FM-210.

The unit is solid-state and has an FET front end. It can be used either for direct or repeater



communications. It features 3-channel independent transmit/receive selected by front-panel controls, an effective squelch system for mobile operation, and a speech compressor for optimum intelligibility. It operates on 12-14 volts d.c. An optional power booster provides high-power operation from either 12-14 volts d.c. or 117 volts a.c. Galaxy

Circle No. 8 on Reader Service Card

LIGHTWEIGHT VIDEO RECORDER

The CV-2600 half-inch video tape recorder is ultra-lightweight—only 31 pounds, is completely portable, and is easy to operate.

Designed for educational and industrial training applications, three simple movements start the recording process. A single lever controls all tape movement, record and playback, as well as rewind and fast forward. Automatic gain control eliminates all manual recording adjustments and a new servo system provides instant picture stabilization. Sony

Circle No. 9 on Reader Service Card

ELECTRONIC SIGNAL ALARM

A new household intrusion alarm system that requires no installation has been introduced as the Model 360. Completely electronic, the alarm

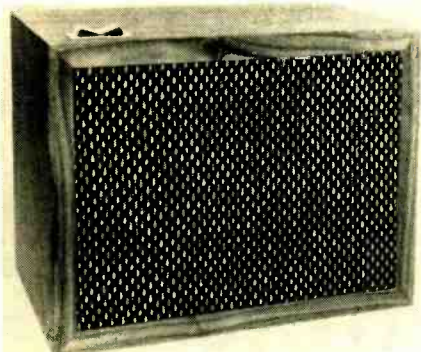

system is housed in a walnut case to blend in with home decor. It is remotely activated by door and window sensors which trigger a powerful bell and turn on lights or outside flashers and sirens. The control unit operates from the 117-volt a.c. power line and the sensors are connected to it by means of transparent low-voltage wire that is taped in place.

A brochure describing system operation is available on request. Peterson

Circle No. 10 on Reader Service Card

CARDIOID MICROPHONE

A new cardioid dynamic microphone, with a rugged all-steel case and acoustic features designed specifically for live entertainment use, has been introduced as the Balladier Model 2266.

Sound cancelling ports on the side of the case provide a controlled cardioid acoustical pick-up pattern which reduces feedback howl and suppresses unwanted background noise. The dynamic microphone cartridge is baffled and isolated to reduce breath noise, popping, and handling noise. The mike covers a frequency range of 50-15,000 Hz, is peak free, and has an output level of -55 dB. Its high impedance matches professional music amplifiers. A low impedance model is available as the 2203. Turner

Circle No. 11 on Reader Service Card

3-CHANNEL COLOR ORGAN

The new LO-104 color organ is a 3-channel unit which provides 500 watts output per channel. Three transistorized frequency-selective am-

December, 1969

Stockbroker, Sr.



B&K 707 Tube Analyzer

Telling customers what or what not to invest in is part of your business. Take tube sales, for example. When it comes to tube sales today, it's not enough just to be a good salesman. Many customers have to be *shown* that tube replacement is necessary. That's where the Stockbroker comes in. It's the "Silent Partner" that actually *shows* your customer the need for new replacement tubes.

The B&K 707 professional tube analyzer is designed to make tube checking a simple, routine job. It can handle both color and black-and-white TV tubes, radio tubes, nuvistors, novars, both types of 10-pin tubes, 12-pin compactrons, European hi-fi tubes, voltage regulators, and just about every industrial tube on the market.

It combines the best of two types of tube analysis. The multiple-socket section is an accurate, dynamic

mutual conductance tube checker which makes tube analysis a fast, easy operation. It features exclusive B&K patented automatic line voltage compensation. And it's four times less time-consuming than using multiple switch-type testers.

The switch section of the 707 provides obsolescence protection on your investment. Tubes which may not be analyzed on the multiple-socket section may be analyzed with precision accuracy in this emission section (which produces current loads to simulate actual operating conditions).

**B&K Tube Analyzer
Model 707. Net: \$199.95**

For more information on how the Stockbroker can encourage clients to buy your stock, write to:

Product of Dynascan Corp.
1801 W. Belle Plaine
Chicago, Illinois 60613

**B&K puts an end to test equipment.
We've developed Silent Partners.**



CIRCLE NO. 143 ON READER SERVICE CARD

FREE Catalog Of The WORLD'S
FINEST GOV'T
SURPLUS ELECTRONIC BARGAINS

**Now BIGGER and
BETTER Than Ever!**

MAIL COUPON TODAY

NAME:

ADDRESS:

CITY: STATE: ZIP NO.:

FAIR RADIO SALES

Dept. EW • BOX 1105
LIMA, OHIO 45802

CIRCLE NO. 134 ON READER SERVICE CARD

**Deluxe ELECTRONICS WORLD
MAGAZINE CASES**
DESIGNED TO HOLD A FULL YEAR'S COPIES



Constructed of reinforced fibreboard and covered in rich leatherette, these durable cases guard against soiling and tearing of your magazines while lending themselves handsomely to the decor of any room. The magazine cases are available with embossed gold lettering in either all black or attractive maroon back with black sides.

These decorative cases are just what you've been looking for to keep your copies of Electronics World Magazine in easy-to-find order.

\$3.50 ea., 3 for \$10, 6 for \$19
FULLY GUARANTEED

Ziff-Davis Publishing Co., Dept. SD
1 Park Ave., N.Y., N.Y. 10016

Please send _____ Electronics World Magazine Cases. Also send cases for the magazine titles indicated below:

- All black, gold embossed
 Maroon back, gold embossed/black sides

NAME _____

ADDRESS _____

CITY _____

STATE _____

ZIP _____

Enclosed is \$ _____ at \$3.50 per case, 3 for \$10, 6 for \$19 (Quantity prices apply for combination orders of more than one title). Orders outside U. S. A. \$4.50 ea., 3 for \$13, 6 for \$25.

(Payment must accompany order)

**STEREO
MUSIC
CENTER**

from "shelf
speakers"

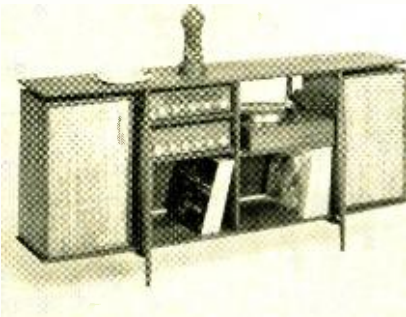

model 303

we can't seem to stop designing new and better cabinets. . . have you seen our brochure lately? it's free. for a fast reply, mail this ad with your return address.

audio originals

546 S. Meridian • Indianapolis, Ind.

CIRCLE NO. 144 ON READER SERVICE CARD

86

plifiers divide the audio spectrum into three ranges. Each amplifier is sensitive and active within its given range, and has an intensity control to enable the user to adjust relationship between channels.

A total of nine 150 watt or eighteen 75 watt spot/flood lights can be connected to each unit. Controls include "on/off" and three intensity adjustments. The unit measures 6 $\frac{3}{4}$ " x 6" x 2 $\frac{3}{4}$ " and comes completely wired and tested. Science Workshop

Circle No. 12 on Reader Service Card

REGULATED POWER SUPPLY

An all-silicon, fully IC-regulated laboratory power supply for bench use has been introduced as the LL Series. The units in the series measure 5 $\frac{3}{8}$ " x 5 $\frac{1}{4}$ " x 3 $\frac{3}{4}$ " and weigh less than 4



pounds. They can lie flat or stand up since the binding posts on the side are located so that leads are out of the way.

Regulation is 0.01% +1 mV for line variations from 105-132 volts a.c. and 4 mV for load variations from no load to full load. Ripple and noise are 250 μ V r.m.s., 1 mV p-p. The series is provided with wide input voltage and frequency ranges of 105-132 volts a.c., 47-440 Hz. Operating temperature range is 0 to +50 degrees C. Four models are available: 0-10, 0-20, 0-40, and 0-120 volts, with current ratings to 1 ampere. Lambda

Circle No. 13 on Reader Service Card

PHONO CARTRIDGE

A new version of the "Super Trackability" phono cartridge has been introduced as the V-15 Type II Improved. Similar in appearance to the previous model, the new unit has increased trackability across the entire audible spectrum at the lightest possible tracking forces. It is capable of tracking the majority of records at $\frac{3}{4}$ gram, including those containing heavily modulated drum, tympani, organ pedal, or piano passages. Shure

Circle No. 14 on Reader Service Card

DUAL-BEAM SCOPE

The D51 is a low-cost dual-beam oscilloscope covering d.c. to 6 MHz for channel 1 and d.c. to

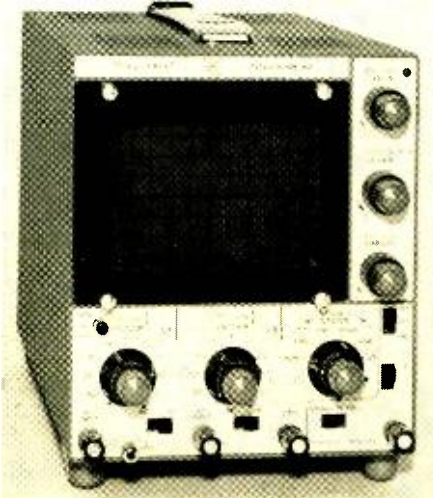

3 MHz for channel 2. Deflection factors are from 100 mV/cm to 50 V/cm for both channels, sweep rates from 1 μ s/cm to 100 ms/cm in six steps, measurement accuracy is within 5%, and it provides selectable sweep triggering including TV field.

The oscilloscope measures 9" high x 7" x 18" long and weighs approximately 20 pounds. Tequipment

Circle No. 15 on Reader Service Card

CARTRIDGE/CASSETTE CASES

A new line of "Stor-A-Tape" Library Albums which can be supplied to hold 6 cassettes, 8 cartridges, 12 blank cartridges, or 8 prerecorded cassettes is now available for distribution.

All units are of rigid construction to prevent tape damage, and indexed for quick and easy selection.

The covers are either of hi-gloss or embossed leatherette (both washable) and come in psychedelic blue, hot red, or grained black. The storage cases are gold stamped on spine, front cover, and index.

An attractive four-color data sheet on these cases is available on request. Modern Album

Circle No. 16 on Reader Service Card

COMPACT L.F. SPEAKERS

A new high-power, low-frequency speaker assembly which measures only 34 inches high and provides 80 watts output is now available as the Model 6A392.

Designed for auditoriums, theaters, and other large audience enclosures where there is minimal

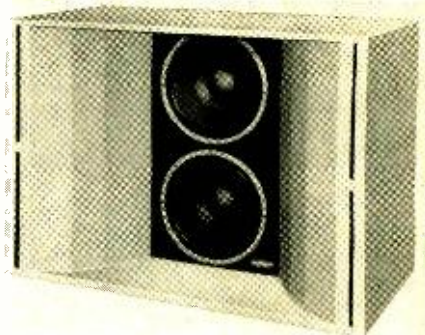

space over the proscenium on front of the stage, the speaker uses four-inch voice coils driven by 11-pound magnet assemblies through two 15-inch diaphragms to provide the high power levels. Front horn loading eliminates folds and bends in the diaphragms and contributes to the smoothness of reproduction, according to the company.

Cabinets are constructed of $\frac{3}{4}$ -inch plywood, rigidly braced and damped for minimum vibration. The cabinet weighs 250 pounds with speakers installed. DuKane

Circle No. 17 on Reader Service Card

MANUFACTURERS' LITERATURE

COLOR-TV & STEREO DATA

Two pocket-size folders, each containing 24 colorful pages, have been published describing a complete line of color-TV and color-TV/stereo combinations and stereo systems in decorator cabinets.

All of the models are shown in living room settings and details on the cabinetry, finish options, and sizes are included. A brief rundown on technical features is also supplied for each model. Packard Bell

Circle No. 18 on Reader Service Card

PC DRAFTING AIDS

A comprehensive, fully illustrated catalogue covering a complete line of pressure-sensitive electrical and electronic drafting aids for PC draftsmen, engineers, and artists is now available for distribution.

The line includes multiple transistor pads, 8-, 10-, and 12-pin micrologics; flat packs and

ELECTRONICS WORLD

plug-ins; special configurations; die cuts; registration targets; component orientation symbols; board delineation marks; translucent precision grids; schematic symbols; and connector strips.
Circuit Aids

Circle No. 19 on Reader Service Card

RELAY CROSS REFERENCE

A relay selector disc that cross-references the company's general-purpose relays with those of Potter & Brumfield is now available. Open or enclosed a.c. or d.c. relays are covered, all of which have 10-amp contact ratings. Cornell-Dubilier

Circle No. 20 on Reader Service Card

SW RECEIVER BULLETIN

A two-page bulletin describing the SZ-122A AM broadcast and general-coverage short-wave receiver has been released for distribution.

The bulletin, S-1050, details the specs of the receiver and its accessories. Hallicrafters

Circle No. 21 on Reader Service Card

INSTRUMENT RENTALS

General Electric Company, Distribution Service, 1 River Road, Schenectady, New York 12305 has issued a 42-page catalogue (Bulletin GEC-1551C) which lists more than 200 new items, gives the monthly rates, and ordering information for a wide variety of analytical instruments, electro-mechanical measuring devices, and electrical and electronic instrumentation available to industry through rentals.

Technicians are available to operate the rental instruments or to conduct electro-mechanical measurements on site.

For full details on the available equipment and services, write for a copy of the bulletin on your business letterhead.

FREQUENCY INSTRUMENTATION

A comprehensive, 10-page, two-color catalogue describing the electrical and mechanical characteristics of its broad line of frequency instrumentation products is now available from The Hallicrafters Co., 600 Hicks Road, Rolling Meadows, Illinois 60008.

Catalogue # 094-005173 covers frequency synthesizers, multipliers, dividers, crystal frequency standards, precision crystal oscillators, and component ovens made by the company.

Direct your letterhead requests to the Frequency Instrumentation Dept. at the above address.

TTL INTEGRATED CIRCUITS

An 80-page brochure on its Series 54/74 TTL integrated circuits has been issued by Texas Instruments.

The publication provides data on three transistor-transistor logic IC series—the standard Series 54/74, the high-speed Series 54H/74H, and the low-power Series 54L/74L.

Comprehensive catalogue listings are furnished for more than 90 distinct functions in the TI line, including 35 medium-scale integration circuits. The MSI functions listed are data selectors/multiplexers, decoders, memories/latches, shift registers, counters, parity generator/checker, and arithmetic elements.

Letterhead requests should be addressed to Texas Instruments Incorporated, Inquiry Answering Service, P. O. Box 5012-M/S 308, Dallas, Texas 75222. Please specify the "TTL Brochure."

STANDARD IC LINE

Fairchild Semiconductor, 3131 Fairchild Drive, Mountain View, California is now distributing a second edition of its publication "Total Capability with CCSL Building Blocks."

This 54-page 8½" x 11" brochure was specially prepared for design engineers. It gives full-page descriptions of more than 40 CCSL (compatible current sinking logic) building blocks, together with their special features and suggested uses. The coverage extends to 14 new products not previously announced.

A major portion of the brochure is devoted to digital MSI's but also contains descriptions of

memory circuits, interface circuits, and special circuits.

Letterhead requests for this publication should be sent to the above address.

INTEGRATED CIRCUITS

The Semiconductor Division of Sylvania Electric Products Inc. has made available a new brochure describing all of its monolithic TTL integrated circuits included in the SUHL I and SUHL II families. Logic diagrams, descriptions, and type numbers are given for each product. The pocket-sized brochure is indexed according to family and each section is categorized by function.

Letterhead requests for this 8-page brochure should be sent to the company at 1100 Main Street, Buffalo, N. Y. 14209.

STEREO-FM DECODER

A 6-page construction article describing a

monolithic integrated stereo-FM decoder system is now available. Designed around a Motorola MC1304 integrated circuit, the unit is said to provide excellent channel separation across the entire audio range. The company's 1359 series coils have been incorporated in the design. J. W. Miller.

Circle No. 27 on Reader Service Card

CAPACITORS & RESISTORS

The Electronic Products Division of Corning Glass Works, Corning, N. Y. 14830 has issued a short-form catalogue (EPD DSF-1) covering its line of capacitors and resistors.

The four-page brochure's center fold lists performance characteristics, physical descriptions and military designations for each of the company's glass and glass-ceramic capacitors and glass tin-oxide film resistors.

Copies of the catalogue are available on letterhead request to the company. ▲



UNIVERSITY JUST MADE YOU A SOUND INSTALLATION EXPERT



University just invented TCS — Totally Coordinated Sound systems so painstakingly pre-engineered *anyone* can install them. Everything you need comes with each system: speakers, amplifiers, microphones, color-coded cables, plus assembly and installation instructions. All pre-engineered, pre-matched, pre-sized, for hundreds of applications.

If you can twist a wire, screw a screw, push a plug into a socket — congratulations! University just made you a sound installation expert.

TCS = Totally Coordinated Sound systems you can install yourself.

Write for details today about how you can install your own PA sound system tomorrow.

UNIVERSITY SOUND
A DIVISION OF LTV LING ALTEC INC.



CIRCLE NO. 96 ON READER SERVICE CARD

Put The Sound of Christmas In

Announcing The New Heathkit® AR-29 100-Watt
AM-FM-FM Stereo Receiver

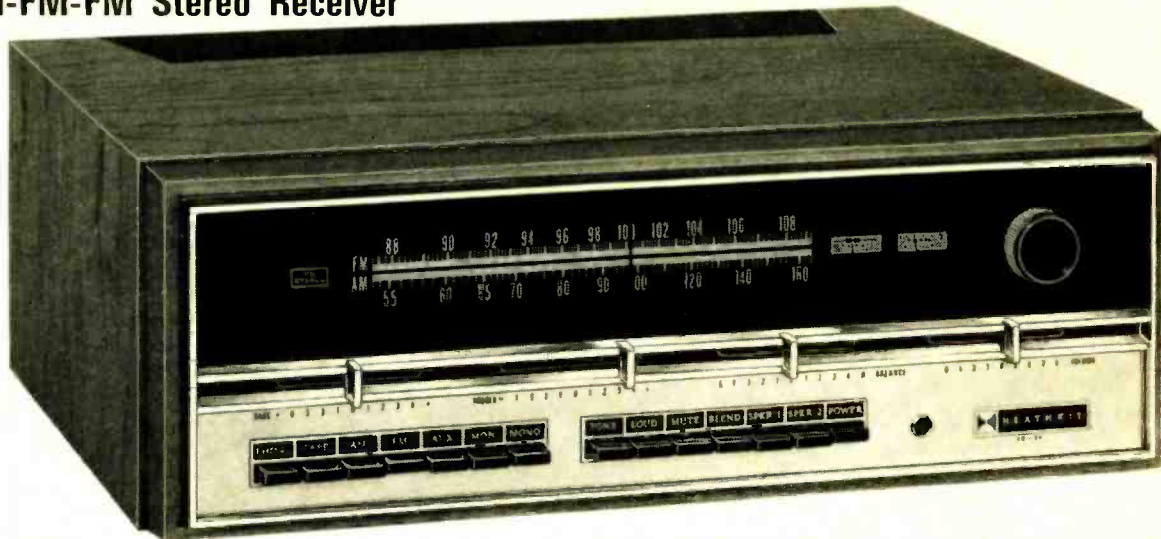

The World's Finest Medium Power Stereo Receiver ...
Designed In The Tradition Of The Famous Heathkit AR-15 ... \$285.00*



Quietly distinctive when not in use ... its impressive midnight black and chrome face unmarred by dial or scale markings. A touch of the power switch and the dial and scale markings appear.

All solid-state design ... 65 transistors, 42 diodes and 4 Integrated Circuits.

Assembled, aligned FET tuning unit.

Advanced 9-pole L-C Filter for greatest selectivity ... a first in the industry.

Plug-In Circuit Boards for easier assembly, easier service ... another first in kits.

Built-In Test Circuitry for voltage and resistance checks without external instruments during construction and after.

Massive Power Supply ... just loafs along at 100 watts output.

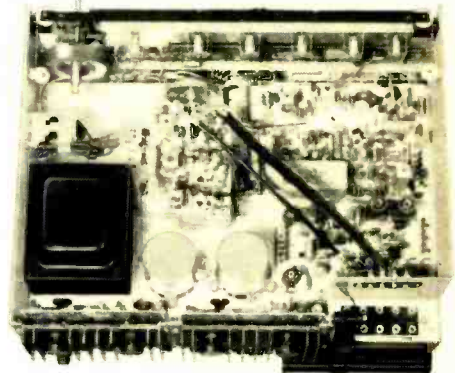

- All solid-state design • 100 watts music power output at 8 ohms • 7-60,000 Hz frequency response • Less than 0.25% Harmonic & 0.2% IM Distortion at full output • Transformerless, direct-coupled outputs with dissipation-limiting circuitry for output protection • Ball-bearing inertia flywheel tuning • Advanced L-C filter gives 70 dB selectivity and elimination of IF alignment • Assembled, aligned FET FM tuner for better than 1.8 uV sensitivity • New Mute Control attenuates between-station FM noise • New Blend Control attenuates noise on FM-Stereo stations • SCA filter • Linear Motion Controls for Bass, Treble, Balance & Volume • Individually adjustable input level controls for each channel of each input keeps volume constant when switching sources • Switches for 2 separate stereo speaker systems • Center speaker capability • Two front-panel meters for precise station tuning • Stereo indicator light • Stereo headphone jack • Swivel AM rod antenna • 300 & 75 ohm FM antenna inputs • Massive, electronically regulated power supply • New Modular Plug-In Circuit Board designed for easy enjoyable assembly

Another Design Leader ... reflecting the heritage of the world-famous Heathkit AR-15. A new milestone in audio history is here: the world's finest medium power stereo receiver ... the Heathkit AR-29.

The Finest Stereo Amplifier In Any Receiver ... delivers a full 100 watts music power, 70 watts continuous — drives even the most inefficient speakers. A giant fully regulated & filtered power supply, 4 individually heat-sinked and protected output transistors and the best specs in the industry add up to unmatched audio fidelity.

The Heath Mark Of Quality: FM Stereo Performance ... now more apparent than ever. The assembled, aligned tuning unit uses FET circuitry for high overload capability, low cross modulation and 1.8 uV sensitivity. Three IC's in the IF give greater AM rejection, hard limiting, excellent temperature stability & reliability. Another IC in the Multiplex section performs four different functions ... assures perfect stereo reproduction.

Kit Exclusive: 9-Pole L-C Filter ... delivers an ideally shaped bandpass with greater than 70 dB selectivity, superior separation and eliminates IF alignment forever.

AM That Sounds Like FM. Three FET's in the AM RF section combine superior sensitivity with greater signal handling capability to give the finest AM reception available. A built-in AM rod antenna swivels for best signal pick-up.

Kit Exclusive: Modular Plug-In Circuit Board Construction ... for simplified assembly ... easier, faster service.

Kit Exclusive: Built-In Test Circuitry lets you not only assemble, test & align your new AR-29, but also completely service it — without external test equipment.

You Be The Judge. Compare the specifications ... exciting styling concepts ... the dozens of features ... the price. You'll find that the new Heathkit AR-29 is, indeed, the world's finest medium power stereo receiver. Order yours soon.

Kit AR-29, (less cabinet), 33 lbs. \$285.00*

Assembled AE-19, oiled pecan cabinet, 10 lbs. \$19.95*

PARTIAL AR-29 SPECIFICATIONS — AMPLIFIER: Continuous power output per channel: 35 watts, 8 ohms. **IMF Power output per channel:** 50 watts, 8 ohms. **Frequency response:** —1 dB, 7-60,000 Hz, 1 watt level. **Power Bandwidth for constant 0.25% THD:** Less than 5 Hz to greater than 30 kHz. **Total harmonic distortion:** (Full power output on both channels) Less than 0.25%, 20-20,000 Hz; less than 0.1% @ 1000 Hz. **IM Distortion:** Less than 0.2% (full output, both channels). Less than 0.1% (1 watt output, both channels). **Hum and noise:** (phono input) —65 dB relative to 100 uV signal. **Phono input sensitivity:** 2.2 millivolts (overload 155 millivolts). **FM: Sensitivity:** 1.8 uV or better. **Volume sensitivity:** Below measurable level. **Selectivity:** Greater than 70 dB. **Image rejection:** 90 dB. **IF Rejection:** 90 dB. **Capture ratio:** 1.5 dB. **Total harmonic distortion:** 0.5% or less. **IM Distortion:** 0.4% or less. **Spurious rejection:** Greater than 90 dB. **FM STEREO: Separation:** 40 dB min. @ mid-frequencies; 30 dB @ 50 Hz; 25 dB @ 10 kHz; 20 dB @ 15 kHz. **Frequency response:** ±1 dB, 20-15,000 Hz. **Total harmonic distortion:** 0.5% or less @ 1000 Hz, 100% modulation. 19 kHz & 38 kHz. **Suppression:** 55 dB. **SCA Suppression:** 55 dB. **AM SECTION: Sensitivity:** (using built-in rod antenna): 200 uV/M @ 600 kHz; 300 uV/M @ 1400 kHz (IHF rated). **Selectivity:** Greater than 40 dB alternate channel. **Image rejection:** 60 dB @ 600 kHz; 45 dB @ 1400 kHz. **IF Rejection:** Greater than 50 dB. **Harmonic distortion:** Less than 2%. **Hum & Noise:** —35 dB.

Your Home With Heathkit® Stereo



Kit AR-15
\$349.95*
(less cabinet)

Wired
ARW-15
\$540.00*
(less cabinet)

HEATHKIT AR-15 Deluxe Solid-State Receiver

The Heathkit AR-15 has been highly praised by every leading audio and electronics magazine, every major testing organization and thousands of owners as THE stereo receiver. Here's why. The powerful solid-state circuit delivers 150 watts of music power, 75 watts per channel, at ± 1 dB, 8 Hz to 40 kHz response. Harmonic & IM distortion are both less than 0.5% at full rated output. The world's most sensitive FM tuner includes these advanced design features . . . Cascode 2-stage FET RF amplifier and an FET mixer for high overload capability, excellent cross modulation and image rejection . . . Sensitivity of 1.8 μ V or better . . . Harmonic & IM distortion both less than 0.5% . . . Crystal Filters in the IF section give a selectivity of 70 dB under the most adverse conditions. Adjustable Phase Control for maximum separation . . . elaborate noise operated squelch . . . stereo only switch . . . stereo indicator light . . . two front panel stereo headphone jacks . . . front panel input level controls, and much more. Easy circuit board construction. For the finest stereo receiver you can buy anywhere, order your AR-15 now. 34 lbs. Optional walnut cabinet, AE-16. 10 lbs. . . \$24.95*



Kit AD-27
\$179.95*

HEATHKIT AD-27 FM Stereo Compact

Heath engineers took the highly-rated AR-14 solid-state Stereo Receiver circuitry, matched it with the precision BSR McDonald 500A Automatic Turntable and put this quality component combination in a sliding tambour door walnut cabinet. Performance? The AD-27 delivers 30 watts music power . . . full 15 watts per channel — enough to drive any reasonably efficient speaker system. Response is virtually flat from 12-60,000 Hz, and Harmonic & IM Distortion are both less than 1% at full output. Tandem Volume, Bass, Treble & Balance Controls give you full range command of the sound. Flick the rocker-type switch to select the FM stereo mode, and tune smoothly across the dial with the inertia flywheel tuning. You'll hear stations you didn't know existed, with a clarity and separation that will amaze you. An adjustable phasing control assures best separation always, and the automatic stereo indicator light comes on when the station is broadcasting in stereo. AFC eliminates drift too. The BSR McDonald 500A includes cueing/pause control, variable anti-skating adjustment, stylus pressure control, automatic system power and many other features usually found only on very expensive units. Includes a famous Shure diamond stylus stereo cartridge too. Add this handsomely-styled, top performing stereo compact to your home now. 41 lbs.

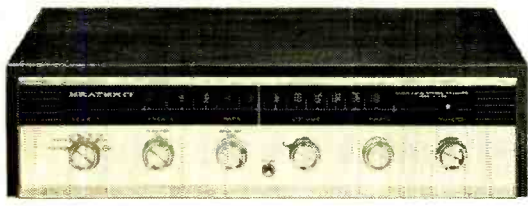

Kit AR-14
\$119.95*
(less cabinet)

Assembled
ARW-14
\$169.95*
(with AE-55 cabinet)

HEATHKIT AR-14 FM Stereo Receiver

The AR-14 has been rated as the best value obtainable in a medium power stereo receiver . . . and it's easy to see why. The all solid-state circuit delivers 30 watts music power from 15-50,000 Hz . . . total distortion is less than 1% at full output. The AR-14 may be small, but its FM tuner section boasts high sensitivity, excellent selectivity and very low noise to give you FM stereo performance you will marvel at. Complete inputs and outputs, of course, for greatest system flexibility. Other features include stereo headphone jack, stereo indicator light and filtered outputs for beat-free taping. Make this amazing little receiver the heart of your new stereo system now. 18 lbs.

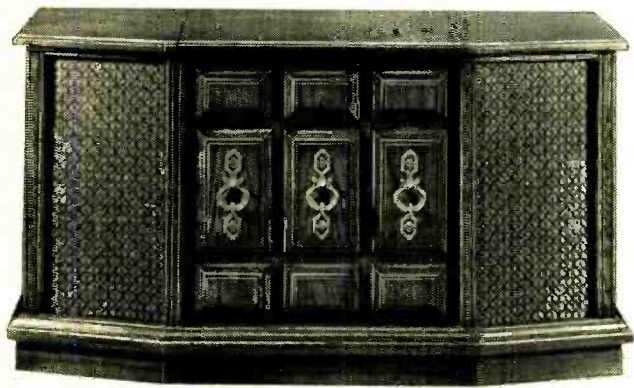

New Heathkit "Component Credenza" Combines Quality Stereo Components With Beautiful Mediterranean Styling . . . \$299.95*

- Combines all solid-state FM stereo receiver, 4-speed automatic turntable with diamond stylus and two full-range, two-way speaker systems into a luxurious Mediterranean cabinet • 15 watts per channel music power output
- Full range tone controls • Very low Harmonic & IM Distortion • Excellent channel separation • Transformerless output circuit for minimum phase shift, wide response • Electronically filtered power supply • Stereo headphone jack • Auxiliary input • Filtered tape output • Excellent FM tuner selectivity & sensitivity • 4-stage IF • AFC • Stereo indicator light • SCA filter • High quality BSR McDonald 500A Automatic Turntable with low mass counterbalanced aluminum tone arm plays up to 6 records • Comes with Shure diamond stylus magnetic cartridge • Vernier stylus pressure adjustment
- Anti-Skate control • Cue/Pause control • Two ducted-port reflex 2-way speaker systems for performance comparable to fine component-type separate speaker systems • Each system contains 10" high compliance woofer & 3 1/2" ring-damped tweeter for 60-16,000 Hz response • Complete system housed in a magnificent factory assembled Mediterranean cabinet of beautiful oak veneers with solid oak trim • Easy assembly with the famous Heathkit Manual . . . build only the receiver & install the components • The finest value anywhere in quality stereo consoles



Lifting the spring loaded hinged top reveals the heart of the new AD-19 . . . the famous Heathkit AR-14 Stereo Receiver circuitry, combined with the precision-crafted BSR McDonald 500A Automatic Turntable. Note the clean control layout . . . everything easily in reach from a standing position. A handy compartment in front keeps your records clean and convenient.

Real Stereo Performance Demands Real Stereo Components . . . the kind used for custom-designed systems. The new "Component Credenza" as the name implies, integrates separate components into a single functional unit. Here are those components . . .

Component-Quality FM Stereo Receiver. The heart of the new AD-19 is the famous Heathkit AR-14 FM-FM-Stereo Receiver circuitry. The amplifier produces a solid 30 watts IHF music power. The FM Stereo tuner features 5 μ V sensitivity, excellent separation and flywheel tuning. The AR-14 has been rated as the best value obtainable in a medium power receiver.

Component-Quality 4-Speed Automatic Turntable with such professional features as Cue/Pause control, Anti-Skate control, adjustable stylus pressure and famous Shure diamond stylus magnetic cartridge.

Component-Quality Speaker Systems. Two independent, ported speaker systems, each with a 10" woofer and 3 1/2" tweeter deliver 60-16,000 Hz response for remarkable fidelity.

Elegant Mediterranean Oak Cabinet . . . a fine example of cabinet-making, flawlessly executed in oak veneer with solid oak trim. Rigidly constructed using fine-furniture techniques.

The New Heathkit AD-19 "Component Credenza" . . . A Masterpiece in sight and sound. Put it in your home now.

Kit AD-19, 158 lbs. \$299.95*

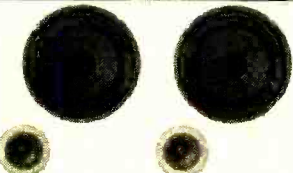

Component-Quality Speaker Systems. The new AD-19 cabinet houses two completely independent, ported speaker systems for reproduction comparable to that of systems of individual components. The 10" woofer and 3 1/2" tweeter combine to give clean, lifelike response from 60 Hz to 16,000 Hz.

Make This Christmas a

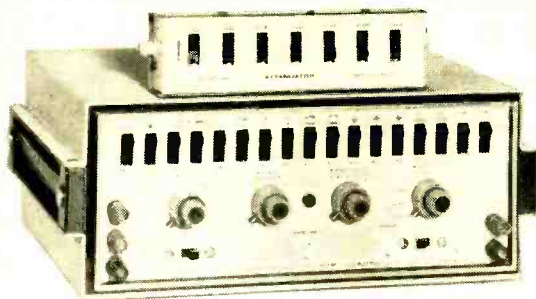

NEW Kit IG-57A

\$135⁰⁰*



NEW
Kit IG-28

\$79⁹⁵*

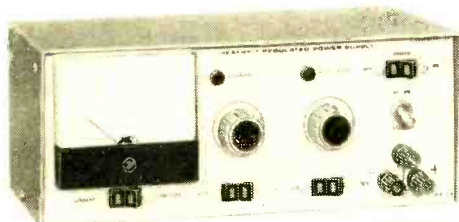

NEW
Kit IP-28

\$47⁵⁰*



NEW
Kit GR-78

\$129⁹⁵*



NEW
Kit GD-209A

\$149⁹⁵*

NEW, Improved Heathkit IG-57A Solid-State Post Marker/ Sweep Generator . . . Now With Built-In Video Sweep Modulator

Now align virtually every color and B&W TV set on the market with the new Heathkit IG-57A. New built-in Video Sweep Modulation eliminates the need for external equipment—the IG-57A and a scope are all you need to check the overall frequency response from the antenna terminals thru the tuner, IF strip, video detector to the color bandpass amplifier outputs. And you don't have to worry about video detector diode load. Another new feature is the addition of two individually adjustable 15 volt bias supplies with switchable polarity. Additional features: 15 crystal-controlled markers for color bandpass, TV sound, IF frequencies between 39.75 & 47.25 MHz and picture & sound carriers for channels 4 & 10 . . . switchable retrace blanking . . . adjustable phase control . . . trace reverse function for proper display . . . built-in switchable 400 Hz modulator . . . Zener regulated power supply . . . external attenuator for 1, 3, 6, 10 & 20 dB steps up to 70 dB . . . complete with all test leads, cables, connectors & plugs. Put complete servicing facilities on your bench now, with the new Heathkit IG-57A. 14 lbs.

NEW Heathkit Color Bar-Dot Generator . . . Advanced Integrated Circuitry Produces 12 Patterns Plus Clear Raster, Eliminates Divider Chain Instability Forever

The new IG-28 is the signal source for all color and B&W TV servicing. No other instrument at any price will give as much stable, versatile TV servicing capability. Its solid-state circuitry produces dots, cross hatch, vertical and horizontal bars, color bars, and shading bars in the familiar 9x9 display . . . plus exclusive Heath 3x3 display of all these patterns . . . plus a clear raster that lets you adjust purity without upsetting AGC adjustment. Fifteen J-K Flip-Flops and associated gates count down from a crystal controlled oscillator, eliminating divider chain instability and adjustments. And for time-saving convenience the IG-28 has variable front panel tuning for channels 2 through 6. Plus & minus going video signals at the turn of a front panel control . . . for sync, in-circuit video or chroma problems, use the front panel sync output. Two front panel AC outlets for test gear, TV set, etc. Built-in gun shorting circuits and grid jacks too. Add any service-type scope with horizontal input and you have vectorscope display capability as well. Fast, enjoyable circuit board-wiring harness construction. You can't beat the Heathkit IG-28 for versatility or value . . . put it on your bench now. 8 lbs.

NEW Heathkit 1-30 VDC Solid-State Regulated Power Supply

The new modestly priced IP-28 is an excellent power supply for anyone working with transistors. Compact Heathkit instrument styling with large, easy-to-read meter . . . two voltage ranges — 10 V., 30 V. . . two current ranges — 100 mA, 1 A. External sensing permits regulation of load voltage rather than terminal voltage. Adjustable current limiting prevents supply overloads and excessive load current. Convenient standby switch. Fast, easy assembly with one circuit board and wiring harness. Order yours today! 9 lbs.

NEW Heathkit GR-78 Solid-State General Coverage Receiver . . . Tunes 190 kHz To 30 MHz In Six Bands

The new GR-78 combines wide coverage, superior performance and portability with sharp styling to provide a remarkable value in general coverage receivers. Tunes AM, CW & SSB signals from 190 kHz to 30 MHz in six switch-selected bands. The all solid-state circuit employs modern FET's in the RF section and 4 ceramic filters in the IF to deliver maximum sensitivity and sharp selectivity. Bandspeed Tuning is built-in, and can be calibrated for either Shortwave Broadcast or Amateur Bands. Completely portable . . . comes with a nickel-cadmium rechargeable battery pack and built-in charger that operates from 120 or 240 VAC and 12 VDC. Many built-in features . . . 500 kHz crystal calibrator . . . switchable Automatic Noise Limiter . . . switchable Automatic Volume Control . . . Receiver Muting . . . Headphone Jack and many more. Order yours today. 14 lbs.

NEW Heathkit Deluxe Radio-Controlled Screw-Drive Garage Door Opener Semi-Kit

The next best thing to a personal doorman. The "wireless" factory assembled transmitter operates up to 150 feet away. Just push the button and your garage door opens and the light turns on . . . and stays on until you're safely inside your home. The giant 7 ft. screw mechanism coupled with the 1/4 HP motor mean real power and reliability and the adjustable spring-tension clutch automatically reverses the door when it meets any obstruction . . . extra safety for kids, pets, bikes, even car tops. Assembles completely without soldering in just one evening. Easy, fast installation on any 7' overhead track (and jamb & pivot doors with accessory adapter). Order yours now. 66 lbs.

Adapter arm for jamb & pivot doors, Model GDA-209-2, \$7.95*

Heathkit® Holiday



Heathkit "681" Color TV... AFT... New Brighter Picture Tube For More Vivid Colors, Better Resolution

The new Heathkit GR-681 is the world's most advanced Color TV with more built-in features than any other set on the market. Automatic Fine Tuning on all 83 channels... power push button VHF channel selection, built-in cable-type remote control... or you can add the optional GRA-681-6 Wireless Remote Control any time... plus the built-in self-servicing aids that are standard on all Heathkit color TV's. Other features include high & low AC taps to insure that the picture transmitted exactly fits the "681" screen, automatic degaussing, 2-speed transistor UHF tuner, hi-fi sound output, two VHF antenna inputs, top quality American brand color tube with 2-year warranty. With optional new RCA Matrix picture tube that doubles the brightness, Model GR-681MX only \$535.00.

GRA-295-4, Mediterranean Cabinet shown... **\$124.95***

Heathkit "295" Color TV... New Picture Tube For Brighter, Sharper Pictures

With Optional RCA Matrix Tube... with the same high performance features and built-in servicing facilities as GR-681 above... less AFT, VHF power tuning and built-in cable-type remote control. You can add the optional GRA-295-6 Wireless Remote Control at any time. New optional RCA Matrix tube doubles the brightness, Model GR-295MX, \$485.00.

GRA-295-1, Contemporary Walnut Cabinet shown... **\$64.95***

Both the GR-681 and GR-295 fit into the same Heath factory assembled cabinets; not shown Early American style at \$109.95*

Heathkit "581" Color TV... Sharper, Brighter Viewing With New Picture Tube... AFT

The new Heathkit GR-581 will add a new dimension to your TV viewing. Brings you color pictures so beautiful, so natural, so real... puts professional motion picture quality right into your living room. Has the same high performance features and exclusive self-servicing facilities as the GR-681, except with 227 sq. inch viewing area, and without power VHF tuning or built-in cable-type remote control. The optional GRA-227-6 Wireless Remote Control can be added any time you wish. And like all Heathkit Color TV's you have a choice of different installations... mount it in a wall, your own custom cabinet, your favorite B&W TV cabinet, or any one of the Heath factory assembled cabinets.

GRA-227-2, Mediterranean Oak Cabinet shown... **\$109.95***

Heathkit "227" With New Picture Tube For Increased Brightness & Better Resolution

Same as the GR-581 above, but without Automatic Fine Tuning... same superlative performance, same remarkable color picture quality, same built-in servicing aids. Like all Heathkit Color TV's you can add optional Wireless Remote Control at any time (GRA-227-6). And the new Table Model TV Cabinet and roll around Cart is an economical way to house your "227"... just roll it anywhere, its rich appearance will enhance any room decor.

GRS-227-5, New Cart and Cabinet combo shown... **\$54.95***

Both the GR-581 and GR-227 fit into the same Heath factory assembled cabinets; not shown. Contemporary cabinet \$64.95*

Heathkit "481" Color TV with AFT

The new Heathkit GR-481 has all the same high performance features and exclusive self-servicing aids as the new GR-581, but with a smaller tube size... 180 sq. inches. And like all Heathkit Color TV's it's easy to assemble... no experience needed. The famous Heathkit Color TV Manual guides you every step of the way with simple to understand instructions, giant fold-out pictorials... even lets you do your own servicing for savings of over \$200 throughout the life of your set. If you want a deluxe color TV at a budget price the new Heathkit GR-481 is for you.

GRA-180-1, Contemporary Walnut Cabinet shown... **\$49.95***

Heathkit "180" Color TV

Feature for feature the Heathkit "180" is your best buy in color TV viewing... has all the superlative performance characteristics of the GR-481, but less Automatic Fine Tuning. For extra savings, extra beauty and convenience, add the table model cabinet and mobile cart. Get the value-packed GR-180 today.

GRS-180-5, Table Model Cabinet & Cart combo... **\$42.50***

Both the GR-481 and GR-180 fit the same Heath factory assembled cabinets; GRA-180-2, Early American Cabinet \$94.95*

Add the Comfort And Convenience Of Full Color Wireless Remote Control To Any Rectangular Tube Heathkit Color TV... New Or Old!

Kit **GRA-681-6**, for Heathkit GR-681 Color TV's... **\$64.95***

Kit **GRA-295-6**, for Heathkit GR-295 & GR-25 TV's... **\$69.95***

Kit **GRA-227-6**, for Heathkit GR-581; GR-481 & GR-180

Color TV's... **\$69.95***

Now There Are 6 Heathkit® Color TV's To Choose From

2 Models In 295 Sq. Inch Size

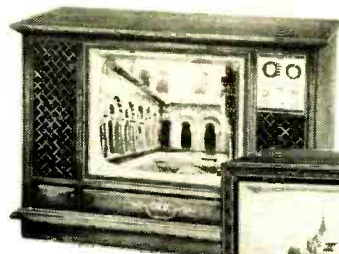

NEW
Kit GR-681
With AFT

\$499.95*

(less cabinet)



Kit GR-295

\$449.95*

(less cabinet)

2 Models In 227 Sq. Inch Size



NEW
Kit GR-581
with AFT

\$419.95*

(less cabinet)



Kit GR-227
NOW ONLY

\$379.95*

(less cabinet
& cart)

2 Models In 180 Sq. Inch Size



NEW
Kit GR-481
with AFT

\$359.95*

(less cabinet)



Kit GR-180
NOW ONLY

\$329.95*

(less cabinet & cart)

Reception Is Simulated
On All Sets Shown



a Schlumberger subsidiary



NEW

FREE 1970 CATALOG!

Now with more kits, more color. Fully describes these along with over 300 kits for stereo/hi-fi, color TV, electronic organs, electric guitar & amplifier, amateur radio, marine, educational, CB, home & hobby. Mail coupon or write Heath Company, Benton Harbor, Michigan 49022.

HEATH COMPANY, Dept. 15-69
Benton Harbor, Michigan 49022

Enclosed is \$ _____, plus shipping.

Please send model (s)

Please send FREE Heathkit Catalog. Please send Credit Application.

Name _____

Address _____

City _____

State _____

Zip _____

*Mail order prices; F.O.B. factory. Prices & specifications subject to change without notice.

CL-370

Olson
ELECTRONICS

FREE

Catalog

Fill in coupon for a **FREE** One Year Subscription to **OLSON ELECTRONICS** Fantastic Value Packed Catalog — Unheard of **LOW, LOW PRICES** on Brand Name Speakers, Changers, Tubes, Tools, Stereo Amps, Tuners, CB, Hi-Fi's, and thousands of other Electronic Values. Credit plan available.

NAME _____
 ADDRESS _____
 CITY _____ STATE _____
 GIVE ZIP CODE _____

If you have a friend interested in electronics send his name and address for a **FREE** subscription also.

OLSON ELECTRONICS

522 S. Forge Street, Akron, Ohio 44308

CIRCLE NO. 117 ON READER SERVICE CARD

ENJOY THE "MUSIC ONLY" FM PROGRAMS

M. A. D.

MUSIC ASSOCIATED'S DETECTOR
NO COMMERCIALS—NO INTERRUPTIONS



It's easy! Just plug Music Associated's Sub Carrier Detector into multiplex jack of your FM tuner or easily wire into discriminator. Tune through your FM dial and hear programs of continuous commercial-free music you are now missing. The Detector, self-powered and with electronic mute for quieting between selections, permits reception of popular background music programs no longer sent by wire but transmitted as hidden programs on the FM broadcast band from coast to coast. Use with any FM tuner. Size: 5 1/2" x 9". Shipping weight approx. 7 lbs

KIT \$49.50
(with pre-tuned coils, no alignment necessary)

WIRED \$75.00

COVER \$4.95 EXTRA

List of FM Broadcast Stations with SCA authorization \$1.00

MUSIC ASSOCIATED

65 Glenwood Road, Upper Montclair, N.J. 07043
 Phone: (201)-744-3387

AUTOMATIC RESET FOR CIRCUIT BREAKER

By STANLEY W. THOMAS/Lawrence Radiation Laboratory*

SOLID-state circuit breakers are much more valuable when they include a provision which automatically restores circuits to their original operating condition.

In the July 1967 issue, the author described a solid-state circuit breaker which required a reset button. Now, with a minor modification, this same circuit can be made to reset automatically. In the original device, fault current passed through *R1* and triggered SCR *D6* into conduction. This bypassed the base drive of the previously saturated series-pass transistor, *Q1*. Since current through *D6* was enough to keep it latched on, *Q1* was off until *D6* was manually reset.

The dashed lines in Fig. 1 show how *D6* can be made to reset automatically. Assume some load resistance. Then, when the breaker operates, the "minus" output rises to that of the "positive" output; and about 140 μ A flows through *C4*, *R6*, and *D7* into *C2*. When the switching voltage of the four-layer diode *D8* is reached (The 20-V potential is also across *C3* since *D6* is on), the diode fires and its voltage drops to almost zero in less than a microsecond.

At this time, a negative pulse is coupled through *C3* to the anode of *D6*. This reverse-biases *D6* and shuts it off. While the pulse is at the anode, it maintains *Q1* in the "off" state. After the pulse has dissipated, the circuit is reset and able to be retriggered.

R5 limits current through *D8* and also stretches the pulse. *D7*'s job is to prevent *D6* from being affected by the load on *C2*. The *R6-C2* combination determines the time to the first reset attempt. Although *R6* can be any value

from 60,000 to 300,000 ohms for the circuit shown, it was chosen to keep *D8*'s holding current less than 0.5 mA when 28 V is impressed across it, yet provide more than *D8*'s switching current when the voltage across it is as low as 8 volts.

Why are *C4* and *R7* needed? When the circuit is in reset, *C4* has no voltage across it. (*R7* provides a leakage current path.) Triggering the breaker raises the "+" end of *C4* to +28 V and current starts to flow. At the end of the reset pulse, *C4* now has about 2 V across it. Thus, every time *C2* charges to 20 V, *C4* charges 2 V more. With a 28-V supply, *C2* can charge to 20 V four times. $V_{\text{supply}} - V_{C2} = 28 - 20 = 8$ V, where V_{C2} is voltage on *C2*. Thus 8 V/2 V per reset = 4 resets. The *C4* and *C2* relationship determines the number of possible reset attempts. Making *C4* larger increases this number.

If voltage across *C4* is greater than 8, *C2*'s potential will be less than 20 V and *D8* will not fire; the circuit will not reset, and the breaker remains open. Holding the Reset button down for a few seconds will allow *C4* to discharge through *R7* enough for one or two reset attempts (the first will occur about 20 s after the button is released).

If the output is permanently shorted, consecutive reset attempts are made after about 3, 7, 12, 23, and again after 63 seconds. Although *R7* limits current flow to *C2* to a value below the firing level of *D8*, it will charge *C2* to the firing voltage. Then pickup or noise may trigger *D8*. When a short or overload is removed, the circuit may reset automatically after 2 or 3 minutes. Normal operation is restored on reset. ▲

*Work performed under auspices of the U.S. Atomic Energy Commission.

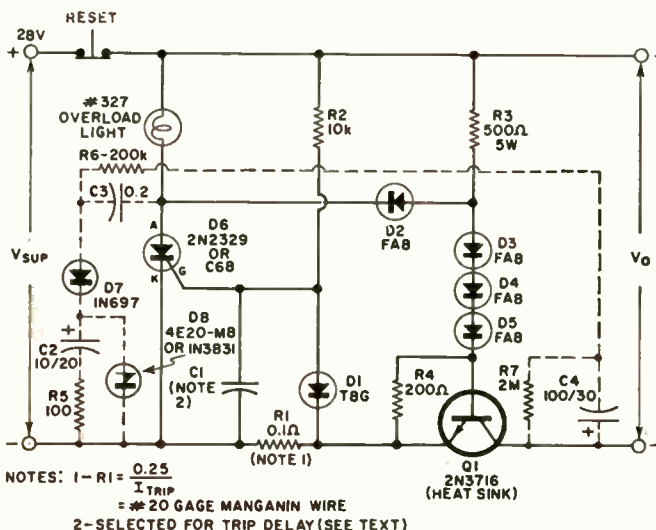
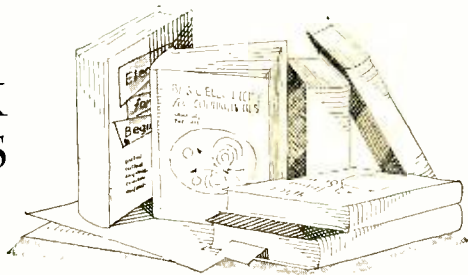

Fig. 1. Solid line drawing is the original circuit of solid-state breaker. When modified by components in dashed lines, it resets automatically three seconds after circuit fault.

BOOK REVIEWS



"CONDENSED COMPUTER ENCYCLOPEDIA" by Philip B. Jordan. Published by *McGraw-Hill Book Company*, New York. 589 pages. Price \$14.50.

This volume is addressed to the non-specialist—the businessman, the student, and junior programmer just starting his career. By alphabetizing the computer terms and then defining the terms in progressively technical form, the material can be selected by the general reader for an answer to his specific question or by student programmers who require more technical details.

In order to keep the volume of usable size, some terms are omitted as separate listings but are included in the material about related terms. An index listing all terms and the appropriate reference assists in locating the material required.

The text is illustrated as required when discussing some esoteric concept.

* * *

"WORKING WITH SEMICONDUCTORS" by A. C. W. Saunders. Published by *Tab Books*, Blue Ridge Summit, Pa. 17214. 221 pages. Price \$7.95.

This is a primer of semiconductor theory and operation for those unfamiliar with the technology and includes a number of simple circuits which the reader can construct or breadboard to gain experience in working with such devices.

After four chapters of basics, the author covers transistor amplifiers, audio amplifier circuits, r.f. and i.f. amplifiers, transistor oscillators, power supplies, the reactance diode or varactor, high-frequency oscillators and amplifiers, FET's, UJT's, zeners and special-purpose diodes, and special-purpose circuits.

The treatment is down-to-earth, the diagrams included are large and lavish, and enough material is discussed to get the neophyte off to a good start toward understanding semiconductors.

* * *

"CB RADIO SERVICING GUIDE" by Leo G. Sands. Published by *Howard W. Sams & Co., Inc.*, Indianapolis, Ind. 158 pages. Price \$3.95. Soft cover.

This is a second edition which updates the author's 1963 volume. As was the case with the first edition, emphasis is on CB servicing, troubleshooting procedures, necessary test equipment, CB rules and regulations, field and shop maintenance, and the business aspects of CB servicing.

* * *

"HANDBOOK OF ELECTRONIC METERS: THEORY AND APPLICATION" by John D. Lenk. Published by *Prentice-Hall, Inc.*, Englewood Cliffs, N.J. 177 pages. Price \$10.95.

This volume is intended to bridge the information gap existing between the makers of electronic meters and their users. It is the author's contention that too often manufacturers assume that the buyer will know how to set up, apply, and service his equipment. Experience has shown otherwise.

The first three chapters cover basics on the various types of meter, accessory probes, procedures and techniques. Next comes a discussion on testing and calibrating meters, then special measurement procedures are outlined. Checking individual components, checking circuit functions, and servicing specific circuits with meters completes the text. Illustrations of various types are used throughout the text.



STEREO/HI-FI DIRECTORY

Giant 180 page buyer's guide listing more than 1,600 individual Stereo/Hi-Fi components by 176 manufacturers. Nine individual sections complete with specs, photos, prices—the works!

1970 #98 \$1.35
1969 #82 \$1.25

TAPE RECORDER ANNUAL

Over 130 pages covering every aspect of tape recording. Complete buyer's guide to the brands and models on the market. Expert tips on equipment—making better tapes—editing—copying—everything you want and need to know about tape recording.

1970 #99 \$1.35
1969 #81 \$1.35

Ziff-Davis Service Division—Dept. W • 595 B'way, New York, N.Y. 10012

I am enclosing \$_____ for the annuals circled below. My remittance includes an additional 25¢ per copy for shipping and handling (Outside U.S.A. all magazines are \$2.00 per copy, postpaid.)

\$1.35 each 81 98 99 **\$1.25 each** 82

Print Name _____ EW-129

Address _____

City _____ State _____ Zip _____

PAYMENT MUST BE ENCLOSED WITH ORDER

The new Bolero's beauty is far more than skin deep. Behind its distinctive fretwork grille is a 10" woofer with a 10-lb. magnet structure acoustically coupled to a 10" phase inverter. That combination means taut, true, unclouded bass response down to 40 Hz. Above 2000 Hz, a newly developed tweeter takes over. It's a compression-driven type, feeding through a rigid cast aluminum horn. The tweeter delivers smooth high frequencies clear in to the 20,000 Hz region, with excellent dispersion. Hear the biggest news—and the biggest sound—in bookshelf speakers today. It's the Bolero. At your Altec dealers. For a catalog describing all our speaker systems, write Altec

We wouldn't put on such a beautiful front if we didn't have the speakers to back it up.



ELECTRONICS MARKET PLACE

COMMERCIAL RATE: For firms or individuals offering commercial products or services. 85¢ per word (including name and address). Minimum order \$8.50. Payment must accompany copy except when ads are placed by accredited advertising agencies. Frequency discount: 5% for 6 months; 10% for 12 months paid in advance.

READER RATE: For individuals with a personal item to buy or sell. 50¢ per word (including name and address). No minimum! Payment must accompany copy.

GENERAL INFORMATION: First word in all ads set in bold caps at no extra charge. Additional words may be set in bold caps at 10¢ extra per word. All copy subject to publisher's approval. Closing Date: 1st of the 2nd preceding month (for example, March issue closes January 1st). Send order and remittance to: Hal Cymes, **ELECTRONICS WORLD**, One Park Avenue, New York, New York 10016.

FOR SALE

JUST starting in TV service? Write for free 32 page catalog of service order books, invoices, job tickets, phone message books, statements and file systems. Oelrich Publications, 4040 North Nashville Avenue, Chicago, Ill. 60634.

GOVERNMENT Surplus Receivers, Transmitters, Sniperscopes, Radios, Parts, Picture Catalog 25¢. Meshna, Nahant, Mass. 01908.

METERS Surplus, new, used, panel or portable. Send for list. Hanchett, Box 5577, Riverside, Calif. 92507.

CONVERT any television to sensitive big-screen oscilloscope. Only minor changes required. No electronic experience necessary. Illustrated plans, \$2.00. Relco-A22, Box 10563, Houston, Texas 77018.

INVESTIGATORS, LATEST ELECTRONIC AIDS. FREE LITERATURE. CLIFTON, 11500-J NW 7th AVE., MIAMI, FLORIDA 33168.

FREE ELECTRONICS PARTS FLYER. Large catalog \$1.00 deposit. BIGELOW ELECTRONICS, BLUFFTON, OHIO 45817.

TREASURE HUNTERS! Prospectors! Relco's new instruments detect buried gold, silver, coins. Kits, assembled models, Transistorized. Weighs 3 pounds. \$19.95 up. Free catalog. Relco-A22, Box 10839, Houston Texas 77018.

MUSIC LOVERS, CONTINUOUS, UNINTERRUPTED BACKGROUND MUSIC FROM YOUR FM RADIO, USING NEW INEXPENSIVE ADAPTER. FREE LITERATURE, ELECTRONICS, 11500-Z NW 7th AVE., MIAMI, FLORIDA 33168.

EUROPEAN wholesale new products catalog. \$1.00 refundable. Deecow, 10639 Riverside, North Hollywood, Calif. 91602.

JAPAN & HONG KONG DIRECTORY. Electronics, all merchandise. World trade information. \$1.00 today. Ippano Kaisha Ltd., Box 6266, Spokane, Washington 99207.

FREE Catalog low priced, high performance sub-miniature listening devices direct from manufacturer. Dealers welcome. Emery W 12, 156 Fifth Avenue, New York, N.Y. 10010.

ULTRA-SENSITIVE AND POWERFUL METAL DETECTORS—join the many who are finding buried coins, minerals, relics and artifacts. Don't buy till you see our **FREE** catalog of new models. Write Jetco, Box 132-EW, Huntsville, Texas 77340.

REPAIR YOUR OWN T.V. TUNERS—Color—Transistor—VHF—UHF. Earn to \$1,700 monthly. No customer headaches. Simple, complete course. First of its kind. Copyrighted. Years in preparation. Six sections, 33 chapters. All field-tested. Jigs, fixtures, adapters, "setting-up." Special probes. Quick-checks. How alter and use test sets. Repairs without equipment. Unique power supplies. Fast-fix luxuries. Equipment you can build. Professional tricks. Illustrated schematics, pictures, drawings, sketches. Plans for all items. Troubleshooting. Alignment. All tests and adjustments. Common mistakes. How and where to buy parts. Specific repairs common problems. Index of all tuners. Much, much more. Programmed teaching. Major course: Details, Introduction, plus two sample lessons \$1. Bocek, Box 3236, Redding, Calif. 96001.

SENCOPE TEST EQUIPMENT UNBELIEVABLE PRICES. FREE CATALOG AND PRICE SHEET. FORDHAM RADIO, 265 EAST 149TH STREET, BRONX, N.Y. 10451.

PROXIMITY switch. Detects nearness of human body. Free information. Claremont Products, 860 Reed, Claremont, Calif. 91711.

SEMICONDUCTORS and Parts. Catalogue free over 100 pages. J. & J. Electronics, Box 1437, Winnipeg, Manitoba, Canada. U.S. Trade directed.

ELECTRONIC ignition, various types. Free literature. Anderson Engineering, Epsom, N.H. 03239.

ATWATER KENT receivers; schematics, diagrams, \$2.00. Harnco, Box 5, Staunton, Va. 24401.

HeNe GAS LASER output 3/4 M.W. typical completed tube with internal mirrors and P.S. schematic laser in the visible red. The best in the world in its class. Rush your order to C.W. Radiation, P.O. Box 1299, Mtn. View, Calif. 94040.

IGNITION COILS 400:1 turns ratio, metal case, heavy duty. Limited offer \$5.00 each, 2 for \$8.00. Cary Engineering, Box 6559, San Diego, Calif. 92106.

INTRUDER DETECTION SYSTEM uses microwaves to detect human movement. **ALL SOLID STATE.** Range adjustable to thirty feet. Ideal for home or small business. Kits or assembled units. Plans \$3.00 refundable. Write for free brochure. Microwave Research Co., Box 10147, St. Petersburg, Florida 33733.

PLANS AND KITS

COLOR Organ Kit \$7.50, Power Supplies \$3.98. Catalog. Murphy, 104 Roslyn Ave., Carle Place, N.Y. 11514.

PLANS: LASER \$2.00, Two FM Bugs \$1.00, Tailing Bug \$1.00, Telephone Bug \$1.00, Howard, 20174 Ward, Detroit, Michigan 48235.

INTEGRATED CIRCUIT KITS: COMPUTER, AUDIO, Others. New catalog free. **KAYE ENGINEERING**, Box 3932-B, Long Beach, California 90803.

ELECTRONICS ENGINEERING AND INSTRUCTION

LEARN ELECTRONIC ORGAN SERVICING at home. All Makes including transistors. Experimental kit—troubleshooting. Accredited NHSC. Free Booklet. **NILES BRYANT SCHOOL**, 3631 Stockton, Dept. A, Sacramento, Calif. 95820.

DEGREE in Electronics Engineering earned mostly by correspondence. Free brochure. Dept. G-9, Grantham School of Engineering, 1505 N. Western Ave., Hollywood, California 90027.

\$1 PEP \$1
Dollar Sale
EACH PACKAGE
MONEY BACK GUARANTEE

1 AMP Silicon Rectifier
Choice of Package
Bullet-Glass-Mini-Metal

<input type="checkbox"/> 20-50V	<input type="checkbox"/> 3-800V
<input type="checkbox"/> 17-100V	<input type="checkbox"/> 4-1000V
<input type="checkbox"/> 12-200V	<input type="checkbox"/> 3-1200V

3 AMP

<input type="checkbox"/> 15-50V	<input type="checkbox"/> 4-600V
<input type="checkbox"/> 10-100V	<input type="checkbox"/> 3-800V
<input type="checkbox"/> 8-200V	<input type="checkbox"/> 2-1000V
<input type="checkbox"/> 5-400V	<input type="checkbox"/> 1-1200V

5 AMP

<input type="checkbox"/> 10-50V	<input type="checkbox"/> 4-400V
<input type="checkbox"/> 8-100V	<input type="checkbox"/> 3-800V
<input type="checkbox"/> 6-200V	<input type="checkbox"/> 2-1000V
<input type="checkbox"/> 5-300V	<input type="checkbox"/> 1-1200V

12 AMP STUD

<input type="checkbox"/> 5-100V	<input type="checkbox"/> 2-800V
<input type="checkbox"/> 3-500V	<input type="checkbox"/> 1-1000V

20 AMP STUD

<input type="checkbox"/> 4-50V	<input type="checkbox"/> 2-500V
<input type="checkbox"/> 3-100V	<input type="checkbox"/> 1-1000V

40 AMP STUD

<input type="checkbox"/> 3-50V	<input type="checkbox"/> 1-300V
<input type="checkbox"/> 2-100V	

60 AMP STUD

<input type="checkbox"/> 2-50V	<input type="checkbox"/> 1-1000V
--------------------------------	----------------------------------

ZENER-DIODES
250-400 MW
1 EA 4V-6V-8V-10V

1 WATT
1 EA 4V-6V-8V-10V

2 WATT
12 to 60V
CHOICE OF THREE

3 WATT
10 volt three for \$1.00

SILICON-CONTROLLED RECTIFIER

TO-5 PACKAGE

<input type="checkbox"/> 5-50V	<input type="checkbox"/> 2-800V
<input type="checkbox"/> 4-100V	<input type="checkbox"/> 2-400V

7 AMP

<input type="checkbox"/> 4-50V	<input type="checkbox"/> 2-200V
<input type="checkbox"/> 3-100V	<input type="checkbox"/> 1-800V

GENERAL PURPOSE GERMANIUM TRANSISTOR
SIMILAR to 2N404
8 UNITS

RADIATION FREE TUBE FOR COLOR TV
50,000 Volts. Replaces RCA 3A-3A or equivalent. Guaranteed for life of set or 5 years. Eliminates heat to prolong life of other tubes. **\$8.99 each.**

SPECIAL INTEGRATED CIRCUITS

Dual 4 Input Nand Gate Digital \$1.50
Quad 2 Input Nand Gate Digital \$1.50
J K Flip Flop Master Gate Digital \$1.75
Linear 1 C Operational Amp 709C Type \$1.75

**NO SALES TAX—WE PAY POSTAGE
OTHER PRODUCTS ON REQUEST**
PARK ELECTRONIC PRODUCTS
P.O. Box 78, N. Salem, N.H. 03073
603-893-0276

HARD TO FIND THESE AT SURPLUS PRICES:

CALIB.-CERTIFIED & GRD COUNTERS:
8-digit 10 Hz—220 mhz; H.P. 524D, 525A&B 950.00
Same but base counter is 524C (inf) 995.00
10 Hz-12 kHz; Beckman 7370 plus 7580
Computing Transfer Oscillator 1295.00
7580 only; Works with 7360A, 7370, 6136, 6197,
3449, 6147; Regular \$1650.00, Certified 750.00
OK
Backman 7570/71/72; Extends range of any 10 mhz
counter from which you can get the 1 mhz x10
output, to cover up to 230 mhz. 395.00

Crystal Impedance Meter TS-330/TSM. Same as
REL-349. Brand new, w/spares & book 375.00

SOLID-STATE POWER-SUPPLY BARGAINS:
0-32 v, 1 1/2 A; Metered. Also set current limit
500-300 ma; Regul. 0.1% New, used 139.50
1-12 v 10A; Metered, Regul. 1% mv 125.00
0-60 v 7 1/2 A or 0-7 1/2 A, 0-60 v; Har Labs
metered 2%RB, Regul. 0.2% 225.00
12-36 v, 15 A; Metered, Regul. 18 mv 225.00
Dual 5-36 v 1 A metered, Regul. 100 mv 119.50
5-36 v 30 A; Metered, SCR-regulated 150.00
ASK for complete list including HV supplies.

LINE-FREQUENCY CHANGER BARGAINS:
ELECTRONIC 1 KVA; IN: 208/230 v 1 ph
60 Hz; OUT: 105/30 v 1 ph 330-3900 Hz 350.00
50 HERTZOUS ROTARY; 6 1/2 KVA; IN: 4 1/2
1 ph 60 Hz; OUT: 120/240 v 1 ph 400 Hz. 150.00

RFI & FIELD-STRENGTH METER BARGAINS:
14-250 kHz; Stoddart NM-10B with all accessories,
freshly calibrated 1050.00
150-25,000 kHz; Stoddart NM-30B with all accessories,
freshly calibrated 1250.00
Same for portable (battery) use 995.00
150-350, 550-20,000 kHz; Ferris #32A with
AC pwr. only, freshly calibrated 250.00
150-80,000 kHz; Empire Devices NF-114 with
AC pwr. only, freshly calibrated 950.00
20-400 mhz; Stoddart NM-30A with all accessories,
freshly calibrated 1450.00
375-1000 mhz; Stoddart NM-50 with all accessories,
freshly calibrated 950.00
0.9—10 mhz; Set of 4 plug-ins for Empire
Devices NF-112 Freshly calibrated 6720.00

CALIBRATED & GRD SIGNAL GENERATORS:
600ton 202B FM-AM generator 34 to 216 mhz;
Deviation calib. on meter 0-24, 0-80, and 0-240
kHz; AM calib. on meter 0-50% 595.00
Meas. Corp. #82; 20 Hz to 50 MHz CW or AM up to
50%; Output calib. to 1 v into 50 ohms. It is the
only LF Gen. with Piston Attenuator; easy to use, no
resistor burnouts 450.00
Meas. Corp. #65B 75-30 mhz 525.00
Gen. Radio 1001A 0.05-30 mhz 595.00
Meas. Corp. #80 2-400 mhz 295.50
Marconi TF-801D/1; 10 to 470 MHz CW & AM up to
90%, Xtal-calib. each 5 MHz and resettable dial
hairline AFC keeps level constant, 0.1 uv to 1 v
from 50 ohms into Type N, Cap.-coupled turret
switch, no rubbing contacts, Practically zero leakage
& FM 595.00

**WE PROBABLY HAVE THE BEST INVENTORY OF
GOOD LAB TEST EQUIPMENT IN THE COUNTRY,
BUT PLEASE DO NOT ASK FOR CATALOG; ASK FOR
SPECIFIC ITEMS OR KINDS OF ITEMS YOU NEED!
WE ALSO BUY! WHAT DO YOU HAVE?**

R. E. GODHEART CO. INC.
Box 1220-A, Beverly Hills, Calif. 90213
Phones: Area 213, office 272-5707, messages 275-5342

R.E.I.'s famous (5) week course for the First Class Radio Telephone License is the shortest, most effective course in the nation. Over 98% of R.E.I. graduates pass F.C.C. exams for 1st class license. Total tuition \$360.00. Job placement free. Write for brochure Radio Engineering Incorporated Schools, 1336 Main Street, Sarasota, Florida 33577—or 3123 Gillham Road, Kansas City, Missouri 64109—or 809 Caroline Street, Fredericksburg, Virginia 22401—or 625 E. Colorado Street, Glendale, California 91205.

ELECTRONICS! Associate degree—29 months. Technicians, field engineers, specialists in communications, missiles, computers, radar, automation. Start February, September. Valparaiso Technical Institute, Dept. N, Valparaiso, Indiana 46383.

FCC First Class License in six weeks—nation's highest success rate—approved for Veterans Training. Schools in Dallas, Atlanta, Chicago, New Orleans, Minneapolis and Houston. Write Elkins Institute, 2603C Inwood Road, Dallas, Texas 75235.

F.C.C. License training by correspondence. G.I. Bill approved. Money-Back Warranty. Free brochure. Write: Dept. Z-9, Pathfinder School of Electronics, 1505 N. Western Ave., Hollywood, Calif. 90027.

COMPUTER Dictionary and Handbook. Most suitable for professional use. Hardbound \$12.95. Linc., Box 21007, Denver, Colo. 80221.

DRAFTING (Electronic, Mechanical, Architectural). Home Courses \$25.00. Send \$2.00 first lesson. Prior, Inc., 23-09 169 Street, White-stone, New York 11357.

WANTED

QUICKSILVER, Platinum, Silver, Gold. Ores Analyzed. Free Circular. Mercury Terminal, Norwood, Mass. 02062.

QUICK CASH . . . for Electronic Tubes, Semiconductors, Equipment (Receivers, Transmitters, Scopes, Vacuum Variables, etc.) Send lists now! Write: **BARRY ELECTRONICS**, 512 Broadway, New York, N.Y. 10012 (212-WA 5-7000).

DO-IT-YOURSELF

PROFESSIONAL ELECTRONICS PROJECTS—\$1.00 up. Catalog 25¢. **PARKS**, Box 25665A, Seattle, Wash. 98125.

TAPE AND RECORDERS

BEFORE renting stereo Tapes, try us. Postpaid both ways—no deposit—immediate delivery. Quality—Dependability—Service—Satisfaction—prevail here. If you've been dissatisfied in the past, your initial order will prove this is no idle boast. Free Catalog. Gold Coast Tape Library, Box 2262, Palm Village Station, Hialeah, Fla. 33012.

TAPEMATES make available to you **ALL 4-TRACK STEREO TAPES—ALL LABELS**—postpaid to your door—at tremendous savings. For free brochure write: **TAPEMATES**, 5727 W. Jefferson Blvd., Los Angeles, California 90016.

RENT 4-track open reel tapes—all major labels—8,000 different—free brochure. Stereo-Parti, 55 St. James Drive, Santa Rosa, Calif. 95401.

STEREO TAPES: CARTRIDGES, CASSETTES, REELS, 33% DISCOUNT. UNAVAILABLE ELSEWHERE. MAIL 20¢—CATALOGS. STAR RECORDINGS-EW, BOX 1055, EL PASO, TEXAS 79946.

CASSETTE blanks, also educational and language, accessories and recorders. Literature—write **CASSETTES UNLIMITED**, P.O. Box 13119W, Pittsburgh, Pa. 15243.

TAPES . . . blank recording . . . pre-recorded music. Catalog 10¢. Tower, Lafayette Hill, Pa. 19444.

STEREO TAPES, save 20, 30% and more, postpaid anywhere U.S.A. We discount batteries, recorders, tape/cassettes. 80-page catalog 25¢. **SAXITONE TAPES**, 1776 Columbia Road, N.W., Washington, D.C. 20009.

INTRODUCTION OFFER two 60 minute cassettes \$1.00 plus 25¢ handling. O.B. Electronic, 14418 Grevillea, Lawndale, Calif. 90260.

CLASSIC Radio Shows! Custom taped! Huge catalogue, 50¢. Radio Ltd., P.O. Box 23, Ann Arbor, Michigan 48107.

STEREO TAPE TRANSPORT. Made for leading manufacturer, two speed, pause control, 7" reel, automatic tape lifters, with record, play-back and erase heads. No case. Only 300 left. Send check or M.O. for \$17.50 to Stereo Center, 218 Columbia Street, Utica, New York 13502.

INTEGRATED CIRCUITS & RECTIFIERS SEMICONDUCTORS & TRIACS

TRIACS

PRV	5 AMP	10A
100	.90	1.20
200	1.40	1.75
300	1.75	2.25
400	2.25	2.75
500	2.60	3.25

ER900 TRIGGER DIODES. These bidirectional trigger diodes are one of the best and cheapest methods to trigger SCR's and triacs 3/\$1.00

UNIUNCTIONS!

Similar to 2N2419. RBB of 5-7 stand off ratio of .6 and Ip of 12 with data sheet

SPECIAL \$1.00

ZENERS 750 Milliwatt 7-68V \$.40
10 Watt 7-180V \$.75

MOUNTING HARDWARE KITS.

These kits are used to mount our SCR's Zeners and Rectifiers etc. 6x32 stud (3, 12 amp rectifiers, 7A SCR's) 6 sets/\$1.00

1/4x28 stud (30 amp. rectifiers, 20 amps SCR's.) 4 sets/\$1.00

Send for our latest catalog featuring Transistors and Rectifiers; 325 Elm St., Cambridge, Mass.

2N1163 a TO-3 PNP GERMANIUM TRANSISTOR rated at 35v and a gain of 50 at 25 amps. \$1.75

N-CHANNEL FET'S TO-18 plastic units. low noise, low leakage, 25 volts source to gate. 50 ma gate current Gain to 9000 μ mo's. \$.80

NEON LIGHT OR NIXIE TUBE DRIVERS. An NPN, TO-18, SI Transistor. With a VCBO of 120 3/\$1.00

Silicon Power Rectifiers

PRV	3A	12A	30A
100	.09	.30	.50
200	.16	.50	.80
400	.20	.70	1.20
600	.30	1.00	1.50
800	.40	1.25	1.80
1000	.55	1.50	2.20

WE LEAD THE WAY IN SERVICE AND QUALITY!

Terms: FOB Cambridge, Mass. Send check or Money Order. Include Postage. Average Wt. per package 1/2 lb. No C.O.D.'s. Minimum Order \$3.00

Rated companies 30 days net

9030 8 BIT MEMORIES \$3.95

LINEAR CIRCUITS

CA 3011 FM IF AMPLIFIER \$.90
702C WIDE BAND DC AMPL. \$1.75
709C OPERATIONAL AMPL. \$1.75
710C HI SPEED DIFF. AMP. \$1.75
711C DUAL COMPARATOR \$1.75

DIGITAL RTL CIRCUITS

2-914 QUAD 2 input gate 1.25
900 Buffer \$.75
925 Dual 2 input gate expander \$.75
923 JK flip flop 1.00
2-923 Dual JK flip flop \$1.50

Controlled Avalanche or Epoxy Rectifiers 1 AMP.

PRV	
100	.07
200	.09
400	.12
600	.18
800	.22
1000	.35

Silicon Control Rectifiers

PRV	3A	7A	20A	70A
50	.35	.45	.70	
100	.50	.65	1.00	4.00
200	.70	.95	1.30	8.00
300	.90	1.25	1.70	
400	1.20	1.60	2.10	12.00
500	1.50	2.00	2.50	
600	1.80	2.40	3.00	16.00
700	2.20	2.80		

OLD TATE SALES

Post Office Box 74B

Somerville, Mass. 02143

Tel. (617) 547-4005

CIRCLE NO. 102 ON READER SERVICE CARD

UNUSUAL BARGAINS BY MAIL

SHOPPING MART

A selection of products available by mail for readers of **ELECTRONICS WORLD**. All merchandise sold on money-back guarantee. Order by No. Send check or M.O.

EXCELLENCE for XMAS GIFTS!



Super 6" Astronomical Reflector

Share the wonders of space exploration. Features: aluminumized & over-coated 6" f/8 ground and polished pyrex mirror accurate to 1/2 wave. 48 F.L. 4X achromatic finder scope. 48X, 90X, 102X eyepieces and Barlow to double or triple power. Rack & pinion focuser. Electric clock drive w manual slow-motion. Setting circles. Heavy-duty equatorial mount. Pedestal. Compare to \$295—\$350 models.
Stock No. 85.086AK \$239.50 FOB
4 1/2" REFLECTOR TELESCOPE
Stock No. 85.105AK \$94.50 FOB
3" REFLECTOR TELESCOPE
Stock No. 85.050AK \$29.95 Ppd.



Tune In and Turn On Your Own Psychedelic Light Show

Take one bookshelf sized conservative looking oiled walnut finished light box—with its built-in kicker, an indiv. controlled 3-channel color organ. Activate by attaching to hi-fi or stereo speaker. Plug in and switch on! Music fills the room and the prismatic screen leaps into pulsating life. Patterns are wild and wonderful, or soft and soothing—responding directly in time and intensity to music. Perfect home entertainment, little theater or combo. House current. (18"Wx12"Hx9"D)
Stock No. 80.126AK \$49.95 Ppd.



Long-Wave Black Light Fixture

Extremely versatile, compactly designed, long wave (3200-4000 angstroms) black light (ultraviolet) fixture. Has 8-watt, 110-V lamp with built-in filter—eliminates harmful shorter wave ultraviolet rays. Use to identify minerals, fungi, bacteria—check for surface flaws, oil and gas leakage—perfect for displays with fluorescent paper, paints, chalk, crayons, trace powder, etc. Adjustable aluminum reflector push-button switch, connecting plug. Mount vert., hor., or on corner. 10" L., 1 1/2" W., 1 1/2" H.
Stock No. 70.364AK \$12.00 Ppd.
REPLACEMENT BULB
Stock No. 60.124AK \$4.50 Ppd.



Psychedellic Lighting Handbook

100 information packed pages! Fully explains the latest in psychedellic lighting equipment, techniques, developments. Covers all facets of psychedellic light-show production including strobes, black lights, projectors, crystals, organic dyes, mirrors, color organs, polarized color, light boxes, MusicVision, etc. Shows how to "psychedellicize" parties, musical groups, shows, . . . or how to set up "electric trips" for your own private gatherings. 8 1/2" x 11" loose-leaf paper punched for 3 ring binder. . . . add new developments as they happen.
Stock No. 9100AK \$3.00 Ppd.



New \$99.50 Helium-Neon Laser!

Completely assembled, instant-starting w/three times power output of comparable models. Steady, ripple-free light of moderate (safe) power. Excellent collimation. Particularly useful for studies, experiments in holography, interferometry, diffraction, optical alignment. Simple and safe to use—just plug in, switch on. The 4 1/2" lb. unit reaches 75% power in 2 sec.; full power, typically 0.5 milliwatt (0.3 mW minimum) in 3 mins. Beam divergence only 2 milliradians (far ahead of competition); beam only 2 cm at 40 feet.
Stock No. 79.004AK \$99.50 Ppd.

GIANT FREE CATALOG

148 Pages—1000's of Bargains

Completely new 1970 edition. New items, categories, illustrations. Dozens of electrical and electromagnetic parts, accessories. Enormous selection of Astronomical Telescopes, Microscopes, Binoculars, Magnifiers, Magnets, Lenses, Prisms. Many war surplus items: or hobbyists, experimenters, workshop, factory. Mail coupon for catalog "AK"
EDMUND SCIENTIFIC CO.
300 EDSCORP BUILDING, BARRINGTON, N.J. 08007

NAME _____
ADDRESS _____
CITY _____
STATE _____ ZIP _____

ORDER BY STOCK NUMBER • SEND CHECK OR MONEY ORDER • MONEY-BACK GUARANTEE

EDMUND SCIENTIFIC CO. 300 EDSCORP BUILDING
BARRINGTON, NEW JERSEY 08007

CIRCLE NO. 136 ON READER SERVICE CARD

GREGORY ELECTRONICS

**An Extensive Selection of
General-Electric
Progress Line 2-Way
Mobile Equipment**

30-50 MHz Vibrator Power
14" Case Complete Access.
Fully narrow-band (Tx & Rx)
MA/E 13 6/12v, 30w **\$178.**

MA/E 16 6/12v, 60w **\$198.**

MD/Y 16N 6/12v, 60w **\$138.**

Dynamotor Power Supply **\$228.**

MT/16 12v, 60w **\$228.**

Transistor Power Supply **\$228.**

148-174 MHz Vibrator Power
14" Case Complete Access.
Fully narrow-band **\$198.**

MA/E 33 6/12v, 30w **\$198.**

MA/E 36 6/12v, 60w **\$228.**

Vibrator Power Supply **\$228.**

FA/E 33 6/12v, 30w **\$188.**

MT/33-6/12v, 30w **\$228.**

MT/36-6/12v, 60w **\$248.**

450-470 MHz 15w Vibrator
Power Supply MA/E 42,
with accessories **\$148.**

MT 42 12v, 15w **\$198.**

Transistor Power Supply **\$198.**

**450-470 MHz General-Electric
Progress Line Accents**

10 watts, 12 volts/transistor power supply; front or
rear mount. Complete accessories. Model No. EG48S

Wide Band\$168 Narrow Band..... \$188

EG 48CT (Trunk) EG 48CF (Front)

GE Progress Line Receiver Strips 25-50 MHz
Narrow Band \$45.....Wide Band \$35.

BRAND NEW

DUMONT M430RTN 450-470 MHz Special
50-watt transistor power supply meets latest
FCC narrow-banding specifications, 5 K.C.
deviations.

IN FACTORY-SEALED CARTONS **\$295.**

With tone added, minus reeds **\$345.**

MOTOROLA X43GGV Special!

In 10" case, 150-170 MHz, 30 watts with
accessories. Transmitter N.B., receiver W.B.
Transistorized receiver power supply and vi-
brator powered. 2 freq. transmitter. Receiver
only private line, single squelch, 2
freq. receiver. **\$158.**

Reconditioned & Used FM 2-Way Radio Equipment

We Buy Late Model Equipment for Cash
Send For '69 Catalog—



**GREGORY
ELECTRONICS
CORPORATION**

249 RT. 46, Saddle Brook, N.J. 07662
Phone: (201) 489-9000

CIRCLE NO. 129 ON READER SERVICE CARD

TUBES

TUBES—33¢ each. Year guarantee. Tuner Cleaner
\$1.00. Free catalog. Cornell, 4213-W Uni-
versity, San Diego, Calif. 92105.

**TUBES, SEMICONDUCTORS, ELECTRONIC
EQUIPMENT & COMPONENTS.** Quality mer-
chandise only! Serving engineers, Purchasing
Agents, TV/HiFi Servicemen and Hams for 20
years. Write for Catalog or call 212-WA 5-7000.
BARRY ELECTRONICS, 512 Broadway, New
York, N.Y. 10012.

**RECEIVING & INDUSTRIAL TUBES, TRANSIS-
TORS**, All Brands—Biggest Discounts. Techni-
cians, Hobbyists, Experimenters—Request **FREE**
Giant Catalog and **SAVE! ZALYTRON**, 469 Jer-
icho Turnpike, Mineola, N.Y. 11501.

RADIO & TV TUBES, old type radio and new
type miniatures and compactrons. Send for free
lists. Micro Electron Tube Co., Box 55, Paterson,
N.J. 07501.

TUBES—Lowest world prices. Foreign-American.
Obsolete, current. Receiving, Special Purpose,
Transmitting tubes. Send for tube and parts
catalog. United Radio Company, 56-E Ferry St.,
Newark, N.J. 07105.

HIGH FIDELITY

TRADE IN YOUR OLD CARTRIDGE: Send us
\$6.95 and we will ship **PREPAID** any one of the
following: ADC 220; Grado FTR; Pickering PAC/1;
Shure M3D. **LYLE CARTRIDGES**, 265 East 149th
St., Bronx, New York 10451.

FREE! Send for money saving stereo catalog
#E12W and lowest quotations on your indi-
vidual component, tape recorder or system re-
quirements. Electronic Values, Inc., 200 West
20th Street, N.Y., N.Y. 10011.

TRADE IN YOUR OLD CARTRIDGE: Send us
\$17.95 and we will ship **PREPAID** any one of the
following: ADC 660E; Empire 888E; Pickering
V15ATE-3; Pickering V15AME-3; Pickering XV15-
AT; Shure M55E; Shure M75E; Shure M92E;
Shure M93E; Stanton 500E. **LYLE CARTRIDGES**,
265 East 149th Street, Bronx, New York 10451.

HI-FI Components, Tape Recorders at guaran-
teed "We Will Not Be Undersold" prices. 15-day
money-back guarantee. Two-year warranty. No
Catalog. Quotations Free. Hi-Fidelity Center,
239 (L) East 149th Street, New York 10451.

DON'T THROW YOUR OLD CARTRIDGE AWAY.
Send us \$50.00 and any old used cartridge and
we will ship you via air **PREPAID** anywhere any
one of the following Top Stereo Cartridges:
Shure V-15 Type II, Empire 999VE, ADC 10EMK
II, Stanton 681EE. Write for lowest quotations
all stereo components. Send \$1.00 for our
discount catalog. **DEFA ELECTRONICS**, 2207
Broadway, New York, N.Y. 10024.

**HI-FI components, tape recorders, sleep learning
equipment, tapes.** Unusual Values. Free cata-
log. Dressner, 1523 R Jericho Turnpike, New
Hyde Park, N.Y. 11040.

TRADE IN YOUR OLD CARTRIDGE: Send us
\$10.95 and we will ship **PREPAID** any one of the
following: ADC 770; Empire 808, Grado FTE;
Pickering V15AC-3; Pickering V15AT-3; Shure
M7/N21D; Shure M44-5; Shure M44-7. **LYLE
CARTRIDGES**, 265 East 149th Street, Bronx,
New York 10451.

**HI-FI EQUIPMENT—GET Our "ROCK BOTTOM"
prices on NAME BRAND amplifiers—tuners—
tape-recorders — speakers FRANCHISED — 60
YEARS IN BUSINESS.** Write for this month's
specials—**NOW!** Rabson's 57th St., Inc., Dept.
569, 119 W. 57th St., New York, New York 10019.

DON'T THROW YOUR OLD CARTRIDGE AWAY.
Send us \$19.95 and any old cartridge. We will
ship **PREPAID** any one of the following top
rated elliptical diamond stereo cartridges **NEW:**
Shure M75E, M91E, M92E, Empire 888E, Pick-
ering V15AME3, XV15 ATE, ADC 660E, 550E.
Write for lowest quotations all stereo com-
ponents. Send \$1.00 for our discount catalog.
DEFA ELECTRONICS, 2207 Broadway, New
York, N.Y. 10024.

LOW, LOW quotes: all components and re-
corders. Hi-Fi, Roslyn, Penn. 19001.

TRADE IN YOUR OLD CARTRIDGE: Send us
\$39.95 and we will ship **PREPAID** any one of the
following: ADC 10EMKII; Empire 888VE; Pick-
ering XV750E; Stanton 681EE; Empire 999VE.
LYLE CARTRIDGES, 265 East 149th Street,
Bronx, New York 10451.

AMAZING DISCOUNTS on famous brand high
fidelity stereo components. No small wonder
that we have set new sales records each year
since 1959. Write: **Arkay Electronics**, 1028-02
Commonwealth, Boston, Mass. 02215.

TRADE IN YOUR OLD CARTRIDGE: Send us
\$13.95 and we will ship **PREPAID** any one of the
following: Empire 808E; Empire 888; Pickering
V15AM-3; Pickering V15ACE-3; Pickering V15AC;
Shure M31E; Shure M32E; Shure M44E; Shure
M75-6. **LYLE CARTRIDGES**, 265 East 149th
Street, Bronx, New York 10451.

HYPNOTISM

FREE Hypnotism, Self-Hypnosis, Sleep Learning.
Catalog! Drawer H400, Ruidoso, N.M. 88345.

HYPNOTIC Sleep Learning recordings produce
fabulous results. Details free. ASR Founda-
tion, Box 7021eg Henry Clay Station, Lexington,
Kentucky 40502.

GOVERNMENT SURPLUS

JEeps Typically From \$53.90 . . . Trucks From
\$78.40 . . . Boats, Typewriters, Airplanes, Multi-
meters, Oscilloscopes, Transceivers, Electronics
Equipment. Wide Variety, Condition, 100,000 Bid
Bargains Direct From Government Nationwide.
Complete Sales Directory and Surplus Catalog
\$1.00 (Deductible First \$10.00 Order). Surplus
Service, Box 820-K, Holland, Michigan 49423.

PERSONALS

MAKE FRIENDS WORLDWIDE through interna-
tional correspondence. Illustrated brochure free.
Hermes, Berlin 11, Germany.

SECRET LOANS BY MAIL. Borrow \$100 to \$1500
for any good reason in absolute privacy. No
interviews, no endorsers, no co-signers. Fast
service. Write Dial Finance Co., Dept. M-594,
410 Kilpatrick Bldg., Omaha, Nebraska 68102.

**PHOTOGRAPHY—FILM
EQUIPMENT, SERVICES**

SCIENCE Bargains—Request Free Giant Catalog
"CJ"—148 pages—Astronomical Telescopes, Mi-
croscopes, Lenses, Binoculars, Kits, Parts, War
Surplus bargains. Edmund Scientific Co., 300
Edscorp Bldg., Barrington, New Jersey 08007.

EMPLOYMENT INFORMATION

FOREIGN and USA job opportunities available
now. Construction, all trades. Earnings to
\$3,000.00 monthly. Paid overtime, travel,
bonuses. Write: Universal Employment, Wood-
bridge, Conn. 06525.

**EDUCATIONAL
OPPORTUNITIES**

LEARN ACCIDENT INVESTIGATION. Train at
home to earn \$750 to \$1,000 monthly. Car
furnished. Expenses paid, No selling. No college
needed. Full or spare time. Men urgently needed.
Free placement service. Write for **FREE** infor-
mation. No obligation. Universal Schools CZ-12,
6801 Hillcrest, Dallas, Texas 75205.

**LIBERTY PAYS MORE!
WILL BUY FOR CASH**

ALL TYPES:

- ★ **ELECTRON TUBES**
 - ★ **SEMICONDUCTORS**
 - ★ **TEST EQUIPMENT**
 - ★ **Military Electronic Equipment**
- WIRE—WRITE—PHONE COLLECT!**
We pay freight on all purchases—

**LIBERTY OFFERS MORE!
PRESTEL FIELD STRENGTH
METER**

(Model 6T4G)

Only

\$120.00

F.O.B.

New York

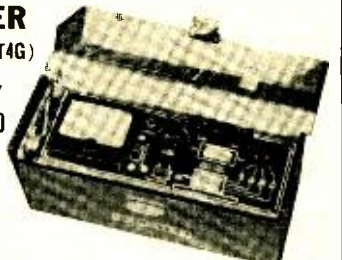

- ★ **Never Anything Like It!**
 - ★ **1-Man Can Do A Better Job than 3 in the Same Time!**
 - ★ **A Gold-Mine for Antenna Installers!**
- Calibrated from 40 to 230, and 470 to 860 in 4
Bands Megahertz, from 10 to 50,000 Microvolts.
Nothing makes it easier to properly and speedily find
the correct place to install TV, FM and Communica-
tion Antennas. You can measure and hear the signals
with this 4½ volt battery economically powered unit.

LIBERTY ELECTRONICS, Inc.
548 Broadway, New York, New York 10012
Phone (212) 925-6000

**CIRCLE NO. 122 ON READER SERVICE CARD
ELECTRONICS WORLD**

USED Correspondence Courses and Books sold and rented. Money back guarantee. Catalog free (Courses Bought). Lee Mountain, Pisgah, Alabama 35765.

LEARN WHILE ASLEEP, Hypnotize! Strange catalog free. Autosuggestion, Box 24-ZD, Olympia, Washington 98501.

INVENTIONS WANTED

INVENTORS! Receive free invention analysis at no risk to you. Send for FREE disclosure form today. New York Invention Service, Dept. 19, 160 Broadway, New York, N.Y. 10038.

PATENT Searches including maximum speed, full airmail report and closest patent copies, \$6.00. Quality searches expertly administered. Complete secrecy guaranteed. Free Invention Protection forms and "Patent Information." Write Dept. 23, Washington Patent Office Search Bureau, 711 14th Street, N.W., Washington, D.C. 20005.

INVENTORS! Sell your invention for cash or royalties! Our client manufacturers eagerly seek new items. Patented. Unpatented. Financial assistance if needed. 25 years proven performance. For free information, write Dept. 25, Gilbert Adams, Invention Broker, 80 Wall St., New York, N.Y. 10005.

MAGAZINES

BACK DATE MAGAZINES! Send needs. Midtown, Box 917-EW, Maywood, N.J. 07607.

BUSINESS OPPORTUNITIES

FREE CATALOGS. Repair air conditioning, refrigeration. Tools, supplies, full instructions. Doolin, 2016 Canton, Dallas, Texas 75201.

I MADE \$40,000.00 YEAR by mailorder! Helped others make money! Start with \$10.00—Free proof. Torrey, Box 318-N, Ypsilanti, Mich. 48197.

JAPANESE Electronics New Products Monthly! Specimen copy \$1, deductible. Dee, 10639-W Riverside, North Hollywood, Calif. 91602.

FREE BOOK "990 Successful Little-Known Businesses." Work home! Plymouth 345-P, Brooklyn, New York 11218.

MAKE BIG MONEY raising chinchillas, rabbits, guinea pigs for us. Catalog—25¢. Keeney Brothers, New Freedom, Pa. 17349.

DIAMONDS, tremendous investment use, get in the market, start small, \$10. Pyramids to \$1000's. Complete information and guide \$1.00. International Sales, P.O. Box 9073, Greensboro, N.C. 27408.

RECORDS

SPECIAL INTEREST RECORDS AVAILABLE, PRODUCED BY THE EDITORS OF THE WORLD'S LEADING SPECIAL INTEREST MAGAZINES. SEND FOR FREE CATALOG. RECORD CATALOG-EW, ZIFF-DAVIS PUBLISHING COMPANY, ONE PARK AVENUE, NEW YORK, N.Y. 10016.

POPULAR organ albums factory direct. Concert Recording, Lynwood, Calif. 90262.

OLDIES—45 RPM—original hits. Over 4000 available. Catalog 25¢. C & S Record Sales, Box 197, Wampsville, N.Y. 13163.

FREE RECORD CATALOG listing thousands of classical, opera, folk, jazz, popular, show, spoken, religious and language records. Mono & Stereo. Buy by mail and save from the largest, exclusive mail order record distributor in the world. Send name, address today to Dept. E, Chesterfield Music Shops, Inc., 12 Warren Street, New York, N.Y. 10017.

RUBBER STAMPS

RUBBER ADDRESS STAMP \$2.00. SIGNATURE \$3.50. FREE CATALOG. JACKSON, BOX 443-G, FRANKLIN PARK, ILL. 60131.

4-LINE office rubber stamp \$3.00. Ink pad \$1.00. Corr, 8014 Wentworth, Sunland, Calif. 91040.

MISCELLANEOUS

WINEMAKERS: Free illustrated catalog of yeasts, equipment. Semplex, Box 122-76, Minneapolis. Minn. 55412.

WORLD TIME 24 cities \$15.75. Calendar, Pendant \$17.50. Hilltop, P.O. Box 370, Syracuse, New York 13201.

December, 1969

DOUBLE BONUS

\$25

Radio, TV Parts Add 25¢ for handling

PLUS
CHOOSE ANY 1 ITEM FREE

BOTH "GIFTS" FREE
WITH \$10.00 ORDERS

709 OPERATIONAL AMPLIFIER \$179

709c

SALE ON FAIRCHILD COUNTING DIGITAL "ICs"

No.	similar	Description	3 For \$16
<input type="checkbox"/> 958	SN749CN	Decade Counter	\$5.95
<input type="checkbox"/> 959	SN7475N	Buffer-Memory	
<input type="checkbox"/> 960	SN7441N	Decoder-Driver	

SILICON RECTIFIERS

PIV	15A	2A
50	.06	.06
100	.07	.07
200	.09	.09
400	.12	.12
600	.16	.16
800	.21	.21
1000	.32	.32

1 AMP 1000 PIV 5 for \$1
 1 AMP 800 PIV 6 for \$1
 2 AMP 1000 PIV 4 for \$1

EPOXY SILICON TRANSISTORS

Type	Sale
2N2222	5 for \$1
2N2368	5 for \$1
2N2711	5 for \$1
2N2368	5 for \$1
2N3396	5 for \$1
2N3565	5 for \$1
2N3568	5 for \$1
2N3638	5 for \$1
2N3641-3	5 for \$1
2N3645	5 for \$1
2N3662	5 for \$1
2N3683	5 for \$1
2N3793	5 for \$1
2N4248	5 for \$1
2N4284-5	5 for \$1

INTEGRATED CIRCUITS

Guaranteed! With Spec. Sheets!

<input type="checkbox"/> 903	3 Input Gate NAND/NOR	\$1
<input type="checkbox"/> 904	Half Adder	
<input type="checkbox"/> 910*	Dual Two Input Gate	
<input type="checkbox"/> 915	Dual 3 Input Gate NAND/NOR	
<input type="checkbox"/> 923	JK Flip Flop	
<input type="checkbox"/> 925	Dual 2 Input Gate, Expander	
<input type="checkbox"/> 927	Quad Inverter	
<input type="checkbox"/> 930	Dual 4 Input Gate NAND/NOR	
<input type="checkbox"/> 932	4 Input NAND/NOR Buffer	
<input type="checkbox"/> 933	Dual Input Gate, Expander	
<input type="checkbox"/> 944	Dual 4 Input Power Gate	3
<input type="checkbox"/> 945	Clocked Flip-Flop	
<input type="checkbox"/> 946	Quad 2 Input Gate NAND/NOR	
<input type="checkbox"/> 952	Dual 2 Input Inverter Gate	for
<input type="checkbox"/> 953	2-2-3 Input and Gate	
<input type="checkbox"/> 954	Dual 4 Input and Gate	
<input type="checkbox"/> 955	8 Input and Gate w/2 outputs	\$2.57
<input type="checkbox"/> 961	Dual 4 Input Gate w/expand	
<input type="checkbox"/> 962	Triple Gate	

COUNTING DIGITAL CIRCUIT

8 Bit memory cell TO-5 case **288**

CIRCLE NO. 110 ON READER SERVICE CARD

RECTIFIERS & TRANSISTORS

Silicon Rectifiers

PIV	25	50	100	200	400	600	800	1000	1200
1A*	-.03	.04	.06	.08	.10	.14	.17	.22	.30
3A	.04	.05	.06	.08	.11	.15	.22	.30	.38
18A**	.09	.15	.19	.29	.39	.49	—	—	—
20A	.15	.20	.25	.39	.50	.75	.90	1.15	1.40
40A	.25	.35	.60	.90	1.20	1.50	1.80	2.10	2.40

*Tophat. Flangeless. **Pressfit. 3, 20, 40 Studs

Silicon Controlled Rectifiers

1500 PIV STUD	PRV	25	50	100	200	400	600
1 AMP	1A*	.08	.12	.18	.30	.55	.85
25¢ EA.	7A	.11	.14	.20	.45	.90	1.20
	18A**	.15	.23	.35	.60	1.10	1.40
	20A	.18	.32	.45	.70	1.15	1.95

*Tophat **Pressfit. 7 & 20 Amp Stud

Germanium Power Transistors

150W-TO-3-7A

2N456A—40V—.25 2N458A—80V—.45
2N457A—60V—.35 2N1021A—100V—.60
2N1038—40V—8/1.00—20/2.00—TO-5-3A

Silicon Power Transistors

2N 389A 85W, 60V—.55 2N1048A 40W 120V—.55
2N 424A 85W, 80V—.65 2N1718 10W 60V—.15
2N 497 4W, 60V—.10 2N1719 10W 100V—.20
2N 498 4W, 100V—.12 2N1724 50W 80V—.65
2N1047A 40W, 80V—.40 2N2151 30W 80V—.25

Silicon Small Signal NPN, TO-5

2N696 7/\$1.00, 2N697 6/\$1.00, 2N699 5/\$1.00
3N34 Tetrode—60¢; IN34A Diodes 100/\$2.25;
2N1142 Ger. Hi-Freq. Amplifier 4/\$1.00; Thermistor Beads, 5000 ohm or 1200 ohm—3/\$1.00; Varicaps—27, 47, or 100 pf, 4V—\$1.25 ea.; P.C. Board 8"x8"/1/16", 1 oz. Copper—2/98¢; Photo Cells, Herm. Glass, 5 Diff. for \$1.00; 2N1300 Series, TO-5 Assorted—25/\$1.00; I.C. Dual-in-Line—20/\$1.00; TO-5—15/\$1.00.

ASSORTMENTS

Precision resistors film	50/\$1.00
Precision resistors wirewound	40/\$1.00
Ceramic capacitors	70/\$1.00
Relays 6 different types	6/\$1.00
Terminal lugs, assorted	200/\$1.00
Tie lugs, assorted	50/\$1.00
Push button switches, on-off, panel	6/\$1.00
Pots, 2-4 watt, assorted	15/\$1.00

Free \$1.00 pack with \$10.00 order; min. order \$3.00; send sufficient postage, overage refunded; fully guaranteed; free catalog.

GENERAL SALES CO.

254 Main (713) 265-2369
Clute, Tex. 77531

CIRCLE NO. 131 ON READER SERVICE CARD

U.S. GOV'T ELECTRONIC SURPLUS

* Nationally Known—World Famous SURPLUS CENTER offers finest, most expensive, Government Surplus electronic units and components at a fraction of their original acquisition cost.

ORDER DIRECT FROM AD or WRITE FOR CATALOGS

COMPUTER TRANSISTORS ON HEAT SINKS

IBM Computer Quality Units

* (#22-928) — Unit consists of one 150-watt power transistor on heavy, ribbed, aluminum heat sink. Many experimental uses. (1 lb.)
Cost Gov't Over \$10.00 **\$1.99**

* (#22-915) — Unit consists of two 150-watt power transistors, 3 pots, several diodes, capacitors, resistors, etc. on heavy, ribbed aluminum heat sinks. Ideal for use as motor speed control. (4 lbs.)
Cost Gov't Over \$35.00 **\$4.91**

RUNNING TIME METER

* (#DX-104) — Use to record number of operating hours of electric lights and electrical devices such as refrigerators, furnaces, etc. Records total hours, tenths and hundredths up to 9,999.99 hours. For 115-volt, 60-cycles. Size 4 1/2" x 1 1/2" x 3/4". Shipping weight 2 lbs.
Cost Over \$29.00 **\$5.69**

12 and 24-VOLT TRANSFORMER

* (#15-920) — General Electric 115-volt, 60-cycle to 12 and 24-volts — 750-watts. Capacity 42-amps. — 24-volts, 64-amps. at 12-volts. Useful for battery chargers, running 110 motors, etc. 7" x 5" x 5". (18 lbs.)
Cost Gov't Over \$35.00 **\$16.72**

EXPANDED SCALE 0 - 15 DCVM

* (#21-900) — Brand new, expensive voltmeter reads 9.5 to 16-volts DC and 5 to 8-volts. Very useful for automotive and aircraft battery charge indicator, etc. 1 1/2" x 1 1/2" x 1 1/2". (3 lbs.)
List \$32.50 **\$12.95**

SURPLUS TELETYPEWRITERS

* (ITEM #22-936) — 1 used but excellent teletypewriter, model 15, complete with 1500-000. Includes 1500-000. Permits using teletypewriter over regular long distance connection. Complete with AC power supply, control telephone, etc. Wt. 168 lbs. Size 22" x 22" x 42".
Orig. Cost \$1500.00
\$249.50

* Also have limited number Model 19 Teletypewriter with perforator, Data-set, etc. Write for sale price.

SURPLUS CENTER

DEPT. EW-129 LINCOLN, NEBR. 68501

CIRCLE NO. 101 ON READER SERVICE CARD

www.americanradiohistory.com

97

LATEST ARCTURUS SPECIALS

- Color focus rectifiers, 14,000 P.I.V. at 1 MA, 99¢ each. 6.5 KV—79¢.
- Color TV yokes 70° & 90° types. Fit almost all sets: \$10.95 each.
- 1700 Transistor types—39¢ each.
- DS-501, 2N278 power transistor types. Cat. #349, 69¢ each.
- HEP170, Motorola HV/Current epoxy silicon rectifiers, 2.5 amps at 1,000 PIV, 49¢ each.
- Fully transistorized UHF tuners. Fit most sets. Cat. #UHF567, \$4.95 each.
- UHF tuners, 1 tube type. Fit most sets. Cat. #UHF3, \$3.95 each.

Complete listings of electronic items at similar bargain prices are available. Write for our latest catalog. Minimum order \$5.00, plus postage.

ARCTURUS ELECTRONICS CORP.

502-22nd St., Union City, N.J. 07087 Dept. EW
Phone 201 - UN4 5568

CIRCLE NO. 145 ON READER SERVICE CARD

TG-34A CODE KEYS

Self-contained automatic, reproduces code practice signals from paper tape, 5 to 25 WPM. Built-in speaker. Brand New, with tech. manual, takeup reel and AC line cord. \$29.50
Code practice tapes for above P.U.R.



BC-645 TRANSCEIVER

455 to 500 Mc. Easily adapted for 2 way voice or code on Ham, Mobile, Television Experimental and Citizens Bands. With tubes, less power supply in factory cartons. Brand new. \$16.95
SPECIAL PACKAGE OFFER: BC-645 Transceiver, dynamotor and all accessories, including mountings, UHF Antenna Assemblies, control box, complete set of connectors, plugs. BRAND NEW \$26.95

TG-5B TELEGRAPH SET for code communications. Bell call system, 1000-cycle howler, key, headpiece, call cards, books. Batteries not included. NEW \$8.95

SCR-274-N, ARC-5 COMMAND SET HQ!

Freq. Range	Type	Exc. Used	Like New	BRAND NEW
RECEIVERS, Complete with Tubes				
190-550 Kc.	BC-453	\$16.95	\$23.50	\$27.50
3-6 Mc.	BC-454	\$16.50	\$19.50	\$22.50
6-9.1 Mc.	BC-455	\$14.95	\$17.95	\$21.50
1.5-3 Mc.	R-25	—	\$19.50	\$21.50
TRANSMITTERS, Complete with Tubes				
4-5.3 Mc.	BC-457	\$ 6.95	\$ 8.95	\$11.95
5.3-7 Mc.	BC-458	\$ 6.95	\$ 8.95	\$12.95
7-9.1 Mc.	BC-459	\$17.95	\$19.50	\$23.50
2-1.3 Mc.	T-18	—	\$ 9.95	\$11.95
3-4 Mc.	T-19	—	\$12.50	\$16.95

AN/APR-4Y FM & AM RECEIVER "FB" FOR SATELLITE TRACKING!

High precision lab instrument, for monitoring and measuring frequency and relative signal strength, 38 to 4000 Mc. in 5 tuning ranges. For 110 V 60 cycle AC. Built-in power supply. Original circuit diagram included. Checked out, perfect. \$88.50
LIKE NEW

All Tuning Units Available for Above

EE-8 FIELD PHONE, checked out, with batteries, excellent used, each \$16.95

600-OHM HEADSET, beryllium units, chamois cushion, with cord & telephone plug, NEW \$3.49

NEW G & G CATALOG!

24 PAGES, crammed with Gov't Surplus Electronic Gear. Biggest Bargain Buys in America! It will pay you to SEND 25¢ for your copy—Refunded with First Order!

TERMS: Either 25% Deposit with order, balance C.O.D.—OR—Remittance in Full. Minimum Order, \$5.00. All shipments F.O.B. our warehouse, NYC. All merchandise subject to prior sale and price change.

G&G RADIO ELECTRONICS COMPANY

Tel.: (212) CO-7 4605

45 Warren St., 2nd Floor, New York, N.Y. 10007

ELECTRONICS WORLD DECEMBER 1969

ADVERTISERS INDEX

READER SERVICE NO.	ADVERTISER	PAGE NO.	READER SERVICE NO.	ADVERTISER	PAGE NO.
148	Alco Electronic Products	16	122	Liberty Electronics, Inc.	96
147	Allied Radio	16	121	Mallory & Co., Inc., P.R.	2
146	Altec Lansing	93	93	McGraw-Hill Book Co.	5
145	Arcturus Electronics	98	120	Methods Research	78
144	Audio Originals	86	119	Mosley Electronics, Inc.	76
143	B & K	85	92	Motorola Consumer Products	75
142	Bay Products, Inc.	4	118	Motorola Training Institute	79
150	Belden Corporation	SECOND COVER		Music Associated	92
141	Burstein-Applebee Co.	78		National Radio Institute	8, 9, 10, 11
	CREI, Home Study Division, McGraw-Hill Book Co.	80, 81, 82, 83		National Technical Institute	60, 61, 62, 63
139	Cleveland Institute of Electronics	70, 71, 72, 73	117	Olson Electronics	92
138	Cook's Institute of Electronics	64	116	Park Electronic Products	94
137	Delta Products, Inc.	14, 15	115	Pioneer Electronics	13
136	Edmund Scientific Co.	95	110	Poly Paks	97
135	Electronic Detection Corp.	74	109	Precision Electronics	67
114	Electro-Voice, Inc.	FOURTH COVER		RCA Institutes	18, 19, 20, 21
134	Fair Radio Sales	85	108	Radarr Devices Mfg. Corp.	25
133	GC Electronics (CALECTRO)	55	107	SCA Services Company	6
	G & G Radio Supply Co.	98	106	Sansui Electronic Co., Ltd.	67
132	Garrard	7	105	Schober Organ Corporation	79
131	General Sales Company	97	104	Sencore, Inc.	77
	Goodheart Company, Inc., R.E.	94	103	Shure Brothers, Inc.	65
130	Grantham School of Electronics	1	102	Solid State Sales	95
129	Gregory Electronics Corporation	96	101	Surplus Center	97
128	Heath Company	88, 89, 90, 91	100	Sylvania Electric	57
127	ICS	6	99	Sylvania Electric	26
126	International Crystal Mfg. Co., Inc.	17	98	Telex Communications Division	59
125	Judson Research & Mfg. Co., Inc.	66	149	Triplet Electrical Instrument Co.	THIRD COVER
124	Kenzac	66	97	United Audio Products	22
94	Lafayette Radio Electronics	58	96	University Sound	87
	Lampkin Laboratories, Inc.	76		Valparaiso Technical Institute	58
123	Leader Instruments Corp.	74	95	Weller Electric Company	69

CLASSIFIED ADVERTISING 94, 95, 96, 97



**Model 630-A
Laboratory V-O-M**

1. $\pm 1\frac{1}{2}\%$ DC, $\pm 3\%$ accuracy.
2. One selector switch minimizes chance of incorrect settings and burnouts.
3. Rugged $5\frac{1}{2}$ " suspension meter movement with $4\frac{1}{2}$ " mirrored scale. \$71 suggested USA user net price



**Model 630-APL
Laboratory V-O-M**

1. $\pm 1\frac{1}{2}\%$ DC, $\pm 3\%$ accuracy.
2. One selector switch minimizes chance of incorrect settings and burnouts. Polarity reversing for DC.
3. Suspension meter movement diode protected against instantaneous overloads. \$71 suggested USA user net price



**General Purpose V-O-M
Model 630-PL**

1. One selector switch minimizes chance of incorrect settings and burnouts. Polarity reversing for DC.
2. 4.4 Ohms center scale, 0.1 ohm to 100 megohms resistance.
3. Meter movement diode protected against instantaneous overloads. \$61 suggested USA user net price



**General Purpose V-O-M
Model 630**

1. One selector switch minimizes chance of incorrect settings and burnouts.
2. 4.4 Ohm center scale, reads from 0.1 ohm up to 100 megohms resistance in 4 ranges.
3. 20,000 ohms per volt DC sensitivity; 5,000 AC. \$61 suggested USA user net price

Laboratory or General Purpose Triplet meets the need precisely

Products of Triplet's long experience in the design and manufacture of high-quality, high-performance V-O-Ms, these representatives of the great Model 630 series offer the most-wanted features combined as perfectly as the skills of dedicated craftsmen can guarantee.

See your Triplet representative or distributor for a free demonstration of any or all of these versatile instruments.



MANUFACTURERS OF THE WORLD'S MOST COMPLETE LINE OF V-O-Ms

CIRCLE NO. 149 ON READER SERVICE CARD



SPANISH / Oak

CONTEMPORARY / Pecan

TRADITIONAL / Cherry

Unretouched photographs and the unvarnished truth about the new ARIES Console Speaker System.

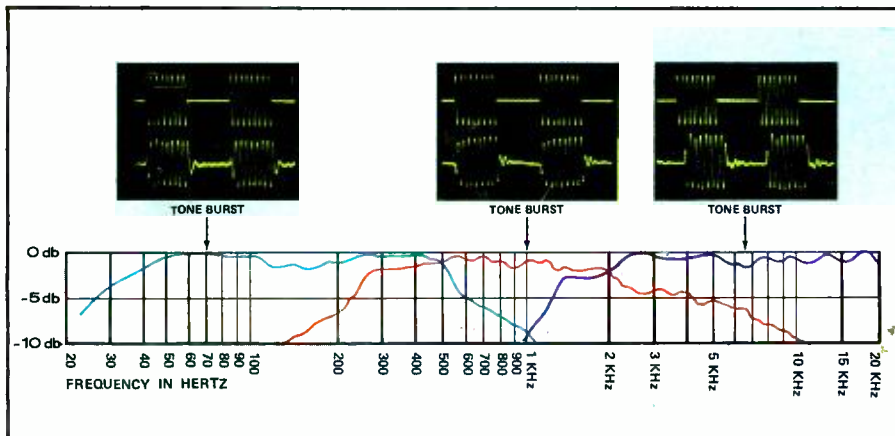

The Aries 2½" cone/dome tweeter is particularly unique. For instance, to obtain ultimate response, damping compound is metered onto the cone within a tolerance of ±0.001 oz. And control of cone/dome materials insures a radiation area that varies predictably with frequency to insure uniform dispersion at all frequencies.

Even the crossover network is unusual. Four inductors (iron-core type for the woofer to avoid losses), three capacitors (with a Mylar type for the tweeter to maintain response beyond the high frequency limitations of electrolytic types), and a 5-position rotary ceramic switch offers precise control with up to 10 db attenuation at 10 kHz.

But Aries is more than a distinguished music reproducer. It is also handsome furniture in its own right. Tasteful design and robust construction set Aries apart from the anonymous styles of the past. In every detail from the hidden 2" x 4" bracing to the authentic hardware and richly finished hardwood veneers, Aries can be an attractive addition to your home... a delight to ear and eye.

See and hear the new Aries at your E-V dealer's soon. Look... touch... and above all, listen. It can be an eye-opening experience. \$275.00.

ELECTRO-VOICE, INC., Dept. 1294N
629 Cecil Street, Buchanan, Michigan 49107

E-V If you are as serious about musical reproduction as we are, the following discussion may help you in choosing your next speaker system. And the actual response curves and tone burst tests may prove most revealing when compared with other speaker systems currently available.

Aries is an uncommon speaker system. Larger than the ubiquitous bookshelf speakers for a very sound reason: greater internal volume permits a worthwhile extension of bass with lower distortion and higher efficiency. Effective use of this volume comes from a 12" woofer with 9½ pound magnet structure, new sealed-foam

half-roll surround, and rigid deep-cone geometry. It's a combination that insures ¼" linear cone movement, precise transient response, and high power handling capacity without frequency doubling.

The mid-range was designed with equal care. A specially treated 6" cone speaker is mounted in its own sealed inner enclosure. Speaker resonance is well below the crossover point to insure peak-free response and clean transients in this sensitive part of the spectrum. Oscilloscope testing of every unit is routine so that laboratory standards are maintained in production.



For name of nearest dealer, call TOLL-FREE: (800) 243-0355
ANY HOUR, ANY DAY. In Connecticut call collect: 853-3600

FOR INFORMATION ON E-V PRODUCTS:

Microphones
CIRCLE NO. 111 ON READER SERVICE CARD
PA Speakers/Accessories
CIRCLE NO. 112 ON READER SERVICE CARD

Musician's speakers/microphones
CIRCLE NO. 113 ON READER SERVICE CARD
High Fidelity speakers/electronics
CIRCLE NO. 114 ON READER SERVICE CARD

www.americanradiohistory.com

Electro-Voice®

A SUBSIDIARY OF GULTON INDUSTRIES, INC.