

Electronics World

NOVEMBER, 1968
60 CENTS

ULTRASONICS FOR NON-DESTRUCTIVE TESTING
A FOUR-TUBE TV RECEIVER
JOB OPPORTUNITIES IN ELECTRO-OPTICS
SILVER CHLORIDE-MAGNESIUM: A POWERFUL BATTERY

SWEEP GENERATORS

For Laboratories
and Service Shops

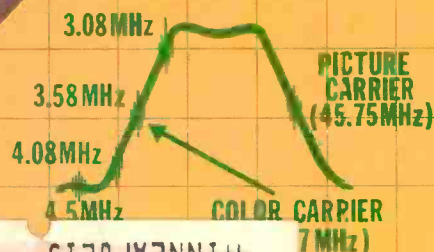
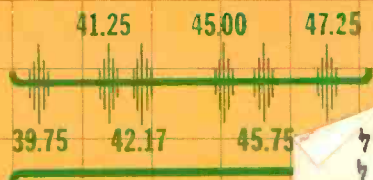
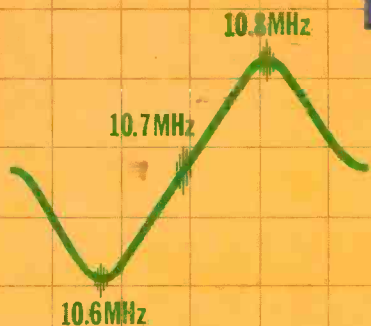
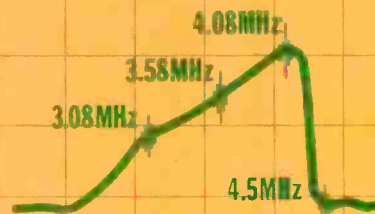

M0371 490684LNE108620K4L
K. J. LYNES
1088-22ND AV SE
MINNEAPOLIS MN 55414
4



The best TV deserves the best antenna!

Install a Zenith Quality-Engineered Antenna!

Model 973-94
designed for far fringe areas

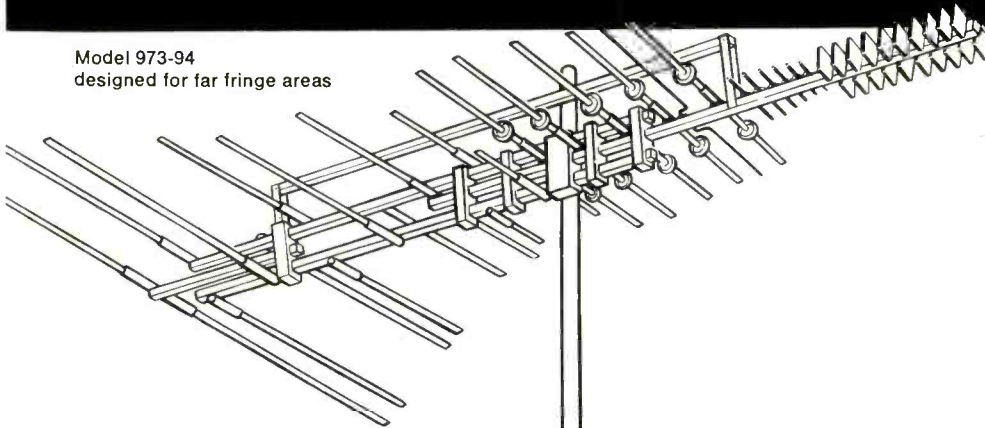

Exciting Surprises
for You—
and Your Family!
Fun for all!
Get the details
at your Zenith
Distributor's
Parts Department.

These features help a Zenith outdoor antenna provide the superior reception that makes for satisfied customers:

- Capacitor coupled cap-electronic VHF dipoles.
- Tapered UHF grid driver.
- Staggered square UHF directors.
- Low-impedance, triple boom construction.

You can choose from twelve all-new Zenith VHF/UHF/FM or VHF/FM antennas. All are gold color alodized aluminum for better conductivity, greater corrosion resistance and longer service.

Ask your Zenith distributor for a *free* technical manual. He has charted the reception characteristics of your area, so he can recommend the best antenna for each installation.



BEST YEAR YET TO SELL THE BEST

ZENITH

*The quality goes in before
the name goes on*

CIRCLE NO. 76 ON READER SERVICE CARD

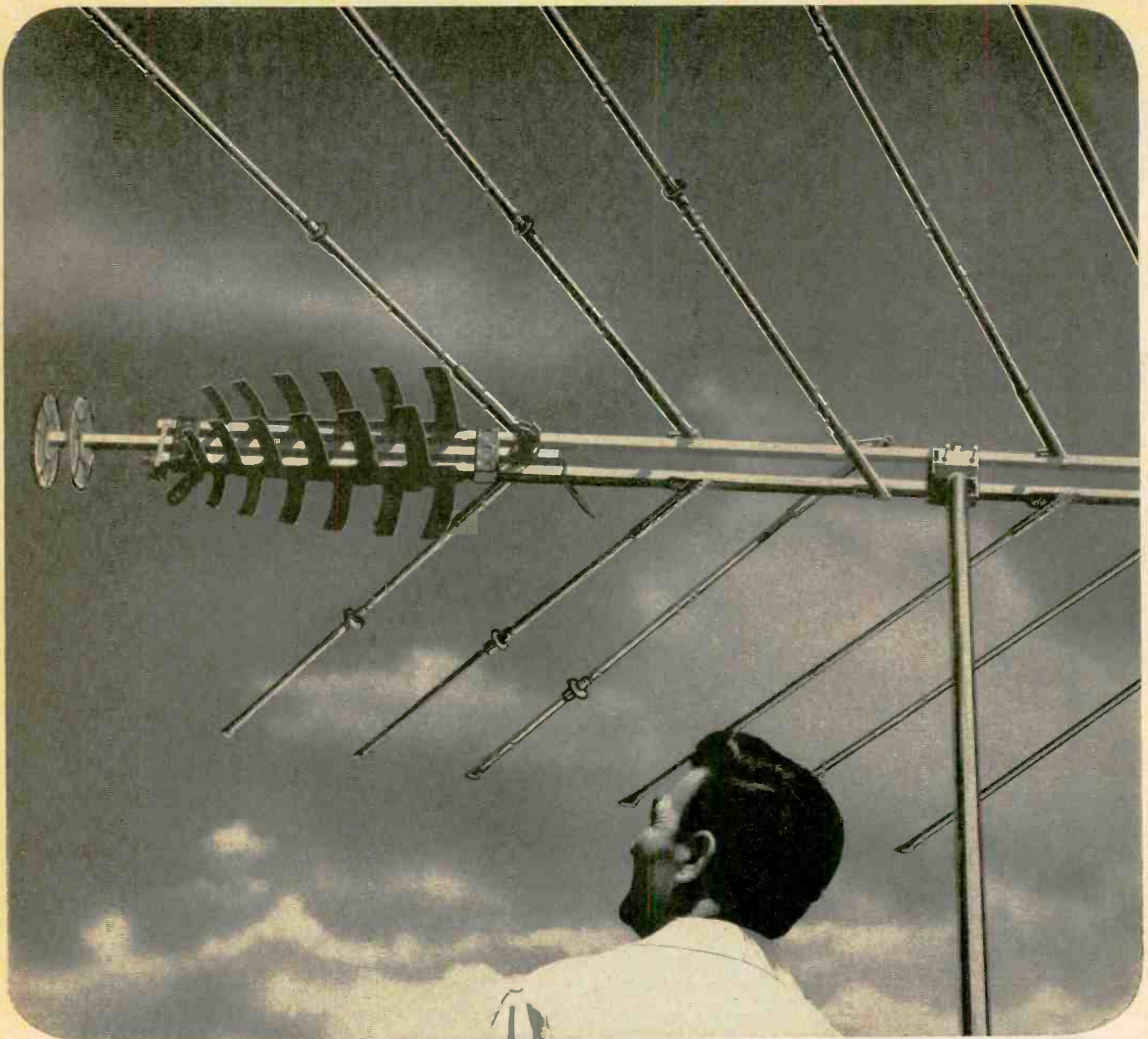

Professional installers count on antenna gain not the numbers game.

If you count elements when you buy antennas, you might be shortchanging yourself and short-circuiting your customer's reception. It's *performance* that counts.

And that's where JFD Color Laser and Log Periodic antennas outclass all other all-channel antennas. Only patented JFD capacitor-coupled perform *double duty* — respond on the fundamental *and* harmonic modes. Actually *multiply* gain and signal-to-noise ratios over larger multi-element

(*but less efficient*) antennas.

That's why professional installers who count on antenna *gain* (not the numbers game) prefer JFD Color Lasers and LPV Log Periodics. Call your JFD distributor and prove it on your next installation.

Did you know that JFD now markets a great new line of solid state Snow-Plow and Program Center amplifier-distribution systems? Ask your distributor!

FROM JFD — ORIGINATORS OF THE ANTENNA THAT REVOLUTIONIZED RECEPTION

JFD® Color Laser and LPV Log Periodic TV antennas.

JFD ELECTRONICS CO.

15 Avenue at 62 Street, Brooklyn, N.Y. 11219

JFD International, 64-14 Woodside Ave., Woodside, N.Y. 11377 JFD Canada, Ltd., Ontario, Canada

JFD de Venezuela, S.A., Avenida Los Haticos 125-97, Maracaibo, Venezuela

LICENSED UNDER ONE OR MORE OF U.S. PATENTS 2,958,031; 2,985,879; 3,011,168; 3,108,280; 3,150,378; 3,210,767, RE. 25,240 AND ADDITIONAL PATENTS PENDING IN U.S.A. AND CANADA. PRODUCED BY JFD ELECTRONICS CO. UNDER LICENSE FROM THE UNIVERSITY OF ILLINOIS FOUNDATION. LICENSED UNDER ONE OR MORE OF U.S. PATENTS 2,955,287 AND 3,075,821 AND ADDITIONAL PATENTS PENDING.

CIRCLE NO. 77 ON READER SERVICE CARD

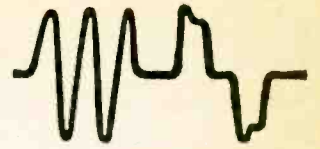

"Trading up" resistors prevents call-backs

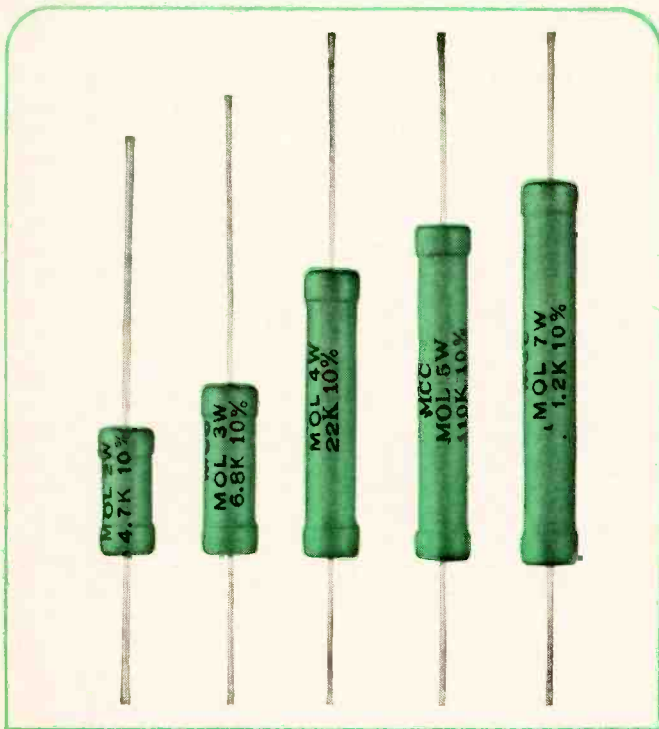

Color television sets contain some potential trouble spots for fixed resistors. Sudden overloads or short-outs of a tube, diode or transistor, or leakage in a by-pass capacitor may cause enough current surge in a carbon resistor to cause it to open or to suddenly increase in value. You wind up with a strange set of symptoms that take a lot of point-to-point testing to unscramble.

EXAMPLE: Suppose a tube or capacitor shorts out. This may cause excessive current drain on the power supply which may affect a resistor in the bleeder network. This resistor may increase in value which would then reduce voltage in subsequent circuits. When this happens, a number of controls must be re-adjusted. By replacing the resistor with a Mallory MOL, the set is brought back to normal operation and the MOL construction virtually precludes this type of difficulty happening in the future.

Granted, resistors don't fail as often as other components. But when it happens, you can take out a simple insurance policy against call-backs by replacing faulty carbon resistors with Mallory MOL's. For just a few pennies more, you're putting a world of extra life and stability in a critical part of the circuit.

In a nutshell, MOL's are metal oxide film resistors with stability comparable to wire-wounds, but far lower in cost. They can stand brief overloads of several times rated wattage without damage. Humidity and vibration don't bother them. They're non-inductive up to 250 mc, so you can use them in rf and if sections without a worry. As for stability, we've run them on load cycle tests up to 10,000 hours and resistance values hold steady within 1%! No wonder every major TV manufacturer is using them.

MOL resistors are usually a bit larger than carbon types, so you may have to bend a few leads to fit them in. They come in 2, 3, 4, 5 and 7 watt sizes (which is more than you'll need in most carbon resistor replacements), in resistance values up to 500K.

Your Mallory distributor stocks MOL's in the values you'll need. And he has an up-to-date cross-reference list which shows you the Mallory part numbers to specify for popular TV sets, by manufacturer and chassis number. See him, or write to Mallory Distributor Products Company, a division of P. R. Mallory & Co. Inc., Indianapolis, Indiana 46206.

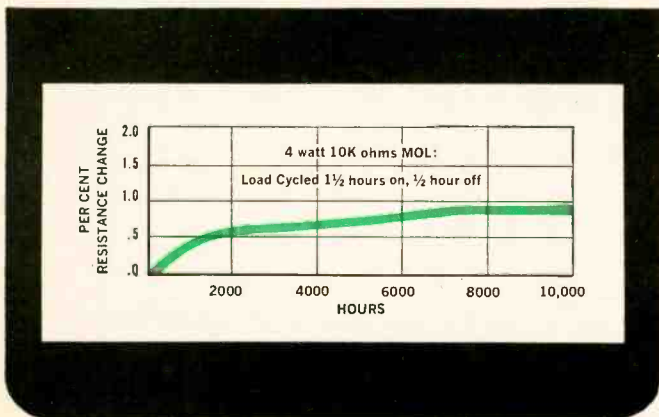

Typical stability test data: 10,000-hour load cycling test. Average resistance change is less than 1%!

DON'T FORGET TO ASK 'EM—*What else needs fixing?*

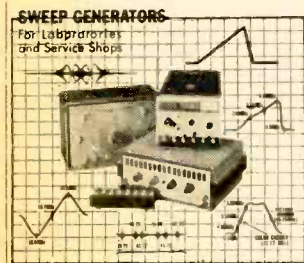

THIS MONTH'S COVER ties in with two articles in this month's issue on sweep generators: "Sweep Generators for TV Service" and "Microwave Sweep Oscillators for the Laboratory." Two of the instruments shown are mainly designed for radio and TV servicing. These are the RCA WR-69A television/FM sweep generator (at the left) and the Heath IG-57 post-marker/sweep generator (center foreground). The small unit at the front is an outboard attenuator for the Heath generator. Atop this instrument is the Hewlett-Packard 8601A generator-sweeper designed for laboratory use. The waveforms in the background are either used in or produced by this type of equipment. They include some typical TV and FM receiver response curves. Photo by Harry Schlack.



Publisher
PHILLIP T. HEFFERNAN

Editor
WM. A. STOCKLIN

Technical Editor
MILTON S. SNITZER

Associate Editors
W. J. EVANZIA
P. B. HOEFER

Contributing Editors
WALTER H. BUCHSBAUM
Prof. ARTHUR H. SEIDMAN
FOREST H. BELT

Art Editor
EUGENE F. LANDINO

Art and Drafting
J. A. GOLANEK

Advertising Manager
JOSEPH E. HALLORAN

Advertising Service Manager
ARDYS C. MORAN

Associate Publisher
LARRY SPORN

November, 1968

Electronics World

NOVEMBER 1968 VOL. 80, No. 5

CONTENTS

- 25 Ultrasonics for Non-Destructive Testing** *Fred G. Weighart*
Without producing harmful radiation, ultrasonics is used to detect flaws in metal parts, find defective railroad rails, airplane wings, and submarine hulls, and in many other important and novel testing applications.
- 29 Reflective Liquid-Crystal Displays** *Al Pinsky*
These electronically changeable displays get brighter with ambient light. Will they lead to flat-screen on-the-wall television picture displays?
- 30 Recent Developments in Electronics**
- 32 A Four-Tube TV Receiver** *R. J. Walker & W. R. Seader*
This set, although not on the market, shows what can be done with just four compactron tubes plus rectifier, tuner, and picture tube.
- 35 New World of Electro-Optics** *Louis Arpino*
- 38 Instant Replay** *J. Peter Kane*
Television viewers can take that important "second look" at sporting events with the aid of this high-speed magnetic disc recorder used by broadcasters.
- 40 Sweep Generators for TV Service** *Dale E. Baldrige*
- 43 Volkswagen's Electronic Fuel-Injection System** *Fred W. Holder*
- 46 Silver Chloride—Magnesium: A Powerful Battery** *Howard J. Strauss*
- 49 Microwave Sweep Oscillators for the Laboratory** *David L. Widman*
- 67 Radar Plotter**
- 68 Transistor Beta vs Source Resistance** *Rufus P. Turner*
- 80 Hi-Fi Show Seminars Program**
- 84 New V.H.F./FM Marine Rules** *Richard Humphrey*

- 22 EW Lab Tested**
Sansui Model 2000 AM-FM Stereo Receiver
Bose 901 Speaker System
- 55 Five Doors to an Electronics Future** *John Frye*
- 62 Test Equipment Product Report**
B & K Model 1450 Oscilloscope
Darcy Model 460 Digital Frequency Meter
Bicron Model 100 Square-Wave Generator

MONTHLY FEATURES

- 4 Coming Next Month**
- 5 Radio & Television News**
- 13 Reflections on the News**
- 16 Letters from Our Readers**
- 82 Book Reviews**
- 86 New Products & Literature**

Electronics World: Published monthly by Ziff-Davis Publishing Company at 307 North Michigan Ave., Chicago, Illinois 60601. One year subscription \$8.00. Second Class Postage paid at Chicago, Illinois and at additional mailing offices. Subscription service and Forms 3579: Portland Place, Boulder, Colorado 80302. Copyright © 1968 by Ziff-Davis Publishing Company. All rights reserved.

Important E & E Books

The VHF Amateur



by Robert M. Brown, K2ZSQ/W9HBF. A completely updated handbook packed with data on vital vhf subjects not available elsewhere. The author formerly published the famous VHF Magazine whose back issues are much in demand.

This new handbook incorporates the finest vhf material from the former publication, plus new data of great interest to both old and new vhf men. 160 pages.

Order EE-65060, only \$4.50

Amateur Radio Incentive Licensing Study Guide



by Robert M. Brown, K2ZSQ/W9HBF, and Tom Kneitel, K2AES. Fully explains the new incentive licensing which affects both newcomers and old-timers. Covers all the new FCC

Regulations and band allocations. Includes multiple-choice questions and answers (as close to actual FCC exams as possible) covering the new Advanced-Class, and the modified requirements for the Extra-Class exams. Also includes sample exams for Novice, Technician, Conditional, and General-Class licensing. 160 pages. Order EE-050, only \$2.75

Commercial Radiotelephone License Q&A Study Guide

by Woodrow Smith and Robert Welborn. An invaluable aid in preparing for the exams for the various grades of radiotelephone license or permit. Questions cover the first four elements of the radiotelephone license exam. Answers are comprehensive and detailed and relevant to the pertinent subjects of the exam. 272 pages. Order EE-031, only \$6.95

Single Sideband: Theory & Practice

by Harry D. Hooton, W6TYH. The one-source reference guide to ssb. Covers the origin and principles of ssb, derivation of ssb signals, carrier suppression techniques, sideband selection, ssb equipment, tests and measurements. Order EE-350, only \$6.95

17TH EDITION OF THE FAMOUS

Radio Handbook

Tells how to design, build, and operate the latest types of amateur transmitters, receivers, transceivers, and amplifiers. Provides extensive, simplified theory on practically every phase of radio. Broadest coverage; all original data, up-to-date, complete. 848 pages. Order EE-167, only \$12.95

Order from your electronic parts distributor or send coupon below.

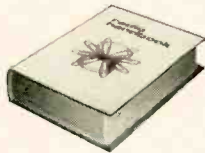

EDITORS and ENGINEERS

P.O. Box 68003, New Augusta, Ind. 46268, Dept. EWE-118

Send me the following books:

EE-65060 EE-031 EE-350
 EE-050 EE-167

Name _____

Address _____

City _____ State _____ Zip _____

CIRCLE NO. 110 ON READER SERVICE CARD

COMING NEXT MONTH

SPECIAL FEATURE ARTICLE:

HI/FI STEREO RECEIVERS

Is there a receiver on your Christmas list? If so, you'll want to check Hirsch-Houck's Lab Tests on some of the new stereo receivers to find the one best suited to your needs. Models from Allied, Altec, Bogen, Eico, Electro-Voice, Fisher, Harman-Kardon, Heath, Kenwood, Lafayette, Sansui, Scott, Sherwood, and University are included.



FREQUENCY DIVIDERS & COUNTERS

Inexpensive, readily available IC's can be used in frequency dividing and counting applications. In this first article of a two-part series, Donald L. Steinhach of Lockheed explains the basics of IC logic elements and their use.

TROUBLESHOOTING FET CIRCUITS

In voltmeters, audio preamps, and in FM and TV front-ends, the field-effect transistor is appearing with greater frequency. Here is how to service equipment using these FET's.

LASER DIODES

This so-called "third laser source" has joined crystals and gases to provide a small, rugged, and simple laser of limited power output. It is especially suited for use in a portable, low-cost laser communications and ranging device.

DIFFERENTIAL TRANSFORMERS

A high-precision electromechanical transducer that is finding wide acceptance in industrial instrumentation, telemetry, and inertial guidance systems is given an in-depth treatment by Sidney Silver.

All these and many more interesting and informative articles will be yours in the December issue of ELECTRONICS WORLD . . . on sale November 19th.

ZIFF-DAVIS PUBLISHING COMPANY

William B. Ziff, Chairman of the Board (1946-1953)

William Ziff
President

W. Bradford Briggs
Executive Vice President

Hershel B. Sarbin
Senior Vice President

Philip Sine
Financial Vice President

Walter S. Mills, Jr.
Vice President, Circulation

Stanley R. Greenfield
Vice President, Marketing

Phillip T. Heffernan
Vice President, Electronics Division

Frank Pomerantz
Vice President, Creative Services

Arthur W. Butzow
Vice President, Production

Edward D. Muhlfeld
Vice President, Aviation Division

Irwin Robinson
Vice President, Travel Division

Furman Hebb
Administrative Vice President

George Morrissey
Vice President

Sydney H. Rogers
Vice President

Editorial and Executive Offices
One Park Avenue
New York, New York 10016 212 679-7200

NEW YORK OFFICE 212 679-7200
Joseph E. Halloran

MIDWESTERN OFFICE
307 North Michigan Avenue
Chicago, Illinois 60601 312 726-0892
Midwestern Advertising Manager, Robert J. Ur

WESTERN OFFICE
9025 Wilshire Boulevard
Beverly Hills, California 90211
213 CRestview 4-0265; BRadshaw 2-1161
Western Advertising Manager, Bud Dean

JAPAN: James Yagi Ishikawa Mansion,
#4, Sakuragaoka Shibuya-ku, Tokyo 462-2911-3

CIRCULATION OFFICE
Portland Place, Boulder, Colorado 80302



Member
Audit Bureau of
Circulations

Radio & TV News • Radio News • Radio-Electronic Engineering Trademarks Reg. U.S. Pat. Off.
SUBSCRIPTION SERVICE: Forms 3579 and all subscription correspondence should be addressed to Electronics World, Circulation Department, Portland Place, Boulder, Colorado 80302. Please allow at least six weeks for change of address. Include your old address, as well as new—enclosing if possible an address label from a recent issue.
EDITORIAL CONTRIBUTIONS must be accompanied by return postage and will be handled with reasonable care; however publisher assumes no responsibility for return or safety of art work, photographs, or manuscripts.
ELECTRONICS WORLD (November, 1968, Vol. 80, No. 5). Published monthly at 307 North Michigan Avenue, Chicago, Illinois 60601, by Ziff-Davis Publishing Company—also the publishers of Airline Management and Marketing, Boating, Business & Commercial Aviation, Car and Driver, Cycle, Flying, Stereo Review, Modern Bride, Popular Electronics, Popular Photography, Skiing, Skiing Area News, and Skiing Trade News. (Travel Weekly is published by Robinson Publications, Inc., a subsidiary of Ziff-Davis Publishing Company.) One year subscription rate for U.S., U.S. Possessions, and Canada, \$6.00; all other countries, \$7.00. Second Class postage paid at Chicago, Illinois and at additional mailing offices. Authorized as second class mail by the Post Office Department, Ottawa, Canada and for Payment of postage in cash.

Radio & Television news

By FOREST H. BELT /Contributing Editor

Combating Green-Face Syndrome

Color-TV viewers still complain about having to adjust the hue control so much whenever they change stations. Even more annoying, they say, are off-color faces in commercials. The trouble, of course, is color-phase differences in the color signal. The root cause has been the subject of hot disagreement for a dozen years or more. Some in the industry—particularly certain broadcasters—refuse even to admit there was a problem.

There is a problem. At last, however, it is being attacked. An *ad-hoc* committee has been put together by the Joint Committee on Inter-Society Coordination. The committee contains broadcast and set-manufacturing people, and representatives of industry associations: Electronic Industries Association, Institute of Electrical and Electronic Engineers, National Association of Broadcasters, National Cable Television Association, and Society of Motion Picture and Television Engineers. The Federal Communications Commission also has someone attending the committee's meetings.

No one knows yet where the finger will point, or even that there is any one specific cause. With our own observations from both the broadcasting and receiving side of the picture, we suspect several corrective measures will be taken. Improvements will be suggested for color film, for signal analysis and adjustment in color cameras, for transmitter measurement and adjustment, and for receiver circuits. One thing is sure: the problem is no longer being ignored. If the meetings don't turn into mere accusation sessions, they may eventually spell an end to this color-viewer annoyance.

Already Being Done

The above problem is already attracted some suggested cures. A Japanese camera company, *Minolta*, has developed and is producing a TV color analyzer that it claims allows precise adjustment of hue. Full details aren't yet available, although at least one of the instruments is slated for use in this country.

An approach that helps the color-TV viewer is used by WAVE-TV, channel 3 in Louisville, Ky. At some station-break intervals, engineers inject signals from a color-bar generator, with a voice announcement and printed labels to identify each color in the sequence. Once the viewer sets the color and hue controls according to the pattern, programs from WAVE-TV remain true in color. That doesn't help when the viewer changes channels, though.

Another approach is suggested by *International Nuclear Corp.* of Nashville, Tenn. Its Model TPC-2 Burst-Phase Corrector lets color-station engineers adjust color-burst phase right at the transmitter. If all cameras and film chains are kept within the 4-degree limit of phase differential that can be seen by the eye, station output can be kept phase-correct. The way to assure constant phase among stations in a locality is to pick one as standard and let engineers of the others use something like a burst-phase corrector to make their own signals coincide.

Trouble About Faulty Sets

We reported last month that there is trouble brewing over color-TV sets arriving at dealers' stores faulty. Other reports tell of defective sets ranging from 10% of them dead on arrival to as many as 25% otherwise faulty. Almost simultaneously came reports that "now" there were very few problems with faulty TV receivers. More word has it that hi-fi dealers complain that 20% of new hi-fi components they receive are faulty.

An informal survey suggests there really is an annoying rash of consumer-electronics products that arrive from the factory (or distributor) operating not at all or not well. This includes black-and-white and color-TV, radios, stereo equipment (especially in the low- and medium-price range), and auto receivers. Dealers who don't complain of dead-on-arrival problems do say there are too many in-warranty failures.

What do they do about them? Fix them, usually. Sending them back or getting factory service is too much trouble. They grumble, but they go ahead and fix the sets—often getting nothing for their trouble. With profit margins steadily declining, service dealers are concerned with manufacturing quality.

The answer? We don't have one, but there are several possibilities: Better quality control; adequate payment for the time spent putting new sets back in order, without so much red tape to collect payment;

better manufacturer-to-dealer-and-back communications; wider field representation, to assure each dealer quick help with such sets. A little of all of these would certainly improve the feelings of dealers we've talked to.

Shortage of B-W TV's?

We've heard that from some TV manufacturers. It reminds us of the time there was so much talk of a color-TV shortage—blamed on every imaginable cause.

There was no shortage of color sets—only of certain models. That's the case this year with black-and-white sets. Some price-leader models will be in short supply up through the Christmas selling season, but not all brands. Most manufacturers will have plenty of sets to supply any reasonable demand. From all indications, about the same number of b-w sets will be sold this year as were sold last year; sales all year have been nearly parallel. It would be a shame if a "run" were to create a shortage in some lines, only to end up as surplus inventories in dealers' showrooms.

Everybody Wants into the Act

Hottest thing right now in the home-entertainment field is the tape cassette. Fidelity is improving, say the chief proponents, and a prerecorded stereo cassette is imminent. Any hot product attracts new outlets; new to the cassette field this fall are jewelry dealers. A lot of them took on tiny portable radios years ago; a few have even been selling TV portables. Now it's cassettes.

Several factors about cassettes and cassette players are attractive. One is low price; another is small size; still another is ease of use. All three make the cassette a fast-moving mass product. It's only a matter of time—weeks, probably, but months at most—until department and discount stores everywhere will stock the players and almost every record counter will sprout its cassette rack.

Another Step Toward 3-D Color-TV

Every few weeks, something brings this big development in home entertainment a step closer. *Toshiba*, familiar as a maker of TV sets, has devised special lasers that can make colored images. Argon and krypton are the gases used, and the lasers have already been shown to produce bright three-dimensional holographic images in color. Another quality that makes these new lasers more likely usable for 3-D color-TV or motion pictures in their long life; most lasers wear out so quickly they're impractical even to consider.

How Much is a Technician Worth?

There's a lot of talk among service-shop owners about charges and salaries. At a recent gathering of technicians and shop owners from all over the country, I posed two questions to many of them. The first: How much money should a one-man service-shop operator be able to earn for himself? The second: How much should a top-notch service technician earn, before taxes, with no management duties such as a shop owner has?

None of these men knew I asked anyone else, nor did they have any chance to compare answers. To a man, they said a technician who has his own one-man shop should pay himself \$15,000 a year. All but two said \$12,000 was what a skilled technician should be paid; those two said \$10,000. (We agreed that a skilled technician is one who can do any kind of TV bench work—black-and-white or color, tube or transistor—and who is also skilled enough at consumer relations to be entrusted with outside calls.)

Flashes in the Big Picture

Eliminating some mechanical parts of Japanese record players are new photoelectric cartridges; some use IC's in phono head, too. . . . One TV shop in California recently raised price of service call to \$17.50; same charge for b-w or color; includes trip and first half-hour in home; reports no drop-off in business. . . . New color-TV to come from *Zenith* will use modules to simplify servicing; concept will be similar to that in *Motorola's* all transistor model. . . . Another market for independent servicing goes down drain as one Midwest retail chain sets up own service center; will handle hospitals, motels, hotels, as well as its own retail customers. . . . New solid-state all-channel TV tuner from *Standard-Kollsman* has no moving parts; uses switching diodes and varactor tuning diode. . . . *RCA* also makes tuner history with all-transistor v.h.f. tuner using MOSFET r.f. amplifier; MOSFET is dual-gate 3583. . . . FCC finally give in to land mobile radio services; proposes to let them have u.h.f. channels 14-20 in major metropolitan areas, except if TV station is already operating on channel. ▲

F.C.C. COMMERCIAL OPERATOR LICENSE

Training

is part of the Grantham

A. S. E. E.

DEGREE CURRICULUM

In today's world of electronics employment, an FCC license is important — sometimes essential — but it's not enough! Without further education, you can't make it to the top. Get your FCC license without fail, but don't stop there. To prepare for the best jobs, continue your electronics education and get your Associate Degree in Electronics.

This is good common sense for those who want to make more money in electronics. It also makes sense to prepare for your FCC license with the School that gives degree credit for your license training — and with the School that can then take you from the FCC license level to the Degree level.

The first two semesters of the Grantham degree curriculum prepare you for the first class FCC license and radar endorsement. These two semesters, in addition to other parts of the Grantham

This booklet
FREE!

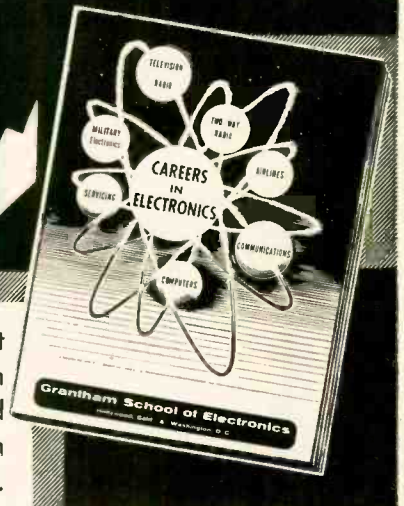

This free booklet explains what an FCC license and ASEE degree can do for your future.

degree curriculum, are available by correspondence* at very reasonable tuition. *The ASEE Degree can be earned by correspondence with a minimum of one semester in residence.*

Accreditation, and G.I. Bill Approval

Grantham School of Electronics is *accredited* by the Accrediting Commission of the National Home Study Council, and is *approved* for both correspondence and resident training under the G.I. Bill. Mail the coupon, or simply write or telephone for your free copy of our Associate Degree Bulletin which gives complete details of our educational program.



GRANTHAM School of Electronics



*Semesters 1, 2, and 3 of the Grantham electronics curriculum are available *also in resident classes* at our Washington, D.C. school — at the address shown below.

• Established in 1951 •

Grantham School of Electronics

1505 N. Western Ave. or 818 18th Street, N.W.
Hollywood, Calif. 90027 Washington, D.C. 20006
Telephone: Telephone:
(213) 469-7878 (202) 298-7460

Grantham School of Electronics EW-11-68
1505 N. Western Ave., Hollywood, Calif. 90027

Please mail me your free catalog, which explains how Grantham training can prepare me for my FCC License and Associate Degree in electronics. I understand no salesman will call.

Name _____ Age _____
Address _____
City _____ State _____ Zip _____



GET A FASTER START IN THE COURSE YOU CHOOSE WITH NRI'S REMARKABLE ACHIEVEMENT KIT

When you enroll with NRI we deliver to your door everything you need to make a significant start in the Electronics field of your choice. This remarkable, new starter kit is worth many times the small down payment required to start your training. And it is only the start . . . only the first example of NRI's unique ability to apply 50 years of home-study experience to the challenges of this Electronics Age. Start your training this exciting, rewarding way. No other school has anything like it. What do you get? The NRI Achievement Kit includes: your first set of easy-to-understand "bite-size" texts; a rich, vinyl desk folder to hold your training material in orderly fashion; the valuable NRI Radio-TV Electronics Dictionary; important reference texts; classroom tools like pencils, a ball-point pen, an engineer's ruler; special printed sheets for your lesson answers—even a supply of pre-addressed envelopes and your first postage stamp.

Learning electronics at home is faster, easier, more interesting with new achievement kit

Only NRI offers you this pioneering method of "3 Dimensional" home-study training in Electronics, TV-Radio . . . a remarkable teaching idea unlike anything you have ever encountered. Founded more than half a century ago—in the days of wireless—NRI pioneered the "learn-by-doing" method of home-study. Today, NRI is the oldest, largest home-study Electronics school. The NRI staff of more than 150 dedicated people has made course material entertaining and easy to grasp. NRI has simplified, organized and dramatized subject matter so that any ambitious man—regardless of his education—can effectively learn the Electronics course of his choice.

DISCOVER THE EXCITEMENT OF NRI TRAINING

Whatever your reason for wanting knowledge of Electronics, you'll find the NRI "3 Dimensional" method makes learning exciting, fast. You build, test, experiment, explore. Investigate NRI training plans, find out about the NRI Achievement Kit. Fill in and mail the postage-free card. No salesman will call. NATIONAL RADIO INSTITUTE, Electronics Division, Washington, D. C. 20016



ELECTRONICS COMES ALIVE AS YOU LEARN BY DOING WITH CUSTOM TRAINING EQUIPMENT

Nothing is as effective as learning by doing. That's why NRI puts so much emphasis on equipment, and why NRI invites comparison with equipment offered by any other school, at any price. NRI pioneered and perfected the use of special training kits to aid learning at home. You get your hands on actual parts like resistors, capacitors, tubes, condensers, wire, transistors and diodes. You build, experiment, explore, discover. You start right out building your own professional vacuum tube voltmeter with which you learn to measure voltage and current. You learn how to mount and solder parts, how to read schematic diagrams. Then, you progress to other experimental equipment until you ultimately build a TV set, an actual transmitter or a functioning computer unit (depending on the course you select). It's the practical, easy way to learn at home—the priceless “third dimension” in NRI's exclusive Electronic TV-Radio training method.

SIMPLIFIED, WELL-ILLUSTRATED “BITE-SIZE” LESSON TEXTS PROGRAM YOUR TRAINING

Lesson texts are a necessary part of training, but only a part. NRI's “bite-size” texts are as simplified, direct and well-illustrated as half a century of teaching experience can make them. The amount of material in each text, the length and design, is precisely right for home-study. NRI texts are programmed with NRI training kits to make things you read come alive. As you learn, you'll experience all the excitement of original discovery. Texts and equipment vary with the course. Choose from major training programs in TV-Radio Servicing, Industrial Electronics and Complete Communications. Or select one of seven special courses to meet specific needs. Check the courses of most interest to you on the postage-free card and mail it today for your free catalog.

Available Under
**NEW
GI BILL**

If you served since
January 31, 1955, or
are in service, check GI
line in postage-free card.

custom training kits “bite-size” texts

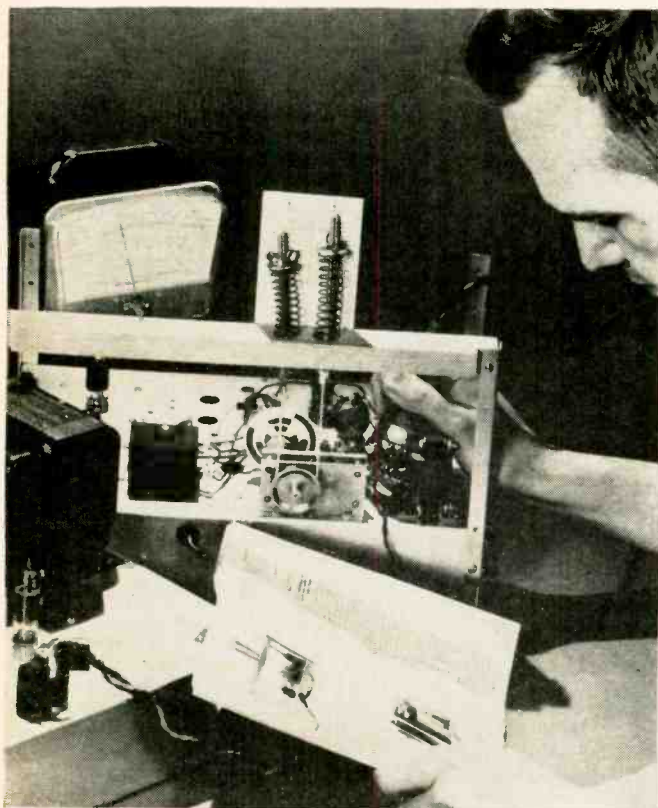

Scott's new LR-88 receiver takes the



out of kit building

Building a kit used to be something you couldn't do with ladies and children present, but Scott's new LR-88 AM/FM stereo receiver kit has changed all that. First, there's the instruction manual. In clear and simple language, it leads you, step-by-step, through every stage of the assembly process. And each stage is illustrated . . . full-size, full-color. Next, there's Scott's ingenious new Kit-Pak®. The parts for each assembly stage are in individual compartments, keyed to the instructions. All wires are color-coded, and pre-cut and pre-stripped to the proper sizes. Difficult or critical sections are pre-wired, pre-aligned, pre-tested, and factory-mounted on printed circuit boards. Is soldering your bugaboo? Scott has provided push-on solderless connectors for the hard-to-get-at spots.

About thirty painless hours after you've started, you've completed one great receiver. The LR-88 is the 100-Watt kit brother to Scott's finest factory-wired beauties. It includes the famous Scott silverplated Field Effect Transistor front end, Integrated Circuit IF strip, all-silicon output circuitry . . . in fact, all the goodies that would cost you over a hundred dollars more if Scott did all the assembling. Performance? Just check the specs below . . . and you'll be amazed at how great a receiver sounds after you've built it yourself. Treat yourself to a weekend of fun and years of enjoyment . . . see the Scott LR-88 at your dealer's today.

LR-88 Control Features: Dual Bass and Treble; Loudness; Balance; Volume compensation; Tape monitor; Mono/stereo control; Noise filter; Interstation muting; Dual speaker switches; Stereo microphone inputs; Front panel headphone output; Input selector; Signal strength meter; Zero-center meter; Stereo threshold control; Remote speaker mono/stereo control; Tuning control; Stereo indicator light.

LR-88 Specifications: Music Power rating (IHF), 100 Watts @ 4 Ohms; Usable sensitivity, 2.0 μ V; Harmonic distortion, 0.6%; Frequency response, 15-25,000 Hz \pm 1.5 dB; Cross modulation rejection, 80 dB; Selectivity, 45 dB; Capture ratio, 2.5 dB; Signal/noise ratio, 65 dB; Price, \$334.95.

CIRCLE NO. 85 ON READER SERVICE CARD

You'll swear by it



SCOTT®

Write for complete information on the new Scott components and kits.

H.H. Scott, Inc., Dept. 160-11,
Maynard, Mass. 01754

Export: Scott International,
P.O. Box 277, Maynard, Mass. 01754

Walnut case optional extra © 1968, H.H. Scott, Inc.

Reflections on the **news**

Electronics Engineers and Technicians . . .

graduating from college or finishing technical school would do well to investigate the computer industry as a source of employment. The shortage of trained computer designers and programmers is so acute that companies have taken to "stealing" personnel from one another by offering higher salaries and better fringe benefits. Computer designers and analysts are among the best paid workers in the electronics industry.

Over the past few years, the demand for computers, peripheral equipment, supplies, and services has been increasing at a rate of more than 30 percent a year. In 1967, computer sales climbed above the \$9-billion mark. Today, there are more than 40,000 computers in operation and these require the services of more than 100,000 analysts and 300,000 programmers.

Yet, this is only the beginning. The number of computers is expected to double within the next few years. Many new companies are using them to help solve clerical and manufacturing problems. The computer "time-sharing" market—where many companies utilize the services of a single computer—is also growing at a rapid pace. Sales in this area are expected to reach \$1.6 billion by 1972.

Some important computer manufacturers are: *International Business Machines Corp.*, *Control Data Corp.*, *Univac Division of Remington Rand Corp.*, *Computer Sciences Corp.*, *International Telephone and Telegraph*, *Burroughs Corp.*, and *Honeywell Inc.*

Unless Telephones . . .

and other ancillary equipment were made or supplied by the *Bell System*, their use with telephone-company-installed lines was frowned upon and subjected to heavy tariffs. In what appears to be a reversal of previous policy, *The American Telephone and Telegraph Company* recently petitioned the Federal Communications Commission for a change in tariff regulations that would allow more customer-provided equipment to be connected to the telephone network.

For some time, numerous electronics companies which manufacture equipment specifically for use with existing telephone facilities have charged harassment by *AT&T* representatives. One company, *Carter Electronics Corp.*, figured prominently in the FCC decision. They manufacture a device called the Carterphone. It's an interfacing device which enables a home telephone to be used with a mobile radio-telephone system. According to an *AT&T* spokesman, the telephone company still gets in the act. All such equipment—Carterphones, data phones, computer modems, etc.—have to go through a telephone-company-supplied protective apparatus for which there is a "use" charge. Essentially, this fusing device is a filter-limiter which controls the bandwidth and the amplitude (voltage) of the signal going into the phone lines.

Incidentally, owners of decorator-type (antique) phones must still purchase working parts from the telephone company. Although ready-to-use antique phone sets are available on the open market, their use with telephone company lines is illegal.

Television . . .

took first prize at this year's Olympic games in Mexico City. It took an army of over 32,000 technicians to broadcast the Twenty-Ninth Summer Olympics to more than 100 million viewers around the world. Live coverage in color reached Japan, Eastern and Western Europe, and the entire United States. And, for the first time in the history of the games, the citizens of most of the countries which had sent athletes were able to see them compete on their home TV sets.

Here are a few of the statistics. There were 12 color cameras, which required the services of over 100 cameramen, 10 commentators, and 10 interpreters to provide the world-wide coverage. Foreign TV coverage was arranged through *Telesistema Mexicano, S.A.*, a private television organization which controls three of Mexico City's television stations.

Collision Avoidance . . .

is probably one of the commercial airlines' chief worry, next to air traffic control. For the past several years the Air Transport Association (ATA) which represents the major U.S. airlines has been

studying the problem. Recently, a 12-man team of experts and specialists from six of the association's members selected the *Martin Marietta Corp.* of Baltimore to conduct a \$1.3-million joint airline-industry flight test and evaluation program of collision avoidance system (CAS) devices. CAS devices are designed to detect potential collision threats and either automatically change an airplane's course or instruct the pilot what evasive maneuvers to make and when. CAS devices built by *Bendix Avionics*, *Collins Radio Co.*, *McDonnell-Douglas Co.*, and a system developed by *Sierra Research* and *Wilcox Electric Co.* will be tested.

Whatever the decision of the evaluating group, much cooperation will be needed from the private flying sector if any CAS system is to be successful. General Aviation tends to oppose developments growing out of airline-sponsored programs. However, one look at the air accident rate involving light aircraft (see *ELECTRONICS WORLD*, September, 1968 issue, page 16) should be enough to convince the most stubborn pilot that a CAS system is needed.

Washington's Rapid Transit . . .

system will use so many electronic devices that several aerospace and electronics firms, *Westinghouse*, *General Electric*, *IBM*, and *Litton*, to name a few, are already eyeing possible profits which could result from fat electronic equipment contracts.

Eventually, the rapid transit system, operated by the Metropolitan Area Transit Authority, will cover 97 miles in Washington and in Maryland and Virginia suburbs. There will be 44.8 miles of subway and 52.4 miles of surface and elevated road-beds. The first six-mile segment is scheduled for operation by early in 1972.

One of the first big contracts to be let will be for train control and communications, including the control center communications network. It's being designed by *Gibbs and Hill* and bidding is due to begin in January. If reports are correct, this portion of the system alone will cost more than \$20-million. Other communications, computer, and security contracts will follow. Washington's transit system will capitalize on experience gained by San Francisco's Bay Area Rapid Transit (BART) system, and incorporate a number of improvements. Trains will be automatically controlled (operator override) and doors opened automatically.

The Invasion of Czechoslovakia . . .

by the USSR may serve to heat up the "cold war" and limit proposed budget cuts, particularly in any area directly or indirectly connected with national defense. In fact, Congress and the President may have to do an about face and revise upward the fiscal 1970 budget now being prepared in the Capitol. This, of course, could mean more dollars for defense electronics production and possibly the restoration of some research and development projects. Expect increased activity in behind-the-scenes pushing for strategic weapons such as the advanced manned strategic aircraft. Other air and ground defense systems such as the SAM-D anti-aircraft system, the VFX airplane, and electronic surveillance and warning systems will be pushed hard.

Some Thoughts . . .

about things going on. . . . The Interstate Commerce Commission's ruling suspending selected railroad freight increases should save electronics manufacturers about \$21 million annually in freight costs. . . . The "history of the ocean floor" may be revealed by scientists working on Project Gofar (Global Geological and Geophysical Ocean Floor Analysis and Research). Oceanographers aboard the U.S.N.S. *Jane* are conducting field and laboratory investigations in an attempt to understand the ocean floor's geological processes and their relationship. Computers are being used to draw a profile of the ocean floor and analyze magnetic signatures, echo soundings, seismic reflections, and refractions, as well as topographical data. . . . Commercial communications capability across the Atlantic was expanded with the launching of the first 1200-circuit Intelsat III (International Telecommunications Satellite Consortium) satellite by the *Communications Satellite Corp. (Comsat)*. Four satellites were already in orbit providing communications service across the Atlantic and Pacific Oceans. . . . The importance of electronics in education was highlighted at the Fourth Annual Conference and Exposition on Education and Training in New York this year. Such topics as training managers in computer technology, the systems approach in training, and the use of television and video tape, figured prominently in discussions on new teacher-training methods and instructional tools. . . . Airlines still looking for a reliable anti-highjacking device. A system developed by a subsidiary of *Lockheed Aircraft Corp.* is being studied. It is designed to detect concealed weapons on a person or in luggage without the need for a physical search. ▲

Shocked? Don't be. Does this man *look* like a criminal?

He's not. This man is in the business of *preventing* crime. (One of the fastest growing industries today.) He's a Radar Sentry Alarm dealer representative.

What could this possibly mean to you? Perhaps nothing. On the other hand, it could change your entire life.

As a Radar representative, you could make \$1,200 a month if you sold only one system each week. Most of our dealers make much more. Two sales a week would net you \$28,000 a year; five a week, \$46,000 a year.

We make the finest solid state microwave burglar alarm system available; one that's easy to install and easy to service...for both home & business.

We're presently expanding our organization of dealer representatives. We'll train you, provide you with leads and offer continuing counsel. You can operate full-time or part-time. Later, you may want to expand and organize your own sales staff.

But for now, let's get better acquainted. Fill out the coupon. In a few days, you'll receive complete details about how you can live a life of crime-and make it pay, *handsomely*.



Radar Sentry Alarm. The Crimebuster.

RADAR DEVICES MFG. CORP.
22003 Harper Ave., St. Clair Shores, Michigan 48080
Rush me RSA Distributor Info.
I understand there is no obligation.

EW-11

Name _____
Address _____
City _____ State _____ Zip _____

Live a life of crime, honestly.



One of a series of brief discussions
by Electro-Voice engineers

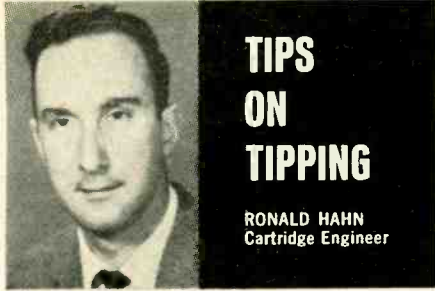

There is no room in today's small, light, stereo ceramic cartridges for sloppy tolerances or poor assembly. And as the design trend continues toward even smaller models, the need for improved uniformity and tighter tolerances increases.

Of course, entirely new designs often will give the desired improvements in performance and uniformity. More often, however, the greatest progress can be seen in improvements of existing products by the application of new techniques and methods.

Such is the case with a popular 2-element plug-in stereo cartridge now being produced by Electro-Voice. Even with the highest standards of manufacture and assembly, it became clear that improvements were necessary to optimize performance and reduce rejects. A study revealed that the primary problem centered about the proper orientation of the two ceramic elements with respect to the needle cap and the cartridge shell.

The original design called for a plastic molded needle cap, to be cemented to the elements using conventional cartridge assembly techniques. Despite great care in assembly, however, the desired level of uniformity could not be satisfactorily maintained in production. Another approach was needed.

At this point, a new assembly technique was developed. The two ceramic elements are introduced directly into the cavity of the mold used to produce the plastic needle cap. Location of the elements is precise, and the additive effect of cumulative tolerances needed for cementing the separate parts is eliminated. An excellent bond between the elements and the needle cap is achieved, using normal thermoplastic materials in standard plastics molding equipment.

The mold itself is unique only in that it includes a removable holder for the elements, precisely machined to locate two close-tolerance ceramic elements so that the tips of the elements extend a specific distance into the mold cavity, and at a specified angular relationship.

The benefits of this new technique have been dramatic. Rejects have dropped to 1/3 their former level, and a larger percentage of completed cartridges fall close to the design center when tested for both mechanical and electrical specifications. Improvements have been noted in more uniform lateral tip location, reduced tip lean, and more uniform needle set-down on turnover models. The improved angular orientation and more uniform parallelism of the elements has increased isolation of stereo signals, lowered distortion, and lessened differences in channel level. The net result has been a significant improvement in performance for the consumer without an increase in the cost of production.

For reprints of other discussions in this series,
or technical data on any E-V product, write:
ELECTRO-VOICE, INC., Dept. 1183N
629 Cecil St., Buchanan, Michigan 49107



CIRCLE NO. 108 ON READER SERVICE CARD
16

LETTERS FROM OUR READERS

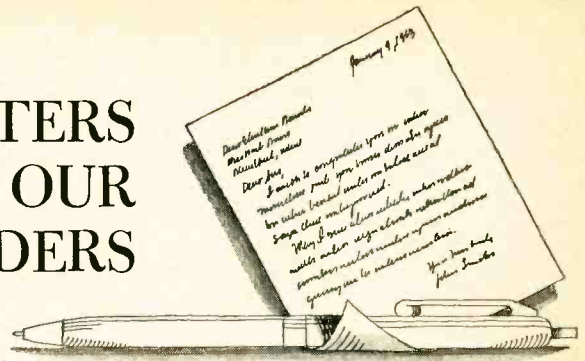

THE WORST IS BEST

To the Editors:

Like everywhere else, and in many other magazines, there is a steady deterioration in correct speech, and certainly in written prose. The example, this time (and there have been many others) is to be found in the May, 1968 issue, page 6, paragraph 2 . . . "the worst generator of color-TV x-rays is the high-voltage regulator tube . . ."

If this tube were the "worst generator" then its emission of x-rays would be very low. Surely, the writer meant "the best generator of color-TV x-rays . . ."

I have read your magazine for many, many years, and have always enjoyed at least two articles each month, and have tried to understand the rest, by reading several times over. In fact, I should think I must be one of the best-read medical men around where electronics is concerned.

HUGH A. L. WAGNER
Kuala Lumpur, Malaysia

Perhaps we should have said "the generator of the worst or most x-rays is the high-voltage regulator tube." In any case, we are sure that our meaning was clear, and, after all, that's the purpose of written communications, isn't it?—
Editors

* * *

THE CO-OP ENGINEER

To the Editors:

The article "The Co-op Engineer" by Greenwald and Seidman in your August issue is noteworthy and may justify some additional comments.

The writer assisted in establishing the second cooperative engineering program at Marquette University, Milwaukee, Wis., in 1919. The first, as the authors state, was established by Dean Schneider at the University of Cincinnati in 1906.

Theoretically, co-op engineering is ideal for the "hardware" engineer, one who is immersed largely in the manufacture, application, and maintenance of equipment for the production of goods and services. This statement is based on the assumption that engineers destined for research and development, creative design, and the more rarified theoretical aspects of engineering,

should be given the benefit of disciplines beyond those available in the co-op and traditional courses. And, it may be questioned, are these primarily engineers or scientists?

Theoretically, co-op type of training could be ideal. Practically, however, this kind of training, as it has been applied and administered, leaves much to be desired. Unfortunately, the tendency is to let the co-op phase degenerate into a job, whose value is largely the monetary reward. Jobs are, in the main, administered by the employer whose all-too-human tendency is to use the student engineer to the company's advantage—not to that of the student. During his co-op years, if the student could get acquainted with the "nuts and bolts" phase of engineering intensification, fewer engineers would emerge as hardware illiterates.

Only close coordination between school and industry, with dedicated surveillance by the school insisting on a program of work, not a job to embrace the widest possible roster of experience, will make this program successful. Students are frequently given drafting or laboratory nit-picking to do, rather than engineering. Let students get acquainted with the "hardware" of engineering and they will emerge better, not only for remunerative work on the production levels, but also on the higher, design levels.

HORACE FROMMELT, President
Frommelt Assoc.
Louisville, Ky.

Dear Mr. Frommelt:

It is true that the majority of co-op employers are engaged in industry where the end product is a piece of hardware; thus, the students' exposure is oriented toward the production aspects of engineering. An ever-increasing number of employers, however, are involved with research and development where the end product is generally a published document, or a state-of-the-art hardware design. Students employed in such R&D organizations have the opportunity to exhibit creativity and on occasion they have authored papers and have patented designs.

We are in total agreement with your

ELECTRONICS WORLD

comment that the student is not always being trained as an engineer and that some employers utilize students for various non-engineering job assignments. Small co-op programs, such as at Pratt, have greater control over co-op assignments because of frequent contact with students, employers, and faculty. Furthermore, a minimum academic standing is required to insure top-quality students. Employers who cannot provide challenging assignments are usually terminated from the program.

S. GREENWALD, A. SEIDMAN
Pratt Institute
Brooklyn, N. Y.

* * *

CERTIFIED ELECTRONIC TECHNICIANS

An item in your May issue, in the "Radio & Television News" column, described the Certified Electronic Technician program instituted by the National Electronic Associations.

It's a pleasure to let you know that we have had well over 100 inquiries from technicians and dealers in many states. Of particular interest to you should be some applications we received from outside the States; two from Canada, one from an electronics firm in Argentina, one from a technician in Brazil, and three from members of the Armed Forces. One of these servicemen has even taken the test in far-off Saigon.

DICK GLASS, President
National Electronic Associations
Indianapolis, Ind.

For further details, our readers should contact Dick Glass directly at 5302 W. 10th St., Indianapolis, Ind. 46224.—Editors

* * *

STATISTICAL TECHNIQUES

To the Editors:

We read with pleasure and interest the article by Sidney Silver in your June, 1968 issue entitled "Electronic Measurements Using Statistical Techniques." We feel the author did an excellent job in explaining this complex subject in non-mathematical terms that can be understood by the average engineer and technician.

Since we manufacture equipment which will perform many of the measurements described in the article, we would like to obtain your permission to reprint it for distribution to our customers.

JOHN M. VAN BEUREN, President
Quan-Tech Laboratories, Inc.
Whippany, N. J.

Several manufacturers of this type of equipment have complimented us on this story. We are, of course, pleased to grant permission to reprint the article—Editors ▲

November, 1968

POWER PLAY.

50 watts of it. That's the power handling capacity of Altec's latest bookshelf speaker. And that's just the beginning of the power play you get. For example, the LF speaker is powered by a massive 10-lb. magnetic structure. (No other speaker this size can boast such strength. Except the Bolero. And that's made by Altec, too.) The high frequency end includes a compression-driven horn of cast aluminum. The sound is clear and brilliant over the entire range: from 45-18,000 Hz. It's all yours in an attractively-styled cabinet of hand-rubbed walnut with snap-on grille. Ask for the Madera (style 892A) at your Altec dealer's. Just \$149.50. Or ask us for your free Hi-Fi catalog.



A Division of LTV Ling Altec, Inc., 1515 So. Manchester Ave., Anaheim, Calif. 92803

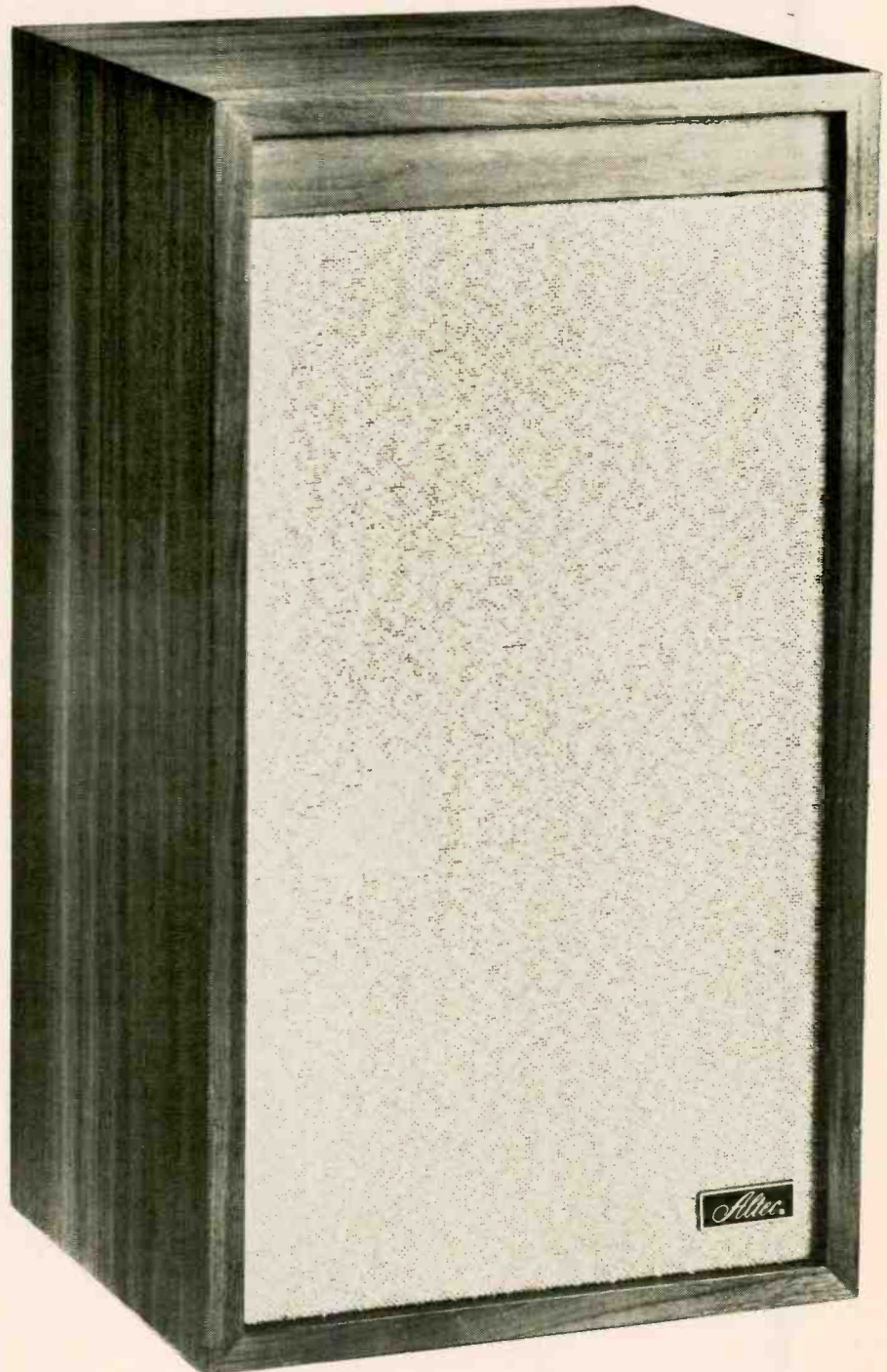

Visit Altec Lansing at Booth 315 at the San Francisco Hi Fi Show at the Civic Auditorium October 31-November 3.
CIRCLE NO. 123 ON READERS SERVICE CARD

**“He’s a good worker.
I’d promote him
right now if he had
more education
in electronics.”**

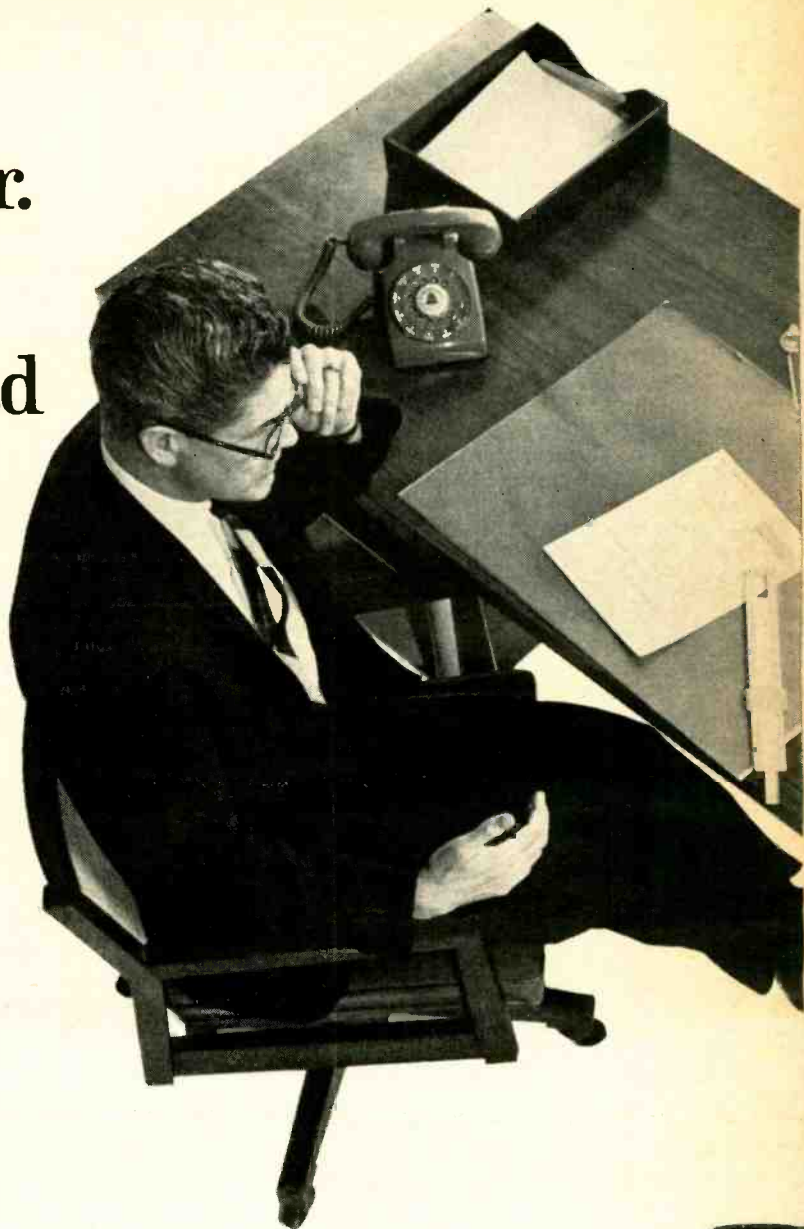

Could they be talking about you?

You'll miss a lot of opportunities if you try to get along in the electronics industry without an advanced education. Many doors will be closed to you, and no amount of hard work will open them.

But you can build a rewarding career if you supplement your experience with specialized knowledge of one of the key areas of electronics. As a specialist, you will enjoy security, excellent pay, and the kind of future you want for yourself and your family.

Going back to school isn't easy for a man with a

full-time job and family obligations. But CREI Home Study Programs make it possible for you to get the additional education you need without attending classes. You study at home, at your own pace, on your own schedule. You study with the assurance that what you learn can be applied to the job immediately.

CREI Programs cover all important areas of electronics including communications, radar and sonar, even missile and spacecraft guidance. You're sure to find a program that fits your career objectives.



You're eligible for a CREI Program if you work in electronics and have a high school education. Our FREE book gives complete information. Airmail postpaid card for your copy. If card is detached, use coupon at right or write: CREI, Dept. 1111G, 3224 16th St., N.W., Washington, D.C. 20010.



**CREI, Home Study Division
McGraw-Hill Book Company
Dept. 1111G, 3224 Sixteenth Street, N.W.
Washington, D.C. 20010**

Please send me FREE book describing CREI Programs. I am employed in electronics and have a high school education.

NAME _____ AGE _____

ADDRESS _____

CITY _____ STATE _____ ZIP CODE _____

EMPLOYED BY _____

TYPE OF PRESENT WORK _____ G.I. BILL

I am interested in Electronic Engineering Technology
 Space Electronics Nuclear Engineering Technology
 Industrial Electronics for Automation
 Computer Systems Technology

APPROVED FOR TRAINING UNDER NEW G.I. BILL

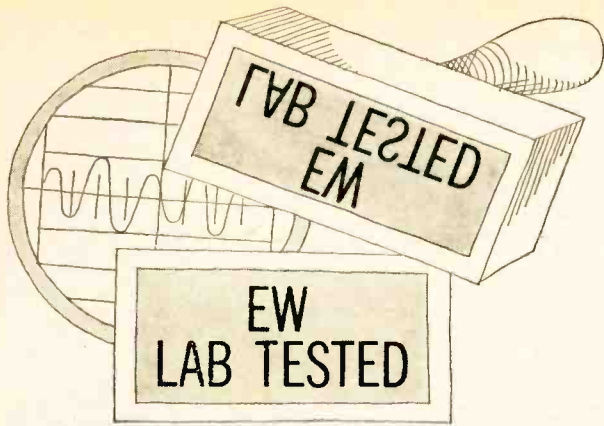

HI-FI PRODUCT REPORT

TESTED BY HIRSCH-HOUCK LABS

**Sansui 2000 AM-FM Stereo Receiver
Bose 901 Speaker System**

Sansui Model 2000 AM-FM Stereo Receiver

For copy of manufacturer's brochure, circle No. 20 on Reader Service Card.



THE Sansui Model 2000 solid-state AM-FM stereo receiver is one of the most interesting pieces of equipment we have tested in some time. It was an impressively fine instrument and one of the better values in high-fidelity components.

The FM-tuner section has two tuned r.f. stages, the first of which uses a field-effect transistor (FET). It has freedom from cross-modulation which the FET has made possible, as well as excellent image rejection. In addition to a four-stage i.f. amplifier, there is a separate i.f. stage, detector, and two-stage amplifier that operates the muting circuits and tuning meter. The muting action is extremely smooth and free from thumps and noise bursts.

The ratio detector output goes to a conventional multiplex circuit, which generates a 38-kHz carrier by full-wave rectification of the amplified 19-kHz pilot carrier. A separate five-transistor circuit performs automatic mono/stereo switching and operates the stereo-indi-

cator lamp. When it lights, the words "FM Stereo" are illuminated against a black dial face. The switching action is imperceptible and the lamp is not triggered by interstation noise. The entire dial has a black background and is visually opaque except when the tuner is in use.

The AM tuner is conventional, with a built-in ferrite antenna, a tuned r.f. stage, and two i.f. stages. It is one of the better sounding AM tuners we have heard, with clean, well-balanced sound and adequate sensitivity for urban and suburban locations.

All audio inputs (including those from the tuners) pass through a two-stage preamplifier. The low-level inputs (magnetic phono and tape head) are equalized for RIAA and NAB characteristics. The tuner and Aux. signals are attenuated before reaching the preamplifier, whose gain is reduced by negative feedback. In addition to the usual phono connectors, the tape recorder input and output jacks are brought to a

five-pin DIN connector, which mates with the plugs widely used on European audio components.

The tone-control amplifiers drive high- and low-cut filters, which are followed by the power amplifiers. The silicon output transistors are protected in two ways against damage from shorted outputs or overdriving. A fast-acting silicon controlled rectifier (SCR) is activated when excessive current is drawn by either output stage, cutting off the amplifier preceding the tone controls. The word "Protector" is illuminated on the dial face when this happens. Shutting off the receiver for a few seconds restores normal operation. In addition, the output transistors are protected by fast-acting fuses.

The styling of the Model 2000 is exceptionally handsome and tasteful. It is distinctive as well—this receiver is not likely to be mistaken for any other make. A row of push-buttons to the right of the tuning dial control Loudness, Muting, Tape Monitor, Reverse, and Mono functions. Along the bottom of the receiver are the tone controls (slip-clutch concentric types), volume and balance controls, input selector, and speaker selector. Either or both of two pairs of speakers can be operated, or all can be switched off for headphone listening via a front-panel jack. The high- and low-frequency filters and power "on-off" are also controlled by push-buttons.

Specifications of the Model 2000 are (Continued on page 75)

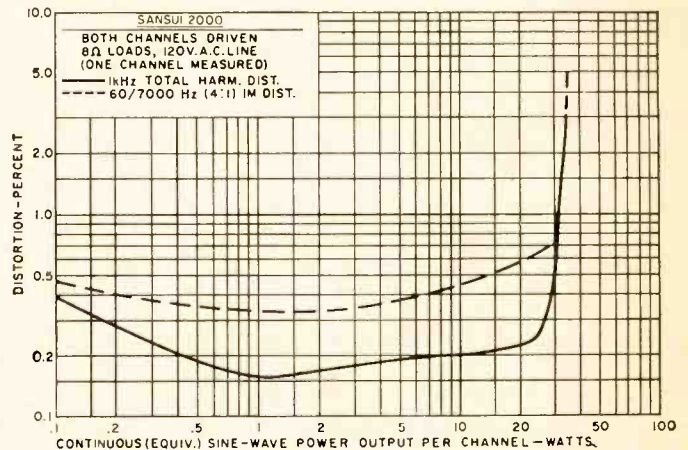
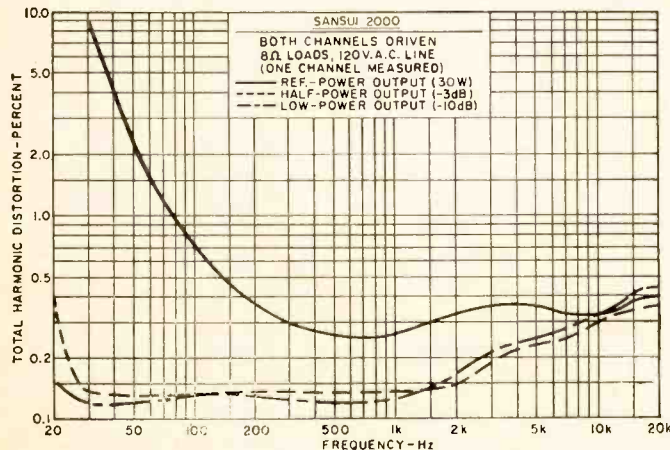

Ask anyone who really knows about hi-fi to recommend an automatic turntable.

Pick out an audio engineer, hi-fi editor, record reviewer or hi-fi salesman at random, and ask him which turntable is the best.

Chances are he'll say Dual. Because he probably owns one.

In fact, 19 out of 20 people whose living depends on hi-fi own Duals. Nineteen out of twenty.

As you might expect, there are good reasons why the experts agree Dual is so good.

It performs quietly and smoothly. With less rumble, wow and flutter than whatever equipment they previously owned. With one record or ten.

The platter (not just the motor) maintains accurate speed, even when

the voltage varies from 80 to 135 volts. And the Dual continuous-pole motor is quieter and more powerful than any comparable synchronous type.

The Dual tonearm is friction-free. That means it can track flawlessly at a stylus force as low as half a gram (about one-fifth the weight of a U.S. dime). No other automatic has an arm that achieves this. And the Dual arm is accident and jam-proof. (A slip-clutch guards it against damage.)

Tonearm settings for tracking force and anti-skating are simple and precise. You just dial them.

And there are, of course, many other facts about Dual that the experts appreciate.

(Like the ultra-gentle cueing control and variable pitch control, for example.)

As for the people who own other brands of turntables, let's just say that they're not the audio engineers, hi-fi editors, record reviewers and hi-fi salesmen.

Most likely, they are all nice people. But would you trust any of them to recommend a turntable?

(For the complete Dual story, ask an expert to show you his Dual, or write for our booklet containing over a dozen complete reviews).

United Audio Products, Inc.,
535 Madison Avenue, 
New York, N.Y. 10022.)



Dual 1212
\$74.50

Dual 1019
\$129.50

Dual 1015F
\$89.50

Dual 1009F
\$109.50

Should you be a nitpicker...

Should you be a nitpicker when it comes to selecting a stereo deck? Only if you want to get yourself a deck you'll be happy with for years to come.

Because every manufacturer *claims* to have the "guts" to make the best sound. But, if you had the opportunity to "tear apart" most of the tape recorders on the market, you'd find a lot of surprises inside.

Like flimsy looking little felt pressure pads to hold the tape against the heads which actually cause the heads to wear out six to eight times faster than Ampex heads.

Like stamped sheet metal and lots of other not-so-solid stuff that gets by but who knows how long? And all kinds of tiny springs and gadgets designed to do one thing or another. (If you didn't know better, you'd swear you were looking at the inside of a toy.)

Like heads that are only adequate. Heads that might work fine at first, but wear out sooner and diminish the quality of sound reproduction as they wear.

There are lots of other things, but that's basically what *not to get* in a deck.

Okay, now for a short course in what *to get*.

Exclusive Ampex dual capstan drive. No head-wearing pressure pads. Perfect tape tension control, recording or playing back.

Exclusive Ampex rigid block head suspension. Most accurate head and tape guidance system ever devised. Solid.

Exclusive Ampex deep gap heads. Cost about \$40 each. Far superior to any other heads on the market. Last as much as 10 times longer. There's simply no comparison.

So much for the "general" advantages of Ampex decks. Ready to nitpick about *specific* features on *specific* machines? Go ahead. Pick.

Pick the Ampex 755 for example. (This is the one for "professional" nitpickers.) Sound-on-sound, sound-with-sound, echo, pause control, tape monitor. Three separate Ampex deep gap heads.

Or, pick the 1455. For lazier nitpickers, because it has automatic two-second threading and automatic reverse. Plus sound-with-sound, pause control and tape monitor. Four separate deep gap heads.

One more thing you should get on your next deck, whichever one you choose: the exclusive Ampex nameplate on the unit. Just big enough to let everybody know you've got the best. (Who says a nitpicker can't be a name-dropper too?)

So, pick, pick, pick. And you'll pick Ampex. Most straight-thinking nitpickers do, you know.

AMPEX

AMPEX CORPORATION
CONSUMER EQUIPMENT DIVISION
2201 LUNT AVENUE
ELK GROVE, ILLINOIS 60007



Model 755



Model 1455

A deck for nitpickers.

And a deck for lazy nitpickers.



ultrasonics for NON-DESTRUCTIVE TESTING

Ultrasonic search units, containing crystal transducers, are available in a great variety of sizes and shapes.

By FRED G. WEIGHART/Chief Electronics Engineer
Automation Industries, Inc.

Producing no harmful radiation, ultrasonics is being used to detect flaws in metal parts, check plywood sheets for blisters, find defective railroad rails, airplane wings, and submarine hulls, and for a host of other testing applications.

ULTRASONICS has become one of the most versatile and sophisticated tools available for non-destructive testing (NDT). The NDT industry has developed into an annual hardware market for \$80 million of equipment, and is growing at an annual rate of 12-14 percent. Old standbys like x-ray and magnetic-particle testing are still widely used, and newer techniques using eddy current and infrared are finding a place, but ultrasonics crosses all the boundaries and is the method very likely to solve that tough problem.

The limitations of other methods are quite basic in nature while the limitations of ultrasonics are not. For example, x-ray testing is limited by (1) radiation safety requirements, (2) access to both sides of the part, and (3) relatively thin sections that can be tested. Ultrasonics has no harmful radiation, can test from either one or both sides, and can test part sizes without practical limit. Magnetic-particle testing is limited to (1) ferromagnetic materials, (2) visual interpretation of defects, (3) detection of defects at or near the surface of the material. By contrast, ultrasonics can test virtually any solid or liquid material, interpretation can be completely automatic, and detection can be at or near the surface or at the far end of a 50-foot shaft.

Additionally, the state of the art in ultrasonic testing is expanding much more rapidly than some older methods. The list of uses is long and varied. Besides the common usage

for detection of flaws in castings, forgings, structural welds, tubes, billets, and the like, applications have extended to nuclear reactors, rocket fuel, hydraulic oil contamination measurement, plywood, brazed joints on submarines, railroad rails, ships' hulls, torque measurement, medical diagnosis, and even the study of the feasibility of testing a spacecraft in flight. Investigations of metallurgical differences and internal stress analysis are opening further avenues for the application of ultrasonic techniques.

In the early 1940's the non-destructive testing industry was in its infancy, and ultrasonic testing was as yet unborn. The seeds were sown in this period, however, as Dr. Floyd Firestone, at a time when radar and sonar were first coming on the scene, invented the "Supersonic Reflectoscope" in 1942. By 1945 the first commercial instruments were in use.

Development of equipment and application techniques steadily increased through the 1950's, but it took two important electronic developments to provide the impetus for more widespread use and acceptance of ultrasonic testing instruments in the early 1960's. The first was the transistor and related solid-state devices, with all the obvious advantages of small size, light weight, long life, and reliability. The second development was the modular method of packaging electronic equipment which was then becoming popular. These two together provide an infinite variation of a central theme. Nothing could better describe the applica-

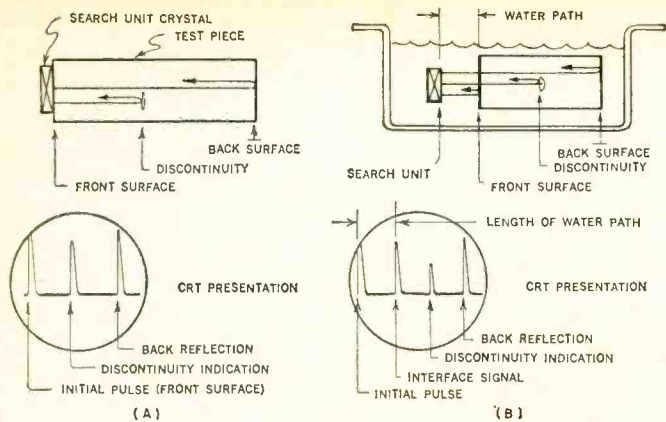

Fig. 1. (A) Principle of ultrasonic testing using contact and (B) immersion techniques. Search unit is crystal transducer.

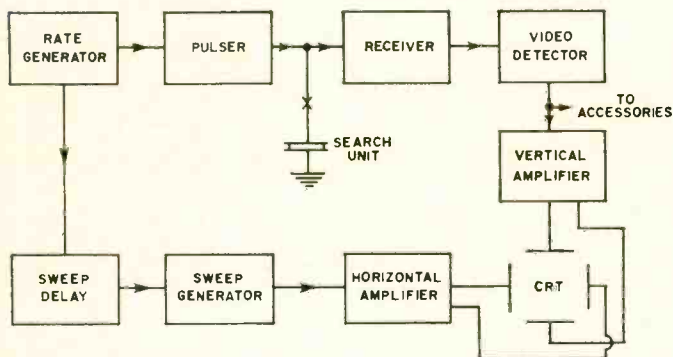

Fig. 2. Block diagram of an ultrasonic tester is shown here.

tion of ultrasonics than this, for rarely is it stereotyped, and usually each problem is similar to one another but . . . a little different. Just a few of these diverse applications will be described later.

Operating Principles

Anyone familiar with radar or sonar systems will readily understand the basic pulse-echo method of ultrasonic testing. A high-amplitude pulse of ultrasonic energy is transmitted through an object or test piece. When the pulse encounters any discontinuity, such as a surface or a flaw, an echo is produced. By displaying the pulse along with its echoes on a linear time base of a cathode-ray tube, the location of the discontinuities can be pinpointed (Fig. 1).

A rate generator (Fig. 2) is the source of all synchronizing signals for the system. It provides pulses at the rate of 60 to 1000 or more per second to both pulser and sweep circuits in order that they will be synchronized for the cathode-ray tube display. Usually the pulser trigger is slightly delayed so the sweep can be started first, allowing time to display the pulser signal.

The pulser is a high-voltage switch which produces a narrow pulse about 1000 volts in amplitude. Thyratrons have long been used here and have been the last component to succumb to replacement by solid-state devices. Only recently have silicon controlled rectifiers become available to provide the high voltage, speed, and current capability required. Risetimes of less than 30 nanoseconds with pulse currents of 10 amperes are necessary for the 1000-volt pulser output. This pulse is either applied directly to the crystal transducer (search unit), depending on the transducer to ring at the desired testing frequency, or it is applied to a tuned network which determines the testing frequency and drives the transducer.

The transducer is a piezoelectric crystal assembly. When a high-voltage pulse is applied to it, it vibrates mechanically at a frequency which is inversely proportional to its thickness (in the range of 1 to 25 MHz for most testing). This

pulse of ultrasonic vibrations is coupled into the material to be tested, and propagates through it. When a discontinuity, in the form of a crack, hole, foreign body, or the far boundary of the material is reached, a portion of the pulse energy is reflected back to the transducer, which converts the ultrasonic echo into a low-level electrical signal. This is usually on the order of a few millivolts, and is connected to the input of the receiver for amplification.

The principal requirements for the receiver are (1) high gain (about 90 dB), (2) ability to amplify a short pulse without ringing, and (3) ability to "recover" from the 1000-volt initial pulse sufficiently to avoid obscuring a millivolt-level signal less than a microsecond later. This provides good resolution, or the ability to show echoes from discontinuities very close to the testing surface along with good sensitivity, or the ability to detect small defects a considerable distance from the testing surface.

Most receivers use synchronous tuning of cascaded amplifier stages. The tuning is fairly broad, with bandwidth about 1 MHz; the frequency of tuning for both pulser and receiver is set by a front-panel selector switch. Tuned stages provide the best signal-to-noise ratio and also recover most rapidly from the saturating effects of the high-level initial pulse. Many instruments use broad-band receivers, which have the least ringing, but these may suffer from recovery and noise problems.

The video detector is usually a simple diode detector and filter. The filter is always a compromise between the desire to follow the envelope of the pulse closely and to provide a smooth signal shape which does not have r.f. in it. The output of the video detector is fed to both the final vertical amplifier and to any accessories, such as gates, alarm and recording devices, or thickness measuring circuits, which might be used. The vertical amplifier is similar to that found in a conventional oscilloscope.

The sweep delay is triggered by the rate generator, and permits starting the sweep at any part of the test period desired. The sweep generator is a linear saw-tooth generator and is of conventional design as is the final horizontal amplifier.

To provide for an extremely wide range of applications and requirements, present-day equipment must be very flexible. Yet if the capability to accommodate all needs were built into one instrument, the result would be too big and

Solid aluminum plates for aircraft wing sections and bulkheads are tested using ultrasonics in 12 by 36-ft immersion tank.

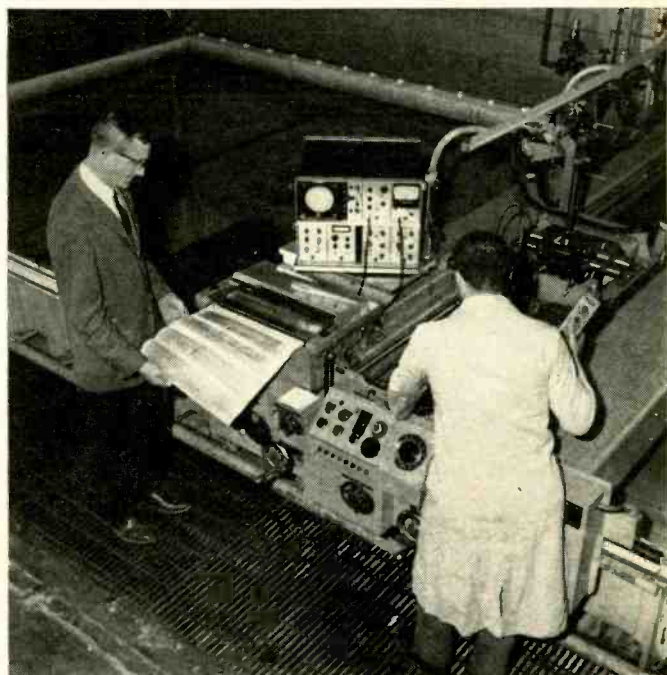

Material	Sensitivity	Resolution	Uniformity	Life	Cost
Quartz	Low	Poor	Excellent	Excellent	Low
Lithium Sulphate	Medium	Excellent	Good	Good	Medium
Lead Zirconate	Highest	Good	Low	Good	Low
Barium Titanate	High	Good	Low	Good	Medium
Lead Metaniobate	High	Good	Good	Excellent	High

Table 1. Materials commonly used in ultrasonic search units.

MATERIAL	FREQUENCY (MHz)				
	1.0	2.5	5	10	25
Aluminum	<0.01	0.02	0.07	0.26	0.86
Glass	0.02	0.06	0.12	0.24	0.6
Lucite	1.5	3.5	7.0	—	—
Magnesium	—	—	—	0.4	1.34
Neoprene	9.0	22.0	—	—	—
Polystyrene	0.8	1.6	3.5	—	—
Quartz, fused	—	<0.007	0.01	0.02	0.07
Carbon tetrachloride	0.05	0.36	1.44	5.7	36.0
Kerosene	0.01	0.06	0.25	1.0	6.2
Water, distilled	0.002	0.016	0.063	0.25	1.56
Air, dried	1.7	11.0	40.0	170.0	—

Table 2. Attenuation in dB/cm for various test frequencies.

too expensive. Modular equipment with optional plug-in combinations provides one answer. Each module may be made with its own plug-in printed-circuit submodule so that the number of options available are multiplied many times.

Transducers & Operating Frequency

The final, vital link in every ultrasonic testing system is the transducer assembly, or search unit. A large variety is the rule as we must adapt to the many variables of test frequency, method, size, crystal material, and special requirements.

Crystal material is an important consideration in choosing a search unit. Table 1 shows the commonly used materials, and their important characteristics.

Search units may be divided into *immersed* or *contact* types. Immersed search units are used under water, usually in a test tank, and are completely waterproof. Available at all testing frequencies, there are unfocused, spherically focused, and cylindrically focused units made in sizes no larger than that of a hypodermic needle, mounting up to several inches across. Contact search units are always used in direct contact with the piece under test, and usually have a liquid couplant, such as oil, to transmit the acoustic energy into the part. These are made for straight-in longitudinal-wave testing, angle beam shear-wave testing, and surface-wave testing. A wide selection of test angles is added to all the other variables previously mentioned. The dual search unit is a special type which has separate transmit and receive crystals. The advantage here is the ability to "see" defects very close to the test surface.

One of the most important search unit types is really a hybrid between contact and immersed types and combines the advantages of each. This is the *wheel search unit*, and consists of an immersed search unit mounted inside a liquid-filled silicone rubber wheel. The wheel rolls on the part under test so there is no sliding and surface wear, and fairly rough and irregular surfaces can be tested. The beam is coupled from the transducer through the liquid in the



Battery-operated ultrasonic flaw detector and thickness measurement instrument can be used in remote or hazardous areas away from a.c. User's hands are free for climbing or testing.

wheel, through the tire and into the part, with a small amount of liquid couplant on the tire. The net result is the ability to do an automatic test on the production line, eliminating the need for hand scanning a contact search unit and without immersing the part in a large tank of water. The combinations and variations of instrument and search unit are dictated by the application (Fig. 3).

In practical testing, selection of frequency depends on sensitivity desired and sound penetration required, high frequency for sensitivity and low frequency for penetration. In general, sound waves of all frequencies will penetrate fine-grain material. However, as the grain structure becomes coarser, interference in the form of scattering may be expected when using higher frequencies (shorter wavelengths) and greater depth of penetration will be obtained by going to lower frequencies (longer wavelengths). Frequencies above 10 MHz are not generally used in contact testing because of the thinness and fragile structure of the high-frequency search-unit elements that are utilized. All test

Fig. 3. The wheel search unit can be used in many ways.

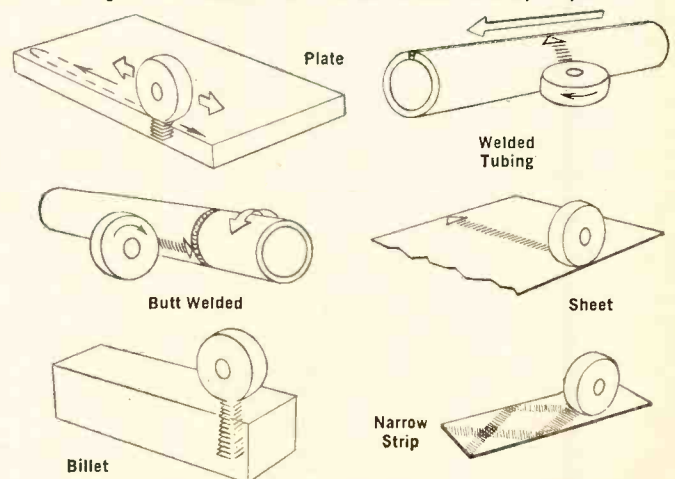

frequencies can be employed in immersion type testing.

Test frequency is mainly determined by the attenuation of the material to be tested and the resolution required. Attenuation increases with frequency as shown in Table 2. Some materials, such as aluminum, have virtually no attenuation at the lower frequencies like 2.25 and 5 MHz, and can readily be tested at the higher frequencies. On the other hand, a plastic like Lucite is virtually untestable above 5 MHz.

Table 3 shows the relationship between frequency and resolution capability. The single pulse length column shows the theoretical limit that could be attained with a single-cycle pulse. In practice, acoustic pulse length cannot be reduced much below 5 cycles due to crystal ringing times.

Industrial Applications

Grumman Aircraft performs complex and expensive machining on solid aluminum plates for aircraft wing sections and bulkheads. Obviously, they don't like to discover a defect in the material after the machine work is done. As a result they require a 100% test of all plates prior to machining. This requires a completely automatic immersed test in a tank 12 feet by 36 feet.

An ultrasonic search unit is mechanically scanned across the full surface of the plate. Since most of the plates have a highly tapered width dimension, much time was lost just scanning water with the conventional rectangular scan. To overcome this, a unique method was developed which uses the same ultrasonic beam which does the testing to sense the presence of the plate. As soon as the beam moves off the edge of the plate, no echo signal appears in a preset zone, and a signal is given to reverse the scan. As a result, the

Small, rolling ultrasonic search unit is shown here checking the underside of an aircraft wing for intergranular corrosion.

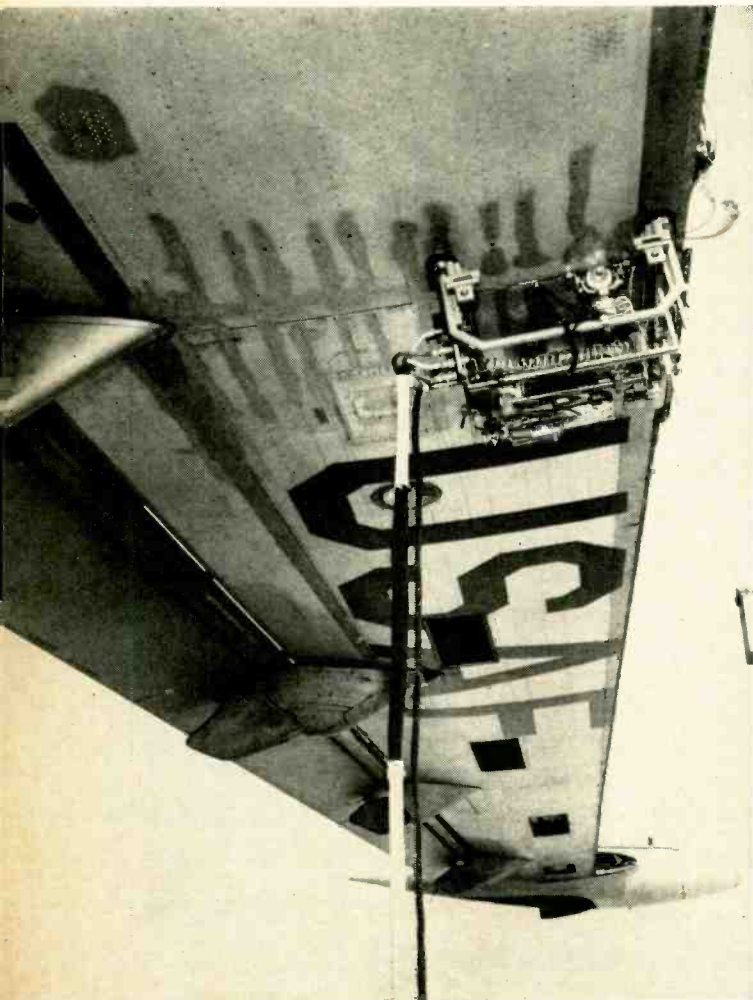

PULSE FREQ. (MHz)	PULSE LENGTH IN CYCLES		
	1	5	10
1	0.12 inch	0.59 inch	1.18 inches
5	0.024	0.12	0.24
10	0.012	0.06	0.12
15	0.008	0.04	0.08
20	0.006	0.03	0.06
25	0.005	0.02	0.05

Table 3. Testing distances that are obscured by initial or echo pulses for various pulse lengths. The shorter the pulse the smaller the distance obscured and the better the resolution. The distances that are given here are for steel material.

scanning search unit follows the outline of any shaped part automatically, with no adjustment required for different shapes. A facsimile recorder shows the outline of the plate and the location of defects which exceed preset levels, determined by reference test blocks.

The *American Oil Company* found that they were doing more and more ultrasonic testing in their refineries. Of particular concern is the structural integrity of the thousands of pipes that crisscross every refinery. Ultrasonics was already in use for measuring wall thickness to detect excessive thinning due to corrosion or erosion. Often these pipes are in high, hard-to-get-at locations, however, and carrying an ultrasonic instrument makes it a hazardous job to reach these locations and make the test. What they really needed, decided the NDT engineers, was a device which could be worn like a vest, leaving both hands free to climb and test. This requirement was met with a 14-pound, solid-state, rechargeable-battery instrument. Battery packs, contained in the back-pack section, can be changed in seconds, or alternatively, the two sections can be fastened together to make a compact bench or hand-carried unit. This development has since been put to use in many diverse applications which require a similar mobility.

It has been common practice in the automotive industry to destructively test every *n*th spot-welded car frame just to be sure that the welds are being properly made. The Manufacturing Development Lab of *Ford* decided there must be a better, less costly way. After months of research, development, and correlation studies, an ultrasonic testing technique was instituted on a production line to detect deterioration in spot-weld quality so that corrective action could be taken.

Aircraft structures have been found, in certain cases, to suffer a malady called intergranular corrosion. This means corrosion around the rivet heads which reduces the inherent strength of the skin material. An ultrasonic scanning device is being used by the Air Force to find this corrosion. It is mounted either on the top or underside of a wing and hangs on like a leech with its suction-cup feet. A small rolling search unit is programmed to scan completely the suspect areas. Standard ultrasonic instruments produce a permanent record of the section. Corrosion conditions can then be quickly spotted and corrective action taken.

The testing of railroad rails is an application whose history dates back to the early 1930's when the induction method of non-destructive in-track testing was developed by Dr. Elmer Sperry. This was perfected through the years until the 1950's when ultrasonic methods for testing rails were adopted. This was initially a supplementary method which extended the ability to find defects into the joint bar area where the induction method was ineffective. The wheel search unit was first developed for this purpose, since no other method could be expected to continuously test rail in track at speeds over 200 inches per second under adverse conditions.

Use of ultrasonics is now a standard method of testing on most of the rail in the country. For example, the New York City subways are regularly tested by an all-ultrasonic test car which performs a full track (Continued on page 74)



Fig. 1. A liquid-crystal digital clock is shown being checked here against a conventional, "old-fashioned" wrist watch.

ELECTRONICALLY changeable displays that reflect light rather than emit it have been developed. The devices employ a new electro-optic effect—"dynamic scattering"—in liquid crystals to display print, pictures, and moving images.

Because they reflect light, the displays are similar to a printed page. They are easier to read as the ambient light increases and, of course, impossible to see in total darkness.

Another advantage of the flat, rugged, and potentially low-cost displays is that they require very little power and therefore can be driven and addressed by solid-state and integrated circuits.

A number of experimental devices that could lead to important new electronic products have been built at RCA Laboratories. Among them are an all-electronic clock with no moving parts (Fig. 1) and a high-resolution pattern display (Fig. 3).

The liquid-crystal displays give promise of becoming practical thin-screen competitors to such vacuum-tube displays as the CRT used in radar and the Nixie tube used to display changing letters and numbers.

Examples of other potential products include electronic clocks and wrist watches, automobile dashboard displays, scoreboards, stock tickers, and, ultimately, pocket-size TV

Fig. 2. Three types of liquid-crystal molecular arrangements compared with random molecular orientation in isotropic liquid.

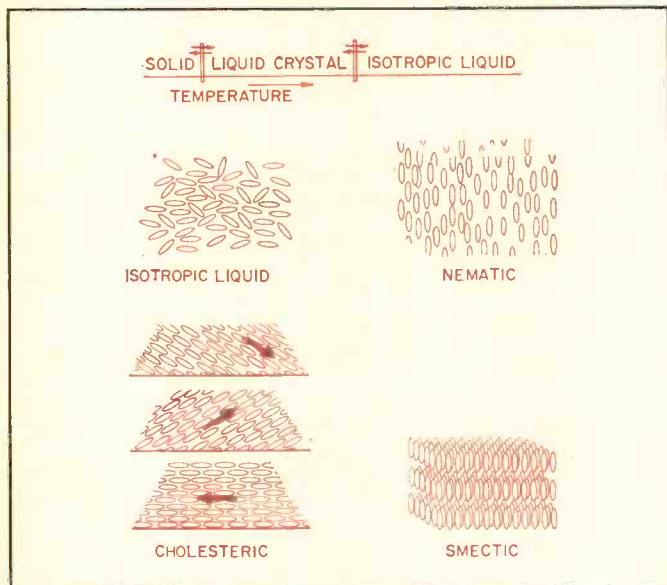

Reflective Liquid-Crystal Displays

By AL PINSKY
RCA Laboratories

Are these electronically changeable displays that get brighter with ambient light an answer to flat-screen on-the-wall television pictures?

receivers that could be viewed in bright sunlight. However, it will be some time before there are any liquid-crystal display products on the market as considerable research and development work remains to be done.

The research program that led to the new technology resulted from the application of two discoveries:

1. That certain liquid crystals can be made opalescent and, hence, reflecting by the application of an electric voltage.

2. That the temperature range over which this occurs—originally confined to only a few degrees at high temperature—can be expanded with new materials to cover a wide temperature range from below freezing to the boiling point of water.

Liquid crystals can be defined as organic compounds that look and act like liquids—they can be poured and take the shape of their container—but their molecules tend to form into large, orderly arrays akin to those that make up such solid crystals as mica, quartz, and diamonds.

Liquid crystals are relatively common in nature—approximately one out of every 200 organic compounds is a liquid crystal. They have three forms—nematic, smectic, and cholesteric (Fig. 2). The RCA displays use nematic liquid crystals; the cholesteric type, (*Continued on page 58*)

Fig. 3. This high-resolution liquid-crystal test-pattern display gets brighter as the high-intensity light is shone on screen.





RECENT DEVELOPMENTS IN ELECTRONICS

Two-Way Radios for Cleveland Transit. (Top left) Recently we wrote in our August issue about a \$6 million two-way radio system for N. Y. City buses. Now, Cleveland Transit is joining the act with a \$1 million system for 950 buses and about 100 cars. Unlike the N. Y. setup which operates on 30 and 159 MHz, the Cleveland radios use four frequencies in the 450-MHz u.h.f. band. Heart of the network is the control center located at the WJW TV transmitter site in Parma, Ohio. There, four dispatcher consoles are installed, designed to operate individually but connected in parallel to permit each operator full control of the entire system. Bus radios are 70-watt transistorized mobile units while the base-station transmitters are 250-watt units. All radio equipment used is manufactured by G-E. The new system will permit bus drivers to have immediate contact with headquarters and radio for assistance in any emergency situation. In addition, dispatching will be expedited and transit delays should be minimized.



Wireless Mike for Broadcasters. (Center) A TV newscaster's lot is not a happy one, especially at the recent national political conventions. Not only did he have to cope with crowds, but he was often trussed up with all kinds of electronic equipment, such as this wireless mike being used by NBC's Edwin Newman. The two units on the newscaster's belt are battery-operated transmitter and receiver, which weigh about 3 1/4 lbs. The oversized tie-clip is the transmitter on-off switch, the only control to be used during interviews. The antenna for the wireless mike is mounted in the headset over which the broadcaster receives instructions from the program director. The system, built by Airborne Instruments Laboratory, operates for two hours on transmit and for six hours on receive. It provides full duplex operation (simultaneous reception with transmission) and provides communications without interference when as many as 50 channels are operating at the same time in the 942-952 MHz band. Transmitter power is 200 mW, frequency modulation is used, and free-space range is 3 miles.



Miniature Photoelectric Light Control. (Left) The miniaturized photoelectric light control held by the lineman is one-third the size of the control installed atop this street light, but it does the same job of automatically turning the light on at dusk and off at dawn. Developed by Tung-Sol (Wagner Electric), the new control uses the same basic components and circuitry as the larger unit, but its small size enables it to be more easily concealed in utility or residential lighting equipment. When the light level drops below two footcandles, the photocell operates a snap-action switch similar to the type used for automotive flashers. The new compact control is capable of handling incandescent lamp loads up to 1000 watts and up to 1800 VA for mercury and fluorescent lamp types.

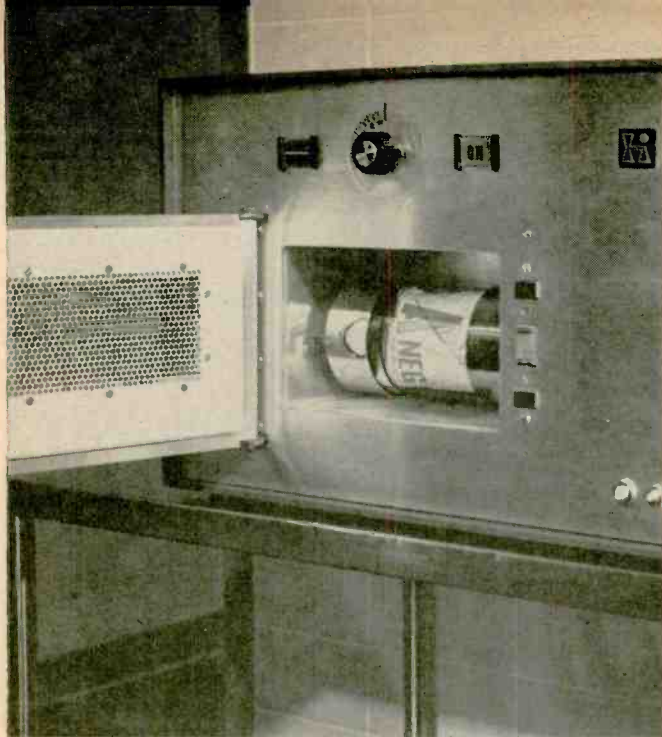

Microwave Blood Warmer. (Top left) This compact microwave oven is able to raise the temperature of refrigerated blood from a typical blood-bank storage temperature of 4°C to near body temperature (35°C) in less than a minute. Blood is heated while still in its plastic pouch container. The warmed blood is then administered directly to the patient from the same plastic pouch. Besides convenience, the warmer is valuable when the rapid transfusion of large quantities of blood is needed. Conventional warming methods take up to five times as long so that when time is important, as for an emergency transfusion, the oven can be employed. A flexible-circuit sensing membrane monitors the temperature of the blood. The warmer, made by Holaday Industries, has been tested at the Mayo Clinic.

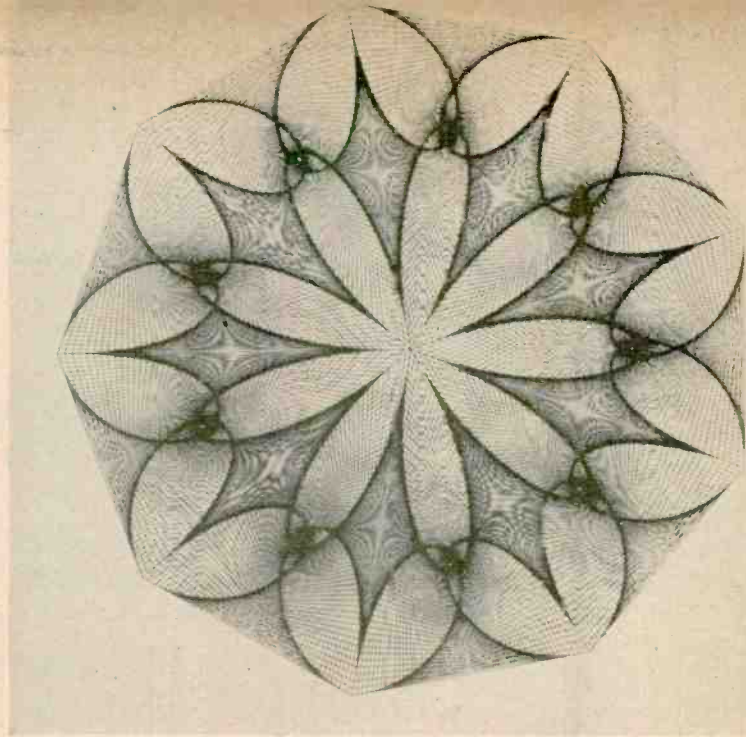

Computer-Drawn Art. (Top right) This is one of eight original computer-plotter produced art designs being exhibited at the Institute of Contemporary Arts in London. The designs are being shown by California Computer Products, Inc. in connection with an international computer-plotter art competition the company is sponsoring. Awards to the top three winners are scholarships of \$5000, \$3000, and \$2000. Deadline for entries is November 1, 1968 at CalComp Awards, Suite 523, 2975 Wilshire Boulevard, Los Angeles, California 90005.



Hearing Tester for Infants. (Center) Another item for hospitals this month is this hearing tester that allows a nurse to check the hearing of infants within hours of birth. The tester is a small, solid-state instrument with four push-buttons, each marked for a precisely calibrated level of sound. The signals produced resemble bird tweets, and the infant responds to them by a jerk or sudden movement of hands, arms, or legs, or by the blinking of an eye. A low-cost, ready available battery provides up to 12,000 two-second tests. Zenith makes the unit.

"Energy Paper" Powers Shaver. (Below right) A new power source, a wafer-thin paper battery weighing less than 1/10 oz, has been developed by Philips of Holland. In order to energize the cell, it is only necessary to dip it in a glass of water. The cell is then inserted into an appliance, such as the electric shaver shown, and it supplies power to the appliance for five minutes. After use, the paper cell is simply discarded. Still in the development stage, neither the cells nor the shaver is available yet. The cell consists of a dry sheet of paper treated with common salt crystals. Beneath this is a layer of dry paper fibers impregnated with potassium persulphate and finely powdered carbon. Zinc or magnesium sheets, which may be built into the appliance, contact both the top and bottom surfaces.

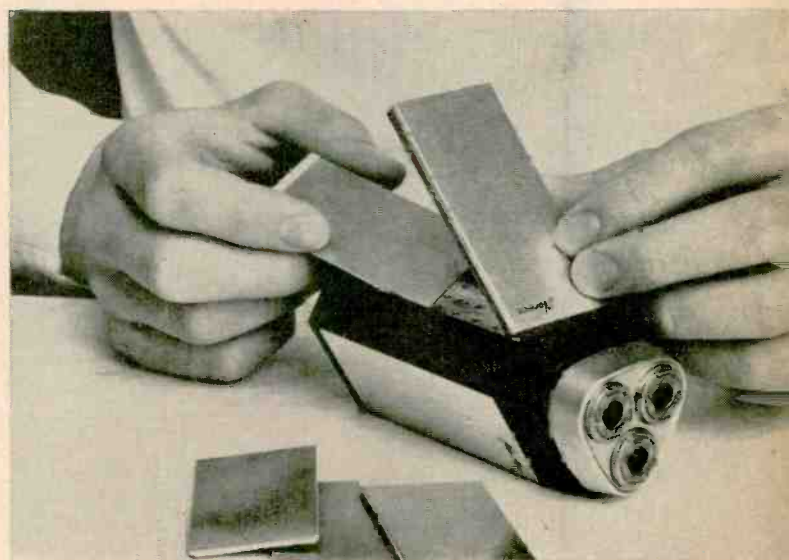

A Four-Tube TV Receiver

By R. J. WALKER, Mgr., Application Engineering
and W. R. SEADER, Applications Engineer
Tube Department, General Electric Co.

Although not yet on the market, this design shows what can be done with just four compactron tubes, plus a rectifier, tuner, and a picture tube.

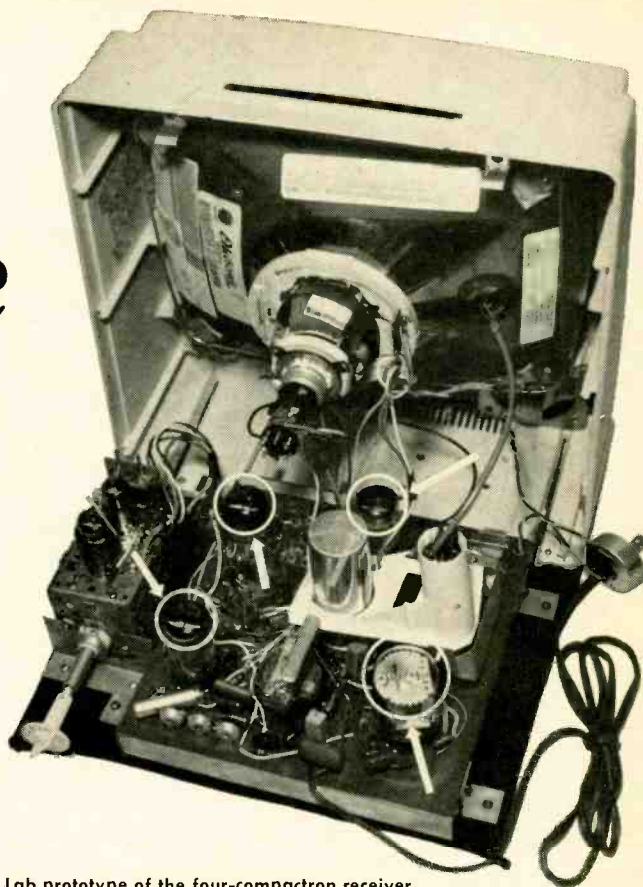

Fig. 1. Lab prototype of the four-compactron receiver.

Editor's Note: The receiver described here was designed as a feasibility study to develop a minimum-cost black-and-white set with adequate performance in medium- and strong-signal areas. Although the receiver is not expected to be marketed as yet, portions of the special simplified circuitry described will be found in some of the new G-E television models. The four tubes used are compactron types, including two specials which are not currently available. The receiver has two additional tubes in the tuner, but this could readily be a solid-state design.

THIS television receiver design is for a low-cost, medium-performance 12-in (diagonal) picture tube monochrome set for the TV viewer who lives in a medium- or strong-signal area. All the necessary circuit functions (except for the tuner) are performed by four compactron tubes and one h.v. rectifier, hence it has been dubbed the "4+1." The "4+1" is the result of a program initiated by the G-E Tube Department to find ways to lower the cost of producing television receivers through more efficient use of vacuum-tube circuitry. A photograph of a laboratory prototype of the receiver is shown in Fig. 1.

The design of the "4+1" began with a typical 12-in receiver. Reviewing the block diagram of such a receiver, there are, excluding the tuner, fifteen apparently essential functions which need to be performed to produce a picture and sound. These functions can, by using multisection compactrons, be performed by six such tubes plus h.v. rectifier. The fifteen functions are assumed to be essential because they are all used in one of the lowest cost monochrome receivers produced for sale to the public. Cost reduction of these circuits by television manufacturers has been so effective that it seems that the only way to substantially reduce cost further would be to eliminate completely several of the functions now considered essential. The "4+1" is the result of the

elimination of five of these functions, as shown in the diagram of Fig. 2.

The television receiver system has been reduced to four multifunction tubes and one h.v. rectifier performing only ten functions. The functions which have been eliminated are the sound i.f. amplifier, one video i.f. amplifier, the vertical oscillator, the horizontal oscillator, and the horizontal a.f.c. circuit. The elimination of these functions permits the removal of two triodes, two pentodes, and one double-diode tube along with most of their associated circuit components.

Among the more unique features of the receiver is the deflection circuitry. The deflection waveforms are generated directly in the output tubes operating in a self-oscillating mode rather than in separate oscillators. These circuits were designed and developed expressly for the "4+1" and their use accounts for the elimination of three of the functions of previous low-cost receivers. The two deflection oscillators are no longer needed and, since the self-oscillating horizontal system is directly synchronized by the horizontal sync pulses, the a.f.c. circuitry is unnecessary.

The removal of one stage of the video i.f. amplifier was made possible by the development of new, very high g_m , i.f. amplifier and video amplifier pentodes. A substantial increase in video amplifier gain compensated, to a large degree, for the loss in i.f. gain so that the total signal channel gain of the receiver is only about 6-dB less than that obtainable with two i.f. stages. Thus removal of one video i.f. amplifier does not appreciably affect the performance of the receiver.

The fifth function which was not considered necessary is the sound i.f. amplifier. This amplifier has been used to boost the 4.5-MHz subcarrier to a level where AM modulation could be clipped off the waveform before demodulation. It was found that the 17BF11 sound demodulator was sensitive enough and stable enough to provide ample output and

AM rejection without the i.f. amplifier when the signal was picked off of the plate of the high-gain video amplifier. Thus another function was eliminated.

New Horizontal-Deflection Circuitry

The self-oscillating horizontal circuit was the first one developed for the "4+1." By comparing the extreme simplicity of the new horizontal deflection circuit (Fig. 3) with that of a conventional horizontal deflection circuit, it can be seen that the new circuit is a very effective cost-cutter. The circuit not only performs all of the necessary horizontal functions, including the generation of deflection current, high voltage, and a.g.c. pulses, but does so without the necessity of a horizontal hold control or a.f.c. circuit.

The horizontal-deflection circuit is basically a blocking oscillator with several important differences. To properly drive the deflection yoke of a picture tube, the sweep tube current must be sharply cut off at the beginning of retrace and remain cut off during the entire retrace period. Some 20 microseconds after the beginning of retrace the sweep tube current turns on, increasing gradually to the maximum value required for a full line scan at which time the next retrace begins, completing the scan cycle.

An ordinary blocking oscillator will turn on regeneratively at the instant the grid voltage allows the tube to begin conduction causing a sharp, regenerative increase in plate current at that instant. Since that condition cannot be tolerated in a television sweep circuit, a diode was inserted in the feedback loop to restrict the feedback to negative pulses so that the sweep tube cannot be turned on except through the normal discharge of the grid circuit capacitance. This permits the tube to turn on and conduct normally without disturbance during the scan period.

Since the grid-circuit components are adjusted to produce

Fig. 2. Block diagram of the simplified system showing ten separate functions being performed by four multisection compactrons plus h.v. rectifier. The abbreviations that are used in blocks are D for diode, T for triode, and P for pentode.

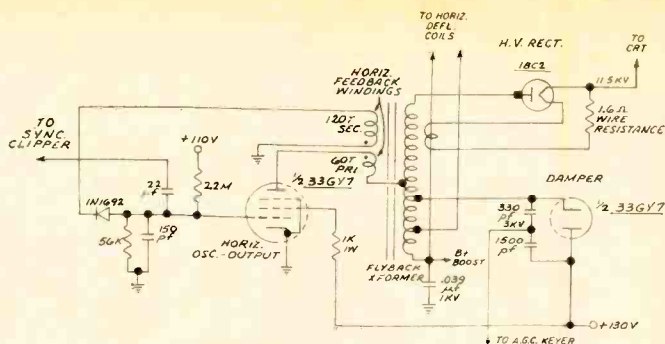
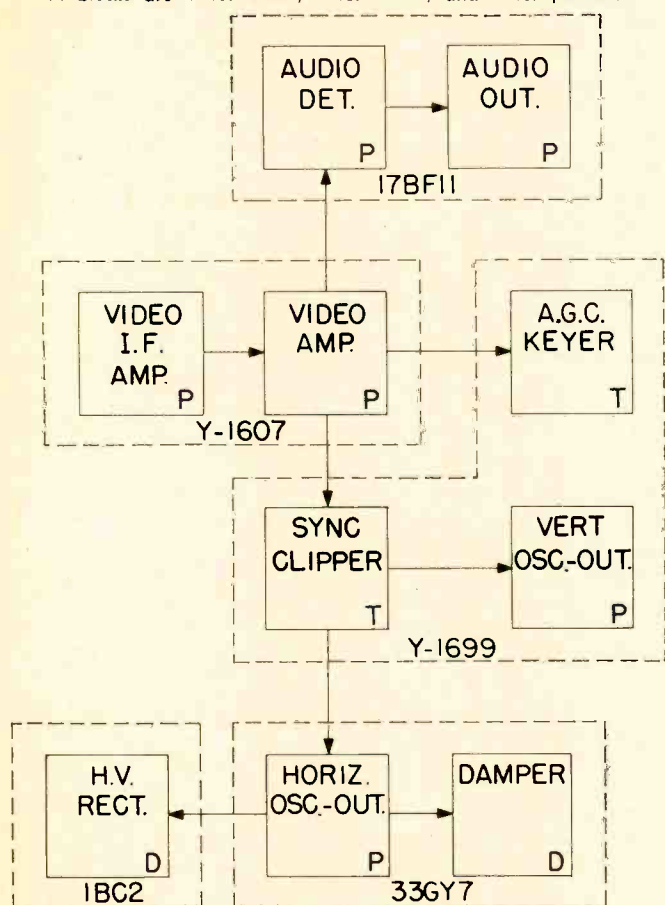

Fig. 3. The self-oscillating horizontal-deflection circuit.

essentially the same drive waveform as that obtained from an oscillator-driven discharge circuit, the self-excited horizontal system behaves as a normal horizontal sweep amplifier during the scan period. During that time the tube current increases. There are small oscillations on the waveform caused by various resonances in the flyback transformer. The changing plate current induces a positive voltage in the feedback transformer secondary.

During the time the plate current is increasing the grid circuit is discharging and its voltage is approaching zero from the negative direction, thus reducing the back bias on the feedback diode. When the induced positive voltage in the feedback winding falls to a value which enables one of the small negative oscillatory voltage excursions to cause the feedback diode to conduct, the sweep tube grid will go slightly negative, triggering a retrace cycle. The regenerative triggering action is very rapid, causing the grid voltage to fall approximately 200 volts per microsecond. Thus the free-run period can be adjusted by controlling the grid-discharge waveform, the slope of the plate current waveform, or the number of turns on the secondary of the feedback transformer.

When television sync pulses are being received from the sync clipper, the circuit operates in a triggered mode with the retrace being triggered by a negative sync pulse at the grid of the sweep tube. Since a sync pulse is short and of relatively low amplitude, the high-frequency response of the feedback loop must be adequate to permit a high loop gain to the sync-pulse wave front. The required high-frequency response could not be obtained by coupling a single feedback winding to the output transformer through the flyback core, so it was necessary to use a feedback transformer rather than a feedback coil. The primary and secondary of the feedback transformer are wound on the same bobbin, physically close to each other, to enhance the high-frequency gain of the feedback loop, thus assuring accurate and faithful synchronization of the horizontal scan circuit.

Although the circuit performs well with the feedback transformer magnetically independent of the flyback transformer, it can be mounted on the core of the flyback. This provides the economic advantage of not requiring a separate core for the feedback transformer. In addition, the losses in the flyback core and windings aid in damping unwanted ringing in the feedback circuit.

The noise immunity of the self-excited horizontal sweep circuit is very good. During the first 20 μ s after retrace has been initiated, the loop gain of the circuit is zero because the grid is at a large negative potential, so the circuit is completely immune to unwanted triggering. A negative noise pulse cannot affect tube current because the grid is already below cut-off voltage and, even through an unusually large positive noise pulse might cause some tube conduction, the feedback diode prevents such a pulse from causing any regeneration in the circuit.

For the next 20 or so microseconds the tube is in conduction, but the grid bias is still high enough so that the g_m of the tube, and hence the loop gain, is too low for the circuit

An optical physicist is shown here making adjustments on an elaborate optical laboratory projection system.

job opportunities in the

new world of electro—optics

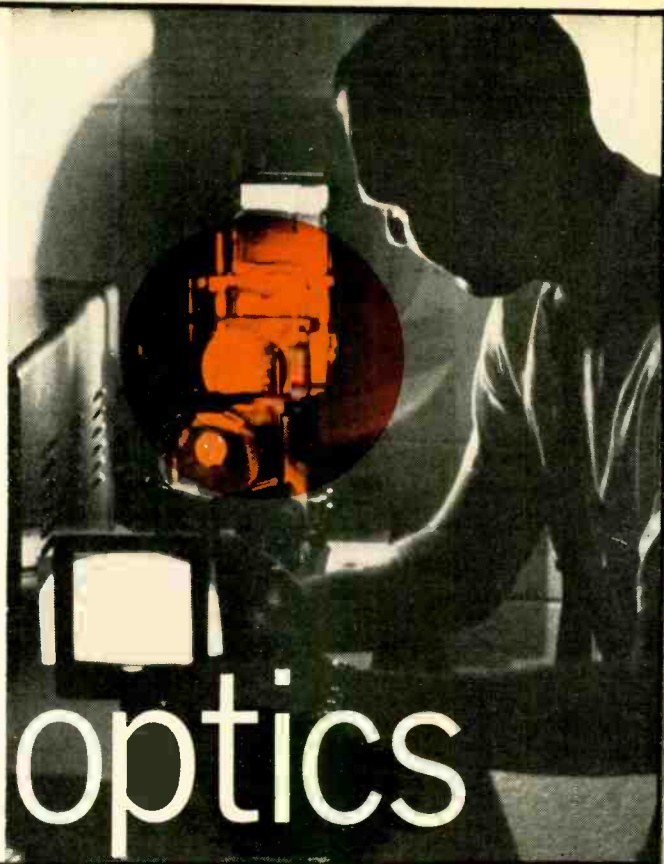

By LOUIS ARPINO, Product Mgr.
Electro-Optical Devices Div., Ampere Electronic Corp.

Embracing such diverse components as laser trackers and photomultipliers, this field offers exciting professional and vocational possibilities for engineers and technicians.

THERE are few scientific disciplines that offer opportunities in the future as well as stability in the present. But such a field is electro-optics. The union of two different technologies, electronics and optics—to form electro-optics (E-O), has spawned many offspring that are showing prodigious growth. Words like phenomenal, revolutionary, and extraordinary invariably enter into a discussion of the future of electro-optics. The entire field is characterized by an uncompromising optimism in terms of rate of development, number of people that will be needed to fill positions, and its impact on mankind.

Despite its youth, the field is not earthbound. It has already penetrated space by tracking missiles and providing TV hookups within spacecraft to study the reactions of astronauts. Another example is the series of spectacular pictures, as well as the analysis of the moon's surface, transmitted to earth by recent lunar probes.

In its military role, E-O has many functions; for example, it provides night vision to front-line troops to enable them to see the enemy. This enhanced sight is also useful in military planes which are being equipped with infrared systems and low-light television screens to view troop action in darkness. Planes of the future might well be equipped with such systems to assist in emergency landings. Boats could also use night vision to maneuver within the confines of a harbor in the dark.

In the field of medicine, electro-optics will help reduce the number of exploratory operations which are performed to study the condition of internal organs. A dramatic application of this new technique uses fiber optics, which are thin, flexible glass or plastic fibers that contain and transmit light.

Properly inserted into the body, these are manipulated until they reach an organ. The fiber optic assembly illuminates and transmits the image of that area to the physician. When processed, the image, enhanced by a photomultiplier, is transmitted to a diagnostician miles away or is recorded on video tape for future reference.

Defining E-O

The E-O group at *Bendix* asserts that "electro-optics is a field begging for a definition." While it is true that E-O is generally concerned with the transfer of information, the disciplines encountered make a meaningful definition difficult. For example, one could make a case for including night vision, television, coherent optics, sonar, and radar as E-O related work. One begins to appreciate the difficulty in even listing the work being done, not to mention attempting to develop a definition that will fit such a broad field.

Some other companies have taken a different approach in the matter of definition. According to *Amperex*, "... an over-all definition of electro-optics might be the science of transferring mass information visually." *Corning* defines the E-O field as "a field of components or equipment in which both optical (including infrared and ultraviolet) and electrical phenomena play major functional roles." Definitions are always tricky and can lead us far afield from our objective—the investigation of job opportunities in the field called electro-optics.

Opportunities and Challenges

The recruiting efforts of many companies have proven that engineers and physicists who are specifically trained

in electro-optics are few in number and technicians hard to find. Engineers lack training and/or experience in solid-state physics, information theory, and advanced mathematics; physicists lack engineering exposure and circuit-design experience. The technician usually doesn't understand optics and can't use optical test equipment.

One area of accelerating activity is in research, development, and manufacture of electro-optical devices. These may be considered to include the familiar cathode-ray tube, camera tubes, the photomultiplier, image intensifiers, the laser, and many other electro-optical transducers. A continuous challenge is presented to engineers, physicists, and technicians in increasing the reliability, improving the performance, and reducing the cost of these devices.

To cope with these challenges, the technician needs some special knowledge and experience besides electronics. He should have an understanding of the corpuscular and wave theories of light, what converging and diverging lenses can do, and what focal length, refraction, reflection, and diffraction mean. The technician working in electro-optics should also be able to measure light intensities and sensitivities and be familiar with various electro-optical transducers.

The working environment is not too dissimilar from that in aerospace and electronic R&D laboratories. Oscilloscopes, meters, signal generators, and other conventional electronic test gear will be found in abundance. There will, however, be a host of optical equipment the technician will have to become acquainted with; these are various light sources like the laser, calibrated light meters, spectral filters, interferometers, spectrophotometers, radiometers, and modulation analyzers. If one were to characterize the type of work the technician will perform, the word would be "delicate."

Both engineer and physicist should be on intimate terms with wave mechanics and be able to apply this powerful branch of physics to practical problems. It goes without saying that one's mathematical background should be strong, especially in transform methods and wave analysis. Ability in modeling is another important requisite; modeling, however, must be performed with a fine sense and feeling for practical realities and difficulties. In addition, the engineer should have knowledge of information theory and optics; the physicist should be familiar with electronic circuits.

Another area of rapid growth is electro-optical systems,

Electro-optical night window for pilots uses image intensifier to product bright pictures of dark, practically invisible areas.

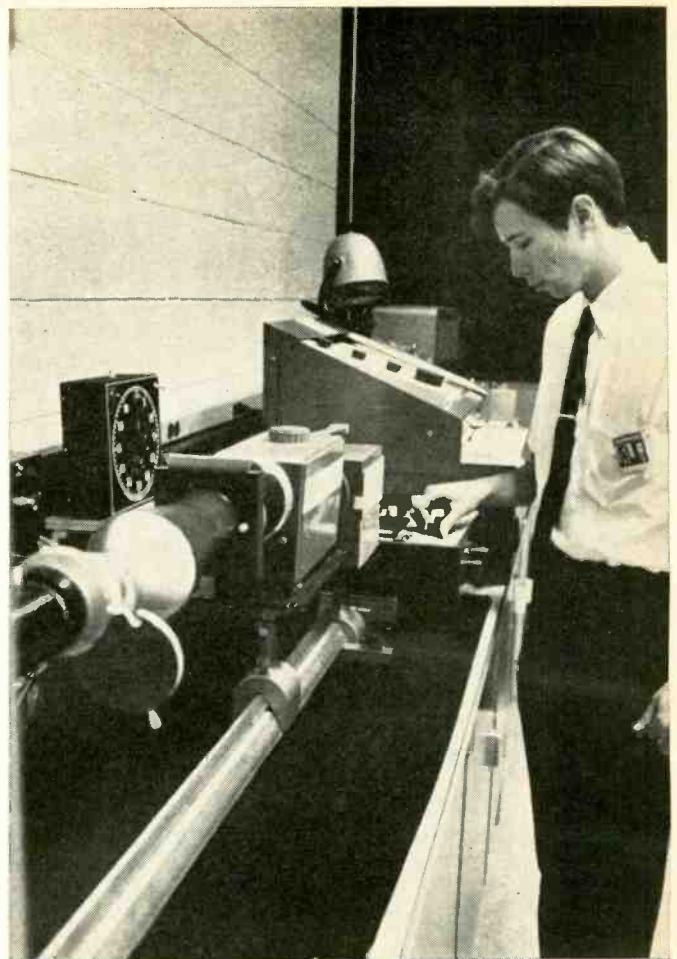

Laboratory technician is using a spectroradiometer to measure the spectral characteristics of a certain light source.

where one or more electro-optical transducers are married to other components to achieve a highly sophisticated system. For example, laser tracking systems are less affected by variations in the index of refraction of the atmosphere than radar and are not affected by unwanted reflections. In contrast to passive optical systems, laser systems discriminate against other optical sources and also measure range. Besides the skills needed for working on electro-optical devices, knowledge of and experience in feedback control systems are invaluable. The technician may also be required to make precision measurements of acceleration and range of the object being tracked. Electro-optical modulators, i.f. amplifiers, balanced mixers, photomultipliers, and digital gates are representative of the circuits with which the engineer, physicist, and technician will be involved.

As another example, electro-optical computers offer a unique method of finding the Fourier transform of a periodic or aperiodic waveform. The waveform to be analyzed is recorded on a photographic film, the recorded image acting like a diffraction grating. When a suitable light source is reflected from the film, the resulting light fringes provide the Fourier components of the waveform. This method has also found use in character-recognition studies. Besides an understanding of the Fourier transform, a knowledge of photographic processes is helpful in this area of electro-optics. One can cite many more examples of the challenges to be found in E-O; there are a good many of them.

Training for E-O

Owing to its newness, universities and technical schools seem to be unaware of the specialized knowledge that is required for electro-optics. One truly interested in pursuing a career in E-O would do well to take courses in his own area



This U.S. Army night-vision sight is used to detect presence of an enemy in faint skyglow or starlight at up to 1200 meters.

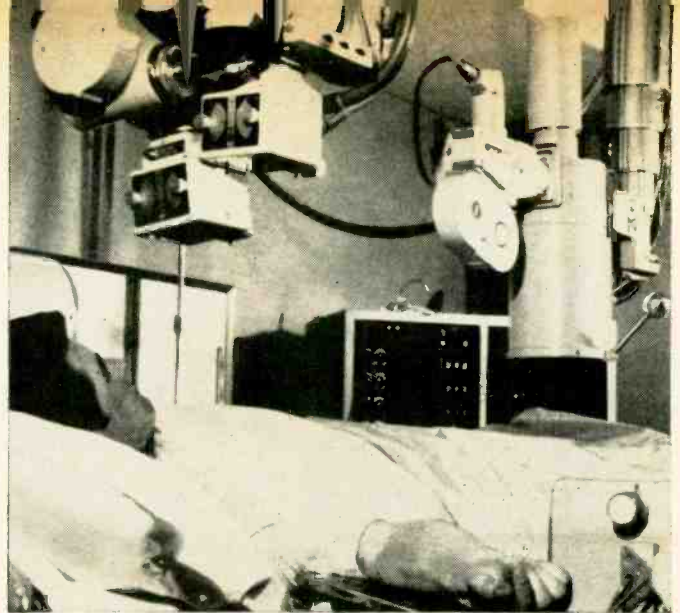

An x-ray image-intensifier tube (in vertically suspended cylinder at right) is being used in this heart catheterization.

of interest and, upon graduation, work in the laboratory of a manufacturing company in the E-O field. The work experience of the engineer can be supplemented with courses like information theory, optics, solid-state physics, and advanced mathematics—all of which can be taken at night in most schools offering graduate programs in physics and engineering. The physicist will find it to his advantage to pursue courses in solid-state circuit design.

Technicians should attend a junior college or technical

Small mobile color-TV pickup camera uses three Plumbicon tubes whose design utilizes advanced electro-optical principles.



November, 1968

school for the basic fundamentals of physics and electronics. Not to be overlooked is training through correspondence courses which can often provide the necessary theoretical background. Because no technical schools, at present, are equipped to train students in all or even most aspects of E-O, companies will find it worthwhile to set up their own training programs for technicians.

Job Offerings

The future of electro-optics should be one of steady and continuing expansion, owing to the growing number and diversity of laser applications, advances in electro-optical transducers, and the emergence of new and sophisticated electro-optical system. Electro-optics was barely discussed fifteen years ago and altogether unknown forty years ago. Some of its possibilities are just beginning to materialize; many more are expected in the future. These considerations should make the field very attractive to the engineer, physicist, or technician, as well as others.

The minimum required for engineering technicians is generally one year with an accredited electronics institute and two to five years of practical experience. Preferably the man should have completed two years with such a school and have obtained an Associate Degree in Electrical Engineering or some similar certificate indicating that he has completed a certain number of hours in training. A correspondence course from an accredited school may also be quite acceptable.

The experience can have been obtained from a closely allied industry. A knowledge of geometrical and physical optics and the ability to pinpoint troubles are highly desirable; the technician should also be capable of using standard electronic test equipment. Depending on the training and experience of an applicant, the starting salary range is from approximately \$370 to \$750 a month.

An engineer must have physics, physics, and more physics; the physicist needs to know and understand circuits. An engineer or physicist with a B.S. or M.S. can earn anywhere from \$7000 to \$20,000 a year, depending on his education, experience, and ability. Those working in research and development will generally earn more than engineers engaged in production or application. Having a Ph.D. can bring a salary as high as \$25,000.

Besides technicians, engineers, and physicists, other skills are in demand. There is a need for device assemblers, chemists, metallurgists, and mathematicians. The prospects for growth in the field appear limitless; opportunities and challenges are there for the taking—that is, if you have what it takes.

iinstant replay

By J. PETER KANE
Video Consultant, Ampex Corp.



Technician operates controls of two Ampex HS-100 slow-motion disc recorders during a UCLA-USC football game. The recorders store up to 30 seconds of continuous action for playback in variable slow motion within a lapsed time of four seconds.

High-speed magnetic disc recorders enable television viewers to take that important "second look" at sports spectacles.

Now let's see that again on 'instant replay.' Familiar? Millions of sports fans have come to accept "instant replay" as a regular part of a sports telecast, like the half-time interview and the post-game run-down on scores from around the country.

Few, however, are aware of just how "instant replay" is obtained. Fewer still have any idea of the men and equipment needed to bring "instant replay" to the home television screen—in vivid color and often in slow motion or step-by-step stop action.

ABC Sports, which has pioneered many innovative techniques in sports coverage, has seen "instant replay" develop from a hit-and-miss, keep-your-fingers-crossed gimmick in the early 1960's, using the first portable videotape recorders, to a precise electronic recording function using magnetic disc recorders specifically designed for sports "instant replay" recording and playback.

"Lots of Luck"

One of the early ingredients still remains. Even with experts calling the plays to be covered and highly reliable disc recorders preserving the action, a little bit of luck is needed. With the isolated camera glued to the league's leading pass catcher as he runs through his pattern on a third and 10 situation, there will be no instant replay if the quarterback decides to send his fullback up the middle.

Success is frequent enough, however, to make "instant

replay" a valuable part of the sports coverage of all three television networks. The fans expect it, crowding around the TV set more intently during the replay of an exciting touchdown gallop than for the game itself.

At least 35 men—20 technicians and 15 production people and a minimum of four cameras, are needed to produce a Saturday afternoon college football game for national television. This number increases when additional cameras are employed. As many as seven color cameras are used during important games.

Camera location is critical. Two cameras are located in the press area near the 50-yard line; one camera is placed on a platform or mobile dolly along the sidelines; and one camera follows the action from the end zone. Often a camera is installed in the announcer's booth to pick up interviews and diagrams showing offensive and defensive formations. Depending on the importance of the game, two additional cameras can be placed in strategic spots around the stadium. Pictures from all of these cameras can be recorded for "instant replay."

Often the decision to record some particular portion of the action for "instant replay" is guided by a member of the TV announcing team. Generally, one of them is a former coach, like Oklahoma's Bud Wilkinson, or an ex-player, like former All-American Jackie Jensen of California. These experts are thoroughly familiar with the game of football, the strategy patterns of the coaches, and the particular

talents of the players in the game. Whether a team is a passing club that makes its critical yardage through the air, or relies on an explosive runner like USC's O. J. Simpson, is important in trying to guess what it will do in any given situation.

For instance, USC may face a third and 4 situation on its opponent's 20-yard line. Wilkinson, knowing that Coach John McKay favors Simpson in such spots, will write Simpson's jersey color and number "32" on a piece of paper. The associate director in the announcer's booth, who is in constant contact with the producer, notifies him that Simpson is the man to watch. The camera director is alerted, and he instructs one of the cameramen to cover No. 32 and at the same time tells engineering to record the output from the camera on the *Ampex HS-100* disc recorder.

In more important games, two cameras and two recorders are assigned to "instant replay" coverage of a given play. Action from one camera is recorded on the *HS-100* or on an *Ampex VR-2000* color videotape recorder. Often one camera is focused on an offensive player, and the other on a defensive player. Both sources are available for instant replay. The picture from the disc recording is available within four seconds for on-the-air showing. On the videotape recorder, which records on reels of magnetic tape, the tape must first be rewound and the action located before it is ready for viewing.

Quick Playback

Today's high quality color "instant replay" is possible because of the *HS-100* disc recorder, designed by *Ampex* at the request of *ABC Sports*. It records up to 30 seconds of action on highly polished aluminum discs. Thus, the "instant replay" machine enables the operator to cue-up any portion of the recording in just four seconds for immediate playback on the air and to play the recorded action as many times as necessary. The replay can be shown in variable slow motion or stop action and its output can be recorded on a videotape recorder and preserved for post-game highlights. A disc recorder is used instead of tape for "instant replay" because pictures are instantly available and because it has variable slow-motion capability and good color quality. The disc records pictures continuously, erasing old information as new information is being stored.

Whirling around at 60 revolutions per second, the 16-inch diameter magnetic discs record 60 fields each second (two fields equal a frame). Individual television fields are recorded as circular tracks (channel width is 10 mils track-to-track center, with a 7½ mil recording track and a 2½ mil guard band) on the surface of the magnetic disc while the recording head stays stationary. Four head assemblies are required to record on the two surfaces of both discs. When head A has completed recording a single field, head B begins recording the next field and head A moves on. When head B completes recording its field, head C records next, then head D, and finally back to head A, which is now in a new location and ready to record again.

Thus, each head records its successive fields in rotational sequence. Heads A and C record odd fields; heads B and D, the even ones.

Head movement is accomplished by a stepping motor which actuates a steel band to which the head is attached. The incremental movement of each head is 0.020 inch along the radius of the disc. The inward motion of the head, that is, motion toward the center of the disc, is such that space is left between the recorded tracks for a subsequent set of concentric tracks to be recorded in an interleaved fashion during the outward motion of the head assemblies.

Recorded tracks are individually erased by means of a d.c. current applied to the head. During any given field period, one head is recording and one head is erasing, and two heads are being re-positioned.

Each individual recorded field may be reproduced any

number of times, depending upon the mode of operation desired. A normal real-time playback will involve a single reproduction of sequential fields. Incremental slow motion is obtained through repeating the fields at a rate equivalent to the ratio of slow motion desired. Therefore, repeating the fields three times will produce ⅓ slow motion. Stop motion is accomplished by the continuous reproduction of an individual field for any period of time required to permit detailed study of the scene.

In normal record mode, 30 seconds of continuous action are recorded. A full minute of recording may be obtained by recording alternate fields.

The machine operator can select any of the following replay modes from a simple control panel (the control panel includes a cueing indicator time clock for locating any recorded segment precisely): Normal—when color television images on the disc are reproduced in real time as many times as desired; three ratios of slow motion control, two fixed and one variable; and freeze frame where the head motion is stopped so that a single image is repeated continuously. It also plays back in reverse motion.

According to Richard Kirchner, sports producer for the *American Broadcasting Company*, "instant replay enables us (the networks) to take people inside an event wherever good taste dictates. We think it helps increase the fans' enjoyment of the game through a better understanding of what exactly is happening on the scene and why."

"The disc recorder is more versatile than tape for this job", says Kirchner. "And surprisingly, it produces pictures equal to and sometimes better than the best tape recordings. So far," he goes on, "the 30-second time limitation has not been a problem in football coverage. Key action is completed in 30 seconds." ▲

Big color camera provides field-level pictures during last year's UCLA-USC college football game. Camera output feeds an *Ampex HS-100* magnetic disc recorder for instant replay viewing and a *VR-2000* color videotape unit.



SWEEP Generators for TV service



By DALE E. BALDRIDGE/Associate Design Engineer, Heath Co.

New swept frequency techniques and generators help make color television servicing easy for the average technician.

WITH the new breed of service sweep generators, alignment of the critical frequency-selective band-pass circuits can be part of the technician's regular service procedure. More advanced methods and concepts have been introduced to make sweep generators easier to use than ever before. Multiple crystal markers, post-injection marker systems, higher outputs, solid-state circuitry, and inclusion of necessary cables and probes, have produced more accurate and reliable sweep instruments to decrease the time involved and cost of a service alignment.

Sophisticated Servicing

With the advent of color television, more sophisticated service equipment has become necessary. To the television technician, the sweep generator has become as important as a voltmeter, color generator, and a wide-band oscilloscope. Basic servicing instruments are indispensable to the service shop, but proper alignment cannot be obtained with them alone. About one-third of an average color receiver consists of tuned circuits which, when misadjusted, cause poor performance even though the components are not defective. Important signal-carrying frequencies can be severely attenuated by mistuned coils. A color generator with i.f., video, audio, and sync signal outputs is adequate for checking proper signal phase relationships for color, but it should never be used as a substitute for a sweep generator. Since sweep alignment is very accurate and gives the best results, most manufacturers specify it in their service notes. Generally, bandwidth alignment and trap adjustments in color receiver circuits are critical and the required accuracy is many times greater than that needed for black-and-white sets.

Since color-TV receivers are dependent on proper operation of the tuned circuits, it is worthwhile to review the circuit theory. To achieve a wide bandwidth, many amplifiers have stagger-tuned circuits in which the first stage is designed to pass a relatively narrow band of frequencies and attenuate all others. A following stage is similarly tuned, but passes a different band of frequencies. Other stages may follow, but the over-all effect is the uniform amplification

of a bandwidth slightly wider than the sum of the bandwidths of each stage. Uniform amplification requires each stage to supply enough gain to compensate for the attenuation of other stages. Input and output impedances can also affect tuning.

In many cases, coils and transformers are common to several stages. In such circuits transformers and traps interact so that using an r.f. generator to adjust each coil for a maximum or minimum voltmeter indication is not a practical nor reliable method of alignment. Transformers and coils adjusted for too much gain or bandwidth will distort the total response and produce improper phase response, resulting in poor color reception. Adjacent-channel interference, grainy pictures, loss of detail, reduced sensitivity and selectivity, and poor fine tuning are characteristics of misaligned receivers.

These examples point to the most important fundamental characteristic of all tuned amplifier circuits—that the *gain-bandwidth product* is far more important than either gain or bandwidth separately. Because the gain-bandwidth product is closely related to frequency response, using a sweep generator to develop a frequency-response curve is a powerful tool in measuring this basic parameter. This unique capability arises from the ability of the sweep generator to produce a band of uniform-amplitude frequencies which can be applied to the test circuit. Although the sweep-frequency signal bears little resemblance to a normal station signal, the manner in which the circuit operates on the test signal is a good indication of what it will do to a signal carrying information. For example, two very important frequencies in the video i.f. stages of a color receiver are the 41.25-MHz sound carrier and the 42.17-MHz color subcarrier. These frequencies are very close to each other on the video response curve. The color subcarrier is usually halfway up the response trace with the sound carrier well in the sound trap. If a check with a sweep generator shows improper positioning due to a misadjusted trap or a mistuned transformer, severe attenuation of the color carrier will result in an unacceptable color picture. However, the narrower bandwidth may still permit good black-and-white reception.

A routine alignment check could have caught this fault and saved much time spent checking the color circuits.

Method of Signal Generation

Various methods have been devised for generating a sweep-frequency signal. Each method uses a basic oscillator in which the inductance or capacitance of the frequency-determining network is caused to vary at a 60-Hz rate by mechanical or electrical means. One of the more successful early methods utilized a motor to rapidly turn the shaft of a variable capacitor, causing the area between the plates and hence the capacitance, to vary rapidly from maximum to minimum. This was later replaced by the vibrating-plate capacitor in which a moving coil is mounted in a magnet assembly in about the same way as a loudspeaker is built. Early models actually fastened a thin metal plate to the paper cone of a loudspeaker and used it as one plate of a capacitor. In later models, the moving coil drives a movable capacitor plate (rotor). The fixed plate is the stator. To increase the capacitance variation, the plates are often constructed coaxially. Fig. 1 shows a vibrating-capacitor arrangement. The center of the frequency band is preset by adjusting the tank coil. The amount of frequency deviation, or sweep width, is determined by the amplitude of the 60-Hz signal applied to the moving coil.

The most common method of generating a sweep signal is an all-electronic system which uses a saturable inductor. In this technique, a ferrite material is used as a core for several oscillator tank coils. A control winding is also wound around the core.

Fig. 2 shows a typical saturable-reactor circuit. This device is more easily understood if you think of it as a current-controlled inductance. An increase in the control winding current increases the flux density of the core, lowering the permeability and decreasing the inductance of the tank coils. Since the core's permeability characteristics are non-linear, a suitable d.c. bias is required in the control winding to move the operating point into a linear region. The coil windings are then switched into the tank circuit of an oscillator to produce the sweep frequency. A better method would be to eliminate all r.f. switching and provide a separate oscillator for each frequency range. Such a method is shown in Fig. 3. Here, the amplitude of the 60-Hz current determines the width of the frequency range. The sweep center control changes the d.c. bias on the core and hence the center frequency of the sweep oscillator. Capacitors C1 and C2 are used to reduce interaction between the two controls. The advantage of this more advanced circuit is that the entire r.f. section is easily shielded, thus reducing stray radiation.

Another method of sweep generation uses a voltage-controlled capacitor, just the opposite of the current-controlled inductor. This solid-state device is simply a semiconductor diode in which the reverse-biased junction capacitance has been optimized for better performance. These devices are quite nonlinear. Special frequency-compensating circuits, such as ramp or adjusted triangular waveforms, are often used instead of the more accessible 60-Hz sine wave. For

Fig. 1. In the vibrating plate capacitor, a moving coil mounted in a magnet assembly drives capacitor rotor.

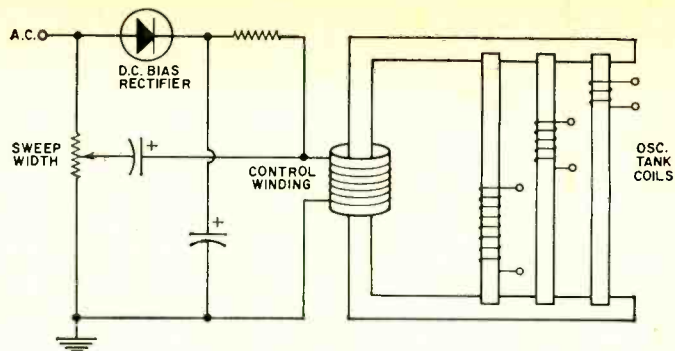
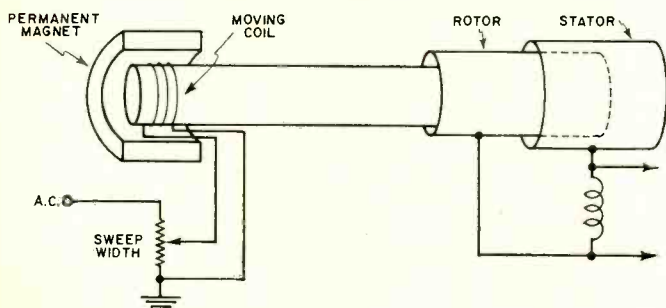

Fig. 2. The current-controlled inductance (saturable reactor) is most popular method of generating sweep signal.

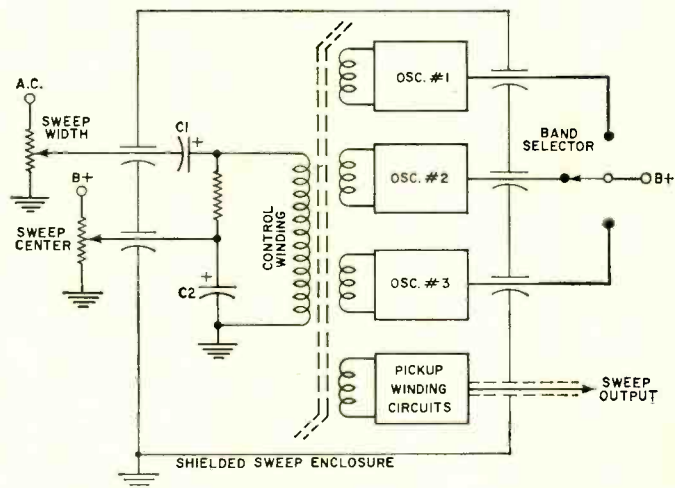

Fig. 3. In this circuit, the r.f. outputs are unswitched.

relatively small sweep widths, such as those encountered in FM i.f. alignment, a voltage-controlled capacitance diode works reasonably well. This type of circuit is available in at least one FM alignment generator, but is more common in the highest priced generators.

Commonly Used Terms

After a service technician has decided to use the sweep method, or if he is stepping up to a later model generator, he is immediately confronted by a new vocabulary describing the functions of an available instrument. The *sweep range* is a measure of what frequencies are available at the sweep output. These frequencies generally range from 2 MHz to 220 MHz in several overlapping bands. A sweeper covering the whole range in overlapping bands has continuous band coverage. Some sweepers are built specifically for the service technician and cover only the ranges most often encountered in television and FM alignment. These are selective band sweepers. The *sweep center* and *sweep width* define the frequencies applied to the receiver under test. For example, the video i.f. stages are usually centered at about 43.5 MHz with adjacent-channel picture and sound carriers at 39.75 MHz and 47.25 MHz, respectively. To sweep these stages set (in some instruments this frequency is internally preset) the sweep center to 43.5 MHz and increase the sweep width until it is about 4 MHz on each side of the center frequency. The *sweep output* and *uniformity* (flatness of the output) are usually expressed together. For service alignment work the generator should have an output of from 0.1 to 0.5 volt r.m.s. with a sweep uniformity of at least ± 1 dB. To control the output sweep amplitude, an *attenuator* is used. This maintains a constant load impedance and reduces standing waves which may cause non-uniform sweep outputs. Most generators use resistors mounted on a rotary switch for attenuation, but this allows relatively

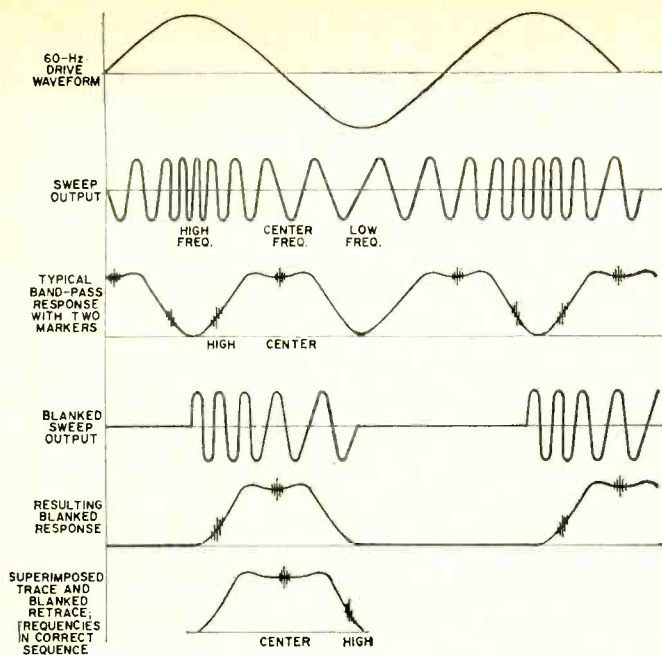

Fig. 4. A comparison of a sweep generator's signals.

high r.f. leakage at lower levels of output voltage. A step attenuator with individually shielded switches provides more accurate attenuation by reducing r.f. leakage.

Needs Bias

During sweep alignment the receiver is operating under no-signal conditions and may require some sort of d.c. bias, possibly as much as -20 volts. Most sweep generators have this convenience feature. The negative bias works fine for today's tube television receivers, but an isolated supply providing either positive or negative bias is needed for some

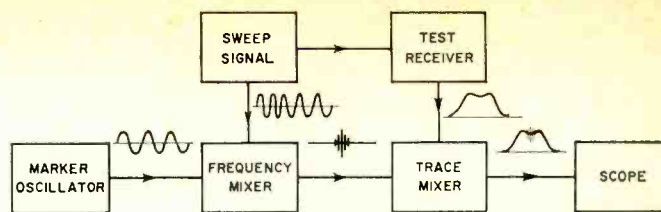

Fig. 5. The marker signal is added after the swept frequency has passed through the receiver. This prevents overloading.

FM receiver alignment. Some manufacturers are producing solid-state color receivers which may require positive bias.

Two other terms commonly associated with sweepers are *blanking* and *horizontal phase control*. These functions are needed because many sweepers use a symmetrical 60-Hz sine wave to control the sweep width. During the first half of the waveform (180°), the higher frequencies are generated first. During the second half of the sine wave, the frequencies are generated in reverse order, that is, from low to high. When this signal is applied to a receiver, two nearly identical response curves are produced which would be somewhat misleading if the return trace, or retrace, were not eliminated by electronically turning the oscillator off and "blanking out" one of the curves. As a final touch, the 60-Hz drive waveform can be applied to the horizontal deflection terminals of a scope. Now, when the scope is switched to the external horizontal drive position, the bandwidth response will be superimposed on the blanked response. This provides a convenient base line for viewing the bandwidth. Of course, the scope must have good low-frequency response to avoid a tilt in the base line. But to be sure the trace and retrace curves actually superimpose, a phase control in the horizontal output circuit varies the phase of the horizontal drive waveform. On some generators, the blanking circuits can be switched on and off. See Fig. 4.

Cables are an important and sometimes troublesome auxiliary to a generator. Many (Continued on page 66)

Table 1. Performance characteristics of five representative service-type sweep generators.

MODEL	OUTPUT BANDS	SWEEP METHOD	BIAS SUPPLY	ACCESSORIES	MARKER FACILITIES	OTHER	PRICE
Eico 369	(five continuous)	saturable reactor	none	Terminated r.f. cable; demodulator probe; shielded 2-wire cable for scope vert. & horiz.	One variable marker oscillator calibrated with 4.5-MHz crystal (supplied); post-marker	A.g.c.; tubes; 50-ohm output	\$ 99.95 (kit) \$149.95 (wired)
	3-7 MHz 0.3 V min.						
	6-16 MHz 0.3 V min.						
	16-42 MHz 0.3 V min.						
	36-95 MHz 0.2 V min.						
75-220 MHz 0.1 V min.							
Heath IG-57	(selective)	saturable reactor	0-18 V isolated from ground; may be used either as positive or neg.	Terminated r.f. cable; attenuator cable; coax clip-lead cable; coax scope vert. cable; demodulator probe; bias & scope horiz. leads	Fifteen crystal markers, eight on video i.f. band; LC-type 100-kHz marker for FM; post-marker circuits	Switchable retrace blanking; external step attenuator; 75-ohm output; solid-state	\$135.00 (kit) \$179.00 (wired)
	2.2-5.5 MHz 0.5 V min.						
	(10.4-11 MHz on harmonics)						
	38-49 MHz 0.5 V min.						
	v.h.f. ch. 4 0.5 V min.						
(v.h.f. ch. 10 on harmonics)							
Knight KG-687	(three continuous)	saturable reactor	Two regulated outputs; 0 to -20 V each	Terminated r.f. cable; coax scope vert. cable; coax clip-lead cable; bias & scope horiz. leads	(same as Eico)	A.g.c.; 75-ohm output; solid-state	\$120.00 (kit) \$185.00 (wired)
	3-50 MHz 0.3 V min.						
	50-120 MHz 0.1 V min.						
120-240 MHz 0.05 V min.							
Precision E410C	(six continuous)	saturable reactor	none	Terminated r.f. cable; marker cable; coax clip-lead cable; scope vert. & horiz. lead	(same as Eico)	A.g.c.; 75-ohm output; solid-state	\$189.00 (wired)
	3-7 MHz						
	6-15 MHz No output						
	13-35 MHz figures						
	33-90 MHz available						
	80-216 MHz available						
400-1080 MHz							
RCA WR-69A	(selective)	vibrating capacitor	Two outputs, 0 to -15 V each	Terminated r.f. cable; 50-ohm to 300-ohm antenna cable	none	Switchable retrace blanking; 50-ohm output; tubes	\$295.00 (wired)
	50 kHz-50 MHz 0.1 V min.						
	54-72 MHz 0.1 V min.						
	76-88 MHz 0.1 V min.						
	80-108 MHz 0.1 V min.						
174-216 MHz 0.1 V min.							

Volkswagen's electronic fuel-injection system

By FRED W. HOLDER/Technical Supervisor, Bendix Field Engineering Corp.

Fuel-injection systems are supposed to up engine efficiency by accurately controlling the fuel fed to an engine. In the newest model Volkswagens, an electronic fuel-injection system uses a computer to control the gas flow.

THE newest electronic automotive innovation is Volkswagen's fuel-injection system. This device, which purports to increase engine efficiency by delivering only the amount of fuel actually needed at any given moment, is available on VW's 1968 Fastback and Squareback models. The new fuel-injection system also reduces the emission of hydrocarbons and carbon monoxide to such low limits that no other anti-smog device is required.

In the past, a few American-made auto models were equipped with fuel-injection systems on an optional basis, the last of these was the 1965 Corvette. Corvette's fuel-injection system was used on a 375-horsepower engine, which boasted 10 horsepower more than the next larger engine. It also cost \$411 more. The Volkswagen fuel injection, on the other hand, is furnished as standard equipment on all Model 1600's. The price has increased only an average of \$36 over 1967 models. It is hard to say how much of this increase was caused by the fuel-injection system because there is no price for the same model with conventional carburetors.

System Development

The system is the result of a two-year development program by Robert Bosch, Inc. of Germany. During development, Bosch worked closely with Volkswagen. Application

work and endurance testing were a joint effort. Approximately one year was devoted to a comprehensive test program involving a large number of vehicles. The program encompassed all kinds of driving conditions over two million kilometers (about 1.2 million miles) in Germany. Periodic inspections were conducted on the test vehicles to detect any possible performance deterioration. The results of these tests were very good. Each system was found to be within specifications after more than 60,000 miles of operation.

Volkswagen's initial design goal was to comply with the exhaust emission limits established for automobiles in the United States. Thus, it was necessary to develop injection characteristics and ignition timing that would give acceptable emission levels without unduly sacrificing fuel economy and engine performance. The final design met all of these criteria: low emission, excellent engine response, and improved fuel consumption.

Measurements made during the testing phase showed that on a level road and at constant speeds of 20, 30, 50, and 75 miles per hour, cars equipped with the fuel-injection system traveled 42.5, 46, 39, and 24 miles per gallon, respectively. The carbon monoxide emission was between 0.15 and 0.3 percent and the unburned hydrocarbon emission was between 20 and 100 parts per million. When tested according to the California test cycle, the carbon-monoxide level was

Fig. 1. View of VW's fuel injection engine showing computer (A), intake air distributor (B), and air cleaner (C).

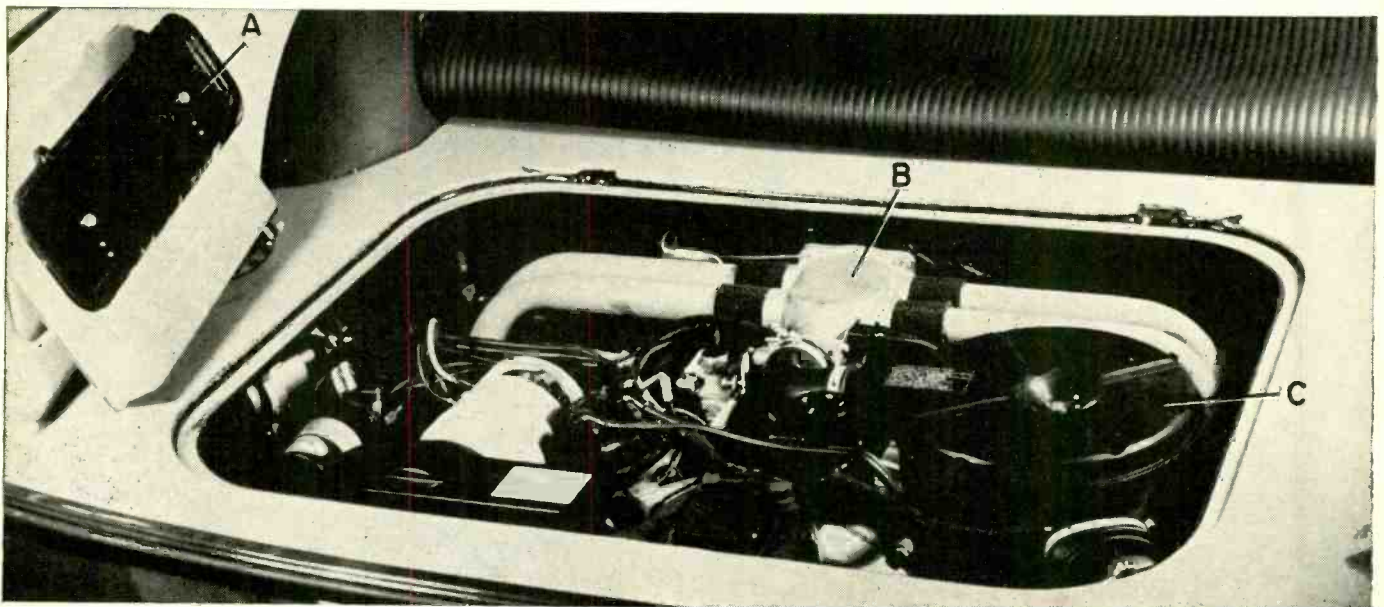

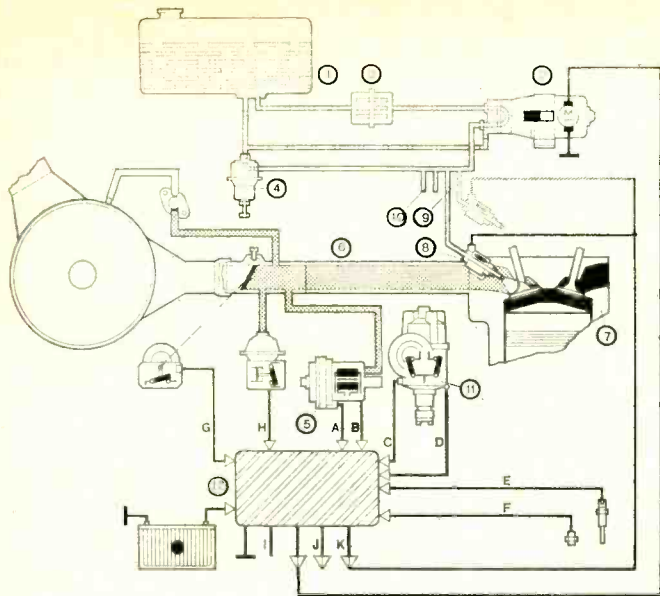
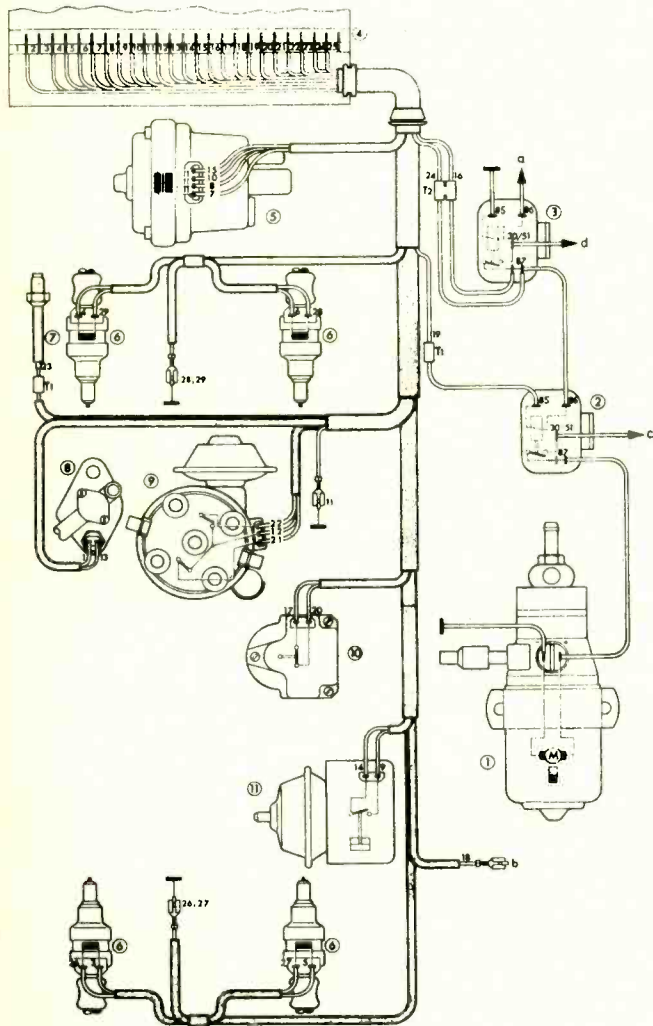

Fig. 2. Simplified layout of Volkswagen's fuel-injection system.

0.3 to 1.0 percent and unburned hydrocarbon was about 180 to 270 parts per million. These measurements were well within the California requirements of 2.3 percent carbon

Fig. 3. Interconnection diagram of the Volkswagen electronic control system showing (1) electric fuel pump; (2) pump relay; (3) main relay; (4) computer; (5) pressure sensor; (6) injectors; (7) temperature sensor on cylinder head; (8) aux. air regulator with temperature sensor in crankcase; (9) distributor with trigger contacts; (10) throttle switch; and (11) the pressure switch.



COMPONENT		SIGNAL	
INDEX NO.	NAME	INDEX LETTER	NAME
1	Fuel tank	A	Pressure sensor
2	Fuel pump	B	Pressure sensor
3	Fuel filter	C	Trigger contacts
4	Pressure regulator	D	Trigger contacts
5	Pressure sensor	E	Temp. sensor
6	Intake air distributor	F	Temp. sensor
7	Cylinder head	G	Throttle switch
8	Injector	H	Pressure switch
9	Fuel pump (left)	I	Starter
10	Fuel pipe (right)	J	Injectors 1 and 4
11	Ignition distributor	K	Injectors 2 and 3
12	Computer		

Table 1. Component and signal index for Fig. 2.

monoxide and 410 parts per million of unburned hydrocarbons.

Test vehicles started readily under all conditions from -10° to $+105^{\circ}$ F. But, for extremely low temperatures, a cold starting kit with an injector added to the intake manifold was developed. In addition, it was found that vapor lock at higher temperatures could be prevented by increasing the primary fuel pressure.

System Operation

The *Volkswagen* system is a pulse-timed manifold injection system (Fig. 1) in which the gasoline is injected into the heads of the intake valves by electromagnetically actuated nozzle valves. Fig. 2 shows a simplified layout of the fuel injection system while Table 1 lists the component and signal indices for the system of Fig. 2.

Each cylinder of the engine has its own injection valve which opens once for each revolution of the camshaft. An electric fuel pump draws fuel from the tank through a filter and pumps it *via* a pressure line into the ring main which distributes the fuel to the four injectors; it also pumps excess fuel to the tank through a special return line. A regulator at the end of the ring main keeps the pressure applied to the injectors at a constant 28 psi.

The prevailing operating conditions determine the amount of fuel injected into each cylinder. When an electronic signal is received from the computer, the injectors are electromagnetically opened $1/12,000$ th of an inch to squirt raw fuel into the area above the intake valve where it is atomized by the air rushing into the combustion chambers. The injectors are operated in pairs (injector pair 1 = cylinders 1 and 4; injector pair 2 = cylinders 2 and 3).

The trigger pulse for fuel injection is synchronized with engine rotation by two trigger contacts located in the lower part of the ignition distributor. One set of these contacts generates a pulse for its injector pair once every revolution of the camshaft. The two trigger sets are spaced 180 (camshaft) degrees apart. When the contacts close, a trigger pulse is generated which opens a pair of injectors and initiates a time delay to control the period the injectors remain open. The time-delay circuit is common to both injector pairs and is switched from one pair to the other by the sequencing of the trigger contacts.

Fig. 3 shows the interconnection of the components of the electronic control system. The "heart" of the system, a foot-long computer, constantly monitors seven pieces of information to determine engine requirements and to maintain a fully controlled and properly metered flow of fuel and air to the cylinders. Engine speed and engine load are the primary parameters used to determine operating requirements of a warm engine. Speed information is available directly from the incoming triggering pulses. The load factor, determined by intake manifold pressure, is measured by an inductive pressure sensor connected to the intake air distributor.

The use of manifold pressure as a load signal has the disadvantage of a slight time lag between a sudden change in

throttle position and the corresponding increase in fuel necessary for acceleration. The delay is only about 50 milliseconds and is practically unnoticeable under normal driving conditions. The Volkswagen system eliminates this problem by providing two additional signals to the computer; a full-load signal and a deceleration signal. When full load is ordered by a sudden change in throttle position (indicated by a drop in the manifold vacuum to a predetermined level) a vacuum-operated switch asks the computer for an enriched fuel mixture. On deceleration, the fuel is completely shut off. This operation is initiated by a Microswitch mounted on the air valve body. At closed throttle position or when the engine speed is above 1800 r/min, a lever on the throttle shaft actuates the Microswitch and signals the computer to suppress the injection pulses. The fuel supply is switched on again when the engine speed drops to 1250 r/min so that a smooth transfer to idling operation is obtained.

During the warm-up period, information necessary to determine mixture adjustments is supplied by temperature sensors located in the cylinder head and the crankcase. These sensors which contain temperature-sensitive resistors (thermistors with positive and negative temperature coefficients) establish, as a function of temperature, the control information used to determine the correct fuel mixture. When starting a cold engine, the fuel mixture is a function of the temperature signal and a voltage signal from the starter.

Clean air is supplied to the intake air distributor inlet, through an air cleaner. A throttle valve located on the inlet side of the intake air distributor controls the amount of air flowing into the engine. This valve is connected to the accelerator pedal by a cable. At idling speed, the throttle valve is fully closed and air passes through an idling circuit into the intake air distributor. When the engine is up to operating temperature, an idling air screw controls the amount of air needed for the engine to operate at 850 r/min. At engine temperatures below 120° F, air required for smooth idling increases. Then auxiliary intake air is channeled into the air distributor through a bypass valve whose air flow is thermostatically controlled by crankcase oil temperature.

The Computer

The computer (see Figs. 4 and 5) contains one power amplifier for each group of injection valves, the time delay network, and miscellaneous circuitry for deceleration control and flooding protection. The power amplifiers are driven by gated pulses generated from the combination of

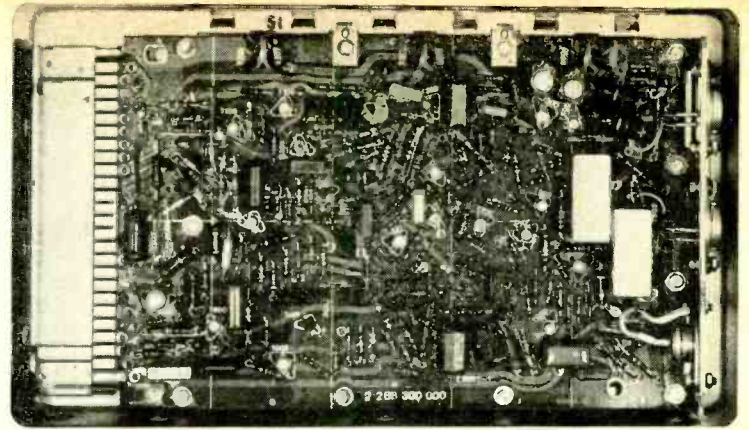

Fig. 5. Computer with cover removed to show component layout.

pulses, from the trigger contacts, and the time-delay circuitry. A logic circuit insures proper correlation between power amplifier and trigger contacts to exclude unwanted fuel injections that could be caused by contact bounce.

The core of the time-delay network is a monostable multivibrator that changes from its stable "off condition" to its unstable "on condition" when a triggering pulse is received. The "on" period of the multivibrator depends primarily on the inductance of the manifold pressure sensor, but is modulated according to the non-linear requirements of the engine fuel characteristics by a corrective speed circuit. Additional circuitry processes and modulates the multivibrator time period to compensate for cold start, warm-up period, and full-load requirements. In addition, the computer houses a voltage calibrating circuit that reduces the injection period slightly to compensate for supply voltage changes. This is necessary because the injector valve rise time decreases and valve closing delay increases with voltage. Without compensation these characteristics would cause an increase in fuel volume with a higher supply voltage.

The computer circuitry also contains a safety feature that disconnects the fuel supply pump unless engine speed is greater than 100 r/min or the cranking motor is being operated. This feature prevents flooding of a stopped engine, should an injection valve fail to close. A time-delay switch in this circuit turns on the fuel pump for 1 to 1½ seconds after the ignition switch is turned on to allow a build-up of fuel pressure in the system.

The computer contains over 200 components, including 25 transistors and 35 diodes. It is connected to the vehicle cable harness by a multiple (Continued on page 102)

Fig. 4. Block diagram of Volkswagen's fuel injection system computer. The various functions are described in text.

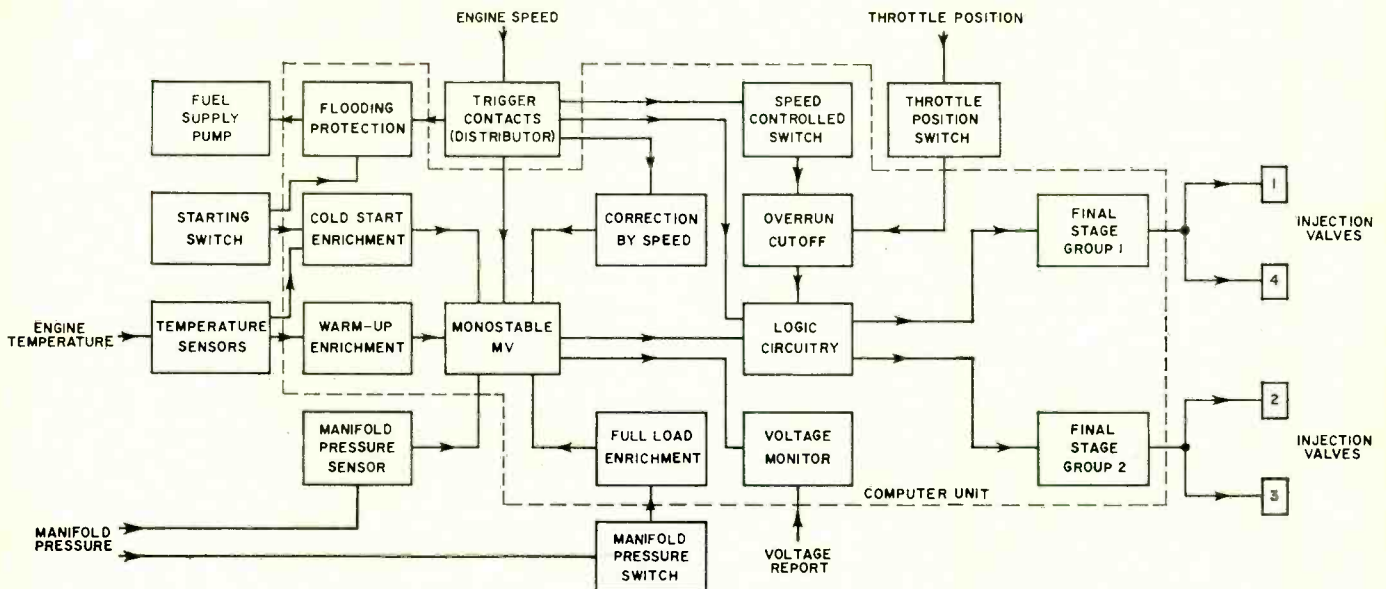

Water-activated AgCl/Mg batteries come in various sizes and shapes. External fusing is sometimes used to assist in activation of battery.

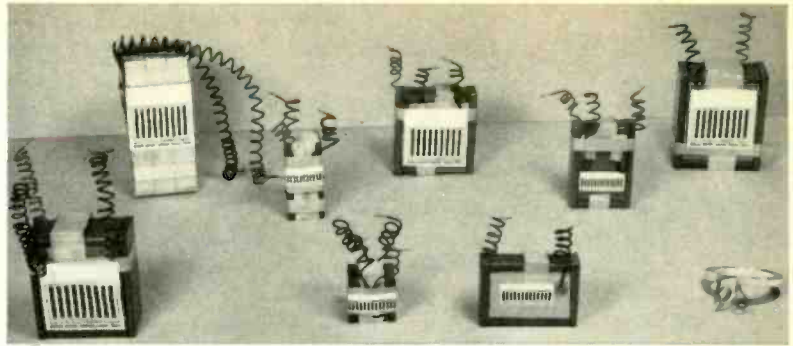

silver chloride–magnesium **A POWERFUL BATTERY**

By HOWARD J. STRAUSS/Director R & D
Burgess Battery Div., Clevite Corp.

These batteries have become a sophisticated power source. Their long and stable shelf life is important to the military.

DURING World War II the silver chloride-magnesium water-activated battery was developed to power sonobuoys. Today, it represents a high degree of sophistication in terms of the electrical services it can provide. Essentially unique in its operating characteristics, the silver chloride-magnesium water-activated battery is also finding additional applications as the power source for radiosonde equipment, air-sea rescue equipment, buoy lights, and a broad variety of marine and high-altitude applications. Because of the growing importance of these areas of activity, we should up-date our knowledge of the silver chloride-magnesium battery.

As its type designation indicates, the silver chloride-magnesium battery is supplied in dry, storage-stable form and activated by introducing water into the space between the electrodes. In most applications, the water is in the form of natural sea water since it contains enough dissolved salts to form a suitable electrolyte. However, the battery is not restricted to activation by salt water, fresh water can be used either with or without salt stored in the battery itself. As can be expected, the battery is most efficient when the electrolyte is natural sea water or brine.

Because it need not carry its own electrolyte, the silver chloride-magnesium battery has a high energy content per unit weight. In most designs the electrodes are very closely spaced so that the system also has a high power capability despite the fact that its electrolyte has low conductivity. Table 1 summarizes the practical levels achieved by current designs, together with comparisons of other systems.

Perhaps the outstanding characteristic of the silver chloride-magnesium (AgCl/Mg) system is its extreme inertness prior to activation. All of the components, including the electrode materials, are essentially inert during ordinary storage. Silver chloride, for example, can be left unprotected in the atmosphere (and even exposed to light) with little deterioration. The magnesium quickly develops its own protective film so that it too remains inert even in atmospheres which are very high in humidity and temperature. Thus, silver chloride-magnesium batteries can be stored almost indefinitely in ordinary containers, provided water is not allowed to enter the space between the electrodes. Even if a small amount of water does get in, the battery suffers no serious power loss unless, of course, sufficient water enters to activate the battery. This extreme stability has been particular-

ly valuable in sonobuoy applications where it is difficult to protect the battery against weather and the sea. Silver chloride-magnesium batteries stored up to 8 or 9 years under "casual" conditions can give satisfactory performance. At the moment, however, 5 to 7 years casual storage is a reliable life-expectancy figure. There are indications that there isn't significant deterioration in batteries stored well over 10 years in closed cans.

In practice, AgCl/Mg batteries are commonly stored under conditions of high temperature and high humidity (165° F, 90 to 100% relative humidity) as well as at extremely low temperatures and low humidities (−60° F and 0% RH). They are also capable of withstanding cyclical changes in temperature and humidity—even a temperature-humidity program which carries the storage atmosphere through the dew point.

Rapid Burst of Power

Depending upon specific designs, another outstanding characteristic of the silver chloride-magnesium system is its ability to be rapidly activated. Generally speaking, activation is brought about by plunging the battery into water. Modern AgCl/Mg batteries have activation times of less than 500 milliseconds.

Under extremely low temperature conditions, a short or fuse can be used to start the battery. This can be done because of the extreme stability of the AgCl/Mg system prior to activation. Upon introduction of water, the initial energy produced by the battery appears as internal heat and very quickly (on the order of 15-45 seconds) raises the electrical performance of the battery to operational levels. Of course, the fuse melts during this time so that only a small frac-

Table 1. The energy yields of reserve batteries.

SYSTEM	OPEN-CIRCUIT VOLTAGE	OPERATING VOLTAGE	WATT-HOURS	
			per lb	per cu in
AgCl/Mg	1.9	1.3-1.6	75	7.5
Ag ₂ O/Zn	1.86	1.3-1.5	50	3.5
CuCl/Mg	1.65	1.1-1.3	35	1.3
PbO ₂ /Pb	2.1	1.6-1.9	20	2.5

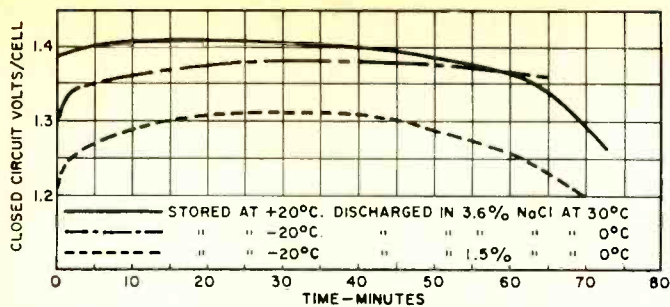

Fig. 1. Typical discharge curves for AgCl/Mg batteries discharged under various conditions of temperature and salinity.

tion of the battery's energy is expended. This technique permits a good deal of latitude in the design of activation characteristics.

As can be expected, activation at higher temperatures presents no problems and can be even more rapid. Once activated, the system is not reversible and the entire energy of the battery must be withdrawn.

A Wide Variety of Characteristics

Electrically, the silver chloride-magnesium battery offers a wide variety of characteristics which are controllable by design. However, the outstanding characteristic of this system is that it is capable of extremely high rates of discharge. It is not uncommon to have discharge rates in which all of the battery's energy is withdrawn in a period of 10 minutes. In sonobuoy work, discharge rates of 30 minutes to one hour are rather common. In addition, the battery is capable of unusually high rates for very short periods of time, for example with pulsed loads. On the other side of the scale, low rate discharges are also possible, but here the internal losses of the battery become high relative to the payload, and discharge rates in excess of 72 hours are not generally recommended for conventional silver chloride-magnesium batteries.

The silver chloride-magnesium battery has an unusually constant discharge voltage. Normally, many batteries exhibit a very high voltage immediately after activation, and even for a substantial portion of the discharge period. Thereafter the battery may exhibit significantly flat voltage-time characteristics. The silver chloride-magnesium battery, however, arrives at its normal operating voltage without overshooting, so that the discharge rate follows an essentially flat curve virtually from the beginning of the discharge period. As the discharge cycle proceeds, as we shall discuss a little later in this article, the conductivity of the silver chloride electrode increases, and the internal resistance of the battery decreases. Thus the polarization effects which normally decrease the voltage output toward the end of the discharge period are, to some degree, counteracted and help maintain the output at a constant level. That the battery does not overshoot its normal operating level at the beginning of a discharge cycle is very important in circuits involving transistors. Since transistors are not capable of withstanding voltages that are very much in excess of rated limits, electronics designers normally use larger (and more costly) components to protect against initially high battery voltages.

Finally, it is interesting to note that the silver chloride-magnesium battery yields essentially constant energy at various discharge rates. This permits the system to be used over a wide range of operating values with clearly established capacities. This very fact enables an AgCl/Mg cell to be used as a basis for developing a timing device. In this case, one or two battery cells are made with small but precise amounts of silver chloride. These cells are physically a part of the over-all battery, but electrolytically isolated from the other cells. A precise load is placed across these cells which causes them to operate for a predictable time

interval. As can be seen from the curve of normal discharge characteristics (Fig. 1), there is a very pronounced voltage change when the silver chloride electrode is exhausted. This voltage change has been used successfully to time various operations. In sonobuoys, for example, "timer" cells are used to take the radio transmitter off the air at a predetermined time. This has permitted the use of sonobuoys in many sensitive intelligence-gathering situations.

A Unique Battery

To more fully appreciate the operating characteristics of the silver chloride-magnesium battery, it is necessary to know a little bit about its construction and chemistry.

The unusual and unique characteristics of the silver chloride-magnesium battery are largely due to the properties of the silver chloride itself. Silver chloride is a non-metallic, non-conductive salt which, nevertheless, can be melted and cast and rolled into sheets of almost any desired thickness. These sheets can be handled by ordinary sheet-metal working techniques, that is, slitting, shearing, bending, and so forth. Therefore, they can be made into electrodes with very exact dimensions and very reproducible electrochemical properties. The magnesium anode, against which it works, is of course readily available in sheet form and can also be worked by conventional techniques to yield electrodes of exact physical dimensions and electrical properties.

When the electrodes are stacked to form a battery, the electrode spacing can be made very small. This close spacing results in a battery with very low internal resistance. In a common form of construction, nylon filaments are used to separate electrodes of opposite polarity. These filaments are about 12 to 20 mils thick, although in special applications batteries have been built with 8-mil nylon filaments. The close spacing has an additional benefit. It permits more battery plates per unit volume and therefore greater energy output.

As stated, the silver chloride electrode is essentially a non-conductor so to provide a means for distributing electrons to the reaction sites, the silver chloride surface is chemically reduced to metallic silver. This metallic silver "grid" acts as a very efficient electron distributor. The reduction of the silver chloride surface to metallic silver is readily accomplished using ordinary photographic developers.

During the discharge cycle, silver chloride is reduced to metallic silver and chloride ions are liberated. This is shown by the following reaction: $2 AgCl + 2e \rightarrow 2Ag^0 + 2Cl^-$.

As discharge proceeds, the cathodic electrode becomes more and more porous and more and more silver is built up. The increased electrode-electrolyte interface helps maintain the potential of the cell against the effects of cell polarization. Furthermore, the silver chloride, which is non-porous in itself, yields a porous form of metallic silver during the course of discharge so that an extended interface between silver, silver chloride, and electrolyte is built up. As could be expected, the discharge of a silver chloride electrode proceeds from the outer surface inward in a more or less uniform manner. Upon complete discharge of a silver chloride electrode, the residue is simply metallic silver from which pure silver is readily recoverable.

The composition of the magnesium electrode (anode) is very critical. Depending upon the specific nature of the application, compositions of pure magnesium and magnesium with up to 8% aluminum and 3% zinc are used. As can be seen from the discharge reaction of magnesium, $Mg + 2Cl^- \rightarrow MgCl_2 + 2e$, the chloride ions which are liberated by the discharge of the silver chloride combine with the magnesium ions generated at the anode to form soluble magnesium chloride. Thus the over-all discharge reaction: $2AgCl + Mg \rightarrow 2Ag^0 + MgCl_2$ is rather straightforward.

In actual practice, however, several competing reactions also occur simultaneously. For example, magnesium metal reacts spontaneously with water according to the reaction:

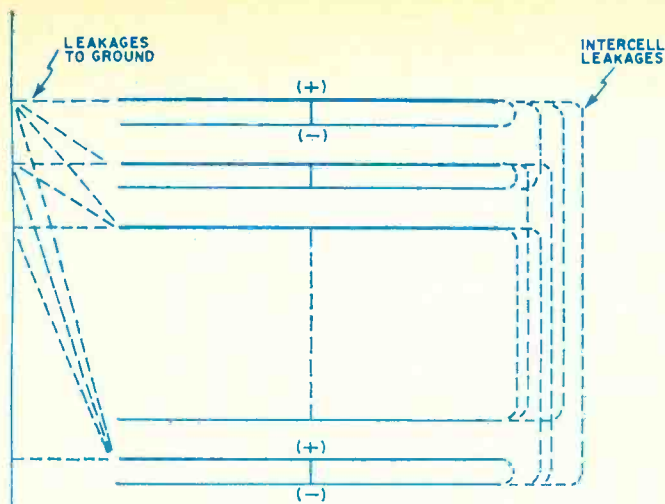

Fig. 2. Leakage current paths in multi-cell batteries.

$Mg + 2 H_2O \rightarrow Mg(OH)_2 + H_2$ to liberate hydrogen and produce insoluble magnesium hydroxide. This magnesium hydroxide forms an interfering layer as far as the ionic transport to and from the surface of the magnesium is concerned, and does indeed act to polarize (decrease the potential) of the electrode. Usually, by choice of the proper magnesium alloy, this magnesium hydroxide can be obtained in a non-adherent, non-protective form. In this case, however, it is necessary to physically remove the magnesium hydroxide from the cell, especially since there is very little room to allow materials of this nature to accumulate between the electrodes. Material is removed by having the cell open to the sea water at both top and bottom so that water can enter and leave the cell freely. The gas generated by the interaction of magnesium and water means that the sea water is continually replaced as the battery operates. Thus, the spacing between the electrodes becomes a compromise between the need to continuously flush the cell with fresh water and the desire for close spacing as required for high power yields.

At first impression, it would appear that the magnesium consumed by the side reaction with water is wasteful. But, on the contrary, this spontaneous "corrosion" of the magnesium is very useful since it also generates a good deal of heat. The heat keeps the internal construction of the battery sufficiently warm to perform properly even in very low temperatures. As mentioned before, in a conventional application of silver chloride-magnesium batteries, they are plunged into $-0.5^\circ C$ sea water after having been stored at $-20^\circ C$. There are really no battery systems that can perform with any reasonable degree of efficiency at these temperature levels. However, the silver chloride-magnesium battery has the unusual capability of being able to heat itself up to a suitable operating temperature so that it does indeed perform very well in such an environment. As a matter of fact, there is really very little loss in total available energy when operating under low temperature conditions when compared to, say, normal ambients.

An unusual thing occurs when batteries are plunged into $-0.5^\circ C$ sea water after having been cooled to $-20^\circ C$. The initial influx of water, coming in contact with a surface at a much lower temperature, tends to freeze; and since the plate spacing is very close, the ice is very likely to block the entrance of the electrolyte. The use of a fuse to generate internal heat, as previously described, frequently prevents such icing. When activated, however, the battery is short-circuited through the fuse and the released energy produces internal heat to prevent such freezing.

Because sea water must enter each cell in order to activate the entire battery, each cell is open at the top and bottom. This introduces a very significant problem in that

each cell is sitting in a common electrolyte. Where there is no communication between the electrolyte from one cell to another, there is no leakage current or internally wasted energy. However, when two or more cells sit in a common electrolyte, the electrodes will short to each other (in various combinations as shown in Fig. 2) and this, of course, robs the battery of available energy. As before, this energy is used to heat the battery and raise it to a suitable operating temperature.

It is entirely possible to control the amount of energy lost through intercell leakage. As can be seen from Fig. 2, it is possible to make the path through the electrolyte which the ions must traverse very long. Since the electrolyte is essentially a high resistance, the leakage currents can indeed be cut to suitable values by proper design. As an example, the edges of the electrodes exposed to the common electrolyte can be covered with tape or lacquer to increase path length. In addition, vent bars can sometimes be placed at or near the vent openings to increase the ion path.

It is interesting to note that the use of vent bars on the top of the battery has a special effect. It will be recalled that one of the products of the magnesium-water reaction is hydrogen gas. By suitable vent bar designs, the free space above the electrodes can be filled with two discontinuous phases of gas and water which in effect eliminate electrolyte leakage paths in this area of the battery. The design of the electrode spacing, the water inlet and outlet ports, and the gas flow path can all be combined to produce precisely the desired performance. However, this phase of the design is practically all empirical and based on prior experience, and is one of the factors that has so far required silver chloride-magnesium batteries to be closely aligned with the apparatus they are intended to power.

There are also leakage currents to ground, since the vehicle in which the battery is housed is generally polarized. The energy content of a silver chloride-magnesium battery is thus consumed in the following ways: 1. through the useful or working load; 2. leakage currents from cell to cell; 3. leakage currents to ground; and 4. spontaneous corrosion of magnesium by water. The proper balance among these various energy consumers, with appropriate attention to the required electrical load and heat effects, accounts for the versatility of the system.

The basic construction of a typical silver chloride-magnesium battery is shown in Fig. 3. It also shows a battery containing a timer cell used to initiate or terminate an event.

In the silver chloride-magnesium system, we have available a versatile electrochemical power source which can be readily coordinated with the operating characteristics needed by the device it is intended to power. Apart from sonobuoys, they power underwater communications systems, safety lighting, marine mensuration, and a great many other devices. The fundamental battery operating properties and construction described in this article are representative of the current state of the art, given in terms which designers must consider in order to take full advantage of the many economical capabilities of the silver chloride-magnesium system. ▲

Fig. 3. Timer cells are part of a typical AgCl/Mg battery.

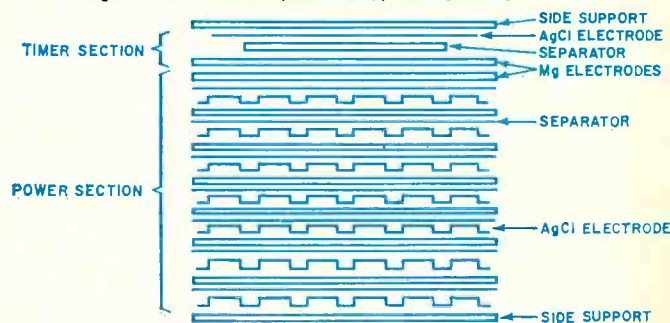

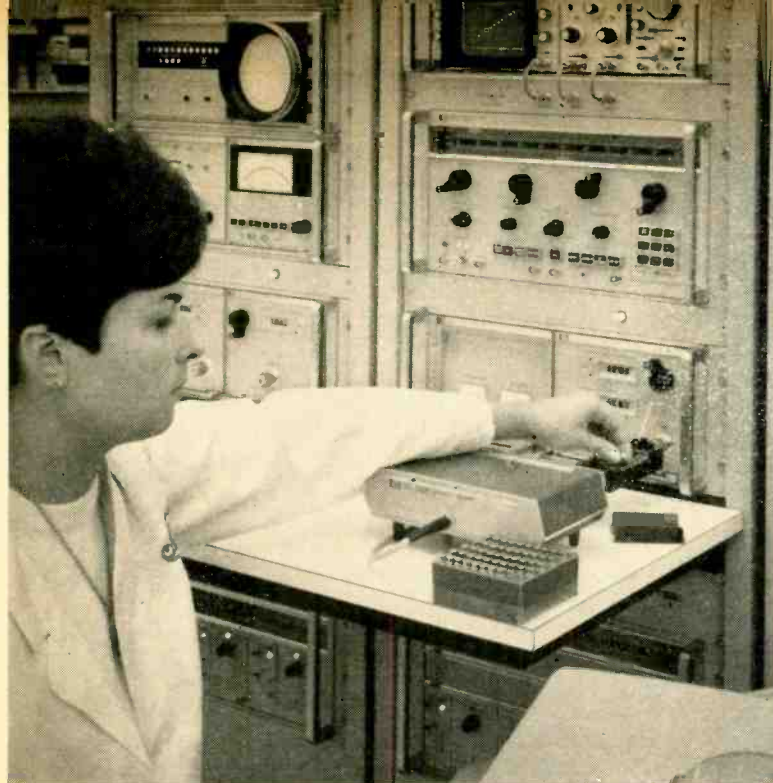

Production testing of transistors with an automatic network analyzer employing a multi-band sweep oscillator as source.

microwave sweep oscillators for the laboratory

By DAVID L. WIDMAN
Applications & Service Engineer, Hewlett-Packard Co.

The fastest way to measure the performance of a network or component over a given frequency range is by swept-frequency techniques. Everything from admittance and bandwidth of circuits to v.s.w.r. and Z parameters can be checked. Here's what the newest equipment will do to speed up microwave measurements.

A SWEEP oscillator is a source of variable-frequency r.f. power. When it is used with other readily available test equipment, the sweeper provides the fastest and most economical way to measure the performance of almost any network or component. Everything from admittance and bandwidth to v.s.w.r. and Z parameters can be determined by swept-frequency techniques. Whether you are trying to align a receiver or design a new wide-band linear microcircuit, a sweeper can help you do the job better and faster.

Sweeper development has gone hand-in-hand with the development of other test equipment. The goal has always been to simplify and speed up the measurement process.

An example of what has happened can be shown by considering the measurement of v.s.w.r. Measuring v.s.w.r. one frequency at a time has always been a slow and tedious process. In 1952 the first wide-band directional couplers came out. These couplers made it possible to easily measure incident power to and reflected power from a device under test. The ratio of incident and reflected power could then be used to calculate the v.s.w.r.

The measurements were still made at single frequencies, however. By 1954 two new instruments had been developed to simplify and speed up the measurements. One instrument was the *Hewlett-Packard* Model 416A ratio meter, which could take the output from the directional coupler and indicate directly in "percent reflection." This could be easily converted to v.s.w.r. The other instrument was the *H-P* Model 670A sweep oscillator. The latter was probably the first microwave sweep oscillator. By today's standards, this instrument was pretty crude. It used a motor drive to mechanically tune a klystron oscillator. Because it was motor driven it didn't sweep very fast, but when used with the ratio meter and an X-Y recorder, it became possible to make a continuous, permanent, swept-frequency performance test of

the v.s.w.r. of many different types of microwave devices. The Model 670A was superseded in 1957 by an electronically tuned sweep oscillator.

B.W.O.'s & Network Analyzers

The voltage-tuned sweeper which appeared in 1957 used a backward-wave oscillator (b.w.o.) as the r.f. source (Fig. 1). Most sweepers sold today still use a b.w.o.

The development of the b.w.o. sweeper again speeded up the measurements. The device could be swept much faster than a mechanically tuned sweeper so the oscilloscope began to be used as the indicating device.

When logarithmic amplifiers are added to the swept display, it is possible to measure return loss from a device under test directly in dB. Return loss is just another way of measuring v.s.w.r. When log amplifiers are used with a swept slotted line, the v.s.w.r. in dB can be indicated directly on the oscilloscope.

The v.s.w.r., however, is only half of the information needed to specify the impedance of a device. Network analyzers now make it possible to measure both the phase and amplitude of the signal reflected from a test device. Such an analyzer will make the phase and amplitude measurements continuously as the frequency is being swept.

The network analyzer is used not only to measure impedance, but to measure gain, loss, or phase shift through a device on a swept-frequency basis. The information can be presented on a meter, oscilloscope, or X-Y recorder. It can even be converted to digital form and processed by a computer so that the data is presented in the final form desired. See Fig. 2.

Today's microwave sweeper is loaded with user convenience. A lot of engineering time has gone into making these instruments easy to use. The performance is extremely well specified. This allows the measurements to be made

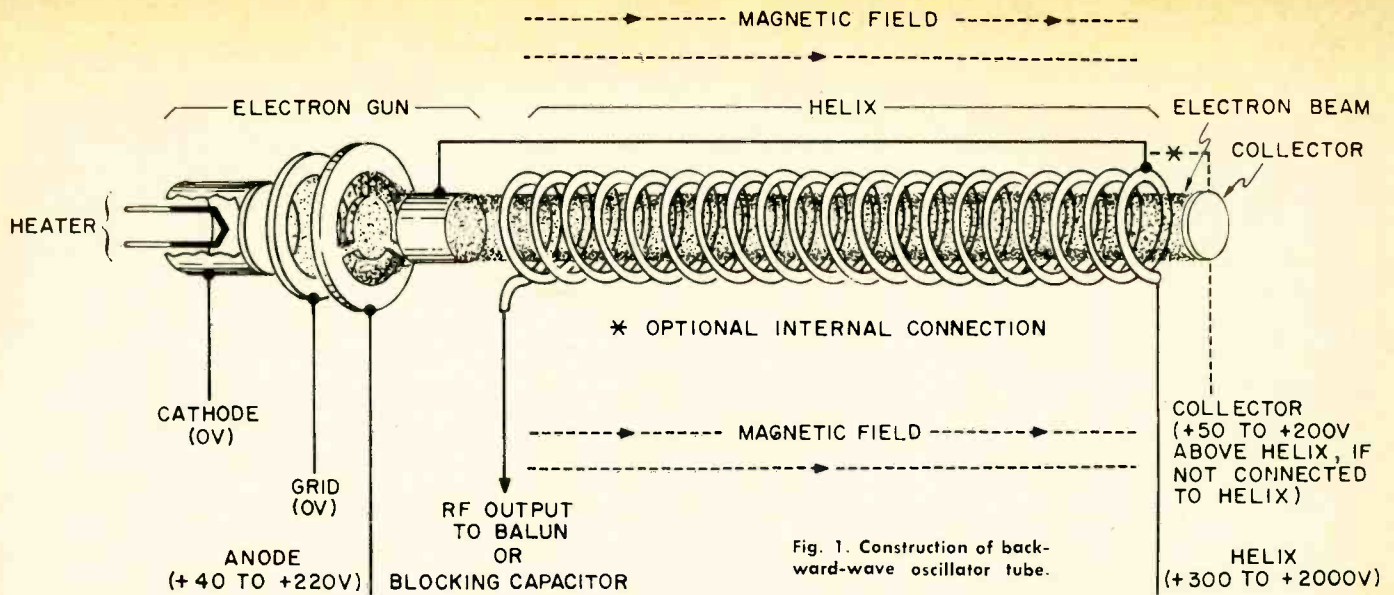

Fig. 1. Construction of backward-wave oscillator tube.

with a minimum amount of concern about the effects on accuracy due to the r.f. source.

The sweep modes have been designed to simplify the most common measurements. The wide-band sweep features independently adjustable start and stop frequencies with end-point frequency accuracy and linearity of sweep specified as equal or better than one percent. Just about all microwave sweepers provide absorption-type markers which cause a dip in r.f. power at the marker frequency. The markers can be used to bracket and determine the frequency of any discontinuity in the measurement. Some sweepers feature a second wide-band sweep mode called "marker sweep" so that once an area of interest has been bracketed by the markers, it can be examined in detail.

For narrow-band work, a symmetrical or *delta-F* sweep is provided. The maximum narrow-band sweep is usually about ten percent of the band. Some sweepers have continuously calibrated symmetrical sweeps, others are calibrated in steps, and some are calibrated only at the maximum symmetrical sweep width.

The Backward-Wave Oscillator

Since nearly all presently available microwave sweepers use a b.w.o. as the oscillator, let us consider the characteristics of this tube. The important thing about a b.w.o. is that the frequency can be predictably controlled by the voltage difference between the helix and cathode. To increase the frequency of a b.w.o. linearly with time, the tuning voltage must increase exponentially with time. A

much larger change in voltage is needed at the top of a b.w.o.'s tuning range than at the bottom to get the same change in frequency.

A b.w.o. is normally tuned by first generating an extremely linear voltage ramp. The ramp is passed through a shaping amplifier and converted to an exponential voltage which tunes the oscillator tube. Normal tuning voltage applied to a b.w.o. ranges from about 300 volts at the bottom of the band to about 2000 volts at the top. The tuning voltage may be applied as a positive voltage to the helix or a negative voltage to the cathode.

Sweepers using a b.w.o. as the source are available over the frequency range from 1 GHz (1000 MHz) to 40 GHz (40,000 MHz).

Between 250 MHz and 1000 MHz some sweeper manufacturers use voltage-tunable magnetrons as the source. The magnetron has a nearly linear tuning characteristic which is desirable. The r.f. signal, however, is not quite as clean as that from a b.w.o., so most sweeper makers switch over to the b.w.o. at 1 GHz.

All b.w.o.'s need a magnetic field to focus the electron beam that flows in the tube. Until 1960 the magnetic field was supplied by an electromagnet. Since 1960 permanent-magnet b.w.o.'s have been used by all sweeper makers.

The b.w.o. has steadily improved. In the past four years, tube warranty life has gone from 1000 hours prorated over one year, for most tubes, to one year unconditional warranty for all b.w.o.'s.

Most of the microwave laboratory sweepers sold these

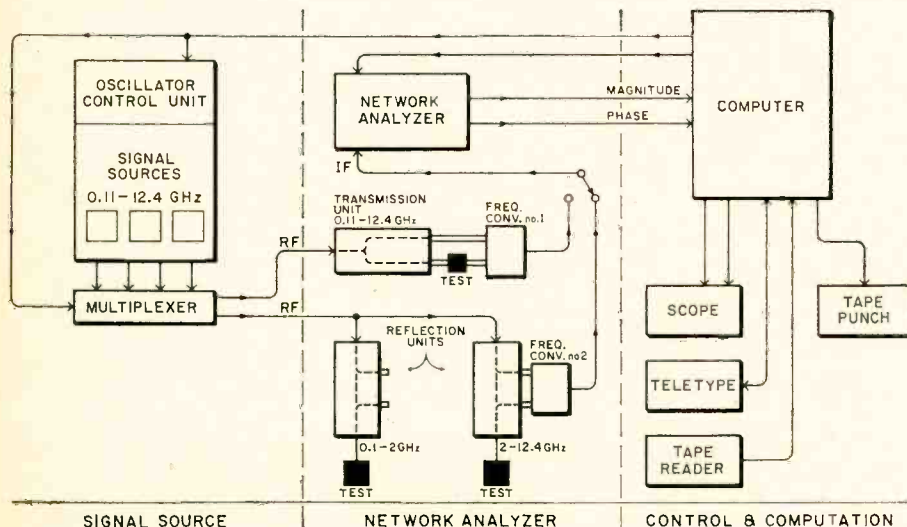

Fig. 2. Block diagram of an automatic network analyzer employing multi-band sweep oscillator as the r.f. source.

days feature plug-in oscillators. This allows the user to change bands simply by changing to a different r.f. unit.

Most of the circuitry in a modern sweeper is transistorized. The low-voltage power supplies are perfectly suitable for driving transistorized oscillators. It is possible right now to buy an all-solid state r.f. unit for a microwave sweeper which will tune between 100 kHz and 110 MHz. Other solid-state plug-ins working up to 4 GHz will soon be available for use in sweepers that were once limited to using a voltage-tuned magnetron or a backward-wave oscillator.

The plug-in r.f. unit has also made it easier to test today's sophisticated wide-band instruments and components.

Features of the Lab Sweeper

What are the differences between laboratory-grade sweepers and the sweeper that is used around most service shops? The lab sweeper is more accurately calibrated. It has better sweep linearity, more sweep flexibility, and lower residual FM. (*It is also much more expensive.—Editor*)

The typical service-shop sweeper has only one sweep mode; a symmetrical sweep. It has only one sweep speed and that is at the line frequency. The accuracy of the frequency dial is not precisely specified and the frequency sweep width control is usually a potentiometer marked "narrow" and "wide" with no accurate calibration in between. The minimum sweep width is usually determined by the residual FM. Residual FM of 100 kHz to 500 kHz is not uncommon. Usually there is no provision for c.w. operation.

The thing that makes these sweepers useful is the fact that just about all of them are supplied with crystal markers. The markers are usually single frequency or harmonic. Since the sweep widths and center frequencies are not exactly calibrated and the sweeps may not be precisely linear, the markers are needed so that you can tell what's going on.

In the latest precision lab sweepers it is possible to set the start and stop frequencies independently, and the frequency accuracy and linearity are within one percent. The sweep speeds are calibrated and variable. Speeds range from about 0.01 to 100 seconds. This allows the sweeper to be used with an X-Y recorder as well as an oscilloscope. Also, the slower sweep speeds allow the testing of narrow-band devices, such as filters, and the use of power meters as detectors.

The oscillators in all lab sweepers are voltage-tuned. Ripple or noise on the power-supply voltages show up as residual FM on the r.f. output. For this reason, the power supply and driver amplifiers for the oscillator are extremely important. Careful design here allows some microwave sweepers to match the c.w. performance of many signal generators covering the same frequency ranges.

The sweeper revolution is already here. The change to all-solid-state sweepers has started. The most noticeable effect of this is that sweepers are getting smaller.

In addition, manufacturers of microwave sweepers have

The H-P 3300A/3305A function generator (left) with sweep plug-in sweeps from 0.1 Hz to 100 kHz in one of three four-decade ranges. Calibrated independent start-stop controls are used.



The Kruse-Storke Model 5000 plug-in, all-solid-state sweeper shown here with 5 plug-in units covering from 50 MHz to 4 GHz.

taken a good look at the typical sweeper operating below 1 GHz and decided that they can make a better instrument to operate in the lower frequency ranges.

The result of this has been the development of all-solid-state sweepers that operate down to about 0.1 Hz. Yet these new sweepers feature the same kind of operating convenience and high level of performance found in microwave sweepers.

Most low-frequency sweepers use transistor oscillators with varactor-diode tuning. A back-biased junction diode acts like a capacitor and can be used as part of a resonant circuit to tune an oscillator. Typically, the diode capacitance can be changed over about a five to one range, although there are some with capacitance ratings of 25 to 1. A five-to-one capacitance change allows the oscillator frequency, which varies as a function of the square root of the capacitance, to vary over about a two-to-one frequency range or one octave.

To get frequency ranges greater than two to one, a mixing technique is usually used. In one example of this type, a varactor-tuned oscillator operating from 200.1 MHz to 310 MHz is mixed with a 200-MHz crystal-controlled signal. The r.f. output is the difference frequency from 0.1 MHz to 110 MHz. This frequency range is covered in two bands, 0.1 MHz to 11 MHz and 1 MHz to 110 MHz. Instead of two-to-one, the coverage is 110 to 1 on each band.

Another approach to wide-band voltage tuning for frequencies below 1 GHz is the RC-tuned phase-shift oscillator. The resistors are replaced by *p-i-n* diodes and the capacitors by varactor diodes. At radio frequencies, a forward-biased *p-i-n* diode acts like a resistor. The effective resistance decreases as the current through the diode increases. The capacitance of the varactor diode goes down as the diode back bias is increased. The oscillator frequency is proportional to $1/RC$. When the forward bias on the *p-i-n* diode and the back bias on the varactor diode are increased together, the tuning range of the oscillator can exceed 20 to 1. This particular type oscillator was recently patented by Kruse-Storke.

For higher frequency oscillators, going well into the microwave region, a sphere smaller than a BB pellet can be used to tune an oscillator. The sphere is a yttrium, iron, garnet ferrite and is called a YIG. When placed in a magnetic field, the YIG acts like a resonant tank circuit. The resonant frequency depends on the strength of the field.

A sweep-frequency source can be made by placing a YIG-tuned oscillator in the field of an electromagnet. Varying the current through the magnet solenoid changes the frequency of the oscillator.

Fortunately, the frequency is linearly related to magnetic field strength. As long as the magnet core doesn't saturate, the field is a linear function of the solenoid current. A linear current through the magnet coil thus gives a linear frequency change. This greatly simplifies the design of the sweep-drive circuits to the oscillator.

For a higher frequency YIG-tuned oscillator, about the only way to make one that works is to use hybrid micro-

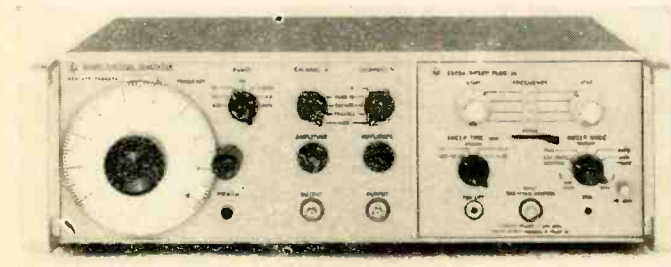

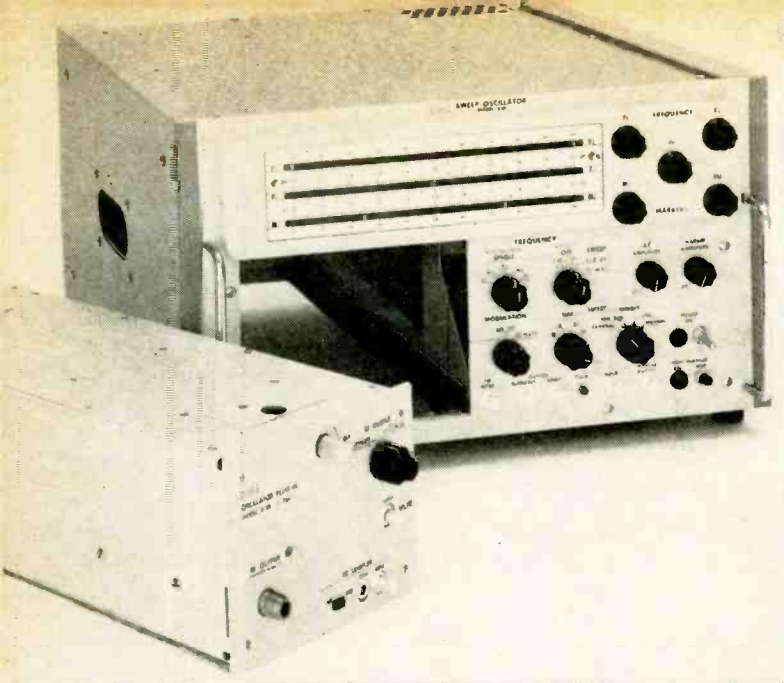

Alfred Electronics Model 650 sweep oscillator uses voltage-tuned magnetron and b.w.o.'s to cover from 250 MHz to 40 GHz.

circuit techniques. In this way, the circuits can be made small enough for tight coupling between the oscillator and the YIG. A complete oscillator, including the magnet solenoid assembly for tuning, can be made which takes only about one-tenth the volume of an equivalent backward-wave oscillator tube.

The solid-state oscillator, not only is small itself, but also will need a much smaller power supply. Operating voltages will be much lower than those needed for a b.w.o. This allows the use of lower wattage resistors and lower voltage capacitors as well as a smaller power transformer. Also, when an instrument is all-solid-state, no filaments are needed to get the electrons moving. The designer doesn't have to worry about getting rid of nearly as much heat. This

This multi-band system, consisting of Hewlett-Packard 8690A sweep oscillator (top) along with control unit and r.f. unit holder, will cover frequency range from 2 to 12.4 gigahertz.



means the circuits can be enclosed in a considerably smaller volume.

In addition to the oscillators, microcircuit techniques can be used to build amplifiers, attenuators, and directional couplers. All of these developments will contribute to making the new sweepers smaller.

There are some problems with solid-state oscillators. One is frequency response, another is power output. Most currently available transistors stop operating above about 4 GHz. Up to 4 GHz typical levelled power is 20 mW or less.

For higher frequencies and more power, one of the most promising sources is the YIG-tuned Gunn-effect diode oscillator. Operation up to at least 12.4 GHz and even higher should be possible in the very near future.

Spectral characteristics of the signal should be about as good as an equivalent-frequency klystron. The r.f. power will probably be a little less than that available from a b.w.o. covering the same range. Also, there is no filament to burn out in a solid-state device.

Multi-band Sweepers & Computers

Another development that will come with the solid-state sources will be the multi-band sweeper. The convenience of working in coax has now been extended to 18 GHz. Improved connectors are the main reason. This has led to the development of equipment designed to operate over the frequency range from d.c. to 18 GHz. Attenuators, detectors, and thermistor mounts that cover all or nearly all of this frequency range are now available.

This has created the need for very broad-band frequency sources to check the performance of these devices. The r.f. unit holder and control unit was developed to allow multi-band testing of these wide frequency range components. One sweeper can now be used to operate up to nine different r.f. units.

The next generation of sweepers designed for multi-band operation will sweep sequentially across three or four of the normal frequency bands using bandswitching which will allow an oscilloscope display with virtually no flicker.

Testing broad-band microwave components, even with multi-band sweepers, can take a long time. Normally this kind of job consists of making the same kind of measurement over and over again. Most microwave measurements are complicated and require the services of a highly skilled technician.

To tie up a good technician this way doesn't make sense to a lot of companies. The result has been the development of digital-computer-controlled systems to make these repetitive measurements. The sweeper, because it is voltage-tuned, makes an ideal source for programmed operation.

There are also resistive voltage dividers which can be controlled by a computer. A ten-line binary-coded resistor can supply over 1000 discrete steps of voltage. When this programmed resistor replaces the c.w. tune control in the sweeper, each voltage step can then set the sweeper to a different frequency.

When under the computer control, the sweeper doesn't actually sweep. The system makes a series of very rapid single-frequency measurements and produces outputs that are in digital rather than analog form. The computer memory can be used to store system errors at each frequency. The errors can then be corrected to improve measurement accuracy.

A programmable multi-band sweeper and a multiplexer to switch r.f. connections, both controlled by a computer, allow tests to be made across a multi-octave frequency range. All that is needed is to have someone connect the device to be checked to the test port of the system. The computer can also supply a permanent record of the test in the final form desired. ▲

FREE

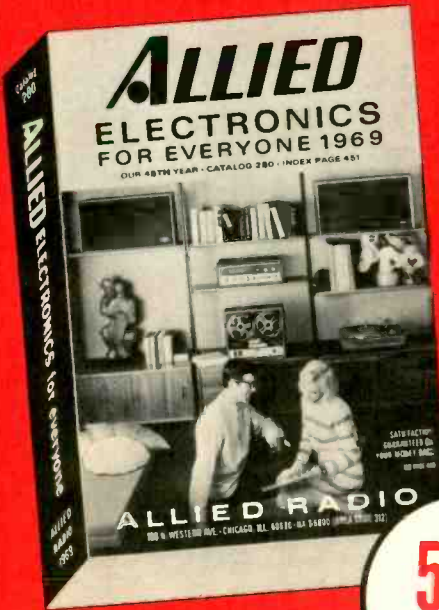

ALLIED New 1969 CATALOG

Jam-packed with the latest in Hi-Fi, Tape Recorders, CB, Kits, Radios, Tools, Electronic Parts, Books. Every item priced to save you money! 536 pages,

536
PAGES

024

(Please Print)

Name _____
First Middle Last

Address _____

City _____

State _____ Zip _____

mail this card
immediately
for your

FREE

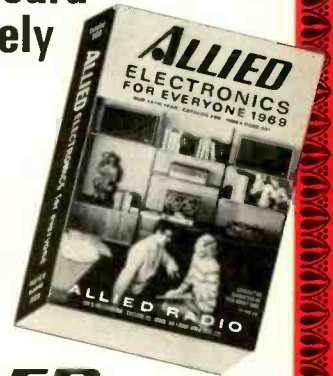

ALLIED 1969 CATALOG

ALLIED ELECTRONIC LIBRARY



SAVE \$3⁰⁰
(\$9.25 if purchased separately)

Complete 14 Volume
Set only **\$6²⁵** Postpaid.
23 PB7-09 EP

Fourteen expertly written, authoritative books—an extremely useful library developed especially for you by Allied's Electronic Experts. An incomparable value... less than 45¢ each when you order the set of 14 volumes. Use the handy order form at the right.

See other side for more details.

**ELECTRONIC BOOKS FOR HOBBY,
SCHOOL, OR HOME STUDY**

025

RUSH ME THE SET

ALLIED ELECTRONIC LIBRARY

23 PB7409 EP

(Fill out coupon below, enclose check or money order for \$6.25, and mail to ALLIED RADIO, P. O. Box 4469, Chicago, Illinois 60680). Shipped postpaid.

(Please Print)

Name _____
First Middle Last

Address _____

City _____

State _____ Zip _____



To:
ALLIED RADIO
 P. O. Box 4398
 Chicago, Illinois 60680

PLACE
 STAMP
 HERE

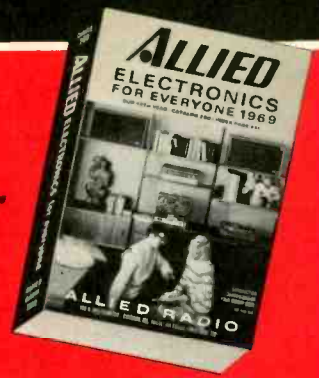

See other
 side for new

FREE

ALLIED 1969 CATALOG

Brand new! One of the world's most complete books of everything that's new and exciting in electronics. Literally thousands of items... many of them never shown before! Mail in the card today and we'll rush you your own personal copy. Remember, all Allied merchandise is available for no money down... with low monthly payments you can afford.

Why Buy by Mail from

ALLIED?

Because You Buy from the Most Unique Store in the World!

Variety, selection, price, and quality-testing are the answers! Our continuous program of quality-testing assures you that everything you buy meets the highest standards. And nowhere else on the face of the earth are so many famous brands gathered together to choose from. When it comes to parts that both beginners and experts need... ALLIED is the one source that has them all. No clerk, no expert, no salesman in all the world could begin to supply you with the wealth of facts, the exact specifications, the comparable data—all at your fingertips in this popular book. Almost anything you may want or need or have an interest in... is pictured, priced, and described in detail. You'll find bargains unmatched anywhere else you may shop. You'll find a whole new way to buy both the commonplace and the rare, the inexpensive and the luxurious.

Best of all—with an ALLIED Credit Fund Account you pay no money down, and take up to 2 years to pay!

*Read About
 Allied's Unique 14 Volume*

ELECTRONIC LIBRARY

- 1 **ALL ABOUT HIGH-FIDELITY AND STEREO**... helps you to select stereo components.
- 2 **BUILT-IN STEREO HI-FI MUSIC SYSTEM**... how to build a "Wall of Entertainment" in your home.
- 3 **USING YOUR TAPE RECORDER**... helpful hints on every phase of recording.
- 4 **ELECTRONICS DATA HANDBOOK**... everything you'll need to know about electronics.
- 5 **DICTIONARY OF ELECTRONIC TERMS**... defines over 4800 electronic terms.
- 6 **ENCYCLOPEDIA OF ELECTRONIC COMPONENTS**... lists over 350 most-used electronic components.
- 7 **UNDERSTANDING AND USING YOUR OSCILLOSCOPE**... tests, measurements, basic principles.
- 8 **BEST WAYS TO USE YOUR VOM-VTVM**... methods of testing capacitors, chokes and switches.
- 9 **GETTING STARTED IN ELECTRONICS**... introduction to basic radio theory.
- 10 **HOW TO BUILD ELECTRONIC KITS**... detailed instruction.
- 11 **UNDERSTANDING TRANSISTORS AND TRANSISTOR PROJECTS**... construction, application and characteristics.
- 12 **UNDERSTANDING SCHEMATIC DIAGRAMS**... as easy to read as a roadmap.
- 13 **INTEGRATED CIRCUITS FUNDAMENTALS AND PROJECTS**... an introduction to integrated circuits in easy-to-follow, non-technical language.
- 14 **UNDERSTANDING AND USING CITIZENS BAND RADIO**... covers all phases of CB radio.

Enclose this order form in an envelope with payment for the Allied Electronic Library.

Save \$3⁰⁰
 (\$9.25 if purchased separately)

The Complete 14 Volume
ALLIED ELECTRONIC LIBRARY ONLY...

\$6²⁵



JOHN FRYE

Five emerging industries selected by an investment firm as having great promise are all involved in electronics.

FIVE DOORS TO AN ELECTRONICS FUTURE

“MAC, I’ve reached a conclusion,” Barney announced to his employer working at the service bench beside him. “So-o-o-o,” Mac drawled; “and am I going to be favored with the fruit of your cogitation?”

“I’ve decided I must start ‘thinking big’ about the word *electronics*. I’ve gotta quit thinking it just means something to do with computers or the entertainment field.”

“Sounds reasonable, but I wouldn’t try to copyright such a gray-bearded idea,” Mac warned with a teasing grin.

“Aw, come on! I *know* electronics takes in a lot more than radio and TV. It’s just that these are the things that pop into my mind when I hear the word spoken. You know. It’s the way I think only of Zsa Zsa when I hear the word ‘Hungarian.’”

“No, I wouldn’t know,” Mac said mockingly. “You forget how old I am. Personally, the word makes me think of goulash.”

“You’re not *that* old,” Barney retorted. “Anyway, I was reminded of all this when my nephew, a freshman at the state university, bounced me last night for advice regarding a career in electronics. He said he didn’t want to be a service technician, be a computer programmer, work in a radio or TV station, or become engaged in any other ‘flyblown’—the word is his—electronic field. He said he wanted to work in a new field in which electronics played a big part, a field that would present lots of opportunity for a young man of his drive and intelligence. Modesty, you notice, sort of runs in our family.”

“I notice,” Mac said drily. “So what did you tell this shrinking violet relative of yours?”

“For once in my life I was all cocked and primed with answers. Just recently I had read a report prepared by the research department of *Merrill, Lynch, Pierce, Fenner, and Smith, Inc.*, in which five ‘emerging industries’ were spotlighted as having great promise; and one thing all five shared was a strong dependence on electronics. The brokerage firm listed seventy-two concerns involved in these five industries as having good investment possibilities, and twenty-six of the concerns were either electronic or electronic related.”

“What were the five industries?”

“Medical Technology, Learning Aids, Pollution Control, Oceanography, and Nuclear Energy. Note the first three are almost entirely dependent on electronics, and Oceanography is actually an offshoot of electronics. The electric companies are constantly developing nuclear energy as a means of generating electricity.

“Another thing all five industries share is their common dependence on government support. Oceanography and air and water pollution control are almost entirely supported by the government, while medical technology, education aids, and nuclear energy depend a great deal on government money.”

“This is good?”

“In a way, yes. While there have been sharp cutbacks in government spending this past year, once military demands in Southeast Asia ease up, funding for these five industries

may be expected to rise again; and we both know the long range trend in government spending for research and development is a steady climb. For example, federal spending in the oceanographic field has increased from \$20 million in 1958 to about \$450 million in 1968.”

“Why is the government willing to spend that kind of money to learn more about the ocean and its phenomena?”

“Because it expects to benefit tremendously from the knowledge gained. For one thing, the ocean exerts a tremendous influence on the weather, and if we’re ever to control the weather or even forecast it accurately, we need to know much more about the ocean, its currents, and their meteorological significance than we do at present. Then, too, there are the oil, gas, and mineral deposits buried beneath the salt water or carried in solution in the brine. Once we have depleted the more accessible deposits on land, we may have to use those in and beneath the ocean to survive. Moreover, speaking of surviving, the ocean is a vast reservoir of potential food, and biological oceanography is the key to that cupboard.”

“Electronic instruments are needed to plumb the depths, detect the currents, measure the pressures and temperatures, evaluate the chemical concentrations, and examine the sea creatures,” Mac interrupted. “Some day man may live in the ocean as comfortably as he now lives on land, but electronics must first explore and tame this hostile environment and provide him with life-supporting facilities and means of reliable communication. I can see where oceanography could be as interesting and exciting as rocketing to the moon.”

“So can I,” Barney agreed, “but allow me to get on with my rat-killing. Medical technology can be just as rewarding a vocation, both emotionally and financially. Total expenditures for medical research by the government, private resources, and industry are about \$2 billion annually, and this is growing at a rate of about 15% a year. We’ve talked of this before, as we are both aware of how the medical profession is leaning more and more heavily upon electronics for the diagnosis of disease and the treatment of patients. Every area of a modern hospital is saturated with electronics gear, no matter whether you consider the diagnostic office, the operating room, the intensive care ward, or the record-keeping-patient-billing departments.

“But we’ve only scratched the surface in this field. The little pacemaker that regulates the beating of a human heart is pointing the way to a whole battery of complete electronically controlled artificial organs in the future. An encouraging sign for future growth in medical technology is the improved relations between doctors and engineers. Doctors are taking more of a hand in the actual development of electronic aids, and electronic engineers are becoming more interested in and knowledgeable about the needs of the medical profession. If I were a young man looking for a rewarding career in electronics, I’d take a long hard look at medical electronics.”

“I suppose you’re thinking of various kinds of teaching machines when you speak of learning aids.”

new SAMS books

How to Build Electronics Projects

by *John Potter Shields*. Clearly and thoroughly describes the methods and tools used in constructing electronics projects. Explains proper circuit layout, metal chassis and panel layout, drilling and punching. Also describes electronic components and their special characteristics; includes special data on semiconductor circuits and etched circuit board construction. 96 pages. Order 20670, only \$2.95

Record Changers—How They Work

by *Louis M. Dezettel*. Provides all the fundamental information on record changers, including motors and their differences, cartridges, and needles. Also describes installation procedures and information on upgrading changers for use with improved cartridges. 144 pages. Order 20661, only \$3.95

Electronics for the Beginner (2nd Ed.)

by *J. A. Stanley*. The author avoids dry theory and introduces the beginner to the fundamentals of constructing electronic devices in a practical manner. Each project grows more difficult, so the beginner picks up electronic theory in practice as he goes along. All projects are fully transistorized. Crystal-clear schematics and wiring diagrams, plus complete parts lists and templates, make building easy and enjoyable. Includes the color code and how to read schematics. 192 pages. Order 20677 (hardbound), only \$5.25
Order 20664 (softbound), only \$3.95

ABC's of Electronic Test Equipment

by *Donald A. Smith*. A very thorough introduction to basic test instruments. Provides a clear understanding of how to use them and how to correctly evaluate readings. Begins with a description of types of meter movements and then progresses into uses of specific instruments. 128 pages. Order 20660, only \$2.95

IMPORTANT RECENT BOOKS

Using Scopes in Transistor Circuits

by *Robert G. Middleton*. The leading authority on test equipment tells when and how to use oscilloscopes to analyze and/or troubleshoot transistor circuits; major emphasis is on scope waveform analysis. The book is intended primarily for the electronic technician. It includes detailed treatment of waveforms and circuit theory in transistor oscillators, amplifiers, waveshaping circuits, monochrome and color TV, and computers. 192 pages. Order 20662, only \$4.50

Color-TV Servicing Guide

by *Robert G. Middleton*. This fine book is a quick, effective servicing tool for color-TV. Shows how to apply fast troubleshooting procedures, based on an analysis of trouble symptoms. Includes many full-color picture tube photos illustrating various operating troubles, accompanied by clear, concise explanations of probable causes and diagnosing procedures. The last chapter explains in detail how to test and troubleshoot with color-bar generators. 112 pages. Order 20358, only \$4.25

Transistor TV Training Course

by *Robert G. Middleton*. Provides a complete understanding of modern transistor television circuitry by progressive analysis of each stage of a typical receiver. Includes review questions. 128 pages. Order 20619, only \$3.95

These and over 300 other SAMS books are available from your Electronic Parts Distributor

Howard W. Sams & Co., Inc.

Order from your Sams Distributor today, or mail to Howard W. Sams & Co., Inc., Dept. EW-11
4300 W. 62nd Street, Indianapolis, Ind. 46226

Send me the following books:

20670 20677 20660 20358
 20661 20664 20662 20619

\$ _____ enclosed

Name _____

Address _____

City _____

State _____

Zip _____

My Distributor is _____

"Right. The education industry is a very big market for electronics. Fifty billion dollars are spent annually on education, with about \$300 million a year devoted to material for instruction. In the past, most of this has been spent on audiovisual equipment: viewers, motion pictures, slides, projectors, records, and tapes; but in the future millions more will be spent on teaching machines of all sorts, on closed-circuit TV, on classroom computers, and on various other educational electronic equipment still to be invented.

"It's only logical to assume electronics will be called on to take up a large part of the burden produced by a worsening shortage of teachers combined with an increasing number of students—which, by the way, are increasing at a rate of about one million a year. Surely a young man could do worse than to become involved in an industry that is as truly basic as education and that secures money from taxpayers as easily as do the demands for educating the young."

"I can't argue with that, and you don't need to go on to give me a song and dance about the future of pollution control. Anyone who reads, listens to the radio, or watches TV can't help knowing that we Americans have been 'fouling our nest' at an alarming and reckless rate. Surely the threat of lung cancer or having to drink polluted water is all the incentive any civilization should need to make a supreme effort to reverse our dangerous trend. Again, electronics must be depended on to detect, measure, and reduce pollution. Instrumentation will range all the way from 'eye in the sky' surveillance systems for detecting air and stream pollution down to the actual 'hardware'—I am thinking of catalysts, precipitrons, etc.—that will prevent pollution from escaping."

"Okay," Barney said, "and that leaves only nuclear energy as the last of our glamorous electronics-based industries, and surely no one needs much selling on that. The idea of each house having its own little nuclear energy generating plant in the basement is not so wild or perhaps even so far away as many people think. The potential of this field is indicated by the fact that while current shipments of nuclear energy electrical generating equipment amount only to \$50 million a year, utilities have ordered a backlog of \$6 billion worth of this equipment."

"That reminds me of something said recently by Milton Klein, Director of the Space Nuclear Division of the AEC. He said advanced technology—and that's what these five industries are all about—will be a central factor in helping solve some of the world's great social problems."

"Hey!" Barney interrupted, "that fits in beautifully with what W. H. Kuhl-

man, Jr., a program manager in the space operations of *McDonnell Douglas Astronautics Company*, said at the 1968 Wescon meeting. He said what this country needs to solve its social problems are more 'big swingers.' I hasten to add that he doesn't mean a Big Daddy type swinger. He is referring to a technological development of sufficient importance to have a primary forcing function on the future of society. The automobile was a big swinger. Current big swingers are the computer, nuclear energy, and space. Each of these has wrought tremendous shifts in the thinking, working, and living habits of great segments of the world's population. What's more, each new technology affects others: a discovery in communications can change travel, medical care, and education; a reduction of noise and pollution reduces the need for zoning and can bring people back into the cities they have been fleeing.

"Because of this close interaction of society and technology, Mr. Kuhlman indicated the solution of urban and social problems depends a great deal on the next big swingers; but both he and Arthur Shef, another *McDonnell Douglas* engineer, point out that *technology develops amorally*. Technology simply provides a framework on which values form, and those values determine whether the new discovery is a blessing or a curse. Social evils do not necessarily accompany a technological advance. While the next big swinger cannot be precisely predicted, it can—with enough determination and good will—be guided in the right direction."

"Well," Mac concluded, "you certainly have provided your young nephew with food for thought. If he can't pick an exciting and rewarding electronics career out of those five industries, there's something wrong with him. I'll confess you've made me wish I were only young enough to be making the choice myself!" ▲



"What's my ace technician looking so smug about?"

VIEW

The RCA WO-33A Super-Portable 3-Inch Oscilloscope helps solve virtually any electronics servicing problem, inside or outside the shop. Its combination of exceptionally low cost and high performance have already made it popular as a monitoring and trouble shooting 'scope in black and white and color TV broadcasting studios, and in professional service. And why not? Here's a 3-inch 'scope that meets your requirements for gain, bandwidth, transient response, accuracy, versatility, and portability. AND IT'S ONLY \$139.00.* Also available in an easy to assemble kit, WO-33A (K).



The RCA WO-91C 5-inch Dual Band Oscilloscope is a reliable, heavy-duty, precision 'scope in use in thousands of installations from classrooms to TV distribution systems...from service benches to broadcast stations. You probably can't find a better value. Applications include waveform analysis, peak-to-peak voltage measurement, square-wave testing, and observation of circuit characteristics. A front-panel switch gives you an easy choice of wide-band or narrow-band (high sensitivity) operation. It's easily portable, AND IT'S ONLY \$269.00.* The WO-91C-V1 is available for 240V operation, no increase in price.



*Optional Distributor resale price. Prices may be slightly higher in Alaska, Hawaii, and the West.

Write for a catalog with complete descriptions and specifications for all RCA test equipment: RCA Electronic Components, Commercial Engineering, Department No. K41W, Harrison, N. J. 07029

LOOK TO RCA FOR INSTRUMENTS TO TEST/MEASURE/VIEW/MONITOR/GENERATE
CIRCLE NO. 90 ON READER SERVICE CARD

The RCA logo, consisting of the letters 'RCA' in a stylized, outlined font.



watts-ville!

**New BELL P/A
MODULAR AMP line
has 20, 45, 90
and 200W output
—RMS ratings**

*Man, what a power output range!
And what a variety of input
configurations . . . practically
unlimited . . . with up to 8 input
modules arrangeable in any
combination (even with separate
muting and limiting functions!)*

The only p.a. amps with FET's
up front for true Hi Z input (or
bal. lo Z with trans.). All silicon
solid state design.

Exclusive, fully automatic
output circuit protection saves
time, labor, components . . .
eliminates guesswork. See your
*local electronics distributor,
or send for full specs.*

BELL p/a
professional appeal

BELL P/A PRODUCTS CORPORATION
1209 North Fifth St., Columbus, Ohio 43201

Liquid-Crystal Displays

(Continued from page 29)

which changes color with temperature, is used in some temperature-indicating devices, while the smectic liquid crystals are of interest to the detergent industry.

When an electric field is applied to certain types of nematic liquid crystals, the field's presence creates ions that travel through the material (Fig. 4). These traveling ions then produce an effective turbulence that causes a dynamic scattering of light and give the liquid crystal its opalescence—a milky white appearance.

To construct a display, a thin film (1/1000th inch thick) of liquid-crystal material is placed between two sheets of thin glass. The inner face of each sheet is coated with an electrode. At least one of the electrodes is transparent so the display can be seen. This electrode is usually conductive film of tin oxide. The other electrode may also be transparent, or it can be reflective, in which case it is ordinarily an evaporated film of metal, such as nickel or aluminum. In effect, the display is a parallel-plate capacitor with the liquid crystal acting as the dielectric. When a charge is applied to the two glass plates, the sandwich takes on the appearance of frosted glass. The frostiness disappears, however, as soon as the charge is removed.

To display patterns such as letters, symbols, or still images, the coatings are shaped in accordance with the desired pattern. The symbols and letters can be changed merely by applying the electric field to different segments. To display motion, the conductive coatings are laid down in the form of a fine mosaic whose individual elements can be addressed independently in accordance with a scanning signal like that used for facsimile, television, and other electronic displays.

However, a television display appears years away because of circuitry and addressing problems. A flat-screen TV would require approximately 300,000 individual elements, and each would have to be addressed and activated at TV speeds. While this is technically feasible at present, it is not yet economically feasible—the integrated circuitry for such a screen might cost many thousands of dollars—and it appears that significant technical advances will be necessary before a practical flat television screen employing liquid crystals for the display can be offered to the public.

The opalescent effect of liquid crystal displays may someday be used for electronically controlled light shutters having no moving parts. Also, it is possible that this opalescent effect will be used to provide glass door panels and windows that can be frosted at the touch of a button to insure privacy for the users. A step away from that is the possibility that liquid crystals can be used to provide electronic curtains or venetian blinds that will automatically control the amount of sunlight admitted into our homes.

The amount of frostiness can be controlled because liquid-crystal displays have a gray scale that varies with the intensity of the applied voltage, which ranges from 6 to 60 volts. The power required for a reflective display is one milliwatt per square inch and can be either d.c. or pulsed.

Compared with whiteness of bond paper, the liquid-crystal displays have an efficiency of 50 to 60 percent. The resolution is 500 lines per inch. The displays can be turned on in 1 to 5 milliseconds, and turned off in about 30 milliseconds. They accept information at a 60-microsecond rate, which happens to be about equal to the time required to scan a single TV line. The contrast of the displays—which is independent of the amount of ambient light—is 15 to 1. ▲

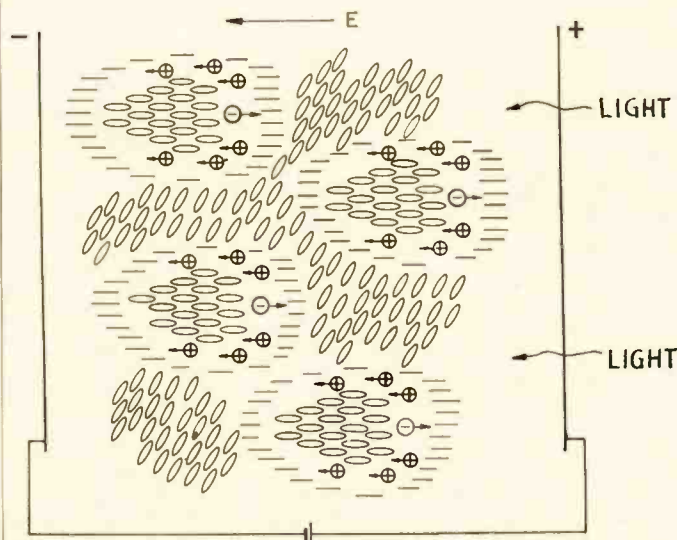
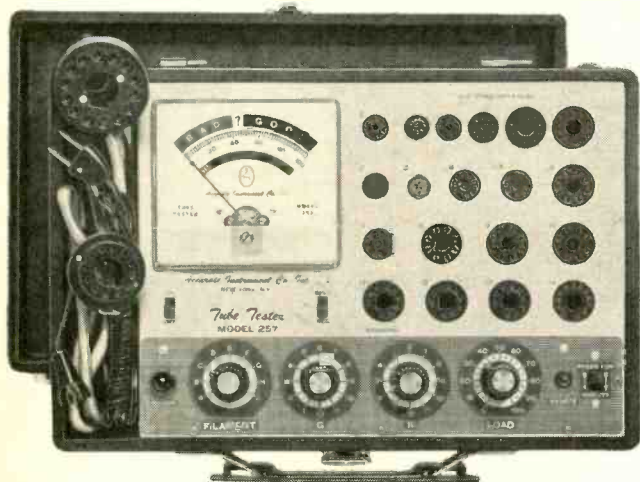

Fig. 4. Ions are produced in nematic liquid because of voltage applied. Resulting turbulence causes molecules to reflect light.

The New 1969 Improved Model 257 **A REVOLUTIONARY NEW TUBE TESTING OUTFIT**



COMPLETE WITH ALL ADAPTERS AND ACCESSORIES, NO "EXTRAS"

STANDARD TUBES:

- ✓ Tests the new Novars, Nuvistors, 10 Pins, Magnovals, Compactrons and Decals.
- ✓ More than 2,500 tube listings.
- ✓ Tests each section of multi-section tubes individually for shorts, leakage and Cathode emission.
- ✓ Ultra sensitive circuit will indicate leakage up to 5 Megohms.
- ✓ Employs new improved 4½" dual scale meter with a unique sealed damping chamber to assure accurate, vibration-less readings.
- ✓ Complete set of tube straighteners mounted on front panel.

BLACK AND WHITE PICTURE TUBES:

- ✓ Single cable used for testing all Black and White Picture Tubes with deflection angles 50 to 114 degrees.
- ✓ The Model 257 tests all Black and White Picture Tubes for emission, inter-element shorts and leakage.

COLOR PICTURE TUBES:

- ✓ The Red, Green and Blue Color guns are tested individually for cathode emission quality, and each gun is tested separately for shorts or leakage between control grid, cathode and heater. Employment of a newly perfected dual socket cable enables accomplishments of all tests in the shortest possible time.

The Model 257 is housed in a handsome, sturdy, portable case. Comes complete with all adapters and accessories, ready to plug in and use. No "extras" to buy. Only

\$47⁵⁰

NOTICE We have been producing radio, TV and electronic test equipment since 1935, which means we were making Tube Testers at a time when there were relatively few tubes on the market, way before the advent of TV. The model 257 employs every design improvement and every technique we have learned over an uninterrupted production period of 32 years. *Accurate Instrument Co., Inc.*

SEND NO MONEY WITH ORDER **PAY POSTMAN NOTHING ON DELIVERY**

Try it for 10 days before you buy. If completely satisfied then send \$10.00 and pay the balance at the rate of \$10.00 per month until the total price of \$47.50 (plus P.P., handling and budget charge) is paid. If not completely satisfied, return to us, no explanation necessary.

ACCURATE INSTRUMENT CO., INC.
Dept. 592 2435 White Plains Road, Bronx, N. Y. 10467

Please rush me one Model 257. If satisfactory I agree to pay \$10.00 within 10 days and balance at rate of \$10.00 per month until total price of \$47.50 (plus P.P., handling and budget charge) is paid. If not satisfactory, I may return for cancellation of account.

Name _____
Address _____
City _____ Zone _____ State _____

Save Money! Check here and enclose \$47.50 with this coupon and we will pay all shipping charges. You still retain the privilege of returning after 10 day trial for full refund.

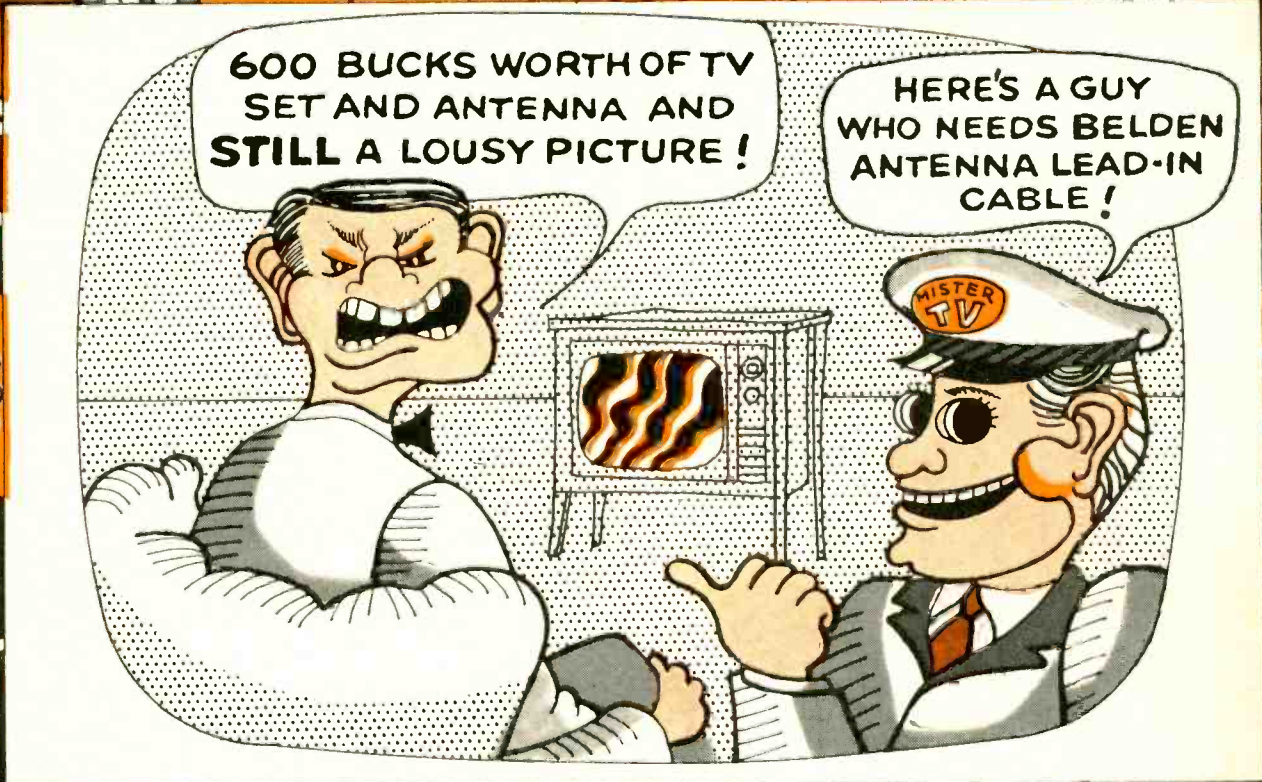

Color or UHF set perfect? Antenna perfect? Then obviously there's a missing link. Check that antenna lead-in cable. Old, worn-out, weather-beaten cable, or the ordinary flat ribbon kind designed for black and white VHF, causes more fuzzy, distorted pictures than you can count. It's your opportunity to upgrade these customers to a cable matched to their particular signal reception situations. One of Belden's Big Four—the link to perfect reception.

FOR CONGESTED AREAS...

8290 SHIELDED PERMOHM®



In congested, in-city areas, stray electrical interference and noise are at their worst. For perfect, all-82 channel reception—color or B/W—replace old cable with Belden's 8290 Shielded PermoHM. Its aluminum Beldfoil® shielding prevents pickup of ghost signals and electrical noise by the lead-in. Weather-proof and water-proof. You can tape it right to the mast. Or install it underground, in conduits—even in rain gutters.



AWG & (Stranding)	Color	Nom. O. D. (inch)	Nom. Velocity of Propagation	Nom. Capacitance (mmf/ft.)	Nom. Attenuation per 100'		Standard Package Lengths in ft.
					mc	db	
22 (7 x 30)	Brown	.305 x .515	69.8%	7.8	57	1.7	50', 75', 100' coils have terminals attached. Available in counter dispenser. 250', 500' spool.
					85	2.1	
					177	3.2	
					213	3.5	
					473	5.4	
					671	6.6	
887	7.7						

Copperweld, 2 conductors, orange polyethylene insulation and web between conductors, cellular polyethylene oval insulation, Beldfoil shield, stranded tinned drain wire, polyethylene jacket.

BELDEN 8285 - PERMOHM

FOR FRINGE AREAS...

8285 PERMOHM®

Antenna cable in uncongested or fringe areas picks up little electrical interference. But does get a lot of weathering, which degrades an already weak signal. These customers need encapsulated cable. Belden 8285 PermoHM. Its special polyethylene jacket protects the energy field, regardless of weather conditions. It delivers the strongest signal of any unshielded twin lead under adverse conditions. Requires no matching transformers and connectors. For all 82 channels, color or B/W.



AWG & (Stranding)	Color	Nom. O. D. (inch)	Nom. Velocity of Propagation	Nom. Capacitance (mmf/ft.)	Nom. Attenuation per 100'		Standard Package Lengths in ft.
					mc	db	
22 (7 x 30)	Brown	.255 x .468	73.3%	5.3	100	1.4	50', 75', 100' coils have terminals attached. Available in counter dispenser. 250', 500' coils and 1000' spool.
					300	2.8	
					500	3.8	
					700	4.8	
					900	5.6	

Copperweld, 2 conductors parallel, orange polyethylene insulation and web between conductors, cellular polyethylene oval jacket.

FOR LOCAL BLACK AND WHITE...

8275 CELLULINE®



Cracked, corroded, weathered cable, full of dirt and moisture, loses signal strength; prevents any TV set from delivering a quality picture. Upgrade B/W VHF and local UHF customers to Belden 8275 Celluline. Performance is improved because all possible moisture between conductors has been eliminated. Abrasion-resistant and weather-resistant for a long, long service life. And, it requires no end sealing.

AWG & (Stranding)	Color	Nom. O. D. (inch)	Nom. Velocity of Propagation	Nom. Capacitance (mmf/ft.)	Nom. Attenuation per 100'		Standard Package Lengths in ft.
					mc	db	
20 (7 x 28)	Brown	.300 x .400	80%	4.6	100	1.05	50', 75', 100' coils in counter dispenser. 250', 500', 1000' spools.
					200	1.64	
					300	2.12	
					400	2.5	
					500	2.98	
					700	3.62	
					900	4.3	

Bare copperweld; 2 conductors parallel, polyethylene jacket with inert gas filled unicellular polyethylene core.

FOR MATV AND CATV...

EN DUOFOIL

8228 DUOFOIL® COAX

Got an apartment or townhouse complex in your area? Motels or hotels? Or is CATV coming? Use Belden's new 75 ohm coaxial cable—8228 Duofoil. Shielding is 100%—sweep tested 100%. Spiral wrapped drain wires provide long flex life. Small diameter saves space in conduit installations. Use Duofoil for all coaxial color and B/W VHF, UHF and CATV applications.



AWG & (Stranding)	Color	Nom. O. D. (inch)	Nom. Velocity of Propagation	Nom. Capacitance (mmf/ft.)	Nom. Attenuation per 100'		Standard Package Lengths in ft.
					mc	db	
18 Solid, Bare	Black	.242	78%	17.3	50	1.5	100', 500', 1000' spools.
					100	2.1	
					200	3.1	
					300	3.8	
					400	4.5	
					500	5.0	
					600	5.5	
					700	6.0	
					800	6.5	
					900	6.9	

Don't forget to ask them what else needs fixing.

See your local Belden distributor for full details or to order. For a free copy of the recent reprint article, "Electronic Cable," write: Belden Corporation, P.O. Box 5070-A, Chicago, Illinois 60680.



8-6-8

Delta Launches the

COMPUTACH[®]*

The
Great
One!



*An exclusive computer-tachometer for precise RPM measurement in easy-to-build Kit form!



ONLY
\$29.95
ppd.

Delta, pioneers in CD ignition who produced the fabulous MARK TEN[®], now offer a precise computer-tachometer which obsoletes any type tachometer on the market today! You achieve unbelievable accuracy in RPM readings due to the advanced, solid-state electronic matched components used in the computer, coupled with the finest precision meter in the world. Works on all 2, 3, 4, and 6 cylinder 2 cycle and with 4-6-8 cylinder—4 cycle 12 volt engines.

- ▲ 0-8000 RPM range
- ▲ Perfect linearity — zero parallax
- ▲ Adjustable set pointer
- ▲ Wide angle needle sweep
- ▲ Translucent illuminated dial
- ▲ Chrome plated die-cast housing
- ▲ All-angle ball & socket mounting
- ▲ Use it with ANY ignition system
- ▲ Meter: 3 1/8" dia. X 3 3/8" deep
- ▲ Calibration kit included, no test eqpt. needed.

Orders shipped promptly.
Satisfaction guaranteed.



DP 0-2

DELTA PRODUCTS, INC.
Send check today!

P.O. Box 1147 EW / Grand Junction, Colo. 81501

Enclosed is \$ _____ Ship ppd. Ship C.O.D.

Please send:

COMPUTACH[®] Kits @ \$29.95 ppd
Sold in Kit Form ONLY!

Name _____

Address _____

City/State _____ Zip _____

CIRCLE NO. 112 ON READER SERVICE CARD
62

TEST EQUIPMENT PRODUCT REPORT

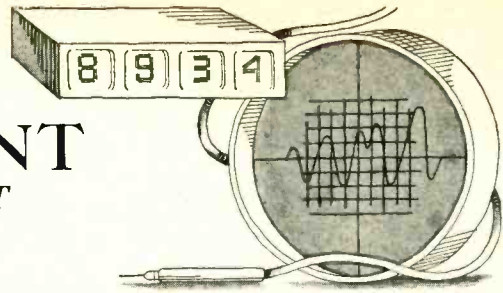

B&K Model 1450 Oscilloscope

For copy of manufacturer's brochure, circle No. 22 on Reader Service Card.

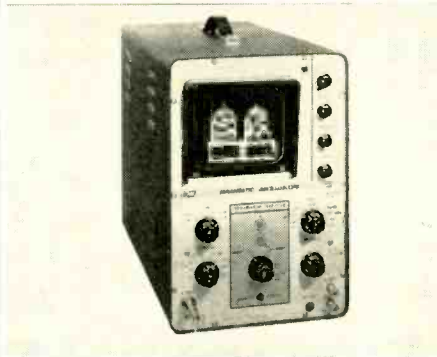

THE new B&K Model 1450 "Diagnostic Oscilloscope" has been engineered especially for the TV service industry. It includes all of the usual functions needed for efficient solid-state and color-TV servicing—plus the following special features:

An intermittent analyzer, consisting of a voltage level sensing circuit that senses changes in signal level when an intermittent occurs. Indicator lamps light when the signal increases or decreases from a preset level. A memory circuit holds the appropriate lamp lit even when the intermittent corrects itself—thus eliminating the need for con-

tinuous monitoring by the service technician.

A double-scale, calibrated screen that reads peak-to-peak voltage measurements direct as easily as a v.t.v.m. The appropriate scale illuminates automatically as the vertical-input, 7-step attenuator is set.

A built-in TV sync separator that simplifies waveform viewing and automatic synchronization that makes patterns stand still regardless of amplitude, further aid in TV servicing. Two TV sweep positions are provided and changing from line sweep to field sweep is done with a single switch.

The Model 1450 also shows vector patterns exactly as specified by color-TV set manufacturers. All vectorscope inputs and controls are located on the front panel for operating convenience.

Bandwidth of the vertical channel is 5 Hz to 5 MHz at a sensitivity of 25 mV (r.m.s.) per inch. A direct low-capacitance 10:1 probe is included with each instrument. The unit weighs 26 pounds and measures 13 1/2" high x 8 3/4" wide x 17 1/2" deep. It operates from 117 V, 60-Hz current. Price of the oscilloscope is \$279.95. ▲

Darcy Model 460 Digital Frequency Meter

For copy of manufacturer's brochure, circle No. 156 on Reader Service Card.



THE need for an inexpensive yet versatile direct-reading frequency meter has led to the development of the Model 460 5-Hz to 10-MHz frequency meter manufactured by Darcy Industries. This rugged instrument combines portability, ease of operation, and

a high degree of accuracy which makes it an asset on any test bench, in the laboratory, on the production line, or in the school laboratory.

The frequency meter provides highly reliable frequency, count or totalizing, ratio and multiple ratio measurements

that are displayed on a four-digit (fifth and six digits optional) Nixie readout. The instrument weighs 12 pounds and measures 5½" high x 8¾" wide x 15" deep. Front and back panels are fabricated of high-impact plastic which does not mar or scratch. The carrying handle doubles as a tilt stand beneath the case to improve front-panel visibility on the service bench.

The simplicity of the instrument derives from the extensive use of integrated-circuit chips. The only exceptions are the transistorized input buffer, crystal oscillator, display time generator, Nixie display drivers, and power supply. All IC's and discrete components are readily accessible for servicing.

The capability of obtaining eight-digit resolution with a four-digit display is a particularly useful feature of the Model 460. This capability comes about as follows. Suppose that the input signal frequency is 9876543.2 Hz and that the 1-ms time-base push-button is actuated. During this time interval, 98765432 Hz will be gated and the four most significant digits 9876 (kHz) will be displayed. Now, when the next longer time base of 10 ms is selected, 876.5 (kHz) will be displayed with the decimal point positioned automatically. Proceeding as before, the selection of progressively longer time-base intervals of 100 ms, 1 s, and 10 s will provide indications of 76.54, 6.543, and .5432, respectively. Thus, by recording the most significant digit for each step, the total frequency of 9876.5432 kHz (eight digits) will be obtained with a four-digit readout.

Bicron Model 100 Square-Wave Generator

For copy of manufacturer's brochure, circle No. 157 on Reader Service Card.

THE recently introduced Model 100 from Bicron Electronics is a solid-state square-wave generator that can be used to test amplifiers and networks, for electronic switching, for testing oscilloscope sweep circuits, and for any other use requiring an accurate source of square waves. Frequency range of the instrument is from 0.05 Hz to 20 MHz at a stability of 0.5 percent. Rise and fall times of the waveform produced are under 20 nanoseconds and the output is 4 volts across a 50-ohm load.

The generator consists of an emitter-coupled astable multivibrator which uses a single capacitor or crystal between the emitters of the two M-V transistors to determine the operating frequency. This frequency can be varied over a 5 to 1 range with the frequency-vernier control. The multivibrator drives a shaping network that produces the flat top and fast rise and fall times. An emitter-follower provides a low-impedance output.

The unit has a trigger output signal that is completely independent of the signal input. The trigger is used to

The heart of this frequency-measuring instrument is the highly stable crystal-controlled time-base generator employing a crystal which has a temperature coefficient of ± 9 parts in 10^6 (0 to 50° C). Translated into terms of ordinary laboratory usage where the temperature is maintained at ± 5 degrees F, stability is better than 1 ppm. The aging rate is 2 ppm per month, and this becomes the determining factor for accuracy. A frequency adjustment capacitor connected across the crystal is used to calibrate the oscillator frequency directly against any reference standard such as the National Bureau of Standards radio transmissions over station WWV.

The input sensitivity of the instrument is 100 mV to 150 V r.m.s. over the full frequency range at the high input impedance of 1 megohm shunted by 30 pF.

The facility for measuring frequency ratio is another attractive feature of the instrument. The rear panel Ratio Input connector will accept a d.c. to 1-MHz signal for direct ratio measurement with respect to the frequency of the signal applied to the front panel Input connector.

Assurance of proper instrument performance results when the self-test feature is used. By placing the Sensitivity control in the Test position, a 1-MHz internally derived signal is substituted for the normal external frequency input and results in the display of this frequency.

Price for the basic instrument is \$470.00. ▲



drive an oscilloscope's sweep circuits.

A capacitor or crystal that determines the basic operating frequency of the generator is simply plugged into the front-panel binding posts. Hence, the user can tailor the output frequency of the unit to meet his own particular needs. Because the circuits can handle such a wide range of frequencies, the generator can be used for sub-audio, audio, ultrasonic, video, and r.f.

The a.c.-operated generator is compact, measuring only about 6¾" by 4¾" by 4¾" deep. Price is \$137.50. ▲

The TRUE electronic solution to a major problem of engine operation!

DELTA'S FABULOUS MARK TEN®



Only \$44.95 ppd.
In easy-to-build Deltakit®
Only \$29.95 ppd.

CAPACITIVE DISCHARGE IGNITION SYSTEM

You've read about The Mark Ten in *Mechanix Illustrated*, *Popular Mechanics*, *Electronics* and other publications!

Now discover for yourself the dramatic improvement in performance of your car, camper, jeep, truck, boat—any vehicle! Delta's remarkable electronic achievement saves on gas, promotes better acceleration, gives your car that zip you've always wanted. Find out why even Detroit has finally come around. In four years of proven reliability, Delta's Mark Ten has set new records of ignition benefits. No re-wiring! Works on literally any type of gasoline engine.

Why settle for less when you can buy the original DELTA Mark Ten, never excelled and so unique that a U.S. Patent has been granted.

READY FOR THESE BENEFITS?

- ▲ Dramatic Increase in Performance and in Fast Acceleration
- ▲ Promotes more Complete Combustion
- ▲ Points and Plugs last 3 to 10 Times Longer
- ▲ Up to 20% Mileage Increase (saves gas)

LITERATURE SENT BY RETURN MAIL
BETTER YET—ORDER TODAY!



P.O. Box 1147 EW • Grand Junction, Colo. 81501
Enclosed is \$_____ Ship ppd. Ship C.O.D.
Please send:

- Mark Tens (Deltakit®) @ \$29.95
- (12 Volt POSITIVE OR NEGATIVE GROUND ONLY)
- Mark Tens (Assembled) @ \$44.95
- 6 Volt: Negative Ground only.
- 12 Volt: Specify Positive Ground Negative Ground

Car Year _____ Make _____
Name _____
Address _____
City/State _____ Zip _____

CIRCLE NO. 111 ON READER SERVICE CARD

**Sylvania goes into the
ghost-fighting business.**

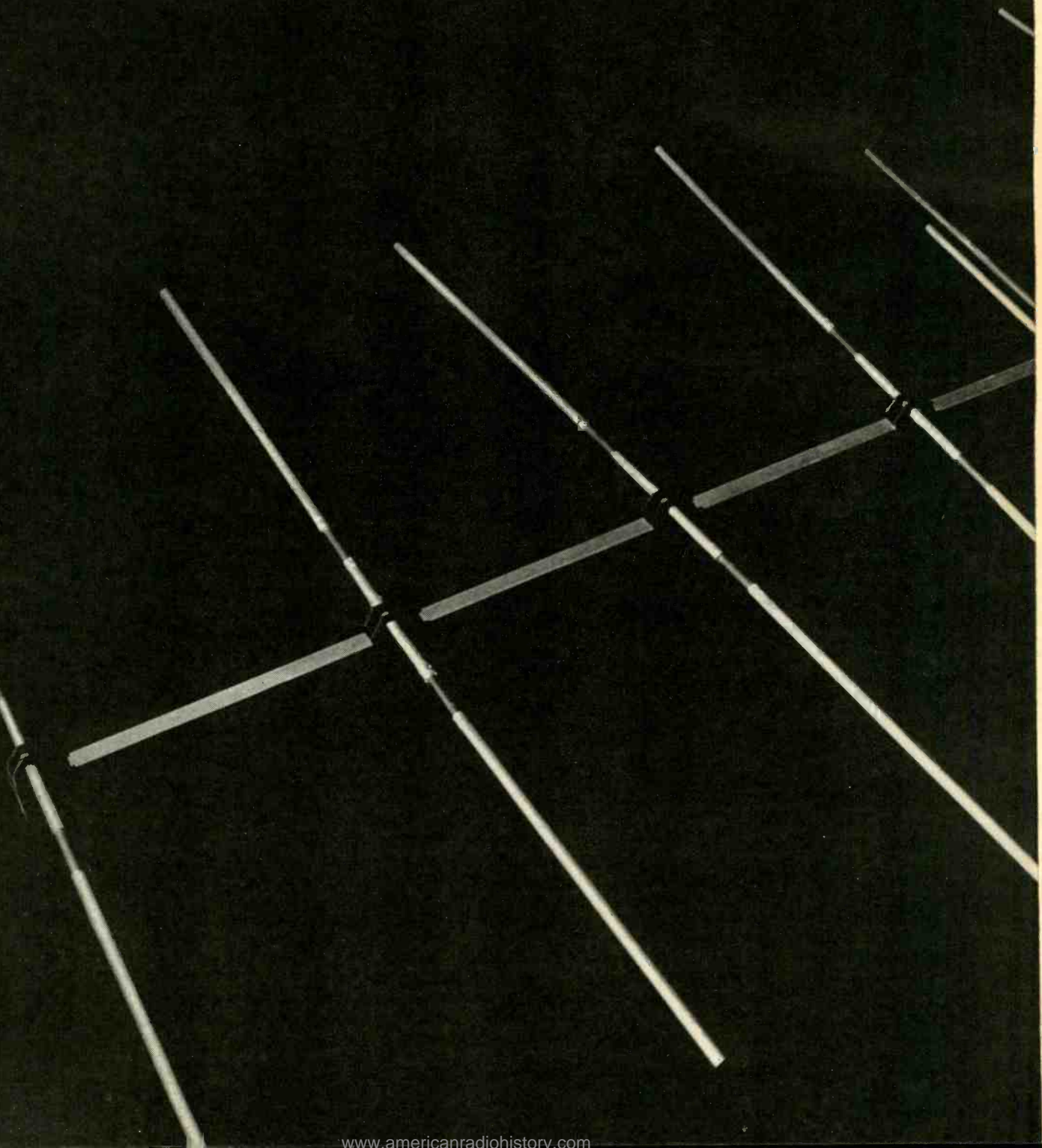

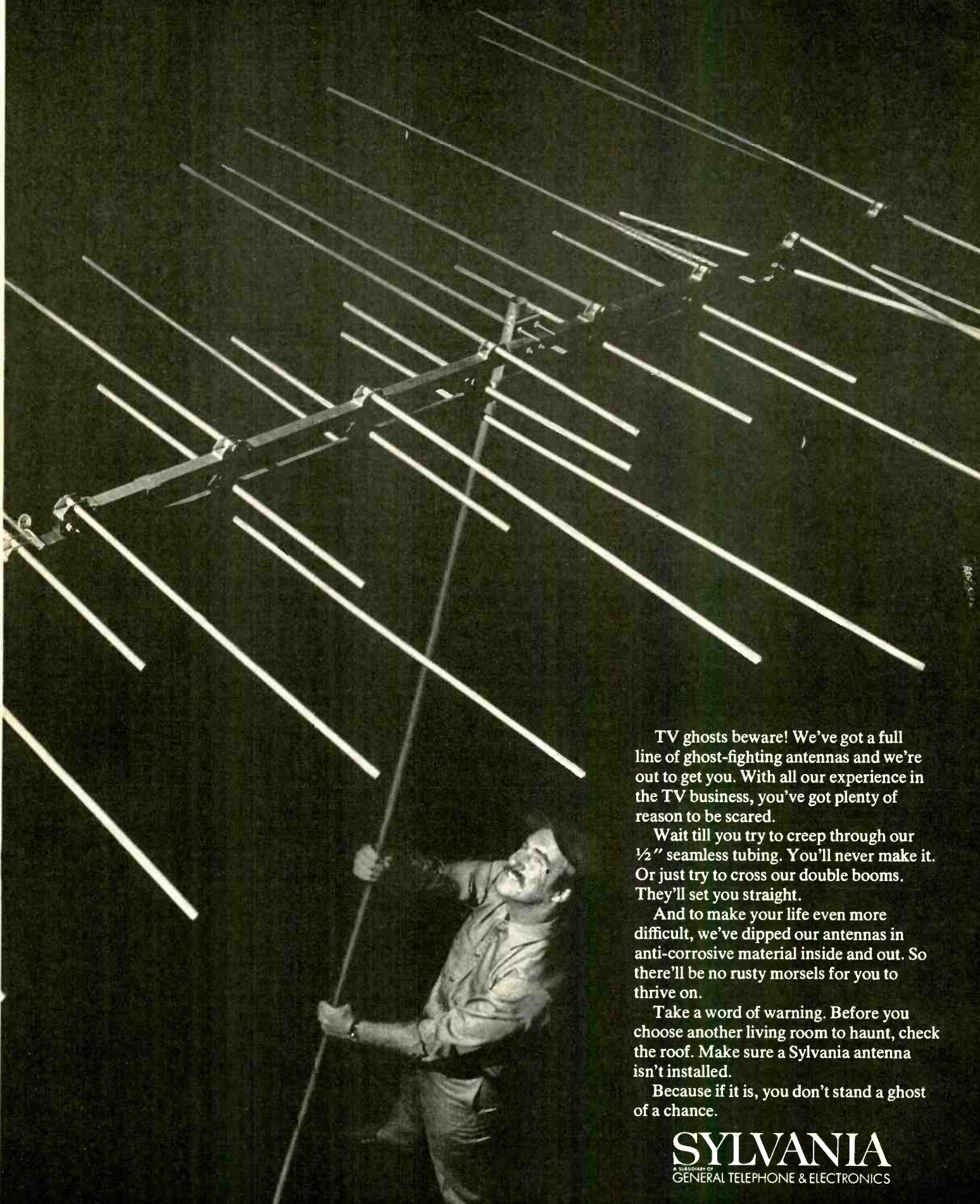

TV ghosts beware! We've got a full line of ghost-fighting antennas and we're out to get you. With all our experience in the TV business, you've got plenty of reason to be scared.

Wait till you try to creep through our 1/2" seamless tubing. You'll never make it. Or just try to cross our double booms. They'll set you straight.

And to make your life even more difficult, we've dipped our antennas in anti-corrosive material inside and out. So there'll be no rusty morsels for you to thrive on.

Take a word of warning. Before you choose another living room to haunt, check the roof. Make sure a Sylvania antenna isn't installed.

Because if it is, you don't stand a ghost of a chance.

SYLVANIA
A SUBSIDIARY OF
GENERAL TELEPHONE & ELECTRONICS

LAFAYETTE RADIO ELECTRONICS

FREE!

**1969 CATALOG No. 690
JUST OFF THE PRESS!!
SEND FOR YOUR EXCITING COPY NOW!**



**BIGGER
& BETTER
THAN EVER**
OVER 500 PAGES!

**YOUR 1st GUIDE TO
EVERYTHING IN
ELECTRONICS**

- ★ CITIZENS BAND 2-WAY RADIO
- ★ STEREO/HI-FI COMPONENTS
- ★ MUSICAL INSTRUMENTS AND AMPLIFIERS
- ★ PUBLIC ADDRESS
- ★ AMATEUR RADIO
- ★ TEST EQUIPMENT
- ★ PARTS
- ★ PORTABLE AND TABLE RADIOS
- ★ PHOTO EQUIPMENT
- ★ TOOLS BOOKS
- ★ AUTO ACCESSORIES
- ★ EDUCATIONAL AND OPTICAL
- ★ TV AND ANTENNAS

Mail This Coupon Today For Your 1969 Catalog No. 690. **LAFAYETTE Radio ELECTRONICS** Dept. 01118, P.O. Box 10, Syosset, L.I., N.Y. 11791

Please send the FREE 1969 LAFAYETTE Catalog No. 690 01118

Name _____

Address _____

City _____ State _____

Zip _____ (please include your Zip Code No.)

CIRCLE NO. 101 ON READER SERVICE CARD

CAR AND DRIVER YEARBOOK

The most exciting, most comprehensive automotive fact book available. A complete buyers guide for domestic and imported models—road tests, accessories, and performance equipment buying guide.
1968 ... \$1.50 ... #51
1967 ... \$1.50 ... #40

CAR AND DRIVER RACING ANNUAL

An almanac of competition information covering the entire racing year. Feature stories of individual races, personality wrap-up on top drivers, box scores on every major event throughout the world plus many dramatic photos.
1967 ... \$1.25 ... #63

Order by number from **Ziff-Davis Service Div., 595 Broadway • New York, N.Y. 10012.** Enclose add'l 15¢ per copy for shipping and handling (50¢ for orders outside U.S.A.)
PAYMENT MUST BE ENCLOSED WITH ORDER

TV Service Generators (Continued from page 42)

different types are used to route and control the sweep signal. Usually a coax cable is used to connect the sweep output signal to a receiver. And-coax cable must be terminated in its proper impedance to keep standing waves low. Often low-impedance coax, 50 or 75 ohms, is used with a series capacitor (rated at least 500 V) to prevent damage to the generator from the receiver's supply voltages. All cables carrying signals from the receiver should be shielded. Some manufacturers supply leads for the bias supply and the scope as well as a demodulator probe for color band-pass work.

A listing of representative service sweep generators is given in Table 1. The upper price limit is \$300 since most service sweep generators fall within this price range. The newer instruments have eliminated or greatly reduced the problems previously encountered with sweep alignment. The old methods of marking frequencies on a response curve by distorting the trace (with "suck-outs") or by injecting the marker into the receiver with the sweep (causing possible overloading) have been largely replaced by a better post-injection marker system. As shown in Fig. 5, this system mixes the output of a fixed marker oscillator with a small portion, or "sample", of the sweep signal. The marker is then added to the sweep signal after it has passed through the receiver under test, thus causing no distortion of the waveform. This system also permits several markers to be added to the response trace and makes interactions between coils easier to observe.

In TV servicing, the newer post-marker type of sweep generator is becoming more and more popular, so let's take a look at what an alignment job is like using one of these models.

Three sections of a color receiver which require alignment are the video i.f. amplifiers, the v.h.f. tuner, and the color band-pass amplifiers. A black-and-white set has similar alignment requirements, but it's a lot simpler since it has none of the color sections.

Alignment Method

Before starting the alignment remove the plate cap from the horizontal output tube and connect a large-wattage resistor load to the supply voltage (this reduces the incidence of interference signals generated by the receiver). Unless the manufacturer says otherwise,

set the v.h.f. channel selector to the highest unused channel. In very strong signal areas it may be necessary to disable the v.h.f. oscillator to prevent strong stations from overriding the sweep signal and overloading the receiver. Connect the r.f. output cable to the tuner mixer grid and connect a clip-lead cable through an isolating resistor to the output of the video detector stage. Set the generator to sweep the i.f. band with a sweep width of about 8 MHz. Adjusting about five or six coils and setting the sound and adjacent-channel traps will complete the alignment. Traps are easiest to set if the frequency is modulated by a low tone and fed into the mixer grid. Crystal-controlled accuracy is ideal here.

The tuner response is observed by injecting the sweep into the antenna terminals through one of the impedance-matching pads shown in Fig. 6. The shunt resistor is not needed if the r.f. output cable is terminated. The output from the mixer grid represents the r.f. amplifier response. Here the channel tuning strips or coils are usually not adjustable and are the only circuit elements different for each channel. Thus, if the alignment is correct for one high-band channel and one low-band channel, it will be correct for the other channels. Channels 10 and 4 are usually used since they are the middle channels for the high and low bands, respectively. Troubles in other channel positions can often be traced to a defective tuning strip or corroded contacts.

Fewer coils and transformers make the color band-pass amplifiers the easiest to adjust. This should be done every time the video i.f. is aligned. Set the generator to a center frequency of 3.5 MHz with a total width of about 3 MHz and inject the signal into the grid of the last color band-pass amplifier. Connect the demodulator probe to the output of the band-pass transformer and adjust it for the usual bell-shaped waveform. Then move the r.f. output cable to the output of the video detector and adjust the band-pass coil of the first color amplifier.

FM i.f. strips have still more coils and transformers to adjust but, in most cases, you adjust for a maximum or minimum output. Connect the sweep generator to the receiver in the same manner as you would an r.f. generator. Set the generator center frequency to 10.7 MHz with a total sweep width of about 600 kHz. The big difference between the two generators is that with the sweep generator you can watch the band-pass curve take shape as you adjust each slug. ▲

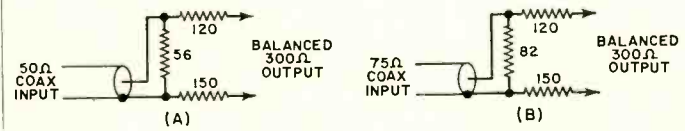

Fig. 6. Typical impedance matching pads for coax cables.

RADAR PLOTTER

System can eliminate collisions by predicting tracks of a target.

A NEW and unique marine radar system, developed by *Marconi Co. Ltd.* claims to provide for the first time, fully automatic plotting of all radar targets, in either true or relative motion, together with a rapid and automatic prediction of the effect of a contemplated change in course or speed.

The radar, called the *Marconi "Predictor"*, provides radar-derived navigational information at a glance without the need for constant radar observation, manual plotting, or the complex computer techniques involved in automatic track-following devices which, by the way, are only able to handle a limited number of targets.

The Predictor continuously updates the radar display to furnish a record of up to six minutes of radar "history", that is, the actual radar tracks of all ships or other targets on the display. A ship's track is shown as a line of four consecutive plots which indicate the target's maneuvers. The distance between each plot indicates target speed. Targets can be shown on the radar display in either a "true motion" mode or a "relative motion" mode.

In the "relative motion" mode of operation, it is possible to set a new course and speed for one's own ship, and then to compute within ten seconds the effect that this would have on the relative motion of all other ships on the display. This prediction mode of operation provides a check on the effectiveness of any action taken to avoid a possible collision, and insures that it does not create a new danger. The radar provides tracks for all targets on the display at the same time and does not rely on a manual preselection of those targets which are thought to present a danger.

The equipment is mostly transistorized, and employs integrated circuits in many parts of the system. The only two tubes used are the transmitter magnetron and the cathode-ray tube display. The transmitter has a peak power of 25 kilowatts and operates in the 3-cm waveband. A slotted waveguide antenna is used with a nominal aperture of 2.45 meters (8 feet). The receiver has a noise factor of better than 11 dB.

The display is a 16-inch CRT fitted in a rotating mounting, which makes it possible to provide a compass-stabilized display with both ship's head-up and north-up presentations. Numerous display ranges, up to 48 miles, are provided. ▲

November, 1968

IT TAKES AN EXACT REPLACEMENT TO HIT THE MARK IN COLOR TV SERVICE

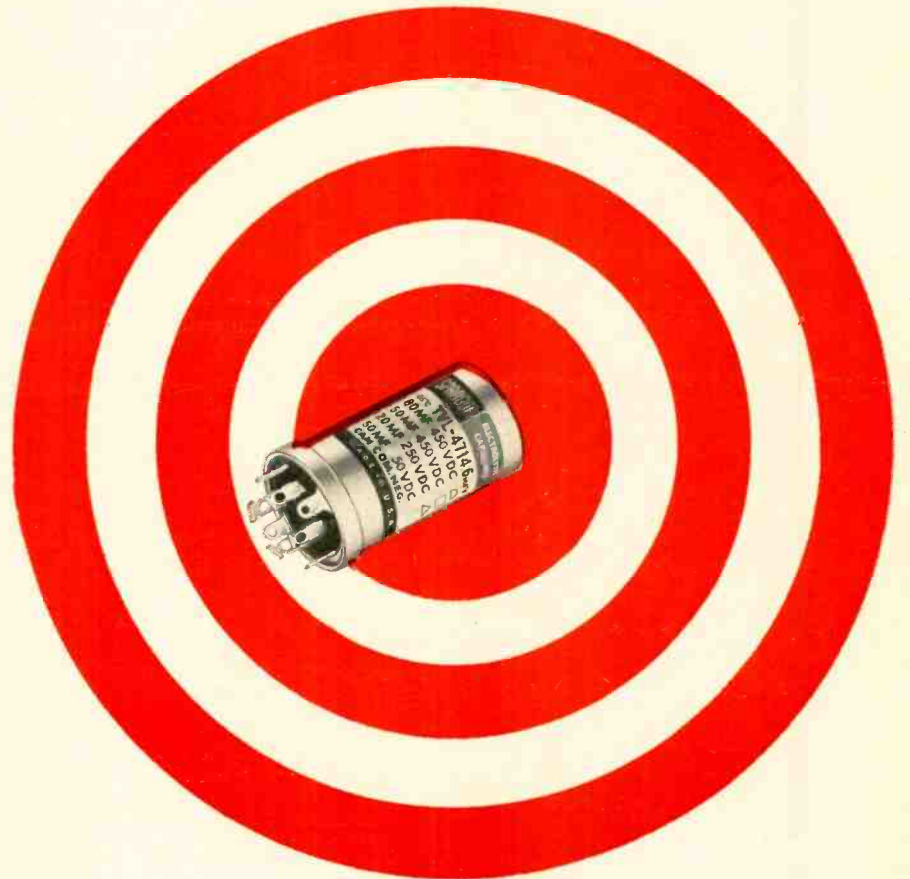

TWIST-LOK® Capacitors
come in the right ratings so you can
make exact replacements

Ask your Sprague distributor for a copy of Sprague's comprehensive Electrolytic Capacitor Replacement Manual K-109 or write to:
Sprague Products Company, 51 Marshall St., North Adams, Mass. 01247.

P.S. You can increase your business 7½% by participating in EIA's "What else needs fixing?" program. Ask your distributor or write to us for details.

65-8128



CIRCLE NO. 80 ON READER SERVICE CARD

how often
could you
have used...

a Seizer?

two-position snap-lock

Handy as an extra hand or helper. Clamps lightly or tightly... for moments or minutes.

A remarkably versatile tool with unusual holding qualities. Clamps tightly. Holds wires for soldering, acts as a heat sink, retrieves small parts from hard-to-reach places. Two-position snap-lock. Box joint construction. Precision machined from perfectly tempered stainless steel.

4 MODELS: 6" (serrated jaws) Nos. 42H straight and 43H curved nose; 5" Jr. (smooth, slim jaws) Nos. 32H straight and 33H curved nose.

XCELITE

XCELITE, INC., 12 Bank St., Orchard Park, N.Y. 14127
In Canada contact Charles W. Pointon, Ltd.
CIRCLE NO. 78 ON READER SERVICE CARD

Transistor Beta vs Source Resistance

By RUFUS P. TURNER

When a transistor is used as a d.c. amplifier, its beta varies with the current-source resistance. This can cause large errors in circuit design if not taken into account.

THE common-emitter-connected transistor is a simple and useful current amplifier. Inject a small current into the base input circuit and you get a large current in the collector output circuit. The transistor current amplification factor (*beta*, β) is this output/input current ratio. In the early days, a *beta* of 10 was attractive enough (put in 100 microamperes and get 1 milliampere out), but now a *beta* of 200 or higher is feasible. Thus, it is possible to obtain considerable amplification of a d.c. signal with only one stage.

Beta has been exploited in a number of devices, including microammeters, electronic voltmeters, sensitive relays, timers, control devices, and potentiometers. However, a number of designers seem to have overlooked the fact that *beta* varies with the resistance of the d.c. signal source. At one resistance, *beta* may be phenomenal and at another only mediocre.

Fig. 1 is a typical d.c. amplifier circuit. Here, the purpose is to adapt a 0-1 d.c. milliammeter (*M*) for measurement of microamperes. The basic meter scale is multiplied by the *beta* of transistor *Q*. An inexpensive General Electric 2N2712 plastic-encapsulated silicon transistor is shown. Since

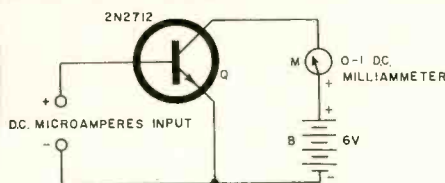

Fig. 1. Typical current amplifier circuit.

the silicon type has low temperature drift and exceedingly low static collector current, it is unnecessary to have either a zero adjustment or an "on-off" switch. The 2N2712 also has high *beta*—anywhere between 80 and 300—which means that the meter will deflect to full scale on an input between 3.3 and 12.5 μA , depending on the individual transistor.

Now, this microammeter is no different from any other in its basic nature; that is, it must be connected in series with the current source and the load. This means that the resistance of the current source (including any series resistance in the circuit under test) is in series with the transistor, often with its base terminal. There would be nothing noteworthy about this, except that this resistance changes the *beta* of the transistor. Fig. 2 shows how the *beta* of a randomly selected 2N2712 varies with source resistance.

The curve was plotted from data obtained with the test circuit shown in Fig. 1. Numerous values of resistance, between 100 and 500,000 ohms, were connected successively in series with the "+ Input" terminal and an adjustable d.c. source, input current adjusted for 1-mA full-scale deflection of meter *M*, and *beta* calculated from the current ratio.

Note in Fig. 2 that as the source resistance increases from 100 to 10,000 ohms, *beta* increases from 30 to the peak value of 140. Then as the resistance is increased further from 10,000 to 500,000 ohms, *beta* decreases from 140 to 120. Calculations from this

Fig. 2. Variation of beta with resistance of the current source that is used.

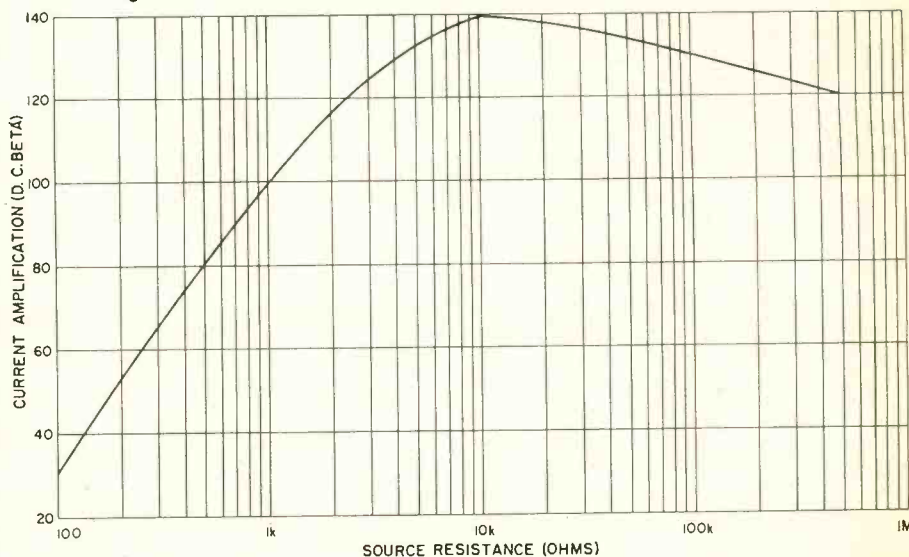

curve show that milliammeter *M* will be deflected to full scale by 7.1 μA if the source resistance is 10,000 ohms, but this sensitivity is not obtained otherwise. Thus, 33- μA input is required for full-scale deflection at 100 ohms, and 8.3 μA at 500,000 ohms.

This *beta* variation explains why various designers all might obtain different results with the circuit of Fig. 1. Although using an identical transistor with the same *beta*, they may be checking current in circuits of different resistance. It also explains why when a milliamperere-type d.c. relay is substituted for the meter, one find that he can close the relay with an amplifier input of 10 μA , whereas another requires 100 μA , yet both find the same *beta* of 100 when the transistor is checked externally in a tester.

The solution is to apply a correction factor based upon a curve, such as Fig. 2, plotted for the actual transistor used. This curve will show how much a meter reading needs to be corrected or how much the nominal input current must be increased to close a relay.

SILVER-SOLDER WARNING

THE Division of Occupational Health, U.S. Public Health Service, has reported two poisoning deaths traced to improper use of silver solder containing cadmium, and warned that this type of industrial material should be carefully used under safe operating conditions.

The deaths occurred in California and Utah. A second non-fatal incident of cadmium poisoning was also discovered in California. In the Utah case, the worker told his physician that he had been working with ammonia and neglected to mention silver solder. His illness was consequently first diagnosed as ammonia poisoning. It was not until after his death that tissue tests revealed the cadmium poisoning.

Part of the problem, the Division of Occupational Health says, is that there are few requirements for labeling of hazardous industrial materials. In the case of the silver solder used in Utah, there was only a 1¼-by-2-inch loose tag which said: "Contains cadmium, emits dangerous fumes if overheated."

The Division of Occupational Health also stresses that all workers should tell their physicians what their jobs are and what types of materials they handle. Occupationally caused illnesses and diseases can be overlooked if physicians do not have this vital information.

The Division also emphasizes that not all silver solders contain cadmium. However, when using any type of this material, precautions should be followed.

1. Warning labels, which should be on all packages, must be carefully read and followed.

2. The working area must be properly ventilated, preferably with specific exhaust systems.

3. Workers must avoid breathing emitted fumes of any description.

Build this magnificent Schober Theatre Organ for only \$1550!*



*Includes finished walnut console. Amplifier, speaker system, optional accessories extra. Only \$1150.50 if you build your own console.

You couldn't touch an organ like this in a store for less than \$3500—and there hasn't been a musical instrument with this vast variety of genuine Theatre Organ voices since the days of the silent movies! Haunting tibias, biting strings, blaring reeds—the whole A to Z gamut of real pipe sounds that make the simplest playing a thrilling experience and give the professional organist everything he needs. If you've dreamed of the grandeur of authentic big-organ sound in your own home, you won't find a more satisfying instrument anywhere—kit or no kit.

The Schober Organ Corp., Dept. RN-59
43 West 61st Street, New York, N.Y. 10023

- Please send me Schober Organ Catalog and free 7-inch "sample" record.
- Enclosed please find \$1.00 for 12-inch L.P. record of Schober Organ music.

NAME _____

ADDRESS _____

CITY _____ STATE _____ ZIP _____

You can learn to play it. And you can build it, from Schober Kits, world famous for ease of assembly without the slightest knowledge of electronics or music, for design and parts quality from the ground up, and—above all—for the highest praise from musicians everywhere.

Send right now for your copy of the full-color Schober catalog, containing specifications of the five Schober Organ models, beginning at \$599.50. No charge, no obligation—but lots of food for a healthy musical appetite!

CIRCLE NO. 86 ON READER SERVICE CARD

TUBE TESTER OWNERS

WE HAVE THE LATEST TUBE DATA AND ADAPTERS FOR →

- EICO
- HEATH
- JACKSON
- KNIGHT
- MERCURY
- NRI-CONAR
- PRECISION
- SYLVANIA

Don't let your tube tester become obsolete

CLIP AND MAIL COUPON TODAY

- COLETRONICS SERVICE INC.
- 1744 Rockaway Ave.,
- Hewlett, N.Y. 11557

• Please send me information on Model No. _____ and Make _____

• Name _____

• Address _____

• City _____ State _____ Zone _____

CIRCLE NO. 113 ON READER SERVICE CARD

Olson®

FREE

Fill in coupon for a FREE One Year Subscription to OLSON ELECTRONICS' Fantastic Value Packed Catalog—Unheard of LOW, LOW PRICES on Brand Name Speakers, Changers, Tubes, Tools, Stereo Amps, Tuners, CB, Hi-Fi's, and thousands of other Electronic Values. Credit plan available.

NAME _____

ADDRESS _____

CITY _____ STATE _____

GIVE ZIP CODE _____

If you have a friend interested in electronics send his name and address for a FREE subscription also.

OLSON ELECTRONICS

982 S. Forge Street Akron, Ohio 44308

CIRCLE NO. 94 ON READER SERVICE CARD

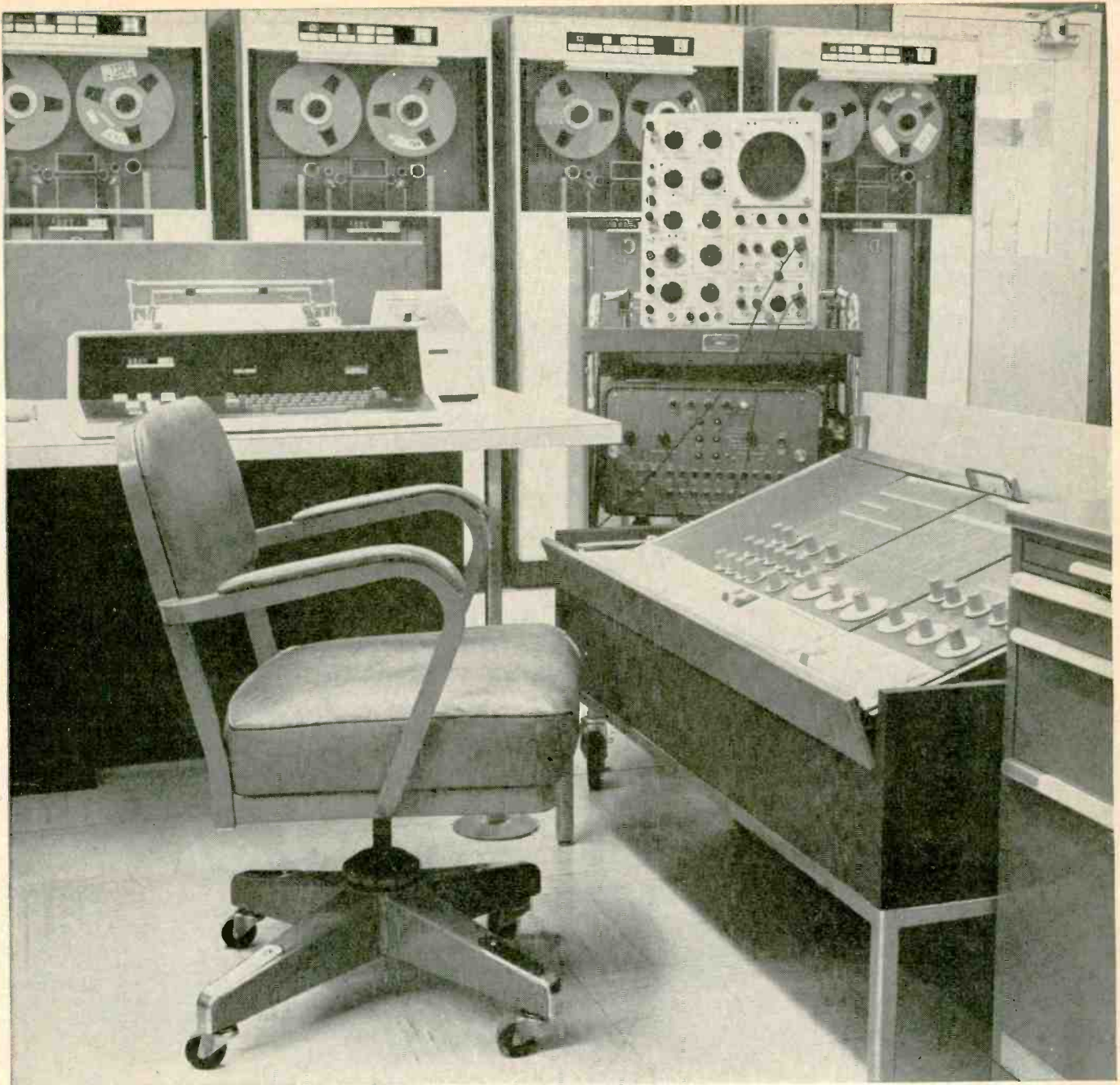

This important job (and its big salary) is reserved for a qualified electronics technician. It can be you!

It's a fact. There are *many thousands* of jobs like this available *right now* for skilled electronics technicians. What's more, these men are going to be in even *greater* demand in the years ahead. But how about you? Where do you fit into the picture? Your opportunity will never be greater...so act *now* to take advantage of it. The first step? Learn electronics fundamentals...develop a practical understanding of transistors, troubleshooting techniques, pulse circuitry, micro-electronics, computers and many other exciting new developments in this booming field. Prepare yourself now for a job with a bright future

...unlimited opportunity...lasting security...prestige... and a steadily-increasing salary.

Thousands of ambitious men are using Cleveland Institute of Electronics Training Programs as a stepping stone to the good jobs in Electronics. Why not join them? You will learn at home, in your spare time, and tuition is remarkably low. Read the important information on the facing page. Then fill out the postage-free reply card and drop it in the mail today. Without obligation we'll send you all the details. But act now...and get *your* high-paying job just that much sooner.

How You Can Succeed In Electronics

... Select Your Future From Six Career Programs

The "right" course for your career

Cleveland Institute offers not one, but six different and up-to-date Electronics Home Study Programs. Look them over. Pick the one that is "right" for you. Then mark your selection on the bound-in reply card and send it to us. In a few days you will have complete details...without obligation.

1. Electronics Technology

A comprehensive program covering Automation, Communications, Computers, Industrial Controls, Television, Transistors, and preparation for a 1st Class FCC License.



NEW!

2. Broadcast (Radio & TV) Engineering

Here's an excellent studio engineering program which will get you a 1st Class FCC License. Now includes Video Systems, Monitors, FM Stereo Multiplex, Color Transmitter Operation, and CATV.



3. First Class FCC License

If you want a 1st Class FCC ticket quickly, this streamlined program will do the trick and enable you to maintain and service all types of transmitting equipment.



4. Electronic Communications

Mobile Radio, Microwave, and 2nd Class FCC preparation are just a few of the topics covered in this "compact" program...Carrier Telephony too, if you so desire.



5. Industrial Electronics & Automation

This exciting program includes many important subjects such as Computers, Electronic Heating and Welding, Industrial Controls, Servomechanisms, and Solid State Devices.



NEW!

6. Electronics Engineering

A college-level course for men already working in Electronics... covers Steady State and Transient Network Theory, Solid State Physics and Circuitry, Pulse Techniques, Computer Logic, and Mathematics through Calculus.



ENROLL UNDER NEW G.I. BILL. All CIE courses are available under the new G.I. Bill. If you served on active duty since January 31, 1955, or are in service now, check box on reply card for G.I. Bill information.

An FCC License...or your money back!

In addition to providing you with comprehensive training in the area indicated, programs 1, 2, 3, and 4 will prepare you for a Commercial FCC License. In fact, we're so certain of their effectiveness, we make this exclusive offer:

The training programs described will prepare you for the FCC License specified. Should you fail to pass the FCC examination after completing the course, we will refund all tuition payments. You get an FCC License... or your money back!

CIE's AUTO-PROGRAMMED® lessons help you learn faster and easier

Cleveland Institute uses the new programmed learning approach. Our AUTO-PROGRAMMED® lessons present facts and concepts in small, easy-to-understand bits...reinforce them with clear explanations and examples. Students learn more thoroughly and faster through this modern, simplified method. You, too, will absorb...retain...advance at your own pace.

Lifetime job placement service for every CIE graduate...at no extra cost

Once enrolled with CIE, you will get a bi-monthly listing of the many high-paying, interesting jobs available with top companies throughout the country. Many Cleveland Institute students and graduates hold such jobs with leading companies like these: American Airlines, American Telephone & Telegraph, General Electric, General Telephone and Electronics, IBM, Motorola, North American Aviation, New York Central Railroad, Raytheon, RCA, and Westinghouse.

CIE lessons are always up-to-date

Only CIE offers new, up-to-the-minute lessons in all of these subjects: Logical Troubleshooting, Laser Theory and Application, Microminiaturization, Single Sideband Techniques, Pulse Theory and Application, Boolean Algebra.

Full accreditation...your assurance of competence and integrity

Cleveland Institute of Electronics is accredited by the Accrediting Commission of the National Home Study Council. You can be assured of competent Electronics training by a staff of skilled Electronics instructors.

CIE Cleveland Institute of Electronics
1776 East 17th Street, Cleveland, Ohio 44114

If card has been removed, mail this coupon for 2 FREE BOOKS

Cleveland Institute of Electronics
1776 East 17th Street, Cleveland, Ohio 44114

Please send me without cost or obligation:

1. Your 40-page book "How To Succeed In Electronics" describing job opportunities in Electronics today, and how your courses can prepare me for them.

2. Your book on "How To Get A Commercial FCC License."

I am especially interested in:

- | | | |
|--|--|--|
| <input type="checkbox"/> Electronics Technology | <input type="checkbox"/> Broadcast Engineering | <input type="checkbox"/> First Class FCC License |
| <input type="checkbox"/> Electronic Communications | <input type="checkbox"/> Industrial Electronics & Automation | <input type="checkbox"/> Electronics Engineering |

Name _____ Age _____

Address _____

City _____ State _____ Zip _____

Check here for G.I. Bill information

EW-51

Ultrasonics for Testing

(Continued from page 28)

inspection. In order to fit into the busy subway schedule the test is run at high speed and recorded on film. Results are interpreted after the test and the defective rails are changed.

Medical Research

Early work done by medical researchers used industrial ultrasonic testing equipment. This has led to the acceptance of ultrasonics in medical diagnosis and equipment designed solely for medical purposes. While the pulse-echo method has been helpful in diagnosing mitral stenosis, determining fetal head size, detecting cirrhosis of the liver, and in many other areas, its most widespread use is in cranial mid-line measurements.

The brain is divided into two laterally displaced halves, separated by what is commonly called the *mid-line*. The mid-line consists of various structures which are located exactly halfway between either ear. The mid-line is easily detected ultrasonically, as it represents a distinct change of acoustic impedance compared to brain tissue. The mid-line echo will appear just halfway between skull tables when a search unit is placed in the region of the temple.

A blow on the head may cause bleeding inside the skull. Since the blood is trapped within the skull it will form a pool and displace the brain and mid-line structures away from it. An ultrasonic test can quickly detect this condition as the distance to the mid-line echo will be different when measured from the left side and the right side. A significant "shift" of mid-line signal indicates trouble which could otherwise be determined only by time-consuming, expensive, and sometimes hazardous tests. The equipment is also useful for the detection of other brain conditions such as tumors and atrophy.

Future Developments

For the future, there will be an increase in the variety of applications for ultrasonics along with a continuing increase in automatic testing. There will be a greater use of computers in adaptive control and in interpretation and storage of data. Integrated circuits will provide flexibility, quality, smaller size and weight, and increased sophistication in the electronics circuitry. Accuracy, stability, linearity, reliability, and all parameters of quality will continue to improve.

Instrument size and shape is now dictated pretty much by cathode-ray tube sizes. The long-awaited picture-frame display will result in instruments carried in attaché cases, or literally hung on the wall. Holographic techniques for producing 3D images of internal structures will be developed far beyond present-day efforts to provide clear, easily attained images. Color will be used to add still another dimension to displayed information. Fewer controls will be used as electronics does more of the work of automatically setting sensitivity and test areas to be scanned. Scanning will be done electronically with no need for mechanical motion whatsoever.

Ultrasonics will still not do all non-destructive testing jobs, but it will be increasingly used in combination with other methods to provide one integrated test at one test station with a single output giving the results of the test. Most test results will be presented in the form of punched cards for production testing. The test stations in the various production processes will also be located closer to the point where defects or out-of-tolerance conditions first occur, and feedback loops will make appropriate corrections to the material while it is being welded or formed.

We seem to have an insatiable appetite for more goods, made better and faster, and non-destructive testing will play a key role in satisfying this demand. ▲

STEREO/HI-FI DIRECTORY

Giant 180 page buyers guide to virtually every new audio component on the market — amplifiers • changers and turn tables • receivers • tuners • tape machines • speakers, etc.

1968 #56

1967 #45

TAPE RECORDER ANNUAL

The only buyers guide of its kind available to the brands and models on the market. Over 132 pages of full information on over 250 models plus articles covering every aspect of tape recording.

1968 #59

1967 #42



Ziff-Davis Service Division—Dept. W • 595 B'way, New York, N.Y. 10012

I am enclosing \$_____ for the annuals circled below. My remittance includes an additional 15¢ per copy for shipping and handling (50¢ for orders outside U.S.A.). I understand quantities are limited and orders will be filled on a first come-first served basis.

\$1.25 each

42 45 56 59

Print Name _____

EW-118

Address _____

City _____

State _____

Zip _____

PAYMENT MUST BE ENCLOSED WITH ORDER

GAS WELDING TORCH



Uses **OXYGEN** and **LP GAS**

- Completely self-contained.
- Produces 5000° pin-point flame.
- Welds, brazes, solders.
- Hundreds of lightweight uses.
- Suggested list — \$19.95.



GET COMPLETE DETAILS AT MOST INDUSTRIAL DISTRIBUTORS, OR WRITE TO MICROFLAME, INC.

MICROFLAME, INC.

7800 COMPUTER AVENUE
MINNEAPOLIS, MINNESOTA 55424

CIRCLE NO. 98 ON READER SERVICE CARD

EW Lab Tested
(Continued from page 22)

quite impressive. What impressed us, however, was the effortless way in which it met or surpassed practically every specification. For example, it is rated at 32 watts per channel into 8 ohms. With both channels driven, we found the clipping level to be just 32 watts. The distortion fell off rapidly below the clipping level and, at 1000 Hz, it was less than 0.2% for all powers below 10 watts down to about 0.4 watt. The IM distortion was below 0.5% for powers under 15 watts.

At 30 watts output, with both channels driven, the distortion was below 0.4% from 180 to 20,000 Hz. It rose slightly at lower frequencies to 2% at 50 Hz. At half power or less, the distortion was less than 0.2% from 25 to 2000 Hz and under 0.5% from 20 to 20,000 Hz.

The bass tone controls, when used in moderation, had the desirable property of affecting response below 200 Hz without affecting higher frequencies. The loudness compensation, boosting both lows and highs, was very moderate and did not produce unnatural coloration. The equalization was unusually accurate, with the RIAA error being +0, -2 dB from 50-15,000 Hz and the NAB error only +0, -0.5 dB over the same range. The filters had only 6-dB-per-octave slopes and they worked very much as supplementary tone controls rather than filters.

The FM tuner was a pleasant surprise. Its IHF usable sensitivity was

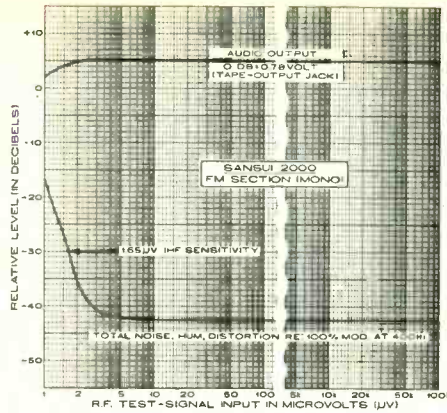

1.65 μV with full limiting at 4 μV which made it one of the most sensitive FM tuners we have tested. Its stereo separation was by far the best we have measured, exceeding 40 dB at frequencies around 1000 Hz and better than 20 dB from 30 to about 10,000 Hz. Until we tested the Sansui 2000, we didn't suspect that our test equipment was capable of separation measurements beyond 40 dB. The frequency response of the tuner section was +0.8, -1.8 dB from 30 to 15,000 Hz.

In all respects, the Model 2000 was a pleasure to use and listen to. Its sensitivity, selectivity, and freedom from distortion and cross-modulation were immediately evident. The amplifiers drove our low-efficiency speakers at any level we could tolerate without straining. The noise level of the amplifier was extremely low, being better than 70 dB below 10 watts even on phono input. All in all, this was one of the easiest-to-live-with receivers we have tested, and it is a notable value at \$299.95. ▲

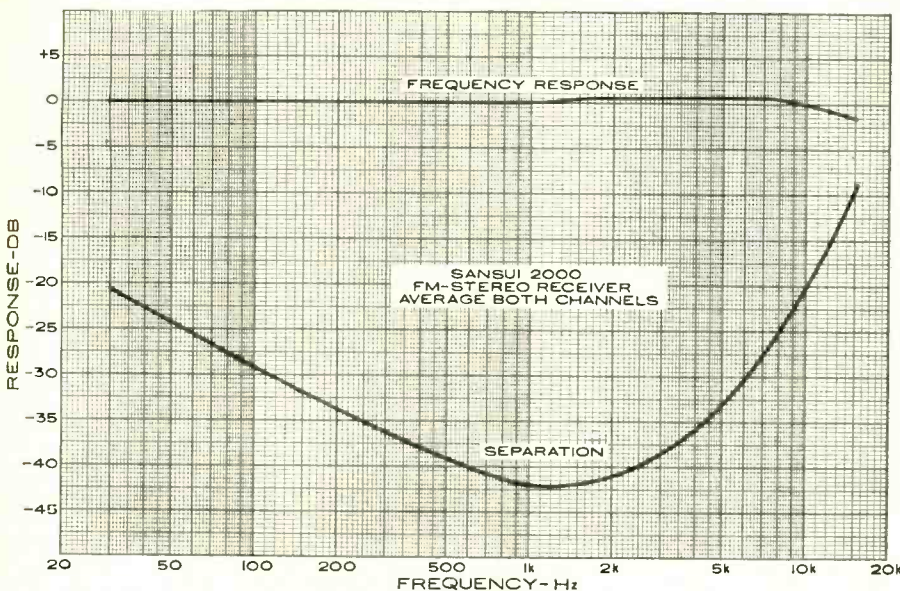

Bose 901 Speaker System

For copy of manufacturer's brochure, circle No. 21 on Reader Service Card.

DEPENDING on one's viewpoint, the Bose 901 speaker system might be considered a revolutionary approach to sound reproduction, or simply a

workable combination of well-established (and sometimes deprecated) techniques. The enclosures house nine small, specially designed drivers that have 4-

DON'T MISS... POLICE and FIRE ACTION
PERFECT FOR INDUSTRIAL, COMMERCIAL and GOVERNMENT USE

DUAL CONVERSION
SMALL SIZE • LOW POWER DRAIN
• HIGH STABILITY • CRYSTAL CONTROLLED

Specifically designed for simplicity of operation... efficiently engineered to give you years of service. Fits the smallest auto yet powerful enough to deliver a clear signal. Operates on 6 crystal controlled frequencies. Dual limiter & Foster Seelye discriminator. Quadruple tuned RF stage for greater image rejection. Noise Free squelch. PLUG IN crystals for instant frequency change. Compatible with major continuous tone systems. Operates on 117VAC and 12VDC. Size: 6 7/8" x 2 5/8" x 8 1/2". Wt. 3 lbs. 8 oz.

FR-104 (25-50 MHz) Complete with AC and DC power cables, mounting bracket, less crystals. Crystals \$5.00 ea.
FR-105 (150-175 MHz) **\$140.00**

SONAR RADIO CORPORATION
73 Wortman Ave., Bklyn, N.Y. 11207 Dept. 721
Please send me information on Model FR-104/105 FM Monitor Receivers.

Name
Address
City Zone State

LISTEN TO: POLICE, FIRE and WEATHER REPORTS!

Perfect for Industrial, Commercial, Utility and Government Use
SONAR SENTRY VHF MONITOR RECEIVERS

Designed and engineered for simplicity of operation, compact enough to fit a shirt pocket yet powerful enough to deliver a clear clean signal—it's dependable • Operates on two crystal controlled VHF channels plus broadcast band • Completely solid state for long life use • Visible battery indicator to show battery condition at all times • Built in antenna • 5 7/8" H x 2 1/2" W x 1 3/4" D. Wt. 11 oz.

FR-103 150-175 MHz With Battery, Earphone, & less Crystals
FR-106 25-50 MHz Crystals \$5.00 ea.

SONAR RADIO CORPORATION
73 Wortman Ave., Bklyn, N.Y. 11207 Dept. 721
Please send me information on Model VHF Monitor Receivers.

Name
Address
City Zone State

CIRCLE NO. 82 ON READER SERVICE CARD

**WORLD'S
FINEST**

**5-CORE
SOLDER**



**ERSIN
MULTICORE**

**NEW EASY
DISPENSER
PAK**

ONLY 69¢

BUY IT AT RADIO-TV PARTS STORES

MULTICORE SALES CORP., WESTBURY, N.Y. 11590
CIRCLE NO. 96 ON READER SERVICE CARD

ARAMCO, one of the largest oil producing companies in the world, is seeking an electronic technician to work in Saudi Arabia. Must be a high school graduate with an additional 3 years technical school training in specialized communications equipment and have a minimum of 5 years work experience in the maintenance & repair of a variety of communications and industrial electronic equipment.

Good opportunity for advancement, travel and saving; all inclusive benefit plans; family housing, schooling, recreation and community facilities similar to any small community in the U.S.A.

Send resume outlining education, work experience and personal history to:

EMPLOYMENT SUPERVISOR
Arabian American
Oil Company
505 PARK AVENUE
New York, New York 10022.

W
A
R
M
U
P
O
R
T
S
M
A
G
A
Z
I
N
E

W
A
R
M
U
P
O
R
T
S
M
A
G
A
Z
I
N
E

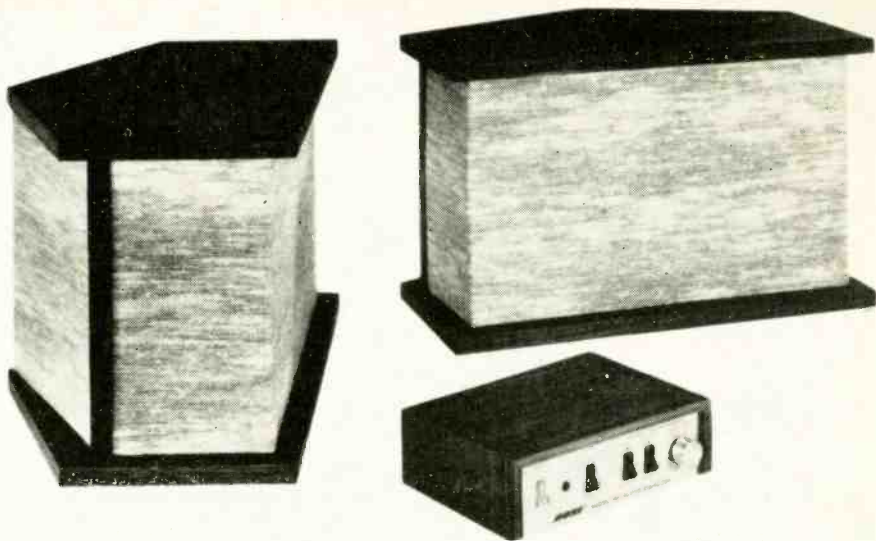

inch cones and powerful magnetic structures. Eight of the drivers are angled to the rear, while the ninth is mounted on the front of the enclosure facing the listening area. This arrangement is intended to achieve approximately the same ratio of direct-to-reflected sound that exists in the concert hall.

The 901's cabinets are quite compact, measuring 12 $\frac{3}{4}$ inches high by 20 $\frac{1}{16}$ inches wide when viewed from the front. Seen from the top, the rear of the enclosure forms a "V" of about 120 degrees. Basic to its operation is the requirement that it be mounted with the "V" facing the wall, the apex being about 12 inches from the wall. When a pair of 901's are so installed, the sound appears to be uniformly distributed across the wall between the speakers, completely free from any "hole-in-the-middle" effect. Since only 11 percent of the sound is radiated directly forward, it is almost impossible to localize the source. In fact, the sound volume hard-

ly changes when one approaches the speakers or even stands between them.

An intrinsic part of the system is an active (ten-transistor) equalizer that handles both channels; it compensates for the high-frequency losses inherent in the reflecting process and also flattens out the bass response. (The uncompensated bass response is down because of the natural bass roll-off resulting from the very small volume of the enclosure.) Housed in a small walnut cabinet, this self-powered equalizing unit is connected either between the preamplifier and power amplifier or in the tape-monitoring signal path of the amplifier or receiver.

There are five controls on the equalizer, four rocker switches and one five-position rotary control. One rocker serves as an "on-off" switch, another as the tape-monitor switch, and the third as a low filter that primarily affects frequencies below 40 Hz. This is intended to reduce rumble or acoustic feedback.

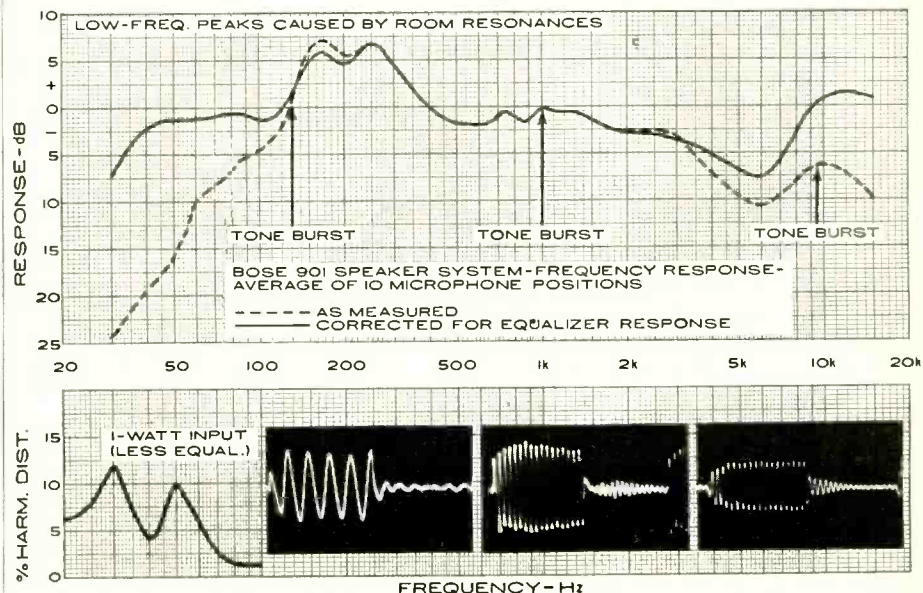

CIRCLE NO. 121 ON READER SERVICE CARD
76

ELECTRONICS WORLD

The fourth rocker switch interacts with a rotary five-position treble contour control. When the rocker switch is set for "normal," the rotary switch provides a boost position, a flat position, and three positions of decreasing high-frequency response from the speakers. When the rocker switch is set for "Treble Decrease," it introduces a depression in the response between 2000 and 6000 Hz. The five switched contours then not only affect the very-high-frequency speaker performance, but also the frequencies between 500 and 2000 Hz that are not affected by the rocker switch in its "Normal" position. In all, ten different high-frequency, mid-range response contours are available.

The active equalizer has unity gain and introduces no perceptible distortion. We measured its distortion at less than 0.13% for any output under 3 volts, which is greater than would be required with any amplifier we know of.

After a couple of months of living with a Bose 901 system, we are convinced that it ranks with a handful of the finest home speaker systems of all time. Because of its unconventional mode of operation, it was doubtful that any frequency response measurements that could be made would account for the remarkable realism of its sound. Difficult as it is to measure the output of a single direct radiator in a normal living room, it is well-nigh impossible to measure an almost perfectly dispersed sound pattern such as that of the 901 without strong influence from room acoustics. Nevertheless, a measurement was attempted.

We placed the speaker in the recommended position relative to the room wall. For frequency response and tone-burst measurements, we did not use the equalizer. Its response was measured separately and added to the speaker response measured to obtain the final curve. Ten microphone positions were used, and their readings averaged. Harmonic distortion was measured at a 1-watt drive level, using the equalizer at its normal setting.

It was no surprise to find that the final response curve was not as flat as some we have measured. There appeared to be a broad rise of about 5 to 6 dB in the 130- to 250-Hz region, although we could not detect its presence by ear. The output fell smoothly above 1000 Hz to -7 dB at 6000 Hz, then rose about to the 1000-Hz reference level between 10,000 and 15,000 Hz.

The low-frequency harmonic distortion measurements were affected somewhat by the speaker and microphone placement. The distortion was 7% at 20 Hz, and reached maxima of 12% at 30 Hz and 10% at 100 Hz. It was considerably lower at other frequencies in the bass range. (As a point of reference,

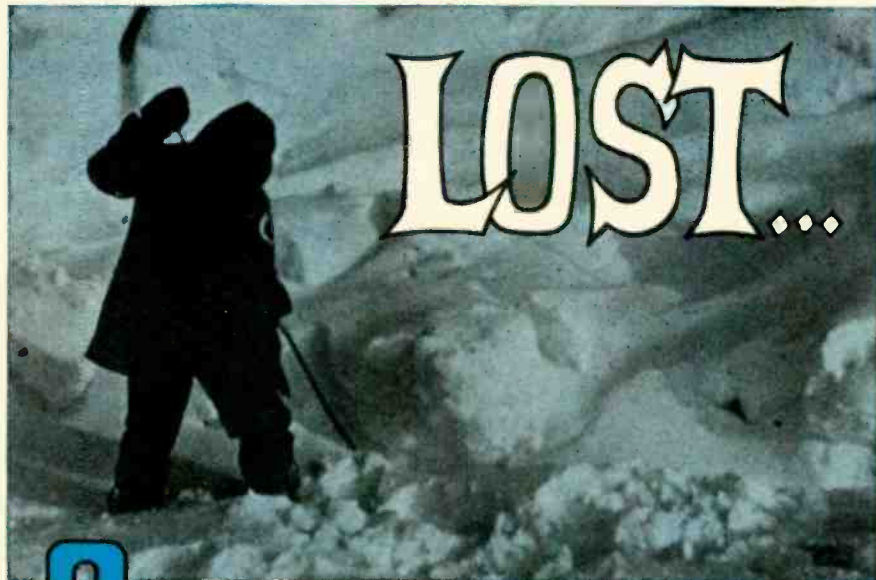

2

JOHNSON MESSENGER III Field Packs at latitude 83° 10' N



Johnson Messenger III Field Pack

Five Messenger III Field Packs were brought to the Arctic by the 1968 Plaisted Polar Expedition. There, they performed admirably through blizzards, -30° cold, and other Arctic hardships. Even a generator malfunction that blew out all the lights in three base camp buildings did not affect the performance of the Johnson units.

Because of aircraft weight limitations, two had to be left behind when the Plaisted group went home after the first successful assault on the North Pole since Perry. If you'd like two perfectly good Messenger III Field Packs, you can pick these up at Ward Hunt Island... 83° 10' N latitude!

Or you can stop in and see your nearest Johnson Dealer. He'll be glad to tell you all about the complete Johnson line... including the new 23 channel, tube type Messenger 223, the new 23 channel, solid state Messenger 320 or the new 2 channel, 3 watt Messenger 109 hand-held. Besides, you'll find his reception a lot warmer than the one you'd get at Ward Hunt Island!



E. F. JOHNSON COMPANY

1176 Tenth Ave. S.W., Waseca, Minnesota 56093

Providing nearly a half-century of communications leadership

CIRCLE NO. 102 ON READER SERVICE CARD

PHOTOGRAPHY ANNUAL

A selection of the World's finest photographs compiled by the editors of Popular Photography. All editions \$1.25 each:

1966 — \$1.25...#1

1967 — \$1.50...#38

1964 — \$1.25...#3

Order by number from Ziff-Davis Service Div., 595 Broadway • New York, N. Y. 10012. Enclose add'l 15¢ per copy for shipping and handling (50¢ for orders outside U.S.A.)

CASSETTES

C-30 1/2 Hr... .55
C-60 1 Hr... .69
C-90 1 1/2 Hr... 1.19
C-120 2 Hr... 1.39

SAXTONE

DISCOUNT MUSIC CATALOGS

4 track open reel;
8 track, OR cassettes.

(Send for blank tape and recorder discount catalog)

Postage 10¢; 5¢ ea. addl. cassette, 12¢ postpaid.

1776 Columbia Rd., N.W.
Washington, D.C. 20009

GET INTO ELECTRONICS



V.T.I. training leads to success as technicians, field engineers, specialists in communications, guided missiles, computers, radar and automation. Basic & advanced courses in theory & laboratory. Electronic Engineering Technology and Electronic Technology curricula both available. Assoc. degree in 29 mos. B. S. also obtainable. G.I. approved. Graduates in all branches of electronics with major companies. Start February, September. Dorms, campus. High school graduate or equivalent. Write for catalog.

VALPARAISO TECHNICAL INSTITUTE
Dept. RD, Valparaiso, Indiana 46383

CONQUER NEW HORIZONS

WITH
CONTROLLED QUALITY CRYSTALS



- *Tried and True*
- **Complete Range**
- *Guaranteed*
- **Ready for you at your dealer**



CRYSTEK

TEXAS CRYSTALS

Division of Whitehall Electronics Corp.

1000 CRYSTAL DRIVE
FORT MYERS,
FLORIDA 33901

*Plants in Fort Myers
and Los Angeles, Calif.*

CIRCLE NO. 200 ON READER SERVICE CARD

the better acoustic-suspension speakers have about half as much measured distortion at similar drive levels.)

We listened to the system in several listening rooms which ranged acoustically from extremely hard and bright to quite dull. It was compared in A-B tests with several of the better speaker systems at our disposal. The *Bose 901* had an utterly clean, transparent, and effortless sound. Its clarity and definition when reproducing complex orchestral passages were, in the writer's opinion, unsurpassed. This impression was confirmed by its tone-burst response, which was uniformly excellent across the frequency spectrum. Its low-bass response was difficult to credit to such a compact system. It had all the room-filling potency of the best acoustic-suspension systems, combined with the tautness and clarity of a full-range electrostatic speaker. The spatial distribution, which brings an entire wall alive with sound, contributes greatly to the sense of realism.

There is, unfortunately, a serious obstacle to the universal acceptance of a speaker such as this. The 12-inch gap necessary between the apex of the speaker and the wall places the front of the speaker about 30 inches from the wall. Bookshelf mounting is generally impractical, and it may be difficult to install the unit in the correct location without disturbing room decor. Many potential users will be forced to choose between style and sound.

Electrically, the system is rather inefficient, and the 18-dB of bass boost supplied by the equalizer requires huge reserves of amplifier power if loud low-frequency passages are to be played. To a lesser degree, the same problem exists at the very-high frequencies. The manufacturer recommends amplifier power ratings from 20 to 200 watts per channel, into 8 ohms. We have used it successfully, with amplifiers at both ends of this range. Unlike most speakers, the 901 sounds as good at a whisper as it does at a roar, but if you are ever tempted to turn up the volume a bit, an amplifier with a continuous power rating of at least 60 watts per channel is strongly recommended. Incidentally, don't worry about overloading the 901. The individual drivers can each handle 30 watts without difficulty, and few of us are likely to be able to apply more than 270 watts to each channel.

In the final analysis, the judgment of a speaker must be subjective and personal in nature. At this moment, we must say that we have never heard a speaker system which could surpass the *Bose 901* for over-all "realism" of sound and it is certainly the equal of anything at or near its price. The *Bose 901* system, consisting of two speaker units and the equalizer, is priced at \$476.00. ▲

Portable "computer" for electronics men.

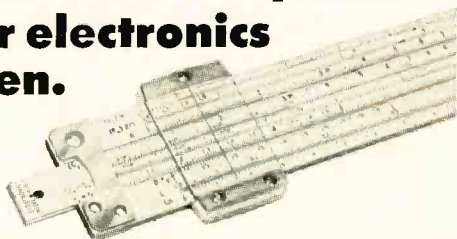

WANT FAST ANSWERS to math and electronics problems? Now, compute them in a flash with this new Electronics Slide Rule.

Calculate resonant frequencies, solve inductive or capacitive reactance problems, find reciprocals for resistance formulas, locate decimal points—all in just seconds, without pencil and paper.

Whiz through regular math problems, too: multiplication, division, square roots, logarithms, even trigonometric functions.

Sturdy 12-inch, all-metal slide rule comes complete with handsome leather carrying case—plus 4-lesson instruction course. Deliberately priced low as our way of making friends with electronics men. FREE booklet gives full details. Mail coupon below today.

Mail Coupon for FREE Booklet

CIE Cleveland Institute of Electronics
1776 East 17th Street, Cleveland, Ohio 44114

Please send me, without charge or obligation, your booklet describing the Electronics Slide Rule and 4-lesson instruction course. Also free if I act at once—a handy, pocket-sized Electronics Data Guide.

Name _____ (Please Print)

Address _____

City _____ State _____ ZIP _____

Accredited Member National Home Study Council
A Leader in Electronics Training... Since 1934 EW-157

CIRCLE NO. 74 ON READER SERVICE CARD



Ask your audio retailer which turntable is the most trouble-free.

We'll save you the time ...it's BSR McDonald.

That's why BSR McDonald can give you the only over-the-counter replacement guarantee plus a one-year warranty on parts and labor.

Every BSR McDonald automatic turntable is precision made in Great Britain to the most exacting engineering specifications. As a matter of fact, practically every one of the hundreds of parts are fabricated by us—to assure uniform excellence.

Upon their arrival in the U.S., every model is unpacked and retested under actual playing conditions. Even the tiniest flaw cannot escape our unique detection system. That's why BSR service calls are the lowest in the industry...and perhaps that also explains why BSR sells more turntables than anyone else in the world.

Because of the extra precautions we take in our quality re-test program, we deliver the most trouble-free turntable in the industry. That's why we can back up this claim with the strongest guarantee ever offered. If any defect is found in a BSR McDonald automatic turntable, your retailer will replace it immediately with a brand new unit with no charge and no questions asked.

On top of this, you get a one year guarantee on every part except the cartridge—including labor as well. Who else dares offer this unique quality guarantee?



Please send FREE detailed literature on all BSR McDonald automatic turntables. E

Name _____

Address _____

City _____ State _____ Zip _____



McDONALD

PRECISION CRAFTED IN GREAT BRITAIN
BSR (USA) LTD., BLAUVELT, N.Y. 10913

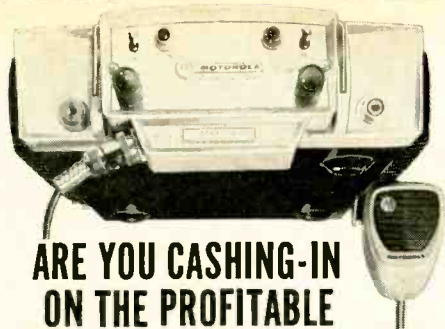

ARE YOU CASHING-IN ON THE PROFITABLE 2-WAY RADIO SERVICE BUSINESS?

- ★ Motorola will train you for this rewarding, elite profession
- ★ Send for our FREE EVALUATION EXAM. Prove to yourself that you are ready to learn FM 2-way radio servicing.

Opportunities in 2-way radio servicing are virtually unlimited. ■ Just one of the hundreds of successful Motorola Service Stations writes, "we would be pleased to interview any graduate of your school that has received some training in 2-way radio maintenance. We are an established firm, 10 years old, with a promise of expansion governed by our ability to obtain competent technicians." ■ Get all the facts today. There is no obligation and no salesman will call.



MOTOROLA TRAINING INSTITUTE

4545 West Augusta Blvd. • Chicago 51, Illinois • Dept. AEW 821

- Send me FREE entrance exam.
- Send full details on Home Study Course on FM 2-way Radio Servicing.
- Send me details on how you can help me prepare for an FCC License.

Name _____ Occupation _____

Address _____

City _____ Zone _____ State _____

CIRCLE NO. 97 ON READER SERVICE CARD

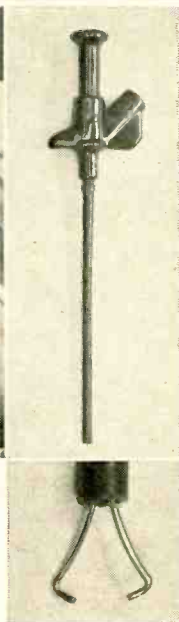
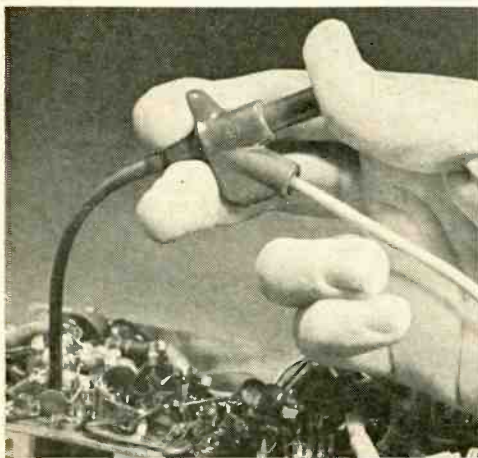

Clever Kleps 30

Push the plunger. A spring-steel forked tongue spreads out. Like this  Hang it onto a wire or terminal, let go the plunger, and Kleps 30 holds tight. Bend it, pull it, let it carry dc, sine waves, pulses to 5,000 volts peak. Not a chance of a short. The other end takes a banana plug or a bare wire test lead. Slip on a bit of shield braid to make a shielded probe. What more could you want in a test probe?



Available through your local distributor, or write to:

\$147

RYE INDUSTRIES INC.
123 Spencer Place, Mamaroneck, N.Y. 10543

CIRCLE NO. 88 ON READER SERVICE CARD

HI-FI SHOW SEMINARS PROGRAM

Oct. 31-Nov. 3, 1968

Civic Auditorium

99 Grove St., San Francisco, Calif.

THURSDAY, OCT. 31

6:30-7:30 p.m. (Novice Symposium)

"INTRODUCTION TO HI-FI COMPONENTS"

DOUGLAS SKINNER, Owner, Skinner, Hirsch & Kaye Co.

7:45-8:45 p.m.

"CHANGERS, TURNTABLES & CARTRIDGES"

Moderator: **BILL STOCKLIN**, Editor, Electronics World

Panelists: **JIM KOGEN**, Chief Engineer, Research & Development, Shure Brothers, Inc.

JOE LESLY, Marketing Representative, United Audio Products, Inc. (Dual)

FRIDAY, NOV. 1

6:30-7:30 p.m. (Novice Symposium)

"INTRODUCTION TO HI-FI COMPONENTS"

CHARLES CATANIA, Owner, Catania Sound

7:45-8:45 p.m. (Live Demonstration)

"ELECTRONIC MUSIC"

BOB MOOG, President, R. A. Moog & Co.

SATURDAY, NOV. 2

3:00-4:00 p.m.

"TAPE & TAPE RECORDERS"

Moderator: **BILL STOCKLIN**, Editor, Electronics World

Panelists: **HAL JONES**, 3M Company

Second panelist to be announced later

6:30-7:30 p.m. (Novice Symposium)

"INTRODUCTION TO HI-FI COMPONENTS"

DON DORSEY, Mgr., Eber Electronics Co.

7:45-8:45 p.m.

"STEREO & THE LISTENER"

Moderator: **BILL STOCKLIN**, Editor, Electronics World

Panelists: **VIC BROCINER**, Assistant to the President, H. H. Scott, Inc.

ABE COHEN, Mgr., Acoustics Div., Instrument Systems Corp./Telephonics (Benjamin)

SUNDAY, NOV. 3

2:00-3:00 p.m. (Novice Symposium)

"INTRODUCTION TO HI-FI COMPONENTS"

NICK NICHOLSON, Mgr., San Francisco Radio & Supply Co.

3:15-4:15 p.m.

"SPEAKERS & AMPLIFIERS"

Moderator: **BILL STOCKLIN**, Editor, Electronics World

Panelists: **CURTIS WESTRA**, Chief Engineer, Sherwood Electronic Labs

JOHN GILLIOM, Chief Engineer, Electro-Voice, Inc.

ELECTRONICS WORLD

TELEQUIPMENT

TYPE S54

Rectangular CRT, 4KV, 6 x 10 cm viewing area illuminated Graticule; P31 phosphor.

X10 Gain increases deflection factor to 10 mV/cm (DC to 4 MHz).

Step Selectors with variables, standard 1-2-5 sequence. Attenuators accurate within 5%.

Convenient line voltage range selector on rear panel.

Portable, 17 lb. space-saving size: 9 in x 7 in x 16 in.

Full Triggering with AUTO or LEVEL selective operation.

TV Frame or line selection for easy TV waveform triggering.

Scope and source selection.

Convenience Jacks include Amplitude Calibrator, Probe Test, EXT input and Sweep output.

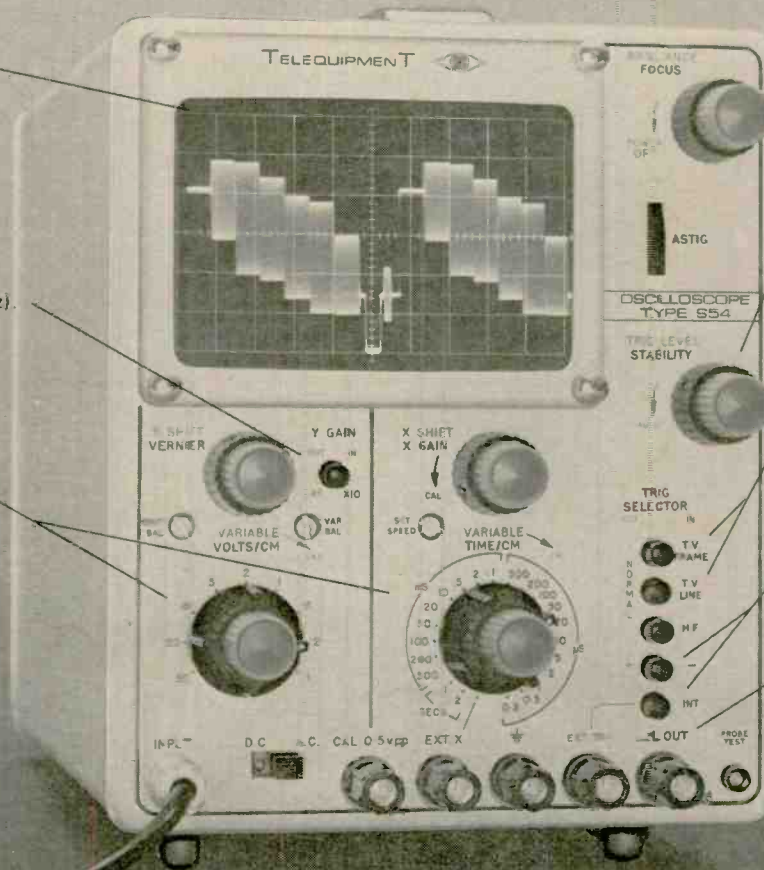

SOLID-STATE OSCILLOSCOPE

DC to 10 MHz

35 ns RISE TIME

TRIGGERED OPERATION

PRICE: \$350

Designed for the service industry; backed by a one year warranty, parts support and 22 service centers; marketed through 48 Tektronix Field Offices.

For more information call your local Tektronix field engineer or write Tektronix, Inc., P.O. Box 500, Beaverton, Oregon 97005.

U.S. Suggested Price FDB Beaverton, Oregon

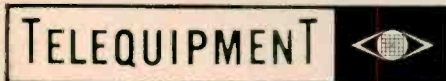

a subsidiary of **Tektronix, Inc.**

CIRCLE NO. 199 ON READER SERVICE CARD

BOOK REVIEWS

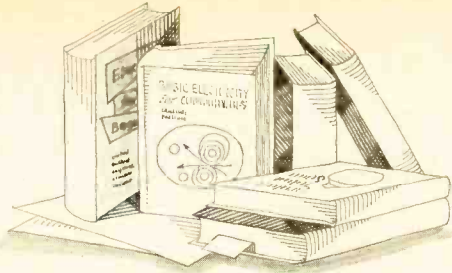

"RCA SOLID-STATE HOBBY CIRCUITS MANUAL" compiled and published by *RCA Electronic Components*, Harrison, N. J. 169 pages. Plus 45 single-sheet drilling templates for the projects. Price \$1.75. Soft cover.

This manual (HM-90) contains 35 circuits of general interest, ranging in complexity from simple code-practice oscillators to fairly elaborate ham gear. The operation of each circuit is described in detail, and photographs, schematic diagrams, parts lists, and construction layouts are given. For many of these circuits, full-size drilling templates are included at the back of the book.

Introductory sections include brief descriptions of the theory and operation of the devices used in the various circuits (silicon rectifiers, transistors, FET's, thyristors, and IC's) and of the basic circuit "building blocks" employed. Information is also provided on construction, tools required, soldering techniques, testing, and troubleshooting.

* * *

"USA STANDARD Y32. 2-1967". Compiled and published by the *U.S.A. Standards Institute*, 10 E. 40th St., New York, N.Y. 10016. 69 pages. Price \$6.00. Soft cover.

This new edition covers graphic symbols for electrical and electronic diagrams as approved for mandatory use by the Department of Defense. This revised standard features new symbols for FET's, power semiconductor devices, magnetic amplifiers, liquid-filled ion-diffusion devices, radiation-emissivity indicators, test-point recognition, and kinds of current. A special 30" x 40" wall chart is included containing all the basic symbols of the "Quick Reference to Symbols" section of the standard, enlarged 150%, for those requiring larger symbols for teaching, reference, or for developing templates, etc.

Firms doing business with DOD, publishers, exporters of electrical and electronic equipment, and those conducting technical courses will find this new standard invaluable.

* * *

"SOURCE BOOK FOR ELECTRONIC CIRCUITS" by John Markus. Published by *McGraw-Hill Company*, New York. 864 pages. Price \$18.50.

This single-volume gold mine is intended to assist circuit designers by telling them where to find complete information on over 3000 different circuits and gives essential construction and adjustment details, design precautions, and other application data.

Each circuit is accompanied by a concise description of its significant features, performance data, and operating characteristics so that the designer can make his choice easily and intelligently.

Both tube and semiconductor circuits are included in this volume and all material is cross-referenced and indexed for maximum convenience.

* * *

"DICTIONARY OF PHYSICAL ELECTRONICS AND CIRCUIT APPLICATIONS" compiled and published by *Funk & Wagnalls Dictionary Staff*. 224 pages. Price \$6.95.

From some viewpoints, reviewing books from galleys may have certain advantages (the time element, for one), but for the reviewer of a dictionary whose illustrations are not included on the galleys and whose preface and explana-

tory notes are missing, there are more con's than pro's.

The standard electronics terminology is covered but we have been unable to determine on what basis the abbreviations are selected. In the case of double-pole, double-throw switches, the abbreviation is given as D.P.D.T., but for the single-pole version, the authors have designated its abbreviation as s.p.s.t. Perhaps these are matters that will be corrected in the final editing and, therefore, will not detract from the usefulness of this handy little volume.

* * *

"MODERN TV CIRCUIT & WAVEFORM ANALYSIS" by Stan Prentiss. Published by *Tab Books*, Blue Ridge Summit, Pa. 17214. 253 pages. Price \$7.95 hard cover, \$4.95 paper.

This is a handbook for the practicing TV technician with emphasis placed on the use of a triggered-sweep scope for diagnosing circuit troubles. By referring to the more than 100 scope patterns, the technician can quickly locate a circuit malfunction which can then be pinpointed by reference to the text.

The volume is divided into ten chapters covering basic waveforms; r.f. and i.f. circuits; the second detector and video amplifier; noise, sync and a.g.c.; the vertical deflection system; the horizontal deflection system; the audio system; power supplies; chroma circuits; and troubleshooting solid-state circuits. The text is lavishly illustrated and the representative selection of models described and discussed should prove helpful to almost any technician.

* * *

"INTEGRATED CIRCUITS: FUNDAMENTALS & PROJECTS" by Rufus P. Turner. Published by *Allied Radio Corporation*, Chicago. 93 pages. Prices 75 cents. Soft cover.

We predict that copies of this little handbook will be snapped up in a hurry. Although there is plenty of engineering and application data on IC's, there is little or nothing written for the experimenter or hobbyist.

Mr. Turner, who has long since mastered the art of making the difficult sound easy, has devised six relatively simple projects to give the experimenter a chance to work with IC's. Each circuit involves the use of a single integrated circuit and, for the most part, the total cost has been kept moderately low. Each construction project contains full construction details, parts lists, over-all views, wiring diagrams and schematics, testing the complete circuit, and how the circuit can be used. Included are a simple audio preamp, a high-gain preamp, a 1/4-watt audio amplifier, a frequency-standard crystal oscillator, an a.f./r.f. signal tracer, and an electronic d.c. voltmeter.

Two introductory chapters cover IC basics and how IC's are used in practical circuits.

* * *

"THE SEMICONDUCTOR DATA BOOK" compiled and published by Technical Information Center, *Motorola Inc.*, P.O. Box 955, Phoenix, Ariz. 85001.

The identification and selection of semiconductor devices are major problems for practically everybody working in electronics. Type numbers are not of much help since they don't indicate device parameters or applications. This comprehensive volume has been prepared to help engineers and designers by providing identification and characterization for all semiconductor devices with 1N, 2N, and 3N numbers registered with the EIA, as well as a broad line of devices carrying in-house type numbers.

The book provides complete data-sheet specs for a wide range of semiconductors from diodes to integrated circuits. There are also carefully prepared selector guides with recommended devices for specific applications.

Another outstanding feature of this data book is the updating service the company provides which keeps each volume current with a minimum of two supplements during each calendar year. ▲

M-11

Solid State Units



All Silicon Transistor VHF-FM Preamplifier - 20 dB, 300 ohm In - 75 ohm Out

M-19

Solid State Units



All Silicon Transistor FM Preamplifier - 20 dB, 75 ohm In - 75 ohm Out

M-116

Solid State Units



82-channel solid state -25 dB Dist. Amplifier Separate UHF and VHF 75 ohm inputs.

M-118

Solid State Units



All Silicon Transistor VHF-UHF Home Amplifier - Four 75 ohm Outputs

M-108

Solid State Units



All Silicon Transistor VHF 40 dB Distribution Amplifier

M-403

Solid State Units



UHF to VHF Crystal Controlled Converter

FINCO MATV EQUIPMENT ...THE COMPLETE LINE

M-170

Solid State Units



Single Channel Strip Amplifier 40 dB Gain

M-248



82-Channel Antenna Mounted Transformer - Die-Cast Housing

M-22

Solid State Units



82-Channel Mast Mounted Preamplifier 15 dB

M-261



Four-Way Back Match 82-Channel Splitter/indoor

M-206



Four-Way Back Match Splitter/indoor

M-210



Eight-Way Back Match Splitter

from the largest broad-band or single-channel strip amplifier... to the smallest connector or any one of over 200 items!

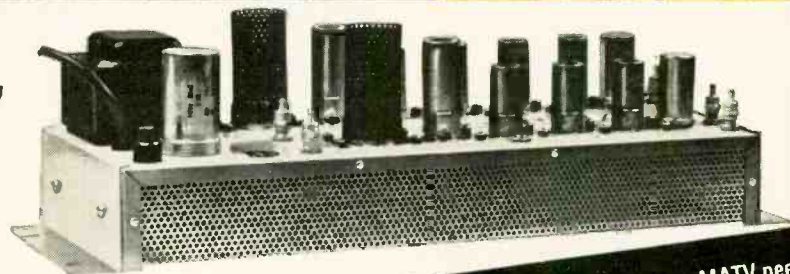

M-110

1 Volt per Channel on 9 Channels, 60 dB Distribution Amplifier

M-304

Dual Output Plate 75 ohm outlet TV 300 ohm outlet FM



- A single source for all your MATV needs.
- Silicon solid state design.
- Built to the highest standards.
- Free MATV layout service.
- Heavy duty 75 ohm MATV Antennas.

M-214



Matched Line Drop Tap - Outdoor Cast Housing

M-213



Matched Line Drop Tap/indoor

M-526



H-Q Single Carrier Trap, 60 dB Attenuation

M-300



Single 300 Ohm output Wall Outlet Plate - VHF

M-552



Variable Attenuator 0 to 82 dB in 1 dB Steps

M-550



Transistorized Field Strength Meter VHF

Solid State Units

Illustrations represent a cross section of over 200 MATV items

USE FINCO MATV ANTENNA SYSTEMS FOR HOTELS • MOTELS • SCHOOLS HOSPITALS • STORES • OFFICE BUILDINGS • APARTMENTS • HOMES



THE FINNEY COMPANY

FINCO is the maker of the world famous Color Spectrum Antennas

Send for FINCO'S FREE 45-page illustrated MATV catalogue and layout information forms.

THE FINNEY COMPANY
34 W. Interstate Street • Dept. 410
Bedford, Ohio 44146

Multi-Band Coverage will MAKE YOU MONEY!



LOW BAND
BUSINESS
AIRCRAFT
MARINE
CITIZENS
BAND
NO EXTRA CRYSTALS

Lampkin Frequency Meter Type 105-B
GUARANTEED ACCURACY .001%
Range: 100 KHz-175 MHz. \$295.00

You can buy separate frequency meters for mobile-radio transmitters in the separate bands — BUT — when you need just ONE channel outside that band, you are money ahead with the LAMPKIN.

Dial readings for virtually EVERY mobile-radio channel (printed by computer) now available at less than 3c per channel.

For complete specifications — MAIL COUPON TODAY!

Use this coupon for FREE booklet "How To Make Money in Mobile-Radio Maintenance" and information on Lampkin meters.

Name _____
Address _____
City _____ State _____ Zip _____

LAMPKIN LABORATORIES, INC.
MFM Div., Bradenton, Fla. 33505

ENJOY THE "MUSIC ONLY" FM PROGRAMS

M. A. D.

MUSIC ASSOCIATED'S DETECTOR
NO COMMERCIALS—NO INTERRUPTIONS



It's easy! Just plug Music Associated's Sub Carrier Detector into multiplex jack of your FM tuner or easily wire into discriminator. Tune through your FM dial and hear programs of continuous commercial-free music you are now missing. The Detector, self-powered and with electronic mute for quieting between selections, permits reception of popular background music programs no longer sent by wire but transmitted as hidden programs on the FM broadcast band from coast to coast. Use with any FM tuner. Size: 5½" x 9". Shipping weight approx. 7 lbs.

KIT \$49.50

(with pre-tuned coils, no alignment necessary)

WIRED \$75.00

COVER \$4.95 EXTRA

Current List of FM Broadcast Stations with SCA authorization \$1.00

MUSIC ASSOCIATED

65 Glenwood Road, Upper Montclair, N.J. 07043
Phone: (201)-744-3387

NEW V.H.F./FM MARINE RULES

By RICHARD HUMPHREY

ON July 25, 1968, the Federal Communications Commission released its Report and Order on that portion of Docket 17295 (Notice of Proposed Rule Making) dealing with the changes in the v.h.f./FM marine band.

Among the almost thirty organizations and individuals filing comments on Docket 17295 (released March 20, 1967 and extended for such comments to April 25, 1967) were AT&T, Bendix Marine, Lorain Electronics, Moran Towing, and the United States Power Squadrons. The major changes are:

1. The number of channels is increased to 39 (from 18) with one "environmental" frequency, 156.75 MHz (ships are not allowed to transmit on this frequency), set aside for receiving broadcasts of weather, sea conditions, time signals, etc. Both this channel and 156.85 MHz (for non-Federal government use in communicating with ship stations) channel were made available September 3, 1968 with the proviso that narrow-band (± 5 kHz) FM be used. The bulk of the channels gained by channel-splitting (reducing the 50 kHz spacing to 25 kHz) become available on March 1, 1969 with two frequencies (156.275 and 156.325 MHz) held back until January 1, 1971 (81.356 and 83.351).

2. The power output of ship stations is limited to 25 watts and a low-power switch that reduces output power to one watt is required on all equipment type-accepted after September 3, 1968. Existing equipment with over 25 watts output and no "low-power" switch can, unless subsequent rules are enacted, be used indefinitely (83.134).

3. The power output of coast stations is limited to 50 watts on all licenses issued after September 3, 1968. Existing licensed stations with more than 50 watts output power may continue in use until January 1, 1974 (81.134).

4. Frequency deviation (modulation) is reduced from ± 15 kHz to ± 5 kHz for both coast and ship stations on March 1, 1969 (excepting 156.75 and 156.85 MHz which require ± 5 kHz deviation on September 3, 1968), but ship stations may use ± 15 kHz for communicating with foreign coast stations until January 1, 1972 (81.142 and 83.137).

5. The frequency tolerance for coast station radios type-accepted after March 1, 1969 is: below 3 watts output, 0.001%; 3 to 100 watts output, 0.0005%; above 100 watts output 0.00025%. Existing type-accepted equipment may use 0.002% tolerance until January 1, 1974 (81.131).

6. The frequency tolerance for ship

stations type-accepted after March 1, 1969, shall be 0.001% with existing type-accepted equipment permitted 0.002% until January 1, 1974 (81.131).

7. 156.8 MHz (channel 16) designated the National Distress Safety & Calling frequency and all ship stations, both commercial and recreational are required to maintain a listening watch effective September 3, 1969. Coast stations are required to have a 156.9-MHz transmit and receive capability and to maintain a listening watch as of March 1, 1969. The major exception is a ship station with single- or dual-channel capability used only for "navigational communications" (81.104 and 83.224).

8. All transmitters type-accepted after March 1, 1969 shall have an audio low-pass filter between the modulation limiter and the modulated r.f. stage. Transmitters type-accepted prior to March 1, 1969 shall be so equipped by January 1, 1974 (81.142 and 83.137).

Additionally, U.S. Coast Guard v.h.f./FM stations have been included in Rule 83.514 which gives passenger vessels (carrying 6 or more persons for hire) the privilege of using v.h.f./FM equipment instead of 2-3 MHz marine-phones when within 20 miles of such Public Correspondence or USCG v.h.f./FM receiver sites. Minimum power for these v.h.f./FM ship stations remains at 20 watts into a 50-ohm dummy load.

The most important change as far as service shops doing recreational-boat work is in rule 81.351 of the FCC Rules and Regulations. Effective September 3, 1968 any "person performing the function of service and supply to vessels other than those used for commercial transport may apply for a coast-station license on one of three frequencies." This permits direct communication between the boat owner and a shore-based repair shop.

The sale, installation, and maintenance of electronic communications and navigation equipment should fit the definition of "service and supply." Previously, having mooring facilities was the requirement that prevented most sales and service organizations from having a shore station in the v.h.f./FM band. This right has also been expanded from one frequency (156.45 MHz) to three (156.475, 156.575, and 156.925 MHz). These frequencies must not be used to sell radio equipment.

Commissioner Nicholas Johnson added a statement to the Report and Order in which he said he was concurring but "hesitantly because of what I believe to be the inadequate measures this Commission uses in making frequency management decisions." ▲

THE MOST SPECTACULAR SOUND EXHIBITION OF STEREO FIDELITY EVER AVAILABLE ON ONE DISC.

This record is the result of two years of intensive research in the sound libraries of several of the world's leading record companies. The Editors of HiFi/Stereo Review have selected and edited those excerpts that best demonstrate each of the many aspects of the stereo reproduction of music. The record offers you a greater variety of sound than has ever before been included on a single disc.

AN ELECTRIFYING EXPERIENCE IN LISTENING

The HiFi/Stereo Review Stereo Demonstration Record is a series of independent demonstrations, each designed to show off one or more aspects of musical sound and its reproduction. Entirely music, the Record has been edited to provide self-sufficient capsule presentations of an enormous variety of music arranged in a contrasting and pleasing order. It includes all the basic musical and acoustical sounds that you hear when you listen to records, isolated and pointed up to give you a basis for future critical listening.

WIDE RANGE OF DEMONSTRATIONS

- Techniques of Separation and Multiple Sound Sources • Acoustic Depth • The Ambiance of a Concert Hall • Sharp Contrasts of Dynamics • Crescendo and Diminuendo • Very High and Very Low Pitched Musical Sounds • Polyphony (two or more melodies going on at once) With Both Similar and Contrasting Instruments • Tonal Qualities of Wind, String and Percussion Instruments • Sounds of Ancient Instruments • Sounds of Oriental Instruments • Sound of the Singing Voice, Both Classically Trained and Untrained • Plus a Large Sampling of Finger Snapping, Hand Clapping, Foot Stamping and Other Musical and Percussive Sounds

13 SUPERB SELECTIONS

STRAUSS: Festive Prelude, Op. 61 (excerpt) Deutsche Grammophon Gesellschaft • Scored for full symphony orchestra plus organ with prominence to the brass instruments. Remarkable for the impressive sense of depth it reproduces.

DEBUSSY: Feux d'artifice (excerpt). Connoisseur Society. • Virtually the entire range of the piano is used, including the full force of the bass notes. This is the sound of a piano in reverberant surroundings heard fairly close-up.

BEETHOVEN: Wellington's Victory (Battle Symphony) (excerpt from the first movement) Westminster • The recording emphasizes extreme directionality. It is a dramatic presentation engineered specifically for stereo reproduction.

MASSAINO: Canzona XXXV à 16 (complete) DGG Archive • Performed on old instruments, and recorded with techniques that combine directionality with depth and ambiance, this band reproduces the sound of the music in its original environment, a large and reverberant cathedral.

CORRETTE: Concerto Comique Op. 8, No. 6, "Le Plaisir des Dames" (third movement) Connoisseur Society • Recording demonstrates the

HiFi/Stereo Review STEREO DEMONSTRATION RECORD

A stunning series of demonstrations, each designed to show off one or more aspects of musical sound and its stereo reproduction.



sound and special layout of a small performing group (harpichord, cello and flutes) in fairly resonant surroundings.

KHAN: Raga Chandranandan (excerpt) Connoisseur Society • This classical Indian music provides some of the most exciting musical experiences imaginable. Directionality between vastly different instruments is the point here, as well as the sheer sound of the instruments themselves.

RODRIGO: Concert—Serenade for Harp and Orchestra (excerpt from the first movement) Deutsche Grammophon Gesellschaft • This excerpt provides a wealth of instrumental color behind a harp solo. The music is clear, colorful, rather classical, and immensely entertaining.

MANITAS DE PLATA: Gypsy Rhumba (complete) Connoisseur Society • The recording puts the listener in the center of a flamenco party by precisely transmitting the directionality, depth and ambiance of this completely impromptu recording session.

MARCELLO: (arr. King): Psalm XVII "The Heavens are Telling" (complete) Connoisseur Society • This arrangement of the brief Marcello Psalm is for brass, choir and organ, who answer one another antiphonally.

PRAETORIUS: Terpsichore: La Bourrée XXXII (complete) DGG Archive • A musical gem played by a raft of renaissance instruments including recorders, viols, lutes, harpsichord, small kettle drums, chimes, bells, and triangle.

BERG: Wozzeck (excerpt from Act III) Deutsche Grammophon Gesellschaft • The acknowledged masterpieces of modern music incorporating the use of many unusual and extraordinary musical devices, including dramatic crescendos for full orchestra.

BARTOK: Sonata for two pianos and Percussion (excerpt from the first movement) Cambridge • The work is a stunning exploration of percussive sounds used as the basic material of the composition.

BEETHOVEN: Wellington's Victory (Battle Victory) (excerpt from the last movement) Westminster • A demonstration of one of stereo's greatest virtues, its unmatched ability to clarify separate contrapuntal voices being played by similar instruments.

Advanced New Anti-static Vinyl

Recorded with the cooperation of Deutsche Grammophon Gesellschaft, Connoisseur Society, Westminster Recording Company and Cambridge Records Incorporated, the Stereo Demonstration Record is processed and pressed on a newly developed, improved vinyl. It is permanently anti-static, repels dust and dirt and promotes longer stylus wear. The use of this material is conducive to low surface noise and contributes to the production of full dynamics and frequency range. The record continually looks new, sounds new and wears longer.

▶ FREE DESCRIPTIVE BOOKLET ENCLOSED WITH EACH ALBUM

Packed with valuable facts to give you a better understanding of the term "stereo high fidelity," including a discussion of the selections appearing on the record, plus a complete description of each selection performed and the purpose behind its demonstration.

▶ 12" STEREO RECORDING AVAILABLE IN YOUR CHOICE OF 33 1/3 RPM OR 45 RPM

The 33 1/3 rpm is of the highest attainable quality at that speed. The higher speed of the 45 enables an even higher quality disc.

ORDER YOUR STEREO DEMONSTRATION RECORD TODAY

Only \$4.98 Postpaid

Stereo Demonstration Record
P. O. Box 3463 • Church Street Station • New York, N.Y. 10008

Please send me _____ HiFi/Stereo Review Stereo Demonstration Record Albums at \$4.98 each, postpaid. My check (or money order) for \$ _____ is enclosed.

Check One: 33 1/3 rpm 45 rpm

(outside U.S.A. please send \$7.00 per album ordered.) New York State residents please add local sales tax.

Print Name _____

Address _____

City _____ State _____ Zip Code _____

PAYMENT MUST BE ENCLOSED WITH ORDER

NEW PRODUCTS & LITERATURE

Additional information on the items covered in this section is available from the manufacturers. Each item is identified by a code number. To obtain further details, fill in coupon on the Reader Service Card.

COMPONENTS • TOOLS • TEST EQUIPMENT • HI-FI • AUDIO • CB • HAM • COMMUNICATIONS

IMPEDANCE/ADMITTANCE BRIDGE

An audio frequency bridge for measuring the complex impedances of inductors, transformers, filter networks, capacitors, and associated components is now available as the Type 1120 Z-Y bridge.

Frequency range is from 20 to 20,000 Hz and



the bridge will measure the X-R of an impedance up to 1000 ohms and G-B of admittance up to 1000 μ mho. Accuracy of the instrument is: $\pm 1\%$ for R, $\pm 2\%$ for G, and $\pm 1\%$ for X and B. The bridge measures 15" x 9" x 7 $\frac{1}{2}$ " and weighs 25 pounds. Freed Transformer

Circle No. 126 on Reader Service Card

MINIATURE ROTARY SWITCH

A 30° angle of throw rotary switch with one, two, or four-pole circuitry is now available. The single deck design requires less than 0.7" behind the panel and the diameter is 0.562".

A choice of other features in this miniature rotary switch include PC or solder-lug terminals, military style or commercial style, shorting or non-shorting contacts, and adjustable or preset stops.

An engineering data sheet which provides complete information and application data will be forwarded on request. Grayhill

Circle No. 127 on Reader Service Card

R.F. SHIELDED INDUCTOR

A $\frac{1}{4}$ -watt axial r.f. shielded inductor that combines high inductance with the smallest possible envelope is now being marketed as the "Nano-Red".

The new inductor measures only $\frac{1}{16}$ " in diameter by $\frac{1}{4}$ " long and weighs no more than 0.28 gram. The non-flammable red epoxy envelope has a total volume of barely 0.002 cubic inch.

Designed to meet the reliability standards of MIL-C-15305C and possessing exceptional "Q" and low distributed capacity, the new inductor is available in 49 stock values from 0.10 μ H to 1000 μ H, within a tolerance of 10%. Lenox-Fugle

Circle No. 128 on Reader Service Card

COUNTER/TIMER

A new d.c. to 50 MHz counter/timer which features simplified remote programming has just been introduced as the Model 110A.

The instrument offers a full range of functions



and BCD output. Applications include measurement of frequency, period, period average, time interval, and totalization. The Model 110A is of integrated circuit design. The IC's are protected against overvoltage and short circuit. It features single wafer switches for all functions except attenuation.

The equipment totalizes direct from 0 to 10⁷ and is precaled from 10 to 10¹⁵. Frequency ratio is measured from 10⁻⁷ to 10⁷. Period average is from 0.1 μ s to 1 second while period and time interval are measured from 1 μ s to 10⁸ seconds.

The instrument provides 7-digit display and an 8-digit option is available. Monsanto

Circle No. 129 on Reader Service Card

RESISTANCE STANDARD

The Model PRO-106L low-resistance standard provides reference resistors with values of 0.001, 0.01, 0.1, 1, and 10 ohms. Standard accuracies are $\pm 0.0008\%$ and stability is 5 ppm per year to 1 ppm per year depending on resistance value. The temperature coefficient of the resistors is less than 3 ppm/ $^{\circ}$ C but in this unit the resistors are free from temperature effects over the ambient temperature range of 0 to 28 degrees C



since the oven is maintained at such temperature accuracy as to never allow a deviation in standard resistance of greater than 0.1 ppm for temperature effects over this ambient range.

Available in case or rack-mount versions, the 30-pound package measures 10 $\frac{1}{4}$ " x 14" x 15" in its case or 19 $\frac{1}{2}$ " x 14" x 15" for rack mounting. Julie Research

Circle No. 130 on Reader Service Card

52-PIECE TOOL KIT

A 52-piece tool kit designed for equipment maintenance contains five basic pliers, a screw-driver-mtdriver set, a soldering iron, solder, a component lead bender, wire stripper, heat sinks, scissors, stripping knives, probes, miniature file set, soldering aids, tweezers, a magnifying loupe, and contact cleaner. Techni-Tool

Circle No. 1 on Reader Service Card

DUAL-POWER SUPPLIES

Two new regulated integrated-circuit dual power supplies are now being marketed, the PSD-30 and PSS-30.

The PSD-30 provides two highly regulated (0.01%) continuously adjustable outputs, each covering the range from 0 to 30 volts at currents from 0 to 1 ampere. Ripple level is below 1 millivolt. When operated in series as one unit, the two supplies will furnish voltages between 0 and 60 volts and at currents up to 1 ampere. Output voltage and current of each supply are monitored by a front-panel meter.

The Model PSS-30 is similar electrically and mechanically except a single voltage control simultaneously determines the voltage of each section. Each unit measures 3 $\frac{1}{2}$ " high x 10 $\frac{5}{8}$ " wide x 9" deep and weighs 9 $\frac{3}{4}$ pounds. Aul Instruments

Circle No. 131 on Reader Service Card

COAXIAL CAPACITANCE STANDARDS

Two new two-terminal coaxial capacitance standards have been added to the company's line as the Types 1405 and 1407.

The Type 1405 standards are stable, low-loss air capacitors of 1, 2, and 5 pF with small, stable, and known series inductance. The Type 1407 capacitor consists of a silvered-mica and foil stack that is clamped under heavy spring pressure for mechanical stability. The low inductance (7 nH) permits all capacitors to be used at megahertz frequencies. The Type 1407 is available in seven values of capacitance from 0.001 μ F to 0.1 μ F.

A certificate of calibration is supplied with each unit, giving the measured capacitance at 1 kHz at a specified temperature and relative humidity, with traceability to NBS. General Radio

Circle No. 132 on Reader Service Card

COILED CORDS

An extensive line of coiled cords for every electronic application where movement of a power-consuming device is required, is now available. Most standard and many special plugs—both male and female—are already tooled. Tooling and molding of other special plugs can be done on a custom basis.

Various insulations are available including shielded, PVC, rubber, neoprene and in all gauges of wire, single and multiple conductors. Con-Trx

Circle No. 133 on Reader Service Card

VIDEO TAPE RECORDER

The Model 6402 helical-scan video tape recorder features a full-field slant-track, two-head frequency-modulated recording system, an all-electronic rotary transformer head assembly, and can operate with $\frac{1}{2}$ " magnetic tape at 9 $\frac{1}{2}$ in/s for maximum 50 or 60 minute recording or playback time on either 7" or 8 $\frac{1}{4}$ " reels.

The audio re-record capability makes it possi-



ble to re-record the sound track without disturbing the video portion. The unit also has automatic audio and video level controls, a built-in 2:1 sync generator, plus slow motion and stop motion facilities.

The recorder measures 18½" wide x 10¼" high x 17½" deep and weighs 59 pounds. Craig
Circle No. 2 on Reader Service Card

UNIVERSAL DIGITAL INSTRUMENT

The Model 805A combines in one package a 12.5-MHz multi-purpose counter/timer and a 0.05% accuracy digital voltmeter. The instru-

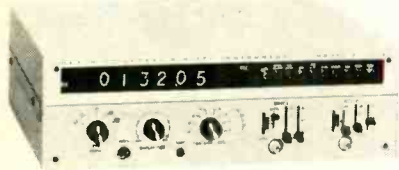

ment can perform as many as seven different functions: frequency meter, period meter, time interval meter, ratio meter, events counter, integrating d.v.m., and voltage integrator.

The instrument uses a modular design based on 16 plug-in cards using TTL integrated circuits. This concept enables card addition of new functions to the instrument and protects it against obsolescence.

The unit features 2-channel input, fast cycling on slow time bases for continuous reading, a unique summing function for continuous summation of measurement without display reset, among others.

Complete specifications on the Model 805A will be forwarded on request. Heath

Circle No. 134 on Reader Service Card

FREQUENCY STANDARD

The Model 5C precision frequency standard will meet its design specs within a 12-hour warm-up period because of the specially processed AT-cut quartz crystal and improved oscillator circuitry.

The unit provides output frequencies of 5 MHz, 1 MHz, and 100 kHz at an amplitude of 1 volt into a 50-ohm load. After 12 hours warm-up, the 5C exhibits an aging rate of less than 5 parts in 10¹⁰, after 30 days, one part in 10¹⁰. Typical power consumption is less than 6 watts. Tracor

Circle No. 135 on Reader Service Card

DIGITAL MULTIMETER

The Model DM 330 is a true 3-digit plus 50% overrange digital multimeter which has been

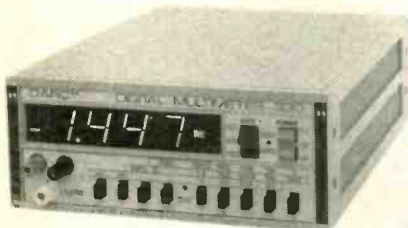

specifically designed to fill the gap between inexpensive v.t.v.m.'s and lab-type d.v.m.'s.

The instrument features push-button control of ranges and functions; 0.1% accuracy on d.c., kohms, and current; common-mode rejection of 100 dB; and optional a.c. volts. Reading speed is as fast as 10 readings per second. Darcy

Circle No. 136 on Reader Service Card

TEFLON TRIMMERS

A new line of miniature Teflon dielectric trimmer capacitors is now available as Models 273-1-1, 273-1-2, and 273-15-1.

Designed for v.h.f. and u.h.f. applications requiring low minimum capacity and delta C, PC-

mounting 273-1-1 provides 0.25 to 1.5 pF capacity in a package only 0.140" diameter and 0.755" long with the adjusting screw fully extended. The 273-1-2 is offered in the same capacity but it is designed for solder-lug mounting. It is 0.140" in diameter and 0.828" long, exclusive of the solder lug. Like the PC version, it is screwdriver adjustable.

Model 273-15-1 is designed for panel mounting and provides 0.30 to 2.9 pF capacity. It is 0.218" in diameter and extends 1" behind the panel and a maximum of ¾" (less panel thickness) in front. Adjustment is by hex socket screw. E.F. Johnson

Circle No. 137 on Reader Service Card

HAND-SIZE V.O.M.'s

Two new hand-size v.o.m.'s are now available as Models 208 and 209. The Model 208 measures current in six ranges from 0-0.6 mA up to 3 A with a sensitivity of 10,000 ohms per volt for both a.c. and d.c. The Model 209 measures current in four ranges from 0-120 mA up to 12 A on d.c. and in six ranges from 0-6 mA up to 12 A for a.c.

Each unit has four lead inputs, a continuity

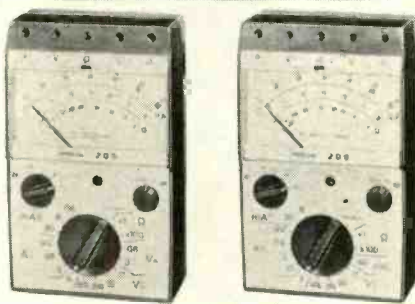

indicator, and illuminated scale. They measure 6" x 3⅝" x 1¼" and weigh 18 ounces. Simpson

Circle No. 3 on Reader Service Card

POWER SUPPLY/VOLTMETER

A new laboratory instrument that includes a plug-in regulated power supply and a plug-in differential voltmeter, with a single high-precision power source, has been introduced as the LS Series. This new combination provides in one instrument a high-impedance power differential voltmeter and a high-precision metered power supply.

Both voltmeter and power supply are offered in five models with ranges to 250 volts d.c. They are all-silicon and convection-cooled, with no blowers nor heat sinks required. Lambda

Circle No. 138 on Reader Service Card

D. C. SERVO MOTOR

The new SA-840B-29D permanent-magnet d.c. servo motor measures slightly over 2 inches long and delivers 8.3 watts of continuous power output at 7000 r/min.

This motor has a speed range of 0-10,000 r/min, a 50-millisecond internal time constant, and a torque inertia of 22,000 rad/s². It weighs 5 ounces.

The motor is especially suited for tape transports, pen drives, and null-seeking devices, or any servo-mechanism requiring a prime mover. Technical literature and operating characteristics of this new motor will be supplied by the manufacturer without charge on request. Servo-Tek

Circle No. 139 on Reader Service Card

CERMET TRIMMER LINE

A new line of low-cost, compact cermet trimmer resistors is now being marketed as Centrim. Designed for commercial, military, and industrial applications where component space is limited, the units are rated at ¼ watt per section at 70° C, derated to zero at 125° C for commercial applications. For industrial use they

(Continued on page 92)

Deluxe ELECTRONICS WORLD MAGAZINE CASES

DESIGNED TO HOLD A FULL YEAR'S COPIES



These decorative, yet sturdily constructed cases are just what you've been looking for to keep your copies of Electronics World Magazine in easy-to-find order.

Constructed of reinforced fiberboard and covered in rich leatherette, these durable cases guard against soiling and tearing of your magazines while lending themselves handsomely to the decor of any room, whether it be a library, study, den, music room or pine-paneled garage. The magazine cases are available with embossed gold lettering in either all black or attractive maroon back with black sides.

Specially designed to hold a full year's copies of Electronics World Magazine, the cases are only

\$3.50 ea., 3 for \$10, 6 for \$19
FULLY GUARANTEED

NOTE: Magazine cases are also available for other of your favorite titles. For prompt shipment, use the coupon below.

Ziff-Davis Publishing Company, Dept. SD
One Park Avenue, New York, N.Y. 10016

Please send _____ Electronics World Magazine Cases. Also send cases for the magazine titles indicated below:

TITLE QUANTITY

All black, gold embossed

Maroon back, gold embossed/black sides.

Enclosed is \$_____ at \$3.50 per case,

3 for \$10, 6 for \$19 (Quantity prices apply for

combination orders of more than one title). Orders

outside U. S. A. \$4.50 ea., 3 for \$13, 6 for \$25.

Name _____

Address _____ EW-118

City _____

State _____ Zip Code _____

Payment must accompany order.

Two more examples of how RCA Institutes provides up-to-the-minute Home Training in all phases of electronics:

NEW CATV LESSONS

The demand is heavy for technicians in the booming field of CATV (Community Antenna Television Systems).

CATV was initially used to make it possible for large numbers of television receiver users to get good reception in remote areas through the use of a common antenna. It now brings to more people more programs than are available from local stations. It also improves reception where multipath signal transmission exists.

RCA Institutes includes two comprehensive lessons, covering the practical phases of CATV systems and servicing in Television Servicing and Communications courses and programs at no additional total tuition cost. Get in on the ground floor of this rewarding and expanding field. Send for full information today!

Prepare yourself for a career in the expanding field of CATV.

NEW COLOR TV KIT

To make courses even more practical and to better prepare you for a more rewarding future, RCA Institutes now includes an exciting Color TV Kit in both the beginner's program and the advanced course in color TV servicing. The cost of the kit is included in the tuition—nothing extra to pay. You also get five construction/experiment manuals plus a comprehensive service manual.

You'll receive all the materials and components to perform over 50 information-packed experiments. When you finish you'll have constructed an 18" (measured diagonally) high quality, color TV set, complete with rich cabinet in wood grain design.

Get all the details on RCA Institutes' valuable new Color TV Kit!

SEND THE ATTACHED CARD TODAY!

This is the high quality color TV set you'll construct, complete with rich cabinet in wood grain design.

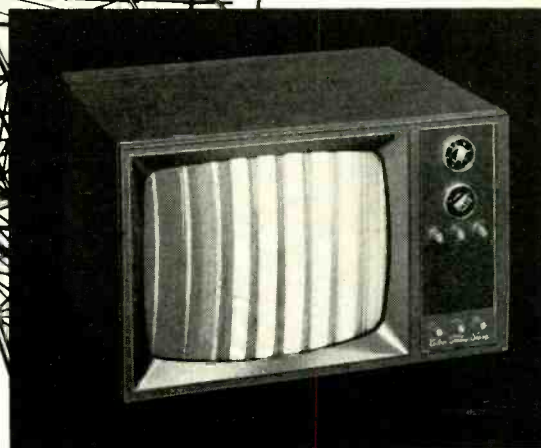

Learn electronics at home faster, easier, almost automatically—with RCA AUTOTEXT

Are you just a beginner with an interest in the exciting field of electronics? Or, are you already earning a living in electronics and want to brush-up or expand your knowledge in a more rewarding field of electronics? In either case, AUTOTEXT, RCA Institutes' own method of Home Training will help you learn electronics more quickly and with less effort, even if you've had trouble with conventional learning methods in the past.

THOUSANDS OF WELL PAID JOBS ARE OPEN NOW TO MEN SKILLED IN ELECTRONICS!

Thousands of well paid jobs in electronics go unfilled every year because not enough men have taken the opportunity to train themselves for these openings. RCA Institutes has done something positive to help men with an aptitude and interest in electronics to qualify for these jobs.

HOME STUDY CAN TRAIN YOU FOR REWARDING CAREER OPPORTUNITIES

To help fill the "manpower gap" in the electronics field, RCA Institutes has developed a broad scope of Home Training courses, all designed to lead to a well paying career in electronics in the least possible time. You also have the opportunity to enroll in an RCA "Career Program" exclusively created to train you quickly for the job you want! Each "Career Program" starts with the amazing AUTOTEXT Programmed Instruction Method. And, all along the way, your program is supervised by RCA Institutes experts who become personally involved in your training and help you over any "rough spots" that may develop.

VARIETY OF KITS ARE YOURS TO KEEP

To give practical application to your studies, a variety of valuable RCA Institutes engineered kits are included in your program. Each kit is complete in itself, and yours to keep at no extra cost. You get the new Programmed Electronics Breadboard for limitless experiments, including building a working signal generator, multimeter, and a fully transistorized superheterodyne AM receiver.

ONLY FROM RCA INSTITUTES— TRANSISTORIZED TV KIT— VALUABLE OSCILLOSCOPE

All students receive a valuable oscilloscope. Those enrolled in the Television program receive the all-new transistorized TV Kit. Both at no extra cost and only from RCA Institutes.

CHOOSE THE "CAREER PROGRAM" THAT APPEALS MOST TO YOU

Start today on the electronics career of your choice. Pick the one that suits you best and mark it off on the attached card.

- Television Servicing
- Telecommunications
- FCC License Preparation
- Automation Electronics
- Automatic Controls
- Digital Techniques
- Industrial Electronics
- Nuclear Instrumentation
- Solid State Electronics
- Electronics Drafting

ADVANCED TRAINING

For those already working in electronics, RCA Institutes offers advanced courses. You can start on a higher level without wasting time on work you already know.

2 CONVENIENT PAYMENT PLANS

RCA Institutes offers a unique tuition plan that lets you progress at your own pace. You only pay for lessons as you order them. You don't sign a contract obligating you to continue the course.

There's no large down-payment to lose if you decide not to continue.

However, if you desire, RCA Institutes also offers a convenient monthly payment plan.

CLASSROOM TRAINING ALSO AVAILABLE

If you prefer, you can attend classes at RCA Institutes Resident School, one of the largest of its kind in New York City. Coeducational classroom and laboratory training, day and evening sessions, start four times a year. Simply check "Classroom Training" on the attached card for full information.

JOB PLACEMENT SERVICE, TOO!

Companies like IBM, Bell Telephone Labs, GE, RCA, Xerox, Honeywell, Grumman, Westinghouse, and major Radio and TV Networks have regularly employed graduates through RCA Institutes' own placement service.

SEND ATTACHED POSTAGE PAID CARD TODAY. FREE DESCRIPTIVE BOOK YOURS WITHOUT OBLIGATION. NO SALESMAN WILL CALL.

All RCA Institutes courses and programs are approved for veterans under the new G.I. Bill.

Accredited Member
National Home Study Council

IF REPLY CARD IS DETACHED—SEND THIS COUPON TODAY

RCA INSTITUTES, Inc., Dept. EWQ-N8
320 West 31st Street, N.Y., N.Y. 10001

Please rush me FREE illustrated catalog. I understand that I am under no obligation, and that no salesman will call.

Name _____ Age _____
(please print)

Address _____

City _____

State _____ Zip _____

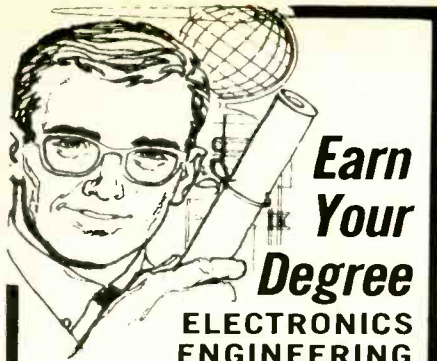

Earn Your Degree

ELECTRONICS ENGINEERING

through HOME STUDY

HIGHLY EFFECTIVE HOME STUDY COURSES IN:

- Electronics Engineering Technology
- Electronics Engineering Mathematics

Earn Your Associate in Science Degree in Electronics Engineering and upgrade your status and pay to the engineering level. Complete college level courses in Electronics Engineering. We're a forward looking school. Outstanding lesson material—thorough and easy to understand. Engineering taught on the basis of application and understanding rather than on the basis of memorization. Up to date in every respect. Acquire the knowledge and ability that means the difference between a low paying technician job and a high paying engineering position. Low tuition cost with low monthly payments. Free engineering placement service for our graduates. Write for free descriptive literature. Ask for bulletin F, no salesman will call on you.

COOK'S INSTITUTE
of Electronics Engineering

Forest Hill Road
P. O. Box 10634
Jackson, Miss. 39209
Established 1945

Formerly Cook's School of Electronics

CIRCLE NO. 73 ON READER SERVICE CARD

A Great NEW

TV[®] LAMP CLOCK

Takes the Guesswork Out of Telling Time!

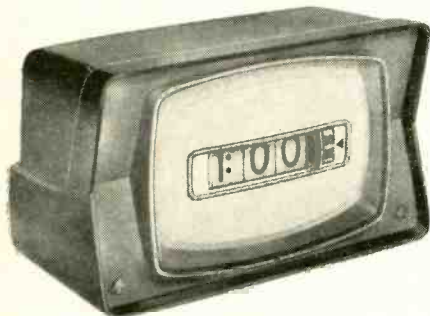

#765 **14⁹⁵** POST PAID

Comforting nightlight for bedroom and nursery. Stops TV eyestrain. Gives your eyes a stare break. Walnut plastic case. 4" high, 7" wide, 3 7/8" deep. One Year Guarantee. 110V 60cy. Made in U.S.A.

At Your Dealer, or DIRECT FROM

PENNWOOD NUMECHRON CO.

DEPT. EW 118

7249 FRANKSTOWN AVE., PITTSBURGH, PA. 15208

CIRCLE NO. 93 ON READER SERVICE CARD

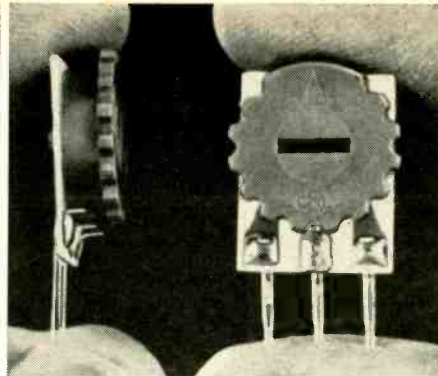

are rated at 3/4 watt per section at 85° C, de-rated to zero at 175° C. Resistance values range from 500 ohms to 1 megohm. Maximum voltage is 350 volts, but this can be exceeded in special applications. Centralab

CIRCLE NO. 140 ON READER SERVICE CARD

EDDY CURRENT INSTRUMENT

The Defectometer is an eddy-current instrument designed for the detection of defects open to the surface in ferromagnetic, non-ferromagnetic, and austenitic materials.

The unit consists of a main power supply, a high-frequency oscillator, an amplifier, a meter which provides indications proportional to defect depth, and adjustable threshold controls which operate in conjunction with a signal lamp that automatically indicates when a defect exceeds a preset depth.

In use, the Defectometer automatically selects the proper test frequency after a three-position

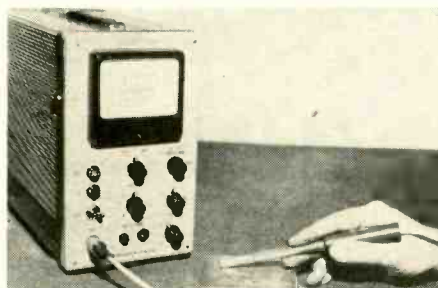

switch is set to the type of material to be inspected. As a hand-held probe is passed over a defect, the eddy current interaction with the probe coil produces a defect signal which is detected, amplified, and displayed on the large instrument meter. The unit measures 13" x 10" x 6".

A brochure giving complete specs on the instrument is available on request. Automation Industries

CIRCLE NO. 141 ON READER SERVICE CARD

VIDEOTAPE RECORDERS

Two new compatible closed-circuit videotape recorders designed specifically for use as instructional aids in education, industry, government, medicine, and to other areas have been put on the market as the Models VP-4900 and VR-5100. The former is a playback unit while the latter is a playback/record unit.



Both units feature a video response of 3 MHz and a horizontal resolution of 300 lines. The video signal-to-noise ratio is 42 dB. A rotary transformer in a drum assembly provides increased reliability of signal transmission from the head, according to the company. Both units feature four-minute rewind and fast-forward speeds. Ampex

CIRCLE NO. 4 ON READER SERVICE CARD

TRIMMERS FOR IC'S

The Type 940 wirewound trimmer has been designed for users of integrated circuits who can now choose a lead-screw actuated trimmer in the dual-in-line package. Both appearance and physical dimensions conform to the standard dual-in-line package so that the trimmer can be handled by the same automatic insertion machinery being used for the IC.

Measuring only 0.200 inch maximum height when mounted on a printed circuit board, it meets the low contour requirements of IC users.

Resistance values range from 10 ohms to 20,000 ohms $\pm 10\%$. Power rating is 1 watt at 40° C. IRC

CIRCLE NO. 142 ON READER SERVICE CARD

HI-FI—AUDIO PRODUCTS

MODULAR AMPLIFIERS

A new series of modular amplifiers for use in commercial and institutional sound systems has just been introduced as the MOD series.

Consisting of 20-, 45-, 90-, and 200-watt solid-state amplifiers, the series offers system flexibility through "stacking". Channel 1 is the base channel and all input modules are stacked to the left. Special control modules, such as "priority paging" or "limiter", may be placed in any channel so as to mute or limit the gain of all inputs to the left of its position. In this way it is possible to control from one to all seven other inputs.

All four models have fully automatic circuit protection (with indicator light), 4, 8, and 16 ohm output, balanced with a 25- and 70-volt line. All are available in package or rack mount. Complete specifications will be supplied on request. Bell P/A

CIRCLE NO. 143 ON READER SERVICE CARD

SPEAKER SYSTEMS

Three new speaker models, two floor standing and one bookshelf, have just been introduced in the EMI line.

The console models are three-way systems with a 15" woofer, an elliptical 10 1/2" mid-range, and two tweeters. A 3-way crossover network provides continuously variable control of the midrange and tweeters. Frequency response is 10-30,000 Hz and the system will handle approximately 100 watts. The cabinets measure 28" high x 27" wide x 18" deep. Both modern and Provincial styling are available in the 300 Series.

The Model 205 is a bookshelf type with 3-way system and two electrical crossover networks. Frequency range of this unit is 25-22,000 Hz. Its cabinet is oiled walnut with a heat-formed front grille. Benjamin

CIRCLE NO. 5 ON READER SERVICE CARD

SOLID-STATE TAPE DECK

The Sony Model 666D solid-state, three-motor, stereo tape deck incorporates two sophisticated electronic systems—the SNR noise reduction system and ESP automatic tape reverse.

The SNR circuit provides noise-free playback of recorded tapes by automatically reducing the gain of the playback amplifier during quiet passages, when background noise is most intrusive. It reduces the noise level to almost inaudibility while doubling the dynamic range of the recorded material. It will work equally well on symphonic music, chamber music, pop singers, bands, or the spoken word.

Other features of the 666D are three motors (two high-torque spooling motors and a capstan drive motor), push-button operation, two vu



meters for recording level control, stereo head-phone jack, scrape flutter filter, ultra-high-frequency bias, vertical/horizontal operation, pause control, and four-digit tape counter. Superscope
Circle No. 6 on Reader Service Card

SPEAKER SYSTEMS

A new line of high-fidelity speaker systems has just been introduced as the "Row 10" series, named for the "best location in the concert hall."

Three bookshelf-type systems are currently available. The LS-10 has a 6" acoustic suspension woofer and a 3" composition-cone tweeter. Response is 40-20,000 Hz, power handling capacity is 30 watts IHF, and impedance is 8 ohms. It measures 15" x 8" x 7". The LS-20 has an 8" woofer and 3" tweeter with level control. Response is 30-20,000 Hz and power handling capacity is 40 watts IHF. It measures 19" x 10" x 9".

The LS-30 is a three-way system incorporating a 10" acoustic-suspension woofer, 5" composi-



tion-cone mid-range, and 3" tweeter with mid-range and tweeter level controls. Response is 38-20,000 Hz, power handling capacity 50 watts IHF, and dimensions are 22" x 14" x 11". Cabinets are of oiled walnut trimmed with brushed aluminum. Bogen

Circle No. 7 on Reader Service Card

AUDIOMETER CALIBRATION SET

The Type 1565-Z audiometer calibration set includes a 9A-type earphone coupler, a Type 1565-A sound-level meter, and a Type 1562-A sound-level calibrator. The 9A-type coupler is mechanically similar to the NBS type 9-A coupler, with the addition of a microphone locating strip.

This compact, portable calibration set makes it possible to check the accuracy of an audiometer before every use, the surest way to establish confidence in hearing-loss measurements. A calibration chart, provided with the set, gives the correct sound-level meter readings for the TDH 39 earphone at a hearing level of 60 dB, based on the ISO-1964 audiometer reference threshold. General Radio

Circle No. 144 on Reader Service Card

PORTABLE SOUND SYSTEM

A new 145-watt peak music power portable sound system for the musician who wants the widest sound distribution is now available as the A103. The system consists of a 1200A control console and one 1202A speaker system.

November, 1968

Capable of controlling up to five independent input signals, the 1200A all-silicon transistorized mixer power amplifier has an output of 145 watts peak or 60 watts r.m.s. It is ruggedly built in its own carrying case. The reverb is built in and has switchable, individual control on each of four channels. For added protection, when the top of the console is closed, the reverb is automatically locked in place to prevent damage. Altec Lansing
Circle No. 8 on Reader Service Card

160-WATT FM-STEREO RECEIVER

The Model S-8000a FM-stereo receiver provides 160 watts music power output and push-button control. The six front-panel push-buttons control main and remote speakers, loudness contour, stereo/mono selection, tape monitoring, and high filter. A front-panel tape jack provides for stereo tape playback and recording of reel-to-reel or cassette tape recorders. Additional rear-panel stereo tape jacks permit dubbing from one



recorder to another or simultaneous stereo recording using two tape recorders.

FM sensitivity is 1.8 μ V (IHF) and capture ratio is 2 dB. Frequency response is 20-20,000 Hz \pm 1/2 dB. The receiver measures 16 1/2" x 14" x 4 1/2" high. Walnut wood or walnut leatherette enclosures are available extra. Sherwood

Circle No. 9 on Reader Service Card

DUAL-POWERED CASSETTE

The Model F-50 is a dual-powered portable cassette recorder which will operate on both batteries and house current. The battery is automatically disconnected when the set is operating from the power line.

The circuit includes automatic record level control permitting recordings to be made from varying distances without the need to adjust sound level. The unit will record and play up to 90 minutes of voice or music and will play back prerecorded cassettes. A 5" speaker is built in. The recorder measures 8 3/4" wide x 4" high x 9" deep and weighs 4 1/2 pounds. Concord

Circle No. 10 on Reader Service Card

TWO-WAY SPEAKER SYSTEM

A new two-way, two-speaker system has just been introduced as the Model SP-30. The system consists of a 6 1/2" mid-range/woofer and a 2" horn-type tweeter, housed in a walnut enclosure with a hand-carved speaker grille. The enclosure is of exclusive "pipe-ducted" construction which helps to reproduce original bass tones faithfully.

An exclusive transformer-type crossover permits each speaker to function in its most suitable frequency range, assuring clear sound even at the crossover point, according to the company.

Frequency response is 50-20,000 Hz with crossover at 7000 Hz. Maximum power handling capacity is 20 watts, impedance is 8 ohms. The enclosure measures 7 7/8" wide x 10 1/16" deep x 16 1/16" high. It weighs 9.9 pounds. Sansui

Circle No. 11 on Reader Service Card

TUNER AND AMPLIFIER

The tuner and amplifier sections of the firm's AR-15 stereo receiver are now available as separate components. The new AJ-15 FM-stereo tuner features a preassembled, prealigned tuning unit



...IN THE
 TIME IT NOW
 TAKES TO INSTALL
 ONE
 MICROPHONE

Install multiple microphones as quickly as you can plug them into the Shure M68 Microphone Mixer. No splicing or soldering, no need to change impedances. Makes it easy to achieve Total Communications*.

(* A superior sound installation in which everybody who needs a microphone has one at his fingertips.)

SHURE
MICROPHONE
MIXER

...YOUR KEY TO TOTAL COMMUNICATIONS

© 1967 Shure Brothers, Inc.

CIRCLE NO. 84 ON READER SERVICE CARD

93

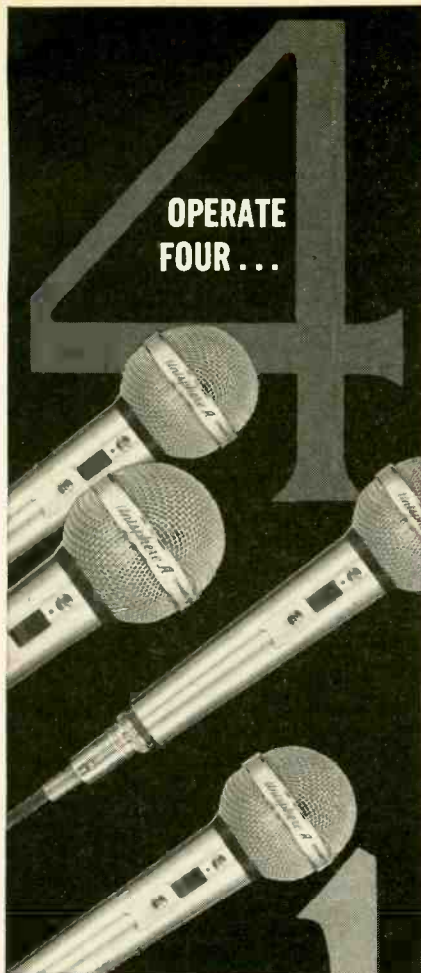

... AS
EASILY AND
COMPETENTLY AS
ONE
MICROPHONE

The Shure M68 Microphone Mixer enables you to teach inexperienced users how to operate a multiple-microphone sound system in seconds! It is your best tool for selling Total Communications*.
(* A superior sound system in which everybody who needs a microphone has one at his fingertips.)

SHURE MICROPHONE MIXER

...YOUR KEY TO TOTAL COMMUNICATIONS
© 1967 Shure Brothers, Inc.
CIRCLE NO. 84 ON READER SERVICE CARD
94

and complete solid-state circuitry throughout. Sensitivity is 1.8 μ V. Two crystal filters in the i.f. strip provide a response curve which requires no alignment. A stereo threshold switch permits a choice of stereo quality. A noise-operated squelch hushes between-station noise while the stereo-only switch permits automatic rejection of mono programming.

The amplifier (AA-15) provides 150 watts of music power output. Harmonic and IM distortion is 0.5% at full rated output. Frequency response is 8-40,000 Hz +1 dB at 1 watt.

Full ordering details and specifications on both the AJ-15 and the AA-15 are available on request. Heath

Circle No. 12 on Reader Service Card

TRANSISTORIZED INTERCOMS

Three new transistorized intercoms, each providing ten times the volume of conventional systems when needed, are now available.

The Master Selective intercom consists of one master station which can communicate with from one to ten substations; a Super Selective system consisting of up to ten master stations, each one of which can communicate with any other; and a Combination system consisting of one or more master stations which can communicate with one or more substations up to a combined total of ten. The Master unit has a built-in paging facility as well. Talk-A-Phone

Circle No. 13 on Reader Service Card

COMPACT MUSIC SYSTEM

Two new compact music systems designed specifically for persons with very limited space have been introduced as the SC1510 and SC1810.

Both units feature a 25-watt solid-state stereo amplifier with automatic safety guard to protect against shorts, a novel speaker switching arrangement which permits the user to install stereo and



mono speakers in various sections of the house without special networks, and a Garrard record changer with Grado pickup.

The SC1810 also includes a planetary-tuned FM-stereo radio. Harman-Kardon

Circle No. 14 on Reader Service Card

SPEAKER SYSTEMS

The new Imperial speaker system is being offered in two enclosure styles: the Imperial I is housed in a walnut cabinet with a hand-rubbed French lacquer finish accented by a selection of

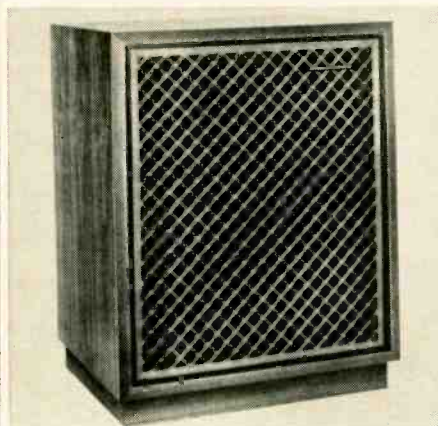

decorator-designed grille fabrics; the Imperial II is hand-crafted from selected hardwoods and has a distressed antique finish. It features a hand-carved wood grille.

Both units feature a three-way design, incorporating five speakers: 12" woofer which crosses over at 700 Hz to a pair of mid-range drivers, crossing over at 6000 Hz to a pair of high-frequency reproducers. Frequency range is 40-20,000 Hz and the 8-ohm systems are capable of handling up to 40 watts. Controls for acoustical balancing are built in. Marantz

Circle No. 15 on Reader Service Card

CB-HAM-COMMUNICATIONS

MONITOR RECEIVER

A new line of low-cost, table-model monitor receivers is now on the market as the CRX-103, 104, and 105. They are designed for firemen on call, policemen, private pilots, CD workers, businessmen, and radio enthusiasts.

The Model CRX-103 tunes the entire low-band range from 27 to 50 MHz, while the 104 is a portable aviation communications center cov-

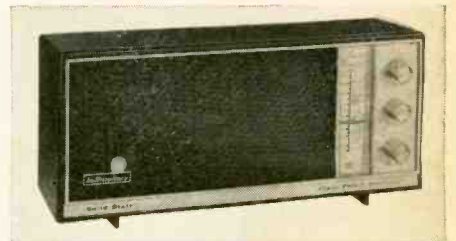

ering 108 to 135 MHz. The CRX-105 tunes from 144 to 174 MHz, the high band.

All of the models are solid-state. They incorporate noise-eliminating squelch control, class-B push-pull amplifiers, and tunable superhet AM and FM circuitry. Full specifications will be forwarded on request. Hallicrafters

Circle No. 16 on Reader Service Card

MICROWAVE CONNECTOR

A new balanced-line microwave connector which incorporates a number of unique features is now available. Designed for two-conductor coaxial cable, it is hermaphroditic in that one connector mates with its identical counterpart. The connector features push-on for quick connect, is polarized to eliminate improper mating, has a mechanical coupling nut to seal against environment, a locked connector of high tensile strength, and a reflection coefficient of 1/2% measured at 500 MHz in common and differential modes.

The new connector is available to accommodate RG-57/U, RG-130/U, and RG-22/U as well as MI-1678 cables. Times Wire

Circle No. 145 on Reader Service Card

MANUFACTURERS' LITERATURE

POWER-SUPPLY CATALOGUE

A 40-page general catalogue covering a complete line of all-silicon, convection-cooled power supplies for systems, laboratory, test equipment, and OEM applications is now available.

The publication gives performance features, detailed specifications, and prices for over 250 models of power supplies for rack or bench use. Complete ordering information is also included. Lambda

Circle No. 146 on Reader Service Card

INSULATED WIRE & CABLE

A four-page, two-color data sheet describing basic specifications and accessory information on the firm's line of Teflon-insulated wire and cable is now ready for distribution. Belden

Circle No. 147 on Reader Service Card

ELECTRICAL WIRE GUIDE

A new wire cable and tubing "easy reference" guide for use on wall or desk slide is designed to provide basic wire and cable specification data in

ELECTRONICS WORLD

a simple-to-use format that includes charts, diagrams, and illustrations.

Included in the new chart is a guide to military specifications for hook-up wire requirements for MIL-W-76-B and MIL-W-16878D, a wire sizes and resistance chart, and a wire stranding chart. There is also an estimator for cut wire and tubing pieces, relating the length of wire or tubing required, to the necessary footage to make 1000 pieces, and to the number of individual pieces that can be cut from 1000 feet of material. Alpha Wire

Circle No. 148 on Reader Service Card

CB ANTENNA CATALOGUE

A new catalogue of CB antennas, organized to meet the requirements of distributors, is now available. The catalogue is sectionalized to facilitate the location of the particular antenna or accessory, with material indexed for quick reference. Antenna Specialists

Circle No. 17 on Reader Service Card

SOUND SYSTEM BOOKLET

A new, updated version of the "Sound Column" booklet has come off the press and is available for distribution. The booklet features a selection guide with which it is possible to solve the "which columns?" problem and accurately in 90% of all potential installations. It also describes the theory of sound columns and gives many installation tips and use ideas. Argos

Circle No. 18 on Reader Service Card

VARIABLE RESISTORS

A new catalogue on the company's line of hot-molded variable composition resistors has been published. Designed for both military and industrial applications, these components meet or exceeded the requirements of MIL-R-94.

The publication offers up-to-date listings of several styles, types, and resistance values that are part of the standard line. Special items are available as well. Precision Electronic

Circle No. 149 on Reader Service Card

PARTS CATALOGUE

A comprehensive master catalogue which lists all parts manufactured by the parent company and its divisions has been issued. Covering over 10,000 items in 300 pages, the catalogue includes all current products, listed under their respective product grouping. Each item is illustrated and clearly defined as to usage and capability.

Copies of catalogue FR-69 will be supplied on request. GC Electronics

Circle No. 150 on Reader Service Card

OPTO-ELECTRONIC COMPONENTS

An 8-page brochure which describes the range of opto-electronic components and controls made by the company is ready for distribution. The line includes photoconductive cells, switching devices, photoelectric read heads and custom arrays, digital translator displays, photo controls, and outdoor lighting controls. The booklet is illustrated. Sigma Instruments

Circle No. 151 on Reader Service Card

MICROWAVE PRODUCTS

An 80-page catalogue covering a broad product line of fixed attenuators, variable attenuators, terminations, low-pass filters, high-pass filters, band-pass filters, band-reject filters, diplexers, manual coaxial switches, remote coaxial switches, transfer switches, mixers, hybrids, directional couplers, line stretchers, and stub tuners, is now available. Catalogue No. 686. RLC

Circle No. 152 on Reader Service Card

DISCHARGE LAMPS

A 28-page illustrated publication entitled "High Intensity Discharge Lamps" has been issued. The publication covers the physical, electrical, and performance characteristics of lamps in three principal categories: mercury, "Multi-Vapor", and "Lucalox."

The booklet discusses the history of light output improvements; lamp parts; bulb shapes and sizes; lamp designations; general operating char-

acteristics; light output maintenance and lamp life; auxiliary equipment such as ballasts; factors affecting lamp performance; spectral energy distribution data; and various general classes of high-intensity discharge lamps. General Electric

Circle No. 153 on Reader Service Card

POWER SUPPLIES

A 24-page illustrated catalogue entitled "Power Supplies Unlimited" provides complete specifications in tables for any laboratory or sophisticated system requiring solid-state d.c. power-supply equipment.

Page references and convenient charts make it easy to cross-index the appropriate power supply models for specific needs such as voltage and current range, regulation, ripple, and proper size.

Units covered include power supplies for systems using voltage and/or current regulated; system "wide-slot" regulated; high voltage d.c.; regulated high voltage; bench or rack; frequency converters; modular power, or special custom d.c. power supplies. NJE

Circle No. 154 on Reader Service Card

SWEEP GENERATORS

A new 28-page catalogue, No. 82, describing a complete line of sweep generators for testing TV tuners and circuits in the i.f., v.h.f., and u.h.f. frequency regions has just been issued.

The catalogue contains complete descriptions and specifications on three basic sweep generator series, 1006, 1010, and 1011, and 39 various "functions" that are, or may be, included with the sweepers to enhance their operation. Telonic

Circle No. 155 on Reader Service Card

AUDIO CABINETS

A full-color, 8-page booklet describing a line of cabinets for component hi-fi systems has been issued. The line includes equipment cabinets, speaker enclosures, and consoles. Each type is illustrated with representative hi-fi components installed for suggested layout. Dimensions are included for all models and interior layouts are detailed. Audio Originals

Circle No. 19 on Reader Service Card

SEALED SWITCHES

A complete line of switches for critical environmental applications is illustrated and described in a new 4-page, 2-color brochure, No. 84-02003-0. The publication facilitates the selection of hermetically or environment-proof basic switches, toggles, and limit switches. Micro Switch

Circle No. 158 on Reader Service Card

INDUSTRIAL RESISTORS

A catalogue describing the new Jeffers JC series of low-cost industrial precision resistors is now available.

The catalogue discusses a number of advantages offered by the new series and includes the results of two performance tests: a graph showing how the temperature coefficient of these resistors compares with that of wirewounds, and scope traces comparing the rise-time responses of the two resistors. Airco Speer

Circle No. 159 on Reader Service Card

PHOTO CREDITS

Page	Credit
22	Sansui Electronics Corp.
25, 26, 27, 28	Automation Industries, Inc.
29	RCA Laboratories
32	General Electric Co.
35, 36 (top)	Corning
36 (bottom)	Kollsman Instrument
37 (top left)	U.S. Army Photo
37 (top right)	Amperex Electronic Corp.
37 (bottom)	Norelco
38, 39	Ampex Corporation
40	Heath Company
43, 44, 45	Volkeswagen
46	Burgess Battery Div.
49, 51 (bottom), 52 (bottom)	Hewlett-Packard
51 (top)	Kruse-Storke Electronics
52 (top)	Alfred Electronics
76	The Bose Corp.



...WITH ONE
VOLUME CONTROL
FOR EACH
MICROPHONE AND
ONE MASTER
VOLUME CONTROL

Shure M68 Microphone Mixers can be stacked and interconnected to accommodate virtually any number of microphones regardless of impedance. They are unusually compact, singularly flexible, and modest in cost. They make Total Communications a practical reality.

SHURE
MICROPHONE
MIXER

...YOUR KEY TO TOTAL COMMUNICATIONS
SHURE BROTHERS, INC., 222 HARTREY AVE.
EVANSTON, ILL. 60204

© 1967 Shure Brothers, Inc.

CIRCLE NO. 84 ON READER SERVICE CARD 95

Make This Christmas



Kit IM-18
\$28⁵⁰
Wired IMW-18
\$47⁹⁵



kit IM-28
\$36⁵⁰
Wired IMW-28
\$56⁹⁵



Kit IM-38
\$39⁵⁰
Wired IMW-38
\$54⁹⁵



kit IM-17
\$21⁹⁵



kit IT-18
\$24⁹⁵



kit IP-18
\$19⁹⁵

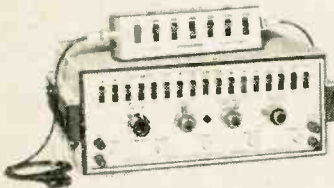

kit IG-57
\$135⁰⁰
wired IGW-57
\$199⁰⁰

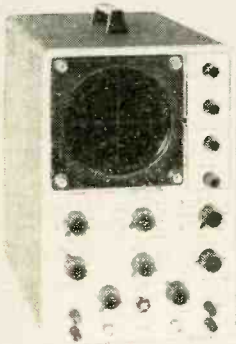

kit IO-18
\$84⁹⁵
wired IOW-18
\$139⁹⁵

NEW HEATHKIT IM-18 VTVM

The new IM-18 is a direct descendent of the world's most popular VTVM — the Heathkit IM-11, and continues the features that made the IM-11 famous . . . 7 AC and 7 DC voltage ranges that measure from 0-1500 volts full scale . . . 7 ohms ranges for resistance measurements from 0.1 ohm to 1000 megohms . . . single probe convenience that ends tangled leads & enables you to change from AC to DC/Ohms measurements with a flip of the switch on the probe . . . the light circuit loading of 11 megohm input impedance . . . ± 1 dB 25 Hz to 1 MHz response . . . precision 1% resistors . . . DC polarity reversing position on the function switch . . . measurement capability for RMS and Peak-To-Peak AC voltages and dB . . . precision $4\frac{1}{2}$ " 200 uA meter for extra sensitivity. In addition, the new IM-18 includes wiring options for 120V. or 240 VAC operation and a three-wire line cord for added safety. 5 lbs.

NEW HEATHKIT IM-28 "Service Bench" VTVM

The new Heathkit IM-28 bears the proud tradition of the IM-13, and it has the same performance specifications as the new IM-18 above — an unbeatable combination! But it also has a number of features that put it in a class by itself, like a large 6" meter with easy-to-read markings . . . extra 1.5 and 5 volt AC ranges for additional accuracy . . . a secure gimbal mounting that allows you to put the IM-28 above, below or in front of your most convenient mounting surface . . . "Set and Forget" calibration — all calibration controls are screwdriver adjustable from the front panel to eliminate disassembly . . . smooth ten-turn vernier control of Zero and Ohms Adjust for greater accuracy and easier setting . . . dual primary transformer for 120/240 VAC operation . . . safe 3-wire line cord as well. The new look of Heathkit instrument styling is evident too — handsome beige & brown color scheme, and new knobs that are easy to turn and fast to read. 7 lbs.

NEW HEATHKIT IM-38 Laboratory AC VTVM

For all around general service work, audio design and trouble-shooting or laboratory analysis, you couldn't find a better value than the new Heathkit IM-38 AC VTVM. Here's why — 10 voltage ranges measure from 0.01 to 300 volts RMS full scale . . . an extended frequency response of 10 Hz to 500 kHz at ± 1 dB . . . 10 megohm input on all ranges for higher accuracy and minimal circuit loading . . . wide dB range: -12 to +2 on the meter and ten switch-selected ranges from -40 to +50 in 10 dB steps . . . VU-type ballistic meter damping . . . amplifier filament voltage transformer winding that's balanced to ground for low AC noise . . . 120/240 AC wiring options and new Heathkit styling in sharp beige & brown with an easy-to-grasp, easy-to-read knob. Heathkit engineering has made assembly easy and performance tops. 5 lbs.

HEATHKIT IM-17 Solid-State Volt-Ohm Meter

Another very popular volt-ohmmeter from Heathkit engineering and it's easy to see why — all solid-state circuitry . . . high impedance FET input, 11 megohms on DC, 1 megohm on AC . . . 4 AC voltage ranges . . . 4 DC voltage ranges . . . 4 ohm ranges . . . $4\frac{1}{2}$ " 200 uA meter . . . 3 built-in test leads . . . DC polarity reversing switch . . . zero-adjust & ohms-adjust controls . . . continuous 12-position function switch. And that's not all — the IM-17 is battery powered for complete portability and comes in a rugged polypropylene case with built-in handle. Simple circuit board assembly. 4 lbs.

HEATHKIT IT-18 In-Circuit Transistor Tester

In-Circuit transistor testers don't have to be expensive, and the IT-18 is proof of that . . . tests DC Beta 2-1000, in or out-of-circuit . . . leakage I_{cbo} and I_{ceo} current 0-5000 uA out-of-circuit . . . identifies NPN or PNP devices . . . tests diodes in or out-of-circuit for opens & shorts . . . identifies unknown diode leads . . . matches PNP & NPN transistors. The IT-18 is completely portable — runs on just one "D" cell. Easy to use too . . . rugged polypropylene case, attached 3' test leads, big $4\frac{1}{2}$ " 200 uA meter, all front panel controls, 10-turn calibrate control. 4 lbs.

HEATHKIT IP-18 1-15 VDC Power Supply

If you work with transistors, this is the power supply for you. All solid-state circuitry provides 1-15 VDC at up to 500 mA continuous. Features adjustable current limiting, voltage regulation, floating output for either + or - ground, AC or DC programming, circuit board construction, and small, compact size. 110 or 220 VAC. 5 lbs.

HEATHKIT IG-57 Solid-State Post Marker/Sweep Generator

The new IG-57 plus a 'scope is all you need . . . no external sweep generator required. Switch selection of any of 15 crystal-controlled marker frequencies (you can view up to six different frequencies on one 'scope trace). Select the sweep range and you are ready to instantly see the results of any changes you make. Four markers for setting color bandpass, one for TV sound, eight at IF frequencies between 39.75 & 47.25 MHz plus picture and sound carrier markers for channels 4 & 10. Three sweep oscillators produce the 5 most-used ranges . . . color bandpass, FM IF, color & B&W IF and VHF channels 4 & 10. Save hundreds of dollars and put full alignment facilities in your shop too — order your IG-57 now. 14 lbs. Kit IG-14, same as IG-57 w/o the sweep, 11 lbs. \$99.95.

HEATHKIT IO-18 Wide-Band 5" 'Scope

The New Heathkit IO-18 is destined to be the world's most popular 'scope, just as its predecessor, the IO-12 was. Features 5 MHz bandwidth, the famous Heath patented sweep circuit — 10 Hz to 500 kHz in 5 ranges, two extra sweep positions which can be preset to often-used rates, frequency compensated vertical attenuation, built-in P-P calibration reference. Z-axis input, retrace blanking, wiring options for 120 or 240 VAC operation and new Heathkit styling in beige and brown. 24 lbs.

A Heathkit® Holiday

**Wish Your Family Merry Christmas This Year
With A New Heathkit Color TV . . . A Better
Buy Than Ever With New Lower Prices**

**NEW Deluxe Color TV With Automatic
Fine-Tuning—Model GR-681** kit GR-681
\$499⁹⁵ (less cabinet)

The new Heathkit GR-681 is the most advanced color TV on the market. A strong claim, but easy to prove. Compare the "681" against every other TV — there isn't one available for any price that has all these features. Automatic Fine Tuning on all 83 channels . . . just push a button and the factory assembled solid-state circuit takes over to automatically tune the best color picture in the industry. Push another front-panel button and the VHF channel selector rotates until you reach the desired station, automatically. Built-in cable-type remote control that allows you to turn the "681" on and off and change VHF channels without moving from your chair. Or add the optional GRA-681-6 Wireless Remote Control described below. A bridge-type low voltage power supply for superior regulation; high & low AC taps are provided to insure that the picture transmitted exactly fits the "681" screen. Automatic degaussing, 2-speed transistor UHF tuner, hi-fi sound output, two VHF antenna inputs . . . plus the built-in self-servicing aids that are standard on all Heathkit color TV's but can't be bought on any other set for any price . . . plus all the features of the famous "295" below. Compare the "681" against the others . . . and be convinced.

GRA-295-4, Mediterranean cabinet shown **\$119.50**
Other cabinets from \$62.95

Deluxe "295" Color TV... Model GR-295 **\$449⁹⁵**
now only
(less cabinet)

Big, Bold, Beautiful . . . and packed with features. Top quality American brand color tube with 295 sq. in. viewing area . . . new improved phosphors and low voltage supply with boosted B+ for brighter, livelier color . . . automatic degaussing . . . exclusive Heath Magna-Shield . . . Automatic Color Control & Automatic Gain Control for color purity, and flutter-free pictures under all conditions . . . preassembled IF strip with 3 stages instead of the usual two . . . deluxe VHF tuner with "memory" fine tuning . . . three-way installation — wall, custom or any of the beautiful Heath factory assembled cabinets. Add to that the unique Heathkit self-servicing features like the built-in dot generator and full color photos in the comprehensive manual that let you set-up, converge and maintain the best color picture at all times, and can save you up to \$200 over the life of your set in service calls. For the best color picture around, order your "295" now.

GRA-295-1, Walnut cabinet shown **\$62.95**
Other cabinets from \$99.95

Deluxe "227" Color TV... Model GR-227 **\$399⁹⁵**
now only
(less cabinet)

Has same high performance features and built-in servicing facilities as the GR-295, except for 227 sq. inch viewing area. The vertical swing-out chassis makes for fast, easy servicing and installation. The dynamic convergence control board can be placed so that it is easily accessible anytime you wish to "touch-up" the picture.

GRA-227-1, Walnut cabinet shown **\$59.95**
Mediterranean style also available at \$99.50

Deluxe "180" Color TV... Model GR-180 **\$349⁹⁵**
now only
(less cabinet)

Same high performance features and exclusive self-servicing facilities as the GR-295 except for 180 sq. inch viewing area. Feature for feature the Heathkit "180" is your best buy in deluxe color TV viewing . . . tubes alone list for over \$245. For extra savings, extra beauty and convenience, add the table model cabinet and mobile cart.

GRS-180-5, table model cabinet and cart **\$39.95**
Other cabinets from \$24.95

Now, Wireless Remote Control For Heathkit Color TV's

Control your Heathkit Color TV from your easy chair, turn it on and off, change VHF channels, volume, color and tint, all by sonic remote control. No cables cluttering the room . . . the handheld transmitter is all electronic, powered by a small 9 v. battery, housed in a small, smartly styled beige plastic case. The receiver contains an integrated circuit and a meter for adjustment ease. Installation is easy even in older Heathkit color TV's thanks to circuit board wiring harness construction. For greater TV enjoyment, order yours now.

kit GRA-681-6, 7 lbs., for Heathkit GR-681 Color TV's **\$59.95**
kit GRA-295-6, 9 lbs., for Heathkit GR-295 & GR-25 TV's **\$69.95**
kit GRA-227-6, 9 lbs., for Heathkit GR-227 & GR-180 TV's **\$69.95**

**Now There Are 4 Heathkit Color TV's . . .
All With 2-Year Picture Tube Warranty**

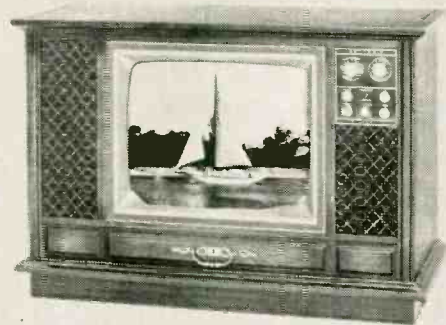

kit GR-681



kit GR-295



kit GR-227



kit GR-180



**New Wireless
TV Remote Control**
For GR-295, GR-227
& GR-180

\$69⁹⁵

**New Wireless
TV Remote Control**
For GR-681

\$59⁹⁵

CIRCLE NO. 103 ON READER SERVICE CARD

There's A "Just Right" Heathkit®



NEW kit AD-27
\$169⁹⁵



NEW kit AD-17
\$109⁹⁵

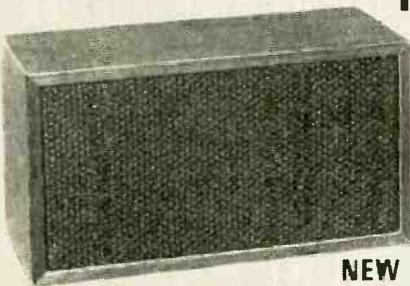

NEW kit AS-18
\$32⁹⁵

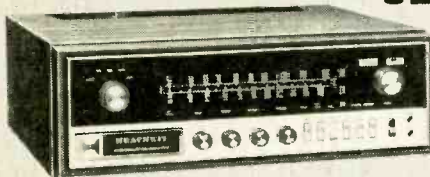

kit AR-15 **Wired ARW-15**
\$339^{95*} **\$525^{00*}**

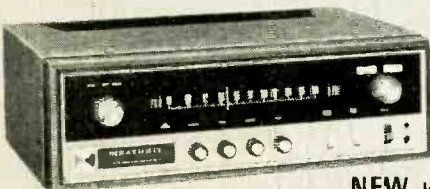

NEW kit AJ-15
\$189^{95*}



NEW kit AA-15
\$169^{95*}

NEW HEATHKIT AD-27 FM Stereo Component-Compact

This new Heathkit AD-27 stereo compact has features not found in other units costing twice as much for one very simple reason. It wasn't engineered to meet the usual level of compact performance. Instead, Heath took one of its standard stereo/hi-fi receivers, the AR-14, and re-arranged it physically to fit a compact configuration. The result is performance that is truly high fidelity without compromise. It features 31 transistor, 10 diode circuitry with 15 watts per channel dynamic music power (enough to let you choose most any speaker system you prefer), full-range tone controls, less than 1% distortion, and 12 to 60,000 Hz response. The pre-assembled FM stereo tuner section with 4-stage IF offers 5 μ V sensitivity, excellent selectivity, AFC, and the smoothest inertia tuning. The BSR McDonald "500" turntable offers features usually found only in more expensive units . . . like low mass tubular aluminum tone arm, anti-skate control, cueing and pause control, plus a Shure magnetic cartridge with diamond stylus. It's all housed in a smart oiled walnut cabinet with sliding tambour door that disappears inside the cabinet. For value and performance choose the AD-27, the new leader in stereo compacts. Shpg. wt. 41 lbs.

NEW HEATHKIT AD-17 Budget-Priced Component-Compact

Heath engineers took the stereo amplifier from the AD-27 above, matched it with the top rated BSR McDonald 400 Automatic Turntable and put both of these able performers in an attractive walnut cabinet. The result is the high performance, low cost AD-17. The all solid-state circuit delivers 15 watts music power per channel — more than enough to drive any reasonably efficient system. Wide response of 12 Hz to 60 kHz \pm 1 dB and harmonic & IM distortion both less than 1% at full output are your guarantee of clean, full range sound. Stereo headphone jack, filtered tape outputs and Tuner & Auxiliary inputs too. The BSR McDonald 400 Automatic Turntable features a cueing and pause control, adjustable stylus pressure, variable anti-skate control and manual or automatic operation on all four speeds. Comes complete with a famous Shure magnetic cartridge. The Heathkit manual makes it easy to build . . . the sound makes it a pleasure to own. Order yours now. 27 lbs.

NEW HEATHKIT AS-18 Miniature Acoustic Suspension System

The new AS-18 features famous high quality Electro-Voice® speakers — 6" woofer and a 2½" tweeter. The wide frequency response of 60 Hz to 20 kHz and the clear, natural sound of these miniature systems will really amaze you. They're the ideal performance mates to the Component Compacts above and are especially suited for apartments, mobile homes, offices, etc. — anywhere that you need superior stereo sound from a small space. Handles up to 25 watts program material and has a high frequency balance control so you can adjust the sound to your liking. Order 2 for superb stereo now. 16 lbs.

HEATHKIT AR-15 Deluxe Stereo Receiver

The World's Most Sophisticated, Most Praised Stereo Receiver. And here are just a few of the reasons why leading audio critics and testing organizations, as well as thousands of owners rate the AR-15 as THE stereo receiver. The all solid-state circuit with 69 transistors, 43 diodes and two integrated circuits has many new design concepts to deliver superior performance. The amplifier section has 150 watts of music power . . . 75 watts per channel. Harmonic and IM distortion are both less than 0.5%. The special design FET FM tuner boasts sensitivity of 1.8 μ V, selectivity of 70 dB and harmonic & IM distortion both less than 0.5%. The Crystal Filters provide an ideally shaped bandpass and are a Heath first in the high fidelity industry. You'll hear stations you didn't even know existed in your area, and the Noise-Operated Squelch, Adjustable Phase Control, Stereo-Only Switch, Stereo Threshold Control and FM Stereo Noise Filter Switch will let you hear them in the clearest, most natural way. Other features include two front panel stereo headphone jacks, positive circuit protection, loudness switch, speaker switch, front panel input level controls, recessed outputs, two external FM antenna connectors and one for AM, Tone Flat control, electronically filtered power supply and "Black Magic" panel lighting. Seven circuit boards and three wiring harnesses simplify assembly and you can mount your completed AR-15 in a wall, your own cabinet or the Heath assembled walnut cabinet. For the ultimate in a stereo receiver, order your AR-15 now. 34 lbs. *Optional walnut cabinet AE-16, \$24.95.

HEATHKIT AJ-15 Deluxe Stereo Tuner

For the man who already owns a fine stereo amplifier, Heath now offers the superb FM stereo tuner section of the AR-15 receiver as a separate unit. The new AJ-15 FM Stereo Tuner has the exclusive FET FM tuner for remarkable sensitivity, exclusive Crystal Filters in the IF strip for perfect response curve and no alignment; Integrated Circuits in the IF for high gain, best limiting; Noise-Operated Squelch; Stereo-Threshold Switch; Stereo-Only Switch; Adjustable Multiplex Phase, two Tuning Meters; two Stereo Phone jacks; "Black Magic" panel lighting. 18 lbs. *Walnut cabinet AE-18, \$19.95.

HEATHKIT AA-15 Deluxe Stereo Amplifier

For the man who already owns a fine stereo tuner, Heath now offers the famous amplifier section of the AR-15 receiver separately. The new AA-15 Stereo Amplifier has the same superb features: 150 watts Music Power; Ultra-Low Harmonic & IM Distortion (less than 0.5% at full output); Ultra-Wide Frequency Response (\pm 1 dB, 8 to 40,000 Hz at 1 watt); Front Panel Input Level Controls; Transformerless Amplifier; Capacitor Coupled Outputs; All-Silicon Transistor Circuit; Positive Circuit Protection. 26 lbs. *Walnut cabinet AE-18, \$19.95.

Gift For Everyone On Your List

Heathkit MI-18 Solid-State Tachometer

The Professional Tach. That's the new Heathkit MI-18. In Design: breaker point, "tach" lead or unique inductive pickup connection; use it with any spark-type engine and any ignition system, 2 cycle 1-6 cyl. engines or 4 cycle, 2-8 cyl. engines . . . all electronics are in the tach itself. In Performance: 0-6000 & 0-9000 RPM ranges . . . 250° edge-lighted dial . . . temperature-compensated, ±4% accuracy from 0° —120° . . . adjustable red line pointer . . . 10.5 to 17.5 VDC operation. In Styling: stainless steel hardware, splash-proof black & chrome case and scratch-proof glass face for use in rugged conditions. The MI-18-1 mounts in your dash — requires only a 3/4" hole & 2 1/4" depth. The MI-18-2 comes with mounting case & hardware. Put a Professional Tach in your car, boat, dune-buggy, or bike now — the Heathkit MI-18! Shpg. wt. 3 lbs.

NEW kit MI-18-1

\$29⁹⁵ Panel Mount

NEW kit MI-18-2

\$32⁹⁵ With Case



NEW kit GR-17

\$43⁹⁵



NEW kit HW-100

\$240⁰⁰

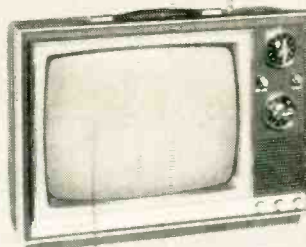

kit GR-104A

\$119⁹⁵



kit GD-325C

\$439⁹⁵

Heathkit GR-17 Solid-State AM-FM Portable Radio

Here's performance the others can't match. The new Heathkit GR-17 portable has a 12 transistor, 7 diode circuit with the same front end as used in Heathkit hi-fi tuners. AM or FM at the flick of a switch and what reception! Big 1/2" ferrite rod antenna, three tuned transformers and amplified AGC pull in more AM stations. The FM section features a collapsible 34" whip antenna, three IF stages and 5 uV sensitivity for reception over greater distances than you would expect from a portable. The 4" x 6" speaker and an audio output of 350 mW provides clean sound and the GR-17 will keep you entertained for up to 300 hours on a single set of batteries. For the greatest sound everywhere, get your GR-17 today. 5 lbs.

NEW HEATHKIT HW-100 SSB-CW 5-Band Receiver

The new Heathkit HW-100 has all the features and performance of the competition at a money saving kit price. And here's what it delivers: the receiver portion has sensitivity of less than 0.5 uV for a 10 dB S+N/N ratio for SSB. Crystal filter selectivity is 2.1 kHz at 6 dB down, 7 kHz at 60 dB down. Image & IF rejection are better than 50 dB. The transmitter has a 180 watt input on either USB or LSB and 170 watts on CW. It operates PTT or VOX on SSB and break-in CW work is provided by operating VOX from a keyed tone, using grid-block keying. Outstanding frequency stability — less than 100 Hz per hour drift after 30 minute warmup . . . less than 100 Hz variation under a 10% line voltage variation. The HW-100 is a really loaded rig — solid-state (FET) VFO . . . 80-10 meter coverage . . . patented Harmonic Drive™ dial mechanism . . . built-in 100 kHz calibrator . . . TALC and much more. Put this hot rig in your shack — order your HW-100 today. 22 lbs.

HEATHKIT GR-104A Solid-State Portable B&W TV

The perfect portable . . . that's the GR-104. Small and light enough to carry from room to room . . . rugged enough to take it . . . and the picture is the sharpest, most realistic you've ever seen, thanks to Heathkit total engineering. 74 sq. in. viewing area . . . all solid-state circuit for extra reliability and performance . . . covers all VHF and UHF channels, 2-83 . . . 2-speed UHF tuning . . . "memory" VHF fine tuning . . . 3-stage IF for maximum gain with controlled bandwidth . . . gated AGC for steady, jitter-free pictures . . . transformer regulated power supply . . . circuit breaker protection . . . one-piece swing out chassis for easy assembly and servicing . . . runs on house current or battery power with the optional GRA-104-1 rechargeable battery pack. 27 lbs.

GRA-104-1, 9 lbs. \$39.95

HEATHKIT GD-325C Low Cost Solid-State Organ

This money-saving kit form of the popular Thomas "Artiste" Organ can have you playing songs after just 50 hours of interesting, enjoyable assembly, thanks to the clear, easy-to-follow Heathkit manual and exclusive Thomas Color-Glo teaching method. Features 10 true organ voices . . . variable repeat percussion . . . 13 note heel and toe bass pedals . . . 2 overhanging 37 note keyboards, range C2 thru C5 each . . . 75 watt peak music power amplifier . . . 12" full response speaker . . . Vibrato . . . manual balance control . . . and the solid-state plug-in tone generators — the heart of the organ, are guaranteed for 5 years. Assembled walnut-finish cabinet included. Discover the fun and enjoyment of live music in your home . . . order your Heathkit/Thomas organ today. 172 lbs.



NEW

FREE 1969 CATALOG!

Now with more kits, more color. Fully describes these along with over 300 kits for stereo/hi-fi, color TV, electronic organs, electric guitar & amplifier, amateur radio, marine, educational, CB, home & hobby. Mail coupon or write Heath Company, Benton Harbor, Michigan 49022.

HEATH COMPANY, Dept. 15-11
Benton Harbor, Michigan 49022
In Canada, Daystrom Ltd.

Enclosed is \$_____ plus shipping.

Please send model (s)
 Please send FREE Heathkit Catalog.
 Please send Credit Application.

Name _____

Address _____

City _____

State _____

Zip _____

Prices & specifications subject to change without notice.

CL-345

CIRCLE NO. 103 ON READER SERVICE CARD

FREE



GIANT 1969 RADIO-TV ELECTRONICS CATALOG

228 GIANT VALUE-
PACKED PAGES



YOUR BUYING GUIDE FOR . . .
TV's, Radios, Recorders, Phonos,
Amateur and CB equipment, elec-
tronic parts, tubes and test equip-
ment . . . plus featuring B-A's
famous bargain packed section!

WRITE FOR YOUR FREE CATALOG TODAY!

BURSTEIN-APPLEBEE CO., DEPT. EWW
3199 MERCIER ST., KANSAS CITY, MO. 64111

Name _____

Address _____

City _____

State _____

Zip Code _____

CIRCLE NO. 116 ON READER SERVICE CARD

Electronic Fuel Injection System (Continued from page 45)

connector that makes contact directly with the contact strips on the unit's printed-circuit board. "Worst-case" evaluation was used throughout for the circuit design. As a result, the unit should function perfectly even if all component values are at unfavorable tolerance limits, and both supply voltage and ambient temperature are at extremes. This design gives a temperature error for the computer that is less than $\pm 2\%$ over its operating range from -22°F to $+180^\circ\text{F}$.

Maintenance

Volkswagen claims the electronic fuel-injection system simplifies maintenance. This seems unlikely on such a complicated system; however, they explain that this system eliminates the guesswork frequently required to adjust temperamental carburetors. Almost any mechanic will agree that this has become an increasing problem with the anti-smog devices required on most automobiles. The only adjustments required for the *Volkswagen* fuel-injection system are the air-pressure regulator and the idle air adjustment. A further example of the simplicity of maintenance for the system is *Volkswagen's* claim that the average mechanic gets a good grasp of this complex system in just two days of the training period provided for mechanics.

The dealer is provided a test unit to check out the fuel-injection system. With this unit, all sensors, the fuel pump, and the injectors are tested according to a set program. The test procedure calls for two types of tests. The first of these is a static test with the computer disconnected from the system. This test checks system voltages and resistances as well as fuel pump operation. The second test is dynamic in nature with the test unit connected between the computer and the rest of the system and with the engine running. This test provides a balance check of trigger contact pairs 1 and 2 and a dynamic check of the pressure switch.

As of now auto mechanics are not allowed to service the computer. If the computer fails, it is removed from the vehicle, replaced, and returned to *Robert Bosch, Inc.* of Germany for inspection and corrective action. According to *Bosch*, they want to evaluate all failures to improve the system as quickly as possible, should specific failures occur in great numbers.

According to a *Volkswagen* spokesman, the computer was not designed to be serviced at the automotive dealer. It is unlikely, however, that all *Volkswagen* owners will willingly pay for a replacement unit if they can find someone capable of servicing the unit. However, the unit is too complicated for the limited electronic knowledge of the average auto mechanic. Therefore, if these units are to be repaired in the field, an electronics technician will have to do the job.

It the *Volkswagen* electronic fuel-injection system continues to maintain acceptable emission levels without the addition of other anti-smog devices, we can expect American auto makers to adopt a similar system in the near future, because current anti-smog devices decrease engine efficiency. Although *Bosch* would not release specific information concerning interest of other auto makers, they stated, "we find great and world-wide interest in our new system and we are constantly adapting our system, for testing purposes, to a great number of engines of big automobile manufacturers."

The figures aren't in yet, but experts expect about 65,000 *Volkswagens* with electronic fuel injection to be imported during 1968 and likely an equal number in 1969. This, in itself, will not greatly increase the task of the electronics technician; however, the continued technological development and growth of electronics in the over-all automobile market indicates that there will be an increasing need for automotive electronics technicians in the near future. ▲

FIRST WITH

- ★ Digital Integrated Circuits
- ★ 4 Crystal-Controlled Oscillators
- ★ Battery & AC Operation Standard



The New Pace-Setting CONAR Model 680
COLOR GENERATOR
KIT \$83.50 WIRED \$114.50

Until now, no commercially available color generator has offered so many quality features in a single instrument at such a low price. Only the CONAR COLOR GENERATOR has all these features at any price: exclusive digital integrated circuits; exclusive 4 crystal-controlled oscillators; exclusive AC or battery operation standard; completely solid state; color amplitude control; color phase adjustment; regulated power supply; stability control; TV station sync and blanking pulses; nine patterns; red, blue and green gun killers; compact; lightweight; portable.

For details write Dept. MB8C.

CONAR instruments

DIVISION OF NATIONAL RADIO INSTITUTE
3939 Wisconsin Ave., Washington, D.C. 20016

WRITE FOR FREE CONAR CATALOG

ELECTRONICS MARKET PLACE

COMMERCIAL RATE: For firms or individuals offering commercial products or services. 85¢ per word (including name and address). Minimum order \$8.50. Payment must accompany copy except when ads are placed by accredited advertising agencies. Frequency discount: 5% for 6 months; 10% for 12 months paid in advance.

READER RATE: For individuals with a personal item to buy or sell. 50¢ per word (including name and address). No minimum! Payment must accompany copy.

GENERAL INFORMATION: First word in all ads set in bold caps at no extra charge. Additional words may be set in bold caps at 10¢ extra per word. All copy subject to publisher's approval. **Closing Date:** 1st of the 2nd preceding month (for example, March issue closes January 1st). Send order and remittance to: Hal Cymes, **ELECTRONICS WORLD**, One Park Avenue, New York, New York 10016.

FOR SALE

JUST starting in TV service? Write for free 32 page catalog of service order books, invoices, job tickets, phone message books, statements and file systems. Oelrich Publications, 6556 W. Higgins Rd., Chicago, Ill. 60656.

GOVERNMENT Surplus Receivers, Transmitters, Snooperscopes, Radios, Parts, Picture Catalog 25¢. Meshna, Nahant, Mass. 01908.

METERS—Surplus, new, used, panel and portable. Send for list. Hanchett, Box 5577, Riverside, Calif. 92507.

CONVERT any television to sensitive big-screen oscilloscope. Only minor changes required. No electronic experience necessary. Illustrated plans, \$2.00. Relco-A22, Box 10563, Houston, Texas 77018.

MUSIC LOVERS, CONTINUOUS, UNINTERRUPTED BACKGROUND MUSIC FROM YOUR FM RADIO, USING NEW INEXPENSIVE ADAPTER. FREE LITERATURE, ELECTRONICS, 11500-Z NW 7th AVE., MIAMI, FLORIDA 33168.

R.F. CONVERTERS World's largest selection. Also CCTV cameras, etc. Lowest factory prices. Catalog 10¢. Vanguard, 196-23 Jamaica Ave., Hollis, N.Y. 11423.

'BUG' DETECTORS, SURVEILLANCE TV, CONFERENCE RECORDERS, TELEPHONE ACCESSORIES, INTRUSION ALARMS. FREE DETAILS: SECURITY ELECTRONICS EW, 13 EAST 43RD STREET, NEW YORK, N.Y. 10017.

TAPE RECORDER, deluxe capstan drive \$9.95; rim drive \$3.95, 6 to 10 transistor radios \$1.50; AM/FM radios \$5.95, items need minor repair. Make money repairing reselling—all sales final. GMP INC., 623 So. Gay St., Knoxville, Tenn. 37902.

JUST out! Interesting catalog of unusual gadgets, parts, kits, 20¢. Franks Scientific Co., P.O. Box 156, Martelle, Iowa 52305.

REGULATED POWER SUPPLIES, need only transformer. 5V-15V .6-4a, \$2.75-\$8.50. GE Triac 10a \$1.75, catalog. Murphy, 204 Roslyn, Carle Place, New York 11514.

GARRARD Record Changers, Hi-Fi Components, Cartridges, Needles, Tape, TV Parts, Schematics. Write for Unbelievable Prices. Gregg Electronics, P.O. Box 184, Glen Head, N.Y. 11545.

PRINTED circuit board kits, materials, free catalog. Seneca Electronics, P.O. Box 2022C, Kokomo, Indiana 46901.

DIAGRAMS, service manuals, TV, radio, HiFi, \$1.00. Technical Services Associates, Box 1167, Berkeley, Calif. 94701.

CATHODIC protection instructions \$1.00. F.F. Knapp, P.O. Box 854, Scottsdale, Arizona 85252.

CRYSTALS . . . largest selection in United States at lowest prices. 48 Hr. delivery. Thousands of frequencies in stock. Types include HC6/U, HC18/U, FT-241, FT-243, FT-171, etc. Send 10¢ for catalog with oscillator circuits. Refunded on first order. Jan Crystals, 2400E Crystal Dr., Fort Myers, Fla. 33901.

TREASURE HUNTERS! Prospectors! Relco's new instruments detect buried gold, silver, coins. Kits, assembled models. Transistorized. Weighs 3 pounds. \$19.95 up. Free catalog. Relco-A22, Box 10839, Houston, Texas 77018.

SURVEILLANCE COUNTERMEASURES BROCHURE \$1.00. ENGINEERING LABORATORIES, BOX 1036, ANDERSON, INDIANA 46015.

PROXIMITY switch detects nearness of human body! Free information. Claremont Products, 860 Reed, Claremont North, Calif. 91711.

NEW Sensitive Treasure Metal Detectors. New low prices. Professional models from \$29.95 to \$129.50. Write for free catalog today. Jetco Electronics, Box 132-E, Huntsville, Texas 77340.

WHOLESALE components: Manufacturers and distributors only. Request free catalog on business letterhead. WESCOM, Box 2536, El Cajon, California 92021.

MAIL ORDER

SHOPPING MART

A selection of products available by mail for readers of Electronics World. All merchandise sold on a money-back guarantee. Order direct by Stock No. Send check or M.O.

EXCELLENT for XMAS GIFTS!

SEE YOUR MUSIC IN DAZZLING ACTION with



MUSIC VISION

Dramatic New Breakthrough In Audio-Visual Enjoyment

Now you can have a thrilling psychedelic "see-in" right in your own home, club, school or business—in fact—anywhere you want to add sensational "mod" effects. Colored light beams dance and prance, whirl and swirl in perfect time with the music—each individual creating its own unique twisting, radiating shape. Adds a spectacularly wild, new dimension to the world of music and entertainment. Combines electronics science and art with dramatic results. Attaches in seconds to your radio, tape recorder, hi-fi or stereo with two alligator clips. Can be used on small screens, large walls, stages and whole auditoriums. Build your own Music-Vision® with low-cost Do-It-Yourself Kit. Loads of fun! Fast! Easy! All you need is a light source. If you don't have one, the versatile Edmund 500m 500 Watt Projector is a terrific bargain. All kinds of other uses too—set up to accept motorized accessories. Also available in 15" x 15" x 27" Walnut Cabinet Model. Tube Unit, or 8" and 12" Sets which include enclosed 8" or 12" Motlondizer. Color Wheel and set of apertures for use with your own 500m projector. Large 12" set provides fabulous effects for commercial applications. Order by stock number listed below. Money-back guarantee. Complete information in new catalog. Send 25¢ in coin for fully illustrated, 16-page Booklet No. 9096AK Introduction to Music-Vision® *Patent pending.

- | | |
|--|---|
| 8" DO-IT-YOURSELF KIT
Stock No. 71.00AK \$22.50 Postpaid | 12" SET (Same as above w/large Motlondizer)
Stock No. 71.02AK \$57.50 Postpaid |
| 8" SET (Motlondizer, color wheel, apertures)
Stock No. 71.03AK \$45.00 Postpaid | WALNUT VENEERED CABINET MODEL
Stock No. 85.181AK \$99.50 F.O.B. |
| EDMUND 500 WATT 500MM PROJECTOR
Stock No. 71.057AK \$24.50 Postpaid | |



3" ASTRONOMICAL TELESCOPE

See the stars, moon, phases of Venus, planets close up. 60 to 180 power. Aluminized and overcoated 3" diameter f/10 primary mirror, ventilated cell. Equatorial mount with locks on both axes. Equipped with 6X eyepiece and mounted Barlow lens. 3X finder telescope, hardwood tripod. Included FREE: "STAR CHART": 272-page "HANDBOOK OF HEAVENS"; "HOW TO USE YOUR TELESCOPE". Stock No. 85.050AK \$ 29.95 Ppd

Stock No. 85.105AK
4 1/4" REFLECTOR \$ 84.60 FOB

Stock No. 85.086AK
6" REFLECTOR \$199.50 FOB



WAR SURPLUS! AMERICAN-MADE 7x50 BINOCULARS

Big savings! Brand new! Crystal-clear viewing—7 power. Every optical element is coated. An excellent night glass—the size recommended for satellite viewing. Individual eye focus. Exit pupil 7mm. Approx. field at 1,000 yds. is 376 ft. Carrying Case included. American 7 x 50's normally cost \$274.50. Our war surplus price saves you real money. Stock No. 1544AK

\$74.80 Pstd. (tax included)
Stock No. 1537AK (6x30) \$23.50 ppd.

GET FREE CATALOG

148 Pages—1000's of Bargains!



EDMUND SCIENTIFIC CO. 300 EDCORP BUILDING, BARRINGTON, N.J. 08007

Completely new 1969 edition. New items, categories, illustrations. Dozens of electrical and electronic parts, accessories. Enormous selection of Astronomical Telescopes, Microscopes, Binoculars, Magnifiers, Magnets, Lenses, Prisms. Many war surplus items for hobbyists, experimenters, workshop, factory. Mail coupon for catalog "AK".

NAME _____
ADDRESS _____
CITY _____
STATE _____ ZIP _____

U.S. GOV'T ELECTRONIC SURPLUS

• Nationally Known-World Famous SURPLUS CENTER offers finest, most extensive, Government Surplus electronic units and components at a fraction of their original acquisition cost.

ORDER DIRECT FROM AD or WRITE FOR CATALOGS

STANDARD DIAL TELEPHONE

• (ITEM #715) -- Standard, commercial telephone same as used throughout U.S.A. Attractive polished black, like new condition. Use as extension phone to private systems or connect several phones together for local intercom systems. Full instructions also furnished. Wt. 9 lbs. Original Cost \$24.50. F.O.B. \$7.50

STEP-BY-STEP AUTOMATIC SWITCH

• (ITEM #138) -- Amazing "up-and-around", electronic telephone switch. Dial any bank pair from 1 to 100. Make your own telephone system. Can also be used to remotely control up to 100 circuits over a single pair of wires.

• One of our FOUR STAR bargains. Comes complete with data, one dial and one line bank. Size 5 1/2" x 7 1/2" x 1 1/2". Wt. 16 lbs. Cost Gov't Over \$74.00. Complete; Switch cover, dial, line bank, instructions..... F.O.B. \$9.95

- TYPICAL BUYS FROM OUR 1968 CATALOGS**
- \$ 350.00 - Geared 2-hp Battery Golf Car Motor \$26.95
 - \$ 15.00 - Westinghouse DC Ammeter, 0 to 300 \$ 7.11
 - \$ 40.00 - Vacuum/Pressure Pump, 12-VDC \$11.95
 - - - 80-MW Walkie-Talkies, Per Pair \$19.60
 - - - Deluxe, Multi-Range, AC/DC Tester \$ 8.98

SPECIAL SALE Correspondence Course In ELECTRICAL ENGINEERING

Sells For \$10.79 Outside U.S.A. \$8.79 Postpaid In U.S.A.

• (ITEM #A181) -- Wonderful chance to obtain technical training at Amazing Low Cost! Lincoln Engineering School has suspended its Correspondence Course because of increased operating costs. We offer a limited number of the school's complete Electrical Engineering Course but without the examination paper grading service. The course consists of 14 lesson unit books. Each book has the regular exams, and in a separate section, "Standard Answers" to each exam question.

• Course is well written, easy to understand, profusely illustrated. Reader's Digest size, easy to carry and study in spare time. Many Lincoln Engineering School students holding excellent jobs as a result of E.E.S. training. Course contains latest information on transistors, silicon diodes, etc. Additional book on how to build and operate a "Home Laboratory and Experimental Bench" furnished with each course.

SEND 25¢ COIN OR STAMPS FOR CATALOGS
All Items FOB Lincoln Money Back Guarantee

SURPLUS CENTER
DEPT. EW-118 LINCOLN, NEBR. 68501

ORDER BY STOCK NUMBER • SEND CHECK OR MONEY ORDER • MONEY-BACK GUARANTEE

EDMUND SCIENTIFIC CO. 300 EDCORP BUILDING
CIRCLE NO. 109 ON READER SERVICE CARD

G & G SURPLUS SPECIALS!

BC-645 TRANSCEIVER, 15 tubes, 335 to 500 Mc. Easily adapted for 2 way voice or code on Ham, Mobile, Television Experimental and Citizens' Bands. With tubes, less power supply in factory carton. Brand new **\$16.95**

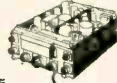

SPECIAL PACKAGE OFFER: BC-645 Transceiver, Dynamotor and all accessories, including mounting, IFR Antenna Assemblies, control box, complete. BRAND NEW **\$26.95**

AN/APR-4Y FM & AM RECEIVER "FB" FOR SATELLITE TRACKING!

High precision lab instrument, for monitoring and measuring frequency and relative signal strength, 38 to 4000 Mc, in 5 tuning ranges. For 110 V 60 cycle AC. Built-in power supply. Original circuit diagram included. Checked out, perfect, LIKE NEW. **\$88.50**

TG-34A CODE KEYS, self-contained, automatic, reproduces code practice signals from paper tape. 5 to 25 WPM. Built-in speaker. Brand new with tech. manual, takeup reel, **\$24.50**



BC-603 FM RECEIVER, 20 to 27 Mc 10 preset push-button channels or manual tuning. Complete with 10 tubes, checked out, exc. Used condition. **\$37.50**

BC-603 FM RECEIVER converted for operation on 35 to 50 Mc. Checked out, guaranteed Exc. Used Cond. **\$52.50**

BC610-E TRANSMITTER made by Hallcrafters. Complete with all tubes, exc. Used **\$325.00**

AIRCRAFT TRANSMITTERS

RT-220 (XN-2) ARN-21 115V AC TRANSMITTER mfd N/A Aircraft. Complete with all tubes and 41 crystals. Exc. Used **\$149.50**

RT-220 (XN-10) ARN-21 27.5 V DC TRANSMITTER. 113V/1/380/420-320/1000 cye. mfd N/A. Complete with all tubes, mounting base, connector plugs, built-in dynamotor. Exc. Used **\$169.50**

RADIO TELEPHONE SIMULATOR

SM-40/UR. 8-channel. Navy fire-control unit. Exc. Used **\$119.50**

FACSIMILE TRANSCIEVER SET

Model "TXC" made by Times Facsimile Corp. 900 to 2700 CPS. Supply: 250 Watts, 100/130 V AC 50/60 cye. Consists of Transceiver, type TT-41A; TXC-1B and rectifier power unit PP-86C/ TXC-1 (less speaker). Exc. Used **\$179.50**

TRANSMITTER RECEIVER

Model AN/TRC-1, freq. range 70 to 99.9 Mc. FM Modulation, power output 10/50 watts. Consists of Transmitter, type T-4D/TRC-1; supply 115 V AC 60 cye; Receiver type T-19D/TRC-1; supply 115V AC 60 cye. (less power supply, antenna and headset). Complete with carrying case. Exc. Used **\$79.50**

BC-929 3-inch Scope, with all tubes, Exc. Used like new **\$16.95**
Conversion Instructions, with diagram, for 110 V AC operation **\$.65**

SCR-274-N, ARC-5 COMMAND SET HQ!

Freq. Range	Type	Exc. Used	BRAND NEW
190-550 Kc.	BC-453	\$18.95	\$23.50
3-6 Mc.	BC-454	\$16.50	\$21.50
6-9.1 Mc.	BC-455	\$14.95	\$19.95
1.5-3 Mc.	R-25		\$21.50

Transmitters, Complete with Tubes	Exc. Used	BRAND NEW	
4-5.3 Mc.	BC-457	\$ 6.95	\$11.95
5.3-7 Mc.	BC-458	\$ 6.95	\$12.95
7-9.1 Mc.	BC-459	\$17.95	\$22.50
2-3 Mc.	T-18		\$10.95
3-4 Mc.	T-19	\$10.50	\$14.95

NEW G&G CATALOG 24 Pages Terrific Buys in Military Electronic Gear. SEND 25c—Refunded with First Order.

TERMS: Either 25% Deposit with order, balance C.O.D. —OR—Remittance in Full. Minimum Order \$5.00. All shipments F.O.B. our warehouse, NYC. All merchandise subject to prior sale and price change.

G & G RADIO SUPPLY COMPANY

Telephone: (212) CO 7-4605

75-77 Leonard St., New York, N.Y. 10013

BARGAIN FLYER AND SIX NEW RESISTORS— 25¢ (stamps or coin) BIGELOW ELECTRONICS, Bluffton, Ohio 45817.

LAW ENFORCEMENT AGENTS AND LEGAL INVESTIGATORS ONLY. FREE LITERATURE, LATEST ELECTRONIC AIDS. REQUEST MUST BE ON YOUR OFFICIAL LETTERHEAD. R. CLIFTON, 11500-J NW 7th AVE., MIAMI, FLORIDA 33168.

WRITE now for free 1969 catalog McGee Radio Company, 1001 bargains. Speakers — Parts — Tubes — High Fidelity Components — Record Changers—Tape Recorders—Kits. Everything in Electronics. 1901 McGee Street, Kansas City (GE), Missouri 64108.

189 NEW WESTERN ELECTRIC J68602C1 1 SIGNAL FREQUENCY GENERATOR \$10.00 each. BRADS, Klatt Box 10000, Anchorage, Alaska.

FIGHT crime. Alarms. Components. Accessories. Professional do-it-yourself kit \$69.95. Annunciator kit \$29.95. Auto alarm \$9.95. Monthly brochures. Free writing letterhead. Otherwise \$1.00 refundable with first order. Silmar Electronics, 3476 N.W. 7th Street, Miami, Florida 33125.

INTEGRATED CIRCUIT & MEMORY UNIT SALE

ICs TO-5 RTL, Gates, Buffers, FFs, etc. w/8 hole test socket, 100 asstd. \$10.95

ICs TO-85 Flatpacks DTL/RTL un-plated w/Augat Test Socket. 100 asstd. \$10.95

Flatpacks, all gold plated w/socket 100 asstd. \$15.95

ICs, DIPs, DTL/TTL unmarked, 100 asstd. \$10.95

DIPs All marked units, asstd. 100 \$17.95

All ICs. Mech. dropouts sample test over 60-80% good, Schematics, Ident. & test info. included.

WEIRD-O MIX, odd unusual diode/res. arrays, micro trans, tiny FP dual trans. ICs. many surprises, 100 \$4.95

JUMBO SILIC. TRANS. 1000 asstd, TO-5, 18, 46 w/3, 4, 6, 8 lead devices. Mostly Trans., duals, darl., FETs, SCRs, ICs & diodes. Sample test 80% good w/Pomona test socket \$19.50, half pack \$9.95. 2 lbs.

Hi-Gain (Darl.) Amplif, TO-18 NPN Sim. 2N998 tested 7—\$2.95 u-test, 15 for \$2.95

FET "P" Chan. Sim. 2N3277 TO-5 tested 4—\$2.95 u-test 10 \$2.95

Dual Trans. (Diff. Amplif) 6L TO-5 P or N Sim. 2N2060 tested 7—\$2.95 u-test, 15 \$2.95

Microclareed relay 3/4"x1 1/4" N/Open 3000 ohm 8-12V 3 ma. 4 for \$2.95

Lampdriver, SCR Module w/6-10V lamp. These test 150-400 PIV, 750 ma. 6 for \$2.95

Epoxy's New TO-18 NPN choice 2N-2368, 3693 or tiny TO-46 P or N, no mix. 30 \$2.95

New TO-8, 2N1486 sil. NPN 25W 3 \$2.95

Clairex Photo Cells CL905HL mounted 12 on Panel with trimpot \$3.95

Diodes silic. small glass asstd. 100—\$1.95 500—\$6.95

Memory Plane 5"x8" 4000, 50 mil bits perfect \$8.95 4 plane stack \$25 damaged plane \$3.95 4 for \$12

Memory Plane 10"x10" w/10,000 bits perfect \$15; 2—\$29; 4—\$50; repairable planes \$7.50; 2—\$14

Matrix Bd. 100 bits or Buffer Memory 224 bits 2 1/2"x4" or 4000 bit panel less frame, choice 2 for \$5 6 pages Memory info/data included

NE-2 Neon lamps 330 each mounted in 8"x12" computer panel. 4 lbs. \$4.95

Exotic parts boards, cost over \$1000 surplus variety of really late type quality useable parts. 20-piece, 5 lb. asstd. \$25.00

Free Goody Bag with \$10 order 25¢ postage

Include postage, extra returned. Calif. orders 5% tax. Free Catalog. 12¢ postage Satisfaction guaranteed.

MIKE QUINN ELECTRONICS 727 Langley St. Oakland Airport Calif. 94614

CIRCLE NO. 91 ON READER SERVICE CARD

ELECTRONIC ignition, various types. Free literature. Anderson Engineering, Epsom, N.H. 03239.

WANTED

QUICK CASH . . . for Electronic Tubes, Semiconductors, Equipment (Receivers, Transmitters, Scopes, Vacuum Variables, etc.) Send lists now! Write: BARRY ELECTRONICS, 512 Broadway, New York, N.Y. 10012 (212-WA 5-7000).

QUICKSILVER, Platinum, Silver, Gold. Ores Analyzed. Free Circular. Mercury Terminal, Norwood, Mass. 02062.

ELECTRONICS ENGINEERING AND INSTRUCTION

ASSOCIATE Degree in Electronics Engineering earned through combination correspondence-classroom educational program. Free brochure. Grantham Technical Institute, 1505 N. Western Ave., Hollywood, Calif. 90027.

LEARN ELECTRONIC ORGAN SERVICING at home. All Makes including transistors. Experimental kit—troubleshooting. Accredited NHSC. Free Booklet. NILES BRYANT SCHOOL, 3631 Stockton, Dept. A, Sacramento, Calif. 95820.

CLASSIFIED ADVERTISING ORDER FORM

Please refer to heading on first page of this section for complete data concerning terms, frequency discounts, closing dates, etc.

1	2	3	4	5
6	7	8	9	10
11	12	13	14	15
16	17	18	19	20
21	22	23	24	25
26	27	28	29	30
31	32	33	34	35

_____ Words { @ .50 Reader Rate } = \$ _____
{ @ .85 Commercial Rate }

Insert _____ time(s) Total Enclosed \$ _____

NAME _____

ADDRESS _____

CITY _____

STATE _____

ZIP _____

SIGNATURE _____

WORD COUNT: Include name and address. Name of city (Des Moines) or of state (New York) counts as one word each. Zip Code numbers not counted. (Publisher reserves right to omit Zip Code if space does not permit.) Count each abbreviation, initial, single figure or group of figures or letters as a word. Symbols such as 35mm, COD, PO, AC, etc., count as one word. Hyphenated words count as two words. EW-1168

HIGHLY effective home study course in Electronics Engineering Mathematics with circuit applications. Earn your Associate in Science Degree. Free literature. **COOK'S INSTITUTE OF ELECTRONICS ENGINEERING**, P.O. Box 36185, Houston, Texas 77036.

ELECTRONICS! Associate degree—29 months Technicians, field engineers, specialists in communications, missiles, computers, radar, automation. Start February, September. Valparaiso Technical Institute, Dept. N, Valparaiso, Indiana 46383.

R.E.I.'s famous (5) week course for the First Class Radio Telephone License is the shortest, most effective course in the nation. Over 98% of R.E.I. graduates pass F.C.C. exams for 1st class license. Total tuition \$350.00. Job placement free. Write for brochure Radio Engineering Incorporated Schools, 1336 Main Street, Sarasota, Florida 33577—or 3123 Gillham Road, Kansas City, Missouri 64109—or 809 Caroline Street, Fredericksburg, Virginia 22401.

RADIO AND TELEVISION REPAIR COURSE, BASIC TEST EQUIPMENT AND INSTRUCTION NECESSARY FOR STARTING PROFITABLE BUSINESS. WRITE HOOSIER TECHNICAL INSTITUTE, BOX 88401, INDIANAPOLIS, INDIANA 46208.

FCC First Class License in six weeks—nation's highest success rate—approved for Veterans Training. Write Elkins Institute, 2603C Inwood Road, Dallas, Texas 75235.

PLANS AND KITS

BUILD-IT-YOURSELF. Save big dollars. Transistor stereo amplifiers. Color organs. Speakers. Write Workshop, Box 393, Bethpage, NY, 11714.

INTEGRATED CIRCUIT KITS; COMPUTER CIRCUIT KITS; Others. New catalog free. **KAYE ENGINEERING**, Box 3932-B, Long Beach, California 90803.

TUBES

TUBES—33¢ each. Year guarantee. Tuner Cleaner \$1.09. Free catalog. Cornell, 4213-W University, San Diego, Calif. 92105.

TUBES, SEMICONDUCTORS, ELECTRONIC EQUIPMENT & COMPONENTS. Quality merchandise only! Serving engineers, Purchasing Agents, TV/HiFi Servicemen and Hams for 20 years. Write for Catalog or call 212-WA 5-7000. **BARRY ELECTRONICS**, 512 Broadway, New York, N.Y. 10012.

RECEIVING & INDUSTRIAL TUBES, TRANSISTORS, All Brands—Biggest Discounts. Technicians, Hobbyists, Experimenters—Request **FREE** Giant Catalog and **SAVE!** **ZALYTRON**, 469 Jericho Turnpike, Mineola, N.Y. 11501.

DON'T BUY TUBES—Radio, TV-Xmitting, special-purpose types until you get our price list! Lowest prices in U.S.A. 5,000 types—Guaranteed Brand New. Send postcard for TV-Special Purpose Price List. **UNITED RADIO COMPANY**, P.O. BOX 1000, NEWARK, N.J. 07101.

TUBES, RCA, SYLVANIA. Eico, Dynakit. Electronic parts. Free catalog. Yankee Electronics, 257 Huntington Ave., Boston, Mass. 02115.

DO-IT-YOURSELF

PROFESSIONAL ELECTRONICS PROJECTS—\$1.00 up. Catalog 25¢. **PARKS**, Box 25665A, Seattle, Wash. 98125.

TAPE AND RECORDERS

BEFORE renting Stereo Tapes, try us. Postpaid both ways—no deposit—immediate delivery. Quality—Dependability—Service—Satisfaction—prevail here. If you've been dissatisfied in the past, your initial order will prove this is no idle boast. Free Catalog. Gold Coast Tape Library, Box 2262, Palm Village Station, Hialeah, Fla. 33012.

TAPEMATES made available to you **ALL 4-TRACK STEREO TAPES—ALL LABELS**—postpaid to your door—at tremendous savings. For free brochure write: **TAPEMATES**, 5727 W. Jefferson Blvd., Los Angeles, California 90016.

RENT 4-track open reel tapes—all major labels—3,000 different—free brochure. Stereo-Parti, 55 St. James Drive, Santa Rosa, CA. 95401.

TAPE RECORDER SALE. Brand new nationally advertised brands, \$10.00 above cost. Amazing discounts on stereo components. Arkay Electronics, 1028-B Commonwealth Ave., Boston, Mass. 02215.

WHOLESALE — 4-8-track STEREOTAPES — Car, Home PLAYERS—CB, Recorders. **MUSICO**, Box 11045, Montgomery, Alabama 36105.

STEREO Tapes, Save 30% and up; no membership or fees required; postpaid anywhere U.S.A. Free 70-page catalog. We discount batteries, recorders, tape/accessories. Beware of slogans, "not undersold," as the discount information you supply our competitor is invariably reported to the factory. **SAXITONE**, 1776 Columbia Road, N. W., Washington, D. C. 20009.

HI-FI Components, Tape Recorders at guaranteed "We Will Not Be Undersold" prices. 15-day money-back guarantee. Two-year warranty. No Catalog. Quotations Free. Hi-Fidelity Center, 239 (LT) East 149th Street, New York 10451.

STEREO Tape Club: Average cost \$3.78—\$4.20. Cartridges, Cassettes, Reels. No minimum monthly purchases. Free brochure—catalog. Star Recordings, Box 1055, El Paso, Tex. 79946.

GREGORY ELECTRONICS

NINIC FM POCKET RECEIVER

\$59⁹⁵



WITH DRY BATTERY

Add \$7.50 for nickel-cadmium battery. Add \$20 for crystals and tuning to your frequency.

30-50 MC or 150-170 MC. All units new. Solid State, modular-assembly construction. Adjustable squelch. Sensitivity 0.3 microvolts to break squelch. Dual conversion crystal controlled. With conventional dry cell or rechargeable nic-cad battery. Weight: less than 1 lb. Size: 6 1/2" x 2 1/2" x 1 1/4".

50-Watt 450-470 MHz

Meets latest FCC narrow banding specifications. DumontM-430 RTN, with transistorized power supply. New! In sealed factory cartons. **\$395.**
with tone added..... \$445., minus reeds.

New! FM 100-Watt Mobile Linear Amplifier

High Band—146-174 MC RF output 90-120 watts into 50 ohms. **\$150.** Gonset Comtron Series—Model 972-A In factory-sealed cartons. Installation Kit, if needed, Model 3459.....\$25

One of many Used Buys!

RCA CMF-100 Dynamotor Power Supply 6/12 volt. complete accessories, fully narrow banded. 25 to 54 MC **\$138.**

Reconditioned & Used FM 2-WAY RADIO EQUIPMENT

We have a most enlarged inventory now on hand for practically everything you need—at savings! Buy now!

We Buy Late Model Equipment for Cash Send For '68 Catalog—Write; Wire or Phone!



GREGORY ELECTRONICS CORPORATION

249 RT. 46, Saddle Brook, N.J. 07662
Phone: (201) 489-9000

CIRCLE NO. 104 ON READER SERVICE CARD

RECTIFIERS & TRANSISTORS

Silicon Rectifiers

PIV	25	50	100	200	400	600	800	1000	1200
1A*	—	.04	.05	.07	.09	.12	.16	.20	.35
3A	.05	.06	.07	.09	.12	.16	.24	.32	.46
18A**	.10	.16	.20	.30	.40	.50	—	—	—
20A	.15	.20	.25	.39	.50	.75	.90	1.15	1.40
40A	.25	.35	.60	.90	1.20	1.50	1.80	2.10	2.40

*Tophat. Flangeless **Pressfit 31, 20, 40 studs

Silicon Controlled Rectifiers

1500 PIV Stud	PRV	25	50	100	200	400	600
200 MA. 50¢ ea.	1A*	.10	.14	.22	.35	.60	.90
	7A	.18	.25	.40	.70	1.25	1.60
	18A**	.18	.25	.40	.70	1.25	1.60
	20A	.25	.40	.55	.85	1.45	1.95

*Tophat. **Pressfit 7. 20 amp—stud

Germanium Power Transistors

20W-TO-5-3A	150W-TO-3-7A
2N1038—40V—4/1.00	2N456A—40V—35
2N1039—60V—3/1.00	2N457A—60V—50
2N1040—80V—2/1.00	2N458A—80V—65
2N1041—100V—70	2N1021A—100V—80

150W-TO-3-25A

2N511, 40V—50; 2N511A, 60V—70; 2N511B, 80V—\$1.00

Silicon Power Transistors

2N 389A 85W, 60V 1.25	2N1048A 40V 120V 1.25
2N 424A 85W, 80V 1.49	2N1718 10W 60V .30
2N 497 4W, 60V .20	2N1719 10W 100V .40
2N 498 4W, 100V .28	2N1724 50W 80V 1.49
2N1047A 40W, 80V 1.00	2N2151 30W 80V .50

Silicon Small Signal NPN, TO-5

2N696 5/\$1.00, 2N697 4/\$1.00, 2698 3/\$1.00, 2N699 2/1.00
3N34 Tetrode —\$1.00; 1N34A Diodes 100/\$2.98; 2N1142 Ger. Hi-Freq. Amplifier—2/\$1.00; Thermistors Beads, 900 ohm or 1200 ohm—\$.50; Varicaps—27, 47, or 100 pf, 4V, 4:1—\$1.25; P.C. Board, 8"x8"x1/16", 1 oz. copper—2/98¢; Photo Cells, Herm Glass, 4 diff. for \$1.00; 2N1300 Series, To-5, assorted—10/\$1.00; i.c. dual-in-line—20/\$1.00; To-5 15/\$1.00.

Assortments

Precision resistors film 50/\$1.00
Ceramic capacitors 70/\$1.00
Electronic Hardware 2lbs/\$1.00
7 pin connector set M & F 3 sets/\$1.00
Free \$1.00 pack with \$10 order. Min. order \$3.00 plus postage. Guaranteed Prompt service.

ELECTRONIC COMPONENTS CO.

Box 2902 Baton Rouge, La. 70821

CIRCLE NO. 107 ON READER SERVICE CARD
November, 1968



FREE Catalog Of The WORLD'S FINEST GOV'T SURPLUS ELECTRONIC BARGAINS

Now BIGGER and BETTER Than Ever!

MAIL COUPON TODAY

NAME:
ADDRESS:
CITY: STATE: ZIP NO.:

FAIR RADIO SALES Dept. EW • BOX 1105 LIMA, OHIO 45802

CIRCLE NO. 106 ON READER SERVICE CARD

LIBERTY PAYS MORE! WILL BUY FOR CASH

ALL TYPES:

- ★ ELECTRON TUBES
- ★ SEMICONDUCTORS
- ★ TEST EQUIPMENT
- ★ Military Electronic Equipment

WIRE—WRITE—PHONE COLLECT!
We pay freight on all purchases—

PRESTEL FIELD STRENGTH METER

(Model 6T4G)

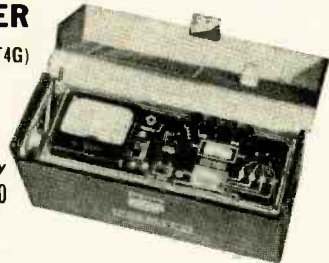

Only
\$120.00

Calibrated from 40 to 230, and 470 to 860 in 4 Bands Megahertz, from 10 to 50,000 Microvolts. Nothing makes it easier to properly and speedily find the correct place to install TV, FM and Communication Antennas. You can measure and hear the signals with this 4½ volt battery economically powered unit. There is nothing else like it!

LIBERTY ELECTRONICS, Inc.

548 Broadway, New York, New York 10012
Phone (212) 925-6000

CIRCLE NO. 100 ON READER SERVICE CARD

“ARCTURUS SALE”

- Tube cartons GAU6 etc. size, \$2.15 per 100. 6SN7 etc. size, \$2.55 per 100. 5U4GB size, \$2.95 per 100. 5U4G size, .03¢ each.
- 7" 90° TV bench test picture tube with adapter. No ion trap needed. Cat. # 7BP7, \$7.99.
- Silicon rectifier, octal-based replacement for 5U4, 5Y3, 5AS4, 5AW4, 5T4, 5V4, 5Z4. With diagram. Cat. # Rect 1, 99¢ each.
- 5 transistor circuit boards containing up to 6 transistors, plus diodes, resistors, capacitors, etc. Cat. # TB10. 99¢.
- Kit of 30 tested germanium diodes. Cat. #100, 99¢.
- RCA-110° flyback transformer, latest type, includes schematic diagram. Applicable to any TV. Cat. # BR-1, \$2.99.
- Color yokes. 70° for all round color CRT's. Cat. # XRC70, \$12.95. 90° for all rectangular 19 to 25" color CRT's. Cat. #XRC90, \$12.95.
- Transistorized U.H.F. tuners used in 1965 to 1967 TV sets made by Admiral, RCA, Motorola, etc. Removable gearing may vary from one make to another. Need only 12 volts d.c. to function. No filament voltage needed. Easy replacement units. Cat. # U.H.F.—567, \$4.95.
- U.H.F. Tuner-original units as used in TV sets such as RCA, Admiral, etc. covering channels 14 through 82, as part #94D173-2. Complete with tube. Drive gearing is removable. Can be used in most sets. Cat. # U.H.F.—3, \$4.95.
- F.M. tuner-Hi-Fi amplifier tuning unit. Tunes from 88 to 108 mc. Contains two 10.7 Mc. I.F. transformers, one 10.7 sound discriminator, R.F. oscillator and mixer stages and 12DT8 tube. I.F.'s are standard "K" type. Circuit diagram for building F.M. radio included. Also plan for building F.M. tuner. Sam's photofact #620 shows 2 applications, 1 for radio, 1 for Hi-Fidelity tuner and amplifier. Cat. #FM-20, \$4.95.

Send for our free catalog listing thousands of similar best buys in tubes, parts, kits, transistors, rectifiers, etc. Orders under \$5.00, add \$1.00 handling charge. Include 4% of dollar value of order for postage. Canadian postage \$1.00 extra.

ARCTURUS ELECTRONICS CORP.

502-22nd St., Union City, N.J. 07087 Dept. MEW
Phone: 201-UN 4-5568

CIRCLE NO. 120 ON READER SERVICE CARD

RENT tapes—no dues. Scotch Tape discounted—catalog. The Tape Library, Box 8146, D.C. 20024.

RECORDS

SPECIAL INTEREST RECORDS AVAILABLE, PRODUCED BY THE EDITORS OF THE WORLD'S LEADING SPECIAL INTEREST MAGAZINES. SEND FOR FREE CATALOG. RECORD CATALOGUE, ZIFF-DAVIS PUBLISHING COMPANY, ONE PARK AVENUE, NEW YORK, N.Y. 10016.

OLDIES—45RPM. Original hits. Over 1500 available. Catalog 25¢. C & S Record Sales, Box 197, Wampsville, N.Y. 13163.

HIGH FIDELITY

FREE! Send for money saving stereo catalog #E11W and lowest quotations on your individual component, tape recorder or system requirements. Electronic Values Inc., 200 West 20th Street, N.Y., N.Y. 10011.

Hi-Fi Components, Tape Recorders at guaranteed "We Will Not Be Undersold" prices. 15-day money-back guarantee. Two-year warranty. No Catalog. Quotations Free. Hi-Fidelity Center, 239 (L) East 149th Street, New York 10451.

HIFI EQUIPMENT—GET Our "ROCK BOTTOM" prices on NAME BRAND amplifiers—tuners—tape-recorders — speakers FRANCHISED — 59 YEARS IN BUSINESS. Write for this month's specials—NOW! Rabson's 57th St., Inc., Dept. 569, 119 W. 57th St., New York, New York 10019.

LOW, LOW quotes: all components and recorders. Hi-Fi, Roslyn, Penn. 19001.

Hi-Fi components, tape recorders, sleep learn equipment, tapes. Unusual Values. Free catalog. Dressner, 1523 R Jericho Turnpike, New Hyde Park, N.Y. 11040.

STEREO Components, tape recorders, tapes, citizen band transceivers, brand names, free catalog, free quotations. GLOBE ELECTRONICS SALES INC., 1160 Globe Avenue, Mountainside, New Jersey 07092.

NEW BSR record changers—\$13. Garrards—\$22. Radio-phono stereo receivers—\$15. "Changers EW", 2737 3rd Ave., Bronx, N.Y. 10454.

GOVERNMENT SURPLUS

JEEPS Typically From \$53.90 . . . Trucks From \$78.40 . . . Boats, Typewriters, Airplanes, Multimeters, Oscilloscopes, Transceivers, Electronics Equipment, Used. 100,000 Big Bargains Direct From Government Nationwide. Complete Sales Directory and Surplus Catalog \$1.00 (Deductible First \$10.00 Order). Surplus Service, Box 820-K, Holland, Michigan 49423.

AUTHORS' SERVICES

AUTHORS! Learn how to have your book published, promoted, distributed. FREE booklet "ZD," Vantage, 120 West 31 St., New York 10001.

PERSONALS

MAKE FRIENDS WORLDWIDE through international correspondence. Illustrated brochure free. Hermes, Berlin 11, Germany.

LEMURIAN VIEWPOINT—Meaningful discussions of Cosmic Truth: the purpose of human life, reincarnation, man's place in a Higher Plan, and subjects from the Lemurian Philosophy. Send for FREE copy. Lemurian Fellowship, Dept. 813, Box 397, Ramona, Calif. 92065.

HYPNOTISM

FREE Hypnotism, Self-Hypnosis, Sleep Learning. Catalog! Drawer H400, Ruidoso, N.M. 88345.

AMAZING HYPNOTIC record kit releases fantastic mental power! Free offer expires soon. Write: Forum, Studio AA11, 333 North Michigan, Chicago 60601.



CHEMTRONICS TUN-O-LUBE®

SPECIALLY FORMULATED

TV TUNER CLEANER
FOR ALL TV TUNERS

- SAFE FOR ALL PLASTICS
- WILL NOT DETUNE TUNERS



106

COUNTER PRICE SCOOP! 10 cv to 10.1 mc on 8 digits accuracy 1 ppm & 1 error on 10 mv in .5 gate times also periods. With NBS—traceable Certif. of Calib. which is double assurance of perfect operation: with books. **450.00**
Above is AN/USM-28 counter plus H.P. #526A Video Ampl. plugin, mfr. Northeastern Engrg. Co. Same thing made by Hewl-Pack (524B/526A) **495.00**
Add for NBS—traceable Calib. Certif. **40.00**
Add for freq. extender plugins to 220 mc. **330.00**
both with Certif. of Calib., both for

At \$37.50 each for #528B Time Interval or #528C Period Multiplier plugins, functionally checked OK.
SOLID-STATE PORTABLE SCOPE similar Tek #422. Only 7" x 9 1/2" x 14". 8x10 cm rect. display. Calib. versatile plugin 10 mv/div. Calib. swt. fast as 0.1 us/div. Shows DC-15 mc easy. In 60db at 8.92 mc. Sq-wv calib. output. Like new. w/all fittings & book. A real cutter! MIL AN/USM-117, not **550.00**
#1423.00 mt. only
FAIRCHILD SOLID-STATE SCOPES all w/dual-trace plugins 25 & 50 mc, w/delayed & undelayed time-base plugins, w/books, w/repeat NBS-traceable calib. 100% gtd. Obtained during corporate change-back to the Dumont name. Low as **875.00**
WRITE FOR LIST of these & others (Tek., H.P.)

MARCONI \$890 Deviat. Meter 5/25/75 **179.50**
kc
001%: Gerlich FM-9 w/DM-2, pwr sply. **375.00**
FM SIGNAL GENERATOR? Enough incidental FM comes from following CW/AM sets for all needs in a 2-way Mobile Radioshop. All completely reconditioned, w/NBS-traceable Cert. of Calib. w/book, w/terminated cord; Meas. Corp. #80 (2-400 mc #295) \$8R (5-475 mc #373). H.P. #608A (10-560 mc. up to 1.0 Vc. \$475)

SILIC RECTIF. 8000 PIV 400 MA, mfr. **5.30**
R-23 ARC-5 Command revr 190-350 kc. **14.95**
A.R.C. 12 # 22 Command revr 540-1600 kc. **17.95**
LM-14 freq. meter, .01% 125 kc-20 mc **57.90**
TS-323/UR freq. meter 20-480 mc., .001% **169.50**
BC-221's OK \$57.50 TS-175 OK **125.00**
CLOSING OUR Radio Receivers \$8-4000 mc at CRAZY LOW PRICES! Ask for APR-47/CY-253 sheet.
ELDICO SSB ADAPTER SBA-1: Converts any revr with 455 kc IF to SSB; select either sideband.
Also adds CW Osc. Exc. w/book **127.50**

R-392: Compact version of R-390! Same digital xtl-calib tuning 75-92 mc. same serial number filter. 80 pwr sply in it; tubes work on 24vdc. GA. Only 11x11x14". only 52 lbs. 455 kc IF. Ready to use. OK grid. w/pwr sply, book, interconnect cord & plug **525.00**
SP-600-JX ultra-clean, in cabinet, aligned, ready to use. 0.54-54 mc, w/xtl filter & provisions for 6 favorite stations to be xtl selected. Only **355.00**
R-44/ARR-5: AM/FM 27-143 mc, modified by us for greater senslt. w/pwr sply, ready to use. IF 5.25 mc. w/book **149.50**
S-36 Hallcrafters commercial version of above, checked OK, ready to use. w/book **179.50**

WE PROBABLY HAVE THE BEST INVENTORY OF GOOD TEST EQUIPMENT IN THE COUNTRY, BUT PLEASE DO NOT ASK FOR CATALOG! ASK FOR SPECIFIC ITEMS OR KINDS OF ITEMS YOU NEED! WE ALSO BUY! WHAT DO YOU HAVE?

R. E. GOODHEART CO. INC.
Box 1220-A, Beverly Hills, Calif. 90213
Phones: Area 213, office 272-5707, messages 275-5342

ADULTS ONLY—HYPNOTIZE SUCCESSFULLY! "Instantaneous"—"One Word"—"Against Will" methods exposed! Complete illustrated course—including "Secret Nerve Pressure Technique"—Self-hypnosis—10" Hypnodisk—\$2.00 RESULTS ABSOLUTELY GUARANTEED! Fowler, Box 4396, Woodbury, New Jersey 08096.

FEMALE, MALE HYPNOTISM! Easily! Instantly! Secret Nerve Centers! \$2.20. Brugenheimer, Box 158-E30, Lexington, Mass. 02173.

HYPNOTIZE MALES, FEMALES!—Unnoticed! Quickly! Nerves! Exciting! \$2.25. Research Enterprises, 29-SN21 Samoset, Woburn, Mass. 01801.

PHOTOGRAPHY—FILM, EQUIPMENT, SERVICES

MEDICAL FILM—Adults only—"Childbirth" one reel, 8mm \$7.50; 16mm \$14.95. International W. Greenvale, Long Island, New York 11548.
SCIENCE Bargains—Request Free Giant Catalog "CJ"—148 pages—Astronomical Telescopes, Microscopes, Lenses, Binoculars, Kits, Parts, War Surplus bargains. Edmund Scientific Co., Barrington, New Jersey 08007.

STAMPS

RUSSIA HIGH-VALUE COLLECTION. 32 different Russia—some over 50 years old! Commemoratives. Czarist Issues, Airmails. Catalog price \$2.99. Special Get-Acquainted Offer—all for only 10¢. H. E. Harris, Dept. GG-13, Boston, Mass. 02117.

MAGNETS

MAGNETS. All types. Specials—20 disc magnets, or 2 stick magnets, or 10 small bar magnets, or 8 assorted magnets, \$1.00. Maryland Magnet Company, 5412-E Gist, Baltimore, Maryland 21215.

BOOKS

FREE CATALOG. BOOKS FOR ADULTS. CATALOG. 2217 LACKLAND, ST. LOUIS, MISSOURI 63114.

EDUCATIONAL OPPORTUNITIES

LEARN While Asleep, hypnotize with your recorder, phonograph. Astonishing details, sensational catalog free! Sleep-Learning Association, Box 24-ZD, Olympia, Washington 98501.

LEARN WHILE ASLEEP Miraculously build Mind Power, achieve Self-Confidence, improve Health, gain Success. Method 92% effective. Details free. ASR Foundation, Box 7021EG Henry Clay Station, Lexington, Kentucky 40502.

USED Correspondence Courses and Books sold and rented. Money back guarantee. Catalog free (Courses Bought). Lee Mountain, Pisgah, Alabama 35765.

INVENTIONS WANTED

INVENTORS We will develop, help sell your idea or invention, patented or unpatented. Our national manufacturer clients are urgently seeking new items for outright cash sale or royalties. Financial assistance available. 10 years proven performance. For free information, write Dept. 42, Wall Street Invention Brokerage, 79 Wall Street, New York, N.Y. 10005.

INVENTORS! Receive free invention analysis at no risk to you. Send for **FREE** disclosure form today. New York Invention Service, Dept. 19, 160 Broadway, New York, N.Y. 10038.

PATENT Searches including maximum speed, full air mail report and closest patent copies, \$6.00. Quality searches expertly administered. Complete secrecy guaranteed. Free Invention Protection forms and "Patent Information." Write Dept. 23, Washington Patent Office Search Bureau, 711 14th Street, N. W., Washington, D.C. 20005.

BUSINESS OPPORTUNITIES

INVESTIGATE ACCIDENTS: Earn to \$1000 monthly. Men urgently needed. Car furnished. Business expenses paid. No selling. No college education necessary. Pick own job location. Investigate full time or earn to \$8 hour spare time. Write for **FREE** information. No obligation. Universal School, CZ-11, 6801 Hillcrest, Dallas, Texas 75205.

FREE CATALOGS. Repair air conditioning, refrigeration. Tools, supplies, full instructions. Doolin, 2016 Canton, Dallas, Texas 75201.

I MADE \$40,000.00 YEAR by mailorder! Helped others make money! Start with \$10.00—Free proof. Torrey, Box 318-N, Ypsilanti, Mich. 48197.

JAPANESE Electronics New Products Monthly! Specimen copy \$1, deductible. Dee, 10639-W Riverside, North Hollywood, Calif. 91602.

FREE BOOK "990 Successful Little-Known Businesses." Work home! Plymouth 245-K, Brooklyn, New York 11218.

MAILORDER . . . Operate cash-in-advance business! Details. Methods, 1408—F.D., Lafayette Hill, Pennsylvania 19444.

REPAIRS AND SERVICES

SPEAKER REPAIR. Hi-Fi, guitar, organ speakers reconed good as new at fraction of new speaker price. For details and Reconing Center in your area write: Waldom Electronics, Inc., Dept. EW, 4625 W. 53rd St., Chicago, Ill. 60632.

PRINTING

WPE—HAM—CB QSL'S samples 25¢. Dick, W8VXK, Gladwin, Mich. 48624.

MUSIC

LEARN guitar. Send self addressed, stamped envelope for information. R.D. Bowen, G-3 Dutch Village, Blacksburg, Virginia 24060.

EMPLOYMENT OPPORTUNITIES

TRANSMITTER MAINTENANCE SUPERVISOR with at least three years experience in maintenance and trouble shooting of AM broadcast transmitters, first class license desirable, for maintenance supervision of two 100 kw transmitters at church-related shortwave radio station in Ethiopia. Qualified applicants write Station Director, Radio Voice of the Gospel, Box 654, Addis Ababa, Ethiopia.

FAIRCHILD "FLAT PAK" BRAND NEW! RTL

INTEGRATED CIRCUITS Sale	
<input type="checkbox"/> 900	Buffer \$1.49
<input type="checkbox"/> 903-903*	3 Input Gate \$1.69
<input type="checkbox"/> 904-904*	Half Adder \$1.69
<input type="checkbox"/> 914-914*	Dual 2 Input Gate \$1.49
<input type="checkbox"/> 923	JK Flip Flop \$1.69
<input type="checkbox"/> 923-923*	JK Flip Flop \$1.98
<input type="checkbox"/> 927	Quad Inverter \$1.69

*First time anywhere two identical IC's in one package, example 923-923 contains two separate JK flip-flops in one package. 914's and 923.30 Basic IC Projects Licensed. 1/4" x 1/4"

LINEAR AMPLIFIERS with circuits & data	
<input type="checkbox"/> 702C	WIDE BAND DC \$3.98
<input type="checkbox"/> 703H	RF-IF-FM \$1.49
<input type="checkbox"/> 709C	HI-GAIN OPERATIONAL \$3.98
<input type="checkbox"/> 710C	HI-SPEED DIFF. COMP. \$3.98
<input type="checkbox"/> 711C	DUAL COMPARATOR \$4.98

FAIRCHILD IN-LINE INTEGRATED CIRCUITS	
<input type="checkbox"/> 952	DUAL 2 INPUT INVERTER GATE \$1.00
<input type="checkbox"/> 953	2-2-3 INPUT AND GATE \$1.00
<input type="checkbox"/> 954	DUAL 4 INPUT AND GATE \$1.00
<input type="checkbox"/> 955	8 INPUT AND GATE W/2 INPUTS \$1.00
<input type="checkbox"/> 956	DUAL INPUT BUFFER \$1.00

100's of other IC's including: Flip-Flops, Registers, Adders, etc. Write for listing.

Buy 10 PAKS & CHOOSE 1 FREE

<input type="checkbox"/>	\$25 SURPRISE PAK: transistors, rect. diodes, etc. ... \$1
<input type="checkbox"/>	6 ONE AMP 800 PIV RECTIFIERS, silicon top hat \$1
<input type="checkbox"/>	2- CLAIREFIX PHOTO ELECTRIC CELL, Hobby must \$1
<input type="checkbox"/>	50 GERMANIUM GLASS DIODES, 1N34, 1N48 no test \$1
<input type="checkbox"/>	40 TOP HAT SILICON RECTIFIERS, no test/asst values \$1
<input type="checkbox"/>	25 EPOXY RECTIFIERS, silicon asst, no test values \$1
<input type="checkbox"/>	40 PRECISION RESISTORS, 1/2-W, 1% test values \$1
<input type="checkbox"/>	30 TRANSISTORS, rf, if, audio, osc, no test values \$1
<input type="checkbox"/>	60 TUBULAR CONDENSERS, to .5mf to 1KV, asst \$1
<input type="checkbox"/>	50 DISC CONDENSERS, to .05mf npo, temp. coef. asst \$1
<input type="checkbox"/>	60 TUBE SOCKETS, receptacles, plugs, audio, etc. ... \$1
<input type="checkbox"/>	30 POWER RESISTORS, to 25 watts, to 24K ohms \$1
<input type="checkbox"/>	3 2N3568 NPN TRANSISTORS, 200mc, 200V, 200hfe. \$1
<input type="checkbox"/>	3 2N3563 TRANSISTORS, npn, 600mc, 100hfe, epoxy \$1
<input type="checkbox"/>	10 VOLUME CONTROLS, to 1 meg, switch too! \$1
<input type="checkbox"/>	10 ELECTROLYTICS, to 100mf, tubulars, too, asst \$1
<input type="checkbox"/>	50 RADIO & TV KNOBS, asst colors & styles \$1
<input type="checkbox"/>	10 TRANSISTOR ELECTROLYTICS to 100mf, asst values \$1
<input type="checkbox"/>	50 COILS AND CHOKES, if, rf, ant, osc, peaking, etc \$1
<input type="checkbox"/>	65 HALF WATTERS, to 1 meg, 5% power values too \$1
<input type="checkbox"/>	60 HI-QUALITY RESISTORS, 1/2, 1, 2W asst values \$1
<input type="checkbox"/>	10 RCA PHONO PLUGS & JACK SETS, tuners, etc. \$1
<input type="checkbox"/>	4 INTEGRATED CIRCUITS, gates, etc. no test \$1
<input type="checkbox"/>	2-PC INFRA-RED DETECTOR & FILTER set science proj \$1
<input type="checkbox"/>	2 FIELD EFFECT TRANSISTORS, n channel, hobby \$1
<input type="checkbox"/>	50 TERMINAL STRIPS, 1 to 8 lug types \$1
<input type="checkbox"/>	3 PHOTO ELECTRIC CELLS, hi. imp. schematic \$1
<input type="checkbox"/>	3 TRANSISTOR AMPLIFIER, WIRED, 3x2x3/4" schematic \$1
<input type="checkbox"/>	10 PRINTED CIRCUIT BOARDS, copper clad, 100 uses \$1
<input type="checkbox"/>	10 TRANSISTOR SOCKETS, for pnp & npn types \$1
<input type="checkbox"/>	10 PANEL SWITCHES, toggle, slide, micro, rotary \$1
<input type="checkbox"/>	4 TRANSISTOR TRANSFORMERS, asst, worth \$25 \$1
<input type="checkbox"/>	5 RAYTHEON CK-72 TRANSISTORS, npn, most pop \$1
<input type="checkbox"/>	5 G.E. 2N107 TRANSISTORS, npn, audio ekts \$1
<input type="checkbox"/>	6 "IBM" COMPUTER BOARDS, many trans, diodes, \$1
<input type="checkbox"/>	40 "MICRO" CONDENSERS, for transistor circuitry \$1
<input type="checkbox"/>	3 1/4W. EPOXY TRANSISTORS, npn, silicon, B-5000, \$1
<input type="checkbox"/>	15 3 to 12 AMP STUD RECTIFIERS, up to 600 PIV \$1

Terms: add postage. Rated: net 30, col's 25%
Phone Orders: Wakefield, Mass. (617) 245-3829
Retail: 211 Albion, St., Wakefield, Mass.

GIANT XMAS CATALOG ON: Parts, Rectifiers, etc. 10¢
 Transistors, SCRs, I.C.'s, Equipment, Etc.

POLY PAKS P.O. BOX 942 W Lynnfield, Mass. 01940

CIRCLE NO. 92 ON READER SERVICE CARD

MISCELLANEOUS

WINEMAKERS: Free illustrated catalog of yeasts, equipment. Semplex, Box 7208, Minneapolis, Minn. 55412.

STOP BURGLARS THE EASY WAY!! Affix authentic "Protected by Electronic Sentry Alarm" Decals to auto windows, doors & windows of home, retail stores; vending machines, etc. Whether you have an alarm or not—thieves stay away! Only \$1.00 for each set of two. J. Ross, 80-34 Kent St., Jamaica, N.Y. 11432. Dept. EW.

EMPLOYMENT Resumes. Get a better job & earn more! Send only \$2.00 for expert, complete Resume Writing Instructions. J. Ross, 80-34 Kent St., Jamaica, N.Y. 11432 Dept. EW.

SEND 6¢ stamp for new exciting "Showcase" catalog and add new dimension to gifts. Vosburgh of Florida, 411 Ed, Ft. Walton, Fla. 32548.

YOUR SERVICE AND QUALITY LEADER

We promise to supply you with the highest quality products at the most attractive prices with the fastest service in the industry.

TRIACS

TO-66
5 AMP

PRV		
100		.90
200		1.40
300		1.75
400		2.25
500		2.60

AVALANCHE MODE TRANSISTORS, used for TRIGGERING SCR's & TRIACS, with diagrams 3/\$1.00

ZENERS 1 Watt 7-68V \$.40
10 Watt 7-200V \$.75

MOUNTING HARDWARE KITS.

These kits are used to mount our SCR's Zeners and Rectifiers etc.

6x32 stud, 6 sets for \$1.00
1/4x28 stud, 4 sets for \$1.00

SIM to 2N3429 (NPN), S1 7/8" stud, min HFE of 30, 7.5 Amps. 175 watts. Vce of 75 \$1.75

N-CHANNEL FET'S TO-18 plastic units, low noise, low leakage, 25 volts source to gate, 50 ma gate current Gain to 9000 μ mo's. \$1.00

NEON LIGHT OR NIXIE TUBE DRIVERS. An NPN, TO-18, S1 Transistor, With a VCBO of 120 3/\$1.00

IN2326 voltage and temperature compensating diodes 4/\$1.00

500 Hfe plastic transistors. NPN, TO-18, S1 unit similar to 2N3565 4/\$1.00

Silicon Power Rectifiers			
PRV	3A	12A	40A
100	.09	.30	.75
200	.16	.50	1.25
400	.20	.70	1.50
600	.30	1.00	1.80
800	.40	1.25	
1000	.55	1.50	

Terms: FOB Cambridge, Mass. Send check or Money Order. Include Postage, Average Wt. per package 1/2 lb. No C.O.D.'s. Minimum Order \$3.00

Rated companies 30 days net
TELEPHONE (617) 547-4005

POST OFFICE BOX 74B
SOMERVILLE, MASS. 02143

featuring transistors & rectifiers
SEND FOR OUR FALL CATALOG

Business Address: 325 Elm St., Cambridge, Mass.

INTEGRATED CIRCUITS



LINEAR CIRCUITS

FM IF AMPLIFIERS.....	\$.90
702C WIDE BAND DC AMPL.....	\$3.50
709C OPERATIONAL AMPL.....	\$4.50
710C HI SPEED DIFF. AMP.....	\$5.00
711C DUAL COMPARATOR.....	\$5.50

DIGITAL RTL CIRCUITS

2-914 QUAD 2 input gates.....	\$1.25
900 Buffer.....	\$1.25
925 Dual 2 input gate expander.....	\$1.25
923 JK flip flop.....	\$1.25
2-923 Dual JK flip flops.....	\$1.50

Controlled Avalanche Rectifiers (Top Hat + Epoxy replacements) 1 AMP.

PRV		
100		.07
200		.09
400		.12
600		.18
800		.22
1000		.35

UNIUNCTIONS!

Similar to 2N2419. RBB of 5-7 stand off ratio of .6 and Ip of 12, with data sheet \$1.50

Silicon Control Rectifiers				
PRV	3A	7A	20A	70A
50	.35	.45	.70	
100	.50	.65	1.00	4.00
200	.70	.95	1.30	8.00
300	.90	1.25	1.70	
400	1.20	1.60	2.10	12.00
500	1.50	2.00	2.50	
600	1.80	2.40	3.00	16.00
700	2.20	2.80		
1000			5.00	24.00

ABOUT YOUR SUBSCRIPTION

Your subscription to **ELECTRONICS WORLD** is maintained on one of the world's most modern, efficient computer systems, and if you're like 99% of our subscribers, you'll never have any reason to complain about your subscription service.

We have found that when complaints do arise, the majority of them occur because people have written their names or addresses differently at different times. For example, if your subscription were listed under "William Jones, Cedar Lane, Middletown, Arizona," and you were to renew it as "Bill Jones, Cedar Lane, Middletown, Arizona," our computer would think that two separate subscriptions were involved, and it would start sending you two copies of **ELECTRONICS WORLD** each month. Other examples of combinations of names that would confuse the computer would include: John Henry Smith and Henry Smith; and Mrs. Joseph Jones and Mary Jones. Minor differences in addresses can also lead to difficulties. For example, to the computer, 100 Second St. is not the same as 100 2nd St.

So, please, when you write us about your subscription, be sure to enclose the mailing label from the cover of the magazine—or else copy your name and address exactly as they appear on the mailing label. This will greatly reduce any chance of error, and we will be able to service your request much more quickly.

Electronics World SUBSCRIBER SERVICE

Please include an address label when writing about your subscription to help us serve you promptly. Write to: Portland Place, Boulder, Colo. 80302

CHANGE OF ADDRESS:

Please let us know you are moving at least four to six weeks in advance. Affix magazine address label in space to the right and print new address below. If you have a question about your subscription, attach address label to your letter.

TO SUBSCRIBE:

Check boxes below.
 New Renewal
 5 years \$21
 3 years \$15
 1 year \$6

SPECIFY:

Payment enclosed—
 You get 1 extra issue per year as a **BONUS!**
 Bill me later.

← AFFIX LABEL →

store	city	address	name	please print	If you have no label handy, print OLD address here.
zip-code					

Add postage: \$1 per year outside U.S., its possessions & Canada.

name please print 0242

address

city

state zip-code

ELECTRONICS WORLD NOVEMBER 1968

ADVERTISERS INDEX

READER	READER
SERVICE NO. ADVERTISER PAGE NO.	SERVICE NO. ADVERTISER PAGE NO.
125 Accurate Instrument Co., Inc 59	100 Liberty Electronics, Inc106
124 Allied Radio53, 54	99 Mallory & Co. Inc., P.R. 2
123 Alltec Lansing 17	98 Microflame, Inc 74
122 Ampex Corporation 24	97 Motorola Training Institute 80
121 Arabian American Oil Company 76	96 Multicore Sales Corp 76
120 Arcturus Electronics Corp106	95 Music Associated 84
119 BSR McDonald 79	National Radio Institute8, 9, 10, 11
118 Belden Corporation60, 61	94 Olson Electronics 69
117 Bell P/A Products Corporation 58	93 Pennwood Numechron Co 92
116 Burstein-Applebee Co102	92 Poly Paks107
CREI, Home Study Division, McGraw-Hill Book Company18, 19, 20, 21	91 Quinn Electronics, Mike104
Chemtronics106	RCA Electronic Components and DevicesFOURTH COVER
115 Cleveland Institute of Electronics70, 71, 72, 73	90 RCA Electronic Components and Devices 57
74 Cleveland Institute of Electronics 78	RCA Institutes, Inc88, 89, 90, 91
113 Coletronics Service Inc 69	89 Radar Devices Mfg. Corp 15
Conar Instruments102	88 Rye Industries Inc 80
73 Cook's Institute of Electronics Engineering 92	87 Sams & Co., Inc., Howard W 56
112 Delta Products, Inc 62	Saxitone 77
111 Delta Products, Inc 63	86 Schober Organ Corp., The 69
110 Editors and Engineers, Ltd 4	85 Scott, Inc., H.H. 12
109 Edmund Scientific Co103	84 Shure Brothers, Inc93, 94, 95
108 Electro-Voice, Inc 16	83 Solid State Sales107
107 Electronic Components Co105	82 Sonar Radio Corporation 75
106 Fair Radio Sales105	80 Sprague Products Company 67
105 Finney Company, The 83	Surplus Center103
G & G Radio Supply Company104	Sylvania64, 65
Goodheart Co. Inc., R.E.106	199 Tektronix, Inc 81
Grantham School of Electronics 7	200 Texas Crystals 78
104 Gregory Electronics Corporation105	81 Triplett Electrical Instrument CompanyTHIRD COVER
103 Heath Company96, 97, 98, 99, 100, 101	79 United Audio Products, Inc 23
77 JFD Electronics Co 1	Valparaiso Technical Institute 77
102 Johnson Company, E.F. 77	78 Xcelite, Inc 68
101 Lafayette Radio Electronics 66	76 ZenithSECOND COVER
Lampkin Laboratories, Inc 84	

CLASSIFIED ADVERTISING 103, 104, 105, 106, 107

Printed in U.S.A.

R-Series
2-sizes: 3-1/2", 4-1/2"

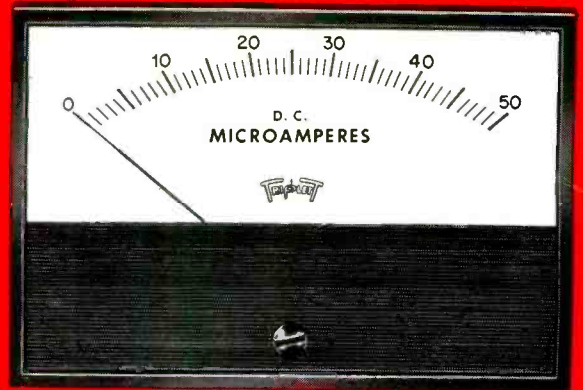

TRIPLET

"CLEAN SWEEP" PANEL INSTRUMENTS

A fresh approach to ultra-modern instrument design provides a "clean sweep" of the pointer over the full scale.

- 1** You get instant readability easier and at greater distances—plus more attractive designs to integrate into your equipment.
- 2** Self-shielded, accurate, reliable D.C. instruments have the exclusive Triplet BAR-RING movements.
- 3** Whatever your panel instrument requirement, look to Triplet for the right size and style, the right capability at the right price.

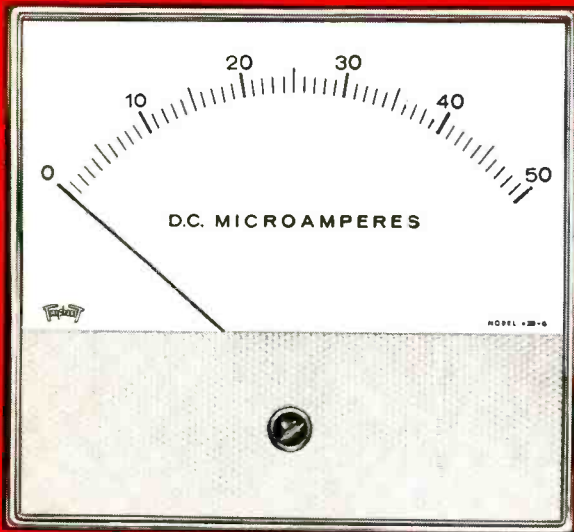

G-Series
5 sizes: 1 1/2", 2 1/2", 3 1/2", 4 1/2", 5 1/2"



MODEL 120 Edgewise Panel Meters

SHIELDED BAR-RING MOVEMENTS

ALNICO MAGNET IS MOUNTED INSIDE SOFT IRON RING; FULLY SELF-SHIELDED

Not affected by magnetic panels or substantially by stray magnetic fields for D.C.

More Torque

Lower Terminal Resistance

Faster Response

Exceedingly Rugged and

Accurate

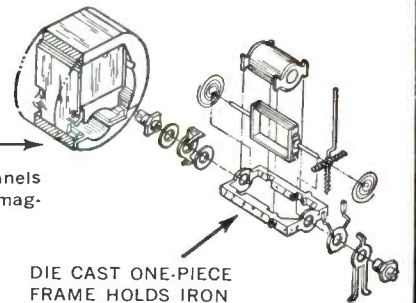

DIE CAST ONE-PIECE FRAME HOLDS IRON CORE IN EXACT ALIGNMENT

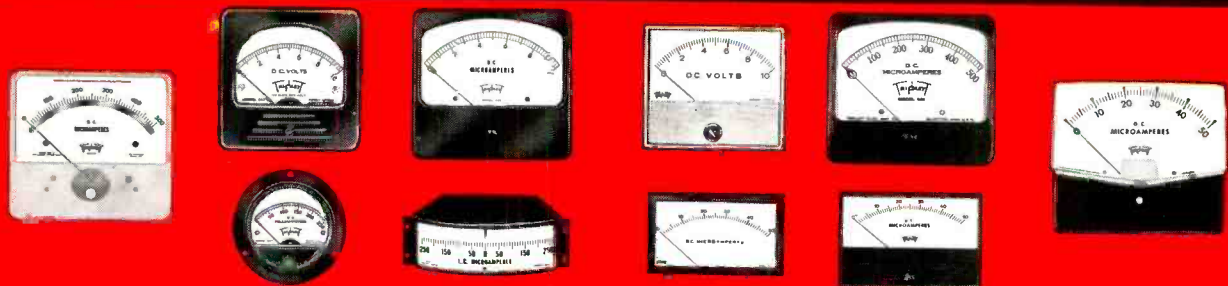

TRIPLET ELECTRICAL INSTRUMENT COMPANY, BLUFFTON, OHIO

CIRCLE NO. 81 ON READER SERVICE CARD

All new from every angle ...RCA HI-LITE

You end all doubts and confusion when you specify RCA HI-LITE. Then you can be certain that here is the all-new replacement picture tube from the leader in Color TV. All-new glass...gun...the works.

OEM QUALITY from every angle: the same tubes that go into original equipment sets, incorporating the latest technology of the world's most experienced color picture tube manufacturer. Everything about them exudes know-how, confidence, leadership.

If you've set your sights on quality, then look to RCA HI-LITE for your replacement tube needs. Available in the broadest line of types in the industry from your Authorized RCA Distributor.

RCA Electronic Components,
Harrison, N. J.



RCA

