

Electronics World

MAY, 1967
60 CENTS

RADIO MEASUREMENTS IN SPACE

MICROWAVE EDUCATIONAL TV

SELECTING FREQUENCY AND TIME STANDARDS

FIELD-EFFECT TRANSISTOR CIRCUITS

SELECTING AND USING PULSE GENERATORS

PLUS

SPECIAL AUTOMOTIVE FEATURES

AUTOMOTIVE ELECTRONICS

- ★ New Ideas on Safety Devices
- ★ New Solid-State Applications
- ★ Electric Car & Its Future
- ★ Control Systems for Electric Cars

AUTOMOBILE DIAGNOSTIC CENTERS

ENGINE TACHOMETER AND "RED LINE" INDICATOR

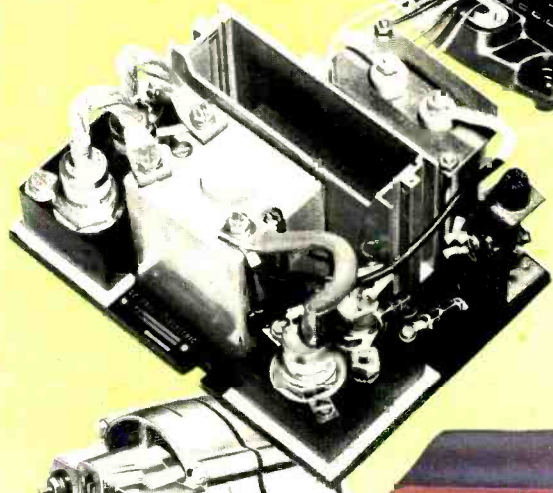
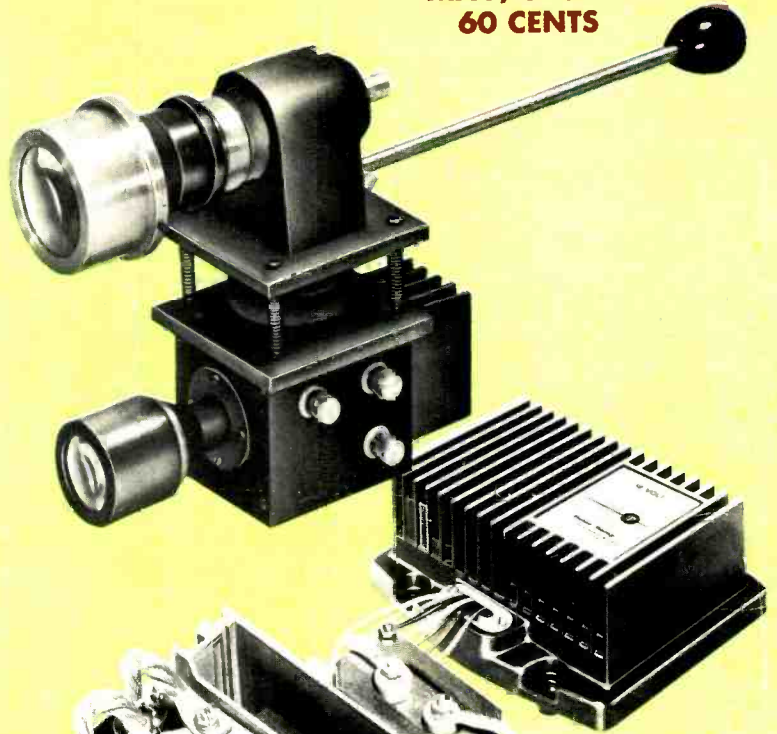

M0568 514700HIN2724LM055
M J HINDMAN
2724 LINCOD
SPRINGFIELD
MO 65804
7

If the
Electro-Voice
Model 664
 picks up
 sound here...

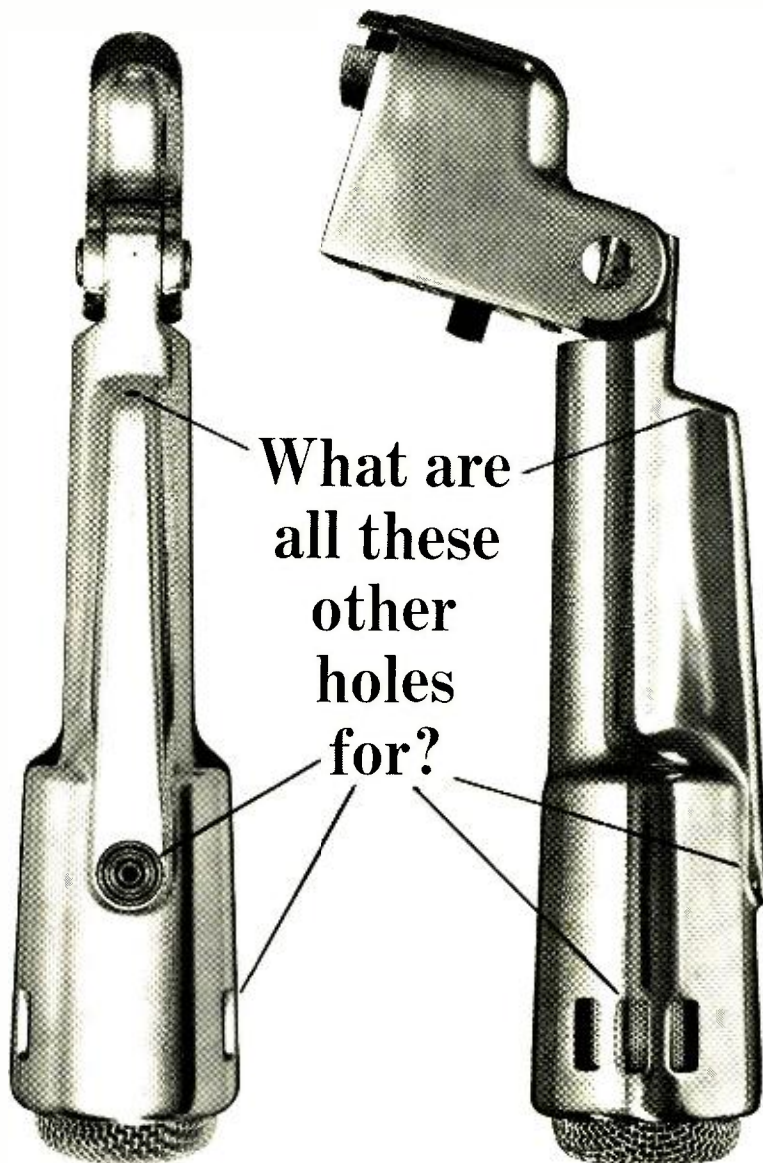

What are
 all these
 other
 holes
 for?

(E.V.) The holes in the top, sides and rear of the Electro-Voice Model 664 make it one of the finest dynamic cardioid microphones you can buy. These holes reduce sound pickup at the sides, and practically cancel sound arriving from the rear. Only an Electro-Voice Variable-D[®] microphone has them.

Behind the slots on each side is a tiny acoustic "window" that leads directly to the back of the 664 Acoustalloy[®] diaphragm. The route is short, small, and designed to let only highs get through. The path is so arranged that when highs from the back of the 664 arrive, they are cut in loudness by almost 20 db. Highs arriving from the front aren't affected. Why two "windows"? So that sound rejection is uniform and symmetrical regardless of microphone placement.

The hole on top is for the mid-range. It works the same, but with a longer path and added filters to affect only the mid-frequencies. And near the rear is another hole for the lows,

with an even longer path and more filtering that delays only the bass sounds, again providing almost 20 db of cancellation of sounds arriving from the rear. This "three-way" system of ports insures that the cancellation of sound from the back is just as uniform as the pickup of sound from the front—without any loss of sensitivity. The result is uniform cardioid effectiveness at every frequency for outstanding noise and feedback control.

Most other cardioid-type microphones have a single cancellation port for all frequencies. At best, this is a compromise, and indeed, many of these "single-hole" cardioids are actually omnidirectional at one frequency or another!

In addition to high sensitivity to shock and wind noises, single-port cardioid microphones also suffer from proximity effect. As you get ultra-close, bass response rises. There's nothing you can do about this varying bass response—except use a Variable-D

microphone with multi-port design* that eliminates this problem completely.

Because it works better, the E-V 664 Dynamic Cardioid is one of the most popular directional microphones on the market. It has both high and low impedance outputs available at the plug. Frequency range is peak-free from 40 to 15,000 Hz (cps). Output is -58 db. To learn more about Variable-D microphones, write for our free booklet, "The Directional Microphone Story." Then see and try the E-V 664 at your nearby Electro-Voice microphone headquarters. Just \$85.00 in satin chrome or non-reflecting gray, or \$90.00 in gold finish (list prices less normal trade discounts).

*Pat. No. 3,115,207

ELECTRO-VOICE, INC., Dept. 572N
 629 Cerril Street, Buchanan, Michigan 49107



CIRCLE NO. 120 ON READER SERVICE CARD

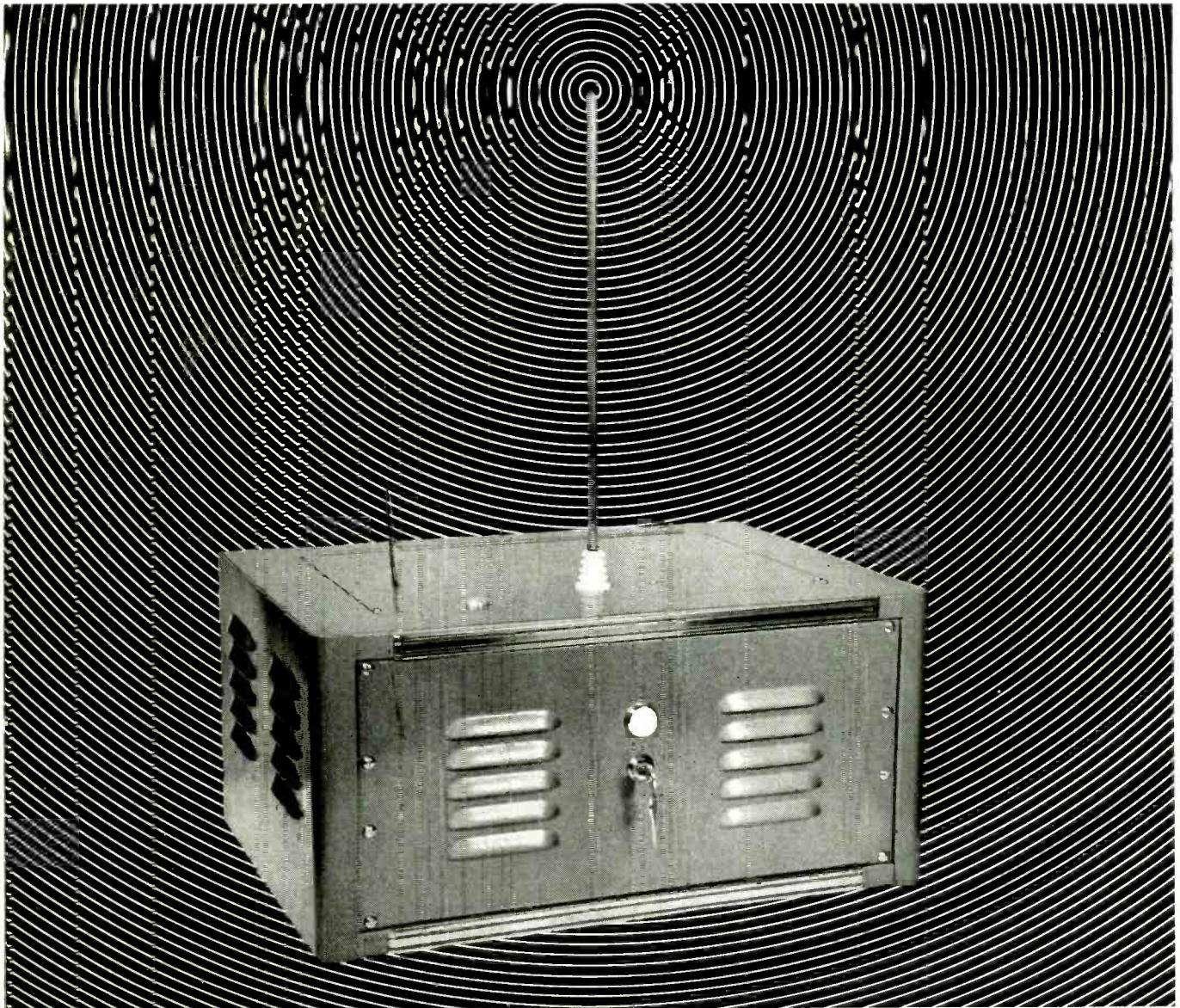

You are now in Radar Sentry Alarm's r.f. microwave field. Don't move a muscle!

This security system is so sensitive, it can be adjusted to detect the motion of your arm turning this page.

And if this Portable Model Unit were within 35 feet of you and you moved... people up to a half-mile away could hear the siren. Plus with optional equipment, it can detect fire... turn on lights... even notify police.

What does a burglar alarm have to do with you?

Just this: Radar Sentry is no ordinary alarm. It is the most modern and effective security system available. And it's also electronic.

That's why we need you. We need Dealers with technical knowledge. For the most successful Dealers for Radar Sentry Alarm are men who know electronics. This is a product that sells itself when demonstrated properly.

It's been proven time after time. In fact, many of the more than one thousand readers of electronics magazines who became Dealers in the past year — sold a system on their *first* demonstration.

And that's why we need men with technical knowledge and experience.

Men like you.

How about it?

Do you want to start a business of your own... or expand your present business with a product that in 8 years has become the world-wide leader in its field?

Do you want to earn up to \$5,000 a year in your spare time?

Do you want to earn \$20,000 and more full time?

We'll show you how.

O.K., now you can move.

Fill out the coupon and get complete Dealer/Distributor information... free.

Mail to: RADAR DEVICES MANUFACTURING CORP.
22003 Harper Ave., St. Clair Shores, Michigan 48080



Please tell me how I can have a business of my own distributing Radar Sentry Alarm Systems. I understand there is no obligation.

Name _____

Address _____

City _____ State & Code _____

EW 4

CIRCLE NO. 100 ON READER SERVICE CARD



RCA
 Transistors
 Rectifiers
 Integrated
 Circuits
 For
**EXPERIMENTERS
 HOBBYISTS
 HAMS
 and
 TECHNICIANS**

LOOK FOR THIS
 DISPLAY AT YOUR
 RCA DISTRIBUTOR

Here displayed on the RCA Solid-State Center is the RCA SK-Series Transistors, Rectifiers, and Integrated Circuits; the new RCA 3N128 MOS Field-Effect Transistor; RCA's 40214 Silicon Stud Rectifier; and three RCA Experimenter's Kits. This new Solid-State Center, in addition to its host of devices, also includes technical literature to support the devices right on the rack. It's the "one-stop" answer to the solid-state needs of experimenter, hobbyist, ham, or the replacement requirements of the service technician.

All devices and kits are packaged in easily identifiable see-through packs for your convenience. Included with each device is broad performance data or specific ratings and characteristics where applicable.

RCA Solid-State Center Includes:

- RCA Experimenter's Kits. Three kits enable you to build a light dimmer or any one of 14 different circuits for dozens of applications around the house.
- RCA SK-Series "Top-of-the-Line" Devices: 17 Transistors, 2 Rectifiers, and 2 Integrated Circuits, for exper-

imenter or replacement use.

- RCA Technical Manuals. Four manuals include: RCA Experimenter's Manual, RCA Transistor Manual, RCA Linear Integrated Circuits Fundamentals Manual, and RCA Tunnel Diode Manual.
- RCA Solid-State Replacement Guide. Lists all RCA SK-Series "Top-of-the-Line" Transistors, Rectifiers, and Integrated Circuits and the more than 7,300 types which they replace.

Keep RCA Experimenter's Kits and the RCA SK-Series in mind when you're shopping for solid-state devices. Look for the RCA Solid-State Center. Now at your RCA Distributor. Do it today!



RCA Electronic Components and Devices, Harrison, N.J.

The Most Trusted Name in Electronics

CIRCLE NO. 102 ON READER SERVICE CARD

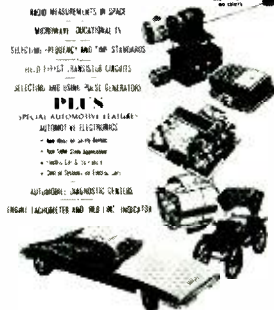

THIS MONTH'S COVER illustrates some of the electronic devices discussed in the automotive electronics articles in this issue. At the top is an experimental laser range measuring device proposed by G-E. Below that is a capacitive discharge ignition system as made by Delco-Remy. The next large unit is a portion of a d.c. motor controller made by G-E and used in d.c.-powered work vehicles. Below the controller is an alternator also made by Delco-Remy. The two cars represent the extremes of the electric car spectrum. The red one from the not-so-demanding past, and the racy green model an artist's version of the electric car of the future.



Publisher
 PHILLIP T. HEFFERNAN
Editor
 WM. A. STOCKLIN
Technical Editor
 MILTON S. SNITZER
Associate Editors
 LESLIE SOLOMON
 P. B. HOEFER
Assistant Editor
 MARSHA JACOBS
Contributing Editors
 WALTER H. BUCHSBAUM
 Prof. ARTHUR H. SEIDMAN
Art Editor
 HERBERT L. SILBERMANN
Art and Drafting Dept.
 J. A. GOLANEK
Advertising Sales Manager
 LAWRENCE SPORN
Advertising Service Manager
 ARDYS C. MORAN

May, 1967

CONTENTS

- 23 Automotive Electronics** *Robert M. Brown*
- 25 D.C. Motor Drive for Electric Cars** *John Mungenost*
- 28 A.C. Motor Drive for Electric Cars** *Robert M. Brown*
- 30 Recent Developments in Electronics**
- 32 Field-Effect Transistor Circuits** *Joseph H. Wujek, Jr. & Max E. McGee*
- 34 Microwave ETV—System Planning & Installation** *L. George Lawrence*
Description of typical educational TV installations and ways of planning for school-originated programs in the new 2500-MHz microwave band.
- 37 IC Engine Tachometer and "Red Line" Indicator** *Robert A. Hirschfeld*
This first application of an IC to automotive electronics produces an accurate and reliable meter-readout engine tachometer that also turns on a lamp when the engine has reached some predetermined rpm.
- 40 Selecting Frequency and Time Standards** *Irwin Math*
- 42 IC's Head for Industrial Market**
- 43 Selecting and Using Pulse Generators** *John D. Lenk*
- 46 Radio Measurements in Space** *Joseph H. Wujek, Jr.*
A new satellite will be launched soon for radio astronomy purposes only. It will use an array of antennas with 750-ft elements. Here are the technical details.
- 48 The Automobile Diagnostic Center** *Leslie Solomon*
A far cry from the greasy innards of old-fashioned service stations, the diagnostic center can perform over 100 tests in a few minutes in a "clean room" atmosphere, with the customer able to see each operation.
- 54 Camera Tube Uses Solid-State Target Electrode**
- 74 Power Output of Solid-State Receivers**

-
- 6 For the Record (Editorial)**
FCC Bears Down on CB
 - 16 EW Lab Tested**
Heath AR-15 Stereo Receiver
Shure Model 565 "Unisphere I" Microphone
 - 50 Ecology and Electronics** *John Fryo*
 - 64 Test Equipment Product Report**
Fairchild Model 7100A Digital Voltmeter
Basic Science Industries Model 100 Electronic Thermometer
Hewlett-Packard Model 211B Square-Wave Generator
-

MONTHLY FEATURES

- 4**
- 12 Letters from Our Readers**
- 69 Electronic Crosswords**
- 78 Radio & TV News**
- 80 Book Reviews**
- 85 New Products & Literature**

Electronics World: Published monthly by Ziff-Davis Publishing Company at 307 North Michigan Ave., Chicago, Illinois 60601. One year subscription \$6.00. Second Class Postage paid at Chicago, Illinois and at additional mailing offices. Subscription service: Portland Place, Boulder, Colorado 80302.
 Copyright © 1967 by Ziff-Davis Publishing Company. All rights reserved.



Don't
buy Sony tape
just to get the
amazing new



"Easy Threader"
tab!

It is a fact that each reel of Sony Professional Recording Tape contains two "easy threader" tabs which make any tape reel instantly and effortlessly self-threading. □ But Sony (maker of the best-selling tape recorders in the world) also makes the world's finest recording tape. And we'd rather have you buy it for that reason!

Sony tape captures the strength and delicacy of any sound. Sony tape reproduces those sounds for perfect playback, over and over again. □ Sony Professional Recording Tape brings out the best in a tape recorder.

And that's why we'd like you to buy it.



AMERICA'S FIRST CHOICE IN TAPE RECORDERS
CIRCLE NO. 93 ON READER SERVICE CARD

COMING NEXT MONTH

MEASURING TRACKING ABILITY OF PHONO CARTRIDGES

James H. Kogen, Chief Engineer at Shure, describes a number of present and proposed methods of measuring this important cartridge parameter including the new variable-speed turntable method, CCIF technique, and use of tone burst, scope observations, and special test records.

OCCUPATIONAL OUTLOOK FOR ELECTRONICS TECHNICIANS

Engineering and science technicians are the fastest growing occupational groups in the U.S., with the demand exceeding the supply for the next decade. Here is up-to-the-minute information on training, where the jobs are, the current salary ranges, and how to prepare for such well-paying careers.

SEMICONDUCTOR SWITCHING OF LOW-POWER CIRCUITS

Semiconductors can be used in place of relays to control d.c. loads up to 35 amps and a.c. loads up to 10 amps. Advan-

tages, as outlined by Aubrey Harris of Ampex, include no contact bounce, wear, or maintenance, along with increased reliability, and reduced noise generation.

FLUID AMPLIFIERS

Small by nature, these new mechanical devices are beginning to find increasing application in the computer industry, replacing electronic circuits. This article explains their operation, special features, and circuit advantages.

SEARCH FOR A HIGHWAY EMERGENCY RADIO PROGRAM

Although up to now much has been said and little done about establishing a means of communications between drivers and local authorities for the purposes of routing, information, and road service, now the race is on to be the first to establish the approved highway emergency radio system which will be adopted nationwide. At stake for the winner are auto-maker contracts, prestige, and federal-aid grants.

All these and many more interesting and informative articles will be yours in the June issue of *ELECTRONICS WORLD* . . . on sale May 18th.

ZIFF-DAVIS PUBLISHING COMPANY

William B. Ziff
Chairman of the Board (1946-1953)

William Ziff
President

W. Bradford Briggs
Executive Vice President

Hershel B. Sarbin
Senior Vice President

Philip Sine
Financial Vice President

Walter S. Mills, Jr.
Vice President, Circulation

Stanley R. Greenfield
Vice President, Marketing

Phillip T. Heffernan
Vice President, Electronics Division

Frank Pomerantz
Vice President, Creative Services

Arthur W. Butzow
Vice President, Production

Edward D. Muhlfeld
Vice President, Aviation Division

Irwin Robinson
Vice President, Travel Division

Editorial and Executive Offices
One Park Avenue
New York, New York 10016 212 679-7200

NEW YORK OFFICE 212 679-7200
James J. Sullivan
Joseph E. Halloran

MIDWESTERN OFFICE
307 North Michigan Avenue
Chicago, Illinois 60601 312 726-0892
Midwestern Advertising Manager, Royce Richard

WESTERN OFFICE
9025 Wilshire Boulevard
Beverly Hills, California 90211
213 CRestview 4-0265; BRadshaw 2-1161
Western Advertising Manager, Bud Dean

JAPAN
James Yagi
Ishikawa Mansion
4-4, Sakuragaoka
Shibuya-ku, Tokyo
462-2911-3

CIRCULATION OFFICE
Portland Place, Boulder, Colorado 80302



Member
Audit Bureau of
Circulations

Radio & TV News • Radio News • Radio-Electronic Engineering Trademarks Reg. U.S. Pat. Off.
SUBSCRIPTION SERVICE: All subscription correspondence should be addressed to Electronics World, Circulation Department, Portland Place, Boulder, Colorado 80302. Please allow at least six weeks for change of address. Include your old address as well as new—enclosing if possible an address label from a recent issue.
EDITORIAL CONTRIBUTIONS must be accompanied by return postage and will be handled with reasonable care; however publisher assumes no responsibility for return or safety of art work, photographs, or manuscripts.

ELECTRONICS WORLD (May, 1967, Vol. 77, No. 5). Published monthly at 307 North Michigan Avenue, Chicago, Illinois 60601 by Ziff-Davis Publishing Company—also the publishers of Airline Management and Marketing, Boating, Business & Commercial Aviation, Car and Driver, Cycle, Flying, HiFi, Stereo Review, Modern Bride, Popular Aviation, Popular Electronics, Popular Photography, Skiing, Skiing Area News, and Skiing Trade News. (Travel Weekly is published by Robinson Publications, a subsidiary of Ziff-Davis Publishing Company.) One year subscription rate for U.S., U.S. Possessions, and Canada, \$6.00; all other countries, \$7.00. Second Class postage paid at Chicago, Illinois and at additional mailing offices. Authorized as second class mail by the Post Office Department, Ottawa, Canada and for payment of postage in cash.

ELECTRONICS WORLD

New Jerrold Colorpeak™ VHF Antenna weathers any reception problem

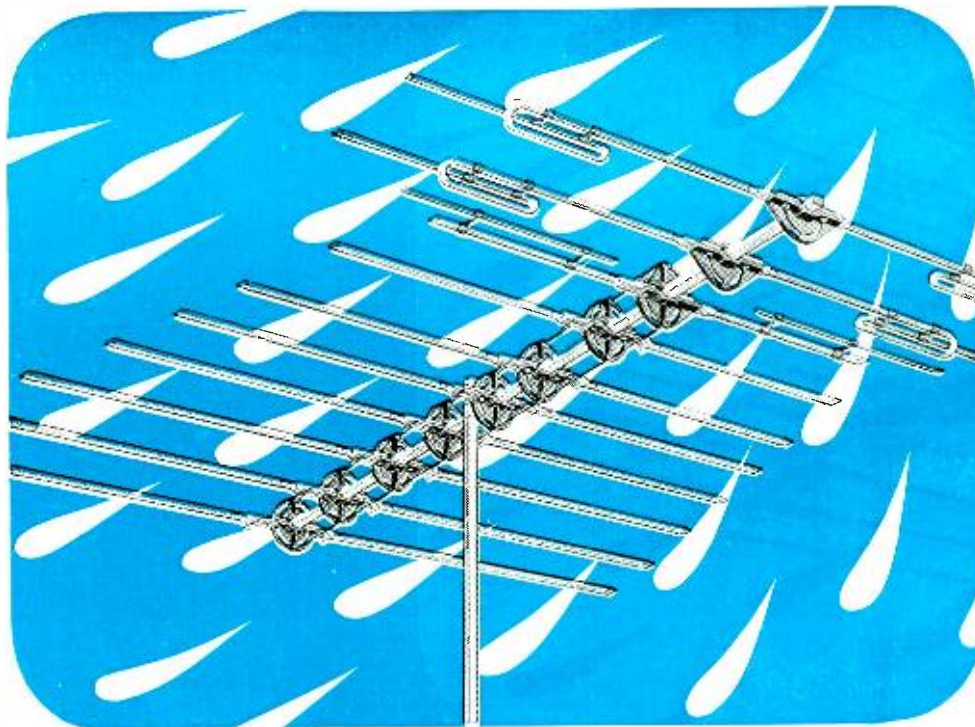

Here's one outdoor antenna that stays put—even in a howling storm. The new Jerrold Colorpeak 300-ohm VHF-FM Antenna.

Colorpeak is a high gain antenna with unusual flatness across the entire VHF-FM band. It picks up strong, clear signals—even in difficult reception areas—because of its excellent front-to-back ratio. And it's built as rugged as a tank.

Vibration-proof point-contact element locks, corrosion-resistant Golden Armor Coating and tough Cyclac insulators make each insulating mount a strong point. No shorting out because of icing. No wavering image as wind whips through the antenna. No flimsy criss-cross conductors for transfer of the signal. Jerrold Colorpeak quality construction sees to all that.

Jerrold Colorpeak antennas,

like Jerrold VUfinder, Paralog Plus and Pathfinder antennas, assemble faster than any other antenna made today. All parts snap into place—anywhere—on the ground or on the roof. For hook-up ease, Colorpeak lead connections are made close to the mast.

For more details on the Jerrold Colorpeak antenna, see your Jerrold distributor.

JERROLD®

Focusing on one thing—
better reception.

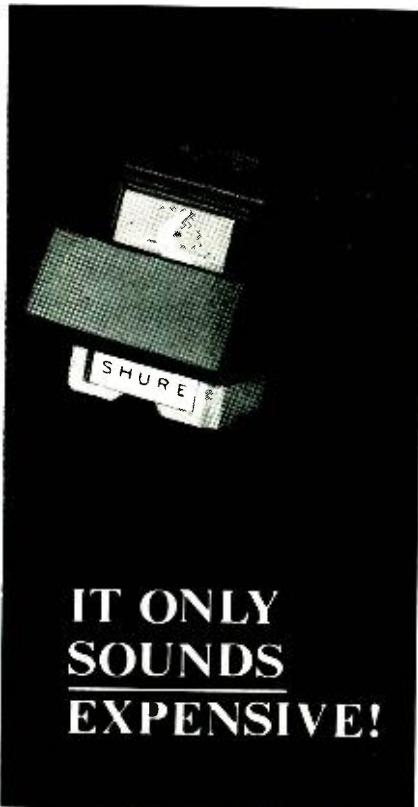

**IT ONLY
SOUNDS
EXPENSIVE!**

SHURE

M75E HI-TRACK

Elliptical Stylus Cartridge For
3/4 to 1 1/2 Gram Tracking

The Shure M75E Hi-Track is a new high trackability cartridge made especially for those who are rich only in music appreciation. This modestly-priced cartridge will upgrade your entire stereo system. You'll get live, natural sound from even difficult-to-track records at 3/4 to 1 1/2 grams tracking force. The M75E Hi-Track also features a Bi-Radial Elliptical Stylus and a built-in stylus guard. Only \$39.50 net.

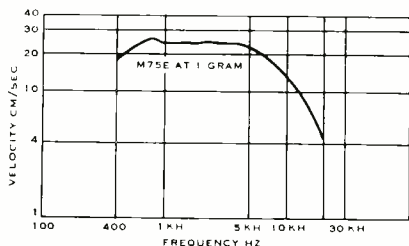

TRACKABILITY CHART

See for yourself! This chart depicts the new performance specification of trackability as it is represented by the M75E Hi-Track cartridge.* Frequency is shown across the bottom, modulation velocities in CM/SEC up the side.

* Trackability at 1 gram tracking force using a Shure/SME Arm:

- 18 CM/SEC at 400 Hz (cps)
- 22 CM/SEC at 1,000 Hz (cps)
- 14 CM/SEC at 10,000 Hz (cps)

Literature:

SHURE BROTHERS, INC.
222 Hartrey Avenue
Evanston, Illinois 60204

CIRCLE NO. 98 ON READER SERVICE CARD



For the record

WM. A. STOCKLIN, EDITOR

FCC BEARS DOWN ON CB

IN a move which could effect sweeping long-range changes on 27 MHz, the FCC has announced its proposal to require "type acceptance" of all class-D CB equipment at point of manufacture.

Although the Commission has stated that this action "does not impose any new or significantly tighter standards other than a requirement for a modulation limiter," close inspection reveals that in reality the move may well be the first step towards a major overhaul of the service, aimed at ridding it of the hobbyist element.

The type-accepted CB set would not be much different from those now being used, although a few interesting limitations will be imposed. For one, the ICAS rating on the final tube will not be allowed to exceed 10 watts. Further, all crystals must be supplied by the manufacturer. If r.f. output is more than 2.4 watts, a "device which automatically prevents modulation in excess of that specified" must be included in the circuit. Finally, panel connectors and controls would be restricted to the following: a.c. plug, mike connector, r.f. output connector, "on-off-volume" control, sideband selector (if SSB set), p.a. switch, channel selector, and transmit-receive switch. What makes these changes significant, however, are not the design limitations so much as the new restrictions on the set owner.

With a type-accepted CB transceiver, the operator will not in any way be permitted to "tube" the output for best matching to the transmission line nor can he substitute crystals. If channel-switching is desired, he will have to either buy a multi-channel set or employ the services of a 1st or 2nd Class Commercial ticket holder. Should component replacement be required, he can use only those parts (including tubes and crystals) listed in the instruction manual by the manufacturer.

Far more important, however, are the regulations concerning even minor circuit changes. Type-accepted CB sets, according to the FCC, "shall be *in no way* modified by the user." Obviously, this will apply to the countless books and magazines presenting do-it-yourself material for souping up receivers, add-on noise limiters, etc.

Dealing a crushing blow to the CB accessory business is another stipulation that strictly prohibits "external connection or addition of any accessory not originally included" with the transceiver. Clearly, this would render illegal all outboard "S" meters, s.w.r. bridges, modulation boosters, etc.

Behind this move is the feeling in

many circles that the CB industry may be contributing to the increasing number of rule violations by including such questionable equipment features as "25-watt construction," "30-channel operation," and occasionally slipshod spurious radiation suppression techniques. By regulating the manufacturing community, the Commission hopes to somewhat improve the caliber of the signal (if not the operator) to be found on 27 MHz.

It is interesting to note that just prior to this type-acceptance disclosure word was out that the FCC was planning to remove unlicensed 100-milliwatt walkie-talkies from 27 MHz and place them on a newly created 49.9-50.0 MHz band. According to the story, millions of dollars worth of transceivers (largely Japanese) would have to be scrapped in favor of redesigned walkie-talkies which would meet tight Commission *type-acceptance* requirements. The idea, apparently, was to rid the CB band of millions of these "toys"—many of which are poorly designed from a technical standpoint—and substitute a new breed of crystal-controlled transceiver (running no more than 60 mW measured "at the battery") on 49 MHz.

Shortly after *The New York Times* stated, in an item "FCC Weighs Ban on Walkie-Talkies" (Feb. 3, 1967), that it had confirmed this report, the FCC all but denied it had ever proposed such a drastic measure. More recently, Commission spokesmen have stated that the 49-MHz plan is just "one of many concepts under consideration" by the agency and that no matter what emerges, "it will take some time yet."

In September of last year Chairman Rosel H. Hyde warned the CB industry that unless something were done to curb the rising tide of rule violations on 27 MHz, the FCC might have to consider "the cessation of issuance of any new Citizens Radio licenses pending a reexamination of the justification for and proper operation of the Service."

Whether the type-acceptance proposal and whatever walkie-talkie solution eventually emerges will materially help upgrade the 27-MHz band, remains to be seen. Although industry cooperation is now at hand, the question is will individual CB-ers respond? Many users seem to think in terms of enforcement and this is one area in which the Commission is hamstrung.

Whether or not Hyde's threat to CB materializes, it is now apparent that the FCC clearly intends to grasp control of the mess on 11 meters. ▲

Amazing "power tool" for electronics men

Still working electronics problems with that old-fashioned manual tool, the pencil? You're not alone. And that's kind of a shame in this wonderful age when power tools have speeded up so many manual jobs. Now here is an amazing "power tool" that zips through electronic calculations like a power saw through soft pine. The CIE Electronics Slide Rule. It has a special scale that works reactance problems in seconds. And another scale that does the same for resonance problems. Plus two more scales that tell exactly where the decimal points go.

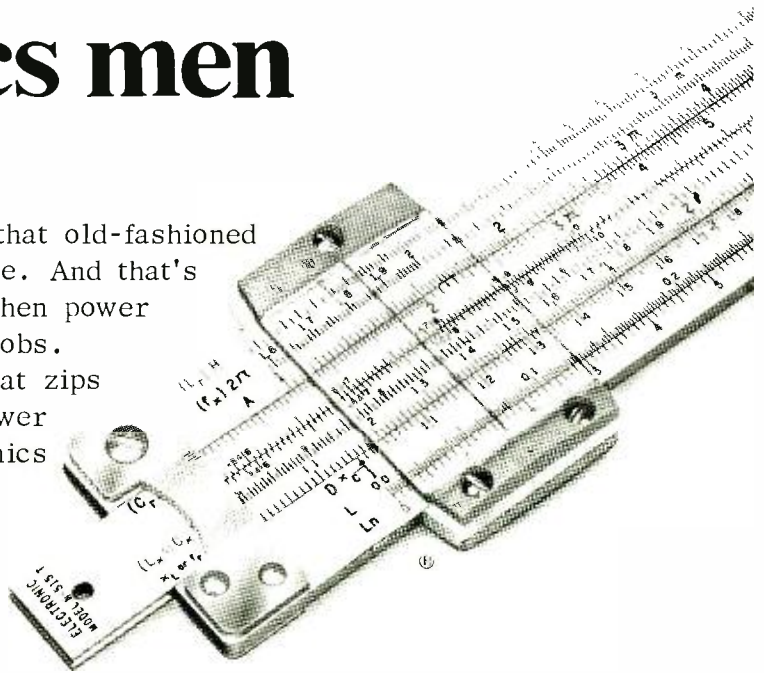

No guesswork. No paperwork. No rough calculations. You get an accurate answer in 20 seconds or less.

It also does the things ordinary slide rules do. Like multiply, divide and extract square roots in one setting. Or find reciprocals for resistance formulas, logarithms for decibel formulas, and trigonometric functions for AC circuitry formulas. And work the formulas in seconds.

The Electronics Slide Rule is easy to use even if you've never worked a slide rule before. It was developed by CIE, one of America's leading electronics schools. And it comes with a 4-lesson course that turns you into an expert. Not just an instruction manual, but a real Instruction Course. With assignments you may send in for grading by our instructors. And when you finish, a Certificate of Achievement that "tells the world" you're an electronics slide rule expert.

The slide rule and course are sold together -- for about half what we think they're worth. It's our way of getting acquainted with men around the country who want to get ahead in electronics.

Mail the coupon for FREE booklet describing this Electronics Slide Rule. Or write to Cleveland Institute of Electronics, Dept. EW-138, 1776 E. 17th Street, Cleveland, Ohio 44114. No charge or obligation.



SEND COUPON TODAY →

CIE Cleveland Institute of Electronics
1776 East 17th Street, Cleveland Ohio 44114

Please send me without charge or obligation your FREE booklet, "How To Solve Electronics Problems In Seconds," describing the CIE Electronics Slide Rule and Instruction Course.

Name _____ (please print)

Address _____

City _____ State _____ Zip _____

Also free if you act now—our famous shirt-pocket Electronics Data Guide with useful formulas, conversion tables, color codes, and more.

Accredited Member National Home Study Council • A Leader in Electronics Training .. Since 1934

EW-138

CIRCLE NO. 123 ON READER SERVICE CARD

**Discover the ease
and excitement of NRI's**

3 DIMENSIONAL METHOD

of ELECTRONICS TV-RADIO TRAINING

10 HOME-STUDY PLANS TO CHOOSE FROM

Ask men whose judgment you respect about NRI's three dimensional method of home-study training. Ask about the new, remarkable NRI Achievement Kit. Ask about NRI custom-designed training equipment, programmed for the training of your choice to make Electronics come alive in an exciting, absorbing, practical way. Ask about NRI "bite-size" texts, as direct and easy to read as 50 years of teaching experience can make them. Achievement Kit . . . training equipment . . . bite-size texts . . . the three dimensions of home-study training; the essentials you must have to make

learning easier, more interesting, more meaningful. You get them all from NRI.

Whatever your interest . . . whatever your need . . . whatever your education . . . pick the field of your choice from NRI's 10 instruction plans and mail the postage free card today for your free NRI catalog. Discover just how easy and exciting the NRI 3-DIMENSIONAL METHOD of training at home can be. Do it today. NATIONAL RADIO INSTITUTE, Electronics Division, Washington, D.C. 20016.

**BEGIN NOW AN ABSORBING
ADVENTURE—LEARN ELECTRONICS
THE EASY NRI WAY—MAIL CARD TODAY**

OVER 50 YEARS OF LEADERSHIP



IN ELECTRONICS TRAINING

1 Start Fast with NRI's New Remarkable Achievement Kit

The day you enroll with NRI this new starter kit is on its way to you. Everything you need to make a significant start in the Electronics field of your choice is delivered to your door. It's an outstanding way of introducing you to NRI training methods . . . an unparalleled "first dimension" that opens the way to new discoveries, new knowledge, new opportunity. The Achievement Kit is worth many times the small payment required to start your training. No other school has anything like it. Find out more about the NRI Achievement Kit. Mail the postage-free card today.



2 NRI "Bite-Size" Lesson Texts Program Your Training

Certainly, lesson texts are a necessary part of any training program . . . but only a part. NRI's "bite-size" texts are simple, direct, well illustrated, and carefully programmed to relate things you read about to training equipment you build. Here is the "second dimension" in NRI's training method. Here are the fundamental laws of electronics, the theory, the training of your choice, presented in a manner you'll appreciate. And in addition to lesson texts, NRI courses include valuable Reference Texts related to the subjects you study, the field of most interest to you.



3 Custom-Designed Training Kits Make Learning Come Alive

Electronics becomes a clear and understandable force under *your* control as you build, experiment, explore, discover. Here is the "third dimension" . . . the practical demonstration of things you read about in NRI texts. NRI pioneered and perfected the use of training kits to aid in learning at home. NRI invites comparison with equipment offered by any other school, at any price. Prove to yourself what 750,000 NRI students could tell you . . . that you get more for your money from NRI than from any other home-study Radio-TV, Electronics school. Mail postage free card for your NRI catalog. (No salesman will call.)

AVAILABLE UNDER NEW GI BILL — If you served since January 31, 1955, or are in service, check GI line in postage-free card.

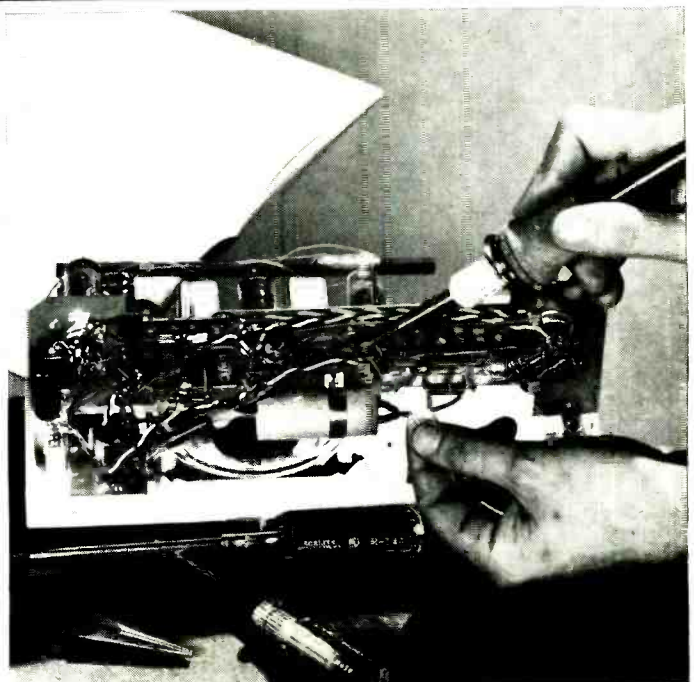



Leadership PRESENTS...

The IDEAL Amplifier SA30-30



- Over 60 watts of dynamite
- Clean Transparent Sound
- Military-Grade Parts, Workmanship & Reliability
- Only 1-3/4" thin, 19" rack mount

Price \$19900

For complete characteristics and specifications write for Bulletin 114, or ask any proud owner.



MODEL 1/4 TRACK STEREO
SX724 ONLY \$995

NEW!

Modular Transport
Low-Noise Circuitry
Third Head Monitoring

World's Finest Recording Quality

Speed	Response	S/N
7-1/2	±2db 30 to 25,000	55db
3-3/4	±2db 30 to 15,000	50db

Crown International
BOX 1000, DEPT. EW-5
ELKHART, INDIANA

MADE ONLY IN AMERICA

LETTERS FROM OUR READERS

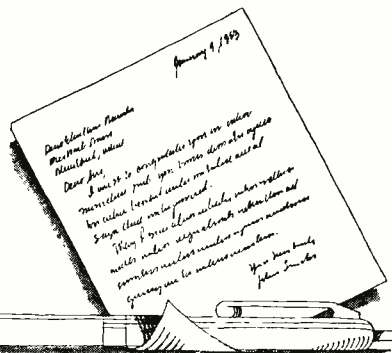

ELECTRONIC EAVESDROPPING

To the Editors:

The article (on "Electronic Eavesdropping" in the April issue) is first-rate and will, hopefully, diminish my naïveté on the subject. It would be most helpful if we could have your permission to reprint the article in our upcoming hearings on the subject.

SEN. EDWARD V. LONG (Dem., Mo.)
Washington, D.C.

We are, of course, pleased to grant permission to reprint our story. Senator Long, as most of our readers know, is Chairman of the Senate Subcommittee on Administrative Practice and Procedure, which has been conducting hearings on the subjects of wiretapping and electronic eavesdropping. On February 8, the Senator introduced a proposed Right of Privacy Act of 1967, as recommended by President Johnson. The bill (identified as S. 928) is designed to protect the right of privacy of individuals by prohibiting wire interception and eavesdropping. For further details on the bill, see "Radio & TV News" on page 78 of this issue.—Editors

* * *

SONALERT PREDECESSOR

To the Editors:

I was surprised to find an old friend in John Frye's column in your January, 1967 issue. The Sonalert[®] description very closely resembles what I called a "P-n-p/n-p-n CPO" in the February, 1962 issue of 73 magazine.

The basis of the circuit was a pillow speaker using a piezoelectric crystal as the frequency-determining element as well as the tone reproducer. The actual circuit was published rather than epoxied.

ROY A. MCCARTHY
Fullerton, Calif.

* * *

SLIDE-RULE SHORT CUTS

To the Editors:

I have found the parallel-resistance formula in the article "Calculating Parallel Resistor Values" by Shu H. Loui (October, 1966, p. 60) very useful in making slide-rule calculations.

Another formula that always gives me problems when I try to use it while making calculations on my slide rule

is the Pythagorean equation $a^2 + b^2 = c^2$. Employing the same principles used to derive the parallel-resistance equation, I have transformed the Pythagorean equation to the following: $c = b \sqrt{(a/b)^2 + 1}$, $a > b$.

Using this formula, it takes two settings of the slide and one of the cursor to perform a calculation that previously required three settings of the cursor and a good deal of paperwork.

The formula for finding b when a and c are known is as follows: $b = a \sqrt{(c/a)^2 - 1}$.

The use of the cursor is not even necessary, but it is convenient, especially if one has a tendency to forget numbers, which the cursor will remember.

JOSHUA LEVIN
Flushing, N.Y.

An even simpler technique for solving this equation is by use of sine and tangent scales on the slide rule. In order to solve a right triangle for which two legs are given, it is only necessary to set the proper index of the slide to the larger leg on scale D and then push the hairline to the smaller leg on scale D. At the hairline, the smaller acute angle of the triangle is read on tangent scale T. This angle is then drawn on scale S under the hairline. Finally, at the index of the slide, the hypotenuse may be read on scale D. This technique is excellent for use with impedance problems involving a resistance and reactance.—Editors

* * *

PREDICTING ACADEMIC SUCCESS

To the Editors:

Recent letters by Cliff Erickson and John Frye in your "Letters" column indicate some disagreement as to what kind of man is successful in studying engineering. Has anyone checked a number of successful engineering students to find out just what makes them tick and why others quit the study of engineering?

RICHARD L. PRENDERGAST
Kansas City, Mo.

A recent issue of Engineer published by the Engineers Joint Council, Inc. contained an article on this very sub-

Let's talk sense about color TV lead-in!

The common sense of the situation calls for *two* 82-channel lead-ins for color and UHF TV... one to give a stronger signal in uncongested fringe areas where interference usually is not a serious problem. The other to give a much cleaner signal in congested or close-in areas where serious interference problems are likely to exist. This is why Belden gives you a choice—the *Color Guard Twins*.

8285

*Color Guard Twin—Belden Permohm**

Use to get stronger signals in uncongested fringe areas, like this . . .



You get an excellent color image . . . because in a 100-foot run, Permohm delivers 38% to 200% more signal voltage than RG-59/U with matching transformers and 23% to 80% more signal voltage than "Low Loss Coax" with transformers.

Permohm obtains the highest efficiency of any available unshielded 300 ohm line when exposed to weathering and industrial atmospheres. Low loss cellular polyethylene insulation around the conductors provides the necessary protection.

You don't need expensive transformers and connectors.

8290

*Color Guard Twin—Belden Shielded Permohm**

Use to get cleaner signals in congested or close-in areas, like this . . .



Belden Shielded Permohm (8290) combines strong signal strength with the clean signal protection of shielded cable.

Shielded Permohm eliminates transmission line pickup of noise and ghost signals. You can install it easily anywhere . . . no need for standoffs, twisting, or inconvenient routing of lead-in. Tape it to a mast, route it through metal pipe, or bury it underground.

Beldfoil† shielding is used to shield against outside signal interference. The jacket is weatherproof polyethylene. The critical signal area is protected from rain, snow, salt, smog, fog and industrial contamination. No expensive transformers or connectors are needed.

Belden Trademarks Reg. U.S. Patent Office
*Patent No. 2,782,251 and Pat. Pending
†Patent No. 3,032,604.

Choose the Color Guard Twin that gives your customer the best 82-channel color TV reception. Get complete information on the Belden Color Guard Twins.

CALL YOUR BELDEN ELECTRONIC DISTRIBUTOR.

Belden

BELDEN MANUFACTURING COMPANY • P. O. Box 5070-A • Chicago, Illinois 60680
CIRCLE NO. 125 ON READER SERVICE CARD

May, 1967

8-8-G

13

COMPLETE SCHEMATICS • COLOR PURITY & CONVERGENCE ADJUSTMENTS • VOLTAGE READINGS & WAVEFORMS • REPLACEMENT PARTS LISTS • ALIGNMENT INFORMATION • TUBE & PARTS LOCATION

Now...TV Tech/Matics gives you full coverage for 8 years of Color TV; 3 years of Black & White

All the essential servicing data you need for ALL color and black & white sets of the major manufacturers and at an annual cost of less than \$20!

TV TECH/MATICS '67 IS OUT NOW!

Covering all 1967 models, color and B&W, in two convenient volumes, opening flat to 29½" x 11". Vol. 1 gives Admiral, Airline, Andrea, Coronado, Curtis Mathes, Dumont, Emerson, General Electric, Hoffman, Magnavox, Motorola, Olympic,

Packard Bell, Philco-Ford. Vol. 2 gives RCA Victor, Sears-Silvertone, Satchell Carlson, Sonora, Sylvania, Truetone, Westinghouse, Zenith. Each volume is only \$9.95!

PART-TIME OR FULL-TIME — IT FITS THE BILL!

Join the thousands of satisfied users who discovered its completeness and convenience, and saved time, money, and space. The '65 and '66 editions have Admiral through Packard Bell in

Vol. 1: Philco through Zenith in Vol. 2. In addition, TV Tech/matics '65 includes a free extra bonus — all color sets '60-'65!

AT YOUR ELECTRONICS DISTRIBUTOR or try it FREE for 10 days!

Mail in the coupon and we'll send you TV Tech/matics for a 10-day free trial with no obli-

gation. Unless you're completely satisfied, send them back. Otherwise — welcome aboard!

Also Brand New From RIDER

THE ELECTRONIC INVASION by Robert M. Brown. An electronics expert and licensed investigator reveals secret techniques, devices, circuits, users, suppliers of bugs and anti-bugs. A completely detailed, technical exposure of the most controversial subject in electronics! 188 pp., #0779, \$3.95

POWER SUPPLIES FOR ELECTRONIC EQUIPMENT by Leo G. Sands. A "must" for anyone working with electronic equipment or devices. Full coverage of all types, custom and off-the-shelf, from batteries to regulated solid state units. 196 pp. Paper, #0735, \$4.25; Cloth, #0736, \$6.25

ject by Dr. Roger D. Augustine. While Dr. Augustine was Assistant to the Dean of Engineering at Michigan State University, he conducted a study of engineering students at three Midwestern universities. Among other things, he found that students who persevered in engineering had the following characteristics. They tended to come from working-class and upper-middle-class socio-economic backgrounds as opposed to lower-middle-class origins. They tended to come from suburban high schools as opposed to city and rural high schools. They generally enjoyed repairing things and thinking about how things work; they had an inclination to "tinker around the house." Often, a close relative or father was an engineer. Their commitment to engineering was made at an earlier age than those who left engineering. They met their first exposure to sophomore technical courses with enthusiasm.

Students who quit engineering seemed to have a strong need for upward social mobility; they attached more importance to working with people than with things; and they had tended to choose engineering studies for materialistic and prestige purposes or to acquire a "good" background for careers in other fields. Many left because the technical courses were too difficult; they felt unable or unprepared to succeed in their engineering programs.—Editors.

* * *

LIFE OF CRYSTAL MICROPHONES

To the Editors:

I have noticed that when crystal microphones are left on a shelf for a few years they go bad. Can you tell me what goes wrong and if it can be fixed? There must be a definite pattern because four of my crystal mikes have gone bad in about three years with no usage at all.

DAVE RUNNION
Prospect Park, Pa.

Here are some comments on Reader Runnion's letter from The Astatic Corp., one of the largest manufacturers of crystal microphones and phono cartridges:

"Although Rochelle salts make the most efficient piezoelectric crystal generators, the efficiency of this material is decreased by extremes of heat and humidity. Temperatures above 120° F will result in permanent damage to crystal microphones and cartridges, as will long-term exposure to high humidity. In general, crystal microphones will perform reliably for many years if they are used and stored under conditions of temperature and humidity where the user would be comfortable. Where climatic conditions of high temperature and humidity prevail, ceramic units are recommended."—Editors ▲

John F. Rider Publisher, Inc. 116 W. 14th Street, New York, N.Y. 10011

Send me the indicated volumes of TV TECH/MATICS at \$9.95 each. After 10 days' use I'll remit payment (plus postage) or return them.

- '67 Vol. 1 '66 Vol. 1 '65 Vol. 1
 '67 Vol. 2 '66 Vol. 1 '65 Vol. 2

Also send me on 10-day approval:

- #0779 #0735 #0736

Name _____

Address _____

City _____

State _____

Zip _____

Indicate if payment enclosed. Publisher pays postage with same return guarantee. EW-5

CIRCLE NO. 113 ON READER SERVICE CARD

Electronics World SUBSCRIBER SERVICE

Please include an address label when writing about your subscription to help us serve you promptly. Write to: Portland Place, Boulder, Colorado 80302

CHANGE OF ADDRESS:

Please let us know you are moving at least 4 weeks in advance. Affix magazine address label in space to the right and print new address below. If you have a question about your subscription, attach address label to your letter.

TO SUBSCRIBE: Check boxes below.

- New Renewal
 5 years \$21 3 years \$15 1 year \$6

SPECIFY: Payment enclosed—You get 1 extra issue per year as a bonus! Bill me later.

If you have no label handy, print OLD address here.

name _____ please print

address _____

city _____

state _____ zip-code _____

↑ AFFIX LABEL HERE ↓

name _____ please print 0167

address _____

city _____

state _____ zip-code _____

World's Most Advanced Stereo Receiver...

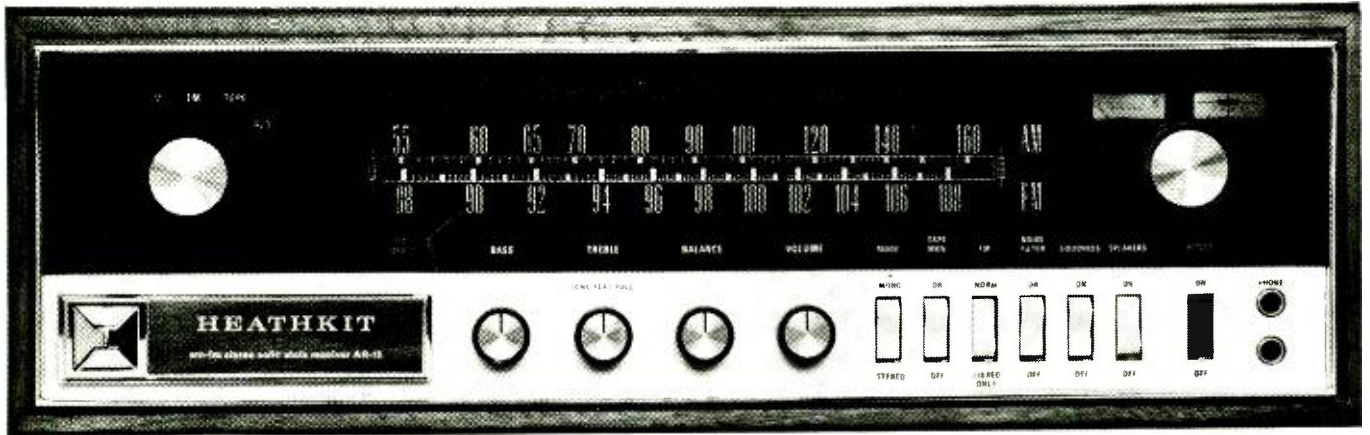

New Heathkit® AR-15...150 Watts...AM/FM/FM...\$329.95†



"Black Magic" Panel Lighting

A touch of the power switch and presto!... The black magic panel lights up with a slide-rule dial for easy tuning, and instant identification of all controls.



Integrated Circuits... two are used in the IF amplifier for hard limiting excellent temperature stability, increased reliability. Capture ratio is 1.8 db. Each IC is the size of a tiny transistor, yet each contains 10 transistors, 7 diodes, and 11 resistors.

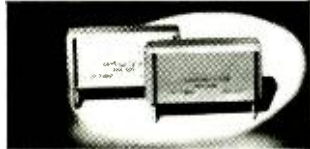

Crystal Filters... two are used in the IF amplifier to replace the usual transformers... Heath hi-fi exclusive. Provide near-perfect bandpass characteristics, (70 db selectivity) yet no adjustment is ever needed!

AR-15 SPECIFICATIONS — AMPLIFIER SECTION: Dynamic Power Output Per Channel (Music Power Rating): 8 ohm load; 75 watts. **Continuous Power Output, Per Channel:** 8 ohm load; 50 watts. **Power Bandwidth For Constant 0.5%:** Total Harmonic Distortion*: 6 Hz to 25 kHz. **Frequency Response (1 watt level):** ±1 db, 6 to 50,000 Hz. +3 db, 4 to 70,000 Hz. **Harmonic Distortion:** Less than 0.5% from 20 to 20,000 Hz at 50 watts output. Less than 0.2% at 1,000 Hz with 50 watts output. Less than 0.2% at 1,000 Hz with 1 watt output. **Intermodulation Distortion (60 Hz; 6,000 Hz - 4:1):** Less than 0.5% with 50 watts output. Less than 0.2% with 1 watt output. **Damping Factor:** 45. **Input sensitivity:** PHONO; 2.2 millivolts (overload 155 mv). TAPE; 200 millivolts (overload 4.5v). AUX; 200 millivolts (overload 4.5v). **Hum & Noise:** Volume control at minimum position; -80 db. PHONO; (10 millivolt-reference); -60 db. TAPE & AUX; (100 millivolt-reference); -65 db. **Channel Separation:** PHONO; 45 db. TAPE & AUX; 55 db. **Output impedance (each channel):** 4, 8 & 16 ohms. **Tape Output Impedance:** 100 ohms. **Input Impedance:** PHONO; 51 K ohm (**RIAA equalized). AUX, TAPE & TAPE MON; 100 K ohm. **Tape Output:** 0.17 volt. **FM SECTION (Mono):** Sensitivity: 1.8 uv*. **Frequency Response:** ±1 db, 20 to 15,000 Hz. **Volume Sensitivity:** Below measurable level. **Selectivity:** 70 db*. **Image Rejection:** 90 db. **IF Rejection:** 90 db minimum*. **Capture Ratio:** 1.5 db*. **AM Suppression:** 50 db*. **Harmonic Distortion:** 0.5% or less*. **Intermodulation Distortion:** 0.5% or less*. **Hum & Noise:** 65 db*. **Spurious Rejection:** 100 db*. **FM SECTION (Stereo):** Channel Separation: 40 db or greater. **Frequency Response:** ±1 db, 20 to 15,000 Hz. **Harmonic Distortion:** Less than 1% at 1,000 Hz with 100% modulation. **19 & 38 kHz Suppression:** 55 db or greater. **SCA Suppression:** 50 db. **AM SECTION: Sensitivity:** 12 microvolts at 1,000 kHz. **Image Rejection:** 60 db at 600 kHz. 40 db at 1400 kHz. **IF Rejection:** 70 db at 1,000 kHz. **Harmonic Distortion:** Less than 1.5% at 400 Hz. 90% modulation. **Hum & Noise:** 45 db. **Power Requirements:** 105-125 or 210-250 volt 50/60 Hz AC. **Dimensions:** Overall, 16 3/4" wide x 4 3/4" high x 14 1/2" deep.

*Rated IHF (Institute of High Fidelity) Standards.

The New Heathkit AR-15... Crowning Achievement Of The World's Most Experienced Solid-State Audio Engineers! There's nothing like it anywhere in the transistor stereo market place. Besides the use of space-age integrated circuits and exclusive crystal filters in the IF section, it boasts other "state-of-the-art" features like these:

150 Watts Dynamic Music Power... 75 IHF watts or 50 RMS watts per channel... the highest power output of any stereo receiver. Delivers the coolest, most natural sound you've ever heard.

All-Silicon Transistor Circuitry... a total of 69 transistors, 43 diodes and 2 IC's for maximum reliability & stability.

Positive Circuit Protection... four Zener diodes and two thermal circuit breakers protect the driver and output transistors from overloads and short circuits of any duration.

Field Effect Transistor FM Tuner... cascode 2-stage FET RF amplifiers and an FET mixer provide high overload capability, excellent cross modulation and image rejection. Sensitivity 1.8 uv. Features a 4-gang variable capacitor and 6 tuned circuits for extreme selectivity under the most adverse conditions. Completely shielded... completely assembled for best performance.

Two Calibrated Tuning Meters... a signal strength indicator tells you when you receive the strongest signal — doubles as a VOM for check-out during or after kit construction. A special "Center-Tune" meter puts you on exact station frequency.

Tone-Flat Switch... bypasses tone control circuit for completely flat response.

Automatic FM Squelch... noise and AFC operated to hush between-station noise before you hear it.

Stereo Only Switch... silences all mono when you wish to listen to stereo broadcasts only. An added tuning convenience!

Super SCA Filter... removes SCA and noise frequencies above 57 kHz for clean, quiet listening.

Massive Power Supply... for low heat and superior regulation — electrostatic and magnetic shielding for lowest hum and noise.

Electronic Filter Circuit... provides power supply with exceptionally low ripple and excellent regulation.

Adjustable Phase Compensator for Station Differences... so you can be assured of the best stereo.

Wide Range Magnetic Phono Inputs... extra overload characteristics (98 db dynamic range). All inputs adjustable from front panel. Plus automatic switching to stereo, transformerless design, filtered outputs and a host of other deluxe features for the discriminating audiophile. An assembled wrap-around walnut cabinet with a vented top is available at \$19.95. Liberal credit terms also available.

† Kit AR-15 (less cabinet), 28 lbs. \$329.95
AE-16, assembled walnut cabinet, 7 lbs. \$19.95



FREE!

World's Largest Electronic Kit Catalog

Contains full descriptions and specifications of AR-15 and over 250 easy-to-build kits... stereo/hi-fi, color TV, electric guitars & amplifier, organs, AM-FM-shortwave radios, test, marine, CB and ham radio. Mail coupon or write Heath Company, Benton Harbor, Michigan 49022.



HEATH COMPANY, Dept. 15-5
Benton Harbor, Michigan 49022

Please send FREE Heathkit Catalog.

Enclosed is \$ _____, plus shipping.

Please send model (s) _____

Name _____

Address _____

City _____ State _____ Zip _____

Prices & specifications subject to change without notice.

HF-202

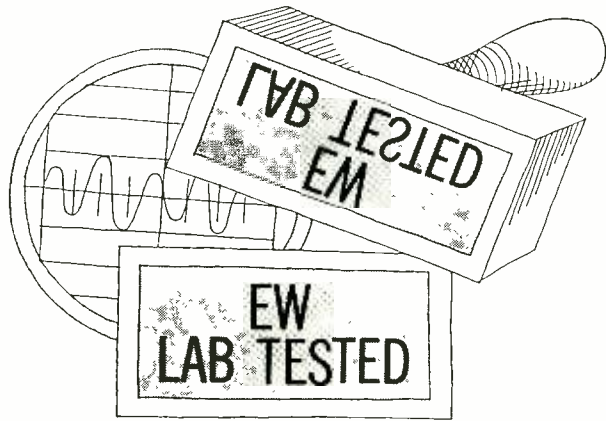

HI-FI PRODUCT REPORT

TESTED BY HIRSCH-HOUCK LABS

Heath AR-15 Stereo Receiver
Shure Model 565 "Unisphere I" Microphone

Heath AR-15 Stereo Receiver

For copy of manufacturer's brochure, circle No. 26 on Reader Service Card.



THE "Heathkit" line of hi-fi equipment has grown in sophistication compared to the rather basic kits of a few years ago. The new AR-15 stereo receiver is one of the most advanced receivers on the market today, with a number of features not found in factory-wired units.

Heath implies strongly that the AR-15 represents a new high in advanced performance and circuit concepts. After testing and living with the AR-15 for a while, we must concur. The unit is among the best receivers we have tested and its FM tuner is especially outstanding.

The receiver is an all-solid-state unit with silicon transistors throughout and with integrated circuits in its FM i.f. amplifier. The AR-15 is large and heavy with much of its weight concentrated in the power transformer. This affirms its great audio power capability, which is rated at 50 watts per channel con-

tinuous, or 150 watts total music-power output.

The AR-15 tuning dial, which covers most of the frontal area, is an opaque jet black when the receiver is turned off. Turning the receiver on illuminates the dial numerals, the input-selector switch markings, function lights, and the two tuning meters. One meter indicates signal strength and the other is a center-tuning indicator for FM reception. The *only* features possessed by any other receiver but not found on the AR-15 are center-channel output, speaker switching provisions, rumble and scratch filters, and tape-head inputs.

Worthy of special mention is the exceptional dynamic range of the magnetic phono-cartridge preamplifier stages, which can handle up to 180 mV without distortion. Even the highest output cartridges can be used with it without danger of over-driving when playing a disc with high recorded levels.

This is achieved by operating the pre-amplifier stages with a 50-volt supply, higher than any other stages in the receiver except the output stages.

The tone controls can be bypassed completely by pulling out the treble tone-control knob. The output transistors are protected against damage from short circuits or over-driving. If the overload persists, thermal cut-outs remove the voltage from them until they cool down to a safe temperature. A red light on the panel indicates operation of the protective circuit breakers.

The FM tuner front-end uses field-effect transistors (FET's) for high sensitivity and freedom from cross-modulation. The FM i.f. amplifier is completely unique. This marks the first use of integrated circuits in a kit receiver. Each IC, about the size of a transistor, contains 10 transistors, 7 diodes, and 11 resistors. Instead of the usual i.f. transformers, which require alignment periodically and have less-than-ideal response characteristics, the receiver uses two crystal lattice filters. Although costly, these have a virtually ideal "flat-topped" response characteristic, with extremely steep skirts which offer a degree of adjacent-channel selectivity unobtainable with conventional i.f. transformers. (For further details, refer to "Integrated Circuits Used in New Hi-Fi AM FM Receiver" in our January, 1967 issue.—Editor)

The IC's have exceptionally fine limiting characteristics, which obviates the need for separate limiter stages. In order to provide automatic gain con-

(Continued on page 82)

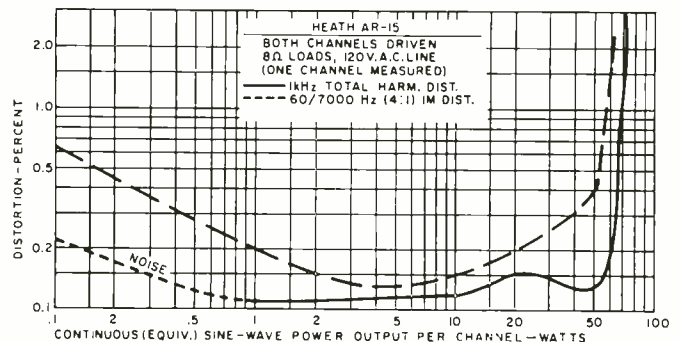
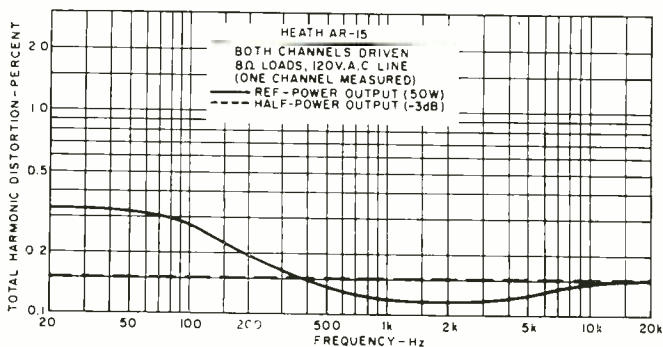



NEW Heathkit®/Thomas "Paramount" Transistor Theatre Organ

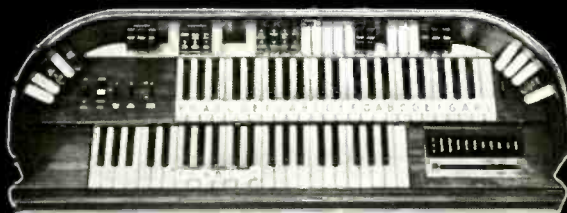

Professional Horseshoe Console Plus Color-Glo Keys . . . a beautiful array of multi-colored stop tablets at your fingertips for convenient selection of all 19 organ voices. Plus famous Thomas Color-Glo lighted keys so you can play complete songs the first time you try it . . . even if you've never played an organ before!

Kit TO-67
\$995⁰⁰

19 Voices, 200 Watts Peak Power, Chimes, 2 Speaker Systems, "Stereo" Sound And Full Professional Features At Over \$500 Savings!

All Genuine Thomas Factory-Made Components With Easy Heathkit Assembly And "Do-It-Yourself" Economy. That's the new deluxe Heathkit version of the Thomas "Paramount" Theatre Organ. And yet you don't have to be an "electronics wizard" to build it, nor a professional organist to play it. Famous "Heath Engi-nuity" reduces assembly to simple steps that require no special skills or knowledge. You even tune the organ with a pre-tuned tone generator. And instant-play Color-Glo starts you playing complete songs on your very first try. Combines a wide array of professional features with a luxurious horseshoe console and cool solid-state circuitry to make it a truly outstanding instrument you'll be proud to have in your home.

15 Manual Voices; 4 Pedal Voices . . . all at the flip of a tab. For solo work . . . diapason 16', bass clarinet 16', trumpet 16', English horn 8', oboe 8', violin 8' and tibia 16', 8', 5 1/2', 4'. For accompaniment . . . diapason 8', saxophone 8', French horn 8', oboe horn 8' and cello 8'. And now, *four* pedal voices . . . diapason 16', major flute 8', bass clarinet 8' and string bass 8'. And you'll soon learn voice combinations to produce the sounds of a Spanish guitar, zither, bagpipes, calliope. Plus other rhythm and voice variations for every musical mood. Rock & roll. Classical. Show tunes. Even religious music.

Two Separate Speaker Systems . . . a built-in 2-speed rotating Leslie plus a main system with two 12" speakers that can handle the 200 watts peak power delivered by two separate amplifiers. You can even create "stereo" sound, since the Leslie also acts as a second standard channel.

Luxurious Hardwood Cabinet And Bench . . . handcrafted and hand-rubbed with a lustrous walnut finish . . . ready for the sub-assemblies as you complete them. Cabinet measures 40" H x 48" W x 25" D.

Other Professional Features Include two 44-note keyboards, 28 notes of electronic chimes, 13-note bass pedals, keyboard and pedal sustain, reverb, selective repeat percussion to produce realistic xylophone, mandolin and marimba sounds; selective attack percussion; manual balance; timbre mellow to emphasize the warm character of orchestral voices; variable vibrato; pedal percussion and volume; expression pedal; stereo headset outlet and 5-year warranty on plug-in tone generators. Liberal credit available, too. Get all the details by sending for your FREE Heathkit Catalog!

Kit TO-67, organ & matching bench, 250 lbs. \$995.00

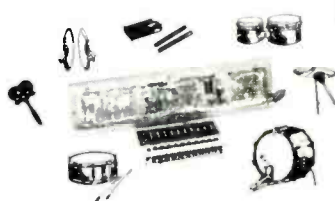

Optional Band Box Percussion

Adds 10 percussion voices to the music you play . . . Bass drums, two bongos, castanets, brush & crash cymbals, claves, blocks, snare drum and drum roll. May be added to all other Heathkit/Thomas organs with TOA-67-2 drawer and slides @ \$35.

Kit TOA-67-1, 8 lbs. \$145.00

Like To Hear It Perform?

Then send for organ demonstration record TOA-67-3 (7", 33 1/3 rpm). Listen to the beautiful voices, true organ tone and professional capabilities of this superb instrument. For GD-325B organ below, order record GDA-325-1. Enclose 50c for postage & handling.



Low Cost Heathkit®/Thomas Color-Glo Organ . . . \$394.90

- All transistor circuit • 10 organ voices
 - 13-note bass pedals • Repeat percussion
 - Instant-play Color-Glo • Two 37-note keyboards
 - 50-watt peak power • Vibrato • Matching preassembled walnut cabinet & bench
 - 5-year warranty on plug-in tone generators.
- Kit GD-325B, 172 lbs. \$394.90

HEATHKIT

HEATH COMPANY, Dept. 15-5
Benton Harbor, Michigan 49022

Please send FREE Heathkit Catalog.

Enclosed is 50c. Please send organ demonstration record no. _____

Enclosed is \$ _____ plus shipping.

Please send model (s) _____

Name _____

Address _____

City _____ State _____ Zip _____

Prices & specifications subject to change without notice. CL-284

Join "THE TROUBLESHOOTERS"

They get paid top salaries
for keeping today's
electronic world running

Suddenly the whole world is going electronic! And behind the microwave towers, push-button phones, computers, mobile radio, television equipment, guided missiles, etc., stand **THE TROUBLESHOOTERS**—the men needed to inspect, install, and service these modern miracles. They enjoy their work, and get well paid for it. Here's how you can join their privileged ranks—without having to quit your job or go to college in order to get the necessary training.

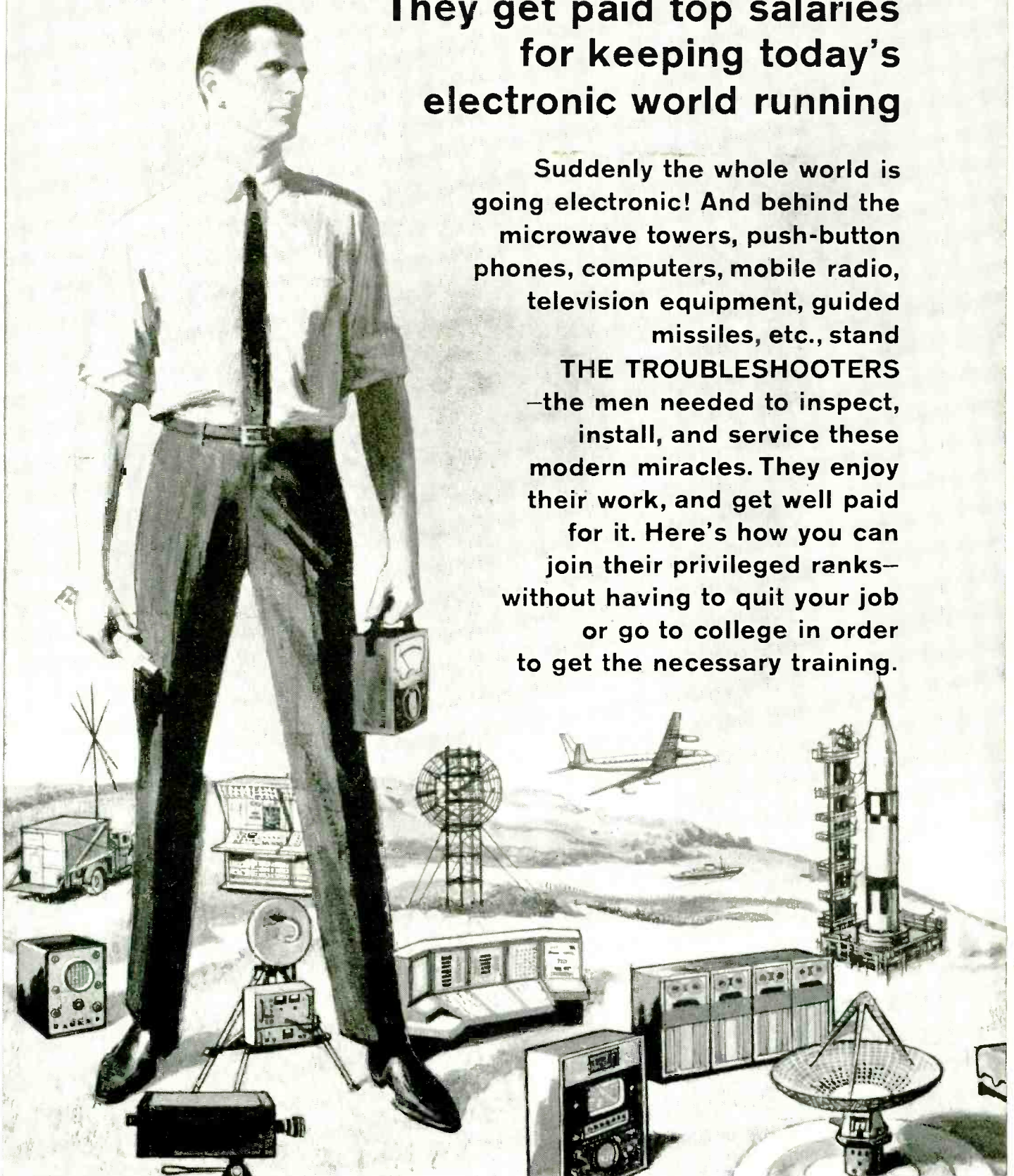

JUST THINK HOW MUCH in demand you would be if you could prevent a TV station from going off the air by repairing a transmitter...keep a whole assembly line moving by fixing automated production controls...prevent a bank, an airline, or your government from making serious mistakes by repairing a computer.

Today, whole industries depend on electronics. When breakdowns or emergencies occur, someone has got to move in, take over, and keep things running. That calls for one of a new breed of technicians—The Troubleshooters.

Because they prevent expensive mistakes or delays, they get top pay—and a title to match. At Xerox and Philco, they're called Technical Representatives. At IBM they're Customer Engineers. In radio or TV, they're the Broadcast Engineers.

What do you need to break into the ranks of The Troubleshooters? You might think you need a college diploma, but you don't. What you need is know-how—the kind a good TV service technician has—only lots more.

Think With Your Head, Not Your Hands

The service technician, you see, "thinks with his hands." He learns his trade by taking apart and putting together, and often can only fix things he's already familiar with.

But as one of The Troubleshooters, you may be called upon to service complicated equipment that you've never seen before or *can't* take apart. This means you have to be able to take things apart "in your head." You have to know enough electronics to understand the engineering specs, read the wiring diagrams, and calculate how a circuit should test at any given point.

Now learning all this can be much simpler than you think. In fact, you can master it without setting foot in a classroom and without giving up your job!

AUTO-PROGRAMMED™ Lessons Show You How

For over 30 years, the Cleveland Institute of Electronics has specialized in teaching electronics at home. We've developed special techniques that make learning easy, even if you've had trouble studying before.

For one thing, our AUTO-PROGRAMMED™ lessons build your knowledge as you'd build a brick wall—one brick at a time. Each piece rests securely on the one that came before it.

ENROLL UNDER NEW G.I. BILL

All CIE courses are available under the new G.I. Bill. If you served on active duty since January 31, 1955, or are in service now, check box on reply card for G.I. Bill information.

In addition, our instruction is personal. When your teacher goes over your assignment, no one else competes for his attention. You are the only person in his class. He not only grades your work, he analyzes it to make sure you are thinking correctly. And he returns it the day it's received so that you can read his comments and corrections while everything is fresh in your mind.

Always Up-To-Date

To keep up with the latest developments, our courses are constantly being revised. This year CIE students are getting new lessons in Laser Theory and Application, Microminiaturization, Single Sideband Techniques, Pulse Theory and Application, and Boolean Algebra.

In addition, there is complete material on the latest troubleshooting techniques including Tandem System, Localizing through Bracketing, Equal Likelihood and Half-Split Division, and In-circuit Transistor Checking. There are special lessons on servicing two-way mobile equipment, a lucrative field in which many of our students have set up their own businesses.

Your FCC License—or Your Money Back!

Two-way mobile work and many other types of troubleshooting call for a Government FCC License, and our training is designed to get it for you. But even if your work doesn't require a license, it's a good idea to get one. Your FCC License will be accepted anywhere as proof of good electronics training.

And no wonder. The licensing exam is so tough that two out of three non-CIE men who take it fail. But CIE training is so effective that 9 out of 10 of our graduates pass. That's why we can offer this warranty with confidence: *If you complete one of our license preparation courses, you'll get your license—or your money back.*

Mail Card for 2 Free Books

Want to know more? Mail the postage-paid reply card bound here. We'll send our 40-page catalog describing our courses and the latest opportunities in Electronics. We'll also send a special book on how to get a Commercial FCC License. Both are free. If the card is missing, just send us your name and address.

CIE

Cleveland Institute of Electronics

1776 E. 17th St., Dept. EW-32, Cleveland, Ohio 44114

Accredited Member National Home Study Council
A Leader in Electronics Training . . . Since 1934



Capacitor stability at bargain prices

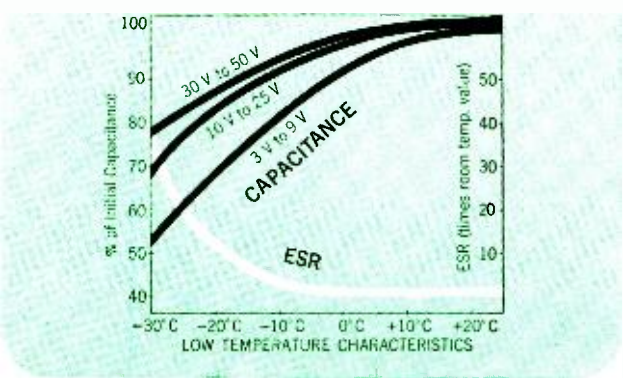
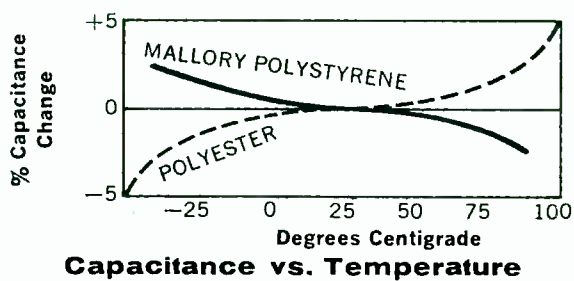
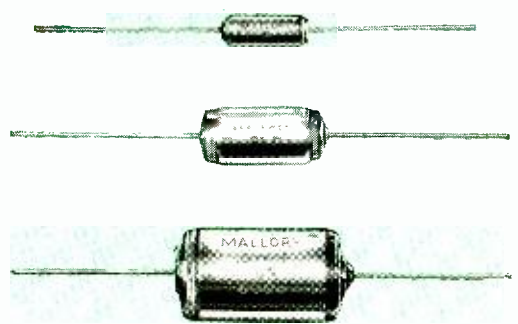

Any capacitor changes its microfarad value when temperature varies. And some capacitors change more than others. In some circuits, capacitance drift with temperature can cause real problems.

Look at circuits where you have fractional microfarad values of paper, film, ceramic or mica capacitors. During warm-up from room temperature to 65° C ambient, a capacitor with a temperature coefficient of, for example, 500 parts per million per degree C will increase capacitance value by 2%. This change is enough to cause troublesome drift in tuned circuits, where inductance *also* increases with temperature. It can knock the accuracy of a timing circuit off, or mess up the performance of a differentiator network. For these applications, we have a new kind of capacitor that beats anything we've seen in the stability race. It's the new Mallory Polystyrene Capacitor. They're made of stretched polystyrene film and high purity aluminum foil. The assembly is fused into one piece, with the polystyrene forming a solid case of clear plastic that you can look through and see the foil. Their temperature coefficient is less than 150 parts per million per degree C, which is about half that of polyester film capacitors. And the coefficient is *negative*; capacitance goes down when temperature goes up, compensating for the upward drift of inductance elements in tuned circuits.

Want more? Mallory Polystyrene Capacitors have the lowest dielectric loss . . . only a small fraction of that of other film capacitors. Their insulation resistance is way above that of mica, film or paper capacitors. And the best part of the whole deal is that they're really *low* in price!

There's something new from Mallory, too, in stable electrolytic capacitors. It's the molded-case MTA, which has temperature stability that beats most metal case types. It has shown up so well on life test that manufacturers are using it in instruments and computers. And while it's priced down with cardboard-case tubulars, it beats them every way on quality.

You can get these stable Mallory capacitors, and everything else you need for service or experimenting, from your nearby Mallory Distributor. Ask him for a copy of our 1967 General Catalog, or write to Mallory Distributor Products Company, a division of P. R. Mallory & Co. Inc., Indianapolis, Indiana 46206.

DON'T FORGET TO ASK 'EM — *“What else needs fixing?”*



In this automotive safety feature of the future (proposed by G-E), a short-range laser ranging device reduces the probability of accidental rear-end collision.

Electrovair II, by General Motors, uses silver-zinc batteries for up to 80 miles of driving before recharge.

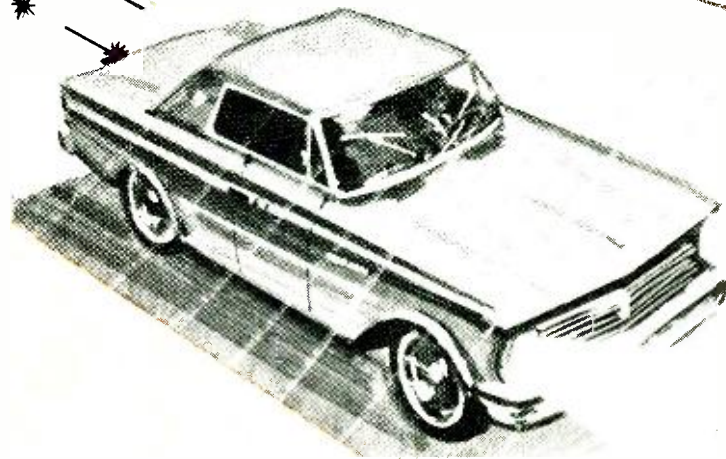
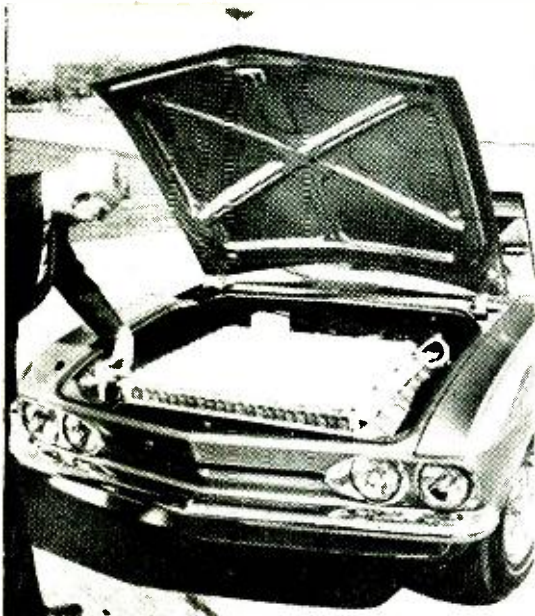

AUTOMOTIVE ELECTRONICS

By ROBERT M. BROWN

Tomorrow's cars will lean heavily on electronics. For example, voltage regulators, fuel warning systems, anti-skid control, and a radar-like laser system to prevent rear-end collisions are among items proposed.

UNTIL quite recently, major developments in the automotive field seemed to be limited to such areas as better styling, improved gasoline consumption rates, and, lately, the feasibility of turbine-powered vehicles. Within recent months, however, electric and electronic equipment has moved to the forefront. To talk about transistorized car radios, automobile safety, and electric autos all in the same article might seem a rather disjointed method of approaching the status of automotive electronics, but these developments are all related and point to the fact that sweeping changes are indeed beginning to be felt in Detroit.

At this writing, it is still not known exactly which safety improvements will actually show up with the 1968 models, but if Dr. William Haddon, Jr., chief of the National Traffic Safety Agency, has his way, twenty stringently imposed features will debut this coming September.

Although most of the controversy has revolved around certain mechanical changes (such as better seat anchorages) and the auto manufacturer's leadtime requirements, considerable fallout has hit both the automotive accessory makers and the original equipment manufacturers (OEM) who now find themselves scurrying about for electronic devices designed to plug the more obvious safety loopholes in the American car. And since considerable Detroit funds have suddenly been diverted to meet Washington's new

demands, a severe cutback is being felt by many standard component R & D companies now faced with the problem of economical and rapid production. The solution appears to be electronics.

Some Electronic Developments

Although we are all familiar with perhaps the first application of solid-state components in the family car—the transistorized radio—the most significant step forward was the use of the silicon diode in the alternator. This move represented a real risk for the automobile manufacturer because his use of these diodes affected both the safety aspect of the car and his costs, both initially and under warranty. The success story of the alternator rectifier was so remarkable that the industry began to take a long, hard look at the electronic technology it had for so long ignored.

The next step was to see what could be done about the voltage regulator. It seemed logical that a transistor could be used for this purpose because a circuit could be designed to respond to the difference between battery voltage and a stable reference source, with this signal controlling the output of the alternator. Fig. 1A illustrates a simplified transistor-type regulator, while Fig. 1B shows an approach using an SCR. Several manufacturers (including Motorola) now have transistorized voltage regulators on the market, while Ford Motor Company has announced that it will be using

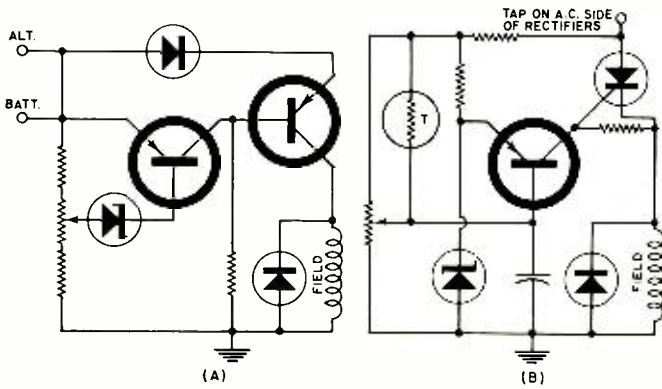

Fig. 1. (A) Simplified voltage regulator using a transistor. (B) Simplified SCR alternator voltage regulator.

some solid-state regulators in many of their 1968 models.

Although transistor ignition systems have been with us for some time, they are still undergoing further development. Of the several approaches commercially available, the capacitor-discharge system appears to be taking the lead, and some of the major auto manufacturers are already supplying such systems as an extra in some of their latest model cars.

In some of the more advanced versions of the transistor ignition system, even the mechanical point contacts are being replaced by either a photoelectric or magnetic pick-up, which, in turn, activates the ignition system.

As this latter approach reaches the customer, it then removes the last mechanical component that stands in the way of an all-electronic transistor ignition and voltage regulator system.

With the safety-equipment drive in full swing, renewed interest in the automatic headlight dimmer has arisen. Currently available in the top cars of the big three auto makers, this unit, in addition to turning the lights off after a predetermined delay, turns the headlights on and off according to ambient light. At present, there is considerable talk of using the same principle in dual-intensity tail lights—one brightness for daytime and a lower one for nighttime. This application has evolved from the problem of temporary "blindness" resulting from the increase in total light given off when a car is braked at night with four, five, or six bulbs across the back of the vehicle.

The day/night rear-view mirrors offered by the leading auto makers on certain models also show the extent to which solid-state circuitry is beginning to be used in safety apparatus. During night driving, if a following auto's headlights are on high beam, a photocell in the mirror sends a signal to a transistor amplifier, which in turn activates a miniature solenoid that flips the mirror to a different angle. This automatic action deflects the bright headlamp reflection away from the driver's field of vision. When the high-

beam light disappears (or the following car switches to the low beam), the mirror flips back to its normal angle.

The acceptance of these devices is significant because it shows that both the automobile manufacturer and the owner are willing to trust certain control functions of the car to solid-state technology.

The Future

While it remains impossible to predict to just what extent the trend toward more and more electronics in the automobile will advance, startling work is currently being done on sophisticated safety device systems that may ultimately find their way into family vehicles. A number of firms (including Bendix) are presently conducting research into the possibility of an anti-skid control circuit, a design that will initially be tested on jet aircraft landing wheels. Since in many instances it is the sharp, prolonged application of pressure to the brakes that causes an automobile to veer into a skid and consequently go out of control, the suggested system would keep this from occurring by partially disengaging the pedal from the brakes while applying a moderate amount of braking by itself. The idea is simply to cause an automatic and gradual slowing down, regardless of how much frantic pumping the driver might exert.

This system will use four transistorized tachometers, one on each wheel, feeding an IC logic circuit which would compare each wheel revolution rate to the rest while at the same time using a fifth feed (consisting of any one of several proposed methods) for arriving at an actual vehicular motion reference (total car speed in relation to the roadway). The logic center would in turn be coupled to an electrical mechanism with override capability that would be attached to the conventional hydraulic brake system normally under driver control. When the IC control sensed a severe departure from the balanced rpm "norm" on any one or more of the wheels and also "felt" that over-all vehicle speed exceeded a safe level, it would apply moderate braking pressure to the wheels. This pressure would vary, depending upon the total motion factor and what was actually happening on that one wheel. Should the skid situation correct itself, full braking control would revert to the driver.

Although considerable research is now underway on just such a control circuit, it is felt in many circles that Detroit will never permit this much of a vehicle's mechanical system to be turned over to solid-state components. "Consider what would happen if the system failed!" is a frequently encountered remark. On the other hand, it is known that a similar system will soon be tested on aircraft grounding apparatus, and the ever-growing confidence in current automotive solid-state devices has far from reached a peak.

General Electric is presently offering interested automobile accessory suppliers its ideas for an anti-tailgating device using a laser beam. The arrangement calls for use of a low-cost laser that would put out low-power pulses of light, coupled with an extremely sensitive solid-state sensor to pick up the light reflections. The laser device would mount on the front of the vehicle and "look" directly ahead for a distance of perhaps 300 to 400 feet, depending upon what range the driver is calling for at the moment. With the sensor feeding a transistor amplifier which in turn might activate a buzzer, lamp, or meter readout, the driver would know approximately how far he is behind the vehicle ahead even though that car might not be visible. Any number of sophisticated laser alerting systems could be developed. However, G-E feels that this system will probably make its debut as an anti-tailgating gadget designed primarily for use in heavy snow, sleet, and fog conditions where even radar is undependable. A spokesman for the company claims that such equipment could be mass-produced at "a very reasonable cost, although it must be stressed that the laser for passenger cars is still far from a reality."

Fig. 2. (A) Headlight-on reminder buzzes when ignition is off and lights are on. (B) Headlight time delay automatically turns headlights off after a 60-90 second delay.

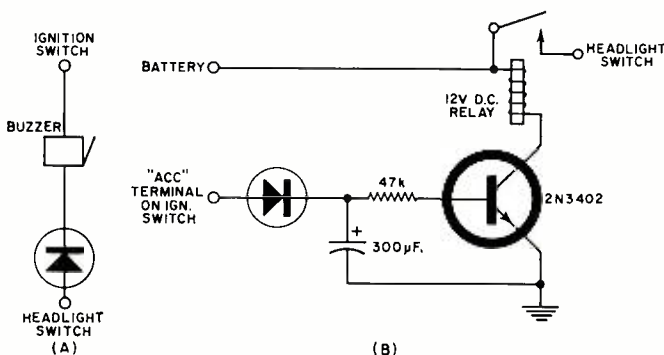

Long before such exotic designs become standard equipment, a host of less complex yet still impressive gadgets will appear. In fact, many such devices are here now.

The Boom in Accessories

A quick glance at the "available equipment" chart (Table I) confirms that solid-state components are presently playing a major role in many new products for the car. For example, let us take a look at what the photoelectric head-

light dimmer has stirred up. Fig. 2A shows a simple way to remind the driver that he left his headlights on after he turned the ignition off. In operation, when both ignition and headlights are on, both sides of the device are at the same potential. If the ignition switch is off and the headlights are on, current flows through the diode, activating the buzzer. Fig. 2B illustrates one method of achieving automatic headlight-off 60- to 90-second time delay. This unit is really two devices in one. (Continued on page 26)

D.C. MOTOR DRIVE FOR ELECTRIC CARS

By JOHN MUNGENAST

Electronic Components Div., General Electric Co.

That workhorse of the electric vehicle field, the fork lift truck, uses a d.c. motor control that has much to offer the electric car.

As we explore the electric drive for vehicles of the future, it is well to draw on the experience with solid-state drives presently being used on tens of thousands of vehicles throughout the world. The basic solid-state control system to be described is over six years old and has been in service in European delivery trucks, American golf carts, lift trucks, and personnel carriers as well as a complete German passenger train. The fundamental principle of a d.c. motor controlled by a solid-state "chopper" makes a natural starting point for discussions of future vehicle drive techniques. In addition, it should be noted that Ford research engineers claim they have in operation d.c. motors weighing only a quarter as much per unit power as the best now available and that these motors promise to be "low in cost and durable."

Essential vehicular drive requirements involve (1) the ability to reverse directions; (2) provision for dynamic braking; and (3) the ability to vary vehicle speed by lowering the voltage applied to the motor.

Categories (1) and (2) are generally provided by conventional methods of mechanical switching and the insertion of an appropriate armature resistance, which has been done conventionally for many years. The efficient reduction of battery voltage for speed control of the motor, however, poses a much more difficult problem.

While a variable resistor could do the job and indeed has been used in past electric vehicle controls, it has the disadvantages of lower efficiency, discernible control "steps," and poorer speed regulation (since the voltage drop changes with the motor current). Phase control, the answer to a.c. motor variation, is out of the question since the power source is a battery or other d.c. source. The power "chopper" mode of operation as shown in Fig. 1 seems like one answer. While this control method supplies the motor with power pulses, the motor responds to the average power level so that little sign of the pulsing is evident in operation.

A "chopper" is essentially a fast-acting switch, mechanical or solid-state, used to convert a d.c. level into a fluctuating wave-shape for purposes of power control, subsequent amplification, etc. (Other "chopper" applications include vibrator power supplies, automotive ignition points, etc.)

The solid-state chopper can use either power transistors or an SCR, and each has certain advantages and disadvantages. But since the majority of high-current choppers use SCR's, this type will be discussed.

The advantage of latching-type operation, where a small momentary signal turns the device on, is offset to some extent by the difficulties in turning the SCR off when it operates from a d.c. source. To turn the SCR off it is necessary for the load current to be interrupted momentarily. The complete circuit for such an operation is shown in Fig. 2—actually an overgrown power flip-flop.

In operation, it functions as follows. SCR1 is the main load-carrying SCR. When its gate is triggered on by unijunction transistor Q1 circuit, current is allowed to flow through half the winding of T3 and through the armature and field coil of the motor, which starts to run. The start of current flow induces a voltage into the other half of T3 which charges up C1. This charge is held until the "off" SCR (SCR2) is triggered by unijunction

transistor Q2 circuit. The voltage across SCR1 is then reversed and turned off. One of the advantages of this circuit is its ability to start reliably. Because of autotransformer T3, capacitor C4 is always charged up whenever load (motor) current starts to flow; thus, commutation energy is always available. The main SCR is turned on again at an interval based on desired motor speed. Variation of motor speed is based on either varying pulse width or pulse frequency, or a combination of both.

A typical control, built by the Industry Control Department of General Electric, is now in use in thousands of electric fork trucks and is shown in the photo below. The SCR's, heatsinks, and commutating capacitor are mounted on the large board with the firing circuit board held in the hand.

The control potentiometer (not shown) is connected to the accelerator pedal. Bypass switch S1 (Fig. 2) is usually energized at the end of accelerator travel, providing direct drive from battery to motor for maximum speed.

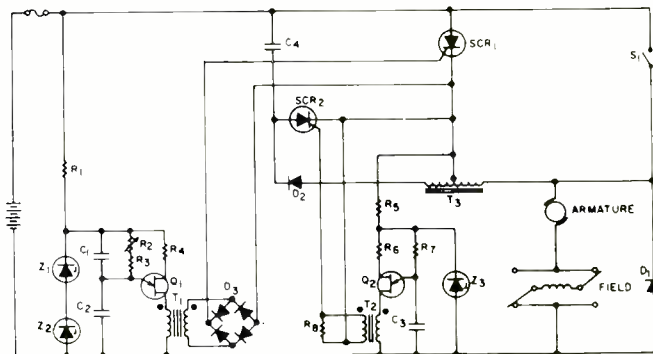

Fig. 2. SCR chopper circuit used for controlling a variety of battery-operated, d.c.-motor-driven electric vehicles.

Large SCR's and commutating capacitors on rear board, with firing circuit located on the smaller board. This system has been used for many years on electric fork lift trucks.

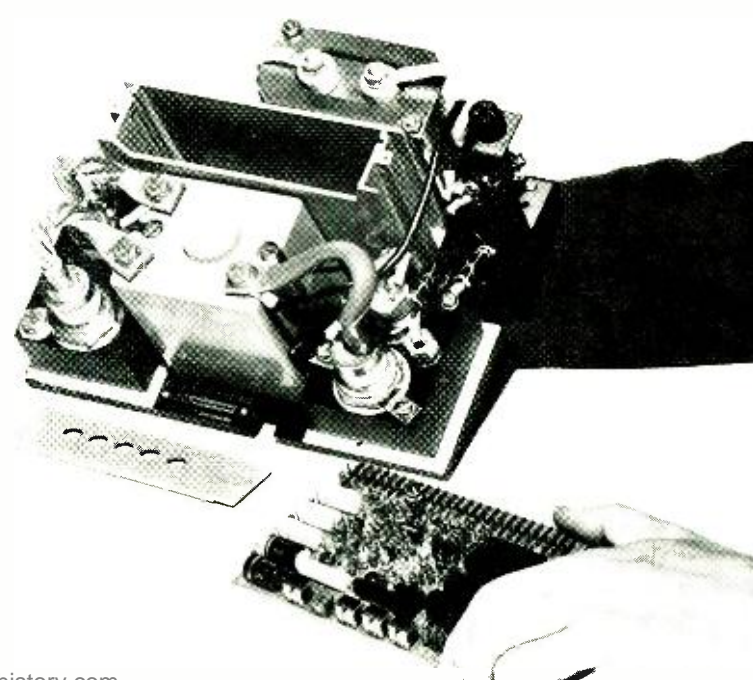
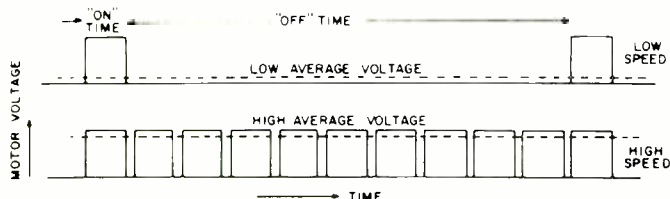

Fig. 1. In a power chopper circuit, the average voltage applied to a motor is a function of pulse "on-off" time.



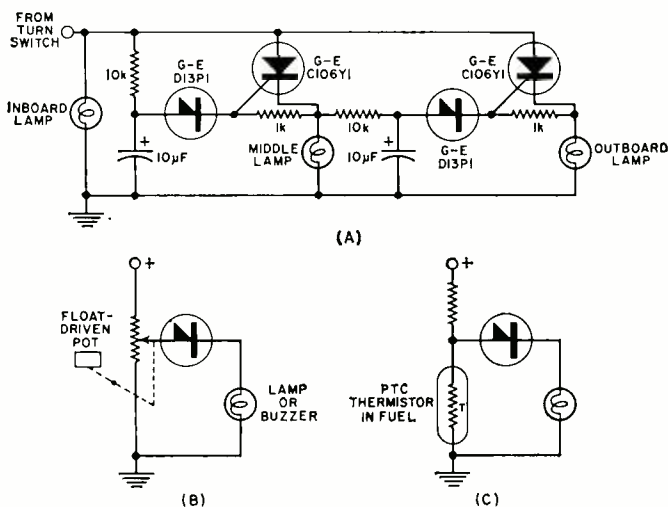

Fig. 3. (A) A system for creating sequential tail-light flashing. (B) Low fuel warning system using float. (C) Low fuel warning system using a self-heated thermistor.

It will delay the light-off signal to illuminate the way down the driveway or automatically turn headlights off should the driver forget.

Several manufacturers are introducing a solid-state module to produce the dazzling sequential tail-light effect now seen on certain cars. One way to do this is shown in Fig. 3A. These systems use SCR's to control the lamps and a conventional thermal flasher to open the circuit and reset the SCR's. A heavy-duty variable load flasher will not work with this system because it has a heater in parallel with the contacts and never really opens the circuit to shut off the SCR's. The breakdown diodes in the schematic are four-layer diodes which breakover (essentially short circuit) at a specific voltage (6 to 10 volts), thus triggering on the associated SCR. These diodes are well suited to such applications as level sensing. For example, one way that a manufacturer might indicate a low fuel supply is shown in Fig. 3B. In this circuit, as the float drops due to lowering of the fuel level in the tank, the potentiometer arm approaches the battery voltage until the diode fires, operating the buzzer or lamp. Fig 3C shows a method of employing a self-

heated thermistor that uses the fuel liquid as a heat sink to achieve the same low-level sensing. When the fuel level goes below the thermistor level, the thermistor heats up, raising its resistance, until the diode voltage is sufficient to cause breakover.

Semiconductors have also been finding their way into products related to service and performance, although permanent auto equipment applications are still being watched very carefully because of the undetermined reliability factor. *Delco-Remy* has introduced a capacitive-discharge ignition system which uses a magnetic arrangement to eliminate the points. This system requires a switch signal amplifier, a transistorized inverter to produce a high voltage for charging a capacitor, and an SCR to switch the capacitor charge through the ignition coil in step with the switch signal.

Three English firms have been demonstrating a fuel-injection system that uses electronics to provide metering information and to control solenoid valves at each cylinder.

The Car of Tomorrow

Arthur E. Fury, a specialist in market development for G-E's Semiconductor Products Division, has some interesting thoughts on the dream car of the future. He visualizes an electronic speedometer used to drive an electroluminescent numeric readout as well as to provide information to the car's system. A laser range finder (an expansion of the proposed anti-tailgating system) supplies information about the distance and relative velocity of other vehicles. An accelerometer measures acceleration and deceleration, while a tachometer measures engine rpm.

Additional solid-state devices? "Thermistors, photocells, and silicon strain gages are placed about the car to measure ambient light, engine temperature, inside temperature, coolant level, gas level, oil level, oil pressure, tire pressure, and so on. Fuel flow is measured by two thermistors in the gas line, and exhaust emission is checked electrostatically. We add a two-way radio, and presto! we have a car that could be driven onto a superhighway and controlled either manually or by autopilot."

How would it work? A driver with such equipment would now have information about his speed condition, efficiency of the car, and road conditions. When it gets dark, his lights

Table 1. Three categories of automotive safety devices divided into electric, non-electric, and electronic divisions.

PERFORMANCE/EFFICIENCY	SAFETY/WARNING	LUXURY/EXTRAS
ELECTRIC	NON-ELECTRIC	ELECTRIC
Tandem fuel pumps that deliver 70 gallons per hour	Magnets that pick up stray bits of metal in engine blocks	Push-button door openers
Fuel flowmeters that read out engine consumption in gallons per hour	Fiber-optic tubes carrying light from outside lamps to warn of malfunctions	Motorized seats, antennas, windows, etc.
ELECTRONIC	ELECTRIC	ELECTRONIC
Alternator/generators, SCR	"Lights on," "Door not closed," etc., warning lights	Power inverters for powering electric shavers, etc.
Transistorized tachometers	Trunk and door locks	Transistorized AM/FM/short-wave receivers, often with reverb.
Solid-state voltage regulators	Transmission lock in "Park"	Transistorized in-car stereo playback systems
Exhaust gas analyzers that measure combustion efficiency and fuel-air ratio for correct carburetor settings	Windshield wipers	Converters for h.f. and v.h.f. reception on AM car radios
Electronic superchargers	Cornering lights, activated by turn signal	Two-way mobile communications equipment (CB, etc.)
Transistorized ignition systems	ELECTRONIC	Sequential tail-light systems for high-style rippling effect
Capacitive discharge ignition systems	Transistorized 4-way emergency flashers	Electronic throttle and speed controls
	Photoelectric headlight activators and dimmers	Automatic climate controls using thermistors and transistor amplifiers to activate outside air flow, heater, air conditioner, etc.
	Delay circuits to keep lights on 90 seconds after ignition is off	
	Siren/flashers for police vehicles	
	Transistorized burglar alarms	
	Overspeed warning devices	
	Flip-flop rear-view mirror using photocells, transistors, solenoids	

would go on automatically and the brake lights would be set to a dimmer degree. Should he go too fast, a buzzer would warn him and then some automatic counterpressure would be applied to the gas pedal. If he approaches the car in front too rapidly, the laser would control his brakes and accelerator. Should he panic, an anti-skid circuit would take over. Dashlights would tell if the gas is low, etc., and a major failure of something such as oil pressure would tell the computer to stop the car. (See "Integrated Circuits and the Automobile" in the February, 1967 issue of this magazine.)

Too way out? Probably, but the publicity over the HELP (Highway Emergency Locating Plan) program two years ago has already given way to GM's DAIR (Driver Aid, Information, and Routing) system now being tested in Detroit. It utilizes a basic CB set in an advanced-design configuration (Fig. 4) which affords the driver the following basic aids:

1. It provides reception of voice messages pertinent to traffic conditions and the road ahead.
2. It provides a display panel on the dashboard which reproduces roadside traffic signs by lights and readout tubes through its reactions to magnetic traps in the roadbed (see Fig. 5).
3. It provides illuminated instructions (turn left, make right, etc.) over a predetermined route, eliminating the necessity for map reference.
4. It provides a facility for tone-coded or voice communications between driver and a service center (on the CB band), permitting the motorist to summon aid or get road information when traveling on non-magnetic highways.

The Phenomenon of the Electric Car

Detroit's 1966 electric car revelation has perhaps more than any other factor been responsible for hastening the transition to solid state in the family vehicle. With the mass media supplying the public with daily reports of electric car R & D progress, potential customers are becoming increasingly aware that if anything truly revolutionary is ever to emerge from the automotive scene, a high degree of ultimate reliance on electronic components is essential. Mechanically inclined teenagers are poring over auto magazines bristling with facts about fuel cells and sodium-sulfur batteries while their parents skeptically await the first production-line electric car. Behind the open "can-it-be-done?" controversy, however, there lies a feverish undercurrent of activity felt not only by the auto makers but indeed by their suppliers and substantially influential segments of the electronics industry.

The reason for much of this is the inherent competitiveness associated with the American auto manufacturing business, well exemplified last fall when *Chrysler*, *Ford*, and *GM* made public for the first time their research into better storage cells. These announcements were made within a week or so of each other. In spite of the massive *GM* work which seemed to culminate in its "Electrovan" and "Electrovair" experimentals, one factor that has kept this entire business from simply becoming relegated to the status of a publicity stunt was *Ford's* public statement that perhaps "within five years we will have a production-line electric car" that would utilize the company's new sodium-sulfur batteries, "good for the life of the vehicle." While *Ford* talked about small two-passenger runabouts and the rest of the industry concentrated on competing with existing gasoline types, electronics engineers were developing improved drive systems utilizing sophisticated SCR control apparatus and IC logic units. Since October, 1966 the over-all size and prototype costs for one such high-voltage system (necessary for the a.c.-motored types *GM* and *Chrysler* envision) have been nearly halved.

Ford, on the other hand, is holding to its simple, low-voltage d.c. drive concept which appears to be gaining

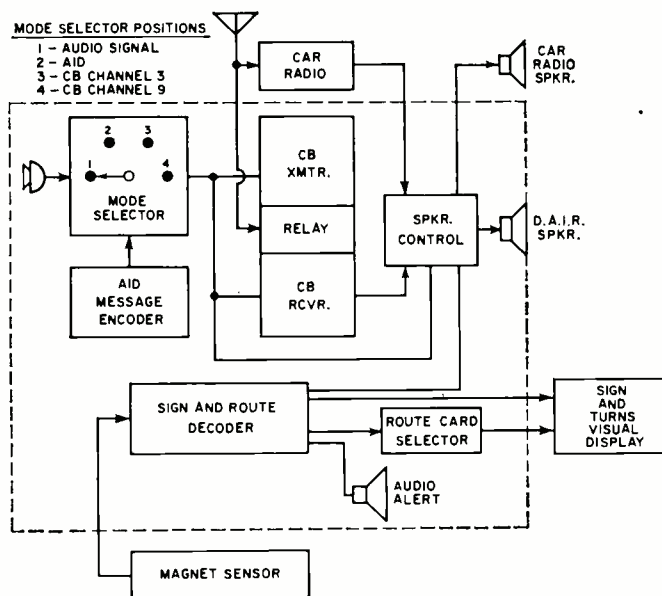

Fig. 4. Basic arrangement of General Motor's DAIR (Driver Aid, Information, and Routing) system now being tested.

steadily in industrial acceptance. A recent Gallup poll confirmed that the public, too, would be interested in seeing *Ford's* scaled-down motorcar. Temporarily compromising for the sake of competition, *Ford* has promised to deliver from its British factory "the first prototype"—using conventional lead-acid storage batteries—"to be shipped to the United States in June." Walter Hayes, a British *Ford* official, admits that "this is going to be no Batmobile . . . but a bigger version could take a minimum of 10 years to get on the road in the U.S." *GM* and *Chrysler* seem to agree but on the surface appear to be sticking to their "average-sized car" battleplans. Rumbblings from the OEM camp and certain segments of the solid-state industry, however, indicate quite the opposite. It remains to be seen just what will eventually emerge from Detroit, but it is quite clear that a considerable amount of auto maker R & D funds is being spent on exploration of various types of electronic car control systems.

However, not all this money is coming from Detroit. The Edison Electric Institute (a trade association of power companies) has earmarked over \$1 million for 1967-68 work on "battery-fuel cell development." Obviously, associated solid-state systems research also falls into this category. U.S. Senator Magnuson's pending bill would grant huge sums of Federal aid to electric car development, and two quite similar bills are currently awaiting action in both houses of Congress. The U.S. Post Office is now test-driving four battery-powered trucks in various sections of the East. *Lear-Siegler* has developed a six-motor electric-driven test bed vehicle for the Army. Since 1964, teams of researchers from the General Atomic Division of *General Dynamics* have been exploring diverse facets of electric cars. And the list goes on and on.

The Role of Solid State

Recurrent off-the-cuff remarks by electronics firms largely dependent upon Detroit contracts would have one believe that all the talk about future scarcity of gasoline, traffic

Fig. 5. In the DAIR system, the magnetic poles are sensed and decoded as programmed vehicle speed. Other magnetic arrangements are used to supply further control commands.

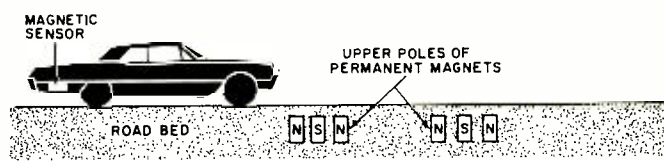

noise, reduced electrical costs, and air pollution is just so much nonsense. This viewpoint has been given momentum by *American Motors'* announcement in February of its intention to market a small combustion-type passenger car which would openly compete with the Volkswagen.

Coupled with the near reality of *Ford's* electric car for city driving, this makes a pretty good argument for those with vested interests in d.c. drive configurations controlled by SCR choppers. Again, though, it is becoming apparent that regardless of the a.c.-d.c. controversy, solid-state com-

ponents will be used as the "heart" of the vehicular drive system.

If fuel cells are employed in mass-production cars, thermistors, transistor amplifiers, and in some cases IC's will be required to maintain required temperature control. The widely publicized hydrogen-oxygen cells require a cooling level between -279°F and -423°F . Most of the experimental motors now in use must be constantly temperature-compensated, using circulating oil as a coolant.

A host of new solid-state safety devices is also imminent,

A.C. MOTOR DRIVE FOR ELECTRIC CARS

PUBLIC excitement over Detroit's sensational electric car disclosures last year was somewhat dampened by the apparent impracticality of available batteries. In the wave of disappointment which followed, one major point was all but overlooked—the fact that a lightweight, a.c. electric-drive system had proven itself in a passenger car, turning in a performance comparable to that of any current internal combustion engine. Not that a.c. electric motors are new by any stretch of the imagination, but the fact that their first trial with an electronic control system in an automobile achieved such satisfactory performance is nonetheless startling. Particularly as employed in cars where the maximum weight area must be allotted to batteries, the a.c. drive system holds much promise for the future.

Squirrel-cage a.c. induction motors have traditionally been used as single-speed machine power sources in applications demanding high rpm action. To supply the motor adequately, it is only necessary to feed it a constant voltage, at a constant frequency, consistent with the requirements of the motor. This consistency depends upon "slip" frequency—the difference between the actual mechanical rotor speed and the rotating stator field speed. (The rotor actually runs a bit behind the field.) Since the "slip" is plainly evident at a constant speed, a prescribed frequency requirement is met with the feed current. Hence, to attain variable speed operation, both the voltage and the frequency would have to be varied. To further complicate matters, the percentage of "slip" may be as

little as 1% or as much as 10%, depending upon motor design and operating parameters.

These obstacles are somewhat diminished when it is considered that this apparatus can also take care of reverse action and braking, while the resultant high rpm will eliminate the necessity for bulky three- or four-speed transmissions. Existing 4:1 gears and differentials can be employed for the sake of expediency.

Several approaches can be taken. The *Henney "Kilowatt"* (a re-fitted *Renault "Dauphine"*) employs electric relays for closing magnetic switches in sequence as the accelerator is pressed to provide six power levels. Yet accelerator technique is tricky and frequently results in blown fuses. Critics also call attention to "uneven acceleration". Electronic switching could be achieved using thyratrons or ignitrons. However, these outdated elements, in addition to being ungainly and heavy, do not solve the "slip" frequency problem.

The Loop A.C. Drive System—GM

Using integrated circuitry and SCR choppers, the "modulating inverter" has been devised to cope with a.c. induction motors. This, in effect, varies both the voltage and frequency in accordance with motor slip requirements and the driver's acceleration. Known as a "loop" control system (Fig. 1), *General Motors* is banking on it for all future electric car research and production, although engineers on the "Electrovair" and "Electrovair" estimate 1966 costs at about \$5000. Part of this expenditure was due to the use of 400-ampere, 1200-volt SCR's which have to be series- and parallel-connected in the inverter. It is hoped that within a few years inexpensive 500-A, 2000-V versions will lower this cost appreciably.

In the loop system, a voltage proportional to motor speed is obtained by a tachometer/generator on the drive motor shaft. This signal is passed to an IC logic circuit where it is compared with a preset voltage (derived from a potentiometer coupled to the accelerator) to produce the frequency for switching the solid-state inverter and power control (SCR's) on and off. Since the inverter reduces the average voltage to the motor by supplying it with power pulses, the ratio of on-to-off time of the pulse determines motor voltage. Varying the ratio of the on-to-off time of the pulse while keeping the pulse frequency constant, accomplished by varying the frequency of repetition of a constant-width pulse, renders a combination of pulse-width and pulse-frequency modulation. This combination has been found to produce excellent variable speed operation of an a.c. induction motor. To change motor speed, the driver alters the value of the preset voltage by depressing the accelerator (connected to a potentiometer). A switch turns the system off each time the accelerator is released.

The Loop Drive System—Lear Siegler

With many organizations attempting to develop high-performance a.c. motor-drive systems simultaneously, it is logical that different approaches would be tried.

Thinking more in terms of heavy-duty truck-type vehicles or applications for railroad transportation (and even drive systems

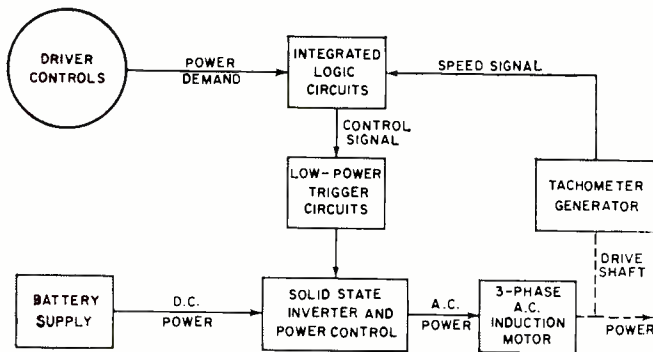

Fig. 1. Loop system of a.c. drive used by General Motors.

Fig. 2. Basic SCR unit of Lear-Siegler changes three-phase power from gas-engine-driven alternator to single-phase a.c. output. Logic circuits control the conversion.

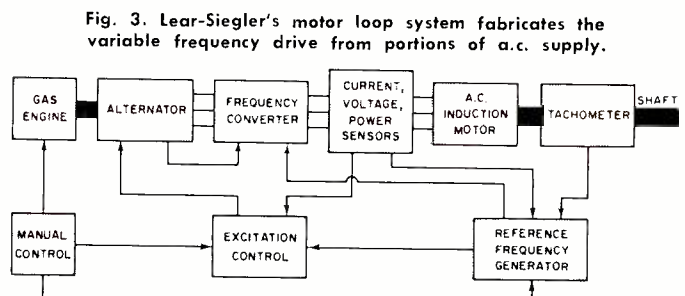
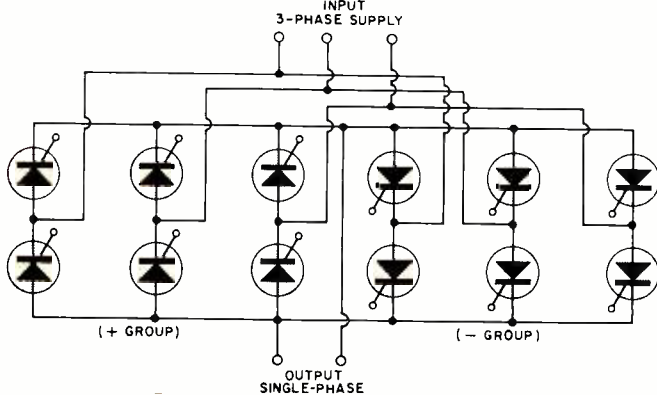

Fig. 3. Lear-Siegler's motor loop system fabricates the variable frequency drive from portions of a.c. supply.

since reliability will again become a major area of concern (power could lock on, motor could overspeed, control lever could slip from forward to reverse, etc.). New warning lights and failure-compensating circuitry will be required. If the GM concept is accepted, adequate safeguards against SCR overheat and over-all system shorting will have to be developed, as well as safeguards against possible danger to the driver as a result of 400-volt, 400-ampere currents, particularly in the event of severe physical vibration or collision with another automobile. Even the low-voltage

Ford approach will ultimately necessitate a means of driver-monitored performance, optional automatic speed-reduction circuits to optimize battery life, and wherever feasible over-all substitution of solid-state components for present mechanical counterparts to achieve the absolute minimum drain on the already overworked storage cells.

Even if electric cars fail to materialize to the degree anticipated, at least the controversy will have left the automotive electronics industry many years ahead of where it might have been without it. ▲

How some companies plan to use an a.c. source as power for their cars. Unique among them is a drive motor mounted within the wheel.

By ROBERT M. BROWN

for large parabolic antennas), Lear Siegler (LSI) took a somewhat more complex approach to the problem. However, the fallout from this research represents still another possibility for a.c. electric passenger vehicles.

Lear Siegler's theory for varying squirrel-cage motor speed is basic. Using fast electronic-switching techniques, a variable-frequency, single-phase input to the motor is created from selected portions of a fixed-frequency, three-phase supply. Originally this was attempted in the post-World War I period with the "cyclo-converter," a mercury-arc system that proved a bit too massive and expensive to be practical at the time. Today, however, the company has revived its interest in this dormant concept because of the availability of suitable SCR's.

The result is an all-a.c. system that can be powered from a commercial three-phase, 60-Hz power source; a battery-powered three-phase inverter source; or an engine-driven, three-phase alternator, probably the most practical of the group.

Lear Siegler's solid-state "cycloconverter" is a step-down frequency device comprising a number of "choppers" interposed between the power source and load. When actuated, the load is selectively coupled to the power source in such a manner that the current to the load is at a lower frequency than the source power frequency. The output is thus "fabricated" from small bits of the input.

The basic module in the frequency converter is a 12-SCR, three-phase-in/one-phase-out unit. Each single-phase module (Fig. 2) uses two groups of three-phase, full-wave rectifying bridges. This permits power from each of the input phases to supply power to the single-phase output.

Using seven integrated-circuit modules in the logic unit, the basic 3-to-1 converter module successively selects the appropriate portions of the supply-voltage waves which will closely approximate a desired waveform for the induction motor. At this point, suitable filtering is introduced to smooth out the waveform so that it is acceptable, although the inherent inductance of the squirrel-cage motor is sufficient, when the motor is used at varying speeds, to cause the current to be almost perfectly smooth to begin with.

Since more segments of the input power waveform are available for fabrication of the output waveform as the frequency ratio is accelerated, it is necessary to limit the minimum input-to-output ratio of the frequency converter to 2 (no limit on the maximum). For example, a conventional 60-Hz alternator produces a 30-Hz output frequency to the motor, which results in a drive motor speed of 1800 rpm, according to LSI. For a higher speed, it would be necessary to supply more than 60 Hz to the converter (which could be accomplished by driving a high-frequency alternator by a 60-Hz induction motor).

The balance of the system is much the same as that previously explored, employing the tachometer/generator at the motor shaft, etc. (See Fig. 3.)

But what about speed? Although LSI's experiments have not been primarily concerned with this factor, the company has developed an Army vehicle which employs an oil-cooled motor that rotates at 16,000 rpm at a vehicle speed of 50 mph. However, this approach uses the vehicle's conventional 6-cylinder gasoline engine to drive a rotary alternator which serves as the prime power source.

Motor Placement

Depending upon application, the a.c. squirrel-cage motors can be placed almost anywhere. LSI's Army test bed vehicle uses six powered wheels, each one capable of 16,000 rpm as indicated above. For the most part, the motor is inside the wheel with planetary reduction gearing just outside, less than two inches from the wheel itself. This arrangement is shown in Fig. 4. The gear mechanism is bolted to the outside of the vehicle frame, with the SCR frequency converter box located with others toward the rear center of the chassis. The result is a compact power wheel that at

first glance looks much the same as conventional types. Fig. 5 shows the electrical arrangement.

An English firm, *Telearchics, Ltd.*, has a prototype of a small three-wheeled electric car that is driven by a single motor on the front wheel. With batteries in the rear, the "Winn City" car can maneuver a right-angle turn at 40 mph (its top speed).

General Motor's experimental "Electrovair" and "Electrovan" make optimum use of available equipment, placing a single a.c. induction motor where the conventional combustion engine would normally be situated and employing a standard differential to achieve rear two-wheel drive. The cooling system is a six-quart-capacity circulating-oil type that also serves to cool the SCR modulating inverter (total cooling system weight is 80 pounds).

It becomes apparent that location of the motor is not at all critical except where engineers must work with specific existing designs. Indeed, the electric car of the future may well be a combination of both approaches, perhaps using two rear LSI-type powered wheels with GM's simplified motor-loop concept. ▲

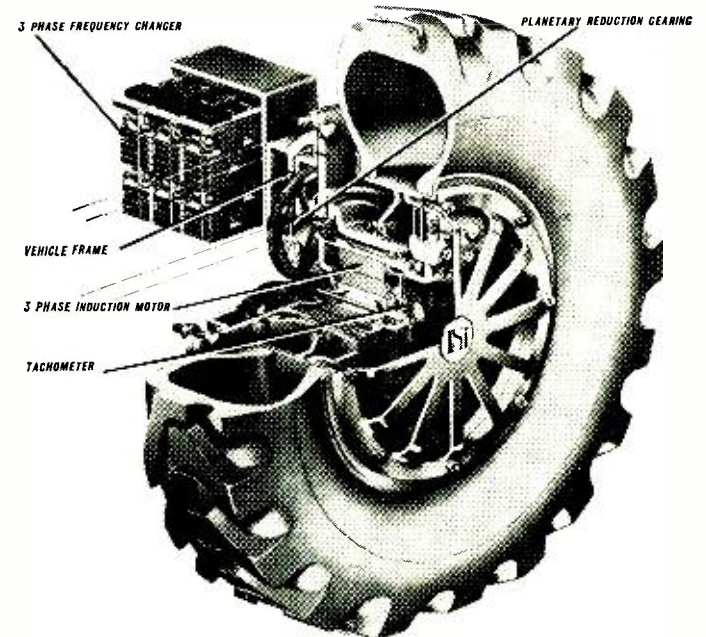
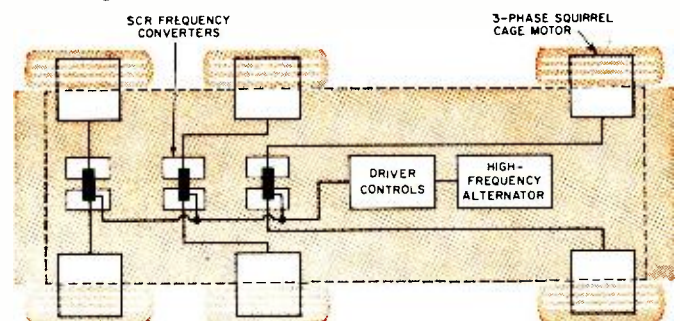

Fig. 4. In the powered wheel, the drive motor and its associated gearing is located within the drive wheel itself.

Fig. 5. Drive layout for the experimental military vehicle.



Field-Effect Transistor Circuits

By JOSEPH H. WUJEK, Jr. and MAX E. McGEE

A grouping of six simple, low-cost circuits that illustrate many of the principles of FET operation.

ONE of the most important new semiconductor devices is the *field-effect transistor (FET)*. This article describes six low-cost circuits which may be built to demonstrate the important properties of FET's. The U-110 and or U-112 *p*-channel FET's are used in the circuits discussed and are relatively low priced. *Siliconix* has offered the U-110 and U-112 together as a package for \$2.75. The U-110 may be had alone for \$1.00 under this offer. The industrial-type FET's, U-146 and U-147, are slightly higher in price. The bipolar transistors used are *General Electric* epoxy devices which sell for \$0.50 to \$1.00 each.

General Properties of FET's



For convenience, the similarities among vacuum tubes, transistors, and FET's are given in Fig. 1. We must recognize the inherent differences which exist among vacuum tubes, transistors, and FET's and the table serves only as an aid in pointing out bias polarities.

The FET resembles the vacuum tube in that the impedance looking into the gate is very high and can be on the order of hundreds of megohms. Also, the FET is a low-noise device, better than bipolar transistors and competitive with vacuum tubes. On the other hand, FET's resemble transistors in the leakage currents which flow between their electrodes when the device is cut-off.

The Source Follower

The source-follower circuit is analogous to the vacuum-tube cathode-follower or transistor emitter-follower. We

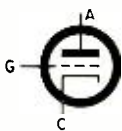
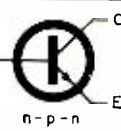
Fig. 1. Tabular comparison of tubes, transistors, and FET's.

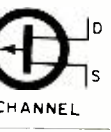
	Vacuum Triode	Bipolar Transistor	Field-Effect Transistor (FET)
Elements	Anode (A) Cathode (C) Grid (G)	Collector (C) Emitter (E) Base (B)	Drain (D) Source (S) Gate (G)
Symbol			
BIAS	Normal linear operation	Collector and base positive with respect to emitter	Drain positive, gate negative with respect to source
	For cut-off operation	Base negative with respect to emitter	Gate more negative with respect to source than for linear operation
COMPLEMENT	Symbol		
	Normal & cut-off operation	Bias opposite of "n-p-n"	Bias opposite of "p" channel

might expect similar behavior from these circuits and such is the case. We thus have high input impedance, relatively low output impedance, and a voltage gain that can be made very close to unity.

Fig. 2 shows a simple source-follower circuit and the bandpass characteristics obtained with two different FET

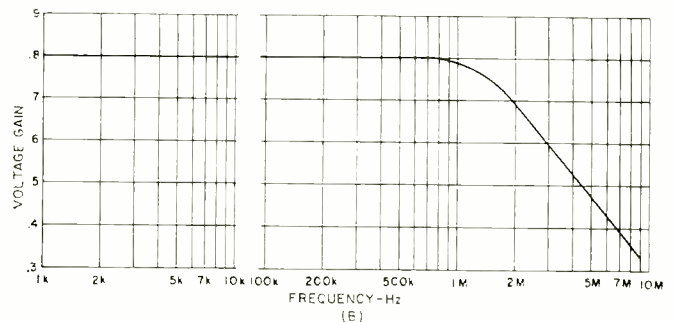
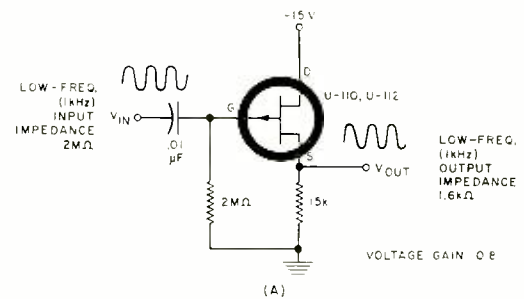

Fig. 2. A source-follower circuit along with frequency response.

Fig. 3. Common-source FET amplifier circuit along with response.

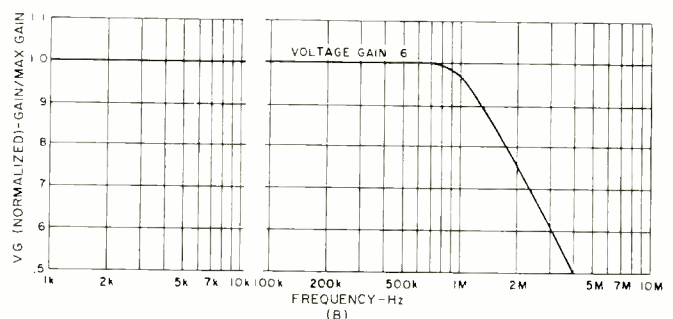
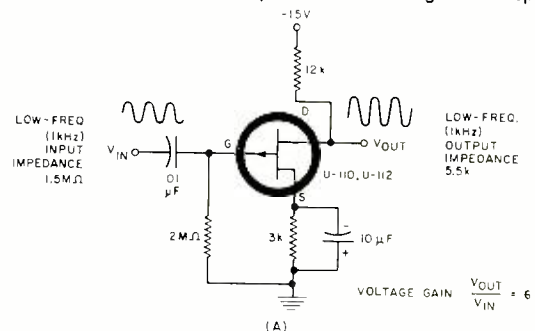

Fig. 3 shows a common-source circuit and the bandpass plot obtained by using either the U-110 or U-112 FET.

Miller Oscillator

The very high input impedance of the FET enables us to build the simple Miller oscillator of Fig. 4. The high impedance of the gate circuit results in light loading of the crystal. The LC combination in the drain circuit is tuned to resonate slightly below the parallel resonance of the crystal. For the type of devices considered in this article, the upper limit of frequency operation is only a few megahertz. For crystals other than the 512-kHz unit shown, the LC combination must be changed accordingly.

The output of the oscillator will not tolerate much loading, but the source-follower circuit can be used as a driver to provide low output impedance without loading the oscillator stage excessively. With differences in FET types and layout details, some modification of the LC network may also be required. For the circuit we tested, "clean" oscillations were observed for the four FET types indicated on the figure without retuning the circuit, and with the supply voltage varying from 6 to 22 volts.

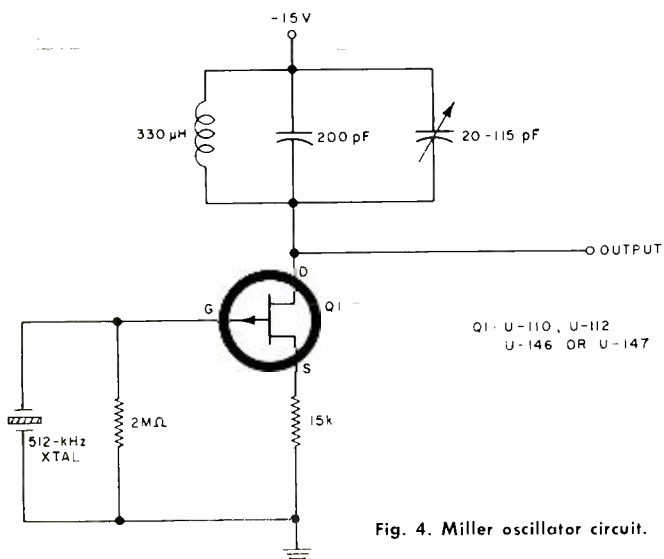

Fig. 4. Miller oscillator circuit.

FET/Transistor Pair

A circuit which performs like an improved source-follower or emitter-follower is shown in Fig. 5. The FET again provides very high input impedance, while the transistor output provides low output impedance. Unlike the source-follower or emitter-follower, this circuit can be built to have a voltage gain greater than unity. This is accomplished by a resistor in the feedback path as shown in Fig. 5A (lower right).

Fig. 5B gives the bandpass characteristics when used with a voltage gain of unity and (Continued on page 75)

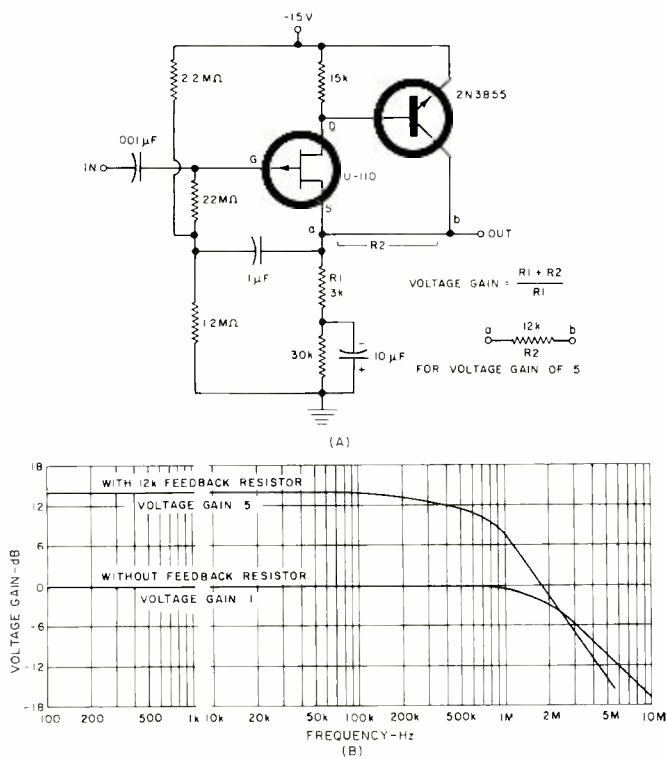

Fig. 5. FET/transistor pair has gain and high input impedance.

devices. The 2-megohm resistor establishes the gate bias and is similar to the grid-leak resistor used in tube work. However, this resistor must be made small enough so that increased leakage current between the gate and source will not drastically change the bias. For the U-110 and the U-112, leakage between gate and source at room temperature is on the order of 5 nanoamps (5×10^{-9} amp), so a 1- or 2-megohm resistor is adequate.

At elevated temperatures the increase in leakage current would dictate that a smaller resistor be used so as to reduce changes in bias with leakage current. It is possible to bias FET's so that very small temperature drift results.

Common-Source Amplifier

The common-source circuit is analogous to the common-emitter transistor and common-cathode vacuum-tube circuits. Again, properties of this circuit are similar to the transistor and tube counterparts. Input and output impedances are intermediate in value and a voltage gain greater than unity may be realized.

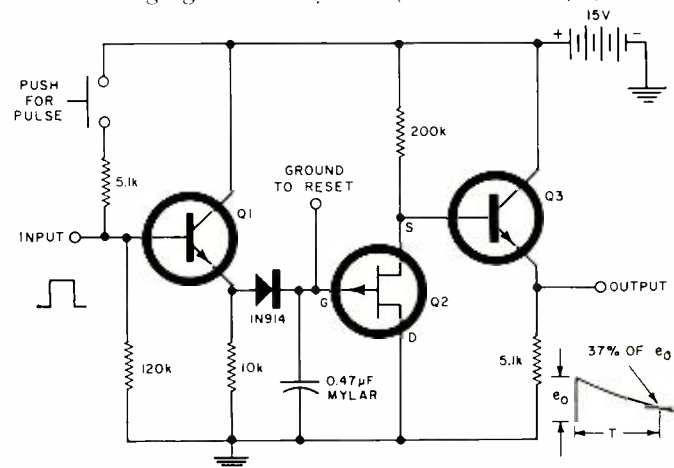

Q1 & Q3 ARE ANY OF THE FOLLOWING	Q2	
	FET TYPE	T (MINUTES)
2N3855 2N3391 2N3394	U-110	4
	U-112	2.5
	U-146	6
	U-147	5

Fig. 6. Pulse-stretcher circuit with FET and transistors.

Fig. 7. A linear gating or amplitude modulator circuit.

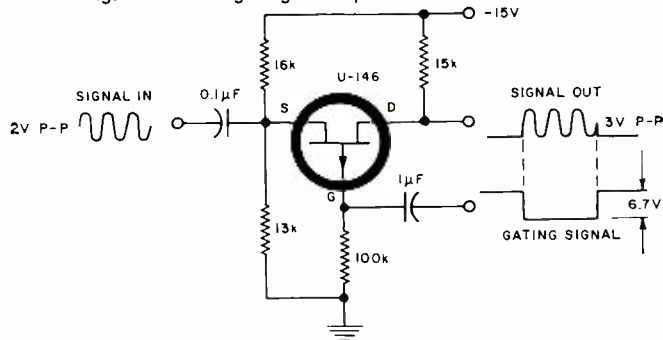

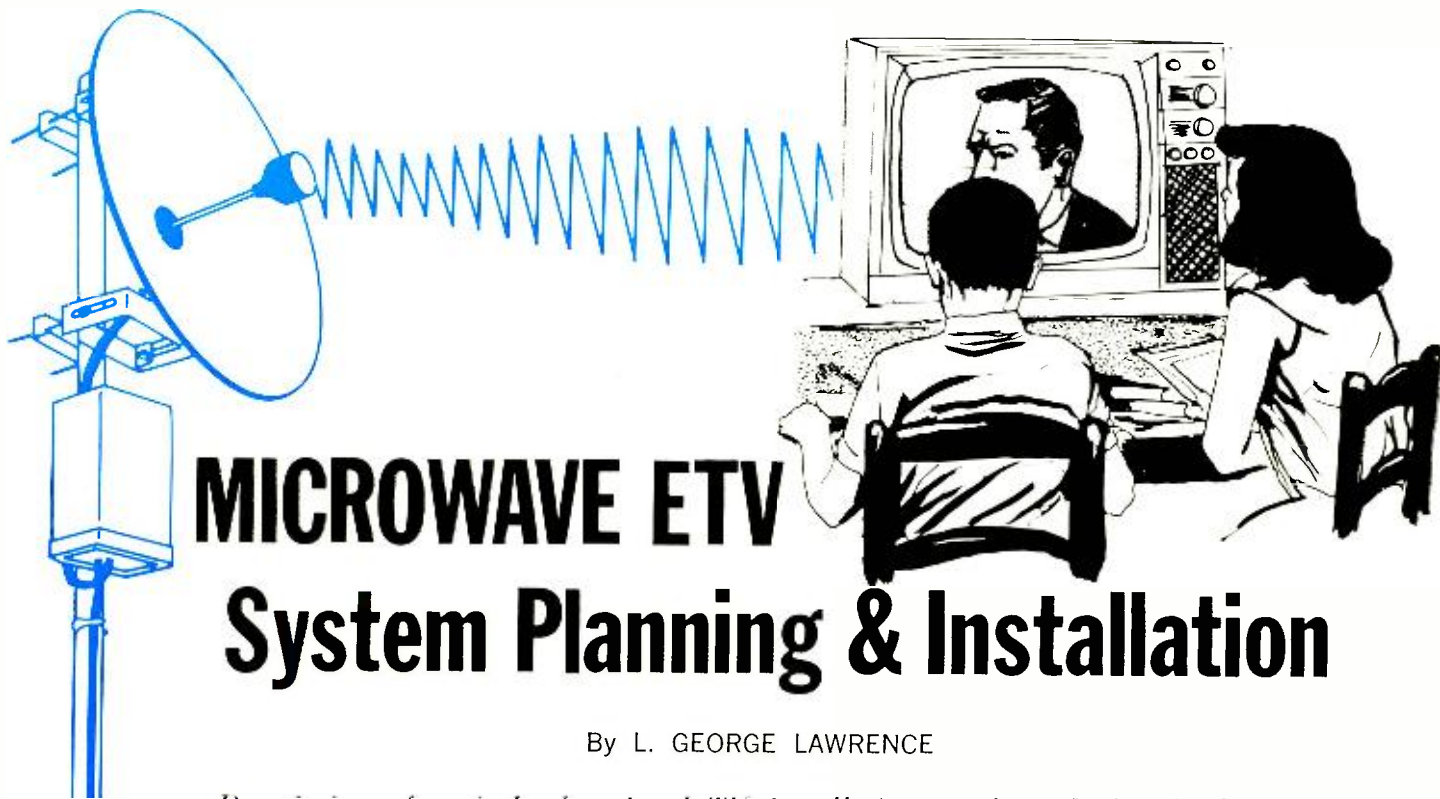

MICROWAVE ETV System Planning & Installation

By L. GEORGE LAWRENCE

Description of typical educational TV installations and methods of planning for school-originated transmissions in the 2500-MHz microwave frequency band.

EDUCATIONAL television, now well into its second decade, has established itself as an outstanding audio-visual tool in a good many teaching situations. Today, microwave transmission is emerging as an effective data carrier between widely separated school districts. The propagation techniques have been learned empirically, and system planning and installation follow but a few basic rules common to line-of-sight transmission paths.

On July 30, 1963 the Federal Communications Commission established the "Instructional Fixed Station Service" to meet the needs of educators for school-originated transmission of visual and aural material. The agency set up thirty 6-MHz channels in the microwave frequency band 2.5 to 2.686 GHz (see Table 1).

With nominal transmitter power set at 10 watts output, the transmission standards are the same as those for regular TV broadcasting, with some exceptions. Vestigial-sideband transmission, for example, is not required, but the lower sideband must not exceed the amplitude of the upper one. The microwave transmitter must maintain the 4.5-MHz sound-carrier separation and the visual carrier may not drift more than ± 60 Hz. Stations are required to transmit call signs consisting of three letters and two digits. These identifications must be transmitted at sign-on, hourly during operation, and at sign-off.

From an electronics point of view, both transmitter and receiver are relatively simple affairs. Fig. 1 shows *Jerrold's* Model SRT-1 transmitter (right) and the same firm's Model SRR-1 school receiver. The transmitter is completely solid-state, including exciter-modulator and power supply, except for the traveling-wave tube in the final output stage. Monitoring is achieved by detecting the output after the final stage. The apparatus requires 300 watts of operating power for the transmitter and 30 watts for the exciter-modulator.

The receiver (Fig. 1, left), a solid-state design, uses a quadruple-tuned cavity preselector, a transistor and varactor oscillator-multiplier chain (crystal-controlled in the 130-MHz region), a two-stage broadband output amplifier, and external power-supply arrangements. The latter consists of a 20-volt a.c. indoor supply feeding the receiver through its coaxial output cable. Power requirement is 24 watts.

The received microwave-frequency signals are converted to v.h.f. signals and injected into the school's MATV system. Fig. 2 shows the common transmission and receiving

Fig. 1. Typical school transmitter at the right consists of an exciter-modulator unit (bottom), the rest of the transmitter (center), and the metered power-supply unit (top). The matching receiver shown at the left is mast-mounted below the antenna.

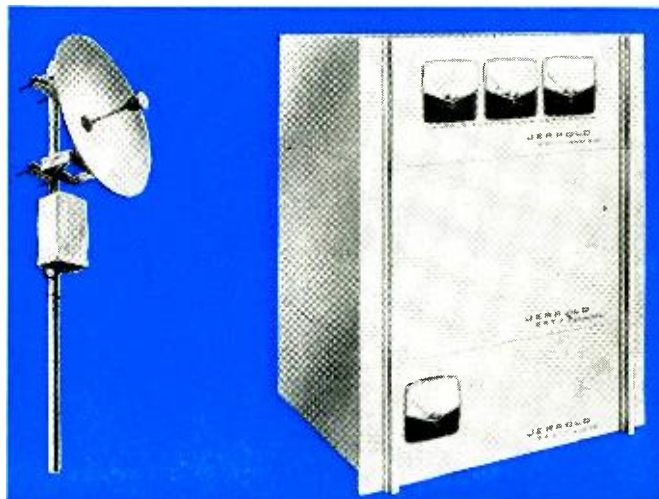

	CHANNEL NUMBER	BAND LIMITS (MHz)
Group A	A-1	2500-2506
	A-2	2512-2518
	A-3	2524-2530
	A-4	2536-2542
Group B	B-1	2506-2512
	B-2	2518-2524
	B-3	2530-2536
Group C	C-1	2548-2554
	C-2	2560-2566
	C-3	2572-2578
	C-4	2584-2590
Group D	D-1	2554-2560
	D-2	2566-2572
	D-3	2578-2584
	D-4	2590-2596
Group E	E-1	2596-2602
	E-2	2608-2614
	E-3	2620-2626
	E-4	2632-2638
Group F	F-1	2602-2608
	F-2	2614-2620
	F-3	2626-2632
	F-4	2638-2644
Group G	G-1	2644-2650
	G-2	2656-2662
	G-3	2668-2674
	G-4	2680-2686*
Group H	H-1	2650-2656
	H-2	2662-2668
	H-3	2674-2680

Upper limit.

Table 1. Frequency allocations for instructional fixed stations.

	1000 MHz	6000 MHz
Path length	25 miles	25 miles
Antennas	6' parabolic	6' parabolic
Free-space path loss	124.5 dB	140.0 dB
Antenna gain (2 antennas)	46.0 dB	77.0 dB
Normal transmitter power	37 dBm	30 dBm
Normal misc. losses (trans. lines, combining filters, circulators, etc.)	8 dB	5.2 dB
Net received signal power	-39.5 dBm	-38.2 dBm

Table 2. Typical path-length characteristics at 1 and 6 GHz.

method. The arrangement's main advantages are low cost, independence of fixed broadcasting schedules, and a more intimate approach to diversified teaching than possible before.

Field Surveys

Specifications for ETV systems can only be detailed after the propagation path has been determined. Bidding on an unsurveyed system can be a dangerous gamble, since a proposing firm may not be fully aware of obstacles and/or electromagnetic interference which can attenuate signals. To cover itself against severe losses, the company must either overbid—which can lose it the contract—or conduct a careful optical and electromagnetic field survey to safeguard against these possibilities.

There are five general types of field surveys, categorized as visual, map, photogrammetric, aerial, and electromagnetic (to detect effective field strength).

1. *Visual surveys* are performed by direct observation. The site of the proposed microwave-receiver antenna structure is marked by a large flag or brilliant light. If great distances are involved, the light may be generated by carbon-arc equipment whose beam is directed towards the site of the observer. The light or flag may then be searched for with

binoculars while the observer is standing at the transmitter site.

The visual method is somewhat limited by the fact that radio waves bend more than light waves; but since antenna towers have not yet been erected, the survey may be conditionally positive in spite of minor obstructions partially blocking off the path of signal propagation.

2. *Aerial surveys*, being an extension of visual surveys, commonly make use of a small helicopter. The craft is used to position the observer at a height relative to that of the final supporting structure for the microwave antenna. Photographs will help to reinforce the observations made.

3. *Map surveys* are path determinations derived from a study of topographic maps. A *profile* of the propagation path is drawn on special graph paper, and the amount by which the line of sight clears terrain obstacles may thus be determined.

Data derived from such surveys is valid over terrain which is not commercially built up. Over city areas, this type of survey tends to become invalid due to interference by large buildings and other structures.

Although map surveys are inexpensive, it should be realized that many pertinent maps are twenty or more years old. Recent detail maps might show intervening structures, but the older ones will not.

4. *Photogrammetric surveys* subscribe to the use of stereoscopic aerial photographs of the signal-path line. The basis of this method is a series of photographs in which the same area is "shot" from two different angles. The pictures are then viewed through special optics which can indicate the relative height of obstructions in the projected transmission path.

5. *Electromagnetic surveys.* Whereas survey methods (1)

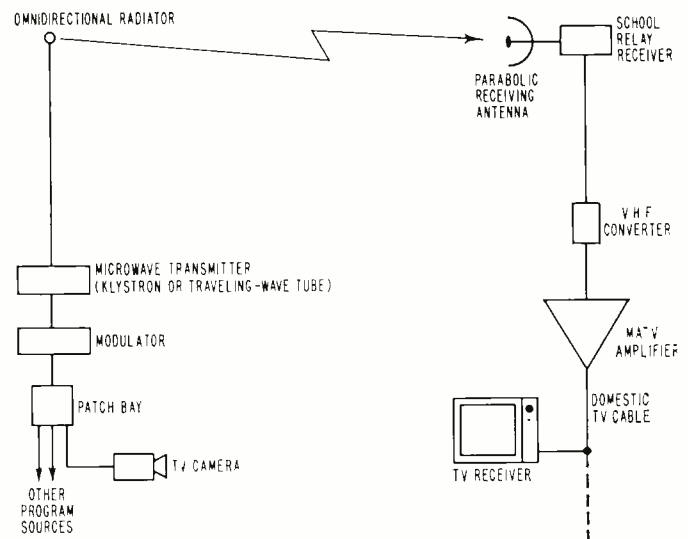

Fig. 2. Basic components of 1-channel, 2.5-GHz ETV system. Receiver output is heterodyned to v.h.f. and fed to MATV system.

through (4) deal with various optical observations that are conditionally acceptable. For precise determination of effective transmission-path characteristics, the electromagnetic simulation process is used. In this case, a small, portable microwave transmitter is taken to the chosen site of transmission, a simple antenna structure elevated, and a modulated signal transmitted to a field-strength meter located at the receiving end.

This method, although more expensive to apply, can provide excellent data under various conditions. If, for example, the local atmospheric situation is such that the air density increases with height, the earth between transmitter and receiver appears to bulge up into the wave fronts. If this bulge reaches the line of sight between transmitter and receiver, microwaves of any frequency will be attenuated



Fig. 3. Weather-shielded microwave antenna housing for studio-to-transmitter microwave relay, photographed at Mt. Wilson, Calif.

about 20 dB. This, in turn, decreases the receiver's signal-to-noise ratio and, for all practical purposes, the picture might be lost.

If the terrain between transmitter and receiver is a good reflector, the cancellations may be severe and very deep fades will result. High-frequency waves tend to cancel each other more often than low-frequency waves because smaller changes in *refraction* are required to cause a difference in paths of one-half wavelength. The 2.5-GHz system might have more fades than a lower frequency system, but these fades will be of shorter duration.

The equipment required for electromagnetic surveys consists of a 2.5-GHz transmitter and a microwave field-strength meter, including suitable antennas for both instruments.

Another electromagnetic method of gathering field-performance data is to substitute for the field-intensity meter an actual microwave receiver. The direct substitution method has proved successful in standard v.h.f. surveys, but, unfortunately, the bulk and weight of the microwave antenna does not invite its enthusiastic use. The method is a valid one, however, and should be employed if at all possible.

Antenna Requirements

Path distances to 12 miles would typically require a two-foot parabolic dish, while a one-foot parabolic dish is typical for 5 miles line of sight. Distances beyond 12 miles must be considered as a non-standard type of installation, requiring antenna-size determinations.

Table 2 gives some rule-of-thumb values for frequencies of 1 GHz and 6 GHz. In both cases, a range of 25 miles has been chosen. It should be noted that the gain of a parabolic antenna increases with antenna area as well as with operating frequency. But for a given microwave path with fixed-size antennas, the path attenuation increases with frequency. Hence, as is so often the case, one effect tends to offset the other.

Simple, unprotected parabolic antenna structures suffice for most purposes. Special considerations are introduced, however, if the service area is subject to extreme weather conditions—especially high winds, freezing rains, and the like. Aside from the possibility of off-target operation due to excessive movement and weight, the dish can be subject to severe electrical damage.

To mitigate such disadvantages, the antenna(s) can be housed in a window-equipped structure erected atop one of

the higher school buildings. Fig. 3 illustrates an excellent installation of this type used for commercial studio-to-transmitter use. It contrasts with the less elaborate but more common educational system illustrated in Fig. 4.

Even though microwave ETV systems are fairly maintenance-free, unpretentious designs, a few simple accessories may be called for. An inexpensive monitor, which not only provides a continuous record of transmitter performance but also gives an acoustical alarm if the apparatus starts to malfunction and/or drifts off frequency, may be added. One such monitor, shown in Fig. 5, can be mounted in a 19-inch rack and connected to the transmitter by way of rear terminals.

The information given in this article is primarily intended for simplified situations. Experience has shown that each ETV system is somewhat unique and must be tailored to suit individual needs. At the present time, the systems are fairly new and much experience is yet to be gained in their use. ▲

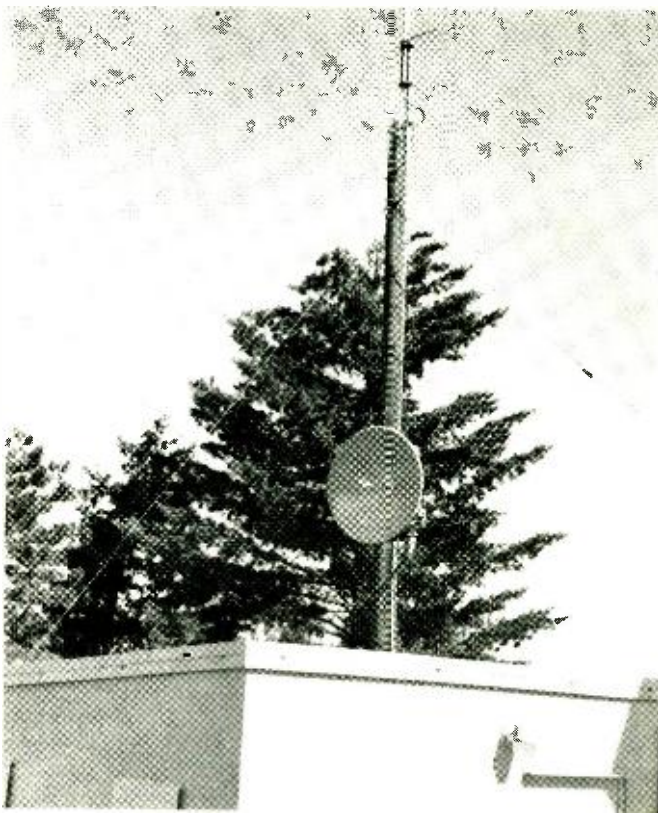
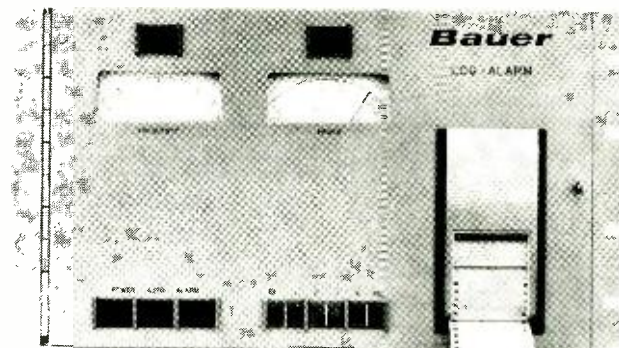

Fig. 4. A simple pole-mounted microwave antenna dish is shown.

Fig. 5. A recording monitor used to log transmitter performance.



IC Engine Tachometer and "Red Line" Indicator

By ROBERT A. HIRSCHFELD / Microcircuit Engineering, Amelco Semiconductor

In this, the first application of integrated circuits to automotive electronics, a red warning lamp comes on at some predetermined value of engine rpm, enabling the driver to shift gears at the correct rpm or indicating that his engine is now hitting its rpm limitations.

DESPITE the increasing popularity of automotive tachometers, their indications are of only academic interest under typical driving conditions. The most useful information a tachometer imparts to manual-shift drivers is the optimum "shift point," and this may be read as known speeds for each gear on the car's speedometer. A meter with a marked red line unfortunately requires the driver to divert his attention from the road in order to read relative pointer position at the critical time when the engine is developing nearly maximum power.

The tachometer described in this article includes an rpm sensing circuit, which can illuminate a warning lamp (electronic "red line") bright enough to signal the driver without distracting him from road conditions. The heart of the circuit is a new dual one-shot microcircuit flip-flop, which works directly from 12-volt auto batteries.

Basic Operation

The block diagram of Fig. 1 illustrates the basic operations performed by the tachometer. Ignition pulses at the distributor points are irregular, usually containing large inductive spikes and r.f. ringing. These pulses are filtered and clipped to prevent damage to low-voltage components of the microcircuit. Each pulse triggers a one-shot multivibrator, causing it to produce an output pulse of fixed width and height. If a metered readout is desired, a d.c. milliammeter is attached at this point. The meter acts as an integrator whose deflection is proportional to the average d.c. value of the pulse train. Since the one-shot pulse duration remains constant and the repetition rate depends upon engine rpm, the average d.c. value and hence meter deflection are accurately proportional to rpm.

The standardized pulse train is fed to a sensitive frequency discriminator, which will be discussed in detail. If the repetition rate exceeds the set threshold, the discriminator drives a saturating switch transistor which lights the indicator lamp.

The frequency discriminator outlined in Fig. 2 requires just the type of standardized output provided by the one-shot tachometer. The waveforms in Fig. 4 illustrate how the discriminator is able to critically sense very small variations

from the set threshold. Capacitor C4 is charged, through D4, every time a pulse appears at point A and begins to discharge through R8, R6, and R7. If this process went unchecked, C5 would soon charge to the same level as C4. But potentiometer R7 and resistor R6 are driving a voltage threshold detector, which goes "on" whenever the voltage at point B drops below a set limit. This causes a switch to short out C5, making it lose its just-acquired charge. Note that for given values of C4, R8, R6, and R7 the discharge curve at point B always looks the same. Whether or not it

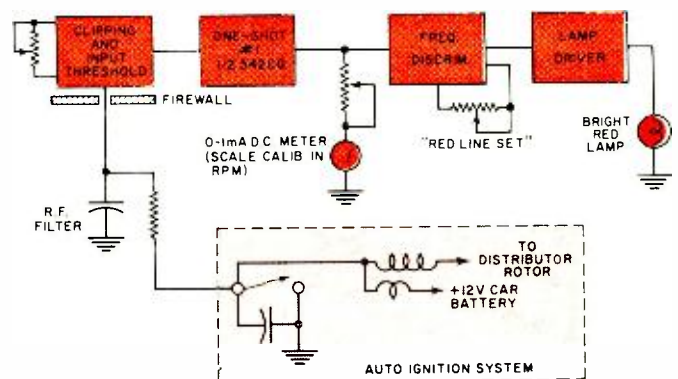
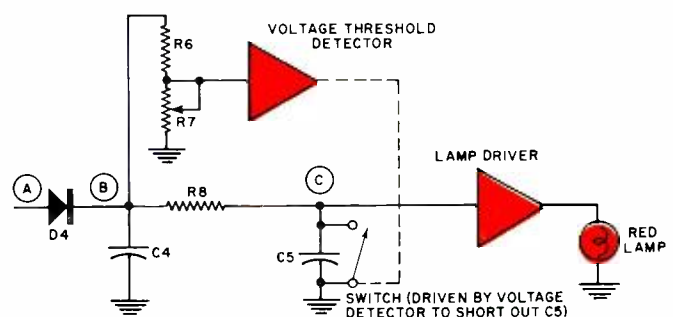
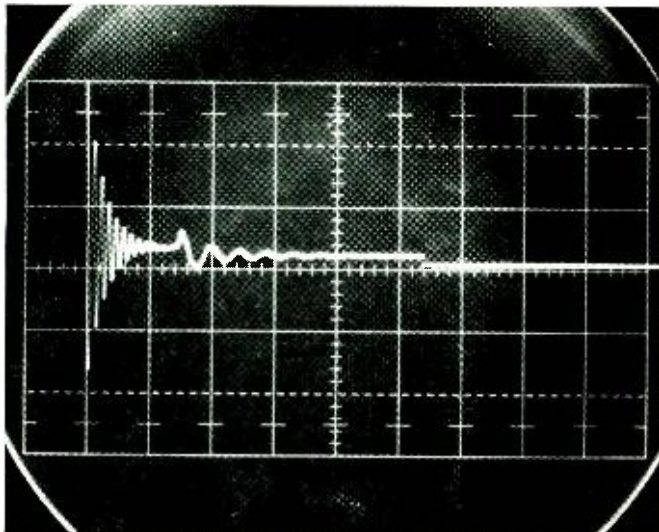

Fig. 1. Basic block diagram of the electronic "red-line" tach.

Fig. 2. Operation of the basic frequency discriminator. Capacitor C5 is kept discharged below preset rpm. When the rpm exceeds the predetermined limit, the red warning lamp glows.





Typical waveforms as measured across the breaker points at idle. Horizontal scale 5 ms/div, vertical scale 100 V/div.

reaches threshold voltage V_T depends upon the time between tachometer pulses. The action of the voltage threshold detector is positive: if V_T is crossed even for a very short time, C5 is completely discharged; if V_T is barely missed, C5 continues to accumulate charge. Thus, the waveform at point C is either a series of abortive charging pulses, for rpm below the threshold, or a fast, steady charge upwards, for rpm above the threshold. This means that the discriminator is able to sense excessive rpm within 4 or 5 ignition pulses of the time it occurs, which is an 8-cylinder engine at 5000 rpm, for example, is about 1.5 milliseconds.

Actual Circuit

A practical complete circuit combining the previously discussed circuits is shown in Fig. 3. Bear in mind that this circuit is a compromise based upon a commercially available microcircuit that was designed for digital computer use (Amelec 342CG). For mass production, a completely monolithic tachometer circuit could be designed containing most of the components external to the present microcircuit, including a voltage threshold detector better suited to compensating for the effects of varying temperatures and supply voltages.

Components R2 and C2 are mounted at the ignition points in the engine compartment. They have no adverse effect upon spark performance and perform several functions. First, they reduce r.f. transients that could damage

Table 1. Capacitor values for full-scale meter indications.

Engine Type	Typical Max. RPM / Freq.	C1-C4 (μ F)
1 cyl. 2 stroke 2 cyl. 4 stroke (motorcycle)	10,000 / 166.6 Hz	0.2
4 cyl. 4 stroke (imported compact or sports car)	6000 / 200 Hz	0.2
2 cyl. 2 stroke (motorcycle)	10,000 / 333.3 Hz	0.1
6 cyl. 4 stroke (domestic or imported 6)	5000 / 250 Hz	0.15
3 cyl. 2 stroke (Saab, Goliath)		
8 cyl. 4 stroke (V-8 engine)	5000 / 333.3 Hz	0.1
12 cyl. 4 stroke (V-12, etc.)	6000 / 600 Hz	0.05

the microcircuit; second, they reduce the amount of r.f. radiated in the passenger compartment from the tachometer input lead, a serious problem in most commercial tachometers (this r.f. appears as interference to the car radio); and third, R2 limits the d.c. current that can be driven into the microcircuit trigger input, even if R11 is set at zero ohms.

The "on" time of one-shot ≈ 1 must be small enough so that adjacent pulses cannot overlap at high rpm. Consequently, at low speeds, the inherent "ringing" of the ignition system could cause multiple pulses for each ignition pulse, making the meter inaccurate. A characteristic of these "ringing" oscillations, however, is that they are damped; that is, the first is always larger than subsequent ones. Potentiometer R11 and resistor R3 set an input threshold which assures triggering only on the first part of each ignition pulse. Diode D1 prevents the voltage at the trigger input from going more negative than ground, which would forward-bias certain components of the microcircuit with respect to their common substrate, damaging the circuit.

The "high" output level at pin 2 can vary with changes in auto battery voltage. To maintain constant height, and hence meter accuracy, R4 and D3 clip the pulse train. R5 is used to calibrate the full-scale meter reading; hence, the exact value of D3's zener voltage is not critical as long as it remains constant.

Pin 13 is used as the input to a voltage threshold detector made from part of the second complete one-shot. Pin 11 goes "low," discharging C5 only when the voltage at pin 13 drops below 2.1 volts; this occurs only at rpm below the level set by R7.

Because of diodes necessary in the "switch" used to discharge C5, this capacitor remains at +1.6 volts at rpm lower than the threshold. Thus, D5, D6, and D7 are used to assure that Q2 and therefore Q1 remain off until the "red line" is reached. If an inexpensive p-n-p germanium power transistor is used for Q1, very bright 12-volt lamps may be driven, provided that the current gain of Q1 is high.

Operation of the "red line" circuit is similar to that of a Schmitt trigger. A certain amount of hysteresis is built in, due to different charging conditions in the regions above and below the threshold. Thus, the rpm level at which the lamp goes off is lower than the critical "on" level, a desirable characteristic since an engine hovering around the threshold rpm would cause a "red line" circuit without hysteresis to flicker erratically.

Construction

Circuit construction is relatively non-critical and may be suited to the particular vehicle in which the tachometer is to be used. An accurate, easily read milliammeter is desirable, and the circuit may be constructed on a board attached to the meter terminals. Owners of cars with built-in tachometers may want to use the circuit for its "red line" function only; in this case, D2, D3, R4, and R5 may be eliminated, as well as the milliammeter itself.

Note that Mylar capacitors are specified for C1 and C4 and that, despite the presence of a built-in diffused resistor (20,000 ohms) within the microcircuit, an external film type is recommended. These measures were found to improve the reading consistency of both metering and "red line" circuits over a wide temperature range. While the internal resistor could be used, its temperature coefficient is large enough to cause discernible shifts in accuracy at relatively high or low temperatures.

It may also be noted that pulses from pin 2 to the "red line" circuit are not directly clipped by D3. This is done to partially compensate for changes that occur in threshold level at pin 13 as battery voltage varies and therefore improves the accuracy of the "red line" limit under these conditions.

Engines having different numbers of cylinders produce

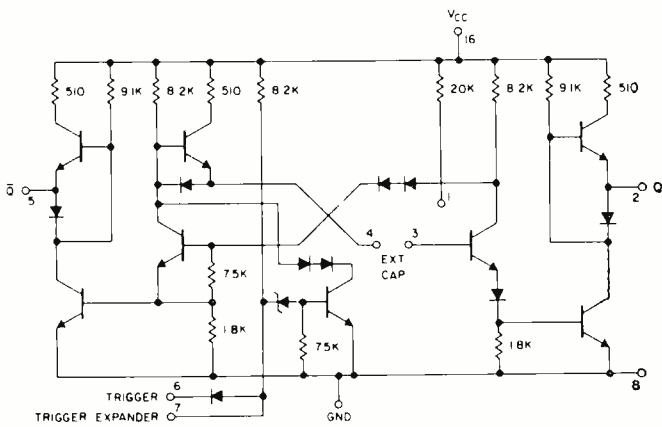

One of two identical M-V's in the integrated circuit.

different numbers of pulses per revolution. The rpm/frequency equation is plotted in Fig. 5 for applications varying from a 1-cylinder, 2-stroke motorcycle engine up to a 12-cylinder racing engine. Optimum values of C1 and C4 for various full-scale tachometer readings for the various engines are given in Table 1.

Calibration

Calibration of the tachometer and "red line" is best done with an audio oscillator of known accuracy. An oscilloscope is useful for verifying that waveforms appear correctly throughout the circuit but is not mandatory. Full-scale markings of the milliammeter depend upon the type of engine with which it is to be used. The scale graduations will be linear. To calibrate, set the audio oscillator (connected to pin 6) to the frequency corresponding to full-scale meter reading, set R5 to maximum resistance, and increase oscillator amplitude until meter deflection is observed. Adjust R5 so that the meter reads exactly full scale. Then set the oscillator to the frequency corresponding to the "red line" (in some cases, this may be equal to the full-scale frequency). Adjust R7 so that the "red line" lamp is off and then slowly readjust R7 so that the lamp just lights. Check operation of the "red line" by moving the oscillator above and below the critical frequency.

Recalling that there is some built-in hysteresis in the "red line," a check of the threshold rpm should be performed by starting at some lower frequency and increasing it until the lamp lights rather than by starting at a higher frequency and reducing it until the lamp extinguishes.

Once the initial calibration has been completed, the circuit may be installed in the vehicle. Set R11 for maximum resistance before starting the engine. After starting, there may be no meter reading with engine idling; decrease R11 until meter deflection occurs and adjust for steady reading at idle. This helps eliminate the "multiple pulsing" mentioned earlier. Checking "red line" operation in the car is best done with the engine warmed up, under actual accelerating conditions, as very high rpm in neutral may damage the engine.

The circuit of Fig. 3, as mentioned previously, is a compromise designed to use an off-the-shelf commercial microcircuit. Nevertheless, the meter and "red line" functions have measured accuracies, in the author's installation, of better than $\pm 2\%$ from 0° to 50°C (typical passenger compartment temperature extremes, corresponding to the range from freezing to 122°F); accuracy is similar for battery voltage variations from 11 to 15 volts. At constant temperature and battery voltage, long-term accuracy is about $\pm 5\%$.

Hysteresis, in the author's 6000-rpm installation, amounts to about a 50 rpm difference between "red line" lighting and extinguishing speeds.

(Editor's Note: The 342CJ IC is now available at \$6.90. This is a direct substitute for the 342CG unit.)

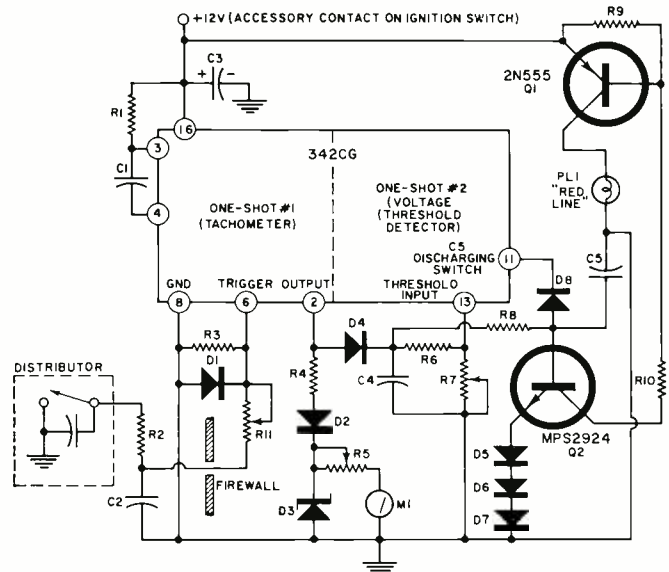

- R1—20,000 ohm, metal film res. (IRC CEC-T-O or equiv.)
- R2—10,000 ohm, $\frac{1}{2}$ W res.
- R3, R6—4700 ohm, $\frac{1}{2}$ W res.
- R4—200 ohms, $\frac{1}{2}$ W res.
- R5—5000 ohm pot
- R7—500,000 ohm pot
- R8—100,000 ohms, $\frac{1}{2}$ W res.
- R9—1000 ohms, $\frac{1}{2}$ W res.
- R10—470 ohms, $\frac{1}{2}$ W res.
- R11—100,000 ohm pot
- C1—Mylar cap. See Table 1
- C2—.01 μF , 1000 V disc cap.
- C3—100 μF , 15 V elect. cap.

- C4—Mylar cap. See Table 1
- C5—1 μF cap. (CDE MFP-1W1 or equiv.)
- D1, D2, D4, D5, D6, D7, D8—1N4001
- D3—Zener diode, 6.8 V
- M1—0.1 mA d.c. milliammeter
- PL1—12 V indicator lamp (type 1815, or any 12-14 V lamp up to 250 mA)
- 342CG or 342CJ—Amelco 11N1L dual one shot IC
- Q1—2N555 or equiv.
- Q2—MPS2924 or equiv.

Fig. 3. Schematic and parts list for the electronic "red line."

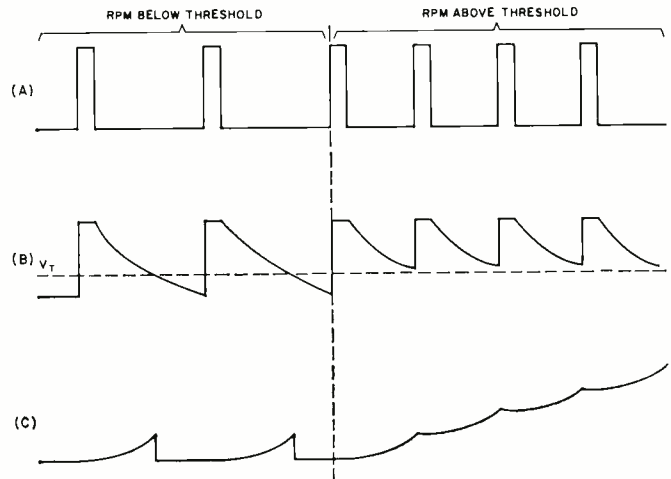
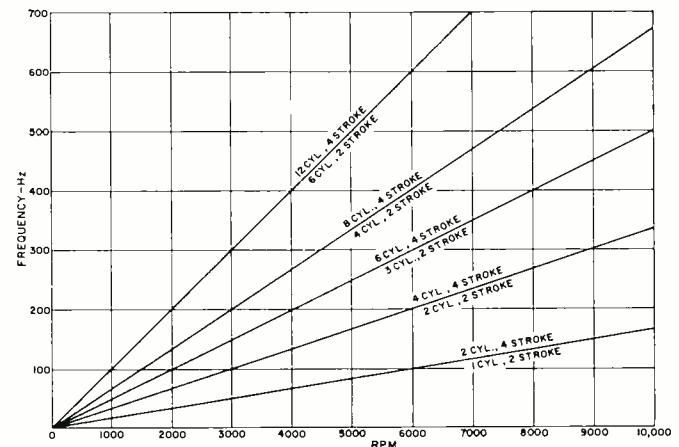

Fig. 4. Basic frequency discriminator waveforms keyed to block diagram of Fig. 2. Point V_T is the trigger level.

Fig. 5. Rpm vs frequency for various engines in common use.



Selecting Frequency and Time Standards

By IRWIN MATH/Project Engineer, Frequency Electronics, Inc.

How precision oscillators and clocks are rated and exactly what they are capable of. A discussion of stability and other important standard specifications.

HIGHLY precise frequency and time standards are becoming more and more widely used in today's sophisticated scientific world. The missile and space age demands, for example, are far in excess of the requirements of only a few years ago. In fact, the stability of the research laboratory's frequency standard of 10 years ago is now taken for granted in the oscillators of many types of modern industrial test equipment.

As a result, all too often the engineer or technician will specify a complex, ultra-stable frequency standard when a much less stable one would have been sufficient for his application. Similarly, he can often mistakenly interpret a lower order oscillator as easily as one of much higher quality. For these reasons, the engineer and technician as well as anyone with even a casual interest in the measurement field should have a good understanding of just how precision oscillators and clocks are rated and exactly what they are capable of doing.

Long-Term and Short-Term Stability

In the "good old days", it was enough to ask for a 1-MHz oscillator with a stability of $\pm 0.001\%$. Anything better than 0.1% was considered rather good. But today things have changed. All but the simplest of oscillators that are used as standards are rated in parts per 10^9 . For example, a 1-MHz oscillator with a stability of ± 1 Hz is rated at 1 MHz ± 1

part in 10^6 or 1 part per million. Similarly, a good frequency standard may have a stability of ± 1 part in 10^{10} . The general expression for frequency stability is $S = \Delta F / F$ where F is the nominal frequency and ΔF is the allowable variation. Therefore, the actual frequency variation of our frequency standard (considering its output is 1 MHz nominal) is ± 0.0001 Hz or $\pm 1 \times 10^{-10}$ of the nominal frequency.

However, this information is not enough. While it does indicate stability, it does not specify over what period of time this stability must be measured. The complete stability of a frequency-standard oscillator must be given in two parts: the long term and the short term.

The long-term stability of an oscillator is basically the average change in frequency over a long fixed period of time as compared to some absolute reference. Usually, long-term stability is measured in one of two ways. The first of these, as indicated in Fig. 1, depends on readings of frequency taken continuously for several days. The maximum peak-to-peak deviation over any 24-hour period is measured and the stability is then defined as \pm one-half this maximum. For example, since both oscillators in Fig. 1 have a peak-to-peak variation of 1 part in 10^9 per day, their long-term stability would be specified as ± 5 parts per 10^9 per day. Notice, though, that oscillator #2 has a much longer average rate of frequency change than does oscillator #1. Therefore, while they both are ± 5 parts in 10^9 per day oscillators, oscillator #2 is obviously superior.

The second method, and by far the more accurate one, is based on the average change of frequency over a given

Fig. 1. Measuring long-term stability by means of peak readings.

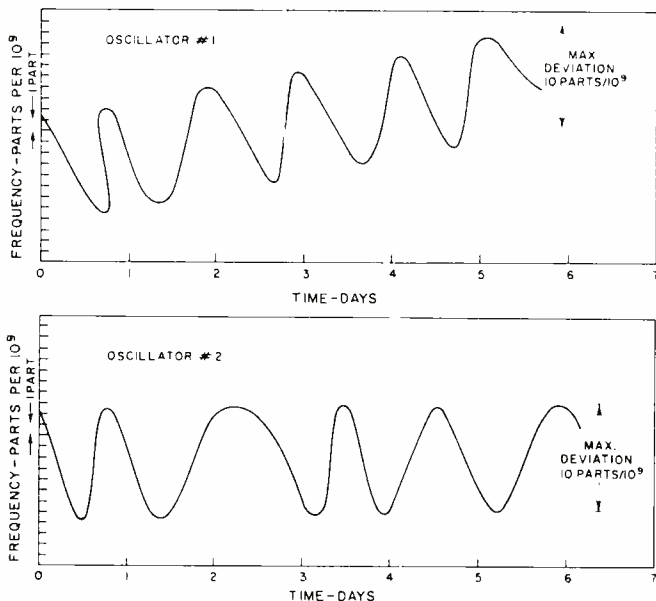
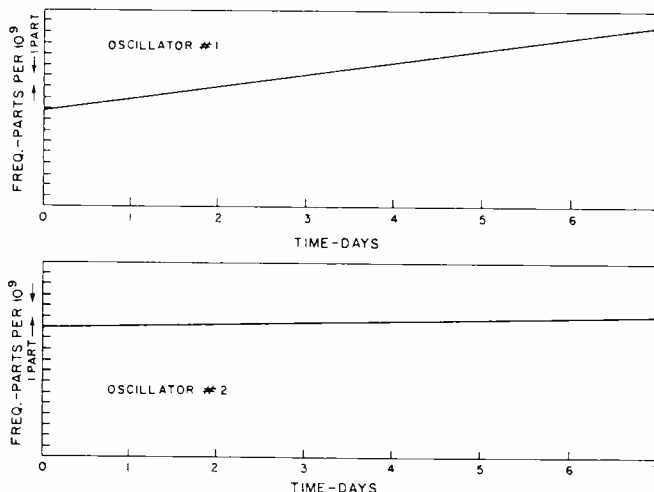

Fig. 2. Measuring long-term stability by average readings.



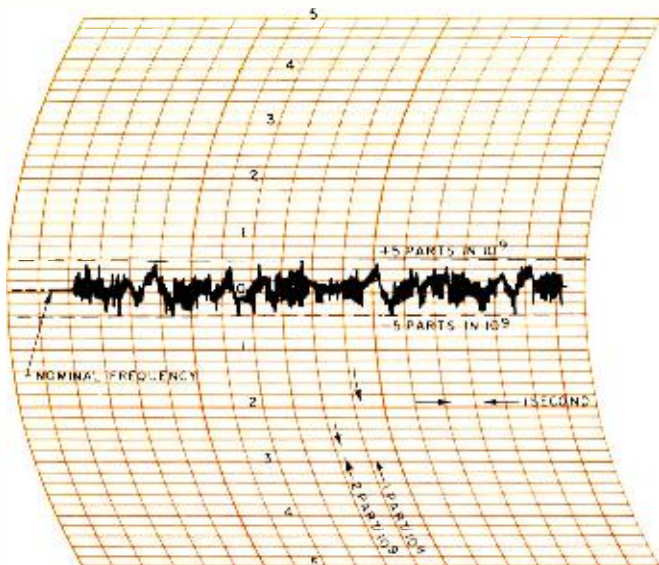

Fig. 3. Automatic recording of an oscillator with a short-term stability of plus or minus 5 parts in 10^9 per second.

time interval. As shown in Fig. 2, the stability of oscillators ± 1 and ± 2 is now determined by the slope of their average frequencies. Now it is easy to see that oscillator #2 is substantially better than oscillator #1.

To further clarify the measurement and eliminate any remaining doubt, a few oscillator manufacturers incorporate both the average long-term frequency change and the day-to-day change in their long-term stability specification. For example, a 1-MHz oscillator such as the one shown in Fig. 4 with a rated long-term stability of ± 1 part in 10^{10} is one whose maximum daily and average frequency will change by no more than ± 1 cycle per 10 billion cycles per day or 0.0001 cycle per day.

The short-term stability of an oscillator is its frequency stability over periods of time from a few seconds to fractions of a second. This type of specification is important when the oscillator is used as the source for a frequency multiplication system, especially into the thousands of MHz. If, for example, a 1-MHz oscillator with a second-to-second variation of ± 1 part in 10^6 were multiplied to 1000 MHz, the variation would now be ± 1000 Hz per second.

As in long-term measurements, there are two general methods. One is similar to long term in that readings of frequency are taken. The time interval, however, is much shorter. Fig. 3 is a recording of an oscillator with a short-term variation of ± 5 parts in 10^9 per second. Notice that in any 1-second interval, the frequency never deviates by ± 5 parts in 10^9 from the nominal. This type of recording is used for intervals as low as 0.1 second. Smaller intervals require too fast a recorder speed and are measured by the second method.

This method involves a statistical approach. The oscillator to be measured is fed to a low-noise mixer along with a very stable reference frequency.

The difference of the two signals is then fed to a counter which measures the period (or wavelength) of this signal. A typical setup is shown in Fig. 5. The difference frequency actually triggers a gate, allowing a very stable 10-MHz signal to drive the counter. Since the period of the difference signal determines how many cycles of 10 MHz will be fed into the counter, great accuracy can be achieved. Assuming that the difference signal is 1 Hz, this means that 10,000,000 cycles will pass into the counter through the gate for each cycle of input. Therefore, only 1/10,000,000 of a second change in the difference signal will cause the counter to indicate a change. Since such great resolution is possible by this technique, extremely short intervals of time can be measured and interpreted as short-term stabilities.

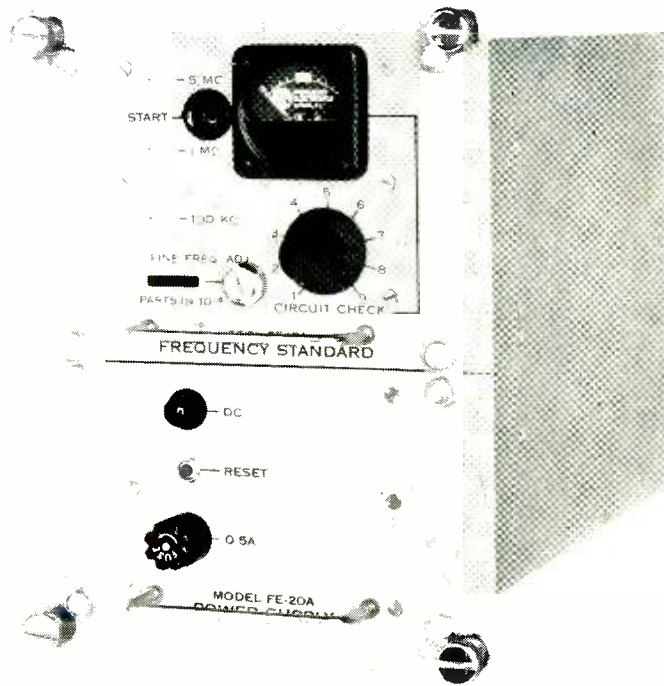
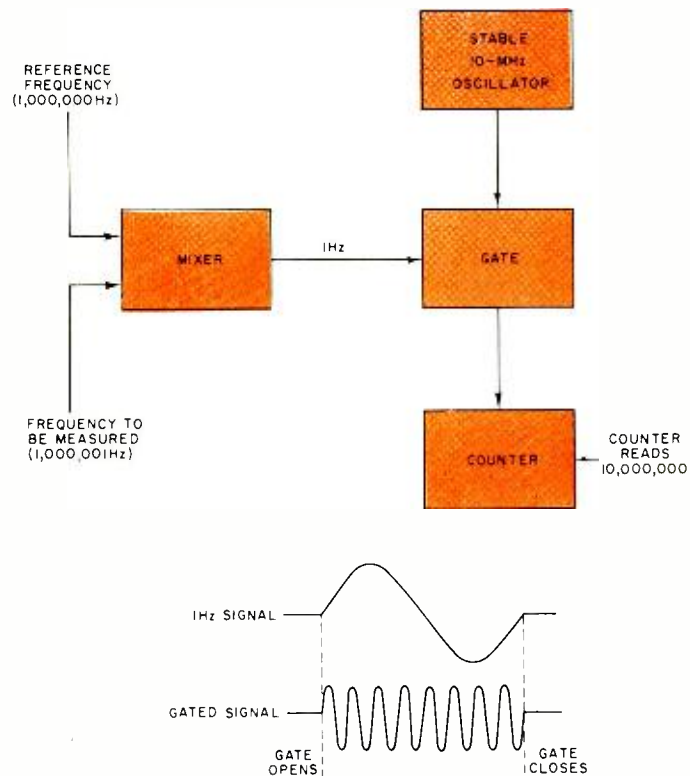

Fig. 4. A typical high-quality frequency standard which has a long-term stability of plus or minus 1 part in 10^{10} .

Usually an oscillator with good short-term stability will not exhibit a good long-term characteristic and *vice versa*. As a result, where both long- and short-term stability must be as good as possible, the technique shown in Fig. 6 is used. A very good long-term standard and a very good short-term standard are fed to a phase detector. The d.c. output of the phase detector is then fed back to a voltage-variable capacitor in the short-term standard which causes its frequency to "lock" to the frequency of the long-term unit. This "phase-locking" technique now produces an output with excellent long- and short-term stabilities.

The stability of an oscillator (Continued on page 68)

Fig. 5. Test setup employed for short-term measurements.



IC's Head For Industrial Market

As the price of IC's comes down, the area of application increases. The continuing trend toward ever bigger circuits in the same small package further eases IC use in many types of industrial equipment.

WITH integrated circuits setting the trend, electronic manufacturers look to industrial equipment as their next big growth market. One major producer, *Texas Instruments*, expects industrial electronics equipment to rise from a current level of \$4.8 billion to \$6.1 billion by 1970, with IC's accounting for some \$400 million sales that year.

Charles Phipps, *TI* integrated circuits marketing manager, says, "Solid-state electronics is no longer restricted to TV, hi-fi, and sophisticated military hardware. Today, builders of machine tools, production-control equipment, and materials-handling machines are already making the switch from their traditional mechanical and hydraulic methods to electronics."

Besides lowering costs, IC's have cut size and weight of equipment by up to 75%, improved quality and reliability from three to five times, and reduced the number of components by a factor of 30.

In 1965, less than 10% of IC sales went to industrial users; in 1966 this figure rose to 20%. *TI* anticipates that by 1970, as much as 60% of the IC market will be industrial types. This dominance will be further reflected by IC's accounting for 40% of all small-signal (non-power) electronic circuits built in 1970. See graph below. This represents an eight-fold increase over current levels, where discrete semiconductor circuits dominate and vacuum-tube networks are the "weakening" second.

The rapid price reductions for IC's and the resultant expansion in markets were possible because of the much shorter "learning cycle" for IC's than earlier semiconductors. IC producers were able to draw heavily on the basic technologies, production techniques, and testing methods developed for transistors. In fact, the "knee" of the price trend (as shown bottom right) occurred after only one million units were produced. Germanium transistors, the first semiconductor in high-volume production did not experience this price break until more than 100 million units were produced. Silicon transistors broke their price barrier at about 10 million units.

First-generation IC's were simple circuit functions, single logic gates which were the equivalent of 10 to 20 discrete components. The second generation, introduced in 1964, were multi-function units containing up to four gates. Today's complex-function networks include up to 10 to 20 circuits, the equivalent of more than 100 individual components. This trend is shown in the upper graph shown below.

The Future

The major advances in the next few years will come from an acceleration of the trend to more and more complex circuits. Large-scale integration (LSI) holds bright promise of further magnifying the advantages of printed circuits.

Today's circuits are batch processed on 1½-inch silicon wafer capable of holding as many as 2000 circuits. They are then sawed apart into individual circuit chips for packaging. In the advanced LSI approach, the circuits are not separated but interconnected right on the slice itself. The whole system is then packaged as a unit. *TI* has already developed 120-gate arrays and is actively working on 250- to 350-gate combinations. It is hoped that in the not too distant future, entire electronic sub-systems of 500 to 1000 circuits can be placed on a slice of silicon, a little larger than a half dollar.

Although this thinking seems to be mainly in the digital computer area, it does not rule out the possibility of entire radio, TV, or FM sets on a single slice. ▲

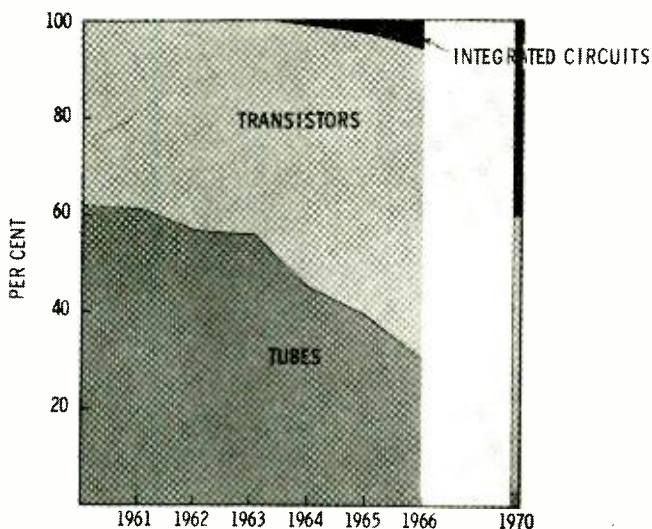

DISTRIBUTION OF TUBES, TRANSISTORS, AND INTEGRATED CIRCUITS
SMALL SIGNAL CIRCUITRY
U. S. A.

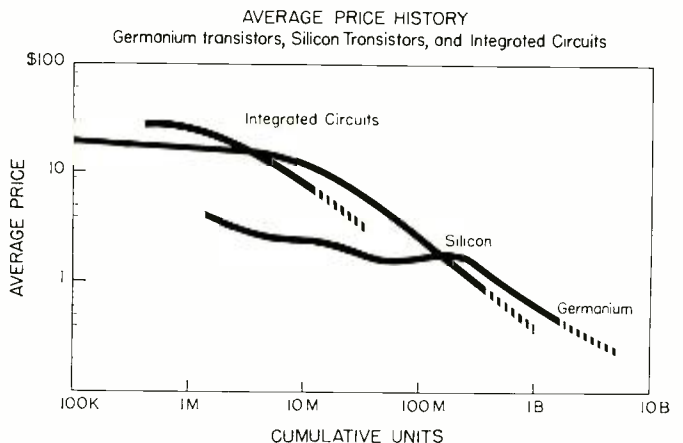
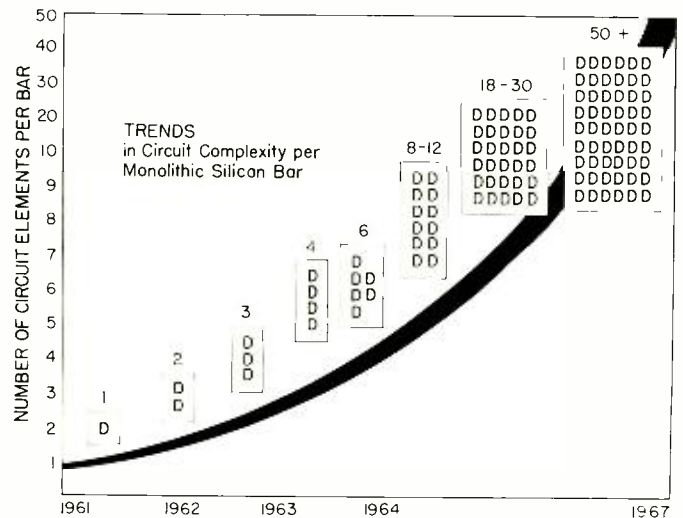

Selecting and Using

PULSE GENERATORS

By JOHN D. LENK

Basically a laboratory version of the square-wave generator, but with adjustable on-off times, this instrument has many uses in developing digital circuitry, in checking diode and transistor switching times, as a klystron modulator, and for impulse testing.

THE output of a pulse generator is similar to that of a square-wave generator. The fundamental difference between the two concerns the signal duty cycle. Square-wave generators have equal "on" and "off" periods, this equality being retained as the repetition frequency is varied. On the other hand, the duration of a pulse generator "on" period is independent of pulse repetition rate. The duty cycle of a pulse generator can be made quite low so that the pulse generator is usually able to supply more power during the "on" period than a conventional square-wave generator.

Pulse generators with fast rise times are widely used in the development of digital circuitry. Teamed with a suitably fast oscilloscope, these generators enable evaluation of transistor and diode switching times. Pulse generators can be employed as modulation sources for klystrons and other r.f. sources to obtain high peak power while maintaining low average power. Pulse generators are also used for impulse testing. A very short pulse is rich in harmonics so that input testing amounts to simultaneous frequency-response testing of components or systems.

Important Characteristics

To adequately describe the characteristics of a pulse generator, it is first necessary to establish uniform terms for pulses. These terms are illustrated in Fig. 1. When actual pulses are very irregular (with excessive tilt, overshoot, or rounding), the definitions may become ambiguous, requiring a more complete description.

The following are typical characteristics of a laboratory pulse-generator output:

Leading Edge Only:

Rise time (T_r): <1.0 nanosecond (ns) (10 to 90%).

Overshoot and ringing: overshoot <5% peak; ringing <±5% of pulse amplitude.

Corner rounding: occurs no sooner than 95% of pulse amplitude.

Time to achieve flat top (T_a): <6 ns.

Trailing Edge Only:

Fall time (T_f): <1.0 ns (10 to 90%).

Overshoot: <5%.

Rounding: occurs no sooner than 95% of fall.

Time to settle within 2% of baseline (T_s): 10 to 25 ns, varies with setting.

Baseline shift: <0.1% under all conditions.

Preshoot: <1%.

Perturbations on flat top: <2% of pulse amplitude.

Peak voltage: >10 volts into 50 ohms. >20 volts into open circuit.

Polarity: positive or negative.

Pulse width (between 50% points): continuously adjustable, zero to 100 ns (zero ns width occurs when 50% points meet, creating an impulse of one-half the amplitude of wide pulses).

Repetition rate (internal): <100 Hz to >1 MHz in 4 ranges.

The quality of the output pulse is of primary importance in the selection of a pulse generator. If the displayed pulse is degraded, a high-quality test pulse will insure that the cause is in the test circuit alone. Rise and fall times should be significantly faster than the circuits or systems to be measured. Any overshoot, ringing, or sag in the test pulse should be known so that these faults will not be confused with similar results caused by the test circuit.

The range of pulse-width control should be wide enough to fully explore the range of operation of a circuit. Narrow pulse widths are useful in determining the minimum trigger energy required in some circuits.

Maximum pulse amplitude is of prime concern if appreciable input power is required by the circuit under test, such as a magnetic core memory. At the same time, the attenuation range should be broad enough to prevent overdriving the test circuits as well as to simulate actual circuit operating conditions.

The range of pulse repetition rates is important if the tested circuits can operate only within a certain range of pulse rates or if a variation in the rate is needed. In some systems, methods of external triggering are also significant. In fast pulse systems, the generator source impedance is an important consideration because a generator which has a source impedance that is matched to the connecting cable will absorb reflections resulting from impedance mismatches in the external system that is used.

Basic Precautions

1. Use proper types of cables, terminations, attenuators, and impedance-matching networks. Always match impedances unless the test circuit specifically calls for a mismatch.

Fig. 1. Terms used in describing output pulse characteristics.

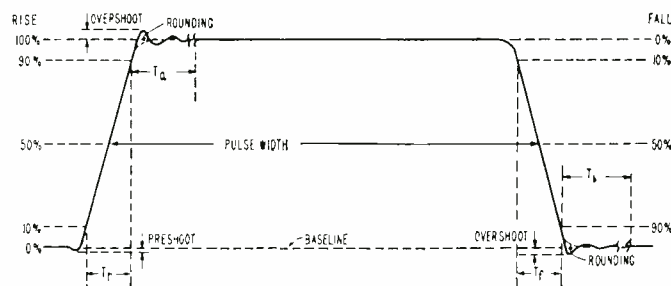

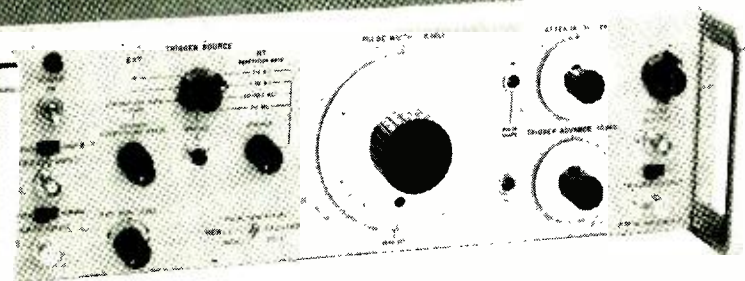

Hewlett-Packard Model 215A pulse generator is shown above.



H-P 213B produces pulse with under 0.1-nanosecond rise time.

2. Keep ground-return paths short and direct. Use heavy conductors to provide low impedance in the ground return.
3. Make sure that all connections are tight and that all connectors are securely assembled.
4. Shield measuring-equipment leads to prevent undesired coupling to other parts of the circuit. Shielding is especially required where pulse radiation is a problem and particularly where high-impedance dividers or circuits are involved.
5. Consider the effects of secondary parameters in components, such as inductance in resistors and in capacitor loads.
6. Consider the possible non-linear behavior of compo-

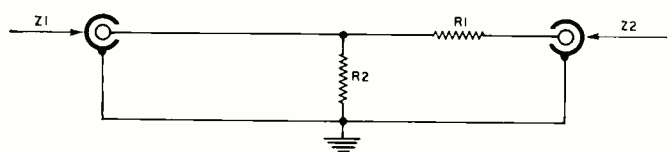

TO MATCH IMPEDANCES:
 $R1 R2 = Z1 Z2$ AND $R1 Z1 = R2 (Z2 - Z1)$ OR: $R1 = \sqrt{Z2 (Z2 - Z1)}$ AND $R2 = Z1 \sqrt{\frac{Z2}{Z2 - Z1}}$

VOLTAGE ATTENUATION SEEN FROM Z1 END:
 $A1 = \frac{R1}{Z2} + 1; 1 < A1 < 2$

VOLTAGE ATTENUATION SEEN FROM Z2 END:
 $A2 = \frac{R1}{R2} + \frac{R1}{Z1} + 1; 1 < A2 < 2 Z2 / Z1$

Fig. 2. Resistive impedance-matching network and formulas.

Fig. 3. Three-way dividing pad circuit for Z measurement.

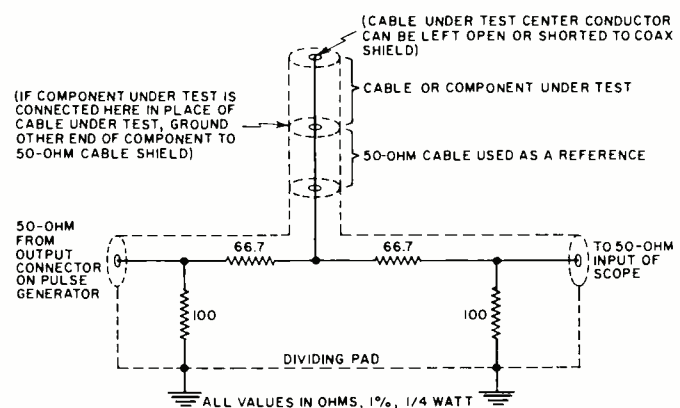

ALL VALUES IN OHMS, 1%, 1/4 WATT

nents due to changes in either voltage or temperature.

7. Select components which function properly at the frequencies and rise times expected to be encountered.

Obviously, the accuracy of rise-time measurements can be no greater than the rise time of the pulse generator. If a pulse generator with a 20-nanosecond rise time is used to measure the rise time of a 15-nanosecond oscilloscope, the measurements would be hopelessly incorrect. Also, if the same pulse generator and oscilloscope were used to measure the rise time of another system, the fastest rise time for accurate measurement would be something greater than 20 nanoseconds.

As a general rule, if the rise time of the test device is at least ten times as long as the rise times of the generator, oscilloscope, or cables, the error introduced will not be more than 1%. If the rise time of the device under test is less than ten times that of the test equipment, it will be necessary to calculate the rise time. The most common method involves finding the square of all rise times associated with the test, adding these squares together, and then computing the square root of this sum. For example, using the 20-ns pulse generator and the 15-ns oscilloscope, the calculation would be: $20 \times 20 = 400$; $15 \times 15 = 225$; $400 + 225 = 625$. $\sqrt{625} = 25$, so 25 nanoseconds is the fastest possible rise time capable of measurement.

Another rule of thumb applying to rise times is that if the equipment being measured has a rise time three times slower than the test equipment, the error is only slightly less than 6%.

If there are significantly long lengths of coaxial cable in the signal path, the above method can be used only as an approximation, since the "skin-effect" losses in coaxial cables do not add properly with this method.

Connecting Pulse Generators

1. In most measurements involving pulse generators, a complete d.c. return path must be provided between the device under test and the pulse-generator output connector.

2. If the pulse is applied to a load which has a d.c. potential across it, the actual amplitude of the pulse is equal to the voltage set by the pulse-generator amplitude control less one-half the d.c. voltage across the load.

For example, assume that the pulse-generator output is connected to a load which has +10 volts across it and that the pulse-generator amplitude control is set to +1 volt. The actual amplitude is found by substituting these values as follows: $V_a = V_s - (V_l/2)$ or $+1 - (+10/2) = -4$ volts where V_a is the actual pulse amplitude, V_s is the voltage setting of the amplitude control, and V_l is the d.c. voltage applied across the load.

3. If it is impossible to use an impedance-matching network, one possible solution is to employ a long coaxial cable between generator and load. This will delay the load's reflections until after the time of interest.

The pulse-generator output can be supplied with an impedance-matching network that will produce a smooth transition of power (no reflections) with a minimum attenuation. Such a network is shown in Fig. 2. To match impedances with the illustrated network, the values of $R1$ and $R2$ must be selected carefully.

For example, to match a 50-ohm system to a 125-ohm system, $Z1 = 50$ ohms and $Z2 = 125$ ohms. Therefore, $R1 = \sqrt{125(125 - 50)} = 96.8$ ohms, and $R2 = 50 \sqrt{125/(125 - 50)} = 64.6$ ohms.

The attenuation as seen from one end of the network does not equal that seen from the other end. Using the equations shown in Fig. 2, it will be noted that a signal applied from the lower impedance source $Z1$ encounters a voltage attenuation $A1$. Also, a signal applied from the higher impedance source $Z2$ will encounter a greater voltage attenuation $A2$.

For example, with an $R1$ of 96.8 ohms and an im-

pedance Z_2 of 125 ohms, $A_1 = (96.8/125) + 1 = 1.77$.

With an R_1 of 96.8 ohms, an R_2 of 64.6 ohms, and an impedance Z_1 of 50 ohms, $A_2 = (96.8/64.6) + (96.8/50) + 1 = 4.44$.

Measuring Impedance

A pulse generator can be used to determine impedance of an unknown device by comparing the reflected pulse with the incident pulse on an oscilloscope. This can be explained as follows.

As a signal travels down a transmission line, each time it encounters a mismatch or different impedance, a reflection is generated and sent back along the line to the source. The amplitude and polarity of the reflection are determined by the value of the impedance encountered in relation to the characteristic impedance of the cable. If the mismatch impedance is higher than that of the line, the reflection will be of the same polarity as the applied signal; if it is lower than that of the line, the reflection will be of opposite polarity.

The reflected signal is added to or subtracted from the amplitude of the pulse if it returns to the source before the pulse has ended. Thus, for a cable with an open end (no termination), the impedance is infinite and the pulse amplitude would be doubled. For a cable with a shorted end, the impedance is zero and the pulse would be canceled.

The following procedure provides a practical method of determining impedance with a pulse generator and scope.

1. Connect the equipment as shown in Fig. 3.
2. Observe the incident and reflected pulses on the oscilloscope. Using Fig. 4 as a guide, determine the values of V_o (incident) and V_r (reflected). (This method is generally limited to the first reflections unless the deviations are small, due to multiple reflections and reflection losses.)
4. Using the following equation, calculate the unknown impedance: $Z = 50 / (2V_o/V_r - 1)$ where Z is the unknown impedance, V_o is the peak amplitude produced by the 50-ohm reference impedance, and V_r is the peak amplitude at the time of reflection.

Using Conventional Oscilloscopes

A pulse generator is often used with a sampling oscilloscope, and generator and oscilloscope manuals describe the procedure. However, a pulse generator can also be used with conventional triggered oscilloscopes. Fig. 5 shows the test connections.

Internal triggering is convenient since no external triggering connections are required. However, with external triggering it is possible to observe the shaping and amplification of a signal pulse in the circuits of a device under test without resetting the oscilloscope triggering controls for each observation. If the external triggering signal is derived from the waveform at the input circuit of the device under test, the time relationship and phase between the output and input waveforms may be seen and compared on the oscilloscope screen.

If the signal from the test device is fast-rise non-repeti-

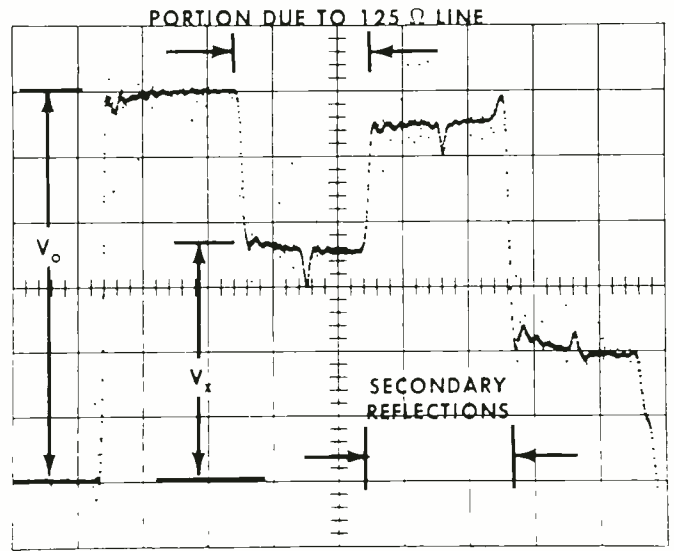

Fig. 4. Waveform obtained with 125-ohm cable and 50-ohm system.

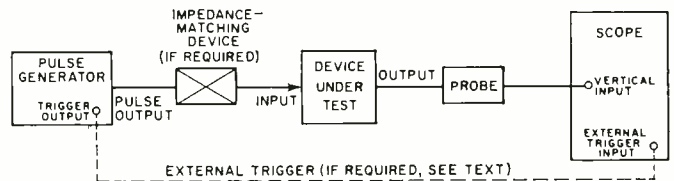
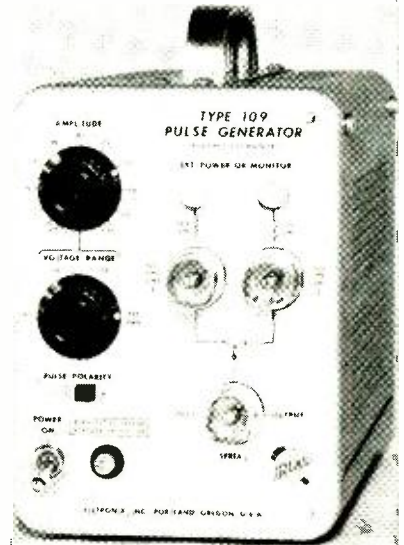

Fig. 5. Test connections using generator with conventional scope.

tive or has a low duty cycle, the oscilloscope used in this setup must have an internal delay line so that the leading edge of the single waveform can be readily observed on the scope. (Continued on page 76)

(Right) Tektronix Type 109 pulse generator has rise time of under 0.25 nanosec.



(Below) Tektronix Type R116 programmable pulse generator.

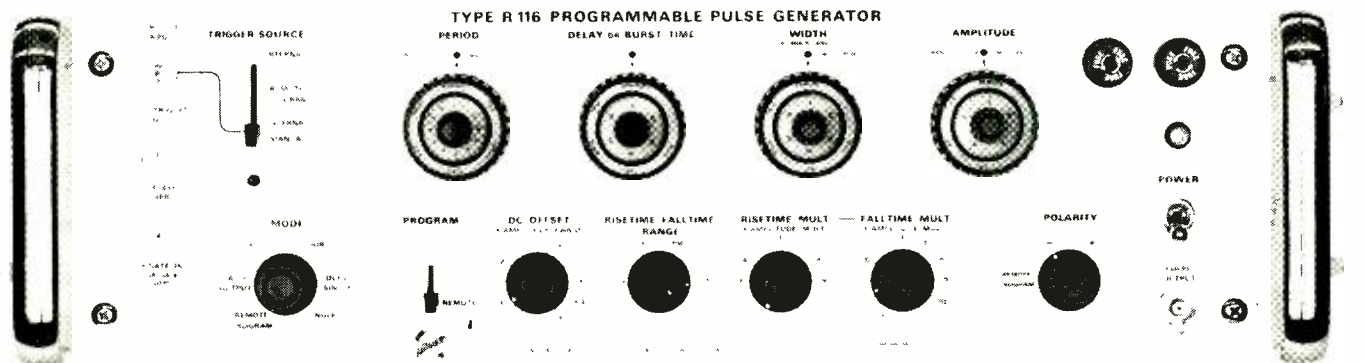

Radio Measurements in Space

By JOSEPH H. WUJEK, Jr.

Scheduled for an early launch is a satellite to be used for radio astronomy purposes only. An array of space antennas having 750-foot elements will be used.

WHEN the brilliant Scots physicist James Clerk-Maxwell (1831-1879) published his classic "A Treatise on Electricity and Magnetism" in 1873, very little was known about the nature of electromagnetic (EM) radiation. Although Maxwell predicted the existence of EM waves, it was not until after 1885 that high-frequency EM waves were generated in the laboratory. Heinrich Hertz (1857-1894) is generally acknowledged to be the first to generate these waves and was recently honored by having the unit of frequency—"hertz"—named for him. The theoretical work of Maxwell and the subsequent experimental research of Hertz thus paved the way for the technology which we now know as radio. We use the term "radio" here to include that region of the EM spectrum which extends from a few hertz to the edge of the infrared region, which is about 1000 gigahertz (1 million megahertz or 1 terahertz).

With the development of radio communications in the twentieth century, major emphasis was placed on gaining a better understanding of the nature of radio propagation

Scale model of the Radio Astronomy Explorer satellite, world's first satellite devoted exclusively to radio astronomy.

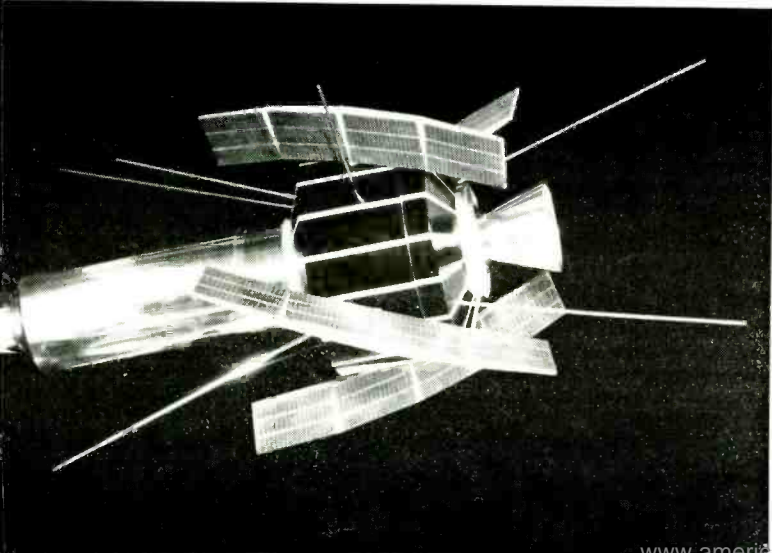

This unusual op-art tracing was made by a portion of an antenna designed for the Radio Astronomy Explorer satellite. The photo was made in a thermal test chamber with a small light bulb attached to the end of about 35 feet of the antenna. The antenna was allowed to swing free in the chamber to give engineers an insight into what the normal deployed pattern would be after the momentum had decreased.

and noise. Measurements of radio propagation and noise characteristics were, and continue to be, made with international cooperation. The National Bureau of Standards (NBS) of the U.S. Department of Commerce guides this effort in the United States with technical coordination maintained among NBS, other government agencies, universities, and industry.

A natural outgrowth of propagation and noise studies was the detection of radio-frequency noise from deep space. Until the recent advancements in space technology, measurement of space r.f. signals was confined to the ground or to those altitudes accessible to aircraft. This was, of course, also true of r.f. propagation studies. While ground-based and aircraft measurements have contributed much to our understanding of these phenomena, measurements from space vehicles enhance these results. Since the earth's atmosphere acts to severely attenuate certain r.f. frequencies, a measurement of r.f. signal strength taken above the atmosphere provides added information regarding the source, strength, and character of these signals.

The science of radio astronomy has also benefited from space r.f. measurements. It has been known for some time that stars, galaxies, and some planets emanate EM waves. The star nearest earth, our sun, exhibits increased flare, or sunspot activity, on a somewhat regular basis. In particular, the occurrence of these flares increases to a maximum every eleven years (Fig. 1). Radio communications in certain frequency bands are severely affected during such increased solar activity.

By studying the nature of the r.f. emanations of the sun and other stars, scientists are able to better understand the energy processes which occur in these bodies. The solar flares, which are believed to be reactions similar to those of a fusion or hydrogen bomb, release enormous amounts of energy. Swarms of charged particles and EM waves are discharged from these reactions. The earth is about 93 million miles or 8 light-minutes from the sun, yet some of these particles and waves find their way through the atmosphere and ultimately reach the earth. In an earlier article ("Radiation

tion Measurements in Space”, August 1966) we showed how energetic particles are detected and measured. Here we will discuss systems used to measure r.f. energy in space.

Space Radiometry

Instruments used to measure radiation in the EM spectrum are called “radiometers”. Many different kinds of radiometers exist; the type used will depend on the portion of the spectrum to be measured. In this article we shall be concerned only with radio-frequency systems.

Radiometers have been used in space experiments from the very beginnings of space exploration. These systems generally consist of an antenna, an amplifier, and a telemetry readout system. The amplifiers are usually of the frequency-selective variety so as to amplify and pass only those frequencies of interest, while all other frequencies are rejected. Some systems use several amplifiers and/or antennas which are shared by means of automatic switching controlled by a programmer subsystem. Ground commands may also be used to select a particular channel when the payload is traversing a given region of space.

As in the case of ground-based systems, antenna design depends on the range of signal frequencies to be gathered. Space radiometers have been developed which have input sensitivities as low as 0.1 microvolt per meter. For some perspective, remember that in order to obtain a good-quality TV picture on most commercial receivers, a signal strength of 100 microvolts per meter is required with a signal-to-noise ratio of at least 30 dB. Space systems can yield higher sensitivities because they are far removed from high-level man-made signals and interference. These higher sensitivities cannot, in general, be verified experimentally in the laboratory due to the high level of surrounding interference.

Radio Astronomy Explorer Satellites

The first Radio Astronomy Explorer (RAE) satellite has been tentatively scheduled for launch this year. This will mark the first time a satellite has been designed and developed for radio astronomy purposes exclusively. Due to be another first in space technology is the array of antennas, each of which is 750 feet in length.

These antennas were first developed by *The de Havilland Aircraft of Canada, Limited*. In addition to functioning as antennas, the long tubular sections provide gravity gradient stabilization of the spacecraft. The principle by which these rods are fabricated is designated STEM, from the name *Storable Tubular Extendable Member*. STEM devices have been used successfully on such space missions as Gemini (16-foot antenna), the Canadian Topsy satellite (60-foot antennas), and the TRAAC satellite (60-foot gravity stabilizing boom).

The STEM device consists of a strip of thin material, usually stainless steel or beryllium-copper alloy, which has been preformed to a tubular configuration. The strip is then wound on a drum or compressed in telescope fashion into a canister. In the case of the longer element lengths, a drive motor rotates the drum to unfurl the STEM device (Fig. 2). The canister-version boom is expanded by removing the canister lid, resulting in a jack-in-the-box unfurling. An explosive bolt or squib is usually detonated by an electrical signal to shear a pin or latch and thus open the canister.

While the principles of antennas are familiar to all of us, the notion of gravity gradient stabilization is perhaps not so familiar. The physics involved here is not too different from the tightrope walker who carries a long pole for balance. In the case of spacecraft stabilization, the small difference in gravity over the length of the rod produces a torque which tends to align the rod parallel to the gravitational field, as shown in Fig. 3. The addition of more long rods to the spacecraft produces more torque which yields a spacecraft attitude which is stable with respect to earth.

Because of the great length and thin walls of STEM devices, several problems appear with their use. The vacuum of space is a cold void except when matter is present to be heated by the sun's radiations. As a result, that side of the STEM device which faces the sun is much warmer than the side which looks away from the sun. Due to contraction and expansion of materials with heating, the element tends to bend under these temperature conditions. Thus, the tip of such an element of 300-foot length, with ½-inch diameter and 0.002-inch walls, may deflect more than 100 feet. The deflection may be reduced by using thicker walls in the tubing, but if this is done, weight is also increased—which is a great disadvantage in a good many space applications. (Continued on page 67)

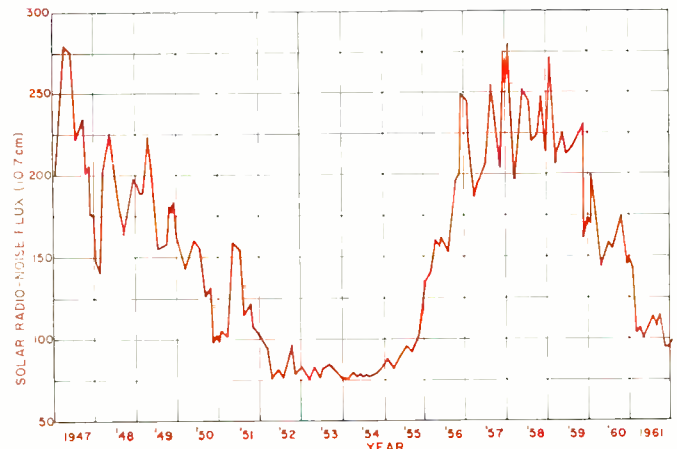

Fig. 1. Graph of noise from solar activity at 2.8 GHz showing the last complete eleven-year cycle. Right now solar activity is on upswing and new peak should occur around 1969.

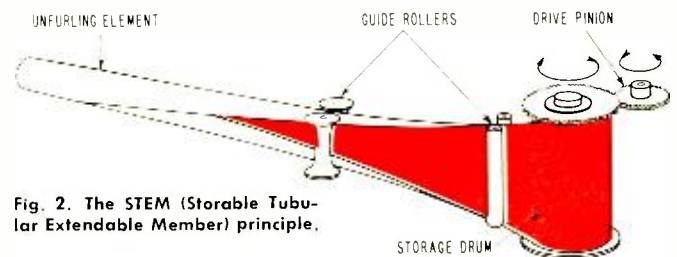

Fig. 2. The STEM (Storable Tubular Extendable Member) principle.

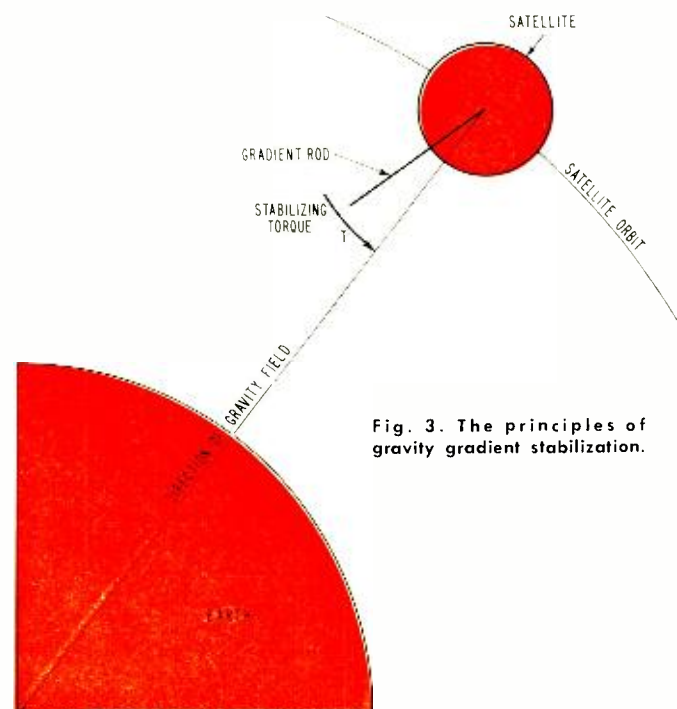

Fig. 3. The principles of gravity gradient stabilization.

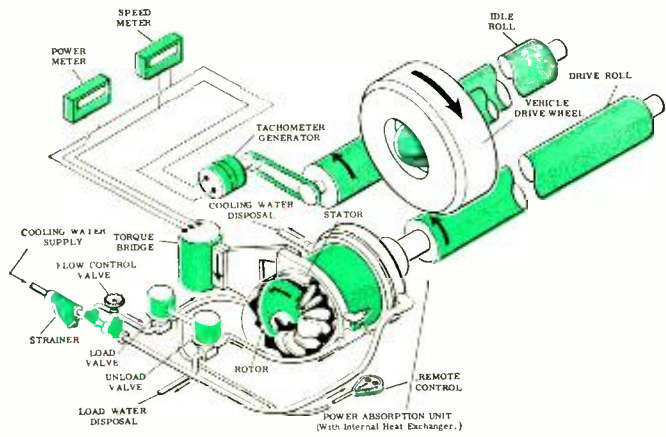

Fig. 4. On this dynamometer (only one side shown), the car can be "driven" at speeds to 70 mph while all tests are being performed. The dynamometer can also be "driven" by the car so that the vehicle's actual road horsepower can be determined. In essence, an instrumented road test.

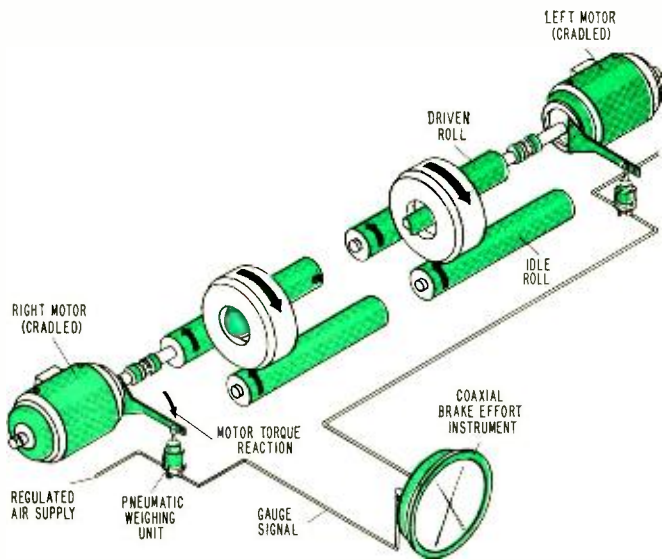

Fig. 5. The brake analyzer is electrically driven but uses hydraulic readout. Almost all rolling tests are performed.

by the automobile manufacturer for that particular model.

We will now take a closer look at each piece of test equipment and explain its basic operation.

Dynamometer

The dynamometer is primarily a hydraulic energy-absorbing device which is able to measure and indicate the power transmitted from the wheels of the vehicle under test. The device may also have the additional capability of providing driving power to the wheels by means of two motors connected to the right and left rollers independently. In use, either the front or rear wheels of the vehicle are cradled between the dynamometer rollers, and when the rollers are rotating, various transducers transmit the torque and speed signals to appropriate readout meters which, in turn, indicate road speed and road horsepower. The dynamometer may also include a declutchable inertia weight to allow simulation of actual road load during acceleration and deceleration operations. Fig. 4 illustrates operation of a typical (in this case, a *Clayton*) dynamometer. The front and rear rollers cradle the drive wheels of the vehicle. The drive roll is coupled to the power-absorption unit shaft. The idle roller drives a tachometer generator that furnishes the current for the dynamometer electrical instruments.

The power-absorption unit consists of a shaft, rotor,

and heat exchanger, all enclosed within a housing and mounted on cradle bearings. The operator uses the remote control to increase or decrease the load imposed on the vehicle by operating the load or unload valves. Opening the load valve allows additional water to enter the power-absorption unit housing, increasing the load presented to the vehicle's wheels. Opening the unload valve allows water to leave the housing, thus decreasing the load.

The force of the load water thrown into the stator from the rotor tends to rotate the cradled power-absorption unit housing. This movement is restrained by the torque bridge attached to the outer end of the power-absorption unit torque arm.

Current, proportional to wheel speed, is supplied by the tachometer generator to the speed meter and to the torque bridge. The torque bridge measures the torque (the force with which the power-absorption unit tends to rotate) and electrically combines the measurement of torque and speed to actuate the power meter, which is calibrated to indicate in horsepower.

As the power is absorbed, the load water temperature increases. The pumping action of the rotor causes a constant circulation of the load water across the tubes of a heat exchanger where the heat is transferred to cooling water.

Brake Analyzer

A typical brake analyzer, such as shown in Fig. 5, consists of two assemblies, each containing two rollers mounted in ball bearings. Attached to each roller section is a cradle-mounted 20-hp electric motor. Each motor is coupled to its rear roller through a flexible coupling.

The vehicle wheels are cradled between the rollers and the rollers are then accelerated to produce an equivalent road speed of about 45 mph. When the brakes are applied, the torquing reaction of each motor is measured by a pneumatic weighing unit and read out on a special large-scale gage. One needle is supplied for each right and left wheel. The instrument readout is calibrated to read in pounds of force exerted on the tire tread by the roller surface.

The brake analyzer will also indicate the rolling resistance of the vehicle. With no brakes applied and the wheels rotating at about 45 mph, the dials will indicate the amount of force required to overcome any resistance caused by tire pressure, tread depth and design, bearing lubricant, and the weight supported by the wheel. Usually, the driver's weight creates a higher rolling resistance on the left wheel and will cause a slightly higher reading on that gage. Differences in rolling resistance between wheels rarely exceeds 6 pounds if tire conditions and pressures are equal and if a brake shoe is not dragging on one wheel. If imbalance is over 11 pounds and is reduced with a light jab on the brake pedal, a sticky shoe condition is indicated, but the test

Fig. 6. One type of engine analyzer found in diagnostic centers. This particular one is suspended from ceiling.



can be continued. Rolling resistance decreases as the tire and wheel-lubricant temperature changes. This change is gradual and is not significant in the tests.

Engine Analyzer

The most electronically complex device in the diagnostic center is the engine tester which includes a variety of meter readouts such as a voltmeter, ammeter, dwell angle, engine rpm (tachometer), and an oscilloscope-like device called an ignition analyzer. A typical unit is shown in Fig. 6. These meters are usually duplicated at the customer's location together with a brief explanation of what is being measured and what each meter reading means. Some consoles also include one or more hydraulic readout meters that

operate in conjunction with the dynamometer or brake tester.

The voltage-measuring section is a basic voltmeter usually having switchable ranges from zero to about 2 volts and zero to about 20 volts. The lower range is used to measure small voltage losses which may have become excessive due to increased electrical resistance in the wiring or components associated with the primary ignition circuit. Examples of circuit points at which these voltage-loss measurements may be taken are battery cables, distributor points, ignition switch, and starter switch. The higher voltage range is used to measure battery voltage, voltage-regulator output, voltage drop across ballast resistor or primary resistance wire, and ignition-coil primary voltage.

Fig. 7. How various types of ignition problems show up on the engine analyzer scope. These are all secondary-voltage patterns.

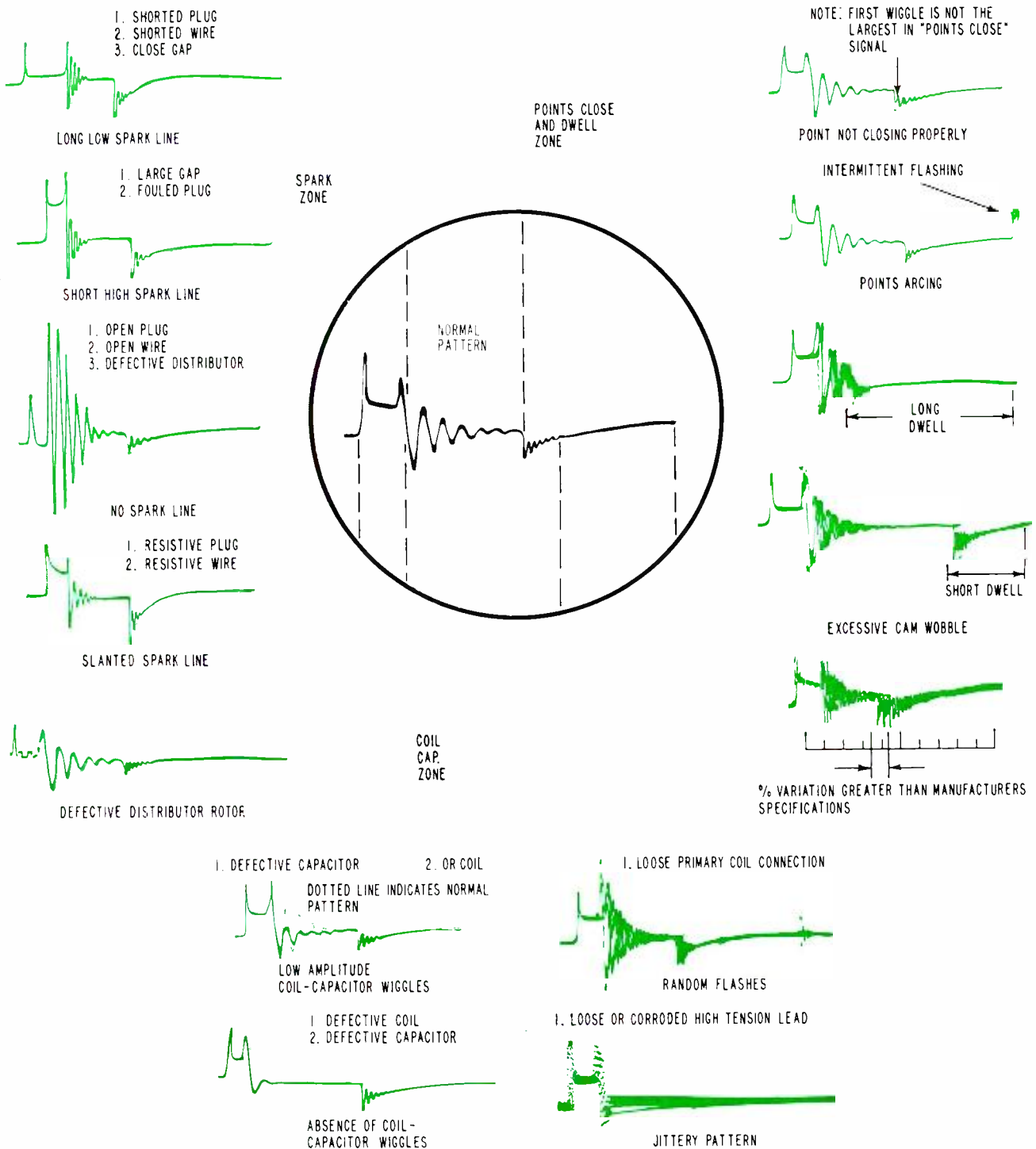

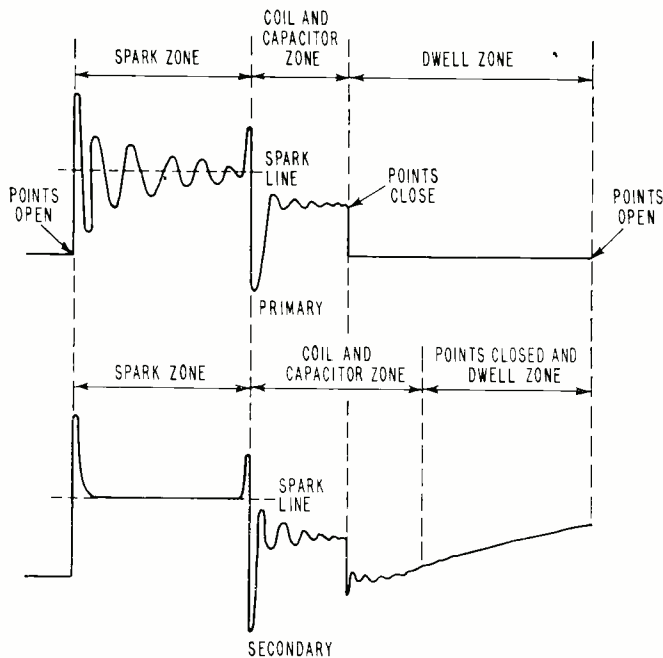

Fig. 8. Ignition coil basic primary and secondary patterns as shown on engine analyzer scope. Variations from these basic patterns may indicate problems. See chart of Fig. 7.

The current-measuring section is a basic ammeter having switchable ranges from zero to 500 amperes and is used for making measurements of battery charge discharge rates, generator/alternator outputs, and voltage-regulator operation. The higher range (500 amperes) is used only to check operation of starting motors.

The first of the actual electronic units, the dwell-angle meter, is the readout for an ohmmeter-type circuit that measures the time that the distributor points are closed during each ignition cycle. The number of degrees indicated on the meter is compared with the dwell time provided by the car manufacturer for that type of engine. A wider ignition-point setting will result in less dwell, while a closer point setting results in increased dwell.

The engine rpm meter (sometimes called tachometer) is the readout for an electronic circuit (usually a one-shot multivibrator) that indicates the average of the circuit's on-to-off time. The circuit is triggered *via* the distributor points, so as the engine is speeded up, the multivibrator switches on and off more rapidly; therefore, the average time, as indicated on the meter, is increased. Conversely, as the engine speed is reduced, the multivibrator switching time decreases, and the meter indicates a lower value. Most engine rpm meters have two or more switchable scale ranges, indicating to about 1200 rpm on one scale and to about 6000 rpm on another; in some cases, a third range is provided from about 2000 to 12,000 rpm. The tachometer is used in conjunction with tests of the carburetor settings, automatic gear-box changeover, ignition timing, and any other tests which may affect engine speed.

Probably the most complex piece of electronic equipment in the display console is the oscilloscope-like engine analyzer. This instrument changes the electrical pulses of the ignition system into a visual display from which almost all engine operating parameters can be measured. These parameters include shorted or open spark plugs, defective distributor points, defective wiring, coil and capacitor problems, incorrect point adjustment (dwell), cracked distributor cap, cracked or burned rotor, worn distributor parts, corroded high-tension wire terminals, reversed polarity, lean fuel mixture, and cam wobble. The ignition analyzer also enables a close "look" at the primary or secondary ignition patterns without changing the hookup to the engine.

Switching is arranged so that the waveforms from a

multicylinder engine can be displayed either "parade" fashion (one following the other across the width of the screen) or "superimposed" (one on top of the other) so that a comparison may be made among all cylinders at once in order to display any discrepancies in the firing waveforms. In the parade mode, the first waveform on the left is the one to which the cable has been attached. The other cylinders follow in the manufacturer's prescribed firing order.

The scope screen is usually calibrated with four different measuring scales. The vertical scale at the left of the screen is used to measure ignition pulses in the range of magnitude from zero to 18 kV, such as spark-plug firing-voltage requirements. The vertical scale at the right of the screen is used to measure ignition pulses in the higher range of magnitude from zero to 36 kV, such as ignition-coil voltage output.

The two horizontal scales at the bottom of the screen are calibrated in degrees and are used to measure the distributor dwell or cam angle. The cam angle is a measurement of the time during which the ignition breaker points remain closed. The upper scale is used to measure cam angle of an 8-cylinder engine, while the lower scale is used for 6-cylinder engines. The 8-cylinder scale reading is multiplied by 2 for measurement of a 4-cylinder engine.

Since a properly operating ignition system presents a characteristic pattern, any deviation from this pattern would indicate some type of difficulty. Therefore, it is necessary to know how each portion of the ignition system affects the normal pattern.

Fig. 8 shows two patterns—the ignition coil primary and secondary. Although both traces are similar and both convey useful information, the secondary trace is more sensitive and informative. The primary trace is typical for one cycle of operation of a normally functioning ignition system and represents the voltage across the breaker points. When the points open, the ignition coil generates the voltage required to make a spark jump across the plug gap. As soon as the spark is initiated, coil-capacitor oscillations take place in the coil primary and continue, diminishing in amplitude, until the spark ends. A slight burst of oscillation appears again when the spark ends, due to the energy remaining in the coil. These oscillations soon die out and are closely followed by the points' close signal shown by the rapid change as the voltage across the points drops to zero. The dwell zone or length of time the points remain closed is the length of the line up to the points' open signal, indicating the start of another cycle.

As shown in the secondary trace of Fig. 8, note that the first voltage peak is developed when the points open. This high voltage causes the initial spark to jump across the plug gap. Once started, the voltage reduces, but enough is left to sustain the spark at the point called the "spark line." Deviations from this spark line will point out difficulties in the high-tension circuits. The secondary coil-capacitor zone is similar to the primary zone. The secondary points' close zone is somewhat different from that of the primary trace due to the removal of the d.c. component by the coil transformer action. When the points close, there is a voltage induced in the secondary winding that oscillates for a short time. This is important since it shows proper closing of the points. The dwell zone, as in the primary trace, shows the length of point dwell time. The height of the initial spark voltage can be read off the right- or left-hand voltage scales on the scope. The waveforms shown in Fig. 7 illustrate the various patterns that can be observed on the scope.

In some consoles, a "power-check" measurement readout is provided. This is an electronic compression check that shows how the engine rpm changes when a selected cylinder does not fire. In the electronic system associated with this test, a timing circuit is so arranged as to prevent the spark plug from firing at the preselected (*Continued on page 90*)

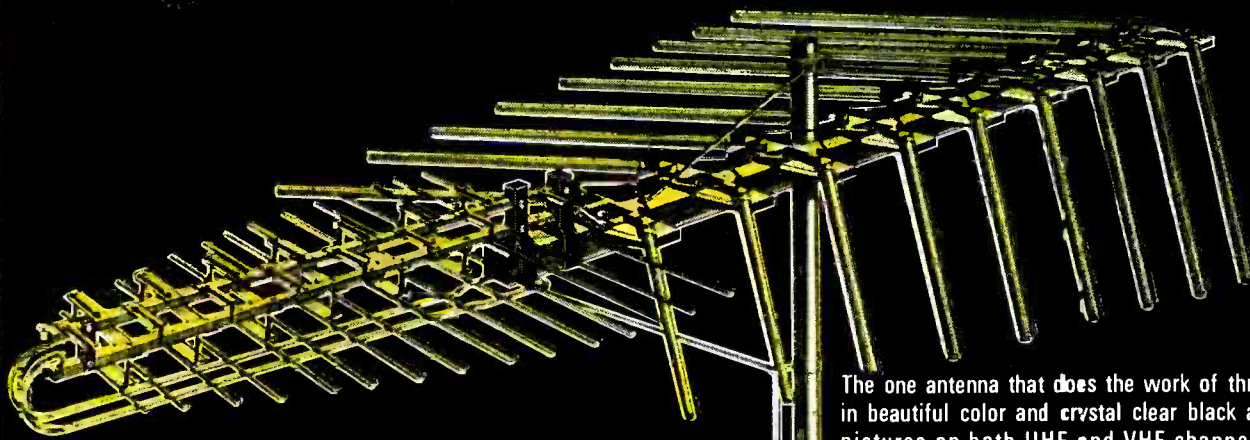

FINCO ALL-BAND UHF-VHF-FM ANTENNA
75 OHM Model CX-UVF-24 \$72.10 List
FINCO ALL-BAND UHF-VHF-FM ANTENNA
300 OHM Model UVF-24 \$59.95 List

The one antenna that does the work of three! Pulls in beautiful color and crystal clear black and white pictures on both UHF and VHF channels... plus the finest stereophonic and monophonic FM sound reproduction.
300-ohm models for normal reception areas from \$18.50 to \$59.95
75-ohm models for poor reception areas from \$42.65 to \$72.10

FINCO

introduces / 75-ohm COLOR VE-LOG ANTENNAS
FOR UHF-VHF-FM RECEPTION

Finco's Swept-Element Antenna challenges all competition. Its unique design assures the finest color and black and white TV reception—plus superb FM and FM Stereo tone quality.

300-ohm models for normal reception areas from \$16.95 to \$54.50

75-ohm models for poor reception areas from \$18.55 to \$62.80

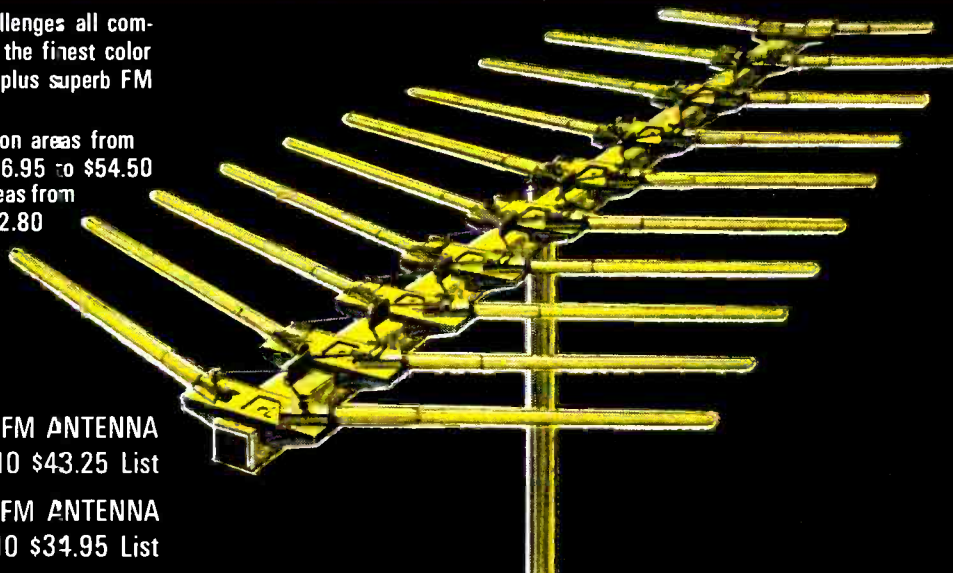

FINCO SWEPT-ELEMENT VHF-FM ANTENNA
75 OHM Model CX-VL-10 \$43.25 List

FINCO SWEPT-ELEMENT VHF-FM ANTENNA
300 OHM Model VL-10 \$34.95 List

FREE! ALL FINCO CX-VL, CX-UVF AND UVF ANTENNAS COME WITH A FREE INDOOR SET-MOUNTED TRANSFORMER, VHF-UHF TRANSFORMER SPLITTER OR VHF-UHF SPLITTER.



THE FINNEY COMPANY

34 WEST INTERSTATE STREET, DEPT. 410, BEDFORD, OHIO

Camera Tube Uses Solid-State Target Electrode

Advanced silicon technology helps create a new TV camera pickup tube that alleviates problems found in the conventional types.

WITH the constant improvement in diffusion techniques, and the many advances made into the understanding of semiconductor action, completely new concepts have evolved in electronics. The latest is a solid-state TV camera pickup tube target electrode to be used in a high-grade vidicon.

In conventional camera tubes (vidicon, orthicon, etc.), bright light or long exposure to fixed scenes can cause a tube defect called optical burn-in. This results in a lingering ghost pattern superimposed on the displayed image. Such optical burn-in can be so severe as to limit the lifetime of the tube. Conventional tubes also exhibit a defect called raster burn which is caused by the continuous pattern produced by the scanning electron beam. This also restricts the lifetime of the tube.

A new TV camera tube, developed at *Bell Telephone Labs.*, combines the best features of a vidicon with the latest in silicon technology. Like most camera tubes, this new one converts an optical image into a pattern of stored electrical charges on the target structure, with the pattern of charges periodically scanned and erased by the scanning electron beam. The video signal is generated as the charge pattern is erased. However, in this new tube, performance is not degraded or modified by exposure to bright light sources, or by electron beam bombardment.

The heart of the new tube is a new type of target structure consisting of a silicon wafer the size of a nickel, containing over a quarter-million silicon photodiodes in an area less than one-half inch square. A section of this target is shown in Fig. 1. The target is fabricated using masking and diffusion techniques identical to those used in making silicon integrated circuits.

The target structure of one experimental version of the silicon camera tube is a 540 by 540 array of electrically isolated, reverse-biased, silicon photodiodes. To make this structure, one side of a thin substrate of *n*-type silicon—with a sensitive area about .001-inch thick and slightly less than one-half inch square—is oxidized to form a silicon dioxide film (see Fig. 2). Photolithographic processes are

used to create an array of holes in the silicon dioxide film, forming a diffusion mask. Boron is then diffused through the array of holes forming islands of *p*-type silicon on one side of the *n*-type substrate. The resulting *p-n* photodiodes are .0003-inch in diameter. The islands have a center-to-center spacing of .0008 inch. The effective beam landing area of each *p*-type island is increased by a gold overlay which produces separate islands of gold centered on each *p*-type region. Finally, the opposite side is coated with an antireflection material that is similar to the type used on high-quality optical lenses.

In normal operation, the *n*-type substrate is held at a positive potential of up to 30 volts. An electron beam scans the photodiode side of the substrate and deposits electrons on the gold surface covering the diodes, thereby charging the islands down to cathode (ground) potential and reverse biasing the diodes. The silicon dioxide coating between islands isolates the *n*-type silicon from the scanning beam and the gold overlay.

The incident light associated with the image penetrates the opposite side of the substrate and creates hole-electron pairs in the *n*-type material. Almost instantly, the holes diffuse through the substrate to the *p*-type islands. There they combine with electrons, discharging the *p-n* photodiodes by an amount proportional to the original light intensity.

This process occurs during a time interval of 1/30th second between successive scans of each frame. The video signal is created as the scanning electron beam recharges successive diodes along the scanning path.

As shown in Fig. 2, the discrete nature of the target does not limit the resolution of the new camera tube since the scanning electron beam is much larger than the diode-to-diode spacing.



Fig. 2. Construction of the new TV camera target element.

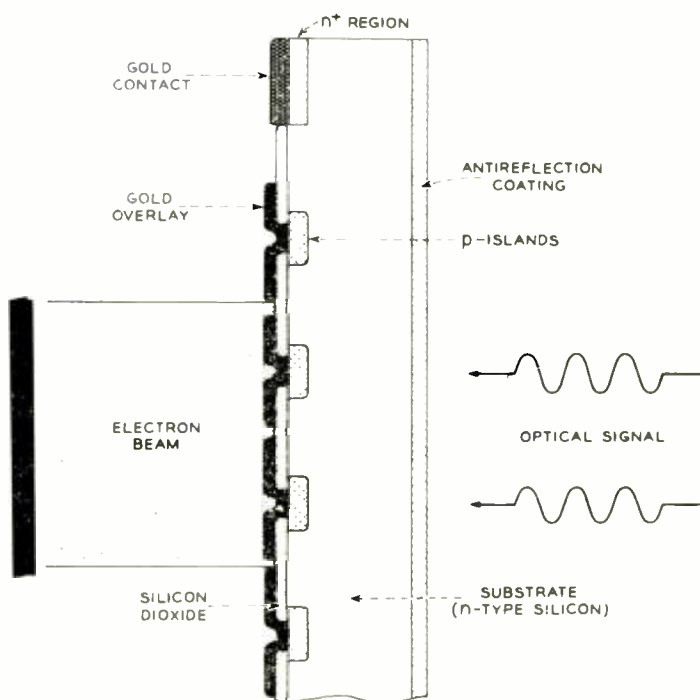
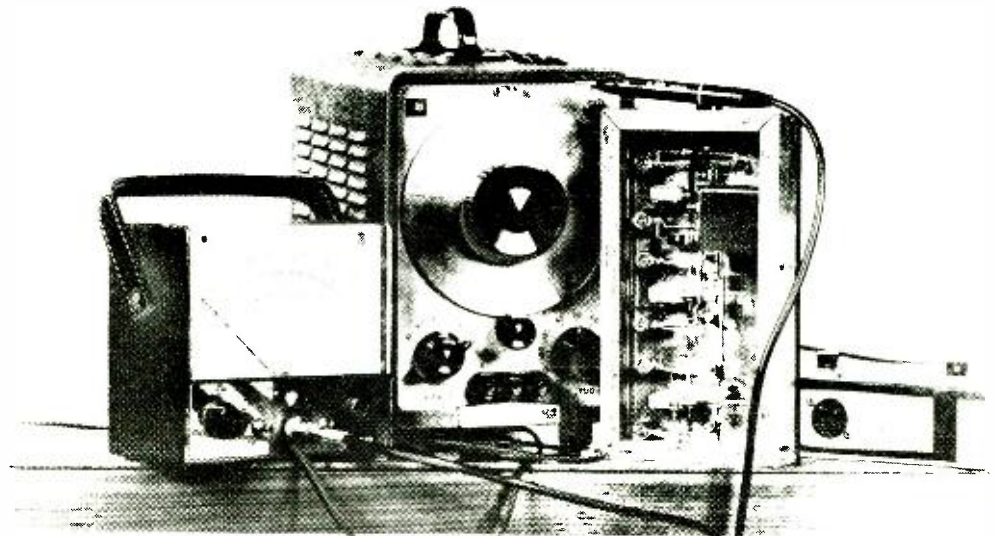

Fig. 1. Section of the photodiode array (white circles) showing their size compared with an ordinary human hair.



SOMEONE SHOULD DEVELOP AN EASY WAY TO LEARN ELECTRONICS AT HOME



RCA INSTITUTES DID!

Here is a whole new approach to learning electronics at home! RCA Institutes, one of the nations' largest schools devoted to electronics, has developed a faster, easier way for you to gain the skills and the knowledge you need for the career of your choice. Here for the first time, is a student-proved, scientifically designed way to learn. If you have had any doubts in the past about home training in electronics—if you have hesitated because you thought you might not be able to keep up—or that electronics was too complicated to learn—here is your answer! Read how RCA Institutes has revolutionized its entire home training ideas!

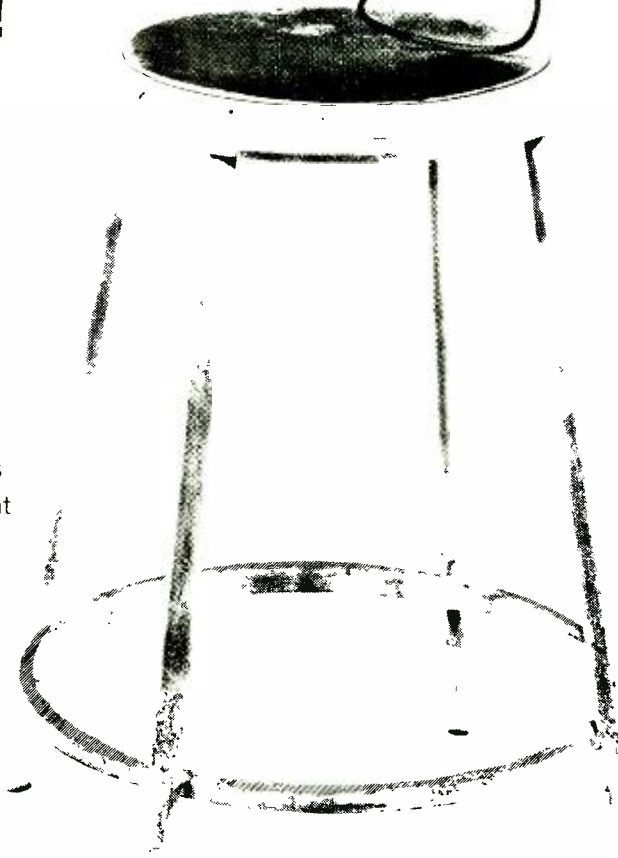

NEW CAREER PROGRAMS BEGIN WITH "AUTOTEXT" INSTRUCTION METHOD!

Start to learn the field of your choice immediately!

No previous training or experience in electronics needed!

With this new revolutionized method of home training you pick the career of your choice—and RCA Institutes trains you for it. RCA's Career Programs assure you that everything you learn will help you go directly to the field that you have chosen! No wasted time learning things you'll never use on the job! The Career Program you choose is especially designed to get you into that career in the fastest, easiest possible way!

And each Career Program starts with the amazing "AUTOTEXT" Programmed Instruction Method—the new, faster way to learn that's almost automatic! "AUTOTEXT" helps even those who have had trouble with conventional home training methods in the past. This is the "Space Age" way to learn everything you need to know with the least amount of time and effort.

CHOOSE A CAREER PROGRAM NOW

Your next stop may be the job of your choice. Each one of these RCA Institutes Career Programs is a complete unit. It contains the know-how you need to step into a profitable career. Here are the names of the programs and the kinds of jobs they train you for. Which one is for you?

Television Servicing. Prepares you for a career as a TV Technician/ Serviceman; Master Antenna Systems Technician; TV Laboratory Technician; Educational TV Technician.

FCC License Preparation. For those who want to become TV Station Engineers, Communications Laboratory Technicians, or Field Engineers.

Automation Electronics. Gets you ready to be an Automation Electronics Technician; Manufacturer's Representative; Industrial Electronics Technician.

Automatic Controls. Prepares you to be an Automatic Controls Electronics Technician; Industrial Laboratory Technician; Maintenance Technician; Field Engineer.

Digital Techniques. For a career as a Digital Techniques Electronics Technician; Industrial Electronics Technician; Industrial Laboratory Technician.

Telecommunications. For a job as TV Station Engineer, Mobile Communications Technician, Marine Radio Technician.

Industrial Electronics. For jobs as Industrial Electronics Technicians; Field Engineers; Maintenance Technicians; Industrial Laboratory Technicians.

Nuclear Instrumentation. For those who want careers as Nuclear Instrumentation Electronics Technicians; Industrial Laboratory Technicians; Industrial Electronics Technicians.

Solid State Electronics. Become a specialist in the Semiconductor Field.

Electronics Drafting. Junior Draftsman, Junior Technical Illustrator; Parts Inspector; Design Draftsman Trainee Chartist.

SEPARATE COURSES

In addition, in order to meet specific needs, RCA Institutes offers a wide variety of separate courses which may be taken independently of the Career Programs, on all subjects from Electronics Fundamentals to Computer Programming. Complete information will be sent with your other materials.

LIBERAL TUITION PLAN

RCA offers you a unique Liberal Tuition Plan—your most economical way to learn. You pay for lessons only as you order them. No long term contracts. If you wish to stop your training for any reason, you may do so and not owe one cent until you resume the course.

VALUABLE EQUIPMENT

You receive valuable equipment to keep and use on the job—and you never have to take apart one piece to build another. **New—Programmed Electronics Breadboard.** You now will receive a scientifically programmed electronic bread-

board with your study material. This breadboard provides limitless experimentation with basic electrical and electronic circuits involving vacuum tubes and transistors and includes the construction of a working signal generator and superheterodyne AM Receiver.

Bonus From RCA—Multimeter and Oscilloscope Kits. At no additional cost, you will receive with every RCA Institutes Career Program the instruments and kit material you need to build a multimeter and oscilloscope. The inclusion of both these kits is an RCA extra.

CLASSROOM TRAINING ALSO AVAILABLE

RCA Institutes maintains one of the largest schools of its kind in New York City where classroom and laboratory training is available in day or evening sessions. You may be admitted without any previous technical training; preparatory courses are available if you haven't completed high school. Coeducational classes start four times a year.

FREE PLACEMENT SERVICE

In recent years, 9 out of 10 Resident School students who used the Free Placement Service had their jobs waiting for them when they graduated. And many of these jobs were with top companies in the field—such as IBM, Bell Telephone Labs, General Electric, RCA, and radio and TV stations and other communications systems throughout the world.

SEND ATTACHED POSTAGE PAID CARD FOR COMPLETE INFORMATION, NO OBLIGATION. NO SALESMAN WILL CALL.

**ALL RCA INSTITUTES COURSES
AVAILABLE UNDER NEW GI BILL.**

RCA INSTITUTES, Inc., Dept. EW-57
A Service of Radio Corporation of America
350 West 4th St., New York, N.Y. 10014



The Most Trusted Name in Electronics



JOHN DRYD

With air pollution rising at an alarming rate, it is time to call on electronics in an effort to solve the problem.

ECOLOGY AND ELECTRONICS

"U-M-M-M boy, that fresh air smells good!" Barney exclaimed as he stood in the open doorway of the service shop sniffing the washed air resulting from a sudden May shower. "Enjoy it while you can," was the dour comment of Mac, his employer.

"What's that crack mean?"

"Just what it says. We ecology students know pure air is becoming harder and harder to come by."

"May I be so bold as to ask what you 'ecology students' study?"

"Interrelationships between organisms, such as men, and their environment. Right now we're particularly interested in what men do to the air they must breathe and what it does right back to them."

"You could, you know, just say you were talking about air pollution. Why are you interested in that?"

"Because I hope to keep on breathing. Can you think of a better reason?"

"Not offhand, but is the pollution picture as black as it is painted?"

"Every bit. On October 26, 1948, a temperature inversion clamped a lid over Donora, Pa. and stopped convection air currents that ordinarily carry away air pollutants. Of the 14,000 residents of the city, 5910 became ill and 20 died—along with several dogs, cats, and canaries. On December 5, 1952, an inversion formed over London that lasted five days. Deaths during that period were 4000 above normal, and 8000 excess deaths occurred during the ensuing two months, most of them apparently caused by respiratory diseases. A thousand more Londoners were killed by extreme air pollution in 1956 and 300 more in 1962. A ten-day inversion over New York City in 1953 produced 200 excess deaths, and another smog ten years later killed 400. Just last Thanksgiving a four-day siege in that city caused 80 excess deaths. The U.S. Assistant Surgeon General warns that these episodes of smog killing people are going to become more and more frequent."

"I suppose that's because the air is becoming more polluted."

"You suppose right. In 1966 the air contained 20 million more tons of air pollutants than it did in 1963, the year Congress passed the Clean Air Act. That makes 145 million tons of man-contributed air pollutants swirling around us."

"Boy! I didn't know the stuff was measured in tons! Where does it come from?"

"Actually, man isn't responsible for all air pollution. Nature produces some of it. When Krakatoa, an East Indies volcano, blew up in 1883, dust from the explosion spread around the globe. The blue haze often seen over large fir forests consists of volatile hydrocarbons called terpenes emitted by the trees. Flowers saturate the air with pollen. Decaying plants and animals give off gases. In fact, the first air-pollution casualty on record, Pliny the Elder, died in 79 A.D. after breathing in too many sulfur oxides from erupting Vesuvius.

"But natural pollutants never increase beyond the capacity of the air to cleanse itself. The big trouble began when

prehistoric man first rubbed two sticks together and started a fire. The combustion principle he discovered is just dandy for polluting the air, and men have been 'combusting' ever since to heat their homes, cook their food, forge their metals, make their machines, generate electricity, and finally power their automobiles.

"Most fuels consist of carbon, hydrogen, oxygen, and nitrogen, together with a little sulfur. Solid fuels also contain incombustible mineral ash. No fuel emits smoke under complete combustion because the final products are carbon dioxide, water vapor, and free nitrogen—all, in themselves, innocuous gases. But for complete combustion to take place, a fuel must be kept in constant contact with enough air for full oxidation while being maintained at a sufficiently high temperature—and that's not easy to do in actual practice.

"Insufficient air results in imperfect combustion of fossil fuels—coal and oil—and particulates and gaseous intermediate products such as carbon monoxide and unsaturated hydrocarbons are released. Particulates, the visible ingredients of smoke, constitute only about 10% of the pollution over the U.S. A full 90% consists of mostly invisible but potentially lethal gases that are *not* removed by air conditioning. More than half the pollution over this country consists of colorless, odorless carbon monoxide exhausted by automobiles, trucks, and buses. A full tenth of the air pollution consists of hydrocarbons, most of which emanate as gaseous compounds escaping from automobile fuel systems. It's estimated that the average car loses a gallon of gasoline a month through evaporation from carburetor and gas tank, and that totals up to 1,000,000 gallons a year releasing contaminating hydrocarbons into the atmosphere.

"The second most plentiful gas pollutant consists of oxides of sulfur produced by home, power-plant, and factory burning of coal and oil. These react with moisture to produce a dilute but corrosive sulfuric-acid mist. This was the chief lethal ingredient of the London smog. Los Angeles smog, on the other hand, contains nitrogen oxide, hydrocarbons, ozone, and peroxyacetyl nitrate, called PAN. The first two react with sunlight to produce a photochemical smog. Ozone (a very active and poisonous form of oxygen) discolors and disintegrates clothing and causes rubber to become brittle and crack."

"Apparently the pollution we see, those smoke particulates you talk about, don't do any harm," Barney observed.

"Not so!" Mac quickly denied. "They make things dirty and grimy. It has been estimated that smoke costs the American people \$2.5 billion annually. Ordinary room air contains 50,000 to 100,000 of these condensation nuclei per cm³, and bacteria is directly proportional to their number. By contrast, air over the open sea usually contains less than 400 nuclei per cm³. Carbon particles that blacken the lungs carry gases absorbed onto their surfaces deeper into the lungs than the gases could make it on their own. Other particulates act as catalysts in the air to speed up the conversion of sulfur dioxide into sulfuric acid.

"Fortunately, these particles are comparatively easy, although expensive, to control. Properly installed venturi



SYLVANIA

SYLVANIA
RADIO
TV
SERVICE

BRIGHT
GUY

scrubbers, sonic-wave precipitators, cyclonic dust collectors, and electrostatic precipitators can do a good job of preventing particles from reaching the open air. *Bethlehem Steel Corporation* has spent \$90 million the past fifteen years on pollution control. A \$2 million installation in its Los Angeles facility collects about 125 tons, or two railroad carloads, of dust a week that formerly was discharged into the air. The Riverside, California *Portland Cement Company* installed a Cottrell electrostatic precipitator that removed 98% of the 100 tons of dust a day the firm had been discharging. It found it could use the collected dust, and at one time the company was making more profit from the recovered potash than from its cement!"

"If we could just make it more profitable *not* to pollute the air, we'd be home safe," Barney observed.

"Now you're talking! That's probably why the Government is stressing the amount of gasoline the motorist will save through the 90-95% efficient anti-evaporation controls it is demanding on 1969 cars. But it will not always be possible to show an individual profit on the installation of air-pollution control equipment. Regard for the common good has to be the motive. While 37 companies sold \$53 million worth of particle-collection equipment in 1965, this is only a fraction of what should have been installed."

"Maybe we need more laws."

"Not according to Mark Henry Holzer, a New York lawyer. He says the common law of nuisance covers every conceivable case of pollution. Lawyers call this the principle of *sic utere tuo*, or 'Use your own property so as not to injure that of another.' We don't need more laws; we need more enforcement of laws and ordinances already on the books."

"The automobile seems to be the chief sinner in air pollution. That's bad. Americans will never give up their cars."

"Let's hope they don't have to, but HEW Secretary John Gardner recently warned, 'The day may come when we have to trade convenience for survival.' Lest you dismiss this as crepe-hanging, listen to what a top official in California's public health department says—and don't forget California is leading the battle against air pollution: 'It is clearly evident that between now and 1980 the gasoline-powered engine must be phased out and replaced with an electric-power package.' He wants legal notice served *now* that after 1980 no gasoline-powered vehicle will be permitted to operate at all in the state of California."

"Can't we stop gasoline-engine pollution?"

"California has tried. Cars sold there

from 1964 on had to be equipped with 'blow-by' connections to feed unburned gasoline in the crankcase back into the intake manifold. All 1966 cars sold in the state had to have devices to reduce carbon monoxide emitted from the tailpipe 50%, and a further reduction in tailpipe emissions will be required in 1970. The Federal government has ordered similar improvements on all 1968 cars. Four types of devices have been approved for use in California. One 'after-burner' type is the only kind of installation on used cars. The other three use catalysts to precipitate the pollutants.

"Unfortunately, tests on cars so equipped that have been driven 20,000 miles show that 87% fail to meet state requirements for the suppression of hydrocarbons and carbon monoxide. The devices become less and less efficient with age and with improper maintenance."

"So now what?"

"So now I believe the electronics industry is faced with a challenge worthy of its youth and power. Can it keep humanity from suffocating in the by-products of civilization—without sacrificing progress? No matter how things go, electronics will be drawn into the battle. It can and should devise new and better instruments for detecting, measuring, and identifying air pollutants. It should find out more about the part that atmospheric static electricity plays in condensation and precipitation. Perhaps the electronics engineer and the meteorologist working together can aid nature in cleansing air that has already been polluted. Or the electronics engineer and the chemist may work out better filters to remove particles and gases from smokestacks and tailpipes. Maybe electronics can improve the combustion of gasoline through better ignition and automatic control of carburetion."

"If the gasoline engine must go, electrical and electronics engineers will work hand in glove with other engineers to produce electric-powered cars. Even now, while *General Motors*, *Ford*, and *Chrysler* are experimenting with electric cars, *General Electric*, *Westinghouse*, *General Dynamics*, and *Union Carbide* are doing research on electric power."

"Stopping air pollution demands the utmost cooperation of individuals, engineers, companies, and nations. While highly industrialized nations contribute most of the air pollution at present, air recognizes no boundaries, and pollution falls equally on the innocent and the guilty—hey, where do you think you are going?"

"Out to get a breath of fresh air," Barney retorted; "you have me gasping like a goldfish that's jumped out of its bowl!"

new Sams books

New 7th Edition of the famous
HOWARD W. SAMS

Transistor Substitution Handbook

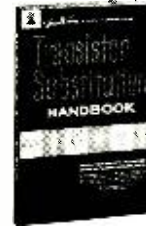

Fully updated and accurately compiled by computer, this invaluable reference is now more complete than ever. Lists thousands of direct substitutions; includes biasing diagrams and polarity indications; shows manufacturers of transistors listed. Provides substitutions for all major classes of transistors: U. S., foreign (including replacements for many Japanese types), home entertainment, and industrial. For

quick, easy reference, all transistor types are presented in a single numerical-alphabetical listing. A "must" reference for everyone concerned with the use of transistors. 128 pages; 5½ x 8½". \$175
Order 20529, only.....

Slide Rule in Electronics

by *Don Carper*. Teaches the proper and efficient use of the slide rule—an ideal tool for making quick, accurate calculations in electronics math. Organized in 12 progressive lessons, this clearly written book explains basic mathematical principles relevant to electronics and shows how they are applied. Tells how to calculate resistance, reactance, impedance, current and voltage relationships, frequencies, phase angles, and many other factors. Includes practice problems and exercises. Ideal for home study. 160 pages; 5½ x 8½". Order 20532, only..... \$425

Troubleshooting With the Oscilloscope, Rev. Ed.

by *Robert G. Middleton*. This updated and easy-to-understand book explains how to use the scope to isolate circuit troubles in any electronic equipment. First, you are shown how to operate a scope, and how to use the proper probes for various tests and measurements; then you learn which test signals are required, the type of waveforms to expect, and how to interpret them properly. You learn further how to isolate defective circuit stages or sections by waveform analysis; numerous waveforms associated with various defective components are shown. Also covers f-m stereo-multiplexing equipment testing, testing of solid-state devices, and use of triggered sweep scopes. 192 pages; 5½ x 8½". \$395
Order 20550, only.....

101 Ways to Use Your Hi-Fi Test Equipment, 2nd Ed.

by *Robert G. Middleton*. This completely revised volume shows how to use harmonic-distortion meters, square-wave generators, intermodulation analyzers, and other specialized instruments for testing hi-fi equipment. Clearly explains the tests which can be performed by each instrument. Describes proper test setups, procedures, and how to evaluate results. Heavily illustrated. 160 pages; 5½ x 8½". \$295
Order 20552, only.....

Basic Electricity & an Introduction to Electronics

by the *Howard W. Sams Technical Staff*. New 2nd edition of this widely used textbook—now incorporates new suggestions and additions contributed by electronics instructors and students. Simply written for easy understanding and fully reinforced by the liberal use of diagrams and illustrations, the book begins with the fundamentals and progresses, step by step, through each phase of electricity. Once this groundwork is laid, the subject of electronics is explained clearly. Ideal for home study. 192 pages; 8½ x 11". Order 20540, only..... \$395

HOWARD W. SAMS & CO., INC.

Order from your Sams Distributor today, or mail to Howard W. Sams & Co., Inc., Dept. FW-5
4300 W. 62nd Street, Indianapolis, Ind. 46268

Send me the following books:

- 20529 20550 20540
 20532 20552

Send FREE Sams Booklist. \$_____ enclosed

Name _____

Address _____

City _____ State _____ Zip _____

My Distributor is _____

CIRCLE NO. 99 ON READER SERVICE CARD

Are you eligible for the Bright Guy Awards?

It's easy to get them—and to get all the business they'll bring you. New customers. More sales. More money.

The Bright Guy Awards is the big program Sylvania's running this year to boost your sales.

Your Sylvania distributor can put your name and address in up to four TV Guide ads in your area. The ads call you "the brightest serviceman in town"—and tell people in your town why they should call you.



You'll get into the Yellow Pages, too, under the heading "TV Service and Repairs."

Once again this year you'll be eligible for over



one hundred valuable, interesting SMB-Bright Guy gifts, just for buying the Sylvania TV replacement parts you normally buy anyway.

And you'll get window displays proclaiming you "the brightest"—the TV serviceman everyone's reading about.

You're eligible for the Bright Guy Awards just by buying Sylvania's famous *color bright 85*[®] color picture tube. And our other picture tubes, and our receiving tubes. So see your Sylvania distributor.

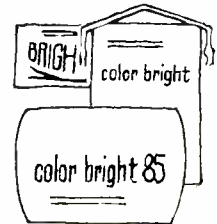

Sylvania Electronic Tube Division, Electronic Components Group, Seneca Falls, New York 13148.

SYLVANIA
SUBSIDIARY OF
GENERAL TELEPHONE & ELECTRONICS **GTE**

CIRCLE NO. 90 ON READER SERVICE CARD

TEST EQUIPMENT

PRODUCT REPORT

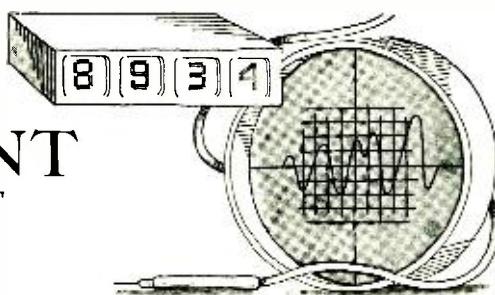

Fairchild Model 7100A Digital Voltmeter

For copy of manufacturer's brochure, circle No. 156 on Reader Service Card.



THIS new digital voltmeter combines the precision, sensitivity, and versatility required by many laboratory applications with the reliability and stability needed for production and system use. The 7100A dual-slope d.v.m. measures voltage, resistance, and ratio. The high accuracy of this instrument, $\pm 0.01\%$ of reading ± 1 digit, makes it suitable for use in many applications where more costly five-digit instruments were previously required. The new voltmeter is priced at \$2075 and it offers features formerly found in \$4000 instruments. The features and price are the result of using integrated circuits in the design. These circuits, already used in a few consumer electronic products, will shortly find their way into other pieces of less expensive test equipment.

Special design features include dual-slope integration and a fully guarded

input which provide excellent performance even in the presence of severe noise. The dual-slope integration principle is illustrated below.

First, the unknown input is fed through an operational amplifier to an integrator. The integrator output is an increasing negative voltage with a slope that is proportional to the input. The integration time is controlled by counting 10,000 pulses from a crystal oscillator. Second, the integrator input is switched to an internal reference and the integrator output is driven back to zero. The slope of the decreasing voltage is proportional to the reference, and the time required to return the voltage to zero is directly proportional to the unknown input. This is measured by counting pulses from the same oscillator used in step one. The count is displayed as the digital readout.

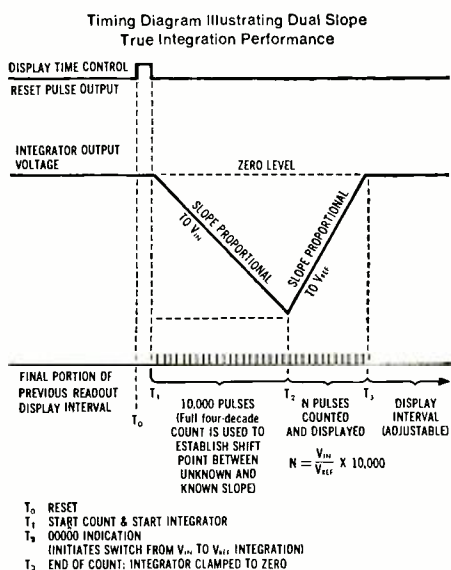

Since the same integrating components and oscillator are used in both steps, any shift in value of components due to temperature changes or aging becomes self-canceling. Also, since the second step is a direct comparison with the internal reference voltage, the instrument has excellent long-term stability. No hourly or daily calibration adjustments are required. The reading represents the unbroken, true average. All hum and noise components, up to full bandwidth of the input amplifier and integrator, are integrated and effectively reduced to zero.

A bonus of the technique is the ability to make ratio measurements by substituting one of the inputs for the reference voltage. Precision resistance measurements are similarly accomplished.

Another feature which contributes to

the noise rejection is guarded construction. The guarded circuit, which is a box within a box, virtually eliminates the errors caused by common-mode pickup and allows the voltmeter to measure low-level signals from thermocouples, strain gages, etc.

The instrument has five voltage ranges from 160 mV to 1100 V, and this latter voltage can be applied on any of the lower voltage ranges without damage. Input impedance is greater than 1000 megohms. ▲

Basic Science Industries Model 100 Electronic Thermometer

For copy of manufacturer's brochure, circle No. 28 on Reader Service Card.

THE introduction of the Model 100 thermometer by Basic Science Industries represents an attempt to meet the need for a low-cost laboratory-quality electronic thermometer for general educational, testing, and research use. This combination of economy and quality is accomplished through ingenious design in electronic circuitry and case construction coupled with standardization on a single general-purpose temperature range.

The thermometer utilizes a calibrated thermistor sensor housed in a nickel-plated brass cylinder as one arm of a Wheatstone bridge. A unique meter-calibration procedure, along with an optimum bridge circuit, makes possible a meter scale which is very near

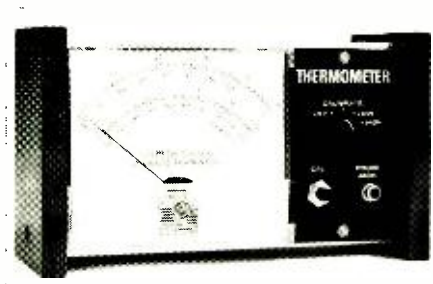

to being linear and has an accuracy of $\pm 1^\circ$ Celsius (centigrade). Readings in terms of relative changes in temperature have even greater accuracy.

A high degree of temperature stability over a wide range of environmental conditions is accomplished by the use of 1% precision carbon-film resistors. All components are mounted on a single-sided printed-circuit board, permitting low cost, quality manufacture.

To match the circuit performance a quality d'Arsonval meter movement with characteristics approaching laboratory instruments is used and a 4½"-wide meter dial with knife-edge pointer permits small changes in temperature to be noted.

In a departure from industry practice of offering a wide variety of temperature ranges, the Model 100 has

been standardized at 0° to 100° Celsius. This was done to keep cost low. The limitations of the single range are offset to a great extent by the ability to switch between a low range of 0-50 degrees C and a high range of 50-100 degrees C. This dual-range feature, along with provision for scale markings in both Celsius and Fahrenheit, has made the instrument a useful one in various areas ranging from photographic or electronic labs to field studies on the skin temperature of snakes.

The ability to provide almost instantaneous remote temperature readings has always been the area in which the electronic thermometer has found its greatest usefulness. The Model 100 with a seven-foot-long sensor cable and a response time of 5 seconds maximum can be used to measure a variety of solids, gases, and liquids. Specific applications are in batch testing of chemicals and monitoring of environmental chambers.

Power for the Model 100 is provided by a common "C" flashlight cell. A minimal current drain enables continuous use of the instrument for over 600 hours before battery replacement is required. Much greater battery life is possible with intermittent use, and in instances where continuous usage for more than 600 hours is desired, an alkaline battery may be used.

The Model 100 thermometer sells for \$35.00, with general-purpose and surface-type thermistor sensors available at \$6.00 and \$7.00 each. ▲

Hewlett-Packard Model 211B Square-Wave Generator

For copy of manufacturer's brochure, circle No. 157 on Reader Service Card.

A NEW all-solid-state square-wave generator from Hewlett-Packard produces square waves of exceptionally clean shape over a wide frequency range, from 1 Hz to 10 MHz. Square-wave rise and fall times are less than 5 nanoseconds while overshoot, preshoot, and ringing are less than 5%. There is no sag, and jitter is less than 0.2% of waveform period at any repetition rate.

Small in size, the new Model 211B takes only half the height of the 7-

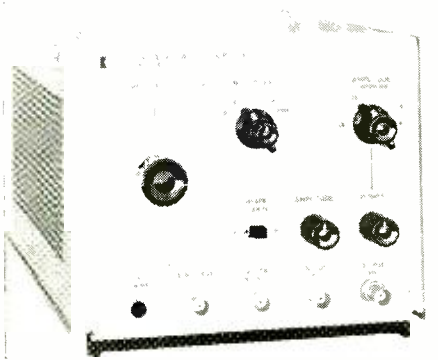

May, 1967

WHY risk your reputation with "just-as-good" capacitors?

When you pay little or no attention to quality in tubular replacement capacitors, you leave yourself wide open for criticism of your work . . . you risk your reputation . . . you stand to lose customers. It just doesn't pay to take a chance on capacitors with unknown or debatable performance records when it's so easy to get guaranteed dependable tubulars from your Sprague distributor!

There's no "maybe" with these 2 great SPRAGUE DIFILM® TUBULARS!

The ultimate in tubular capacitor construction. Dual dielectric . . . polyester film and special capacitor tissue . . . combines the best features of both. Impregnated with HCX®, an exclusive Sprague synthetic hydrocarbon material which fills every void in the paper, every pinhole in the plastic film *before it solidifies*, resulting in a rock-hard capacitor section . . . there's no oil to leak, no wax to drip. Designed for 105°C (220°F) operation without voltage derating.

DIFILM® ORANGE DROP® Dipped Tubular Capacitors



A "must" for applications where only radial-lead capacitors will fit . . . the perfect replacement for dipped capacitors now used in many leading TV sets. Double-dipped in rugged epoxy resin for positive protection against extreme heat and humidity. No other dipped tubular capacitor can match Sprague Orange Drops!



DIFILM® BLACK BEAUTY® Molded Tubular Capacitors

The world's most humidity-resistant molded capacitors. Tough, protective outer case of non-flammable molded phenolic . . . cannot be damaged in handling or installation. Black Beauty Capacitors will withstand the hottest temperatures to be found in any TV or radio set, even in the most humid climates.

For complete listings, get your copy of Catalog C-617 from your Sprague distributor, or write to Sprague Products Company, 51 Marshall Street, North Adams, Massachusetts.

WORLD'S LARGEST MANUFACTURER OF CAPACITORS
CS-6110 R1

CIRCLE NO. 92 ON READER SERVICE CARD



if you're the tape type... Look for the ELPA Endorsement!



When you see the Elpa Seal of Endorsement on a product you can be assured that it is of highest quality and has successfully met Elpa's stringent design and performance standards. REVOX Tape Recorders, EDITall editing and splicing method, and BEYER Microphones all carry the Elpa seal and can be purchased with complete confidence. Write for the Elpa catalog, Dept. 8D5, . . . ELPA MARKETING INDUSTRIES, INC., New Hyde Park, New York 11040.

REVOX / **EDITall** / **BEYER**



CIRCLE NO. 118 ON READER SERVICE CARD

LEARN Electronics Engineering AT HOME

FIX TV, design automation systems, learn transistors, complete electronics. College level home study courses taught so you can understand them. Earn more in the highly paid electronics industry. Computers, Missiles, theory and practical. Kits furnished. Over 30,000 graduates now employed. Resident classes at our Chicago campus if desired. Founded 1934. Catalog. *Vets—write for information about G.I. Bill Training.

American Institute of Engineering & Technology
1141 West Fullerton Parkway Chicago, Ill. 60614

PHOTOGRAPHY ANNUAL

A selection of the World's finest photographs compiled by the editors of Popular Photography. All editions \$1.25 each:

1966 — \$1.25 #1
1964 — \$1.25 #3

1967 — \$1.50 #38
Order by number from Ziff-Davis Service Div., 595 Broadway • New York, N. Y. 10012. Enclose add'l 15¢ per copy for shipping and handling (50¢ for orders outside U.S.A.)

\$500 per month?

Diversify into booming two-way radio maintenance!

Conservative extra income from citizens band and business radio maintenance!

Free booklet tells you how—see coupon below!

105-B MICROMETER FREQUENCY METER



Measures nearby transmitters. Continuous coverage 100 KC to 175 MC, and up. Internal calibrator. Only 8 pounds. \$295.00

205-A FM MODULATION METER



Tunable 25 to 500 MC any channel. Direct reading. Light weight. Measures peak swing 0-1.25, 2.5, 12.5, and 25.0 peak KC. \$340.00

LAMPKIN

dependable low cost equipment used by thousands of engineers.

PPM METER—inexpensive accessory for the 105-B for 0.0001% accuracy on split-channels.

LAMPKIN LABORATORIES, INC
MFM Division, Bradenton, Florida 33505

At no obligation to me, please send me free booklet "How to Make Money in Mobile-Radio Maintenance."

Name _____
Address _____
City _____ State _____

CIRCLE NO. 107 ON READER SERVICE CARD

inch-high space when rack-mounted. It is also light in weight—only 9 pounds.

Square waves are useful test signals where transient response is important and where the phase-delay characteristics of a device or circuit are just as important as gain and frequency response. Distortion in the square wave at the output of a device under test clearly shows any departure from linearity in phase delay vs frequency characteristic.

The extremely fast rise time of the Model 211B reveals frequency response well beyond 50 MHz at the same time that transient response and phase characteristics are examined. Simultaneously, low-frequency response is checked because of the substantial low-frequency content of the square waves.

The new generator supplies 5-volt pulses into a 50-ohm load (10 V open-circuited). A second output, matched for 600 ohms, supplies 30-V peak into 600 ohms or 60 V open-circuited. (Rise time at this output is 70 ns across 600 ohms.) Both output waveforms are d.c.-coupled negative-going but differ in time phase by 180°.

Source impedances are matched to 50 and 600 ohms respectively, to absorb returning signals, thus eliminating reflections that could degrade the waveform. Shorting either output causes no harm, hence the instrument can function as a square-wave current generator for testing low-impedance circuits.

A third output supplies 2-volt trigger pulses into 50 ohms, either positive or negative as selected by a switch, coincident with the leading edge of the 50-ohm square wave. These pulses are useful, of course, for synchronizing an oscilloscope and they also make the new generator useful as a controllable-rate trigger source.

The symmetry of the output waveform (ratio of "on" time to waveform period) may be varied from 25% to 75%, which allows the instrument to function as a rectangular pulse generator. The repetition rate is not affected by the symmetry control and *vice versa*.

Price of the 211B is \$375.00. ▲



"I don't care what it says. You can't have any credit!"

Radio Measurements in Space

(Continued from page 47)

Testing of long STEM devices is also a problem since a low-gravity environment is required. This is particularly a problem for the longer elements. How does one create a low-gravity, high-vacuum, sun-simulating environment for testing? The mechanical forces which act during unfurling are quite complicated and testing is demanded. Engineers at NASA's Goddard Space Flight Center have provided at least a partial solution by using cameras and photographing the trace created by a small lamp attached to the tip of the antenna. Some very interesting light patterns are produced during such tests. One of these is illustrated in the lead photograph on page 46.

The RAE will probably be assigned a three-stage improved Delta launch vehicle with an over-all length of 91 feet. The first stage Thor rocket develops 346,000 pounds of thrust. Recall that jet engines, as used in commercial transports today, typically develop 16,000 pounds of thrust. The second stage develops approximately 7000 pounds of thrust, with the third stage (which carries the spacecraft) producing about 2000 pounds thrust. It is anticipated that an orbital altitude of about 300 kilometers (186 miles) will be used.

The RAE Mission

The mission of the RAE satellite may be categorized by five scientific objectives.

1. To observe low-frequency radio storms on earth. These storms are believed to be interactions between particles emanating from the sun and earth's radiation belts.

2. To monitor large radio noise sources, such as the constellation Centaurus A.

3. To study Jupiter, which is the only planet other than the earth which is known to occasionally emit low-frequency noise bursts.

4. To obtain an EM map of our galaxy (the Milky Way) in the frequency range from 400 kHz to 10 MHz.

5. To gather data on low-frequency bursts of EM energy which emanate from the sun. This data should provide added insight into the nature of the sun's reactions.

In order to achieve orbit and deploy the four 750-foot antennas, a sequence which will require about two weeks will be initiated by ground command from Goddard Space Flight Center, Greenbelt, Maryland.

The data gathered by RAE satellites and their successors may provide space scientists with enough information to formulate new theories concerning the earth and its surroundings. ▲



Sorry, the new Sony FM stereo tuner won't be here until April.

You know the kind of magic Sony works with transistors. Well, they've done it again. This time with a new solid-state FM stereo tuner. But, it won't be available at your hi-fi dealer until April.

Meanwhile, visit your dealer and audition the Sony TA-1120 solid-state stereo integrated amplifier—the one that's drawing rave notices from the high fidelity editors. Tell your high fidelity dealer to save a front-row seat to hear the new Sony FM tuner, available in April.

Sony Corporation of America,
Dept. H, 47-47 Van Dam Street,
Long Island City, New York 11101

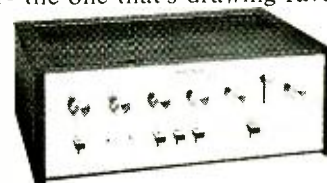

CIRCLE NO. 94 ON READER SERVICE CARD

OVERSEAS EMPLOYMENT OPPORTUNITIES FOR ELECTRONIC TECHNICIANS WITH THE FOREIGN SERVICE OF THE UNITED STATES

The U. S. Department of State needs experienced Electronic Technicians for career appointments in the Foreign Service. These assignments are unique and exciting in the field of technical security. Your family may accompany you overseas. Considerable temporary duty travel permits visiting interesting areas of the world.

REQUIREMENTS:

(1) Electronics certificate from a technical or service school; (2) Accept assignment at any Foreign Service post, minimum tour of duty is two years; (3) Qualify for highest security clearance; (4) Be an American citizen for a minimum of five years. If married, spouse must be an American citizen; (5) Excellent health; and (6) Two to four years of experience. Starting salaries \$7,201 to \$10,667 (plus overseas allowances). Send completed Federal Employment Form 57 (Available at any U.S. Post Office) and resume to:

Office of Security,
Department of State,
Washington, D.C. 20520.

An Equal Opportunity Employer.

Our policies are your best insurance:



Sonotone has been the reliable, quality name in replacement phono cartridges since 1947. We've made and sold 20 million of them. When you service with Sonotone cartridges, you can be assured you are servicing with the best. We'll stake our name on that.

REPLACE WITH SONOTONE CARTRIDGES. There's a complete line for immediate replacement of virtually every cartridge in use today. Prove it to yourself — fill out and mail coupon TODAY for your free copy of Sonotone's 1967 "computer-programmed" cartridge replacement manual.

Send today for complete information:

Sonotone Corporation, Dept. 107
Elmsford, New York 10523

Just fill out and mail this coupon for your free copy of Sonotone's 1967 "computer-programmed" cartridge replacement manual.

YOUR NAME _____
ADDRESS _____
CITY _____
STATE _____ ZIP _____

Visit us at Booth No. 4118, N.E.W. Show
CIRCLE NO. 96 ON READER SERVICE CARD

BUZIT TRANSISTORIZED SIGNAL TRACER

FOR ONLY **\$9.57** DEALER-NET
WITH BATTERIES

NO CLIPS
NO WIRES



MADE IN
U.S.A.

USED FOR TROUBLE SHOOTING

- A.F. CIRCUITS • I.F. CIRCUITS
- R.F. CIRCUITS • CONTINUITY CHECKS • SPEAKERS, ETC.

EXCELLENT FOR TRANSISTOR
RADIOS BECAUSE BUZIT USES
ONLY A 3 VOLT POWER SUPPLY

ASK YOUR ELECTRONIC
PARTS DISTRIBUTOR FOR

MODEL NO. **BZ-1**

MANUFACTURED BY
WORKMAN Electronic
SARASOTA, FLORIDA PRODUCTS, INC.

CIRCLE NO. 89 ON READER SERVICE CARD

WE DON'T CLAIM
OUR ELECTRONIC
IGNITION SYSTEM
IS BEST



OUR
CUSTOMERS DO!
WRITE TODAY FOR FREE LITERATURE

JUDSON
RESEARCH AND MFG. CO.
CONSHOHOCKEN, PA., U.S.A.

CIRCLE NO. 110 ON READER SERVICE CARD
68

Frequency & Time Standards

(Continued from page 41)

with changes in ambient operating temperature is another important factor to consider when specifying high-stability oscillators. Fig. 7 is a curve of the temperature vs frequency characteristics of a typical high-quality crystal. It can be seen that changes in crystal temperature result in significant changes in frequency.

It is therefore extremely important to isolate the crystal from the effects of varying temperatures. Vacuum bottles (dewars) are often employed in the highest stability units and, in most cases, the crystal itself is in a well-regulated, temperature-controlled oven.

Similarly, changes in operating voltage, line voltages, and load impedances are all important and should be considered when choosing oscillators. The effects of these parameters are stated in terms of the maximum frequency changes they produce in the oscillators' output.

Other Important Criteria

Some of the other more important criteria which should be considered when selecting equipment of this nature are:

1. Construction — the equipment should be able to withstand mechanical shock and also occupy the least amount of space, especially where it is to be part of a physically complex system.
2. Power consumption—in portable, airborne, or other such applications, it is desirable to obtain the lowest power consumption of the oscillators in order to realize the longest usable life.
3. Measurements should be the result of exhaustive tests on many units of the type to be used, where possible.

Finally, perhaps the most important "specification" to many technical personnel is cost. While mechanical construction and ambient temperature isolation will determine the cost of a unit to an extent, the primary cost factor is

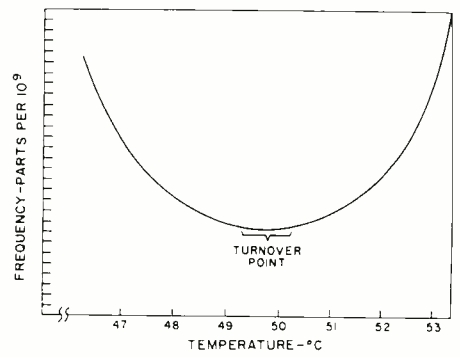

Fig. 7. Typical frequency vs temperature characteristic for a high-quality crystal. Oven is set to "turnover-point" temperature.

the ultimate stability of the unit. The greater the stability required (both long- and short-term) the more elaborate the circuitry required and the better the crystal must be. For example, while a ± 1 part in 10^8 oscillator is available for \$200, a ± 1 part in 10^{10} oscillator can easily cost \$2000. ▲

REMOVING SOLDERED PARTS

By IRWIN MATH

WHEN disassembling a chassis for the purpose of salvaging components, it is often a difficult job to remove parts affixed to lugs on transformers and tube sockets. Most such connections are made by threading the wire through and around the lug with the result that the heat applied to loosen the wire leads more often than not destroys the component or solder lug in the bargain.

An easy method of removing these leads is to first heat the lug and remove excess solder either by a rapid flick of the component, or with the aid of an inexpensive car syringe, modified to use a small piece of plastic tubing as the nozzle.

Cut off the top of the lug (so that it now appears U-shaped). The lug can then be heated so that the wires can be slid off the time of the lug. Enough of the surface will remain so that the lug can be used again. ▲

Fig. 6. A phase-locked oscillator system is illustrated.

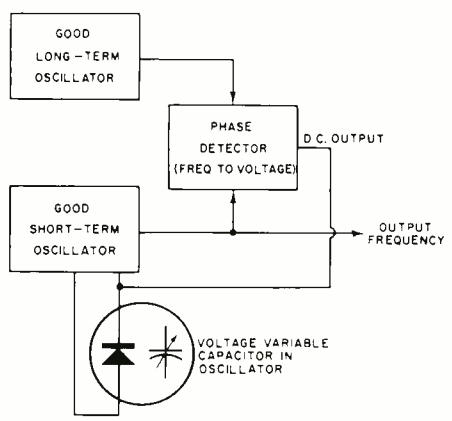

"It'll interpret from any language in the world—once we figure out how to program it."

ELECTRONIC CROSSWORDS

By JAMES R. KIMSEY
(Answer on page 90)

ACROSS

1. One of the essential components in a vacuum tube.
4. Greek letter designating "ohm".
7. Malt beverage.
8. Device used to increase power, voltage, or current of a signal.
12. Familiar trio in Ohm's Law.
14. Mighty African river.
15. Move a TV camera to keep it trained on the subject.
16. The tube electrode to which the main electron stream flows.
18. The prevention of vibration by some means.
19. Mutual conductance (abbr.).
20. Part of the eye.
21. To vary the amplitude, frequency, or phase of an oscillation, usually at a signal frequency rate.
26. Mimic.
29. The male heir.
30. A term used to describe a terminal which has more electrons than normal.
31. A small spring-like clamp.
32. Plate current, in the tube manual.
34. An antenna which is an integral part of a radio or TV receiver.
39. Keyboard instrument.
42. Request.
43. Paddles.
44. deForest.
45. Type of insulation.
46. Resistance network used in coupling two impedances.
47. Miniature receiving tube having nine pins.
48. Water-cooled tetrode capable of providing continuous operation at 50 kW or more in the u.h.f. region.

DOWN

1. Gaseous radioactive products formed by the expulsion of an alpha particle from radium, thorium X, or actinium X.
2. Small coil used to measure a magnetic field.
3. An element combined with oxygen.
4. An oil used in medicine.
5. Myself.
6. Storage of components until their characteristics have become stable and constant.
9. Period of time (abbr.).
10. Guided.
11. General term applied to receivers.
12. Prefix meaning "on".
13. Moved rapidly on foot.
17. For example (abbr.).
22. Perform.
23. World peace-keeping organization (abbr.).
24. Long-nosed metal clip.
25. Widening the volume range of an audio-frequency signal.
26. Cut of type of crystal used for r.f. transmitters between 500 kHz and 10 MHz.
27. 3,1416.
28. Happenings.
33. Massive government agency (abbr.).
34. Antenna matching device used to permit efficient coupling of transmitter having unbalanced output to antenna having balanced transmission line.
35. Employ.
36. General and ex-President.
37. A test.
38. Connecting wires.
40. Fish eggs.
41. Skill.
46. Type of communications system (abbr.).

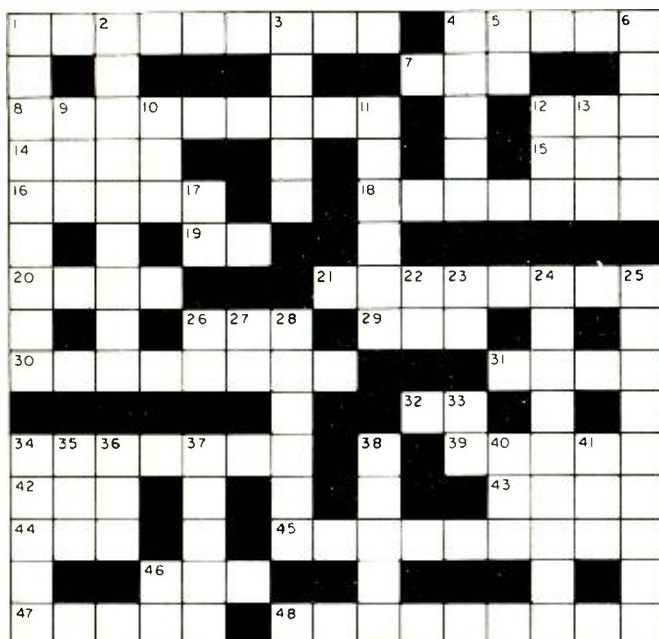

GAS WELDING TORCH



Uses **OXYGEN**
and **LP GAS**

- Completely self-contained.
- Produces 5000° pin-point flame.
- Welds, brazes, solders.
- Hundreds of lightweight uses.
- Suggested list - \$19.95.

GET COMPLETE DETAILS AT MOST INDUSTRIAL DISTRIBUTORS, OR WRITE TO MICROFLAME, INC.



MICROFLAME, INC.

7800 COMPUTER AVENUE
MINNEAPOLIS, MINNESOTA 55424

CIRCLE NO. 105 ON READER SERVICE CARD

**BIGGER... BETTER
THAN EVER!**

FREE!

**SEND TODAY FOR YOUR NEW
40th ANNIVERSARY
1967 CATALOG**

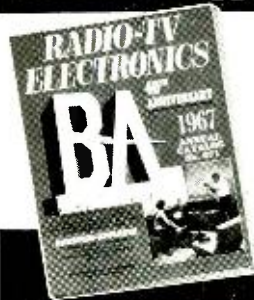

YOUR BUYING GUIDE FOR

- Stereo & Hi-Fi Systems & Components.
- Tape Recorders.
- Electronic Parts, Tubes, Tools.
- Phonos & Records.
- Cameras and Film.
- Public Address.
- Citizens Band.
- Ham Gear.
- Transistor & FM-AM Radios.

**252 GIANT VALUE
PACKED PAGES!**

BURSTEIN-APPLEBEE CO.

Dept. EW 1012 McGee, Kansas City, Mo. 64106
 Rush me the FREE 1967 B-A Catalog.

Name _____
Address _____
City _____
State _____ Zip Code _____

CIRCLE NO. 124 ON READER SERVICE CARD

**“Get more
education
or
*get out of
electronics***

...that’s my advice.”

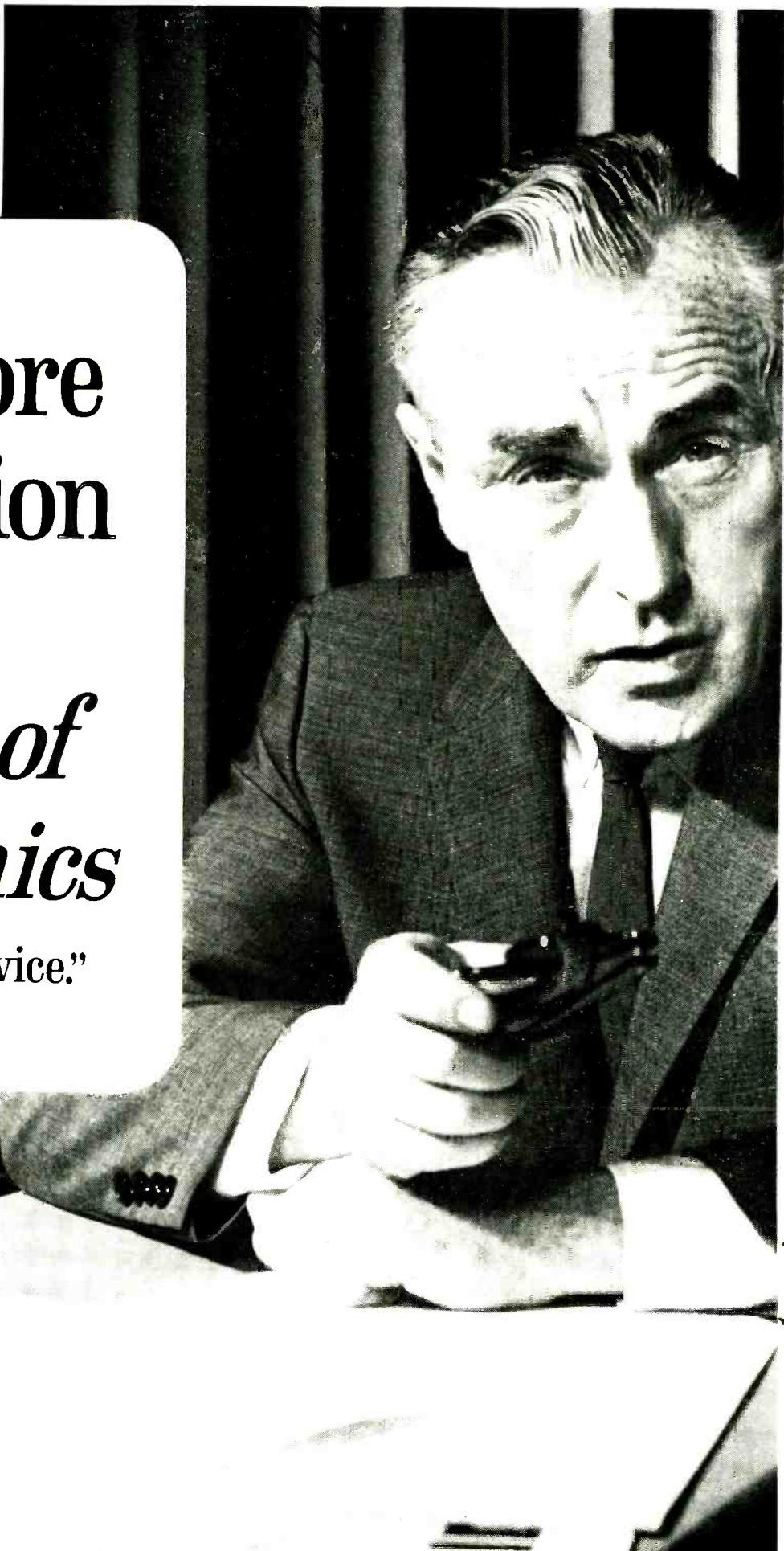

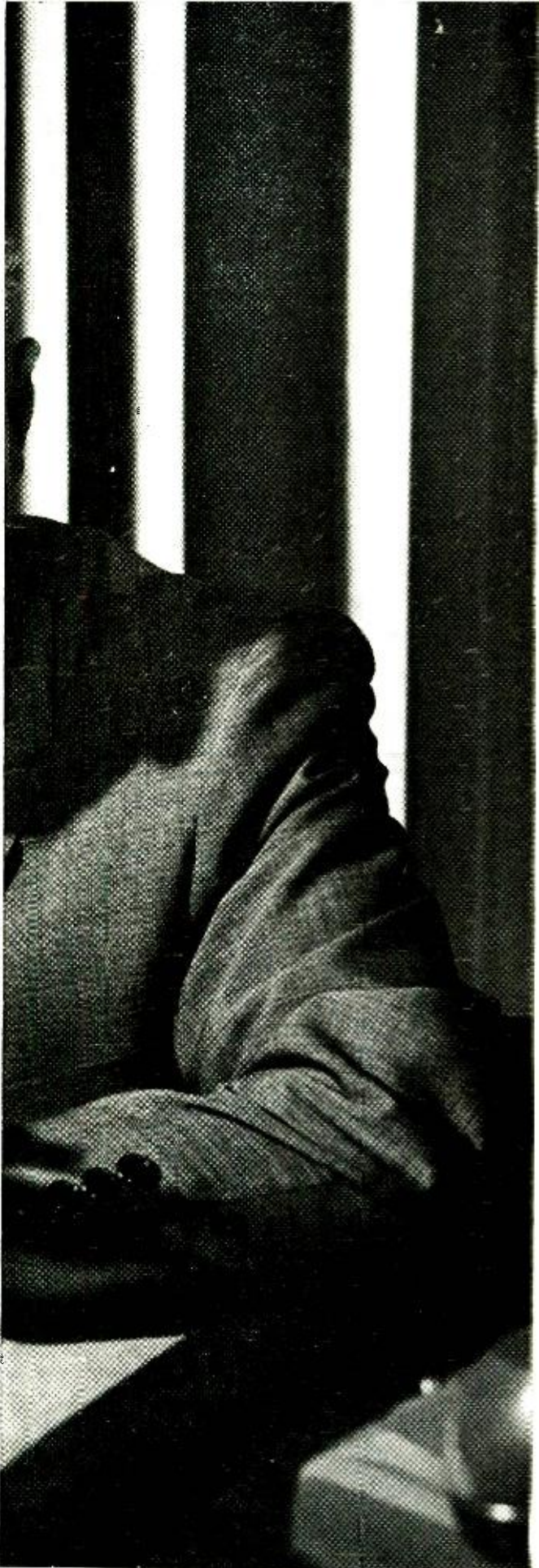

Ask any man who really knows the electronics industry. Opportunities are few for men without advanced technical education. If you stay on that level, you'll never make much money. And you'll be among the first to go in a layoff.

But, if you supplement your experience with more education in electronics, you can become a specialist. You'll enjoy good income and excellent security. You won't have to worry about automation or advances in technology putting you out of a job.

How can you get the additional education you must have to protect your future—and the future of those who depend on you? Going back to school isn't easy for a man with a job and family obligations.

CREI Home Study Programs offer you a practical way to get more education without going back to school. You study at home, at your own pace, on your own schedule. And you study with the assurance that what you learn can be applied on the job immediately to make you worth more money to your employer.

You're eligible for a CREI Program if you work in electronics and have a high school education. Our FREE book gives complete information. Airmail postpaid card for your copy. If card is detached, use coupon below or write: CREI, Dept.1127 E, 3224 Sixteenth Street, N.W., Washington, D.C. 20010.



The Capitol Radio Engineering Institute

Dept. 1127 E, 3224 Sixteenth Street, N.W., Washington, D.C. 20010

Please send me FREE book describing CREI Programs. I am employed in electronics and have a high school education.

NAME _____ AGE _____

ADDRESS _____

CITY _____ STATE _____ ZIP CODE _____

EMPLOYED BY _____

TYPE OF PRESENT WORK _____ GI BILL

- I am interested in Electronic Engineering Technology
 Space Electronics Nuclear Engineering Technology
 Industrial Electronics for Automation
 Computer Systems Technology

APPROVED FOR VETERANS ADMINISTRATION TRAINING

Start a Stereo System of Unparalleled Quality

For Solid State or Tube Amplifiers

...for less than \$40⁰⁰

FABULOUS MUSTANG M-12T

12" 3-WAY SPEAKER SYSTEM.

A new breed of high performance for whole house sound! With 35-40,000 Hz response; extra slim, thin profile; exclusive front or rear baffle mounting design; 12 15/16" dia. by 3 7/8" deep.



...for less than \$70⁰⁰

AWARD WINNING MODEL 6201

12" 2-WAY SPEAKER SYSTEM.

Updated version of the most popular true-coaxial speaker ever made! With axially mounted compression driven, wide-angle reciprocating flare horn tweeter; 28 to 18,500 Hz response; 13" dia. by 6 5/8" deep.



...for less than \$85⁰⁰

AWARD WINNING MODEL 312

12" 3-WAY DIFFAXIAL SYSTEM.

The only integrated single speaker assembly capable of response from 28 to 40,000 Hz! With high compliance woofer; Diffusicone mid-range; exclusive Sphericon tweeter; integral brilliance control; 15 1/2" dia. by 12" deep.

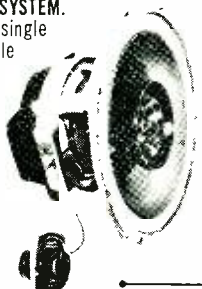

Listen to these and other fine University speakers at your dealers today! Ask about PSE—University's "master blue print" for goof-proof planning and building of your own speaker system. Includes many plans for speaker enclosures designed to deliver the very best in stereo sound. Address inquiries to desk E-75



LISTEN—UNIVERSITY® SOUNDS BETTER

UNIVERSITY SOUND

A DIVISION OF LTV LING ALTEC, INC.

9500 W. Reno Oklahoma City, Oklahoma 73101

CIRCLE NO. 85 ON READER SERVICE CARD

Power Output of Solid-State Receivers

ED Miller of *Sherwood Electronic Labs, Inc.*, has just called our attention to inconsistencies in the IIF dynamic power outputs (W ch) appearing in our solid-state receiver chart in the March, 1967 issue. Although we originally requested from manufacturers power output figures for 8 ohms, it is now apparent that quite a few of them inadvertently supplied 4-ohm figures instead. Below is a corrected chart showing both 4- and 8-ohm char-

acteristics where they are available.

It should be pointed out that most advertising departments quote 4-ohm output figures in all of their promotion material and advertising, since it is usually the larger of the two figures. On the other hand, engineering departments usually quote all of their designing based on 8-ohm figures.

This is another case where standardization within the industry would be most helpful. ▲

MODEL NO.	4 ohms	8 ohms
ALTEC LANSING 711A	50	35*
AUDIO DYNAMICS CORP. ADC-606	45	35
ADC-600	30	30
BOGEN COMMUNICATIONS RT-8000	35	22
RT-7000	32.5	22
TR-100X	30	24
TF-100	30	24
CHANNEL MASTER CORP. 6606	**	30
6602†		
EICO 3566	56	37.5
ELECTRO-VOICE EV1177	32.5	25
EV1179	27.5	20
FISHER RADIO CORP. 700-T	60	45
500-T	45	35
440-T	35	25
220-T	27.5	20
GROMMES, PRECISION ELECT. C-503	35	30
HARMAN-KARDON, INC. SR900B‡	50	35
SR600B‡	40	30
SR400B‡	30	22.5
SR300B‡	30	22.5
720††	40	30
210††	25	18
200††	25	18
HEATH CO. AR-15	50	75
AR-14	13	15
AR-13A	12	33
KENWOOD ELECTRONICS TK-140	65	50
TK-80	45	40
TK-60	30	25
TK-50	30	25
TK-40	18	15

MODEL NO.	4 ohms	8 ohms
KNIGHT, ALLIED RADIO KN-376	30	25
KN-351†		
KNIGHT-KIT, ALLIED RADIO KG-964	37	32
LAFAYETTE RADIO LR-1200T	\$	60
LR-900T	\$	32.5
LR-450T	\$	15
OLSON ELECTRONICS RA-862	\$	20
RA-860	\$	40
RA-845	\$	22.5
RA-830	\$	25
RA-806	\$	10
PIONEER ELECTRONICS SX-1000TA	55	45
RCA MHT67‡	**	25*
MHT60‡	**	10
H.H. SCOTT INC. 388	60	50
348	60	50
344B	42.5	32.5
342	32.5	25
SHERWOOD ELECTRONICS LABS S-8800	70	50
S-8600	35	25
S-7800	70	50
V-M CORP. 1489	**	10
1484	**	37.5

FOOTNOTES:

*Figure differs from that published in March, 1967 issue

**Not recommended for 4-ohm load.

†Discontinued

††New receiver

‡New model number

§Figure not available

FET Circuits

(Continued from page 33)

with voltage gain greater than unity. The bandwidth is dependent upon the impedance of the driving source. When driven by a 600-ohm test oscillator, the upper 3-dB point is 2 MHz. Bandwidth *decreases* as the driving source impedance *increases*. At low frequencies the amplifier input impedance is about 100 megohms and the output impedance is less than 2000 ohms.

Fig. 6 shows a stretcher which senses the peak amplitude of a pulse and holds this voltage level for a time much longer than the width of the pulse. The diagram includes a push-button to provide the pulse, but of course the pulse could be coupled in from a suitable external source.

Transistors Q1 and Q3 provide impedance transformation and isolate the FET from both the source and the load. When the input pulse appears, the capacitor is charged through Q1 and the diode. After the input pulse terminates, Q1 is cut-off and the diode is back-biased. The input impedance of Q2 is very high so that the charge leaks off the capacitor mainly by leakage current through the diode and the capacitor. The FET (Q2) then presents the d.c. level to Q3 which acts as an output driver. Fig. 6 also gives the duration of the output obtained with four different FET's. (Note that the FET is connected in reverse in order to make the drain negative.)

The time constant can be increased by using an FET having a very low gate leakage and by selecting a diode and a capacitor with very low leakage. By using these more expensive components, FET stretcher circuits with output pulse times as long as 30 hours have been built. The circuit can be used as a peak-amplitude detector or to obtain a required time delay. Reset is accomplished by either allowing the output to decay or by shorting the capacitor to ground.

The FET can also be used as a linear gate or electronic switch as shown in Fig. 7. The resistance between source and drain with the switch "closed" is approximately $1/g_m$. With the switch "open", only a small leakage current flows between source and drain. This type of circuit can also be used as an amplitude modulator.

We have presented six simple, low-cost circuits that illustrate many of the principles of FET operation. These circuits are designed to furnish an understanding of the devices and to stimulate thinking toward other applications.

The authors wish to acknowledge the cooperation of Mr. Charles MacDonald of *Siliconix, Inc.* and Mr. Al Kenrick of *General Electric Company.* ▲

Why settle for less? Buy the Best!

THE FABULOUS MARK TEN CAPACITIVE DISCHARGE IGNITION SYSTEM



Available in easy-to-build kit form at only
\$29.95 ppd.!

Only
\$44.95 ppd.!

Dramatically improve the performance of your car—or any vehicle. Racers and Pacers from Sebring to Suburbia by the thousands attest to the peerless performance of the Mark Ten. Delta's remarkable electronic achievement, proven for four years, is often copied, *never excelled.*

Ready for these?

- ▲ Dramatic increase in acceleration
- ▲ Longer point and plug life
- ▲ Improved gasoline mileage
- ▲ Complete combustion
- ▲ Smoother performance

Ready? Order today!

BE YOUR OWN MECHANIC



Tune-up

DWELL METER \$12.95 ppd.

A universal precision instrument for use in tuning all vehicles, regardless of the number of cylinders or battery polarity. Gives correct point dwell readings on vehicles equipped with capacitive discharge, transistor or conventional ignition. Precision accuracy at low cost.

- ▲ Portable, high-impact case for rugged work
- ▲ Large, easy-to-read 3½ inch precision jeweled meter
- ▲ Wide scale — reads dwell angles in degrees
- ▲ All solid state



Tune-up

TACHOMETER \$14.95 ppd.

A universal precision instrument for making carburetor adjustments on all vehicles, regardless of the number of cylinders or battery polarity. Gives precise RPM readings on vehicles equipped with capacitive discharge, transistor or conventional ignition. Gives you better gas mileage, fuel savings and peak engine operation.

- ▲ Large, easy-to-read 3½ inch precision jeweled meter
- ▲ Portable, high-impact case for rugged work
- ▲ Range: 0 to 1200 RPM
- ▲ All solid state



DELTA PRODUCTS, INC.

P.O. BOX 1147 EW • GRAND JUNCTION, COLORADO 81501

Enclosed is \$_____ Ship prepaid, Ship C.O.D.

Please send: Dwell Meters @ \$12.95 Mark Tens (Assembled) @ \$44.95
 Tach Meters @ \$14.95 Mark Tens (Delta Kit) @ \$29.95

Specify — Positive Ground Negative Ground 6 or 12 volt
(12 volt positive or negative ground only)

Car Year _____ Make _____

Name _____

Address _____

City State _____ Zip _____

CIRCLE NO. 122 ON READER SERVICE CARD



It's FUN!
It's EASY! **knight-kit**

FROM
ALLIED RADIO

Headquarters for Everything in Electronics

Set Engine Idle—Auto Trans. Shift Points
CHECK:

- Distributor wear
- Dwell angle
- Voltage regulator
- Condensers
- Point surfaces
- Coil resistance
- Ground circuits
- Alternator diodes
- Engine timing
- Spark output and much more!

Save double on this famous Knight-Kit Auto Analyzer. Build it yourself and save factory assembly costs. Then use it for tuneups and troubleshooting to hold down car upkeep.

Write for special introductory offer.
No Money Down \$5 Monthly

ALLIED RADIO

Dept. 1E, P.O. Box 4398, Chicago, Ill. 60680
CIRCLE NO. 109 ON READER SERVICE CARD



ERSIN MULTICORE

ONLY 69¢

BUY IT AT RADIO-TV PARTS STORES

MULTICORE SALES CORP., WESTBURY, N.Y. 11590
CIRCLE NO. 104 ON READER SERVICE CARD

Pulse Generators

(Continued from page 45)

One of the drawbacks to a conventional oscilloscope is that the frequency response of the test device may fall outside the bandwidth limitations of the vertical amplifier system of the oscilloscope. In some cases, the output signal from a device under test can be observed by direct connection through coupling capacitors to the vertical deflection plates of a conventional oscilloscope. Thus, the limited bandwidth of the oscilloscope vertical amplifier can be bypassed.

The following factors pertaining to the vertical deflection-plate system must be considered for pulse measurement: d.c. operating potential of the plates, lead inductance, deflection-plate capacitance, transit-time limitations, delay lines, and deflection factor.

A typical circuit for direct a.c. coupling to the vertical plates is shown in Fig. 6. This circuit permits the internal vertical amplifier of the oscilloscope to be bypassed but still allows the normal d.c. operating and positioning voltages to be applied to the deflection plates from the internal vertical amplifier. However, when using this circuit, a high-quality external delay line must be used. This will retard the pulse sufficiently to get it on the scope screen.

The values of R_1 and R_2 are found by solving the equation given in Fig. 6. The resonant frequency (F_0) of the leads and the capacitance of the deflection plates (C_0) for use in the equation may be determined by the following procedure:

1. Turn off the oscilloscope power.
2. Disconnect the vertical amplifier leads from the CRT neck pins. (A convenient method of connecting to the deflection-plate pins is to use clips removed from a miniature tube socket.)
3. Cut a wire loop equal in length to the total length of C_1 , C_2 , R_1 , R_2 , R_3 , and R_4 .
4. Temporarily substitute the wire loop for the components between the vertical deflection-plate pins.
5. Bring a grid-dip meter near the loop and measure the resonant frequency (F_0).
6. Remove the wire loop.

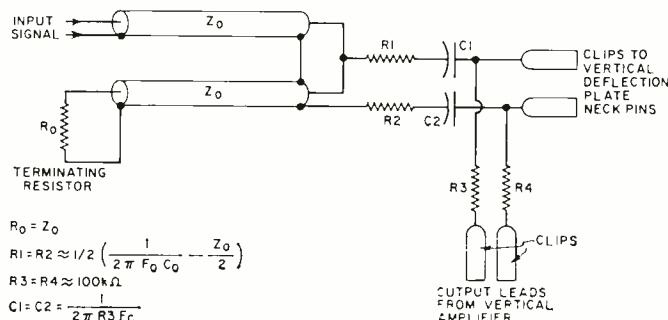

Fig. 6. Circuit for coupling to vertical deflection plates.

7. With a capacitance meter, measure the total capacitance between the plates (C_p) at the deflection-plate neck pins. (Capacitance between the plates can also be found by referring to the specifications of the oscilloscope.)

Since the deflection plates are located close to the path of the electron beam, a small amount of current will flow in the deflection-plate circuits. The values of R_3 and R_4 must be low enough so that this current will not produce a large voltage drop at the deflection plates. If the resistors are too large, distortion, defocusing, or positioning difficulties may be experienced. Since the deflection-plate current varies non-linearly with the position of the beam, the effects are most noticeable when the beam is positioned near the top or bottom of the screen. The approximate value of 100,000 ohms that is given for R_3 and R_4 will probably be satisfactory in most cases.

C_1 and C_2 should be physically small to minimize lead inductance. The values of C_1 and C_2 are selected on the basis of the required low-frequency response and may be calculated from the equation given in Fig. 6. (F_0 is the low-frequency cut-off.) For example, if R_3 and R_4 are 100,000 ohms and if the desired F_0 is about 1.6 kHz, C_1 and C_2 should be 0.001 μF .

The stub cable that connects to terminating resistor R_0 should be long enough so that if a double-transit reflection appears, it can be easily identified and corrected by adjustment of the termination.

For making vertical measurements with the test setup, the deflection factor of the oscilloscope must be known. This can be measured as follows:

1. While the leads from the vertical amplifier are connected to the deflection-plate neck pins, connect a d.c. voltmeter between the pins.
2. Measure the voltage change as the beam is positioned vertically over the full height of the graticule.
3. Divide this voltage excursion by the graticule height in divisions to obtain the deflection factor in volts/division. ▲

(Many of the diagrams and techniques described above are based on information from Tektronix, Inc. and Hewlett-Packard.—Editor)

New Jersey proudly announces the 24-hour day!

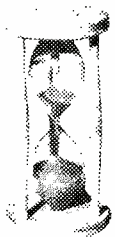

Name your entertainment—simple or sophisticated—and New Jersey has it 'round the clock. Night life that jumps as high as the breakers along New Jersey's 127 miles of seashore. Concerts and ballet as soothing as a scenic panorama from one of the many picturesque mountains here. All-year theater as exciting as a New Jersey ski trail. The fine arts and every type of sports. A perfect blend of neon lights and open spaces.

Now don't get us wrong. New Jersey also has plenty of small, peaceful communities where the sidewalks are rolled up after dark. But a quiet town in New Jersey is different . . . very different, because either

of two impressive "suburbs"—New York or Philadelphia—is only minutes from just about anywhere in the Garden State.

Yes, living in New Jersey is as cosmopolitan as a penthouse apartment or as rustic as a tranquil farm. And the industrial side of the picture is equally bright. Find out why. Our Area Development Department can answer all your questions and give you complete and confidential information concerning possible corporate headquarter, plant, research and warehouse sites in New Jersey.

Write to Public Service Electric and Gas Company, Box HEW, 80 Park Place, Newark, New Jersey 07101.

 PUBLIC SERVICE ELECTRIC AND GAS COMPANY



which one
should
you buy
?

This year, play it smart.

Before you make your next photographic equipment purchase, make sure you're getting the most for your money. Shop before you buy, confidently, with the up-to-the-minute 1967 PHOTOGRAPHY DIRECTORY & BUYING GUIDE.

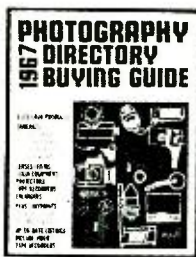

All the guesswork is out! From still cameras to slide projectors, super-8 to video tape recorders... this encyclopedic volume puts every essential buying fact and figure right at your fingertips. With complete point-by-point information on manufacturer, model number, special characteristics and price. Hundreds of photos. Every vital statistic you need to compare all the latest equipment—in virtually every category—and select the best in your price range!

Over 5,000 photographic items in all! Plus a Special Feature! "BUYPOINTS"—an exclusive "what-to-look-for, how-to-buy" guide to movie and still cameras, slide projectors, tape recorders.

This 160-page "shop-at-home" directory has been carefully compiled by the editors of Popular Photography. And that means authoritative, precise information you can bank on. All year long!

GET THE HANDSOME LEATHERFLEX-BOUND EDITION for just \$3 POSTPAID!

The 1967 PHOTOGRAPHY DIRECTORY & BUYING GUIDE is also available in a splendid deluxe edition. Rugged Leatherflex cover provides lasting protection yet is softly textured and gold embossed for the look of elegance. A collector's item—a superb addition to your permanent reference library. And it's yours, for just \$3 postpaid, when you check the appropriate box on the order form.

Use the coupon below to order your copy of the 1967 PHOTOGRAPHY DIRECTORY & BUYING GUIDE today! Only \$1.25

ZIFF-DAVIS SERVICE DIVISION • DEPT. PD
595 Broadway • New York, N.Y. 10012

Please send me a copy of the 1967 PHOTOGRAPHY DIRECTORY & BUYING GUIDE as checked below:

\$1.25 enclosed, plus 15c for shipping and handling. Send me the regular edition. (\$1.75 for orders outside the U.S.A.)

\$3.00 enclosed. Send me the Deluxe Leatherflex-bound edition, postpaid. (\$3.75 for orders outside the U.S.A.) Allow three additional weeks for delivery.

name please print EW-57

address

city

state

zip

PAYMENT MUST BE ENCLOSED WITH ORDER

RADIO & TV NEWS

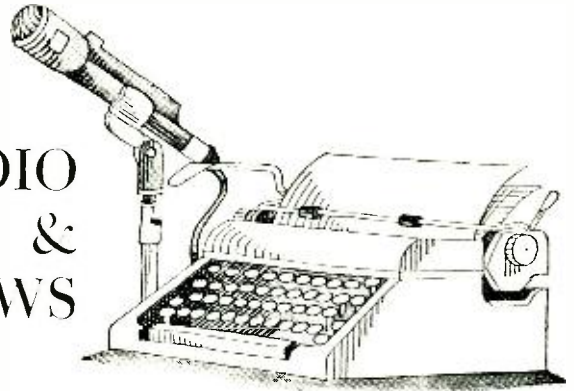

APROPOS the electronic eavesdropping situation, the Senate is soon to consider Bill S.928 "Right of Privacy Act of 1967" sponsored by Sen. Long (D. Mo.).

The heart of the bill is Section 3. It establishes a new chapter, composed of Sections 2510-2515 in Title 18 of the U.S. Code. Section 2510(a) is a blanket provision prohibiting wire interception without the consent of one of the parties to the communication. The disclosure or use of any information so obtained is also barred. The sole exception from this far-reaching prohibition in Section 2510 is the minor exclusion in Section 2510(b) for routine activities by employees of a communication common carrier or the FCC. The maximum criminal penalty for violation of Section 2510 is a \$10,000 fine or five years imprisonment, or both.

Section 2511 deals with eavesdropping. It contains a series of provisions which, taken together, constitute a comprehensive ban on the use of electronic, mechanical, or other devices to eavesdrop on a private conversation without the consent of a party to the conversation. It also bars the disclosure or use of any information so obtained. As is the case with Section 2510, the maximum criminal penalty for violation of Section 2511 is a \$10,000 fine or five years imprisonment, or both.

In order to cut off the source of supply of the devices used by wire-tappers and eavesdroppers, Section 2512 contains sweeping prohibitions banning the manufacture, shipment, or advertisement of devices useful for the purpose of wire interception or eavesdropping. Violations of this Section carry a maximum criminal penalty of a \$25,000 fine, or one year imprisonment, or both.

Section 2513 is a confiscation provision. It authorizes the seizure and forfeiture of any device used, shipped, or manufactured in violation of Sections 2510, 2511, or 2512.

The above material is directly quoted from a letter to the Vice President from Ramsey Clark, the Attorney General of the United States.

Senator Long concluded his preface to the bill as follows: "It is my hope

that in the very near future there can be brought before the Senate, the soundest bill possible to regain and maintain that right referred to by Justice Brandeis as the right most valued by civilized men, the right of privacy."

Germanium IC's

Until now, all integrated circuit technology has been confined to silicon devices. This is because during certain steps in the fabrication of the IC, selected areas of the wafer must be protected by some sort of easily formed, chemically impervious layer. In silicon, this protection can be provided by forming a silicon dioxide (glass) layer over the to-be-protected area. In germanium, such a layer has been difficult to form because easily formed dioxides of germanium are chemically unstable. This is the chief reason why silicon has completely dominated the IC field, despite the inherently higher operational speeds of comparable germanium devices.

Scientists at the IBM Research Division Labs. have reported the successful creation of germanium IC's, which despite their relatively early stage of development, are already faster than the fastest silicon circuit thus far reported. These circuits take advantage of the inherently greater speed, or mobility, of the electrons and holes in germanium, which permits switching speeds about three times faster than those of silicon devices of comparable size.

The experimental germanium IC's have measured switching delays of 350 picoseconds (trillionths of a second). This includes an estimated 100 picoseconds delay due to the test package, and an isolation capacitance delay of about the same amount. It should also be pointed out that the germanium devices were about three times larger than the smallest silicon devices.

Vive La Difference

Do you know the difference between an analog and digital computer engineer?

Upon viewing a shapely female form, the analog computer man visualizes a complex curve function, while the digital computer man thinks 36-24-36. ▲

fill the gaps... WITH A COMPLETE SELECTION OF ANNUALS, YEARBOOKS, DIRECTORIES AND

HANDBOOKS from the world's largest publisher of special interest magazines. Take a moment to review the titles and issues currently available. You're sure to find many of your favorites to help complete your library and fill those wide open spaces on your bookshelves.



PHOTOGRAPHY ANNUAL

A selection of the World's finest photographs compiled by the editors of Popular Photography. 212 pages—24 in full color.

1967 — \$1.50 #38
1966 — \$1.25 #31
1964 — \$1.25 #3

ELECTRONIC EXPERIMENTER'S HANDBOOK

Many challenging projects for the electronics hobbyist.

1966 — Fall Edition—\$1.25 #39
1966 — Spring Edition—\$1.25 #36
1965 — Fall Edition—\$1.25 #9
1965 — Spring Edition—\$1.25 #14

CAR & DRIVER YEARBOOK

A complete buyers guide covering virtually every car available in the United States... Road tests... Technical specifications... Accessories and performance equipment buying guide... Guide to racing with action-packed photos.

1967 — \$1.50 #40
1966 — \$1.25 #15
1965 — \$1.25 #17

INVITATION TO PHOTOGRAPHY

A unique 116 page guide to better picture taking by the Editors of Popular Photography. Basic down-to-earth advice that helps you eliminate costly trial and error, time-consuming guess work. 20 complete, fact-and-photo packed articles in all.

1966 — \$1.25 #35



PHOTOGRAPHY DIRECTORY

World's most complete photographic buying guide.

1967 — \$1.25 #41
1966 — \$1.25 #22

TAPE RECORDER ANNUAL

Everything you need to know about tape recording including a complete directory of mono and stereo recorders.

1967 — \$1.25 #42
1966 — \$1.25 #30
1965 — \$1.00 #31

ELECTRONICS INSTALLATION AND SERVICING HANDBOOK

The only complete guide for servicemen and hobbyists to every major phase of consumer electronics servicing.

1967 — \$1.25 #43
1966 — \$1.25 #32

FLYING ANNUAL

The most valuable aviation yearbook ever compiled... Pilot reports... Aircraft directory... How to buy a used airplane... Navcom directory... Learn to fly section.

1967 — \$1.50 #44
1966 — \$1.25 #27
1965 — \$1.25 #28

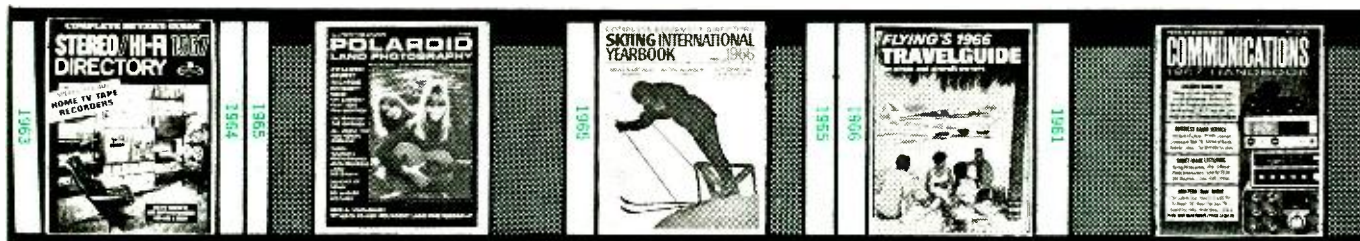

STEREO/Hi Fi DIRECTORY

Complete buyers guide for virtually every Hi Fi component manufactured.

1967 — \$1.25 #45
1966 — \$1.25 #29

POLAROID LAND PHOTOGRAPHY

Complete guide and only comprehensive and up-to-date handbook on Polaroid Land Photography.

1966 — \$1.25 #24
1963 — \$1.00 #25

SKIING INTERNATIONAL YEARBOOK

A luxuriously illustrated compendium of 1966's important events... A timely forecast of the excitement-packed 1967 season —by the editors of Skiing Magazine.

1967 — \$1.25 #48
1966 — \$1.25 #26

FLYING TRAVELGUIDE

Here's the first really useful guide to flying vacations. Everything you need to know about: lodgings, restaurants, resorts, sightseeing, recreation, sports activities, airport facilities, children's fun, price information, special information for the gals —and much more.

1967 — \$1.25 #46
1966 — \$1.25 #34

COMMUNICATIONS HANDBOOK

The most complete and up-to-date guide to the exciting world of specialized radio communications.

1967 — \$1.25 #47
1966 — \$1.25 #18
1965 — \$1.00 #19

TO PLACE YOUR ORDER, circle the numbers of the annuals you wish to receive on the coupon, clearly print your name and address and enclose your remittance. Please be sure to enclose an additional 15¢ shipping and handling for each copy ordered. Add 50¢ per copy for orders outside U.S.A.

Ziff-Davis Service Division—Department W · 595 Broadway, New York, N. Y. 10012

I am enclosing \$_____ for the annuals circled below. My remittance includes an additional 15¢ per copy for shipping and handling (50¢ for orders outside U.S.A.). I understand quantities are limited and orders will be filled on a first come-first served basis.

1 3 9 14 15 17 18 19 20 22 24 25 26 27 28 29
30 31 32 34 35 36 38 39 40 41 42 43 44 45 46 47 48

Name _____
Address _____
City _____ State _____ Zip Code _____

PAYMENT MUST BE ENCLOSED WITH ORDER

BOOK REVIEWS

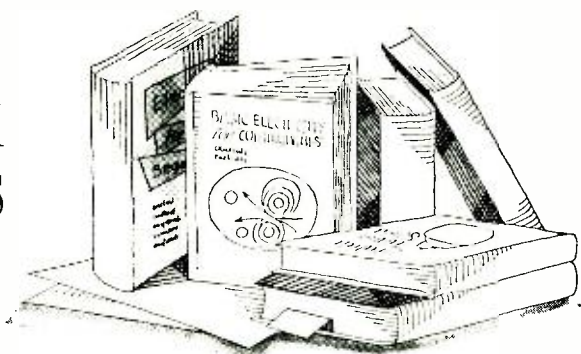

"RCA RECEIVING TUBE MANUAL" compiled and published by Electronic Components and Devices, *Radio Corporation of America*, Harrison, N.J. 597 pages. Price \$1.25. Soft cover.

This revised and updated tube manual introduces several new features which users—including engineers, service technicians, educators, experimenters, hams, hobbyists, students, and others—will find helpful and informative.

One change is that the Technical Data Section has been restricted to coverage of active RCA tube types while the basic data for replacement and discontinued tubes has been shifted to a "replacement use" table. Included in the listings are all types of home-entertainment-type receiving tubes, black-and-white and color-TV picture tubes, and voltage-regulator and voltage-reference tubes.

There is also a revised circuit section which includes detailed write-ups of many practical tube applications. These write-ups explain the function and operation of individual stages and complete circuits so that students and experimenters can understand and construct the circuits.

There is new text material on basic system functions, tuned amplifiers, wide-band amplifiers, and TV scanning, sync, and deflection circuits.

"INTRODUCTION TO DIGITAL ELECTRONICS" by Arthur W. Lo. Published by *Addison-Wesley Publishing Company, Inc.*, Reading, Mass. 01867. 220 pages. Price \$10.75.

The author, professor of electrical engineering at Princeton, has addressed this text to seniors and/or engineering graduate students. It is designed to serve as an introduction to the digital operation of solid-state electronics devices and circuits as used in digital computers and other digital devices.

In addition to its application as a textbook, the information will be equally helpful to those working with digital systems, solid-state electronics, or computer sciences. The text is divided into six chapters dealing with the basic concepts, transistor logic circuits, cryoelectric and optoelectric circuits, magnetic logic circuits, logic circuits using nega-

tive-resistance switching elements, and random-access memories.

Math is used as required to amplify the text but anyone with a grasp of college algebra will be able to handle the equations and perform the requisite operations.

"TRANSFORMERS FOR ELECTRONIC CIRCUITS" by Nathan R. Grossner. Published by *McGraw-Hill Book Company*, New York. 311 pages. Price \$14.00.

As a consulting engineer specializing in transformer design, the author is aware of the information gaps which exist in this area. This book, although addressed to those who use transformers whether in circuits, systems, or as standards, is not intended to make a transformer designer out of the reader but rather to equip him with an understanding of transformer functions so that he can use any type of transformer to best advantage.

There are eleven chapters devoted to a survey of transformers, the power transformer, reliability and environment, temperature rise and thermal design, ratings and sizes of power transformers, inductance and losses, polarized transformers and inductors, wide-band transformer analysis, wide-band transformer synthesis, and analysis and synthesis of the pulse transformer.

The author uses charts, graphs, formulas, line drawings, and schematics with a lavish hand to provide the maximum amount of useful data in a book of reasonable size.

"ANALYSIS AND SYNTHESIS OF TUNNEL DIODE CIRCUITS" by J. O. Scanlan. Published by *John Wiley & Sons*, New York. 268 pages. Price \$9.75.

The author, lecturer in the Department of Electrical and Electronic Engineering, The University of Leeds, Leeds, England, has placed his emphasis on circuit principles rather than the practical applications of tunnel diode circuits and has limited his discussion to sinusoidal applications of the diode.

Because of this application and the mathematical treatment of the subject, only practicing engineers and physicists or graduate students will derive full benefit from this text. For those engaged in tunnel diode circuit design or applica-

tion, the author's thorough coverage of tunnel diode physics, equivalent circuits, tunnel diode amplifiers, broadband tunnel diode amplifiers, and non-linear sinusoidal applications offers a wealth of basic background material with which to work.

"CIRCUIT DESIGN FOR AUDIO, AM/FM, AND TV" by Engineering Staff, *Texas Instruments Incorporated*. Published by *McGraw-Hill Book Company*, New York. 344 pages. Price \$14.50.

This is the fifth book in TI's practical handbook series for circuit designers. Special emphasis has been placed on both cost-saving and time-saving procedures throughout the step-by-step analysis. The examples cited by the authors incorporate the most modern devices available from the transistor industry.

For example, in the audio section, the authors discuss output and driver design and input design. The AM-FM section deals with amplifiers, tuners, and applications, with special emphasis on the practical design of i.f. strips. Topics in the TV section include v.h.f. tuners, video i.f. amplifiers, a.g.c., the audio amplifier system, sync separators, and vertical and horizontal oscillators. The examples used to demonstrate the various designs were selected to suggest the broad applications of the procedures.

Since this volume is written by engineers for engineers there has been no attempt to simplify the treatment or offer concessions in the matter of a non-mathematical approach. For those with the requisite engineering and mathematical background, this book should provide needed stimulation and much worthwhile information on designing with transistors.

"PRINTED CIRCUITS HANDBOOK" edited by Clyde F. Coombs, Jr. Published by *McGraw-Hill Book Company*, New York. 536 pages. Price \$15.00.

This is a detailed how-to-do-it guide representing a compilation of valuable material contributed by experts in the various fields. The editor is manager of Corporate Process Engineering at *Hewlett-Packard* and he has called on engineers from *Fairchild*, *Westinghouse*, *Insulectro*, *Universal Instruments*, *Alpha Metals*, *General Electric*, *Consolidated Electrodynamics*, and his own firm to provide authoritative data on various phrases of PC processes.

The text covers the entire scope of printed-circuit design, fabrication, assembly, and testing. It is written for both engineers and production personnel, with information on all phases of the printed-circuit process to permit the establishment of a production facility and control of the process.

There are five main sections covering engineering, fabrication, assembly, sol-

dering, and testing. Recent developments such as multilayer printed-circuit processing and automatic component insertion are covered along with basic information on the entire technique.

"WORLD RADIO TV HANDBOOK" compiled and published by World Radio-Television Handbook Co. Ltd., Denmark. Available in North America from Gilfer Associates, P.O. Box 239, Park Ridge, N.J. 07656. 304 pages. Price \$4.95 postpaid. Soft cover.

This is the 21st edition of the handbook that SWL's have come to depend on as much as their short-wave receivers. It lists all broadcasting facilities (AM, FM, TV, and short-wave) for 193 countries with details on frequencies, call-signs, slogans, power, operating hours, languages transmitted, interval signals, personnel, addresses, and verification.

In addition to the listings, the book contains a table of abbreviations, DX clubs, charts, and a table of world time in all countries to help the SWL in scheduling his listening. It is hard to see how any SWL hobbyist could get along without the handbook especially one that is as up-to-the-minute and complete as this one.

CHICAGO TO BE "ELECTRONICS CAPITAL"

IN June, Chicago will be the "Electronics Capital" of the United States when manufacturers of everything from the latest in electrified harmonicas and pianos to giant community antenna systems will converge on the city for a series of trade shows, conventions, and business sessions expected to attract an estimated 40,000 persons.

The electronics gatherings will begin with the National Electronic Distributors Association (NEDA) annual meeting on June 18th and continue to the end of the month with the closing of the five-day 66th annual Music Show sponsored by the National Association of Music Merchants.

The NAMM Music Show and the annual convention of the National Community Television Association will open on Sunday, June 25th, with the CATV sessions closing June 28th.

Following the opening of the NEDA meeting, the Electronics Parts Show will run from June 19th to 21st, heralding the return of this event to Chicago after an absence of two years. Concurrently with the Parts Show, five big electronics associations have scheduled joint meetings on June 21. Included are Association of Electronic Manufacturers, EIA, WEMA, ERA, and NEDA.

On Friday, June 23, the annual meeting of the All-Industry Electronics Conference is scheduled while on the following day there will be a session of the executive board of NATESA.

Meetings the following week, in addition to the Music Show and CATV convention, include the Radio Old Timers and the Electronic Young Tigers.



**The Heart
of your
Radio
is Its**

TEXAS
CRYSTALS

**INSIST ON
CQC***

* Controlled Quality Crystals available only from Texas Crystals dealers. Extensive precision testing throughout manufacture enables Texas Crystals to unconditionally guarantee their frequency control crystals. Use of Texas Crystals in space program and by other governmental agencies is evidence of the quality you can count on.

If your dealer can't supply your needs, send his name with your request for catalog to our plant nearest you.



TEXAS CRYSTALS
1000 Crystal Drive
Fort Myers, Fla. 33901
Phone: 813-936-2109



4117 W. Jefferson Blvd.
Los Angeles, Calif. 90016
Phone: 213-731-2258
Division of Whitehall Electronics Corp.

CIRCLE NO. 198 ON READER SERVICE CARD

NEW 17TH EDITION of the world-famous RADIO HANDBOOK

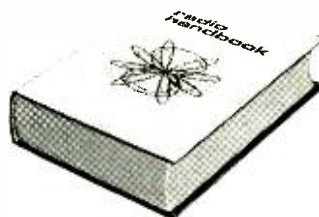

Completely revised and enlarged—the comprehensive how-to-build communications manual. Presents design data on latest amplifiers, transmitters, receivers, transceivers; includes sections on SSB equipment and design; semiconductors; extended coverage of r-f amplifiers, special vacuum tube circuits, and test equipment. Clearly explains theory involved in practically every phase of radio. Broadest coverage; up-to-date; complete. 832 pages; hardbound. Invaluable for amateurs, electronics engineers, and designers.
Order No. EE-167, only.....\$12.95



Order from your electronic parts distributor or send coupon below.

EDITORS and ENGINEERS, Ltd.

P. O. Box 68003
New Augusta, Ind. 46268, Dept. EWE-5

Send me EE167, the new 17th Edition of the RADIO HANDBOOK at \$12.95.

\$_____encl. Check Money Order

Name _____

Address _____

City _____ State _____ Zip _____

CIRCLE NO. 83 ON READER SERVICE CARD

Enjoy the "music-only" programs now available on the FM broadcast band from coast to coast.

- NO COMMERCIALS •
- NO INTERRUPTIONS •



It's easy! Just plug Music Associated's Sub Carrier Detector into multiplex jack of your FM tuner or easily wire into discriminator. Tune through your FM dial and hear programs of continuous, commercial-free music you are now missing. The Detector, self-powered and with electronic mute for quieting between selections, permits reception of popular background music programs no longer sent by wire but transmitted as hidden programs on the FM broadcast band from coast to coast. Use with any FM tuner. Size 5 1/2" x 9". Shipping weight approx. 7 lbs.

KIT \$49.50
(with pre-tuned coils, no alignment necessary)

WIRED \$75.00

COVER \$4.95 EXTRA
Current List of FM Broadcast Stations with SCA authorization \$1.00

MUSIC ASSOCIATED
65 Glenwood Road, Upper Montclair, New Jersey
Phone: (201) 744-3387

CIRCLE NO. 103 ON READER SERVICE CARD

Live Better Electronically With
LAFAYETTE
 RADIO ELECTRONICS



5 WATTS of POWER
 You Can Hold In Your Hand

only **99⁹⁵**
 No Money Down

99-3087L* with Leather Shoulder Strap
DYNA-COM 5

- ★ 3 Switchable Crystal Controlled Transmit and Receive Channel Positions for All 23 Channels
- ★ 5-Watt FCC Maximum Input . . . with the Power of the Most Powerful Base and Mobile CB Transceivers
- ★ 13 Transistors, 6 Diodes
- ★ 7-Stage Transmitter for Maximum Transmit Power!
- ★ Operate Mobile in Your Car with Optional Cigarette Lighter Plug-in Adapter
- Superheterodyne Receiver with Less Than 1 Microvolt Sensitivity for 10 db S + N/N Ratio
- Automatic Compressor Range Boost—Assures High Talk Power
- Variable squelch and Automatic Noise Limiting for Minimum Noise

Imported*



FREE
 1967
 Catalog No. 670
 512 Pages

Everything in Electronics for Home and Industry from the "World's Hi-Fi Electronics Center"

LAFAYETTE Radio ELECTRONICS
 Dept. RE-7, P. O. Box 10
 Syosset, L. I., N. Y. 11791

Send me the FREE 1967 LAFAYETTE Catalog 670 RE-7

Name _____

Address _____

City _____

State _____ Zip _____

CIRCLE NO. 108 ON READER SERVICE CARD

GET INTO **ELECTRONICS**



V.T.I. training leads to success as technicians, field engineers, specialists in communications, guided missiles, computers, radar and automation. Basic & advanced courses in theory & laboratory. Electronic Engineering Technology and Electronic Technology curricula both available. Assoc. degree in 29 mos. B. S. also obtainable. G.I. approved. Graduates in all branches of electronics with major companies. Start September, February. Dorms, campus. High school graduate or equivalent. Write for catalog.

VALPARAISO TECHNICAL INSTITUTE
 Dept. RD, Valparaiso, Indiana

EW Lab Tested
 (Continued from page 16)

trol voltage and signal-strength meter operation, a conventional i.f. amplifier is included, together with separate amplifiers and detectors for a.g.c. and meter operation.

The interstation squelch circuit of the AR-15 is unusually elaborate and effective. It uses a total of 11 transistors and 6 diodes, more than the total complement of many FM tuners. Most squelch circuits operate on the reduction of noise when an FM station is tuned in. This invariably results in a burst of noise when the squelch goes in and out of action. In the AR-15, the noise reduction is not sufficient to turn on the receiver. In addition, the receiver must be tuned to nearly the center of the channel, as indicated by the center-zero tuning meter. Since the quieting is already effective when the squelch operates, there is no noise burst. Signals appear and disappear abruptly as the receiver is tuned. Only when two signals are on adjacent channels (200-kHz apart) can an occasional noise burst be heard when tuning between them.

There is also an adjustable stereo threshold circuit which switches the receiver from stereo to mono when the signal strength falls below a predetermined level. Normally, stereo mono switching is fully automatic, but the receiver can be controlled manually or set to respond only to stereo signals if desired. A switchable FM-stereo noise filter reduces noise on weak stereo signals, with no loss of high-frequency response but with a noticeable reduction of channel separation.

The AR-15 AM tuner is a basic design, with one r.f. amplifier and one i.f. amplifier. It lacks a 10-kHz whistle filter and while its sound is pleasant, it does not match the quality and performance of the FM tuner section.

Our laboratory measurements confirmed the specified performance of the receiver in all essential respects. When

delivering its rated continuous power output of 50 watts per channel, the distortion was under 0.33% between 20 and 20,000 Hz. At half power, the distortion was 0.15% between 20 and 20,000 Hz. The 1000-Hz harmonic distortion was under 0.15% at any power up to 50 watts and the IM distortion averaged a few tenths of 1% at any power up to 50 watts. These measurements were made with 8-ohm loads. (According to the manufacturer, the maximum music power output of 75 watts channel is obtained at this impedance. At 16 ohms, music power drops to 45 watts, and at 4 ohms it drops to 50 watts.—Editor)

The tone controls had adequate range, with the desirable property of not having any effect on middle frequencies between 700 and 3000 Hz. The RIAA phono equalization was very accurate, within ± 1 dB from 20 to 20,000 Hz.

The most impressive part of the receiver was its FM tuner. Featuring outstanding sensitivity and an excellent limiting characteristic, its IHF usable sensitivity was 1.45 microvolts, and limiting was complete at 2 microvolts. We were unable to find any stations which did not limit fully, with silent backgrounds. We also were able to receive stereo broadcasts from a distance of 70 miles, only 200 kHz from a powerful local station, without interference, a remarkable feat. For this we used a moderately priced 8-element yagi antenna, only 25 feet high.

The FM-stereo separation was about 40 dB at middle frequencies, reducing to 23 dB at 30 Hz and to 13.5 dB at 15 kHz. The frequency response was very flat to 10 kHz, rolling off slightly at 15 kHz. This was evidently due to the low-pass filters which removed any ultrasonic signals which might cause beats when tape recording FM-stereo broadcasts.

The unit we tested was an engineering model. We have not seen the kit construction manual, but it is obvious that this is a complex unit and probably not for the neophyte kit builder.

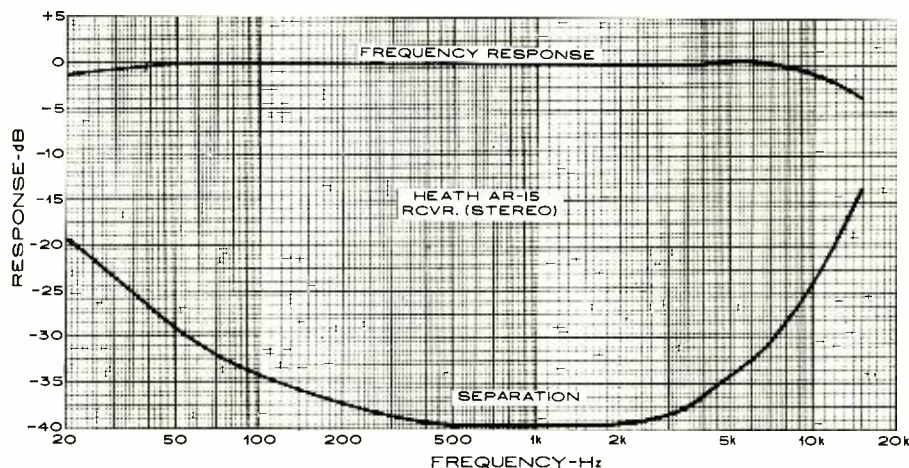

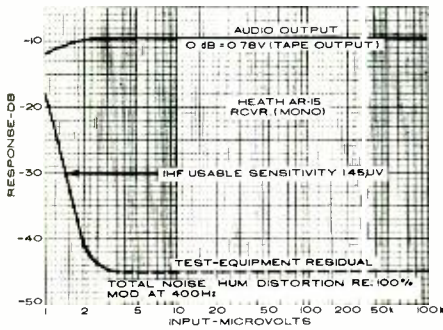

It is constructed on seven printed-circuit boards and inter-cabling is minimized by mounting most front-panel controls and their rear input connectors directly on their associated circuit boards. The signal meter is used as a voltmeter and ohmmeter for checking out the receiver as it is constructed and no additional test equipment is needed for alignment. Most of the normal alignment procedures are eliminated by the use of the crystal filters in the i.f. and by a pre-aligned front-end. (Esti-

ated construction time, according to the manufacturer, is expected to be around 35 hours.—Editor)

We found the AR-15 easy to operate and easy on the ears. Its enormous reserves of clean power make for effortless listening at any level, and the FM tuner brought in more listenable FM broadcasts, as many as 15 to 20 on a single sweep of the dial, than we had realized existed in our area.

The few amplifiers which can match or surpass the AR-15 in power or ultra-low distortion cost considerably more than the entire AR-15 receiver. The tuner portion is among the most sensitive we have ever checked. Considering these facts, this is a remarkable value at \$329.95 in kit form. We noticed a reaction of several people to the effect that they could buy a very good factory-wired receiver for that price. So they could, but it would be hard to find one which would match the over-all performance of the Heath AR-15. ▲

Shure Model 565 "Unisphere I" Microphone

For copy of manufacturer's brochure, circle No. 27 on Reader Service Card.

PUBLIC-address microphones require certain performance characteristics not needed in recording or broadcast applications. The proximity of loudspeakers, usually operating at high volume, makes acoustic feedback a potentially serious problem. Speakers or vocalists have a tendency to perform very close to the microphone, many of which are prone to unnatural "bassiness" under these conditions. Obviously, a microphone which will be held close to the user's face should be reasonably small and lightweight.

The Shure Model 565 "Unisphere I" microphone represents an effective solution to these problems. It is a unidirectional, cardioid-pattern dynamic microphone, only 6½ inches long and weighing 10½ ounces (less the detachable cable). The active element of the microphone is enclosed in a 2-inch diameter wire mesh sphere. The response of the 565 is uniform in the plane at right angles to its axis due to its symmetry of construction, but it strongly rejects sounds coming from the rear of the microphone. Its side cancellation is approximately 6 dB and its rear response is typically 15 to 20 dB below the front

response. The polar pattern is essentially uniform with frequency.

The spherical mesh screen serves a dual purpose. It prevents the user from getting too close to the dynamic element and serves to protect the diaphragm from wind and breath noises. The cardioid pattern makes it possible to orient the microphone so as to reject sound coming from the loudspeakers which it drives, permitting operation at relatively high volume levels without acoustic feedback.

The 18-foot shielded three-conductor cable supplied has an Amphenol MC4M microphone plug on the end which mates with the conductor on the end of

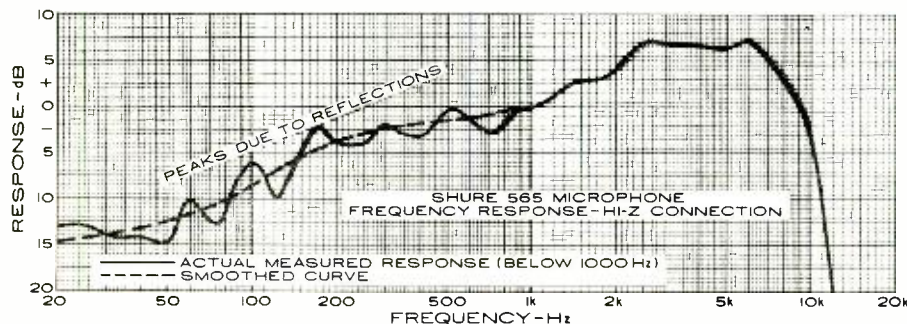

FIRST AND ONLY compact SCRULOX® screwdriver sets

Increasing use of Scrulox square recess screws in appliances, radios, TV sets, electronic instruments...even the control tower at Cape Kennedy...has created a need. A need for compact, versatile driver sets. Small enough to tuck in a pocket. Complete enough to be practical on shop bench or assembly line.

Now, here they are... from Xcelite, of course.



PS44
COMPACT
CONVERTIBLE SET

Five color coded midget Scrulox drivers—#00 thru #3

One midget nutdriver—¼" hex
"Piggyback" torque amplifier handle increases reach and driving power

See-thru plastic case doubles as bench stand



99SL
INTERCHANGEABLE
BLADE KIT

Five Scrulox blades—#00 thru #3

Shockproof, breakproof, Service Master handle
Durable, see-thru plastic case



XCELITE, INC., 12 BANK ST., ORCHARD PARK, N. Y.
CIRCLE NO. 88 ON READER SERVICE CARD

Complete TUNER REPAIR

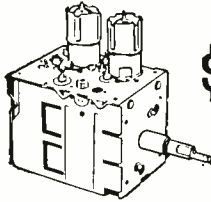

ONLY
\$950

Includes ALL parts (except tubes) . . . All labor on ALL makes. Fast, dependable service with 1-year warranty

Sarkes Tarzian, Inc., largest manufacturer of TV and FM tuners, offers unexcelled tuner overhaul and factory-supervised repair service.

Most Tarzian-made tuners received one day will be repaired and shipped out the next. More time may be required on other makes. Every channel checked and realigned per original specs. And, you get a full, 12-month guarantee against defective workmanship and parts failure due to normal usage. Cost, including labor and parts (except tubes) is only \$9.50 and \$15 for UV combinations. Replacements at low cost are available on tuners beyond practical repair.

Always send TV make, chassis and Model number with faulty tuner. Check with your local distributor for Sarkes Tarzian replacement tuners, parts or repair service. Or, use the address nearest you for fast, factory-supervised repair service.

TUNER SERVICE CORPORATION



(Factory-supervised tuner service authorized by Sarkes Tarzian)

MIDWEST—817 N. Pennsylvania St.
Indianapolis, Ind. Box 1642
Tel: 317-632-3493

EAST—547-49 Tonnele Ave.
Jersey City, New Jersey • Tel: 201-792-3730

SOUTH-EAST—938 Gordon St., S.W.
Atlanta, Georgia • Tel: 404-758-2232

WEST—SARKES TARZIAN, Inc.
Tuner Service Division
1065 Magnolia Blvd., N. Hollywood, Calif.
Tel: 213-769-2720

CIRCLE NO. 81 ON READER SERVICE CARD

the microphone. By a simple change of cable connections in the 5-pin plug, either low-impedance (150 ohms nominal) or a high-impedance, 10,000-ohm output may be selected.

The nominal frequency response is 50 to 15,000 Hz. We were able to make an approximate measurement of its frequency response by comparison with our calibrated capacitor microphone, by locating the microphone about two feet in front of the loudspeaker and then making a frequency-response plot. We made automatic plots, on the same chart paper, of our standard microphone and of the Model 565, with both positioned identically with respect to the speaker. Since the reference microphone is essentially flat in the frequency range we covered, the difference between the two curves is an indication of the response of the microphone.

We used the term "indication" intentionally. Since the reference microphone is non-directional and the 565 is sharply directional, one would expect to find some differences between their outputs from the test signal source. The test was not made in anechoic surroundings, although the proximity to the speaker minimizes the effects of room resonances. The curve we obtained had a series of small ripples below 1000 Hz, which were evidently due to reflections from the front of the speaker cabinet and surrounding objects. Drawing a smooth curve through these points, we found a rising response curve quite smooth and free from peaks or holes, increasing at about 3 dB/octave from 20 Hz to 6 or 7 kHz. It fell off quite rapidly at higher frequencies and the upper limit was, for all practical purposes, about 10 kHz.

Bearing in mind the inevitable increase in bass when close-talking, one might expect the response of the mike under these conditions to be relatively uniform over the entire range. We verified this by recording with it on one track of a stereo recorder and with another microphone lacking the spherical windscreen, but with comparable overall frequency response, on the other track. The 565 was clearly superior in this test, both in close-talking, where it excelled, and in more distant pickup where it still had a live, natural sound free from the heaviness which characterizes some microphones whose response measures "flat".

Subjectively, the mike was slightly bright in comparison with the other microphone, but when listened to by itself it sounded "just right". A practical test with a small combo confirmed the effectiveness of its cardioid pattern in avoiding feedback and its generally excellent sound. It is compact and unobtrusive and well suited to this sort of musical pickup as well as for speech.

The Shure 565 microphone sells for \$95 (list).

FROM HiFi STEREO REVIEW DELUXE PADDED DUST-PROOF RECORD AND TAPE CASES

plus FREE cataloging forms



These decorative, yet sturdily constructed cases are just what you've been looking for

to keep your records and tapes from getting tossed about and damaged, disappearing when you want them most and just generally getting the "worst of it" from constant handling. They're ideal too for those valuable old "78's" that always seem to get thrown about with no place to go.

Constructed of reinforced fiberboard and covered in rich leatherette in your choice of nine decorator colors, the HiFi/STEREO REVIEW Record and Tape Cases lend themselves handsomely to the decor of any room, whether it be your library, study, den, music room or pine-paneled garage. The padded leatherette back (in your color choice) is gold tooled in an exclusive design available only on HiFi/STEREO REVIEW Record and Tape Cases. The sides are in standard black leatherette to keep them looking new after constant use. With each Record and Tape Case you order you will receive, free of charge, a specially designed record and tape cataloging form with pressure-sensitive backing for affixing to the side of each case. It enables you to list the record names and artists and will prove an invaluable aid in helping you locate your albums. The catalog form can be removed from the side of the case at any time without damaging the leatherette.

Extra
Record Cases are available in three sizes: for 7", 10" and 12" records. Each case, with a center divider that separates your records for easy accessibility, holds an average of 20 records in their original jackets. The Recording Tape Case holds 6 tapes in their original boxes.

● The Tape Cases and the 7" Record Cases (with catalog forms) are only \$3.25 each; 3 for \$9; 6 for \$17.

● The 10" and 12" Record Cases (with catalog forms) are \$3.50 each; 3 for \$10; 6 for \$19. Add an additional 75c per order (regardless of number of cases ordered) for shipping and handling.

Ziff-Davis Publishing Company, Dept. 5D
One Park Avenue, New York, N. Y. 10016

My remittance in the amount of \$_____ is enclosed for the Cases indicated below.

Quantity

_____ Tape Case at \$3.25 each; 3 for \$9; 6 for \$17.
_____ 7" Record Case at \$3.25 each; 3 for \$9; 6 for \$17.
_____ 10" Record Case at \$3.50 each; 3 for \$10; 6 for \$19.
_____ 12" Record Case at \$3.50 each; 3 for \$10; 6 for \$19.

Add 75c PER ORDER for SHIPPING and HANDLING

Check color choice for back of case (sides in black only):

Midnight Blue Red Saddle Tan
 Pine Green Orange Yellow
 Grey Black Spice Brown

Name _____ EW 57

Address _____

City _____ State _____ Zip Code _____

PAYMENT MUST BE ENCLOSED WITH ORDER



TAPE RECORDER ANNUAL

1967 — \$1.25 — #42
1966 — \$1.25 — #30
1965 — \$1.00 — #31

Everything you need to know about tape recording including a complete directory of mono and stereo recorders.

Order by number from Ziff-Davis Service Div., 595 Broadway • New York, N. Y. 10012. Enclose add'l 15¢ per copy for shipping and handling (50¢ for orders outside U.S.A.)

NEW PRODUCTS & LITERATURE

Additional information on the items covered in this section is available from the manufacturers. Each item is identified by a code number. To obtain further details, fill in coupon on the Reader Service Card.

COMPONENTS • TOOLS • TEST EQUIPMENT • HI-FI • AUDIO • CB • HAM • COMMUNICATIONS

10-Hz TO 1-MHz OSCILLATOR

Frequencies between 10 Hz and 1 MHz can be selected with four-place precision on the new Model 4204A test oscillator. Frequency selection is made with detented rotary controls. Each of four selects a decimal digit of the de-

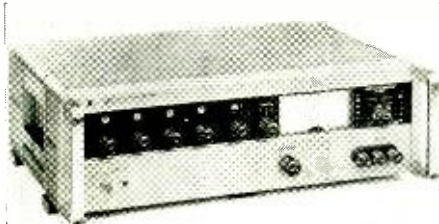

sired frequency and a fifth control selects one of the four decade ranges. A vernier frequency control provides infinite resolution where needed between digital steps.

The fifth control, in selecting a range, sets the decimal point and displays the units of measurement, i.e., Hz or kHz. With the 4-place numerical readout, this results in a complete in-line display of frequency selected and assures that there can be no ambiguity in its reading.

The new unit is designed for use in production testing and other repetitive measurements where certain frequencies are selected over and over again. Frequency resettability is better than 0.01%, assuring consistency where measurements are repeated. Over-all frequency accuracy is 0.2%. Hewlett-Packard

Circle No. 126 on Reader Service Card

MIL-SPEC SWITCHES

A complete series of push-button switches certifiable to the new MIL-S8805/3 specification is being marketed as the Series W190. The new series includes 110 moisture-proof push-button switches rated for loads of 10 amperes resistive, 5 amperes inductive, and 3 amperes lamp at 28 volts d.c. or 115 volts, 60 and 400 Hz a.c.

The line includes five different circuit arrangements, seven different mounting styles, and a choice of red or black push-buttons in two styles appropriate to either momentary or push-pull action. Designed to withstand shock, vibration, and other critical standards, the switches have an electrical endurance in excess of 25,000 operations at rated loads. Controls Co. of America

Circle No. 127 on Reader Service Card

WIRELESS REMOTE-CONTROL UNIT

The new "Teleswitch" is a wireless, remote "on-off" switch which can be used to operate such devices as lamps, fans, hi-fi equipment, radios, or TV sets. The unit is in two parts—



a miniature battery-operated ultrasonic transmitter and a receiver. The device will operate at distances up to 40 feet.

There is no installation involved. The device to be controlled is plugged into the "Teleswitch" unit which is then connected to any 117-volt, 60-Hz wall outlet.

The unit is fully transistorized and requires no warm-up. The relay contact rating is 7½ amperes, 860 watts maximum. The transmitter is housed in a contoured plastic enclosure which is easy to handle. Euphonia

Circle No. 1 on Reader Service Card

THERMOCOUPLE ASSEMBLY KIT

A thermocouple assembly kit which permits the assembly of a wide variety of thermocouple probes in only minutes has just been announced.

The kit contains all necessary components to construct the probes from cryogenic through high temperatures. A complete instruction manual, giving important thermocouple data, accompanies each kit.

A product bulletin (#965) giving complete information on the kits will be forwarded on request. Omega Engineering

Circle No. 128 on Reader Service Card

BROADBAND COAXIAL SWITCH

A new high-performance s.p.d.t. coaxial switch which is less than half the size of its predecessor and weighing less than 1¼ ounces is now available as the MA-7530.

The new subminiature switch has a high



isolation of 60 dB minimum and low (typically 1.3:1 max.) v.s.w.r. over the frequency band from d.c. to 12.4 GHz. Over-all volume of the switch is less than 0.75 cubic inch.

This level of performance, not previously attainable in the X-band, is provided in combination with switching time of 20 msec maximum and an r.f. power rating of 15 watts c.w. Actuation is remote, by 22-30 volts d.c. Microwave Associates

Circle No. 129 on Reader Service Card

COLOR GENERATOR

A new deluxe color generator featuring an automatic timer heating element and movable single dot and single vertical and horizontal line patterns has been introduced at the CG141 "Color King".

Compact and completely portable, the unit is housed in a mar-resistant vinyl-clad steel case with removable protective lid. A plate-glass mirror is shock-mounted in the lid for convenient set-up and convergence in the home.

The automatic timer heating element is thermostatically controlled to maintain a mini-



mum operating temperature of 80 degrees. Stability is thus assured whether the outside temperature is 20° below or 140° in the shade.

The new movable single patterns, exclusive in this instrument, make it possible to follow the set manufacturer's convergence recommendations without the confusion sometimes caused by multiple lines and dots. The single dot and single vertical and horizontal line patterns can be positioned at any point on the CRT screen. Sencore

Circle No. 2 on Reader Service Card

SQUARE TRIMMER

A new line of commercial, wirewound ¾" trimming potentiometers has just been introduced as the Series 3600.

These square trimmers will fit the cards of any standard ¾" or ½" square trimmer. It is only 0.200" high for low card space applications.

The new design permits a longer mandrel than that of rectangular trimmers and thus offers up to 131% better resolution than that offered by ¾" rectangular trimmers, according to the company. The new design offers up to 85% better resolution than that specified by MIL-R-27208B, RT24.

Resistance values are available from 100 to 20,000 ohms. Power rating is 0.5 watt at 40°C. Operating temperature range is from -65°C to +125°C. The trimmers feature silver-brazed terminations, gold-plated terminals, and a damage-proof clutch. Amphenol Controls.

Circle No. 130 on Reader Service Card

PC ASSEMBLIES & KITS

A broad line of printed-circuit assemblies and kits designed specifically for the hobbyist and experimenter market is now available.

Designed for use in home entertainment equipment, ham gear, p.a. and intercom systems, units currently available include a wide choice of low-power amplifiers, preamps for ceramic cartridges, stereo tape preamps for 8-track cartridges, and a 20-watt mono amplifier. Details on the full line of available units will be supplied on request. Amperex

Circle No. 3 on Reader Service Card

LOW-COST INDICATOR LIGHTS

The new bi-pin cartridge lamps offer a choice of three transparent and two translucent lens caps. They may be mounted in a lampholder for easy replacement or, for maxi-

imum economy, may be permanently mounted to a panel with a Tinnerman nut and connected with a #499-058 connector. Voltage range in this line is 6 to 120 volts. Data sheet #6700 giving full details on this new line is available on request. Drake

Circle No. 131 on Reader Service Card

HEAT-SHRINKABLE TUBING

Two new types of heat-shrinkable polyolefin tube are now available: "Heat-Grip" 800, a colored, flame-retardant tubing and "Heat-Grip" 805, a nearly transparent tubing. The new tubing will shrink to half its original diameter upon heating to 250° F for several seconds or in less time at higher temperatures. The molecular cross-linking of the special formulations results in materials which become elastomeric. They do not melt or flow upon heating, have much longer heat life, and greater resistance to solvents, according to the company.

The tubing is available in black, white, red, yellow, blue, or clear in sizes from 1/8" to 1" i.d. Natvar

Circle No. 132 on Reader Service Card

SOLID-STATE VARIABLE FILTER

A highly flexible, all-solid-state variable electronic filter has made its appearance on the market as the Model 3202. Providing basic low-pass and high-pass modes, the unit can (by interconnecting its two channels) also be operated as either a bandpass or band-reject filter.

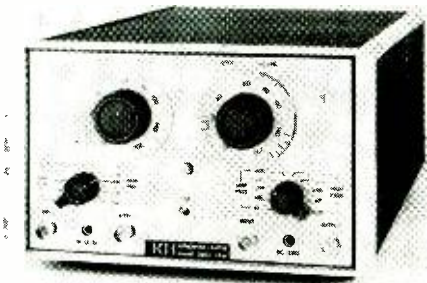

In addition, cascading the two channels can increase the basic 24 dB per octave attenuation slope to 48 dB per octave in the low-pass and high-pass modes.

The Model 3202 tunes continuously over the frequency range of 20 Hz to 2 MHz and is available in either bench or rack mounted versions. Krohn-Hite

Circle No. 133 on Reader Service Card

ANTENNA SYSTEMS FOR HOMES

A factory-engineered antenna system designed to be built into new homes is now being offered in kit form. The system permits up to eight TV/FM sets to operate simultaneously from one antenna without interaction.

The new system is offered in two versions: Model 1-4BK is for the 1-4 family unit and is designed for installation in new homes and small multiple unit dwellings. The Model 5-8BK 5-8 family unit kit is designed for apartment houses, motels, hotels, and larger dwellings.

These kits, designed for use with 300-ohm line, include a golden anodized TV antenna, the distribution system, and non-electrical outlets. Mosley

Circle No. 4 on Reader Service Card

POWER RHEOSTATS

A new line of power rheostat-potentiometers for industrial electronic applications has just been introduced as the Style MP.

Available in 25- and 50-watt sizes, the new units feature all-ceramic construction (core, base, hub), vitreous enamel bonding, self-lubricating shoe, compact design, and smooth high-resolution action.

Available in all popular resistances values to 5000 and 10,000 ohms for 25- and 50-watt sizes, respectively, the new units are directly

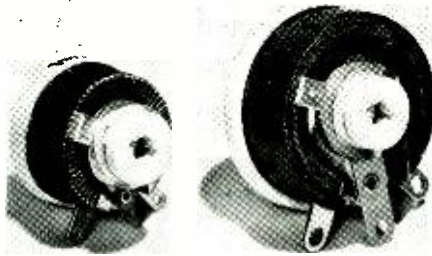

interchangeable with those of major manufacturers. Standard tolerance is $\pm 10\%$ and functional output is linear. Ward Leonard

Circle No. 134 on Reader Service Card

MOTOR SPEED CONTROLS

Three new models, Nos. 100, 101, and 102, of long-life motor speed controls are now available. Encased in an aluminum extrusion, the solid-state, full-wave circuitry used will control universal a.c.-d.c. motors from "off" to full speed. Output voltage may be adjusted from 5 volts to full a.c. line voltage and they may also be used to vary the speed of permanent split-capacitance type a.c. motors.

The Model 100 will handle a maximum of 600 watts at 5 amps, 120 volts a.c.; the 101 will control 1200 watts at 10 amps, 120 volts a.c., while the 102 is designed to control 1800 watts at 15 amps, 120 volts a.c. All models are fused for overload protection and all models measure a mere 2" x 3" x 5" long and weigh less than 2 pounds. Slocum Industries

Circle No. 5 on Reader Service Card

MONOLITHIC VOLTAGE REGULATOR

The new Type LM-100 monolithic voltage regulators are adjustable over a 2 to 30 volt output voltage range and are capable of handling output currents up to 5 amps by the addition of external transistors. The new units can be used either as a linear, dissipating regulator or a high-efficiency switching regulator with essentially the same performance in either application.

The units feature regulation better than 1% for widely varying load and line conditions. Temperature stability is better than 1% over the full military temperature range. As a



linear regulator, the design provides current limiting, excellent transient response, and unconditional stability with any combination of resistive or reactive loads, according to the company. As a switching regulator, the circuit will operate at frequencies up to 100 kHz with an efficiency of 85%. National Semiconductor

Circle No. 135 on Reader Service Card

HI-FI—AUDIO PRODUCTS

HIGH-GAIN FM-STEREO ANTENNAS

Three "Stereo-Probe" FM antennas designed to overcome the critical dB loss in multiplex reception in fringe areas have been introduced. The new antennas introduce the series-fed dipole concept to FM arrays. According to the company, this new phase relationship of

end-fire, series-fed dipoles also results in high front-to-back ratios, minimizing stray pick up.

The Model 9 is designed for fringe to deep fringe, the Model 6 for near fringe to fringe, while the Model 4 is for suburban to near fringe area applications. Channel Master

Circle No. 6 on Reader Service Card

COMPACT STEREO RECEIVER

A bookshelf-size, solid-state FM-stereo receiver has recently been introduced as the Model 606. Measuring 9" deep x 17" wide x 5" high, the receiver is housed in a walnut case with large, sloping FM dial for easy station identification and a log-scale dial face for pinpoint tuning. Simple alignment of a pointer at the center of an illuminated tuning meter provides optimum visual tuning.

Other front-panel features include a stereo indicator light, tape monitoring facilities, two sets of speaker switches, a stereo headset outlet, input facilities for magnetic and ceramic car-



tridges, musical instrument, tape, or auxiliary program sources. The 606 will drive two pairs of stereo speakers, either as a single pair or in combination, with independent front-panel control. Other controls are tuner/phone, auxiliary/normal, tape/normal, stereo/mono, plus volume, bass/treble, and balance.

According to the company, frequency response is virtually flat to 20,000 Hz, FM stereo separation is in excess of 35 dB, total HD is 0.3%, and output is 30 watts per channel. ADC

Circle No. 7 on Reader Service Card

WIRELESS MICROPHONE

The Sony CR-6 wireless microphone features a battery-operated receiver with provision for a.c. operation. The system consists of a compact, lightweight, solid-state FM transmitter, capacitor microphone, solid-state a.c.-d.c. receiver, and two battery packs. The miniaturized transmitter and microphone are housed in a capsule less than 3 inches long. For hand-held use, power is supplied by a battery-contained capsule which is directly attached to the mike-transmitter or the separate battery pack connected by a small cable permits use as a lavalier.

The transmitter and receiver can be separated by distances up to 300 feet. A squelch circuit prevents interference. The monitor speaker and volume control are built in. The system operates at 42.98 MHz but 35.02 or 33.15 MHz operation can be provided if specified at the time the unit is ordered. Frequency response is 50-10,000 Hz, signal-to-noise ratio is greater than 35 dB. Superscope

Circle No. 8 on Reader Service Card

HANDSET MICROPHONE

A close-talking, noise-canceling dynamic microphone telephone-type handset is now available for use in "Vocoder" systems. It can be used in environments of high ambient noise and reverberant acoustics.

The microphone has a frequency response of 70 to 5000 Hz and noise discrimination averages 15 dB. Output impedance is 150, 250 ohms. The unit is available in red (or black) for use in military and government "hot line" systems. Altec Lansing

Circle No. 9 on Reader Service Card

90-MINUTE BLANK CASSETTES

The C-90 cassettes which provide 90-minute recording time have been released for use with

all tape recorders utilizing the cassette system. The new blank units have the same physical dimensions as the original C-90 versions and are completely compatible and interchangeable on all mono and stereo cassette machines. The C-90 provides 45 minutes of recording time on each side because technological advances permit use of thinner tapes within the compact containers. Note:leo

Circle No. 10 on Reader Service Card

FM-STEREO TUNER

The "Knight" Model KN-290 FM stereo tuner features all-silicon transistors, built-in a.f.c., built-in tuning meter for hairline tuning, and an

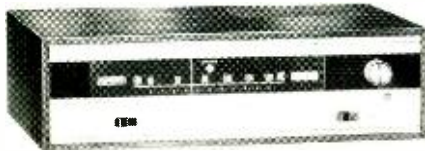

indicator light to signal a stereo transmission. A special feature, the automatic multiplex switch, activates the stereo sections of the circuit when a stereo signal is received and cuts off the areas not required for mono reception.

The tuner measures 13" wide x 10" deep x 3 1/2" high. It is supplied with a brushed, extruded aluminum panel and simple controls. An oiled-walnut wood case is available separately.

Sensitivity is 1.5 μ V for 20 dB quieting, 3 μ V IHF; image rejection is over 90 dB and capture ratio is 3 dB. Response is 50 to 15,000 Hz \pm 1.5 dB. The tuner is designed to operate on 110-130 V, 60 Hz a.c. Allied Radio

Circle No. 11 on Reader Service Card

BLANK TAPE CARTRIDGES

The new loaded blank "Audiopak" cartridges are designed to fit playback and recording systems for both home and automobile. Currently

there are two conventional loop cartridge systems on the market which record as well as play back—the Roberts 1725-8L and Muntz. In addition, two other firms (Lear-Jet and Pioneer) have announced their intention to produce systems that will record.

The unrecorded "Audiopak" 4 contains 300 feet of tape while the 8 contains 150 feet of tape. The packaged tapes come with instruction booklet and two pressure-sensitive labels. Audio Devices

Circle No. 12 on Reader Service Card

PROFESSIONAL TAPE RECORDER

A new series of professional audio recorder/reproducers designed specifically for use by radio stations, small recording studios, government, and industry is on the market as the AG-500 Series.

Major features of the new series include solid-state electronics and a precision-milled, die-cast top plate which eliminates flexing problems and assures stability in the most demanding mobile applications. A new drive motor and an open-type motor flywheel for a cool operating drive motor are designed to improve operational reliability.

The new series is available in a one-channel



version, a two-channel stereo version, and a two-channel quarter-track stereo version. All three configurations have two inputs with built-in mixing facilities for each electronics channel. A one-channel portable model is 20" wide x 14" high x 9" deep and weighs 42 pounds. Tape speeds can be specified as 7 1/2 and 15 ips or 3 3/4 and 7 1/2 ips. Ampex

Circle No. 13 on Reader Service Card

AUDIO SYSTEM TEST SET

A sophisticated instrument for testing and measuring audio components and sound systems is now available as the Model 9704A transmission measuring set. The instrument will measure gain, loss, frequency response, and signal levels of individual audio devices or complete installations. It consists of two separate systems—one for signal source at a definite dB level and one for signal output. Simultaneous input and output measurements may be made with the Model 9704A.

Frequency response of the unit is 10-20,000 Hz \pm 0.2 dB; input impedance is 600 ohms from the oscillator. Source impedances are 600, 250, 150, and 50 ohms, terminated or unterminated, while load impedances are 500, 250, 150, 16, 8, and 4 ohms. Altec Lansing

Circle No. 14 on Reader Service Card

WIRELESS FM MIKE

The new Model 6433 wireless FM microphone operates within the commercial FM band with output power which meets FCC regulations. It is designed for p.a. and portable one-way communications as well as for home entertainment and recording applications in conjunction with any FM radio or tuner.

The 9-volt, solid-state, battery-powered unit is adjustable over a 90-106 MHz range in the FM band with the anti-capacity alignment tool supplied. The field strength is such that, at permissible transmission distances, its output will overpower a commercial station to permit break-

CARBON COMPOSITION AND WIRE-WOUND POTENTIOMETERS

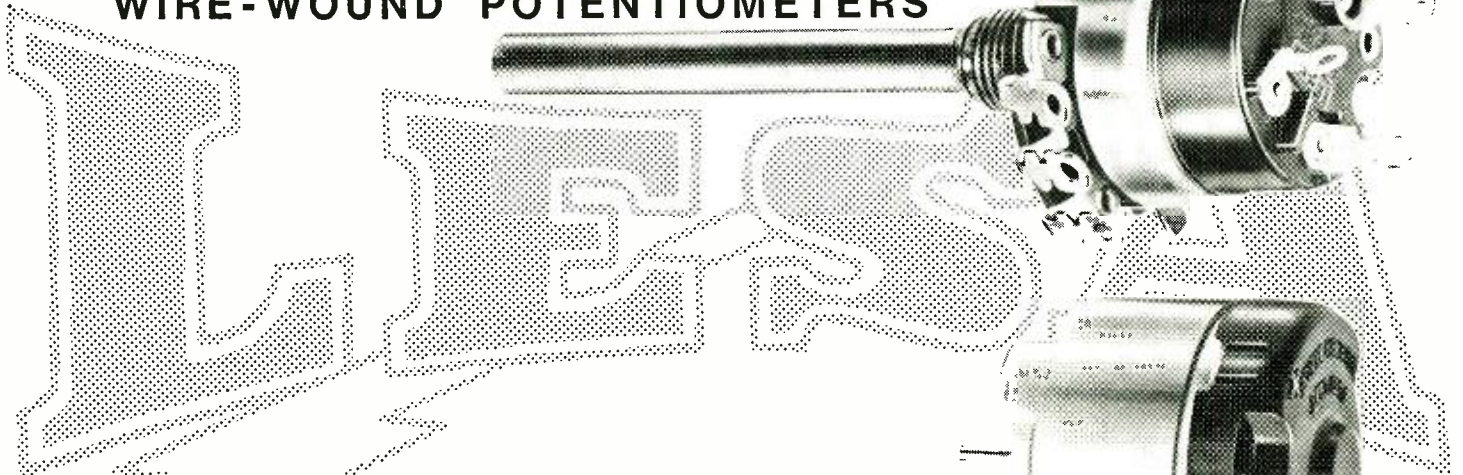

FRACTIONAL HP ELECTRIC MOTORS

AC. AND D.C. OPERATED, WITH OR WITHOUT SPEED REGULATOR



OF AMERICA CORP, 521 FIFTH AVENUE, NEW YORK, N.Y. 10017, TEL. 212 697.5838

COSTRUZIONI ELETTROMECCANICHE S.p.A., VIA BERGAMO, 21, MILANO, ITALY

DEUTSCHLAND GMBH, 1 WIESENTALSTRASSE, FREIBURG i/Br. WEST-GERMANY

ELECTRA, S.A., VIALE PORTONE 27, BELLINZONA, SWITZERLAND

FRANCE S.A.R.L., 19 RUE DUHAMEL, LYON, FRANCE



CIRCLE NO. 200 ON READER SERVICE CARD



in communications in businesses using regular FM radio for background music.

Tuned out of the range of local stations, the mike can be employed by a roving speaker when used with a tuner and p.a. amplifier. Frequency response of the lightweight unit (under 4 ounces) is 100 to 10,000 Hz. Input is provided for an external low-impedance dynamic mike as well. Channel Master

Circle No. 15 on Reader Service Card

HIGH-VOLUME HORN TWEETERS

Two new speakers, designed to deliver sound at concert hall volume, have been put on the market as the Models CH26SQ08 and CH39SQ08. Both models have 2.5 ounce magnets, 8-ohm voice coils, and power handling capacity of 20 watts. The former is 2" x 6" in size and has a frequency response of 1500 to 20,000 Hz. The latter is a 3" x 9" unit with a frequency response of 900 to 20,000 Hz. Oxford

Circle No. 16 on Reader Service Card

MODIFIED TURNTABLE SUSPENSION

A new, improved type of spring suspension for installation on early models of the firm's TD-150AB turntables is now available. The new system is being incorporated in the current TD-150AB run and the free kit will be supplied to purchasers of the earlier versions. Franchised dealers will provide the kit consisting of rubber grommets, foam rubber discs, together with a set of step-by-step instructions. No special tools are required.

Owners of early models (prior to December 1966) should apply to their franchised dealers to obtain the kit. Elpa Marketing.

CB-HAM-COMMUNICATIONS

31-CHANNEL TRANSCEIVER

The "Poly-Comm 30" transceiver has now been modified to offer 31 channels instead of 30. This coverage includes all 23 channels for long-range mobile communications plus 8 additional Part 15 channels that can be used to monitor short-range walkie-talkie communications.

By using frequency synthesis, only a few crystals are required to achieve the new performance. The receiver is a dual-conversion superhet with nuvistor r.f. amplifier and mixer stages to insure 0.15 μ V for 10 dB signal-to-noise ratio. Polytronics

Circle No. 17 on Reader Service Card

SOLID-STATE CB TRANSCEIVER

The new Model Y7050 CB transceiver transmits and receives up to 10 miles, depending on terrain and conditions. Either of two crystal-controlled frequencies—channel 11 or 16—may be used by simply flipping a channel selector switch.

A special feature of this new walkie-talkie is power source flexibility. It can be operated with standard "AA" penlight batteries or with rechargeable nickel cadmium batteries which are optional. With optional accessories, a.c.

house current, a car cigarette lighter, or 12-volt storage battery can be used.

In addition to the 51-inch telescoping antenna, a jack is provided for connection to an external antenna. This feature, along with adaptability to a variety of power sources, makes the unit usable as a base station.

The set weighs 1.7 pounds with batteries and measures 7 $\frac{5}{8}$ " high x 3 $\frac{1}{4}$ " wide x 1 $\frac{3}{8}$ " deep. Input power is 1 $\frac{1}{2}$ watts. General Electric

Circle No. 18 on Reader Service Card

30-WATT TWO-WAY RADIO

A new 30-watt, two-way radio, FCC-type-accepted and powered for the business and commercial operator, has been introduced as the "Fleet Courier 30B."

The completely self-contained unit provides more usable channels and greater power input for increased range in the 25-35 MHz bands. Full technical specifications will be forwarded on request. Courier Communications

Circle No. 19 on Reader Service Card

CB BEAM KITS

Three CB beam kits featuring everything within a single package to do the entire stacking job (with the exception of lead-in coax) are now on the market as the "Stack'Its."

Included are two "Scotch-Master" beams, stacking harness, guy rope, boom, necessary hardware, and assembly instructions. According to the company, stacking their beams results in an additional 4 dB gain over a single beam. Kits available are the SKT-3 including two 3-element antennas and stacking kit; SKT-4 including two 4-element antennas and stacking kit; and the SKT-5 with two 5-element antennas and stacking kit. Mosley

Circle No. 20 on Reader Service Card

MANUFACTURERS' LITERATURE

ALKALINE BATTERIES

A new 8-page illustrated brochure (Bulletin KO-115b) describing the company's expanded KO series of rechargeable, pressure-vented, nickel-cadmium batteries has been issued.

Specifications are given for 16 types of cells which can be used in any position and which will not spill even when completely inverted. In addition, the booklet presents several graphs which illustrate charging characteristics. Gulton

Circle No. 136 on Reader Service Card

TOOL CATALOGUE

A new 24-page general catalogue of professional hand tools (No. 166) is currently available. Illustrated in full color, the booklet includes screwdrivers, nutdrivers, specialized automotive tools, service kits, pliers, snips, and adjustable wrenches. Xcelite

Circle No. 21 on Reader Service Card

POWER DRILLS

A new 4-page illustrated catalogue (Form 111) describing a line of nine electric power drills for home craftsmen and professional users has been issued. The line includes standard, deluxe, heavy-duty, and variable-speed models in 1 $\frac{1}{4}$ ", 3 $\frac{3}{8}$ ", and 1 $\frac{1}{2}$ " sizes. Also shown in the booklet is a sturdy plastic carrying case. Wen

Circle No. 22 on Reader Service Card

ELECTRONIC COMPONENTS

A new 26-page illustrated short-form catalogue (No. 67) covering a full line of electronic components has been published. Included in the booklet is a wide range of jacks, plugs, switches, connectors, and audio accessories. Switchcraft

Circle No. 137 on Reader Service Card

NEW ELECTROMETER

A new 6-page foldout brochure describing the company's newly announced Model 401 all-solid-state vibrating-reed electrometer has been released. Contained in the booklet is information on the unit's operation, features,

electrical and mechanical specifications, and accessories. Applications include physical measurements, nuclear research, mass spectrometry, and biomedical research. Cary Instruments

Circle No. 138 on Reader Service Card

CARTRIDGE REPLACEMENT

A new 30-page 1967 cartridge replacement manual (No. SAC-25) has been released. More than 6600 cartridge listings are contained in the booklet, which is divided into two sections: Section I provides cross-references to cartridges manufactured by more than 60 competitors, while Section II lists replacements according to the phonograph model numbers of over 100 companies.

In addition, the manual includes a performance specifications chart covering the company's full line of cartridges. Sonotone

Circle No. 23 on Reader Service Card

SWEEP GENERATORS

A new 64-page 1967 catalogue covering a full line of sweep generators and accessories has been published. Contained in the booklet (No. 70) are descriptions and specifications of 30 sweep instruments, plus information on such accessory equipment as marker systems, attenuators, detectors, and coax switches.

Featured in the catalogue is a 23-page application section which discusses sweep frequency measurement in general, as well as specific techniques for testing crystal response, spectrum analysis, frequency identification, and alignment of color-TV tuners. Telonic

Circle No. 24 on Reader Service Card

"N-P-N" TRANSISTORS

Information on a complete line of high-voltage "n-p-n" transistors for military and industrial applications is contained in a new 6-page catalogue. Included are low-, medium-, and high-power devices.

All data is arranged in convenient tabular form, and four graphs illustrating typical "n-p-n" characteristics appear on the back page of the booklet. Industro

Circle No. 139 on Reader Service Card

RESISTOR-TRANSISTOR LOGIC

A comprehensive summary of milliwatt resistor-transistor logic with design rules for employing the company's Series US-0900 "Uni-circuit" integrated circuits is now available in a new 20-page semiconductor application note (No. 25,075).

The illustrated engineering bulletin also contains information on noise margins, propagation delay, and power consumption. Sprague Electric

Circle No. 140 on Reader Service Card

MANUAL SWITCHES

Complete information on modular and integral types of push-button switches (with or without lighted display color) and toggle switches is contained in a new 44-page illustrated catalogue (No. 51).

The booklet, printed in full color, is divided into twelve sections, each covering a series of manually operated switching devices. Mounting instructions are provided, along with applications and detailed specifications. Micro Switch

Circle No. 141 on Reader Service Card

RELAY CATALOGUE

A new stiff-cover 48-page catalogue describing the company's line of relays and solenoids is now available. More than 40 types of devices are covered, including latch and adjustable time-delay relays. Information on applications and accessories is also provided. Mossman-Elliott

Circle No. 142 on Reader Service Card

PRESSURE TRANSDUCERS

A new 6-page condensed catalogue of pressure transducers for industrial and aerospace applications has been issued. Included in the

illustrated booklet (No. SF-41) are linear variable differential transformer (LVDT) devices, d.c.-to-d.c. types, pressure transducers for severe environment, special-purpose units, and strain-gage transducers.

Featured in the catalogue is a quick-reference selector chart of the company's line. Consolidated Controls

Circle No. 143 on Reader Service Card

POWER MODULES

A new 24-page catalogue supplement (No. 142) on the "Transpac" line of solid-state power modules is now available.

The illustrated booklet covers silicon-repairable, germanium-repairable, and transparent-encapsulated d.c. power modules that meet applicable MIL Specs; standard silicon d.c. power modules, programmable models, and high-voltage types; and germanium low-cost d.c. power modules, high-voltage devices, and d.c.-to-d.c. converters. Electronic Research Associates

Circle No. 144 on Reader Service Card

THERMISTORS

A new 4-page illustrated application data bulletin (Section 3703) covering performance characteristics and applications of thermistors has been issued. Performance parameters include zero-power resistance-temperature, static volt-ampere, and current vs time; and applications discussed are measurement and control of temperature and other phenomena, temperature compensation, and applications using the current-time characteristic. General Electric.

Circle No. 145 on Reader Service Card

MICROWAVE COMPONENTS

A new 16-page illustrated brochure (No. W602) describing all the components required for a microwave communication waveguide system, from radio equipment output to antenna feed, has been published.

Entitled "Waveguide and Accessories for Microwave Communication Systems," the booklet presents data on a number of waveguide systems and also covers a complete line of circular waveguide components for single and dual polarized 6- and 11-GHz installations. Airtron

Circle No. 146 on Reader Service Card

FLEXIBLE CABLES

A new illustrated booklet on the manufacturing techniques and applications of flexible cables and circuitry has been released. Entitled "Techniques," the publication traces the history and manufacturing procedures to date in the development of flexible cables and circuitry and outlines advantages and disadvantages of their use.

Included in the booklet is a handy reference chart listing physical properties and limitations of the various cables. Methode

Circle No. 147 on Reader Service Card

FLASHING INDICATOR

Information on the company's new flashing indicator light is offered in a new illustrated catalogue sheet (No. L-202). Described in the data sheet are the device's solid-state circuitry, flashing rate, materials, and finishes. Dialight

Circle No. 148 on Reader Service Card

OPERATIONAL AMPLIFIERS

A new 6-page illustrated catalogue describing a complete line of solid-state silicon operational amplifiers has been issued. Specifications for 18 chopper-stabilized and differential amplifiers are listed, along with nine diagrams of case size and pin configuration. Fairchild Instrumentation

Circle No. 149 on Reader Service Card

SCR FIRING CIRCUITS

A new 16-page handbook (Bulletin No. 5001) on SCR firing circuits has recently been

published. Containing over 50 diagrams, waveforms, and other illustrations, the booklet covers single- and three-phase systems, protection of the firing circuit from failure, on-to-off ratio, sensitivity, and gate pulses. Firing Circuits

Circle No. 150 on Reader Service Card

ROTARY RELAYS

Information on rotary relays for use in a wide range of environmentally severe signal-switching functions in military and aerospace applications is contained in a new 26-page illustrated catalogue.

Complete descriptions, mounting dimensions, contact rating curves, and coil data are provided for all devices listed. Couch Ordnance.

Circle No. 151 on Reader Service Card

TRANSFORMER CATALOGUE

Complete information on the company's expanded line of transformers and toroids is contained in a new 34-page illustrated 1967 catalogue. Featured in the publication is a new section listing commercial industrial transformers and reactors. Microtran

Circle No. 152 on Reader Service Card

CATV EQUIPMENT

A new catalogue supplement containing descriptions and specifications of the "Pacesetter" series of amplifying and control devices for CATV applications is now available. Consisting of seven separate data sheets, the supplement also includes connectors and terminator as well as a complete price list. Ameco

Circle No. 153 on Reader Service Card

MOTOR CATALOGUE

Complete information on a line of motors and related components is presented in a new 32-page illustrated catalogue No. G65-1266. Described in the booklet are stepper, synchronous, servo, viscous- and inertial-damped,

FAMOUS ZENITH QUALITY TUBES for greater reliability, longer life



TV Picture Tubes

A complete line of more than 200 top-quality tubes. For color, black-and-white, or special purposes.

Zenith black & white replacement picture tubes are made only from new parts and materials except for the glass envelope in some tubes which, prior to reuse, is inspected and tested to the same high standards as a new envelope. In Color tubes the screen, aperture mask assembly and envelope are inspected and tested to meet Zenith's high quality standards prior to reuse. All electron guns are new.

"Royal Crest" Circuit Tubes

A full line of more than 875 tubes... the same quality tubes as original Zenith equipment. Your assurance of the world's finest performance.

Order all genuine Zenith replacement parts and accessories from your Zenith distributor



BUILT TO THE QUALITY STANDARDS OF ZENITH ORIGINAL PARTS

ZENITH

The quality goes in before the name goes on[®]

CIRCLE NO. 87 ON READER SERVICE CARD

35 fascinating ways to spend your next 250 spare hours

Announcing the Spring 1967 edition of the "what-to-do-with-your-spare-time" problem-solver: the **ELECTRONIC EXPERIMENTER'S HANDBOOK!**

Roll up your sleeves, heat up the iron and get set to meet 35 of the most challenging, fun-to-build electronics projects you've ever seen . . . or assembled with your own two hands!

Included are: a transistorized auto-light minder • a \$2 intrusion alarm • a tape recorder echo chamber (for under \$10!) • a powerhouse 2-tube SW receiver • a solid-state scope calibrator • and even a supercharged salt shaker!

You get complete schematics, illustrations, parts lists and easy-to-follow instructions . . .



PLUS expert tips 'n techniques designed to build your electronics skill. You'll keep up with the latest advances in the field, learn many valuable professional methods and short-cuts . . . and develop that extra technical know-how that comes only from practical, firsthand experience.

Don't chance missing your copy of the Spring 1967 **ELECTRONIC EXPERIMENTER'S HANDBOOK**. Use the coupon below to order yours **today!** **only \$1.25**

Get the handsome **LEATHERFLEX-BOUND** edition for just \$3 postpaid! The Spring 1967 **ELECTRONIC EXPERIMENTER'S HANDBOOK** is also available in a splendid deluxe edition. Rugged Leatherflex cover provides lasting protection yet is softly textured and gold-embossed for the look of elegance. A collector's item—a superb addition to your electronics bookshelf. And it's yours, for just \$3 postpaid, when you check the appropriate box on the order form.



ZIFF-DAVIS SERVICE DIVISION • DEPT. EEH-S
595 Broadway • New York, N. Y. 10012

OK! Send me the all-new SPRING 1967 **ELECTRONIC EXPERIMENTER'S HANDBOOK**.

\$1.25 enclosed, plus 15c for shipping and handling. Send me the regular edition. (\$1.75 for orders outside the U.S.A.)

\$3.00 enclosed. Send me the Deluxe Leatherflex-bound edition, **postpaid**. (\$3.75 for orders outside the U.S.A.) Allow three additional weeks for delivery.

name _____ please print _____ E.W. 57
address _____
city _____ state _____ zip _____

PAYMENT MUST BE ENCLOSED WITH ORDER

Boy, do I have spart time! Send me the big **Fall 1966** edition, too! I want the regular edition Deluxe Leatherflex-bound edition. (Prices same as above.)

braked, and special-purpose motors, as well as stepper driver and logic elements. Concluding the booklet is a section covering practical design formulas. Kearfott

Circle No. 154 on Reader Service Card

PANEL DESIGN SWITCH GUIDE

A new 20-page brochure entitled "Switch Guide for Panel Design" is now available. Printed in full color, the booklet stresses maximum design freedom in the use of lighted and unlighted push-button switches and indicators, switch display matrices, toggle switches, panel meters, and various special-purpose switches. Micro Switch

Circle No. 155 on Reader Service Card

SOUND RECORDING TAPE

The 1967 "Audiotape" catalogue of professional-quality sound recording tape and accessories has been issued. Features of the company's five formulations—all-purpose, triple-recording, low-print, low-noise, and lubricated—are outlined in the 12-page booklet, along with a concise listing of the bases, lengths, and reel sizes in which each type is available. Audio Devices

Circle No. 25 on Reader Service Card

DEPOSITION CONTROL

A new 8-minute, 16-mm color sound movie describing the latest techniques for automatically controlling multi-layered, multi-source depositions is now available free on a one-week loan basis. The film traces a layered evaporation through pump-down, pre-heat, and degas cycles, automatic rate and thickness control, source switching, sequence recycling, and final venting.

The movie is available from Sloan Instruments Corp., Box 4608, Santa Barbara, Calif. Write the company for scheduling information.

PHOTO CREDITS

Page	Credit
16	Heath Company
23	General Motors Corp.
25	General Electric Co.
29	Lear Siegler
34	Jerrold Electronics Corp.
36 (bottom right)	Bauer Corp.
44, 65	Hewlett-Packard
45	Tektronix
46, 47 (Fig. 1)	NASA
47 (Figs. 2 & 3)	de Havilland Aircraft of Canada, Ltd.
48, 49 (right) 49	Mobil Oil Corp.
49 (left)	Ford Motor Company
50	Marquette
64 (top)	Fairchild
64 (right)	Basic Science Industries
83	Shure Bros.

Answer to Puzzle appearing on page 69



Diagnostic Center (Continued from page 52)

cylinder. Since no firing pulse is provided, engine power is reduced, causing a drop in engine rpm. Further electronic circuitry then processes this information for a power-check readout.

Findings

The following is a *partial* listing of results obtained from tests performed on approximately 15,000 cars. (This information is contained in a survey conducted by Automotive Center Consultants, Inc., an industry-wide organization.)

In a general test, 71.72% of all cars tested had faulty headlight focus and light output, 61.35% had oil or coolant leaks, 25.13% had faulty tail/stop lights, and 20.02% had faulty exhaust systems.

As far as brakes were concerned, 28.14% had poor brake effort balance, 28.35% had brake-lining contamination, 21.96% had faulty brake-shoe action, and 16.96% had poor brake-pedal reserve.

In the tire department, 50.73% had poor wheel balance, 55.91% had improper caster, 49.40% had poor toe-in, and 32.96% had faulty shock absorbers.

In the battery-starter-generator area, 44.47% had cable problems, while 17.98% had poor voltage regulators. In the ignition-system tests, 49.08% had poor points, 53.95% had poor spark plugs, 43.57% were off in their basic timing, and 36.27% had improper ignition dwell time.

The Future

Ford foresees the time when test equipment will be modified to allow hookup to the vehicle without the necessity of disconnecting parts. The company also feels that car design will be altered so as to facilitate these tests.

In the area of test equipment, the firm believes that a computerized approach is obviously needed for speeding up operations. In this method, a computer will compare the car's "health" with the values recommended by the manufacturer and produce a printed-form readout.

Ford also suggests that some thought be given to test equipment that could actually identify potential component failures, thus allowing preventive maintenance before an actual breakdown.

Stanford Research Institute predicts that auto makers will wire their cars to facilitate analysis. They also feel that the diagnostic lane will be computerized, that analysis time will be cut in half, and that the diagnostician will become little more than a verbal expression of what the machines report about the condition of each car. ▲

ELECTRONICS MARKET PLACE

COMMERCIAL RATE: For firms or individuals offering commercial products or services. 70¢ per word (including name and address). Minimum order \$7.00. Payment must accompany copy except when ads are placed by accredited advertising agencies. Frequency discount: 5% for 6 months; 10% for 12 months paid in advance.

READER RATE: For individuals with a personal item to buy or sell. 40¢ per word (including name and address). No Minimum! Payment must accompany copy.

GENERAL INFORMATION: First word in all ads set in bold caps at no extra charge. Additional words may be set in bold caps at 10¢ extra per word. All copy subject to publisher's approval. **Closing Date:** 1st of the 2nd preceding month (for example, March issue closes January 1st). Send order and remittance to: Hal Cymes, **ELECTRONICS WORLD**, One Park Avenue, New York, New York 10016

ELECTRONICS ENGINEERING AND INSTRUCTION

ELECTRONICS! Associate degree—29 months. Technicians, field engineers, specialists in communications, missiles, computers, radar, automation. Start September, February. Valparaiso Technical Institute, Dept. N, Valparaiso, Indiana 46383.

LEARN ELECTRONIC ORGAN SERVICING at home. All Makes including transistors. Experimental kit—troubleshooting. Accredited NHSC. Free Booklet. **NILES BRYANT SCHOOL**, 3631 Stockton, Dept. A, Sacramento, Calif. 95820.

HIGHLY—effective home study review for FCC commercial phone exams. Free literature! **COOK'S SCHOOL OF ELECTRONICS**, P.O. Box 517, Monticello, Ky. 42633.

ASSOCIATE Degree in Electronics Engineering earned through combination correspondence-classroom educational program. Free brochure. Grantham Technical Institute, 1505 N. Western Ave., Hollywood, Calif. 90027.

FCC LICENSE in six weeks. First class radio telephone. Results guaranteed. Elkins Radio School, 2603C, Inwood, Dallas, Texas 75235.

WANTED! TV—Radiomen to learn aircraft electronics servicing. Numerous job openings everywhere. Write: **ACADEMY AVIONICS**, Reno/Stead Airport, Reno, Nevada 89500.

CORRESPONDENCE COURSES—B.Sc., Engineering, Electronics. Catalog \$1. Canadian Institute of Science & Technology, 263G Adelaide St. W., Toronto.

TELEVISION TROUBLESHOOTER answers all your service problems. Waste no time on book theory. Spot faults in seconds. Used by "pros" in repairing all makes and models. Write specifying black/white, color. **NATIONAL TECHNICAL RESEARCH LABS**, 6420 S. Western Avenue, Whittier, Calif.

HIGHLY effective home study course in Electronics Engineering Mathematics with circuit applications. Earn your Associate in Science Degree. Free literature. **COOK'S INSTITUTE OF ELECTRONICS ENGINEERING**, P.O. Box 517, Monticello, Ky. 42633 (Established 1945).

REI First Class Radio Telephone License in (5) weeks Guaranteed. Tuition \$295.00. Job placement free. **(KANSAS CITY) R.E.I.**, 3123 Gillham Road, Kansas City, Missouri, Telephone WE1-5444. **(SARASOTA) R.E.I.**, 1336 Main Street, Sarasota, Florida 33577, Telephone 955-6922.

MUSIC LOVERS, CONTINUOUS, UNINTERRUPTED BACKGROUND MUSIC FROM YOUR FM RADIO, USING NEW INEXPENSIVE ADAPTOR. FREE LITERATURE. ELECTRONICS, 11500-NW 7th Ave. MIAMI, FLORIDA 33168.

MESHNA'S Transistorized Converter Kit \$5.00. Two models converts car radio to receive 30-50mhz or 100-200mhz (one mhz tuning) Meshna, No. Reading, Mass. 01864.

FREE CATALOG—Loads of Electronic Bargains. R.W. Electronics, Inc. 2244 South Michigan Ave., Chicago, Illinois 60616.

SURVEILLANCE EQUIPMENT—NEW HIGH PERFORMANCE SUBMINIATURE MODELS. ELECTRONIC COUNTERMEASURE DEVICES TO PROTECT PRIVACY. FREE DATA: SECURITY ELECTRONICS-EW, 15 EAST 43RD STREET, NEW YORK, N.Y. 10017.

CRYSTALS . . . largest selection in United States at lowest prices. 48 Hr. delivery. Thousands of frequencies in stock. Types include HC6/U, HC18/U, FT-241, FT-243, FT-171, etc. Send 10¢ for catalog with oscillator circuits. Refunded on first order. **Jan Crystals**, 2400E Crystal Dr., Fort Myers, Fla. 33901.

GET IT from GOODHEART!

SOMETHING NEW in Surplus Test Equipment: At your request will furnish dated NBS-traceable Certificates of Calibration. **EVERYTHING UNCONDITIONALLY GUARANTEED!**

STANDARD SIGNAL GENERATORS

LP-952 10 to 50 mc, w/100 sply & book	129.50
Gen. Radio 305-C 10 to 60 mc, Certified	129.00
TS-113C U 10 to 100 mc, crystal only	229.50
AN URM-25 U 10 to 25 mc, crystal only	129.00
Bonton Universters: 100 to 25 mc	129.00
Meas. Corp. Mod. 40: 2 to 100 mc, Gen. Ppk	75.00
Meas. Corp. Mod. 80R: 5 to 15 mc, Certified	409.00
URM-26: Compact MIL version, 4-108 mc	149.50
Hewl-Pack. 608A 10 to 50 mc, crystal only	99.00
Gen. Radio -1021A 10 to 150 mc	259.00
TS-608/U 10 to 80 mc, 2-100 Watts Ppk	699.00
TS-118A/U: 100 to 1000 mc, w/100 sply	299.00
Hewl-Pack. 614A: 500-2100 mc	1179.00
TS-119 U 200-2000 mc, w/100 sply	295.00
Hewl-Pack. 616A: 1.8 to 1.8 mc	69.00
TS-103A/U, Hewl-Pack. 5400 as -611 B	695.00
URM-39: 1 to 3 mc, crystal only	129.00
PRD-909 MC 852Z 1 to 3 mc, 100 W Ppk	699.00
Hewl-Pack. 623B 1 to 100 mc	89.00
Hewl-Pack. 623C 1 to 100 mc	259.00
TS-739B/UPM-10 5.5 to 2.4 mc, 50 dbm	175.00
Polarad SS-1218: 1.2 to 1.2 mc	129.50

V-Fw UHF Oscillators: Tell us your needs.

FM & AM/FM SIGNAL GENERATORS

Bonton #132A: 1 to 40 mc AM/FM	229.50
Kay Radarweep #380A: 20 to 40 Mc, AM/FM	429.00
TS-152 U: 1 to 108 mc, built-in 100 W Ppk, FM	129.00
Bonton 202E W 207E: 0.1-206 Mc AM/FM	79.00
Bonton 202F 1 to 20 mc AM/FM	129.00
URM-75: 1 to 20 mc FM, w/100 sply	129.50
URM-16: AM/FM 100 to 1000 Mc	999.00
Kay Radarweep #111A: 1 to 25 mc	129.00
PHD #907: 1 to 100 mc FM	129.00

CMC #226A Universal Calibrator for 1 mc to 1 mc. H.P. 521D, 525A, B, 540A 0.01 to 5 mc 129.00
PRD #340 Ppk, Mod, 100,000 mc 299.00
Tektronix 511AD DC to 10 Mc, 200 dbm 129.00
Digital Voltmeters will furnish parts. ASK!

ASK FOR YOUR SPECIFIC LABORATORY NEEDS!

ALL-BAND 55B RCVR BARGAIN! If it fits, fits it! R-1737. Mid-1950's. 100 to 140 mc. Includes: Voltage, CW, MW, Damped, Grid, Wave, ZFR, 2-4ES, 250 Mc. Interchangeable 1-3 Mc, 3-100 Mc. Section. Sixty channels. Less: 10W sply 129.00
 on 100 sply 230.00. **55B** prod. detectors 520

TIME PAY PLAN: Any purchase totaling \$100 or more, down to 10¢ a day. **10%**

ATTENTION! Buyers of Lab Test Equipment: This show is a small sample of what is for you! Inventory. We can furnish L&N Tools, Bridges, Measuring Bridge, Boarding, 2 Meters, Kay Scan, Attenuators, DVM's, Counters, Graphite Resistors, Related Test Nuts, etc. etc. **DON'T CIRCLE NUMBER!** Write direct telling us what you need! We can't help on with catalogs! **WE ALSO BUY!** We want Test Equipment, Radios, Receivers, Video, and Test Equipment, etc. etc. And Military Surplus articles of all kinds.

R. E. GOODHEART CO. INC.
 Box 1220-A, Beverly Hills, Calif. 90213
 Phones: Area 213, office 272-5707, messages 275-5342

FOR SALE

JUST starting in TV service? Write for free 32 page catalog of service order books, invoices, job tickets, phone message books, statements and file systems. Oelrich Publications, 6556 W. Higgins Rd. Chicago, Ill. 60656.

GOVERNMENT Surplus Receivers, Transmitters, Snooperscopes, Radios, Parts, Picture Catalog 25¢. Meshna, Nahant, Mass. 01908.

TRANSISTORIZED Products Importers catalog. \$1.00. Intercontinental. CPO 1717, Tokyo, Japan.

METERS—Surplus, new, used, panel and portable. Send for list. Hanchett, Box 5577, Riverside, Calif. 92507.

INVESTIGATORS, FREE BROCHURE, LATEST SUBMINIATURE ELECTRONIC SURVEILLANCE EQUIPMENT. ACE ELECTRONICS, 11500-J NW 7TH AVE., MIAMI, FLA. 33168.

R.F. CONVERTERS World's largest selection. Also CCTV cameras, etc. Lowest factory prices. Catalog 10¢. Vanguard, 196-23 Jamaica Ave., Hollis, N.Y. 11423.

CONVERT any television to sensitive big-screen oscilloscope. Only minor changes required. No electronic experience necessary. Illustrated plans, \$2.00. Relco-A22, Box 10563, Houston, Texas 77018.

FREE ELECTRONICS (new and surplus) parts catalog. We repair multimeters. Bigelow Electronics, Bluffton, Ohio 45817.

DETECTIVES! Free brochures! Electronic Surveillance devices. **SILMAR ELECTRONICS**, 3476 N.W. 7th Street, Miami, Florida 33125.

SUDYMONT acoustic baffles. Plans \$5.95; Baffle \$26.95; with cabinet for \$39.95. Send speaker size. **SUDYMONT**, 120 Liberty Str., NYC. 10006.

ELECTRONIC Ignition Kits, Components Free Diagrams. Anderson Engineering, Epsom, New Hampshire 03239.

UNUSUAL BARGAINS
 . . . MANY U.S. GOV'T SURPLUS

GIANT WEATHER BALLOONS

"Balls of fun" for kids, traffic stoppers for stores, terrific for amateur meteorologists. Create a neighborhood fun sensation. Great backyard fun. Exciting beach attraction. Made of heavy duty neoprene, inflated with vacuum cleaner or auto air hose; or locally available helium for high rise.

- =60, 568AK (8' diam) \$2 Pbd.
- =60, 632AK (16' diam) \$7 Pbd.

FASCINATING MOIRE PATTERN KITS

Now explore the world of "Op Photography"! Fantastic visual effects. Limitless applications. 1,000's of uses for hobbyists, photographers, home experimenters. Fun! **Probable!** Contains 8 basic patterns on both clear acetate and white neoprene. 150 dot screen on film, book. Other sets incl. negatives available. Write for details. Stock No. 70-719AK. \$8.50 Pbd.

SAME KIT IN FULL COLOR
 Stock No. 60-530AK. \$12.50 Pbd.

NEW SURPLUS NI-CD BATTERIES

Save more than 50%! Long life—accept, don't charge and discharge cycles. 1.25 Volts per cell—750 milliamp hours capacity. Excellent charge retention. Hermetically sealed. Indefinite storage life. Multiple cells welded in series—easily cut, combine to form 100, 200, 400, 800, 1600 cells. 1" diam, 8 1/2" high. Spec. price for 100 up. Low-cost charger separate.

Order #	Cells	DC Volt.	Price Pbd.
40-986AK	1	1.25	\$ 1.50
40-987AK	2	2.50	2.75
60-633AK	3	3.75	3.60
60-634AK	4	5.00	4.80
70-812AK	Trickle Charger (1-10 cells)		10.95

Edmund Scientific Co., Barrington, N.J. 08007

MAIL COUPON for FREE CATALOG

SEND FOR FREE CATALOG "AK"

Completely new 1967 edition. New items, categories. Illustrations. 148 easy-to-read pages packed with nearly 4000 unusual items. Enormous selection of Astronomical Telescopes, Microscopes, Binoculars, Magnifiers, Magnets, Lenses, Prisms. Many war surplus items for hobbyists, experimenters, workshop. **Factory Price!** Write for Catalog "AK." Edmund Scientific Co., Barrington, New Jersey 08007.

NAME _____

ADDRESS _____

CITY _____ STATE _____ ZIP _____

CIRCLE NO. 115 ON READER SERVICE CARD May, 1967

CIRCLE NO. 121 ON READER SERVICE CARD 91

U.S. GOV'T ELECTRONIC SURPLUS

* Nationally Known-World Famous SURPLUS CENTER offers finest, most expensive, Government SURPLUS electronic units and components at a fraction of their original acquisition cost.

ORDER DIRECT FROM AD or WRITE FOR CATALOGS

STANDARD DIAL TELEPHONE

(ITEM #715) - Standard commercial telephone same as used throughout U.S.A. Attractive polished Black like new condition. Includes extensive plans to operate systems in direct or indirect service together for local or long distance. Full system furnished. **F.O.B. \$5.95**



STEP-BY-STEP AUTOMATIC SWITCH

(ITEM #738) - Amazing "step-by-step" step-by-step automatic switch. Total any bank post paid for 1 to 100. Make your own telephone system. Can also be used as a remote control for 100 circuits over a single pair of wires.
 * One of our FOUR STAR batteries. Comes complete with 100. Make your own telephone system. 2 1/2" x 7 1/2" x 1 1/2". With 100. Post paid for \$15.00.
 Complete. Single order. **F.O.B. \$9.95**



TYPICAL BUYS FROM OUR 1967 CATALOGS

- \$ 350.00 - Geared 2-hp Battery Golf Car Motor **\$24.95**
- \$ 15.00 - Westinghouse DC Ammeter, 0 to 300 **\$ 7.11**
- \$ 40.00 - Vacuum Pressure Pump, 12-VDC **\$11.95**
- 80-MW Walkie-Talkies, Per Pair **\$19.60**
- Deluxe, Multi-Range, AC DC Tester **\$ 8.98**
- \$4000.00 - Carrier Telephone Amplifier System **\$13.91**

SPECIAL SALE

Correspondence Course In ELECTRICAL ENGINEERING



Send For \$10.75 **\$8.79** Postpaid Outside U.S.A.

(ITEM #A181) - Wonderful chance to obtain technical training in Amazing Free Post Paid Electrical Engineering School has suspended its correspondence course because of increased operating costs. We offer a limited number of the school's complete Program of Engineering Education without the examination paper grading service. The course consists of 12 lesson and books. Each book has the regular exams and a separate section, "Standard Answers" to each exam question.
 * Course is self-paced, easy to understand, includes illustrations. Readers Digest size, easy to carry and study in spare time. Many include 1000 words and 1000 words holding up 1000 jobs as a result of U.S. training. Course contains latest information on transistors, silicon diodes, etc. Additional book on how to build and operate a 400 mc Laboratory and Experimental High Q Furnished with each course.

SEND 25c COIN OR STAMPS FOR 3 MAIN CATALOGS

All Items FOB Lincoln Money Back Guarantee

SURPLUS CENTER

DEPT. EW-057 LINCOLN, NEBR. 68501

CIRCLE NO. 91 ON READER SERVICE CARD

BIG CATALOG

World's "BEST BUYS" in GOV'T. SURPLUS Electronic Equipment

BC-603 RECEIVER

BC-603 RECEIVER F.M. 20-27.9 MC Continuous tuning and 10 preset push button channel selector. With sensitivity squelch & volume controls, 2 watt output to self contained speaker, one (1) microwatt sensitivity, 2.65 KC I.F. 10 tubes: 3/6AC7, 1/6J5, 2/12SG7, 2/6SL7, 1/6H6, & 1/6V6GT. Voltage required 12/24 volts for filament, 220 VDC @ 80 MA. for high volt. Size: 1 1/2 x 6 3/4 x 12 1/2". Wt.: 35 lbs. Used: **\$32.95**

BC-603 CONVERTED

To 30 to 45 MC.—Used: **\$44.95**

AC POWER SUPPLY For BC-603—Transformer type plugs into same place as dynamotor, no conversion required except adding switch, with instructions:
 Wired: **\$14.95** Kit of Parts: **\$10.00**

DM-34 Dynamotor for 12 Volt DC operation—New.... **\$4.95**

DM-36 Dynamotor for 24 Volt DC operation—New.... **4.95**

TRANSMITTERS—RECEIVERS:

BC-453 Receiver—190 to 550 KC.Used: **\$16.95**

BC-455 Receiver—6 to 9 MC.—

Gov't. Reconditioned, w/Dyn.: **14.95**

BC-456 ModulatorUsed: **3.95**

BC-696 Trans.—3 to 4 MC., Gov't. Recond.: **12.95**

T-20 Trans.—4 to 5.3 MC.....New: **9.95**

T-21 Trans.—5.3 to 7 MC.....New: **9.95**

T-22 Trans.—7 to 9 MC.....New: **18.95**

BC-348 Receiver—200 to 500 KC.—

1.5 to 18 MC.....Used: **69.50**

NEW CATALOG—

JUST OFF PRESS—SEND 25c (stamps or coin) and receive 50c CREDIT on your order! Address Dept. EW • Prices F.O.B. Lima, O. • 25% Deposit on C.O.D.'s • Minimum Order \$5.00

FAIR RADIO SALES

1016 E. EUREKA • Box 1105 • LIMA, OHIO • 45802

NEW supersensitive transistor locators detect buried gold, silver, coins. Kits, assembled models. \$19.95 up. Free catalog. Relco-A22, Box 10563, Houston, Texas 77018.

DISCHARGE IGNITION, PHOTOFLASH parts, kits. Free catalogs. REVSPARK, Carlisle, Massachusetts.

\$500,000.00 Inventory Late Electronics \$3500.00 Stanley Kluzek Company, Dawson, Illinois 62520.

SAMS Photo Facts 181-320, meters, tubes, write John Vasso, 306 Hillside Ave., Torrington, Conn. 06790.

IBM TRANSISTOR CIRCUIT BOARDS, 6 for \$2 ppd. L. Short, Box 332, Kennesaw, Georgia 30144.

INTEGRATED CIRCUIT Experiment Kit, \$6.95. Others. Catalogue 25c. KAYE ENGINEERING, Box 3932, Long Beach, California 90803.

ATEC Electronic Counter Model 5A35 excellent condition cost new \$1025.00 asking now \$600.00. Benthos, Inc., Main St., No. Falmouth, Mass. 02556.

TAPE RECORDERS direct from importer. Three motor, six head, automatic reverse. Famous make. Also battery with A.G.C. All solid state. Write for special prices, duty paid. DOK (USA) INC., EW Box 2494, Culver City, California 90230.

TUBES

FREE Catalog. Electronic parts, tubes. Wholesale. Thousands of items. Unbeatable prices. Arcturus Electronics ZD, 502-22 St., Union City, N.J. 07087.

RECEIVING & INDUSTRIAL TUBES, TRANSISTORS, All Brands—Biggest Discounts. Technicians, Hobbyists, Experimenters—Request FREE Giant Catalog and SAVE! ZALYTRON 469 Jericho Turnpike, Mineola, N.Y. 11501.

TUBES, SEMICONDUCTORS, ELECTRONIC EQUIPMENT & COMPONENTS. Quality merchandise only! Serving engineers. Purchasing Agents, TV/HIFI Servicemen and Hams for 20 years. Write for Catalog or call 212-WA 5-7000. BARRY ELECTRONICS, 512 Broadway, New York, N.Y. 10012.

TUBES—33¢ each. Year guarantee. Tuner Cleaner \$1.09. Free catalog. Cornell, 4213-W University, San Diego, Calif. 92105.

DON'T BUY TUBES—Radio, TV, Xmitting, special-purpose types until you get our price list! Lowest prices in U.S.A. 5,000 types—Guaranteed Brand New. Send postcard for TV—Special Purpose Price List. UNITED RADIO COMPANY, P.O. Box 1000, NEWARK, N.J. 07101.

WANTED

MILITARY SURPLUS EQUIPMENT NEEDED: ARC-34, ARC-38, ARC-44, ARC-52, ARC-54, ARC-55, ARC-66, ARC-73, ARC-84, ALSO ARN-14C, ARN-54, ARN-59, COLLINS 51x-2, 51V-3, 51Y-3, 51R-3, 17L-4, 17L-7, 618S-1, 18S-4. BENDIX TA-21, RA-21, APR-14, PRC-25, RT-66 THRU RT-70/GRC, APN-22, APN-117, APN-133. TEST SETS WANT WITH ARM, UPM, URM, RSM, SG PREFIXES. TOP CASH DOLLAR PAID IMMEDIATELY. SLEP ELECTRONICS CO., DRAWER 178-EW, ELLENTON, FLORIDA 33532, PHONE (813) 722-1843.

QUICKSILVER. Platinum, Silver, Gold. Ores Analyzed. Free Circular. Mercury Terminal, Norwood, Mass. 02062.

QUICK CASH . . . for Electronic Tubes, Semiconductors, Equipment (Receivers, Transmitters, Scopes, Vacuum Variables, etc.) Send lists now! Write: BARRY ELECTRONICS, 512 Broadway, New York, N.Y. 10012 (212-WA 5-7000).

MAKE MONEY BY PHONE!!

YES! You can make BIG MONEY by calling us collect—today!—if you have any of the following equipment. It's urgent, and must buy the following:

RED Radio Transmitters, RT-67 and RT-68/GR Transmitters, RT-109/GR Power Supply, R-110/GR Receiver, C-133 and C-131/GR Controls, AN/URK-13 and 35 Radio Receivers, AN/ARC-27, 31, 32 Transmitters, PL-5 and 14 quality military or commercial TEST EQUIPMENT. We pay the most—fastest—with a smile! CALL TODAY!

COLUMBIA ELECTRONICS, Dept. EW
 4365 West Pico Blvd., Los Angeles, Calif. 90019
 Phone: (213) 938-3731

GREGORY ELECTRONICS Reconditioned & Used FM 2-WAY RADIO SAVINGS

Partial list—Send for New '67 Catalog

Voice Commander



132 to 172 MC, 1W 9.5" x 5.3" x 1.7" Lowest price ever, including brand New Rechargeable Nickel Cadmium Battery Pack

\$148

If crystal & tuning is desired add \$45.00
 Battery charger for these units \$16.00

Write for Quantity Prices

VOICE COMMANDER

Monitor Receiver only—**\$78**
 Tuned & Crystalled with dry Batteries

EXTRA SPECIAL MOTOROLA CONTROLHEAD MODEL #P9022, with microphone **\$9.50**

MOTOROLA P33 Series Pack Set 5 Watt 150-170 MC with Nicad Supply and Nicad Batteries **\$95.00**

MOTOROLA T41GGV 30-50mc 6/12 V, 30 watt vibrator power supply fully narrow banded complete with accessories **\$148**
 less crystals and antenna
 Add \$45.00 for tuning to desired frequency and new antenna

MOTOROLA 30-50mc 6/12 V, T51GGV vibrator power supply. Fully narrow banded (TX & RX) **\$198**
 Above price include accessories less crystals and antenna (less accessories, deduct \$30.00)
 To tune unit to desired frequency including new antenna add \$45.00

GE DT03 150-170mc 5 channel telephone unit with duplexer less accessories **\$248**

RCA 12 VOLT CRYSTAL OVENS PER DOZEN **\$36**

4ET5 6v 30 watt 40-50mc **\$10**

4ET5 12v 30 watt 40-50mc **\$15**

G.E. PACERS—EG43SA6 150-170 mc Transistorized Power Supply 13-15 watts, 12 v Front Mount (Complete accessories, less crystals and antenna) **\$108.00**

We Buy Late Model Equipment for Cash—Write: Wire or Phone!

GREGORY ELECTRONICS CORPORATION

249 RT. 46, Saddle Brook, N.J., 07662
 Phone: (201) 489-9000

CIRCLE NO. 114 ON READER SERVICE CARD

PHILCO 'SAFARI' Optical unit must be in perfect condition. E. A. Jagers, 16, Place Des Nations, Tangier, Morocco.

BLONDER-TONGUE AUDIO BATON. Roosbroeck, 19 Whittredge, Summit, N.J. 07901.

WANTED TO BUY—TV tuners. Any make, any quantity. Write: J. W. Electronics, Box 518, Bloomington, Indiana 47401.

DO-IT-YOURSELF

PROFESSIONAL ELECTRONICS PROJECTS—\$1.00 up. Catalog 25¢. PARKS, Box 25565B, Seattle, Wash. 98125.

TAPE & RECORDERS

RENT STEREO-8 CAR TAPES. 10¢/day. Send refundable \$10.00 deposit and name of first selection. Autotapes, Box 19086-E, Indianapolis, Ind. 46219.

BEFORE renting Stereo Tapes, try us. Postpaid both ways—no deposit—immediate delivery. Quality—Dependability—Service—Satisfaction—prevail here. If you've been dissatisfied in the past, your initial order will prove this is no idle boast. Free Catalog. Gold Coast Tape Library, Box 2262, Palm Village Station, Hialeah, Fla. 33012.

STEREO TAPES. Save up to 60% (no membership fees, postpaid anywhere USA). Free 60-page catalog. We discount batteries, recorders, tape accessories. Beware of slogans "not undersold," as the discount information you supply our competitor is usually reported to the factory. **SAXITONE**, 1776 Columbia Rd., Washington, D. C. 20009.

RENT Stereo Tapes—over 2,500 Different—all major labels—free brochure. Stereo-Parti. 1616—E. W. Terrace Way, Santa Rosa, California 95404.

TAPE RECORDER SALE. Brand new, nationally advertised brands, \$10.00 above cost. Arkay Sales, 1028 Commonwealth Avenue, Boston, Mass. 02215.

HI-FI Components. Tape Recorders at guaranteed "We Will Not Be Undersold" prices. 15-day money-back guarantee. Two-year warranty. No Catalog. Quotations Free. Hi-Fidelity Center, 239 (LT) East 149th Street, New York 10451.

GOVERNMENT SURPLUS

JEEPS Typically From \$53.90. . . Trucks From \$78.40. . . Boats, Typewriters, Airplanes, Electronics Equipment, Photographic Equipment, used. 100,000 Bargains Direct From Government. Complete Sales Directory and Surplus Catalog \$1.00 (Deductible First \$10.00 Order). Surplus Service, Box 820-K, Holland, Michigan 49423.

HIGH FIDELITY

FREE! Send for money saving stereo catalog #E5W and lowest quotations on your individual component, tape recorder or system requirements. Electronic Values Inc., 200 West 20th Street, N.Y., N.Y. 10011.

HI-FI Components. Tape Recorders at guaranteed "We Will Not Be Undersold" prices. 15-day money-back guarantee. Two-year warranty. No Catalog. Quotations Free. Hi-Fidelity Center, 239 (L) East 149th Street, New York 10451.

HIFI EQUIPMENT—GET Our "ROCK BOTTOM" prices on NAME BRAND amplifiers—tuners—tape-recorders—speakers **FRANCHISED—59 YEARS IN BUSINESS.** Write for this month's specials—**NOW!** Rabson's 57th St., Inc., Dept. 569, 119 W. 58th St., New York, New York 10019.

LOW, LOW quotes: all components and recorders. Hi-Fi, Roslyn, Penna. 19001.

HI-FI components, tape recorders, sleep learn equipment, tapes. Unusual Values. Free catalog. Dressner, 1523 R Jericho Turnpike, New Hyde Park, N.Y. 11040.

AUTHORS' SERVICES

AUTHORS! Learn how to have your book published, promoted, distributed. **FREE** booklet "ZD," Vantage, 120 West 31 St., New York 10001.

HYPNOTISM

FREE Hypnotism, Self-Hypnosis, Sleep Learning. Catalog! Drawer H400, Ruidoso, N.M. 88345.

HYPNOTIZE FEMALES!—Unnoticed! Instantly! Nerves! Exciting! Send \$2.25. Research Enterprises, 29-SN21 Samoset, Woburn, Mass. 01801.

FEMALE HYPNOTISM! Easily! Instantly! Secret Nerve Centers! \$2.20. Brugenheimer Publishers, Box 158-E30, Lexington, Mass.

EDUCATIONAL OPPORTUNITIES

LEARN While Asleep, hypnotize with your recorder, phonograph. Astonishing details, sensational catalog free! Sleep-Learning Association, Box 24-ZD, Olympia, Washington 98501.

OUR TRANSISTORS & RECTIFIERS ARE GUARANTEED TO WORK

All transistors are checked for minimum voltage & gain to insure our customers a good transistor within the category we advertise. All rectifiers costing over \$.10 are checked for forward voltage and leakage as well as PRV. The gates on our SCR's are also checked. All nonoperable units will be refunded or exchanged immediately.

Users of the above mentioned items in large quantities send us your specifications. We feel we can meet them at a competitive price.

SIM. to 2N1640 (PNP) Bi-directional transistors. A TO-5 silicon unit in which collector & emitter are interchangeable. Ea. \$.75

GLASS DIODES color coded. Silicon 20/\$1.00
6E 30/\$1.00

10 WATT ZENERS. 2-180v. State desired voltages. Ea. \$.75

SILICON BILATERAL SWITCH. Replaces two SCR's by firing in either direction when breakdown voltage is exceeded. Used in light dimmers, etc.75 ea.

GaAs VARACTORS, sim. to AP-1, AP-6, etc. 70 GHz at 150 MW. Ea. \$4.00

"N" Channel Fet's Similar to 2N3088 Used As Amp, Switch, Chopper—Very High Input Z \$1.50 Each

INTEGRATED CIRCUITS



SR Clocked Flip Flops . . . \$1.15
SRT Flip Flops . . . \$1.15
Expandable OR Gates . . . \$1.00
JK Flip Flops . . . \$1.15
Dual NAND Nor Gates . . . \$1.00
TO-18 flat pack guaranteed to work. They come complete with schematic, elect. characteristic sheet & some typical applications. \$9.00-\$15.00 values from original manufacturer. We have other types of IC's in these series available. Send requests to:

Silicon Power Rectifiers

PRV	3A	20A	40A
100	.10	.40	1.00
200	.20	.60	1.75
400	.25	.80	2.00
600	.35	1.20	2.50
800	.45	1.50	3.00
1000	.55	1.80	4.00

5A Insul Top Hat & Epoxy 750 MA

PRV	3A	7A	20A
100	.35	.50	.80
200	.50	.70	1.35
300	.75	1.05	1.90
400	1.25	1.60	2.45
500	1.50	2.10	2.85
600	1.75	2.80	3.50
700	2.00	3.00	
800	2.25	3.50	
1000		5.00	

240A Rectifiers

PRV	3A	7A	20A
100	5.00		
200	7.50		
400	15.00		
600	20.00		
1000	35.00		

Silicon Control Rectifiers

PRV	3A	7A	20A
50	.35	.50	.80
100	.50	.70	1.35
200	.75	1.05	1.90
300	1.25	1.60	2.45
400	1.50	2.10	2.85
500	1.75	2.80	3.50
600	2.00	3.00	
700	2.25	3.50	
1000		5.00	

SIM. to 2N728. A high frequency TO-18 unit extending to the UHF range 3/\$1.00

SIM. to 2N995 (PNP). Silicon in TO-18 case. 500 MW power, to 180 Mhz frequency 3/\$1.00

SIM. to 2N2875 (PNP). Silicon 20 watts with 30 Mhz cut off \$.75

SIM. to 2N1648 (NPN) high voltage 20 Watt silicon unit, used in power output stages & power transistor drives \$.75

NPN dual transistors. A TO-5 package (2N2060) containing 2 high gain 100 MHz NPN silicon transistors \$1.50

PNP dual transistors. A TO-5 package (2N2807) containing 2 high gain 100 MHz PNP silicon transistors \$1.50

High voltage NPN 150V. VBCBO at 2.5A., High HFE in TO-66 pack \$.75

High voltage assemblies 6000V. at 150 mils. These silicon assemblies may be put in series to achieve high voltages \$1.50

DUAL 20 μF at 350 V Electrolytics 3/\$1.00

28-101 P CERAMIC TRIMMERS 6/\$1.00

Terms: FOB Cambridge, Mass. Send check or Money Order. Include Postage, Average Wt. per package 1/2 lb. Allow for C.O.D. Minimum Order \$3.00



POST OFFICE BOX 748
SOMERVILLE, MASS. D2143
SEND FOR OUR LATEST CATALOG

Name _____
Address _____
City _____ State _____

CIRCLE NO. 97 ON READER SERVICE CARD

CLASSIFIED ADVERTISING ORDER FORM

Please refer to heading on first page of this section for complete data concerning terms, frequency discounts, closing dates, etc.

1	2	3	4	5
6	7	8	9	10
11	12	13	14	15
16	17	18	19	20
21	22	23	24	25
26	27	28	29	30
31	32	33	34	35

_____ Words (@ .40 Reader Rate) = \$ _____
(@ .70 Commercial Rate)

Insert _____ time(s) Total Enclosed \$ _____

NAME _____

ADDRESS _____

CITY _____ STATE _____ ZIP _____

SIGNATURE _____

WORD COUNT: Include name and address. Name of city (Des Moines) or of state (New York) counts as one word each. Zone or Zip Code numbers not counted. (Publisher reserves right to omit Zip Code if space does not permit.) Count each abbreviation, initial, single figure or group of figures or letters as a word. Symbols such as 35mm, COD, PO, AC, etc., count as one word. Hyphenated words count as two words. EW-567

RECTIFIERS, TRANSISTORS & COMPONENTS

6 tube Amplifier, New 4 lbs. 2 @	\$1.98
1/4 Watt Resistors, asstd. 50 @	1.00
1/2 Watt Resistors, asstd. 60 @	1.00
Ceramic Disc Capacitors, asstd. 75 @	1.00
Precision Resistors, asstd. 50 @	1.00
Pots. 2-4 Watt, asstd. 15 @	1.00
R. F. Coils, asstd. 25 @	1.00
Axial Lead mica, asstd.	30/1.00
Tantalum Capacitors, asstd. 10 @	1.00
Mercury Battery 5.4V	4/1.00
2N2944 Sil. Chopper To-46	1.00
50W. Zeners 10 + 0 19 Volts	1.00
Thermistor bead, 900 or 1200 ohm. 2 @	1.00
2N1021, Ger. Power, 7amp, 100V. To -3	.60
2N456A, 7A. 40V. Ger. Power To -3	.45
2N1718 Sil. Power, 10W., 60V., Heatsink, 3 @	1.00
70 amp Stud. 50PIV-\$2.50; 100PIV	\$3.50
SILICON CONTROLLED RECTIFIERS	
AMPS. 300PRV. 400PRV. 500PRV.	
1A. 1.50 2.15 2.75	
10A. 2.15 2.65 3.25	
Pots. 1W. 100K. or 1/2W. 500K. 5 @	1.00
Surprise Kit, 10 lbs. components	2.50
Epoxy Hi-Vol diode, 200ma, 3000PIV	.98
Computer Board, TO-3 Power, Heat Sink	1.50
I.C., TO-5, untested, 5 @	1.00
I.C., Dual-inline, untested 10 @	1.00
2N389.85W 60 V. T053	.79
2N3707-11 Asstd. Plastic Silicon Xisters 20 @	1.00
2N3704-3706, Asstd. Plastic Sil. Xisters 10 @	1.00
2N2151, Sil. Power Xister	.65
2N1009 Ger. Min. Xister untested 30 @	1.00
3N35 Tetrode, NPN, untested 5 @	1.00
Ger. Diodes, Asstd. 15 @	1.00
2N458A, 7A. 80V. Ger. Power. TO -3	.55
Sil. Diodes, Switching, Signal, Asst. 15 @	1.00
2N118, Silicon, NPN	10/1.00
2N149, Silicon, NPN, untested	20/1.00
2N1300, Untest. PNP & NPN, 1/4" leads @	25/1.00
2N1714, Silicon Power 10W, 60V.	4/1.00
Computer Boards, Parts Free, per transistor	.05
Germanium Power, 2N457A, 7A, 60V	.50
Silicon Power 40 W, 2N1047, TO-57 2 @	1.00
Tophats 750 ma., Tophats 200PIV-8c,	
400, 12c, 600PIV	.18
Varicaps, 27, 47, or 100 pf	1.25
2N1038, Germanium 20 W, 40 V	4/1.00
With any \$10.00 Order any \$1.00 item Free. On \$25.00 order any (3) \$1.00 items Free. Catalog.	

ELECTRONIC COMPONENTS

Post Office Box 2902 Baton Rouge, Louisiana 70821

CIRCLE NO. 119 ON READER SERVICE CARD

USED Correspondence Courses and Books sold and rented. Money back guarantee. Catalog free. (Courses Bought). Lee Mountain, Pisgah, Alabama 35765.

LEARN WHILE ASLEEP. Miraculously build Mind Power, achieve Self Confidence, improve Health, gain Success. Method 92% effective. Details free. ASR Foundation, Box 7021 Henry Clay Station, Lexington, Kentucky 40502.

RUBBER STAMPS

RUBBER ADDRESS STAMP \$1.50. SIGNATURE \$2.88. FREE CATALOG. JACKSON PRODUCTS, 1433 WINNEMAC, CHICAGO, ILL. 60640.

PHOTOGRAPHY—FILM, EQUIPMENT, SERVICES

MEDICAL FILM—Adults only—"Childbirth" one reel, 8mm \$7.50; 16mm \$14.95. International W. Greenvale, Long Island, New York 11548.

SCIENCE Bargains—Request Free Giant Catalog "CJ"—148 pages—Astronomical Telescopes, Microscopes, Lenses. Binoculars, Kites, Parts. War Surplus bargains. Edmund Scientific Co., Barrington, New Jersey 08007.

BUSINESS OPPORTUNITIES

INVESTIGATE Accidents—Earn \$750 to \$1,400 monthly. Men urgently needed. Car furnished. Business expenses paid. No selling. No college education necessary. Pick own job location. Investigate full time. Or earn \$6.44 hour spare time. Write for Free Literature. No obligation. Universal, CZ5, 6801 Hillcrest, Dallas, Texas 75205.

FREE BOOK "990 Successful, Little-Known Businesses." Work home! Plymouth-145Y, Brooklyn, New York 11218.

I MADE \$40,000.00 YEAR by mailorder! Helped others make money! Start with \$10.00—Free proof. Torrey, Box 318-N, Ypsilanti, Michigan 48197.

FREE CATALOGS. Water air conditioning, refrigeration. Tools, supplies, full instructions. Doolco, 2016 Canton, Dallas, Texas 75201.

LEARN TECHNICAL WRITING—at home. High paying prestige careers not requiring college. Growing demand, all industries for tech writers now. Low monthly tuition. Easy to understand. **FREE** career book, sample lesson. **APPROVED FOR VETERANS.** American Technical Writing Schools, Dept. EWC-57, 5512 Hollywood Blvd., Hollywood, Calif. 90028.

BRITISH Engineer, having invented finger print operated lock, wishes to contact organization willing to manufacture and distribute it. Demonstration prototype available. E. A. Jaggars, 16, Place Des Nations, Tangier, Morocco. Telephone Tangier 174-93.

EMPLOYMENT INFORMATION

FOREIGN and USA job opportunities available now. Construction, all trades. Earnings to \$2,000.00 monthly. Paid overtime, travel, bonuses. Write: Universal Employment, Woodbridge, Connecticut 06525.

YOUR RESUME—Make it sell you! Instructions, samples: \$2. Executive, Box 246EL, Montclair, N.J. 07042.

FOREIGN EMPLOYMENT. Construction, other work projects. Good paying overseas jobs with extras, travel expenses. Write only: Foreign Service Bureau, Dept. D, Bradenton Beach, Florida 33510.

INVENTIONS WANTED

INVENTORS. We will develop, help sell your idea or invention, patented or unpatented. Our national manufacturer clients are urgently seeking new items for outright cash sale or royalties. Financial assistance available. 10 years proven performance. For free information, write Dept. 42, Wall Street Invention Brokerage, 79 Wall Street, New York, N.Y. 10005.

RENT SAMS PHOTOFACTS BY MAIL! TV FOLDER \$1.25 RADIO-HI-FI \$1.00

1. Send set description and all numbers you can find. Be sure to include make and model of set. Send \$3.00 deposit.
2. Keep folder 5 days, copy information you require then return the folder to Cornell in the same condition received.
3. Immediately upon return of folder you will receive \$1.75 refund on Radio/hifi folder or \$1.50 refund on TV folder (deposit less rental and .25 shipping).

CORNELL

33¢

PER TUBE

100 TUBES OR MORE: 30¢ PER TUBE

TUBES

1 YR. GUARANTEED

Mutual Conductance Lab-tested, Individually Boxed, Branded and Code Dated, Tubes are new, or used and so marked.

OZ4	6A55	6CD6	6K6	6X4	12BF6
1B3	6AT6	6CF6	6K7	6X8	12BH7
1J3/1K3	6AT8	6CG7	607	7A7	12BL6
1H5	6AU4	6CG8	654	7A8	12BY7
1L4	6AU5	6CM7	6SA7	7B6	12C5
1T4	6AU6				12CA5
1U4	6AV6				12SN7
1X2	6AW8				12SQ7
3BZ6	6AX4				25L6
3DG4	6BA6				25Z6
5U4	6BC5				35W4
5UR	6BD6	6CZ5	6SH7	7C5	35Z3
5V4	6BG6	6D6	65J7	7N7	50L6
5Y3	6BJ6	6DA4	65K7	7Y4	
6A6	6BL7	6DE6	65L7	12AD6	24
6A8	6BN4	6DQ6	65N7	12AE6	27
6AB4	6BN6	6EA7	65Q7	12AF6	77
6AC7	6BQ6	6EM5	65R7	12AT7	78
6AG5	6BQ7	6F6	6U7	12AU7	84/6Z4
6AK5	6BZ6	6GH8	6U8	12AX7	5687
6AL5	6C4	6H6	6V6	12BA6	6350
6AN8	6C6	6J5	6W4	12BD6	6463
6AQ5	6CB6	6J6	6W6	12BE6	7044

Other tubes at low prices. send for free list

NO SUBSTITUTIONS WITHOUT YOUR PERMISSION

TUBE CARTONS

HIGH GLOSS CLAY COATED RED & BLACK WITH FULL DIAGONAL PARTITIONS

SIZE	TUBE SIZE	PRICE PER 10 CARTONS	PRICE PER 100 CARTONS
10	6AL5	29	2.59
10	6BY7	39	3.49
10	6BT	59	5.29
6	6A6	89	7.99



RADIO-TV TUBE TESTER

2.89 Plus 30c Shipping

TEST AND REPAIR TV & RADIO SETS APPLIANCES

Special! With every \$10 Order **25¢** per tube

(No Limit) from this list
6AG5 6SN7
6AQ5 6CB6 6S4
6AU6 6J6 6W4

NEW! EASY TO USE!

COLOR TV DEGAUSSER \$3.95

BARGAIN CORNER

Cleaner	.89
Solder Iron	1.49
Elec. Tape	.89
Silicon (pr.)	.89
Epoxy (pr.)	.79
Diode Kit	.39
Noise Filtr.	.89
Tube Saver	1.29
Neon Tstr.	.59
Solder	.59
Ant. Cplr.	1.89
Btry. Chgr.	4.95
Tool Kit	.69

Prestige & Success are yours as an ELECTRONIC EXPERT

FOR CORNELL CUSTOMERS ONLY by special arrangement with the publisher, these amazing bargains are available.

COMPLETE RADIO SERVICING AND BASIC ELECTRONICS COURSE ONLY \$3.00 (12.50 - 50% savings charge)

NEW PRACTICAL TV TRAINING COURSE ONLY \$3.50 (13.00 - 50% savings charge)

Both above courses \$6.00

CORNELL ELECTRONICS CO.

Dept. EW 5 4217 University Ave., San Diego, Calif. 92105

TERMS: Add 3c per tube shipping. Orders under \$5.00 add 3c per tube shipping plus 50c handling. Canadian orders add approximate postage. Send 25% deposit on C.O.D. orders. No C.O.D. orders under \$5.00 or to Canada. No 24 hr. free offer on personal check orders. **5-DAY MONEY BACK OFFER**

SEND FOR FREE CATALOG

CIRCLE NO. 84 ON READER SERVICE CARD

G&G CATALOG!

NEW 24 Pages - the BEST in Military Electronic Gear. SEND NOW FOR YOUR COPY! Please include 25¢ Refunded with first order.



LORAN APN-4 FINE QUALITY NAVIGATIONAL EQUIPMENT

4 Channel long range dual units, will determine exact geographic position of your boat or plane. Indicator and receiver complete with all tubes and crystal. **INDICATOR ID-6B/APN-4 RECEIVER \$88.50 R-9B APN-4**, complete with tubes, Exc. Used

LORAN R-65/APN-9 RECEIVER & INDICATOR

4 Channel single unit system, used in ships and aircraft. Determines position by radio signals from known transmitters. Accurate to within 1/2 of distance. Complete with tubes and crystals. **\$88.50** IN LIKE NEW Condition.



All Accessories for Loran Equipment in Stock.

FAMOUS BC-645 TRANSCEIVER

15 Tubes 435 to 500 MC
Easily adapted for 2-way communication, voice or code, on ham band 430-450 mc, citizens radio 460-470 mc, fixed and mobile 450-460 mc, television experimental 470-500 mc. Now comes into 480 mc. With tubes, less power supply in factory carton. Shipping Weight 25 lbs. **BRAND NEW \$16.95**



OUR LOW PRICE
Dynamotor, Antenna, Plugs, All Accessories Available

AN/APR-4Y FM & AM RECEIVER "FB" FOR SATELLITE TRACKING!

High precision lab instrument, for monitoring and measuring frequency and relative signal strength, 38 to 4000 Mc. in 5 tuning ranges, for 100 Vcc eye Vcc. Built-in power supply, original circuit diagram included. Checked out, perfect. **\$88.50**

All Tuning Units Available for Above

SCR-274-N, ARC-5 COMMAND SET HQ!

Freq. Range	Type	Exc. Used	BRAND NEW
RECEIVERS, Complete with Tubes			
190-550 Kc.	BC-453	\$18.95	\$23.50
3-6 Mc.	BC-454	\$16.50	\$21.50
6-9.1 Mc.	BC-455	\$14.95	\$19.95
1.5-3 Mc.	BC-456	\$12.50	\$17.50
TRANSMITTERS, Complete with Tubes			
4-5.3 Mc.	BC-457	\$ 6.95	\$11.95
5-3.7 Mc.	BC-458	\$ 6.95	\$12.95
7-9.1 Mc.	BC-459	\$17.95	\$22.50
2-1.3 Mc.	T-18	\$10.95	\$14.95
3-4 Mc.	T-19	\$10.50	\$14.95
MODULATOR, Complete with 3 Tubes			
Voice	BC-456	\$ 2.75	\$ 4.95

All Command Set Accessories in Stock

SCR-625 MINE DETECTOR	\$32.50
EE-B FIELD PHONES, Exc. Used, Each	\$16.95
BC-221 Freq. Meter, Modulated, Exc. Used	\$129.50
BC-221 Freq. Meter, Unmodulated, Exc. Used	\$79.50
LM Freq. Meter, Exc. Used	\$79.50
BC-1206-C Beacon Recvr, 200-400 Kc. NEW	\$12.95
SCR-522 Transmitter-Receiver, Like New	\$39.50

TG-34A CODE KEYS \$24.50
Brand New in original carton \$18.95
Exc. Used \$18.95

DYNAMIC MICROPHONE

Low impedance, with rubber-cased on-off switch and removable ventilated rubber mouthpiece. Has rubber-covered cable with phone plug. Made by Permo-Flux. **New \$2.65**

Please include 25¢ Deposit with order—Balance C.O.D., or Remittance in Full. 50¢ Handling Charges on all orders under \$5.00. All shipments F.O.B. Our Warehouse, N.Y.C. All Merchandise subject to Prior Sale and Price Change.

G & G RADIO SUPPLY COMPANY
Telephone: (212) CO 7-4605
75-77 Leonard St., New York, N.Y. 10013

PATENT SEARCHES, \$6.00! FREE "Invention Record"/Information. Miss Hayward, 1029HE Vermont, District of Columbia 20005.

INVENTIONS—IDEAS developed: Cash/Royalty Sales. Member: United States Chamber Commerce, Raymond Lee, 130-GE West 42nd, New York City 10036.

INVENTIONS wanted! Highest cash or royalties. Financial assistance. Free analysis. International Invention Institute, Dept. 31, 160 Broadway, New York, New York 10038.

INVENTORS! Get your "Little Piggy" to market. Highest cash or royalties. New York Invention Service, Dept. 13, 160 Broadway, New York, N.Y. 10038.

STAMPS

FREE Wonderful New United States Catalog! Postage and Airmails Complete. 786 Illustrations. Special offers, Bargains Galore—Everything! Send Today. H.E. Harris, Dept. FC-1, Boston, Mass. 02117.

MISCELLANEOUS

WINEMAKERS: Free illustrated catalog of yeasts, equipment. Semplex, Box 7208, Minneapolis, Minn. 55412.

EMPLOYMENT Resumes. Get a better job & earn more! Send only \$2.00 for expert, complete Resume. Writing Instructions. J. Ross, 80-34 Kent St., Jamaica, N.Y. 11432 Dept. EW.

LEMURIAN VIEWPOINT—Thought-provoking discussions of Universal Truth, man's purpose on earth, reincarnation, and subjects from Lemurian Philosophy. Send for FREE copy. Lemurian Fellowship, Dept. 647, Ramona, California 92065.

ZIP CODE DIRECTORY, over 35,000 listings, 50 states. \$2.00 "STANDARD", Dept. 82, Box 16213, Phoenix, Ariz. 85011.

MONEY WE PAY \$10 hr. for NOTHING but your opinions, written from home about our clients' products and publications, sent you free. Nothing to buy, sell, canvass, or learn. No SKILL. **NO GIMMICKS.** Just honesty. Details from RESEARCH, 2D-3, Box 669, Mineola, N.Y. 11501.

STOP BURGLARS THE EASY WAY!! Affix authentic "Protected by Electronic Sentry Alarm" Decals to auto windows, doors & windows of home, retail stores, vending machines, etc. Whether you have an alarm or not—thieves stay away! Only \$1.00 for each set of two. J. Ross, 80-34 Kent St., Jamaica, N.Y. 11432. Dept. EW.

BEERS, PEACH BRANDY, WINES—Strongest Formulas. \$2.25. (complete brew supplies hydrometers catalog 10¢)—Research Enterprises, 29-D Samoset, Woburn, Mass. 01801.

AS YOU READ THESE PAGES more than 196,000 monthly buyers of **ELECTRONICS WORLD** are doing the same. If you want to do business with these active Electronics Professionals your Classified Advertising belongs here now! Complete information and a handy order form are printed in this section. Send copy and payment now for inclusion in July issue, closing May 1st. Write: Hal Cymes, Class. Adv. Mgr., **ELECTRONICS WORLD**, 1 Park Ave., NYC 10016.

BACK ISSUES AVAILABLE

Use this coupon to order back issues of **ELECTRONICS WORLD**

We have a limited supply of back issues that can be ordered on a first-come, first-served basis. Just fill in the coupon below, enclose your remittance in the amount of 75¢ for each copy ordered.

ZIFF-DAVIS SERVICE DIVISION
Dept. BCEW, 595 Broadway
New York, New York 10012

Please send the following back issues of **ELECTRONICS WORLD**

I am enclosing _____ to cover cost of the magazine, shipping and handling.

Month _____ Year _____
 Month _____ Year _____
 Month _____ Year _____
 Name _____
 Address _____
 City _____
 State _____ Zip _____

Payment must be enclosed with order

Solid State KING

FREE

\$25 BONUS WORTH \$1 #1 + add 25¢ for handling

BONUS #2 FREE

\$1 FREE: YOUR CHOICE OF ANY \$1 POLY PAK LISTED BELOW FREE

BOTH FREE WITH \$10 ORDERS

New! FROM THE SPACE PROGRAM

ONE AMP 'GLASS AMP' SILICON RECTIFIERS

- ★ Outperforms Top Hats and Epoxies!
 - ★ Handles 2 Amps Comfortably!
 - ★ Encapsulated in Glass!
 - ★ High Output, Temperature Reliability!
 - ★ Only 3/16 x 1/8" Diameter!
 - ★ Worth Many Times Our Sale Prices!
- | PIV | Sale | PIV | Sale | PIV | Sale |
|-----|------|-----|------|------|------|
| 50 | 9c | 400 | 19c | 1000 | 51c |
| 100 | 12c | 600 | 27c | | |
| 200 | 15c | 800 | 39c | | |

General Instrument ★ Handles 2 Amps

1 AMP 800 PIV

ONE AMP 'GLASS AMP' SILICON RECTIFIERS **3 For \$1**

New! 'PANCAKE' Transistors

Silicon Epitaxial Planars

Like	Watts	VCB	HFE	mc
2N706	.4	20	20	200
2N870	.5	50	120*	80
2N1613	.8	50	120	80
2N1893	.8	100	120*	70
2N2049	.8	50	300*	85
2N2645	.5	50	300*	85
2N2314	.4	60	50	150
2N2434	1.5	80	185	100

4 For **\$1** (NPN)

New! SILICON CONTROLLED RECTIFIERS "N" Channel Fet

PRV	3 AMP	7 AMP	16 AMP	25 AMP
50	30	48	70	80
100	50	70	1.05	1.20
200	80	1.05	1.30	1.70
300	1.05	1.60	1.90	2.20
400	1.60	2.10	2.30	2.70
500	2.10	2.80	3.00	3.30
600	2.50	3.00	3.30	3.90

Vacuum Tube Equivalent **C-610** NOW **\$1.00** ONLY

DC MICROAMMETERS **ZENERS**

288 GE

Volts	Volts	Volts	Volts
5.4	14	43	100
8.0	20	47	110
9.1	24	51	120
10	27	56	130
12	30	62	150
13	33	68	160
		75	180
		82	200
		91	

2 1/4" 0-100

SILICON POWER STUD RECTIFIERS

AMPS	Factory	50 PIV	100 PIV	200 PIV
3	7c	11c	17c	
15	22c	40c	65c	
45	75c	90c	1.25	
AMPS	400 PIV	600 PIV	800 PIV	1000 PIV
3	21c	31c	40c	59c
15	90c	1.35	1.59	1.79
45	1.59	1.90	2.50	2.95

1-Amp SILICON RECTIFIERS

PIV	Sale	PIV	Sale	PIV	Sale
50	5c	600	19c	1400	69c
100	7c	800	25c	1600	89c
200	9c	1000	45c	1800	99c
400	11c	1200	59c		

10¢ FOR OUR "SUMMER" BARGAIN CATALOG ON: Semiconductors Poly Paks Parts

POLY PAKS TERMS: send check, money order. Include postage—avg. wt. per pak 1/2 lb. Rated net 30 days. CUDS 25¢

P.O. BOX 942W
50. LYNNFIELD, MASS.
"PAK-KING" of the world



**eeny meeny,
miney, mo!**

Well, that's one way to buy a tape recorder . . . But we've got a better idea. It's called the

1967 TAPE RECORDER ANNUAL

—your guide to the tape recorder brands and models on the market right this minute. The only buyer's guide of its kind available in the field!

Oh, it may not be as exciting as the "blindman's bluff" method, but it sure is a lot less costly . . . and less disappointing. This encyclopedic volume will arm you with all the essential data you need to go out and pick the very best recording equipment in your price range. Without a qualm, without an "after-you-get-it-home" let-down. Without a blindfold!

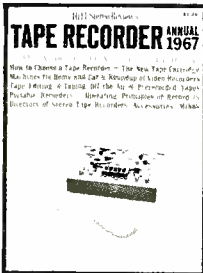

You'll find more than 132 pages of full information on over 250 models from virtually every major manufacturer. Stereo and mono. Portables and full home installations. Even video tape recorders and the new car cartridge machines! All the model numbers, specifications, dimensions and prices. Almost 200 photos. Every vital statistic you need to compare the newest recorders and select the one that will bring you the greatest value for your dollar!

And that's only half the story. After you buy your recorder, turn to the articles on microphone selection, basic tape recorder theory, taping off the air, creative editing or the special accessories section. You'll get expert tips by the dozens. Ten complete features covering every aspect of tape recording. All designed to give you better performance, greater versatility and a lot more fun from your tape recorder!

How much for this indispensable treasury of sound advice?

Just \$1.25.

A small price for a big eye-opener.

**Get the Handsome
Leatherflex-covered
Edition for \$3
Postpaid!**

THE 1967 TAPE RECORDER ANNUAL is also available in a splendid deluxe edition. Rugged Leatherflex cover provides lasting protection yet is softly textured and gold-embossed for the look of elegance. A collector's item—a superb addition to your permanent reference library. And it's yours, for just \$3 postpaid, when you check the appropriate box on the order form.

Ziff-Davis Service Division, Dept. TRA
595 Broadway, New York, N. Y. 10012

Please send my copy of the 1967 TAPE RECORDER ANNUAL as checked below:

I am enclosing \$1.25 plus 15c for shipping and handling for the **Regular Edition**. (\$1.75 for orders outside U.S.A.)

I am enclosing \$3.00. Please send me, **postpaid**, the **Leatherflex-covered Deluxe Edition**. (\$3.75 for orders outside U.S.A.) (Please allow 3 additional weeks for delivery of the Deluxe Edition.)

name _____ (please print) EW-57

address _____

city _____ state _____ zip code _____

ELECTRONICS WORLD MAY 1967

ADVERTISERS INDEX

READER SERVICE NO.	ADVERTISER	PAGE NO.	READER SERVICE NO.	ADVERTISER	PAGE NO.
109	Allied Radio	76	106	Mallory & Co. Inc., P.R.	22
	American Institute of Engineering & Technology	66	105	Microflame, Inc.	69
125	Belden Manufacturing Company	13	104	Multicore Sales Corp.	76
124	Burstein-Applebee Co.	69	103	Music Associated	81
	Capitol Radio Engineering institute, The	70, 71, 72, 73		National Radio Institute	8, 9, 10, 11
	Cleveland Institute of Electronics	7	102	Poly Paks	95
	Cleveland Institute of Electronics	18, 19, 20, 21	197	Public Service Electric & Gas Co.	77
	Columbia Electronics	92		RCA Electronic Components and Devices	FOURTH COVER
84	Cornell Electronics Co.	94	101	RCA Electronic Components and Devices	2
86	Crown International	12		RCA Institutes, Inc.	56, 57, 58, 59
122	Delta Products, Inc.	75	100	Radar Devices Manufacturing Corp.	1
	Department of State	67	113	Rider Publishing, Inc., John F.	14
83	Editors and Engineers, Ltd.	81	99	Sams & Co., Inc., Howard W.	61
121	Edmund Scientific Co.	91	98	Shure Brothers, Inc.	6
120	Electro-Voice, Inc.	SECOND COVER	97	Solid State Sales	93
119	Electronic Components	94	96	Sonotone Corporation	67
118	Elpa Marketing Industries	66	94	Sony Corp. of America	67
	Fair Radio Sales	92	93	Sony/Superscope, Inc.	4
117	Finney Company, The	53	92	Sprague Products Company	65
	G & G Radio Supply Co.	95	91	Surplus Center	92
115	Goodheart Co., Inc., R.E.	91	199	Sylvania Electronic Tube Division	55
114	Gregory Electronics Corporation	92	90	Sylvania Electronic Tube Division	62, 63
112	Heath Company	15, 17	198	Texas Crystals	81
111	Jerrold	5	95	Triplett Electrical Instrument Company	THIRD COVER
110	Judson Research and Mfg. Co.	68	81	Tuner Service Corporation	84
108	Lafayette Radio Electronics	82	85	University Sound	74
107	Lampkin Laboratories, Inc.	66		Valparaiso Technical Institute	82
200	Lesca of America Corp.	87	89	Workman Electronic Products Inc.	68
			88	Xcelite, Inc.	83
			87	Zenith	89

CLASSIFIED ADVERTISING 91, 92, 93, 94, 95

Electronics World

OCTOBER, 1966
40 CENTS

FREQUENCY AND FREQUENCY MEASUREMENTS
AN INTEGRATED CIRCUIT FOR CONSUMER PRODUCTS.
GE- LINE OPERATED TRANSISTOR TV SET

**SPECIAL
ISSUE**

**CHOKES
and
COILS**

Read each month by
the world's largest audience
of electronics professionals.



FIRST CLASS

PERMIT NO. 25682

PHILADELPHIA, PA.

BUSINESS REPLY MAIL

NO POSTAGE NECESSARY IF MAILED IN U. S. A.

Postage will be Paid by

Electronics World

P. O. Box 7842

Philadelphia, Pa. 19101



FIRST CLASS

PERMIT NO. 25682

PHILADELPHIA, PA.

BUSINESS REPLY MAIL

NO POSTAGE NECESSARY IF MAILED IN U. S. A.

Postage will be Paid by

Electronics World

P. O. Box 7842

Philadelphia, Pa. 19101

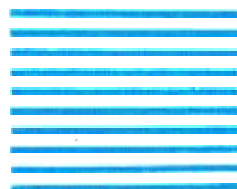

READER SERVICE CARD

To get more information, promptly, about products or services mentioned in this issue, simply circle the number corresponding to the ad or editorial mention and send us the card.

IMPORTANT

BLACK numbers are of general interest and you do not have to include your company name and address to receive the information requested.

BLUE numbers below correspond to an ad or editorial mention of professional interest. Manufacturers will honor your request only if it is to be mailed direct to your company—so be sure to include your company's name and address.

Use only one card to obtain the information you want.

(Void 60 days after date of issue)

I AM EMPLOYED IN: INDUSTRY -1 COMMERCIAL -2
COMMUNICATIONS -3 MILITARY/GOVERNMENT -4 OTHER -5

NAME (Print Clearly) _____ TITLE _____

ADDRESS _____

CITY _____ STATE _____

(Fill in the following only if you circle any **BLUE** numbers below)

SB 567

NAME (Print Clearly) _____ TITLE _____

COMPANY NAME _____

COMPANY ADDRESS _____

CITY _____ STATE _____ ZIP CODE _____

Please send me additional information on products I have circled.
(Key numbers for advertised products also appear in Advertisers Index.)

1 2 3 4 5 6 7 8 9 10 11 12 13 14 15 16 17 18 19 20 21 22 23 24 25
26 27 28 29 30 31 32 33 34 35 36 37 38 39 40 41 42 43 44 45 46 47 48 49 50
51 52 53 54 55 56 57 58 59 60 61 62 63 64 65 66 67 68 69 70 71 72 73 74 75
76 77 78 79 80 81 82 83 84 85 86 87 88 89 90 91 92 93 94 95 96 97 98 99 100
101 102 103 104 105 106 107 108 109 110 111 112 113 114 115 116 117 118 119 120 121 122 123 124 125
126 127 128 129 130 131 132 133 134 135 136 137 138 139 140 141 142 143 144 145 146 147 148 149 150
151 152 153 154 155 156 157 158 159 160 161 162 163 164 165 166 167 168 169 170 171 172 173 174 175
176 177 178 179 180 181 182 183 184 185 186 187 188 189 190 191 192 193 194 195 196 197 198 199 200

I AM EMPLOYED IN: INDUSTRY -1 COMMERCIAL -2
COMMUNICATIONS -3 MILITARY/GOVERNMENT -4 OTHER -5

NAME (Print Clearly) _____ TITLE _____

ADDRESS _____

CITY _____ STATE _____ ZIP CODE _____

(Fill in the following only if you circle any **BLUE** numbers below)

SA 567

NAME (Print Clearly) _____ TITLE _____

COMPANY NAME _____

COMPANY ADDRESS _____

CITY _____ STATE _____ ZIP CODE _____

Please send me additional information on products I have circled.
(Key numbers for advertised products also appear in Advertisers Index.)

1 2 3 4 5 6 7 8 9 10 11 12 13 14 15 16 17 18 19 20 21 22 23 24 25
26 27 28 29 30 31 32 33 34 35 36 37 38 39 40 41 42 43 44 45 46 47 48 49 50
51 52 53 54 55 56 57 58 59 60 61 62 63 64 65 66 67 68 69 70 71 72 73 74 75
76 77 78 79 80 81 82 83 84 85 86 87 88 89 90 91 92 93 94 95 96 97 98 99 100
101 102 103 104 105 106 107 108 109 110 111 112 113 114 115 116 117 118 119 120 121 122 123 124 125
126 127 128 129 130 131 132 133 134 135 136 137 138 139 140 141 142 143 144 145 146 147 148 149 150
151 152 153 154 155 156 157 158 159 160 161 162 163 164 165 166 167 168 169 170 171 172 173 174 175
176 177 178 179 180 181 182 183 184 185 186 187 188 189 190 191 192 193 194 195 196 197 198 199 200

ONE MILLION OHMS PER VOLT



V-O-M

Model 630-M
VOLT-OHM-MICROAMMETER

\$210.00

Suggested U.S.A. user net



Triplet Model 630-M features the input impedance of a VTVM with the convenience of a V-O-M. The 630-M's sensitivity is derived from the singular achievement of its basic 0-1 D.C. microampere movement. The 630-M incorporates no amplifiers, no warm-up, and no power requirements. Model 630-M is a true V-O-M whose engineering excellence is based on 60 years of instrument manufacturing, and contains the top quality associated only with Triplet.

- 1** 1,000,000 ohms per volt D.C. for greater accuracy on high resistance circuits. 20,000 ohms per volt A.C.
- 2** 1 ua Suspension Meter Movement. No pivots, bearings, or rolling friction. Extremely rugged. Greater sensitivity and repeatability.
- 3** 61 ranges, usable with frequencies through 100KC. Temperature compensated. 1½% D.C. accuracy, 3% A.C. in horizontal position.

TRIPLET ELECTRICAL INSTRUMENT COMPANY, BLUFFTON, OHIO
CIRCLE NO. 95 ON READER SERVICE CARD



MANUFACTURERS OF PANEL AND PORTABLE INSTRUMENTS; ELECTRICAL AND ELECTRONIC TEST EQUIPMENT



Service your Color TV customers with confidence...
with RCA HI-LITE picture tubes!

Customer satisfaction... and consequently your service reputation... can very often depend on the quality of the replacement parts you use. When it comes to replacement picture tubes, you can depend on an RCA HI-LITE for picture brightness and color fidelity at its finest. Install them and you literally "up-date" your customer's set with the same quality... the same tubes... that go into today's original equipment sets.

Enjoy the confidence of offering the finest. Rely on RCA picture tubes to protect your service reputation. They are designed to protect the biggest reputation in the Color TV industry

RCA Electronic Components and Devices, Harrison, N. J.



The Most Trusted Name in Electronics

