

Electronics World

MARCH, 1967
60 CENTS

COMPLETE DIRECTORY

including performance characteristics of all

SOLID-STATE HI-FI TUNERS & RECEIVERS

WEATHER SURVEILLANCE BY SATELLITE

ELECTRONICS IN OCEANOGRAPHY

PLUS

SPECIAL CB & BRS FEATURES

- ★ CITIZENS BAND COMMUNICATIONS
- ★ BUSINESS RADIO COMMUNICATIONS
- ★ ANTENNAS FOR CB & BRS
- ★ TEST EQUIPMENT FOR CB & BRS



M 0568 514700HIN2724LM053
M J HINDMAN
2724 E LINWOOD
SPRINGFIELD MD 21084





If you like
big speakers,

listen
to the mammoth
little E-V SEVEN!

ⓔ The E-V SEVEN is the small speaker for people who don't really want a small speaker. Built in the shadow of one of the biggest speakers of them all (the vast Patrician 800) the E-V SEVEN refuses to sound as small as it is.

But why does an E-V SEVEN grow up when it's turned on? Our engineers point to years of painstaking exploration in the byways of sound. They'll patiently explain the virtues of our low resonance 8" woofer and 3½"

cone tweeter with symmetrical damping (an E-V exclusive). They may even mention—with quiet pride—the unusual treble balance RC network that adjusts E-V SEVEN response more smoothly than any conventional switch or volume control.

But when it comes to describing the sound, our engineers prefer to let the E-V SEVEN speak for itself. And while they'd be the last to suggest that the E-V SEVEN sounds just like speak-

ers many times larger (and costing much more) they treasure the pleased look of surprise most people exhibit when they hear an E-V SEVEN for the first time.

If you have just 19" of shelf space, 10" high and 9" deep... and have \$66.50 to invest in a speaker, by all means listen carefully to the E-V SEVEN. It might well be the biggest thing to happen to your compact high fidelity system!

high fidelity systems and speakers • tuners, amplifiers, receivers • public address loudspeakers • microphones • phonograph needles and cartridges • organs • space and defense electronics

ELECTRO-VOICE, INC., Dept. 374N, 629 Cecil Street, Buchanan, Michigan 49107

CIRCLE NO. 117 ON READER SERVICE CARD

www.americanradiohistory.com

Electro-Voice®

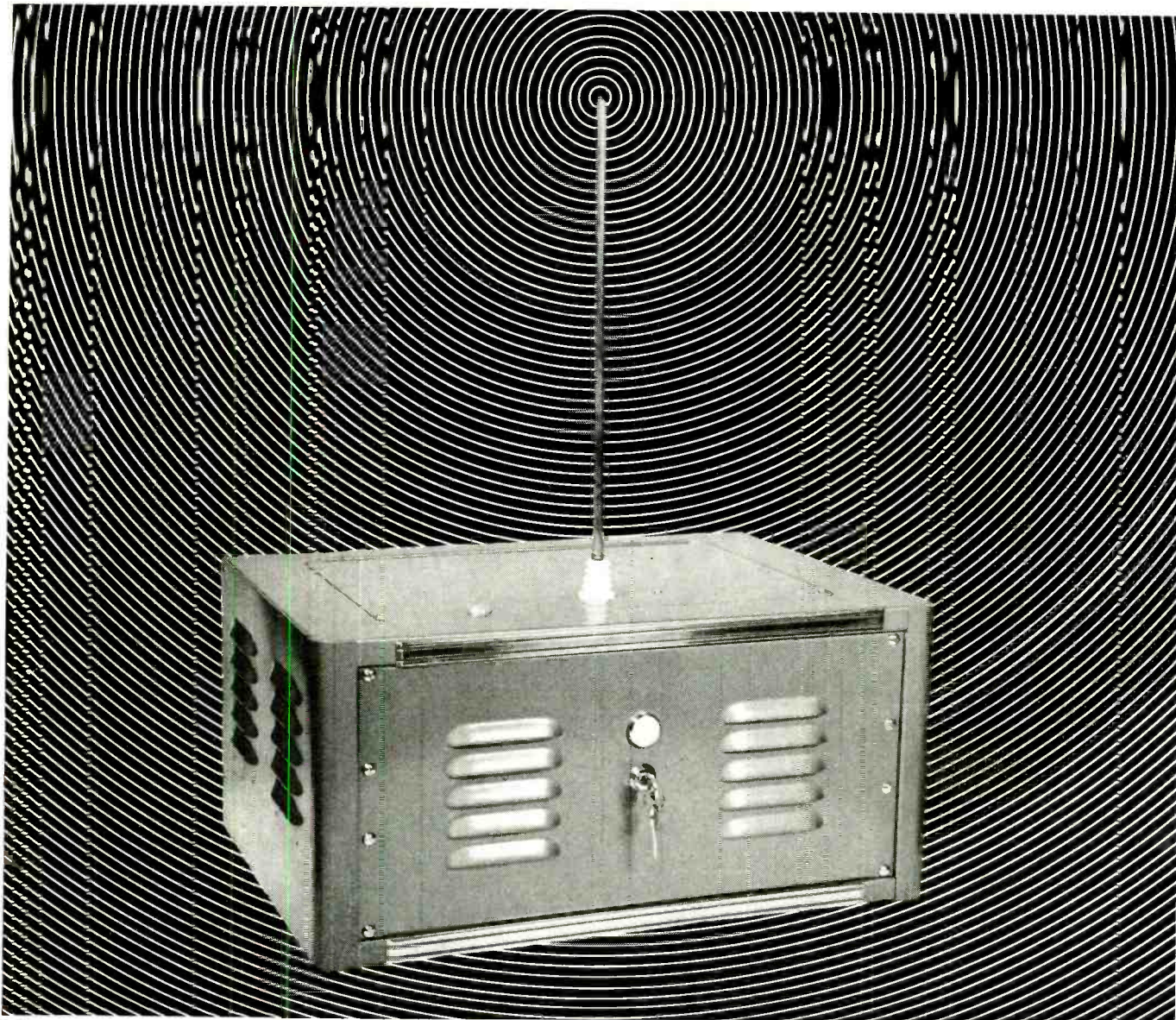

You are now in Radar Sentry Alarm's r.f. microwave field. Don't move a muscle!

This security system is so sensitive, it can be adjusted to detect the motion of your arm turning this page.

And if this Portable Model Unit were within 35 feet of you and you moved... people up to a half-mile away could hear the siren. Plus with optional equipment, it can detect fire... turn on lights... even notify police.

What does a burglar alarm have to do with you?

Just this: Radar Sentry is no ordinary alarm. It is the most modern and effective security system available. And it's also electronic.

That's why we need you. We need Dealers with technical knowledge. For the most successful Dealers for Radar Sentry Alarm are men who know electronics. This is a product that sells itself when demonstrated properly.

It's been proven time after time. In fact, many of the more than one thousand readers of electronics magazines who became Dealers in the past year — sold a system on their *first* demonstration.

And that's why we need men with technical knowledge and experience.

Men like you.

How about it?

Do you want to start a business of your own... or expand your present business with a product that in 8 years has become the world-wide leader in its field?

Do you want to earn up to \$5,000 a year in your spare time?

Do you want to earn \$20,000 and more full time? We'll show you how.

O.K., now you can move.

Fill out the coupon and get complete Dealer/Distributor information... free.

Mail to: RADAR DEVICES MANUFACTURING CORP.
22003 Harper Ave., St. Clair Shores, Michigan 48080



Please tell me how I can have a business of my own distributing Radar Sentry Alarm Systems. I understand there is no obligation.

Name _____

Address _____

City _____ State & Code _____

EW 4

Incomparable Performance at an Unbeatable Price

Time-saving features of the new Hewlett-Packard 427A Multi-Function Meter include: No need to change input connections to measure ac and dc volts—just change the function switch. Only one zero set for dc and resistance measurements . . . no need to re-zero when switching from dc to ohms measurements . . . seldom "zero" on the 1 v range and above. Instantaneous turn-on. Field-operate the compact hp 427A to typically 300 hours from one internal dry-cell battery (regulator included). AC-battery operation available at \$35 additional. All Hewlett-Packard voltmeter accessories, such as dividers, adapters and leads, available for flexible performance.

...the hp 427A Multi-Function Meter!

You can tell this is a measurement-packed instrument just by looking at the front panel. To see the 427A run through its paces, call your Hewlett-Packard field engineer. For complete performance details, write Hewlett-Packard, Palo Alto, California 94304, Tel. (415) 326-7000; Europe: 54 Route des Acacias, Geneva.

Data subject to change without notice. Prices f.o.b. factory.



1481

Volts dc.
± 2%
Accuracy

Volts ac.
to 1MHz
± 2%
Accuracy

0.1mv
resolution

Negligible
zero
Calibration
adjustment

Ohms
± 5%
of midscale
reading
accuracy

INPUT
10 MΩ
Floating

\$195

HEWLETT · PACKARD
427A VOLTMETER

FUNCTION RANGE

ACV OHMS DCV BATT. 1.5V MIN. OFF

X1K 1 X100 3 X10 1 AC ONLY .03 .01

X10K 3 10 X100K 30 X1M 100 X10M 300 1000

VOLTS COM OHMS DC ZERO / ∞



THIS MONTH'S COVER shows representative examples of equipment designed for the Citizens and Business Radio bands. Included are transceivers, test equipment, and antennas which are fully described in our cover story on page 28 of this issue. The equipment ties in with the four special features we are running this month on the subjects of Citizens Band communications, Business Radio communications, test equipment for CB and BRS, and antennas for CB and BRS. These articles may be located by referring to the adjacent table of contents. (Cover photograph: Bruce Pendleton).



Publisher
PHILLIP T. HEFFERNAN
Editor
WM. A. STOCKLIN
Technical Editor
MILTON S. SNITZER
Associate Editors
LESLIE SOLOMON
P. B. HOEFER
Assistant Editor
MARSHA JACOBS
Contributing Editors
WALTER H. BUCHSBAUM
Prof. ARTHUR H. SEIDMAN
Art Editor
CHARLES FREELING
Art and Drafting Dept.
J. A. GOLANEK
Advertising Sales Manager
LAWRENCE SPORN
Advertising Service Manager
ARDYS C. MORAN

March, 1967

Electronics World

MARCH 1967

VOL. 77, No. 3

CONTENTS

- 23 Weather Surveillance by Satellite** *Joseph H. Wujek, Jr.*
Global weather information is now being provided by Tiros, Nimbus, and successor NASA satellites. One day we may be able to use this information for weather control.
- 26 Recent Developments in Electronics**
- 28 Cover Story**
- 29 Business Radio Communications** *Robert M. Brown*
- 32 Test Equipment for CB and Business Radio** *David Walker*
- 34 Buying a Hi-Fi Tuner?** *Leonard Feldman*
- 35 Hi-Fi Tuner and Receiver Directory**
Covering the present market in solid-state tuners and receivers, this directory includes the electrical and mechanical characteristics of 31 tuners of 16 manufacturers and 52 receivers made by 20 manufacturers.
- 38 Antennas for CB and Business Radio**
- 40 Selecting a CB Transceiver** *Len Buckwalter*
- 44 Electronics in Oceanography** *John Althouse*
A description of the various mechanical and electronic instruments that can accurately measure temperature, pressure, conductivity, speed of sound, tide, and wave motion.
- 47 Digital Plotting Techniques** *Louis E. Frenzel, Jr.*
- 61 Silicon—Carbide Light Diode**
- 68 A Solid-State Microphone "Transformer"** *James B. Wood*
- 71 SCR Protective Circuit for Hi-Fi Amplifier**
- 76 Laser-Recorded Digital Memory**
- 78 New Frontiers in Semiconductors**
- 86 Characteristics of Limiter Amplifiers**

-
- 14 EW Lab Tested**
Scott 342 FM-Stereo Receiver
Ortofon S-15T Phono Cartridge
- 56 CB and Integrated Circuits** *John Frye*
- 58 Test Equipment Product Report**
Fairlane Electronics Model LBO-5SA Oscilloscope
Semitronics Model 1000 Transistor Tester & Set Analyzer
Wahl Series HS-8 "Heat Spy" Electronic Thermometer

MONTHLY FEATURES

- 4 Coming Next Month** **66 Radio & TV News**
6 Letters from Our Readers **72 Book Reviews**
88 New Products & Literature
-

Electronics World: Published monthly by Ziff-Davis Publishing Company at 307 North Michigan Ave., Chicago, Illinois 60601. One year subscription \$6.00. Second Class Postage paid at Chicago, Illinois and at additional mailing offices. Subscription service: Portland Place, Boulder, Colorado 80302. Copyright © 1967 by Ziff-Davis Publishing Company. All rights reserved.

How Would YOU Like To Have An EXCLUSIVE FRANCHISE For The Greatest Value In Business Band Two-Way Radios?

Poly-Comm Business Band two-way FM radios cover the same distances as competitive units costing twice as much. And by using the exclusive Poly-Range-Booster approach, you can design a low-cost system to meet your customer's needs today . . . and supply him with a full range of quality accessories to fit his changing needs tomorrow. Poly-Range-Boosters will convert the basic 18 watt units (high or low band) to 50 or 100 watts at a remarkably low cost.

Polytronics quality has long been famous in the two-way radio field, and it is now teamed up with an aggressive drive to capture and keep a fair share of the Business Band market . . . a drive supported by national advertising, unusual dealer discounts, new equipment.

For more information about how YOU can get in on the ground floor with a company on the way up, just mail in the coupon below!



POLYTRONICS LABORATORIES, INC.
900 Burlington Ave., Silver Spring, Md.

Please send me full information about Polytronics Two-Way FM Business Band Radios and accessories, and tell me how I can receive a Poly-Comm Communications Center Franchise.

w37

Name

Company..... Phone.....

Address

City..... State..... Zip.....

CIRCLE NO. 84 ON READER SERVICE CARD

COMING NEXT MONTH

SPECIAL ISSUE: RELAYS



This 24-page section will cover the design and application of all major types of relays. The nine articles, written by industry authorities, include: **Relay Coil Considerations** by M.S. Steinback, Chief Engineer, Magnecraft Electric Co.; **Reed Relays** by Roger L. Rosenberg, Systems Project Engineer, C.P. Clare & Co.; **Mercury-Wetted Contact Relays** by Arthur J. Koda, Senior Development Engineer, C.P. Clare & Co.; **Trade-Offs in Relay Selection** by George C. Underwood of Cornell-Dubilier and a **Checklist for Ordering Relays**, also by Mr. Underwood; **Relay Operate and Release Times** by W. Warren Wright, Assistant Chief Engineer, Guardian Electric; **Time-Delay Relays** by Jerry Elpers, Sales Manager for Solid-State Products at Potter & Brumfield; **Electrical Contact Considerations** by Arthur O. Capp, Jr., Engineering Manager of Fansteel's Electrical Products Division; and **Arc-Surge Noise Suppression** by R.M. Rovnyak, Staff Engineer for Product Design, Automatic Electric Company.

ELECTRONIC EAVESDROPPING

"Bugs" in phones, furniture, cars, offices, and shirt pockets have become commonplace. Robert M. Brown surveys the field and provides detailed descriptions of currently available units, how they operate, and how they can be detected.

INTEGRATED-CIRCUIT I.F. AMPLIFIER USED IN NEW FM RECEIVER

By using four IC's as i.f. amplifiers and limiters in its new receivers, Scott has

obtained improved sensitivity and selectivity, more stereo separation and AM rejection, and better capture ratio—all with a basically simpler i.f. strip.

NEW Q-BAND MARINE RADAR

Radar operating at 8-mm (about 35,000 MHz) wavelength is now being used on the crowded European waterways. It provides better resolution, will pick up smaller targets and display their shapes. This article describes the new Model SCR260 unit developed by Philips.

All these and many more interesting and informative articles will be yours in the April issue of **ELECTRONICS WORLD** . . . on sale March 21st.

ZIFF-DAVIS PUBLISHING COMPANY

William B. Ziff
Chairman of the Board (1946-1953)

William Ziff
President

W. Bradford Briggs
Executive Vice President

Hershel B. Sarbin
Senior Vice President

Philip Sine
Financial Vice President

Walter S. Mills, Jr.
Vice President, Circulation

Stanley R. Greenfield
Vice President, Marketing

Phillip T. Heffernan
Vice President, Electronics Division

Frank Pomerantz
Vice President, Creative Services

Arthur W. Butzow
Vice President, Production

Edward D. Muhlfeld
Vice President, Aviation Division

Irwin Robinson
Vice President, Travel Division

Radio & TV News • Radio News • Radio-Electronic Engineering Trademarks Reg. U.S. Pat. Off.

SUBSCRIPTION SERVICE: All subscription correspondence should be addressed to Electronics World, Circulation Department, Portland Place, Boulder, Colorado 80302. Please allow at least six weeks for change of address. Include your old address, as well as new—enclosing if possible an address label from a recent issue.

EDITORIAL CONTRIBUTIONS must be accompanied by return postage and will be handled with reasonable care; however publisher assumes no responsibility for return or safety of art work, photographs, or manuscripts.

ELECTRONICS WORLD (March, 1967, Vol. 77, No. 3). Published monthly at 307 North Michigan Avenue, Chicago, Illinois 60601, by Ziff-Davis Publishing Company—also the publishers of Airline Management and Marketing, Boating, Business & Commercial Aviation, Car and Driver, Cycle, Flying, HiFi Stereo Review, Modern Bride, Popular Aviation, Popular Electronics, Popular Photography, Skiing, Skiing Area News, and Skiing Trade News. Travel Weekly is published by Robinson Publications, Inc., a subsidiary of Ziff-Davis Publishing Company. One year subscription rate for U.S., U.S. Possessions, and Canada, \$6.00; all other countries, \$7.00. Second Class postage paid at Chicago, Illinois and at additional mailing offices. Authorized as second class mail by the Post Office Department, Ottawa, Canada and for payment of postage in cash.

Editorial and Executive Offices
One Park Avenue
New York, New York 10016 212 679-7200

NEW YORK OFFICE 212 679-7200
James J. Sullivan
Joseph E. Halloran

MIDWESTERN OFFICE
307 North Michigan Avenue
Chicago, Illinois 60601 312 726-0892
Midwestern Advertising Manager, Royce Richard

WESTERN OFFICE
9025 Wilshire Boulevard
Beverly Hills, California 90211
213 CRestview 4-0265; BRAdshaw 2-1161
Western Advertising Manager, Bud Dean

JAPAN
James Yagi
c/o Fukushima
19-14 Minami 3-chrome
Koenji, Suginami-ku
Tokyo, Japan

CIRCULATION OFFICE
Portland Place, Boulder, Colorado 80302



Member
Audit Bureau of
Circulations

ELECTRONICS WORLD

A New Electronics Slide Rule with Self-Training Course

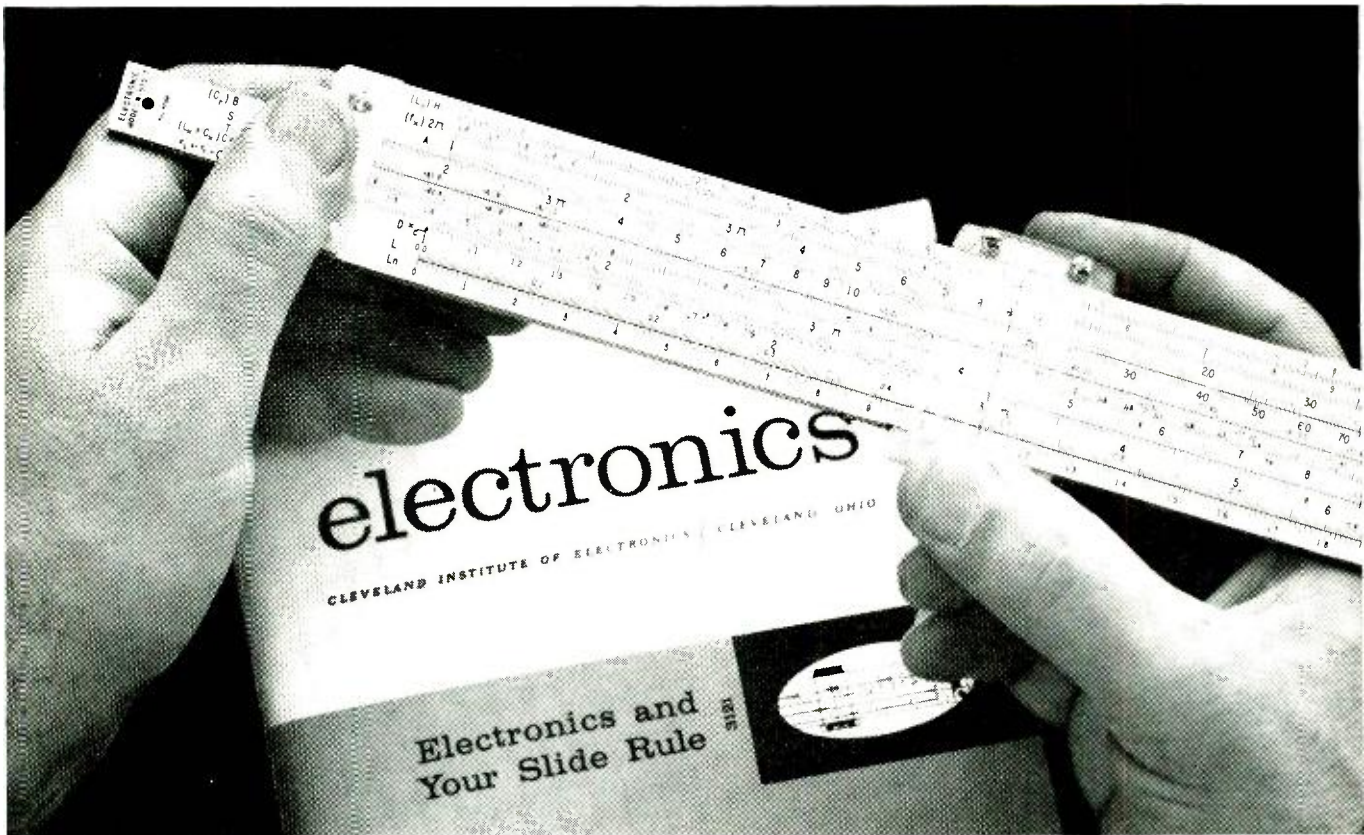

Why didn't someone think of this before?

Here's a great *new* way to solve electronic problems accurately . . . easily. The Cleveland Institute Electronics Slide Rule* is the only rule designed specifically for the exacting requirements of electronics computation. It comes complete with an illustrated Instruction Course consisting of four AUTO-PROGRAMMED* lessons . . . each with a short quiz you can send in for grading and consultation by CIE's expert instructors. With this personal guidance, you'll soon be solving complex electronics problems in seconds while others still struggle along with pad and pencil.

Here's what Mr. Joseph J. DeFrance, Head of the Electrical Technology Dept., New York City Community College, has to say about it:

"I was very intrigued by the 'quickie' electronics problem solutions. It is an ingenious technique. The special scales should be of decided value to any technician, engineer, or student. The CIE slide rule is a natural."

See for yourself. Learn how to whip through all kinds of reactance, resonance, inductance, AC and DC circuitry problems in seconds . . . become a whiz at conventional computations too!

This all-metal 10" rule is made to our tough specs by Pickett, Inc. . . . comes complete with top grain leather carrying case *and* Instruction Course. A \$50 value for less than \$25. Send coupon for FREE illustrated booklet *and* FREE Pocket Electronics Data Guide. Cleveland Institute of Electronics, 1776 E. 17th St., Dept. EW-136, Cleveland, Ohio 44114.

*TRADEMARK

GET BOTH FREE!



Cleveland Institute of Electronics

1776 E. 17th St., Dept. EW-136 • Cleveland, Ohio 44114

Please send FREE Electronics Slide Rule Booklet.
SPECIAL BONUS: Mail coupon promptly . . . get FREE Pocket Electronics Data Guide too!

Name _____ (Please Print)

Address _____ County _____

City _____ State _____ Zip _____

A leader in Electronics Training . . . since 1934

Complete TUNER REPAIR

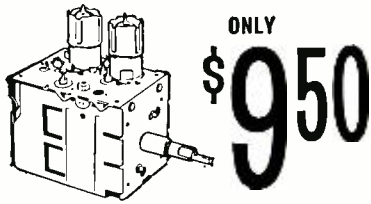

Includes ALL parts (except tubes) . . . All labor on ALL makes. Fast, dependable service with 1-year warranty

Sarkes Tarzian, Inc., largest manufacturer of TV and FM tuners, offers unexcelled tuner overhaul and factory-supervised repair service.

Most Tarzian-made tuners received one day will be repaired and shipped out the next. More time may be required on other makes. Every channel checked and realigned per original specs. And, you get a full, 12-month guarantee against defective workmanship and parts failure due to normal usage. Cost, including labor and parts (except tubes) is only \$9.50 and \$15 for UV combinations. Replacements at low cost are available on tuners beyond practical repair.

Always send TV make, chassis and Model number with faulty tuner. Check with your local distributor for Sarkes Tarzian replacement tuners, parts or repair service. Or, use the address nearest you for fast, factory-supervised repair service.

TUNER SERVICE  CORPORATION

(Factory-supervised tuner service authorized by Sarkes Tarzian)

MIDWEST—817 N. Pennsylvania St.
Indianapolis, Ind. Box 1642
Tel: 317-632-3493

EAST—547-49 Tonnele Ave.
Jersey City, New Jersey • Tel: 201-792-3730

SOUTH-EAST—938 Gordon St., S.W.
Atlanta, Georgia • Tel: 404-758-2232

WEST—SARKES TARZIAN, Inc.
Tuner Service Division
10654 Magnolia Blvd., N. Hollywood, Calif.
Tel: 213-769-2720

CIRCLE NO. 88 ON READER SERVICE CARD



LEARN TECHNICAL WRITING

for prestige, high pay, advancement

WRITE YOUR WAY TO SUCCESS Electronics, aerospace, glamour industries need trained writers now. Technical Writing is one of the highest paying careers NOT requiring college. The demand for trained writers is growing with thousands needed in all areas.

ATWS WILL TRAIN YOU AT HOME AT LOW COST. ATWS home training is fast moving, fascinating, easy to follow. Includes

everything you need to become a top notch Tech Writer. Low cost. Send today for free career book and sample lesson. No salesman will call. APPROVED FOR VETERANS.

AMERICAN TECHNICAL WRITING SCHOOLS, Dept. EW-37
5512 Hollywood Boulevard, Hollywood, California 90028

LETTERS FROM OUR READERS

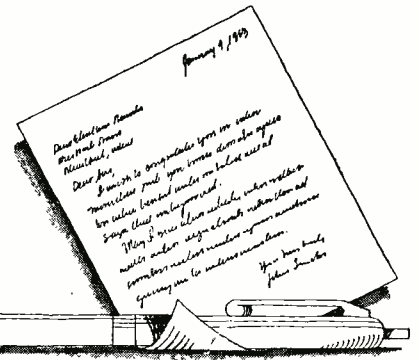

THE HAM AS ENGINEER

Our January "Letters from Our Readers" column contained a letter from Cliff Erickson commenting on John Frye's column "Predicting Academic Success" which appeared in our August issue. Mr. Erickson felt that ham network activity helps prepare men for college engineering courses. Here are some comments from Author Frye:

Dear OM:

I just read your letter in the January issue of ELECTRONICS WORLD—I had not had an opportunity to see it before—and I thought I should do a little explaining. I am afraid, Cliff, you missed the point I was hoping to make; *viz.*, no criterion of expected performance in college works, including the holding of a ham ticket. I freely admit this surprised me, too, for I have always felt that a fellow who passed the ham exam would naturally do well in engineering; but this is not true any more than it is true that the boy who "loves to tinker with cars" can be expected to do well in mechanical engineering.

The really dedicated technician who does much of his experimenting in the ham field cannot be placed in the same category with the run-of-the-mill ham because the former is already on the way to being an engineer when he enters college. In other words, your quarrel is not with me; it is with the statistics carefully collected at Purdue and other universities where they are searching for some reliable indicator of future performance in engineering.

I am not sure if you know I am an amateur, for EW does not use my call; but I have been a ham for 35 years—active all this time except for the period when we were off the air during World War II. I spent many years in the Army Amateur Radio System as a traffic handler on c.w.; I was one of the original members of the Indiana Fone Net and still check into this net daily; my equipment is all Heath (SB-100, SB-200, "Monitorscope"), and that is only a cut from "store-bought" equipment. I use Hy-Gain's TH4CK tri-band beam and 2BDQ 80-40 trap antenna.

So you see, I was not trying to "put down" the hams I mentioned. I simply

said you could not depend on their being hams to expect outstanding performance in a college engineering course.

We may as well face it, Cliff; not all hams are budding engineers any more than all pipe smokers and dog lovers are fine fellers. When I lived in Arkansas, I knew more than one pipe smoker and dog lover who was a wife-beater and a child-neglector!

JOHN T. FRYE, W9EGV
Logansport, Ind.

* * *

IC TERMINAL NUMBERS

To the Editors:

The article in the November issue on "Linear Integrated Circuits: What's Available?" by Donald E. Lancaster covers the current items that are available at the present time very well.

I do think that a word of caution must be offered, however, concerning the terminal numbers describing the Westinghouse device. The WC183 as described and shown is really the flat-pack WC183G. Since mention was made of the TO-5 can variety, I think the user should first check available data sheets because the terminal numbers of the WC183T are not exactly the same as those for the WC183G. This is also true in the equivalent flat packs and TO-5 can varieties of other manufacturers, since flat packs can have as many as fourteen terminals and TO-5 cans only twelve.

C. N. BUSHEY
Linthicum Heights, Md.

* * *

A.G.C.-OPERATED POWER CONTROL

To the Editors:

Before more letters start arriving from readers, let me note some errors in the drawing and some possibly significant omissions in my article "A.G.C.-Operated Power Control" as it appears in the December, 1966 issue (p. 81).

C3 is shown incorrectly polarized. The negative side of C3 should be connected toward the plate of the 2D21 thyratron. C2, a 0.005- μ F capacitor, may be a disc ceramic, mica, or paper with a rating of 200 volts or more. It is not, as indicated, an electrolytic type.

RL1 is correctly drawn as an s.p.d.t. but is listed as a d.p.d.t. type. A note (Continued on page 12)

Let's talk sense about color TV lead-in!

The common sense of the situation calls for two 82-channel lead-ins for color and UHF TV... one to give a stronger signal in uncongested fringe areas where interference usually is not a serious problem. The other to give a much cleaner signal in congested or close-in areas where serious interference problems are likely to exist. This is why Belden gives you a choice—the *Color Guard Twins*.

8285 ▶

*Color Guard
Twin—Belden
Permohm**

Use to get stronger signals in uncongested fringe areas, like this . . .



You get an excellent color image . . . because in a 100-foot run, Permohm delivers 38% to 200% more signal voltage than RG-59/U with matching transformers and 23% to 80% more signal voltage than "Low Loss Coax" with transformers.

Permohm obtains the highest efficiency of any available unshielded 300 ohm line when exposed to weathering and industrial atmospheres. Low loss cellular polyethylene insulation around the conductors provides the necessary protection.

You don't need expensive transformers and connectors.

◀ **8290**

*Color Guard
Twin—Belden
Shielded Permohm**

Use to get cleaner signals in congested or close-in areas, like this . . .



Belden Shielded Permohm (8290) combines strong signal strength with the clean signal protection of shielded cable.

Shielded Permohm eliminates transmission line pickup of noise and ghost signals. You can install it easily anywhere . . . no need for standoffs, twisting, or inconvenient routing of lead-in. Tape it to a mast, route it through metal pipe, or bury it underground.

Beldfoil† shielding is used to shield against outside signal interference. The jacket is weatherproof polyethylene. The critical signal area is protected from rain, snow, salt, smog, fog and industrial contamination. No expensive transformers or connectors are needed.

Belden Trademarks Reg. U.S. Patent Office
*Patent No. 2,782,251 and Pat. Pending
†Patent No. 3,032,604

Choose the Color Guard Twin that gives your customer the best 82-channel color TV reception. Get complete information on the Belden Color Guard Twins.

CALL YOUR BELDEN ELECTRONIC DISTRIBUTOR.

Belden

BELDEN MANUFACTURING COMPANY • P. O. Box 5070-A • Chicago, Illinois 60680

CIRCLE NO. 83 ON READER SERVICE CARD

B-8-6

7

Electronics comes alive with NRI Training Kits

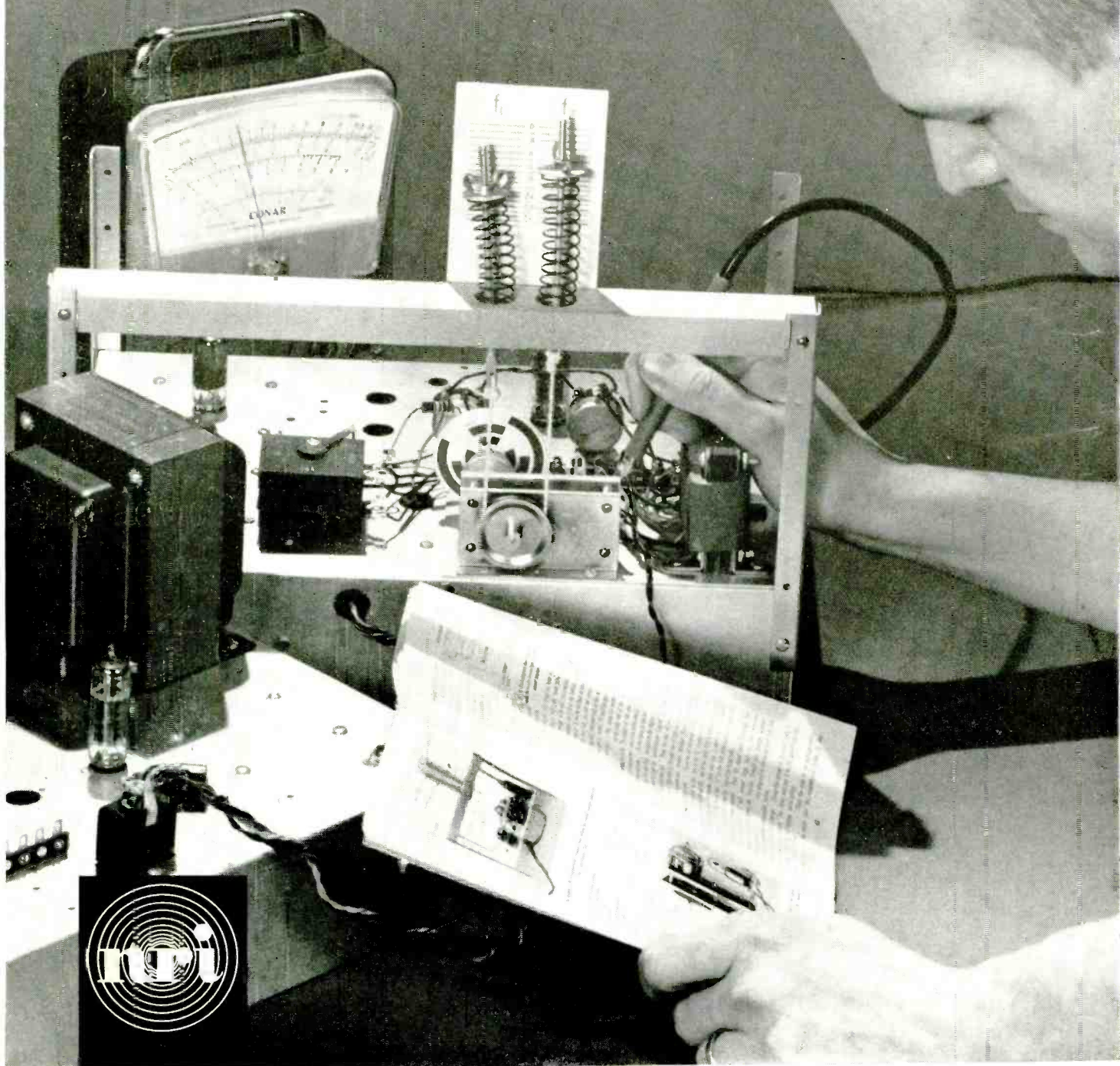

DISCOVER THE EASE AND EXCITEMENT OF TRAINING AT HOME THE NRI WAY

New Achievement Kit—Custom Training Kits—"Bite Size" Texts

Only NRI offers you this pioneering method of simplified "3 Dimensional" home-study training in Electronics, TV/Radio and Broadcasting/Communications. It's a remarkable teaching idea unlike anything you have ever encountered, the result of more than half a century of simplifying, organizing and dramatizing learning-at-home techniques. If you are an ambitious man—regardless of your education—you can effectively learn the Electronics field of your choice the NRI way.

NRI has *simplified* Electronics by producing "bite size" lesson texts averaging only 40 pages each. Dozens of illustrations open wide a picture window through which you'll see and understand practical uses of Electronics. You start out with NRI's exclusive Achievement Kit, containing everything you need to get started fast. (Illustrated at right.)

NRI has *organized* Electronics training to take you step-by-step from the first stages into more intriguing areas. Once you know the fundamentals thoroughly, it's easy to grasp more advanced theory and techniques. You move with confidence and enthusiasm into a new adventure filled with the excitement of discovery.

NRI has *dramatized* Electronics through the careful development of special training equipment that is *programmed* into your training systematically . . . beginning with your first group of lessons. Things you read about come alive in your hands as you build, experiment, purposely cause "problems" in circuits—and solve them. You learn to use test equipment, to build radios and TV sets, transmitter, or computer circuits. It's the priceless "third dimension" in NRI training . . . practical experience.



YOU GET MORE FOR YOUR MONEY FROM NRI

Mail postage-free card now for your free NRI catalog. Then, compare. You'll find—as have thousands of others—NRI training can't be beat. Read about the new Achievement Kit sent the day you enroll; about "bite-size" texts and custom designed training equipment. See why NRI gives you more value. Whatever your reason for wanting more knowledge of Electronics, NRI has an instruction plan for you. Choose from major programs in TV/Radio Servicing, Industrial Electronics and Complete Communications. Or select from special courses to meet specific needs. Check the course of interest to you on postage-free card and mail today for free NRI catalog. No salesman will call. NATIONAL RADIO INSTITUTE, Electronics Div., Washington, D.C. 20016.

Available Under NEW GI BILL

If you served since January 31, 1955, or are in service, check GI line in postage-free card.

More than 50 years of leadership
in Electronics Training



Career? Part-Time Earnings? Hobby? Choose From 12 Training Plans

1. TELEVISION-RADIO SERVICING — Learn to fix all TV sets, including Color. Includes your choice of NRI Color Kit or 19" black-white TV Kit. Also covers radios, stereo hi-fi, etc. Profitable field spare or full-time.

2. INDUSTRIAL-MILITARY ELECTRONICS — Basics to computers. Starts with fundamentals, covers servos, telemetry, multiplexing, phase circuitry, other subjects.

3. COMPLETE COMMUNICATIONS* — Operation, service, maintenance of AM, FM and TV broadcasting stations. Also covers marine, aviation, mobile radio, facsimile, radar, microwave.

4. FCC LICENSE* — Prepares you for 1st Class FCC License exams. Begin with fundamentals, advance to required subjects in equipment and procedures.

5. MATH FOR ELECTRONICS — Brief course for engineers, technicians seeking quick review of essential math: basic arithmetic, short-cut formulas, digital systems, etc.

6. BASIC ELECTRONICS — For anyone wanting a basic understanding of Radio-TV Electronics terminology and components, and a better understanding of the field.

7. ELECTRONICS FOR AUTOMATION — Not for beginners. Covers process control, ultrasonics, telemetering and remote control, electromechanical measurements, other subjects.

8. AVIATION COMMUNICATIONS* — Prepares you to install, maintain, service aircraft in-flight and landing systems. Earn your FCC License with Radar Endorsement.

9. MARINE COMMUNICATIONS* — Covers electronic equipment used on commercial ships, pleasure boats. Prepares for FCC License with Radar Endorsement.

10. MOBILE COMMUNICATIONS* — Learn to install, maintain mobile transmitters and receivers. Prepares for FCC License exams.

11. ELECTRICAL APPLIANCE REPAIR — Learn to repair all appliances, including air conditioning, refrigeration, small gas engines. Leads to profitable part or full-time business.

12. ELECTRONICS FOR PRINTERS — Operation and maintenance of Electronic equipment used in graphic arts industry. From basics to computer circuits. Approved by major manufacturers.

* You must pass your FCC License exams (any Communications course) or NRI refunds in full the tuition you have paid.

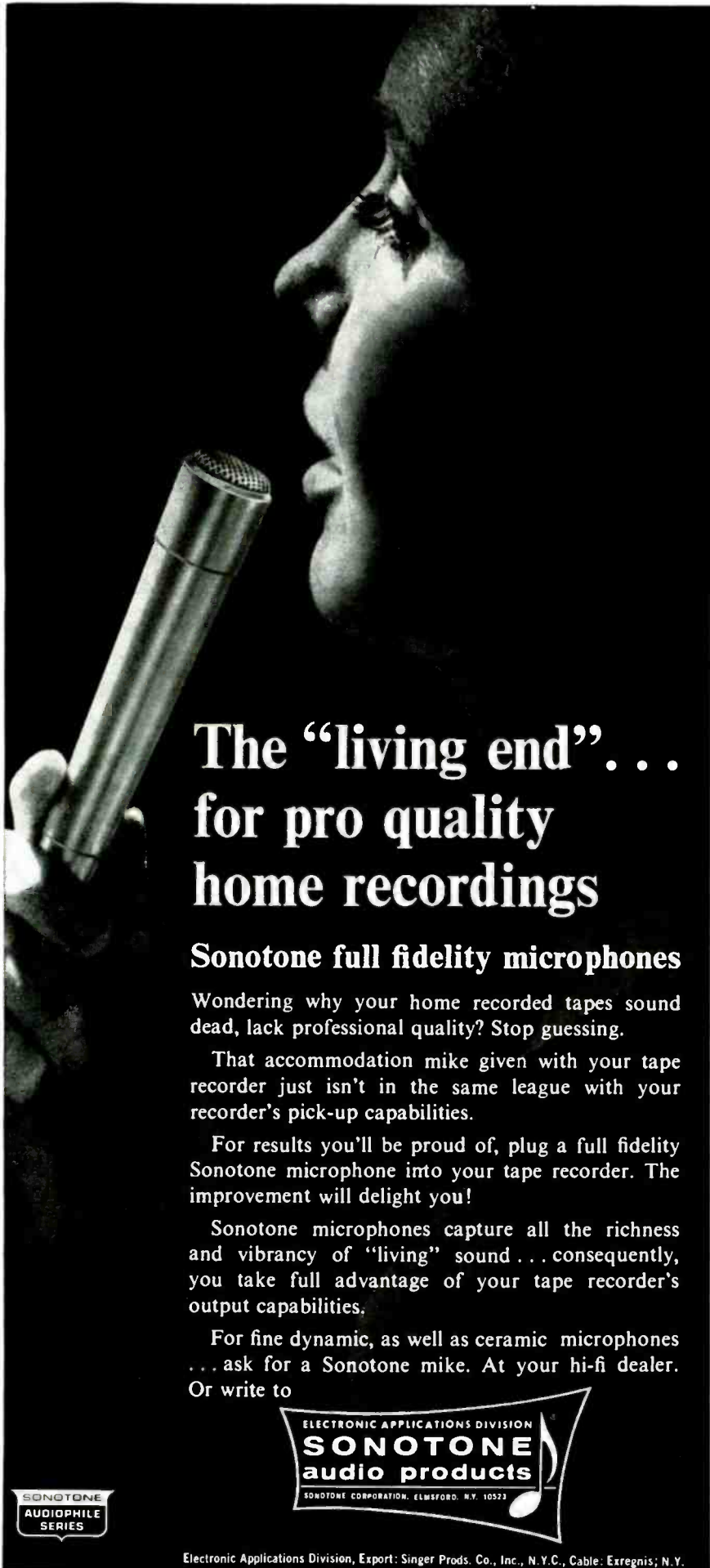

The "living end" . . . for pro quality home recordings

Sonotone full fidelity microphones

Wondering why your home recorded tapes sound dead, lack professional quality? Stop guessing.

That accommodation mike given with your tape recorder just isn't in the same league with your recorder's pick-up capabilities.

For results you'll be proud of, plug a full fidelity Sonotone microphone into your tape recorder. The improvement will delight you!

Sonotone microphones capture all the richness and vibrancy of "living" sound . . . consequently, you take full advantage of your tape recorder's output capabilities.

For fine dynamic, as well as ceramic microphones . . . ask for a Sonotone mike. At your hi-fi dealer. Or write to



Electronic Applications Division, Export: Singer Prods. Co., Inc., N.Y.C., Cable: Exregnis; N.Y.
CIRCLE NO. 93 ON READER SERVICE CARD

(Continued from page 6)

was included with my original manuscript—or should have been—that both sets of normally open contacts are paralleled to prolong contact life and/or to increase the current-carrying capacity.

In editing and shortening the text, some omissions were made. I believe it important to mention that the control range, using the indicated circuit values, is from -0.4 volt to -7.0 volts. This is a considerable range and makes the circuit quite versatile for other uses: industrial, experimental, and so on. Also, the input circuit does not load the circuit to which it connects at all, as it operates on voltage-level changes in the negative region only. No power is taken from the circuit.

It might profitably be mentioned that this circuit was developed to switch on and off a 120-volt a.c., solid-state tape recorder, which recorded the intelligence on the radio channel monitored. Since the recorder required no warm-up and only operated when the desired signals were present, the resulting recording had no blank gaps, nor did it require constant attention. The economies in tape, in tape readout, and in personnel time are evident.

A. W. EDWARDS
Corpus Christi, Texas

Our thanks to Author Edwards for the additional information.—Editors

* * *

ELECTRONIC METAL LOCATORS

To the Editors:

In your article "Electronic Metal Locators" on page 39 of your December, 1966 issue, the author neglected to include my firm in his listing of manufacturers. We make a "Coin Finder" locator employing a small coil that is especially suited to coin locating. This locator is of the beat-frequency type. We also manufacture a proton magnetometer for use by archeologists.

ART HOWE
Art Howe and Co.
811 Kansas Ave.
Atchison, Kan.

We have also received a note from Clarence E. Farris of IGWT Associates indicating that 8 of the 9 locators produced by this company are beat-frequency types rather than induction-balance units as shown in our table. In addition, this company manufactures an underwater locator.

We have also heard from Relco Industries, P.O. Box 10563, Houston, Texas 77018 indicating that this firm is a manufacturer of underwater detectors and has been for a number of years. The company has several such models available, and it also produces special coin- and nugget-retrieval units for underwater and out-of-water uses.

—Editors





New way to balance stereo systems

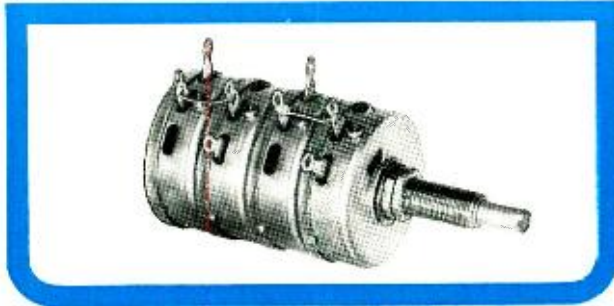
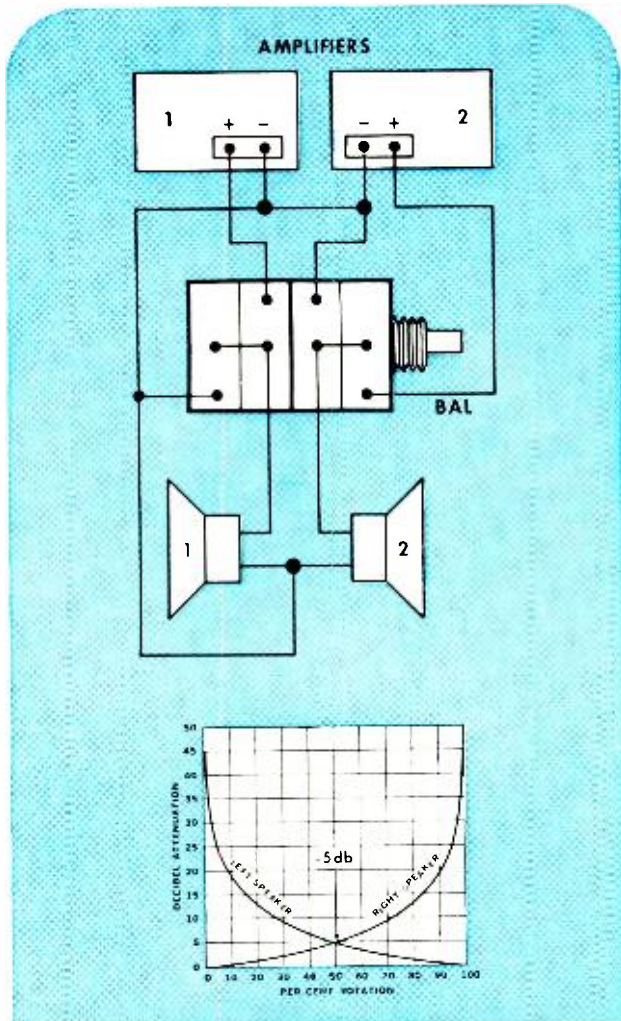

If your stereo system has the usual independent volume controls for each channel, you've probably gone through all sorts of headaches getting right and left in just the right balance. And just when you've finally brought the whole works into perfect shape, somebody twiddles the knobs. So then you start all over again . . . going back and forth between channels until everything comes out right.

We have a tip that can add an extra touch of convenience to your set up. It's the new Mallory stereo balance control (BAL 8 and BAL 16). It's a pair of L pads on the same shaft, back-to-back . . . or maybe head-to-toe describes it better. As you turn the shaft, one pad *increases* attenuation and the other *decreases*. They're both audio tapers, so that on each side of dead center you get a smooth, gradual change in attenuation with rotation; this makes fine adjustments of balance easier. The center point loss in both channels is only 5 db, which you'll never miss.

How about remote speakers? You can hook up a Mallory LL pad right in the speaker enclosure in minutes, and get on-the-spot control that won't disturb your main speakers. You'll save yourself many a trip back to the amplifier location . . . and this can be a real convenience when your remotes are in the recreation room or out on the porch. If you'd like to get a lower-cost control for inexpensive remote speakers, try the Mallory RR 50 dual rheostat.

Your Mallory Distributor is the one to see for audio controls . . . from miniature MRL, MRT and MRL pads up to the 50-watt MGL and MGT types. Plus handsome new PPS1 push-pull switches. And for everything else you need in capacitors, resistors, batteries and semiconductors. See him for a copy of our new general catalog . . . or write Mallory Distributor Products Company, a division of P. R. Mallory & Co. Inc., Indianapolis, Indiana 46206.

DON'T FORGET TO ASK 'EM — *“What else needs fixing?”*

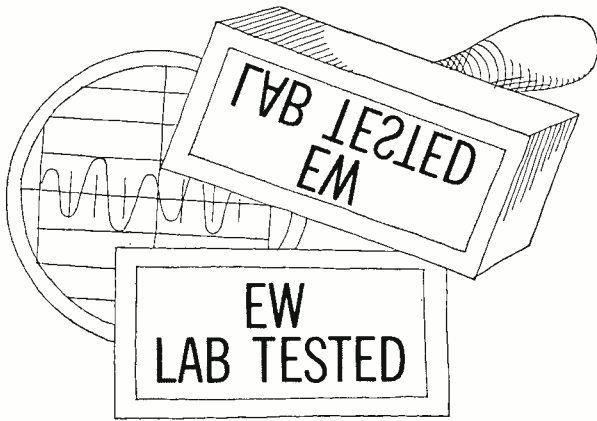

HI-FI PRODUCT REPORT

TESTED BY HIRSCH-HOUCK LABS

Scott 342 FM-Stereo Receiver
Ortofon S-15T Phono Cartridge

Scott 342 FM-Stereo Receiver

For copy of manufacturer's brochure, circle No. 33 on Reader Service Card.



THE Scott 342 is an FM-stereo receiver featuring field-effect transistors (FET's) in the front end for improved sensitivity and freedom from cross-modulation and having a total music-power rating of 50 watts into 8-ohm loads or 65 watts into 4 ohms. The FET, unlike an ordinary transistor, is able to handle a wide range of signal levels without the annoying cross-modulation which imposes the program of a strong station on that of a weaker station. It also has a very low internal noise figure, allowing sensitivities equaling or surpassing those of the best vacuum-tube tuners.

The FM-multiplex demodulator

switches automatically to stereo when a 19-kHz pilot carrier is present in the received signal, lighting a blue lamp on the dial face to indicate stereo reception. The automatic stereo switching is completely unambiguous and will not give any indication when it is tuning between stations or when it is being subjected to high-frequency modulation peaks from a mono broadcast. A switch on the panel disables the automatic FM feature and parallels the two channels for noise-free reception of weak stereo signals or for playing mono records with a stereo cartridge when it is desired to cancel vertical rumble components.

The 342 has inputs for a magnetic cartridge and a high-level extra source, selected by the switch on the panel which can also cut in a sub-channel filter for reduced noise on stereo-FM reception. Two degrees of phono sensitivity can be chosen by this switch to accommodate cartridges with high or low output levels. There are inputs and outputs for a tape recorder, with a front-panel switch to permit monitoring a recording from a three-head recorder while it is being made.

There are two pairs of speaker outputs, either of which can be selected by another switch on the panel. In the "Off" position of this switch, all speakers are disabled, and a pair of stereo phones can be plugged into the low-impedance output jack on the front panel.

The tone controls and volume control are concentric types with slip clutches. Channel balance is accomplished by holding one knob and adjusting the other volume control knob until the same level appears from each speaker. A balance switch on the panel facilitates this comparison by feeding the same signal to one speaker at a time as the controls are adjusted. There is also a noise-filter switch on the panel, reducing high-frequency response.

The tuning dial, a slide-rule type, operates very smoothly and is attractively and softly edge-lit. A tuning meter, indicating relative signal strength,

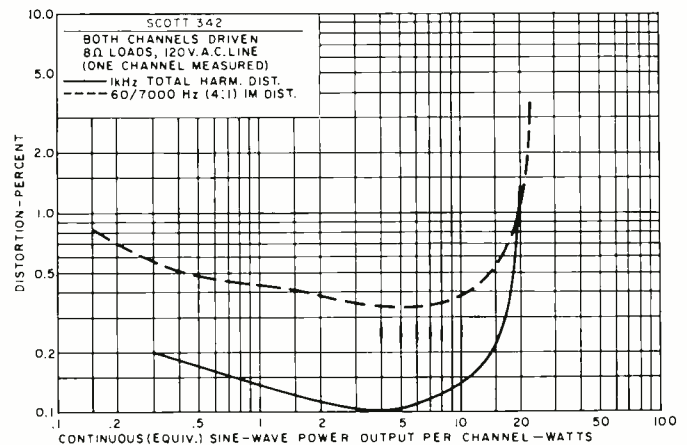
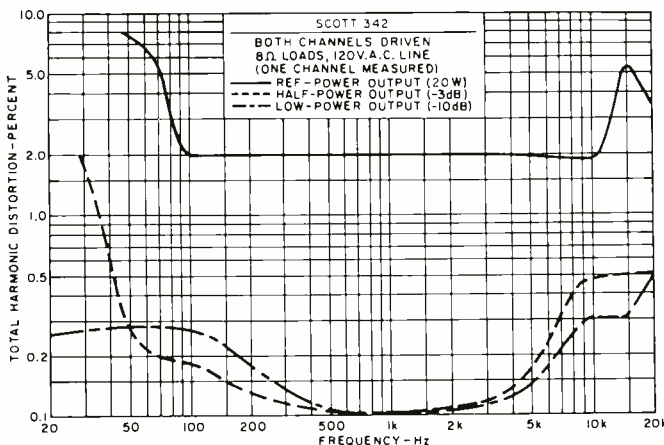

Your Sylvania distributor is up-to-date on your business. Use him: it's like adding an electronic consultant to your staff... free.

We keep him up-to-date with frequent reports and analyses of your maintenance and design needs. We give him plant tours and technical training. And ready access to Sylvania product and applications engineering staffs.

He knows the features of each and every tube we make. And he knows how *you* use them. He's up on the latest developments. He knows our competitors' tubes inside out, too.

Get a free analysis, by your Sylvania distributor, of your tube and semiconductor replacement needs. He can prevent emergencies, prepare an inventory--and save you money. He's an expert. Depend on him for service and for fast delivery--in any quantity.

Sylvania Electronic Tube Division, Electronic Components Group, Seneca Falls, New York 13148.

SYLVANIA
SUBSIDIARY OF
GENERAL TELEPHONE & ELECTRONICS **GTE**

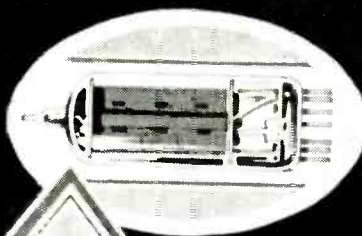

Thinking of college
and a
space age career in
electronics?

How to prepare for
YOUR CAREER
in Engineering Technology and Engineering

MSOE
MILWAUKEE SCHOOL OF ENGINEERING

Send for this booklet on
**ENGINEERING TECHNOLOGY
AND ENGINEERING**

Learn how you can prepare for a dynamic career as an electrical or mechanical engineering technician or engineer in such exciting, growing fields as avionics, missiles, reliability control, fluid mechanics, data processing, metallurgy, microelectronics, and advanced aerospace research.

MSOE offers residence study programs leading to these degrees in engineering technology and engineering:

2 years—Associate in Applied Science
4 years—Bachelor of Science

Also get facts about scholarships and financial aids, job placement and other student services, plus photographs of MSOE technical laboratories and student activities. For your copy, just mail the coupon — no obligation.

Programs approved for veteran training.

MSOE

Milwaukee School of Engineering
Dept. EW-367 1025 N. Milwaukee St.,
Milwaukee, Wisconsin 53201

Please send the "Your Career" booklet.
I'm interested in
 Electrical fields Mechanical fields

Name.....Age.....

Address.....

City.....State.....ZIP.....

MS-289

CIRCLE NO. 106 ON READER SERVICE CARD
16

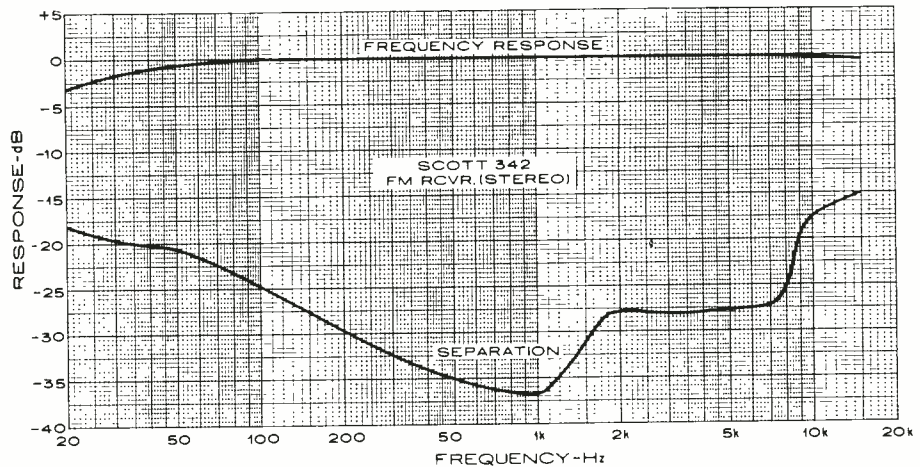

is deeply recessed into the dial area and can only be seen from the front of the receiver. It read nearly full scale on all signals we could hear so that it was not too useful as an aid to antenna orientation, although it served very well to show the optimum tuning point (which was quite non-critical).

In our laboratory measurements, the IIF usable sensitivity of the Scott 342 was 1.9 microvolts, slightly better than the rated 2.2 microvolts. The steep limiting curve shows that limiting is complete at 4 microvolts. This was evident in listening tests, in which every signal we heard (and they were many) was of excellent quality, free from background noise. The audio level did not change more than 0.5 dB from 2 microvolts to 200,000 microvolts input, emphasizing the remarkably effective a.g.c. and limiting action of the receiver.

Stereo-FM separation was better than 35 dB at mid-frequencies and better than 25 dB from 100 Hz to 8000 Hz. The audio amplifiers delivered 20 watts (continuous power output) per channel into 8 ohms, about 25 watts into 4 ohms, and 18 watts into 16 ohms. These measurements were made with both channels driven and are consistent with the music-power rating of the amplifier.

Distortion at full power was 2% from 100 Hz to 10,000 Hz. At half power, distortion was under 0.5% from 45 Hz to 20,000 Hz and was in the vicinity of 0.1% over much of that range. At 2 watts output, the distortion was under 0.3% from 20 Hz to 15,000 Hz. Measuring total harmonic distortion at 1000 Hz, we found it to be under 0.2% from 0.3 watt to 15 watts. The IM distortion averaged about 0.5% over most of the power range from below 0.5

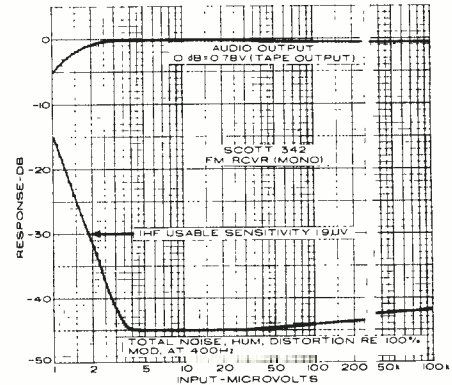

watt to 15 watts, reaching 1% at 20 watts output.

For reasons not immediately evident, the designers have applied loudness compensation to the volume control, with no means of disabling it. Since the volume control is normally set below the 12:00 o'clock position, where the bass boost of the compensation becomes quite pronounced, the sound has a heavy quality which we found disturbing. Reducing the bass response with the tone control corrects this effect fairly well, but we wish that a switch had been provided to disable the compensation.

In all other respects, the receiver performed admirably and is difficult to find fault with. Its sensitivity was most impressive, as was the total freedom from crosstalk under conditions which have proved to be too severe for many other receivers we have tested. The audio performance was first-rate, once the bass tone control was set to compensate for the bass boost of the volume (loudness) control. Hum and noise were inaudible.

The price of the Scott 342 is \$299.95. ▲

Ortofon S-15T Phono Cartridge

For copy of manufacturer's brochure, circle No. 34 on Reader Service Card.

THE name of Ortofon has long been associated with moving-coil cartridges of superior quality. The firm's new S-15T stereo cartridge contains several refinements which, combined with state-of-the-art performance, give

it a place among the elite of phono reproducers.

The Danish-made S-15T has a 0.3 × 0.7 mil elliptical diamond stylus, with an equivalent tip mass of 0.9 milli-
(Continued on page 74)

fill the gaps... WITH A COMPLETE SELECTION OF ANNUALS, YEARBOOKS, DIRECTORIES AND HANDBOOKS

from the world's largest publisher of special interest magazines. Take a moment to review the titles and issues currently available. You're sure to find many of your favorites to help complete your library and fill those wide open spaces on your bookshelves.



PHOTOGRAPHY ANNUAL

A selection of the World's finest photographs compiled by the editors of Popular Photography. 212 pages—24 in full color.

- 1967 — \$1.50 #38
- 1966 — \$1.25 #1
- 1964 — \$1.25 #3

ELECTRONIC EXPERIMENTER'S HANDBOOK

Many challenging projects for the electronics hobbyist.

- 1966 — Fall Edition—\$1.25 #39
- 1966 — Spring Edition—\$1.25 #36
- 1965 — Fall Edition—\$1.25 #9
- 1965 — Spring Edition—\$1.25 #14

CAR & DRIVER YEARBOOK

A complete buyers guide covering virtually every car available in the United States... Road tests... Technical specifications... Accessories and performance equipment buying guide... Guide to racing with action-packed photos.

- 1967 — \$1.50 #40
- 1966 — \$1.25 #15
- 1965 — \$1.25 #17

INVITATION TO PHOTOGRAPHY

A unique 116 page guide to better picture taking by the Editors of Popular Photography. Basic down-to-earth advice that helps you eliminate costly trial and error, time-consuming guess work. 20 complete, fact-and-photo packed articles in all.

- 1966 — \$1.25 #35



PHOTOGRAPHY DIRECTORY

World's most complete photographic buying guide.

- 1967 — \$1.25 #41
- 1966 — \$1.25 #22

TAPE RECORDER ANNUAL

Everything you need to know about tape recording including a complete directory of mono and stereo recorders.

- 1967 — \$1.25 #42
- 1966 — \$1.25 #30
- 1965 — \$1.00 #31

ELECTRONICS INSTALLATION AND SERVICING HANDBOOK

The only complete guide for servicemen and hobbyists to every major phase of consumer electronics servicing.

- 1967 — \$1.25 #43
- 1966 — \$1.25 #32

FLYING ANNUAL

The most valuable aviation yearbook ever compiled... Pilot reports... Aircraft directory... How to buy a used airplane... Navcom directory... Learn to fly section.

- 1967 — \$1.50 #44
- 1966 — \$1.25 #27
- 1965 — \$1.25 #28



STEREO/Hi-Fi DIRECTORY

Complete buyers guide for virtually every Hi-Fi component manufactured.

- 1967 — \$1.25 #45
- 1966 — \$1.25 #29

POLAROID LAND PHOTOGRAPHY

Complete guide and only comprehensive and up-to-date handbook on Polaroid Land Photography.

- 1966 — \$1.25 #24
- 1963 — \$1.00 #25

SKIING INTERNATIONAL YEARBOOK

A luxuriously illustrated compendium of 1966's important events... A timely forecast of the excitement-packed 1967 season —by the editors of Skiing Magazine.

- 1967 — \$1.25 #48
- 1966 — \$1.25 #26

FLYING'S 1966 TRAVELGUIDE

Here's the first really useful guide to flying vacations. Everything you need to know about: lodgings, restaurants, resorts, sightseeing, recreation, sports activities, airport facilities, children's fun, price information, special information for the gals —and much more.

- 1967 — \$1.25 #46
- 1966 — \$1.25 #34

COMMUNICATIONS HANDBOOK

The most complete and up-to-date guide to the exciting world of specialized radio communications.

- 1967 — \$1.25 #47
- 1966 — \$1.25 #18
- 1965 — \$1.00 #19
- 1964 — \$1.00 #20

TO PLACE YOUR ORDER, circle the numbers of the annuals you wish to receive on the coupon, clearly print your name and address and enclose your remittance. Please be sure to enclose an additional 15¢ shipping and handling for each copy ordered. Add 50¢ per copy for orders outside U.S.A.

Ziff-Davis Service Division—Department W • 595 Broadway, New York, N. Y. 10012

I am enclosing \$_____ for the annuals circled below. My remittance includes an additional 15¢ per copy for shipping and handling (50¢ for orders outside U.S.A.). I understand quantities are limited and orders will be filled on a first come-first served basis.

1 3 9 14 15 17 18 19 20 22 24 25 26 27 28 29
30 31 32 34 35 36 38 39 40 41 42 43 44 45 46 47 48

Name _____

Address _____

City _____ State _____ Zip Code _____

PAYMENT MUST BE ENCLOSED WITH ORDER

You can earn more money if you get an FCC License

...and here's our famous CIE warranty that you will get your license if you study with us at home

NOT SATISFIED with your present income? The most practical thing you can do about it is "bone up" on your electronics, pass the FCC exam, and get your Government license.

The demand for licensed men is enormous. Ten years ago there were about 100,000 licensed communications stations, including those for police and fire departments, airlines, the merchant marine, pipelines, telephone companies, taxicabs, railroads, trucking firms, delivery services, and so on.

Today there are over a million such stations on the air, and the number is growing constantly. And according to Federal law, no one is permitted to operate or service such equipment without a Commercial FCC License or without being under the direct supervision of a licensed operator.

This has resulted in a gold mine of new business for licensed service technicians. A typical mobile radio service contract pays an average of about \$100 a month. It's possible for one trained technician to maintain eight to ten such mobile systems. Some men cover as many as fifteen systems, each with perhaps a dozen units.

Coming Impact of UHF

This demand for licensed operators and service technicians will be boosted again in the next 5 years by the mushrooming of UHF television. To the 500 or so VHF television stations now in operation, several times that many UHF stations may be added by the licensing of UHF channels and the sale of 10 million all-channel sets per year.

Opportunities in Plants

And there are other exciting opportunities in aerospace industries, electronics manufacturers, telephone companies, and plants operated by electronic automation. Inside industrial plants like these, it's the licensed technician who is always considered first for promotion and in-plant training programs. The reason is simple. Passing the Federal government's FCC exam and getting your license is widely accepted proof that you know the fundamentals of electronics.

So why doesn't everybody who "tinkers" with electronic components get an FCC License and start cleaning up?

The answer: it's not that simple. The government's licensing exam is tough. In fact, an average of two out of every three men who take the FCC exam fail.

There is one way, however, of being pretty certain that you will pass the FCC exam. And that is to take one of the FCC home study courses offered by the Cleveland Institute of Electronics.

CIE courses are so effective that better than 9 out of every 10 CIE-trained men who take the exam pass it...on their very first try! That's why we can afford to back our courses with the iron-clad Warranty shown on the facing page: you get your FCC License or your money back.

There's a reason for this remarkable record. From the beginning, CIE has specialized in electronics courses designed for home study. We have developed techniques that make learning at home easy, even if you've had trouble studying before.

In a Class by Yourself

Your CIE instructor gives his undivided personal attention to the lessons and questions you send in. It's like being the only student in his "class." He not only grades your work, he analyzes it. Even your correct answers can reveal misunderstandings he will help you clear up. And he mails back his corrections and comments the same day he receives your assignment, so you can read his notations while everything is still fresh in your mind.

It Really Works

Our files are crammed with success stories of men whose CIE training has gained them their FCC "tickets" and admission to a higher income bracket.

Mark Newland of Santa Maria, Calif., boosted his earnings by \$120 a month after getting his FCC License. He says: "Of 11 different correspondence courses I've taken, CIE's was the best prepared, most interesting, and easiest to understand."

Once he could show his FCC License, CIE graduate Calvin Smith of Salinas, California, landed the mobile phone job he'd been after for over a year.

Mail Card for Two Free Books

Want to know more? The postpaid reply card bound-in here will bring you free copies of our school catalog describing opportunities in electronics, our teaching methods, and our courses, together with our special booklet, "How to Get a Commercial FCC License." If card has been removed, just send your name and address to us.

THESE CIE MEN PASSED... NOW THEY HAVE GOOD JOBS

Matt Stuczynski,
Senior Transmitter
Operator, Radio
Station WBOE

"I give Cleveland Institute credit for my First Class Commercial FCC License. Even though I had only six weeks of high school algebra, CIE's AUTO-PROGRAMMED™ lessons make electronics theory and fundamentals easy. I now have a good job in studio operation, transmitting, proof of performance, equipment servicing. Believe me, CIE lives up to its promises."



Chuck Hawkins,
Chief Radio
Technician, Division
12, Ohio Dept.
of Highways



"My CIE Course enabled me to pass both the 2nd and 1st Class License Exams on my first attempt...I had no prior electronics training either. I'm now in charge of Division Communications. We service 119 mobile units and six base stations. It's an interesting, challenging and rewarding job. And incidentally, I got it through CIE's Job Placement Service."

Glenn Horning,
Local Equipment
Supervisor, Western
Reserve Telephone
Company

"There's no doubt about it. I owe my 2nd Class FCC License to Cleveland Institute. Their FCC License Course really teaches you theory and fundamentals and is particularly strong on transistors, mobile radio, troubleshooting and math. Do I use this knowledge? You bet. We're installing more sophisticated electronic gear all the time: what I learned from CIE sure helps."



ENROLL UNDER NEW G.I. BILL: All CIE courses are available under the new G.I. Bill. If you served on active duty since January 31, 1955, OR are in service now, check box on reply card for G.I. Bill information.

CIE Cleveland Institute of Electronics
1776 E. 17th St., Dept. EW-29, Cleveland, Ohio 44114

Accredited by the Accrediting Commission of the National Home Study Council, and the only home study school to provide complete coverage of electronics fundamentals plus such up-to-date applications as: Microminiaturization • Laser Theory and Application • Suppressed Carrier Modulation • Single Sideband Techniques • Logical Troubleshooting • Boolean Algebra • Pulse Theory • Timebase Generators...and many more.

ELECTRONICS WORLD



Cleveland Institute of Electronics

WARRANTY

of success in obtaining a Government FCC License

The Cleveland Institute of Electronics hereby warrants that upon completion of the Electronics Technology, Broadcast Engineering, or First-Class FCC License course, you will be able to pass the FCC examination for a First Class Commercial Radio Telephone License (with Radar Endorsement);

OR upon completion of the Electronic Communications course you will be able to pass the FCC examination for a Second Class Commercial Radio Telephone License;

AND in the event that you are unable to pass the FCC test for the course you select, on the very first try, you will receive a FULL REFUND of all tuition payments.

This warranty is valid for the entire period of the completion time allowed for the course selected.

G. O. Allen

G. O. Allen
President

Going to profit here?

Then profit here.

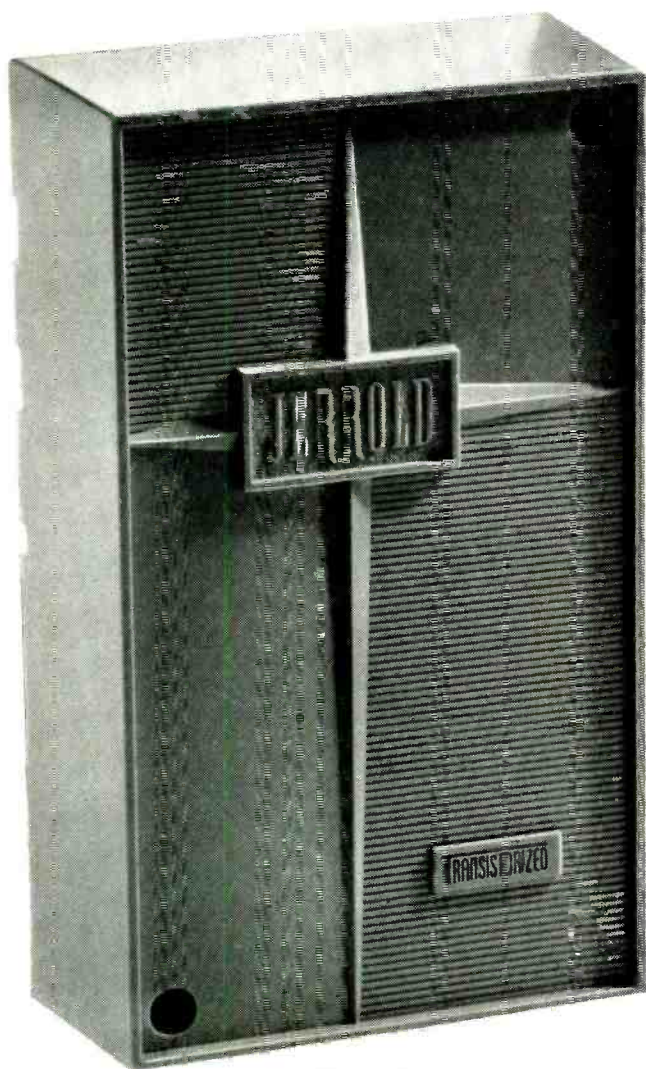

82 Channel TAC-4
List Price \$72.50

VHF Only Model TC-88
List Price \$39.95

New Jerrold 82 Channel Coloraxial Home System makes perfect sales mate with Color TV Antennas

Look around you. Every home—every new housing development—is a potential profit-making sales spot for you and the TAC-4 Home Master TV System. Here's why:

TAC-4 makes good color TV go a long way. Every color TV set needs a top-grade antenna for good reception. TAC-4 makes this good reception possible anywhere in the house by providing extension antenna outputs in various rooms for portable TV and FM sets as well as extra sets. *You can tie-in a TAC-4 with every antenna sale.* And don't forget, it's a handy sales feature that housing developers like to use to help sell a home.

TAC-4 handles all 82 TV channels (color and black and white) as well as FM. It's the industry's *first* amplified coupler that can handle all present and future channels. Just connect the antenna to the input

and then connect four or more sets to the outputs.

TAC-4 is easy to install. Coaxial inputs and outputs make connections simple. Coaxial cable can be run right along with other electric wires—without interference with the signal. And cail backs are practically unheard of because the amplifier is completely solid-state.

TAC-4 pleases customers. It's the first truly professional installation for assuring better TV and FM reception anywhere in the house. It's the superior amplifier-coupler to sell with any TV set or antenna such as the Jerrold Pathfinder series. Sell them together. Customers get top reception. You get top profits.

For more details, see your distributor.

JERROLD

DISTRIBUTOR SALES DIVISION
401 Walnut St., Phila., Pa. 19105

CIRCLE NO. 112 ON READER SERVICE CARD

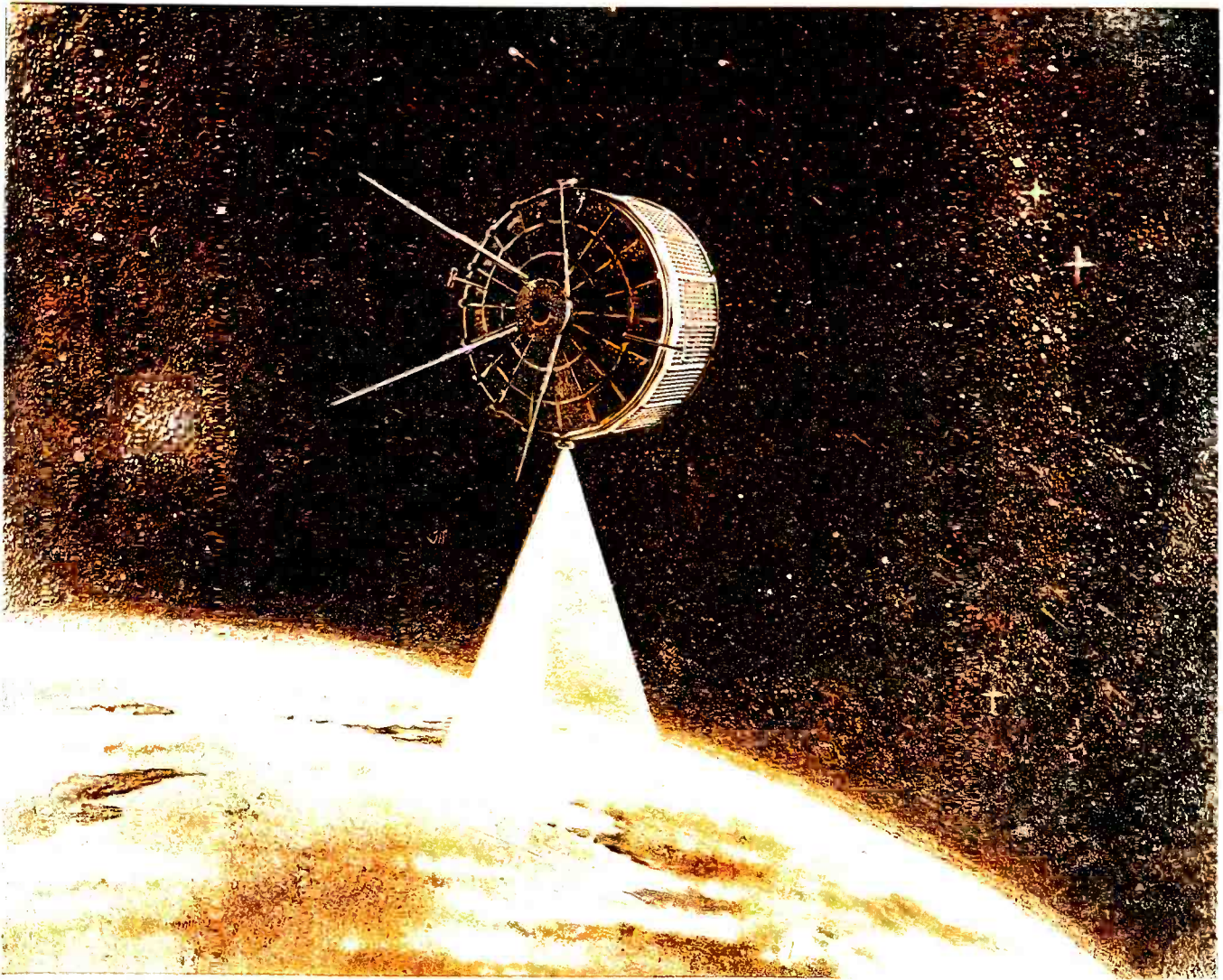

The new "cartwheel" Tiros photographs the earth as the satellite rolls along like a wheel in a near-polar orbit.

Weather Surveillance by Satellite

Tiros, Nimbus, and successor ESSA satellites are providing global weather information that may one day lead to global weather control.

By JOSEPH H. WUJEK, Jr.

To a great extent, man has learned to use the forces of nature beneficially. A notable exception is our inability to control those forces in nature which we know collectively as *weather*. Weather plays an important part in the social and economic well-being of a nation. Agricultural output is strongly tied to the weather, as is the movement of ships at sea, aircraft, and land transport. Indeed, commerce as a whole depends to some degree on the behavior of the elements. In war as in peace, a nation's fate may be decided by the perversities of the weather. The defeat of the Spanish Armada, as well as the defeat of Napoleon's armies on the plains of Russia, were due in large measure to severe weather conditions.

In view of all this, it is not surprising that meteorologists are continually searching for new tools to aid them in understanding the weather. With increased knowledge of weather comes the ability to predict the kind of weather a region will experience. President Johnson, when Vice-President and Chairman of the National Aeronautics and Space

Council, estimated the saving which our nation could realize if accurate weather predictions were available *only five days in advance*. These yearly savings include: \$2.5 billion in agriculture; \$45 million in the lumber industry; \$100 million in surface transportation; \$75 million in retail marketing; and \$4 billion in water resources management. Beyond these dollar savings, we have the priceless savings in human life which result when hurricanes, tidal waves, and the like are detected in advance. Clearly, then, research into the nature of weather will have a profound effect upon our welfare.

Until early 1960, meteorologists were somewhat earth-bound in their measurements of weather phenomena. True, aircraft and weather balloons were launched to measure wind speed, barometric pressure, and other weather variables. Later, sounding rockets were also used to obtain these measurements. But these measurements are somewhat localized in that only a small region of the atmosphere or stratosphere is sampled. And, as we know, weather is by



This view of the Nile River and its Delta, the Red Sea, and the eastern Mediterranean was taken by Tiros III from an altitude of 400 miles.

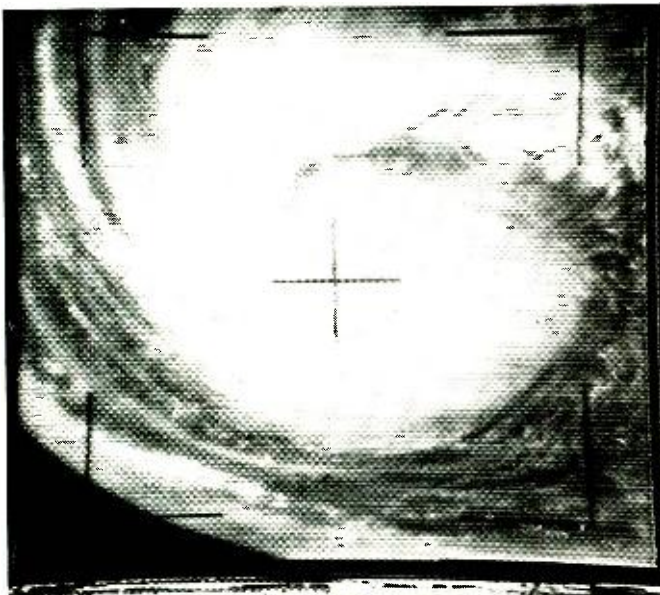

The vortex of the Hurricane Daisy photographed several year ago off the east coast of the United States by the Tiros V satellite.

no means predictable by immediate local conditions. A storm front in the far reaches of Canada's Hudson Bay on Tuesday can create havoc with cattle ranches in North Dakota on Thursday. Even with many remote weather stations positioned at strategic points around the world, severe weather conditions can be building up while unobserved by these stations. A system for weather surveillance which could survey large sectors of the earth was urgently needed.

The Tiros Satellite System

The Tiros (Television Infra-Red Observation Satellite) series provides a partial solution to this requirement. These vehicles, equipped with television cameras and infrared (IR) radiometers, gather data for analysis by meteorologists within hours after the observation. The first in the series, Tiros I, was launched from Cape Kennedy on April 1, 1960. At this writing, ten Tiros satellites have been launched.

Table 1. Specs for Thor-Delta booster which launched Tiros.

STAGE	FUEL	THRUST (lbs)	BURN TIME
First	Liquid	170,000	2 min, 25 sec
Second	Liquid	7,500	2 min, 40 sec
Third	Solid	3,000	40 sec

The Tiros is an 18-sided vehicle, 22 inches high by 42 inches in diameter, weighing about 300 pounds. Each of the 18 faces of the satellite is an array of solar cells. These 9000 solar cells furnish charging current for the 63 nickel-cadmium cells which furnish power throughout orbit. Two 18-inch receiving antennas extend from the top of the satellite and are used to receive ground commands. Four 22-inch telemetry transmitting antennas are located on the underside of the package. Tiros I through VIII had two vidicon TV cameras mounted on the underside of the satellite. Later Tiros spacecraft have side-looking TV cameras mounted on opposite sides.

The Tiros series is put into orbit by the three-stage Thor-Delta launch vehicle. Table 1 gives important specifications for this space booster. For some perspective, recognize that jet engines used on modern commercial airliners have typical ratings of 16,000 pounds thrust per engine. Hence, the first stage alone of the launch vehicle delivers more thrust than ten of these aircraft engines. Launch vehicles have since been developed which generate more than *two million* pounds of thrust.

Tiros orbits range from 450 miles to 860 miles, with periods (time for one revolution) of 90 minutes to 113 minutes, respectively. At the 450-mile orbit a region on earth of 800 to 1000 miles in diameter is covered by one transmitted TV picture.

Tiros I through VIII were placed in a general east-west orbit, resulting in coverage of about 25% of the earth's surface. Later Tiros launches resulted in a north-south, or polar orbit. The polar orbit permits coverage of nearly all the earth's surface. The polar orbit is also selected so as to be nearly synchronous with the sun. The sun-sync orbit results in backlighting from the sun during the northward pass of the satellite, producing high-quality photographs.

Tiros I-VII made use of a focal-plane shutter in conjunction with the two vidicon TV cameras. Pictures are stored on the tube face and converted to data bits for storage on magnetic tape or direct readout by ground stations. Each orbit results in 64 pictures, or 32 pictures per tape. Transmission of data to the ground station requires about three minutes. The data transmission simultaneously erases the magnetic tapes for the next data-gathering pass. The operation of the readout system as well as the timing of the picture-taking sequence is accomplished by ground command. The ground command sets timers which activate the camera system when the satellite passes over the region of interest.

Starting with Tiros VIII, a new system of data readout was used. The new system is designated Automatic Picture Transmission (APT). Rather than construct a TV picture line by line, electronically photograph the screen, and then store or transmit, APT uses a system similar to that used by newspapers and the press services to transmit photos. A facsimile recorder then reproduces the picture as received.

Ground receiving stations for Tiros are Wallops Island, Virginia; San Nicolas, California; and Fairbanks, Alaska. Over-all direction of the Tiros system stems from Goddard Space Flight Center, Greenbelt, Maryland. These stations are capable of receiving data when the satellite draws to within 1500 miles of the station. The received pictures are photographed by 35-mm camera for immediate analysis by meteorologists. In particular, these photos reveal conditions of cloud cover as well as the presence of hurricane conditions.

In addition to the TV camera, infrared radiometers measure the amount of reflected and absorbed solar IR energy. The amount of IR energy absorbed and reflected determines the heat balance of the earth and therefore affects the weather. The IR data is transmitted and received as non-photographic data. This data is later reduced and plotted on weather maps for analysis. While the IR data is not immediately useful to meteorologists, it never-

theless provides a kind of long-range insight into the weather behavior of our planet.

The initial design of Tiros called for a mission life of three to four months. The first Tiros was operational for 2½ months. Later Tiros vehicles operated for well over one year. In the first three years of operation some 300,000 TV photographs were transmitted. Tiros I completed 1302 orbits and relayed 22,592 pictures to ground stations.

As seen in the accompanying photographs, Tiros has produced some startling results. Of particular importance were other photos taken by Tiros III in Sept. 1961. These photos revealed the build-up of Hurricane Carla. As a result of this early warning, approximately 350,000 persons withdrew from the storm region involved and injuries and loss of life were held to an absolute minimum.

Second-Generation Satellites

In addition to the ten Tiros launchings, two each ESSA (Environmental Survey Satellite) and the Nimbus satellites that have been orbited.

The ESSA satellites are similar to the earlier Tiros systems and operate in the "cartwheel" mode. ESSA I was launched on February 3, 1966 and carried two half-inch vidicon TV cameras into a circular 460-mile-high polar orbit, having a period of about 100 minutes. ESSA II carried two APT cameras into a circular 860-mile-high polar orbit with a 113-minute period. NASA plans to keep two ESSA satellites in orbit at all times. As one ESSA vehicle ceases to transmit, a replacement will be launched. The ESSA satellites represent the operational system for which the Tiros vehicles were the research and development packages.

The Nimbus represents a more sophisticated weather satellite system. In particular, Nimbus is not restricted to photographing the earth during daylight. By means of its high-resolution infrared radiometer (HIRR) system, night photos are obtained. These photos appear as dark or light regions, depending on whether more or less heat is radiated, respectively.

In addition to the HIRR system, three vidicon cameras are used. From an orbit of 575 miles, resolution of one-half mile is possible. The APT system was also flown on the Nimbus.

Nimbus I was moderately successful after launch on August 28, 1964. The second stage of the launch vehicle did not burn as long as required, resulting in an elliptical orbit of 252 miles perigee and 578 miles apogee, rather than the planned circular 575-mile orbit. The satellite transmitted many useful photos until a solar panel locked and was thus unable to track the sun. As a result, Nimbus I ceased operation on September 23, 1964.

Nimbus II was successfully launched May 15, 1966, carrying HIRR, APT, and vidicon systems. NASA plans to launch a Nimbus satellite approximately every 18 months. Future vehicles

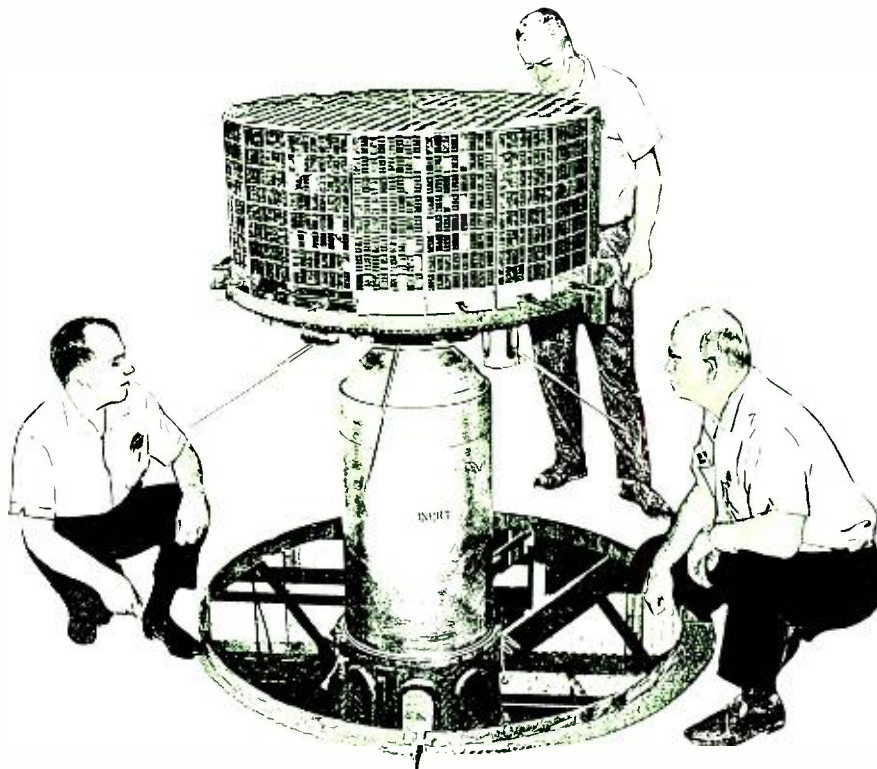

The Tiros VII being checked out prior to its launch into space.

will serve to test new systems for improved weather observations.

The Tiros vehicles and successors form the Tiros Operational System (TOS), which is a joint undertaking of the U.S. Weather Bureau and NASA. In addition to the benefits already listed, the Tiros system may provide scientists with new insight into such phenomena as clear-air turbulence (CAT) and the nature of the "jet-stream."

Perhaps history will someday show that Tiros provided a significant advance toward a goal we have desired, *control* of the weather. A system of sophisticated Tiros-like satellites, relaying weather data to a central computer which directs corrective (and as yet unknown) action to smooth the weather, is presently but a dream. But the translation from dream to design to hardware has been foreshortened considerably as our technology advances. ▲

The APT ground receiving system uses fairly simple, inexpensive ground-based equipment which employs conventional facsimile recorder.

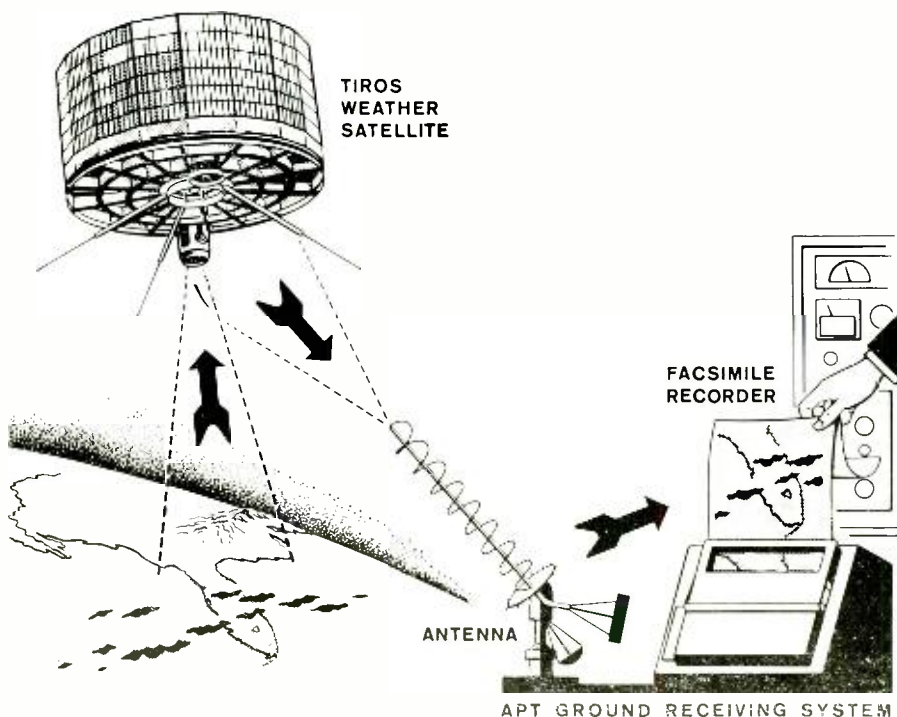

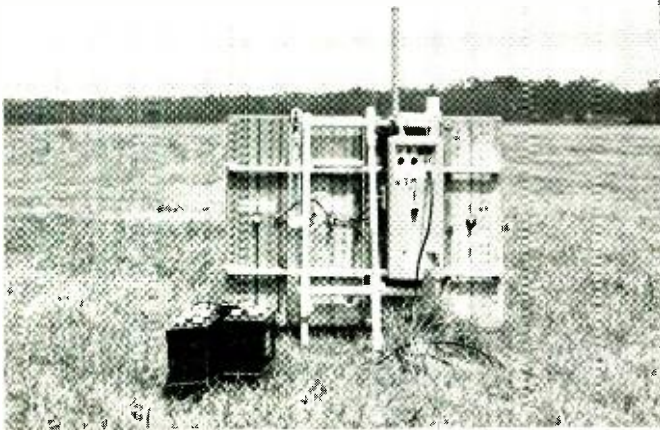

RECENT DEVELOPMENTS IN ELECTRONICS

Portable Landing System. (Top left) An Air Force twin-jet trainer is shown making an accurate approach over a portable ground station during technical evaluation at Wright-Patterson Air Force Base. When interrogated, the ground unit provides range and range rate as well as conventional glide path and localizer information to enable the pilot to remain in full command during approach and landing. The system is being developed by Honeywell to meet pressing military requirements for an effective all-weather landing system in remote combat areas. The system operates on the C band (5100 MHz) and has a range of 10 nautical miles. Four foldable flat-plate antenna arrays are used along with an omnidirectional antenna, control box, and optical bore-sight, all mounted on a tripod. It can be set up and aligned by one man in five minutes. Power is supplied by a motor generator, with standby 28-volt batteries. The present prototype weight is 55 pounds but this can be reduced.



Computer-Generated Vocal-Tract Model. (Center) Accurate synthetic speech is now being produced with the aid of a controllable, computer-generated model of the vocal tract developed at Bell Labs. The model, based on information stored in a computer, is actually a geometric description of vocal-tract areas as they are shaped to produce various sounds. When synthesizing speech, a researcher can see an outline of the vocal tract displayed on an oscilloscope and, at the same time, hear the sound which corresponds to the displayed shape. By operating switches and turning knobs at a computer console, the researcher can change shape and sound simultaneously. Thus, synthetic speech is improved.

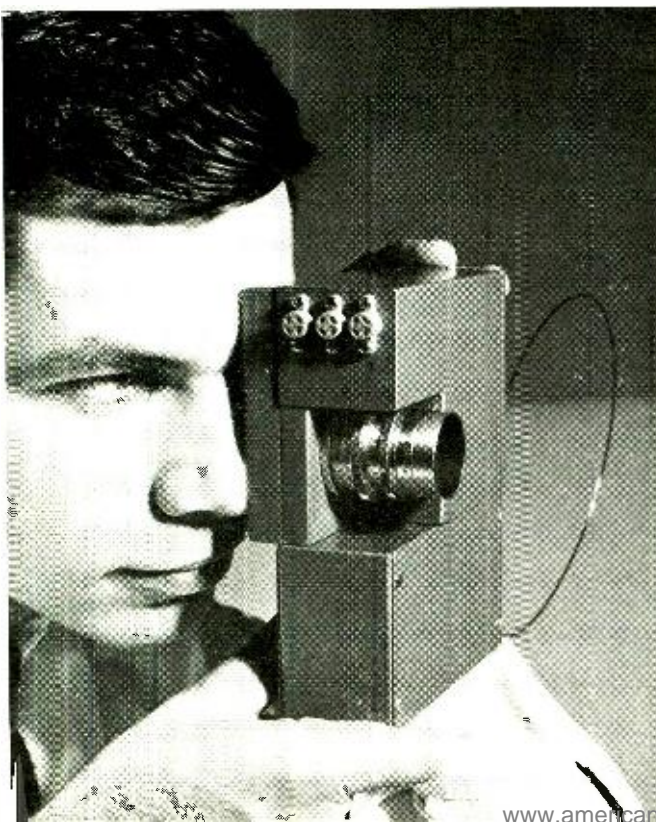

Tubeless TV Camera. (Bottom left) A revolutionary tubeless TV camera is being demonstrated here by RCA Laboratories technician, prior to its delivery to the U.S. Air Force Avionics Laboratory, sponsor of the development. The device is described as a first step toward a new era of personal TV communication systems, with eventual application in military, space, medical, industrial, and home functions. The camera employs arrays of 132,000 thin-film elements deposited on four glass slides only one-inch square to perform functions similar to those of a pickup tube and picture-processing elements in a standard TV camera. Contained in the lower portion of the device as shown here is a miniature transistorized transmitter that broadcasts picture signals to a special receiver that is located across the room.

Applications Technology Satellite. (Right) This is the new 790-lb satellite that was launched from Cape Kennedy early in December. This satellite, the ATS-1, is expected to bring practical benefits to mankind from space technology. It has already been placed in a synchronous orbit at the intersection of the Equator and the International Date Line. From this point it has relayed conversations between a ground flight controller in the U.S. to a number of commercial and government aircraft flying over the Pacific and the United States. It has also photographed weather conditions and relayed color-TV signals. Five ATS satellites are being built by Hughes.

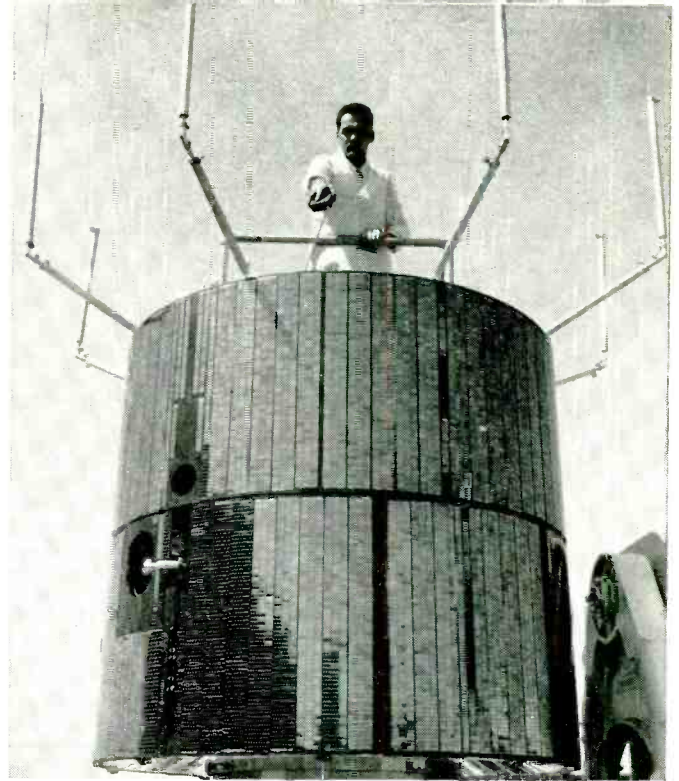

VOR Radio-Range Antenna System. (Center) Resembling a giant mushroom ring, these antennas guide jet aircraft in rugged mountains near Ruedesheim, Germany. Previous systems were afflicted with dangerous errors due to reflections of the radio waves from the craggy mountain peaks. The antenna system, developed by Standard Elektrik Lorenz, ITT subsidiary, is employed in a doppler v.h.f. omnidirectional radio range. The pattern of the new VOR antenna is identical with that of the standard system and aircraft equipment need not be modified.

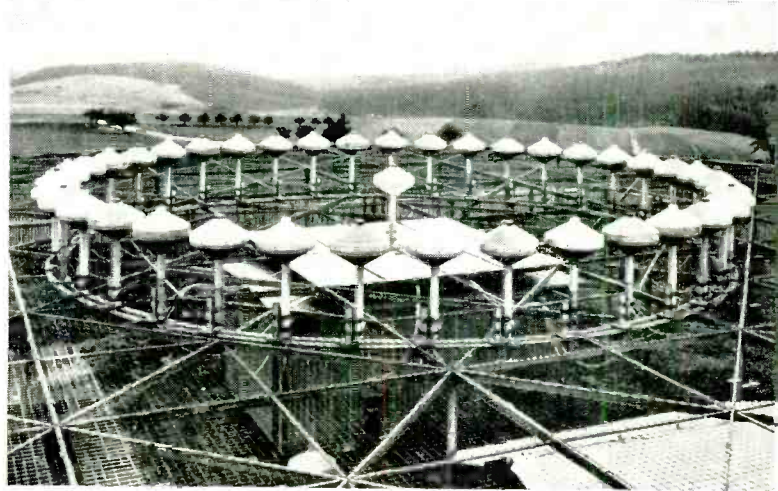

CCTV Weather Briefing System. (Below left) Weathervision—a closed-circuit television system for briefing pilots on weather and flight conditions—is to be used by our Strategic Air Command and Tactical Air Command in the U.S. and Europe. The closed-circuit camera scans information displayed on the console, then relays the picture to monitors in briefing rooms distant from the central control point. Two-way audio hookup permits conversation between briefing officer and pilots. Some 72 such systems are being installed at 67 bases under a \$3 million contract awarded to Canoga Electronics.

High-Speed Fiber-Optic CRT Oscillograph. (Below right) A new recording oscillograph which makes use of a special fiber-optic cathode-ray tube to achieve unprecedented direct print-out writing speeds is shown here. The measured signal, also monitored by the small scope at the upper right, is recorded on 6-in-wide photosensitive paper that passes over the face of the tube during operation. The instrument, introduced by Honeywell, will measure and record high-frequency analog data at up to one million hertz, and has a data print-out capability nearly 100 times faster than any other direct-write system on the market. Writing speed is more than a million inches/sec.

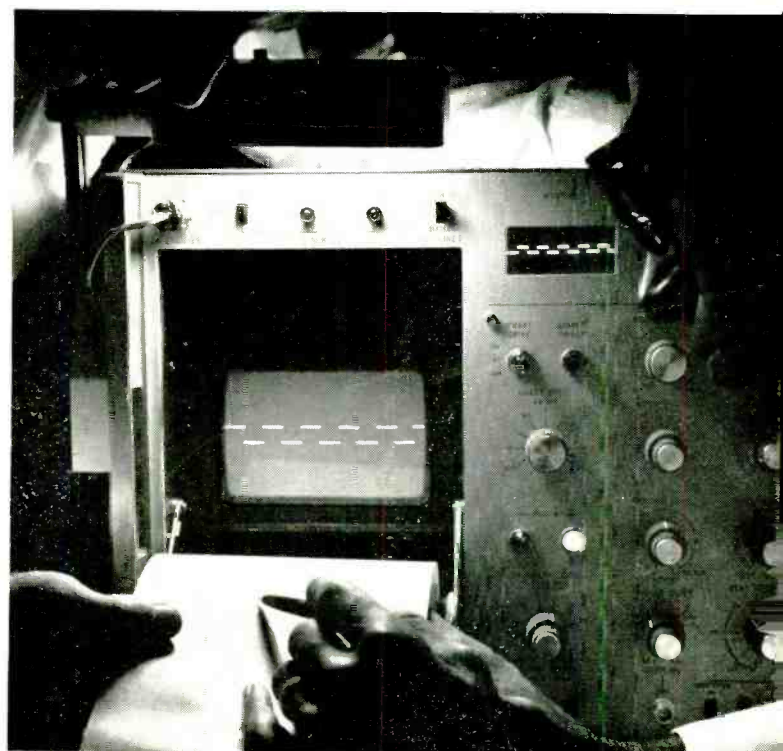
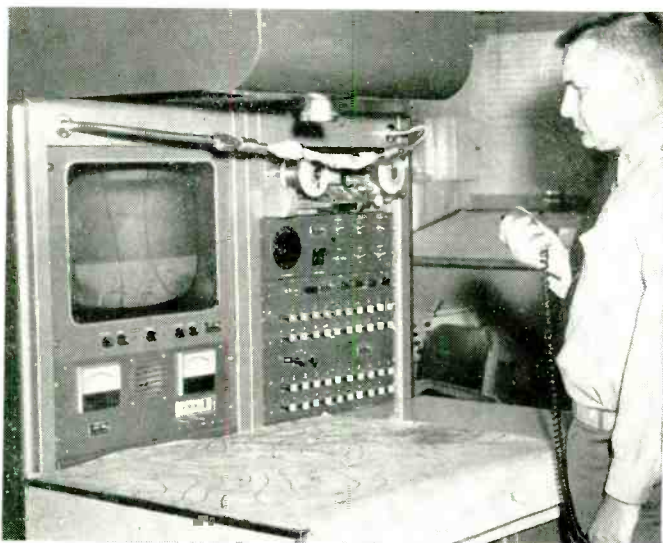

COVER STORY

THE group of products on our cover this month are representative examples of Citizens Band and Business Radio equipment. We have included a number of transceivers, as well as some test equipment and antennas for these services. Each product has been keyed with a number to match the descriptions given in the following paragraphs.

(1) *International Crystal C-12B* frequency meter is a portable secondary frequency standard designed to service CB transmitters and receivers. The meter comes with 23 crystals installed covering the 23 channels. Frequency accuracy is $\pm 0.0015\%$. The beat-frequency method of frequency checking is used with the difference frequency between the unit being checked and the crystal standard being counted directly displayed on a meter. The meter also includes a modulation checker and power-output meter. (Price: \$300)

(2) *Polytronics "Poly-Comm B"* and "Poly-Comm RC-1" are a Business Radio transmitter-receiver unit and a remote-control head for this unit. This equipment is designed to transmit and receive phase-modulated signals on one channel in the 27.29 to 35.98 MHz Business Radio band. Plate power input to the final is 18 W with at least 10 W output. The receiver has built-in squelch and a sensitivity of better than $0.25 \mu\text{V}$ for 20-dB quieting. (Price of Model B is \$299.95 and the optional RC-1 is \$69.50.)

(3) *Seco 520-A* antenna tester provides direct reading of forward or reflected power and s.w.r. It is designed for 50-ohm lines and equipment operating in the 3.5 to 160 MHz range. R.f. power is measured directly from 0.5 to 1000 watts on three scales. The unit does not require external shunts nor correction charts; it has negligible insertion loss and may be left in the line. (Price: \$49.95)

(4) *Pace II-S* is a 5-watt all silicon transistor CB transceiver. An MOS field-effect transistor is used for precise frequency control. The double-conversion receiver has adjustable squelch, a two-step noise limiter, and a signal-strength meter. The unit can also be used as a portable p.a. system. The transceiver operates from a 12-volt d.c. source with either side grounded. (\$179)

(5) *Lampkin 105-B* frequency meter has a fundamental frequency averaging from 2330 to 2670 kHz, a spread of 1.14 to 1. By means of harmonics and their combinations, nearby transmitters can be monitored in a continuous range from 100 kHz to 175 MHz. Radio receivers may also be aligned accurately using the meter as an unmodulated signal source. Accuracy is guaranteed to be better than 0.002% on all frequencies. (\$295)

(6) *Antenna Specialists "Mach III"* is a base-loaded, shunt-fed, electrical quarter-wave CB whip antenna. The whip itself is 32 inches long and is made of stainless steel. A spiral printed-circuit loading coil is suspended inside the sealed base. The antenna is d.c. grounded. (From \$11.20 to \$25, depending on hardware.)

(7) *E. F. Johnson "Messenger 350"* is a solid-state single-sideband CB transceiver. Either upper or lower sideband on two channels is available for use. Diode switching is employed rather than mechanical relays. The receiver uses adjustable squelch and noise silencer. The unit can also be

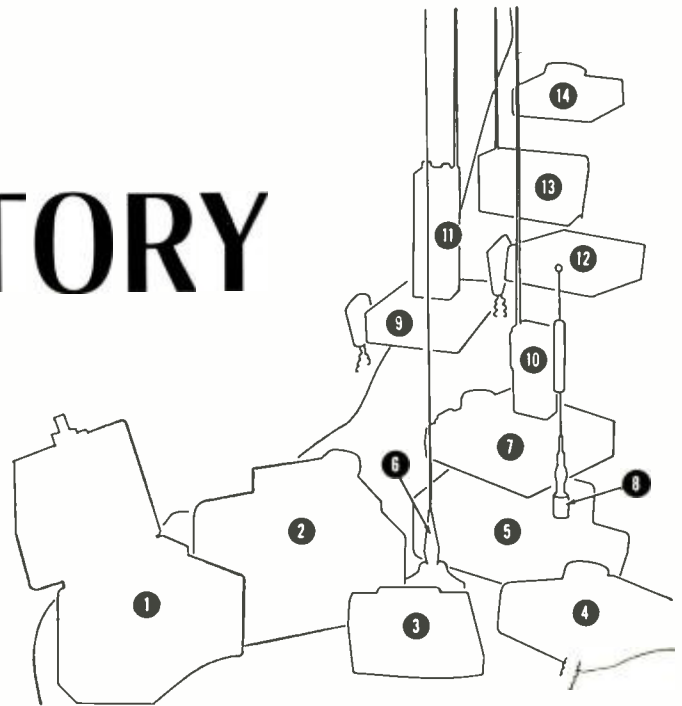

utilized as a public-address system, if this is desired. (\$299.95)

(8) *Mosley "Demon"* is a short whip antenna designed for CB use. The stainless-steel whip element is about 14 inches long, over-all height is a few inches more. The element is center-loaded by means of a coil. (\$13.19)

(9) *Allied "Knight-kit Safari III"* is a 5-watt all silicon transistor CB transceiver in kit form. Receiver has adjustable squelch, signal-strength meter, and fine-tuning adjustment for stations that are slightly off channel. A series-gate noise limiter is also incorporated. Twelve-volt d.c. operation is standard, although a separate a.c. power supply is available. (\$84.50)

(10) *Hallcrafters CB-11A* is a pocket transportable transceiver for CB use. It is completely self-contained, with a battery power supply (ordinary 9-V battery), built-in dynamic mike and speaker, battery-replacement indicator, and telescoping antenna. Power input is 100 milliwatts and no license is required for operation. (\$74.95 per pair)

(11) *Lafayette "Dyna-Com 5"* is a 5-watt hand-held CB transceiver. It has three crystal-controlled transmit and receive channel positions. The superhet receiver has less than $1\text{-}\mu\text{V}$ sensitivity for 10-dB signal plus noise to noise ratio, and uses a mechanical filter for high selectivity. An automatic compressor provides high "talk power" on transmit. Battery pack consists of 12 nickel-cadmium batteries in a removable holder. (\$99.95)

(12) *"Heathkit" GW-14* is a solid-state 5-watt CB transceiver. The receiver has squelch, noise limiting, and a signal-strength indicator. The transmitter, along with some of the other units shown, features a twin- π antenna matching network for high efficiency and low harmonic radiation. Unit operates from 12 V, negative ground, or from a.c. using accessory power supply. (\$89.94 in kit form, \$124.95 assembled)

(13) *Eico 715 "Trans-Match"* is a ham and CB transceiver test set. It can measure r.f. output power up to 50 watts, standing-wave ratio, modulation percentage, and field strength. The instrument has a built-in dummy load for power measurements. (\$34.95 in kit form, \$44.95 assembled)

(14) *Amphenol 675* is a 5-watt all silicon transistor CB transceiver. The receiver is a double-conversion superhet with automatic noise limiting and squelch. Transmitter uses speech clipping for more "talk power." Like other similar units shown, this transceiver is quite compact. This unit measures only $2\frac{1}{2}$ inches by $6\frac{1}{2}$ inches by 9 inches deep. It operates from a 12-V power source. (\$179.95) ▲

Business Radio Communications

By ROBERT M. BROWN

Who can use the Business Radio Service? What are its advantages? What frequencies and powers are available? What about performance and its range?



A typical transmitter-receiver unit for BRS operation. This is the e.c.i. "Fleet Courier"—30B, a 30-W (input) AM unit operating on 5 channels around 27 MHz. The tube unit is \$219.



A high v.h.f. band (152-174 MHz) transmitter-receiver. This Aerotron 625U has 25 watts output on two channels, uses FM modulation, and is transistorized except for final. Price \$485.



Monitor receiver for the low-band channels. Sonar Radio's Model FR-101X covers the frequencies from 25 to 50 MHz or it may be fixed-tuned by crystal to 1 channel. Price \$109.

EVERY business, no matter how large or how small, has much in common. Time is money and lack of control means loss of time. A big restriction on the expansion of many industries by businessmen has been their inability to exercise the same degree of control they once did when the number of their employees and job responsibilities were few. Typically, we find that as the volume of business goes up, the percentage margin of profit goes down. Inefficiency and lack of direction cause the retail price of the service or product delivery to go up, thus losing for the businessman the competitive advantage which enabled growth in the first place.

The ability to communicate with personnel on the job gives absolute control and more effective supervision. There are many other reasons why businesses use two-way radio, but they all add up to the single fact that vehicles become more productive and men become more efficient.

When the FCC created the Business Radio Service (BRS) in the fall of 1958, it was with the understanding that all might take advantage of this new tool. To quote the Rules and Regulations, "The following . . . when engaged in lawful activities are eligible to hold authorization to operate radio stations in the Business Radio Service (1) Any person engaged in a commercial activity. . . ."

Although a multitude of other radio services exists (see Table 1), Business Radio is by far the most prominent since it is non-restrictive and quite accessible. The latest licensing statistics indicate that nearly 45% of all two-way radio applications are for BRS authorizations. This is happening for several reasons, not the least being that many users find it more convenient to obtain a BRS license even though they may qualify in one of the other, more specialized classifications. Additionally, the set manufacturer's representative (dealer), who must be called upon to assist in the preparation of the formal FCC application, is more often than not oriented towards Business Radio and is hesitant about dealing with services unfamiliar to him.

Behind this preference for BRS is the fact that dealers work directly with the FCC in obtaining the license, whereas in other services an intermediate Frequency Coordinating Chairman must "okay" the application before it is forwarded to Washington. This results in a prolonged period of anxiety for the user, during which he may decide to can-

cel his order. Many dealers report that their area coordinating men turn down applications not specifying a particular "correct" brand of radio. The same people accuse the coordinators of favoring one of "the big three" set manufacturers (G-E, Motorola, and RCA) and using their positions to influence the user to switch dealers.

Prior to soliciting the services of any dealer, who invariably offers only one company's equipment, it is helpful to examine equipment requirements, compare set types, and generally become familiar with the frequencies and the possibilities that are available.

System Considerations

Before arbitrarily specifying radio service, AM or FM equipment, or operational frequency, communications personnel should consider the basics of an intelligent systems analysis. Environment, range requirements, and even reliability can markedly affect the total expenditure of the smallest of systems.

Knowledge of the nature of the specific business involved is the one requisite most often overlooked by planners. In addition to frequently being a deciding factor in radio service classification, it is often found that some types of equipment are better suited for a particular application than others.

Table 1. The major areas of activity in commercial two-way radio use. It should be added that some specific categories in the Industrial Radio Services (example, Relay Press) can operate in the 1.75-1.80 MHz range using radioteletypewriter and SSB with a maximum plate power input of 2000 watts. Vast majority of licensees are licensed under Business Radio rules in the Industrial Service.

	MAXIMUM PLATE POWER INPUTS (WATTS)			
	27.23-27.28 MHz	LOW V.H.F. BAND	HIGH V.H.F. BAND	U.H.F. BAND
Industrial Radio Services ¹	30*	500	600	600
Land Transportation Radio Services ²	30*	500	120	120

1. Forest Products, Industrial Relocation, BUSINESS, Motion Picture, Petroleum, Power, Relay Press, Spec. Industrial, Manufacturers, Tele. Maintenance, Automobile Emergency, Motor Carrier, Railroad, Taxicab.
2. Represents the area where most new AM equipment is being employed. Frequency range is also shared with government services. AM transmitters must be FCC Type Approved.

CONDITIONS OF USE	27 MHz	LOW V.H.F. BAND	HIGH V.H.F. BAND	U.H.F. BAND
No restrictions	27.390 MHz 27.410	35.940 MHz 35.960 35.980	151.925 MHz 151.955	
Operation restricted to specific permanent area, maximum 180 watts input	27.430 27.450 27.470	Every 20 kHz from 35.060 to 35.180, plus 35.700, 35.720, 35.880, 35.900, 35.920, 42.960, and 43.000	151.655 151.805 151.685 151.835 151.715 151.865 151.745 151.895 151.775 154.540	Every 50 kHz from 461.05 to 462.00, and every 50 kHz from 463.25 ^a to 464.20 ^a
Stations that are often transferred from one location to another	27.490	35.040	151.625	464.50 ^{a, b} 464.55 ^{a, b}
Stations outside of metropolitan areas that will not cause interference with stations in Taxicab Service			152.300 152.360 152.560 157.620 157.680	

^aThese frequencies to be shared with stations in the class A Citizens Band Radio Service.

^bMaximum plate input restricted to 60 watts.

Table 2. Sampling of channel frequencies available to licensees in the Business Radio Service. Most u.h.f. band stations are of a remote-control and repeater variety, since commercial transmitter-receiver manufacture is presently limited to other bands for cost reasons. AM may be used as well as FM on all these channels. Each selection of appropriate channel must be okayed by system engineer (mobile dealer) and the FCC. To change a particular channel later is just as complex and time-consuming as installation, so careful selection is a "must."

27 MHz	LOW V.H.F. BAND	HIGH V.H.F. BAND	U.H.F. BAND
27.51 MHz 27.53	30.84 MHz 31.16 31.20 31.24 33.14 33.16* 33.40* 42.98	154.57 MHz 154.60	466.50 MHz 466.55 466.60 466.65 466.70 466.75 466.80 466.85 466.90 466.95

*Restricted to one-half watt input.

Table 3. Recent boom in BRS "personal portables" is largely due to the availability of these channels on which walkie-talkie operation is possible. Maximum power input for these channels is 3 watts and either AM or FM type of equipment is permissible.

Another major consideration is the advance determination of the maximum number of base and mobile units required to do the job while bearing in mind projected future needs. Along with this, an estimate of the most common form of communication (point-to-point, base-to-mobile, etc.) should be made immediately.

Range requirements should be examined in depth, since more than any other factors, these will tend to inflate the over-all system cost when not fairly and realistically approached. If most communications will be over a 15-mile radius but with a need to reach 25 miles in one direction twice a month, specify 15 as the maximum *usual* mileage and 25 as the *absolute* maximum of coverage. In arriving at this figure, be certain to consider the duration of the upper-limit communications as well as their occurrence in relation to the usual radio work.

If directional grouping appears to be a possibility, note the area of needed coverage, (for example, 90° north to east). This element can indicate whether directional high-gain antennas can be successfully employed.

From a purely practical standpoint, it is important to find out just how many people will be operating the sets. This is best averaged on a user-per-unit basis and can tell the planner a great deal about the likelihood of human error. If no more than two persons will be operating each transmitter, a fair degree of complexity in the equipment can be considered. If there will be more operators, then the

more conventional, foolproof designs should be contemplated.

Selection of actual operating frequency is often determined by the hours of primary use. Will it be a 9-to-5 or a 2-hour daily workload? This should also be kept in mind when examining equipment designs.

Most commercial two-way radio units are designed for specific applications, with environment a governing factor, and are priced accordingly. For this reason, it is imperative to take into account the amount of shock, vibration, fumes, and high humidity to which the equipment will be exposed.

Finally, it is well to remember that the degree of required reliability for every installation is not the same. A practical appraisal of real need can often result in considerable cash savings over expensive "high-reliability" or "100% performance" designs.

With this basic information at hand, either the manufacturer's representative in the area can be contacted with a fair amount of assurance that requirements are generally known, or the analysis can be followed through to its natural conclusion by converting known facts to figures and doing a conventional job of addition or subtraction. If the latter is attempted, however, the engineer should be well-versed in both "gain" and "loss" conversions and should be equipped to handle such items as actual path loss and realistic antenna system gains in the three fundamental BRS frequency ranges. This procedure, however, is usually left to professional business systems dealers and consultants who make the calculations based upon information supplied by the prospective system user.

Regardless of when the outside representative is called in, the more informed the buyer is, the more liable he is to save money on the over-all system.

The Three Bands

"Low-band" communications (generally accepted as 25 to 50 MHz) occurs between the high end of the class-D CB band and the lower edge of the six-meter ham band. Characteristics here include a signal's ability to achieve substantial distances in rolling or even semi-mountainous terrain. At certain times of the year, though, sporadic-E skip will be noted, bringing in unwanted signals from other areas of the country. Unlike CB restrictions, low-band users can employ transmitter power up to 500 watts input on some channels to suit their needs. Although ignition noise and skip interference are common in this range, high-powered equipment, frequently coupled with directional antennas, often overcomes these difficulties.

The "high v.h.f. band" (152 to 174 MHz) is commonly noted for possessing the greatest number of operational advantages in comparison with the other allocations. Rarely affected by noise and never by skip interference, the high v.h.f. band is widely used for urban and densely populated suburban applications. Although the useful range is on the order of 20% less than that achieved in the 25- to 50-MHz region, saturation of a given area is more thoroughly accomplished. The inherent lack of noise in this band makes it possible to design a system utilizing relatively low power equipment, a distinct advantage when considering the effect of battery drain on a vehicle which may stand at a given job for some time. Also, fewer dead spots occur due to the shorter wavelength and tendency of the signal to be reflected from hard surfaces.

The "u.h.f. band" (falling between 450 and 470 MHz) is used most extensively in point-to-point and blanket-coverage applications. Signals here are highly reflective and will effectively saturate populated metropolitan areas. Special BRS provision by the FCC makes this band available for community repeater stations which can take advantage of available high locations for extended line-of-sight work. Little conventional base-to-mobile work is done in this range, primarily because of the lack of available equipment. (Refer to Tables 2 and 3.)

Safeguarding Channel "Privacy"

An increasing problem for the communications industry is the attitude expressed by a number of BRS users that they should "own" or otherwise be insured of privacy on "their" assigned frequency. Indeed, with congestion becoming a factor in large metropolitan areas, customers in many cases are requesting new channels a few kHz removed from their present frequencies in an attempt to "get off" the busy airwaves in their locales. Although there is nowhere the pile-up intensity reached on the 27-MHz Citizens Radio band, the congestion that does, in fact, exist when coupled with the attitude just discussed is making for serious difficulty at the manufacturing level and is well worth considering by the potential system user.

It should be remembered that except in rare instances the actual decision to select a particular frequency for radio use is left entirely up to the set buyer. Obviously, the more thought behind this choice, the better a company's chance of enjoying relatively clear channel use. For this reason, it is suggested that the opinions of several area "experts" be solicited on this point as well as personal observations made through the use of an inexpensive but well-calibrated monitor receiver. An official reassignment at a later date is often a complex procedure and involves a 60- to 90-day waiting period.

Another problem the Business Radio industry faces is a form of fallout from the "congestion crisis." Particularly with small system users not well-versed technically in communications, there is found to be a growing paranoid-type personality evolving which at the very least is difficult to cope with. It seems that whenever one user hears another on "his" channel, the businessman in this category tends to suspect that all of his transmissions are being overheard. What is happening now is that these businesses are climbing on the frequency-reassignment bandwagon to avoid surreptitious monitoring by their competitors across town.

The result at the commercial level has been that the recent trend by manufacturers to low-profile, solid-state equipment has been met by potential buyers with demands for further assurance of privacy with the new units. Two things are being done here to keep sales moving: (1) a compatibility effort at the factory level, and (2) the development of a multitude of tone-signaling devices as optional accessories.

The growth of selective calling in the last few years has been phenomenal. Basically, two design types are available: the tone pulse which affords individual calling of anywhere from 10 to 1500 mobile units, and tone squelches which offer a relatively uncomplicated means of receiver muting. With the latter, a somewhat recent addition to selective calling equipment, the circuit employs a low-frequency tone (67 to 250 Hz) which is transmitted continuously at one-tenth the normal voice level whenever the transmitter is keyed. At the other end, the almost subliminal tone actuates the receiver and is filtered out of the voice signal, permitting normal conversation.

The desire for privacy of transmissions has also helped sales of the "new breed"—the lines of AM BRS equipment made by *Aircraft Radio, Comco, E. F. Johnson*, and others. Although this type of equipment is not nearly as popular as conventional FM, interest in amplitude-modulated radio is growing all the time. One reason for this is the retail price,

which is generally much lower than for the FM sets produced by the industry leaders, *G-E, Motorola*, and *RCA*.

Also making a strong bid for lower priced system sales are a number of other companies, many of whom have risen from the ranks of 27-MHz CB manufacture. These include *Aerotron, e.c.i., General Radiotelephone, Gonset, Hallicrafters, Lafayette, Pearce-Simpson, Polytronics*, and *Sonar*, with still more appearing all the time. Some offer both AM and FM units, although most seem to be pushing sets designed for low-power applications.

It should be mentioned here that this compulsion on the part of a great number of present buyers for transistors and resonant reeds has resulted in a growing stockpile of the older vacuum-tube sets. This surplus should not be overlooked, especially since 95% of it is still relatively new in terms of useful component life and meets required FCC Type Acceptance specifications. Additionally, enormous savings can frequently be realized with the older radios.

We have been discussing basic fixed stations and mobile units which, in general, cost from \$200 to \$900 each, although some base stations run to \$2500.

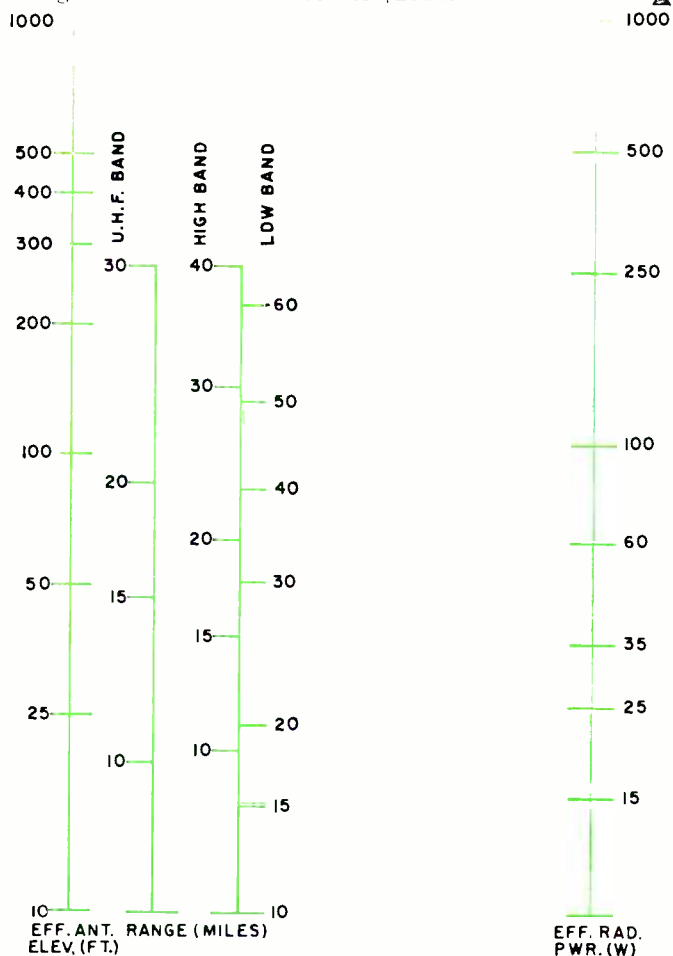

Predictable range nomogram. A straightedge between a given value of effective radiated power and a given antenna elevation will indicate approximate ranges for three BRS bands.

This graph, from G-E, is based on actual plate input power, not effective radiated power, and it affords fairly accurate information on Business Radio possibilities with example shown.

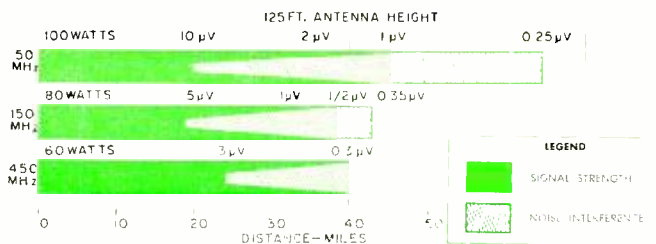

TEST EQUIPMENT FOR CB AND BUSINESS RADIO

By DAVID WALKER

Radio Specialty FM deviation meter shows total deviation under actual voice conditions. A special oscilloscope and broadband FM receiver are built in. (\$618)

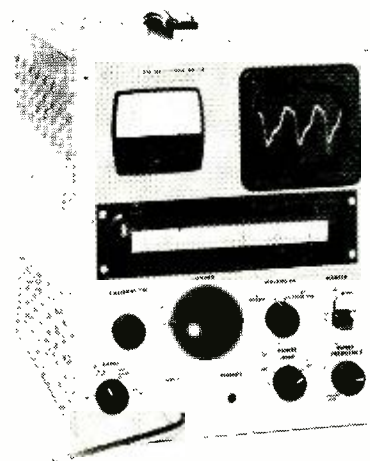

A good selection of generalized and special-purpose test equipment is available for both the user and the service technician who maintains and services CB and BRS gear.

WITH an estimated three million CB transceivers in operation, test-equipment producers offer a variety of instruments to meet every contingency—from tune-up and troubleshooting to the critical measurement of frequency. Another growing branch of communications is the Business Radio Service. Available to anyone engaged in a lawful commercial activity, the BRS offers any business man the benefits of two-way radio. Prior to 1958, neither individuals nor businesses could own and operate communications gear unless engaged in some highly specialized activity.

Since technical specifications affect the choice of test equipment in each category, it is a good idea to obtain a copy of the rules for the desired service. For CB and BRS, respectively, the publications are Volume VI (\$1.25) and Volume V (\$2.50) of FCC Rules and Regulations. They are available from the Superintendent of Documents, U.S. Government Printing Office, Washington, D.C. 20402.

To keep a CB transceiver from causing undue interference to other stations, the FCC technical regulations are most stringent on input power to the final r.f. amplifier (5-watt maximum), percentage modulation (not to exceed 100%), and transmitting frequency tolerance ($\pm 0.005\%$).

When a CB operator is cited by the FCC for violating any of these limits, he is usually instructed to have the repair made by a licensed technician (one who holds a first or second class radiotelephone ticket). During normal tune-up and servicing, however, there is much that may be done without a license. For example, the receiver, which comprises most of the circuit, may be repaired.

The critical area in a CB transceiver where only a licensed technician may move is in the frequency-determining circuits of the transmitter. This is the transmitter crystal oscillator and its associated components. Mistuning of resonant circuits in this stage could produce an off-frequency condition, which is a shift of about 1300 Hz from the nominal 27-MHz carrier frequency. The rules are liberal in what they permit in the way of adjustments in the transmitter's final r.f. amplifier. Aware that transceiver output should be optimized for a given installation, regulations allow anyone to vary controls which resonate and match the output stage into the transmission line and the antenna.

While much CB service is apparently done by either the transceiver owner or a local service technician, the situation changes for Business Radio. Standards are considerably tighter and there is greater risk of interfering with other services which may share some of the channels. R.f. input power is often many times that of a CB unit, and split-

channel operation utilizes critical narrow-band FM. Transmitter tolerance requirements can be as close as $\pm 0.0005\%$ (as opposed to CB's $\pm 0.005\%$). For these reasons, it is expected that servicing on BRS equipment will be done by a first or second class ticket holder, or a technician working under the direct supervision of one.

Three Levels of Necessity

Despite the differences just pointed out, much basic test equipment functions for either service. Some items are sophisticated instruments drawn from the field of two-way radio, but refined slightly for CB calibration. There is also an emerging generation of inexpensive test equipment conceived exclusively for CB. Often called the "CB tester," it combines within one instrument functions once divided among separate units.

Whether a particular instrument operates in both CB and BRS is initially a matter of power capacity and frequency coverage. CB and BRS on the low band nearly coincide, but the BRS may extend to u.h.f. R.f. input wattages for BRS might be 180, 500, or even 600 watts, for example, while CB will not exceed 5 watts. Thus the owner of the equipment or the troubleshooter should check the specifications to see which instruments are suitable for the transmitter to be serviced. (The Rules will assist in this choice.) The most significant differences occur when servicing is more than casual, and will include critical measurements of frequency and FM modulation percentage.

The question of which instruments are needed might be answered by examining tests in three categories. First are devices which often prove indispensable during *initial installation* and *tune-up*. The transceiver manufacturer cannot predict precise conditions in the field and his factory adjustments may not be optimum for a specific installation. An antenna might need adjustment, or a loading coil require "pruning." These variables, which significantly affect range, are difficult to monitor and control without suitable instruments.

The next level is *routine servicing* and *troubleshooting*. Here, familiar radio-TV test instruments—v.o.m., v.t.v.m., r.f. signal generator, and oscilloscope—comprise the basic complement for CB and BRS servicing. Finally, there are instruments intended for the *specialist* in CB or BRS service. One is the frequency meter capable of checking a transceiver against FCC standards. Another is the modulation meter to check FM deviation of FM equipment.

One of the most valuable test devices for installing and tuning the new transceiver is the *field-strength meter*. Of-

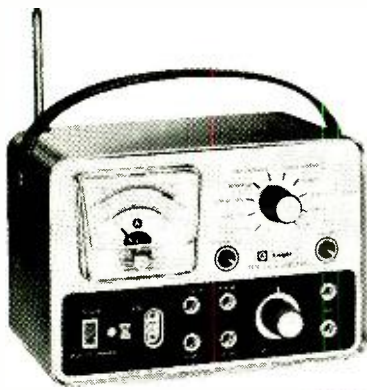

Allied Radio "Knight-kit Ten-2" CB tester measures s.w.r., percent modulation, r.f. power output, relative field strength, and crystal activity. (\$29.95 as a kit or \$39.95 assembled)



Cushman Model CE-2B FM communications monitor is a direct-reading frequency meter with accuracy better than .0001% over four bands. It also measures FM deviation and generates highly accurate c.w. and FM signals. (Price of the monitor is \$3145)



Pace Model 5404 is a precision CB signal generator providing 24 crystal-controlled channels with variable modulation. (\$645)

Singer Metrics "Gertsch" FM-9 combines the functions of direct-reading frequency meter, FM deviation meter, and accurate signal generator. Its accuracy is 0.0002%. (\$1595)



ten little more than a whip antenna, diode, and meter movement, it yields a relative indication of r.f. output which serves as a tuning reference. It is positioned near the antenna and viewed for maximum indication as transmitter output controls are adjusted. Since the meter responds to the radiated signal, it is also a check on the condition of the transmission line and antenna.

The passive-type field-strength meter is a useful r.f. monitor, but additional benefits are conferred by models which contain a transistor amplifier. Pickup sensitivity is vastly improved and the meter responds at far greater distances. The active-type instrument is easier to operate when checking a base-station antenna which may be roof-mounted and out of convenient reach. Also, greater physical separation improves accuracy since the meter responds less to an antenna's induction field (which remains close to the antenna) and more to the electromagnetic radiation field which mainly propagates the wave. This advantage might be important in checking lobes of a directional beam, or the pattern of a mobile whip.

The next instrument, an *s.w.r. indicator*, complements the field-strength meter. Readings of field strength alone are relative and yield little clue to the efficiency of an antenna system. Inserted into the transmission line, an *s.w.r. indicator* checks standing-wave ratio; the amount of forward vs reflected power due to impedance mismatch. Transmitter output tuning, antenna elements, loading coils, and coaxial line may be checked or adjusted for a recommended *s.w.r.* of approximately less than 2-to-1. Although the *s.w.r. meter* can sometimes substitute for the field-strength meter, the two instruments can be used simultaneously. However, *s.w.r.* measurement tends to be critical in a less-than-perfect antenna system and readings could prove misleading. A check on the error is possible with the field-strength meter; as *s.w.r.* reading falls, field strength should rise.

Although it is not specifically a test instrument, the *dummy load* is often used during check-out procedures. An FCC requirement is that radiation be confined except during brief tune-up periods or actual communications. The dummy load dissipates r.f. energy as heat during extended tests. One advantage of a dummy load is that it permits accurate measurements of r.f. output power. The device, with its specially wound wire element, is designed to minimize any inductive effects and presents an accurate 50-ohm resistive load to the transmitter. With this figure fixed, it is an easy matter to measure r.f. output voltage with a high-frequency probe and v.t.v.m., then to calculate the output wattage ($P = E^2 / R$).

Equipment described thus far might represent a minimal complement for making an effective installation. The devices also help pinpoint trouble at a future time; *e.g.*, *s.w.r.* may increase if the antenna system deteriorates, or field strength drop because of a failing component.

Combination Instruments

During the past year, an increasing number of "CB testers" has appeared. They are a combination of circuits useful for both installation and troubleshooting. A principal benefit of these instruments is that they are self-contained, easily portable, and require no a.c. power source. Thus they can be carried outdoors to the CB mobile unit to measure or detect a variety of conditions. Another advantage occurs on the service bench. Since they are expressly designed for CB use, they can often generate or receive signals with less bench set-up time and complexity than for equivalent service instruments. As to be described, some models eliminate the need for an r.f. signal generator, audio oscillator, and oscilloscope.

The CB tester rarely requires internal connections to the transceiver circuits. The usual hookup is to insert the tester into the transmission line with a short length of coaxial cable and appropriate connectors. When the tester serves as a signal generator or field-strength meter, no physical connections are required since signals are received and transmitted *via* a telescoping whip.

There is some variation in the number and type of functions offered by the combination CB unit. Certain features are commonly found on most of these testers; virtually all contain a field-strength and *s.w.r.* meter, as well as an internal 50-ohm dummy load. Another common feature is a wattmeter directly calibrated in r.f. output watts. Some testers can indicate modulation percentage and include a jack for earphone checking of audio quality as transmitted over the air.

All the functions just mentioned are usually accomplished with passive circuitry; the instrument has a sensitive microammeter driven by r.f. power obtained from the CB transmitter output signal. There is no internal amplifier and thus no batteries are required. This feature—no batteries—might serve as a convenient dividing line for classifying CB testers into passive and active types.

The active CB tester, in addition to functions described, may also include several signal-generating modes. Equipped with an internal transistor oscillator stage, it will generate an r.f. signal on 27MHz. Frequency is controlled by a CB crystal inserted into a (Continued on page 77)

BUYING A HI-FI TUNER?

By LEONARD FELDMAN/Engineering V. P., Crestmark Electronics Inc.

The important parameters of an FM or FM/AM tuner—sensitivity, drift, signal-to-noise ratio, distortion, and frequency response—as well as some of the less important characteristics, should be understood prior to the purchase of such equipment. Here is how the IIF specifies them.

WITH FM stereophonic broadcasting stations rapidly approaching the 50% point in terms of total FM stations in the United States, no well-planned home music system can long ignore this increasingly popular program source. Besides pleasurable listening, FM stereo also provides a practical way for the serious tape recordist and music lover to create his own hand-picked library of stereophonic tapes and, *providing the accrued tapes are used only for private listening enjoyment*, such a library can be amassed at the sole cost of the recording tape itself.

FM programming has long been noted for its diversity as well as for its adult approach to musical fare, drama, and better-than-average public affairs content. With the new FCC ruling governing separation of AM and FM programming over jointly owned AM and FM outlets (for at least 50% of all program time), choice of available programs (and hence suitable music) becomes even more varied.

With the increased usefulness of FM and FM stereo as a high-fidelity program source, selection of a tuner must be done with as much care as selection of the other elements of a well-matched high-fidelity stereophonic system. Bear in mind that while today's trend in component manufacture seems to favor the so-called integrated receiver (in which tuner and amplifier are all combined in one chassis), one must still treat the tuner specifications as if they applied to a "separate" tuner component. In general, manufacturers of complete receivers will list the tuner specifications separately from those of the amplifier in any case. (Applicable amplifier specifications were covered in the January, 1967 issue of this magazine.)

Industry Standards

It is now nearly eight years since the Institute of High Fidelity issued standards for measuring and specifying the characteristics of FM and FM/AM tuners. Happily, the intervening years have brought some measure of standardization of specifications, thanks to almost universal adherence to the suggested IIF standards on the part of most reputable hi-fi component manufacturers. Unfortunately, the last eight years have also brought about revolutionary changes in tuner design *per se*, not the least of which are the gradual (and as yet incomplete) transition from vacuum tubes to transistors and the incorporation of FM-stereo circuitry (not even anticipated in the 1958 IIF standards) into all but the least expensive tuners and receivers.

In considering the selection of a tuner (or the tuner section of a receiver) it might be advisable, therefore, to divide evaluation into two distinct areas: those specifications which will help define a quality product for conventional monophonic FM reception (in search of which the original IIF standards will be most helpful), and those additional criteria which will help define quality of stereo FM reception which, for the moment, we shall attempt to enumerate briefly in the last sections of this article.

A manufacturer desiring to rate his tuner product in accordance with IIF standards may list IIF sensitivity, signal-to-noise ratio, harmonic distortion, drift, and fre-

quency response of each tuner model that he manufactures.

Other specifications involving capture ratio (ability of the tuner to reject an interfering signal having the same frequency as the desired station), selectivity (ability of the tuner to discriminate between two stations having closely spaced frequencies), IM distortion (the same as the term used in amplifier evaluation), hum and noise, and the ability of the FM portion of the tuner to suppress AM signal components must also be stated by the manufacturer desiring to give a more complete performance evaluation to his product.

IIF Sensitivity

This specification, when properly expressed, gives a very direct indication of the "station-pulling" abilities of the tuner in question. Stated in "microvolts for least usable sensitivity," the figure denotes how many microvolts of signal must reach the antenna terminals of the tuner to produce a signal which is 30 dB greater than any residual noise and distortion. Such a ratio is considered adequate for satisfactory enjoyment of the incoming program, though it is by no means ideal. Obviously, a tuner capable of yielding such a "quiet" program with only 3 microvolts of antenna input signal is more sensitive than one requiring 5 microvolts of signal input at the antenna.

Signal-to-Noise Ratio

While 30 dB of "quieting" are considered adequate for FM listening, it is of interest to know what the very best quieting capability of a tuner under consideration can be, given a powerful incoming signal from a nearby station. Noise, in this specification, includes both the harsh, random, static kind as well as that caused by the power supply of the tuner, commonly called hum. Here, the higher the signal-to-noise ratio stated, the better the equipment; 50, 60, and even 70 dB of maximum signal-to-noise capability (albeit with a 1000-microvolt input signal at the antenna terminals) is not uncommon in better tuners.

Harmonic Distortion

It may seem odd, at first, that harmonic distortion, normally associated with audio equipment such as pre-amplifiers and power amplifiers, should be included in a list of tuner specifications. The fact is that while the meaning of harmonic distortion (the presence of undesired harmonics or multiples of the desired musical tone in some fixed, measurable percentage) remains the same for audio amplifiers and tuners, the cause of such distortion in a tuner's output is quite different from that associated with audio equipment.

Usually, the presence of significant percentages of harmonic distortion in a tuner will indicate poor or insufficient bandwidth. FM stations are permitted a maximum frequency deviation (departure from center frequency in the course of imparting information to the radio-frequency energy) of ± 75 kHz. The louder the musical passage to be transmitted, the closer the deviation approaches this maximum.
(Continued on page 69)

Hi-Fi Tuner and Receiver Directory

COVERING only solid-state tuners and receivers (all stereo with one tuner exception), this directory lists the electrical characteristics, physical dimensions, and prices of 31 tuners made by 16 manufacturers, and 52 receivers made by 20 manufacturers.

The standard used for tuner measurement is IHF-T-100, which is also used for the measurement of the tuner portions of the receivers.

The audio amplifier portions of the receivers are checked in accordance with IHF-A-201.

Solid-State Tuners

Model	With AM	IHF usable sens. (µV)	IHF capture ratio (dB)	IHF selectivity (dB)	THD @ 100% mod. (%)	FM tuner audio frequency response (mono) @ rated output and 100% mod. (%)	Drift (kHz)	R.m.s. output voltage @ full limiting (V)	Interstation muting	SCA or noise filter	A. f. c.	Physical size (inches)			Assembled price (\$)	Kit price (\$)	Cabinet (\$)
												W	H	D			
ACOUSTECH, INC., Div. of Koss Electronics, Inc., 139 Main St., Cambridge, Mass. 02142																	
VIII	no	2	2	55	.5	20-20 k	10	1	yes	yes	no	15 3/4	5	10	299.00	—	24.50
BOGEN COMMUNICATIONS, P.O. Box 500, Paramus, N.J. 07652																	
TT100	yes	—	3	—	.7	30-15 k	—	—	—	yes	—	15	3 3/4	11 3/4	150.75	—	metal inc. wood 26.65
EICO ELECTRONIC INSTRUMENT CO. INC., 131-01 39th Ave., Flushing, N.Y. 11352																	
3200	no	2.4	4.5	45	.75	20-15 k	neg.	.7	no	yes	yes	12	3 3/8	7 3/4	119.95	89.95	inc.
ELECTRO-VOICE, INC., Buchanan, Mich. 49107																	
E-V 1155	no	2	2.5	—	1	20-20 k	20	.2	no	yes	yes	8 1/4	3 3/8	10 1/4	160.00	—	inc.
FISHER RADIO CORP., 11-40 45th Rd., Long Island City, N.Y. 11101																	
TFM-1000	no	1.8	.6	70	.2	20-15 k	10	2	yes	yes	no	16 3/4	5 1/8	12 3/8	499.50	—	24.95
TFM-300	no	1.8	2	55	.4	20-15 k	10	2	yes	yes	no	15 1/8	4 1 3/16	11 1/8	279.50	—	—
TFM-200	no	1.8	2.2	55	.5	20-15 k	10	2	yes	yes	no	15 1/8	4 1 3/16	11 1/8	229.50	—	—
R-200-B	yes	1.8	2.5	50	.4	20-15 k	10	2	yes	yes	no	15 1/8	4 1 3/16	13	349.50	—	24.95
GROMMES, PRECISION ELECTRONICS INC., 9101 King St., Franklin Park, Illinois 60131																	
2000	yes	2	4	50	.5	20-20 k	10	1	yes	SCA	no	15	6 1/2	13 1/2	289.95	—	inc.
C-107	yes	2	4	50	.5	20-20 k	10	1	yes	SCA	no	15	4 7/8	11	199.95	—	inc.
HEATH CO., Benton Harbor, Mich. 49022																	
AJ-43D	yes	2	3	—	1	20-20 k	—	.5	yes	yes	yes	15 3/4	5 1/2	14 3/4	—	109.00	6.95
AJ-33A	yes	3	4	—	1	20-20 k	—	.5	yes	yes	yes	15 5/8	3 3/4	11 1/2	—	94.50	inc.
AJ-14	no	5	3	—	1	20-15 k	—	.5	no	SCA	yes	12	3 1/4	9 3/4	—	49.95	3.50
KENWOOD ELECTRONICS INC., 3700 S. Broadway Pl., Los Angeles, Calif. 90007																	
TK-500	no	1.8	2	20	.6	20-20 k	10	2	yes	yes	no	15 1/4	5 1/2	12 1/4	149.95	—	inc.
KLH RESEARCH AND DEVELOPMENT CORP., 30 Cross St., Cambridge, Mass. 02139																	
18	no	3	4	40	.6	30-15 k	10	.8	no	yes	no	8 7/8	4	5 3/8	116.95	—	inc.
KNIGHT, ALLIED RADIO CORP., 100 N. Western Ave., Chicago, Illinois 60680																	
KN-265B	yes	3	3	—	.5	20-20 k	25	—	no	yes	yes	13 3/8	4 1/2	12	149.95	—	14.95
KN-290	no	3	3	—	1	20-20 k	neg.	—	no	yes	yes	13	3 1 3/16	10	89.95	—	14.95
KNIGHT-KIT, ALLIED RADIO CORP., 100 N. Western Ave., Chicago, Illinois 60680																	
KG-790	yes	2.5	2	—	.7	—	neg.	1.25	yes	yes	yes	16 3/4	5	15	—	139.95	19.95
KG-765A	yes	2.5	9	—	1	20-20 k	neg.	1	yes	yes	yes	13	2 3/4	11	—	99.95	12.95
LAFAYETTE RADIO ELECTRONICS CORP., 111 Jericho Tpke., Syosset, L.I., N.Y. 11791																	
LT-325T	yes	2	3	42	.5	20-15 k	—	.2	no	yes	no	13	3 3/4	9 3/8	99.95	—	inc.
LT-250T	no	4	3.5	38	.9	20-15 k	—	—	no	yes	no	13	3 3/4	9 3/8	84.95	—	inc.
OLSON ELECTRONICS, INC., 260 S. Forge St., Akron, Ohio 44308																	
RA-940	yes	2	4	—	.5	20-20 k	neg.	.5	no	SCA	yes	14 1/2	4 1/4	10	54.98	—	inc.
RA-856	yes	3	—	—	1	20-20 k	neg.	.7	no	SCA	yes	6 5/16	9 5/16	6	85.00	—	inc.
RA-803	yes	5	—	—	1	20-20 k	neg.	.5	no	SCA	yes	10 3/4	3 1/2	8 3/8	75.00	—	inc.
H. H. SCOTT INC., 111 Powder Mill Rd., Maynard, Mass. 01754																	
315	no	2.7	6	40	1	20-20 k	20	1	no	yes	no	15 5/16	4 3/16	12 1/4	184.95	—	13.95
312-C	no	1.7	4	45	1	20-20 k	20	1	no	yes	no	15 1/16	4 1 5/16	12 1/4	249.95	—	13.95
LT-112B	no	1.8	4	45	1	20-20 k	20	1	no	yes	no	15 5/16	4 1 5/16	12 1/4	—	179.95	13.95
SHERWOOD ELECTRONIC LABS., INC., 4300 N. California Ave., Chicago, Illinois 60618																	
S-3500*	no	1.6	2.2	55	.3	20-20 k	10	1.5	yes	no	yes	14	4	10 1/2	129.50	—	7.50
S-3300	no	1.6	2.2	55	.3	20-20 k	10	1.5	yes	yes	no	14	4	10 1/2	167.50	—	7.50
S-2300	yes	1.6	2.2	55	.3	20-20 k	10	1.5	yes	yes	no	14	4	10 1/2	199.50	—	7.50
V-M CORP., P.O. Box 659, Benton Harbor, Mich. 49023																	
1487	yes	5	—	—	—	20-20 k	100	.25	no	yes	yes	11	3 3/8	7	129.95	—	inc.

All information supplied by manufacturer. All tuner measurements in reference to FM section only. It is assumed that among these quality manufacturers, the tuner signal-to-noise ratio, IM distortion, hum and noise, and stereo separation are all well within the IHF limits. * Mono.

Solid-State Receivers

Model	With AM	IHF usable sens. (μV)	IHF capture ratio (dB)	IHF selectivity (dB)	Tuner THD (400 Hz) @ rated output (%)	Tuner freq. response @ rated output (Hz)	Drift (kHz)	Interstation muting	SCA or noise filter	AFC	IHF dynamic power (W/chan.)	Continuous power (W/chan.)	Power bandwidth (Hz)	THD @ rated power (1 kHz) (%)	THD @ 1 W (1 kHz) (%)	IM @ rated power (%)	IM @ 1 W (%)
ALTEC LANSING, 1515 S. Manchester Ave., Anaheim, Calif. 92803																	
711A	no	2.2	2.5	—	.15	20-20k	neg.	—	SCA	no	25	—	—	.5	—	—	—
AUDIO DYNAMICS CORP., Pickett District Rd., New Milford, Conn. 06776																	
ADC-606	no	1.6	3	—	.5	50-15k	neg.	no	SCA	yes	45	30	20-20k	.5	.1	.5	.2
ADC-600	no	2.0	3	—	.8	50-15k	neg.	no	SCA	no	30	22	20-20k	.5	.1	.8	.2
BOGEN COMMUNICATIONS, P.O. Box 500, Paramus, N.J. 07652																	
RT-8000	yes	2.3	2.8	35	.7	30-15k	10	no	both	yes	35	27.5	20-15k	.6	.4	.5	.3
RT-7000	no	2.5	3	35	.5	30-15k	—	no	both	no	32.5	—	20-20k	.8	—	.8	—
TR100X	yes	2.7	3	35	.7	30-15k	—	no	both	no	30	—	20-20k	1	—	1	—
TF100	no	2.7	3	35	.7	30-15k	—	no	both	no	30	—	20-20k	1	—	1	—
CHANNEL MASTER CORP., Ellenville, N.Y. 12428																	
6606	yes	1.2	2	—	1	20-40k	neg.	no	both	yes	30	25	20-20k	—	—	—	—
6602	yes	4	2	—	1	50-20k	neg.	no	SCA	yes	10	9	50-20k	—	—	—	—
EICO ELECTRONIC INSTRUMENT CO. INC., 131-01 39th Ave., Flushing, N.Y. 11352																	
3566	no	2	4.5	40	.5	20-15k	neg.	yes	both	yes	37.5	25	8-60k	.5	.3	1	.3
ELECTRO-VOICE, INC., Buchanan, Mich. 49107																	
EV1177	no	2	2.5	—	1	20-20k	20	no	both	yes	32.5	18	—	1.5	.5	—	—
EV1179	no	—	2.5	—	1.5	20-20k	20	no	both	yes	27.5	15	—	1.5	.5	—	—
FISHER RADIO CORP., 11-40 45th Rd., Long Island City, N.Y. 11101																	
700-T	no	1.8	2	50	.4	20-15k	10	yes	both	no	60	50	20-24k	.8	—	.8	—
500-T	no	1.8	2.2	50	.5	20-15k	10	yes	both	no	45	32	22-30k	.8	—	.8	—
440-T	no	2	2.2	50	.5	20-15k	10	yes	both	no	35	25	22-30k	.8	—	.8	—
220-T	yes	2.5	2.5	50	.5	20-15k	10	yes	both	no	27.5	20	28-30k	.8	—	.8	—
GROMMES, PRECISION ELECTRONICS INC., 9101 King St., Franklin Park, Illinois 60131																	
C-503	yes	2	3	45	.5	20-15k	10	yes	both	no	30	25	20-20k	.8	.1	.3	.2
HARMAN-KARDON, INC., 401 Walnut St., Philadelphia, Pa. 19105																	
SR900	no	1.8	2.5	—	.5	10-20k	1	yes	SCA	no	50	40	3-75k	.5	.1	1	.1
SR600	no	1.9	2.5	—	.5	10-20k	1	no	SCA	no	40	34	6-50k	1	.1	1	.1
SR400	no	2.9	4	—	1	10-20k	1	no	SCA	no	30	26	9-24k	1	1	1	1
SR300	yes	2.9	4	—	1	10-20k	1	no	SCA	no	30	26	9-24k	1	1	1	1
HEATH CO., Benton Harbor, Mich. 49022																	
AR-15	yes	1.8	2.5	70	.5	20-15k	low	yes	both	no	75	50	5-25k	.2	.2	.5	.2
AR-14	no	5	3	—	1	20-15k	low	no	SCA	yes	15	10	15-30k	.5	.5	1	1
AR-13A	yes	2	3	—	1	20-15k	low	yes	both	yes	33	20	15-30k	.3	.3	1	1
KENWOOD ELECTRONICS INC., 3700 S. Broadway Pl., Los Angeles, Calif. 90007																	
TK-140	yes	2	2.5	45	.6	20-20k	—	yes	—	—	65	50	20-30k	.5	—	—	—
TK-80	no	2	2.5	40	.7	20-20k	10	yes	both	yes	40	32	20-30k	.9	.15	.5	.3
TK-60	yes	2	2.5	40	.5	20-20k	10	no	both	no	25	20	20-30k	.9	.2	2	.3
TK-50	no	2	2.5	40	.5	20-20k	10	no	both	no	25	20	20-30k	.9	.2	2	.3
TK-40	yes	2.5	2.5	45	.6	20-20k	—	—	—	—	15	10	20-30k	.5	—	—	—
KNIGHT, ALLIED RADIO CORP., 100 N. Western Ave., Chicago, Illinois 60680																	
KN-376	yes	3	3	—	.5	20-20k	—	no	no	yes	35	20	30-20k	1	.25	1.6	—
KN-351	yes	3	6	—	.9	20-20k	—	no	both	yes	28	18	40-15k	1	.5	1.5	—
KNIGHT-KIT, ALLIED RADIO CORP., 100 N. Western Ave., Chicago, Illinois 60680																	
KG-964	yes	2.5	8	—	1	20-20k	—	no	both	yes	32	18	25-20k	1	1	1.5	1
LAFAYETTE RADIO ELECTRONICS CORP., 111 Jericho Tpke., Syosset, L.I., N.Y. 11791																	
LR-1200T	yes	1.5	2.2	—	.5	20-20k	—	yes	yes	yes	60	45	—	1	—	.8	.3
LR-900T	yes	2	2.5	—	.6	20-20k	—	no	yes	—	32.5	27	—	1	—	.8	—
LR-450T	no	2	3	—	1	20-15k	—	no	yes	—	15	10	—	1	—	.8	—
OLSON ELECTRONICS, INC., 260 S. Forge St., Akron, Ohio 44303																	
RA-862	no	3.4	3	—	.9	20-20k	neg.	no	SCA	yes	20	15	50-20k	.8	.4	3	1
RA-860	yes	1.9	2.5	35	.5	20-20k	neg.	no	SCA	yes	40	30	30-30k	.8	.25	2.5	.3
RA-845	yes	2	2.5	35	.6	20-20k	neg.	no	SCA	yes	22.5	17	30-20k	.8	.25	2.5	.3
RA-830	no	1	1	—	.9	20-20k	neg.	no	SCA	yes	25	20	40-20k	.5	.3	2.8	1
RA-806	no	3	—	—	1	35-20k	neg.	no	SCA	yes	10	7	50-20k	.9	.5	3	1
PIONEER ELECTRONICS, U.S.A. CORP., 140 Smith St., Farmingdale, L.I., N.Y. 11735																	
SX-1000TA	yes	2.2	3.5	45	.6	20-16k	20	yes	both	yes	45	—	15-40k	.5	.2	1	.4
RCA SALES CORP., 600 North Sherman Drive, Indianapolis, Indiana 46201																	
MT-67	yes	2	6	—	.8	30-15k	neg.	no	both	yes	20	—	35-20k	—	1	—	—
MT-60	yes	2	3	—	.8	30-15k	neg.	no	both	yes	10	—	40-15k	—	1	—	—
H. H. SCOTT INC., 111 Powder Mill Rd., Maynard, Mass. 01754																	
388	yes	1.7	2.5	45	.8	10-20k	20	no	both	no	60	40	20-20k	.8	.25	2	.5
348	no	1.7	2.5	45	.8	10-20k	20	yes	both	no	60	40	20-20k	.8	.25	2	.5
344B	no	1.9	2.5	45	.8	10-20k	20	no	both	no	42.5	25	20-20k	.8	.25	2	.5
342	no	2.2	3	40	.8	10-20k	20	no	both	no	32.5	18	20-20k	.8	.25	2	.5
SHERWOOD ELECTRONIC LABS., INC., 4300 N. California Ave., Chicago, Illinois 60618																	
S-8800	no	1.6	2.2	55	.3	20-20k	10	yes	both	no	50	40	12-35k	.3	.1	.8	.1
S-8600	no	1.8	2.4	55	.4	20-20k	10	no	both	no	25	20	16-30k	.6	.2	1	.2
S-7800	yes	1.6	2.2	55	.3	20-20k	10	yes	both	no	50	40	12-35k	.3	.1	.8	.1
V-M CORP., P.O. Box 659, Benton Harbor, Mich. 49023																	
1489	yes	5	—	—	—	20-20k	100	no	both	yes	10	7.5	—	3	1.5	—	—
1484	yes	1.8	—	—	—	20-20k	100	no	both	yes	37.5	15	—	3	1.5	—	—

All information supplied by manufacturers. All power bandwidths at better than 1% distortion. All tuner measurements in reference to FM section only. It is assumed that among these quality manufacturers, the tuner signal-to-noise ratio, IM distortion, hum and noise, and stereo separation are all well within the IIF limits.

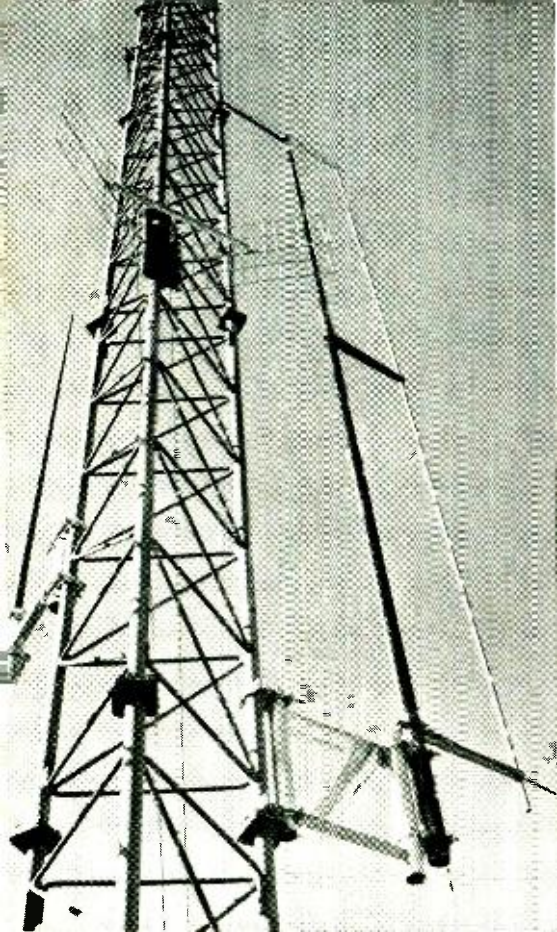

Three Andrew base-station antennas are shown mounted on the tower. At the top center is Type 3606 corner-reflector antenna with a 9-dB gain over a half-wave dipole. This antenna is designed for 450 to 470 MHz (\$100). The antenna at the left is Type 460, a high-gain omnidirectional unit with 7-dB gain, designed for 450 to 470 MHz. Within fiber glass covering is a multi-element colinear array in conjunction with ground radials (\$160). Finally, the antenna at the right is Type 151, a high-gain offset unit with a 7.6-dB gain, designed for 136 to 174 MHz. It, too, is a colinear array within a fiber glass covering employed along with ground radials (\$240).

ANTENNAS FOR CB AND BUSINESS RADIO

The proper antenna system will often mean the difference between good communications and none. A large number of suitable units are readily available for any type of coverage that is desired.

It has been said that the CB operator is never completely satisfied with his communicating range, while the industrial user of two-way radio may rarely exploit his system's maximum distance. One of the significant variables is the antenna system. CB antennas are restricted to a maximum height of 20 feet over a man-made or natural formation and towers are prohibited. The Business Radio antenna, on the other hand, may rise some 170 feet above ground level on its own tower. Another factor is transmitter power. The CB operator is granted a 5-watt maximum input; the BRS transmitter might operate at 500 or 600 watts. These differences in regulations markedly affect the choice and installation of antennas.

CB and BRS antenna systems are, in a way, approached from opposite directions. In CB, conditions such as power and height are fixed. This has led to a diversity of antenna models to satisfy the persistent demand for best possible range under the regulations. CB designs often run to the

Hy-Gain Electronics "Duo-Beam 100" consists of two five-element parasitic arrays with reflectors and directors. A heavy-duty rotator is used to orient beam which is said to effectively boost input power of a CB rig from 5 to 120 watts (\$99.95).

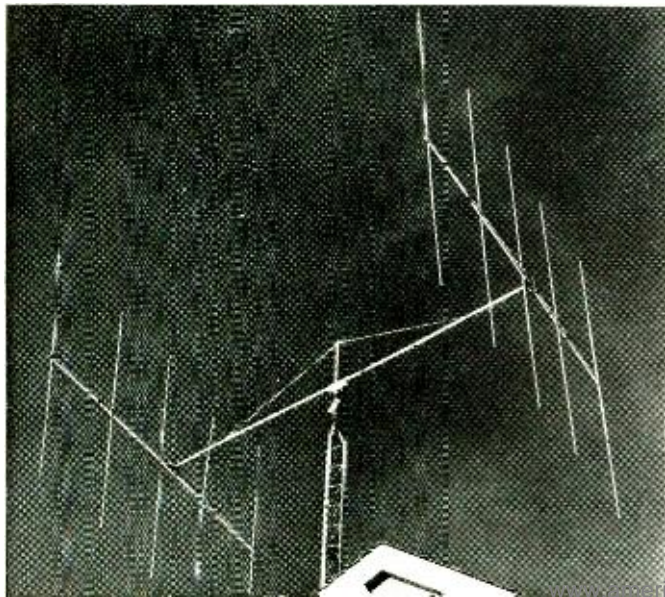

exotic to exploit every possible improvement in performance. There are models which feature horizontal and vertical polarization, for example, or electronic rotation of the signal.

The approach to a BRS antenna system, however, confronts the installer with a complex set of *variable* factors. Not only can the installer control range by selecting transmitter power but antenna height as well. These interrelated factors must be juggled at the time an antenna design is considered. Since cost often weighs heavily in the BRS system, the installer might want to seek assistance offered by equipment manufacturers. They often make available technical information and charts for calculating range, or provide mobile units to survey the geographic area and test actual conditions in the field.

There are FCC requirements, too. The BRS antenna location must be identified by latitude and longitude (which may require the services of a local surveyor) and there might also be tower painting and lighting requirements. The rules covering these details should be on hand before the installation is contemplated (they appear in Volume V of FCC Rules and Regulations). The CB antenna installation is less formal since the consistent 20-foot height rule (an FAA specification) eliminates any hazard to air traffic.

Many other factors governing antenna systems apply equally well to CB and BRS operation. In general, each signal is mainly propagated *via* line-of-sight despite differences in frequency. CB and low-band BRS signals (about 25-50 MHz) tend to diffract around obstacles and rough terrain somewhat better than high-band BRS (152-174 MHz). BRS on the u.h.f. band (about 450-470 MHz) begins to assume the reflective properties of light which might be an advantage in built-up urban areas. Let's first consider the automobile antenna system for mobile operations.

Mobile Whips

Physical size and mounting point are prime considerations in the mobile antenna. Here the BRS antenna has a slight edge over CB. Since the whip is based on the quarter-wave Marconi (working against the vehicle body as a ground), it grows shorter as operating frequency increases.

The full-size CB whip rises to nearly 9 feet, while the BRS antenna shrinks progressively until it becomes about 1½ feet long in the high v.h.f. band and only some 6 inches long at u.h.f. Thus the BRS whip can often mount inconspicuously on the vehicle roof, front cowl, or rear trunk deck.

The quarter-wave, or full-size, CB whip represents the most efficient omnidirectional mobile antenna but one that is impractical for roof-top mounting. Positioning its base on the rear bumper may solve the problem of excessive height, but here it encounters another difficulty. Much radiation occurs near the antenna base, point of maximum current feed, and the bumper height is extremely low.

Actual measurements taken by one antenna manufacturer with a full-size whip at six different vehicle mounting points are shown in Fig. 1. The drawing is illuminating in two ways; it reveals the advantage of height and central location. Consider the center-of-roof mounting; the pattern is most nearly equal in every direction. In each of the remaining cases, maximum radiation occurs over the longest metal path presented by the car to the antenna. Thus, the antenna on the right rear fender tends to emit strongest signals in the direction of the left front fender. This is due to the ground-plane action of the automobile and should be considered when a whip is not centrally mounted. (In an emergency situation, it might even be possible to communicate with a distant station if the whip's directionality is known. The car is turned and aimed in beam-rotating fashion.) An unequal whip pattern, however, is not normally a significant factor until signals approach marginal strength for good communications. Worst case in the series of Fig. 1 is the highly distorted, narrow pattern of the left rear bumper mount. It reveals the problem of mounting a whip low on the car.

CB antenna makers resort to the loading coil to reconcile conflicting factors of whip length and high mounting point. The loading coil permits mechanical shortening of the whip while preserving its quarter-wave electrical characteristics. Although the coil reduces the antenna's efficiency somewhat, it is believed this is more than offset by higher roof-and-deck-mounting options and less warping of the pattern. The loaded whip may be less than half the length of the full-size 9-foot model.

There are several variations on the loaded whip. Some manufacturers resort to continuous loading, where a spiral of wire is embedded within a glass-fiber rod. One antenna maker utilizes a printed-circuit coil in a plastic housing near the whip's bottom. But the basic division is whether the whip is bottom, center, or top-loaded. There are proponents of each method. The earliest models were often loaded at the antenna base. If placed at a higher point, the coil would be subject to physical damage or excessive sway due to leverage developed when situated high on the whip. Newer coils, however, are usually slimmer, lighter, and sealed in plastic. Since they help eliminate some of the earlier problems, some manufacturers have relocated the coil higher on the whip.

The diagram of Fig. 2 reveals the effect of loading-coil position on radiation. It may be seen that the higher the coil, the more it distributes current, and thus radiation, at higher levels. Adherents of this approach state that range is improved since surrounding obstacles, including the car, are more easily cleared by the signal. Supporters of base loading, however, feel that the coil at the bottom cannot sway as the vehicle moves and thus it maintains a fixed capacitive effect between coil and car body. It is felt that antenna impedance remains constant and the v.s.w.r. stays low. Another benefit of base loading is stated to be the provision for grounding the antenna through the base coil to help short-circuit noise. There is much agreement that range, in any case, improves as the antenna grows longer and is mounted higher.

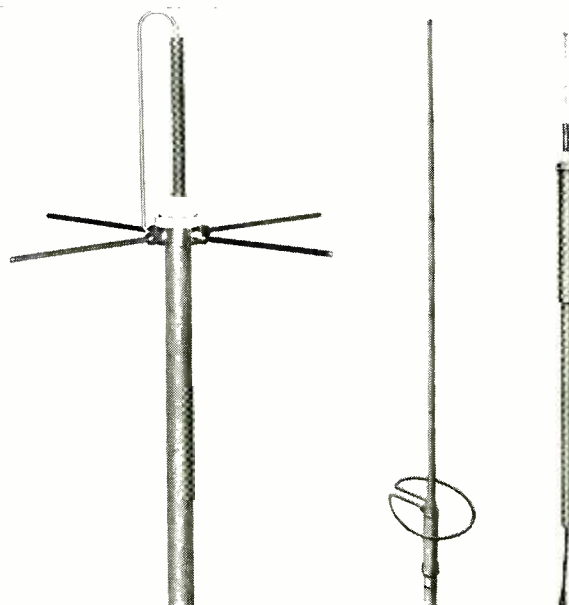

(Left) Kreco FGP-155 is a ground-plane antenna with a folded vertical element, available for from 108 to 175 MHz (\$52). (Center) Cush-Craft "Ringo" CR-1 is a half-wave vertical antenna for CB. Circular element is for impedance matching (\$16.95). (Right) Communication Products 83-509 is omnidirectional coax antenna for h.f. and v.h.f. (\$52).

A number of refinements in whip antennas improve versatility. A whip might have a fitting which permits it to be "split" and lowered when the car is garaged. One antenna maker features a magnetic base which permits roof-mounting with no need for drilling holes. There are also hole-less mountings which rely on special fittings clamped in the crack between trunk lid or hood and car body. Not to be overlooked in mobile work is the *diplexer*, a small accessory to eliminate the car's regular AM broadcast antenna (which occupies a convenient mounting point for the CB whip). The device contains a simple frequency-selective network that enables the CB antenna to serve both CB and AM.

(Continued on page 84)

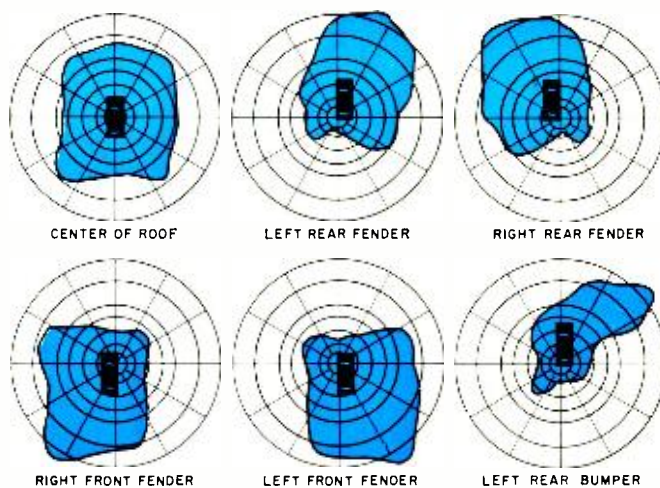
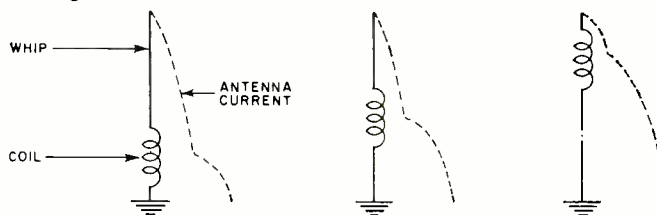

Fig. 1. Measurements made by Hy-Gain Electronics of radiation pattern of 9-ft CB whip at various mounting locations.

Fig. 2. Effect on the antenna current of raising loading coil.



Selecting a CB Transceiver

By LEN BUCKWALTER

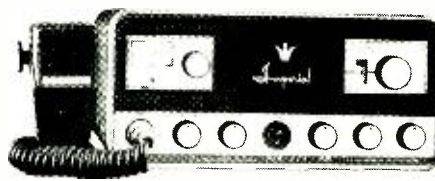

Regency "Imperial" transmits a DSB signal with either reduced or no carrier, and receives either upper or lower sideband or both sidebands conventionally. (\$299)



Squires-Sanders "23'er" is an all-channel solid-state transceiver using speech clipping in the transmitter and a crystal lattice filter and special noise silencer in receiver. (\$235)



Sonar J-23 is a solid-state 23-channel CB transceiver using dual-conversion receiver, squelch, a.n.l., and p.a. operation. (\$239.95)

Browning "Eagle" CB base station includes separate receiver (left) and transmitter (right) with 23 crystals. (\$359 for both)

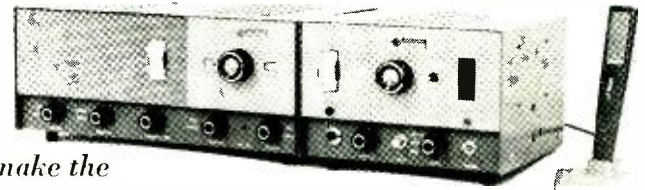

A wide variety of special features and circuit improvements make the modern CB transceiver a better buy than it was only a few years ago.

"BUY only the features you need" is the familiar recommendation to the prospective purchaser of a CB transceiver. It is advice which certainly appeals to the sensibilities and the pocketbook. But a meticulous effort to single out features or fit a transceiver to an immediate need could prove to be a risky procedure. For one thing, the CB transceiver doesn't serve up its circuits cafeteria-style. There has been little effort to modularize features and purchasing, say, a crystal filter but no "S"-meter is rarely practical.

Many of today's transceivers, rather, have evolved through a succession of refinements which saw the industry adapt concepts and hardware from the older field of two-way radio communications. Thus, the broad superregenerative receiver yielded to the sharp, dual-conversion superhet. Noise limiters went from simple clipping diodes to automatic, self-adjusting types. Audio modulation acquired a boost in effectiveness.

The point is simply that contemplating isolated features may overlook the heart of the matter. The premium in CB is on sensitivity, selectivity, and maintaining high modulation percentages; which is, after all, what the textbooks have said all along. Hence, a tally of switches, meters, or functions displayed on the front panel could be a poor index to communications effectiveness. More likely, the ability to handle traffic on CB is better described about midway down the spec sheet in small type. Will the circuit reject adjacent channels which may occur just 10 kHz away? Can modulation average 80, not 30, percent? Will the transceiver be versatile enough with respect to frequency coverage?

How Many Channels?

For the serious-minded operator, the ideal transceiver might be a functional, one-channel black box which got the message through. While the logic is sound it may overlook some facts of CB life, plus some pending developments. As the number of licenses hovers near the million mark, CB claims the distinction of being the FCC's largest division. It is some three times larger than ham radio and almost ten times the size of industrial two-way radio. Yet the sprawl of CB, often cited as its bane, is also proving to be its boon.

As the thrill of speaking without wires fades, CB-ers in vast numbers tend to revive their enthusiasm by turning to public service. They have created a diversity of on-the-air services freely available to anyone equipped with the right channels. It is a development worth watching when considering the number of channels in a new transceiver.

Here are some examples of what's happened in the nine years of CB's existence on the 27-megahertz band.

It has been a matter of FCC policy not to allocate CB's 23 channels for special use; e.g., technicians on one frequency, skydivers (known to use CB while in free fall) on another, etc. Yet the Commission has placed no obstacle in the way of local CB groups who wish to contrive their own "assignments". It has led to the development of channel 9 as the unofficial "calling" frequency, and 13 as the marine channel for pleasure boats. At least one CB group maintains a transceiver at a telephone-answering service to provide a 24-hour alert for distress calls. Anyone touring the country by car should increasingly encounter roadside signs informing him that certain channels are monitored. Local CB stations are ready to respond with route instructions, motel reservations, and other helpful assistance.

The transceiver with few channels may provide ample home-to-car communications, but place these other services beyond reach. It might also preclude access to HELP, the *Highway Emergency Locating Plan* now being promoted by major Detroit automakers. The auto industry has petitioned the FCC to set aside two frequencies in the CB spectrum for assisting stranded motorists. Many state-level organizations, like the New Jersey Turnpike Authority, are either experimenting with a HELP-type service or operating one on a trial basis. As traffic mounts on the interstate highway system, officials are looking to CB as the answer to detecting emergencies. Regular state police patrols even now prove inadequate.

Today's transceivers resort to a number of systems to provide coverage up to 25 channels. (Although 23 channels prevail, there may be provision for possible additional HELP frequencies.) Most sets employ a straightforward channel selector that inserts the appropriate pair of crystals into receive and transmit oscillator circuits. (One crystal set is usually supplied by the manufacturer; the buyer must purchase additional crystal pairs which are plugged into sockets.) There are enough variations in channel-selecting circuits to cause possible confusion. With careful study of the manufacturer's literature, however, it should be possible to discern which of the following systems is being offered. It could significantly affect price and function.

When a transceiver is listed as "23-channel", determine whether it refers to receiver, transmitter, or both. In selecting a 12-channel transceiver, for example, determine from the literature whether crystal control applies to *both* transmitter and receiver. The transmitter, by law, is crystal-controlled, but the receiver may have only *continuous* tuning. Since the continuous dial is only approximate, it



B&K "Cobra CAM-88" is a transceiver featuring speech compression in transmitter and fine tuning in the receiver. (\$214.95)

Multi-Elmac "Citi-Fone 55" is a 23-channel transceiver using frequency synthesis and a double-conversion receiver. (\$169.50)



Tram "Titan" CB base station uses frequency synthesis, audio compression, mechanical filter in receiver, multi-function meter. (\$434)

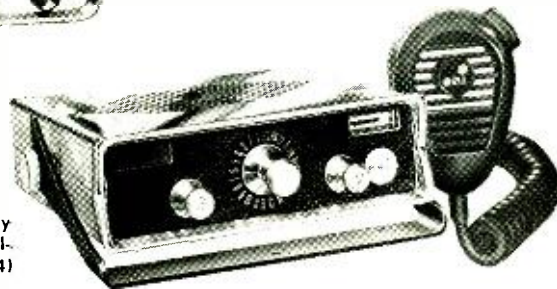

The e.c.i. "Courier TR-235" is a compact, silicon-transistor CB transceiver measuring only 5 1/4" x 1 7/8" x 6 1/4" deep. (\$169)

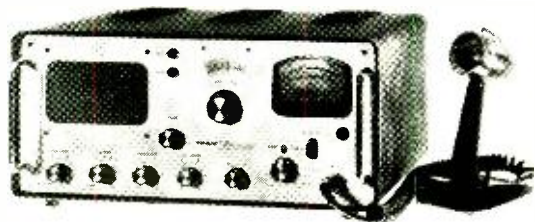

Eico "Nova-23" is a solid-state 23-channel crystal-controlled 5-watt transceiver using crystal lattice filter. (\$189.95, wired)

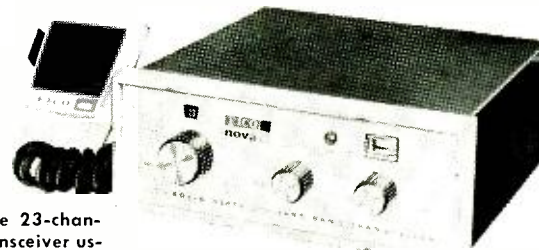

is not easily preset or useful for quick, precise receiver tuning. Crystal-control for receive is indispensable in mobile operation. If continuous tuning is provided in addition to crystals, it is best considered an extra—with some possible use as a check on over-all band activity. This information might reveal low-activity channels in a specific area and thus help you select future crystal frequencies.

In its own class is the 23-channel rig which is completely crystal-controlled. Here, too, the system must be correctly identified. When the transceiver utilizes "frequency synthesis", all crystals are factory-installed. The reason is that full frequency coverage can be obtained with eleven crystals instead of the customary 46 (2 per channel).

The concept of frequency synthesis is shown in Fig. 1. When the operator selects a channel, a pair of crystals is energized for receive or transmit. A mixing process places the resulting signal on the desired transmit channel, or creates the receiver i.f. frequency for the same channel during receive. By careful calculations, the circuit designer has selected 11 crystal frequencies which ultimately yield 23 channels. A single crystal, for example, may participate in creating five or six different channels (receive or transmit).

Another type of all-channel transceiver is the circuit which provides a dual 23-channel selector switch and 46 crystal sockets. Although the manufacturer may provide only one pair of crystals, the remaining sets are at the buyer's option. He may choose any number of desired channels at a later date, up to the full complement.

How many crystal-controlled channels are needed? This is a matter of personal choice. The total, however, should take into consideration the following possibilities. Two channels are desirable for personal use. These would be selected from channels 1 through 8 or 15 through 22, now reserved for intrastation use (units operating under the same call sign). Two frequencies permit a change in channels if communications become difficult due to co-channel interference. Two additional frequencies might be chosen in the *interstation* channel group (9 through 14 and 23) to permit contact with other stations (operating under different call signs).

The most active channels are 9 and 11, and an emergency call for assistance on either is apt to evoke a response in most areas of the country. This could prove helpful during long motor trips. If there is regional monitoring in your locale, a crystal on that frequency is suggested. The boating enthusiast may wish to have communications on channel 13. Thus, there is a potential need for a minimum of five or six channels, not counting the possible intro-

duction of two HELP, or other special CB frequencies.

Receiver Sensitivity

Some CB receivers achieve a bandwidth which rivals that of an expensive communications receiver. Yet there is a frequent argument against high selectivity: "If you live in a sparsely populated area, with little CB activity, good selectivity is a useless, costly feature." The suggestion may have had currency a year or two ago, but a new factor now touches the CB medium. It is the sunspot cycle. It recently passed the trough of its 11-year cycle and is rising toward a peak which should occur in about five years. With each passing month it improves skip conditions on 27 MHz. The sunspot phenomenon will carry adjacent-channel interference to the most remotely located CB installation. Considering that channels are spaced either 10 or 20 kHz on the band, sharp selectivity should be as welcome in New York as in York, Pa. It will result in the rejection of distant stations arriving on adjacent channels, and such stations may easily attain the strength of locals.

Another factor in favor of superior selectivity is the rate of CB expansion which puts more and more stations on the band every day. Despite a series of rules tightening, the imposition of an \$8 license fee, the levying of fines for violations (often \$100), and stern warnings from official sources, CB continues to be a growth industry. Recent reports show that license applications continue to reach the FCC at a rate of about 16,000 per month.

When exploring the techniques used by manufacturers to shape receiver bandwidth, you'll encounter a number of familiar or possibly surprising circuits. There is the conventional dual-conversion i.f. strip. A recent transceiver typifies the approach: it initially mixes the 27-MHz signal down to 6 MHz, a rather high i.f. frequency which helps reject possible images. The second conversion step reduces 6 MHz to 455 kHz, where tuned circuits operate with good selectivity. Another manufacturer uses a conventional crystal filter for sharpening the i.f. response. But the surprising development is the entry of the mechanical filter into CB circuitry. The device, normally associated with expensive, high-quality communications and amateur gear, has appeared in a number of moderately priced transceivers, for good reason.

The original mechanical filter introduced by Collins is a rugged, precise component. To meet military and industrial specifications, it had to offer exceptional characteristics under environmental extremes of temperature, humidity, and vibration. But in evaluating the device for potential CB applications, it was found that conditions

were not nearly as stringent. Thus, many cost-boosting, superfluous features were dropped: the high-tensile plated steel casing reverted to plastic; hermetic seals and special shock-absorbants were eliminated. Shape factor of the filter was altered from a narrow 2-to-1 to a wider 3-to-1 by reducing the number of internal metal discs from 7 or 9 to just 5. The revamped filter for CB is rated by *Collins* for selectivity of 6 kHz at -3 dB and 20 kHz at -60 dB, which yields a desirable flat-topped, steep-sided response curve. CB manufacturers were offered the filter at less than \$7 in production quantities.

The circuit of Fig. 2 shows how the mechanical filter supplants an i.f. transformer in the receiver. In operation, the electric signal on 455 kHz is converted to equivalent mechanical motion by a coil and driving rod. This energy drives a series of metal discs which start to resonate with high "Q" on 455 kHz, thereby rejecting off-frequency signals. Mechanical energy reverts to an electrical signal at the filter's output by another driving rod and coil combination. There are other versions of the mechanical filter in current CB transceivers. The operating principle is fundamentally the same, but input and output transducers usually differ. Instead of the *magnetostrictive* arrangement, the other filters might use ceramic elements as signal transducers.

The trend toward higher selectivity in CB transceivers has been accompanied by at least one minor difficulty. An incoming signal may only partially squeeze into the receiver's bandwidth. (There is a permissible shift of several kHz due to CB's frequency tolerance of 0.005%.) To prevent loss in received-signal gain, many manufacturers install an additional receiver control labeled "Delta Tuning", "Bandspread", or "Variable Tuning". It is simply a vernier on one of the receiver's local oscillators to permit a variation of about 2 or 3 kHz to properly center the signal in the receiver's passband.

Sensitivity and Noise Limiters

There is some justification in placing less emphasis on receiver sensitivity than on selectivity. Although front-end circuits differ—there may be one or two r.f. amplifiers, a cascode circuit, possibly *nuvistors*—there is probably no vast difference in the ability of reasonably good receivers to separate signals from noise. Comparing small differences in microvolt rating may be purely academic. What produces a vast impact on receiving is a factor which has little to do with sensitivity: it is man-made noise. The number of microvolts introduced by noise may quickly obliterate any advantage accruing from high receiver sensitivity. The problem is acute during mobile reception,

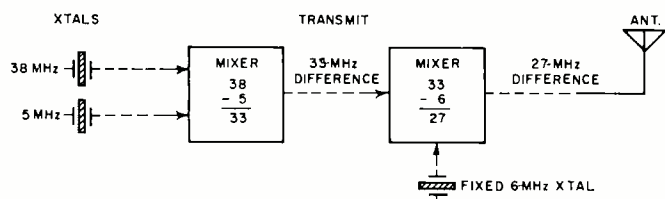
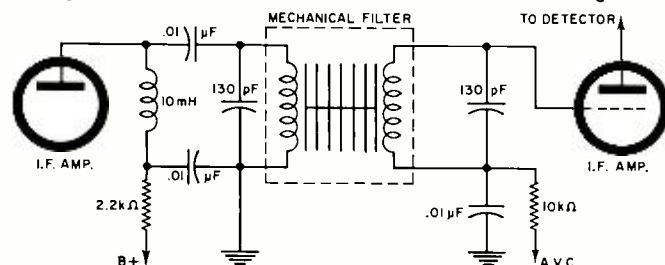

Fig. 1. In frequency synthesis, two crystals mix to ultimately produce transmit frequency. Same crystals can also be employed to create a 6-megahertz intermediate frequency during receive.

Fig. 2. A mechanical filter is inserted between i.f. stages.



where spark plugs, distributor, generator, and other items in the ignition system radiate an inordinate amount of r.f. energy on 27 MHz. For this reason, sensitivity and noise limiters can be considered under a single heading.

Virtually all transceivers utilize noise-limiter circuitry to either clip noise spikes or interrupt ("punch holes" in) receiver response during transient impulse noises. A popular circuit is the series-gate, shown in Fig. 3, which automatically adjusts to signal level and regulates clipping action according to conditions. CB, too, picks up the trend from other services which place the noise limiter further forward in the receiver—away from the detector and into the i.f. strip. The advantage of the system, usually termed a "silencer", is that noise is removed at lower signal levels which prevents distortion products from developing in an i.f. amplifier stage.

But the best noise limiter is not a sophisticated section of receiver circuitry. It is, rather, a thorough job of suppressing every possible noise source in the automobile with conventional techniques of bypassing, filtering, and shielding. Once the car is electrically quiet, the receiver's noise-limiter circuitry can more effectively handle noise radiated from external sources, namely, from nearby vehicles, power-line leakage, or fluorescent lighting. In some recent transceivers a noise-limiter switch on the panel may be omitted. This may simply indicate the circuit is self-adjusting and needs no manual attention.

Audio Improvement

In an increasing number of transceivers there is some system for boosting audio modulation. Its basis is the fact that *average* modulation at normal voice levels may hover around 30 percent. Range and intelligibility enjoy a significant increase when average modulation is raised to more than double that figure. The basic modulator circuitry of many CB transceivers introduces a simple form of limiting. According to law, modulation should not exceed 100 percent and designers often choose modulator arrangements which cannot create voltages which produce overmodulation. This in itself can raise average level—the operator merely speaks closer to the mike, the circuit is self-limiting. The pitfall is that this can also cause distortion and splatter if overdone. Nevertheless, if optimum speaking distance and voice level are maintained, little more is required for effective communications.

Special boost-type circuitry, however, might prove valuable where the transceiver is used by a number of people some of whom fail to observe best mike techniques. Two circuits for achieving the boost are the limiter and compressor. In the limiter, the clipping action of a diode slices all signals exceeding a given level. Due to possible distortion produced by "flattened" audio, a limiter is usually followed by a high-pass filter to attenuate spurious products. The compressor circuit, on the other hand, performs like a.g.c. A portion of the audio signal is sampled at the output, or modulator stage, then rectified to a d.c. control signal. Fed back to an earlier audio amplifier, it can boost soft sounds or reduce loud ones by varying tube or transistor bias. The compressor is less prone to distortion but some operators believe that it produces less audio "punch" than the limiter.

Tube vs Transistor

After a tentative start, the solid-state transceiver is now displacing much tube-type gear in the lines of CB manufacturers. It has been especially welcome in mobile operation where small size and low current drain prove attractive. Yet the tube is far from dead. The acceptance of transistors by today's CB operators is not yet universal. According to the manager of one large CB distributor, solid-state units are being purchased for mobile operation but sales of tube transceivers for home or base-station use

Electronics in OCEANOGRAPHY

By JOHN ALTHOUSE

A review of the mechanical and electronic instruments that can accurately measure the temperature, pressure, conductivity, speed-of-sound, tide, and wave motion.

“**S**HORTLY after World War II, attempts were made to introduce electronics into oceanographic instrumentation. The effects were essentially disastrous and resulted in greatly delaying the successful introduction of electronics until 1950 and later.” Thus James Snodgrass of the Scripps Institution of Oceanography describes the early history of electronics in the ocean.

Many promising electronic instruments failed to meet the needs of oceanographers in terms of cost, reliability, and accuracy. Since the early days, however, a number of successful electronic instruments have been designed and are in daily use in the ocean. They permit observations to be made rapidly, greatly speed data processing, and have opened several new fields of measurement.

Despite the advantages of electronic measurement, mechanical instruments are still widely used by oceanographers. To shed some light on this paradox, this article will examine several important physical properties of the ocean and describe mechanical and electronic instruments that are used to measure them.

Temperature and Pressure

Knowledge of water temperature is of fundamental importance to oceanographers. Temperature has a great effect on the physical properties of ocean water and, at great depths, temperature variations are quite small. Thus, it is desirable to know temperature to an accuracy of about 0.02°C .

The traditional instrument for measuring temperature is the reversing thermometer shown in Fig. 1. This is a mercury-in-glass thermometer with a mercury column that separates when the thermometer is inverted, locking the reading in place. It is lowered upright to the desired depth, and a metal weight is then sent down the supporting wire to release a trip mechanism which inverts the thermometer. It is then pulled back to the surface to be read.

The thermometers are used in pairs. One is protected against water pressure while the other is not. From the difference in the readings of the two thermometers, it is possible to determine the depth. The depth measurement is important since there is no assurance that the supporting wire will hang straight down, and thus its length is not an accurate measure of depth.

The accuracy of measurement possible with the reversing thermometer (about 0.01°C) has kept it in general use for almost a hundred years. However, it gives a single temperature reading each time it is lowered, not the desired continuous temperature profile.

The electronic bathythermograph (EBT) was devised to provide a continuous temperature record. Temperature is

measured with a thermistor or a platinum-wire probe. In several commercial designs, the resistance element is used to control the frequency of an oscillator, as shown in Fig. 2. In this circuit, the frequency of oscillation varies inversely as the square root of the probe resistance. When coupled with the non-linear temperature-resistance characteristic of a thermistor, the oscillator frequency can be made to vary linearly with temperature.

The EBT also monitors pressure. Since the water pressure increases with depth approximately 0.44 psi/ft , the pressure measurement can be used to determine the depth of the probe. A typical pressure transducer utilizes a vibrating wire to control an oscillator. The tension of the wire, and thus the frequency of oscillation, is a function of pressure.

By using a temperature oscillator and a pressure oscillator on different frequencies, their signals can be sent to the surface along a single-conductor insulated wire. The sea water provides the return path. D.c. to power the oscillators can be sent down the same wire.

There is no question but that resistance thermometry, in the laboratory, provides a high degree of accuracy. The accuracy of the EBT, however, is the subject of heated debate.

Errors are introduced in the transfer from resistance to its frequency analog. Furthermore, the high pressures at ocean depths, on the order of 10,000 psi, can distort the resistance sensor and modify its calibration. Nevertheless, the obvious advantages of the electronic method have made the EBT the object of intense development.

Salinity

Salinity, a measure of the salt content of ocean water, is of prime interest to the oceanographer. When ocean water evaporates or freezes, most of the salt is left behind and the remaining water increases in salinity. An influx of fresh water from rivers, rainfall, or melting ice reduces salinity. As water of either low or high salinity moves through the ocean, its path can be traced by taking salinity measurements.

The classical measurement method, still in use, is chemical titration. Typically, a water container is sent down with reversing thermometers. When the thermometers are tripped, the sample bottle is closed, and the sample is then brought to the surface and analyzed. This is an accurate but slow method.

The application of electronic techniques to salinity measurement has produced the induction conductivity meter which measures the electrical conductivity of the water. If water temperature and pressure are measured at the same

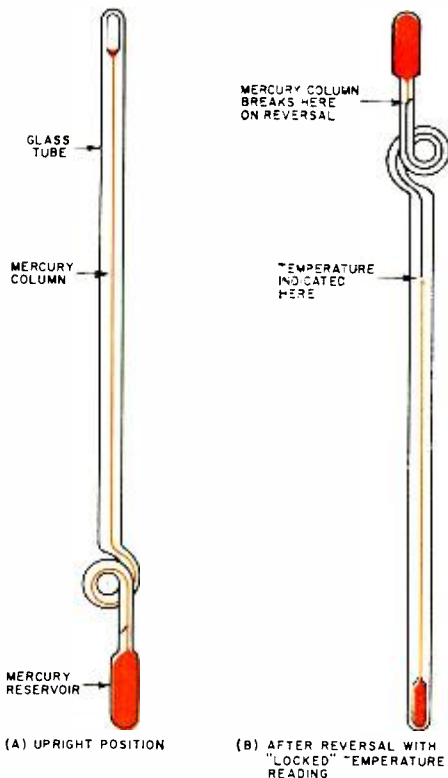

Fig. 1. The reversing thermometer is lowered in the upright position, tripped over to record temperature then pulled back up.

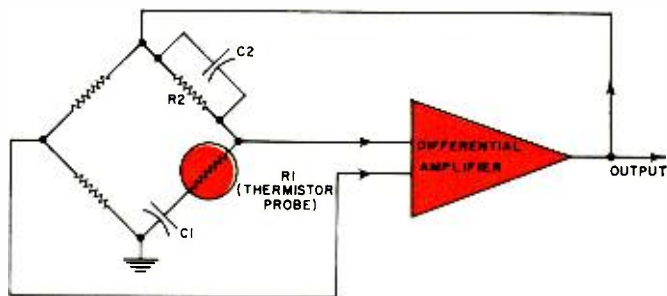

Fig. 2. The electronic bathythermograph uses a Wien-type bridge whose frequency varies with temperature/resistance changes in the thermistor. The EBT also measures water pressure.

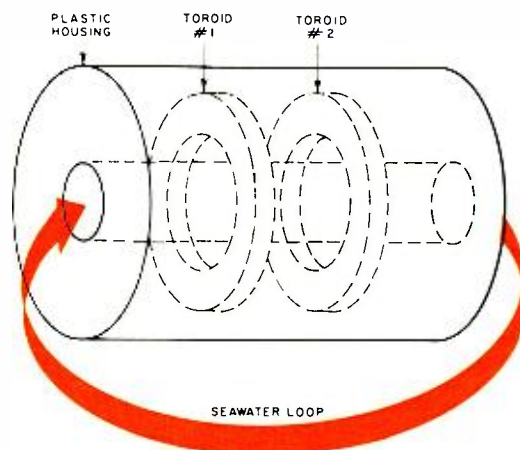

Fig. 3. Probe construction of the induction conductivity meter. The seawater forms the coupling between the toroids.

time, the salinity of the water under test can be computed.

Fig. 3 illustrates the electrical principle of this instrument. Two toroids are encased in plastic, and a hole of known size allows sea water to pass through their centers. The water forms a one-turn conductor that couples the toroids electrically.

If an audio oscillator is connected to a winding on toroid #1, as shown in Fig. 4, current flows through the sea-water loop. The amount of current flow in this loop, as well as the voltage induced in the winding of toroid #2, is proportional to the conductivity of the water. The voltmeter connected to the winding of toroid #2 can be calibrated to read conductivity.

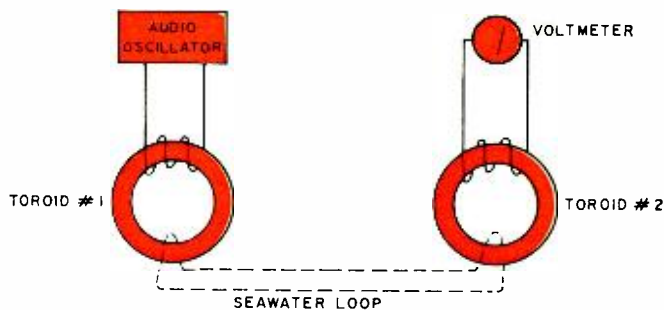

Fig. 4. Electrical operation of the induction conductivity meter. Sea-water conductivity determines induced voltage.

It is important that the area and length of the tube of sea water that couples the toroids together remain constant. One of the design problems is to prevent the high pressure encountered in deep water from distorting the probe.

A more serious problem lies in the fact that the meter measures conductivity and not the desired salinity. The computation of salinity from conductivity requires a very accurate knowledge of water temperature, on the order of 0.02° C. It is difficult to measure temperature to this accuracy in the ocean.

However, the striking advantage of the continuous readout provided by the induction conductivity meter, the availability of computers to perform the salinity calculation, and recent improvements in temperature-measurement techniques have brought this meter into wide use.

Acoustic Velocimeter

Water transmits sound more rapidly and with much less energy loss than air. Thus, sound is used extensively in the ocean for communication and navigation. Sonar, a tracking system using sound, replaces the radar used on land. Water depth is measured with sound pulses, and fishermen use these sonic pulses to find and track fish.

Sonar devices measure the time difference between the transmission of a sound pulse and its reception after reflection from an object. Distance can then be computed if the speed of sound in sea water is known.

The speed of sound in the ocean is about 5000 ft/sec but is by no means constant. It changes with water tempera-

ture, pressure, and salinity, and tables are available that give the speed of sound in terms of these variables. An electronic instrument, the acoustic velocimeter, measures sound speed directly with high accuracy.

The famous "sing-around" circuit is most often used in

Fig. 5. Block diagram of sing-around acoustic velocimeter.

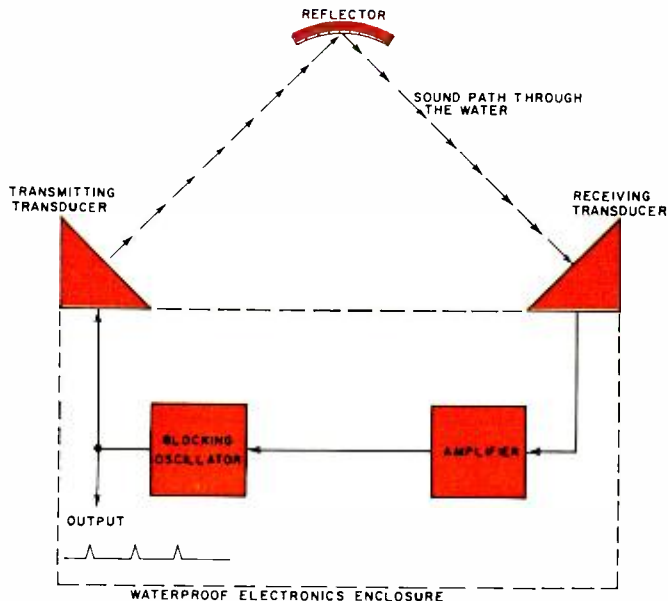

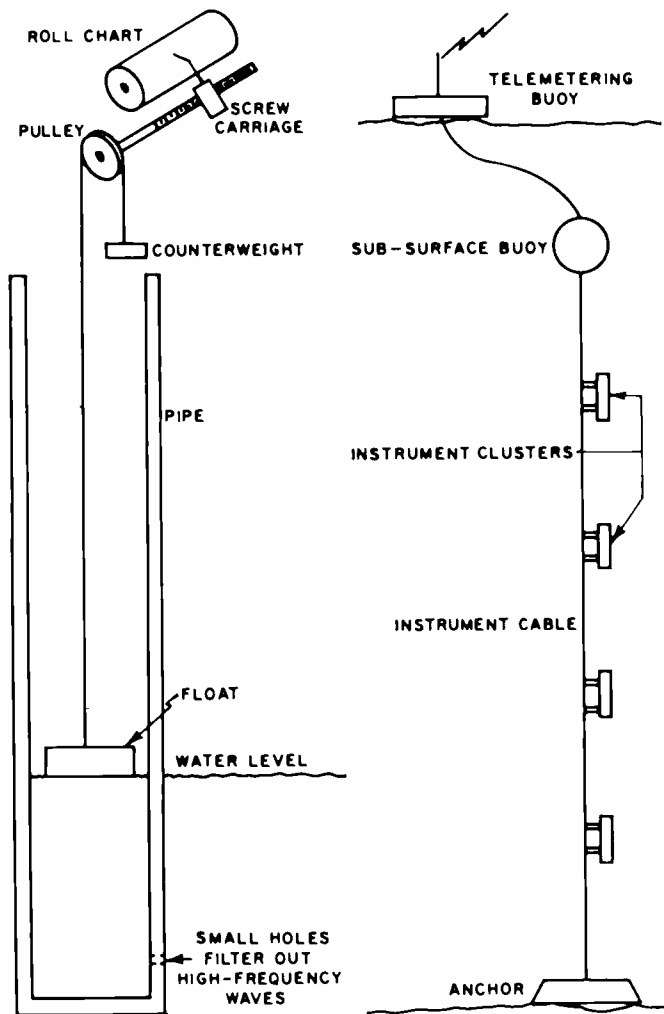

Fig. 6. (Left) The tide gage is a mechanical instrument. (Right) The telemetry buoy stores the data on a film or magnetic tape for later retrieval by surface vessel.

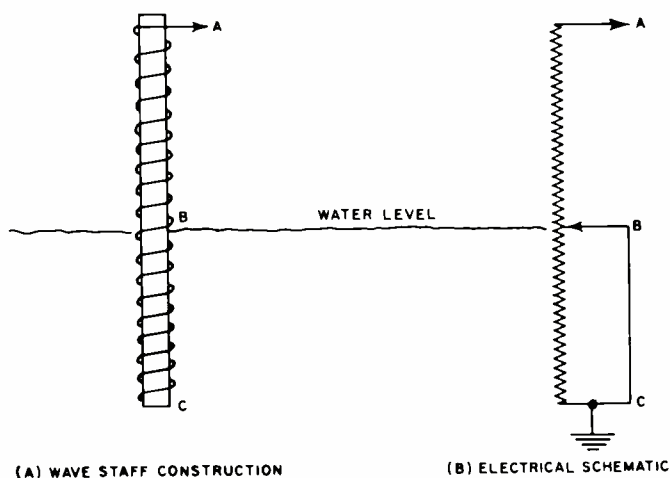
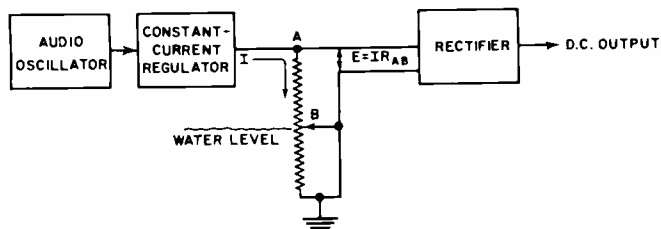

Fig. 7. A wave staff is a water-controlled potentiometer.

Fig. 8. The electronic wave staff uses a.c. to prevent electrolytic action that renders the device unworkable.



commercial velocimeters. The circuit was developed at the National Bureau of Standards and is shown in block diagram form in Fig. 5.

A pulse from the blocking oscillator shock-excites the transmitting transducer and the sound pulse thus generated is transmitted through the water to the receiving transducer. Its output signal is amplified and used to trigger the blocking oscillator which then emits another pulse. This sing-around process continues and the blocking oscillator output is a continuous series of pulses. Pulse spacing is determined by the time required for the acoustic pulse to travel through the water.

The length of the water path is held constant by careful mechanical design. The time required for the electrical pulses to go through the amplifier and blocking oscillator is small and constant. Thus, the repetition rate or frequency of the blocking oscillator is a direct measure of the speed of sound in water.

Instruments using this principle achieve accuracies of better than one part in 10,000.

Wave Staff

Measurement of wave and tide height is usually confined to shoreline or shallow water areas where a fixed mounting platform is available. As is common in many geophysical measurements, a 1-Hz wave is of "high frequency." Waves of tidal period, 0.0001 Hz and lower, are of particular interest, and meaningful measurements of such waves are quite difficult to make from floating platforms.

The low frequency of waves has made designers favor mechanical rather than electrical filters. A good example of this is the tide gage shown in Fig. 6 (left). The water level is measured in a pipe which is connected to the surrounding ocean water by small holes below the water level. They act as a low-pass filter to remove high-frequency ripples, and the float sees only low-frequency tides.

As the float moves up and down, a scribe moves with it to mark the chart paper. A clock mechanism advances the chart paper to provide a time record of tide height.

The electronic wave staff has recently come into prominence to measure higher frequency waves, and it can also be used for tidal measurements.

The basic sensor is shown in Fig. 7. A long plastic tube or rod is wrapped with a spiral winding of resistance wire; total resistance is several hundred ohms. When partially immersed in conductive sea water, the portion of the winding below the water level is shorted. Thus, the wave staff is a variable resistor with resistance inversely proportional to wave height.

The response of the wave staff is on the order of 10 Hz and its accuracy is better than 1% of full scale.

Since the wire of the staff is in contact with sea water, it cannot be operated with d.c. because electrolytic action starts and a polarizing voltage appears at the junction of the wire and the water that prevents meaningful measurements.

A typical design using a.c. excitation is shown in Fig. 8. An audio oscillator drives the staff through a constant-current regulator, and the wave-staff voltage is directly proportional to its resistance. A rectifier and filter then produce a d.c. voltage that is a function of wave height.

Telemetry Buoy

The telemetry buoy uses electronic instrumentation and radio transmission to allow long-term data to be collected from a single location in the ocean.

Most oceanographic measurements are taken from ship-board but it is quite expensive to hold a ship on location for extended periods of time. Therefore, recording buoys are often used. The data, recorded on film or magnetic tape, is retrieved at intervals by (Continued on page 75)

DIGITAL PLOTTING TECHNIQUES

By LOUIS E. FRENZEL, Jr.

Curves, charts, maps, drawings, and other displays can be generated as analog plots of digital data from computers. Plotters are employed in weather forecasting, for geophysical and petroleum surveys, to display business financial data, in roadbuilding, and for automatic drafting.

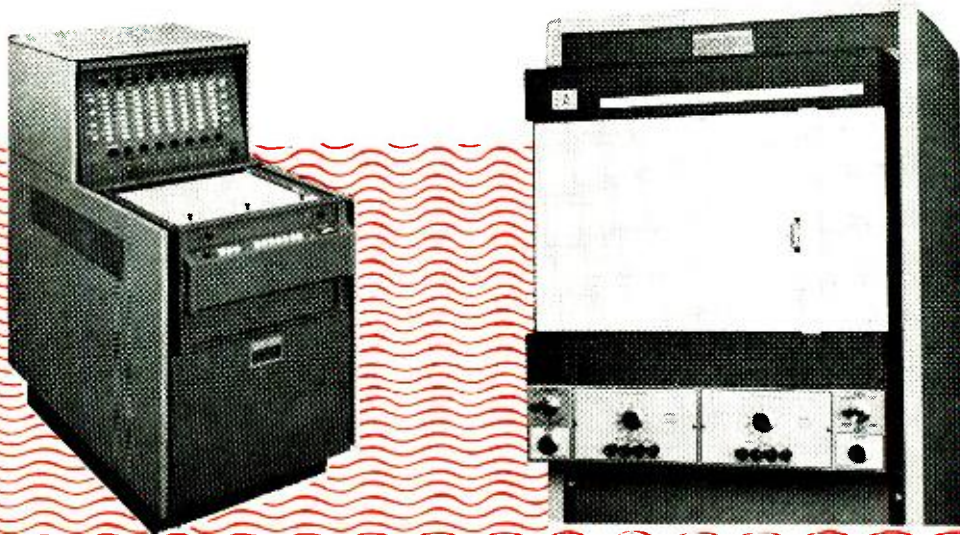

Fig. 1. (Left) A typical eight-channel strip-chart recorder and (right) X-Y plotter.

THERE are many different types of peripheral devices available for today's modern digital computer. These devices perform two basic functions—auxiliary storage and display. Computer data may be stored on punched cards, paper tape, or magnetic tape; and in many large systems magnetic drums or discs are used. Other peripheral units display or read out computer data. The most common displays are the I/O typewriter, the high-speed line printer, and the CRT. Another very useful but perhaps less well-known display device is the *digital plotter*. This is a device which accepts digital data either directly from the computer on-line or off-line from any one of the three most common auxiliary storage devices mentioned above and generates an analog plot of the digital data. An almost infinite variety of displays can be generated from the digital data. Maps, charts, curves, mathematical functions, and drawings of any kind are a few such possibilities.

Why Plot Digital Data?

Today's high-speed digital computers can generate volumes of data in an extremely short period of time. This data is most often read out by feeding it to a line printer or the I/O typewriter. The line printer displays the data in tabular form, which may or may not be the handiest form for easy assimilation. Usually it is not too convenient in this form and to get a picture, graph, or other visual representation of the digital data, one must manually plot the tabular values. This can be time-consuming, especially if there is a lot of data to be processed and analyzed.

Here is where a digital plotter really comes in handy. The plotter will automatically draw the desired curve, chart, map, or other visual display, thus eliminating the need for

personnel to do a manual plotting job. It saves a tremendous amount of time and provides a meaningful graphic display for immediate evaluation or approval.

In short, a digital plotter expedites the analysis of computer output results. Some data is meant to be presented in tabular or list form; other data is not. It may not always be obvious to an observer what the tabular line printer readout actually represents. For example, the printout may be the solution to a second-order differential equation which resulted from the simulation of some physical system on the computer. Just looking at a list of numbers will not indicate what the numbers represent, but if a plot of the data is made, the observer might readily recognize the amplitude *vs* time curve obtained as the solution to the differential equation.

Analog Plotters

Whenever one thinks of a display device that generates an analog plot, he usually assumes that an analog signal is driving it from an analog computer, a data-acquisition system, or some other analog source. While it is true that systems and devices which generate or process analog data use analog displays, there is no reason why digital data cannot be converted into analog form for display purposes. And that is exactly what happens in a digital plotter. The digital data is converted to analog form and displayed on an analog plotter.

There are two basic kinds of analog plotters—those that plot data as a function of time and those that can plot data either as a function of time or of another variable. Strip-chart recorders and recording oscillographs are examples of the first kind while the well-known X-Y plotter of analog computer fame is an example of the latter. The X-Y

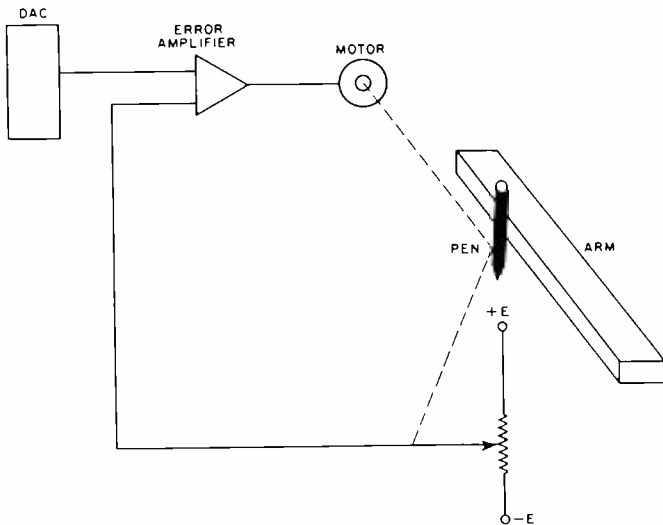

Fig. 2. Simplified block diagram of analog plotting pen servo.

plotter is the most versatile since it can display a signal with respect to time or as a function of another signal. Of course, the strip-chart-type recorders have the advantage of being able to display data over a longer period of time.

Fig. 1 shows both types of analog plotter, the eight-channel strip-chart recorder (left) and the X-Y plotter (right). Digital plotters can use either type of analog display, but the X-Y plotter is the most popular and is the kind which will be discussed here.

The general-purpose X-Y plotter in Fig. 1 contains two complete, independent, and accurate servo-positioning systems. One of these servo systems positions the movable vertical arm above the plotting surface in the left/right or X direction. The other servo system positions the plotting pen on the moving vertical arm in the up, down or Y direction.

How the Digital Plotter Works

A simplified block diagram of one servo system in an X-Y plotter is shown in Fig. 2. It works like any other servo system. The two signals to be plotted are applied to the error-detector amplifier inputs where the error signals thus generated are amplified and used to drive the motors that position the vertical arm and the pen. The arm and the pen move in an attempt to reduce the error to zero and at the same time plot a curve that is a composite of the two inputs that are employed.

Fig. 3. A digital plotting system with magnetic tape input unit.



A typical digital plotting system with its magnetic tape input unit is shown in Fig. 3. The plotter consists of a standard analog X-Y plotter, a digital-to-analog converter (DAC), and the appropriate control circuits. Fig. 4 is a simplified block diagram of a digital plotting system. As can be seen, the plotter may receive off-line inputs from several sources: its built-in programming keyboard, magnetic tape, punched paper tape, or punched cards. On-line it receives its input directly from a digital computer. Off-line use is preferred since the plotter is slow.

The digital input data is converted into analog voltages by the DAC. These voltages are fed to the X-Y plotter as X and Y coordinate values where they position the plotting arm and pen on the plotting surface in order to produce the composite curve.

Another type of digital plotter uses incremental step motors and digital servo systems instead of conventional electrical motors and continuously variable analog servos. One of the digital servos and stepping motors moves the plotting pen while the other moves the paper. Instead of a fixed sheet of paper and a movable arm, a fixed arm with a movable pen is used to plot on graph paper that is moved by means of rollers. The advantage of this particular type of digital plotter is that its accuracy is not dependent on the voltage stability of analog circuits in systems that use digital-to-analog conversion. However, such a system using step motors cannot plot a true straight diagonal line since it can only move in steps. But since the steps are very small, usually a hundredth or several thousandths of an inch, and because the plotting pen is not infinitely fine, a very satisfactory diagonal line can be plotted with this particular system.

Most plotters operate in one of two modes—point plot or line plot. In the point-plot mode the plotter is fed one set of X-Y coordinates. When the arm and pen are properly positioned, the pen is lowered and a point is made. The pen is then raised and the plotter is given a new set of X-Y coordinates. The procedure is repeated until the desired plot is obtained. In the line-plot mode, the plotter is given a starting set of X-Y coordinates. When the position is reached, the pen is lowered. The plotter is then given another set of coordinates. The pen remains lowered and it draws a straight line between the starting point and the next point. New coordinate sets are sequentially fed to the plotter and the pen will trace a line between the points, forming the desired plot. Fig. 5 shows a curve plotted in the line-plot (top) and point-plot (center) modes.

The digital data to be plotted should be stored in the computer or on tape so that it can be given to the plotter sequentially in the form of X and Y coordinate values. This calls for some attention to output programming techniques in the computer. The techniques are certainly not difficult and most digital plotters are supplied with a complete software package.

Many digital plotters also contain a symbol printer usually mounted with or adjacent to the plotting pen on the movable X-coordinate arm. The printer is positioned along with the pen by Y-coordinate selection. The printer consists of a turret of solenoid-operated printed hammers that can print the alphabet, numbers, or special symbols; an automatic take-up ribbon; and the appropriate selection circuitry. The printer is convenient for labeling the pen plots and it saves time by eliminating the need for the plotter to do the lettering in the more time-consuming line-plot mode. The symbol printer can also be used like the pen in the point-plot mode to produce curves or drawings like that shown in Fig. 5 (bottom).

Digital Plotter Applications

As might be expected, the digital plotter is extremely useful and its application as a display device is almost limitless. Wherever digital data is to be displayed in analog

form, a plotter can be used, and it will save time and reduce the amount of work required while doing the job. Consider some of these applications.

Fig. 6 shows an isobar-type weather map produced by a digital plotter. The contours were plotted from digital data generated by a digital computer. The computer was programmed to predict weather conditions from given information such as present conditions, past predictions, and other factors. Before the introduction of the plotter, it took several hours to plot one of these maps by hand. Now the plotter does it in a few minutes. Plotters are used extensively in weather prediction and meteorological research.

Plotters are also used quite extensively in the geophysical and petroleum industries, especially where research and oil exploration are concerned. The search for new oil deposits involves the collection of data about the earth's subsurface and then an analysis of this data to determine the exact location and extent of the possible deposit. Digital computers are now widely used to process and analyze the data collected, and digital plotters provide an excellent means of displaying the results of this analysis. Plotters are used to display seismic reflection and refraction traces, isopachous contour maps resulting from well log data and magnetic or gravity measurements, and other similar plots generated by the computer to which the plotter is connected. Fig. 9 shows a typical, large-scale plotter reproducing a geophysical contour map. Here the big advantage of the computer/plotter combination is that it saves a tremendous amount of time in the processing and analysis of the great volumes of geophysical data available.

Business and industry use plotters to display graphs that result from the processing of financial and statistical data. Many companies use computers to keep track of financial and economic conditions and to predict such things as possible sales, profits, losses, inventory, and production. A digital computer would present such information in tabular form, while the plotter will generate an analog curve or graph of, say, profit vs time in months. This quick, automatic reduction of a mass of business data enables those concerned to see significant trends and to make rapid appraisal of complex situations.

The civil engineering field makes good use of digital plotters in surveying and in road planning. After a road site has been surveyed, the data obtained is given to a computer for processing. A plotter then makes a complete drawing of the proposed roadway. Cross-sections of the highway at a number of points along its length are also planned on the computer and displayed on the plotter. The planning of new roads, highways, and city subdivisions is done with the help of a computer and the results of such planning can be quickly and accurately displayed.

Clothing manufacturers use computer/plotter systems for automatic pattern grading. The pattern for an item of apparel is copied or "digitalized" by a plotting device and the resulting digital data is stored and fed to a computer. The computer makes calculations and corrections and new results are plotted. The plotter will reproduce a complete run of the original pattern in all the various sizes needed. Automating this process saves time and money for the manufacturer and provides a better fitting item of apparel for the customer.

All of these applications demonstrate not only the usefulness of the digital plotter, but also the versatility of a digital computer when connected to an appropriate peripheral device such as a plotter.

Automatic Drafting

One of the most fascinating applications of electronic plotting equipment is automatic drafting. Drafting is an essential part of any engineering operation since all types of drawings, diagrams, schematics, graphs, and charts are used in designing and producing any component, device,

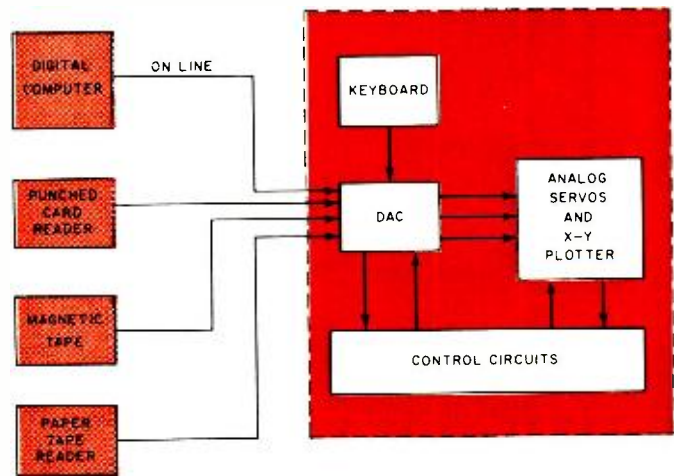

Fig. 4. A simplified block diagram of a digital plotting system.

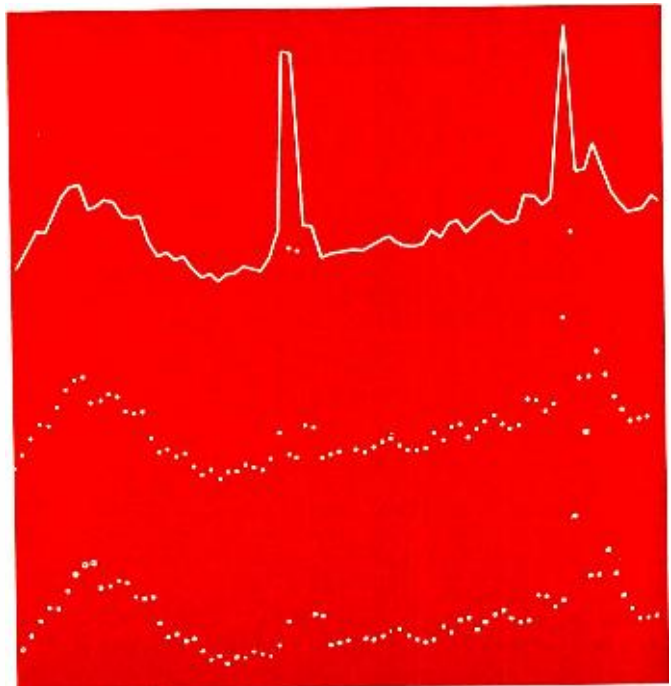
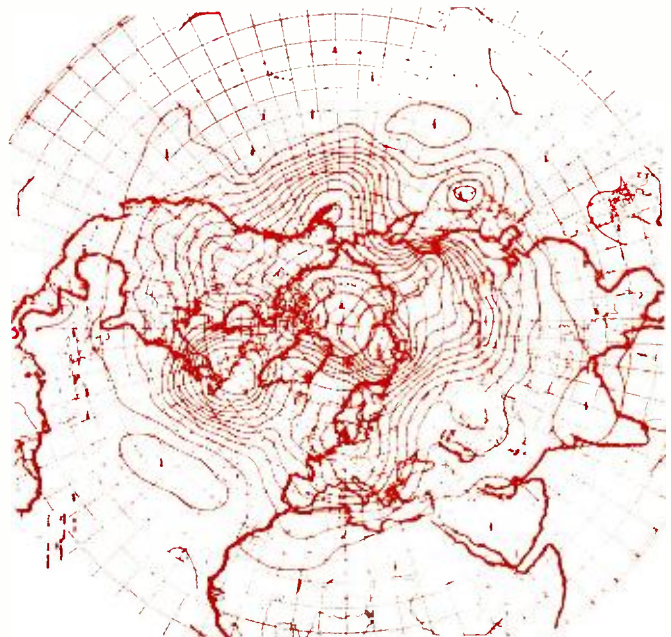

Fig. 5. (Top) Line, (center) point, (bottom) symbol plots.

Fig. 6. Isobar weather map produced by a digital plotter.



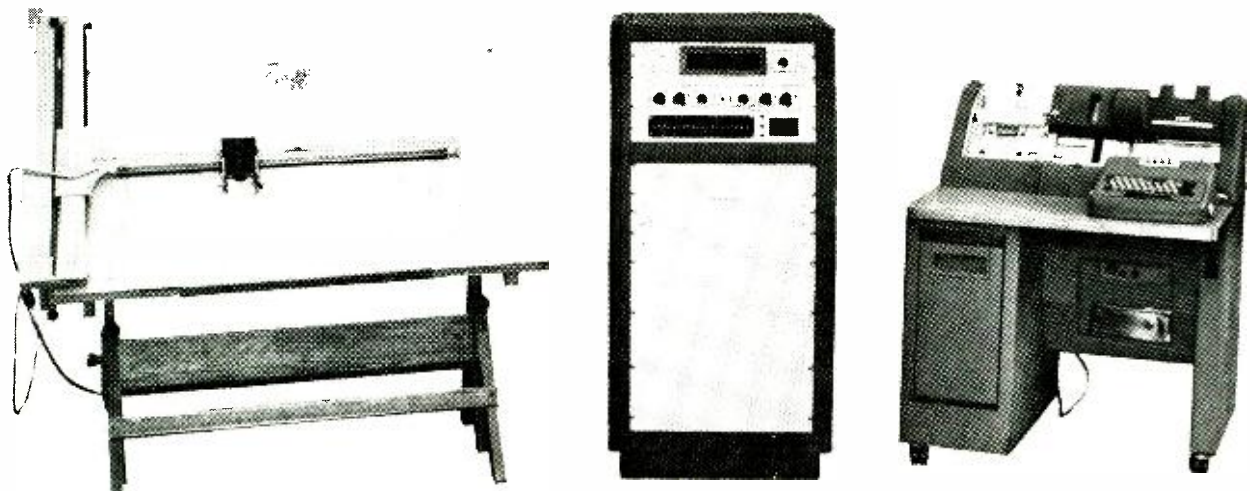

Fig. 7. An automatic drafting machine along with an IBM card punch that is employed to "digitize" drawings.

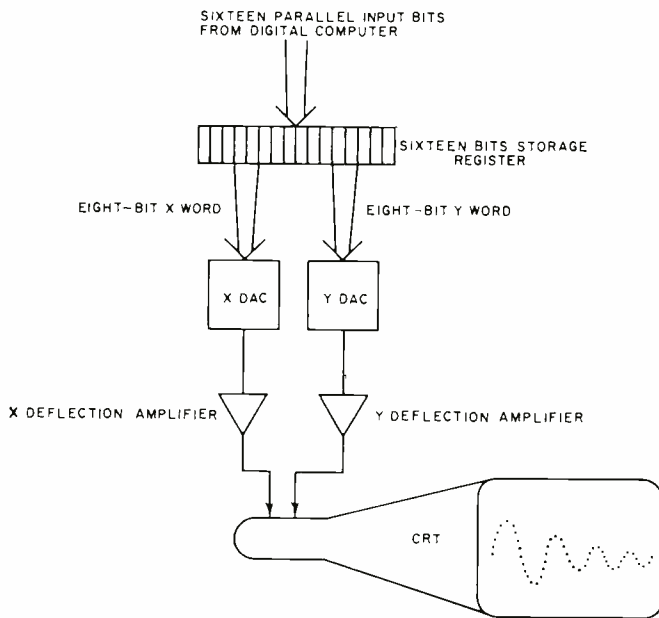

Fig. 8. Arrangement used for digital cathode-ray-tube display.

or piece of equipment. A draftsman must carefully draw each diagram by hand and, as might be expected, this is a very time-consuming process. Additional time is consumed in making copies of the drawings for engineering and production use and in filing and keeping track of the master drawing.

By using digital plotting equipment for drafting operations, it is possible to save drawing, filing, and reproduction time as well as improve accuracy and minimize human

Fig. 9. Digital plotter generating geophysical contour map.



error. For example, consider the system shown in Fig. 7. With this system any drawing can be "digitalized" and stored on punched cards or paper tape. To reproduce this drawing, the cards or tape can be read by a card or tape reader feeding a plotter. The drawing will be reproduced by the digital plotter. If desired, cards may be read by a reader and the binary data output of the reader can be recorded on magnetic tape. In this way, many drawings can be stored on a reel of magnetic tape. This type of storage reduces the size of a drawing file substantially and permits rapid location and reproduction of a desired drawing.

By adding a small computer to the automatic drawing equipment many interesting and useful operations can be performed. Consider some of these examples.

1. A master computer program could allow the automatic location and reproduction of any drawing in storage (on magnetic tape). An operator would enter the number of the desired drawing with the computer's input typewriter and immediately the computer would search its memory and output the drawing to the plotter.

2. The computer would allow drawing modifications to be made without actually going back to the original hand-made master drawing. Changes in program or data word format would generate the modification.

3. Special computer programs can be used to change a simple front-, side-, and top-view drawing into an orthographic projection or other type of 3-D presentation. This particular operation is really a drafting time saver and in most cases it can be done by a digital plotter with special analog computer circuitry. Of course, a digital computer could be used, but it is not a necessity. In the same way, an orthographic or other 3-D-type presentation can be reduced to a simple top view. A very useful application of this technique is in making top-view maps directly from aerial photographs. By knowing the angle from which the photograph was taken and the altitude and by correcting for factors such as the curvature of the earth and camera focal length, an accurate top-view map can be made of the area photographed.

4. A computer-plotter system can be used to simplify, speed up, and optimize design. For example, when designing digital logic circuitry, it is possible to feed into the digital computer a set of Boolean algebraic equations describing the desired operations and then have the computer generate a complete, but minimized, logic diagram. The logic diagram using standard *and/or* or *nand/nor* gates, flip-flops, and other digital circuit symbols properly interconnected will be reproduced by the digital plotter while connected on-line to the computer. The computer/plotter combination can be used to generate a plot of any mathematical expression which can be stored in (Continued on page 67)



Why We Make the Model 211 Available Now

Although there are many stereo test records on the market today, most critical checks on existing test records have to be made with expensive test equipment.

Realizing this, HiFi STEREO REVIEW decided to produce a record that allows you to check your stereo rig, accurately and completely, just by listening! A record that would be precise enough for technicians to use in the laboratory—and versatile enough for you to use in your home.

The result: the HiFi STEREO REVIEW Model 211 Stereo Test Record!

Stereo Checks That Can Be Made With the Model 211

- ✓ Frequency response—a direct check of eighteen sections of the frequency spectrum, from 20 to 20,000 cps.
- ✓ Pickup tracking—the most sensitive tests ever available on disc for checking cartridge, stylus, and tone arm.
- ✓ Hum and rumble—foolproof tests that help you evaluate the actual audible levels of rumble and hum in your system.
- ✓ Flutter—a test to check whether your turntable's flutter is low, moderate, or high.
- ✓ Channel balance—two white-noise signals that allow you to match your system's stereo channels for level and tonal characteristics.
- ✓ Separation—an ingenious means of checking the stereo separation at seven different parts of the musical spectrum—from mid-bass to high treble.

ALSO:

- ✓ Stereo Spread
- ✓ Speaker Phasing
- ✓ Channel Identification

PLUS SUPER FIDELITY MUSIC!

The non-test side of this record consists of music recorded directly on the master disc, without going through the usual tape process. It's a superb demonstration of flawless recording technique. A demonstration that will amaze and entertain you and your friends.

NOW...GET THE FINEST STEREO TEST RECORD ever produced

for just...\$4.98

Featuring Tests Never Before Available Outside Of The Laboratory

UNIQUE FEATURES OF HiFi/STEREO REVIEW'S MODEL 211 STEREO TEST RECORD

- Warble tones to minimize the distorting effects of room acoustics when making frequency-response checks.

Warble tones used are recorded to the same level within ± 1 db from 40 to 20,000 cps, and within ± 3 db to 20 cps. For the first time you can measure the frequency response of a system without an anechoic chamber. The frequency limits of each warble are within 5% accuracy.

- White-noise signals to allow the stereo channels to be matched in level and in tonal characteristics.
- Four specially designed tests to check distortion in stereo cartridges.
- Open-air recording of moving snare drums to minimize reverberation when checking stereo spread.

All Tests Can Be Made By Ear

HiFi STEREO REVIEW's Model 211 Stereo Test Record will give you immediate answers to all of the questions you have about your stereo system. It's the most complete test record of its kind—contains the widest range of check-points ever included on one test disc! And you need no expensive test equipment. All checks can be made by ear!

Note to professionals: The Model 211 can be used as a highly efficient design and measurement tool. Recorded levels, frequencies, etc. have been controlled to very close tolerances—affording accurate numerical evaluation when used with test instruments.

DON'T MISS OUT—ORDER NOW

The Model 211 Stereo Test Record is a disc that has set the new standard for stereo test recording. There is an overwhelming demand for this record and orders will be filled by ELECTRONICS WORLD promptly upon receipt. At the low price of \$4.98, this is a value you won't want to miss. Make sure you fill in and mail the coupon together with your check (\$4.98 per record) today.

FILL IN AND MAIL TODAY!

Stereo Test Record
ELECTRONICS WORLD—Dept. SD
One Park Ave., New York 16, N.Y.

Please send me _____ test records at \$4.98 each. My check (or money order) for \$_____ is enclosed. I understand that you will pay the postage. (Orders from outside the U.S.A. add 50c to partially defray postage and handling costs.)

Name _____
(Please Print)

Address _____

City _____ Zone _____ State _____

SORRY—No charges or C.O.D. orders! EW-37

“Get more
education
or
*get out of
electronics*

...that's my advice.”

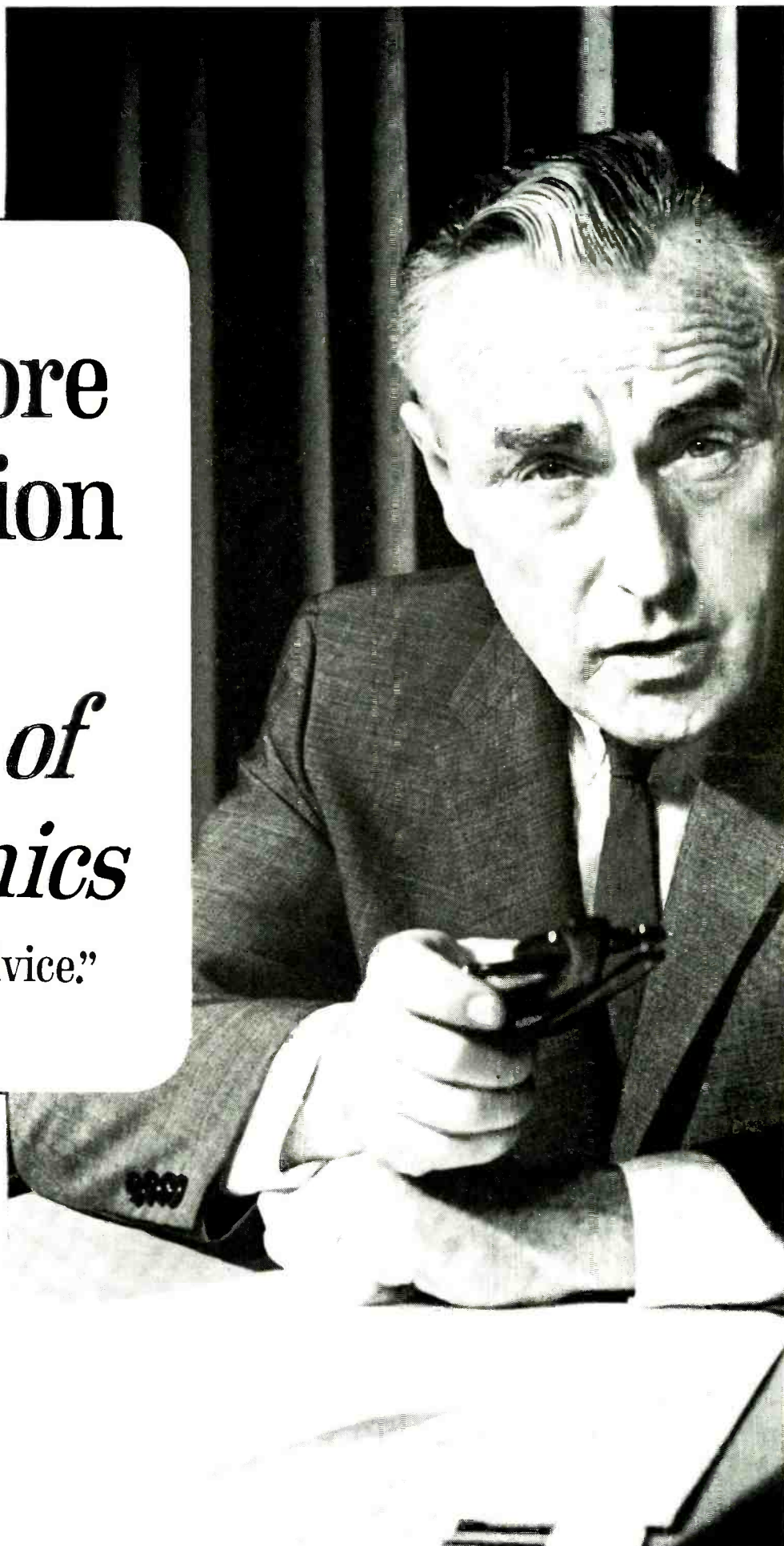



Ask any man who really knows the electronics industry. Opportunities are few for men without advanced technical education. If you stay on that level, you'll never make much money. And you'll be among the first to go in a layoff.

But, if you supplement your experience with more education in electronics, you can become a specialist. You'll enjoy good income and excellent security. You won't have to worry about automation or advances in technology putting you out of a job.

How can you get the additional education you must have to protect your future—and the future of those who depend on you? Going back to school isn't easy for a man with a job and family obligations.

CREI Home Study Programs offer you a practical way to get more education without going back to school. You study at home, at your own pace, on your own schedule. And you study with the assurance that what you learn can be applied on the job immediately to make you worth more money to your employer.

You're eligible for a CREI Program if you work in electronics and have a high school education. Our FREE book gives complete information. Airmail postpaid card for your copy. If card is detached, use coupon below or write: CREI, Dept. 1125 E, 3224 Sixteenth Street, N.W., Washington, D.C. 20010.

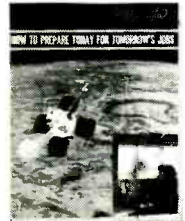

The Capitol Radio Engineering Institute

Dept. 1125E, 3224 Sixteenth Street, N.W., Washington, D.C. 20010

Please send me FREE book describing CREI Programs. I am employed in electronics and have a high school education.

NAME _____ AGE _____

ADDRESS _____

CITY _____ STATE _____ ZIP CODE _____

EMPLOYED BY _____

TYPE OF PRESENT WORK _____ GI BILL

- I am interested in Electronic Engineering Technology
 Space Electronics Nuclear Engineering Technology
 Industrial Electronics for Automation
 Computer Systems Technology

APPROVED FOR VETERANS ADMINISTRATION TRAINING



JOHN KING

While the newest solid-state transceivers contain highly sophisticated circuitry, IC's promise still more advances.

CB AND INTEGRATED CIRCUITS

BARNEY stood peering out the window of Mac's Service Shop as he listened to the sleet scratching against the plate glass and watched the freezing rain fattening the drooping light wires. "You know, Mac," he called over his shoulder to his employer in the service department, "this weather is almost bad enough to bring on an urge to put up a TV, ham, or CB antenna."

Mac nodded in appreciation. "Why is it most antenna work seems to be done when the weather is worst?" he asked.

"Probably because that's when most of the operating, and consequently most of the thinking about the signal, is done," Barney suggested. "When the weather is nice, we're all picnicking, swimming, going on vacation, and otherwise swinging with the weather. On a day like this, though, about all a ham or CB operator wants to do is tickle the ether waves, and then his fancy lightly turns to thoughts of a new antenna or changing the old one."

"Speaking of the Citizens Band, last night I was at the house of a friend inspecting a posh new solid-state transceiver he had bought, and I continue to be amazed at how sophisticated CB equipment has become in such a short time. This transceiver happened to be a *Lafayette* HB-600, but it is representative of several other new transceivers, both of Japanese and American manufacture, that represent what I would call a 'third generation' of solid-state CB transceivers."

"Why do you say that?"

"Well, the first generation of transistorized transceivers *did* use transistors and *would* receive and transmit after a fashion, but that is about all you could say for them. The receiving portion was temperature-sensitive and drifted badly, while the transmitting-section output did not compare with a tube job. The second generation overcame most of these faults through the use of silicon transistors, zener diodes, and improved circuits. While they may have been a little lacking in ability to handle strong signals without overloading, and they did not always produce high-level linear modulation, their compactness and freedom from tube troubles made up for this. They began giving tube transceivers a real run for their money, especially in mobile installations, where their low current drain was an added advantage."

"But now comes the third generation of solid-state transceivers containing really sophisticated circuitry and prepared to challenge tube transceivers on just about any ground you can mention. Transistorized CB transceivers can crowd a lot of circuitry into a very small space, and this permits them to add multi-stage circuitry without increasing substantially either bulk or weight. The noise-silencer circuit in that HB-600 is a good example. It employs five stages; yet the whole circuit occupies little more space than would a single tube."

"How does it work?"

"Actually, the receiver has both a noise-limiter and a noise-silencer circuit, together with a switch that permits cutting both out, using only the limiter, or throwing both

limiter and silencer into operation. The limiter is the conventional automatic type employing diodes that limits the amplitude of noise spikes to a level only a trifle higher than the modulated carrier level. It's effective in reducing noise pulses that greatly exceed the signal level, but it's not so effective on noise just about equal to the signal. The noise silencer does an excellent job on rapid pulses of very short duration, such as an ignition system puts out, because it actually silences the receiver for the duration of each narrow pulse."

"You still haven't told me how it works," Mac persisted.

"Keep your cool. I'm coming to that. Ignition noise covers a wide spectrum; so an input circuit tuned to 25 MHz, just below the CB band, picks off the antenna the identical noise—but without any signal—that is being fed into the receiver. This noise is amplified by two 25-MHz r.f. stages with not too high a 'Q' because passing noise pulses through highly selective circuits tends to widen the pulses. Then the diode detector changes the a.c. pulse waveforms into d.c. pulse voltages. Finally, these pulses are fed through two noise pulse amplifier stages that shape and amplify them, and then they are put into a balanced second mixer that converts the second i.f. of 6.2 MHz to 455 kHz for introduction into the mechanical filter. This rather unusual mixer stage is so arranged that a negative-going pulse from the final pulse amplifier temporarily back-biases the two diodes used in the mixer and causes it to present a very high resistance to the passage of the signal. That's why it's called a second mixer *and* noise gate. The end effect is that the signal path through the receiver is interrupted at the precise instant each noise pulse is trying to pass. Since these interruptions are of 10 microseconds or less duration, the 'holes' punched out of the signal are hardly noticed."

"Hey, that's clever," Mac applauded. "You virtually make the noise pulses cut their own throats. But is this something new?"

"No, not really," Barney admitted. "The basic idea was introduced to amateur radio in an article by James Lamb in *QST* thirty years ago. Some of the more expensive ham receivers have it or offer it as an option. What impresses me, though, is how simply it is added to this solid-state receiver and the apparently little effect it has on the overall price. One of the 'high-priced-spread' amateur transceivers offers the noise silencer as an option but at a cost more than half as much as the whole CB transceiver costs."

"How does the noise silencer work on static crashes?"

"It doesn't. Neither is it any good on a steady grinding noise such as that put out by neon lights. Noise pulses must be sharp and narrow, lasting no more than 10 microseconds, for the silencer to deal with them; but it certainly does a job on ignition interference. Before I forget it, that CB transceiver has another interesting feature. It uses a single crystal for both receiving and transmitting on a given channel. Since it provides crystal-controlled reception and transmission on all 23 channels, this makes quite a saving on crystals."

"Go on. This is your day to lecture. Tell me how they do it."

"It's really quite simple. Take an example of receiving channel 1 on 26.965 MHz. The receive crystal is on 33.165 so that the difference first i.f. frequency of 6.2 MHz is produced in the first mixer. This frequency is combined in the second mixer with a 5.745-MHz frequency from a crystal oscillator to produce the 455-kHz frequency accepted by the mechanical filter. And, incidentally, this 5.745-MHz crystal is flanked by two others, 2.5 kHz on either side, so that any one of the three can be selected with a three-position switch to provide 'delta tuning' for picking up stations a little higher or lower than the precise channel frequency. This is a good idea because the mechanical filter has a steep-sided response and rejects signals very far off its center frequency."

"How do you get a 26.965-MHz channel-1 transmit frequency out of that 33.165-MHz receive crystal?"

"By mixing the output of the receive crystal with a 6.2-MHz frequency from a crystal oscillator and feeding the difference frequency of 26.965 MHz from the mixer through a passband filter accepting all frequencies from channel 1 through channel 23 into a first transmitter r.f. amplifier. In the same way, a single crystal will do double-duty on any one of the remaining twenty-two channels. See, I told you it was simple."

"I see that some of the manufacturers are coming out with SSB CB transceivers," Mac noted. "Have you had a chance to inspect any of those?"

"Not yet, but I'd like to. My ham station has been SSB for several years, and I know how effective it is there; but I have never even heard a side-band signal on the Citizens Band."

"Wouldn't do you much good if you did. You couldn't copy it on that AM transceiver of yours with no product detector or even a b.f.o. to reinsert the suppressed carrier."

"Oh come on! Give me credit for a little resourcefulness. I'll simply use a signal generator to reinsert the carrier right at the antenna. This makes for ticklish signal-generating tuning at 27 MHz, but it can be done."

Mac began rummaging around in a drawer as he answered.

"I've a notion 'you ain't seen nothin' yet' in miniaturized and sophisticated CB equipment. Integrated circuits and CB gear should go together like a folk singer and a guitar. Last night, when you looked inside that transceiver, you saw mostly transistors, diodes, resistors, and capacitors. Well, an integrated circuit can easily produce more than 80 of these components on a silicon chip no larger than one-twentieth of an inch square.

Last year more than 35 million IC's were produced; and when you consider that Jack Kirby of *Texas Instruments* developed the first one in the summer of 1958 and that they did not become generally available until four years ago, that's really something."

"I know IC's save space and weight, but in lots of electronic equipment these things are not very important. Why are they so popular?"

"Because they have lots more going for them: things like reliability, low cost, and speed of operation. Remember, electric current travels about a foot in a billionth of a second; so when we get into microwaves or really high-speed computers, lead lengths connecting components together act like unwanted delay lines. In IC's these lengths are only a tiny fraction of an inch long; so IC's are a natural in high-speed or high-frequency service."

"I've read lots of magazine articles on IC's, but most of these stories are apparently aimed at the guy who intends to make, not use, integrated circuits," Barney complained. "Manufacturing details were interesting the first time I read them, but what I want now is dope on what IC's can and can't do, equipment to which they are best adapted, and instructions on how to handle, install, and test them."

"Right here you are," Mac said, tossing a booklet from the drawer to the youth. "That's 'Integrated Circuit Projects from Motorola,' a part of their HEP (Hobbyists and Experimenters Projects) program. It contains a good glossary of the most common terms used in IC work; advice on handling the devices; a short resumé of binary computer math; and detailed instructions on how to use *Motorola* IC's to build a binary computer, an organ, a square-wave generator, a code practice oscillator, a glidetone, and an electronic string guitar. It's the quickest way I know for a person to become familiar with integrated circuits. And to back it up," he continued, tossing over another book as thick as a *Montgomery Ward* catalogue, "here's a copy of *Motorola's* 'The Semiconductor Data Book.' You'll find exhaustive data on everything from zener diodes and a full range of transistors to integrated circuits. It goes up there on the shelf beside our *RCA* and *G-E* semiconductor manuals. I'm certainly delighted to see some of the really large manufacturers putting out material of this sort."

"Okay," Barney said with a sigh of resignation. "With outfits like *Motorola*, *Texas Instruments*, *Westinghouse*, *Fairchild*, *RCA*, and *G-E* all burning the midnight oil to make better IC's and find new applications for them, I'd better take these books home and get a little HEP on them myself!" ▲

Live Better Electronically With
LAFAYETTE
RADIO ELECTRONICS



- DYNA-COM 5**
- ★ 3 Switchable Crystal Controlled Transmit and Receive Channel Positions for All 23 Channels
 - ★ 5-Watt FCC Maximum Input . . . with the Power of the Most Powerful Base and Mobile CB Transceivers
 - ★ 13 Transistors, 6 Diodes
 - ★ 7-Stage Transmitter for Maximum Transmit Power!
 - ★ Operate Mobile in Your Car with Optional Cigarette Lighter Plug-in Adapter
 - Superheterodyne Receiver with Less Than 1 Microvolt Sensitivity for 10 db S + N/N Ratio
 - Automatic Compressor Range Boost-Assures High Talk Power
 - Variable squelch and Automatic Noise Limiting for Minimum Noise
- Imported +

FREE
1967
Catalog No. 670
512 Pages
Everything in Electronics for Home and Industry from the "World's Hi-Fi Electronics Center"

LAFAYETTE Radio ELECTRONICS
Dept. RC-7, P. O. Box 10
Syosset, L. I., N. Y. 11791

Send me the FREE 1967 LAFAYETTE Catalog 670 RC-7

Name

Address

City

State Zip

CIRCLE NO. 110 ON READER SERVICE CARD

GET INTO **ELECTRONICS**



V.T.I. training leads to success as technicians, field engineers, specialists in communications, guided missiles, computers, radar and automation. Basic & advanced courses in theory & laboratory. Electronic Engineering Technology and Electronic Technology curricula both available. Assoc. degree in 29 mos. B. S. also obtainable. G.I. approved. Graduates in all branches of electronics with major companies. Start September, February. Dorms, campus. High school graduate or equivalent. Write for catalog.

VALPARAISO TECHNICAL INSTITUTE
Dept. RD, Valparaiso, Indiana

TEST EQUIPMENT

PRODUCT REPORT

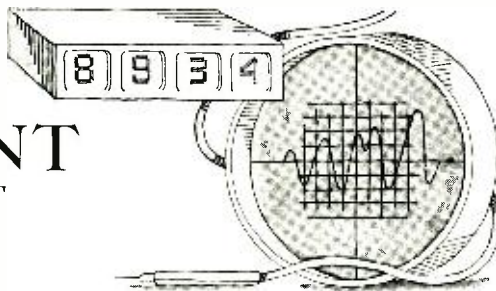

Fairlane Electronics Model LBO-5SA Oscilloscope

For copy of manufacturer's brochure, circle No. 35 on Reader Service Card.

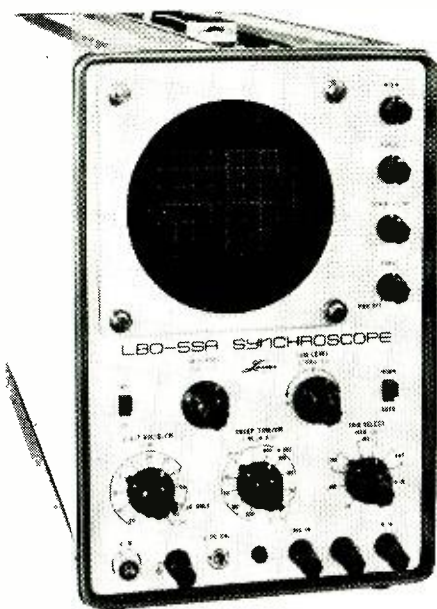

THE Fairlane Electronics Model LBO-5SA oscilloscope provides capabilities usually associated with far more sophisticated and more expensive devices with features such as a calibrated and triggered sweep and a rise time of 80 nanoseconds. The a.c. input has sensitivities down to 10 mV p-p/cm. Frequency response is d.c. to 5 MHz. The instrument may be used to measure d.c. voltages as well as rise time,

pulse width, and decay time of voltage or current pulses using the calibrated and triggered sweep. In addition, the scope may be employed for applications utilizing the free-running sweep.

The sweep generator is controlled by a triggering signal which is derived from the input signal as it passes through the vertical-channel amplifier. There are two modes of operation, "Normal" (triggered) and "Automatic" (free-running), depending upon the switch selection. By proper choice of the point on the slope of the waveform, the sweep generator starts the sweep and continues it as long as the input is applied.

The input circuit consists of an eleven-position attenuator composed of resistance-capacitance networks for full frequency compensation. The input probe is simply a 9-megohm resistor shunted by a compensating capacitor.

The vertical amplifier is push-pull and is direct-coupled with three stages. D.c. balance is accomplished by a front-panel adjustment. The frequency response is extended to 5 MHz with peaking coils in the plate circuits of the second and final stages.

The trigger circuit has a three-position switch which can select an input from either the vertical amplifier, the 60-Hz line, or an external source. After

amplification and phase conversion, the signal goes to a Schmitt trigger where it is shaped into a rectangular waveform. This waveform is then integrated and fed to a sweep-gating multivibrator which acts as a switch for the time-base generator.

Pulses in the negative direction cut off the disconnect diodes so that the Miller run-up circuit will operate. The positive pulses from the sweep-gating multivibrator act to unblank the CRT.

The Miller run-up circuit consists of the run-up tube, a neon lamp, the disconnect diodes, and associated resistors. The circuit is designed so that the charging current for the timing capacitor through the timing resistor is constant. Thus, the voltage at the cathode of the run-up tube will rise linearly and is used for the sweep. The sweep speed is determined by selection of the appropriate resistance-capacitance combinations by the "Sweep Time / Cm" switch. The "Fine" control is used to vary the sweep speeds between the calibrated steps. The length of the sweep is set by adjusting the voltage which starts the sweep-gating MV.

The return trace is blanked by preventing the time-base circuit from being triggered by the hold-off circuit. This is done by keeping the grid at the input of the sweep-gating multivibrator at a high potential, preventing it from being triggered. The time for the hold-off is controlled by the timing capacitor.

In order to maintain control of the triggered operation, the "Stability" control is adjusted so that the sweep-gating multivibrator is prevented from free-running. When this control is set clockwise, the sweep-gating multivibrator will be in a free state, which is similar to the operation of a conventional scope.

The horizontal amplifier produces the deflection of the CRT spot in the horizontal direction and consists of an input cathode follower and push-pull output stage. The sweep magnification switch for "Mag X5" is used to increase the amplifier gain five times by cutting out the input voltage divider.

The one-volt p-p calibrating voltage is derived from a zener diode which is used for clipping the a.c. input.

Price of the oscilloscope is \$299.95, and complete specs are available from the manufacturer. ▲

Semitronics Model 1000 Transistor Tester & Set Analyzer

For copy of manufacturer's brochure, circle No. 36 on Reader Service Card.

INCORPORATING eight analyzers in one unit, the new Semitronics Corp. Model 1000 transistor tester and set analyzer functions as a transistor tester, diode tester, voltmeter, ammeter, signal generator, in-circuit tester, battery

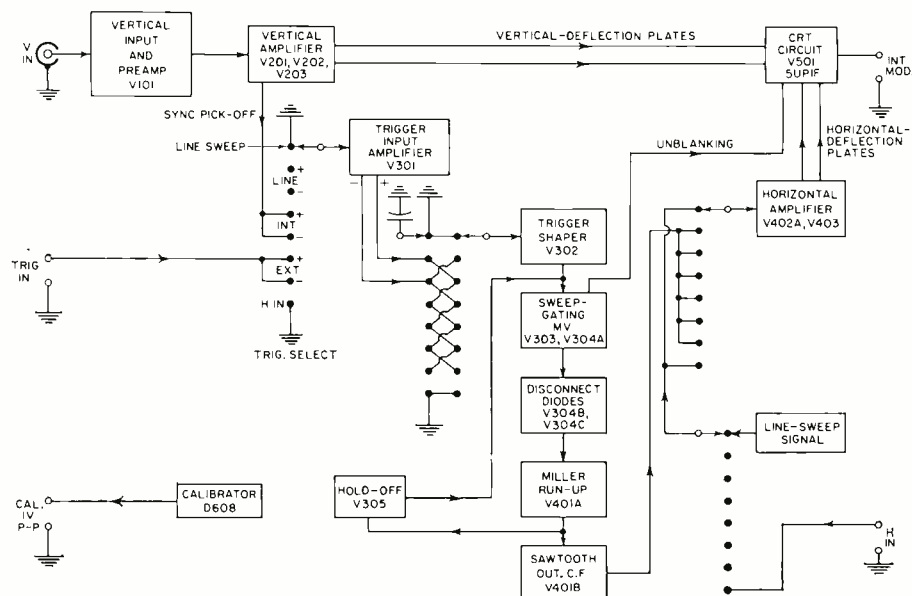

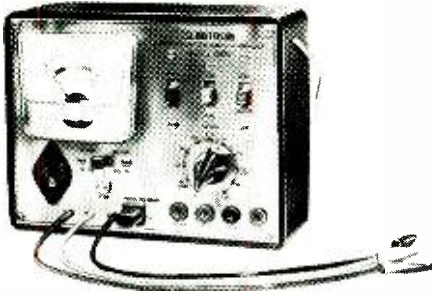

tester, and a.c. and d.c. beta tester. The unit has been designed to be a complete laboratory for the testing, maintenance, and repair of solid-state equipment. It can be used for checking power transistors, small-signal transistors, diodes, and rectifiers (both germanium and silicon) used in radio and television receivers, hi-fi stereo amplifiers, or any other solid-state equipment.

Since many problems in transistorized equipment arise as a result of weak or dead batteries, the tester can be used to check the battery in the receiver. This is done under actual load conditions with the tester functioning as a voltmeter and with the set under test in its "on" position.

With the instrument set in its current-reading position, current drain of solid-state equipment can be checked. Again, this is a "live" test, with the tester leads inserted in series with the battery leads of the equipment. The absence of current flow, insufficient current flow, or excessive current is a direct indication of a defective component or transistor.

The 1000 is also a harmonic signal generator. The fundamental frequency is 5000 Hz, but the signal is so rich

in harmonics that it is usable for audio, i.f., and r.f. circuits. No dial setting is required. The signal output can be fed successively into the audio amplifier of a receiver, the i.f., and then the r.f. stages, thus providing an extremely rapid yet highly effective method of locating a defective stage and narrowing the search down to one or more components.

An additional advantage of this instrument is its use as an in-circuit transistor tester, especially for circuits in which transistor leads are soldered into position. The only precaution is to make certain that the transistor is not shunted by any component having a value of 150 ohms or less. In any event, it is much simpler to lift one lead of such a component, permitting the in-circuit test to be performed, than to attempt to remove (and possibly damage) the suspected transistor.

As a continuity tester, the device employs a basic circuit for checking opens and shorts for quick identification of a defective component.

The 1000 can be used for checking germanium diodes or rectifiers but silicon rectifiers can only be tested for shorts or opens. Additional checks for peak voltage and current ratings are necessary. The instrument can also determine whether a transistor is a *p-n-p* or *n-p-n* type. It can be used to test power transistors as well.

The unit comes equipped with non-detachable, insulated clip leads that form an integral part of the instrument. It is readily portable, utilizing a fold-back handle.

The Model 1000 is available for \$34.95 completely wired and ready for use. ▲

Wahl Series HS-8 "Heat Spy" Electronic Thermometer

For copy of manufacturer's brochure, circle No. 152 on Reader Service Card.

SELECTIVE non-contact temperature measurement of small components can now be achieved with a completely portable, pistol-type thermometer—"Heat Spy" Series HS-8. The instrument measures the surface temperature of components as small as 0.1" in diameter and is available in four models covering 60 to 1000° F or the centigrade equivalents.

Used for measuring temperature-critical electronic and electrical components during assembly, "breadboarding," and actual use, "Heat Spy" detects temperature by measuring the infrared energy emitted from the surface of any stationary or moving object. The hand-held instrument is operated simply by aiming at the surface to be measured and pulling the trigger. Temperature is indicated on a large direct-reading meter above the pistol grip.

The center of the target area is de-



defined by a light beam which assures accurate aim at the desired component. An emissivity calibration control allows compensation for measurement of various surfaces, making the unit an extremely versatile instrument for

compact sets

SPEED DRIVING OF BRISTOL AND ALLEN HEX TYPE SCREWS



No. 99PS-60 Bristol Multiple Spline Type Screwdriver Set



4 and 6-flute blades with diameters from .048" thru .183"



No. 99PS-40 Allen Hex Type Screwdriver Set



Hex diameters from .050" thru 3/16"

Compact, interchangeable blade, Xcelite sets permit quick selection of the right tool for the job. With greater reach than conventional keys, these handy blade and handle combinations make it easier to get at deep set or awkwardly placed socket screws, simplify close quarter work.

Each set contains 9 precision formed, alloy steel, 4" blades; 4" extension; shockproof, breakproof, amber plastic (UL) handle with exclusive, positive locking device.

Sturdy, see-thru plastic cases fit pocket, have flat bases for use as bench stands.

WRITE FOR BULLETIN N365



XCELITE, INC., 12 BANK ST., ORCHARD PARK, N. Y.
Canada: Charles W. Pointon, Ltd., Toronto, Ontario
CIRCLE NO. 86 ON READER SERVICE CARD

NEW! 17TH EDITION

of the world-famous

RADIO HANDBOOK

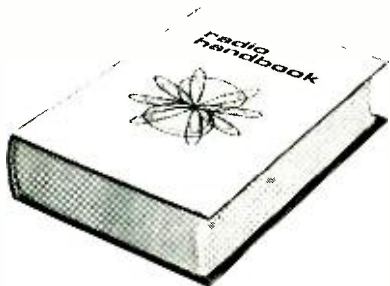

- the most comprehensive how-to-build-it source
- top problem-solver for builders of practical equipment

Completely revised and enlarged by William I. Orr, W6SA1. This is the comprehensive communications manual which is the industry standard for electronic engineers, technicians, and advanced radio amateurs. Explains in authoritative detail how to design and build all types of radio communications equipment.

NEW HOW-TO-BUILD DATA

The new 17th Edition of the RADIO HANDBOOK presents design data on the latest amplifiers, transmitters, receivers, and transceivers. Includes greatly enlarged sections on single-sideband equipment and design, and semiconductors. Gives extended coverage to r-f amplifiers, special vacuum-tube circuits, and computers. All equipment described is of modern design, free of TVI-producing problems.

THOROUGHLY REVISED & UPDATED

Provides a complete understanding of the theory and construction of all modern circuitry, semiconductors, antennas, power supplies; full data on workshop practice, test equipment, radio math and calculations. Includes aspects of the industrial and military electronics fields of special interest to the engineer and advanced amateur. The 17th Edition of the RADIO HANDBOOK provides the broadest coverage in the field—complete information on building and operating a comprehensive variety of high-performance equipment. All data is clearly indexed. 832 pages; 6 1/2 x 9 1/4"; hardbound. Invaluable for electronic engineers, designers, builders, amateurs, and technicians.

ORDER TODAY

New 17th Edition of the famous
RADIO HANDBOOK
No. EE167, Only.... \$12.95



Order from your electronic parts distributor or send coupon below.

EDITORS and ENGINEERS, Ltd.

P. O. Box 68003
New Augusta, Ind. 46268, Dept. EWE-3

Send me EE167, the new 17th Edition of the RADIO HANDBOOK at \$12.95.

\$_____encl. Check Money Order

Name _____

Address _____

City _____ State _____ Zip _____

CIRCLE NO. 122 ON READER SERVICE CARD 60

temperature detection during quality-control, processing, and research and development operations.

Infrared emissions (from 2 to 20 microns) are focused by the optics (parabolic mirror) of the instrument—after error effects of ambient light have been removed—onto an infrared heat-detecting element. The output is amplified by a battery-powered temperature-compensated solid-state circuit. The output of the amplifier drives the indicating meter.

The only moving parts in the unit are contained in the indicating meter, which is a taut-band meter (as opposed to pivot and jewel) designed to withstand the rugged use to which a portable instrument is subjected. The instrument has an external check switch and zero alignment controls which provide a simple and instantaneous check to assure proper functioning of batteries, meter, and circuitry. Power is provided by two standard mercury batteries which have a normal use life of six months and a shelf life of one year. A safety strap and convenient carrying holster are included with each instrument.

Series HS-8 will measure temperatures in surface spot sizes from 0.1" in diameter at a distance of 1/2" from the surface to 0.8" in diameter at a 4" distance. The instrument reads the infrared energy in a cone field of view, and the target area must fill this field of view to obtain accurate temperature measurement. Temperature measurement is made with an accuracy of ±2% full scale with a response time of two seconds.

An external emissivity adjustment is provided to allow the instrument to be used with just about any type of material. The recommended environmental operating temperature for the unit is from 60 to 110 degrees F.

Series HS-8 is available directly from the manufacturer at a price of \$750. ▲

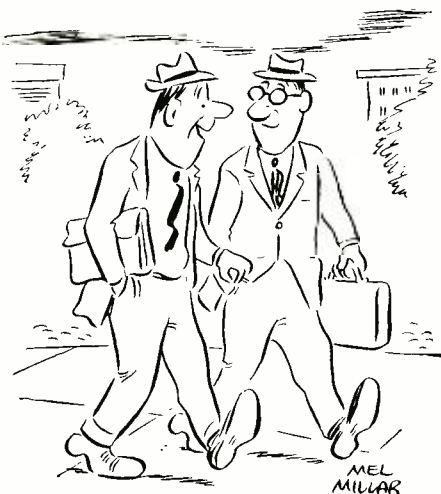

"I'm a coordinator... I have a desk between two expediters."

FROM HiFi STEREO REVIEW

DELUXE PADDED DUST-PROOF RECORD AND TAPE CASES

plus FREE cataloging forms



These decorative, yet sturdily constructed cases are just what you've

been looking for to keep your records and tapes from getting tossed about and damaged, disappearing when you want them most and just generally getting the "worst of it" from constant handling. They're ideal too for those valuable old "78's" that always seem to get thrown about with no place to go.

Constructed of reinforced fiberboard and covered in rich leatherette in your choice of nine decorator colors, the HiFi/STEREO REVIEW Record and Tape Cases lend themselves handsomely to the decor of any room, whether it be your library, study, den, music room or pine-paneled garage. The padded leatherette back (in your color choice) is gold tooled in an exclusive design available only on HiFi/STEREO REVIEW Record and Tape Cases. The sides are in standard black leatherette to keep them looking new after constant use. With each Record and Tape Case you order you will receive, free of charge, a specially designed record and tape cataloging form with pressure-sensitive backing for affixing to the side of each case. It enables you to list the record names and artists and will prove an invaluable aid in helping you locate your albums. The catalog form can be removed from the side of the case at any time without damaging the leatherette.

Extra

Record Cases are available in three sizes: for 7", 10" and 12" records. Each case, with a center divider that separates your records for easy accessibility, holds an average of 20 records in their original jackets. The Recording Tape Case holds 6 tapes in their original boxes.

• The Tape Cases and the 7" Record Cases (with catalog forms) are only \$3.25 each; 3 for \$9; 6 for \$17.

• The 10" and 12" Record Cases (with catalog forms) are \$3.50 each; 3 for \$10; 6 for \$19.

Add an additional 75c per order (regardless of number of cases ordered) for shipping and handling.

Ziff-Davis Publishing Company, Dept. SD
One Park Avenue, New York, N. Y. 10016

My remittance in the amount of \$_____ is enclosed for the Cases indicated below.

Quantity

_____ Tape Case at \$3.25 each; 3 for \$9; 6 for \$17.
_____ 7" Record Case at \$3.25 each; 3 for \$9; 6 for \$17.
_____ 10" Record Case at \$3.50 each; 3 for \$10; 6 for \$19.
_____ 12" Record Case at \$3.50 each; 3 for \$10; 6 for \$19.

Add 75c PER ORDER for SHIPPING and HANDLING

Check color choice for back of case (sides in black only):

Midnight Blue Red Saddle Tan
 Pine Green Orange Yellow
 Grey Black Spice Brown

Name _____ EW-37

Address _____

City _____ State _____ Zip _____

PAYMENT MUST BE ENCLOSED WITH ORDER

ELECTRONICS WORLD

SILICON-CARBIDE LIGHT DIODE

These new light-generating diodes may create a much simplified, low-cost, 8-mm home movie sound system.

CONVENTIONAL sound-on-film modulation techniques use a source of the sound to be recorded, audio amplifiers, and a light source, usually generated in a relatively high-powered and expensive lamp, and focused through a series of complex lenses onto a narrow area of film adjacent to the frames.

As an alternative in home movies, some film manufacturers have been supplying a film having a magnetic stripe (similar to the magnetic tape commonly used in tape recorders), running down one edge. This requires a modified tape recorder to lay the audio down the magnetic stripe. However, this approach requires a special camera and projector, and is usually considerably higher in cost than similar, silent devices.

A third solution has now been offered by the Norton Company. They have developed a tiny (.03 x .03 x .015 inch, less than one thousandths of a cubic inch) silicon-carbide electroluminescent diode that emits a needle-thin beam of cold yellow light capable of being modulated at audio frequencies up to 6 kHz. The diode is capable of being battery operated. The system requires no lenses or optics and requires only the addition of a small solid-state amplifier and microphone to put into operation.

The electroluminescent effect is achieved by passing current through a *p-n* junction of silicon carbide (this is similar to the modulation techniques used with solid-state laser diodes). Both the light and efficiency of the diode are determined by carefully controlled amounts of impurities in the silicon-carbide material. The diamond-hard surface and high temperature stability of silicon carbide makes it into a durable device, and electronic components capable of operating at temperatures up to 500° C are possible.

In operation, the sound is amplified, and then impressed across the diode, which then produces flashes of light at the applied audio rate. Because it produces a very thin beam, and has very little physical volume, the diode can be mounted very close to the film, thus each flash of light is directly recorded on the film, without the use of intervening optics. ▲

March, 1967

WHY risk your reputation with "just-as-good" capacitors?

When you pay little or no attention to quality in tubular replacement capacitors, you leave yourself wide open for criticism of your work . . . you risk your reputation . . . you stand to lose customers. It just doesn't pay to take a chance on capacitors with unknown or debatable performance records when it's so easy to get guaranteed dependable tubulars from your Sprague distributor!

There's no "maybe" with these 2 great SPRAGUE DIFILM® TUBULARS!

The ultimate in tubular capacitor construction. Dual dielectric . . . polyester film and special capacitor tissue . . . combines the best features of both. Impregnated with HCX®, an exclusive Sprague synthetic hydrocarbon material which fills every void in the paper, every pinhole in the plastic film *before it solidifies*, resulting in a rock-hard capacitor section . . . there's no oil to leak, no wax to drip. Designed for 105°C (220°F) operation without voltage derating.

DIFILM® ORANGE DROP® Dipped Tubular Capacitors



A "must" for applications where only radial-lead capacitors will fit . . . the perfect replacement for dipped capacitors now used in many leading TV sets. Double-dipped in rugged epoxy resin for positive protection against extreme heat and humidity. No other dipped tubular capacitor can match Sprague Orange Drops!



DIFILM® BLACK BEAUTY® Molded Tubular Capacitors

The world's most humidity-resistant molded capacitors. Tough, protective outer case of non-flammable molded phenolic . . . cannot be damaged in handling or installation. Black Beauty Capacitors will withstand the hottest temperatures to be found in any TV or radio set, even in the most humid climates.

For complete listings, get your copy of Catalog C-617 from your Sprague distributor, or write to Sprague Products Company, 51 Marshall Street, North Adams, Massachusetts.

WORLD'S LARGEST MANUFACTURER OF CAPACITORS

CS 6-10 91

CIRCLE NO. 91 ON READER SERVICE CARD

SPRAGUE®
THE MARK OF RELIABILITY

TAKE THE FIRST BIG STEP TOWARD A REWARDING CAREER IN ELECTRONICS

Mail card to RCA Institutes today

Thousands of well paid jobs for
Electronics Technicians are
unfilled now

*RCA Institutes Can Train You—
At Home—And Help You Qualify
For This Work*

It's a sad, but true, fact that today, with so many men yearning for better jobs and better incomes, thousands of well paid jobs are unfilled in the vast electronics industry.

Many of the men who could fill these jobs — that is, men with the aptitude and native interest to enjoy a career in electronics—are handicapped because for one reason or another they have not had the opportunity to train themselves for these lucrative positions.

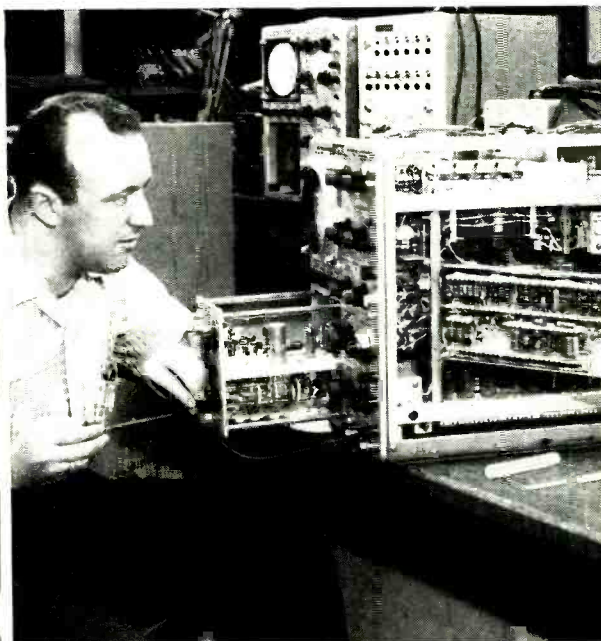

NOW— THANKS TO RCA INSTITUTES HOME STUDY— YOU CAN TRAIN FOR A CAREER IN ELECTRONICS

Realizing that thousands of technical jobs—well paid jobs—in electronics are going unfilled each week, RCA Institutes has done something positive about the problem. To benefit the electronics industry, with its crying need for trained men . . . and to help men who really want to move into a well paid electronics job, RCA Institutes offers an ideal home training program!

HOME STUDY CAN PROVIDE CAREER OPPORTUNITIES!

To help meet the need for qualified men in the electronics field, RCA Institutes has created a wide variety of Home Training Courses, all aimed toward a profitable, exciting electronics career in the shortest possible time. Included are exclusive "Career Programs" designed to train you quickly for the job you want! Your study program is supervised by RCA Institutes experts who work with you, help guide you over any "rough spots" that may develop along the way.

OFF TO A FLYING START WITH AMAZING RCA "AUTOTEXT" METHOD

Each "Career Program" starts with the amazing "AUTOTEXT" Programmed Instruction Method — the new, faster way that's almost automatic! "AUTOTEXT" helps even those who have had trouble with conventional learning methods in the

past. It is truly the "Space Age" way to learn everything you need to know with the least amount of time and effort.

RCA INSTITUTES ENGINEERED KITS SPEED YOUR PROGRESS

To speed you on your way to a successful electronics career, your "Career Program" will include a variety of RCA Institutes engineered kits at no extra cost—each complete in itself. As a bonus, you will also receive and build a valuable Oscilloscope. You'll get the new Programmed Electronics Breadboard for limitless experiments, including building a working signal generator and a fully transistorized superheterodyne AM receiver and Multimeter.

CHOOSE YOUR CAREER PROGRAM NOW

To get a head start today on the electronics career of your choice, look over this list of RCA Institutes "Career Programs", pick the one that appeals most to you, and check it off on the attached card:

- Television Servicing
- Telecommunications
- FCC License Preparation
- Automation Electronics
- Automatic Controls
- Digital Techniques
- Industrial Electronics
- Nuclear Instrumentation
- Solid State Electronics
- Electronics Drafting

To meet other specific needs, RCA Institutes also offers a wide variety of separate courses which may be taken separately from the "Career Programs". These range from Electronics Fundamentals to Computer Programming. They are described in the material you receive.

ADVANCED TRAINING TOO

If you are already working in electronics or have some experience but want to move on up, you may start RCA Institutes training at an advanced level. No tedious repetition of work you already know!

UNIQUE TUITION PLAN

With RCA Institutes, you learn *at your own pace*, and you pay only as you learn. There are no long term contracts to sign . . . no staggering down-payments to lose if you decide to stop...no badgering bills. You pay for lessons only as you order them, and should you decide to interrupt your training at any point, you may do so and not owe one cent.

CLASSROOM TRAINING AVAILABLE

RCA Institutes Resident School is one of the largest schools of its kind in New York City with classroom and laboratory training available in day or evening sessions. Coeducational classes start four times a year. Just check "Classroom Training" on the attached card for more details.

FREE PLACEMENT SERVICE, TOO!

In recent years, 9 out of 10 Resident School students who used the Free Placement Service have been placed before or shortly after graduation. This Service is now available to Home Study students.

**ALL RCA INSTITUTES COURSES
AVAILABLE UNDER NEW GI BILL.**

**SEND ATTACHED POSTAGE PAID
CARD TODAY FOR COMPLETE
INFORMATION. NO OBLIGATION.
NO SALESMAN WILL CALL.**

RCA INSTITUTES Inc. Dept. EW-37
A Service of Radio Corporation of America
350 West 4th Street, New York, N. Y. 10014



The Most Trusted Name in Electronics

new Sams books

BRAND-NEW UP-TO-DATE 10TH EDITION
of the famous **HOWARD W. SAMS**
Tube Substitution Handbook

2-IN-1 PACKAGE!

Regular size for your bench—
Compact copy for your caddy



Here's what you get in this great low-cost package: 1. Latest 10th edition handbook (5½ x 8½" for bench use)—completely revised and expanded. The most complete, up-to-date direct tube substitution guide available. Now includes more than 11,300 substitutions for all types of receiving and picture tubes. Seven sections include:

1. Cross-reference of all American receiving types. 2. Picture tube substitutions. 3. Cross-reference of miniature tubes. 4. Industrial substitutions for receiving tubes. 5. Substitutions for communications and special-purpose tubes. 6, 7. Cross-reference of American and foreign tubes. 2. Caddy-size tube substitution handbook—contains the complete, identical data included in the larger edition—an ideal handy reference for outside calls. Each handbook tells you when and how to make proper substitutions. Both handbooks come in one vinyl-wrapped package. Order **TUB-10P** \$2.25
Twin-Pak, both books for only..... \$2.75
Shop edition only (5½ x 8½"; 128 pages)—worth its weight in gold on your bench!
Order **TUB-10**, only..... \$1.75

101 More Ways to Use Your Scope in TV. 2nd Ed.

by Robert G. Middleton. Newly revised handbook describes additional and somewhat more advanced uses of the scope not covered in the first volume. Includes use of lab-type triggered-sweep scopes as well as standard service type. Uses range from basic troubleshooting procedures to the more complex testing of circuit components. Explanations are easy to follow; each test describes equipment required, proper connections, test procedure and evaluation. Includes many actual photos of both circuit and specialized testing waveforms. 128 pages; 5½ x 8½". Order **TEM-7A** only..... \$2.95

Silicon Controlled Rectifiers

by Allan Lytel. A complete and clear explanation of the fast-growing SCR solid-state field. Explains principles of SCR operation and shows their use in a variety of practical control circuits. Clearly describes phase shift control of a-c and d-c power; discusses circuits such as ring counters, temperature controls, and voltage regulation. Includes informative chapter on SCR testing. An invaluable book for everyone who wants to be up on this important new solid-state development. 128 pages; 5½ x 8½". Order **SCL-1**, only..... \$2.75

How to Repair Small Appliances. Vol. 2

by Jack Darr. Makes it simple to repair seemingly complicated household appliances. Explains how to repair the following electrical appliances not covered in Vol. 1: Portable heaters, hair dryers, carving knives, tooth brushes, bottle warmers, sewing machines, and nine other electrical appliances. A remarkably useful guide for profit-making or money-saving repairs. Fully illustrated. 128 pages; 5½ x 8½". Order **APD-1**, only..... \$2.75

HOWARD W. SAMS & CO., INC.

Order from your Sams Distributor today, or mail to Howard W. Sams & Co., Inc., Dept. EW-3
4300 W. 62nd Street, Indianapolis, Ind. 46268

Send me the following books:

- TUB-10P TEM-7A APD-1
 TUB-10 SCL-1

Send FREE Sams Booklist. \$_____enclosed

Name _____

Address _____

City _____ State _____ Zip _____

My Distributor is _____

CIRCLE NO. 96 ON READER SERVICE CARD
66

RADIO & TV NEWS

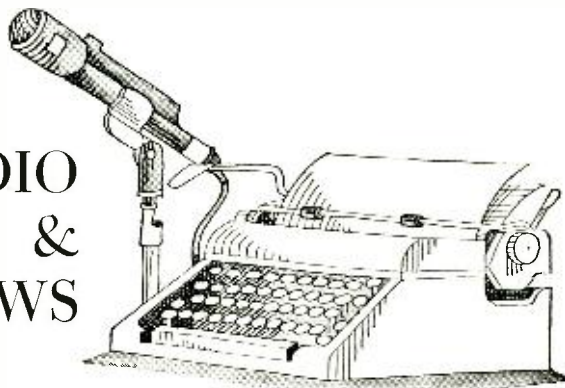

RADIO is still America's most popular entertainment medium. In fact, this country has 25% more radios than people—242 million radios compared to a population of 195 million. The average U.S. family has four radios in its possession.

Price has been a key element in making radios so common, with total sales reaching 34 million annually. A typical U.S.-made transistor set costs just 25% of what it did seven years ago and imports, which account for half of all radios sold in the U.S., have dropped to an average wholesale price of \$5.95 with sets from Hong Kong wholesaling at an average price of \$2.57.

In the first nine months of 1966, Hong Kong sent 5,500,000 sets to the U.S. while Japanese imports for the same period added up to 9,600,000.

Americans are far ahead of the rest of the world in the use of radios. Compared to more than one set per person in the U.S., there is only one set per three people in Western Europe, one for every six in Russia, and one for every 40 in southeast Asia.

The Long Flight

Mariner IV, launched more than two years ago, has flown more than one billion miles in space and continues to operate properly, reporting its condition to Earth stations three times each week.

Information from the spacecraft indicates that its attitude control system has a nitrogen gas supply capable of keeping it stabilized for more than another year, and that all system voltages and temperatures are as expected.

If Mariner IV continues to function until June 1967, communications to it may be stepped up. Mariner's orbit will bring it to within 30 million miles of Earth in September 1967, when it is planned to attempt several engineering experiments.

During its record flight, Mariner encountered a severe solar storm last September, causing a slight loss in power from its solar panels. Because such a probability was expected, the panels were designed to retain their output even with a 20% degradation.

Halfback Telemetry

Did you ever wonder how much punishment a football halfback takes when he is pounced upon by several behemoths from the opposing team? Well, the scientists at Northwestern University did and came up with a special helmet wired to produce an electroencephalogram (EEG).

The purpose of the study was to determine how much the helmet protected the player from head injuries.

The electrodes for the EEG were attached to the player's scalp and connected to a transistorized telemetry transmitter also contained within the helmet.

After one year of study, the scientists concluded that the helmet offered sufficient protection.

The scientists are now using similar devices to test "brain waves" of a number of patients suffering from various ailments.

More Laser Uses

Two more uses for the laser have been reported recently. Engineers at *Space Ordnance Systems, Inc.* have developed a system they call LEED (Laser Energized Explosive Device) in which the electric wire method of detonating explosives is replaced by a fiber optic light pipe with the remote end leading to a laser. More than one charge may be fired at one time.

This system offers complete immunity to any electrical environment thus eliminating the danger of premature detonation by stray electrostatic or r.f. energy of any magnitude. The extremely high temperatures used by the system eliminate the accidental triggering by stray light.

The other use is proposed by the *Westinghouse Research Labs.* and is called LASS (Light-Activated Silicon Switch). Basically, this device is a light-activated SCR triggered on by application of a laser beam. This eliminates accidental turn-on by sunlight or artificial light. This system allows faster turn-on time of the switch and permits firing a stack of them at the same instant by piping the laser light to each *via* fiber optic bundles. ▲

Digital Plotting Techniques
(Continued from page 50)

and programmed on the computer. These are only a few of the many applications of computer-controlled automatic drafting machines. The possibilities are limited only by the imagination and the ability of the programmer using the system. Computer-plotter drafting systems show promise in revolutionizing drafting departments. Perhaps draftsmen in years to come will be more computer programmer than artist.

The CRT Display

Another type of display that is receiving more attention as a computer output device is the cathode-ray tube display. A cathode-ray tube can also be used to plot digital data in analog form. The electron beam can be focused to a fine point of light on the face of the CRT and with the horizontal and vertical deflection plates in an electrostatic CRT (or with a magnetic yoke in an electromagnetic CRT), the point of light on the CRT face can be positioned as desired. The d.c. voltages applied to the deflection plates determine the exact location of the light point. These d.c. positioning voltages can be derived from digital-to-analog converters that are fed by a digital system.

Fig. 8 is a block diagram of a digital CRT display. The computer is programmed so that the data to be displayed can be outputted to the CRT in the form of X and Y coordinate values. The computer output is a parallel binary word or bit pattern. For example, 16 bits of data from the computer output could represent an X or Y value or both X and Y values if only 8-bit coordinate words are acceptable. In Fig. 8, the 16-bit word from the computer is made up of two 8-bit words, one representing the X value and the other the Y value. The X and Y words feed two digital-to-analog converters which change the binary bit patterns into d.c. analog voltages that position the light spot. If the computer outputs coordinate words at a very high rate, the light point will move rapidly across the CRT screen. Because of persistence of vision and the closeness of the points through proper programming and high-speed output, the curve on the CRT screen will appear stationary even though the coordinate values from the computer are occurring sequentially. The curve can be repetitively displayed if the computer output program is a continuous loop. The output display is actually equivalent to a point-plot type of display on conventional plotters, but it is produced much faster so that in-

if you service Citizens Radio Transceivers



you should have...

AN INTERNATIONAL C-12B FREQUENCY METER

Four Instruments In One The C-12B is more than a frequency standard — it measures power output, measures AM modulation, and is a signal generator... all self contained in one convenient unit.

check these features!

- **Frequency Measurement** — Range 26.965 mc to 27.255 mc. Frequency stability $\pm .0025\%$ 32°F to 125°F; $\pm .0015\%$ 50°F to 100°F.
 - **Power Measurement** — 0 to 5 watts, accuracy $\pm \frac{1}{4}$ watt.
 - **Counter Circuit** — Frequency range 0 to 3 kc. Residual error 100 CPS @ zero beat.
 - **AM Modulation Measurement** — Range 0 to 100%. Accuracy 3% @ 400 CPS @ 80% modulation.
 - **Signal Generator** — Frequency range 26.965 mc to 27.255 mc. Low output 1 microvolt through special pick-off box furnished with meter. High output 100 microvolts through output jack.
 - **Panel Controls** — Channel selector, 24 positions • "Hi-Lo" frequency adjust • RF level control • Modulation set • Power • Meter calibration adjust • Function selector, 7 positions • Modulation • RF • Deviation • Calibration • Battery Test "A" • Battery Test "B" • Battery Test "C".
 - **Battery Power Required** — 1½ vdc @ 60 ma, 67½ vdc @ 5 ma, 9 vdc.
- The C-12B is capable of holding 24 crystals and comes with 23 crystals installed. Everything you need including connecting cable, PK box, dummy load, and batteries.
Cat. No. 620-101.....\$300

WRITE FOR COMPLETE CATALOG

Manufacturers of precision electronic products for home, industry and aerospace needs.



CIRCLE NO. 113 ON READER SERVICE CARD

FINCO "has 'em both!"



Model #65-1
\$2995
list

Model #65-2
\$3995
list

BOOSTER COUPLERS FOR 300 OR 75 OHM For Deluxe Home or Commercial Use

Now available for either 75 OHM CO-AX or 300 OHM operation . . . you can't beat the price, quality and performance of Finco's famous 2-tube, 4-set VHF or FM Distribution Amplifiers. Finco challenges 'em all! Equip either model with Finco low loss splitters (#3001 or #3003) and you can drive up to 16 sets in a master antenna system!

All Finco Products Are Engineered for Color!



THE FINNEY COMPANY
34 West Interstate Street, Bedford, Ohio

CIRCLE NO. 118 ON READER SERVICE CARD

Olson



FREE

Fill in coupon for a FREE One Year Subscription to OLSON ELECTRONICS' Fantastic Value Packed Catalog—Unheard of LOW, LOW PRICES on Brand Name Speakers, Changers, Tubes, Tools, Stereo Amps, Tuners, CB, Hi-Fi's, and thousands of other Electronic Values. Credit plan available.

NAME _____
ADDRESS _____
CITY _____ STATE _____

GIVE ZIP CODE _____

If you have a friend interested in electronics send his name and address for a FREE subscription also.

OLSON ELECTRONICS, INC.

578 S. Forge Street Akron, Ohio 44308

CIRCLE NO. 101 ON READER SERVICE CARD

stantaneous complete display is the result. Of course, like the plotter, the CRT display may be used on-line or off-line from a magnetic tape or other source. The CRT is much faster than a standard plotter so it will be more economical of computer time when used on-line. Another advantage of the CRT display is that because of its speed, several different curves can be displayed simultaneously by time sharing the computer output through proper programming. This time sharing is known as time-division multiplexing and is similar to that used in PCM telemetry systems.

The big disadvantage of a CRT dis-

play is that the image is not permanent like the curve drawn in ink on paper by a conventional plotter. However, if a camera is available, a permanent record can be made by photographing the image.

To produce lettering of a display, special letters and number generators can be built into the CRT deflection circuitry and brought into operation at the desired time and place. The character generators are special circuits that produce the deflection voltages necessary to display a letter or number. Computer programming could also be used in place of special generators if desired. ▲

A Solid-State Microphone "Transformer"

By JAMES B. WOOD / Vidor Corp.

Construction of a 2-stage direct-coupled operational amplifier to match low-Z mikes to hi-Z amplifier inputs.

ONE of the advantages enjoyed by circuits employing solid-state devices over their vacuum-tube counterparts is their ability to provide impedance-matching in varied circuit configurations. This ability has been exploited successfully in providing direct, transformerless drive to loudspeakers, resulting in almost unlimited frequency response and nearly ultimate damping.

The circuit described here may prove valuable to the audiophile who wishes to eliminate all transformers from his sound system. Not only does this device surpass the specifications of the typical impedance-matching microphone transformer, but it can be constructed for about one-third the cost of even an inexpensive one.

The design satisfies the twofold requirement of providing (1) impedance matching for low-impedance (50- to 150-ohm) professional microphones and (2) sufficient voltage gain to drive, as per the author's standard, 1-volt r.m.s. program inputs.

The device is actually a two-stage, direct-coupled operational amplifier with the input transistor (Q1) in a common-base configuration. The input resistor (R1) is chosen to match the microphone's nominal impedance and the feedback resistor (R2) to set the closed-loop voltage gain. By deriving Q1's base current from the divider in Q2's emitter, a high degree of d.c. feedback is established to compensate for component variations and temperature coefficients. As input and output signals are out of phase, neutralization was found unnecessary for stabilization.

Inexpensive, high-beta p-n-p silicon transistors were employed in the design of this unit, and types similar to the Motorola 2N3906 should be used. Others tried and found to work equally well were the G-E 2N2925 and the Fairchild 2N3644. N-p-n varieties may

also be used if all polarities are reversed.

The author constructed five of these units on a single circuit board. The complex was terminated in a patching-jack field and powered by a well-regulated negative 24-volt supply. As 50-ohm microphones were principally employed (the characteristic impedance of most moving-coil assemblies, sans transformers), the input resistor in each case was a 51-ohm unit. A feedback resistor of 100,000 ohms provided optimum gain to drive the 1-volt r.m.s. program lines.

Measured frequency response of this device was found to be within ± 3 dB from 5 Hz to 250 kHz. Noise is almost entirely dependent upon the power supply used, battery operation being, for all purposes, totally noiseless. ▲

Circuit diagram and parts listing of the two-stage microphone preamplifier.

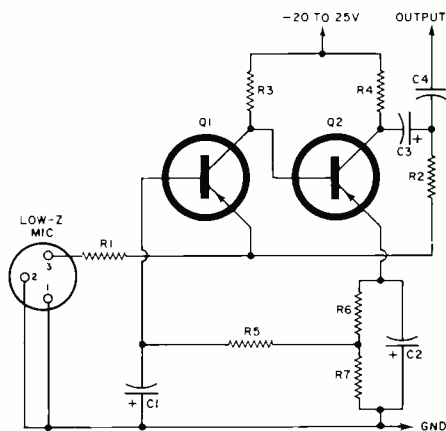

R1, R2—See text
R3—100,000 ohm, 10%, 1/2 W carbon res.
R4, R5—10,000 ohm, 10%, 1/2 W carbon res.
R6—2200 ohm, 10%, 1/2 W carbon res.
R7—560 ohm, 10%, 1/2 W carbon res.
C1—30 μ F, 6 V elec. cap.
C2—100 μ F, 6 V elec. cap.
C3—5 μ F, 25 V elec. cap.
C4—0.22 μ F, 200 V Mylar cap.
Q1, Q2—2N3906 transistor (or equiv.)

Buying a Hi-Fi Tuner?
(Continued from page 34)

imum. If the tuner in question cannot respond linearly to these large frequency excursions, harmonic distortion will result, and audible distortion will reach the listener during these loud moments of the program.

Actually, most well-designed tuners have bandwidths far exceeding the minimum (150 kHz), but some require large signal inputs before full bandwidth is exhibited. Thus, harmonic distortion should be noted for both weak and strong signals and, of course, the lower the figure (expressed as percentage) the better the product. Distortion of less than 1% for full deviation rivals the equivalent figure for the best amplifiers and preamplifiers.

Drift

The characteristic detuning of a station as the tuner "warms up" (because of increased heat affecting the tuning circuits associated with station selection) has become much less of a problem since the introduction of solid-state tuners because much less heat is generated by transistors as compared with vacuum tubes. However, improperly designed tuning sections can exhibit annoying drift, with its attendant annoyance to the user who has to constantly get up to retune the station, whether they are of solid-state or tube construction. A few kHz of drift from a cold start is not objectionable, since adequate bandwidth of the system will not result in significant detuning of the desired station. Drift of more than 50 kHz before final stability is attained can be quite annoying, however. Some less expensive systems use a.f.c. to counteract drift.

Frequency Response

Since FM stations are permitted to broadcast all audio frequencies from 50 Hz to 15 kHz, while AM is sometimes restricted to a top frequency of only 5 kHz, equipment designed to receive FM signals should certainly be capable of reproducing all transmitted audio frequencies in their proper relative proportions. Response should be flat from 50 to 15,000 Hz "plus or minus" as few dB as possible, and this specification is completely analogous to the one normally associated with other audio components.

Transistors Are Replacing Tubes

As this latest directory of tuners and receivers is examined, it will be noted that the majority of the products listed have made a successful (if sometimes painful) transition from tubes to transistors. The redesign of these products was not without pitfalls. Early attempts at solid-state tuner design often resulted in unforeseen problems such as overloading of r.f. stages and cross-modulation (simultaneous reception of two adjacent stations on the FM band). Performance of even the best transistors intended for high-frequency use left much to be desired.

Today, however, development of certain grades of high-frequency silicon transistors (notably the field-effect type) has made possible r.f. front-end designs fully compatible with the performance expected of a high-quality product. Considering related advantages of longevity of associated parts and decreased drift because of the absence of heat, the modest differential in price between solid-state and tube types (which still abound, if one insists upon them) may well be worth the extra investment.

AM or Not?

Tuners and receivers often include AM radio, and units so equipped are necessarily somewhat more expensive than the FM-only types. Since AM is not truly a high-fidelity source of program material, its inclusion in a purchase will really depend upon other factors, such as whether or not

QUALITY

from **PEARCE-SIMPSON**

...THE LEADER*



IBC 301

30 WATT AM 2-WAY BUSINESS BAND RADIO with remote head* 12 Volt Model • \$329.90

Frequencies FCC allocated for business/industrial use.

*Can be dash mounted as a complete radio or the removable 2½ lb. remote control head can be installed independently with its own mounting cradle • Solid state power supply and receiver for low power drain (.6 amps.)



GUARDIAN 23

CB TWO-WAY RADIO • \$269.90

23 CHANNELS—features exclusive HETROSYNC circuitry. Two signals are combined instead of the usual 3 providing outstanding stability and maximum protection against spurious signals.

- Dual conversion superhet receiver with low noise Nuvistor front end • RF gain control, tone control and noise limiter switch • Illuminated "S" meter • Transistorized universal (AC/DC) power supply.

***WORLD'S LARGEST PRODUCER OF MARINE RADIOTELEPHONES**

Please send me full details and specifications on the: "IBC 301" CB "GUARDIAN"

Name.....

Address.....

City.....

State..... Zip.....

EW-367



PEARCE-SIMPSON, INC.

P.O. Box 800—Biscayne Annex • Miami, Fla. 33152

CIRCLE NO. 100 ON READER SERVICE CARD

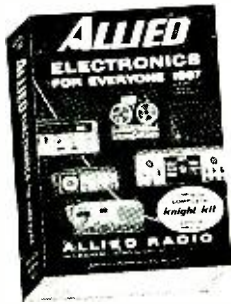

FREE

NEW 514-PAGE
1967
ALLIED
CATALOG

Top savings on the best
in electronics for everyone

SAVE MOST ON:

- Famous Knight-Kits
- Stereo Hi-Fi
- Tape Recorders & Tape
- CB 2-Way Radio
- Walkie-talkies
- FM-AM & AM Radios
- Short Wave & Ham Gear
- Portable TV & Phonos
- Intercom & P.A.
- Automotive Electronics
- Test Instruments
- TV Antennas & Tubes
- Power Tools, Hardware
- Tubes, Transistors
- Parts, Batteries, Books

Shop by mail and save at Allied, world's largest electronics headquarters. Hundreds of money-saving values, including fun-to-build Knight-Kits, and many specials available only from Allied. **NO MONEY DOWN! 24 MONTHS TO PAY!** Enjoy the things you want now, while you pay for them on the convenient Allied Credit Fund Plan.

Send for new 1967 **ALLIED** Catalog.

FREE!

ALLIED RADIO, DEPT. 1-C
P.O. BOX 4398, Chicago, Ill. 60680

Send FREE 1967 **ALLIED** CATALOG

Name _____
PLEASE PRINT
Address _____
City _____ State _____ Zip _____

CIRCLE NO. 125 ON READER SERVICE CARD

Enjoy the "music-only" programs
now available on the FM broadcast
band from coast to coast.

- NO COMMERCIALS •
- NO INTERRUPTIONS •



It's easy! Just plug Music Associated's Sub Carrier Detector into multiplex jack of your FM tuner or easily wire into discriminator. Tune through your FM dial and hear programs of continuous, commercial-free music you are now missing. The Detector, self-powered and with electronic mute for quieting between selections, permits reception of popular background music programs no longer sent by wire but transmitted as hidden programs on the FM broadcast band from coast to coast. Use with any FM tuner. Size: 5 1/2" x 6". Shipping weight approx. 7 lbs.

KIT \$49.50

(with pre-tuned coils, no alignment necessary)

WIRED \$75.00

COVER \$4.95 EXTRA

Current List of FM Broadcast Stations with SCA authorization \$1.00

MUSIC ASSOCIATED

65 Glenwood Road, Upper Montclair, New Jersey
Phone: (201)-744-3387

70

favorite programs are available on FM as well as on AM. If AM is to be listened to a good deal, it is still better to listen to it *via* a high-fidelity system. To whatever degree the AM broadcast does possess limitations, at least they won't be further penalized by the inadequacies of the typical "table-model" AM radio with its minimal amplifier and loudspeaker arrangement.

FM-Stereo Circuitry

Switching from monophonic to stereo FM has unnerved many a seasoned audiophile. In order to squeeze two channels of information onto a single FM frequency, signal-to-noise ratio had to suffer if all other parameters were to remain as good as they were for mono FM. Accordingly, sensitivity and signal-to-noise specs become even more important in the light of stereo FM reception problems.

A good stereo FM tuner will offer at least 20 to 25 dB of separation between left and right channels, though the stereo "effect" is quite discernible with separations of as low as 15 dB. Present-day FM-stereo tuners will invariably feature some form of indicator (such as a light) to advise the user that stereo is being received. Other new features include automatic switching (from mono to FM stereo, in the presence of a stereo signal) and a defeat switch to enable the listener to return to the mono mode if the stereo signal received is not strong enough for satisfactory noise-free listening.

Antennas

While this analysis of tuners is supposed to be confined to the "electronic" specifications, no discussion of FM stereo would be complete without making emphatic reference to the need for a well-placed and properly selected outdoor (if possible) FM antenna. True, one should start with the most sensitive tuner one can afford, but unless all the available signal present in one's location actually reaches the antenna terminals of the tuner or receiver, the most sensitive circuits can do little to provide pleasurable FM-stereo listening.

The proper type of antenna to use will depend upon certain physical circumstances, such as distance from stations, presence or absence of large, reflecting structures which create a form of distortion in FM stereo known as "multipath" (analogous to ghosts in TV), and the presence of stations in many directions. A local dealer can advise as to the preferred type of FM antenna for a particular situation.

Careful attention to published specifications together with intelligent and extensive auditioning and a review of the hints detailed above should result in selection of a trouble-free tuner or receiver capable of many years of top performance.

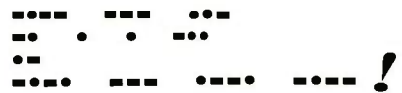

Whether you're a ham, short wave listener or CB'er . . . a newcomer to the fascinating world of radio communications or an oldtimer who cut his teeth on crystal sets . . .

You definitely need a copy of the new 1967 **COMMUNICATIONS HANDBOOK!**

It's the world's most complete guide to communications. 148 fact packed pages of "how to do it—how to do it better" features written by the experts in each category. From choosing your field . . . to getting your license . . . to selecting your equipment . . . to operating your own station.

And we do mean complete. Not only do you get valuable directories of the latest equipment for both novice and technician class, but also exclusive listings of all code practice LP's and tapes, SWL clubs, call-books, program guides!

To repeat our coded message above: You need a copy . . . of the 1967 **COMMUNICATIONS HANDBOOK!** Use the coupon below to order yours today. It's just \$1.25.

ZIFF-DAVIS SERVICE DIVISION • DEPT. CH
595 Broadway • N. Y., N. Y. 10012

Send me the new 1967 **COMMUNICATIONS HANDBOOK.**

\$1.25 enclosed, plus 15c for shipping and handling. Send me the regular edition. (\$1.75 for orders outside the U.S.A.)

\$3.00 enclosed. Send me the Deluxe Leather-flex-bound edition, **postpaid.** (\$3.75 for orders outside the U.S.A.) Allow three additional weeks for delivery.

name _____ please print EW-37

address _____

city _____

state _____ ZIP _____

PAYMENT MUST BE ENCLOSED WITH ORDER

SCR PROTECTIVE CIRCUIT FOR HI-FI AMPLIFIER

THE new Sony TA-1120 solid-state integrated stereo amplifier incorporates an interesting high-speed protective circuit to prevent damage to the output transistors in the event of a short across the output terminals. The circuit, shown below, acts as an electronic fuse that opens the supply to the driver stages within microseconds of an overload. This kills the audio drive instantly and protects the output transistors. The circuit, which employs a silicon controlled rectifier, operates at a much higher speed than would a conventional fuse.

Operation of the circuit, according to Sony engineer H. Hasegawa, is as follows. Normally, the SCR is nonconducting, the base voltages of the two "pass" transistors are such that they are turned on. Under these conditions, the positive supply voltage is applied to the driver transistors normally.

In the event of an overload or an output short circuit, current rises in the 0.5-ohm emitter resistors located in one of the output transistors in each of the channels of amplification. This rising current produces a higher-than-normal positive voltage which is applied through the isolating diode to the gate of the SCR. The SCR now fires immediately, reducing its anode voltage to a few tenths of a volt. This drops the base voltage of the upper transistor. As a result, both transistors are cut off and the positive supply voltage is removed from the driver stages. The supply voltage remains disconnected (because the SCR continues to conduct) until the protection circuit is reset by pressing the power switch "off" and then "on" again. ▲

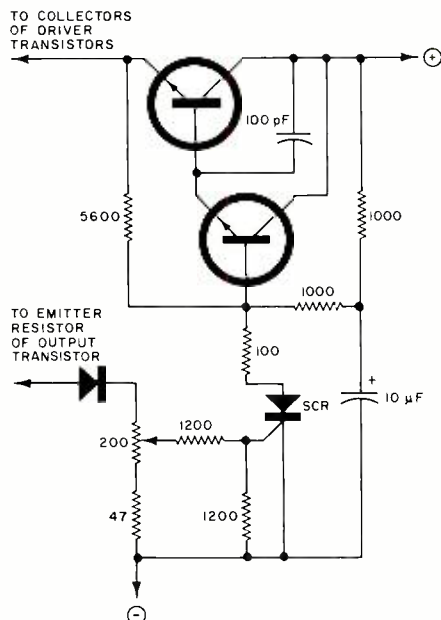

March, 1967

if you relax with records... Look for the ELPA Endorsement!



When you see the Elpa Seal of Endorsement on a component you can be assured that it is of highest quality and has successfully satisfied Elpa's stringent design and performance standards. THORENS superb turntables, ORTOFON cartridges, and CECIL E. WATTS record cleaning equipment all carry the Elpa seal and can be purchased with complete confidence. Write for the Elpa catalog, Dept. 9D3, Elpa Marketing Industries, Inc., New Hyde Park, New York 11040

THORENS / *Ortofon* / CECIL E. WATTS Ltd.



CIRCLE NO. 119 ON READER SERVICE CARD

SAY YOU SAW IT IN
**ELECTRONICS
WORLD**

LEARN Electronics Engineering AT HOME

Fix TV, design automation systems, learn transistors, complete electronics. College level Home Study courses taught so you can understand them. Earn more in the highly paid electronics industry. Computers, Mi-sites, theory and practical. Kits furnished. Over 30,000 graduates now employed. Resident classes at our Chicago campus if desired. Founded 1934. Catalog, "Vets—write for information about G. I. Bill Training."
American Institute of Engineering & Technology
1141 West Fullerton Parkway Chicago, Ill. 60614

\$500 per month?

Diversify into booming two-way radio maintenance!

Conservative extra income from citizens band and business radio maintenance!

Free booklet tells you how—see coupon below!

105-B MICROMETER FREQUENCY METER

Measures nearby transmitters. Continuous coverage 100 KC to 175 MC, and up. Internal calibrator. Only 8 pounds. \$295.00



205-A FM MODULATION METER

Tunable 25 to 500 MC any channel. Direct reading. Light weight. Measures peak swing 0-1.25, 2.5, 12.5, and 25.0 peak KC. \$340.00

LAMPKIN

dependable low cost equipment used by thousands of engineers.

PPM METER—inexpensive accessory for the 105-B for 0.0001% accuracy on split-channels.

At no obligation to me, please send me free booklet "How to Make Money in Mobile-Radio Maintenance."

Name _____

Address _____

City _____

State _____

LAMPKIN LABORATORIES, INC
MFM Division, Bradenton, Florida 33505

CIRCLE NO. 109 ON READER SERVICE CARD

BOOK REVIEWS

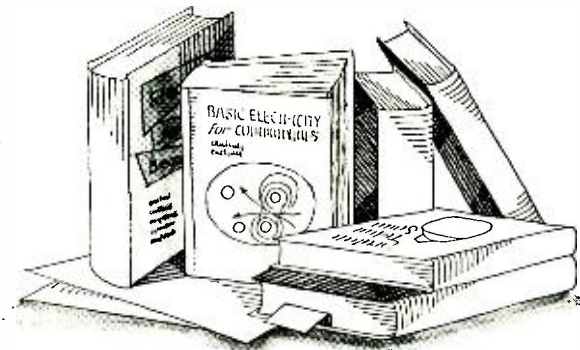

"THE EVOLVING SOCIETY" edited by A. M. Hilton. Published by The Institute for Cybercultural Research, 225 E. 63rd St., New York, N.Y. 10021. 410 pages. Price \$8.95.

This volume represents the Proceedings of the First Conference on the Cybercultural Revolution which was held in New York City in June of 1964.

The field of cyberculture is concerned with the possible effect the "marriage" of computers and controls, together with their progeny, automation, will have on man and society. Here is a brief sampling of some of the papers presented by the experts at the Conference: "The Revolution in Communications" (W.S. Caldwell), "Computer Machines in Medicine" (R.S. Ledley), "Intelligent Machines" (P. Arner), "Production Control" (T.F. Silvey), "The Social Cost of Cybernation" (B.S. Seligman), "Our Concepts of Man: Rational or Reasonable?" (J. Garai), and "Evolving Structures of Men and Machines" (L. Sutro).

Anyone concerned with the impact of automation on our way of life—and, indeed, we cannot help but be concerned—will find this book most stimulating.

* * *

"ELECTRONICS & NUCLEONICS DICTIONARY" by John Markus. Published by McGraw-Hill Book Company, New York. 752 pages. Price \$16.50.

This is the revised and updated Third Edition of a book which originally appeared in 1945 and has been used as a reference source ever since. Almost 16,000 terms as used in medical, industrial, space, and military electronics; television; radio; avionics; radar; nuclear science; and nuclear engineering are included. There are 1500 illustrations, judiciously scattered throughout the book, to clarify and enhance certain of the definitions.

The terms are alphabetized letter by letter, ignoring spaces and hyphens, to give a consistent sequence and to expedite reference. Each definition is given only once—with synonyms listed in their own alphabetical order, followed by the generic term, in italics, for which the complete definition is given.

Each term being defined is printed

in clear, bold-face type making it easy to find the required listing. The only improvement we can suggest would be thumb indexing to make the book easier to handle.

* * *

"DESIGNING TRANSISTOR I.F. AMPLIFIERS" and **"TRANSISTOR BANDPASS AMPLIFIERS"** by W. Th. Hettterscheid. Published by Philips Technical Library. Distributed in the U.S. by Springer-Verlag New York Inc., 175 Fifth Ave., New York, N.Y. 10010. 330 and 312 pages, respectively. Prices \$11.40 and \$12.00, respectively.

Both of these volumes are addressed to engineers who are involved in the design and construction of i.f. amplifiers and bandpass amplifiers used in transistorized radio, television, and radar receivers.

The author's treatment is painstaking and thorough, and for those with the requisite engineering and mathematical background these volumes constitute excellent "how-to-do-it" handbooks for designing radio and television sets.

A bibliography is appended to each chapter but since the bulk of the references are to European publications, American engineers may find this less helpful than anticipated unless they work for firms with extensive reference libraries.

* * *

"GREAT IDEAS IN INFORMATION THEORY, LANGUAGE AND CYBERNETICS" by Jagjit Singh. Published by Dover Publications, Inc., New York. 332 pages. Price \$2.00. Soft cover.

The author, winner of UNESCO's 1963 Kalinga Prize for outstanding achievement in disseminating scientific information to the public at large, has written this volume for researchers and students in such fields as social engineering, linguistics, government, business administration, etc.

The book surveys the work being done in the different areas of computer technology, such as the digital computer, learning machines, information retrieval, game-playing machines and their potential extension into models for decision-making processes and self-organization, much like those made by the human brain.

While the author was forced to re-

sort to some mathematics, his accompanying explanations are disarmingly simple and, as he remarks, anyone with a grasp of the principles of the race track, the slide rule, the chart-room, and the classroom should be able to understand this volume.

* * *

"101 QUESTIONS AND ANSWERS ABOUT TRANSISTORS" by Leo G. Sands. Published by Howard W. Sams & Co., Inc., Indianapolis. 108 pages. Price \$2.50.

This little volume follows this publisher's earlier "101" format and it works surprisingly well in presenting information about transistors and their applications. The treatment is non-mathematical and for the most part, not-too-technical.

The first part of the book covers questions about basic transistor types, functions, characteristics, and testing while the remaining four parts deal with applications. The text material is well illustrated by photos, graphs, line drawings, and schematics or partial schematics.

* * *

"ELECTRONIC TROUBLESHOOTING" by Staff of Philco Technical Institute. Published by Prentice-Hall, Inc., Englewood Cliffs, N.J. 276 pages. Price \$12.50.

This is another of Philco's excellent programmed texts which can be adapted to self-instruction as well as classroom use. Because of the complexity of today's commercial and military electronic systems and equipment, there is a crying need for highly trained, skilled maintenance technicians.

The text is divided roughly into two parts—the first part being concerned with locating the problem and the second dealing with troubleshooting. The well-illustrated text and the authors' clear and concise writing makes this a fine "do-it-yourself" volume for the man who wants to upgrade his vocational skills.

* * *

"APPLICATIONS OF NEON LAMPS AND GAS DISCHARGE TUBES" by Edward Bauman. Published by Carlton Press. Available from Signalite Inc., 1933 Heck Ave., Neptune, N.J. 07753. 160 pages. Price \$2.95 plus 25 cents postage and handling.

This volume is written by the vice-president of engineering for Signalite and covers application data on a wide variety of neon glow lamps in electronics. The text material is lavishly illustrated with many practical circuit diagrams which can be immediately adopted by engineers, technicians, and students.

The author provides a number of specific examples of actual circuit designs using close-tolerance neon glow lamps as oscillators, timers, switches, voltage regulators, etc. ▲

Special Introductory Offer to new members of the electronics and control engineers' book club

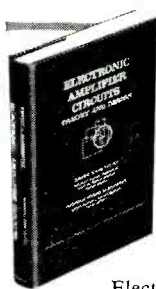

Pub. Price
\$10.50
Club Price
\$8.95

Electronic Amplifier Circuits by J. M. Pettit and M. M. McWhorter. Code #723



Pub. Price
\$16.75
Club Price
\$14.25

Electronic and Radio Engineering by F. E. Terman. Code #509

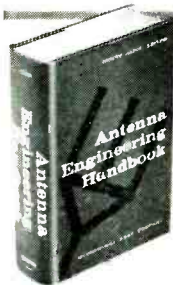

Pub. Price
\$25.00
Club Price
\$17.95

Antenna Engineering Handbook by Henry Jasik. Code #290

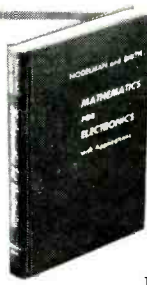

Pub. Price
\$7.00
Club Price
\$5.95

Mathematics for Electronics with Applications by H. M. Nodelman. Code #850



Pub. Price
\$7.50
Club Price
\$6.40

Electronic Measuring Instruments by H. E. Soisson. Code #565



Pub. Price
\$15.00
Club Price
\$12.75

Transistor Circuit Design by the Engineering Staff of Texas Instruments, Inc. Code #737



Pub. Price
\$12.50
Club Price
\$10.65

Integrated Circuits by the Engineering Staff of Motorola, Inc. Code #525



Pub. Price
\$10.00
Club Price
\$8.50

Field-Effect Transistors by L. J. Sevin. Code #355



Special \$1.00 bonus book comes to you with your first club selection

SAVE TIME AND MONEY BY JOINING THE electronics and control engineers' book club

Here is a professional club designed specifically to meet your day-to-day engineering needs by providing practical books in your field on a regular basis at below publisher prices.

HOW THE CLUB OPERATES. Basic to the Club's service is its publication, the *Electronics and Control Engineers' Book Club Bulletin*, which brings you news of books in your field. Sent to members without cost, it announces and describes in detail the Club's featured book of the month as well as alternate selections which are available at special members' prices.

When you want to examine the Club's feature of the month, you do nothing. The book will be mailed to you as a regular part of your Club service. If you prefer one of the alternate selections — or if you want no book at all for that month — you notify the Club by returning the convenient card enclosed with each *Bulletin*.

As a Club member, you agree only to the purchase of four books over a two-year period. Considering the many books published annually in your field, there will surely be at least four that you would want to own anyway. By joining the Club, you save both money and the trouble of searching for the best books.

MAIL THIS COUPON TODAY

electronics and control engineers' book club
582 PRINCETON ROAD
HIGHTSTOWN, N. J. 08520

Please enroll me as a member of the Electronics and Control Engineers' Book Club and send me the two books indicated below. I am to receive the higher priced of the two for just \$1. and my first selection at the special Club price. These books are to be shipped on approval, and I may return them both without cost or further obligation. If I decide to keep the books, I agree to purchase as few as four additional books during the next two years at special Club prices (approximately 15% below list).

Write Code # of higher priced selection here

Write Code # of lower priced selection here

NAME _____

ADDRESS _____

CITY _____

STATE _____ ZIP _____

(This offer good in United States only)

E 33011

NEW POWER FROM FINCO

Model 65-3 VHF-TV ANTENNA AMPLIFIER

improves reception of WEAK VHF-TV signals in FRINGE AREAS even where strong local TV or FM signals are present. AMPLIFIES UP TO 7 TIMES for Better Color and B/W



Model 65-3 VHF-TV ANTENNA AMPLIFIER

Let Finco solve your Color and B & W reception problems. Write for complete information, schematics and specifications. Form #20-357.

A two-transistor-amplifier. Engineered to provide the lowest noise and highest amplification with the most desirable over-load characteristics.

Amplifier used in conjunction with dual outlet power supply for one, two, or multiple set installations. 117 V 60 cycle input. AC power up to amplifier: 24 volts-60 cycle.

THE FINNEY COMPANY

34 West Interstate St. - Bedford, Ohio 44014 - Dept. 410

CIRCLE NO. 82 ON READER SERVICE CARD

WORLD'S FINEST



ERSIN MULTICORE

ONLY 69¢

BUY IT AT RADIO-TV PARTS STORES

MULTICORE SALES CORP. WESTBURY, N.Y. 11590
CIRCLE NO. 103 ON READER SERVICE CARD
74

EW Lab Tested

(Continued from page 16)

gram (slightly less than the company's earlier Model SPE/T, which is still available). Its static compliance is 20×10^{-6} cm/dyne, a twofold increase over the SPE/T. The rated tracking force is 1 to 2 grams, with the latter figure preferred.

The stylus cantilever of the S-15T is protected by a rigid tubular sleeve, whose end is shaped to allow the stylus to retract if excessive vertical force is applied. When this happens, the polished end of the protective tube rides on the record surface, preventing damage to stylus or record. Should the stylus ever require replacement, the entire cartridge must be returned to the importer, *Elpa Marketing Industries, Inc.* Only two days are normally required for stylus replacement.

The cartridge contains a pair of Mu-metal shielded step-up transformers for raising the very low output from the moving-coil elements to about 4 to 5 millivolts. A portion of the internal wiring (from coils to transformers) uses a tiny printed board for increased ruggedness. Because of the built-in transformers, the cartridge weighs 18.5 grams compared with the 6- to 12-gram weight of most magnetic cartridges. Certain tonearms may require additional counterweights for static balance when the S-15T is actually installed.

Our frequency-response and cross-talk measurements were made with the CBS STR100 sweep record and the General Radio 1521-B level recorder. No equalization was used, and the ideal response would be a horizontal line above 500 Hz and a 6 dB/octave downward slope below that frequency. (In reproducing the curves, we have re-plotted values below 500 Hz with respect to the zero-dB reference line. Hence, ideal response would be a straight horizontal line.—Editor) The cartridge had a response within ± 2 dB of the ideal curve, from 40 Hz to 16,000 Hz, and was down only 4 dB

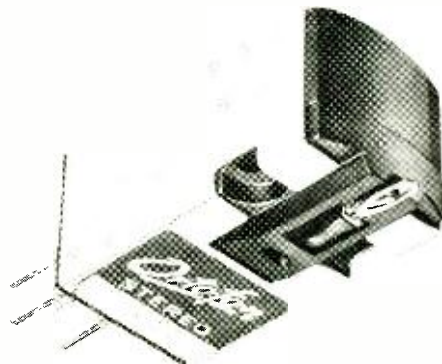

at 19,000 Hz. The smoothness of the response curve was noteworthy, with no peaks larger than 2 dB. The cross-talk was about -25 dB from 500 Hz to 2000 Hz and was not less than -15 dB over the entire useful audio range.

A low-frequency sweep, from 200 Hz to 10 Hz, did not reveal any resonance in that range (with the cartridge installed in an SME 3012 arm). This is consistent with the high stylus compliance and relatively large arm/cartridge mass, which we would expect to resonate slightly below 10 Hz.

Prior to testing the cartridge, we listened to it briefly. It was immediately apparent that this was an exceptionally fine cartridge. The frequency-response curve, excellent though it was, did not fully explain the outstanding quality which we heard. However, the square-wave and intermodulation-distortion tests provided the corroborative evidence.

The 1000-Hz square wave (see photo) from the CBS STR110 test record was reproduced with near-perfection. There was a very slight ringing, which appeared to be at 8 or 9 kHz.

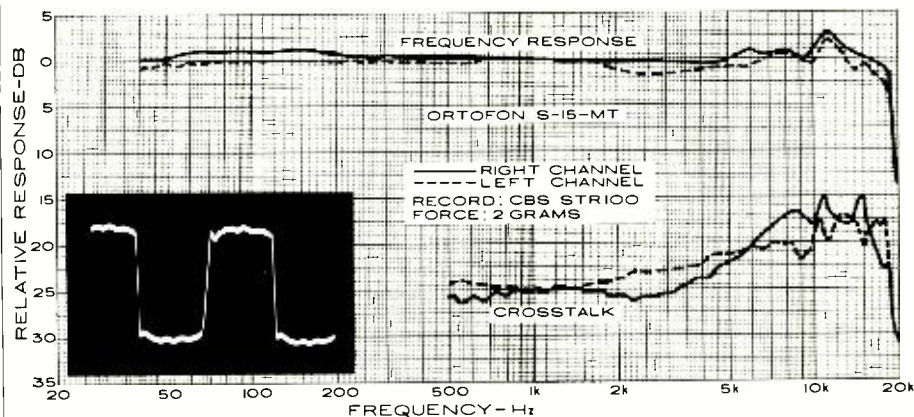
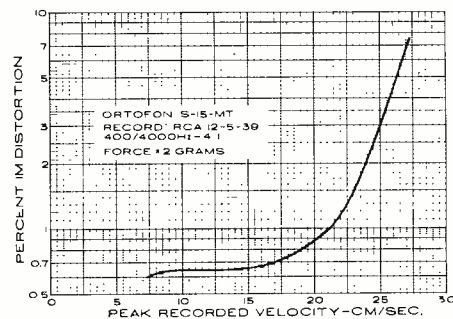

We have rarely seen as good a response to this record with other cartridges.

The IM distortion, playing the RCA 12-5-39 record, was the lowest we have ever measured from a phono cartridge. In fact, we did not know that the residual distortion of the record itself was that low. At almost any velocity likely to be encountered (up to 17 cm/sec), the IM was under 0.65%. It reached only 2% at 23.7 cm/sec, corresponding to the loudest momentary peaks on a few heavily recorded discs.

The measurements clearly indicate that the S-15T is a top-flight cartridge. It sounded every bit as good as it tested, with superb definition. We were soon aware that it did not sound strained even on the loudest portions of some records which sounded fuzzy or hashy when played with most other cartridges. Although the price makes it a connoisseur's cartridge, its sound quality is consistent with its price tag.

The Ortofon S-15T sells for \$80. It can be purchased installed in an Ortofon plug-in shell, as the S-15MT, for \$85. This shell plugs directly into an Ortofon or SME arm. ▲

Oceanography

(Continued from page 46)

ship. Unfortunately, buoys left unattended in the ocean often disappear, and if the recording buoy is lost, so is its data.

The telemetering buoy can be interrogated at intervals and its data recorded on land. Thus, even if the buoy is lost, all data collected to its last interrogation is saved. Also, periodic examination of the telemetered data gives warning if one or more sensors are malfunctioning.

A typical telemetering buoy installation is shown in Fig. 6 (right). An anchor at the sea floor holds the assembly at a fixed location. A buoy below the surface, where it is not subjected to wind and wave forces, attempts to hold the instrument cable in vertical position. Instruments are placed along the cable at various depths and are wired to the subsurface buoy.

The telemetering buoy floats on the surface. Typically, it will contain a recorder, receiver, transmitter, antenna, and meteorological sensors.

Data is recorded at the buoy as programmed by the timer. When interrogated by radio, the recorded data is transmitted to shore to be recorded and processed there.

Present designs utilize the 2- to 20-MHz band for transmission, have transmitter power in the 25- to 100-watt range, and can be interrogated at distances of more than 1000 miles. ▲

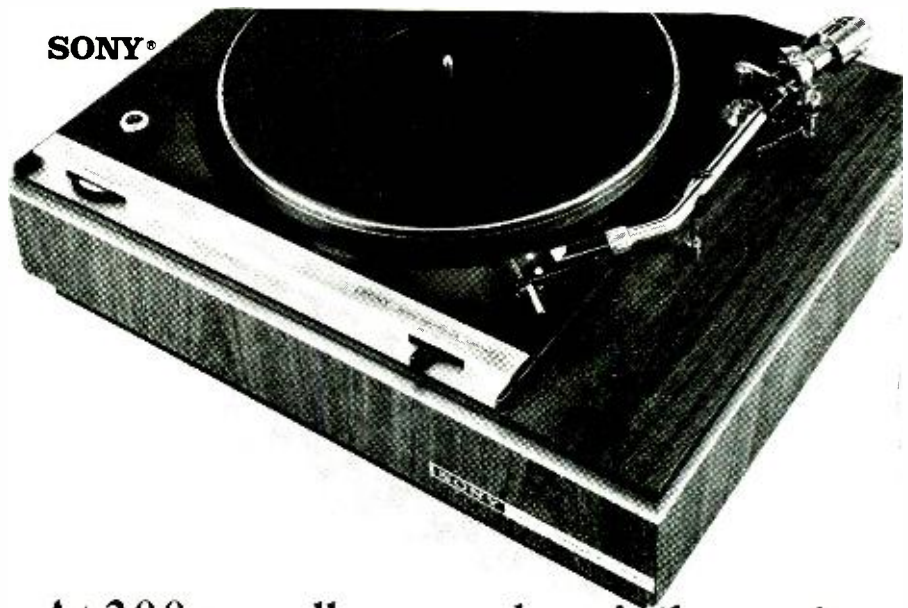

At 300 rpm all you can hear is the music.

Most turntables utilize motors that operate at 1800 rpm. The new Sony Servo-Controlled TTS-3000 employs a motor that provides optimum torque at 300 rpm. The slower the motor, the less chance of rumble-producing vibration intruding upon your record-listening pleasure.

For precise speed-regulation, Sony employs the first precision servo-controlled motor ever used in a turntable. No rumble, no noise, precise speed, beautiful music from the Sony TTS-3000. \$149.50 (base extra).

For the finest playback system, add the Sony VC-8E moving coil cartridge, \$65 and the PUA-237 professional arm, \$85. Prices, suggested list. At your Sony high fidelity dealer. Sony Corporation of America, Dept. H, 47-47 Van Dam Street, Long Island City, N.Y. 11101

CIRCLE NO. 92 ON READER SERVICE CARD



The Heart of your Radio is Its

TEXAS CRYSTALS

INSIST ON

CQC*

* Controlled Quality Crystals available only from Texas Crystals dealers. Extensive precision testing throughout manufacture enables Texas Crystals to unconditionally guarantee their frequency control crystals. Use of Texas Crystals in space program and by other governmental agencies is evidence of the quality you can count on.

If your dealer can't supply your needs, send his name with your request for catalog to our plant nearest you.

TEXAS CRYSTALS



1000 Crystal Drive
Fort Myers, Fla. 33901
Phone: 813-936-2109

4117 W. Jefferson Blvd.
Los Angeles, Calif. 90016
Phone: 213-731-2258



Division of Whitehall Electronics Corp.

CIRCLE NO. 89 ON READER SERVICE CARD

when does
5=2977?

5=2977
 when you use
Workman's
MIRACLE 5
TRANSISTORS.....
 they will replace
2977 transistors for
entertainment use
in radio, phono,
tape recorders and
amplifiers!

- AA1 PNP AUDIO
- AA2 NPN AUDIO
- AA3 PNP HIGH FREQUENCY
- AA4 POWER DIAMOND BASE
- AA5 POWER STUD BASE

Ask for our **FREE**
 Pocket Cross Reference No. X52

AVAILABLE AT ALL
 ELECTRONIC PARTS DISTRIBUTORS
 LOW PRICED

only from
WORKMAN *Electronic*
 SARASOTA, FLORIDA PRODUCTS, INC.

CIRCLE NO. 87 ON READER SERVICE CARD

WE DON'T CLAIM
 OUR ELECTRONIC
 IGNITION SYSTEM
 IS BEST

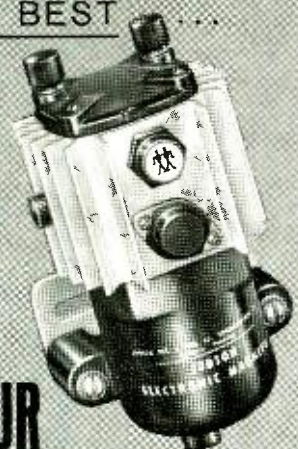

OUR
CUSTOMERS DO!
 WRITE TODAY FOR FREE LITERATURE

JUDSON
 RESEARCH AND MFG. CO.
 CONSHOHOCKEN, PA., U.S.A.



CIRCLE NO. 111 ON READER SERVICE CARD
 76

LASER-RECORDED DIGITAL MEMORY

Capable of storing 645,000,000 bits of digital information per square inch, one reel of this tape can store as much information as 47,500 similar reels of conventional tape.

IT has been estimated that the average American will generate about 500 pounds of printed or written material during his lifetime, of which about 10% will become permanent or semi-permanent documentation. Also consider that it has been estimated that throughout the world some 100,000 pages of information are generated every hour, and that this volume is expected to double within 10 years.

Storing all this information has become a problem. For example, 100 years ago the Library of Congress was contained in shelves occupying about 500 feet of floor space. Today, its 44 million items, even with microfilm storage, occupy several large buildings.

A key to mass storage and processing of information was found in translating it into binary form and storing it on punched paper. This produced a storage density of about 10 bits of digital data per square inch. The next step was the use of magnetic tape which increased the storage density up to about 5600 bits per square inch.

Now the laser has entered the picture. The *Precision Instrument Co.* has reported the use of a laser digital recording system that has produced a storage capacity of 645,000,000 bits of digital information per square inch packing density. One standard 2400-foot reel of the special tape used in this system can store as much data as 47,500 similar reels of conventional magnetic tape.

Called the UNICON (unidensity coherent light recording) process, it is not a photographic method but makes use of the laser to burn minute holes in the tape storage medium.

The laser's continuous radiation is gated by an electro-optical modulator to produce bits corresponding to the digital data input. The opaque coated polyester tape is moved by a helical-scan transport system (in a similar manner to the tape path taken in a helical-scan video tape recorder) around the imaging circle of the laser aperture. The laser aperture is imaged to produce a one-micron image having a temperature of 3000°K (over 4500°F) on the 4 micron thick opaque tape coating. As each laser burst strikes the tape, it vaporizes the coating to produce a hole (as shown in the accompanying photo). The clear polyester tape backing itself is not harmed, but the image is permanently recorded by the hole in the coating.

Due to the scanning-like process, each line has the capacity of over 600,000 holes. As the tape advances, successive parallel lines are recorded. A control track running along one edge provides a binary file accession code to locate each individual track for readout.

As the light passes through the vaporized holes in the tape, it is collected in a light pipe and conducted to a photomultiplier and converted into electrical pulses. These are compared, in real time, with the data input to verify the recording. An alarm circuit signals the failure of the detected light bits to correspond to the digital input at the modulator. This provides the read-while-write capability that has been the ultimate objective of memory system designers.

Retrieval is accomplished by a similar helical-scan transport with the tape breaking the light path of a low-power laser. Light passing through the holes is detected to produce the same bits as were recorded. The power output of the readout laser is insufficient to alter the opaque coating of the tape.

The company estimates that the entire Library of Congress collection could be included on 5½ UNICON mass memory reels.

Precision also points out that besides the 645 million bits per second storage density, recording speeds of 12 million bits per second are demonstrable. Also, because the information is stored in the form of holes, it cannot be accidentally erased, it will not fade with the passage of time, and has no print-through problem.

The development has reached the stage of laboratory models that demonstrate all the functions of the process except elements of the tape transport mechanism. These are still in the development stage. ▲

The array of 1.5-micron holes produced by the laser on the tape opaque coating.

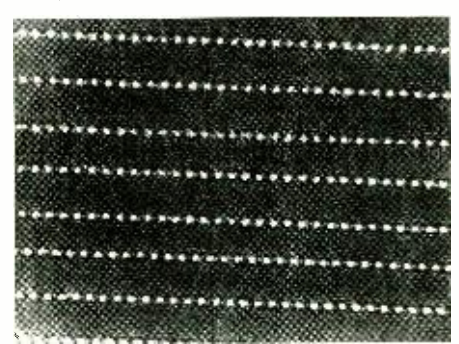

Test Equipment for CB and BRS

(Continued from page 33)

panel socket. That signal can be used as an approximate check on a receiver's performance or for alignment. When the instrument is capable of generating r.f., it often includes an audio oscillator stage for tone modulation. The pure audio tone is also made available separately for checking a transceiver's audio section. Typically, instruments in this class can read relative activity of a crystal.

The choice between active and passive CB testers may relate to individual need. Fewer functions of the passive instrument tend to limit it primarily to installation and tune-up, and possibly to help detect troubles like faulty connectors and cables. The more elaborate tester, with its signal-generating features, could conceivably be used for much troubleshooting and alignment, with little more required than a v.t.v.m. for voltage and resistance checks. Also, an active instrument may ease the load on a test bench tied up with radio and television servicing.

Service Specialist

The licensed technician who wishes to specialize in CB and BRS servicing can make many essential adjustments with the test equipment already described. Power input is measured by voltmeter and ammeter, output voltage with an r.f. v.t.v.m. and dummy load. Modulation percent of an AM signal is readily viewed and measured on any service scope with provision for direct connection to its vertical deflection plates. The only other major instrument for CB servicing is the frequency meter. With a minimum accuracy of $\pm 0.0025\%$ it can be used to peak and resonate the transmitter's crystal oscillator, especially after servicing in that circuit. Not only does the instrument serve as a



signal generator, but for running frequency checks on transceivers which are apparently in good condition. (It is generally recommended that such checks be done at intervals of six months.)

There are two main types of frequency meter available to the CB service technician. One is a CB-only version which contains a highly accurate crystal on each assigned channel. Crystals are switch-selected and may be guaranteed accurate to within $\pm 0.0015\%$ when the instrument is operated within an ambient temperature of 50 to 100 degrees F. The other type is the frequency meter intended for general two-way radio service. Its circuitry may be of the heterodyne or frequency-counter type, but the instrument is characterized by extremely wide frequency coverage and accuracy well within FCC requirements. It may be used to service virtually all two-way radio equipment the technician is apt to encounter, including CB, BRS, marine, aviation, and land mobile. Manufacturers may provide special calibration for convenient selection of CB frequencies, or adapters for accurate frequency checks in the higher v.h.f. and u.h.f. bands.

Another instrument which can be classed as "professional" is the modulation meter. It is required for BRS service where bandwidth of the FM signal must be checked. In the narrow-band or split-channel mode, the meter must measure maximum transmitter deviation of ± 5 kHz. A typical modulation meter might accept a transmitter signal anywhere from 25 to 500 MHz and read out its frequency deviation directly in kHz.

Thus the choice of test equipment largely depends on the intended degree of servicing. Much can be done to maintain CB equipment with relatively inexpensive and simple instruments. But when total service of CB and BRS transceivers is contemplated, professional instruments—including a frequency and modulation meter—are a necessity. ▲

A SELECTION OF ANNUALS STILL AVAILABLE
FROM THE WORLD'S LARGEST PUBLISHER OF SPECIAL INTEREST MAGAZINES

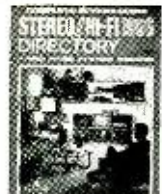
 <p>CAR & DRIVER YEARBOOK A complete buyers guide covering virtually every car available in the United States... Road tests... Technical specifications... Accessories and performance equipment buying guide... Guide to racing with action-packed photos.</p> <p>1966 — \$1.25 #15 1965 — \$1.25 #17</p>	 <p>FLYING ANNUAL The most valuable aviation yearbook ever compiled... Pilot reports... Aircraft directory... How to buy a used airplane... Navcom directory... Learn to fly section.</p> <p>1966 — \$1.25 #27 1965 — \$1.25 #28</p>
 <p>TAPE RECORDER ANNUAL Everything you need to know about tape recording including a complete directory of mono and stereo recorders.</p> <p>1966 — \$1.25 #30 1965 — \$1.00 #31</p>	 <p>STEREO/Hi Fi DIRECTORY Complete buyers guide for virtually every Hi Fi component manufactured.</p> <p>1966 — \$1.25 #29 1965 — \$1.00 #37</p>

Order by number from Ziff-Davis Service Division, 595 Broadway, N.Y., N.Y. 10012. Enclose add'l 15¢ per copy for shipping & handling (50¢ for orders outside U.S.A.)

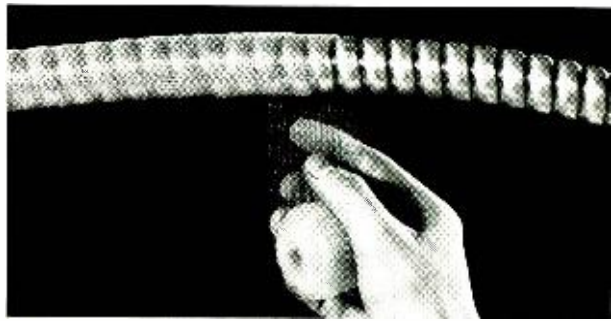

Metex RFI Shielding Tape

...the ideal inexpensive approach for shielding cable assemblies

Shielding tapes can be provided in several materials. The most popular materials are monel, aluminum, silver plated brass and tin plated copper clad steel. These tapes can be provided in continuous lengths in widths from 1/2".

They are highly flexible and easy to apply to odd shaped cable assemblies or equipment to provide excellent shielding coverage. Write for free samples, prices, literature, or ask us for engineering assistance!

METEX Corporation
Walnut Avenue, Clark, New Jersey 07066
(201) FU 1-7272 • TWX 710-744-4530
West Coast: 5057 W. Washington Blvd., Los Angeles

CIRCLE NO. 200 ON READER SERVICE CARD

New Frontiers in Semiconductors

New materials, combined with new techniques, can produce transistors capable of operating at several GHz, and microwave diodes that can deliver 1.1 watts at 12 GHz.

WITH the increasing sophistication of fabrication and deposition equipment, and with the constant search for new materials, scientists are now able to produce many advanced forms of semiconductors that far outstrip their predecessors.

Transistors

At *Westinghouse*, they have been using a material called indium arsenide to produce a thin-film transistor capable of operating to several GHz, at temperatures between -452°F (close to absolute zero), up to 300°F .

This new transistor also points the way to a new capability in integrated circuits.

Although not yet commercially perfected, the indium arsenide transistor demonstrates the feasibility of a thin-film device that should outperform conventional silicon transistors in high-frequency response, in resistance to damaging radiations, in stability over a very wide temperature range, and, ultimately, in cost.

Up until this time, thin-film IC's have had little impact on microelectronics mainly because there has been no satisfactory thin-film amplifier that compares in performance with the transistors incorporated into the silicon circuits.

At best, thin-film IC's have been "hybrids" in which separate, soldered-in transistors and diodes are interconnected between thin-film passive elements. This technique sacrifices the economic and technical advantages of an all-integrated thin-film structure. It is hoped that the indium arsenide transistor will change this picture, bringing about what might be termed the "second generation" of these increasingly important devices.

By evaporating successive layers of various materials through the proper masking technique, an integrated thin-film circuit that includes both passive and active devices can be made, having characteristics not obtainable with the older silicon technique.

A typical FET-type transistor, shown in Fig. 1, is fabri-

cated by evaporating a layer of indium arsenide on the quartz or glass substrate, via the desired masking shapes, evaporating the connecting element metal ohmic contact, then an insulating layer over these, and finishing up with another metal layer to form the gate electrode. The layers are typically five to 10 millionths of an inch thick.

Meanwhile, scientists at *Bell Telephone Labs.* are reporting transistors having a cut-off frequency of more than 7 GHz with a power gain of more than 4 dB at 4 GHz. Improved fabrication techniques that allow the internal dimensions of the transistor to be greatly reduced are responsible for the high gain and high cut-off frequency.

To obtain good operation at the very high frequencies, the transistor must have a very thin base layer (about 0.1 micron thick), and a narrow emitter strip (about 1 micron wide) as shown in Fig. 2. These dimensions are held without resulting in emitter-collector shorts, which can be caused during the base and emitter diffusions by the use of a new technique in precisely controlled shallow diffusions.

This technique also meant that improved optical systems using high resolution lenses to fabricate the more precise masks had to be produced.

Another new technique, the deposition of a thin metallic (nickel or chromium) film between the silicon dioxide layer and the photoresist layer, increased the resolution of the photoresist layer. Without this metallic deposition, incident light waves interfered with reflected light from the silicon surface, and sufficient definition could only be obtained for a strip about 2 microns wide.

Another fundamental problem—base-to-emitter shorts through the overlay contact—was minimized by using an extremely thin layer of phosphorus glass as a source for the emitter diffusion. Because only negligible interaction occurs between a very thin layer of phosphorus glass and the silicon dioxide layer, the protective silicon dioxide layer is preserved during the diffusion.

Diodes

In the area of diodes, *Bell Labs.* also has developed silicon diodes that are used with external microwave circuitry to operate as an oscillator, that generate 1.1 watts of continuous-wave power at 12 GHz, with 8% efficiency. This performance represents the highest c.w. power reported at this frequency for semiconductor microwave oscillators.

This power is twice as great as previously reported at 12 GHz for silicon *p-n* junction diodes, and nearly eight times greater than that reported for Gunn-effect devices. The diode's efficiency is about 2% greater than that of previous silicon diodes and more than double that of c.w. Gunn-effect devices at 12 GHz.

Bell credits the better performance primarily to improvements in mounting and bonding, resulting in a more efficient heat flow away from the diode, and closer control

Fig. 1. This indium arsenide thin-film FET transistor uses layers only five to 10 millionths of an inch thick.

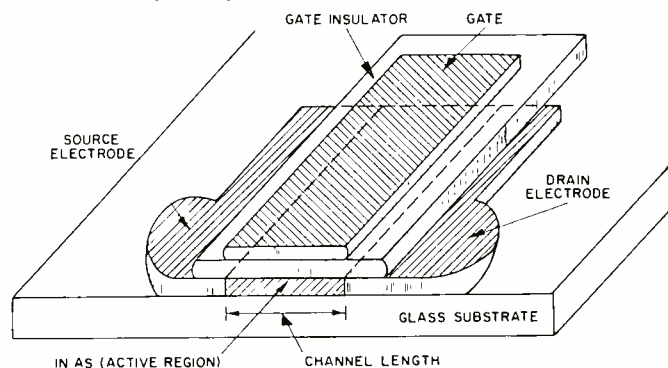

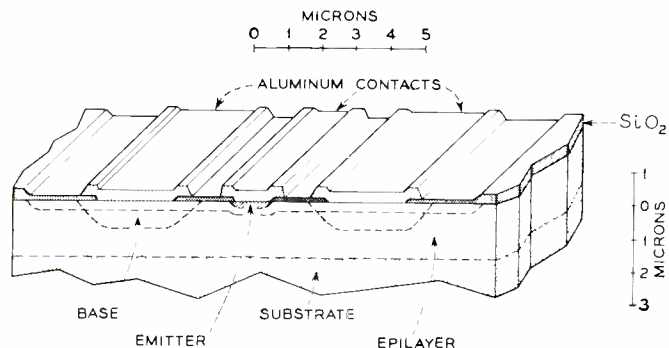

Fig. 2. Base layer of this new high-frequency transistor is 0.1 micron thick, emitter is only one micron wide.

of processing techniques resulting in increased efficiency. As shown in Fig. 3, the diodes are mounted "upside down" in their metal housings, a complete departure from conventional diode mounting practices. This upside-down arrangement places the $p-n$ junction closer to the metal mount, thus reducing thermal resistance between the junction and the metal.

Better device efficiency is produced by controlling the impurities, or doping profile, of the semiconductor, and by reducing the n -type region of the diode to the minimum necessary thickness. Controlled doping enables the diodes to attain peak efficiency under normal operating conditions (efficiency of the earlier diodes increased as the input voltage to the diode increased, but the diodes usually burned out before reaching their peak efficiency). The reduction in thickness of the n -type region reduces the electrical resistance of the diode.

The devices used in the *Bell* experiments are simple $p-n$ junction diodes that generate microwaves by combining the effects of avalanche and transit time.

Avalanche is a high field discharge caused by impact ionization of carriers; that is, under the influence of a high field, the carriers acquire enough energy to knock valence electrons into the conduction band. This generates new carriers, which by the same process, create still new carriers.

Transit time is the time it takes electrons to travel through a region in the semiconductor material.

By applying a reverse bias to the diode, for example, avalanche occurs principally at the $p-n$ junction producing electrons and holes. Electrons travel through the n -type region of the diode and produce power. The holes are collected through the p -type region but contribute only in a minor way to the power. The operating frequency of the diode is dependent on the time required for the electrons to travel through the semiconductor—the faster the transit time, the higher the frequency. ▲

Fig. 3. This "upside-down" mounted diode can oscillate at 12 GHz and deliver 1.1 watts of power. In conventional diodes, "N+" substrate is bonded to metal base.

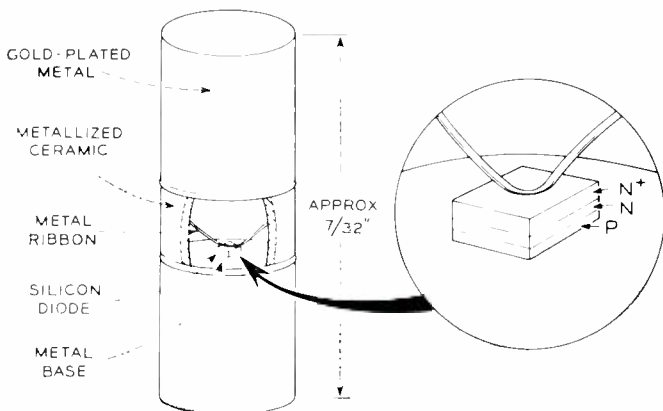

BIGGER... BETTER THAN EVER!

FREE!

SEND TODAY FOR YOUR NEW 40th ANNIVERSARY 1967 CATALOG



YOUR BUYING GUIDE FOR

- Stereo & Hi-Fi Systems & Components
- Tape Recorders.
- Electronic Parts, Tubes, Tools.
- Phonos & Records.
- Cameras and Film.
- Public Address.
- Citizens Band.
- Ham Gear.
- Transistor & FM-AM Radios.

252 GIANT VALUE PACKED PAGES!

BURSTEIN-APPLEBEE CO.

Dept. EW, 1012 McGee, Kansas City, Mo. 64106
 Rush me the FREE 1967 B-A Catalog.

Name _____
 Address _____
 City _____
 State _____ Zip Code _____

CIRCLE NO. 124 ON READER SERVICE CARD

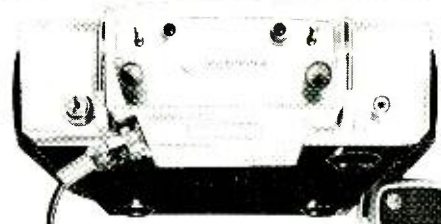

ARE YOU CASHING-IN ON THE PROFITABLE 2-WAY RADIO SERVICE BUSINESS?

- ★ Motorola will train you for this rewarding, elite profession
- ★ Send for our FREE EVALUATION EXAM. Prove to yourself that you are ready to learn FM 2-way radio servicing.

Opportunities in 2-way radio servicing are virtually unlimited. Just one of the hundreds of successful Motorola Service Stations writes, "we would be pleased to interview any graduate of your school that has received some training in 2-way radio maintenance. We are an established firm, 10 years old, with a promise of expansion governed by our ability to obtain competent technicians." Get all the facts today. There is no obligation and no salesman will call.



MOTOROLA TRAINING INSTITUTE

4545 West Augusta Blvd. • Chicago 51, Illinois • Dept. AEF710

- Send me FREE entrance exam.
- Send full details on Home Study Course on FM 2-way Radio Servicing
- Send me details on how you can help me prepare for an FCC License.

Name _____ Occupation _____
 Address _____
 City _____ Zone _____ State _____

CIRCLE NO. 104 ON READER SERVICE CARD

How To Have Fun While You Save...

NEW Harmony-By-Heathkit® Electric Guitars & Heathkit Guitar Amplifier



Kit TA-16 \$129⁹⁵

A NEW Heathkit Transistor Guitar Amplifier — Compare It To Units Costing Several Times as Much

60 watts peak power; two channels — one for accompaniment, accordion, organ or mike — the other for special effects . . . with both variable reverb and tremolo; two 12" heavy-duty speakers; line bypass reversing switch for hum reduction; one easy-to-wire circuit with 13 transistors, 6 diodes; 28" W x 9" D x 19" H leather-textured black vinyl cabinet of 3/4" stock; 120 v. or 240 v. AC operation; extruded aluminum front panel, 52 lbs.

Famous American Made Harmony-By-Heathkit® Guitars

All wood parts factory assembled, finished and polished . . . you just mount the trim, pickups and controls in predrilled holes and install the strings . . . finish in one evening.

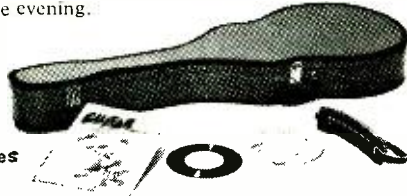

These Valuable Accessories Included With Every Guitar Kit

Each guitar includes vinylized chipboard carrying case, cushioned red leather neck strap, connecting cord, Vu-Tuner® visual tuning aid, tuning record, instruction book and pick . . . worth \$19.50 to \$31.50 depending on model.

Kit TG-46 \$219⁹⁵
(save \$111.55)



Kit TG-26 \$99⁹⁵
(save \$47)



Kit TG-36 \$119⁹⁵
(save \$40.55)



B Deluxe Guitar . . . 3 Pickups . . . Hollow Body Design

Double-cutaway for easy fingering of 16 frets; ultra-slim fingerboard — 24 1/4" scale; ultra-slim "uniform-feel" neck with adjustable Torque-Lok reinforcing rod; 3 pickups with individually adjustable pole-pieces under each string for emphasis and balance; 3 silent switches select 7 pickup combinations; 6 controls for pickup tone and volume; professional Bigsby vibrato tail-piece; curly maple arched body — 2" rim — shaded cherry red. 17 lbs.

C Silhouette Solid-Body Guitar . . . 2 Pickups

Modified double cutaway leaves 15 frets clear of body; ultra-slim fingerboard — 24 1/4" scale; ultra-slim neck for "uniform-feel"; Torque-Lok adjustable reinforcing rod; 2 pickups with individually adjustable pole-pieces under each string; 4 controls for tone and volume; Harmony type "W" vibrato tailpiece; hardwood solid body, 1 1/2" rim, shaded cherry red. 13 lbs.

D "Rocket" Guitar . . . 2 Pickups . . . Hollow Body Design

Single cutaway style; ultra-slim fingerboard; ultra-slim neck, steel rod reinforced; 2 pickups with individually adjustable pole-pieces for each string; silent switch selects 3 combinations of pickups; 4 controls for tone and volume; Harmony type "W" vibrato tailpiece; laminated maple arched body, 2" rim, shaded cherry red. 17 lbs.

NEW Heathkit®/Magnecord® 1020 4-Track Stereo Recorder Kit

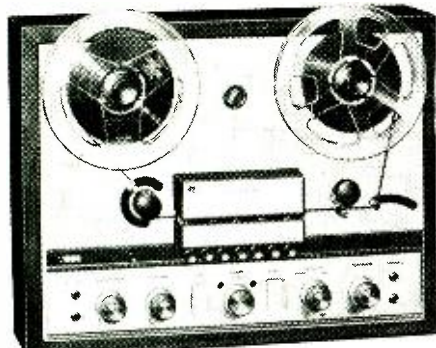

Kit AD-16 \$399⁵⁰
(less cabinet)

Save \$170 By Doing The Easy Assembly Yourself.

Takes around 25 hours. Features solid-state circuitry; 4-track stereo or mono playback and record at 7 1/2 & 3 3/4 ips; sound-on-sound, sound-with-sound and echo capabilities; 3 separate motors; solenoid operation; die-cast top-plate, flywheel and capstan shaft housing; all push-button controls; automatic shut-off at end of reel; plus a host of other professional features. 45 lbs. Optional walnut base \$19.95, adapter ring for custom or cabinet installation \$4.75

NEW 12" Transistor Portable TV — First Kit With Integrated Circuit

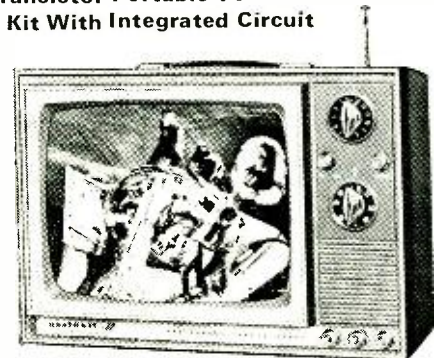

Kit GR-104 \$119⁹⁵

Plays anywhere . . . runs on household 117 v. AC, any 12 v. battery, or optional rechargeable battery pack (\$39.95). New integrated sound circuit replaces 39 TV parts; 3-stage IF for maximum gain with controlled bandwidth; gated AGC for steady, jitter-free pictures; instant "on" AC operation; preassembled & aligned tuners for peak performance; transformer-operated power supply; front panel speaker; 12-hour assembly; rugged plastic cabinet: 11 1/2" H x 15 1/4" W x 9 3/8" D. 27 lbs.

Build Your Own Heathkit® Electronics!



**23-Channel 5-Watt
Transistor
CB Transceiver**

Assembled GWW-14
\$124⁹⁵
(Kit GW-14 \$89.95)

23 channel crystal-controlled transmit & receive. Only 2 7/8" H x 7" W x 10 1/2" D . . . ideal for car, boat, any compact installation. Front panel "S" meter, adjustable squelch, ANL, built-in speaker, PTT mike, aluminum cabinet. Operates on 12 v. DC. 8 lbs. GWA-14-1 AC power supply, 5 lbs. . . \$14.95. GWA-14-2, 23-channel crystal pack, 1 lb. . . \$79.95, GWA-14-4, 6 to 12 v. DC converter, 3 lbs. . . \$14.95.



**2-Watt Walkie-Talkie . . .
Completely Assembled**

Assembled
GRS-65A
\$99⁹⁵

Up to 6 mile inter-unit range . . . up to 10 miles with 5-watt CB base station; \$20 rechargeable battery; 9 silicon transistor, 2 diode circuit; superhet receiver with RF stage; adjustable squelch and ANL; aluminum case, 3 lbs. Optional 117 v. AC battery charger plus car cigarette lighter cord \$9.95. Crystals extra . . \$1.99 each with order.

NEW! Deluxe Solid-State FM/FM Stereo Table Radio



Kit GR-36
\$69⁹⁵

Tuner and IF section same as used in deluxe Heathkit transistor stereo components. Other features include automatic switching to stereo; fixed AFC; adjustable phase for best stereo; two 5 1/4" PM speakers; clutched volume control for individual channel adjustment; compact 19" W x 6 1/2" D x 9 1/4" H size; preassembled, prealigned "front-end"; walnut cabinet; simple 10-hour assembly. 24 lbs.

NEW Transistor Portable Phonograph Kit



Kit GD-16
\$39⁹⁵

Worth At Least 50% More! And it sounds better. Assembles in just 1 to 2 hours . . . simply wire one small circuit board, mount the 4" x 6" speaker and plug in the preassembled changer . . . ideal beginner's kit. Features automatic mono play of all 4 speeds; dual Sapphire styli for LP's or 78's; 45 rpm adapter; olive and beige polyethylene over sturdy, preassembled cabinet. Operates on 117 v. AC. 23 lbs.

30-Watt Solid-State FM/FM Stereo Receiver

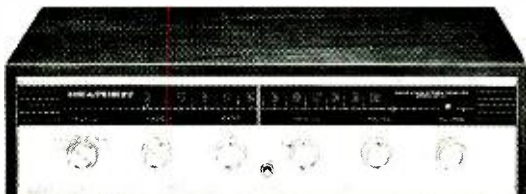

World's Best Buy In Stereo Receivers. Features 31 transistors, 10 diodes for cool, natural transistor sound; 20 watts RMS, 30 watts IHF music power (± 1 db, 15 to 50,000 Hz; wideband FM/FM stereo tuner; plus two pre-amplifiers; front panel stereo headphone jack; compact 3 7/8" H x 15 1/4" W x 12" D size. Custom mount it in a wall, or either Heath cabinets (walnut \$9.95, beige metal \$3.95). 18 lbs.

Kit AR-14
\$99⁹⁵
(less cabinet)

NEW! Compact 2-Way 2 Speaker System With Acoustic Suspension Design

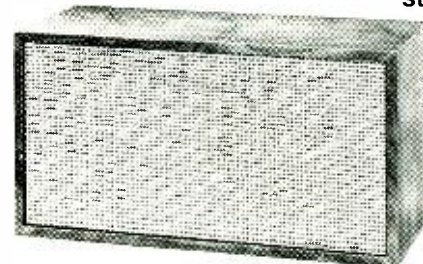

Kit AS-16
\$49⁹⁵

Handles 10 to 25 watts of program material. Features wide 45 to 20,000 Hz response; 8" acoustic suspension woofer with 6.8 oz. magnet; 3 1/2" tweeter with 4.8 oz. magnet; high frequency level control; 8 ohm impedance; 1500 Hz crossover frequency; assembled walnut veneer cabinet has scratch-proof clear vinyl covering for easy cleaning. Measures 10" H x 19" W x 8 1/2" D. Speakers are already mounted; just wire the crossover and connect cables — complete in one or two hours! 17 lbs.



FREE!
World's Largest
Electronic Kit
Catalog!

Describes these and over 250 kits for stereo/hi-fi, color TV, amateur radio, shortwave, test, CB, marine, educational, home and hobby. Save up to 50% by doing the easy assembly yourself. Mail coupon or write Heath Company, Benton Harbor, Michigan 49022

HEATH COMPANY, Dept. 15-3
Benton Harbor, Michigan 49022
In Canada, Daystrom Ltd.



Enclosed is \$ _____, plus shipping.

Please send model (s) _____

Please send FREE 1967 Heathkit Catalog.

Name _____

Address _____

City _____

State _____

Zip _____

Prices & specifications subject to change without notice.

CL-277

PERMANENT PROTECTION!



Electronics World

Deluxe Magazine Files
that hold a full
year's copies!

Designed to keep your periodicals orderly and easy to refer to. These durable files guard against soiling, tearing, wear or misplacement of issues. They look, feel like leather and are washable! 23kt. gold lettering and exquisite 2-color binding make them highly-decorative additions to your bookshelves.

Shipped POSTPAID! FULLY GUARANTEED!
Only \$3.50 each — 3 for \$10, 6 for \$19

Order several today—for ELECTRONICS WORLD
and all your other favorite magazines.

Jesse Jones Box Corp., Box 5120, Dept. EW
Philadelphia 41, Pa.

Enclosed is \$_____. Please send me _____
Electronics World Magazine Files in the colors checked
below

- Black backing/maroon sides
 Maroon backing/black sides

NAME _____

ADDRESS _____

CITY _____ STATE _____ ZIP CODE _____

Orders outside U.S.A. please add \$1 additional for
each file ordered.

(Payment must accompany order)

It only sounds expensive!



The Shure M75E *Hi-Track* is a new high trackability cartridge made especially for those who are rich only in music appreciation. This modestly-priced cartridge will upgrade your entire stereo system by delivering live, natural sound from even difficult-to-track records. Also features a bi-radial elliptical stylus and built-in stylus guard. 1½ grams maximum tracking. Only \$39.50. Literature: SHURE BROTHERS, INC., 222 Hartrey Avenue, Evanston, Illinois 60204

SHURE

M75E HI-TRACK

Elliptical Stylus Cartridge For
¾ to 1½ Gram Tracking

CIRCLE NO. 95 ON READER SERVICE CARD

Antennas for CB and BRS

(Continued from page 39)

Since CB is essentially a mobile medium, and position and distance between base station and car vary, the standard base-station antenna is non-directional and vertically polarized. One of the earliest CB base antennas, the ground plane, survives today. It is a 9-foot vertical radiator with several radial elements protruding from the lower portion to simulate an electrical ground. The reason for its popularity is that of cost; it is simple in construction and offers a straight-through match to the 50-ohm transmission line. But the ground plane has been outpaced by the taller half-wave end-fed and colinear (¾-wavelength) types. These rise to 18 or 20 or more feet.

The advantage of the longer antennas relates to their radiation angles. The ground-plane antenna has the relatively high radiation angle of about 5 or more degrees. Thus a portion of its signal is emitted skyward and is lost. The longer antennas, however, concentrate the pattern at lower angles which places more signal within the communicating area (Fig. 3). The matching networks found in the base of these antennas usually provide a d.c. ground for static and some protection against nearby lightning strikes which may induce voltage in the antenna elements.

One antenna type, the *coaxial*, has found limited acceptance in the CB field. It is essentially a half-wave vertical about 18 feet in length with a "skirt" encircling the lower half (for decoupling the transmission line from the antenna). Although a rather efficient antenna, its high radiation angle is the limiting factor. At least one manufacturer, however, offers a coaxial antenna for small-boat installation. The advantages in this special application are no protruding radials of any kind and the elimination on a ground plate on the bottom of the boat. Radiation angle should present little problem in CB marine work since range over water is excellent, often three times that over land.

Base antennas for CB have their counterparts in the BRS. For the business band, however, there are several types which have proved to be mainstays in the over-all field of two-way radio. One reason for the difference between CB and BRS antennas is that smaller physical size (due to higher frequency) permits additional stacking of elements in the BRS service. The

duo-ground plane, for example, employs two sets of ground-plane radials spaced about a quarter-wave apart to obtain a simple antenna of lower radiation angle than the conventional type mentioned earlier. The *unipole* antenna is actually a ground plane with a folded upright element (half of a folded dipole) which provides a d.c. path to ground for static discharges and a good impedance match from the feedline. The *co-plane* antenna places ground-plane radials below a half-wave coaxial radiator for achieving low radiation angles.

The BRS antennas, incidentally, are ordered cut to a specific frequency. These antennas, in general, are priced 20 to 30 percent higher than their CB counterparts, but many of them appear to be somewhat better constructed and more conservatively rated in terms of gain.

In the effort to increase communicating range on CB (which is permitted to extend a maximum of 150 miles) manufacturers offer a number of directional, or beam, antennas. These systems multiply power of a radiated (and received) signal by concentrating the nondirectional pattern into less than 360 degrees. The gain and sharpness of a beam increase with the number of elements.

The heart of one common type of directional beam is a half-wave driven dipole (about 18 feet) to which is added one reflector at the rear and one or more director elements at the front. By mounting two such multi-element beams side by side, additional gain and directivity are realized. Among the largest models now offered is a twin 5-element model.

In nearly all cases a mechanical rotator is needed to orient the beam to the desired direction, especially when communications are between base and mobile units. A fixed beam is solely for point-to-point use. Since it is often impossible to predict a vehicle's location, some CB operators use a nondirectional antenna to acquire the mobile signal, then switch over to the beam (which is oriented) to continue communications.

Other directional antenna systems in CB eliminate mechanical rotation by utilizing some form of phasing or element switching. In the phasing system, two conventional vertical antennas are mounted a specific distance apart. A control box mounted near the transmitter may switch-select a network (consisting of varying lengths of coaxial cable) which phases the signal feed.

Fig. 3. Longer base-station antennas produce lower radiation angles shown here.

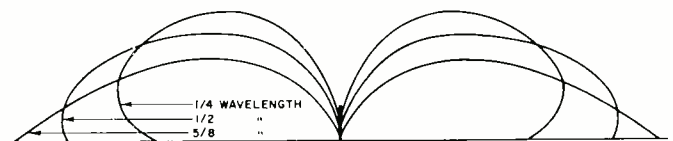

Looking for Hi-Fi equipment, but in the dark about which to buy? Well you can always . . .

1



Ask your Uncle Fred. He used to fix your toaster . . .

2



Inquire from store to store to store to store . . .

3



Choose the one that looks nicest. And cross your fingers . . .

OR you can get a copy of the

1967 STEREO/HI-FI DIRECTORY



and forget about the first 3!

If you think buying hi-fi equipment has to be a game of "musical chairs" . . . chance not choice . . . we've got news for you! Now there's a quick, easy, foolproof way to plan your next equipment purchase: with the all-new 1967 STEREO/HI-FI DIRECTORY. It's a giant, 180 page buyer's guide to virtually every new audio component on the market—

- amplifiers • changers and turntables • cartridges
- arms—accessories • receivers • tuners • tape machines • speakers/cabinets • hi-fi systems • miscellaneous accessories

PLUS—special directories for home TV tape recorders and tape cartridge machines for cars and boats!

Every technical specification, measurement, special feature, optional accessory, price and model number of all the latest products is at your fingertips. Including detailed photos. To help you compare similar items—feature for feature, dollar for dollar—and decide which is best for you. Before you buy!

Forget the guesswork, costly mistakes and "after-you-get-it-home" disappointments. With the 1967 STEREO/HI-FI DIRECTORY as your authoritative guide, you buy with confidence—and know you're getting the greatest value for your money on every piece of equipment you select.

The price for this valuable "encyclopedia" of hi-fi information? Just \$1.25. A very small investment when you think of the time, trouble and money it's guaranteed to save you. So don't delay. Use the coupon below and order your copy of the 1967 STEREO/HI-FI DIRECTORY today! Also available in a leatherflex bound DELUXE EDITION — a superb addition to your permanent reference library. \$3.00

ZIFF-DAVIS SERVICE DIVISION • DEPT. SD
595 Broadway • New York, N. Y. 10012

- Send me the new 1967 STEREO/HI-FI DIRECTORY.
- \$1.25 enclosed, plus 15c for shipping and handling. Send me the regular edition. (\$1.75 for orders outside the U.S.A.)
 - \$3.00 enclosed. Send me the Deluxe Leatherflex-bound edition, postpaid. (\$3.75 for orders outside the U.S.A.) (Allow three additional weeks for delivery.)

name _____ please print _____ EW-57

address _____

city _____

state _____ zip code _____

PAYMENT MUST BE ENCLOSED WITH ORDER

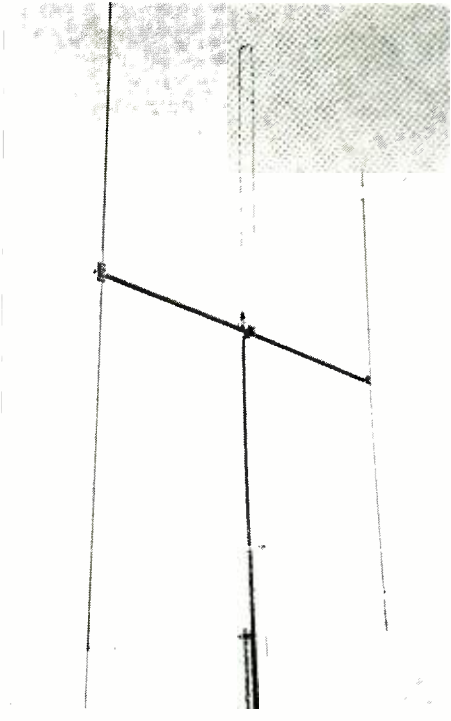

Mark Products MJ-3 is a 3-element parasitic CB beam with folded driven element, reflector, director (\$39.95).

Interacting fields at the antennas aid or cancel in the desired directions. The second method of rotating of a pattern electronically is accomplished by one model with three half-wave verticals closely spaced in a circle. Relays controlled by the operator permit any single element to become active; the remaining two serve to shape the pattern into one or more directions.

Comparable directional antennas are used for business radio applications. (A difference occurs at higher frequencies where small u.h.f. dimensions permit the use of screen reflectors similar to those used for u.h.f. TV reception.) In BRS service there is usually a greater selection of antennas which offer figure-8 (or bidirectional) and cardioid patterns to enable the installer to shape radiation. This not only reduces signal in undesired directions, but helps to attenuate interfering signals arriving from some directions.

It may be seen that the choice of CB or BRS antenna may take into account matters of coverage area, gain, pattern, and interference. For CB, the typical installation can be handled by selecting a nondirectional antenna of low radiation angle and the highest possible mounting point. It is generally believed that additional losses introduced by a longer transmission line may be offset by the height advantage and use of lower-loss coaxial cable (such as a foam-filled type). Planning the BRS installation, however, will require a careful evaluation of additional factors, namely, tower height, operating frequency, and transmitter power, which combine to determine ultimate range. ▲

NEW, Mosley, Deluxe, High Performance CB Mobile Antenna!



No longer must you choose between looks and performance in a mobile antenna . . . when Mosley offers you both in the New CB Lancer 23!

CHECK THESE FEATURES:
(1) Construction of Top Quality corrosion-proof aluminum, chrome plated brass and stainless steel. (2) Revolutionary 'Space Age' custom styling -- from the futuristic Corona Ring at antenna tip, to Corona Disks, at antenna center, machined by Mosley craftsmen. (3) Hinge within lower whip section for quick antenna fold-over. (4) Exclusive design for use on ham bands too (if you become a ham). (5) Low SWR.

Yes, CB'ers, all these features and more are yours in a CB Lancer 23! Write for more information and price.

MOSLEY ELECTRONICS, INC.
4610 N. Lindbergh Blvd.,
Bridgeton, Missouri 63042

Please send me FREE information on the New CB Lancer 23 Dept. 126

Name _____

Address _____

City/State _____ Zip _____

Mosley Electronics, Inc. 4610 N. Lindbergh Blvd.,
Bridgeton Missouri 63042

CIRCLE NO. 105 ON READER SERVICE CARD



SMALL BUT POWERFUL
DON'T BE FOOLED BY IMITATIONS!
Get the ORIGINAL

SYDMUR SOLID STATE "CD" IGNITION SYSTEM!
High Quality Components used throughout. Fiberglass Printed Circuit Board. Unitized Construction. Simplified Kit Assembly.
Construction Article in Nov. 1966 Popular Electronics. Thousands of satisfied customers. Write for Free Literature TODAY.
COMPAC Assembled . . . \$34.75*
COMPAC KIT . . . 24.95*
*Add 75c for mailing and handling
N.Y. State Residents add Sales Tax.
SYDMUR ELECTRONICS SPECIALTIES
1268 E. 12th St. Brooklyn, N.Y. 11230

Characteristics of LIMITER AMPLIFIERS

Maintaining a constant output for great variation in input level is the job of the limiter amplifier. However, some distortion can arise even when the limiter amplifier is functioning correctly.

THE limiter amplifier is a specialized member of the amplifier family. Any amplifier which, without human intervention, acts to change the amplification in a patterned manner is known as an automatic gain control (a.g.c.) amplifier. A.g.c. amplifiers are generally divided into two broad groups: those which act to increase the dynamic range of an audio program and those which act to reduce the dynamic range. The latter are called gain-reduction amplifiers.

Some gain-reduction amplifiers are designed to compress the over-all amplitude fluctuations of an audio program into a lesser range and are aptly called compressor amplifiers. These usually have a rather slow acting time. But others are meant to act extremely fast and only when the audio signal reaches certain well-defined amplitudes. These last amplifiers are called limiter amplifiers.

The definitions contained in the foregoing two paragraphs are difficult to apply to many commercial units because the ingenuity of design engineers has resulted in "combination" devices. Unfortunately, even a bare listing of the various units which have appeared on the market would require much space.

Limiter amplifiers have been made in forward-acting and reverse-acting versions. The former reduces gain when an input signal reaches a certain amplitude, and the latter acts on the amplitude of the output signal. It is the reverse-acting type that we will discuss.

Fig. 1A depicts the system of the type of limiter under discussion. This is a feedback circuit in that a portion of the output is sampled to correct an "error." The error is defined as the degree to which the output signal amplitude exceeds the set "limit." No feedback system can ever completely

Fig. 1. (A) Block diagram of limiter. (B) Idealized limiting characteristics. (C) Input wavetrain. (D) The output wavetrain.

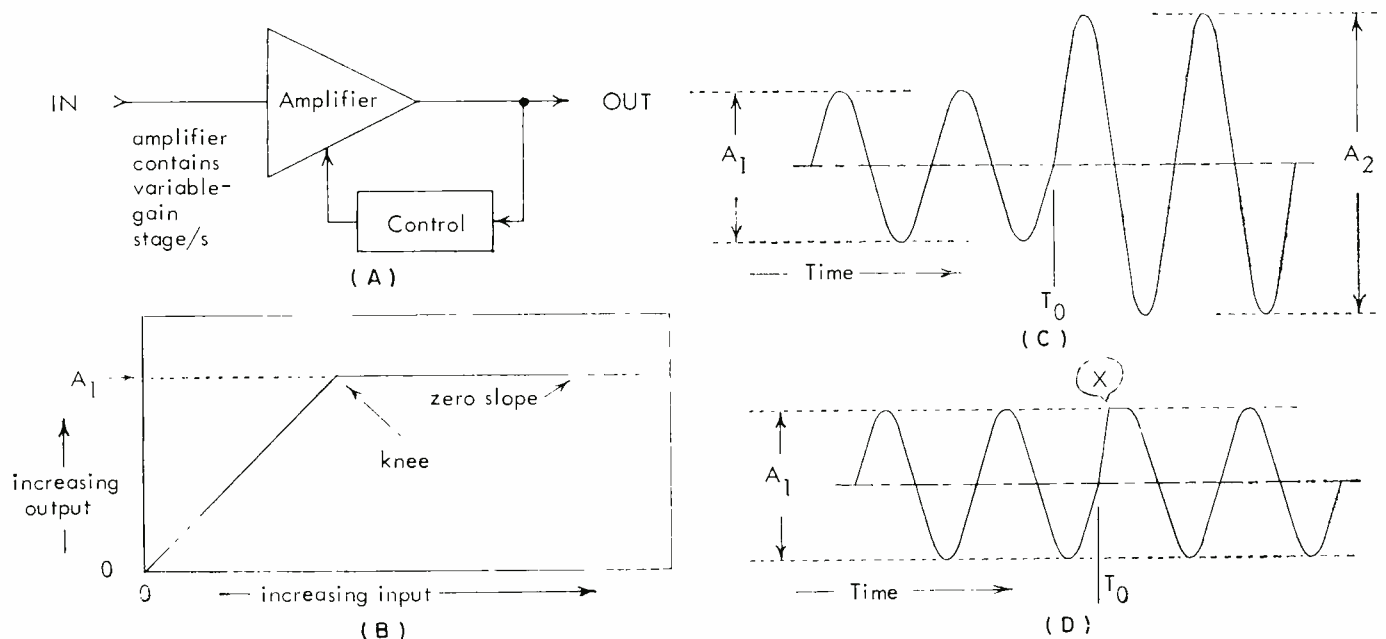

eliminate error; it can only reduce it. However, because good design can reduce limit overrun to a negligible factor, this property is not to be considered as a defect that is inherent in the system. It is only something to be recognized and minimized. (It is theoretically possible to design a forward-acting unit that has no increase or decrease in output past the limit point, but the problems entailed are formidable.) As a matter of fact, the limiter has only one inherent fault and that is the unavoidable generation of an unwanted transient signal when it "attacks." (It may be argued that the main defect of a limiter is that it does indeed change gain, the very purpose for which it is designed.)

Fig. 1B shows the input/output characteristic of the limiter amplifier shown in Fig. 1A. It is idealized, showing perfect limiting action and a perfectly sharp "knee." The 0 input point may be assumed to be the system background noise (lower limit of the possible dynamic range), and the A1 output point is defined as the desired upper amplitude limit to be imposed on system output. Practical units have sharp knees and low slopes; thus the idealized characteristics will suffice as a basis for discussion.

Let us examine what happens when the wavetrain in Fig. 1C is introduced to the input of the limiter. Note that the initial amplitude just reaches the output limit and that at time T_0 it increases from this value (A1) to a greater value (A2). The amplitude change occurs at the base line of the waves. The two amplitudes are assumed to be of perfect sine function, thus facilitating limiter action analysis. Further assumptions that apply to our "perfect" limiter amplifier are (1) the attack time (time required for the effective reduction of gain), which is zero, and (2) harmonic generation (except that associated with the limiting action itself), which is zero.

Fig. 1D shows the waves after passage. Amplitude A1 is unchanged, but A2 has been reduced to the level of A1, a change in gain having occurred at point X.

Our immediate interest is in the shape of the segment existing from T_0 to a point 90° later. It is evident that a transient signal has been generated and added to the wanted signal.

Bear in mind that this was done by our "perfect" limiter amplifier. The device has done exactly what it was designed for; it held the output to the "limit level." The gain change was not instantaneous; it began gradually at point X and stopped at the crest of the A2 input wave. Let us suppose for a moment that the output wave of Fig. 1D was

not the result of action by an automatic reduction amplifier but resulted from the action of an incredibly agile human operator who turned down an attenuator control at precisely the right moment and at exactly the correct rate. The same transient would have been generated.

An enlargement of detail from Fig. 1D is shown in Fig. 2B. The rise portion of the wave is sinusoidal, for it is identical to the A2 wave in Fig. 1C. The falling portion (after the flat portion) is also sinusoidal. Fig. 2A shows the shape of the generated transient. It is also composed of two sine functions, being computed by subtracting a sine half-cycle from the wave in Fig. 2B. The amplitude A_x may be shown to be $A_x = A1 [1 - (A1/A2)]$. The formula is accurate for gain-reduction conditions: A2 must be greater than A1.

Overshoot, which is the result of long attack time, is shown in Fig. 2C. This generally occurs at very high audio frequencies in limiter amplifiers. However, long attack time is sometimes designed into compressor amplifiers, and overshoot may occur at frequencies above the mid-range. Overshoot is not particularly objectionable, providing the attack time is at least reasonably short. However, it may cause overmodulation of a radio station or overcutting of a disc recorder. Note also that the gain-change transient (Fig. 2A) is greatly suppressed by the overshoot.

Fig. 2D shows a condition known as thump or pop. It is the result of the gain-control signal getting into the program signal. (This was quite common with electron-tube limiter amplifiers.) Gain-reduction amplifiers which are subject to thump generation are generally equipped with balancing controls so that the user may adjust for the minimum effect.

The thump shown in Fig. 2D is actually quite moderate. Referring back to Fig. 1A, it will be seen that any gain-reduction amplifier which is subject to thump is actually regenerative for control signals and may actually be completely cut off by sharp transients.

Good gain-reduction amplifiers are difficult to design. To this date there has never been a good limiter amplifier on the market (domestic or foreign) that could be called adequate by discriminating audio technicians. This statement is made with full realization of the brilliant and ingenious design work which has resulted in the various highly useful limiter amplifiers in present use.

The above article was taken from the *Langevin Engineering Letter* (published by *Langevin*, 1801 E. Carnegie Ave., Santa Ana, Calif. 92705) of September, 1966. ▲

Fig. 2. (A) A transient pulse. (B) Detail of Fig. 1D. (C) Example of overshoot. (D) An example of a thump transient.

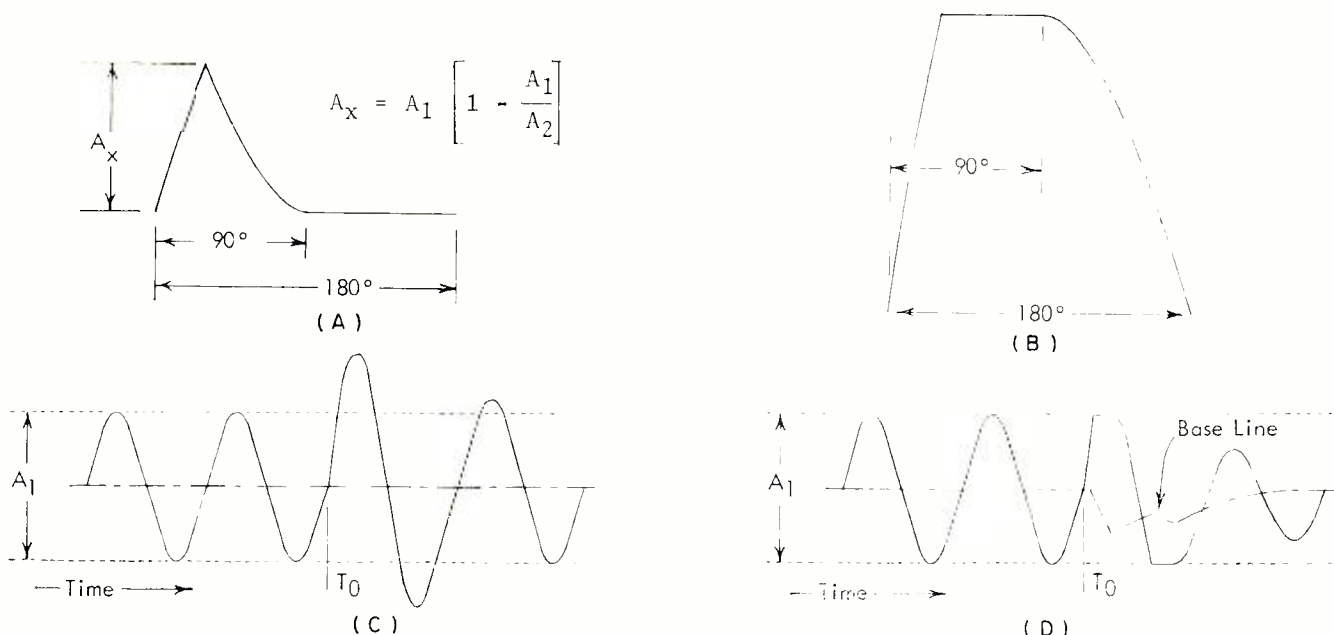

NEW PRODUCTS & LITERATURE

Additional information on the items covered in this section is available from the manufacturers. Each item is identified by a code number. To obtain further details, fill in coupon on the Reader Service Card.

COMPONENTS • TOOLS • TEST EQUIPMENT • HI-FI • AUDIO • CB • HAM • COMMUNICATIONS

SOLID-STATE VTR SYSTEM

A new, solid-state video tape recorder system designed primarily for the educational, business training, and industrial markets has just been introduced in two models—a portable 3-piece unit and a mobile console.

The basic VTR system is made up of a recorder, a CCTV camera, and a 12-inch monitor (74 square-inch viewing area). Accessory equip-



ment includes a microphone, tripod, connecting cable, and recording tape.

The distinctive feature of the new system, according to the company, is its simplicity and ease of operation. The solid-state camera may be operated by anyone: there are only two controls—the “on-off” switch and a focus knob. It is equipped with a crystal oscillator to provide optimum picture stability. Camera resolution is approximately 500 lines when displayed on a standard video monitor. General Electric

Circle No. 1 on Reader Service Card

EPOXY-MOLDED TRANSISTORS

A new line of ten low-cost “n-p-n” and “p-n-p” general-purpose transistors with unit prices on the order of 25 cents each has just been introduced.

The “Gem” transistors have all of the inherent performance and stability characteristics of silicon devices, according to the company. Their extremely low cost has been made possible by the use of new materials in manufacture, improved assembly techniques, and the use of automatic testing on the assembly.

The line includes low-level/high-gain units, u.h.f. transistors, and diffused epitaxial types for a variety of uses in data processing, communications, radio, television, and home-entertainment electronic equipment. Type numbers include 2N3793, 3794, 4284, 4285, 4286, 4288, 4290, 4291, 4292, and 4293. Power dissipation for these devices is typically 250 mW. National Semiconductor

Circle No. 126 on Reader Service Card

IR TESTING WINDOW

The problem of checking electronic circuits after they are fully enclosed in a cabinet, rack, or console has been solved inexpensively by leaving out one side of a cabinet and substituting a sheet of clear polyethylene which permits a “Thermograph” infrared camera to “see” the electronic circuitry without interference.

The major usefulness of infrared thermograph is its ability to reveal areas that are hotter or

colder than expected, thus indicating conditions that were not anticipated in the equipment’s thermal design. Moreover, once acceptable gradients have been established, any deviations are symptomatic of abnormal operation and locate areas of potential failure.

The Model T-4 camera used with this technique creates a thermogram in much the same manner as a TV picture and displays the result of up to 60,000 individual temperature measurements. Over-all range of the camera is -170 to $+250$ degrees C, the specific black-to-white picture range being adjustable from 1 to 250 degrees C. Barnes Engineering

Circle No. 127 on Reader Service Card

HIGH-POWER BATTERIES

The new “Vidor” high-power batteries are a third generation development designed for applications requiring relatively high current for long periods and where voltage maintenance is important. According to the company, they offer the benefits of increased stability, power, and longevity without the expense of alkaline or mercury systems.

Three $1\frac{1}{2}$ -volt styles are available: HP2 (“D” size), HP11 (“C” size), and HP14 (“AA” size); all use an electrolytic manganese system. IRC

Circle No. 2 on Reader Service Card

VIDEOTAPE RECORDER/RECEIVER

A new closed-circuit videotape recorder/TV receiver combination which permits the recording of television broadcasts for instant replay has just been introduced as the VR-6175. The new recorder/receiver is designed for commercial, industrial, and home use. It is housed in an oiled walnut furniture cabinet.

The 21” television receiver, Model TR-821, is made by Motorola and modified so that, when used with a recorder, no additional equipment or professional installation is required to record and play back television programming. The TV receiver is available separately as is a companion camera, the CC-6450, which allows the user to make his own live recordings. Ampex

Circle No. 3 on Reader Service Card

ULTRASONIC “BIRD CHASER”

A new bird repeller which provides an ultrasonic output of 134.8 dB (at 20 kHz) is now being marketed as the “Ultrason-A2”. Newly engineered circuitry permits a reduction in compressed air and eliminates the need for an air pressure regulator.

The unit maintains a constant, continuous u.h.f. sound output when powered by air pressures ranging anywhere from 10 psi to 55 psi. The repeller has no moving parts and is not affected by weather extremes. It is constructed of stainless steel and aluminum. One unit will cover an area of up to 6000 square feet. Bird-X

Circle No. 4 on Reader Service Card

INTEGRATED-CIRCUIT V.H.F. AMPLIFIER

The Model E13-711 linear integrated circuit is suitable for oscillator, video, and i.f. amplifier applications, including frequencies in the v.h.f. band.

Output characteristics of this new device include a dynamic range of 3.0 minimum and 4.0 typical volts peak-to-peak at 25° C and 2.5 minimum and 3.5 typical over the operating range of -55° C to $+125^{\circ}$ C. The d.c. level at 25° C ranges from a minimum of 2.4 to a maximum of 3.4 volts, with 3 volts the typical characteristic.

Output capacitance and admittance range from a typical 7 to a maximum 15 pF and from 0.6 typical to 1.5 maximum mmhos. Input characteristics are -10 minimum and -25 pF typical and 10 mmhos typical. Voltage gain ranges from a minimum 13 to a maximum 17 dB with 15 dB typical. Bandwidth (-3 dB) is typically 110 MHz, with 60 MHz minimum.

Complete specifications, including diagrams and performance curves, are available on request. Amelco

Circle No. 128 on Reader Service Card

SILICON POWER TRANSISTORS

Three new JEDEC-registered “n-p-n” power transistors, intended primarily for power amplifier applications, have been introduced. The 2N4862 is in a TO-46 package for use where minimum space is available; the 2N4863 is in

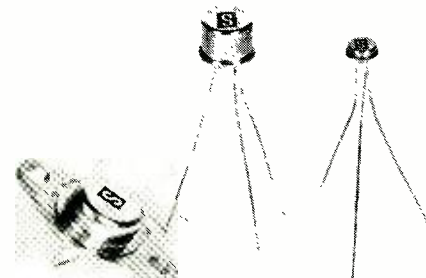

the popular TO-5 package; and the 2N4864 is in a TO-66 package to utilize full power capabilities of the transistor (28 W at 25° C case).

These 2-amp transistors have a 120 V minimum sustaining voltage and are characterized at 0.5 A collector current with h_{FE} of 50-150, $V_{CE(sat)}$ of 0.2 V maximum, and $V_{BE(sat)}$ of 1.2 V maximum. Minimum cut-off frequency is 50 MHz. Solitron

Circle No. 129 on Reader Service Card

TV-FM ANTENNAS

A new, improved line of color-TV antennas is being marketed as the “Paralog-Plus” series. Special features of the new line include extra high gain for sharp directivity, flatness within ± 1 dB per channel, and match for both 300- and 75-ohm outputs.

The new antennas incorporate a unique “Bi Modal” director system whose parasitic elements combine two high-band directors into a single director covering the entire low band, plus all FM channels.

There are eight models in the new series including four, five, seven, eight, and ten driven elements with various parasitic elements. A four-page data sheet containing full specs on each model will be forwarded on request. JFD

Circle No. 5 on Reader Service Card

LOW-COST TUNNEL DIODE

The first practical low-cost tunnel diode—priced as low as 50 cents in large quantities—is on the market as the TD700 line. The new devices are available either in an axial lead package for conventional circuits or in pellet form for use in hybrid integrated circuits.

A combination of planar and thin-film fabrication techniques is the basis for the new line. The key development is a new technique used to form the tunnel junction with the germanium.

The TD700H line consists of high temperature germanium tunnel diodes which are de-

signed to meet military specs and are capable of operating at 125° C. Both the TE700 and TD-700H lines are available with peak currents of 0.5, 1.0, 2.2, 4.7, and 10 milliamperes. General Electric

Circle No. 130 on Reader Service Card

RC GARAGE-DOOR OPENER

A new radio-controlled automatic garage door opener system, the "Genie Model 401", features a one-piece cover removable with a single screw for faster, easier access to the interior. It uses front mounting of all circuit components for easier servicing.

In addition, there is a built-in time delay for the garage light and a new streamlined housing. The control may be actuated by either push-button or by a small RC radio transmitter that may be carried in car, purse, or pocket.

The receiver uses nuvistors in a newly developed circuit which is said to provide increased reliability and longer life. Alliance

Circle No. 6 on Reader Service Card

COMPACTRON TEST ADAPTER

A new compactron tube test adapter, designed for measuring the cathode current of 6JS6 and 6JM6 horizontal output tubes in color sets, is now available as the Model 2712.

The unit provides alligator test leads running from the interrupted No. 2 pin of the adapter. When the test adapter is installed between tube and tube socket, the technician can measure cathode current and adjust the circuit to operate within specifications. Pomona Electronics

Circle No. 7 on Reader Service Card

MICROMINIATURE POT

The Model 3282 microminiature adjustment potentiometer with "Palirium" resistance elements measures only 3/8" square and weighs approximately 0.1 ounce. The new unit provides infinite resolution, has a standard resistance range of 2000 ohms to 1 megohm, and an operating temperature range of -65° C to +175° C. Resistance tolerance is ±10% standard with closer tolerances available. The insulation resistance at 500 volts d.c. is a minimum of 1000 megohms.

The Model 3282 has positive wiper stops at both ends of travel and, to prevent damage from forced adjustment, the wiper assembly idles at both ends of travel. The model is available in five configurations and is guaranteed under the company's Reliability Assurance Program. Bourns, Trimpot Div.

Circle No. 131 on Reader Service Card

CUSTOM METER SCALES

A customized meter scale service which permits electronic equipment designers to indicate meter quantities such as MHz, dB, pH factor, etc.

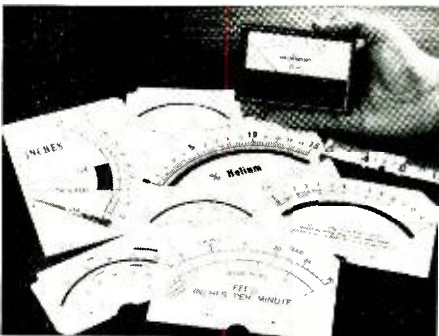

is now being offered. In addition to the custom designations, the scale design may include the company name, logo, or trademark—all in a variety of printing colors.

The artwork from which the engravings are made is retained by the manufacturer so that the customer may reorder without delay. Information on this new service will be forwarded on request. Triplett

Circle No. 132 on Reader Service Card

HI-FI—AUDIO PRODUCTS

RADIO/RECORDER/PLAYER

The new "Radiocorder" functions as an AM radio, a tape recorder, and a tape player—all in a compact package weighing 5 pounds. It can be used to record directly from the radio, to play previously recorded tapes, for regular radio lis-



tening, and as a general tape recorder. Operation is by means of push-buttons. Since the unit operates on both batteries and household current, it can play and record anywhere. An added feature of the instrument is a dynamic microphone with remote control for taping "live" performances or party activity.

The unit uses standard size tape and may be operated at either 3 3/4 or 1 7/8 ips. Each reel provides over two hours of playing time. The instrument measures 10" long x 9 1/2" high x 4 1/2" deep and comes equipped with recording and battery level meter and an outlet for use with extension speakers. Concord

Circle No. 8 on Reader Service Card

CONSOLE SPEAKER SYSTEM

The Model V is the latest addition to the "Concertmaster" line of speaker consoles. It features a 24-inch woofer (the 224MS) made of "polymer formulas", a cast aluminum frame, a 14-pound magnet of Alcomax II, and "Magnetic Suspension".

Frequency response is from 16 to 25,000 Hz with crossover at 350 Hz with a 12 dB droop per octave. The enclosure is treated with "Sound-sorbers". The cabinet is of oiled rubbed walnut veneer and measures 39" high x 29" wide x 18" deep. Hartley

Circle No. 9 on Reader Service Card

SOLID-STATE STEREO AMP

The "Knight" KN-975 is a 75-watt stereo amplifier which incorporates all of the advantages of solid-state design. Twenty-one semiconductors are used in the circuit. With temperature-control convectors and a spacious chassis, all transistors operate at full efficiency.

Frequency response is 20-22,000 Hz ± 1 dB; harmonic distortion is less than 1%; hum and noise is -80 dB tuner and -65 dB magnetic phono; tuner sensitivity is 0.25 V. Inputs include: magnetic phono, tape head, tuner, aux. =1, aux. =2, tape monitor, while outputs are 4, 8, or 16 ohms; two high-Z to recorder; low-Z stereo

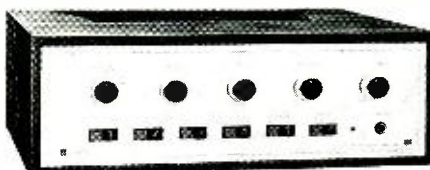

headphones. Controls are bass, treble, balance, loudness-volume, hi-cut and low-cut, mono/stereo, tape monitor, loudness, speaker main/remote, and selector.

The amplifier measures 4 1/4" high x 13 7/8" wide x 12 3/4" deep. Optional walnut wood and brown metal cases are available. Allied Radio

Circle No. 10 on Reader Service Card

130-WATT AM-FM RECEIVER

The Model TK-140 is a solid-state, AM-FM stereo receiver with 130 watts of power and a number of new engineering features. According to the company, the four-gang FET front-end provides excellent sensitivity and image rejection. Five i.f. stages with four limiters and wide-band ratio detector provide 45 dB alternate channel selectivity and freedom from noise and interference.

Frequency response of the all-silicon-transistor amplifier is 20 to 30,000 Hz. There is automatic "stereo-mono" mode switching with a stereo light indicator, interstation muting circuit, a four-diode time-division multiplex circuit for 38 dB channel separation, and a patented blow-out-proof automatic circuit breaker to protect power transistors.

The "Feather-Touch" control panel incorporates a loudness control, tape monitor switch, muting circuit switch, and high- and low-filter switches. There are four sets of speaker terminals and a front-panel speaker selector switch.

The receiver is housed in a walnut-finished case which is included in the basic price of the instrument. Kenwood

Circle No. 11 on Reader Service Card

GUITAR AMPLIFIER

A fully portable, four-input solid-state guitar amplifier is now on the market as the "Cabalero". The amplifier provides instant sound on either battery power or its own built-in a.c. power supply. It accepts up to four guitars or any combination of instruments and microphones simultaneously.

Output is 15 watts on battery and 50 watts on



a.c. with separate control and mixing of the four inputs. The amplifier also has bass and treble controls, a 12" speaker, and tremolo with speed and strength controls which may also be operated by a foot switch. The cabinet is of hardwood in black with gold trim and a blue and gold control panel. Sparks Communications

Circle No. 12 on Reader Service Card

SOLID-STATE SCA TUNER

An all-silicon, solid-state SCA multiplex tuner designed expressly for the background music industry has recently been introduced as the Model ST-300.

The new tuner features FET's in the front end. Double r.f. stages eliminate cross modulation and provide increased sensitivity and selectivity. Crystal-controlled oscillators eliminate frequency drift; all i.f. transformers contain silver mica

capacitors for highest "Q"; a unitized circuit board is used for rugged, uniform construction; 100% electrostatic circuit shielding is provided; while an emitter-follower output permits both remote installation of the tuner and prevents possible component damage through error or short-circuit.

Detailed specifications on the Model ST-300 will be forwarded on request. Browning
Circle No. 13 on Reader Service Card

AUTO/HOME SPEAKERS

"Stereo Modulators", a new concept in auto/home speakers, are now on the market. Designed to replace conventional type speakers for use with tape cartridge systems or other electronic components, the new units consist of 13 frequency-tuned pipes. Each of the pipes, which



vary in length, reproduces a different frequency.

The "Modulators" have a frequency response of 40 to 13,000 Hz. Dimensions are 6 1/4" deep x 8 3/8" wide x 10" high. Weight is 2 pounds. The units can be mounted in the auto's rear deck, between the rear seat and the back window, extending only a maximum of 5" in height and thus avoid cutting into doors where many conventional speakers are placed. Each kit comes complete with mounting plate and other materials needed for installation. Capitol Records
Circle No. 14 on Reader Service Card

WIDE-BAND AUDIO TRANSISTOR

A new wide-band audio transistor with high gain, low distortion, and more than 1 watt of audio power handling capability is now available as the MM2264.

This "n-p-n" silicon "Annular" transistor has an extremely flat beta characteristic over the collector current range of 1 mA to 500 mA to insure linear amplifier operation in large signal audio applications. The company suggests its suitability for the audio output stages in radios, TV sets, and as driver transistors in higher power, high-fidelity entertainment circuits. Motorola
Circle No. 15 on Reader Service Card

SELF-ENERGIZED SPEAKER SYSTEM

The Model 4400 is a self-energized stereo speaker system consisting of two walnut speaker enclosures of bookshelf size. Each contains an 8" woofer and 3 1/2" tweeter with crossover network.

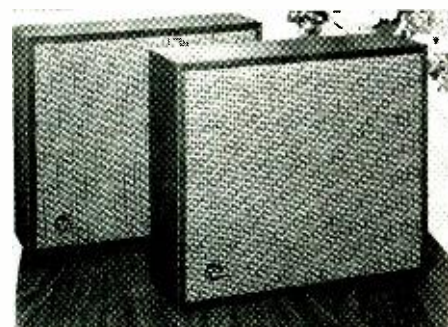

The enclosures are acoustically matched to the speakers. A 60-watt solid-state stereo power amplifier is built into one of the enclosures. The amplifier feeds both speakers and comes with "on-off", volume control, bass-boost switch, and stereo headphone jack.

Each speaker enclosure measures 16" x 14 1/8" x 5" deep. Viking of Minneapolis
Circle No. 16 on Reader Service Card

200-WATT AMPLIFIER

A 200-watt all-silicon-transistor amplifier which may be operated from either a.c. or d.c. power sources is now in production as the Model 1590A. The new instrument is designed to provide full output with a 0.8-volt r.m.s. input. The circuit features an exclusive solid-state dissipation-sensing device which provides protection for any load impedance, including short-circuit, at any driving level. When the load is partially short-circuited, the driving signal is temporarily cut off if it reaches a level which endangers the output transistors. The amplifier recovers its normal function automatically as soon as the output fault is removed.

An engineering information data sheet on the Model 1590A is available on request. Altec Lansing
Circle No. 17 on Reader Service Card

HEAVY-DUTY 10" SPEAKER

A heavy-duty musical instrument speaker, designed specifically for use with guitars and organs, features a 20-ounce magnet and a 1 1/2-inch voice coil. The speaker will handle up to 32 watts peak audio.

Total depth of the new speaker is only 3 3/4" so that it will fit into most cases which originally housed speakers with 10-ounce magnets. Rubberized cone edges and cotton-covered, 66-strand voice-coil leads prolong operating life. Impedance is 8 ohms. Utah
Circle No. 18 on Reader Service Card

SOLID-STATE AMPLIFIER

The Model 6552-1 solid-state audio amplifier is designed for screen room use in performing audio frequency susceptibility tests per MIL-I-6181D, MIL-I-26600, MIL-STD-826, and other RFI specifications.

The unit has a wide frequency response and provides up to 100 watts at 1000 Hz into 2.4 ohms at low distortion levels. The unit requires 0.6-volt input for maximum power output at 1000 Hz. A feedback circuit is incorporated for flat response within 1 dB from 30 to 100,000 Hz at reduced levels. There is no output protective circuit.

The amplifier measures 8 1/8" wide x 9" high x 14 5/8" deep. Solar
Circle No. 133 on Reader Service Card

MULTICELL HORNS

A new line of multicell horns which incorporate six improvements over conventional horn structures is now on the market.

Among the new features are changes in the couplings between cells and electro-mechanical drivers; greater precision in the shaping and assembly of the cells; closer dimensional tolerance for the throat openings of individual cells; improved insulation; and horns fully enclosed on four sides to reduce vibration and prevent incursion of wind, rain, snow, and ice between the cells.

These new "Medallion" horns are offered in seven sizes from three to fifteen cells, with 20-degree angular dispersion per cell. DuKane
Circle No. 19 on Reader Service Card

MINIATURE AUDIO AMP

A miniature audio amplifier for use as a tape record, power, and line amplifier and as a mike preamplifier, tape playback, and magnetic cartridge preamplifier is now in production as the Model 614A. The unit is also suitable for use with hydrophones, accelerometers, biomedical sensors, and transducers.

The amplifier mounts in any standard nine-pin miniature tube socket or may be used with a printed-circuit board. It has a flat frequency response from 6 to 100,000 Hz \pm 0.25 dB. With a 600-ohm source and 600-ohm load operating at 40 V, the open loop gain tested at 57 dB with noise at -130 dBm. American Nucleonics
Circle No. 134 on Reader Service Card

PORTABLE P.A. SYSTEM

A solid-state personal, portable public-address system, the "Escort" Model 802, weighs only 9 pounds and measures 11 1/2" high x 6 1/2" wide x 14" deep. A low-impedance, 5 1/2-ounce dynamic microphone is used with the system feeding a high-quality 8" cone speaker. There are two phone jacks for extension speakers and a tape recorder. Controls include an "on-off" switch



and volume control. The unit is powered by a self-contained supply using two 6-volt lantern batteries.

The system is housed in a vinyl covered luggage-type case with brass hardware. Van San Assoc.
Circle No. 20 on Reader Service Card

LOW-POWER AUDIO AMPLIFIER

A five-transistor, solid-state audio amplifier which can be used in low-power p.a. systems, as a guitar amplifier, in alarm systems, as a monitor or earphone amplifier, in science projects, or ham-radio applications is now on the market as the AA-100.

The amplifier, which measures 5 1/2" long x 1 3/4" wide x 1" high, delivers 200 mW of power. Frequency response is 100-12,000 Hz with a distortion figure under 3%. The unit may be powered from any well-filtered 9 V d.c. source or can be operated from any 9 V battery capable of delivering 50 mW. A volume control is premounted on the circuit board. Round Hill
Circle No. 21 on Reader Service Card

CB-HAM-COMMUNICATIONS

SSB TRANSCEIVERS

The new "Single-Banders" provide high-performance SSB communications on 80, 40, or 20 meters; offer front-panel selection of upper or lower sideband operation; feature improved audio and a.v.c. response; provide microphone and gain control, plus bias adjustment on the front panel for convenience in changing from fixed to mobile operation.



The location of the front panel controls has been improved over earlier models to provide more convenient operation. The units are housed in modern, streamlined enclosures.

The "Single-Banders" provide a full 200 watts p.e.p. SSB fixed or mobile. Over 90% of the components are mounted on a heavy-duty circuit board for reliable performance. The receiver is a 14-tube superhet with 1 μ V sensitivity, 2.7 kHz selectivity, and slow a.v.c. action for optimum SSB reception. The v.f.o. dial is calibrated in 2 kHz divisions. A crystal lattice filter produces identical characteristics for upper and lower sideband signals for clean transmitted signals, with the carrier and unwanted sideband at least 45 dB down.

The kit is available in 75 meter, 40 meter, and 20 meter models with mobile and fixed-station power supply kits also available as accessory items. Heath

Circle No. 22 on Reader Service Card

NAVIGATIONAL INSTRUMENT

A solid-state, transistorized marine navigational instrument which indicates at a glance speed, distance, depth of the bottom, and gas vapor leakage is now offered as the Model "300".

This compact unit features a unique modular circuit board for the various functions which

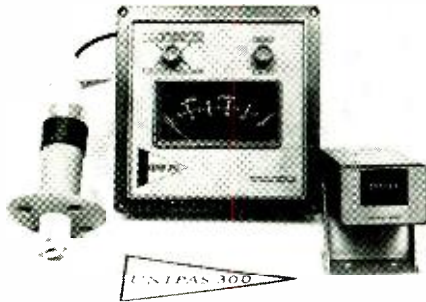

enables the user to select the information best suited to his requirements. The boat speed and water depth information can be switched from normal scale to expanded scale when ultra-fine sensitivity is desirable. Another feature is the boat-speed-through-hull fitting—a unique non-fouling water wheel—which is hydrodynamically designed to present almost unmeasurable resistance. Unipas

Circle No. 23 on Reader Service Card

100-mW TRANSCEIVER

An inexpensive 100-milliwatt hand-held transceiver with special applications in business, personal, and agricultural fields has been recently introduced.

This transceiver features a crystal-controlled superhet receiver with excellent sensitivity. Audio output is more than adequate to permit operation in noisy areas. There is a built-in battery meter for easy checking on battery strength and a rugged case, complete with leather carrying strap.

No license is required to operate this transceiver. E.F. Johnson

Circle No. 24 on Reader Service Card

SOLID-STATE CB RADIO

The Model J-23 Citizens Band radio comes complete with all 23 channels installed. Power output is 3.2 watts nominal from a 12.6 V d.c. source for 5 watts input. Modulation is 100% class B. The unit is designed to operate over a temperature range of -20 to +50 degrees F.

The radio may be used as a p.a. unit with an output of 2 1/2 watts into a 3.2 ohm speaker. The receiver section provides adjacent channel rejection of at least 60 dB, spurious rejection of at least 55 dB, and 455 kHz i.f. rejection of 100 dB. Audio output is 2 watts at 0.3 mV 100% modulation. Audio response is 250 to 3500 Hz. A special automatic noise limiter provides positive noise elimination with no audio loss, according to the company.



The unit is housed in a heavy gauge all-aluminum enclosure which also contains a 2" x 6" oval speaker. An a.c. power supply is available for base-station applications. Sonar

Circle No. 25 on Reader Service Card

MANUFACTURERS' LITERATURE

R.F. CONNECTORS

A new 12-page illustrated catalogue (No. SC-1) covering the "SUBminax" 27 Series and 5116 Series of subminiature r.f. connectors is now available. Both screw-on and push-on coupling styles are offered.

Also included in the booklet is a section on coaxial cables which describes available dielectric and cable jacket combinations. Amphenol RF Div.

Circle No. 135 on Reader Service Card

TWO-WAY RADIO

A new 10-page illustrated brochure (No. TIC-2033B) detailing the advantages of the HT Series "Handie-Talkie" two-way FM radios has been published. Entitled "Instant Communications for Your Men on Foot," the booklet describes three basic models as well as a variety of accessories. Motorola Communications Div.

Circle No. 26 on Reader Service Card

INDICATOR LIGHTS

A complete line of one- and two-terminal sub-miniature indicator lights for translucent-panel

ZENITH LOG PERIODIC ANTENNAS

offer high
signal gain and
ghost rejection

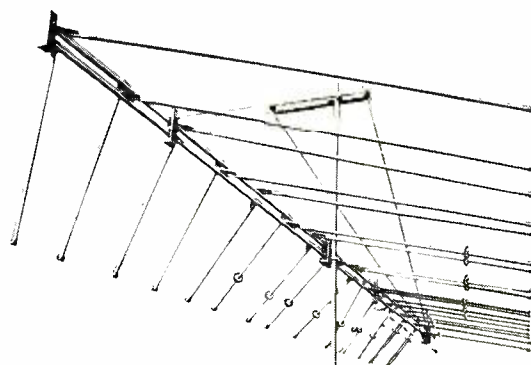

All-channel VHF/UHF/FM and F'M Stereo

Developed by the University of Illinois antenna research laboratories, each Zenith log periodic antenna works like a powerful multi-element Yagi . . . not on just one or a few channels, but across the entire band it's designed for.

Order Zenith antennas and all genuine Zenith replacement parts and accessories from your Zenith distributor.

BUILT TO THE QUALITY STANDARDS OF ZENITH ORIGINAL PARTS

Also Zenith periodic antennas for

- UHF • VHF
- FM AND FM STEREO
- PLANAR HELICAL UHF



The quality goes in
before the name goes on

CIRCLE NO. 85 ON READER SERVICE CARD

edge-lighting applications is presented in a new 8-page illustrated catalogue (No. L-158F).

Also offered are light-emitting or inset lens top indicator lights and dimming and non-dimming lights with extended necks. Dialight.

Circle No. 136 on Reader Service Card

TV LENSES

More than 1000 different lenses, including zoom optics, cine camera types, and cine and slide-projector lenses, are listed in a new TV lens guide. The lenses range in size from 1/2" to 40", and the cover page of the guide gives tips on how to select and use lenses for various effects. Burke & James

Circle No. 137 on Reader Service Card

PRESSURE-SENSITIVE TAPE

A new full-color foldout brochure describing the entire line of pressure-sensitive "Curve-Line" tapes in handy dispensers is now available. This new product is especially suited for use on charts, graphs, and maps.

The selection includes glossy- and matte-finish tapes in a wide range of colors, fluorescent tapes in 4 colors, transparent tapes in 11 projectable colors, chrome and gold tapes, and 10 different projectable pattern tapes in 7 colors. Chart-Pak

Circle No. 27 on Reader Service Card

TEST EQUIPMENT

A complete line of test equipment is described and illustrated in a new 16-page 1967 catalogue. Included are tube testers, a solid-state color generator, an in-circuit capacitor tester, a v.t.v.m., a v.o.m., a component substitutor, and a signal generator. Mercury

Circle No. 28 on Reader Service Card

OPTO-ELECTRONIC DEVICES

A new short-form catalogue covering the company's line of "Raysistor" opto-electronic devices is now available. Raytheon

Circle No. 138 on Reader Service Card

FIBER OPTICS

The properties and applications of flexible optical fibers—glass fibers that may be bent or twisted without interruption of light transmission—are discussed and illustrated in a new 2-page data sheet. Corning

Circle No. 139 on Reader Service Card

MASTER RECORDER

A new 8-page illustrated brochure describing the features of the new all-solid-state Model AG-300 console recorder for master-recording applications in recording studios, broadcast stations, and school systems is now available. Ampex

Circle No. 29 on Reader Service Card

TAPE RECORDER CATALOGUE

A new 20-page illustrated 1967 tape recorder catalogue has been published. Featured are portable "sound cameras" for use by photographers, tape recorders with built-in radios for instant recording of broadcasts, cartridge units, conventional console types, and solid-state stereo tape recorders. Concord

Circle No. 30 on Reader Service Card

POTENTIOMETERS

More than 25 bushing-mount, servo-mount, and clock-face precision potentiometers are described and illustrated in a new 8-page short-form catalogue (No. 4).

In addition, the booklet lists a variety of accessories and special products, including turn-counting dials, adjustment potentiometers, time delays, voltage sensors, and microcomponents. Bourns, Trimpot Div.

Circle No. 140 on Reader Service Card

TOOL CATALOGUE

Over 1500 items are listed in a new 58-page illustrated catalogue (No. 266) of tools for electronic assembly and precision mechanics. Included are screwdrivers, wrenches, pliers, tool kits, drills, and soldering equipment.

The booklet also contains 4 pages of technical data on tool selection, known as "Tool Tips," which cover, in part, metal conductivity, color coding, wire and insulation data, temperature conversion, and drill sizes. Jensen

Circle No. 31 on Reader Service Card

MINIATURE COMPONENTS

A new 52-page engineering catalogue of miniature electrical and electronic components (No. G-304) has been published. Presented in the booklet is a wide selection of push-button and rotary switches, binding posts, test jacks, sockets, and module cases. Grayhill

Circle No. 141 on Reader Service Card

MICROWAVE EQUIPMENT

A new 8-page foldout brochure describing a line of components that can be employed in laboratory experiments and for evaluating the use of microwave energy in industrial processes has been issued.

Presented in the brochure is a variety of power packs, applicators, microwave hardware, and suggested test setups for lab experiments in the chemical and plastics fields. Eimac Div. of Varian

Circle No. 142 on Reader Service Card

OSCILLOSCOPES

A new 6-page illustrated brochure which describes a complete line of oscilloscopes and accessories has been issued.

The booklet covers two broad classes of instruments—plug-in amplifier types and built-in amplifier types. Single- and dual-beam oscilloscopes are available in both classes. Data Instruments

Circle No. 143 on Reader Service Card

FLUIDICS PUBLICATION

A new bulletin of interest to persons working in the technology of fluidics is now being published quarterly in newsletter form. The first issue of "Fluidics Forum" appeared in November.

The new publication will serve as a medium of exchange for ideas and experiences between users of fluidic systems and the company, and it will feature readers' reports and schematic drawings of significant fluidic applications. Fluidic Products Dept., Corning

Circle No. 144 on Reader Service Card

COLORIMETRY EQUIPMENT

Complete technical information on a line of quality-control instruments for appearance measurements is provided in a new 52-page illustrated 1967 catalogue.

Included are reflectometers, colorimeters and color-difference meters, glossmeters, special-purpose instruments, and visual color instruments. Gardner Laboratory

Circle No. 145 on Reader Service Card

PLASTIC POTENTIOMETERS

A complete line of precision conductive plastic potentiometers is presented in a new 12-page illustrated catalogue (No. K-1).

The components described in the booklet are available in standard resistances ranging from 500 ohms to 100,000 ohms, and all units can be provided with bushing or servo mounts. Keltron

Circle No. 146 on Reader Service Card

ELECTRONICS EDUCATION

A new 4-page illustrated brochure (No. S/R-1001) entitled "Today's Challenge in Electronics Education" is now available. The booklet describes a flexible program of training in electronics which can be planned to prepare high-school students for college or employment.

Courses in the program include all training aids, equipment, textbooks, and teacher training. Simpson Educational Systems

Circle No. 32 on Reader Service Card

TECHNICAL GLOSSARY

The revised second edition of the "Glossary of Instrument Terms" has been announced. The

new 8-page booklet contains 155 technical words or phrases which are peculiar to electronics, electromechanics, theoretical mechanics, biophysics, and electrical engineering. Brush

Circle No. 147 on Reader Service Card

COMPONENT SUPPLEMENT

A new 16-page supplement to the 1965-66 component selector is currently being offered. Designed to bring the component selector up to date, the supplement contains new products that have been introduced by the company since the selector was published. Cornell-Dubilier

Circle No. 148 on Reader Service Card

RELAY CATALOGUE

Approximately 1700 different relays are described and illustrated in a new 50-page catalogue. The products are divided into 23 classifications, and complete engineering data is provided for all devices listed. Standard Relay

Circle No. 149 on Reader Service Card

COMPONENTS CATALOGUE

A complete line of single- and multi-turn wirewound precision potentiometers, Cermet trimming pots, non-wirewound precision pots, special devices, and dials is offered in a new 72-page color-coded illustrated catalogue. Helipot Div., Beckman

Circle No. 150 on Reader Service Card

RFI FILTERS

A new 16-page RFI filter catalogue has been prepared to help the design engineer select the proper filter for specific applications. The booklet contains the company's line of stock standard filters. Cornell-Dubilier

Circle No. 151 on Reader Service Card

ELECTRONICS STUDY COURSE

A new three-part self-study course in the fundamentals of basic electronics is now being offered. It is designed to give the user a general familiarization with electronics and is also suitable as a refresher course.

Three separate handbooks are offered, covering general fundamentals, fundamentals of electronic tubes, and fundamentals of semiconductor devices and molecular electronics.

The complete three-handbook study course costs \$3.00 and is available from Basic Electronics Course, Westinghouse Electric Corp., Printing Div., Box 398, Trafford, Pa. 15085. Orders should specify handbooks SA-9498, SA-9498 Pt. A, and SA-9498 Pt. B. ▲

PHOTO CREDITS

Page	Credit
14	H.H. Scott, Inc.
23, 24, 25	Goddard Space Flight Center
26 (top), 27 (bottom right)	Honeywell Test Instruments Div.
26 (center)	Bell Telephone Laboratories
26 (bottom)	RCA Laboratories
27 (top)	Hughes Aircraft Company
27 (center)	International Telephone and Telegraph Corporation
27 (bottom left)	Canoga Electronics
29 (top), 41 (center)	e.c.i.
29 (center left), 40 (center left)	Sonar Radio Corp.
29 (center right)	Aerotron
32	Radio Specialty Co.
33 (top left)	Allied Radio Corporation
33 (top right)	Cushman
33 (center left)	Poce
33 (center right)	Singer Metrics
40 (top center)	Regency
40 (top right)	Squires-Sanders
40 (center right)	Browning Labs
41 (top left)	B&K
41 (top right)	Multi-Elmac
41 (bottom left)	Tram
41 (bottom right)	Eico
47, 49, 50	Electronic Associates Inc.
74	Elpa Marketing Industries, Inc.
76	Precision Instrument Co.

ELECTRONICS MARKET PLACE

COMMERCIAL RATE: For firms or individuals offering commercial products or services. 70¢ per word (including name and address). Minimum order \$7.00. Payment must accompany copy except when ads are placed by accredited advertising agencies. Frequency discount: 5% for 6 months; 10% for 12 months paid in advance.

READER RATE: For individuals with a personal item to buy or sell. 40¢ per word (including name and address). No Minimum! Payment must accompany copy.

GENERAL INFORMATION: First word in all ads set in bold caps at no extra charge. Additional words may be set in bold caps at 10¢ extra per word. All copy subject to publisher's approval. **Closing Date:** 1st of the 2nd preceding month (for example, March issue closes January 1st). **Send order and remittance to:** Hal Cymes, **ELECTRONICS WORLD**, One Park Avenue, New York, New York 10016

ELECTRONICS ENGINEERING AND INSTRUCTION

ELECTRONICS! Associate degree—29 months. Technicians, field engineers, specialists in communications, missiles, computers, radar, automation. Start September, February. Valparaiso Technical Institute, Dept. N, Valparaiso, Indiana.

REI First Class Radio Telephone License in (5) weeks Guaranteed. Tuition \$295.00. Job placement free. Radio Engineering Institute, 1336 Main Street, Sarasota, Fla.

LEARN ELECTRONIC ORGAN SERVICING at home. All Makes including transistors. Experimental kit—troubleshooting. Accredited NHSC. Free Booklet. **NILES BRYANT SCHOOL**, 3631 Stockton, Dept. A, Sacramento, Calif. 95820.

HIGHLY—effective home study review for FCC commercial phone exams. Free literature! **COOK'S SCHOOL OF ELECTRONICS**, P.O. Box 10634, Jackson, Miss. 39209.

ASSOCIATE Degree in Electronics Engineering earned through combination correspondence-classroom educational program. Free brochure. Grantham Technical Institute, 1505 N. Western Ave., Hollywood, Calif. 90027.

FCC LICENSE in six weeks. First class radio telephone. Results guaranteed. Elkins Radio School, 2603C, Inwood, Dallas, Texas.

CORRESPONDENCE COURSES—B.Sc., Engineering, Electronics. Catalog \$1. Canadian Institute of Science & Technology, 263G Adelaide St. W., Toronto.

WANTED! TV—Radiomen to learn aircraft electronics servicing. Numerous job openings everywhere. Write: **ACADEMY AVIONICS**, Reno/Stead Airport, Reno, Nevada.

TELEVISION TROUBLESHOOTER answers all your service problems. Waste no time on book theory. Spot faults in seconds. Used by "pros" in repairing all makes and models. Write specifying black/white, color. **NATIONAL TECHNICAL RESEARCH LABS**, 6420 S. Western Avenue, Whittier, Calif.

FOR SALE

JUST starting in TV service? Write for free 32 page catalog of service order books, invoices, job tickets, phone message books, statements and file systems. Oelrich Publications, 6556 W. Higgins Rd. Chicago, Ill. 60656.

GOVERNMENT Surplus Receivers, Transmitters, Snooperscopes, Radios, Parts, Picture Catalog 25¢. Meshna, Nahant, Mass. 09108.

TRANSISTORIZED Products Importers catalog. \$1.00. Intercontinental, CPO 1717, Tokyo, Japan.

INVESTIGATORS, FREE BROCHURE, LATEST SUBMINIATURE ELECTRONIC SURVEILLANCE EQUIPMENT. ACE ELECTRONICS, 11500-J NW 7TH AVE., MIAMI, FLA. 33168.

CANADIANS—Giant Surplus Bulk Packed Catalogs. Electronics, Hi-Fi, Shortwave, Amateur, Citizens Radio. Rush \$1.00 (Refunded). ETCO, Dept. Z, Box 741, Montreal, Canada.

CANADIANS, transistors, all semiconductors and components. Free catalogue contains reference data on 300 transistor types. J.&J. Electronics (Dept. EW), P.O. Box 1437 Winnipeg, Manitoba, Canada.

METERS—Surplus, new, used, panel and portable. Send for list. Hanchett, Box 5577, Riverside, Calif. 92507.

R.F. CONVERTERS World's largest selection. Also CCTV cameras, etc. Lowest factory prices. Catalog 10¢. Vanguard, 196-23 Jamaica Ave., Hollis, N.Y. 11423.

CONVERT any television to sensitive big-screen oscilloscope. Only minor changes required. No electronic experience necessary. Illustrated plans, \$2.00. Relco-A22, Box 10563, Houston 18, Texas.

FREE ELECTRONICS (new and surplus) parts catalog. We repair multimeters. Bigelow Electronics, Bluffton, Ohio 45817.

SURVEILLANCE EQUIPMENT—NEW HIGH PERFORMANCE SUBMINIATURE MODELS. ELECTRONIC COUNTERMEASURE DEVICES TO PROTECT PRIVACY. FREE DATA: SECURITY ELECTRONICS-EW, 15 EAST 43RD STREET, NEW YORK, N.Y. 10017.

DETECTIVES! Free brochures! Electronic Surveillance devices. **SILMAR ELECTRONICS**, 3476 N.W. 7th Street, Miami, Florida 33125.

CRYSTALS . . . largest selection in United States at lowest prices. 48 Hr. delivery. Thousands of frequencies in stock. Types include HC6/U, HC18/U, FT-241, FT-243, FT-171, etc. Send 10¢ for catalog with oscillator circuits. Refunded on first order. Jan Crystals, 2400E Crystal Dr., Fort Myers, Fla. 33901.

McGEE RADIO COMPANY. Big 1966-1967 catalog sent free. America's best values. HiFi amplifiers—speakers—electronic parts. Send name, address and zip code number to McGee Radio Company, 1901 McGee Street, Dept. EG, Kansas City, Missouri 64108.

ELECTRONIC Ignition Kits, Components Free Diagrams. Anderson Engineering, Epsom, New Hampshire 03239.

NEW supersensitive transistor locators detect buried gold, silver, coins. Kits, assembled models. \$19.95 up. Free catalog. Relco-A22, Box 10563, Houston 18, Texas.

UNIQUE relay to build variety of remote controls, model railroads, liquid level control, weather detector, burglar alarm, games, trick circuits. 20 design ideas included free. \$3.95 prepaid. Dept. C, Alco, Lawrence, Mass.

DIAGRAMS, servicing information. Radio \$1.00. Television \$1.50. **BEITMAN**, 1760 Balsam, Highland Park, Illinois 60035.

POLICE AUTO ALARM PROTECTS YOUR CAR AGAINST THEFT & TAMPERING! Instant installation! Insurance Co. approved & recommended. Ten Year Guarantee! Free decal. Only \$9.95 postpaid. J. Ross, 80-34 Kent St., Jamaica, N.Y. 11432. Dept. E.W.

GET IT from GOODHEART!

PROFESSIONAL HI-FI CONDENSER MICROPHONE
Brand new \$114.85 capsule only, but we include div. of Paramount Picture's cathode-follower preamp using only 34 batteries, 3 resistors, 3 capacitors, 1 5718 tube. Mfr's specs: "—1 db from DC to 121.2 kc, usable beyond 25 kc; 25 pf; —75 db across 10 meg load for 10 v and load changes 0 to full load; will work past 170 dbm; will stand 200 G shock; 1" Uni-directional. Size: Will fit in 2-1/4" circle; 7/8" thick (A). **WHILE THEY LAST**, postpaid, only \$27.50

KEEP LINE VOLTS CONSTANT AUTOMATICALLY
These Regulators, ALL AT LOW SURPLUS BARGAIN PRICES, hold output at 115/120 v despite line changes 95-130 v and load changes 0 to full load.
CV: Tuned saturating isolating transformer hold to 1%, have 147 harmonics. EM: Servo, hold to 1%, 2400 harmonics. SSB: Electronic, hold to 0.1%, 3% max. harm. Sola, Sorenson, Superior Elect.
CV: 1KVA 69.50 1 KVA 99.50
S/IE: 500 VA 89.50 2 1/2 KVA 199.50
2 KVA 179.50 5 KVA (230v 1 ph) 350.00
3 KVA 279.50
10 KVA (95-130v, 1 ph, 50/60 cy) 595.00
EM: 6 KVA, \$279.50 (Incl. Gen. Radio 1570AL)
EMT (transistorized) 28 KVA 230V 1 ph. 350.00

EVERYTHING UNCONDITIONALLY GUARANTEED!
ALL-BAND SSB RCVR BARGAIN: Hüllerfilters R-15, AM-FM, 550 kc to 43 mc continuous, 149.50
Less pwr spl; 60 cy nvr spl; \$30. SSB product detector: \$20

TIME PAY PLAN: Any purchase totaling \$160.00 or more, down payment only . . . 10%

DZ-1 Superhet revr 15-70 & 100-1500 kc. 89.50
R-23/ARC-5 Command revr 190-550 kc. 14.95
A.R.C. 12 = 22 Command revr 540-1600 kc. 17.95
APR-1Y AM-FM Revr mod. to 115 v 50/60 cy, with our plus book, tuners 58-1000 mc. 250.00
CV-253/ALR Tuner hand new 38-1000 mc. 250.00
APR-1Y with CV-253 425.00
P.U.R. for tuners 975-2200 and 2175-4000 mc.
URR-13 Revr 222.75 404 mc AM, w/book 249.50
Handbook for AN/URR Revr 10.00
Handbooks for AN/ARC-3 or for APR-13 10.00
Other Handbooks, or Schematics, ask for them!
RA-62-B is AC pwr spl for SCR-522, only 19.50
TDQ xmr 45 W Po A2, A3, 115-156 mc. 295.00
TDZ xmr 20 W Po A2, A3, 225-400 mc. 495.00
LM-14 Iron. meter, 0-1 1/2 125 kc-20 mc. 57.50
TS-323/UR freq. meter 20-480 mc., .001% 169.50

ATTENTION Buyers of LAB Test Equipment: See our ad, p. 94 for a small sampling of our terrific inventory. We can furnish dated NIST-traceable Certificates of Calibration, L&N Pots, Bridges, Marconi Bridges, Bantam Q-Meters, Kay Step Attenuators, Signal Generators, Scopos, DVM's, Counters, Graphic Recorders, Regulated Pwr Spl's, etc. etc. **DON'T CIRCLE NUMBER!** Write direct telling us what you need! We can't keep up with catalogs! **WE ALSO BUY!**

R. E. GOODHEART CO. INC.
Box 1220-A, Beverly Hills, Calif. 90213
Phone: Area 213, office 272-5707, messages 275-5342

CIRCLE NO. 116 ON READER SERVICE CARD
March, 1967

RECTIFIERS, TRANSISTORS & COMPONENTS

6 tube Amplifier, New 4 lbs. 2 @	\$1.98
1 Watt Resistors, asstd. 60 @	1.00
1/4 Watt Resistors, asstd. 50 @	1.00
1/2 Watt Resistors, asstd. 60 @	1.00
Ceramic Disc Capacitors, asstd. 75 @	1.00
Precision Resistors, asstd. 50 @	1.00
Pots, 2-4 Watt, asstd. 15 @	1.00
H. F. Coils, asstd. 25 @	1.00
Axial Lead mica. col	30/1.00
Tantalum Capacitors, asstd. 10 @	1.00
Merc. Battery 5.4V.	4/1.00
Armature Relays, asstd. 4 @	1.00
Dipped Mica Cap. Dogbone, asstd. 20 @	1.00
Rotary switches, asstd. 4 @	1.00
Power Resistors, to 60 Watt 5 lb. @	1.00
Paper Capacitors, asstd. 5 lb. @	1.00
Resistance tubes, asstd. 15 @	1.00
Radio & Industrial tubes, asstd. 10 @	1.00
Wafers for rotary switches, asstd. 10 @	1.00
Radio Knobs 30 @	1.00
Rheostat, 100 W, 5 or 12 ohm	.95
Ni-cad Battery, Lamp-hr, 1/2" dia. x 3 1/2", 1.25V	1.49
Surprise Kit, 10 lbs. components	2.50
Epoxy Hi-Vol diode, 200ma, 3000PIV	.98
Computer Board, TO-3 Power, Heat Sink	1.50
I.C., TO-5, untested, many good 5 @	1.00
I.C., Dual-in-line, untested 10 @	1.00
2N389.85 W 60 V, TO530 bull lead(testk) @	.79
2N3707-11 Asstd. Plastic Silicon Xisters 20 @	1.00
2N3704-3706. Asstd. Plastic Sil. Xisters 10 @	1.00
2N1009.25V Ger. Miniature Xister, untested 30 @	1.00
3N35 Tetrode, NPN, untested 5 @	1.00
Ger. Diodes, oaes, swr, Signal, Asst. New 15 @	1.00
Silicon Diodes, Switching, Signal, New, Asst. 15 @	1.00
2N118, Silicon, NPN, tested 10 @	1.00
2N1149, Silicon, NPN, untested	20/1.00
2N1300, Asstd. PNP & NPN, 1/4" leads 20 @	1.00
2N1714, Silicon Power 10W, 60V	4/1.00
Computer Boards, Parts Free, per transistor	.08
Germanium Power, 2N457A, 7A; 60V @	.60
Silicon Power 40 W, 2N1047, TO-57 2 @	1.00
Tophats 200PIV-8c, 400PIV-12c, 600PIV	.18
TO-18 FET's, untested 10 @	1.00
Variacs, New 27, 47, or 100 pf	1.25
2N1038, Germanium 20 W, 40 V @	1.00

Minimum order \$3.00 plus postage, C.O.D.'s 25%
ELECTRONIC COMPONENTS
Post Office Box 2902 Baton Rouge, Louisiana 70821

CIRCLE NO. 120 ON READER SERVICE CARD
93

CLASSIFIED ADVERTISING ORDER FORM

Please refer to heading on first page of this section for complete data concerning terms, frequency discounts, closing dates, etc.

1	2	3	4	5
6	7	8	9	10
11	12	13	14	15
16	17	18	19	20
21	22	23	24	25
26	27	28	29	30
31	32	33	34	35

_____ Words (@ .40 Reader Rate) = \$ _____
 (@ .70 Commercial Rate)

Insert _____ time(s) Total Enclosed \$ _____

NAME _____

ADDRESS _____

CITY _____ STATE _____ ZIP _____

SIGNATURE _____

WORD COUNT: Include name and address. Name of city (Des Moines) or of state (New York) counts as one word each. Zone or Zip Code numbers not counted. (Publisher reserves right to omit Zip Code if space does not permit.) Count each abbreviation, initial, single figure or group of figures or letters as a word. Symbols such as 35mm, COD, PO, AC, etc., count as one word. Hyphenated words count as two words. EW-367

BACK ISSUES AVAILABLE

Use this coupon to order back issues of ELECTRONICS WORLD

We have a limited supply of back issues that can be ordered on a first-come, first-served basis. Just fill in the coupon below, enclose your remittance in the amount of 75¢ for each copy ordered.

ZIFF-DAVIS SERVICE DIVISION
 Dept. BCEW, 595 Broadway
 New York, New York 10012

Please send the following back issues of
ELECTRONICS WORLD

I am enclosing _____ to cover cost of the magazine, shipping and handling.

Month _____ Year _____

Month _____ Year _____

Month _____ Year _____

Name _____

Address _____

City _____

State _____ Zip _____

Payment must be enclosed with order

"N" Channel Fet's Similar To C-610 Used As Amp. Switch, Chopper—Very High Input Z \$1.50 Each

SIM. to 2N1640 (PNP) Bi-directional transistors. A to-5 silicon unit in which collector & emitter are interchangeable. Ea. \$.75

SIM. to 2N728. A high frequency to-18 unit extending to the UHF range 3/\$1.00

SIM. to 2N995 (PNP). Silicon in to-18 case. 500 MW power, to 180 MHz frequency 3/\$1.00

SIM. to 2N1648 (NPN) high voltage 20 Watt silicon unit, used in power output stages & power transistor drives .75

SIM. to 2N2875 (PNP). Silicon 20 watts with 30 MHz cut off \$.75

GLASS DIODES color coded Silicon 20/\$1.00
 6E 30/\$1.00

10 WATT ZENERS. 2-180v. State desired voltages. Ea. \$.75

SILICON BILATERAL SWITCH. Replaces two SCR's by firing in either direction when breakdown voltage is exceeded. Used in light dimmers, etc. .75 ea.

GaAs VARACTORS, sim. to AP-1, AP-6, etc. 70 GHz at 150 MW. Ea. \$4.00

4" x 10" SPEAKERS. 8 Ω. 1.5 oz Magnet. Ea. \$2.50

INTEGRATED CIRCUITS

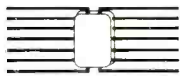

ARE NOW AVAILABLE

JK Flip Flops \$1.15
 Dual NAND Nor Gates \$1.00
 TO-85 flat pack guaranteed to work. They come complete with schematic, elec. characteristic sheet & some typical applications. \$9.00-\$15.00 values from original manufacturer. We have other types of IC's in these series available. Send requests.

PRV	3A	20A	40A
100	.10	.40	1.00
200	.20	.60	1.50
400	.25	.80	2.00
600	.35	1.20	2.50
800	.45	1.50	3.00
1000	.65		4.00

PRV	5A Inset Base		Top Hat & Epoxy 750 MA	
	200	400	100	200
200	.40		.07	
400	.60		.09	
600	.80		.12	
800	1.25		.20	
1000	1.40		.25	
1200	1.60		.50	

PRV	5.00	7.50	15.00	20.00	35.00
100	5.00				
200	7.50				
400	15.00				
600	20.00				
1000	35.00				

PRV	7A	20A
50	.50	.80
100	.70	1.35
200	1.05	1.90
300	1.60	2.45
400	2.10	2.85
500	2.80	3.50
600	3.00	
700	3.50	

6" x 9" SPEAKERS. 20 Ω. 1.5 oz Magnet. Ea. \$2.50

4" SPEAKERS. 3.2 Ω. 1 oz Magnet. Ea. \$1.25

DUAL 1 MEG. POT. with off-on switch 4/\$1.00

455 KHz IF XRMS Dual Slug Transistor Type 3/\$1.00

252 KHz IF XRMRS Dual Slug Tube Type 3/\$1.00

DUAL 20 μF at 350 V Electrolytics 3/\$1.00

28-101 P CERAMIC TRIMMERS 6/\$1.00

NPN dual transistors. A TO-5 package (2N2060) containing 2 high gain 100 MHz NPN silicon transistors \$1.50

PNP dual transistors. A TO-5 package (2N2807) containing 2 high gain 100 MHz PNP silicon transistors \$1.50

High voltage NPN 150V. VBCBO at 2.5A. High HFE in TO-66 pack \$1.50

High voltage assemblies 3000-6000V. at 150-200 mils. These silicon assemblies may be put in series to achieve high voltages \$2.00

Terms: FOB Cambridge, Mass.

Send check or Money Order. Include Postage. Average Wt. per package 1/2 lb. Allow for C.O.D. Minimum Order \$3.00

Electronics World SUBSCRIBER SERVICE

Please include an address label when writing about your subscription to help us serve you promptly. Write to: Portland Place, Boulder, Colo. 80302

Change of Address:
 Please let us know you are moving at least 4 weeks in advance. Affix magazine address label in space to the right and print new address below. If you have a question about your subscription, attach address label to your letter.

To Subscribe:
 Check boxes below.

- New Renewal
 5 years \$21
 3 years \$15
 1 year \$6

Specify
 Payment enclosed — You get 1 extra issue per year as a Bonus!
 Bill me later.

AFFIX LABEL

state city address name please print zip-code

If you have no label handy, print OLD address here.

name _____ please print _____ 0158

address _____

city _____

state _____ zip-code _____



POST OFFICE BOX 74B
 SOMERVILLE, MASS. 02143
 SEND FOR FREE CATALOG

Name _____

Address _____

City _____ State _____

CIRCLE NO. 94 ON READER SERVICE CARD

G & G CATALOG!



24 pages - Full of the BEST in Military Electronic Gear! Send Now for your Copy! Please include 25¢ - refunded with first order.



TG-34A CODE KEYS
Self-contained automatic unit, reproduces code practice signals recorded on paper tape. By use of built-in speaker, provides code-practice signals to one or more persons at speeds from 5 to 25 WPM.
BRAND NEW
In Original Carton **\$24.50**
Exc. Used **\$18.95**

FAMOUS BC-645 TRANSCEIVER

15 Tubes 435 to 500 MC
Easily adapted for 2-way communication, voice or code, on ham band 430-435 mc, citizens radio 460-470 mc, fixed and mobile 450-460 mc, television experimental 470-500 mc. New covers 460 to 490 mc. With tubes, less power supply in factory carton, shipping weight 25 lbs.

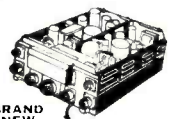

OUR LOW PRICE **\$16.95**
Dynamotor, Antenna, Plugs, All Accessories Available

AN/APR-4Y FM & AM RECEIVER "FB" FOR SATELLITE TRACKING!

High precision lab instrument, for monitoring and measuring frequency and relative signal strength, 48 to 4000 Mc, in 5 tuning ranges. For 110 V 60 cycle AC. Built-in power supply. Original circuit diagram included. Checked out, perfect.
LIKE NEW **\$88.50**

All Tuning Units Available for Above

SCR-274-N, ARC-5 COMMAND SET HQ!

Freq. Range	Type	Exc. Used	BRAND NEW
RECEIVERS, Complete with Tubes			
190-550 KC.	BC-453	\$18.95	\$23.50
3-6 Mc.	BC-454	\$16.50	\$21.50
6-9.1 Mc.	BC-455	\$14.95	\$19.95
1.5-3 Mc.	R-25		\$21.50
TRANSMITTERS, Complete with Tubes			
4.5-3 Mc.	BC-457	\$ 6.95	\$11.95
5-3.7 Mc.	BC-458	\$ 6.95	\$12.95
7-9.1 Mc.	BC-459	\$17.95	\$22.50
2.1-3 Mc.	T-18		\$10.95
3-4 Mc.	T-19	\$10.50	\$14.95
MODULATOR, Complete with 3 Tubes			
Voice		\$ 2.75	\$ 4.95

SCR-625 MINE DETECTOR	\$32.50
EE-8 FIELD PHONES, Exc. Used, Each	\$16.95
BC-221 Freq. Meter, Modulated, Exc. Used	\$129.50
BC-221 Freq. Meter, Unmodulated, Exc. Used	\$79.50
LM Freq. Meter, Exc. Used	\$79.50
BC-1206-C Beacon Recvr., 200-400 Kc. New	\$12.95
SCR-522 Transmitter-Receiver, Like New	\$39.50



DYNAMIC MICROPHONE
Low impedance, with rubber-based on-off switch and removable unidirectional rubber microphone. Has rubber-covered cable with phone plug. Made by Permo-Flux, NEW **\$2.65**

Please include 25¢ Deposit with order—Balance C.O.D., or Remittance in Full, 50¢ Handling Charges on all orders under \$5.00. All shipments F.O.B. Our Warehouse, N.Y.C. All Merchandise subject to Prior Sale and Price Change.

*For NEW COMPLETE CATALOG, send 25¢, refunded with first order.

G & G RADIO SUPPLY CO.

Telephone: (212) CO 7-4605
75-R Leonard St. New York, N.Y. 10013

MUSIC LOVERS, CONTINUOUS, UNINTERRUPTED BACKGROUND MUSIC FROM YOUR FM RADIO, USING NEW INEXPENSIVE ADAPTOR. FREE LITERATURE. ELECTRONICS, 11500-Z NW 7th AVE. MIAMI, FLORIDA 33168.

CONVERTERS, transistorized, 50mc in, 14mc out. \$10. Syntex, 39 Lucille, Dumont, N. J. 07628.

LAMPKIN 105-B Trade for F.M. Stereo. Kenneth Linch, 312 Brook, Nevada City, Calif. 95959.

PROTECT any meter against destructive overloads with \$5.00, Rapid disconnect electronic circuit. Schematic - parts list - explanation - \$2.50. Sol-Lite Mfg. Co., Box 224, Lorain, Ohio 44052.

FREE Catalog: Transistors, Diodes, Parts. Solid State. Pax, P.O. 206, Dorchester, Mass. 02124.

RADIATION from billion Stars CONVERGES everywhere causing gravitation. Copyrighted Theory. \$1.00 Refundable. Carnahan, 1413 Yorkshire, Austin, Texas 78723.

TUBES

TUBES—33¢ each. Year guarantee. Tuner Cleaner \$1.09. Free catalog. Cornell, 4213-W University, San Diego, Calif. 92105.

TUBES, SEMICONDUCTORS, ELECTRONIC EQUIPMENT & COMPONENTS. Quality merchandise only! Serving engineers, purchasing agents, TV/Hifi servicemen and hams for 16 years. Write for catalog or call WA 5-7000. **BARRY ELECTRONICS, 512 Broadway, New York, N.Y. 10012.**

FREE Catalog. Electronic parts, tubes. Wholesale. Thousands of items. Unbeatable prices. Arcturus Electronics ZD, 502-22 St., Union City, N.J. 07087.

RECEIVING & INDUSTRIAL TUBES, TRANSISTORS, All Brands—Biggest Discounts. Technicians, Hobbyists, Experimenters—Request FREE Giant Catalog and SAVE! ZALYTRON 469 Jericho Turnpike, Mineola, N.Y. 11501.

TAPE & RECORDERS

BEFORE renting Stereo Tapes, try us. Postpaid both ways—no deposit—immediate delivery. Quality—Dependability—Service—Satisfaction—prevail here. If you've been dissatisfied in the past, your initial order will prove this is no idle boast. Free Catalog. Gold Coast Tape Library, Box 2262, Palm Village Station, Hialeah, Fla. 33012.

STEREO TAPES. Save up to 60% (no membership fees, postpaid anywhere USA). Free 60-page catalog. We discount batteries, recorders, tape accessories. Beware of slogans "not undersold," as the discount information you supply our competitor is usually reported to the factory. SAXITONE, 1776 Columbia Rd., Washington, D. C. 20009.

Hi-Fi components, tape recorders, sleep learn equipment, tapes. Unusual Values. Free catalog. Dressner, 1523 R Jericho Turnpike, New Hyde Park, N.Y. 11040.

RENT Stereo Tapes—over 2,500 Different—all major labels—free brochure. Stereo-Parti, 1616 -E. W. Terrace Way, Santa Rosa, California 95404.

RENT CAR TAPES by mail. All 8-track and STEREO-8 cartridges. Free information. Autotapes, Box 19086E, Indianapolis, Indiana 46219.

TAPE RECORDER SALE. Brand new, nationally advertised brands, \$10.00 above cost. Arkay Sales, 1028 Commonwealth Avenue, Boston, Mass. 02215.

WANTED

QUICKSILVER, Platinum, Silver, Gold. Ores Analyzed. Free Circular. Mercury Terminal, Norwood, Mass. 02062.

CASH Paid! Sell your surplus electronic TUBES. (Want UNUSED, CLEAN Radio/TV Receiving, Transmitting, Special Purpose, Magnetrons, Klystrons, Broadcast Types.) Want military and commercial Lab/Test Equipment. Want commercial Ham Receivers and Transmitters. For a Fair Deal Write: BARRY ELECTRONICS, 512 Broadway, New York, N.Y. 10012 (WA 5-7000)

MILITARY SURPLUS EQUIPMENT NEEDED: ARC-34, ARC-38, ARC-44, ARC-52, ARC-54, ARC-55, ARC-66, ARC-73, ARC-84, ALSO ARN-14C, ARN-54, ARN-59, COLLINS 51x-2, 51V-3, 51Y-3, 51R-3, 17L-4, 17L-7, 618S-1, 18S-4, BENDIX TA-21, RA-21, APR-14, PRC-25, RT-66 THU RT-70/GRC, APN-22, APN-117, APN-133. TEST SETS WANT WITH ARM, UPM, URM, RSM, SG PREFIXES. TOP CASH DOLLAR PAID IMMEDIATELY. SLEP ELECTRONICS CO., DRAWER 178-EW, ELLENTON, FLORIDA 33532. PHONE (813) 722-1843.

WANTED wow and flutter bridge for high quality tape recorders. J. Miro, 185 Bronx River Rd., Yonkers, N.Y. 10704.

HIGH FIDELITY

FREE! Send for money saving stereo catalog #E3W and lowest quotations on your individual component, tape recorder or system requirements. Electronic Values Inc., 200 West 20th Street, N.Y., N.Y. 10011.

U.S. GOV'T ELECTRONIC SURPLUS

• Nationally Known-World Famous SURPLUS CENTER offers finest, most expensive, Government Surplus electronic units and components at a fraction of their original acquisition cost.
ORDER DIRECT FROM AD or WRITE FOR CATALOGS

LABORATORY EXPERIMENTAL KIT

PERFORM 100'S OF FASCINATING ELECTRICAL EXPERIMENTS

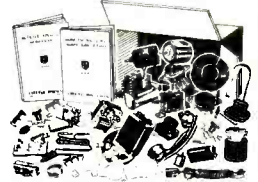

Gov't Acquisition Cost Of Parts Over \$50.00
\$14.85
F.O.B.

- (ITEM #A222) - Amazing Value! Valuable gift for sons and husbands. Hundreds of interesting experiments. Teaches modern electronic theory and practice. Easy, interesting way to learn.
- Experiment with electro-plating, electro-magnetic phenomena, resonance, burglar alarm, relay circuits, rectification, test circuits, overdeveloping, motor experiments, transformer phenomena, etc.
- Kit Contains: DC motor, AC motor, electro-conductive coils, ac and dc relays, set of lab capacitors, compass, test bulbs, plating chemicals, silicon diodes, germanium diode, burglar alarm actuator, carbon microphone, overdeveloping element, test sockets, permanent magnets, telephone handset, cards, test clips, wire and other items. Over 35 pages. Includes the Experimental Manual with drawings, procedures, etc., written by professional engineers.
- Also furnished with each kit our popular book Home Laboratory Bench and Experimental Priorities (Reg. \$1.00). Shows how to build wonderful home laboratory test bench and how to get the most out of your experimental work. (12 lbs.). Parts cost gov't over \$50.00.

AC PROGRAM TIMING CLOCK

• (ITEM #158) - 7000 Hz 115-V AC program timer. Use for periodic signaling, work breaks, school classes, turn on radio for news casts, etc. Adjustable dials permit switching on or off any time during 24-hour period. Sufficient clips for multiple programming. Also has "skip-ahead" feature. Contacts can handle up to 15 amps. Size: 6 1/2" x 4 1/2" x 1 1/2". Gov't cost over \$30.00.
Instructions furnished. F.O.B. **\$9.49**



AUTO-PILOT GYROSCOPE

• (ITEM #115) - In motor driven, gimballed mounted gyroscope. Ultra-responsive precision unit used for "steer" large, multi-engine planes. Deviation from established plane sends potentiometer controlled signals to steering mechanism. Also has other features. Unit can be used as autopilot for boats. Wonderful class room unit to demonstrate and study gyro action. Missiles, planes, boats all use gyros. Size: 9 1/2" x 8 1/2" x 10 1/2". Wt. 21 lbs. Gov't cost over \$300.00.
F.O.B. **\$12.47**

Instructions furnished. F.O.B. **\$9.49**

STANDARD DIAL TELEPHONE

• (ITEM #715) - Standard commercial telephone, same used throughout U.S.A. Attractive polished black, like new condition. Use as extension phone, to private systems, or connect several phones together for local intercom system. Full instructions are furnished. Wt. 9 lbs. Original cost \$24.50.
F.O.B. **\$5.95**



STEP-BY-STEP AUTOMATIC SWITCH

• (ITEM #738) - Amazing "up-and-around" electro-magnetic telephone switch. Dial six bank pair from 1 to 100. Make your own telephone system. Can also be used to remotely control up to 100 circuits from a single pair of wires.
• One of our F.O.B. STAR bargains. Comes complete with data one dial and one line bank. Size: 9 1/2" x 2 1/2" x 1 1/2". Wt. 10 lbs. Gov't cost over \$10.00.
Complete Switch, cover, dial, line bank, instructions..... F.O.B. **\$9.95**



STEP UP/DOWN TRANSFORMER

• (ITEM #543) - Step voltage up or down. Has many uses. Will step 115 volts up to 250 volts or step 250 volts down to 115 volts. Will also transform 115 volts to 35 volts. Rated 1.75 amps, output with 175-watt capacity. Size: 4 1/2" x 3 1/2" x 2 1/2". Wt. 4 lbs. Gov't cost \$12.75.
F.O.B. **\$4.99**

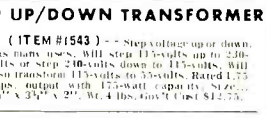

TYPICAL BUYS FROM OUR 1967 CATALOGS

- \$ 350.00 - Geared 2-hp Battery Golf Car Motor **\$24.95**
- \$ 15.00 - Westinghouse DC Ammeter, 0 to 300 **\$ 7.11**
- \$ 40.00 - Vacuum Pressure Pump, 12-VDC **\$11.95**
- 80-MW Walkie-Talkies, Per Pair **\$19.60**
- Deluxe, Multi-Range, AC DC Tester **\$ 8.98**
- \$4000.00 - Carrier Telephone Amplifier System **\$13.91**

SPECIAL SALE

Correspondence Course In ELECTRICAL ENGINEERING



Sells for \$10.79 Outside U.S.A. **\$8.79** Postpaid In U.S.A.
• (ITEM #A181) - Wonderful chance to obtain technical training at Amazing Low Cost! Lincoln Engineering School has suspended its Correspondence courses because of increased operating costs. We offer a limited number of the school's complete Electrical Engineering Course but without the examination paper grading service. The course consists of 14 lesson unit books. Each book has the regular exams, and in a separate section, "Selected Answers" to each question.
• Course is well written, easy to understand, profusely illustrated. Reader's Digest size, easy to carry and study in spare time. Many Lincoln Engineering School students holding excellent jobs as a result of E.E.S. training. Course contains latest information on transistors, silicon diodes, etc. Additional book on how to build and operate a "Home Laboratory and Experimental Bench" furnished with each course.

SEND 25¢ COIN OR STAMPS FOR 3 MAIN CATALOGS
All Items FOB Lincoln Money Back Guarantee
SURPLUS CENTER
DEPT. EW-037 LINCOLN, NEBR. 68501

UNUSUAL BARGAINS

... MANY U.S. GOV'T SURPLUS

"Balls of Fun" for Kids... Traffic Stoppers for Stores...
Terrific for Amateur Meteorologists...
SURPLUS GIANT WEATHER BALLOONS



At last... available again in big 8-1/2' diameter. Create a neighborhood sensation... Great backyard fun... Excellent beach attraction... Blow up with vacuum cleaners or auto air hose. Sturdy enough for play; all other uses with reasonable care. Can be punctured and show objects. Filled with helium (available locally) use balloons high in the sky to attract crowds, advertise store sales, announce fair openings, etc. Amateur meteorologists use balloons to measure cloud heights, wind speeds, temperature, pressure, humidity at various heights. Photographers can utilize for low-cost aerial photos. Recent Gov't. surplus of heavy, black, new one mile.
Stock No. 60,568AK \$2.00 Ppd.

BATTERIES GUARANTEED RECHARGEABLE FOR 5 YRS.



Use these remarkable space-age Nickel-Cadmium batteries in flashlight, portable radios, toys or flash guns. Obsolete all others! Low-cost kit includes compact, highly efficient battery charger and 2 "D" size Ni-Cd batteries guaranteed rechargeable to full power for 5 yrs. Power output remains constant—doesn't fade away as with lead-acid cells. Durable, black plastic charger 5 1/2" x 3 1/2" x 1 3/4" fits into standard wall outlet. Completely charges 1 or 2 "D" or "C" size batteries in 16 hrs. Light shows when unit is charging will not over-charge.
Stock No. 60,591AK \$9.95 Ppd.
Stock No. 60,592AK (Charger only) \$5.98 Ppd.
Stock No. 60,593AK (Two "D" Cells only) \$5.98 Ppd.

Order by Stock No.—Send Check or Money Order. Money-Back Guarantee. Edmund Scientific Co., Barrington, N.J. 08007

MAIL COUPON for FREE CATALOG

SEND FOR FREE CATALOG "AK"

completely new 1967 edition. New items, categories, illustrations. 148 easy-to-read pages packed with nearly 4000 unusual items. Extensive selection of Astronomical Telescopes, Microscopes, Binoculars, Magnifiers, Magnets, Lenses, Prisms. Many "surplus items" for hobbyists, experimenters, workshop, factory. Write for Catalog "AK," Edmund Scientific Co., Barrington, New Jersey 08007.



NAME _____

ADDRESS _____

CITY _____ STATE _____ ZIP _____

CIRCLE NO. 121 ON READER SERVICE CARD

BIG CATALOG

World's "BEST BUYS" in GOV'T. SURPLUS
Electronic Equipment



BC-603 RECEIVER

BC-603 RECEIVER F.M. 20—27.9 MC Continuous tuning and 10 preset push button channel selector. With sensitivity squelch & volume controls. 2 watt output to self contained speaker, one (1) microvolt sensitivity, 2.65 KC I.F. 10 tubes: 3/6AC7, 1/6J5, 2/12SG7, 2/6SL7, 1/6H6, & 1/6V6GT. Voltage required 12/24 volts for filaments, 220 VDC @ 80 MA. for high volt. Size: 1 1/2 x 6 3/4 x 12 1/2". Wt.: 35 lbs. Used: \$32.95

BC-603 CONVERTED

To 30 to 45 MC.—Used: \$44.95

AC POWER SUPPLY For BC-603—Transformer type plugs into same place as dynamotor, no conversion required except adding switch, with instructions:
Wired: \$14.95 Kit of Parts: \$10.00

DM-34 Dynamotor for 12 Volt DC operation—New \$4.95
DM-36 Dynamotor for 24 Volt DC operation—New 4.95

TRANSMITTERS—RECEIVERS:

BC-453 Receiver—190 to 550 KC. Used: \$16.95

BC-455 Receiver—6 to 9 MC.—
Gov't. Reconditioned, w/Dyn.: 14.95

BC-456 Modulator Used: 3.95

BC-696 Trans.—3 to 4 MC., Gov't. Recond.: 12.95

T-20 Trans.—4 to 5.3 MC. New: 9.95

T-21 Trans.—5.3 to 7 MC. New: 9.95

T-22 Trans.—7 to 9 MC. New: 18.95

BC-348 Receiver—200 to 500 KC.—
1.5 to 18 MC. Used: 69.50

NEW CATALOG—

JUST OFF PRESS—SEND 25¢ (stamps or coin) and receive 50¢ CREDIT on your order! Address Dept. EW • Prices F.O.B. Lima, O. • 25% Deposit on C.O.D.'s • Minimum Order \$5.00

FAIR RADIO SALES
1016 E. EUREKA • Box 1105 • LIMA, OHIO • 45602

HI-FI Components, Tape Recorders at guaranteed "We Will Not Be Undersold" prices. 15-day money-back guarantee. Two-year warranty. No Catalog. Quotations Free. Hi-Fidelity Center, 239 (L) East 149th Street, New York 10451.

HIFI speaker system. Small, walnut. Magnificent. \$29.95. TANG, Box 162A, Framingham Ctr., Mass. 01701.

HIFI EQUIPMENT—GET Our "ROCK BOTTOM" prices on NAME BRAND amplifiers—tuners—tape-recorders—speakers FRANCHISED—59 YEARS IN BUSINESS. Write for this month's specials—NOW! Rabson's 57th St., Inc., Dept. 569, 119 W. 58th St., New York, New York 10019.

SEND us \$9.95 and any old cartridge. We will ship you prepaid any one of these cartridges New—Shure M3D, Empire 880P, ADC 770, Pickering V15AC2, Empire 808, Pickering V15AT2, Shure M7/N21D, Grado BTR. Write for lowest quotations all stereo components. Defa Electronics, 2207 Broadway, N.Y., N.Y. 10024.

LOW, LOW quotes: all components and recorders. Hi-Fi, Roslyn 9, Penna.

DO-IT-YOURSELF

PROFESSIONAL ELECTRONICS PROJECTS—\$1.00 up. Catalog 25¢. PARKS, Box 25565B, Seattle, Wash. 98125.

REPAIRS AND SERVICES

TV Tuners Rebuilt and Aligned per manufacturers' specification. Only \$9.50. Any make UHF or VHF. We ship COD Ninety Day written guarantee. Ship complete with tubes or write for free mailing kit and dealer brochure. JW Electronics, Box 51B, Bloomington, Ind. 47401.

GOVERNMENT SURPLUS

JEEPS Typically From \$53.90. . . Trucks From \$78.40. . . Boats, Typewriters, Airplanes, Electronics Equipment, Photographic Equipment, used, 100,000 Bargains Direct From Government. Complete Sales Directory and Surplus Catalog \$1.00 (Deductible First \$10.00 Order). Surplus Service, Box 820-K, Holland, Michigan 49423.

MUSIC

POEMS wanted for songs. Send poems. Crown Music, 49-EL West 32, New York 10001.

EMPLOYMENT OPPORTUNITIES

TRAINING INSTRUCTOR (ELECTRONICS) Immediate openings. Need at least 3 years electronic or electrical experience and pass electronics test. As civilian instructor of military electronic technicians for fleet service, you'll enjoy career civil service status, equal employment opportunity, good pay, and other liberal benefits. Navy Employment Center (CIRD), Building 3400, Great Lakes, Illinois 60088. Phone (312) 688-2222.

AUTHORS' SERVICES

AUTHORS! Learn how to have your book published, promoted, distributed. FREE booklet "ZD," Vantage, 120 West 31 St., New York 10001.

SONGWRITERS WANTED! Send song material for recording consideration. Tin Pan Alley, 1650 Broadway, New York 10019.

PUBLISH your book! Join our successful authors: publicity advertising promotion, beautiful books. All subjects invited. Send for free appraisal and detailed booklet. Carlton Press, Dept. ZDO, 84 Fifth Avenue, New York 10011.

HYPNOTISM

FREE Hypnotism, Self-Hypnosis, Sleep Learning. Catalog: Drawer H400, Ruidoso, N.M. 88345.

FREE TRIAL!! Sensational self-hypnosis record kit improves memory, concentration, personality. Results guaranteed! Forum, 333-AA3 Michigan, Chicago 60601.

PHOTOGRAPHY—FILM, EQUIPMENT, SERVICES

MEDICAL FILM—Adults only—"Childbirth" one reel, 8mm \$7.50; 16mm \$14.95. International W. Greenvale, Long Island, New York 11548.

SCIENCE Bargains—Request Free Giant Catalog "CJ"—148 pages—Astronomical Telescopes, Microscopes, Lenses, Binoculars, Kits, Parts, War Surplus bargains. Edmund Scientific Co., Barrington, New Jersey 08007.

EDUCATIONAL OPPORTUNITIES

LEARN TECHNICAL WRITING—qualify at home for high paying prestige career not requiring college. Growing demand in all industries for tech writers now. Low monthly tuition. Easy to understand. FREE career book, sample lesson. American Technical Writing Schools, Dept. EWC-37, 5512 Hollywood Blvd., Hollywood, Calif. 90028.

LEARN While Asleep, hypnotize with your recorder, phonograph. Astonishing details, sensational catalog free! Sleep-Learning Association, Box 24-ZD, Olympia, Washington 98501.

LEARN while asleep. Remarkable, scientific, 92% effective. Details free. ASR Foundation, Box 721, Dept. e.g., Lexington, Kentucky 40502.

USED Correspondence Courses and Books sold and rented. Money back guarantee. Catalog free. (Courses Bought). Lee Mountain, Pisgah, Alabama.

RUBBER STAMPS

RUBBER ADDRESS STAMP \$1.50. Signature \$2.88. Free catalog. Jackson Products, 1433 Winnemac, Chicago, Ill. 60640.

INVENTIONS WANTED

INVENTIONS—IDEAS developed: Cash/Royalty Sales. Member: United States Chamber Commerce. Raymond Lee, 130-GE West 42nd, New York City 10036.

INVENTORS. We will develop, help sell your idea or invention, patented or unpatented. Our national manufacturer clients are urgently seeking new items for outright cash sale or royalties. Financial assistance available. 10 years proven performance. For free information, write Dept. 42, Wall Street Invention Brokerage, 79 Wall Street, New York, N.Y. 10005.

PATENT SEARCHES, \$6.00! FREE "Invention Record"/Information. Miss Hayward, 1029HE Vermont, District of Columbia 20005.

EMPLOYMENT INFORMATION

FOREIGN and USA job opportunities available now. Construction, all trades. Earnings to \$2,000.00 monthly. Paid overtime, travel, bonuses. Write: Universal Employment, Woodbridge, Connecticut 06525.

FOREIGN EMPLOYMENT. Construction, other work projects. Good paying overseas jobs with extras, travel expenses. Write only: Foreign Service Bureau, Dept. D, Bradenton Beach, Florida 33510.

DON'T BUY TUBES!! RADIO or T.V.-XMITTING

or SPECIAL-PURPOSE TYPES UNTIL YOU GET OUR PRICE LIST. GUARANTEED TO BE THE LOWEST PRICES IN THE U.S.A. OVER 5000 TYPES—ALL 100% GUARANTEED BRAND NEW

"WE'RE NEVER UNDERSOLD"
SEND POST CARD FOR T.V. OR SPECIAL PURPOSE PRICE LIST

ESTABLISHED 1920
UNITED RADIO CO.
56 FERRY ST. NEWARK, N.J.
P.O. BOX 1000 — ZIP CODE - 07101

GREGORY ELECTRONICS
Reconditioned & Used FM
2-WAY RADIO SAVINGS
 Partial list—Send for New '67 Catalog

Voice Commander



132 to 172 MC, 1W 9.5" x 5.3" x 1.7" Lowest price ever, including brand New Rechargeable Nickel Cadmium Battery Pack

\$148

If crystal & tuning is desired add \$45.00
 Battery charger for these units \$16.00
 Write for Quantity Prices

VOICE COMMANDER

Monitor Receiver only—Tuned & Crystalled with dry Batteries

\$78

EXTRA SPECIAL
MOTOROLA CONTROLHEAD MODEL
 #P9022, with microphone **\$9.50**

MOTOROLA P33 Series Pack Set 5 Watt 150-170 MC with Nicad Supply and Nicad Batteries **\$95.00**

MOTOROLA 450 mc—complete with accessories, less crystals and antenna—
 T44A6 **\$ 78.00**
 T44A6A **\$ 88.00**
 T44AAV **\$108.00**

MOTOROLA—U41GGT special 30 watt—consisting of transistorized power supply 30-40 mc Tx and 2.5 mc AM receiver, complete with accessories less crystals and antenna (deduct \$30.00 if accessories are not required. Deduct \$20.00 if AM receiver is not needed) **\$128.00**

T41GGV special 30 watt low band Motorola—same as U41GGT except contains vibrator power supply (deduct \$30.00 if accessories are not required) **\$20.00**

T41G Series—same as GGV above
FMTR80D special 6 or 12 volt 30 watt Tx 30-40 mc receiver 2.5 mc AM, less accessories **\$98.00**

G.E. PACERS—EG43SA6 150-170 mc Transistorized Power Supply 13-15 watts, 12 v. Front Mount (Complete accessories, less crystals and antenna) **\$35.00**

We Buy Late Model Equipment for Cash
 —Write: Wire or Phone!

GREGORY ELECTRONICS CORPORATION

249 RT. 46, Saddle Brook, N.J., 07662
 Phone: (201) 489-9000

CIRCLE NO. 115 ON READER SERVICE CARD

BUSINESS OPPORTUNITIES

INVESTIGATE Accidents—Earn \$750 to \$1,400 monthly. Men urgently needed. Car furnished. Business expenses paid. No selling. No college education necessary. Pick own job location. Investigate full time. Or earn \$6.44 hour spare time. Write for Free Literature. No obligation. Universal, CZ-3, 6801 Hillcrest, Dallas, Texas 75205.

FREE BOOK "990 Successful, Little-Known Businesses." Work home! Plymouth-145W, Brooklyn, New York 11218.

I MADE \$40,000.00 YEAR by mailorder! Helped others make money! Start with \$10.00—Free proof. Torrey, Box 318-N, Ypsilanti, Michigan 48197.

CITIZENS BAND Radio Dealerships Available. Sell Full or Part Time. Knox Electronic, Dept. 274, Galesburg, Ill. 61401.

March, 1967

FREE CATALOGS. Repair air conditioning, refrigeration. Tools, supplies, full instructions. Doolco, 2016 Canton, Dallas, Texas 75201.

SELL AMERICA'S Biggest Value Wedding Line! Big 40% Profit Showing Wedding Invitations and Over 50 Exciting Accessory Items. Sideline For Printing, Christmas Card Salesmen. Free Display Album. Elmcraft, 7201 S. Cicero, Dept. EW-177, Chicago, Illinois 60629.

PLANS AND KITS

COINCIDENCE FM RECEIVER. Construction Plans for ultrasensitive circuit \$3.00. RL Electronics, 20 Grove Street, Hilton, New York 14468.

BOOKS

CANADIANS—Fabulous Electronic Book Catalog—Listing over 500 Titles—Free—Books, Box 796, Dept. A, Montreal 3.

STAMPS

FREE—Mint British Colonials from Antarctic Territory, Borneo, Brunei, St. Christopher, Nevis, Caymans, Trengganu, Pitcairns. Free with approvals. VIKING, Great Neck 50, N. Y.

MISCELLANEOUS

WINEMAKERS: Free illustrated catalog of yeasts, equipment. Semplex, Box 7208, Minneapolis, Minn. 55412.

TEN Winemaking Recipes and Winemaking Supplies Catalog. 10¢. Country Winemaker, Box 243EGA, Lexington, Mass. 02173.

YOUR OPINIONS EARN \$10 HOUR. Written in your Spare Time from home about free products and publications. Need no skill, nothing to buy or sell. Details from Research ZD-3, Box 669, Mineola, N.Y. 11501.

YOUR Ideas may be worth a Million Dollars, but . . . if they stay in your head they're not worth a nickel! Now through membership in the International Idea Club, Inc. you can sell your ideas and get maximum cash rewards. Legally protected, your ideas are consistently exposed to interested parties. Send only \$1.00 today for big illustrated book "Millions For Your Ideas", showing how you can profit by membership in one of the nation's most dynamic organizations. International Idea Club, Inc., Dept. EW, 135 Columbus Ave., Boston, Mass. 02116.

EMPLOYMENT Resumes. Get a better job & earn more! Send only \$2.00 for expert, complete Resume. Writing Instructions. J. Ross, 80-34 Kent St., Jamaica, N.Y. 11432 Dept. EW.

AS YOU SCAN THESE COLUMNS, more than 191,000 monthly buyers of **ELECTRONICS WORLD** are doing the same. These men are all Electronics Professionals—individuals involved actively in electronics from a business or hobby viewpoint. They look to the pages of the **ELECTRONICS MARKET PLACE** for prime sources of products and services of interest to them. They will buy from you if your advertising appears regularly in their favorite magazine. Use the handy order form printed in this section or write today to: Hal Cymes, Classified Advertising Manager, **ELECTRONICS WORLD**, One Park Avenue, New York, New York 10016. **REMEMBER:** May issue, on sale April 20th, closes March 1st.

2? 3? 4? 5? 6? FORGET 'EM ALL!

When you do business with Number One, you can afford to forget Number 2, 3, 4, 5 and 6! We want to buy electronics and test equipment—both military and commercial. If you have a single piece or a carload, we'll pay you top dollar—bar none! We pay freight and air-mail your check on receipt of goods! Save time, money, headaches and aggravation! Tell us what you have, what you want, and P.S. Do it today!

COLUMBIA ELECTRONICS, Dept. EW
 4365 West Pico Blvd. Los Angeles, Calif. 90019
 Phone: (213) 938-3731

FREE! PLUS CHOOSE ANY \$1.00 ITEM FREE

\$25 WORTH OF TRANSISTORS, RECTIFIERS, RESISTORS, CONDENSERS, DIODES, ETC.

Both FREE WITH ANY \$10 ORDER

100 AMP RECTIFIERS PIV Sale 50 2.59, 100 2.89, 200 3.95, 400 5.75, 600 7.65

1 AMP 800 PIV TOP HAT RECTIFIERS 5 for \$1

1 amp New! SILICON CONTROLLED RECTIFIERS

PRV	3 AMP	7 AMP	16 AMP	25 AMP
50	30	48	70	90
100	50	70	1.20	1.50
200	80	1.05	1.70	2.10
300	1.05	1.60	2.20	2.70
400	1.60	2.10	2.70	3.00
500	2.10	2.80	3.30	3.80
600	2.50	3.00	3.90	4.30

WORLD'S MOST POPULAR \$1 PARTS PAKS

- 30 "YELLOW" MYLAR CONDENSERS, asstd val
- 60 CERAMIC CONDENSERS, discs, npns, to .05
- 60 TUBULAR CONDENSERS, to .5mf, to 1Kv, asst
- 40 DISC CONDENSERS, 27mmf to .05mf to 1KV
- 60 TUBE SOCKETS receptacles, plugs, audio, etc.
- 30 POWER RESISTORS, 5 to 50W, to 24 Kohms.
- 65 HALF WATTERS, asst incl: A.B., 5% tol
- 60 HI-Q RESISTORS, 1, 1.2W, 1% & 5% values
- 10 VOLUME CONTROLS, to 1 meg, switch tool
- 10 ELECTROLYTICS to 500mf, asst FP & tubulars
- 50 RADIO & TV KNOBS, asstd, colors & styles

Integrated Circuits include Gates, Buffers, Flipflops, etc. Asstd. **\$1.89**

FET'S "N" CHANNEL TRANSISTORS 1 for \$1, 2 for 1.01

2 AMP SILICON RECTIFIER SALE!

GLASS CAPS METALLIZED

PIV	Sale	PIV	Sale	PIV	Sale
50	7¢	600	25¢	1400	89¢
100	9¢	800	39¢	1600	1.25
200	12¢	1000	55¢		
400	19¢	1200	69¢		

Actual Size

MOTOROLA IGNITION TRANSISTORS NEW

2N1100 \$1.77

15 AMP VCB 100

PNP 100Watt/15 Amp HI Power
 T036 Case! 2N441, 442, 277, 278, DS501 up to 50 Volts **\$1**

DC MICROAMMETERS **\$3.88**

ONE WATT ZENER DIODES EACH 44¢

Volts	Volts	Volts	Volts
5.4	15	43	100
6.4	20	47	110
8.0	22	51	120
9.1	24	56	130
10	27	62	150
12	30	68	160
15	33	75	180
18	36	82	200
20	39	91	

10¢ GIANT SPRING CATALOG ON PARTS & RECTIFIERS TRANSISTORS SCRS ZENERS

POLY PAKS

TERMS: Send check, money order Add Postage—Avg. wt. per pak 1 lb. Rtd net 30 days. COD 25% deposit.

P.O. BOX 942W
 50, LYNNFIELD, MASS.
 "PAK-KING" of the world

CIRCLE NO. 99 ON READER SERVICE CARD

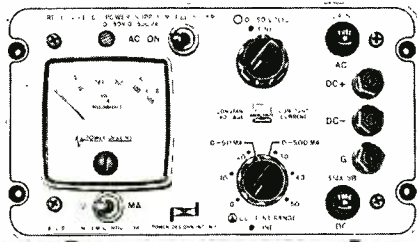

HIGH RELIABILITY POWER SOURCE AT LOW COST

CONSTANT CURRENT

DUAL RANGE
0 TO 50 MA
0 TO 500 MA

AND

CONSTANT VOLTAGE 0 TO 50 VOLTS DC

Automatically transfers
between the two at any
predetermined operating
point.

SPECIFICATIONS

Operating Mode	Regulation	Ripple Plus Noise
Voltage	0.005%	350 μ V
Current	0.02%	300 μ A

MODEL 5005R

\$149⁵⁰

Send for complete specifications



POWER DESIGNS, INC.

1700 SHAMES DRIVE • WESTBURY, N. Y.
516 EDgewood 3-6200 TWX: 510-222-6561

POWER DESIGNS PACIFIC, INC.

3381 JUNIPERO SERRA • PALO ALTO, CALIF.
415-321-6111 TWX: 910-373-1251

ELECTRONICS WORLD MARCH 1967

ADVERTISERS INDEX

READER SERVICE NO.	ADVERTISER	PAGE NO.	READER SERVICE NO.	ADVERTISER	PAGE NO.
125	Allied Radio	70	105	Mosley Electronics, Inc.	85
	American Institute of Engineering & Technology	71	104	Motorola Training Institute	79
	American Technical Writing Schools	6	103	Multicore Sales Corp.	74
83	Belden Manufacturing Company	7	102	Music Associated	70
124	Burstein-Applebee Co.	79		National Radio Institute	8, 9, 10, 11
	Capitol Radio Engineering Institute, The	52, 53, 54, 55	101	Olson Electronics, Inc.	68
123	Cleveland Institute of Electronics	5	100	Pearce-Simpson, Inc.	69
	Cleveland Institute of Electronics	18, 19, 20, 21	99	Poly Paks	97
	Columbia Electronics	97	84	Polytronics Laboratories, Inc.	4
122	Editors and Engineers, Ltd.	60	199	Power Designs	98
121	Edmund Scientific Co.	96	108	RCA Electronic Components and Devices	FOURTH COVER
117	Electro-Voice, Inc.	SECOND COVER		RCA Institutes, Inc.	62, 63, 64, 65
120	Electronic Components	93	98	Radar Devices Manufacturing Corp.	1
119	Elpo Marketing Industries, Inc.	71	96	Sams & Co., Inc., Howard W.	66
	Fair Radio Sales	96	95	Shure Brothers, Inc.	84
118	Finney Company, The	68	94	Solid State Sales	94
82	Finney Company, The	74	93	Sonotone Corporation	12
	G & G Radio Supply Co.	95	92	Sony Corporation of America	75
116	Goodheart Co., Inc., R. E.	93	91	Sprague Products Company	61
115	Gregory Electronics Corporation	97	90	Surplus Center	95
114	Heath Company	80, 81, 82, 83		Sydmur Electronics Specialties	85
196	Hewlett-Packard	2	198	Sylvania Electronic Tube Division	15
113	International Crystal Mfg. Co.	67	89	Texas Crystals	75
112	Jerrold Distributor Sales Division	22	97	Triplet Electrical Instrument Company	THIRD COVER
111	Judson Research and Mfg. Co.	76	88	Tuner Service Corporation	6
110	Lafayette Radio Electronics	57		United Radio Co.	96
109	Lampkin Laboratories, Inc.	71		Valparaiso Technical Institute	57
	McGraw-Hill	73	87	Workman Electronic Products, Inc.	76
107	Mallory & Co., Inc., P. R.	13	86	Xcelite, Inc.	59
200	Metex	77	85	Zenith	91
106	Milwaukee School of Engineering	16			

CLASSIFIED ADVERTISING 93, 94, 95, 96, 97

PROTECTS AGAINST • Bent Pointers • Burned-Out Resistors
 • Damaged Pivots • Overheated Springs • Burned-Out Meter
 • Changes in Accuracy Due to Overheating



Model 630-PLK

BURNOUT PROOF V-O-M

\$89.00

Suggested
U.S.A. User Net

USES UNLIMITED

School Classrooms • Field Engineers • Application Engineers
 • Electricians, Radio, TV, and Appliance Servicemen • Electrical
 Contractors • Factory Maintenance Men • Industrial Elec-
 tronic Maintenance Technicians • Home Owners, Hobbyists

FACTS MAKE FEATURES:

- 1** Comprehensive overload protection.
- 2** One selector switch minimizes chance of incorrect settings
- 3** Polarity reversing switch

Additional protection is provided by Model 630-PLK's new transistorized relay circuit. Transistorized overload sensing device does not load circuit under test, eliminating the possibility of damaging circuit components. A special meter shorting feature on "off" position offers high damping when moving tester. The exclusive patented Bar Ring Movement provides self-shielding and is not affected by stray magnetic fields. Wider spread scales, and unbreakable clear plastic window assure maximum readability. Diode network across meter protects against instantaneous transient voltage.

TRIPLETT ELECTRICAL INSTRUMENT COMPANY, BLUFFTON, OHIO

CIRCLE NO. 97 ON READER SERVICE CARD

RANGES

DC Volts:	0-2.5-10-50-250-1,000-5,000 at 20,000 ohms/volt. 0-.25 at 100 microamperes.
AC Volts:	0-3-10-50-250-1,000-5,000 at 5,000 ohms/volt.
Decibels:	-20 to +11 +21, +35, +49, +61, +75; "0" DE at 1 MW on 600 ohm line.
DC Microamperes:	0-100 at 250 Mv.
DC Milliamperes:	0-10-100-1,000 at 250 Mv.
DC Amperes:	0-10 at 250 Mv.
Ohms:	0-1,000-10,000 (4.4-44 at center scale).
Megohms:	0-1-100 (4.4-440,000 at center scale).

Output Volts (AC): 0-3-10-50-250-1,000 at 5,000 ohms/volt; jack with condenser in series with AC ranges.

CARRYING CASE

Model 639-OS black leather carrying case, built-in stand, Flaps open to permit use of tester in the case. Suggested U.S.A. User Net.\$14.00

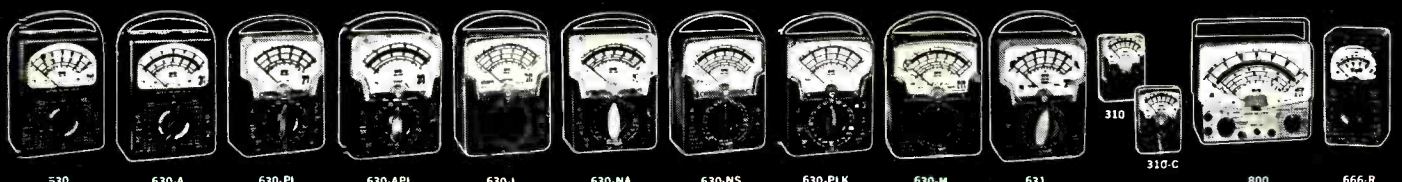

THE WORLD'S MOST COMPLETE LINE OF V-O-M'S. AVAILABLE FROM YOUR TRIPLETT DISTRIBUTOR'S STOCK.



RCA
Transistors
Rectifiers
Integrated
Circuits
For
EXPERIMENTERS
HOBBYISTS
HAMS
and
TECHNICIANS

**LOOK FOR THIS
 DISPLAY AT YOUR
 RCA DISTRIBUTOR**

Here displayed on the RCA Solid-State Center is the RCA SK-Series Transistors, Rectifiers, and Integrated Circuits; the new RCA 3N128 MOS Field-Effect Transistor; RCA's 40214 Silicon Stud Rectifier; and three RCA Experimenter's Kits. This new Solid-State Center, in addition to its host of devices, also includes technical literature to support the devices right on the rack. It's the "one-stop" answer to the solid-state needs of experimenter, hobbyist, ham, or the replacement requirements of the service technician.

All devices and kits are packaged in easily identifiable see-through packs for your convenience. Included with each device is broad performance data or specific ratings and characteristics where applicable.

RCA Solid-State Center Includes:

- RCA Experimenter's Kits. Three kits enable you to build a light dimmer or any one of 14 different circuits for dozens of applications around the house.
- RCA SK-Series "Top-of-the-Line" Devices: 17 Transistors, 2 Rectifiers, and 2 Integrated Circuits, for exper-

imenter or replacement use.

- RCA Technical Manuals. Four manuals include: RCA Experimenter's Manual, RCA Transistor Manual, RCA Linear Integrated Circuits Fundamentals Manual, and RCA Tunnel Diode Manual.
- RCA Solid-State Replacement Guide. Lists all RCA SK-Series "Top-of-the-Line" Transistors, Rectifiers, and Integrated Circuits and the more than 7,300 types which they replace.

Keep RCA Experimenter's Kits and the RCA SK-Series in mind when you're shopping for solid-state devices. Look for the RCA Solid-State Center. Now at your RCA Distributor. Do it today!

RCA Electronic Components and Devices, Harrison, N.J.



The Most Trusted Name in Electronics

CIRCLE NO. 108 ON READER SERVICE CARD

www.americanradiohistory.com