

Electronics World

DECEMBER, 1964
50 CENTS

DESIGN TRENDS IN RECEIVER FREQUENCY CONTROL
NEW SCR DEVELOPMENTS • ELECTRONIC TIME-DELAY RELAYS



Portable TV Sets

M J HINDMAN
2724 E LINWOOD
SPRINGFIELD
MO 65702
M0466 515020HIN2724LM06K



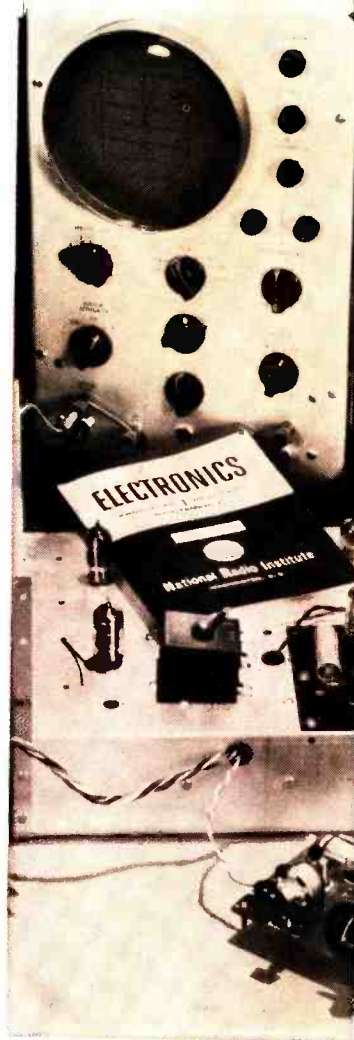
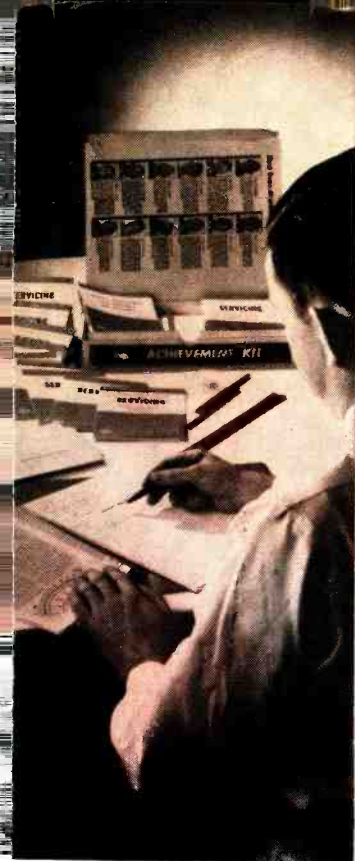

GET A FAST START WITH NRI'S ABSORBING, NEW ACHIEVEMENT KIT

Delivered to your door—everything you need to make a significant start in the Electronics field of your choice! This new starter kit is an outstanding, logical way to introduce you to NRI. What's in it? Your first group of lesson texts; a rich vinyl desk folder to hold your study material; the industry's most complete Radio-TV Electronics Dictionary; valuable reference texts; lesson answer sheets; pre-addressed envelopes; pencils; pen; engineer's ruler, and even postage. No other school has anything like it.

ELECTRONICS COMES ALIVE WITH CUSTOM TRAINING KITS

You get your hands on actual parts and use them to build, experiment, explore, discover. NRI pioneered and perfected the "home lab" technique of learning at home in spare time. Nothing is as effective as learning by doing. That's why NRI puts emphasis on equipment, and why it invites comparison with equipment offered by any other school. Begin now this exciting program of practical learning created by NRI's Research and Development Laboratories. It's the best way to understand fully the skills of the finest technicians—and make their techniques your own.

"BITE-SIZE" LESSON TEXTS PROGRAM YOUR TRAINING AT HOME

Certainly, lesson texts are necessary. NRI's programmed texts are as simple, direct and well illustrated as 50 years of teaching experience can make them. They are carefully programmed with NRI training kits to make the things you read about come alive. You'll experience all the excitement of original discovery.

HOBBY? CAREER? PART-TIME EARNINGS? MAIL COUPON TO NRI

Whatever your reason for wanting to increase your knowledge of Electronics . . . whatever your education . . . there's an NRI instruction plan to fit your needs. Choose from three major training programs in Radio-TV Servicing, Industrial Electronics and Communications or select one of seven specialized courses. Mail coupon for NRI catalog now.

DISCOVER THE EXCITEMENT OF NRI ELECTRONICS TRAINING

Founded 50 years ago—in the days of wireless—NRI pioneered the "learn-by-doing" method of home-study. Today, NRI is the oldest, largest home-study Electronics School, offering the kind of instruction that makes learning exciting, fast. You build, test, experiment, explore. Whatever your interest, your need, your education, investigate the wide variety of NRI training plans . . . find out about the NRI Achievement Kit. Cut out and mail the postage-free card now. No salesman will call. NATIONAL RADIO INSTITUTE, Electronics Division, Washington, D.C. 20016.

50 YEARS OF LEADERSHIP IN ELECTRONICS TRAINING

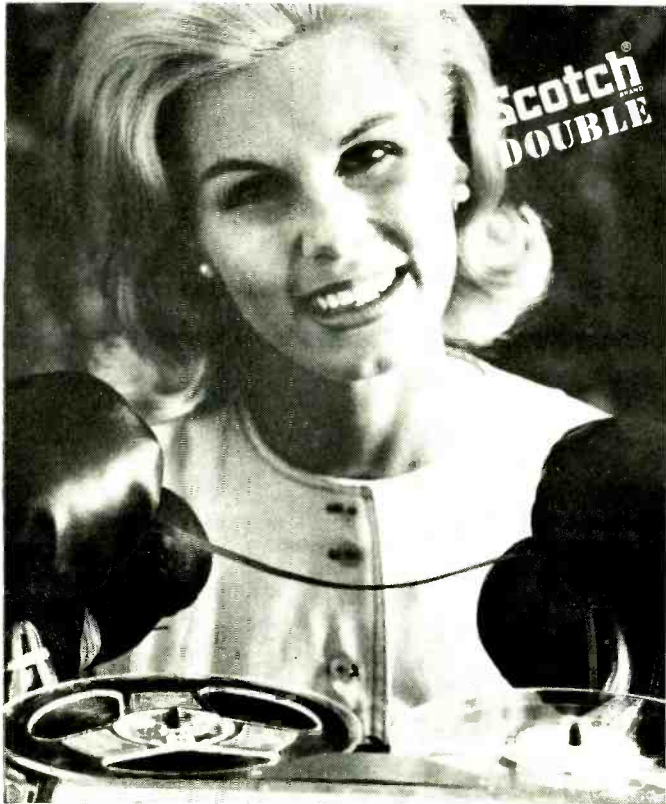

GOOD-BYE
thread-up problems!

FREE long-roll bonus!

A self-threading reel with purchase of 7" roll of double or triple length tape!



No more tape fumbles, even with boxing gloves on! Just lay tape inside this reel, start recorder—and watch the reel thread-up automatically. Takes any tape thickness or leader tape. Releases freely on rewind. Get one free in the special pack shown. Just purchase a regular 7" reel of either double or triple length SCOTCH® Brand Recording Tape (up to 6 hours recording time at 3¾ ips). See your dealer for this long-roll bonus.



HELLO
new mailing ease!

FREE short-roll bonus!

New heavy-duty plastic mailer with each "Living Letter" tape!



New high-strength, dust-free case for "Living Letters" makes handling, storage, mailing of taped correspondence the easiest, most secure ever. Conforms to new postal regulations. Address label included. Built-in post holds reel securely. *New reel, too!* Fits all reel-to-reel recorders. Only 3" reel available that holds full 600' of triple length tape (an hour recording at 3¾ ips). 150' and 300' lengths also offered. Look for new "mailbox" display at your dealer.

"SCOTCH" AND THE PIA D DESIGN ARE REG. TMS OF 3M CO., ST. PAUL, MINN. 55119 ©1964 3M CO.

December, 1964

Magnetic Products Division **3M**
 COMPANY

NOW DIRECT CRYSTAL CONTROL TO 160 mc With AOC Plug-In Transistor Oscillators

- Portable Signal Standards • Signal Generators For Receiver Alignment • Band Edge Markers
- Frequency Markers For Oscilloscopes • Quick-Change Plug-In Oscillators • Accessory Cases

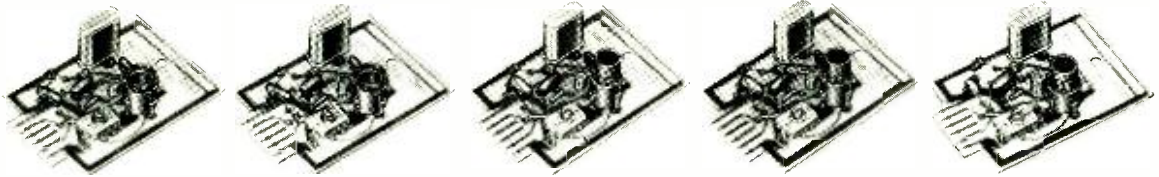

HIGH FREQUENCY (20 mc – 160 mc)

Five transistor oscillators covering 20 mc - 160 mc. Standard 77°F calibration tolerance $\pm .0025\%$. The frequency tolerance is $\pm .0035\%$. Oscillator output is .2 volts (min) across 51 ohms. Power requirement: 9 vdc @ 10 ma. max.

OSCILLATOR TYPE	OSCILLATOR RANGE	CRYSTAL TYPE	TEMPERATURE TOL. -40° F TO 150° F	OSCILLATOR (LESS CRYSTAL) PRICE	CRYSTAL FREQUENCY	CRYSTAL PRICE
OT-24	20-40 mc	CY-7T	$\pm .0035\%$	\$ 9.10	20-60 mc	\$ 6.90
OT-46	40-60 mc	CY-7T	$\pm .0035\%$	9.10	60-100 mc	12.00
OT-61	60-100 mc	CY-7T	$\pm .0035\%$	15.00	101-140 mc	15.00
OT-140	100-140 mc	CY-7T	$\pm .0035\%$	15.00	141-160 mc	18.00
OT-160	110-160 mc	CY-7T	$\pm .0035\%$	15.00		



18 NORTH LEE OKLAHOMA CITY, OKLA.

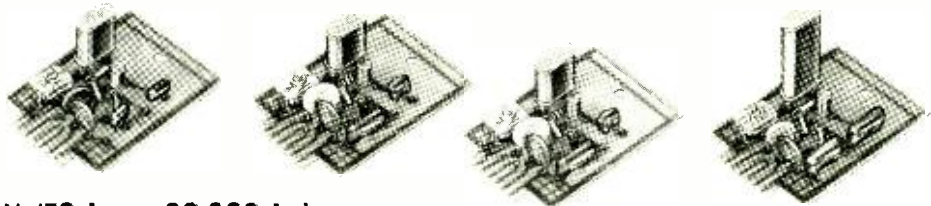

LOW FREQUENCY (70 kc – 20,000 kc)

Four transistor oscillators covering 70 kc - 20,000 kc. Trimmer capacitor for zeroing crystal. When oscillator is ordered with crystal the standard will be $\pm .0025\%$. Oscillator output is 1 volt (min) across 470 ohms. Power requirement: 9 vdc @ 10 ma. max.

OSCILLATOR TYPE	OSCILLATOR RANGE	CRYSTAL TYPE	TEMPERATURE TOL. -40° F TO + 150° F	OSCILLATOR (LESS CRYSTAL) PRICE	CRYSTAL FREQUENCY	CRYSTAL PRICE
OT-1	70-200 kc	CY-13T	$\pm .015\%$	\$7.00	70-99 kc	\$22.50
OT-2	200-5,000 kc	CY-6T	200-600kc $\pm .01\%$ 600-5,000kc $\pm .0035\%$	7.00	100-200 kc	15.00
					200-499 kc	12.50
					500-849 kc	22.50
OT-3	2,000-12,000 kc	CY-6T	$\pm .0035\%$	7.00	850-999 kc	15.00
					1,000-1,499 kc	9.80
					1,500-2,999 kc	6.90
OT-4	10,000-20,000 kc	CY-6T	$\pm .0035\%$	7.00	3,000-10,999 kc	4.90
					11,000-20,000 kc	6.90



FOT-2C

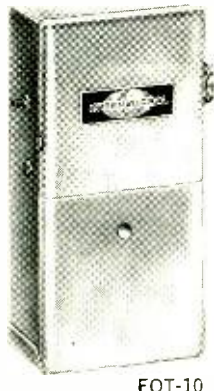

FOT-10

AOC OSCILLATOR CASES

Small portable cases for use with the OT series of plug-in oscillators. Prices do not include oscillators. (When oscillator and crystal are ordered with FOT-10 case a 77°F tolerance of $\pm .001\%$ may be obtained at \$2.00 extra per oscillator/crystal unit. When oscillator/crystal units are ordered with FOT-20 case, a single unit can be supplied with temperature calibration over a range of 40° F to 120° F. Correction to $\pm .0005\%$. Add \$25.00 to the price of FOT-20 and oscillator/crystal unit.)



- FOT-20** For high accuracy calibration requirements. Includes battery and output jack, output meter circuit and battery check, as well as thermistor temperature measuring circuit. **\$87.50**
- FOT-10** Basic case with battery and output jack for general wider tolerance applications. **\$14.50**
- MT-1** Oscillator board mounting kit. **\$4.95**

Order direct from International Crystal Mfg. Co.

- 25 New SCR Developments** *Donald Lancaster*
Recently introduced SCR's are much less expensive, are now self-protecting, immune to transients, and able to conduct in both directions.
- 28 Portable TV Sets** *Leslie Solomon*
- 31 Capacitance Nomogram** *Frank D. Gross*
- 32 Recent Developments in Electronics**
- 34 FM-Stereo Demodulator** *J. W. Englund, L. Plus & H. A. Hansen*
Design of a multiplex adapter that uses inexpensive transistors. The circuit features high noise immunity and automatic mode switching.
- 36 Using Hook-up Wire** *Joseph Tartas*
A piece of ordinary hook-up wire can take on the characteristics of a capacitor, resistor, or a tuned circuit, depending on how it is used at r.f. frequencies.
- 39 Substituting Silicon for Germanium Transistors** *William O. Hamlin*
With the simple circuit modifications discussed, it is possible for the user to employ some of the new silicon transistors and improve performance.
- 42 Early Vacuum Tubes** *Paul G. Watson*
- 44 Electronic Time-Delay Relays** *Louis E. Frenzel, Jr.*
- 46 High-Speed Electronic Printer** *A. W. Edwards*
- 49 Advances in Photosensitive Devices** *John R. Collins*
Research into the phenomenon of photosensitivity has produced many new chemical combinations that make these units respond faster and improve sensitivity to a variety of radiations. Packages also get much smaller.
- 52 Design Trends in Receiver Frequency Control** *Jim Kyle*
The crowded r.f. spectrum and the use of advanced modulation systems require the utmost accuracy in receiver tuning. The latest techniques for achieving such accuracy are described, including digital tuning and frequency synthesis.
- 75 Organ Kit Uses Diode Switching**
- 86 Electronics World 1964 Index (Vols. 71-72)**

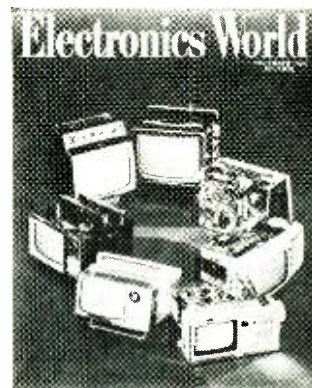

THE seven portable TV sets shown on the cover are only a sample of the ever-increasing number of battery portables soon to be made available. Starting at top center, and proceeding clockwise, they include the G-E 9-inch, Panasonic 9-inch, Realtone 6-inch, Delmonico 4½-inch, Sony 5-inch, Sharp 6-inch, and the Philco 9-inch sets. The three open sets show the typical printed-board techniques used for ease of maintenance. Except for the Delmonico, each of these sets must be operated from an external battery (not shown). Each can be operated from the ordinary a.c. power line. . . . (Photo: Jay Seymour, Burns Bros. N.Y.)



- 6 For the Record (Editorial)** *W. A. Stocklin*
New York Hi-Fi Show
- 18 EW Lab Tested**
Uher 3000 Tape Recorder
Electro-Voice "Sonocaster" Speaker
- 56 Service Shop of the Future** *John Frye*
- 64 Test Equipment Product Report**
Mercury Model 1400 In-Circuit Capacitor Tester
Sencore MX129 FM-Stereo Multiplex Generator
Bird Model 6154 R.F. Wattmeter

MONTHLY FEATURES

- Coming Next Month 4Reader Service Page 15
- Letters from Our Readers 12Radio & TV News 60
- New Products & Literature 79

Publisher
PHILLIP T. HEFFERNAN

Editor
WM. A. STOCKLIN

Technical Editor
MILTON S. SNITZER

Associate Editor
LESLIE SOLOMON

Associate Editor
P. B. HOEFER

Assistant Editor
MARSHA JACOBS

Industrial Consultant
WALTER H. BUCHSBAUM

Art Editor
RICHARD KELLY

Art and Drafting Dept.
J. A. GOLANEK

Advertising Sales Manager
LAWRENCE SPORN

Advertising Service Manager
ARDYS C. MORAN

Copyright © 1964 by Ziff-Davis Publishing Company. All rights reserved.

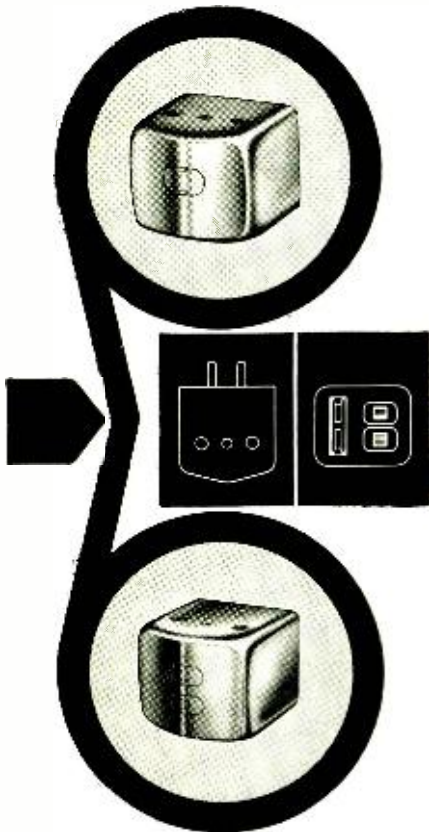

NORTRONICS ANNOUNCES... New Line of Tape Heads!

For true broadcast quality and maximum enjoyment from your investment in tape equipment, replace worn heads with new Nortronics laminated core replacement heads! Available for more than 500 popular tape recorders, these moderately priced replacement heads have highly polished, all-metal faces, and offer extended high frequency response, even at slower tape speeds. Other features include deposited quartz gaps and low-loss core structures.

ALL TAPE HEADS WEAR OUT!

Check today for head wear—both Nortronics new replacement heads and "Quik-Kit" mounting hardware are correctly matched to your recorder, and are available from your Hi-Fi Dealer, Radio-TV Serviceman or Camera Store!

"Music sounds best on Tape—
Tape Sounds Best with Nortronics Heads!"

Nortronics
8127 Tenth Ave. N., Minneapolis, Minn. 55427

Write today for your FREE copy of NORTRONICS
Tape Head Replacement Guide.

Name _____
Address _____
City _____ State _____
I own a _____ Model _____ tape recorder

CIRCLE NO. 242 ON READER SERVICE PAGE

COMING NEXT MONTH

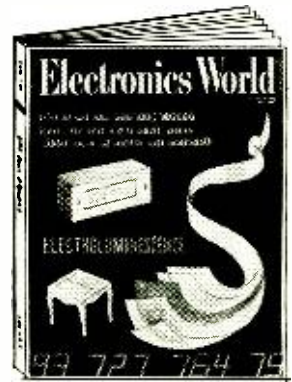

ELECTROLUMINESCENCE

Sylvania expert covers principles of operation, technical characteristics of this new form of display illumination, and phosphors. Both home lighting applications and readout and display uses in industry are covered in this article.

MULTIPURPOSE ELECTRONIC CONTROL

This 200-watt, full-range unit provides proportional control using a small audio or 60-cps control signal. It can be used as a dimmer, as a visual indicator of stereo separation, or of high noise levels.

AUTOMATIC WIRING CHECKOUT

High-speed scanning techniques permit analysis of up to 100,000 terminations on a complete wiring assembly. During these tests, the device points out circuit wiring errors.

NOISE PERFORMANCE OF TRANSISTORS IN AUDIO CIRCUITS

Results of testing a large number of different transistor types show that ger-

manium-alloy units are quieter than tubes and other transistor types for this application. The design of a low-noise phono preamp, using the information obtained during the tests, is also included.

ELECTRONIC PUMPS

An all-electronic method of producing a vacuum is described in this article. It is used to keep large microwave tubes and electron accelerators gas free and in the deposition of thin films for integrated circuits.

SCR HEAT SINK DESIGN CHART

What size heat sink should be used for 115-volt SCR circuits or for other semiconductors at various powers? This article provides the answers.

"CHIRP"—A NEW RADAR TECHNIQUE

Using a swept-frequency approach, this new radar has greatly improved range and target resolution over conventional pulse methods and is also less susceptible to most of the present-day jamming techniques.

All these and many more interesting and informative articles will be yours in the JANUARY issue of *ELECTRONICS WORLD*... on sale December 17th.

ZIFF-DAVIS PUBLISHING COMPANY

William B. Ziff
Chairman of the Board (1946-1953)

William Ziff
President

W. Bradford Briggs
Executive Vice President

Herchel B. Sarbin
Vice President and General Manager

Philip Sine
Treasurer

Walter S. Mills, Jr.
Circulation Director

Stanley R. Greenfield
Vice President

Phillip T. Heffernan
Vice President

ZIFF-DAVIS PUBLISHING COMPANY
Editorial and Executive Offices
One Park Avenue, New York, N.Y. 10016
212 ORegon 9-7200

MIDWESTERN OFFICE
434 South Wabash Avenue, Chicago, Ill. 60605
312 Wabash 2-4911
Midwestern Advertising Manager, Royce Richard

WESTERN OFFICE
9025 Wilshire Boulevard, Beverly Hills, Cal. 90211
213 CRestview 4-0265
Western Advertising Manager, Bud Dean

FOREIGN ADVERTISING REPRESENTATIVE
D. A. Goodall Ltd., Empire House,
London, E.C.1, England. MONarch 0577



Member
Audit Bureau of
Circulations

Radio & TV News • Radio News • Radio-Electronic Engineering Trademarks Reg. U.S. Pat. Off.

SUBSCRIPTION SERVICE: All subscription correspondence should be addressed to Electronics World, Circulation Dept., Portland Place, Boulder, Colorado 80311. Please allow at least six weeks for change of address. Include your old address as well as new—enclosing it possible an address label from a recent issue.

EDITORIAL CONTRIBUTIONS must be accompanied by return postage and will be handled with reasonable care; however publisher assumes no responsibility for return or safety of art work, photographs, or manuscripts.

ELECTRONICS WORLD (December, 1964, Vol. 72, No. 6) is published monthly by Ziff-Davis Publishing Company at 434 South Wabash Avenue, Chicago, Ill. 60605. (Ziff-Davis also publishes Popular Photography, Popular Electronics, HiFi/Stereo Review, Popular Boating, Car and Driver, Flying, Modern Bride, Amazon, and Fantastic.) Subscription rates: one year United States and possessions \$5.00; Canada and Pan American Union countries \$5.50; all other foreign countries \$6.00. Second class postage paid at Chicago, Illinois and at additional mailing offices. Authorized as second class mail by the Post Office Department, Ottawa, Canada and for payment of postage in cash.

PAYMENT MAY ALSO BE REMITTED in the following foreign currencies for a one year subscription: Australian pounds (2/16); Belgian francs (310); Danish kroner (43); English pounds (2 4/6); French francs (31); Dutch guilders (22); Indian rupees (31); Italian lire (3900); Japanese yen (2100); Norwegian kroner (45); Philippine pesos (25); South African rands (4.50); Swedish kronor (33); Swiss francs (27); West German marks (25).

ELECTRONICS WORLD

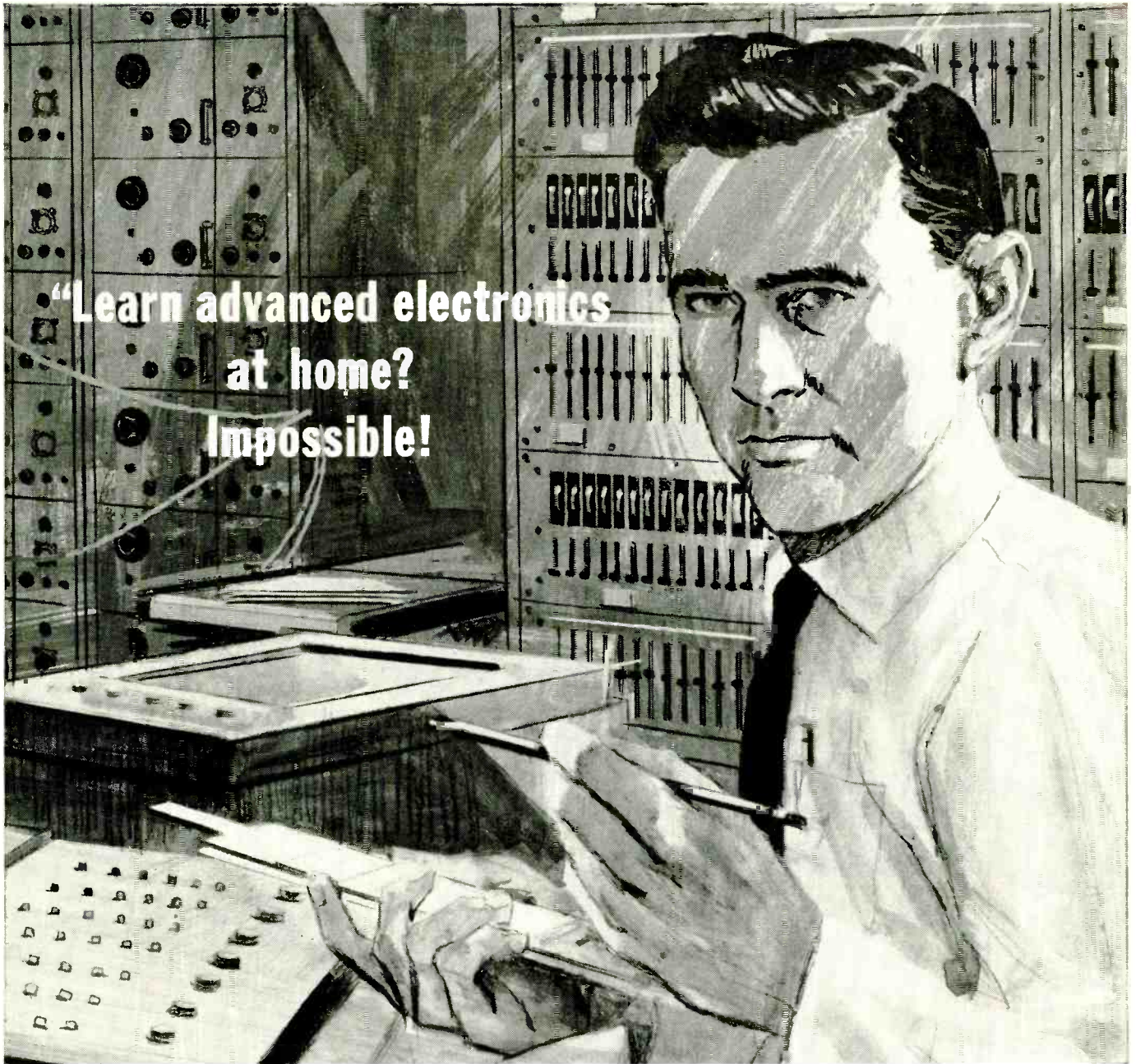

A CREI Program helped Edward W. Yeagle advance to project engineer at Barnes Engineering Co., Stamford, Conn.

...that's what I thought until I found out about CREI'

"Sure, I knew that home study programs were fine for a man who wanted to learn basic electronics. But, I needed to study advanced electronics to put myself in line for a better job. Thought I couldn't do it without quitting my job and going back to school. But then my supervisor told me about CREI. I've had two salary increases since I enrolled—and my company recognizes the value of this education."

This man is one of the thousands of men in every phase of electronics who are moving ahead with the help of CREI Home Study Programs. If you are employed in electronics, CREI can help you, too. For complete information, send for FREE book. Use coupon or write: CREI, Dept. 1112B 3224 Sixteenth St., N.W., Washington 10, D. C.



CREI

Founded 1927
Accredited Member of the
National Home Study Council

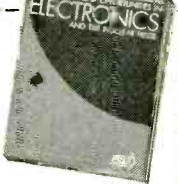

The Capitol Radio Engineering Institute
Dept. 1112B 3224 16th St., N.W., Washington 10, D. C.

Please send me FREE Book describing career opportunities and CREI Programs in advanced electronics. I am employed in electronics and have a high school education.

Name _____ Age _____

Address _____

City _____ Zone _____ State _____

Employed by _____

Type of Present Work _____

53

...for

NATURE LOVERS...



Record nature sounds. Set on auto operation. Sound starts and stops it automatically.

SLIDES & SOUND

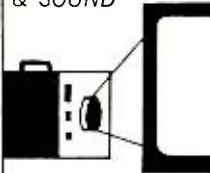

Built-in automatic synchronizer advances slides; coordinates them with commentary or music.

SECRET RECORDINGS...



For investigations, interrogations, gathering of evidence. Works unattended. Voice starts and stops it.

DICTIONATION...



Use voice operation or remote-control microphone. Dictate anywhere — office, home or on the road.

MUSIC WHEREVER YOU GO...



Enjoy music at the beach, on your boat, anywhere. Play commercial tapes or your own selections from radio or records.



World's First Fully-Automatic Voice-Operated Portable Tape Recorder!

CONCORD 330

You'll find all sorts of "hands-free" uses for Concord's amazing portable 330 — applications not possible with an ordinary recorder. You don't even have to be there. Sound starts it; sound stops it. Just set it and forget it! □ The 330 is packed with features: automatic slide projector advance; automatic Synctrol for home movies; automatic self-threading too! Up to 6 hours playing time on 5" reels; 2 speeds; VU meter/battery life indicator and an optional AC adaptor. □ See your Concord dealer right away for a demonstration. Under \$200.00.* Other Models to \$450.00.

For Connoisseurs Of Sound

CONCORD 330

CONCORD  ELECTRONICS CORPORATION

809 N. Cahuenga Blvd., Dept. 24 Los Angeles 38, Calif. *price slightly higher in Canada.

CIRCLE NO. 171 ON READER SERVICE PAGE



For the record

WM. A. STOCKLIN, EDITOR

NEW YORK HI-FI SHOW

THIS year's New York segment of the Hi-Fi Show, sponsored by the Institute of High Fidelity, Inc., was a resounding success despite a slight reduction in attendance. There were four display floors housing hi-fi components of all sizes and shapes from over 70 different manufacturers. Just about every exhibitor whose display room we visited seemed to be enthusiastic not only about his own new products but optimistic about his future sales.

This feeling is a natural one because of the tremendous growth of the hi-fi component industry. In the mid-1950's, annual sales were only about \$25 million; by last year sales had quadrupled to an estimated \$100 million. During this time, while there was a general rise in most prices for goods and services, component high-fidelity equipment prices remained fairly steady. In some cases, prices for equipment of comparable performance were even reduced. So far, the greatest market penetration has been in urban areas, and there is still room for growth and increased sales in the future. For example, according to Walter O. Stanton, president of the Institute, even in urban areas only about 25 percent of homes now have a stereo system installed. It is his feeling that the remaining 75 percent represents a major growth area in the years ahead.

One feature of the Show this year was a full-fledged *Discotheque*. As recreated on the second floor of the New York Trade Show building, this looked like a typical French cafe, complete with checkered tablecloths, soft lights, and refreshments. The music, however, instead of being supplied by live musicians, was coming from four large hi-fi speaker systems connected to hi-fi amplifiers and phono equipment. Although there was room for dancing, most Show visitors took advantage of the relaxed atmosphere to rest and refresh themselves.

Not far from *Discotheque* was a large hall where semi-technical panel discussions and lectures for the hi-fi novice were held. The three panel discussions on hi-fi amplifiers, tape recorders, and music listening, as well as the four lectures on hi-fi components, were well attended, with many standees spilling out into the adjoining hallway. From the great number of questions that were asked at these sessions, it was obvious that there is a large and serious interest in component hi-fi.

As far as the display rooms and equipment were concerned, everyone had his new models on display. The over-all sound level was more restrained this year than it has been in years past.

Visitors usually had to go into the exhibitor's rooms in order to hear the demonstrations instead of being blasted at on all sides while walking through the connecting halls.

In general, we heard some very good sound at the Show this year, much of it emanating from some fairly small-sized speaker systems. It seems that the "bookshelf" speaker has finally gotten small enough to actually fit comfortably on a bookshelf. Several companies were showing such compact speaker systems and most of them were doing an excellent job of producing really good sound with a very small enclosure.

A further trend toward diversification was evident this year. There were some speaker manufacturers introducing lines of amplifiers and tuners; and there were some amplifier companies showing their own loudspeaker systems.

Another trend was that of integration by some of the manufacturers. A large number of stereo receivers, with their all-in-one tuner and amplifier combination, were on display. Also, several companies displayed complete portable, packaged stereo systems made up of separate components but designed together as a single system. Some of these components were of their own manufacture, and others were made by other companies exhibiting at the Show.

The move toward complete transistorization of equipment continued this year. A few companies have gone so far as to completely discontinue vacuum-tube amplifiers and tuners. On the other side were one or two manufacturers steadfastly refusing to go to solid-state equipment as yet. But the great majority of companies had both tube and transistor equipment on display, with the newest models being mainly solid-state.

When transistors came to hi-fi a year or two ago, we saw two types of equipment. One type was very high in performance and quality, but also fairly elaborate and rather expensive. The second type had performance somewhat below that of vacuum-tube equipment but at a more reasonable cost. This year we saw the beginning of a merger of these two design philosophies. Prices have come down on some of the transistor equipment, but high quality has been maintained.

All-in-all, the Show was highly successful. The attendance for the four-day period was about 22,000. For those of you who missed the New York Show at the beginning of October or the previous San Francisco Show in September, you have another chance at the Los Angeles Show to be held in April. ▲

ELECTRONICS WORLD

Pick the course for your career...

Electronics Technology



A comprehensive program covering Automation, Communications, Computers, Industrial Controls, Television, Transistors, and preparation for a 1st Class FCC License.

Electronic Communications

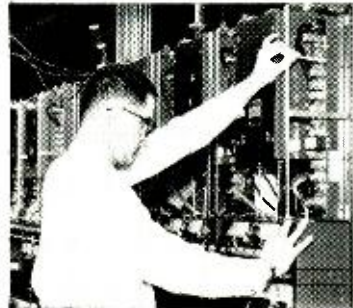

Mobile Radio, Microwave and 2nd Class FCC Preparation are just a few of the topics covered in this "compact" program . . . Carrier Telephony too, if you so desire.

First Class FCC License



If you want a 1st Class FCC ticket quickly, this streamlined program will do the trick and enable you to maintain and service all types of transmitting equipment.

Broadcast Engineering



Here's an excellent studio engineering program which will get you a 1st Class FCC License and teach you all about Program Transmission and Broadcast Transmitters.

Get A Commercial FCC License ...Or Your Money Back!

A Commercial FCC License is proof of electronics skill and knowledge. Many top jobs require it . . . every employer understands its significance. In your possession, an FCC Commercial Ticket stamps you as a man who knows and understands electronics theory . . . a man who's ready for the high-paid, more challenging positions.

Cleveland Institute home study is far and away the quickest, most economical way to prepare for the FCC License examination. And that's why we can make this exclusive statement:

The training programs described above will prepare you for the FCC License specified. Should you fail to pass the FCC examination after completing the course, we will refund *all* tuition payments. You get an FCC License . . . or your money back!

Before you turn this page, select the program that fits your career objective. Then, mark your selection on the

Cleveland Institute of Electronics

1776 E. 17th St., Dept. EW-96
Cleveland, Ohio 44114



Accredited Member

coupon below and mail it to us today. We'll send you . . . without obligation . . . complete details on our effective Cleveland Institute home study. Act NOW . . . and insure *your* future in electronics.

Mail Coupon TODAY For FREE Catalog

Cleveland Institute of Electronics

1776 E. 17th St., Dept. EW-96
Cleveland, Ohio 44114

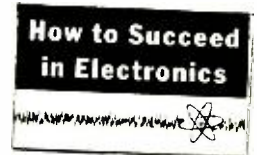

Please send me your FREE catalog, "How to Succeed in Electronics." I am over 17 years of age and interested in (check one):

- | | |
|---|--|
| <input type="checkbox"/> Electronics Technology | <input type="checkbox"/> First Class FCC License |
| <input type="checkbox"/> Industrial Electronics | <input type="checkbox"/> Electronic Communications |
| <input type="checkbox"/> Broadcast Engineering | <input type="checkbox"/> Advanced Engineering |

Your present occupation _____

Name _____ (please print) Age _____

Address _____ County _____

City _____ State _____ Zip _____

A leader in electronics training . . . since 1934



are you ready

FOR THE NEW AGE OF ELECTRONICS SPECIALIZATION?

RCA Institutes Home Training can help protect your future and increase your earning power

Career Security is Today's Problem. Before you finish reading this, another significant step forward will be made in some field of Electronics. A new advance in nuclear instrumentation. A breakthrough in automatic controls. An important development in computer programming. And so on. How will this affect your future? Will your career in Electronics be secure? These are today's vital career questions.

RCA Institutes Specialized Training is the Answer. Whatever field you may now be in, or no matter how advanced your present Electronics training may be, RCA Institutes has a Home Training Course exactly suited to your needs. With

RCA Institutes Specialized Training you can help to secure your present career and be in a better position to advance yourself. It's today's best career insurance.

Advanced Standing Available. If you are a person who works in Electronics, or who has had Electronics Training in the past, you may apply for Advanced Standing in any of the RCA Institutes Home Training Courses. If you are just starting out, you can also be assured of the same opportunities for professional success and security. RCA Institutes has Home Training Courses specifically designed to give you the required fundamental background on which to build a career.

HOME TRAINING

CHOOSE ANY OF THESE SPECIALIZED COURSES

- Automation Electronics
- Automatic Controls
- Industrial Applications
- Nuclear Instrumentation
- Digital Techniques
- Computer Programming
- Transistors
- Mobile Communications
- Communications Electronics
- FCC License Preparation
- Monochrome and Color TV
- Drafting

RCA Institutes Home Training Courses are complete, step-by-step, easy to understand units. You get top quality equipment, and all kits furnished to you are yours to keep and use on the job. Doesn't it make sense to protect the investment you've

already made in your career, and look forward to a future of increased earning power? Send the attached postcard today for complete information. It won't cost you anything, and it may mean a great step forward to you. Act now!

JUST STARTING OUT IN ELECTRONICS? BEST HOME TRAINING TODAY IS RCA!

Full selection of beginning courses to choose from. Master the essentials of Electronics and go on to a profitable career now!

Faster, Easier Way to Begin — Exclusive With RCA Institutes. If you are considering a future in electronics, now is the time to start! The RCA "AUTOTEXT" Instruction Method developed by RCA and introduced by RCA Institutes, will help you master the fundamentals of electronics almost automatically. It is a system of programmed instruction, which has been proved with thousands of students. Even people who have had trouble with conventional home

training methods in the past, are finding it easier and more fun to begin their training this new way.

Liberal Tuition Plan. RCA Institutes liberal tuition plan affords you the most economical possible method of home training. You pay for lessons only as you order them. If, for any reason, you should wish to interrupt your training, you may do so and you will not owe one cent until you resume the course. No long-term obligations.

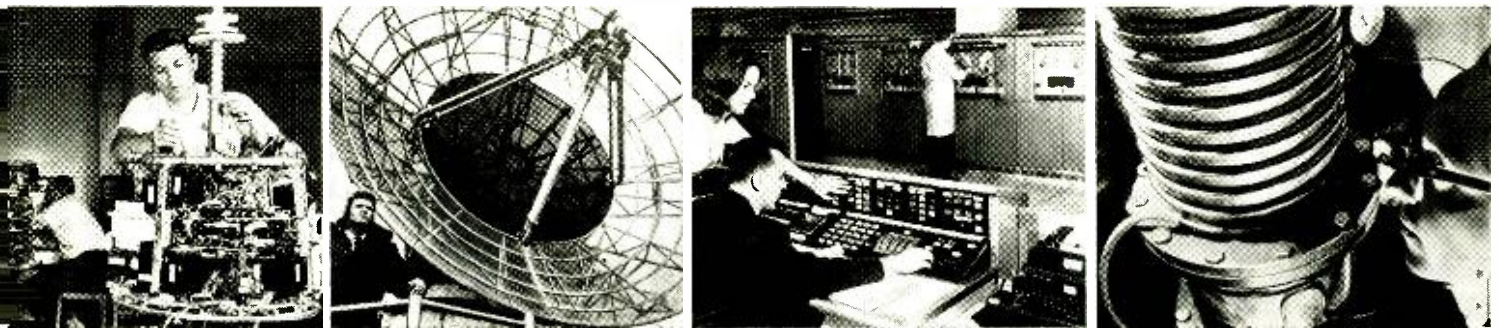

CLASSROOM TRAINING AVAILABLE

RCA Institutes Resident School in New York City offers classroom training that will prepare you to work in rewarding research and production positions in many fields of electronics. No previous technical training required for admission. You are eligible even if you haven't completed high school.

Free Placement Service. RCA Institutes Resident School graduates are now employed in important jobs at military installations, with important companies such as IBM, Bell Telephone Labs, General Electric, RCA, in radio and TV stations and in communications systems all over the country. Many other graduates have opened their own businesses. A recent New York Resident School class had 91% of the graduates who used the FREE Placement Service accepted by leading electronics companies, and had their jobs waiting for them on the day they graduated!

Coeducational Day and Evening Classes. You can prepare for a career in electronics while continuing your part-time or full-time employment. Regular classes start four times a year.

SEND POSTCARD FOR FREE ILLUSTRATED BOOK TODAY! SPECIFY HOME STUDY OR CLASSROOM TRAINING.



RCA INSTITUTES, INC. Dept. EW-D4
A Service of the Radio Corporation of America,
350 West 4th St., New York, N. Y. 10014



The Most Trusted Name In Electronics



Leisurely taped on the fabulous



88 STEREO COMPACT

Choice of Music-Lovers and Music-Makers.

Features exclusive "Edit-Eze" cuing and editing. Superb 30-18,000 cps frequency response for finest mono or stereo recording with three hyperbolic heads. Monitor-off-tape, Sound on Sound, Erase-Protek, automatic shut-off, tapelifters, are but some of the many features to let you thoroughly enjoy high quality tape recording.

4-track model \$339.95
2-track model \$347.95
Walnut enclosure ... \$ 15.95

For portable model with speakers ask to see the "880."

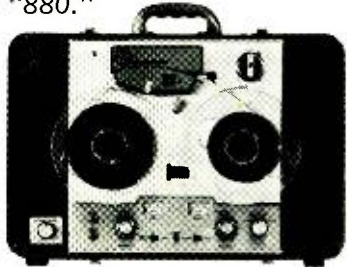

MADE BY SKILLED
AMERICAN CRAFTSMEN AT



OF MINNEAPOLIS, INC.

9600 Aldrich Ave. So. Minneapolis, Minn. 55420

LETTERS FROM OUR READERS

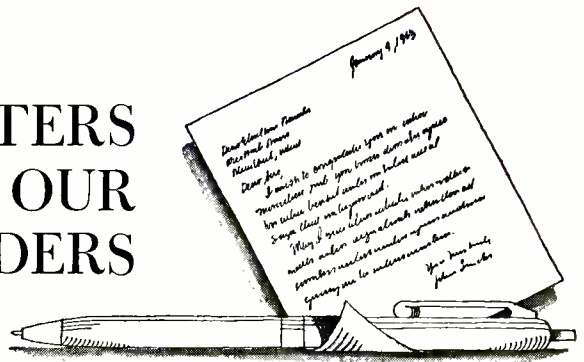

PRECISE MEASUREMENT OF R.F.

To the Editors:

In the matter of mixing heterodyned signals for the purpose of separating various combinations of their numerical orders, it appears that there should be realized a distinction in the terminology of the associated circuitry with respect to non-linear impedances, etc. Reference is made to this circuit element in the article "Precise Measurement of Radio Frequencies" by J. Richard Johnson in the August, 1964 issue of *ELECTRONICS WORLD*.

Non-linear amplification (detection) is a holdover from the old days of "grid-leak" and galena detectors, wherein the amplification was greater in the positive direction than in the negative direction, or *vice-versa*. With the advent of "power detectors" of various types, however, and in the absence of any incidental amplification, a far greater efficiency of frequency conversion is obtainable with a linear rectifier circuit. The more linear the rectifier, the greater this efficiency. A perfect rectifier would thus be more properly classed as a unilateral device rather than a non-linear one.

Modern diode rectifiers (more properly demodulators than detectors) operate at comparatively high signal levels which tend to wash out the small degree of non-linearity at the lower knee of their curve, and it becomes desirable to operate them up on the linear portion of their characteristic slopes in order to obtain the most linear output wherever so desired. This is of paramount interest in the design of beat-frequency audio oscillators, wherein the ratio of the mixed radio frequencies is maintained near a ratio of approximately 10:1 for closest to sine-wave audio output.

FRANK J. BURRIS
Yucaipa, Calif.

REMOTE VOLUME CONTROL

To the Editors:

Please refer to "Remote Volume Control" by Charles Martel in your July issue.

I am puzzled. I also have a commercial killer by my easy chair, with the same two connections to the present volume control, the same two small low-voltage wires, etc. On the end of the wires I placed a 25,000-ohm potentiome-

ter which gives me complete control from the volume as set at the TV to zero. It has been working fine for 3 or 4 years.

Am I doing something wrong? If not, why get more sophisticated? Your explanation would be greatly appreciated.

M. G. MARTIN
Riverside, Conn.

The running of long leads from the TV set's volume control, which is a high-impedance circuit, often results in serious loss of high frequencies and hum pickup. A more satisfactory and equally simple technique would be to use a low-resistance potentiometer across the speaker voice-coil leads.

However, the purpose of the article in question was not merely to show how to build a commercial killer. Articles of this type also serve to introduce new types of products to our readers and to suggest other uses and applications for such products. If the only job that the device could do would be to act as a commercial killer, then we feel reasonably certain that the company would realize that there are simpler ways of doing the job and would not have come out with this product which, indeed, has many other applications suggested by the one shown.—Editors.

PIANO TUNING ELECTRONICALLY

To the Editors:

This is in answer to many inquiries I have received concerning the availability of the book *Piano Tuning and Allied Arts* which I mentioned in my article "Piano Tuning—The Electronic Way" (September issue).

The book is available from the *Tuners Supply Co.*, 88 Wheatland St., Somerville, Mass., at a price of \$6.15 postpaid.

FREDERICK VAN VEEN
General Radio Co.
West Concord, Mass.

CITIZENS BANO DSB

To the Editors:

The article by Bruce E. Packham in your August issue ("DSB and the Citizens Bander") is open to question. If he is talking about improperly adjusted, cheap equipment, and lack of know-how, then he may be right. I won't take up my time or yours in technical rebut-

HOBSON'S CHOICE? NEVER AGAIN!

If, in 1631, you went to rent a horse from Thomas Hobson at Cambridge, England, you took the horse that stood next to the door. And no other. Period. Hence, Hobson's Choice means No Choice.

And, as recently as 1961, if you went to buy a true high fidelity stereo phono cartridge, you bought the Shure M3D Stereo Dynetic. Just as the critics and musicians did. It was acknowledged as the ONLY choice for the critical listener.

Since then, Shure has developed several models of their Stereo Dynetic cartridges—each designed for optimum performance in specific kinds of systems, each designed for a specific kind of *porte-monnaie*.

We trust this brief recitation of the significant features covering the various members of the Shure cartridge family will help guide you to the best choice for you.

THE CARTRIDGE

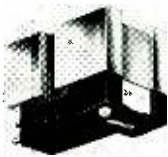

V-15



M55E

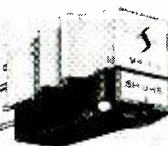

M44



M7/N21D



M99



M3D

ITS FUNCTION, ITS FEATURES ...

The ultimate! 15° tracking and Bi-Radial Elliptical stylus reduces Tracing (pinch effect), IM and Harmonic Distortion to unprecedented lows. Scratch-proof. Extraordinary quality control throughout. Literally handmade and individually tested. In a class by itself for reproducing music from mono as well as stereo discs.

Designed to give professional performance! Elliptical diamond stylus and new 15° vertical tracking angle provide freedom from distortion. Low Mass. Scratch-proof. Similar to V-15, except that it is made under standard quality control conditions.

A premium quality cartridge at a modest price. 15° tracking angle conforms to the 15° RIAA and EIA proposed standard cutting angle recently adopted by most recording companies. IM and Harmonic distortion are remarkably low . . . cross-talk between channels is negated in critical low and mid-frequency ranges.

A top-rated cartridge featuring the highly compliant N21D tubular stylus. Noted for its sweet, "singing" quality throughout the audible spectrum and especially its singular recreation of clean mid-range sounds (where most of the music really "happens".) Budget priced, too.

A unique Stereo-Dynetic cartridge head shell assembly for Garrard and Miracord automatic turntable owners. The cartridge "floats" on counterbalancing springs . . . makes the stylus scratch-proof . . . ends tone arm "bounce."

A best-seller with extremely musical and transparent sound at rock-bottom price. Tracks at pressures as high as 6 grams, as low as 3 grams. The original famous Shure Dynetic Cartridge.

IS YOUR BEST SELECTION

If your tone arm tracks at 1½ grams or less (either with manual or automatic turntable)—and if you want the very best, regardless of price, this is without question your cartridge. It is designed for the purist . . . the perfectionist whose entire system *must* be composed of the finest equipment in every category. Shure's finest cartridge. \$62.50.

If you seek outstanding performance and your tonearm will track at forces of ¾ to 1½ grams, the M55E will satisfy—beautifully. Will actually improve the sound from your high fidelity system! (Unless you're using the V-15, Shure's finest cartridge.) A special value at \$35.50.

If you track between ¾ and 1½ grams, the M44-5 with .0005" stylus represents a best-buy investment. If you track between 1½ and 3 grams, the M44-7 is for you . . . particularly if you have a great number of older records. Both have "scratch-proof" retractile stylus. Either model under \$25.00.

For 2 to 2½ gram tracking. Especially fine if your present set-up sounds "muddy." At less than \$20.00, it is truly an outstanding buy. (Also, if you own regular M7D, you can upgrade it for higher compliance and lighter tracking by installing an N21D stylus.)

If floor vibration is a problem. Saves your records. Models for Garrard Laboratory Type "A", AT-6, AT-60 and Model 50 automatic turntables and Miracord Model 10 or 10H turntables. Under \$25.00 including head shell, .0007" diamond stylus.

If cost is the dominant factor. Lowest price of any Shure Stereo Dynetic cartridge (about \$16.00) . . . with almost universal application. Can be used with any changer. Very rugged.

SHURE

Stereo Dynetic®

HIGH FIDELITY PHONO CARTRIDGES . . . WORLD STANDARD WHEREVER SOUND QUALITY IS PARAMOUNT

Shure Brothers, Inc., 222 Hartrey Ave., Evanston, Illinois

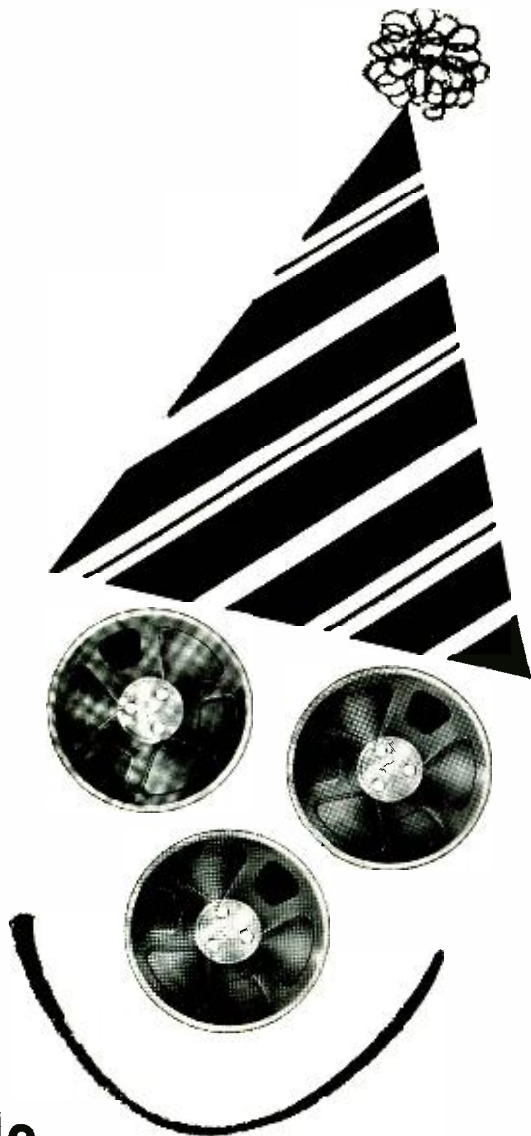

Triple your tape recording fun (buy Tarzian Tape three reels at a time!)

There are some sounds that you *plan* to preserve. You know in advance—"Here is something I will want to keep, permanently, on tape." You're ready for them.

There are other sounds, though, that you can't predict or schedule. They just come along, never to come again. Do you have an extra reel of tape on hand? Are you ready for the moment that cannot otherwise recur?

Why not take this good advice? When you buy tape, buy at least three reels. And buy brand name tape, so you can be confident of its quality and certain it won't harm your recorder.

Of course, we hope you'll choose Tarzian Tape. We thoroughly test other brands along with our own—and the impartial equipment in our labs assures us that you can't do better.

FREE: Our 32-page booklet tells you how to get more out of your tape recordings. Write for your copy.



SARKES TARZIAN, Inc.

World's Leading Manufacturers of TV and FM Tuners • Closed Circuit TV Systems • Broadcast Equipment • Air Trimmers • FM Radios • Magnetic Recording Tape • Semiconductor Devices

MAGNETIC TAPE DIVISION • BLOOMINGTON, INDIANA

Export: Ad Auriema, Inc., N.Y. • Canada: E. J. Piggott Enterprises Ltd., Toronto, Ont.

tal, but Mr. Packham had better come down from his ivory tower to practical realism. If he is an amateur, then so much the more.

I have been utilizing DSB and SSB since 1953, including use on the Citizens Band (11 meters). Ask any ham who has been working SSB or DSB for 5 to 7 years the relative merits between AM and SSB or DSB and become more educated. And there are thousands of these hams.

C. M. PRUETT, K4BHV
Atlanta, Ga.

We are quite sure that neither we nor our author would disagree with Reader Pruett insofar as the merits of single-sideband equipment are concerned. As a long time ham who has used SSB, we don't have to be sold on the value of SSB. Such equipment has proven its usefulness not only on the amateur bands but also for military applications.

The type of equipment that the author was discussing, however, was modified double-sideband CB equipment in which a portion of the carrier is transmitted. His point was that some of this equipment results in only marginal improvement in performance. With pure DSB, using complete carrier suppression, or with SSB, there is no question as to the improvement in performance and range.—Editors.

SIMPLE "Q" METER

To the Editors:

In my article "Design of Simple 'Q' Meter" (September issue), the formula for calculating inductance from the coil's dimensions was omitted. This formula will give the inductance accurate to about 1%, thus greatly increasing the calibration accuracy of the "Q" meter.

The formula is as follows:

$$L = \frac{n^2 r^2}{9r + 10l}$$

where L is inductance in microhenrys, n is number of turns, r is radius in inches, and l is length in inches.

Carefully count the number of turns, measure the coil dimensions, and calculate the inductance from these figures. As stated in the article, the inductance will be about 100 microhenrys for the dimensions given, but the use of the formula will allow corrections for errors in turns counting, form size, and wire insulation thickness variations. For instance, the actual (calculated) inductance of my standard coil turned out to be 110 microhenrys.

DAVID H. SANDROCK
Tuscon, Ariz.

The editor who handled the story felt that the above formula, included in Author Sandrocks's original story, would be fairly familiar to many of our readers. However, in answer to some inquiries, here it is.—Editors ▲

PROFESSIONAL USE ONLY

Total Number of Requests

NAME (PRINT CLEARLY) _____ TITLE _____

COMPANY NAME _____

COMPANY ADDRESS _____

CITY _____ STATE _____ ZONE _____

I AM EMPLOYED IN: INDUSTRY COMMERCIAL COMMUNICATIONS
MILITARY/GOVERNMENT OTHER

Please send me additional information on products I have circled.
(Key numbers for advertised products also appear in Advertisers Index.)

1	2	3	4	5	6	7	8	9	10	11	12	13	15	16	17	18	19
20	21	23	24	25	26	27	29	30	39	40	43	44	45	46	47	48	
49	50	51	52	53	54	57	59	64	128	134	137	138					

ELECTRONICS WORLD (VOID AFTER DECEMBER 31, 1964) 12
P. O. BOX 7842, PHILADELPHIA 1, PA.

READER SERVICE PAGE

Since many products and services mentioned are primarily for professional use only, we are using two different coupons.

To get more information, promptly, about products and services mentioned in this issue, simply circle the number corresponding to the ad or editorial mention and send the proper coupon to us. Your request will be sent to the manufacturer immediately.

FOR PROFESSIONAL USE: In requesting information on products and services listed in this coupon it is necessary to fill out the coupon COMPLETELY, stating your company, address, and your function or title. If the coupon is incomplete it cannot be processed.

FOR GENERAL USE: In requesting information on products and services listed in this coupon, please use only your home address.

You can use both coupons, since each contains specific items, if each coupon is filled out completely.

Mail to: ELECTRONICS WORLD P. O. BOX 7842, PHILADELPHIA 1, PA.

GENERAL USE ONLY

Total Number of Requests

NAME (PRINT CLEARLY) _____

ADDRESS _____

CITY _____ STATE _____ ZONE _____

Please send me additional information on advertised products I have circled.
(Key numbers for advertised products also appear in Advertisers Index.)

128	134	137	138	152	156	161	163	170	171	172	174	177
178	180	181	183	184	185	186	187	189	191	194	198	
200	203	206	210	214	217	221	224	225	228	229	233	
235	237	238	242	243	245	246	248	251	252	258	259	

NEW PRODUCTS & LITERATURE

1	8	12	14	15	22	25	28	29	30	31	32	33	34	35	36
37	38	41	42	45	46	47	54	55	56	58	59	60	61	62	63

ELECTRONICS WORLD (VOID AFTER DECEMBER 31, 1964) 12
P. O. BOX 7842, PHILADELPHIA 1, PA.

The antenna that challenges

NEW Swept Element

"COLOR-VE"

BY

FINCO

Finco's Color Ve-Log challenges all competition on color or black and white reception and stands behind this challenge with a "Guarantee of Supremacy". ■ The swept element design assures the finest in brilliant color and sharply defined black and white television reception — as well as superb FM monaural and stereo quality. ■ FINCO precision-engineered features make these advanced-design antennas indispensable to good home sight-and-sound systems. And, of course, they carry the famous unconditional guarantee from the leading manufacturer in the field — FINCO. ■ Promote the Color Ve-Log Antennas with pride, sell them with confidence, and profit handsomely.



One-piece cross-over drive line assembly has no joints between adjacent driven elements. Eliminates loose connections, shorts, broken drive line sections. Polystyrene snap-lock spacers, with center 'air insulator' space.



Elements are made of triple thick aluminum to stand up in severe weather. Die stamped bracket fastened with tough, thick-gauge rivet holds proportional length sleeve reinforcing shell into which element fits.



First from Finco and exclusive — double contact between drive line and driven element bracket assembly for perfect drive-line support and electrical continuity. Positive, vibration-free, non-corrosive contact.

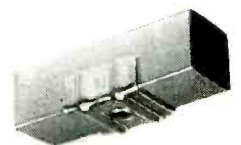

Boom reinforcing back up brackets at elements add triple strength to the riveted assembly, mounted on a rigid, non-crushable 1" heavy duty square boom. Boom rolled square from 1 1/4" diameter round aluminum for increased strength.

Write for color brochure #20-307, Dept. 410

all competition!

LOG



VL-10
 9 driven elements
 1 parasitic element
 List price \$34.95

Featuring Finco's Exclusive Gold Corodizing



Finco's boom-mast bracket, rust-proofed by zinc plate-gold dichromate dip process, is the finest available. It has positioned cleats to assure sag-free positive direction of the antenna. Locks tight. Can't tilt. Antenna stays in proper position at all times.



High impact polystyrene insulators are reinforced with strong aluminum shields. This gives quadruple strength in supporting triple-thick snap-in elements. Lifetime assembly with fitted aluminum cup to hold oversize aluminum rivet.



VL-5
 5 element VHF-FM
 5 driven elements
 List price \$16.95



VL-7
 7 element VHF-FM
 7 driven elements
 List price \$23.95



VL-15
 15 element VHF-FM
 9 driven elements
 6 parasitic elements
 List price \$46.95



VL-18
 18 element VHF-FM
 9 driven elements
 9 parasitic elements
 List price \$54.50

The FINNEY Company • 34 Interstate Street • Bedford, Ohio

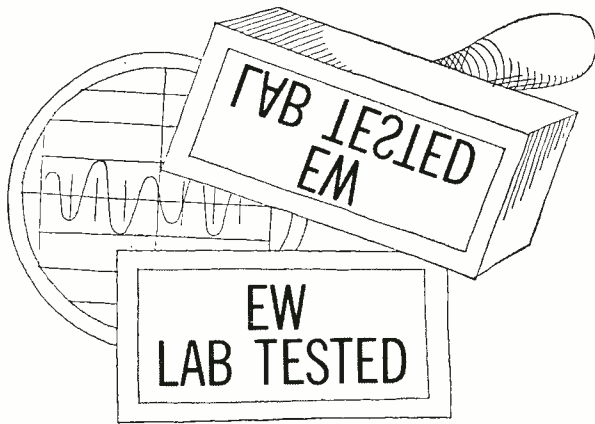

HI-FI PRODUCT REPORT

TESTED BY HIRSCH-HOUCK LABS

Uher 8000 Tape Recorder Electro-Voice "Sonocaster" Speaker

Uher 8000 Tape Recorder

For a copy of manufacturer's brochure, circle No. 60 on coupon (page 15)



It is interesting to see how much operating flexibility can be built into a tape recorder without unduly increasing its size, weight, and cost. The *Uher 8000*, manufactured in West Germany, is certainly one of the most versatile machines on the market, yet is complete in an attractive, plastic-covered case about the size and shape of a portable typewriter, and weighs about 23½ pounds. Because of its fully transistorized circuitry, it consumes only about 30 watts from the power line.

The recorder is a four-speed machine, with tape speeds of 1½, 1⅞, 3¾, and 7½ ips. It will record or play back four-track mono or stereo tapes, and has separate recording and playback systems so that a program can be monitored from the tape as it is being recorded. By means of a single function-selector switch, it can operate in mono or stereo modes, record a delayed playback signal for echo effects, play one track while simultaneously recording on the other, and copy one track on to the other, combined with an external program source.

A "Dia-Pilot" feature allows a control signal to be recorded on one track simultaneously with a spoken commentary on the other track, by pressing a button on the recorder. In playback, this tone can be used to change slides automatically on a slide projector designed for automatic operation. This makes possible a fully automatic slide program, with commentary, without an operator.

Although other recorders have many of these features, most of them require signals to be "patched" from the playback output to the recording input. In this unit, all signal connections are made by the function selector.

The speed change knob has an "off" position between each pair of speeds and turns the entire machine on and off. Being transistorized, it comes on instantly, without any warm-up. The recorder has built-in power amplifiers and monitor speakers, with playback volume and tone controls. It can also drive external speakers or amplifiers. There are separate recording level controls for microphone and radio inputs, which can be mixed. No provision is made for individual channel level or balance adjust-

ments. A control labeled "Balance" actually switches the playback amplifier from the input signal to the output of the playback amplifier for monitoring purposes. In mono reproduction it does control the volume balance between the two built-in speakers.

Colored lights clearly indicate the record or playback status of each channel, according to the setting of the function switch. Twin "vu-type" meters monitor recording and playback levels. There is an interlocked "Record" button, a "Pause" button which stops and starts the tape almost instantaneously, and an index counter. If the tape is fitted with metallic end leaders, the machine will shut off automatically at the end of a reel.

The stopping and starting of the tape transport is controlled by two "piano-key" push-buttons. A bar in front of the "Stop" button is moved to right or left for fast forward or rewind operation. All of the connectors are of the *Hirschmann* type widely used in Europe. Adapter cables, which terminate in standard American phono plugs, are supplied. The line cord is stored in a compartment in the rear of the recorder, which is covered by sliding doors when not in use.

The 7½-ips playback response, measured with an *Ampex 31321-04* tape, was ± 2.5 db from 80 to 15,000 cps, and was down 6 db at 50 cps. The over-all record/playback frequency response was within ± 3 db from 30 to 20,000 cps at

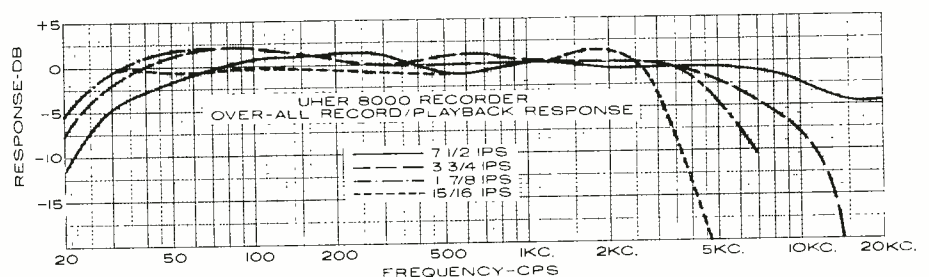
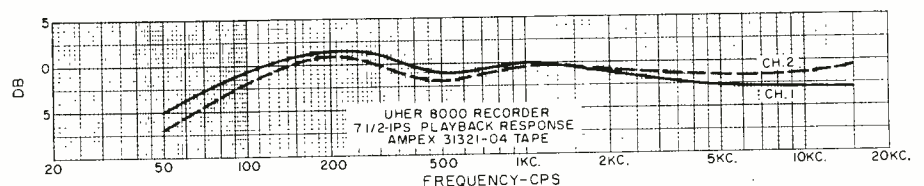

Scott's top rated LT-110 FM Stereo Tuner Kit now at a new low price...\$139.95!

"...1.88 uv sensitivity by a home alignment procedure without instruments...an exceptional feat..." *Electronics Illustrated*



Here's terrific news for kit builders! Now, the famous Scott LT-110 tuner kit . . . the same kit top rated by every audio expert . . . the same superbly engineered FM Stereo tuner built by thousands of hi fi enthusiasts . . . is now available in handsome new styling at a truly modest price.

Look at the outstanding features of this superb tuner. It includes a heavily silver-plated front end that is pre-wired and tested in Scott's engineering laboratories. The critical multiplex section is also completely pre-wired and tested with the most

advanced multiplex equipment available. Among the LT-110-B's many pluses: Stereo Separation in excess of 30 db, Sonic Monitor Stereo indicator, 60 db signal-to-noise ratio, sensitive tuning meter.

Here's what the technical editor of *Electronics Illustrated* said about the LT-110: "If you have hesitated to go into stereo FM because of imagined complexities and highly technical skills and knowledge that might be required, fear no more. The LT-110 shows you how to enjoy stereo FM the easy way."



New LK-72B 80-Watt Stereo Amplifier Kit. Here's a popular integrated stereo amplifier kit at an outstanding price. Rugged stereo output stages deliver 80-watts, can be used with any speaker systems. Every conceivable control feature is found on this versatile amplifier including a switched front panel headphone output, complete recording facilities, and provision for driving a third or center channel loud-speaker system without additional amplification. Only \$149.95

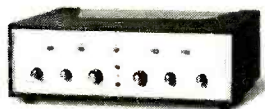

LK-48B 48-Watt Complete Stereo Amplifier Kit. More than enough power for the majority of music systems. The all-new LK-48B has two new convenience features, a switched front panel headphone output for private listening, and a powered center channel output to drive extension speakers. 13 front panel controls. Complete tape recording facilities. Typical Scott luxury features include all-aluminum chassis and DC-operated heaters for lowest hum. Only \$129.95

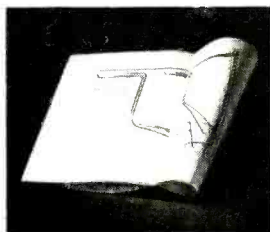

Exclusive FULL-COLOR instruction Book "eliminates just about the last possible chance of wiring errors . . ." Every part and every wire are shown in natural color and proper position. In addition, each full-color illustration in the instruction book is accompanied by its own PART-CHART, another Scott exclusive. The actual parts described in the illustration are placed in the exact sequence in which they are used.

FREE 1965 STEREO GUIDE

H.H. Scott, Inc., 111 Powdermill Rd., Maynard, Mass.



160-12

- Please send me your new 20-page full-color 1965 Stereo Guide and complete catalog.
- Send me complete information on new consoles by Scott . . . component quality in beautiful, hand-finished cabinets.

Name

Address

City..... Zone..... State.....

SCOTT®

Price slightly higher West of Rockies. Subject to change without notice.

W91OP PUTS THE WORLD AT YOUR FINGER TIPS!



FAMOUS "SECOND OP"

Essential DX operating aid, provides vital data like: beam headings; list of world QSL bureaus; includes logging space. See needed prefixes at a glance, increase your odds of a QSO because you have full information instantly.



NEW "Q" DIAL

A must for every active operator, ham or C.B. Over a dozen vital information tables including: Q-signals, 10-signals, abbreviations, all U.S. radio districts and prefixes, time conversion, logging space for CW-SSB-CB. Saves time for efficient operation.

At your E-V microphone headquarters, or send \$1.00 each to:
ELECTRO-VOICE, INC.
Dept. 1243N, Buchanan, Michigan 49107

Electro-Voice
SETTING NEW STANDARDS IN SOUND

CIRCLE NO. 180 ON READER SERVICE PAGE 20

7½ ips, 25 to 7000 cps at 3¾ ips, 22 to 5000 cps at 1⅞ ips, and 22 to 3100 cps at 1⅜ ips. The fast-forward and rewind tape speeds were relatively slow, requiring about 3 minutes to handle 1200 feet of tape.

Wow and flutter at 7½ ips were 0.02% and 0.10% respectively as measured with the Ampex 31326-01 tape. At slower speeds, no wow or flutter could be heard, except at 1⅜ ips, where the flutter was audible. Since this speed would normally be used only for voice recording, this is of little importance. The signal-to-noise ratio of the recorder ranged from 51 db at 7½ ips to 42 db at 1⅜ ips.

In use tests, the recorder proved itself capable of excellent sound when played through an external amplifier and speaker system. Good "background-music" quality was obtained at 1⅞ ips. Using a 3600-foot reel of ½-mil tape, up to 13 hours of stereo or 26 hours of mono programs can be recorded on one 7" reel at 1⅞ ips. A voice-operated dictation accessory, which starts and stops the tape automatically, is available. Using the 1⅜ ips speed, over 50 hours of dictation can be recorded on one reel of tape.

Despite its unusual flexibility (or perhaps because of it), the unit does have its drawbacks. The functions of several of the controls are by no means clear from their labeling. The instruction manual is comprehensive and is written in four languages. This is not a machine which can be used without studying the manual, no matter how familiar the user is with other tape recorders.

The sound quality through the built-in speakers is minimal; in fact, negligible difference can be heard between the 1⅜ and 7½ ips tape speeds.

A machine such as this is most likely to appeal to the user with special interests and requirements, such as slide programming, dictation, special-effects recording, and the like. It is hard to beat for such applications and it is also capable of good, high-fidelity sound when used with an external playback system. Its light weight and compact dimensions make it a truly portable recorder, unlike many which have carrying handles but are actually too heavy to carry for any appreciable distance.

The Uher 8000, which is handled in the U.S. by Martel Electronics Sales, Inc. of Los Angeles, sells for \$499.95. ▲

Electro-Voice "Sonocaster" Speaker

For copy of manufacturer's brochure, circle No. 61 on coupon (page 15).

WITH the growing popularity of outdoor and patio living, there is a corresponding need for high-fidelity components that can bring good music out of doors. It is a simple matter to extend speaker wiring, but conventional speakers are rarely adaptable to out-of-doors use. Even if they are small and light enough to be carried outside, their furniture finishes are easily damaged by sun and rain, and most speaker cones do not take kindly to wetting.

The new Electro-Voice "Sonocaster" is an interesting and very satisfactory solution to the outdoor speaker problem. It is a portable unit, equally suited to being carried from room to room within the house, out of doors, or on a vacation

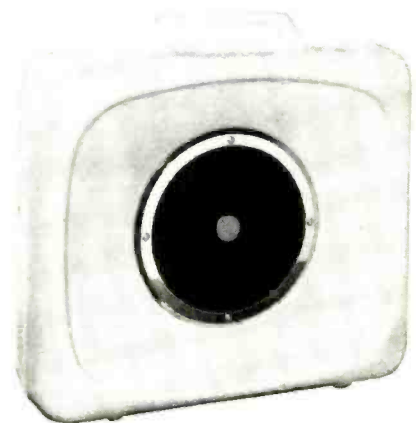

trip. It resembles a small piece of luggage, about the size of a portable type-

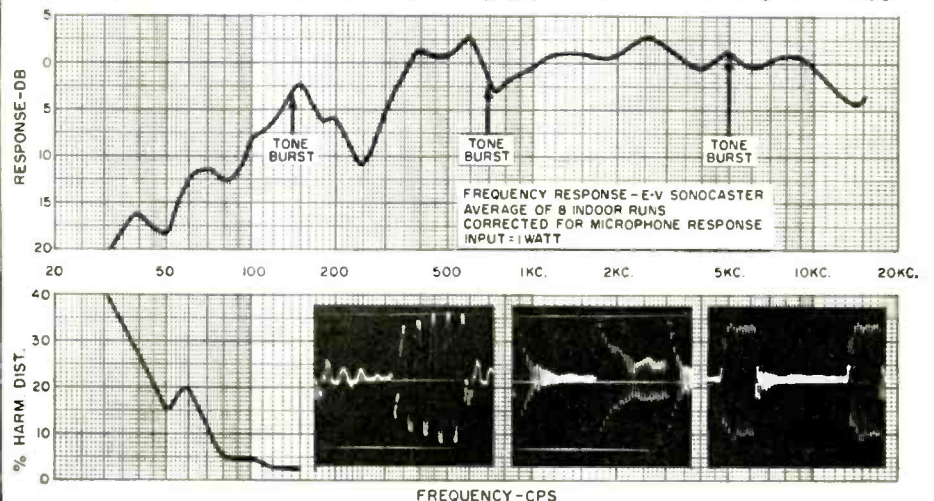

ELECTRONICS WORLD



Can you recognize these three great stars?

The first two are obvious to movie goers: Rock Hudson and Doris Day starring in Universal's new comedy, "Send Me No Flowers." The third is ours and it's on the table. It's the Incomparable Concertone 800. This unique stereo tape recorder plays a vital role in this hilarious new movie. When the script called for a tape recorder, Universal Pictures wanted the finest, most modern machine available. That's why they selected the Concertone 800 to appear. It's as modern and sophisticated as the live stars of the movie. □ The

Concertone 800 is the only stereo tape recorder with double Reverse-o-matic® and six heads—allowing you to record and play continuously without reel turnover. The 800 (portable or tape deck) is priced realistically and provides an exclusive combination of features. It starts as low as \$379.95. Send for a free Concertone 800 brochure and the name of your nearest dealer. Write to Concertone, Box 3866, South El Monte, Calif.

C O N C E R T O N E 

ROCK HUDSON and DORIS DAY star in "SEND ME NO FLOWERS"

New Bogen sound products deliver the message best

In the factory

Reach important executives and production personnel in noisy areas. Provide background music for improved morale and production. Bogen does it best.

New!

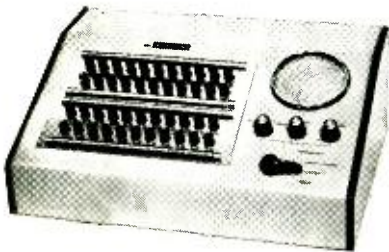

New SA Series Intercom/P.A. Systems. High-powered (12w.) intercoms for 21 or 42 stations; optional chime and light annunciators; emergency all-call paging; inputs for music program sources; 25v. output; mixes private and non-private remotes in any combination; provision to add booster amplifier.

In the office

Inter-office phones save time and steps, keep the telephone switchboard from being overburdened. Bogen does it best.

New!



Series "TSL" Telephones. Sell your customer the economy of unique inter-office telephone. Fast (no dialing); 100% trunkage; no central switchboard; conference calls; desk or wall mounting; provision for paging thru plant P.A. system. Systems for up to 16 phones.

In the school

Efficient communications systems guarantee, increased efficiency — portable players enhance music, drama, and extra-curricular programs. Bogen does it best.

New!



New Bogen "VP" Series All-Transistor Portable High Fidelity Transcription Players. 20 to 40 watts (sine wave ratings). Handsome carrying cases. Exclusive variable-speed control. Automatic cueing. Inputs: 2 mic., tape, tuner, phono.

In the church

Sound systems deliver the "message" loud and clear throughout the church—serve to assure successful social events as well! Bogen does it best.

New!

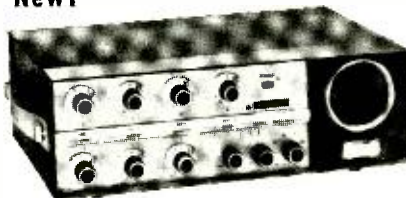

Bogen MX30A and MX60A Deluxe 30-watt and 60-watt P.A. Amplifiers —with 5 mic. inputs; peak limiter; power curve—21 to 30,000 cps; calibrated low-frequency notch filter; 5 speech filters; remote volume control and mic. precedence; frequency response—10 to 38,000 cps; wide variety of accessories.

For Fall Catalog write desk W-12, Bogen Communications Div., Paramus, N.J.

writer, with a carrying handle on top. The "Sonocaster" is made of a tough, flexible, beige-colored plastic, and weighs only 8 pounds. It has mounting clips for permanent or semi-permanent wall or post installations.

According to the manufacturer, the speaker is unaffected by weather and may be left out of doors permanently. Its driver is an 8-inch unit, completely waterproofed, including the cone. It has a 2½-inch-diameter "whizzer" cone, for improved high-frequency response, with a mechanical crossover from the main cone at 6000 cps. This is the well-known "Radax" design which has been used in E-V speakers for many years. The speaker is built on a heavy, die-cast frame and has a ceramic magnet assembly.

The specifications of the speaker state that its frequency response is from 70 to 13,000 cps, with a peak power handling capacity of 30 watts. We tested the unit indoors, making response measurements at eight different microphone locations. The averaged response curve is noteworthy for its exceptional smoothness at middle and high frequencies. From 330 cps to 12,000 cps, its output is uniform within ±3 db. At lower frequencies, the output naturally falls off, with a hole at 250 cps and a peak at 150 cps. These are probably due to resonance effects within the non-rigid enclosure, which vibrates perceptibly. The harmonic distortion is acceptably low down to 70 cps, and the total response variation from 70 to 15,000 cps is ±7.5 db. Not only does this diminutive speaker, which encloses less than ½ cubic foot, cover most of the audio frequency spectrum as well as many far larger and costlier speakers, but it easily meets its advertised specifications. This is relatively unusual among speakers, in our experience.

The tone-burst response of the speaker was quite good at low and high frequencies, although it had a pronounced ringing at 700 cps which appeared to be associated with an enclosure resonance. At 5 kc., the tone-burst response was nearly perfect, which is consistent with the speaker's flat response in the upper frequency region.

The unit sounds very fine indeed. Its quality is fully compatible with any good high-fidelity system, with clean, extended highs and good over-all definition. The lows, of course, are a trifle thin, but one is not aware of this unless the sound is compared to that of a larger system with good bass response. It can be used effectively to up-grade the sound of portable phonographs, transistor radios, and TV sets, as well as for portable p.a. applications. Voices are reproduced with excellent, natural quality, free from boominess or unpleasant coloration.

The *Electro-Voice* "Sonocaster" is priced at \$36.00. ▲

BOGEN
COMMUNICATIONS DIVISION



LEAR SIEGLER, INC.

you get **PRODUCT PLUS** from your Sylvania Distributor

suddenly

**COLOR TV
HAS A NEW
RED STANDARD**

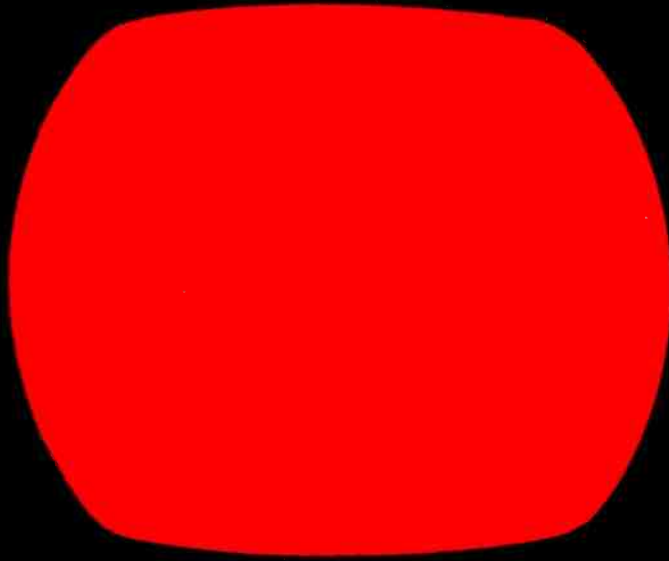

Sylvania's new EUROPIUM RED.

New COLOR BRIGHT 85 picture tube brings more natural color to television and increases monochrome brightness 43%.*

The startling news in the television industry is Sylvania's new picture tube, and its new, truer red phosphor.

EUROPIUM RED, developed at GT&E Laboratories, is the brightest red known to the industry. And, to match it, now the full brightness of blue and green is used. The result is a color picture tube that gives the entire television industry a boost.

Because the COLOR BRIGHT 85 tube is *really* bright, dealers can demonstrate color TV effectively in normally lighted showrooms. As the set's brightness is adjusted, the colors remain true—not shifting to unnatural tones in the highlights of the picture.

Another thing, black and white performance is far better than you've ever seen before in a color tube. Be-

sides the increased brightness, there's improved contrast in a sharp, vivid picture.

The new, exciting COLOR BRIGHT 85 picture tube is a product plus from Sylvania for the entire color television industry, and particularly for dealers. In color, as in black and white, you know it's good business to handle the Sylvania line.

SYLVANIA
SUBSIDIARY OF
GENERAL TELEPHONE & ELECTRONICS GTE

NEW CAPABILITIES IN: ELECTRONIC TUBES • SEMICONDUCTORS • MICROWAVE DEVICES • SPECIAL COMPONENTS • DISPLAY DEVICES

*Tests show the COLOR BRIGHT 85 tube is 43% brighter, on the average, than standard color picture tubes.

EICO BRAND NEW FOR '65

NEW EASY-TO-BUILD EICO KITS / OVER 230 LABORATORY PRECISION KITS

COLOR TV LAB

THREE COMPACT, PORTABLE INSTRUMENTS FOR SHOP OR HOME COLOR TV SERVICING. ADD ONE MORE AND YOU'RE SET FOR FM-MPX STEREO.

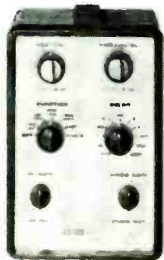

EICO 380 COLOR GENERATOR

PORTABLE. SOLID STATE N.T.S.C. STANDARD COLOR SIGNAL & DOT-BAR GENERATOR (PAT. PEND.). **GENERATES 11 DIFFERENT COLOR SIGNALS**, ONE AT A TIME. PROVIDES N.T.S.C. COLOR SIGNALS EXACTLY AS SPECIFIED. TAKES THE GUESSWORK OUT OF COLOR TV SERVICING.
KIT ONLY \$129.95.
WIRED \$169.95.

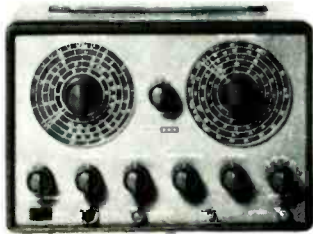

EICO 369 SWEEP AND POST-INJECTION MARKER GENERATOR

FOR EASIEST, FASTEST VISUAL ALIGNMENT OF COLOR OR B & W TV AND FM RF AND IF CIRCUITS. FIVE SWEEP RANGES FROM 3-220 MC/S. FOUR MARKER RANGES FROM 2-225 MC/S. CRYSTAL MARKER OSCILLATOR. POST INJECTION OF MARKERS.
KIT ONLY 89.95.
WIRED \$139.95.



EICO 435 3-INCH OSCILLOSCOPE

ULTRA COMPACT! TAKE IT ALONG ON SERVICE CALLS. BRIGHT, **SHARP TRACE** ON FLAT-FACE 3-INCH CRT **EXPANDABLE** SEVERAL DIAMETERS. FLAT DC TO 4.5 MC/S. EDGE LIT CALIBRATION GRID. ZENER CALIBRATOR. **OUTPERFORMS 5-INCH SCOPES** THREE TIMES AS BIG AND TWICE AS HEAVY. TRUE LAB QUALITY.
KIT ONLY \$99.95.
WIRED \$149.95.



EICO 342 FM-MPX SIGNAL GENERATOR

FOR PROFITABLE SERVICING IN THE FAST-GROWING FM STEREO MARKET. PROVIDES BOTH A COMPOSITE AUDIO SIGNAL FOR DIRECT INJECTION INTO MPX SECTION AND FM RF PLUS SYNC OUTPUT.
KIT ONLY \$99.95.
WIRED \$149.95.



THESE FAMOUS BEST SELLERS FROM EICO'S SELECTION OF 230 KITS AND WIRED UNITS.

EICO 232 VTVM PEAK-TO-PEAK



KIT \$29.95.

WIRED \$49.95.

A MUST FOR COLOR OR B & W TV AND INDUSTRIAL USE. 7 NON-SKIP RANGES ON ALL 4 FUNCTIONS. WITH UNI-PROBE®.

EICO 667 TESTER



TESTS RECEIVING, SPECIAL PURPOSE, NUVISTOR AND COMPACTRON TUBES FOR **DYNAMIC CONDUCTANCE**. TWO-STEP TRANSISTOR TEST.

KIT \$79.95. WIRED \$129.95.

TUBES & TRANSISTORS

EICO 324 RF SIGNAL GENERATOR



150 KC/S TO 435 MC/S RANGE. FOR IF-RF ALIGNMENT AND SIGNAL TRACING OF TV, FM, AM, CB AND MOBILE. BUILT-IN AND EXT. MODULATION.

KIT \$28.95. WIRED \$39.95.

EICO 460 5-INCH OSCILLOSCOPE



KIT \$89.95. WIRED \$129.50.

DC WIDEBAND 0-4.5 MC FOR COLOR & B & W TV SERVICE & LAB USE. PUSH-PULL DC VERTICAL AMP. BAL. OR UNBAL. INPUT. AUTOMATIC SYNC LIMITER AND AMP.

EICO 1064 DC POWER SUPPLY



KIT \$45.95. WIRED \$54.95.

FOR BENCH TESTING AUTORADIOS, CB, MOBILE AND TONE EQUIPMENT. VOLTMETER AND A.M. METER. LOW RIPPLE FOR TRANSISTOR EQUIPMENT. 0-8V/0-16V OUTPUTS.

NEW

EICO SENTINEL 23 CITIZENS RADIO



CRYSTAL CONTROLLED TRANSMIT AND RECEIVE ON ALL 23 CHANNELS. TRANSISTOR POWER SUPPLY. "S" METER. EXCEEDS ALL FCC STANDARDS. A BEST BUY AT ONLY \$189.95 WIRED.

NEW EICO 3566 SOLID STATE FM-MPX STEREO TUNER AMPLIFIER



IN THE HIGHEST QUALITY RANK, WITH 43 TRANSISTORS, 19 DIODES, 6 RECTIFIERS. • 112 WATTS INTO 4 OHMS • 72 WATTS INTO 8 OHMS. • 38-40 DB CHANNEL SEPARATION. • AUTOMATIC STEREO SWITCHING. • INTERSTATION MUTING. FRONT-END, IF AND MPX SECTIONS PRE-WIRED AND PRE-ALIGNED. PLUG-IN TRANSISTORS.
KIT ONLY \$229.95. WIRED WITH CAB. \$349.95.

MOST COMPLETE LINE OF KITS AND WIRED TEST EQUIPMENT, CB AND HI-FI COMPONENTS.

SEND FOR  **FREE KIT-O-LOG**

EICO Electronic Instrument Co., Inc. Flushing, New York 11352

EW-12

SEND 1965 KIT-O-LOG LISTING 230 EICO PRODUCTS.

NAME _____

ADDRESS _____

CITY _____ STATE _____ ZIP _____

NEW SCR DEVELOPMENTS

Some of the recent four-layer gate-controlled semiconductor switches are very low in cost, are self-protecting, and are transient-immune. Bilateral SCR's are also readily available.

By DONALD LANCASTER

THE silicon controlled rectifier has come of age. These four-layer gate-controlled semiconductor switches are now used in an amazingly diverse range of applications. SCR's are now directly replacing ignitrons, power thyratrons, and other bulky, inefficient devices, operating as high as 1500 volts at current levels exceeding 500 amperes. They are now serving as microminiature, lightweight switches in computer and satellite circuitry, reliably switching milliamperes of current at low voltage levels. They enable power supplies and regulators to operate in switching mode at efficiencies very nearly approaching 100%. SCR's serve in motor and power-tool controls that provide variable speed and variable torque at the turn of a knob. An entire industry has begun with the SCR home light dimmer and workshop power-tool controls. In special circuits, the SCR is an efficient radar modulator, a power inverter, and an effective d.c.-to-d.c. converter.

There have been some recent developments in the SCR field that promise to make these components even more useful and may possibly create a whole new class of circuitry that has no present counterpart. These same developments can also greatly simplify currently popular devices as well as contribute to reduced cost.

These recent developments take several directions, the most significant of which are extremely low-cost SCR's, self-protecting SCR's, and transient-immune SCR's. Of equal importance are newly

Some typical examples of low-cost silicon controlled rectifiers showing their simple case design.

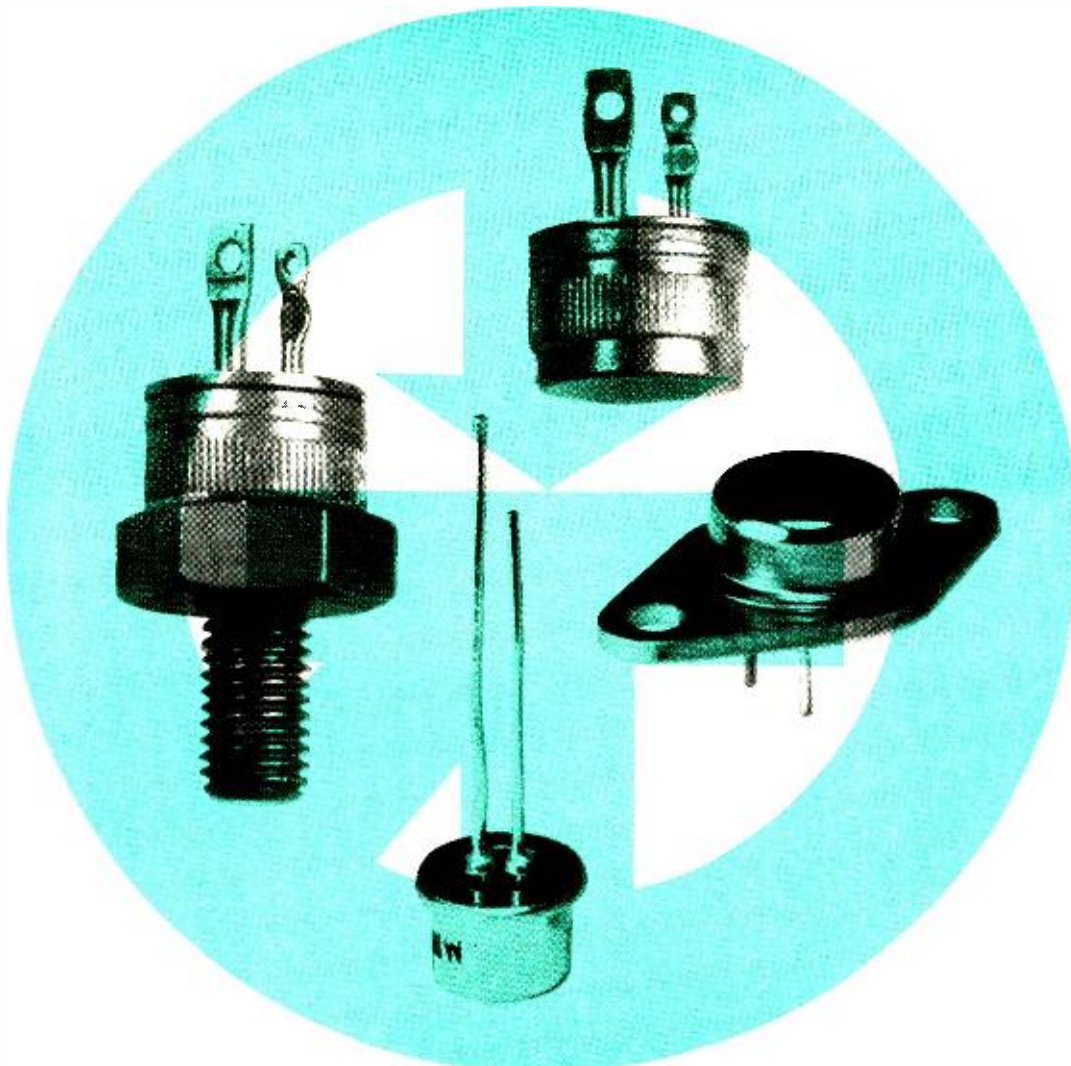

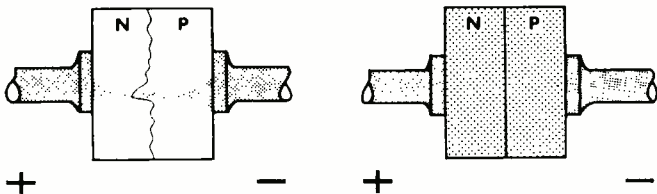

Fig. 1. When the reverse breakdown of a non-uniform p-n junction (left) is exceeded, it breaks down at its weakest point. High current density at this point melts the structure and creates a short. A uniform, controlled-avalanche structure breaks down uniformly across the entire surface. Under these conditions, the current density is low and no damage is done.

available SCR "offspring." These include a class of SCR's that can be turned off by a gate pulse as well as on, and new bilateral SCR's that work equally well in either current direction. The former may be operated from an uninterrupted, uncommutated d.c. source. The latter are capable of operating directly off the a.c. line, allowing a single bilateral SCR to provide full-wave, non-inverted proportional a.c. control without the use of other power components.

We will assume that the reader has a basic familiarity with the conventional SCR and its operation. (See "Silicon Controlled Rectifiers" in the October 1963 issue of this magazine, one of the SCR manuals, or design information provided by virtually all the SCR manufacturers, *Motorola, Texas Instruments, General Electric, RCA, Transistron, Sarks Tarzian, International Rectifier, SSPI, Westinghouse*, among others.) Suffice it to say that the SCR is a four-layer semiconductor switch that is capable of switching large amounts of current through the use of minute control signals applied to a third or gate electrode. This article will investigate these new developments which promise to make the new silicon controlled rectifiers intrinsically more useful.

Economy SCR's

One of the most welcome developments is the creation of a line of economy SCR's which are designed for the consumer electronics market for use in appliances and dimmers. SCR's are now available, in quantity, for less than \$1.00 apiece and singly for slightly over \$1.50. These SCR's can control 5 amperes at 200 volts, while lower voltage SCR's are available at even lower cost. The new SCR economy has been achieved by employing several techniques. One is planar construction, a more efficient method of fabricating the silicon structure which is the heart of the SCR. A second factor is sheer volume of production and high production yields made possible by volume markets and automatic equipment.

The most significant contribution to reduced cost has been the redesign of the case. Since a large fraction of any semiconductor's cost is in the case, the leads, and the assembly, the hermetically sealed, stud-mounted design has been abandoned in favor of cases which are merely tabs or small cups of metal. These inexpensive packages are entirely adequate for the environmental conditions encountered in consumer products.

Each manufacturer has his own approach to an ideal economy package. Some of these are shown in the photographs. *RCA* uses a flat diamond-shaped washer and a small metal cup. This is similar to the typical power-transistor case, although much lighter and smaller. This package is usually bolted or riveted to a heat sink. *Texas Instruments* uses the top-hat diode case, now with two leads out the top. It is soldered directly to a heat sink (usually with a disc solder preform and an oven) or glued to a beryllium oxide insulating washer. The anode connection is by way of a spring clip or directly through the heat sink. The *Transistron* package is a simple cup, somewhat similar to the *TI* design.

Motorola uses a special cartridge type case designed to fit into a fuse clip or be soldered directly to a heat sink. This is one of the smallest SCR packages presently available at the

8-ampere current level. *General Electric* uses a press-fit cup for its economy SCR's, similar to the diodes used on automotive alternators. Many other manufacturers use this same package on their 18- to 25-ampere medium-power SCR's. This type of package lends itself to easy mounting as it is simply pressed into a .500-inch hole in a heat sink. An arbor press is normally used for this operation, but an ordinary bench vise works just as well.

Manufacturers, in their volume packaging, haven't forgotten the small-quantity manufacturer or the experimenter. Almost all of the types shown have modified designs which

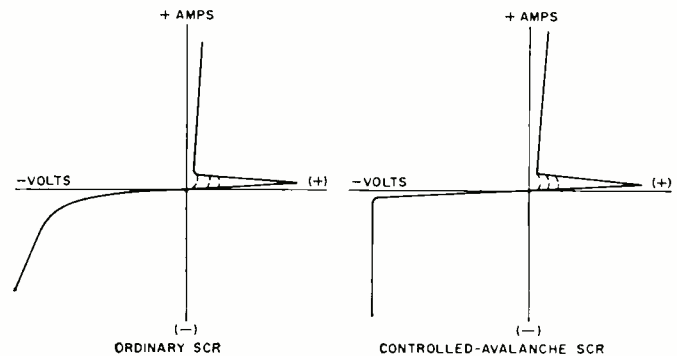

Fig. 2. The sharp zener knee in the reverse direction of the controlled-avalanche SCR makes this device self-protecting. Transients are absorbed without local destructive breakdown.

provide studs or additional leads to allow the traditional nut-and-bolt type of assembly. Obviously, these additions increase the SCR cost, but in many instances the modified case is priced only 10 to 25 cents above the production case.

SCR's are now available from many manufacturers in a choice of case connections. In the older SCR's, the case was invariably connected to the anode of the structure to permit rapid dissipation of heat. The new planar construction eliminates this requirement as heat sinking at the cathode is just as efficient. The price of the SCR with either connection is the same. This leads to greatly simplified heat-sink design in circuits operating two SCR's back-to-back or in circuits using multiple SCR's. This, in itself, can drastically reduce complexity and assembly time in many circuits.

There is a tremendous hidden significance in this new SCR economy. Previous SCR applications replaced the thyatron,

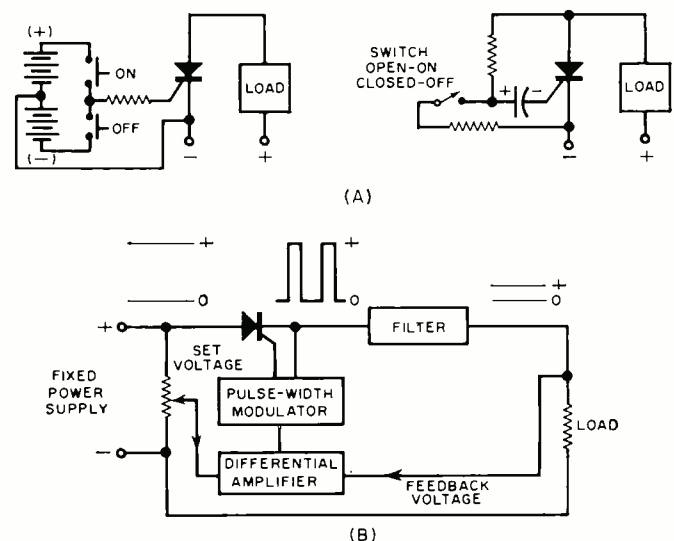

Fig. 3. (A) Using gate turn-off SCR as a latching relay. When the gate is pulsed positive, the SCR turns on. With a negative pulse, SCR turns off. (B) A switching-mode regulated supply with very high operating efficiency. Varying the on time compared to off time of the fixed power input results in a variable power output. The filter smooths out the on-off-on-off waveform so that resultant output is a smooth d.c. voltage.

the ignitron, the variable autotransformer, the magnetic amplifier, and others. Practically all present SCR applications have had their earlier counterparts. The new SCR economies and small sizes open the way for a host of new industrial and consumer applications that have been impractical or prohibitively expensive until now.

For instance, dimmers built directly into conventional desk and table lamps will allow the brightness of the lamp to be varied to suit individual needs. Power tools whose speed or torque increases as the trigger pressure is increased are now possible, as is soldering equipment with instantly and continuously variable temperature control. Also in the cards are store-lighting fixtures that can automatically compensate for increases and decreases in daylight levels, photographic lighting that provides exact shadow control—the list is limited only by the imagination of the designer. These are not expensive “dream devices” but currently feasible low-cost devices which should be available soon.

The currently popular wall-mounting dimmers and home workshop power-tool controls offer just a hint of the vast possibilities of economical SCR a.c. proportional control.

Self-protecting SCR's

Protecting SCR's against voltage transients has been a severe design problem ever since their introduction. The problem becomes especially critical in high-voltage, high-current industrial motor and process controls. Transient protection is mandatory in reversing motor drives where a shorted SCR can destroy a motor, or perhaps an entire production line.

The specific problem is reverse breakdown. A voltage transient in the forward direction merely turns the SCR on. In the reverse direction, when the peak inverse voltage of the SCR was exceeded, violent breakdown occurred, ruining the SCR and perhaps the rest of the circuit. Previously, SCR controls had to have protecting varistors, thyristors, and other transient suppression circuitry.

A new technique eliminates all of this. Called “controlled avalanche” this new breed of SCR's is made to behave like a zener diode when its peak inverse voltage is exceeded. The transient is simply absorbed by the SCR and dissipated as heat. Not only is the SCR not damaged, but it has eliminated a transient that could do further circuit damage.

To explain controlled avalanche, we must delve into a bit of solid-state physics. The troublemaker in this case is temperature. If the instantaneous temperature of any part of a semiconductor gets too hot, it simply melts and loses its semiconducting properties. The cause of temperature is heat and, in this case, the cause of the heat is current. It is not current itself, but *current density* (amps./sq. in.) that causes the destructive temperature rise.

This effect can be demonstrated by first passing a 5-amp current through a #14 wire and then repeating the experiment with #40 wire. Although both wires passed the same current, one is still at room temperature while the other has disintegrated in a wisp of smoke.

By the same token, a substantial current can flow through a semiconductor *if it flows through the entire available cross section*. On the other hand, if that same current is concentrated in a small area, the temperature rise may be destructive. This is shown in Fig. 1, where a uniform and a non-uniform *p-n* junction is diagrammed. The non-uniform junction will reverse breakdown at the defect shown. The resultant high current density will destroy the junction at this point. Since the other semiconductor regions around the defect have not broken down, they conduct no current. The short produced exists only over a very small area, but it is still a short. The uniform junction breaks down uniformly. The same current as before is now distributed over the entire surface. The resultant current density is very low. Although the same amount of heat is produced in both cases, the uniform junction temperature remains at a safe level.

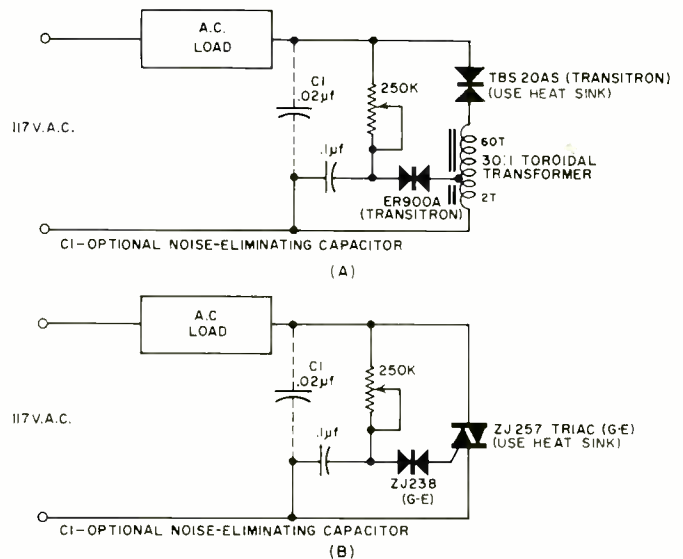
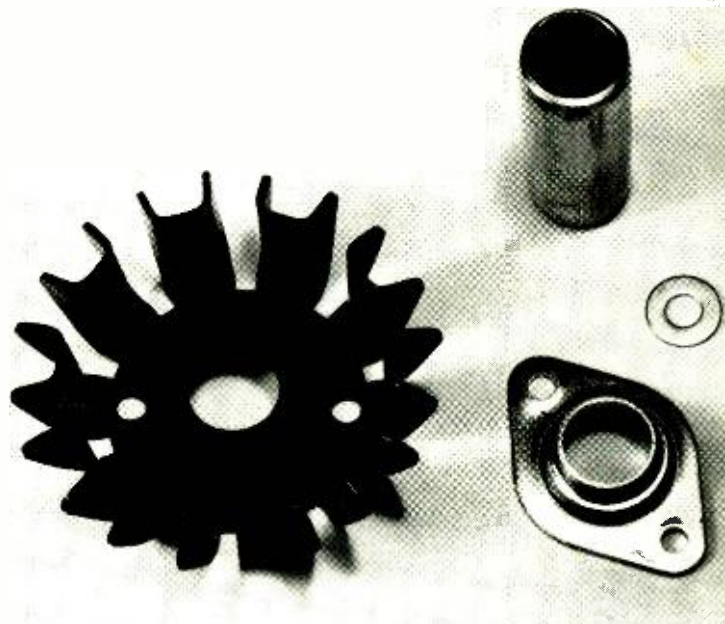

Fig. 4. (A) The new bilateral SCR's extremely simple light-dimmer and power-control circuitry. This circuit uses gateless bilateral SCR to give full-range 600-watt proportional control. (B) The gated bilateral SCR allows 600-watt a.c. proportional control with only four parts. Performance and cost are about the same as circuit shown at (A). Both types of bilateral SCR are available in much higher power ratings.



Typical mounts for press-fit SCR's. Half-inch hole is used.

In an ordinary diode or SCR, reverse breakdown first takes place in one or two small regions, damaging the device. In a zener diode, and in the new controlled-avalanche SCR's, reverse breakdown is uniform across the entire junction, preventing damaging local temperature rise. Fig. 2 compares the reverse breakdown of a regular and a controlled-avalanche SCR.

Controlled avalanche results from careful SCR design and improved control of the SCR properties during fabrication. Beveling the silicon structure in a critical manner helps create the required uniform breakdown. Passivating the silicon structure (coating with a “paint” of oxide or nitride) also prevents edge or surface contamination that could encourage uneven breakdown.

The significance of the controlled avalanche SCR lies in its inherent self-protection. The SCR is now a *transient-eliminating* device instead of a

(Continued on page 70)

PORTABLE TV SETS

By LESLIE SOLOMON, Associate Editor

With the development of the low-power CRT, a number of transistorized portable TV sets have made their appearance. New a.g.c. systems and a unique method of generating intermediate high voltage have been developed for these circuits.

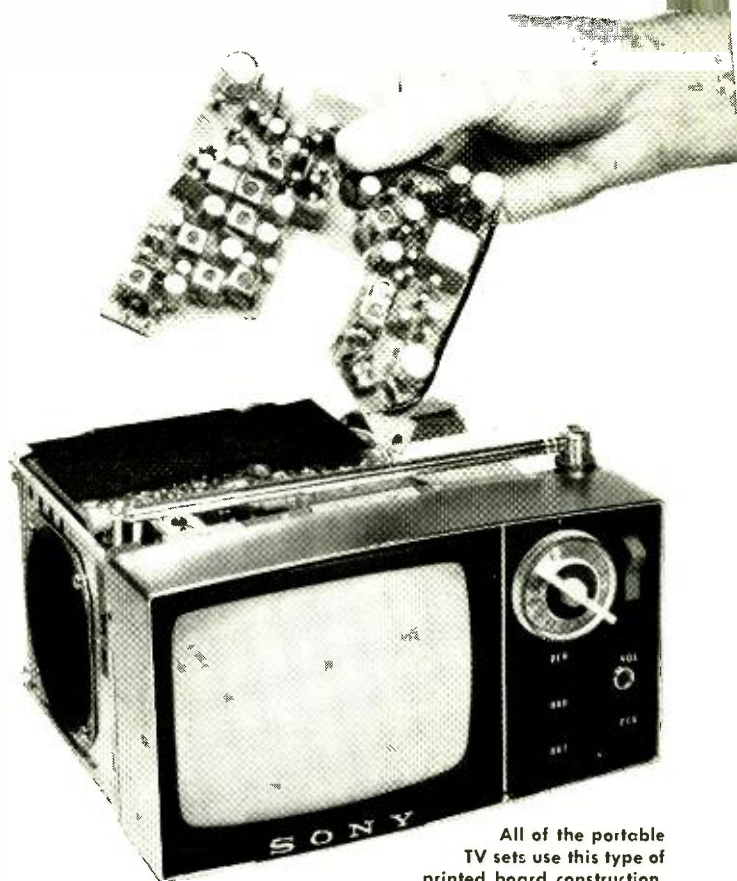

All of the portable TV sets use this type of printed board construction.

IN the early days of TV, sets were physically large but screens were small, and, in fact, the 10-inch version reigned supreme for a long time. As TV reached more people, the demand for a larger screen soon followed and set picture size went up through 19-, 21-, 24-, and even 30-inch direct-view CRT's. For a short period of time even these were not large enough, and projection systems became the vogue.

During the past few years, however, some standardization in picture tube size has come about, and the bulk of today's a.c.-powered sets consist of an 11- to 19-inch version used as a so-called portable and a 23-inch version usually used as the living room set. These are all a.c.-powered and use vacuum tube circuits. There are, at the present writing, some a.c.-powered transistorized sets appearing on the market. However, this article covers only the fully portable sets; that is, sets that are *not* dependent on the a.c. line as a source of power (although they all can be operated in this fashion if desired).

The key to the fully portable TV set is the transistor and the low-power-consumption CRT. As is well known, the transistor is perfectly capable of full operation at reasonably low supply voltages (about 12 v.) and a lot of basic research has gone into the development of a low-power CRT. For example, the 5-inch rectangular CRT as used in the *Sony* Model 5-303W has a 12-v. heater at 70 ma. for a total heater power of less than 1 watt; it uses an 8 kv. anode voltage at a beam current of 50 μ a.; deflection angle is 70°; it needs no ion trap, focusing is electrostatic, and the control grid requires only -25 volts for full spot extinction. Although the tube has a diagonal screen dimension of 5 $\frac{3}{4}$ inches, its full length is only 6 $\frac{1}{2}$ inches. This small tube has a horizontal resolution of 300 lines and a vertical resolution of 400 lines for a full picture.

Other sets covered in this article also use very low power CRT's. However, there are some differences in the deflection angle. For example: *Delmonico* uses a 4 $\frac{1}{2}$ -inch, 55° tube; *Sony* uses a 5-inch, 70° tube; *Reclatone* has a 6-inch, 90° tube; *Sharp* uses a 6-inch, 90° tube; while *Panasonic*, *Philco*, and *G-E* use 9-inch, 90° tubes. Without exception, all of these miniature CRT's are rectangular and their screen color ranges from black-and-white to an off blue.

Although the sets are classified as completely transistorized, they do use tiny, low-power vacuum diodes as high-voltage rectifiers. This high voltage (approximately 4 to 8 kv.), generated by the horizontal output transformer, is used to operate the CRT. For the lower d.c. voltages such as used for CRT focus (approximately 0 to 150 v.), second grid voltage (approximately 300 v.), and the d.c. voltage for the video amplifier (approximately 60 v.), semiconductor rectifiers are used.

The horizontal output transformer is used primarily as a power transformer (the horizontal yoke is driven directly from the horizontal output transistor), and the vacuum diodes are used as voltage doublers or triplers to supply the necessary high voltage for the CRT. As these diodes require very low filament power, a one- to two-turn filament winding around the transformer core will suffice for their heater operation.

Set weight ranges from about 8 to 13 pounds. In most cases, this does not include the weight of the external battery and case that may reach another 5 pounds. The one set that includes the battery within the body of the case (*Delmonico* 4-inch) weighs a total of 8 $\frac{1}{2}$ pounds.

Because the sets are classified as "personal portables," they have provisions for individual earphone operation. When the earphone is plugged in, the loudspeaker is taken out of operation.

Disassembly of the sets for service is relatively easy. A typical set uses a number of separate circuit boards that are easily removable from the mounting frame. This permits rapid replacement of a faulty board so that the set can be placed back in service promptly. (See photo above.)

Available Sets

As previously stated, the sets covered in this article are fully transistorized and do not depend on the a.c. power line for operation. The sets shown on the cover are representative of those presently available to the prospective purchaser. Several companies, both Japanese and American, have plans to market other screen sizes in the near future. In fact, some of the manufacturers represented on the cover have sets with other size screens on the market now, and the models shown

on the cover are only a sampling of present portable lines.

All presently available, fully portable sets are designed to operate either from a 12-volt d.c. (battery) source or from the 117-volt a.c. power line. Almost all have provisions for operation from a 12-volt automobile storage battery.

The battery power for these sets is obtained from rechargeable cells. One set (*Delmonico* 4-incher) has the batteries mounted within the body of the TV set while others use some form of separate battery holder. Connection to the set is through a polarized power cable. In some cases, the battery recharging circuit is within the set itself, while in others the recharger is mounted in the battery holder.

Circuit Innovations

The bulk of the circuitry used in these small sets is quite conventional for transistorized circuits. Tuner circuits, video and sound i.f. stages, audio amplifiers, and power supply circuits are not very different from set to set. Most of them use four stages of stagger-tuned video i.f. amplifier, except for the *Panasonic* which uses three. All use 4.5-mc. inter-carrier sound systems. Most of the major circuit distinctions lie in the a.g.c. and sweep circuits.

The a.g.c. circuit used in the *Sony* Model 5-303W (5-inch set) is shown in Fig. 1A. This fast-acting circuit is designed for 1/1000 of a second operation as opposed to the 1/10- to 1/20-second action of conventional a.g.c. systems. This permits set operation in a moving vehicle where signal level can vary at 1/100-second rate and also serves to reduce flutter caused by passing aircraft.

Operation of the circuit is as follows. Transistor *Q1* is a 25-mc. oscillator that cannot oscillate until d.c. voltage is applied to the circuit. The base of this transistor is supplied with the video signal from the video detector while the collector circuit is furnished with a negative-going voltage (rectified by *D1*) supplied from a winding on the horizontal flyback transformer. This action produces relatively noise-free operation since the a.g.c. circuit is only activated (gated) during the horizontal flyback period. The amplitude of the oscillation is dependent on the level of the video signal appearing at the base.

The oscillator output is rectified by *D2* and applied to the base of d.c. amplifier *Q2* through a filter circuit. The time constant of this filter is made very small so that a.g.c. action will be fast. The a.g.c. voltage is applied to the first and second video i.f. stages.

To assist a.g.c. action, a diode is connected in parallel with the primary of the first i.f. transformer to lower the "Q" of this coil when the input level exceeds 10 mv.

A variation of this fast-acting a.g.c. circuit is also used in the *Sony* Model TV9-304W (9-inch set). In this variation, the a.g.c. voltage developed at the emitter of the d.c. amplifier is used to vary the base bias of an impedance converter (see Fig. 1B) that will change the impedance across the collector and emitter circuit. Since the collector of the impedance converter is connected in series with the emitter of the first i.f. stage, the amount of negative feedback applied to the first i.f. stage varies in accordance with the variations in a.g.c. current. Thus, the gain of the first i.f. stage varies as the input signal level varies.

Another approach to keyed a.g.c., as used in the *Philco* Model 1052 (9-inch set), is shown in Fig. 2B.

In this circuit, the negative-going video signal from the first video amplifier is fed to the base of the gated a.g.c. stage *Q1*. This stage is gated on by the application of a negative collector voltage signal supplied from a winding on the horizontal flyback transformer *T1* and rectifier *D1*. In this fashion, *Q1* is permitted to operate only during the horizontal flyback interval, thus eliminating any noise present during the remainder of the line video signal. The voltage level of the negative signal present on the emitter is governed by the level of the video signal applied to the base, and the setting of the "A.G.C." control. This signal is then applied

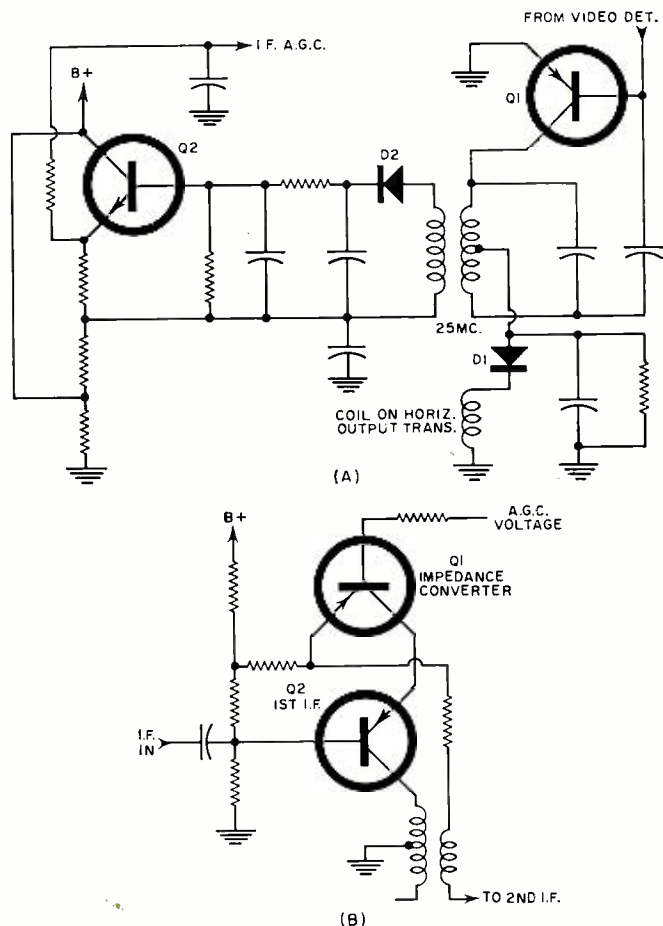

Fig. 1. (A) The a.g.c. circuit as used in Sony 5-inch set. (B) Modification of this circuit for use in the 9-incher.

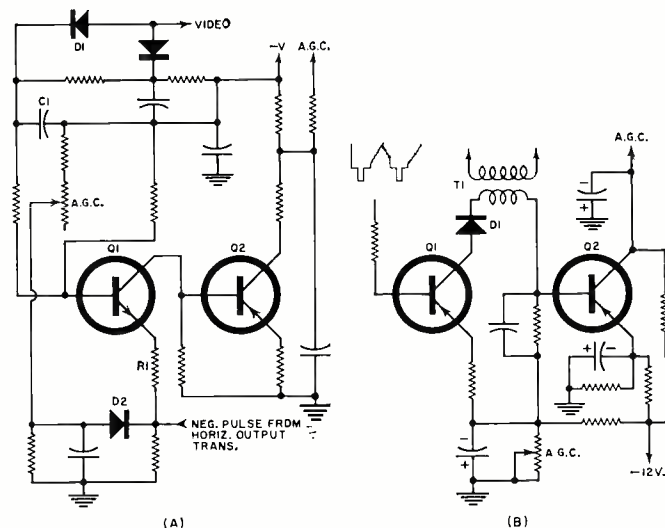

Fig. 2. (A) Gated a.g.c. circuit used in Panasonic 9-incher. (B) The gated a.g.c. circuit as used by Philco in its set.

to the a.g.c. output stage *Q2* which acts as a d.c. amplifier.

The negative voltage present at the collector of this stage is determined by bucking the "B-" voltage normally present on the collector by a positive-going voltage generated by the negative a.g.c. voltage being applied to the base. Because the bucking voltage is a function of the video input signal level, the a.g.c. voltage will then be a function of the signal level entering the set's antenna.

The a.g.c. system used in the *Panasonic* Model "Mitey 9" (9-inch set) is shown in Fig. 2A. This peak-keyed a.g.c. system was developed by *Matsushita Electric* specifically for

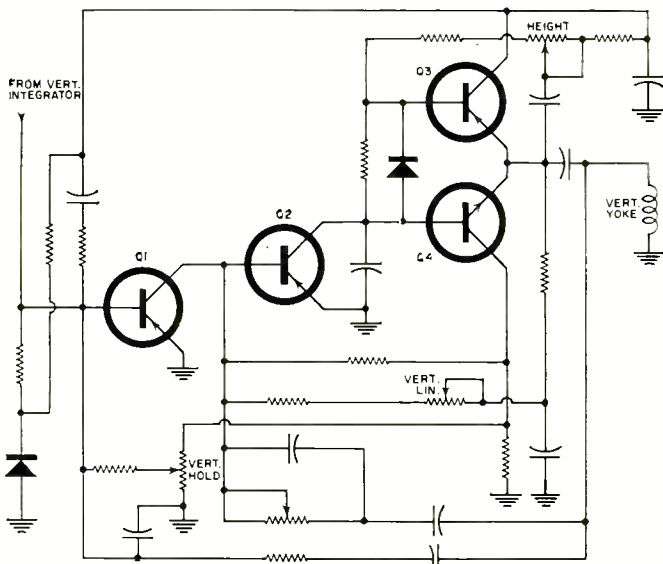

Fig. 3. Delmonico's vertical output stage is a high-quality audio amplifier with feedback making it into an integrator.

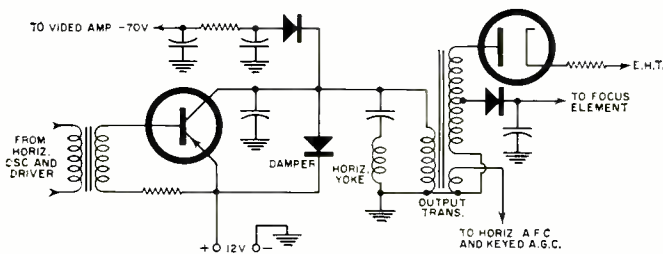

Fig. 4. The horizontal output stage as used in the Sharp set is typical of those used in many other transistorized sets.

use in this particular model of their transistor TV sets. The video signal is supplied to Q1 through diode D1, with the voltage appearing across C1 having the peak value of the horizontal sync signal. A negative-going pulse from the horizontal output transformer (greater than 12 volts), clipped by D2, is applied to the emitter of Q1 through R1. The voltage waveform at the collector of Q1 is amplified

and rectified by Q2 and then applied as a.g.c. bias to the v.h.f. tuner and the base of the first and second i.f. stages. A diode is connected in parallel with the primary of the first i.f. transformer to compensate for changes in the coil "Q" due to changes in a.g.c. bias.

When a positive a.g.c. bias voltage is applied to the base of the i.f. stage, the transistor input and output impedance becomes greater because the emitter current decreases. The "Q" of the transformer becomes greater, resulting in a sharper, more peaked response curve. The diode across the transformer primary provides "Q" damping as the voltage across it is varied with signal strength. With low voltages, such as found in weak signal areas, the response curve will be more peaked (although the bandwidth narrows somewhat), while in relatively strong signal areas the response curve will broaden out (while the over-all gain decreases).

One of the interesting circuits used in the Delmonico Model 4T-40-UHF (4-inch) TV set is the vertical deflection circuit shown in Fig. 3.

The circuit is very similar to a high-quality audio amplifier with a special feedback network. Transistors Q2, Q3, and Q4 operate as a current amplifier, similar to an audio amplifier. The special feedback networks convert this amplifier into an integrator circuit. The output of this constant-current integrator is fed to Q1 so as to control the signal. The signal applied to the vertical yoke is an exceptionally linear saw-tooth and operates very efficiently in this class B output circuit.

Although there are some differences between sets, Fig. 4 shows a typical horizontal output stage. This particular circuit is used in the Sharp Model TRP-602 (6-inch set).

Although not shown in the circuit, an a.f.c.-controlled blocking oscillator is used to generate the line frequency. This signal is fed through a driver stage to the horizontal output circuit shown in Fig. 4.

The output of this typical stage serves many purposes: it is used to supply the horizontal portion of the deflection yoke with the horizontal sweep signal (with suitable damping); the horizontal pulse at the collector is also rectified and filtered to generate the relatively high "B+" voltage required by the video amplifier; the horizontal pulse drives a transformer that generates

(Continued on page 69)

Characteristics of the portable TV sets shown on the cover. These are typical of most sets found in today's market.

Name	DELMONICO	SONY	SHARP	REALTONE	GENERAL ELECTRIC	PHILCO	PANASONIC
Model	4T-40 UHF*	Micro-TV 5-303W	TRP-602	TR-6867	TR-805	1052	Mitey 9
Screen Size (inches)	4½	5	6	6	9	9	9
Set Dimensions (inches)	4¾ x 8⅝ x 8⅝	4¼ x 7⅝ x 7¼	5½ x 8¼ x 7¾	5½ x 10¼ x 8½	9¼ x 10½ x 9¾	10 x 9 x 9	7¾ x 9 x 8¾
Set Weight (pounds)	8½	8	9.9	10	13	10¾	10½
Power Sources	self-contained 12-v. battery: 117-v. a.c.	external 12-v. battery: 117-v. a.c.	external 12-v. battery: 117-v. a.c.	external 12-v. battery: 117-v. a.c.	external 12-v. battery: 117-v. a.c.	external 12-v. battery: 117-v. a.c.	external 12-v. battery: 117-v. a.c.
Power Consumption (watts)	d.c.—3.5 a.c.—5	d.c.—9.6 a.c.—13	d.c.—10 a.c.—18	12	d.c.—12 a.c.—30	d.c.—11 a.c.—17	9.5
Operating Time Per Battery Charge (hours)	8	4	4	4	4	4	5
Transistors	28	25	24	25	24	27	27
Diodes	32	20	17	27	17	15	20
Speaker Size (inches)	2½	3	3½	3	4 x 2½	3½	4 x 2½
Sound Output Power (milliwatts)	200	150	200	200	200	250	200
Antenna	Telescopic dipole	Telescopic monopole	Telescopic monopole	Telescopic monopole	Telescopic monopole: u.h.f. loop	Telescopic monopole: u.h.f. loop	Telescopic monopole
Picture I.F. (mc.)	26.75	26.75	26.75	45.75	45.75	45.75	45.75
Sound I.F. (mc.)	22.25	22.25	22.25	41.25	41.25	41.25	41.25

All sets have provisions for earphones. All can use external antennas. All can be operated from 12-v. car batteries.
*Distributed by Allied Radio as 24SC343-R.

CAPACITANCE NOMOGRAM

Relation among capacitance, voltage, stored charge, and amount of energy available upon discharge of capacitor.

By FRANK D. GROSS

HERE is a nomogram relating the capacitance of a capacitor (C), the voltage across its terminals (V), the stored charge (Q), and the available energy if the capacitor is discharged (W). It is optimized about $C=1 \mu\text{f}$. This allows the nomogram to cover most of the capacitor values normally encountered in timing circuits, SCR firing circuits, and pulse-forming networks. V is in volts, Q , the stored charge, is microcoulombs; and W , the energy, is in microjoules.

The basis for the nomogram are two capacitor equations: $Q=C \times V$ and $W=Q \times V \times \frac{1}{2}$. (Note: By substituting $(C \times V)$ for Q in the second formula, we obtain the more familiar $W=(C \times V) \times V \times \frac{1}{2} = \frac{1}{2} CV^2$.)

Knowing any two of the variables lets a solution for the other two to be found.

To use the nomogram, find the point of intersection of the

two known values, and then read out the unknown values.

Example 1. A $2\text{-}\mu\text{f}$. capacitor is charged to 25 volts. What is the charge and the stored energy? The intersection point between $C=2 \mu\text{f}$. and $V=25$ volts is found (point A). The charge is then read vertically downward and is seen to be 50 microcoulombs. The stored energy is between the 500- and 1000-microjoule lines and is nearer to the 500 line. Interpolation will give a value of 625 microjoules.

Example 2. An SCR needs 1000 microjoules of energy to insure firing. A capacitor charging voltage of 30 volts is available. What is the minimum value of capacitance that can provide this energy? The intersection between the $W=1000$ and $V=30$ is found (point B). Although this is close to the $C=2 \mu\text{f}$. line, $2 \mu\text{f}$. is not quite enough to provide this energy. A value closer to $2.23 \mu\text{f}$. or $3 \mu\text{f}$. would have to be chosen for this particular application. ▲

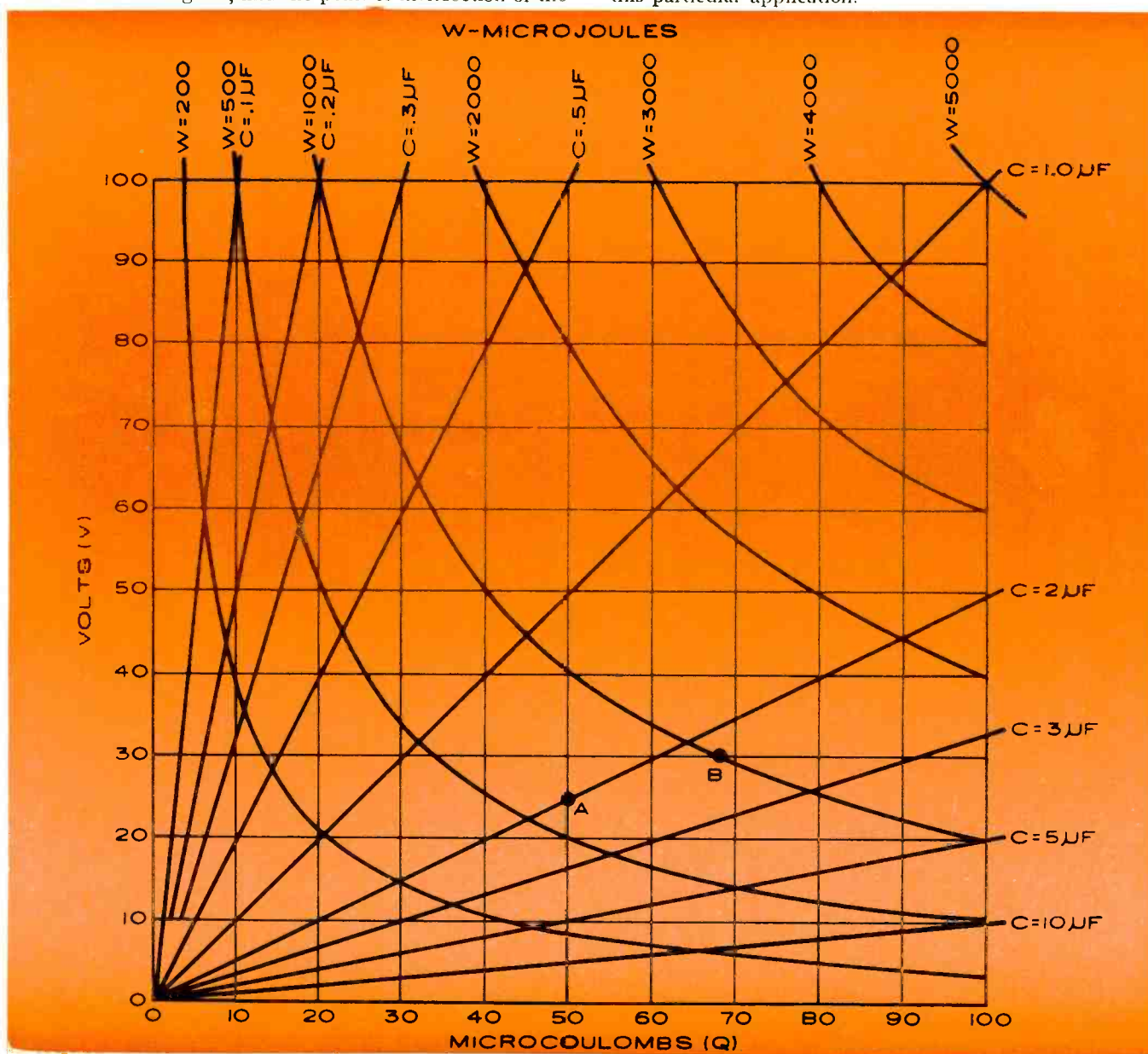

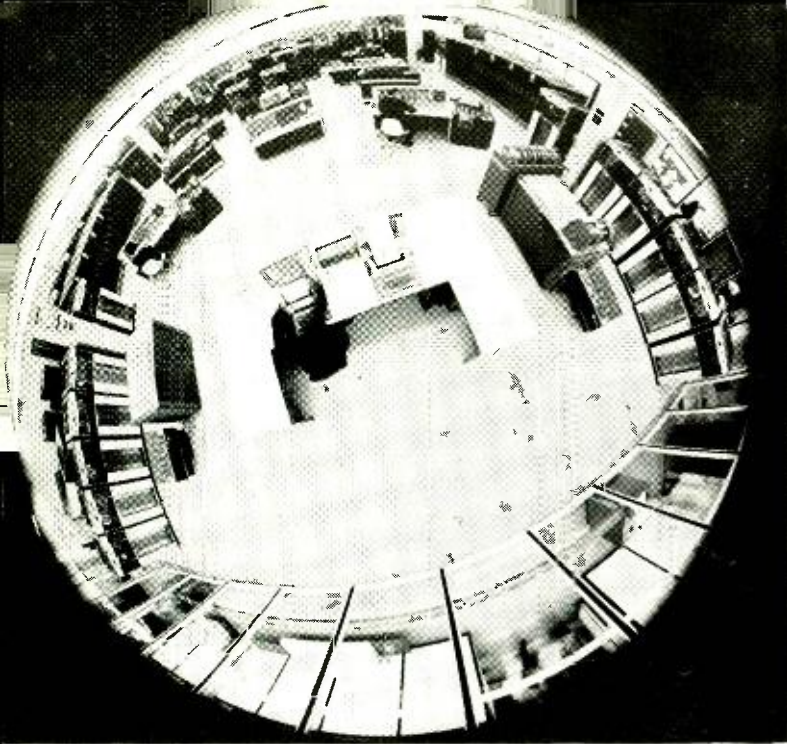

RECENT DEVELOPMENTS in ELECTRONICS

Airlines Reservations Computer. Ninety separate pieces of equipment making up American Airlines' "Sabre" reservations system are shown in this photo made at the airline's electronic reservations center at Briarcliff Manor, N.Y. Built by IBM for \$30.5 million, "Sabre" is the largest commercial real-time data-processing system in operation. Each agent at the airlines' nationwide offices has a desk-size console that permits direct communications with the center. Receipt of each of the many reservations queries is acknowledged within seconds.



Laser Range Finder. Eight laser range finders, recently delivered to the U.S. Army, are among the first military devices using lasers to be produced in this country. Here one of the RCA-built units is shown being tested in the field. The major advantage of such light-pulsing laser devices for the military is rapid high accuracy from a single location with a degree of security not obtainable with radar devices. The pulsing device, called a "Q-spoiler," is a rotating mirror which causes the laser to fire when the plane of the mirror becomes perpendicular to the longitudinal axis of the ruby laser rod. Range is obtained by measuring travel time of the light pulses.

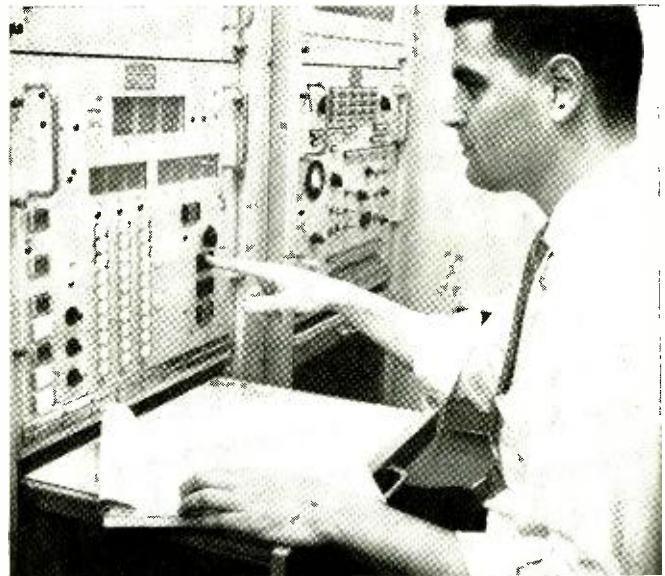

Automatic Fault Finder. A new Air Force fault locator that is able to automatically check out airborne equipment is shown being operated above. The device cuts manual checkout time from several hours to a few minutes, and actually prints out any needed repair instructions on an electric typewriter. The heart of the unit, built by Sperry, is a digital computer in which is stored over 500 different instructions to make the necessary electrical connections and measurements through cabling from its small trailer. The computer will order signal generators, also mounted in the trailer, to simulate the full range of electronic signals that the airborne system would actually experience in flight. Signals can be varied to fit any checkout routine.

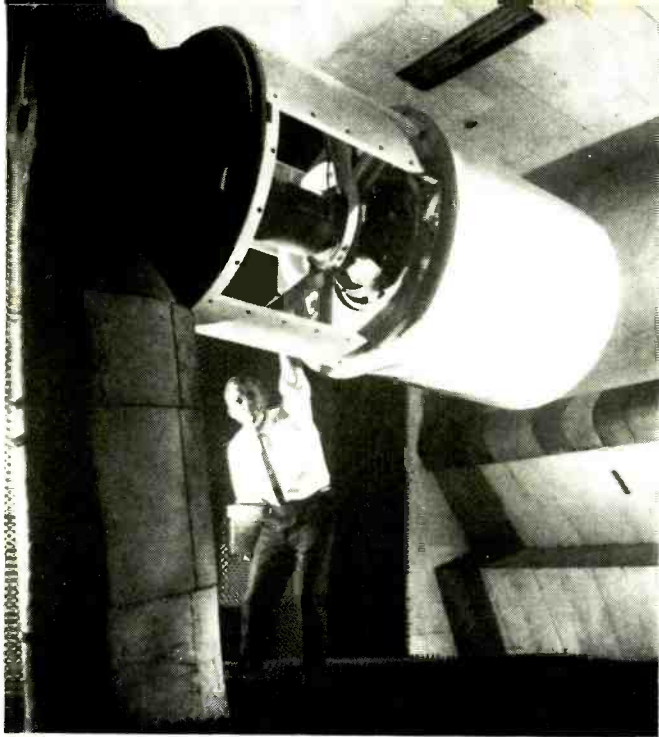

Tacan Antenna Test. A Tacan (tactical air navigation) antenna is shown being tested in an r.f. anechoic chamber which reduces radio-frequency reflections to a minimum. The antenna, supplied by International Telephone and Telegraph Corp., is part of the FAA common air-navigation system being established through the United States and Allied nations for point-to-point guidance of military and civil aircraft. The company was recently awarded a \$3.5 million contract for a number of antennas.



Laser Retina Welder. Light beam from a laser retina welder, developed by Honeywell, is aimed by holding compact ophthalmoscope-like instrument to doctor's eye. Index finger rotates focusing disc correcting for myopic or hyperopic errors. Knurled handle top (above finger) selects proper beam energy. Thumb button fires 500-microsecond burst of laser light into the patient's eye, welding the torn retina by means of the heat scars.

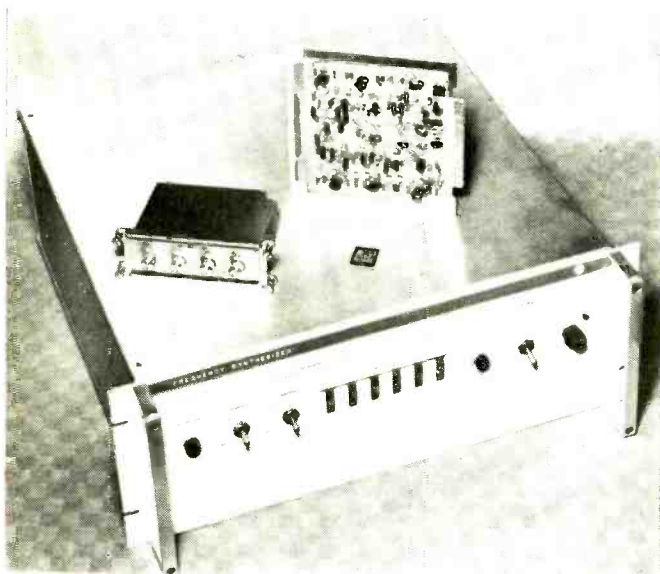

Microelectronic Frequency Synthesizer. A comparison between a conventional frequency synthesizer using printed circuits and a compact synthesizer using microelectronic techniques gives graphic evidence of what miniaturization can accomplish. The small, square thin-film wafer in front of the circuit board of the miniature synthesizer indicates the size reduction possible. The compact synthesizers, built by Collins, are for use in portable field communications pack sets. The circuits operate at a frequency of 40 mc. with a power consumption of only 4 milliwatts. The unit consists of 410 semiconductor components and utilizes 33 thin-film circuits. Providing 1-kc. channel spacing, stability is said to be one part in one million.

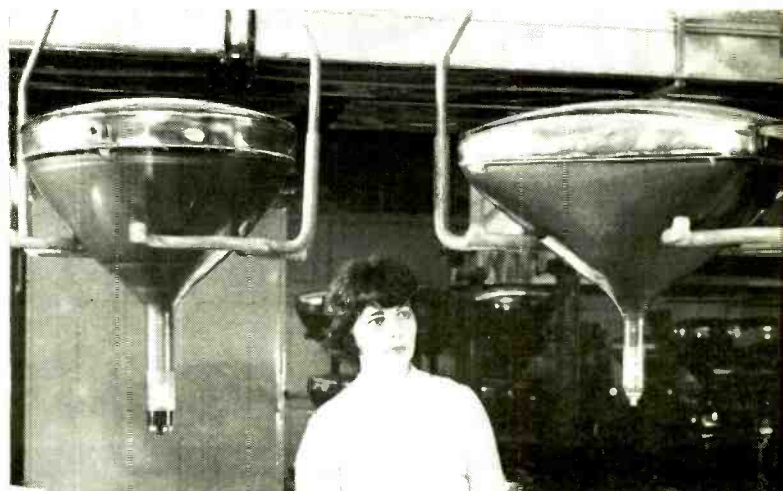

Rectangular 25-inch Color Tube. The picture tube at the right is one of the new, shorter 25-inch rectangular color-TV picture tubes moving on an overhead conveyer at the RCA plant in Lancaster, Penna. Samples of the new tube were delivered to the nation's color-TV set makers recently. At the left is the 21-inch, round color tube which is expected to provide the bulk of color-set sales for the year 1965. The new tube will be commercially available in limited quantities at a price of \$152.50 with the price being reduced to no more than \$130 by the first of the year. The round tube currently sells to manufacturers for \$89.50 for a non-laminated tube and \$98 for a laminated tube with glare-free safety window. Also being worked on by the company is a 19-inch, 90-degree rectangular color tube. Overall length of the new tube is just under 21 inches, which represents a 4 1/3-inch reduction over the standard 70-degree tube.

Transistorized

FM-STEREO DEMODULATOR

By J. W. ENGLUND, L. PLUS & H. A. HANSEN / Radio Corporation of America

Design of a multiplex adapter, using inexpensive transistors, which features noise immunity and automatic mode switching.

MOST commercially available stereo demodulators that employ automatic switching function properly with high signal levels and in the absence of noise. However, when an FM tuner is tuned to a weak station, or between stations, any attendant noise is filtered and amplified in the stereo demodulator and switches the demodulator to stereo operation. Because the signal-to-noise ratio of stereo reception is 23 db worse than that for monophonic reception, such erroneous switching of the demodulator results in a substantial degradation of the receiver performance.

This article describes a transistorized stereo demodulator which utilizes time-share detection, an effective noise-immunity circuit, as well as a stereo program indicator.

Circuit Description

Fig. 1 is the schematic diagram and parts list for the time-share stereo demodulator. This unit uses five transistors and five point-contact diodes.

At the input, C2 and L1 form a parallel resonant trap which provides SCA filtering. This filter produces less deterioration of the composite signal than a series resonant trap to ground. Transistor Q1 serves as a pilot separator. The load for the collector is a double-tuned, top-capacitance-coupled 19-kc. transformer (L2, L3, C6) which provides a high degree of selectivity for the pilot frequency. In addition, Q1 serves as an emitter follower for the composite signal. The emitter resistor (R4) is partially bypassed by C4 to compensate for the high-frequency roll-off of the stereo subchannel by the SCA filter. This stage provides an input impedance of about 15,000 ohms to the composite signal, and prevents excessive loading of the FM detector.

The threshold amplifier, together with the 19-kc. amplifier-limiter, comprise the noise-immunity circuit. Transistor Q5 serves as a selective amplifier for the 19-kc. signal. The un-bypassed emitter resistor (R14) raises the input impedance of the Q5 stage and minimizes loading of the double-tuned transformer (L2, L3). Resistor R16 is an isolation resistor between the threshold amplifier and the 19-kc. amplifier-limiter. The threshold detector diode (D1) develops forward bias for Q2. The pilot and regenerated subcarrier is well limited to minimize phase shift over a wide range of pilot levels. Reverse biasing is applied to Q2 through the threshold control (R7); R6 limits this reverse bias within transistor specifications.

At high tuner sensitivity levels or during interstation tuning where the noise level is high, the threshold control can be adjusted to prevent Q2 from conducting. Since the noise spectrum from the FM detector is wide band, but the pilot channel filtering (L2, L3) and the threshold amplifier channel filtering (L6) select only the 19-kc. portion of this spectrum, the noise spectrum power is very low at the threshold detector diode compared to even a weak 19-kc. pilot signal. As a result, the noise-immunity circuit can discriminate between noise and weak pilot signals (as obtained under high tuner sensitivity conditions).

When an acceptable pilot level is reached, the developed forward bias overcomes the pre-set reverse bias; Q2 then

conducts and opens the subcarrier-regenerating stages. The amplified signal appearing across R5 is added to the L3 secondary voltage to form the input signal for Q5. Therefore, the developed forward bias to Q2 increases substantially and biases Q2 to optimum operating point and gain.

The operating point of Q2 remains fairly constant with pilot-level variation at the input to the adapter because the bias for Q2 is a function of *both* the pilot level at the input to Q5 and the amplified pilot signal developed across R5 by Q2; the amplified pilot signal developed across R5 being relatively insensitive to pilot level changes while in limiting. As a result, when the input pilot level is reduced, Q2 remains in conduction below its "turn on" input pilot level.

The amplified 19-kc. is fed to a balanced full-wave rectifier composed of the secondary of L4 and D2 and D3. The output of the rectifier circuit is unfiltered and provides frequency doubling with a d.c. component. The d.c. component turns on Q3, permitting the 38-kc. signal to be amplified. In addition, the amplified d.c. in the emitter of Q3 provides drive for Q4 and turns on the stereo indicator lamp. Fig. 2 shows a modified version of the indicator circuit which uses an inexpensive lamp.

The 38-kc. signal from Q3 is applied to the primary of L5, and the composite signal from the emitter of Q1 is applied to the secondary center-tap of L5. When a properly phased regenerated subcarrier is added to the composite signal, a 38-kc. amplitude-modulated signal is formed having one envelope of right-channel information and one envelope of left-channel information. Diode D4 and D5 each permit the passage of only one-half of the two-envelope signal.

R21 and C22 form the de-emphasis network. L8, C20, and C18 constitute a low-pass filter; L8 and C20 also serve as a trap for the 38-kc. residual. Matching components are used in the other channel output to perform similar functions.

Alignment Procedure

The following laboratory-type equipment is required: an a.c. vacuum-tube voltmeter; a multiplex stereo generator; a wide-range audio oscillator; a 12-volt, 25-ma. d.c. power supply; an oscilloscope having provisions for horizontal input and 1-mc. vertical-amplifier response; and an FM signal generator.

The recommended alignment procedure is outlined below. The first 22 steps apply to the demodulator only; steps 23 to 30 to both the demodulator and the tuner.

1. Set threshold potentiometer to mid-position.
2. Provide 10,000-ohm resistive terminations at both outputs.
3. Connect the demodulator to the 12-volt power supply.
4. Attach the a.c. v.t.v.m. to the emitter of Q1.
5. Apply a 100-mv. r.m.s. 72-kc. input signal to the demodulator input.
6. Tune L1 for null on the v.t.v.m.
7. Attach the a.c. v.t.v.m. to the right output.
8. Feed 38-kc. signal into point A.
9. Null the meter by tuning inductor L7.
10. Repeat for left output, using L8.

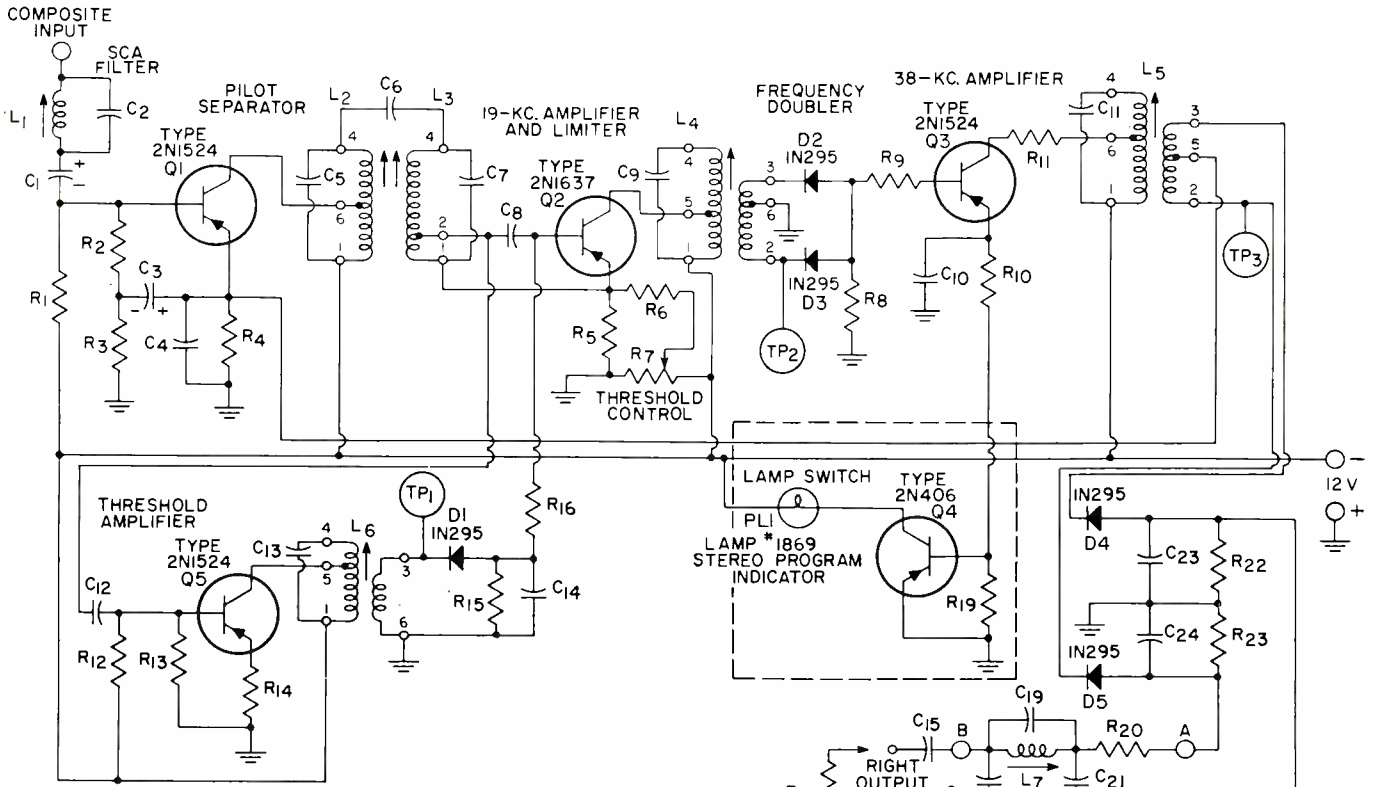

Fig. 1. Diagram of FM-stereo multiplex demodulator with noise-immunity circuit.

- R1—39,000 ohm, 1/2 w. res.
 - R2—3900 ohm, 1/2 w. res.
 - R3—4700 ohm, 1/2 w. res.
 - R4—470 ohm, 1/2 w. res.
 - R5, R14—1000 ohm, 1/2 w. res.
 - R6—5600 ohm, 1/2 w. res.
 - R7—100,000 ohm pot ("Threshold Control")
 - R8, R15, R16, R17², R18², R22, R23—10,000 ohm, 1/2 w. res.
 - R9—2200 ohm, 1/2 w. res.
 - R10—1200 ohm, 1/2 w. res.
 - R11—270 ohm, 1/2 w. res.
 - R12—47,000 ohm, 1/2 w. res.
 - R13—8200 ohm, 1/2 w. res.
 - R19—560 ohm, 1/2 w. res.
 - R20, R21—3300 ohm, 1/2 w. res.
- *R17 and R18 are to be used if input impedance to stereo amplifiers is considerably higher than 10,000 ohms. If input impedance is lower, these resistors should be omitted.

- C1—10 μ f., 6 v. elec. capacitor
 - C2—560 pf. mica capacitor
 - C3—100 μ f., 3 v. elec. capacitor
 - C4—.005 μ f. disc ceramic capacitor
 - C5, C7, C9, C13—1000 pf. mica capacitor
 - C6—18 pf. mica capacitor
 - C8, C10, C12, C14—.05 μ f. disc ceramic capacitor
 - C11—390 pf. mica capacitor
 - C15, C16—1 μ f., 3 v. disc ceramic capacitor
 - C17, C18—1600 pf. disc ceramic capacitor
 - C19, C20—120 pf. disc ceramic capacitor \pm 10%
 - C21, C22—.02 μ f. disc ceramic capacitor
 - C23, C24—4700 pf. disc ceramic capacitor
- L1—SCA trap, 10 mhy. var. inductor (TRW 14039R1)
- L2—19 kc. coil (TRW 15485R3 or equiv.)
 - L3—19 kc. coil (TRW 15486R3 or equiv.)
 - L4—19 kc. coil (TRW 15360R9 or equiv.)
 - L5—38 kc. coil (TRW 15361R7 or equiv.)
 - L6—19 kc. coil (TRW 15759R1 or equiv.)

L7, L8—38 kc. trap, 150 mhy. var. inductor (TRW 17198 or equiv.)

Note: A complete set of eight coils required is available from TRW Electronic Components Div., 666 Garland Place, Des Plaines, Illinois 60016 at a price of \$15. Individual coils are available at \$2.75 each.

- D1, D2, D3, D4, D5—1N295
- PL1—1869 lamp (10 v. @ 14 ma.)
- Q1, Q3, Q5—2N1524 transistor
- Q2—2N1637 transistor
- Q4—2N406 transistor

11. Attach the a.c. v.t.v.m. to TP1.
12. Feed a 20-mv. r.m.s. 19-kc. pilot into the demodulator unit from the multiplex stereo generator.
13. Peak L2, L3, and L6. The stereo program indicator lamp should not light during this step. (If the lamp does light, retard the threshold level by turning the control counter-clockwise until the light extinguishes, and re-peak L2, L3, and L6.)

14. Increase the threshold potentiometer clockwise until the indicator lamp lights.
 15. Attach the a.c. v.t.v.m. to TP3.
 16. Peak L4 and L5.
 17. Reset the threshold potentiometer to mid-position.
 18. Connect the audio oscillator to multiplex generator.
 19. Apply a 500-mv. r.m.s. 1-kc. (L=R) 10% pilot composite signal from the
- (Continued on page 76)

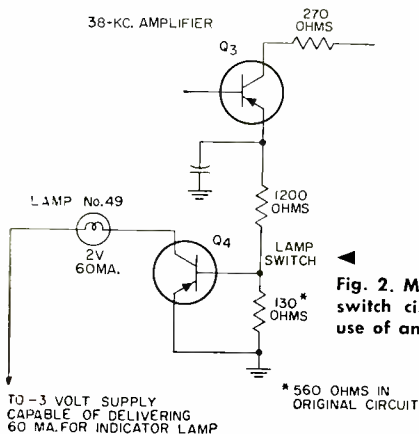

Fig. 2. Modification of lamp switch circuit to permit the use of an inexpensive lamp.

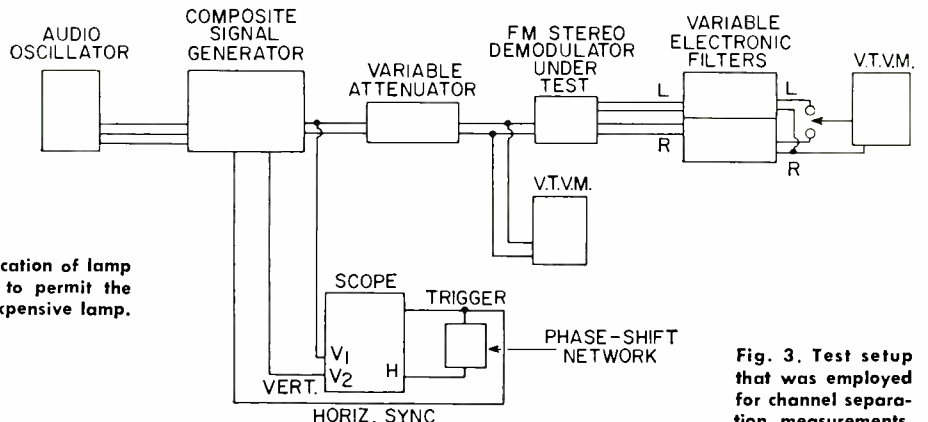

Fig. 3. Test setup that was employed for channel separation measurements.

USING HOOK-UP WIRE

By JOSEPH TARTAS

There is a lot more to a piece of wire than is visible. It can act as an inductor, resistor, capacitor, or tuned circuit, depending on how and where used, and at what frequency.

HOOKUP wire, as used in conventional electronic circuits, is a slender length of copper usually insulated with a coating of non-conductive enamel or other insulating material. However, take that same piece of wire and bend it, coil it, or place it near an electrical ground, magnetic field, or metallic surface, or allow an electric current to flow through it, and you no longer have "a piece of wire." Change its temperature and you change its physical and electrical constants. Add or change its insulating cover material and the chances are you've changed one or more of its physical, electrical, or magnetic characteristics.

At d.c. and audio frequencies, the characteristics of major concern are resistivity and power dissipation. The resistivity depends entirely on the cross-sectional area and the type of material used in the wire. Because resistivity can vary widely, the selection of the conductor is usually determined by the end use. The term "conductor" thus becomes a fairly flexible word. Nichrome resistance wire used in appliance heating elements is a *conductor* with a high *resistance*, and can be referred to by either term. It is, however, still a *wire*. It is sometimes difficult to remember the basics, and the resistance relation of larger diameter conductors is one of these. What happens to the resistance if the diameter is doubled? If we picture a length of conductor or resistor split into four quadrants, with each having the same resistance, the total length resistance is then the same as if we put the four resistors in parallel or $\frac{1}{4}$ the resistance of one unit. Since the current is the same in each unit, then the total current is four times as great as a single unit. Because the resistance is the same in each unit, then the voltage drop across each must be exactly the same as one, and the power dissipated must be four times as great, since the current in each one has not increased.

Since most conductors or wires commonly used have round cross-sections, the area is always a "circular mil" area rather than a square area. A circular mil is the *square of the diameter* in mils. (A mil is 1/1000 of an inch, or .001".)

One advantage of knowing wire diameter in mils is to facilitate the determination of number of turns-per-inch for coil winding. The number of turns is simply the reciprocal of the wire diameter (in inches), or 1000 divided by the wire diameter in mils.

It should be mentioned that most wire tables are based on *bare wire* dimensions. For enamel, single Formex or Formvar (E) (SF) insulation add 1 mil to the diameter; for single silk, double Formex or Formvar (SSC) (HF) add 2 mils; for single cotton (SCC) add 4 mils; for double cotton (DSC) add 8 mils, and for silk-covered enamel (SCE) add 3 mils.

In the past decade, many new insulating materials have been developed. However, the selection of insulated wire depends upon such requirements as temperature range; exposure to weather, chemicals, or abrasion; voltage between turns or layers; corona effects; and other characteristics. To meet

these requirements, there are plastic, Teflon, silicone, glass, fiberglass, epoxy, and many other combinations.

For the technician, experimenter, and amateur, enameled and Formvar wire are most commonly used. "Formex" is a tradename for one brand of Formvar. The difference between enamel and Formvar is that the latter is a tough, durable, varnish-type resin-base insulation. It is not as easy to scratch or nick, nor will it peel off when making a sharp bend in the wire, as will enamel. While it may be removed by scraping, like enamel, a chemical stripper is available to remove the coating without danger of nicking or damaging the wire itself. When using a chemical stripper, observe the precautions on the container. If you splash it on your skin, it must be washed off at once or it will cause a minor burn.

Audio & Ultrasonic Frequencies

We are familiar with the effects of 60-cycle hum pickup. This usually results from the presence of a wire as a conductor (even though it is at a d.c. ground potential) in a changing magnetic field. Another cause may be the flow of a heavy a.c. current, such as in a tube filament return or in a ground bus wire. In the former case, the fluctuating a.c. current is induced in the finite, though low value, inductance by the changing magnetic field around the wire and, in the latter case, by the finite, though low value, resistance in this short length of wire. In both cases, the a.c. voltage that results is in accordance with the very basics of electricity, *i.e.*, a changing magnetic field causes a current to flow in the inductance (hence induction) and a current flowing through a resistance causes a difference of potential across that resistance (according to Ohm's law).

Radio Frequencies

As we go higher in frequency, several other effects occur. A piece of wire is no longer a piece of wire and a resistor or capacitor is no longer just a resistor or capacitor because it also has wire leads. As a result, a resistor (Fig. 1A) appears alternately as a resistor, an inductance, or an inductance in series with a resistor (depending upon the resistance value), an equivalent resistor, or a capacitor, with the changes occurring with the continually increasing frequency.

A capacitor, Fig. 1B, appears alternately as a capacitor with a negligible series resistance, a series combination of capacity and resistance (as the capacitive reactance approaches the resistance), a low resistance in series with a series-resonant circuit, which in effect is a higher resistance, and a high-impedance inductive circuit when X_C gets small and X_L gets large.

In Fig. 1C, an inductance is similar to a resistor, except that the resistance value is high for the resistor and relatively low for the inductor. The important fact here (and its relation to our main subject) is that in an inductor, the inherent

inductance is intentional, while for the resistor and capacitor, the inductance that is present is purely a part of the physical structure and is unavoidable.

Even the resistance of a wire is a relative thing. At higher frequencies the currents tend to travel closer to the surface and eddy current losses increase beneath the surface. This is the so-called "r.f. or skin resistance." At higher frequencies, a copper tube is a better conductor of r.f. than a solid conductor, and silver plating helps if its thickness is adequate. Wire size is not always the answer, contrary to common belief (i.e., the larger the diameter, the higher the coil "Q," or lower the r.f. resistance). There is an optimum size of wire for each coil configuration, not necessarily the largest diameter. The depth of penetration or minimum depth of a conductive coating varies with the resistivity of the conducting material, as shown in Fig. 2. There are times when it is necessary to use poorer conductor materials to reduce galvanic corrosion (such as on antennas, or in marine equipment) with a compensating increase in skin thickness.

At the lower frequencies (0.3 to 3 mc.), the use of Litz wire, consisting of many fine wire strands, is common to minimize the r.f. resistance. However, as the frequency increases, the d.c. resistance of the wire becomes the greater part of the resistance and the required wire size then becomes too great to be practical. Insulation losses with increasing frequency also become prohibitive.

In order to properly select the correct conducting materials, the relative resistance of the metals shown in Fig. 2 and the position of these metals in the galvanic series table must be considered.

Metals that are close together in the galvanic series are least likely to corrode, with the lower end of the series as noble metals (those that tend to resist chemical action).

Because of its cost, availability, low resistivity (only silver is lower), and ease of handling, copper is by far the most popular and convenient conductor material, with aluminum running a close second in high-tension lines and heavy motor and transformer applications.

A straight wire has inductance, although it is insignificant below 10 or 15 mc. Above that, the small inductance becomes an increasing portion of the resonating inductance in combination with stray capacities, and must be taken into consideration when selecting components, bus-wire sizes and lengths, and best layout of circuitry.

The inductance of a wire is dependent on its diameter and length and may be computed from the formula: $L (\mu\text{hy.}) = 0.00508 l (2.303 \log_{10} \frac{4l}{d} - 0.75)$ reaching a maximum value as frequency increases of $L (\mu\text{hy.}) = 0.0058 l (2.303 \log_{10} \frac{4l}{d} - 1)$ where l =length (in inches) and d =diameter (in inches).

In r.f. wiring it is customary to use a wiring layout that keeps r.f. connections to a minimum and, in the u.h.f. region, connections are usually made by means of the components themselves, or with short heavy copper straps. Even these have some inductance, although extremely small. However, at these frequencies even this small inductance is of significant value and often forms, along with the stray or lumped circuit capacities, a resonant circuit. Often as not, such a circuit occurs when least desirable—within a vacuum-tube structure, a circuit component, or connecting leads. Sometimes this resonance can be a nuisance by causing high-frequency oscillations in a relatively low-frequency amplifier. Other times, the resonance can be put to use as a more perfect r.f. bypass.

If the frequency of operation is quite high, the internal inductance then becomes part of the total inductance, since the two are in series. At frequencies where the external inductance is practically zero, a tube with less internal inductance, capacitance, or both must be substituted. A tube like

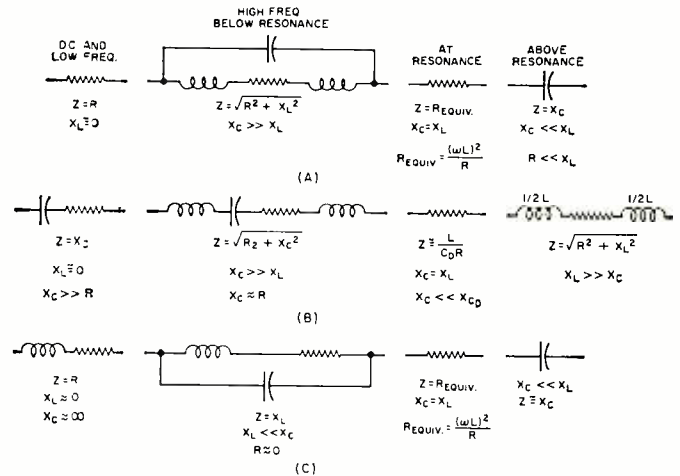

Fig. 1. (A) Shows the various "looks" of a resistor at different frequencies while (B) and (C) show similar effects produced by a typical capacitor and inductor respectively.

the G-E 7077 ceramic triode has such low internal reactances that it is possible to build an amplifier at 1000 mc., using a wire loop as a coil and a tubular trimmer as the tuning capacitance, with this tube. Without such a tube, tuned lines or coaxial cavities would be necessary.

Since such a tube will function well as an amplifier, it is not difficult to utilize it as an oscillator and thus a signal generator or grid-dip oscillator in the 900 to 1000 mc. range is quite a simple matter.

Of course, circuits of this type require the use of high-frequency techniques and this brings us to the utilization of the internal inductance of a component to improve its high-frequency characteristics.

A 1000-pf. bypass capacitor (often used above 10-15 mc.) may be found in any of a dozen configurations. There are mica, Mylar, paper foil, and several ceramic styles. In the

Fig. 2. The r.f. penetration (skin resistance) of various metals changes with frequency of operation. At the higher frequencies, a thin coating of silver is all that is required.

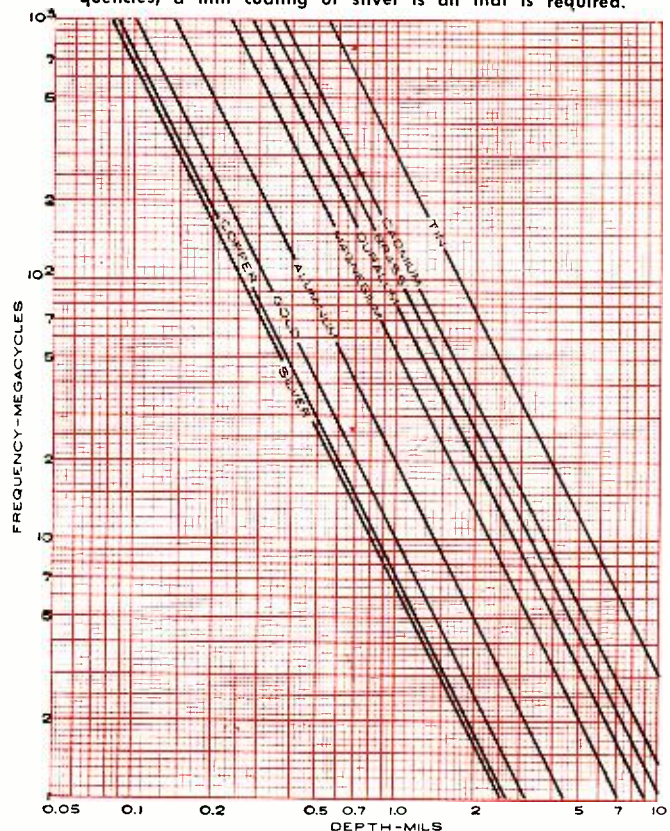

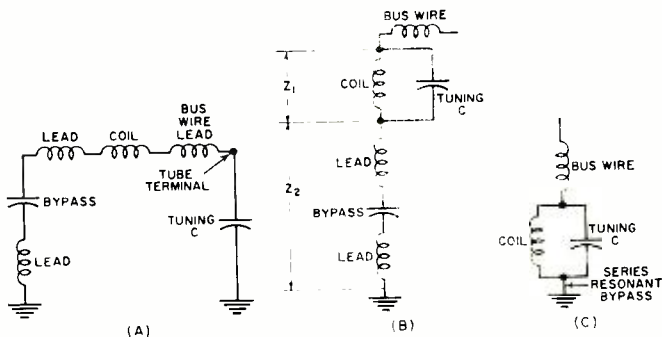

Fig. 3. (A) Tuned circuit equivalent when tuning capacitor is not connected directly across the coil. (B) A parallel tuned circuit showing effects of bypass leads as series impedance. (C) Series-resonant bypass produces no ill effects.

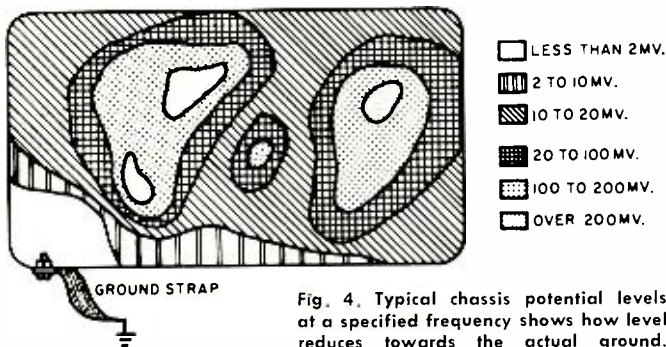

Fig. 4. Typical chassis potential levels at a specified frequency shows how level reduces towards the actual ground.

ceramic types are found disc, screw-in and threaded-mount feedthroughs, filter types that use lossy ferrite sleeves, stand-off types, tubulars, and others. For each style there is a different body length and a different method of attaching its leads. Each of these physical characteristics affects the total series inductance which, with the capacitance of the body, form a series-resonant circuit.

The resonant frequency of such a capacitor is pretty well fixed (for a given value of capacity) but its *installed resonant frequency* will depend upon the length of the leads, the length of the terminals to which it is attached, and the inductance of the wires that connect these terminals to the tube elements. This includes internal tube inductance, length of socket terminals, and length of bus wire if the capacitor is terminated at a coil form and the coil is connected to the socket terminal through a wire.

Tuned Circuit Effects

Fig. 3A shows the equivalent high-frequency circuit of a common tuned circuit and bypass capacitor when the tuning capacitor is not connected directly across the coil. Note the added series inductance presented by the component leads and associated wiring. Fig. 3B shows the equivalent circuit

Fig. 5. (A) Separate leads connected to a ground lug can act as a mutual inductance (B) and a similar form of coupling within a dual bypass capacitor can be experienced at higher frequencies. This shows importance of separate ground returns.

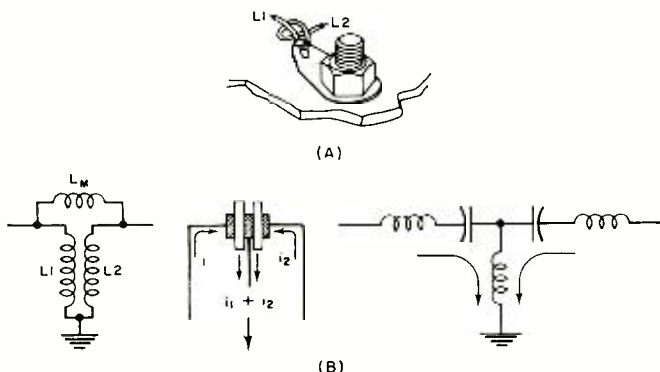

when the tuning capacitor is connected directly across the coil with minimum lead lengths. Here, the coil inductance alone determines the resonant frequency of the combination. The series impedance of the bypass and its associated leads lowers the r.f. voltage available to the tube.

If a bypass capacitor is selected in such a way that the capacity and leads (total from coil to ground) form a series resonant circuit at the same frequency as the parallel tuned circuit, then it forms the *lowest* possible impedance to ground as shown in Fig. 3C. Since the series resonant frequency is almost identical to the parallel frequency when the resonant "Q" is not too low (10 or above), the adjustment of such a circuit is simple.

If the leads are cut to the approximate length at which they are to be used, and the ends are soldered together, a parallel-resonant circuit is then formed. It is simple to couple this to a grid-dip oscillator and measure this frequency. If its resonant frequency is too high, it may be lowered by selecting a higher value of capacitance or increasing the length of one or both leads. The inductance of the leads may be further increased by coiling them, making sure that adjacent turns do not become shorted.

When the proper frequency has been attained, install the capacitor in such a way that a minimum of additional stray inductance or capacitance results. This means adequate space between the component and an adjacent shield, chassis, or other component. Once it has been installed in the circuit, it may be adjusted to the exact frequency without too much difficulty. It is surprisingly simple to couple the grid-dip oscillator to such a tuned circuit, but care must be taken to insure coupling to the correct resonant circuit, since at these frequencies there are usually several.

Grounds Can Be "Inductances"

A final word of caution in visualizing the relation of conductors and inductances at the higher frequencies. Since r.f. currents travel through the chassis, shield partition, or ground lug, it is quite possible to have coupling between circuits in a ground or between ground leads in a component. A map of r.f. potentials, made by *Collins Radio Co.* on a typical chassis, is shown in Fig. 4. It gives a good indication of the various r.f. levels that exist within a supposedly good ground, where you would normally think that all the r.f. voltages would be essentially zero (or less than 2 mv. in this case). Note that the best ground is only within a small area around the actual ground *connected through a minimum inductance*.

Component leads to a ground lug may also act as a common inductively coupled circuit. Fig. 5 shows two possibilities. At (A) the two "grounded" wires are coupled together by the common magnetic fields and hence by mutual inductance. In (B) the same sort of coupling might exist in a dual bypass capacitor as has been experienced at the higher frequencies. Where possible, it is best to use separate bypasses and return each one to its own circuit ground.

Any time you think of a chassis, ground, lugs, ground straps, or conductors in general, keep in mind not only r.f. circuitry, but switching circuits as well, where fast rise times are involved (since these are also functions of frequency since $T=1/F$). A rise time of 0.05 microsecond is equivalent to a switching frequency of 20 mc., a value not too uncommon in today's high-current transistor circuits.

The lowest inductance, in the case of the loop, is achieved by placing the fields (from each half) 180° out of phase. In this case, cancellation takes place and the over-all inductance is a minimum. For the twisted leads, such as might be found in a tube heater lead, note that the total inductance for a twisted pair is considerably less than a single wire returned through the chassis.

The next time you pick up a piece of wire or a component for use at the higher frequencies, think carefully before you wire it in. It may be the reason the device doesn't work. ▲

SUBSTITUTING



Silicon for Germanium

Simple circuit modifications required to permit the use of newer transistor types for better performance.

TRANSISTORS

By WILLIAM O. HAMLIN

MOST transistor users have shown a preference for the germanium transistor ever since its development. This popularity can be attributed to habit, familiarity, and the availability of low-priced units.

Today, not only are there many different kinds of germanium transistors from which to choose, but they are facing real competition from the new silicon planar transistors which are now available at low prices. In many applications the silicon planar device can do a better job and, for this reason, you may wish to substitute the newer type for the old in a particular circuit. Replacing one transistor by another can be done in a few simple steps.

Fig. 1 diagrams a number of popular germanium transis-

tor constructions. Note that the usual alloy-junction transistor (A) has a large cross-section which limits its maximum frequency. Alloy transistors capable of operating above 15 mc. are rare. Making the cross-section narrower, as in the micro-alloy transistor (B), increases the maximum frequency to hundreds of megacycles. An alloy power transistor is large in both cross-section and area in order to handle high currents and to remove the heat that is generated. Such a transistor is shown at (C). Maximum frequency of the alloy power transistor is below 1 mc. for most inexpensive units.

Good or bad performance is only relative to the technology of the time and the price you pay. The advent of the silicon planar transistor set up new bases of comparison for the industry. You can judge the relative merits of the two technologies by checking the characteristics in Table 1.

The advantages of the silicon planar transistor result from its unique construction. Fig. 2 shows the various internal configurations and packages used for the v.h.f. 2N697, the u.h.f. 2N918, and the epoxy entertainment transistors. The planar chip or die is formed by a series of diffusions through one side only—hence the name “planar.” A series of patterns is imposed on the surface by photographic techniques so that diffusions of *n* and *p* impurities form microscopic transistors with extreme precision. Ultra-high-frequency types are made in the smallest sizes; lower frequency high-power types are large and mounted so as to allow efficient removal of heat.

Fig. 1. Popular alloy-junction type germanium transistors.

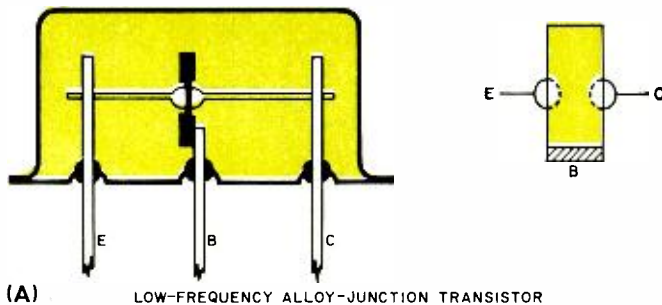

(A) LOW-FREQUENCY ALLOY-JUNCTION TRANSISTOR

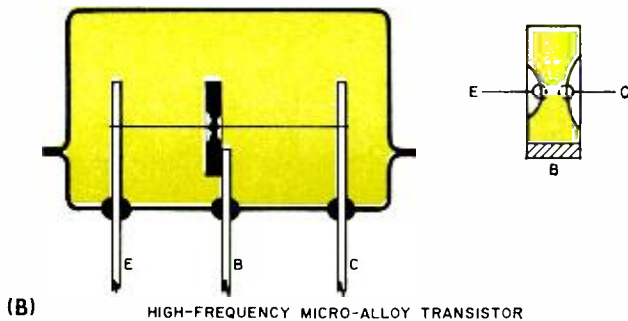

(B) HIGH-FREQUENCY MICRO-ALLOY TRANSISTOR

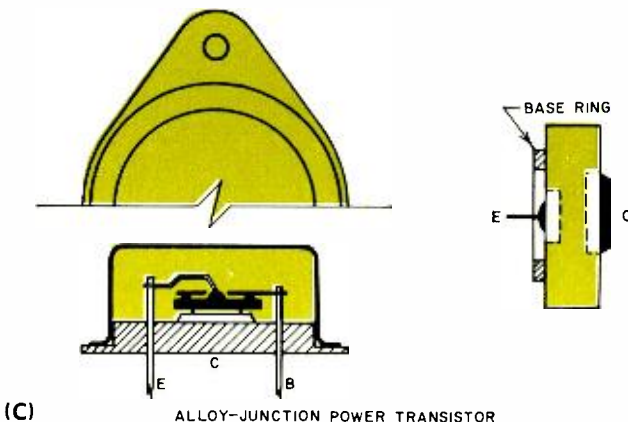

(C) ALLOY-JUNCTION POWER TRANSISTOR

Fig. 2. Construction of the planar-type silicon transistor.

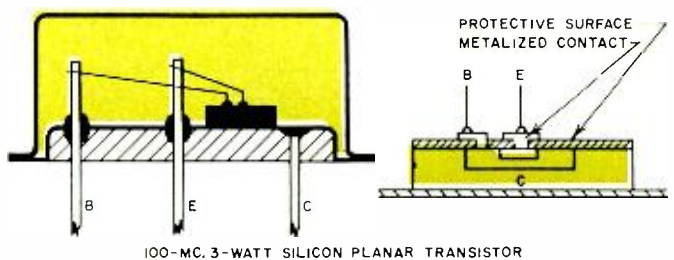

100-MC. 3-WATT SILICON PLANAR TRANSISTOR

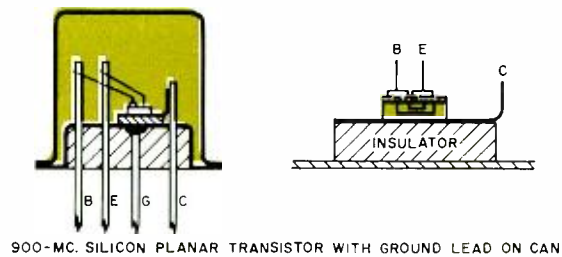

900-MC. SILICON PLANAR TRANSISTOR WITH GROUND LEAD ON CAN



PLASTIC PACKAGE FOR ENTERTAINMENT TYPES

All silicons can be used for audio irrespective of their maximum frequency. In fact, their low leakage allows direct coupling of audio stages without complicated temperature compensation and thus a transformer can often be eliminated.

The planar process lends itself to efficient mass production up to the attachment of the leads and, as a result, the price has dropped to a point where silicon planars are competitive with germanium. Many of the new transistorized TV sets utilize the same high-quality planar chips, in low-cost molded epoxy, as are placed in metal cans for military use. Some of the recommended types, because they are widely available and reasonably priced, are listed in Table 2.

Replacement of Transistors

Published circuits often utilize transistor types the author happened to have on hand. You may want to improve performance and reliability, especially in portable and mobile gear. The changeover to silicon planar transistors is easy if you follow these rules:

1. Select a transistor with approximately equal current gain to the one being replaced.
2. If the silicon transistor has higher amplification, its base current will have to be reduced.
3. In most cases silicon transistors have higher frequency characteristics than germanium alloy devices, so bandwidth will be extended or r.f. performance improved. For v.h.f. applications, where drift, surface barrier, or micro-alloy devices are specified, check the maximum frequency characteristics to find a planar device which has an equal or higher f_t .
4. The base voltage of the germanium transistor is about 0.4 volt less than the silicon transistor for a given collector current, so a simple calculation is required to establish the proper bias current. (See Fig. 3.)
5. If a $p-n-p$ type is replaced by an $n-p-n$ type, all the voltages are reversed. Most silicon planar transistors are of the $n-p-n$ type.
6. In any new construction or replacement, a final check should be made of collector-to-emitter voltage to see if a bias adjustment is necessary.

The comparison of data on one type against another in order to make a sensible solution is often troublesome, especially with older germanium transistors, because different characteristics may be used to express the performance of the two types. It is not difficult, however, to convert one to the other.

Gain for alloy germanium units is frequently given as $alpha$

Fig. 3. Silicon transistors have somewhat higher V_{BE} values

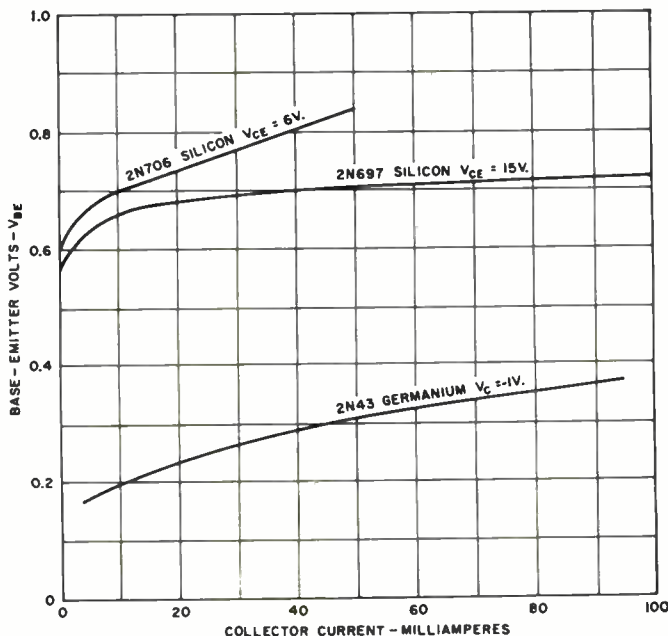

	GERMANIUM	SILICON
Maximum Temperature	85°C (167°F)	200°C (or more) (392°F)
Leakage Current (C to B)		
At room temp.	2 μ a.	0.002 μ a.
At 55°C (131°F)	16 μ a.	0.016 μ a.
Voltage (C to E)		
UHF type	15 v.	20 v.
Other	20-40 v.	40-120 v.
Maximum Frequency	1 mc. to over 1000 mc.	60 mc. to over 1000 mc.
Voltage drop as switch	0.3 v. @ 100 ma.	1 v. @ 100 ma.*

*Epitaxial devices available with much lower drops.

Table 1. Comparison between germanium, silicon signal transistors.

(a), measured from the emitter while gain for planar units is usually given as $beta$ (β), measured from the base. (Note that β is also called h_{fe} and α is called h_{fb} .) The equations to convert these two parameters are: $\beta = \alpha / (1 - \alpha)$ and $\alpha = \beta / (\beta + 1)$. For example, if a germanium transistor has an α listed as 0.98, then $\beta = 0.98 / (1 - 0.98)$ or $.98 / .02$ or 49.

The frequency characteristics are also given in several ways. The frequency at which α becomes 0.7 of its low-frequency value is called $f_{\alpha 0.7}$ or $f_{\beta 0.7}$. The frequency at which

Fig. 4. Bias-network changes for replacement of 2N293 "n-p-n" germanium transistor with 2N706 silicon unit in an i.f. stage.

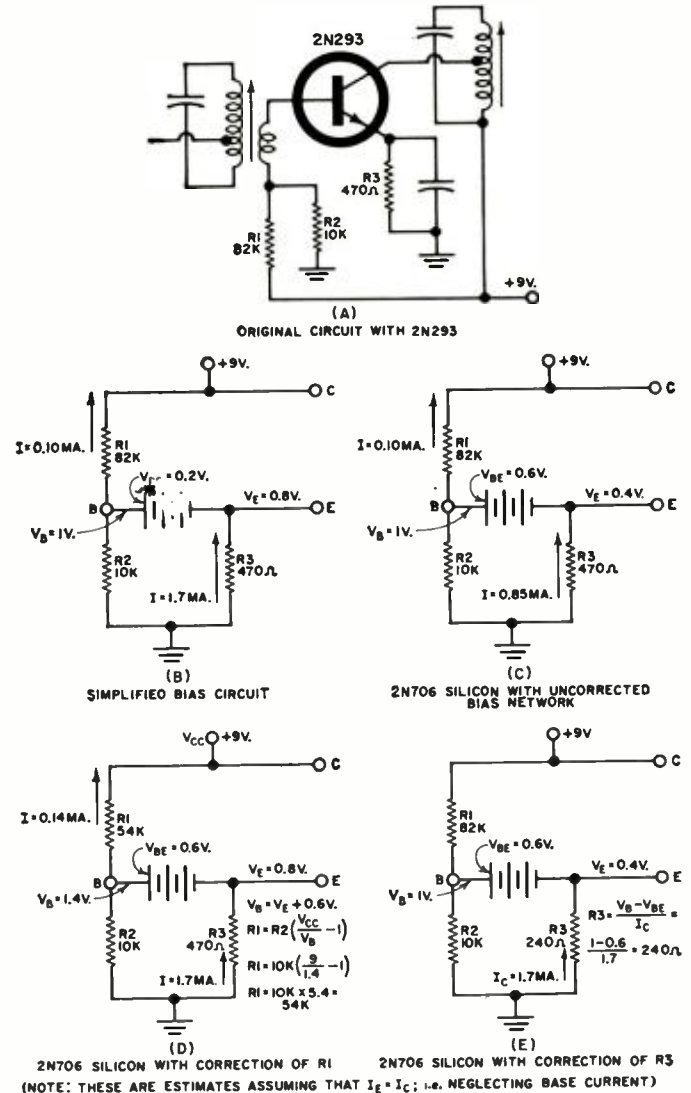

(NOTE: THESE ARE ESTIMATES ASSUMING THAT $I_E = I_C$; i.e. NEGLECTING BASE CURRENT)

TYPE	WATTS DISSIP.		MAX. COLL. VOLT.	D.C. CURRENT GAIN	A.C. CURRENT GAIN	f _t (mc.)	PRIMARY USES				
	No heat sink	With perfect heat sink					A	B	C	D	E
2N696	0.6	2.0	40	40 @ 150 ma.	3 @ 20 mc.‡	60		X		X	X
2N697	0.6	2.0	40	75 @ 150 ma.	4 @ 20 mc.‡	80		X		X	X
2N698	0.6	2.0	80	40 @ 150 ma.	3 @ 20 mc.‡	60				X	X
2N699	0.6	2.0	80	80 @ 150 ma.	3.5 @ 20 mc.‡	70				X	X
2N706	0.3	1.0	20	40 @ 10 ma.	4 @ 100 mc.†	400	X		X		
2N708	0.36	1.2	20	40 @ 10 ma.	4.5 @ 100 mc.†	450	X		X		
2N718	0.4	1.5		same as 2N697 but with small can					X	X	
2N720	0.4	1.5		same as 2N699 but with small can					X		
2N1975	0.8	3.0	80	140 @ 50 ma.	38 @ 1 kc.*	50		X			X
2N1984	0.6	2.0	25	70 @ 1 kc.*	2 @ 20 mc.‡	40	X	X			
2N1985	0.6	2.0	25	30 @ 1 kc.*	2 @ 20 mc.‡	40	X	X			
2N1986	0.6	2.0	40	150 @ 150 ma.	2 @ 20 mc.‡	40				X	X
2N1987	0.6	2.0	40	50 @ 150 ma.	2 @ 20 mc.‡	40				X	X
2N1989	0.6	2.0	60	40 @ 30 ma.	2 @ 20 mc.‡	40				X	X
2N1991*	0.6	2.0		- 20 p-n-p complementary to 2N1985							X

*Collector current = 1 ma.; †collector current = 10 ma.; ‡collector current = 50 ma.; f_t = maximum gain-bandwidth.

KEY TO USES:

A. Small-signal video or r.f. amplifier; B. Small-signal audio-frequency amplifier; C. Low-power r.f. or a.f. oscillator; D. Medium-power r.f. or a.f. oscillator and amplifier; E. Medium-power switching—relay substitute, power converters, etc.

Table 2. Important characteristics and applications for readily available silicon diffused "n-p-n" transistors.

β becomes 0.7 of its low-frequency value is called f_{α_c} or f_{β} . The frequency at which β becomes 1 is called f_t . One can be converted to the other as follows:

$f_{\alpha_c} \approx (1-\alpha)f_{\alpha_b}$, where α is the low-frequency gain and $f_{\alpha_b} \approx \beta \times f_{\alpha_c}$, where β is the low-frequency gain. Also, $f_t \approx 0.85 \times f_{\alpha_b}$, and $f_t = \beta$ (at high frequency) $\times f$ (frequency) as can be seen in Table 2.

As an example, to compare one type of transistor with another, consider a 2N1178 germanium drift transistor listed with an $\alpha = 0.976$ and $f_{\alpha_b} = 140$ mc.

$f_{\alpha_c} = (1-\alpha)f_{\alpha_b} = 0.024 \times 140 = 3.36$ mc., which is the frequency at which gain (β) is down 3 db; and $f_t = 0.85 \times 140 = 119$ mc. The replacement should thus have an f_t above 119 mc. A common silicon type, the 2N706, with an f_t of 400 mc. would be more than satisfactory.

Bias Adjustment

After selecting the planar transistor to be used, the circuit's bias network is adjusted. Two examples, an i.f. and an audio circuit in Figs. 4 and 5, illustrate how this is done. Both circuits have a two-resistor voltage divider to supply the proper base voltage and an emitter resistor for added stability. The example here assumes that the original design gave proper consideration to stability and gain so that a simplified approach may be taken for the silicon substitute.

First calculate the bias of the germanium transistor to be replaced. Assume that the collector current is the same as the emitter current since any error thus introduced is negligible. If the collector current is known, then simple multiplication of this current by the emitter resistor, R_3 , gives the emitter voltage. Adding the emitter-base drop of 0.2 volt gives the base voltage.

If the collector current is unknown, it can be estimated. In Fig. 4B the total drop of 9 volts across the bleeder R_1 plus R_2 produces a current of 0.1 ma., establishing the voltage at the base as 1 volt. Subtracting the estimated base-emitter voltage of 0.2 volt gives the emitter voltage of 0.8 volt. Then by Ohm's law, this drop across the 470-ohm emitter resistor results in a current of 1.7 ma. These calculations are approximations, since they consider that the base current is very small compared to the bleeder current.

To substitute the silicon transistor it is only necessary to change the 0.2-volt drop to 0.6 volt. Referring to Fig. 4C, it can be seen that if the resistance of the bias network is not changed the collector current will drop to 0.85 ma. Fig. 4D shows how a lower value of R_1 increases the base voltage to the proper amount to re-establish a collector current of 1.7 ma. Fig. 4E shows how the emitter resistor, R_3 , can be changed for the same effect.

The circuit of Fig. 5 is a p-n-p medium-power audio stage.

Here the same procedures are used as for the i.f. stage just discussed. However, the polarity of the voltage and the ground point are changed. Note that the emitter of the circuit in Fig. 5A is connected to +9 volts through R_3 . Thus the collector is a -9 volts when the common point at the lower end of the bias network is the reference, as redrawn in Fig. 5B. The new n-p-n silicon circuit shown in Fig. 5C without bias correction has ground at zero potential and the collector at +9 volts. (Continued on page 58)

Fig. 5. Bias network changes for replacement of 2N1415 "p-n-p" germanium transistor with 2N697 silicon unit in an a.f. stage.

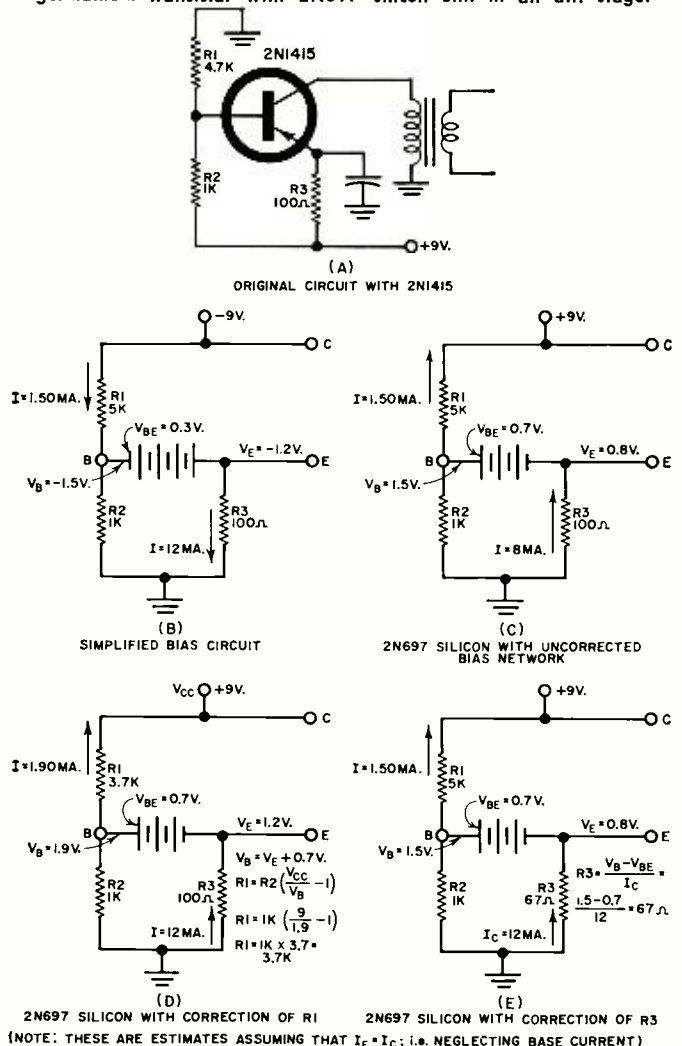

EARLY VACUUM TUBES

Description of some early Edison-effect lamps and oscillation valves developed by Fleming at the beginning of this century.

By PAUL G. WATSON, Cmr. USNR (Ret.)

TO tell the full story of the beginnings of what we today call "electronics" would involve the writing of several large volumes. The story would begin in the late 1700's and early 1800's when some of the eminent scientists of that day noticed the existence of a "field" around incandescent metal objects. Increased availability of sensitive electrical instruments would play a part and the experimenting with incandescent electric lamps would bring us to the threshold of our subject, electronics.

There was much activity among experimenters in the field of incandescent electric lamps; the first by an Englishman, De La Rue in 1820, through to Edison in 1879 when the first practical electric lamp was made.

Edison's basic concept of a high-resistance filamentary lamp enclosed in an evacuated glass envelope solved the problem. After conducting thousands of experiments to find

a satisfactory filament material, Edison on October 19, 1879 lighted the first successful incandescent lamp. It used a bamboo filament which burned for approximately forty hours, finally going out on October 21, 1879.

Edison Effect

During the winter of 1879-1880 while experimenting with various forms of his lamps, Edison noted the blackening of the inside of the glass envelope surrounding the filament, increasing in density as the lamp burned. In his notebooks dealing with these experiments, dated in February 1880, is the earliest mention of "carrying current," which we now know as "Edison effect." Edison had become aware that more than light and heat was being emitted from the incandescent filament.

It was found that with a small metal plate or wire within

◀ Fig. 1. Collection of Edison-effect lamps located in the Science Museum, London. Four oscillation valves in the bottom row are a few of the types made in 1905 for Marconi to test. (Photograph: British Crown Copyright, Science Museum, London.)

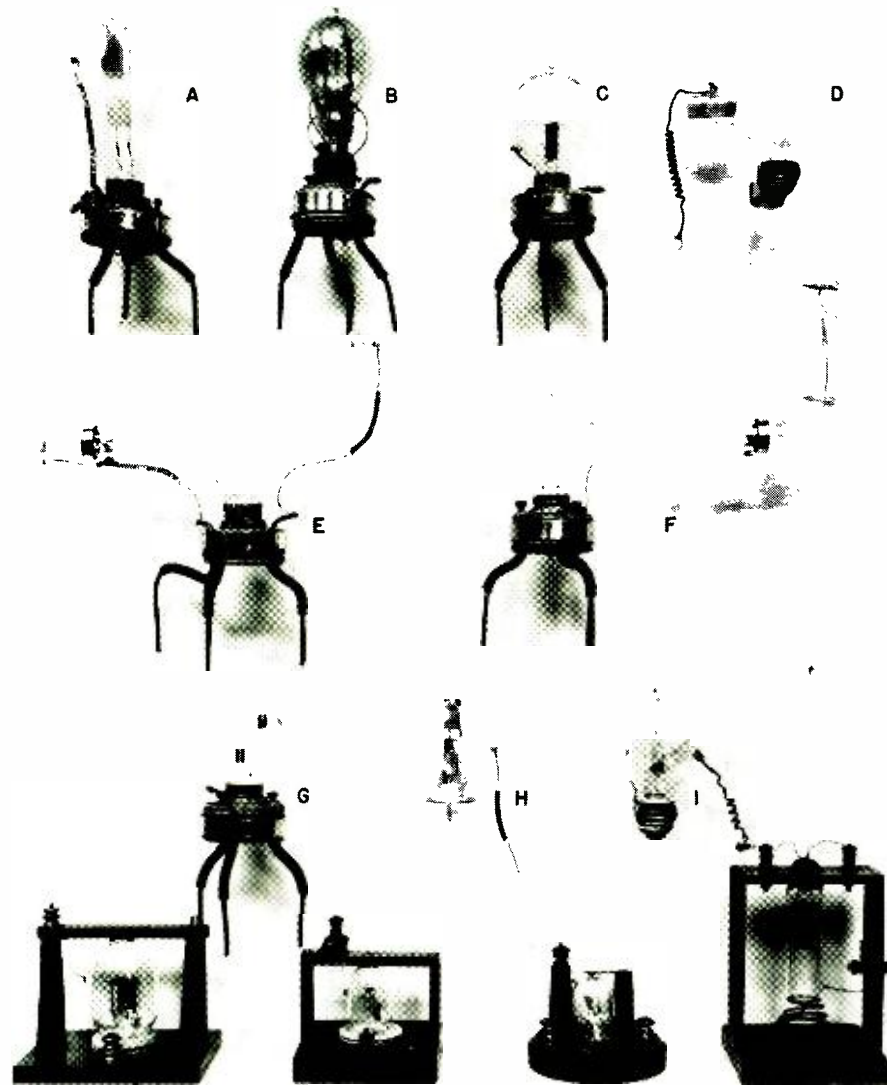
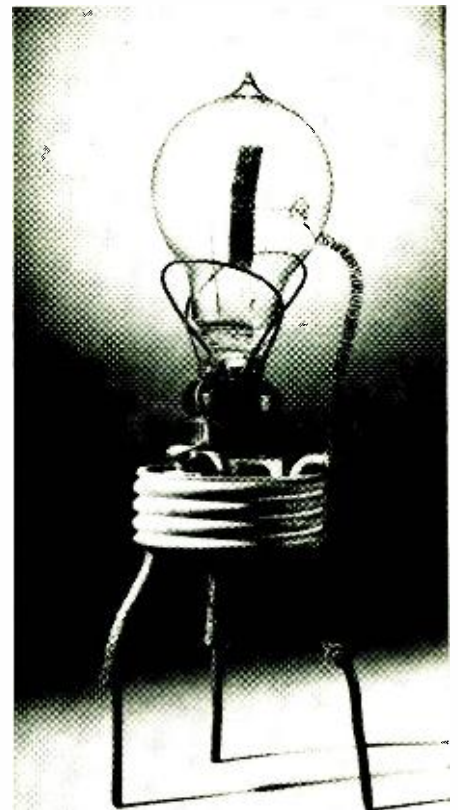

Fig. 2. The Edison-effect lamp which Fleming employed in October 1905 to detect wireless signals for the very first time. (Photograph credit: Science Museum, London, England. British Crown Copyright.)



the glass envelope, heating the filament to incandescence caused the plate or wire to become charged. When a galvanometer was connected between this plate and the positive leg of the filament, a flow of current was indicated. When connected to the negative leg of the filament, no current flowed.

This effect, filament emission and the flow of current through a vacuum to a positive electrode, was the start of all modern thermionic devices.

Subsequent to these experiments Edison found, while evacuating his lamps with a "de-gassing current" warming the filament, that a blue glow occurred at certain levels of vacuum. It was evident that some electrical discharge was passing between the filament legs even though a much lower resistance path existed through the filament itself.

Edison never made any practical use of the discovery of either of these phenomena. He did file a patent application covering their use as "critical voltage indicators" in connection with his lamps.

It remained for an English scientist, J. J. Thomson in 1901, to determine that the emission from the filament, which Edison had discovered, was charges of negative electricity. Thomson called these "corpuscles," today we call them "electrons." Further work in America by O. W. Richardson in this same period showed that the "corpuscles" (electrons) were emitted solely because of their kinetic energy and needed no chemical action at the surface of the filament for their release.

Early in 1881, after the formation of the *Edison Electric Light Company of London*, John Ambrose Fleming was ap-

pointed electrical adviser to the company. He was thus brought into contact with many of the problems relating to incandescent electric lamps. Fleming verified many of Edison's experiments and later extended his field beyond that covered by Edison.

Beginning in 1889 and through 1896 Fleming made many experimental "Edison-effect lamps" in his study of the phenomenon. Some of these lamps can be seen in the Science Museum in London. A number of these lamps, used by Fleming in the period between 1889 and 1896, are shown in Figs. 1 and 3. In many cases these lamps have been the subject of extensive papers presented before a number of scientific groups.

Of the lamps shown in Fig. 1, A and B are carbon-filament lamps with metal plates, used in the general verification of the Edison effect. C is a lamp with a platinum filament and a metal plate, used to determine the existence of Edison effect when using a metal filament. It was found to exist in the same manner as with the carbon filament. D, E, and F were used to determine how far the particles from the filament would travel towards a positively charged plate and whether they could travel around a bend or only in straight lines. It was found that the current became weaker as the distance between the filament and the plate increased and was absent altogether unless the particles could travel in a straight line from the filament to the plate. G and H (also J in Fig. 3) were used to investigate the emission from various parts of the filament. The emission was shown to be almost zero if the negative leg of the

(Continued on page 78)



Fig. 3. Three Edison-effect lamps. "J" has one filament leg screen; "K" has a folded-wire plate; "L" has a metal plate. (Photograph: Marconi copyright. Reproduced by courtesy of the Marconi Company, Ltd., Chelmsford, England.)

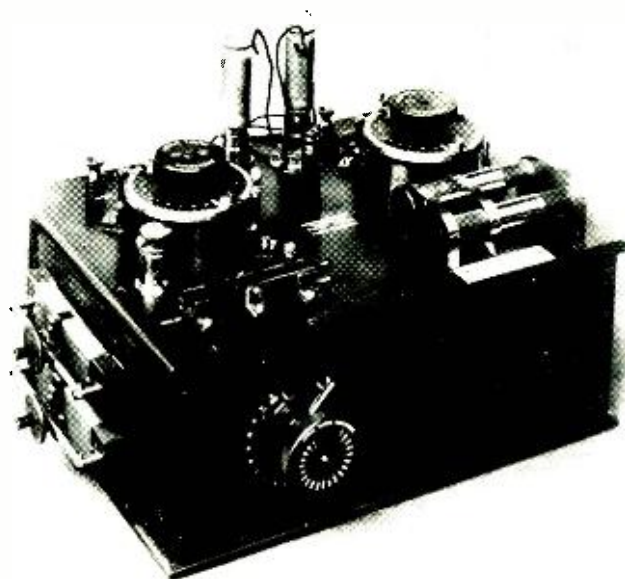
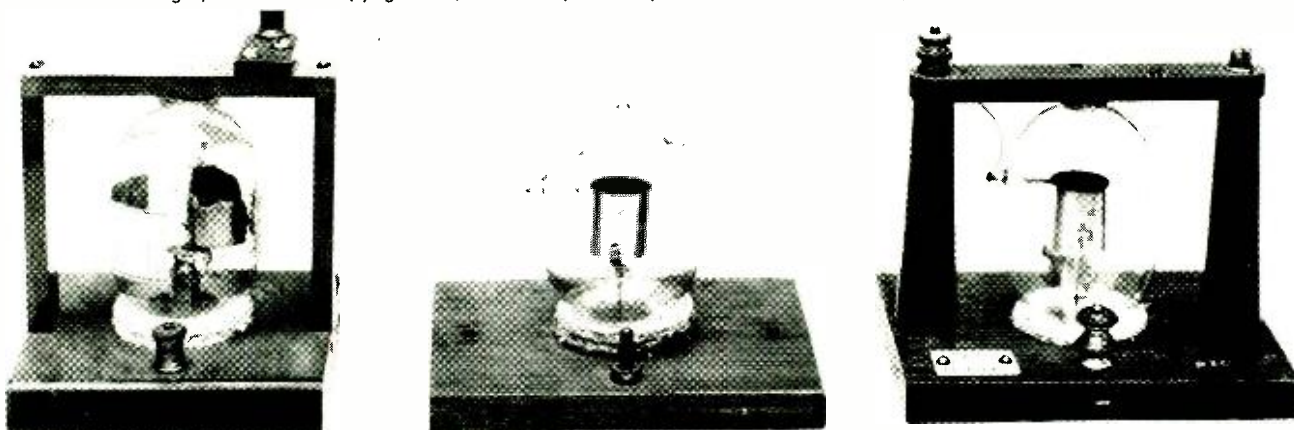

Fig. 4. British Marconi Company receiver of the 1912 era, showing the duplicate Fleming "oscillation valves" at the top rear. (Photograph: Marconi copyright. Reproduced courtesy of Marconi Company, Ltd., Chelmsford, England.)

Fig. 5. Three of the "oscillation valves" made in the year 1905 for Dr. J. A. Fleming and employed by Marconi. (Photograph: Marconi copyright. Reproduced by courtesy of the Marconi Company, Ltd., Chelmsford, England.)



THERMAL RELAYS, THERMISTORS, RC NETWORKS, SCR CIRCUITS, UNIJUNCTION TRANSISTORS— ALL WILL PROVIDE TIME-DELAY OPERATION.



Typical thermal and solid-state electronic time-delay relays.

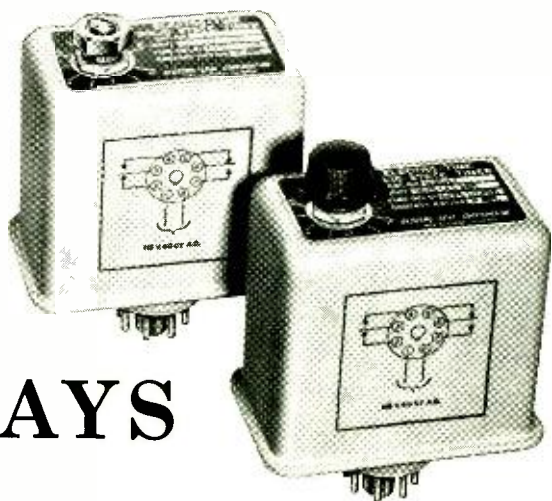

ELECTRONIC TIME-DELAY RELAYS

By LOUIS E. FRENZEL, Jr.

A TIME-DELAY relay is a circuit or device that actuates a relay some predetermined time after an initiating signal is applied. These devices are used in a variety of applications requiring the timing and sequencing of various operations. Timing problems of many kinds can be solved with time-delay relays.

When an engineer turns on the local broadcast transmitter, power is first applied to the tube filaments and a time-delay relay. A set time later the relay operates and applies high voltage to the rectifiers. A time delay is needed to prevent damage to the mercury rectifier tubes that must be adequately heated by their filaments before they can withstand the high voltage.

Time-delay relays are widely used in industrial control applications. For example, they are often used to time-sequence the operations in a chemical plant. Valves, pumps, conveyor belts, or other devices may be actuated at the correct time by time-delay relays to ensure the proper flow or mixture of the chemicals. Other uses are photographic process timing, electric welder control, and light flashing.

Thermal Relays

Many circuits and devices are capable of producing a controlled time delay, but the most useful and versatile are the thermal and electronic time-delay relays. Of these, the thermal time-delay relay is probably the simplest and least expensive. One type of thermal relay works on the principle of metal expansion with heat. A bimetal strip bends when heated and makes contact with a fixed strip, thus forming a switch. The bending occurs because of the different expansion rates of the two metals in the strip. As the temperature is raised by a heating element supplied with an electrical current, one piece of metal in the strip expands faster than the other, and since they are firmly bonded to one another, bending occurs. It takes a set amount of time for the bimetallic strip to heat and bend so that it touches the fixed contact. This is the delay time, and it is a function of the metals' particular expansion rates and the contact spacing that is employed.

The time delay is also dependent upon the amount of voltage applied to the heating element. The greater the voltage, the faster the heating and the shorter the time delay. Although d.c., a.c. of any frequency, or pulses can be used for heating, 6.3-volt, 60-cps a.c. is the most commonly used source. Heating elements that use 2.5 to 117 volts a.c. are also available.

This type of time-delay relay is capable of producing a fixed delay in the 2 to 180 seconds range. While the tolerance depends upon the amount of delay, it is generally better than 10%. Longer time delays can be obtained by

decreasing the heater current that is required with a series resistor or else by the cascading of a number of relays.

Thermistors

Another type of thermal time-delay relay uses a thermistor. A thermistor is a heat-sensitive resistor that has a negative temperature coefficient. When the thermistor is heated, either by the surrounding air or by self-heating produced by current flow, the resistance decreases. The thermal time lag that exists between the application of heat and the change in resistance can be used to produce a controlled amount of time delay.

A typical thermistor time-delay relay is shown in Fig. 1. When S1 is closed, current flows through the thermistor, R1, and the relay but it is not sufficient to cause the relay to operate. The resistance of the thermistor and R1 keeps the current below the relay pull-in value. The current in the circuit produces self-heating which causes the thermistor resistance to decrease. This causes the current to increase and, in turn, it produces greater self-heating, a lower resistance, and increased current. This process continues until the current is high enough to operate the relay. When the relay operates, the lower set of relay contacts shorts out the thermistor so that it immediately begins to cool. This last operation also increases the relay current to ensure that it locks in until de-energized by opening S1. Delay times from several milliseconds to many minutes can be obtained with this circuit.

The biggest disadvantage of thermal-delay relays is that they cannot be re-cycled rapidly. This means that as soon as they heat and operate they cannot be de-energized and used immediately again for the same delay time. Thermal lag prevents them from cooling rapidly to their normal surrounding temperature.

In the thermistor circuit of Fig. 1, the cooling time is minimized by shorting the thermistor with contacts on the relay. When the relay is energized, the lower contact set shorts the thermistor preventing current from flowing through

Fig. 1. Thermal time-delay relay circuit using a thermistor.

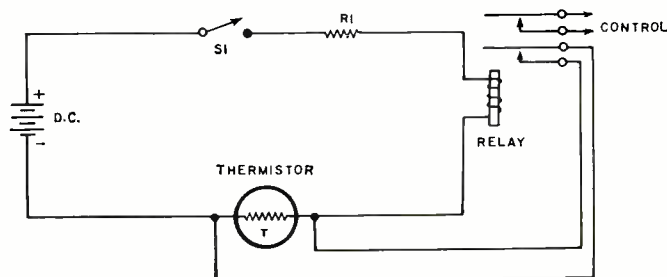

it. It immediately starts to cool and is ready to use again in a short time.

Instantaneous recycle thermal-delay relays similar to the one in the photo are now available for those applications requiring it. A standard thermal relay is used with an external d.p.d.t. magnetic relay in such a way that the total delay time is the sum of the heating and cooling times. At the end of the delay time, the relay has already cooled and is immediately ready to be used again.

RC and SCR Circuits

Electronic time-delay circuits use the charge or discharge of a capacitor through a resistor controlled by an electron device. A typical arrangement is shown in Fig. 2A. In this circuit the relay is normally inoperative because no plate current flows through it. The control tube V1 is held cut-off by the cathode bias supplied by the zener diode D1. R2 sets the quiescent current level in the zener. When the switch is closed, capacitor C begins to charge through R1. As soon as the voltage across C overcomes the zener bias voltage, the tube conducts and actuates the relay.

The delay time between the closing of S1 and the actuation of the relay is a function of the values of R1, R3, C, E_{bb} , and the zener breakdown voltage. Delays of a few milliseconds to several minutes are possible. The accuracy is dependent upon the components used, but 10% is easily obtained. This same circuit works quite well with junction transistors, field-effect transistors, thyratrons, and other control devices.

A somewhat similar arrangement using a silicon controlled rectifier is shown in Fig. 2B. Here again the relay is inoperative because no current flows through it. As soon as S1 closes, the capacitor begins to charge toward the supply voltage through R1 and the load (the relay coil). When the voltage on the capacitor exceeds the zener breakdown voltage, gate current flows, turning on the SCR and actuating the relay. As in the previous circuit, the time delay is dependent upon the values of R1, C, the supply voltage, and the zener voltage. The advantage of this particular circuit is its ability to handle fairly high power loads.

Monostable Multivibrator

The monostable multivibrator in Fig. 3A makes a good time-delay circuit. In its normal state Q2 is saturated because of the base current path provided by R_b . The collector output voltage of Q2 is nearly zero; Q1 is cut off. During this time C charges to V_{cc} through R_c . When a negative trigger pulse is applied to the base of Q2 through D1, Q2 cuts off and the collector voltage becomes V_{cc} . This applies forward bias to the base of Q1, turning it on. C begins to discharge through R_b and in doing so reverse biases the base of Q2 to prevent it from conducting. As soon as C has discharged to the point where it no longer keeps Q2 cut off, Q2 conducts and its collector returns to near ground potential while transistor Q1 cuts off.

The time-delay period is from the start of the trigger pulse when Q2 is turned off to the time when Q2 turns on. This time is a function of C and R_b , and delays of several milliseconds to many seconds are quite possible with good accuracy.

The output pulse at the collector of Q2 can be used to control external circuitry or to drive a relay. If desired, one of the collector load resistors can be replaced by a relay coil. Another arrangement possible is the elimination of the need for an externally applied trigger pulse and the addition of a push-button actuator.

These are only a few of the many electronic time-delay circuits possible. Others use the RC charge/discharge characteristic controlled by thyratrons, cold-cathode triodes, neon lamps, and unijunction transistors. Two commercial time-delay units using unijunction transistors are shown in the

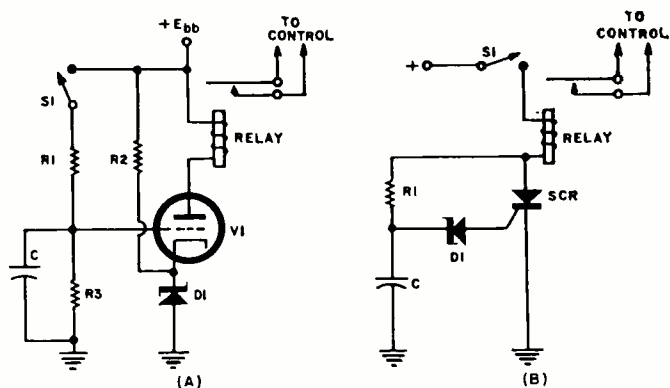

Fig. 2. (A) RC network in conjunction with vacuum tube produces delay. (B) SCR-zener diode circuit provides delay.

photo at the beginning of this article. These units are the two that are at the extreme right on the previous page.

Turn-on/Turn-off Operation

All of the time-delay relays discussed thus far are those that operate the relay a set time after the circuit is turned on. Another type of time-delay relay operates when power is applied and remains on for a predetermined length of time after which it turns off. A simple way of obtaining this type of operation is with the circuit of Fig. 3B. When push-button switch S1 is closed, d.c. is applied to the relay which actuates immediately. Capacitor C1 charges instantly to the battery voltage. Switch S1 is opened, but the relay remains on because current is supplied to it by the discharge of C1. The relay remains on until the capacitor discharge current drops below the holding current for the relay. Relay on-time depends on the relay drop-out current and the time-constant RC_1 , where R is the d.c. resistance of the relay coil. Numerous other circuit arrangements are capable of producing this mode of operation.

An example of an application for such a relay is the control of liquid flow with a valve. A valve operated by an electrical solenoid could be opened when the relay is first turned on. The liquid would flow through the valve for the delay time after which the relay would drop out and close the valve. The delay time could be set so that the correct amount of fluid would flow.

It is sometimes necessary to produce time delays shorter or longer than those of which the above circuits are capable. For delays in the microsecond regions and lower, delay lines can be used. Cable, lumped LC, and magnetostrictive delay lines are available in a wide range of delays. The monostable multivibrator of Fig. 3A is also quite capable of microsecond delays. For delay times longer than several minutes, motor-driven switches can be used. Delays up to 100 hours are possible. The electronic circuits of Fig. 2 can produce delays of several hours if care is taken in design. For highly accurate time delays, special types of digital circuitry can be employed. ▲

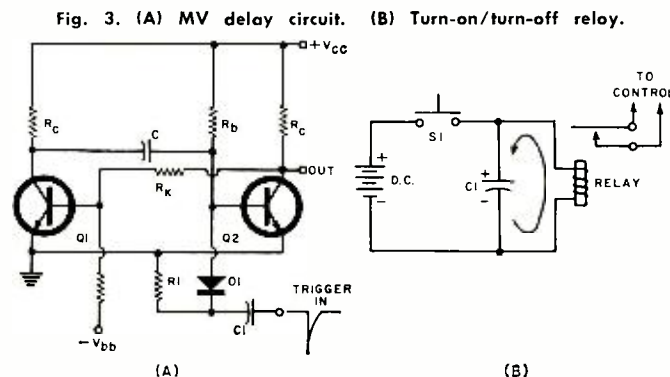

Fig. 3. (A) MV delay circuit. (B) Turn-on/turn-off relay.

HIGH-SPEED ELECTRONIC PRINTER



A bank of fluorescent lamps, visible in the opening at the right, serves as ultraviolet light source that is employed in this printer to develop the visible image on the paper.

By A. W. EDWARDS
Century Electronics & Instruments, Inc.

Description of an all-electronic, non-impact type of printer using a special CRT and fiber-optic techniques.

THE continued improvement in direct writing (or direct print) ultraviolet-sensitive papers and the development of fiber optics have brought techniques of high-speed electronic printing into the realm of practicality. It is now a routine matter to print desired information at rates exceeding 6000 characters per second and to attain print-out rates of 8100 lines per minute, or more. As further advances are made in the direct-write recording media, even higher speeds will be achieved. Although presently available direct-write papers are much improved, their reaction times remain a principal limiting factor in the capability of the system to be described.

For those not familiar with the technique of direct-write recording, it should perhaps be explained that this is one which utilizes a photosensitive chemical, bonded to a paper base, much as do blueprint papers. The chemicals used are rather like a slow photographic film, except that they react quite fast to the ultraviolet end of the spectrum.

Direct writing has been extensively used in the field of oscillography. In this service, the ultraviolet source is concentrated and reflected from small mirrors that are suspended on tiny, hermetically sealed coils. Such assemblies are called *light-beam galvanometers*. These galvanometers are positioned in a strong magnetic field. When signals are applied to the galvanometer, the coil is displaced according to the instantaneous signal magnitude and polarity, as the magnetic forces seek to establish an equilibrium. Since the mirror is physically attached to the coil suspension, this displacement produces a transverse motion of the incident light ray. The moving ray, focused as a spot on the moving recording paper, produces a varying trace which is an analog display of the input signal. (See "The Photographic Oscillograph" by Ray A. Shiver in the July 1962 issue.)

The traces produced by this action are invisible, or latent. Upon subsequent exposure to mild ultraviolet sources (fluorescent lamps are universally used), the paper begins to develop. The desired traces represent virtual saturation of the chemical agent; thus, as a slow development occurs under the influence of weak ultraviolet radiation, the latent

traces appear in very good contrast. The simultaneous application of heat (passing the paper over a heated platen, for example) and light greatly accelerates the development of the paper. Latent traces may also be developed by a darkroom chemical bath process.

The electronic printing system to be described makes use of direct-write paper to achieve the high print rates described. By the use of a special CRT, one which employs a

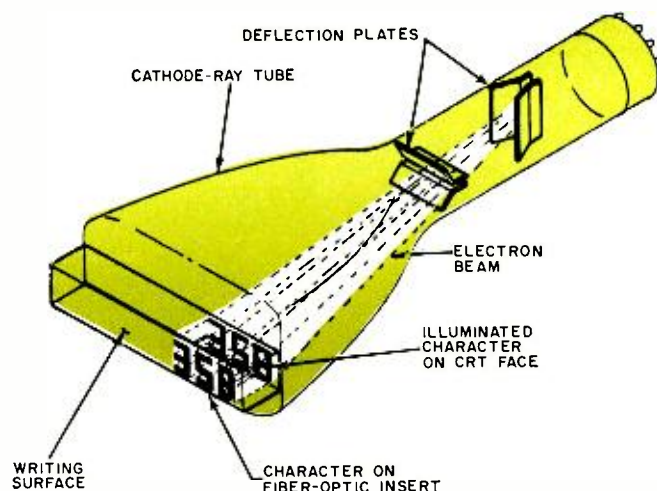

Fig. 1. Special CRT used in the electronic printer described.

fiber-optic bundle insert as an integral part of the CRT face, the desired characters actually are traced out by signals applied to the deflection plates and control grid. Fig. 1 illustrates the essential construction of the printing CRT, with its fiber-optic insert at the front of the tube.

The solid rectangular insert is composed of many thousands of extremely small (20 microns in cross-section) glass rods. These rods are carefully oriented to lie parallel to each other, are fused together, and polished at each end surface. Actually, each individual rod is composed of two types of

glass, with a different refractive index, but with very similar thermal expansion coefficients. Consider one a tube and the other a solid rod that fits inside this tube. The type of glass with the lower index of refraction is used for the core and the second type, with the higher refractive index, is the sheath, or outer cover. Light rays incident on the ends of these rods become trapped in the cores and are transmitted down their length.

As may be inferred from Fig. 1, the figures that appear at the writing surface are projections of the trace that is produced by an accurately deflected electron beam. The unique feature of this CRT is that the back surface of the fiber-optic bundle is actually under the high vacuum of the CRT envelope, just as the deflection plates and other elements are. A type P-11 phosphor is deposited directly on the inside surface of the insert, and the electron beam is adjusted to focus on and sweep across that surface only. The traces produced by the action of the deflecting and blanking circuitry are transmitted with negligible light loss to the front, or writing surface, of the optic insert.

The major advantages of fiber optics in this application are, in fact, the small attenuation of available light transmitted to the outer writing surface, and the small physical dimensions of the bundle. The design parameters of the rods result in almost no diffraction ("crosstalk") between adjacent rods. The bundle used in the electronic printer has a resolution of approximately 200 photographic lines per millimeter. These fiber optics are 60 to 80 times more efficient than lens systems of the highest quality, employing the widest aperture lenses available. Additionally, fiber optics are much more compact than any lens system that might be suitable to this printing technique, and further, never require cleaning or lose their adjustment.

The direct-print paper passes over the outer, or writing, surface, in contact with it. Thus it is exposed to the light generated at the phosphor side of the insert. After receiving the transmitted light patterns, the paper issues onward, is developed by a bank of fluorescent lamps contained in the printer, and emerges as readable copy.

This particular printer prints up to 32 columns of data, which data may be read out as either numerals and special symbols, or as fully alphanumeric print. The latter version has the 26 letters, the ten digits, plus some special symbols ("+", "-", etc.). Other models of this printer provide up to 64 columns per line, using side-by-side CRT's. In this version, the fiber optic inserts are cut on a slant, to enable the writing surfaces to meet in sufficient proximity that no break or gap in the printed line results.

Fig. 2 illustrates, in simplified form, the sections of a basic electronic printer. Essentially, the printer must con-

Fig. 2. Major essential sections shown in block form.

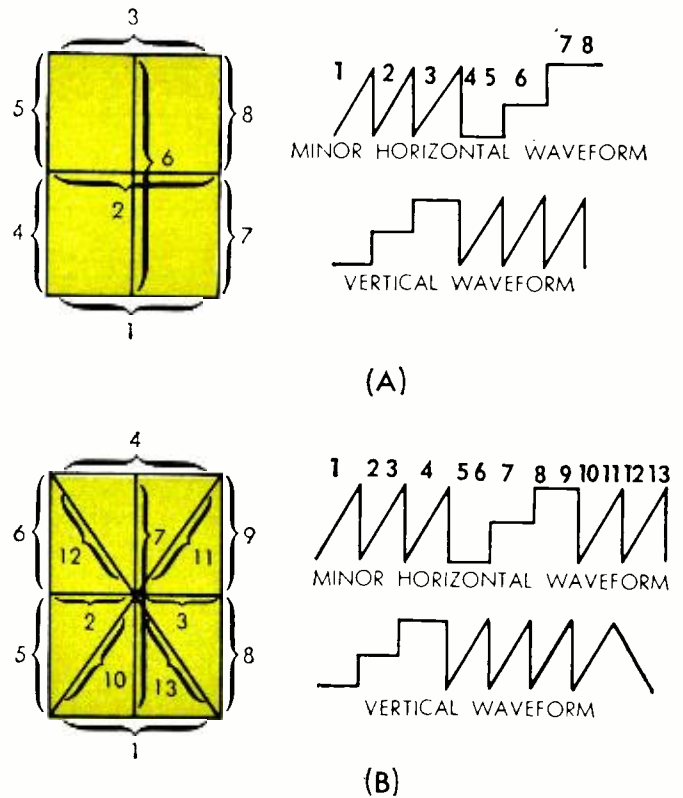
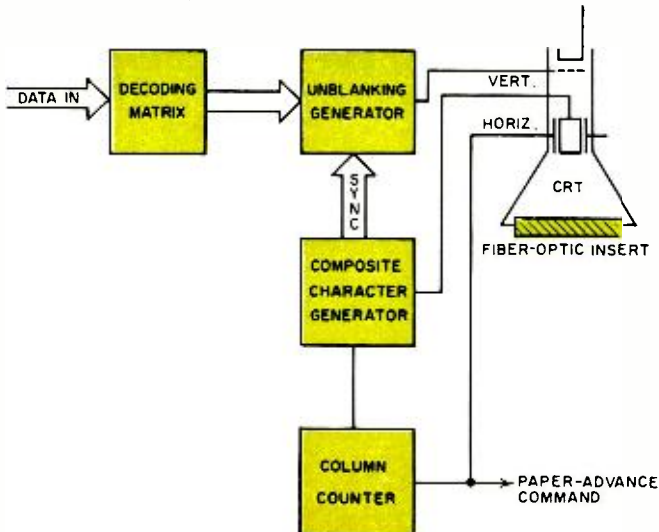

Fig. 3. Composite character generation for (A) numeric and (B) alphanumeric print-out. In both cases the simultaneous application to the CRT plates of the synchronous-deflection waveforms causes the tracing of character elements in the sequence indicated. Discrete characters are formed by selectively unblanking certain segments of this composite figure as required.

tain these elements: a special cathode-ray tube and optical projection system, a composite character generator, a synchronous unblanking circuit, a decoding matrix, a column counter, and a means for paper transport.

System Operation

Fig. 3 illustrates the composite character traced for both numeric-only (Fig. 3A) and alphanumeric (Fig. 3B) print-out. Beside each composite character is a representation of the vertical and horizontal waveforms that are applied to the corresponding CRT plates to produce this entire character. The generation of individual letters and numerals available in the "electronic font" will be explained in the following paragraphs.

In operation, the deflection voltages from the composite character generator are applied (along with the column counter voltages) repetitively and continuously for every column across the width of each line of print. The beam from the electron gun, however, is cut off by a voltage from the unblanking generator, applied to the control grid. Therefore, until this cut-off voltage is removed (or the CRT unblanked) there is no beam to be deflected, and no electrons to reach the phosphor and produce light.

The unblanking circuit serves to remove the cut-off voltage selectively from the CRT control grid. When this is done at prescribed intervals of the composite character tracing, only the desired segments of this character are traced on the phosphor, as the electron beam impinges on it. Unblanking waveforms for the generation of numerals are shown in Fig. 4. These segment selections are caused by the action of the discrete input codes, and the input data then results in the desired print-out of numbers, letters, symbols, etc.

For the generation of the letter "T," only the portions of the applied waveform that produced lines 4 and 7 would be unblanked and a "T" would be printed on the paper in that column (see Fig. 3B).

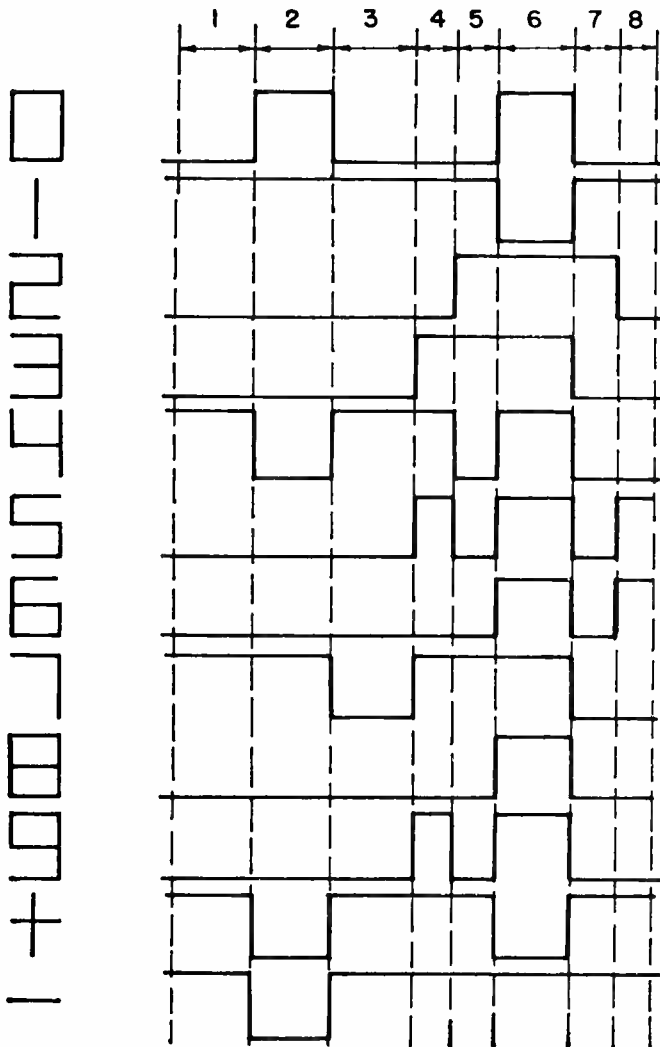

Fig. 4. Unblanking-amplifier outputs for numeric print-out.

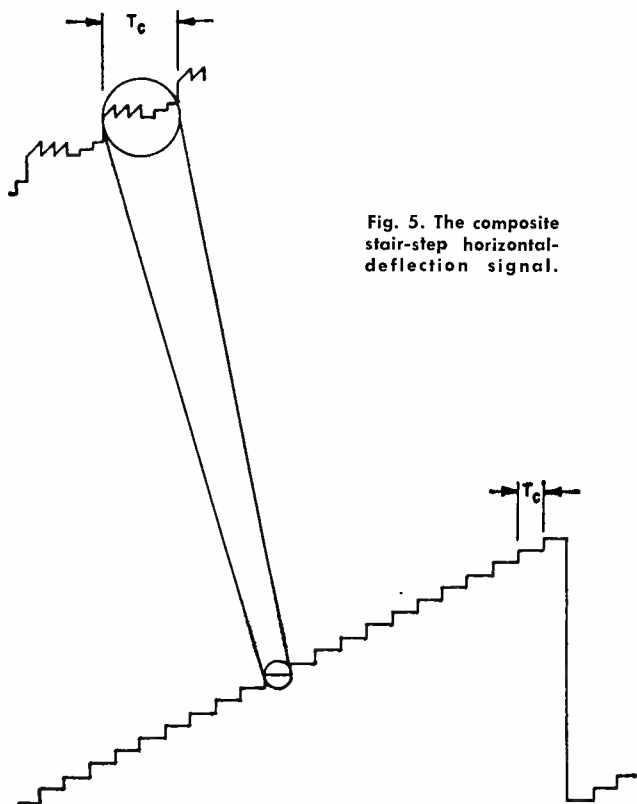

Fig. 5. The composite stair-step horizontal-deflection signal.

Appropriate voltages are introduced into the horizontal deflection circuit to advance the trace column by column across the writing surface. Fig. 5 illustrates the voltage waveform for an entire print line. Each "step" is the voltage increase that moves the beam one column's width across the writing surface. The small inset shows the horizontal sweep voltage within the column, as the composite character is traced out. After the entire line is printed, an end-of-line pulse is sent to the paper advance mechanism, and the horizontal deflection voltage falls to a value representing a return to the opposite side of the writing surface.

Current models of the electronic printer employ a stepped motor that advances the paper vertically across the writing surface in increments of one line, on receipt of an electrical pulse command. The stepped motor operation is synchronous with the print cycle, inasmuch as the motor driving impulse is developed by the column counter at the end of each printed line. The particular servomotor employed is easily controlled to operate over a wide speed range. Its action is positive, and response to speed change is instantaneous.

The logic level used in the printer is 0 volt = binary 0 and -12 volts = binary 1. For numeric print-out, a 4-bit binary is required, and for alphanumeric print-out, a 6-bit binary is required. Special printer driver circuits may be provided to adapt the normal printer input requirements to a wide variety of other data formats.

Advantages of Electronic Printing

Speed is an expected feature of electronic data manipulation, but the ability to achieve rapid, virtually noiseless printing on paper, with the added bonus of high reliability, ensures the electronic printer a bright future in data-handling centers. In such centers, it is imperative that distracting and fatiguing noise be kept to a minimum. Moreover, it is highly desirable that the printer be extremely reliable. Both these goals are successfully approached by the concepts inherent in the design of an all-electronic, non-impact printer.

As to noise—and the same factors will apply to wear, vibration, misadjustment—the mechanical printer inevitably must involve the use of print drums, or type faces (these have weight and require a substantial energy source to fling them back and forth), ribbons, hammers, solenoids, carriage shifts and returns, and other violent start-stop motions. These mechanical motions not only produce noise, and require real power for their actuation, but also severely limit the top data-handling rate.

By dispensing with virtually all mechanical contrivances (except for the very straightforward paper advance mechanism), the electronic printer concept eliminates immediately an entire category of potential failures. To name but a few: critical clearances, spring tension adjustments, complex mechanical linkage throws, cam lifts and alignments, friction points, and so on. Not only, then, is the time between failures increased, but the necessity for frequent adjustment and maintenance is largely overcome.

Applications & Future Trends

Presently the most active market for these printers is that of the space program, the military activity, and larger industrial applications. Wherever the need exists to accept and display high-speed digital data in alphabetic or numeric form, these devices are "naturals." It may be in "on-line" monitoring of an automated process, or the immediate display of telemetered burst of data from an orbiting space vehicle; whatever the task, these printers maintain a fast pace and their maximum capabilities usually exceed the system requirement.

It is only logical that the electronic printer should fall heir to the data-handling chores of a speed-conscious society. ▲

ADVANCES IN PHOTONSENSITIVE DEVICES

By JOHN R. COLLINS

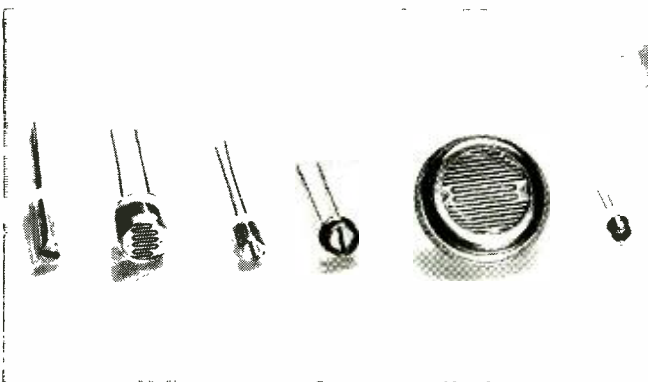
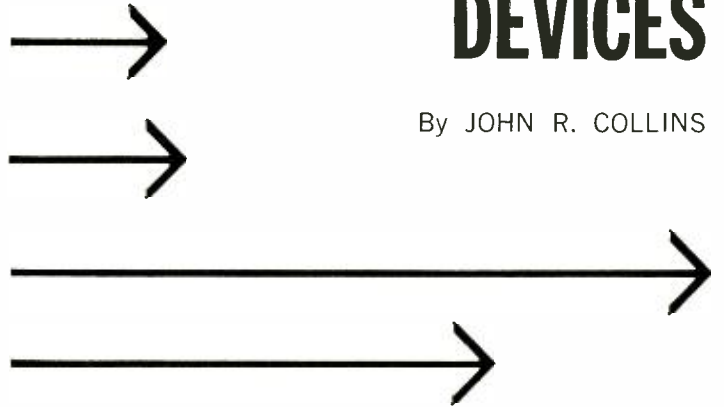
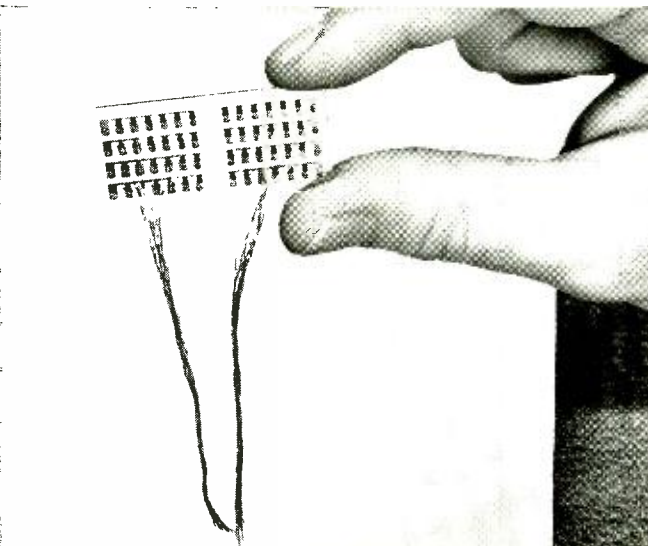

Fig. 1. Cadmium-sulphide and cadmium-selenide photoconductive cells are made in many varied shapes by various manufacturers.

Fig. 2. Photoconductor mosaics are often used as tape readers.



PHOTOELECTRIC devices for opening doors or sounding alarms have always been popular with hobbyists and experimenters, and light-actuated mechanisms for counting and sorting products or monitoring processes have enjoyed a significant place in industry for many years. Recent developments have opened up wider areas, however, leading to important new applications in both military and industrial sectors. Major gains have been made in sensitivity, speed of response, spectral range and, in the case of photovoltaic cells, power output. As a by-product, the technician now finds a greater selection of sensitive photocells (Fig. 1) from which to choose when designing circuits.

Recent applications of photosensitive devices are far too many to detail, but a few examples will illustrate the scope. Photocells in mosaic arrangements (Fig. 2) provide a solution to the problem of high-speed card or tape readers for input to electronic computers. Light impressed on the card or tape passes through to the mosaic where a hole has been punched, illuminating a corresponding photocell. Where there is no hole, the light is blocked. Thus, a pattern corresponding to the information on the tape is transferred to the mosaic. Readers using modern fast-response photocells can now handle 1000 characters per second on tape, or 1000 cards per minute.

Photocells operating in the infrared region are used to detect fires in enclosed areas of aircraft, such as engines, which are difficult to monitor visually. Their speed and sensitivity are so great that in the case of military aircraft an infrared device will detect an incendiary bullet making a direct hit on a fuel tank and will trigger a detonator which spreads an extinguishing agent through the fuel *before* the bullet passes through the wing.

Overheated journal boxes on freight cars, once a leading cause of melted axles and derailments, used to cost the railroads millions of dollars annually. Now, hot-box detectors capable of monitoring the condition of the journal box on each wheel of a freight train traveling 70 miles per hour are installed on each side of the track at check points along the lines. An infrared detector unit generates a pip which is amplified and recorded as each journal box passes it. The height

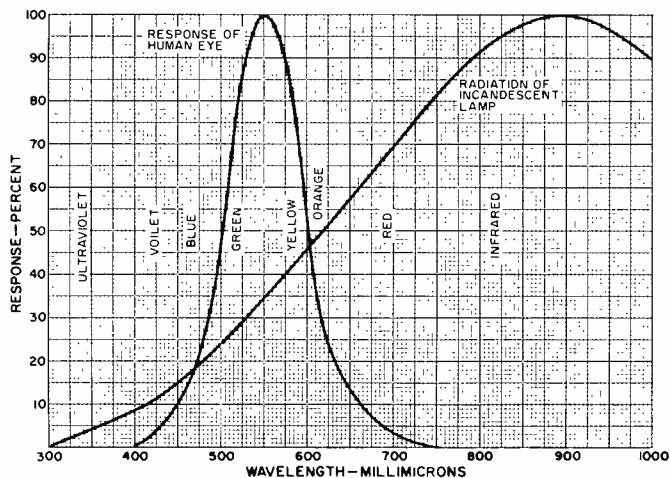

Fig. 3. Spectral response of human eye and incandescent lamp.

of the pip is proportional to the heat of the box. If it exceeds a safe limit, a repair is made at the next terminal.

With modern photocells, it is no longer necessary for an intruder to cross an invisible beam in order to be detected. His presence can now be discovered simply from the radiation given off by his body. Similarly, military infrared equipment no longer depends on surveying an area which is irradiated with infrared light. Passive detectors are now able to pinpoint the location of troops, vehicles, etc., from the normal infrared radiation which they emit.

Although photocells that produce output power have been known for years and have supplied the energy needed to move the indicator in light meters, it is only recently that they have become efficient enough to adjust the lens of a camera without the aid of a battery. In addition to their use in automatically adjusted cameras, cells of this kind are used to power small radios or operate tiny motors from energy supplied by the sun. Similar types are used to supply power needed to operate electronic equipment in space satellites.

Characteristics of Light

According to modern physics, light is an electromagnetic radiation, similar to radio waves but of much shorter wavelength. For this reason, wavelength of light is expressed not in meters but in microns (μ), equal to 1 millionth of a meter. Even this unit is rather large, so it is not uncommon to find wavelengths in either millimicrons ($m\mu$) equal to 1 thousandth of a micron, or in Angstroms (\AA) equal to 1 ten-thousandth of a micron.

Fig. 3 shows the optical spectrum in millimicrons, together with the characteristic response of the average human eye. Note that the shortest wavelength to which the eye responds is violet (about 400 $m\mu$) and the longest is red (about 750 $m\mu$), with peak sensitivity in the green/yellow region at about 550 $m\mu$. Wavelengths shorter than violet and longer than red fall into the ultraviolet and infrared regions, respectively. Although invisible, they can be detected by photocells, and both regions have been exploited for a variety of pur-

poses. It is interesting to note that the common incandescent lamp used for illumination radiates about 90% of its energy in the invisible infrared region.

Light energy is emitted from a source, such as an incandescent lamp, in tiny packets called photons. The energy of a given photon, expressed in electron volts, is equal to the product of the frequency of the light and Planck's constant. Since ultraviolet light has a shorter wavelength and therefore a higher frequency than visible light, photons of ultraviolet light contain more energy than photons of visible light. Both ultraviolet and visible-light photons have more energy than the infrared-light photons, especially in the far infrared region. The low energy of infrared photons makes detection of the long infrared waves more difficult.

Photoconductive Cells

Photoconduction dates back to 1873, when it was discovered that selenium rods intended to serve as high-resistance elements in apparatus for testing submarine cables decreased in resistance in the presence of light. This action of light on selenium metal is known as intrinsic photoconduction and is illustrated in Fig. 4A. The outer shell of an atom contains electrons which make up the valence band. These electrons can be raised to the conduction band by absorbing energy from light. Once in the conduction band, they can take part in current flow, thus reducing the resistivity of the material.

The conduction band is separated from the valence band by the so-called forbidden energy band. It is important to note that the amount of energy needed to move an electron across the gap is dependent upon the wavelength of the light, not on its intensity. As explained before, the energy of light is greatest at the shortest wavelengths. Therefore, if a photoconductive cell were responsive, say, to blue light, it might not react to even very intense red light. The energy of the red light would be absorbed and would serve to raise the temperature of the cell but would not cause electrons to jump the forbidden gap if the photons were too weak. However, a violet light, since it has a shorter wavelength than blue and therefore photons of greater energy, would cause the cell to react.

The forbidden energy gap is different for different materials, and although practically all materials are susceptible to the high-energy photons produced by x-rays, only a comparatively few react to visible light and even fewer to infrared. This limitation is overcome, however, by a system of doping various compounds with impurities so that the impurity level is close to the conduction band, as shown in Fig. 4B. This process permits greater sensitivity as well as greater versatility in selection of desired operating range.

Cadmium and Lead Salts

In the visible region, cadmium-sulfide photoconductive cells provide high sensitivity. Their peak sensitivity ranges from about 515 $m\mu$ to 615 $m\mu$, depending on impurity levels and method of treating in fabrication. One type has been devised with peak sensitivity at 550 $m\mu$ to match the human eye. This characteristic is especially useful for light meters, cameras, street-lighting switches, and color-measuring equipment. Cadmium-sulfide cells peaking at longer wavelengths are used in the new automatic dollar-bill changers which examine and pass on the authenticity of the paper and ink before making change.

Resistance change with light for cadmium sulfide is relatively linear. A typical response curve is shown in Fig. 5. It has appreciable inertia, however, which slows its response to changes in light level. Also CdS cells typically exhibit hysteresis effects which cause the resistance vs light characteristics to vary depending on previous exposure.

Faster and more sensitive cells are made from cadmium selenide ($CdSe$) which has peak sensitivity in the range from 690 $m\mu$ to 735 $m\mu$. Its fast rise time of 1 millisecond from

Fig. 4. How carriers are generated within a photoconductor. (A) Intrinsic photoconductor and (B) doped photoconductor.

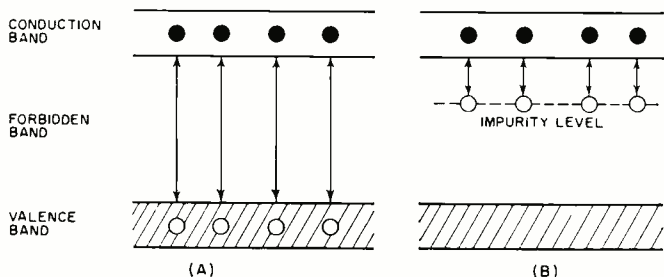

zero to 63% conductance makes it useful for high-speed counters and choppers. It is also quite sensitive, its resistance dropping rapidly with even very weak illumination.

In the infrared region, various lead salts, usually doped with oxygen, provide extremely sensitive photoconductive cells. The principal types in general use are lead sulfide (*PbS*), lead selenide (*PbSe*), and lead telluride (*PbTe*). The lead salts are usually deposited by vacuum evaporation in a film about 1 micron thick on a substrate of glass or quartz, or they may be chemically deposited. In either case, oxygen is introduced into the process to increase the sensitivity. All three of the lead-salt detectors peak at a wavelength longer than 1 μ at normal temperatures and, when cooled to about -195°C , are useful in the range from 4 to 6 μ .

Lead-salt photocells are characteristically more sensitive than the cadmium types discussed before and have shorter time constants. A typical lead-sulfide cell, for example, has a time constant of 50 microseconds, while lead-selenide types are available with time constants less than 5 microseconds. Their wide spectral range and fast response have won lead-salt photocells an important place as detectors in military weapons systems, since they are sensitive to the long wavelength radiation of warm objects as well as the shorter wavelengths of objects which are almost red-hot.

It is an interesting fact that lead-sulfide cells are widely used in industrial equipment because of their favorable characteristics even where sensitivity in the infrared region is unnecessary. Lead-sulfide cells are used in the card- or tape-reader mosaic shown in Fig. 2, which could operate equally well in the visible range. However, its sensitivity to infrared permits the lamps which supply the source radiation to be operated at a temperature below incandescence for longer service life. Lead-sulfide cells are also commonly used for motion-picture sound reproduction.

Doped Germanium

Very long infrared wavelengths in the range from 4 to 40 microns can be detected by germanium doped with gold or zinc. Gold gives the greater response to a signal but cuts off at about 10 microns. Zinc permits detection at the longer wavelengths. In either case, it is necessary to cool the detectors to cryogenic temperatures to keep thermal energy from causing electrons to jump the very small forbidden energy gap. Liquid helium must be used for zinc-doped cells.

Ordinary glass or quartz will not pass very long waves, so special windows must be used to pass the infrared radiation to the cooled cell. Silicon windows can be used to about 10 μ , but sapphire is needed for the far infrared. These special requirements and the attendant expense allow the use of doped germanium for only the most important applications.

Photovoltaic Cells

Photovoltaic cells, in which a voltage is generated when illuminated, are practically all semiconductor types in which the active area is a *p-n* junction. When light is absorbed near this junction, new mobile holes (positive charges) and electrons are released, causing a difference of potential to occur. Current flows when there is a complete circuit.

As in the case of photoconductive cells, photovoltaic cells will not respond to light of energy insufficient to raise an electron into the conduction band, a factor which is influenced primarily by the materials used.

A popular photovoltaic-cell material is selenium, whose response, like *CdS* described before, matches the characteristics of the human eye. Selenium photovoltaic cells are made by depositing a thin layer of pure selenium on a metal base plate under vacuum, annealing at high temperature to convert to crystalline form, then vacuum depositing cadmium to form the photoelectric junction. An ultra-thin layer of gold may be deposited on the surface to increase conductivity. Terminals, or collector strips, are made of a cadmium alloy applied by spraying, and flexible wire leads may be attached

RESISTANCE vs. LIGHT

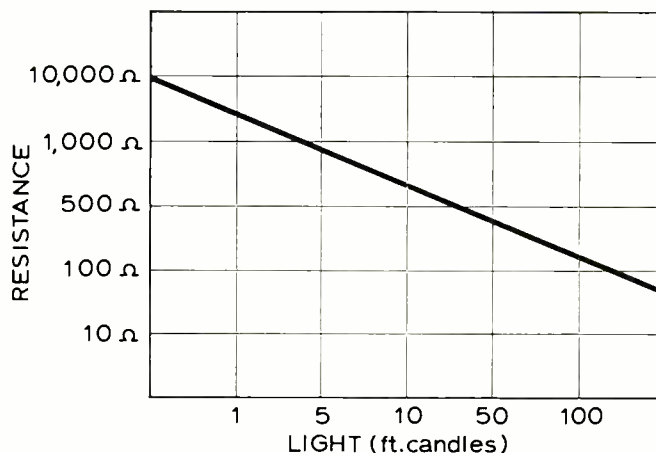

Fig. 5. Characteristic response of a cadmium-sulphide cell.

to these. A transparent resin is then applied for protection.

The manufacturing process for silicon cells is more difficult, resembling the process for making silicon transistors. Purified silicon is melted in quartz crucibles and doped with minute amounts of phosphorus, arsenic, or antimony to make *n*-type silicon. An elongated single crystal is grown under carefully controlled conditions from the molten silicon. Slices are cut from the crystal which are then ground, lapped, cleaned, and placed in an electric furnace where boron is diffused into the outer surface to form a *p-n* junction. By nickel-plating and tinning, a thin strip is formed on the *p*-layer to function as the positive terminal. The *n*-layer serves as the negative terminal.

Silicon photovoltaic cells cover a broad spectral range from about 400 $m\mu$ to 1100 $m\mu$, peaking near 800 $m\mu$.

Both silicon and selenium photovoltaic cells may be used as sources of power for small motors, radios, or to operate sensitive relays. Where a single cell does not provide enough power, several cells may be connected in series or series-parallel to obtain the necessary output. Fig. 6A shows such a circuit using selenium photovoltaic cells in a relay circuit which will throw a switch when exposed to sunlight without requiring any other source of power.

Photovoltaic cells may also be used as photoconductive cells in battery circuits, as shown in Fig. 6B. When employed in this way, they require a smaller voltage than is customary with photoconductive cells. Where great sensitivity to weak lights is desired, they can be used in the circuit with a transistor amplifier, as in Fig. 6C.

Indium antimonide (*InSb*) has undergone intense development for production of photovoltaic cells for the far infrared. Cells made of this material have a very small energy gap and must be cooled to reduce noise and the spontaneous generation of carriers as the result of heat. To date, they have been of primary interest to the military for advanced weapons systems. They can be operated either as photovoltaic or photoconductive devices, and they reach peak sensitivity at about 6 microns. ▲

Fig. 6. (A) A sun-powered relay. (B) A photovoltaic cell used with battery. (C) Sensitive transistorized photoelectric relay.

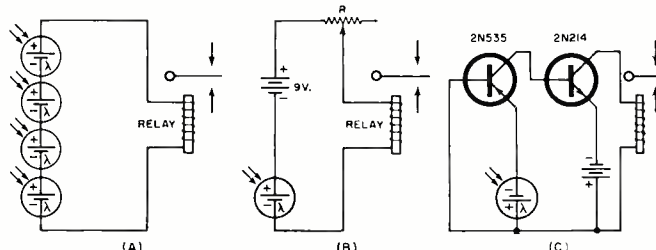



DESIGN TRENDS



IN RECEIVER



FREQUENCY CONTROL

By JIM KYLE

The use of digital tuning, frequency synthesis, spectrum generators, stable master oscillators, continuous transfer systems, and many other techniques in communications receivers in order to permit precise frequency tuning.

IN years past, the subject of frequency control for communications receivers attracted relatively little attention. Operating channels were wide, and as long as the received signal could be tuned in easily and would remain in the receiver's passband, things were satisfactory. When the utmost in stability was required, as for commercial point-to-point communications links, crystal control of receiver frequency was regarded as the ultimate answer.

Today, however, this is no longer the case. Crowding of the r.f. spectrum by a vastly increased number of users has resulted in the application of advanced modulation systems, requiring the utmost accuracy in receiver frequency control. For reception of single-sideband signals, as an example, receiver frequency must be kept within an absolute accuracy of 50 cycles per second. And if the channel frequency happens to be in the 8-mc. band, for instance, that means a frequency accuracy of $\pm 0.000625\%$. Crystals may be made that accurate, but when such precision is required in combination with rapid frequency changes, crystal control may no longer be considered to be the ultimate answer.

To meet the challenge, design engineers have turned to several techniques, most of which are not to be found in the textbooks. The result is that today's frequency control methods are capable of meeting the required precision, while retaining instant channel-change capabilities and the ability to cover a broad portion of the spectrum.

Digital-Tuning Techniques

One of the better-known of these modern techniques is the "digital-tuning" technique employed by *Collins Radio Company* on a number of military communications receivers, some of which are now finding their way into commercial and private use.

This technique does away with the familiar tuning dial of the receiver, replacing it with a series of 10-position switches. To tune the receiver to a desired frequency, the digits of that frequency are entered on the switches: for example, to tune to a frequency of 23.505 mc. with the receiver in the AN/ARC-58 radio set, the leftmost switch is rotated until the digits 2 and 3 appear in the first two windows. The next switch is set to 5, the third to 0, and the final switch to 5. This tunes the entire receiver to 23.505 mc., with an accuracy of better than 50 cycles either way.

The tuning steps may be made as small as desired, giving the ability to tune from say, 3 to 30 mc. in 100-cycle steps. In practice, the smallest step usually used is 1 kc.

The secret of this approach lies in a technique known as "frequency synthesis," by which a signal crystal or a small group of crystals may be made to control a large number of oscillator frequencies. The following example, although crude, gives an idea of this basic technique.

The starting point of our example is a 1-kc. crystal-controlled oscillator, which is adjusted to be precisely in step with the NBS station WWV. This assures us an accuracy of at least 1 part in a hundred million (10^{-8}) for our 1-kc. fre-

quency, which is equivalent to a percentage accuracy of 0.000001%.

Output of this oscillator is fed to a "times-10" multiplier as shown in Fig. 1, to provide a 10-kc. source, also accurate to the same precision. The 10-kc. signal is multiplied by 10, again, to obtain a 100-kc. source, and the process is repeated until high-accuracy frequency sources are obtained at 1, 10, and 100 kc., and 1 and 10 mc.

Signals from each of these five sources then go to harmonic generators, which produce output signals at integral multiples of their input frequencies. Output of the 100-kc. harmonic generator would be at 100, 200, 300, 400, 500, 600, 700, 800, and 900 kc., for example. At the output of each harmonic generator, switchable tuned filters select the desired multiple to be passed on to the mixer group. The switches controlling these filters are the front-panel tuning switches (see Fig. 2).

The five stable frequencies selected by the switches then go to a group of mixers, which produce sum and difference frequencies from their inputs. Only the sum frequencies are of interest here. For instance, if outputs of 30 kc. and 6 kc. are chosen from the respective harmonic generators, the mixer output would be at both 24 and 36 kc. Other filters, ganged to the harmonic-generator filters, reject the 24-kc. signal and pass on the 36-kc. frequency.

In this manner, the digits of the final output frequency desired are selected and added together in such a manner as to obtain that frequency at the output of the final mixer, accurate to 0.000001%.

While this example shows how a single crystal can control hundreds of thousands of output frequencies, the particular arrangement chosen to illustrate the point has a serious shortcoming in practice. It is almost impossible to filter out all of the *undesired* mixer products from such a long mixing chain, with the result that in addition to the desired output frequency, several dozen undesired output frequencies are also present.

To overcome this problem, the designer has a choice of two techniques. Both are in use at the present time.

Spectrum Generator

Most similar to the basic system is the "spectrum-generator" approach. A spectrum generator uses multiple mixing to

eliminate the undesired output frequencies. The desired harmonics are obtained by a keyed oscillator such as that shown in Fig. 3, which produces a group of harmonics of the input reference signal spaced about the normal free-running oscillator frequency at which the two triodes would operate in the absence of the keying circuit. Tuning of this oscillator circuit provides the initial adjustment of desired output frequency range.

Output of this keyed oscillator is then applied to a mixer as shown in Fig. 4. A stable frequency derived either from additional crystals or from a similar unit operating at lower frequency, is applied as the other mixer input. The difference-frequency output of this mixer is then applied to a narrow-band filter which has a bandwidth chosen so that only *one* of the several dozen output frequencies actually present can pass through. Filter output is applied to a second mixer where it is mixed again with the same low-frequency signal applied to the first mixer. This time the sum-frequency output is used, and it is identical to the desired output harmonic from the generator.

Operation of this type of filter is more easily understood with a numerical example. If the desired output frequency is 2400 kc., and the desired step spacing between output frequencies is 1 kc., then the harmonic generator would be keyed with output of a 1-kc. stable reference source, and tuned to 2400-kc. output. Its output would be a spectrum of frequencies at precise 1-kc. intervals around 2400 kc., including 2400.000 kc.

This output spectrum would be fed to Mixer 1, along with a second frequency of 1945 kc. The difference-frequency spectrum at the output of Mixer 1 would include frequencies of 452, 453, 454, 455, 456, 457, and 458 kc. along with others extending at 1-kc. intervals in either direction.

The 455-kc. spectrum would go to a 455-kc. filter having a total bandwidth of less than 1 kc. A signal at 455 kc. would pass through, but those at 454 and 456, as well as the rest farther removed from the desired frequency, would be blocked. If total bandwidth of this filter is made as great as 500 cps, the low-frequency reference signal could be off as much as 500 cps without harming the precision of the output.

The 455-kc. single frequency at the output of the filter then would go to Mixer 2, to be mixed again with the 1945-kc. reference. Frequencies present at the output of Mixer 2 would be 455 kc., 1945 kc., 1490 kc. (difference), and 2400 kc. (sum). A sharp cut-off high-pass output filter would remove the three frequencies below 2000 kc., leaving only the 2400-kc. output.

If the 1945-kc. signal were not precise, it would make no difference to the accuracy of the output, since this signal is first subtracted from the input, then added back, and any error cancels out. For instance, if the actual frequency were 1945.2 kc., the output spectrum of the first mixer would be centered around 454.8 kc. instead of around 455 kc. However, the 500-cycle bandwidth of the filter would still allow the 454.8-kc. component to pass through and when it was subsequently added to the 1945.2-kc. reference, the output would again be 2400.000 kc.

Since any inaccuracies of these "transfer references" do cancel out in this system, usual practice is to employ a group of 10 ordinary crystals rather than to derive these frequencies from the high-precision standard.

Selection of the next 1-kc. step is made by changing the frequency of the transfer reference. For instance, using a frequency of 1946 kc. instead of 1945 in our example would give an output frequency of 2401 kc., since the only component of the input spectrum which would produce a 455-kc. frequency to pass through the filter would be the 2401-kc. input. Tuning of the keyed oscillator tank circuit selects the 10-kc. segment of the spectrum in which operation is desired.

Thus with the values used in this example, only two panel

controls are necessary to cover a wide range of r.f. spectrum in 1-kc. steps. The problem of rejecting undesired output frequencies is overcome by transferring output to a low frequency for filtering, and re-transferring back to the desired output. The result is simple and dependable operation, yet with the precision required for today's needs.

Multiple Crystals

The other type of frequency synthesis in use at present is known as the "multiple-crystal" technique, and is illustrated in Fig. 5. This approach has been used in a number of recent Citizens Band transceivers and, to a lesser degree, in other equipment. When covering a limited portion of the r.f. spectrum, it is less costly than the single-crystal spectrum-gener-

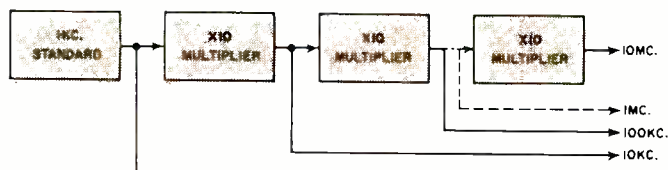

Fig. 1. A series of multipliers provides desired harmonics.

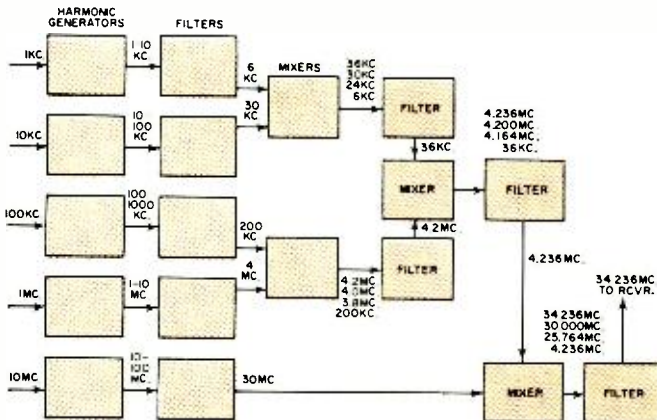

Fig. 2. Arrangement of harmonic generators, filters, and mixers are employed in order to produce the exact frequency required.

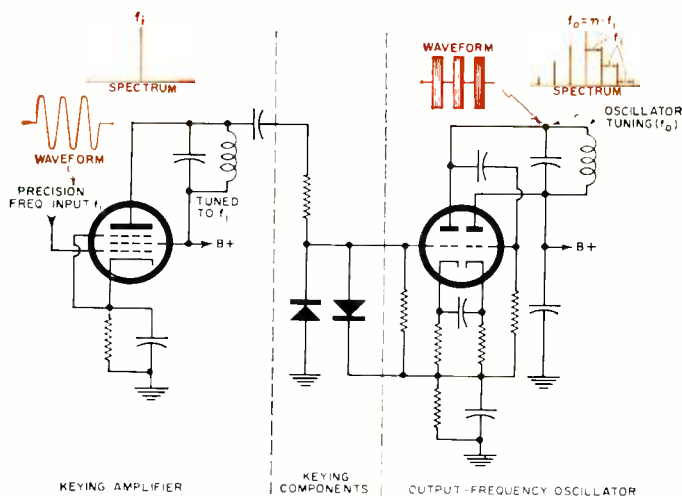
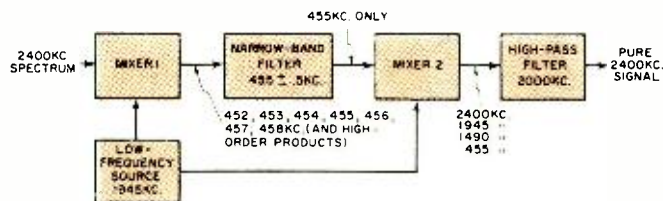

Fig. 3. A spectrum generator eliminates undesired harmonics.

Fig. 4. Use of keyed oscillator in frequency synthesis technique.



ator technique, but its accuracy is inherently limited by manufacturing tolerances of the larger number of precision crystals required.

The frequencies shown for crystals in Fig. 5 are chosen to produce output on class-D CB channels. They do not necessarily reflect the actual frequencies used in any commercial application of the idea, but are simply to show how it works.

The multiple-crystal technique will produce as many output frequencies as the product of the number of crystals used at each mixer input; thus with five crystals at input 1, and five more at input 2, 25 output frequencies may be obtained. If both sum and difference output frequencies are used, the number of possible outputs is doubled. However, in the interests of simplicity, most applications of this technique restrict output to one or the other but not both.

To cover the 23 assigned channels of the class-D CB service, a minimum of 10 crystals is necessary. With six at one input and four at the other, 24 output frequencies are available. With five at each input, 25 outputs can be had. However, output frequencies other than those allowable for use are undesirable, so the setup of Fig. 5 uses six crystals on one input and four on the other to reduce the number of possible but undesired output frequencies to two.

CB channels progress at 10-kc. intervals, skipping every fifth step, and cover a band approximately 300-kc. wide. By selecting the four crystals for input 1 at 10-kc. spacing, they select adjacent channels, while the six at input 2 are spaced 50-kc. apart to allow 300-kc. coverage.

To select a single channel, both switches must be set. For instance, to select channel 1 (26.965 mc.), switch 1 is set to position 2 and switch 2 to position 1. This selects crystal frequencies of 15.915 and 11.050 mc. and the sum of these

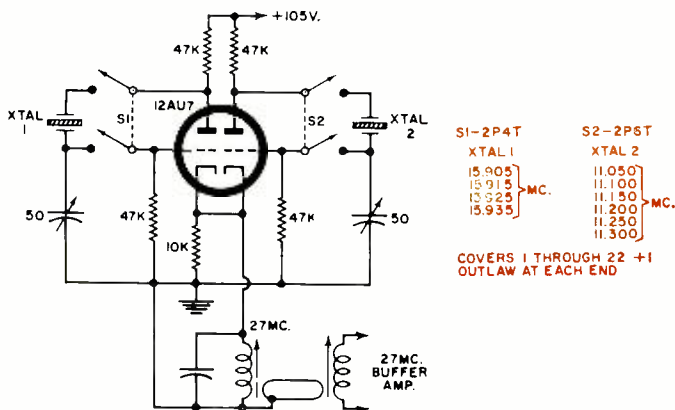
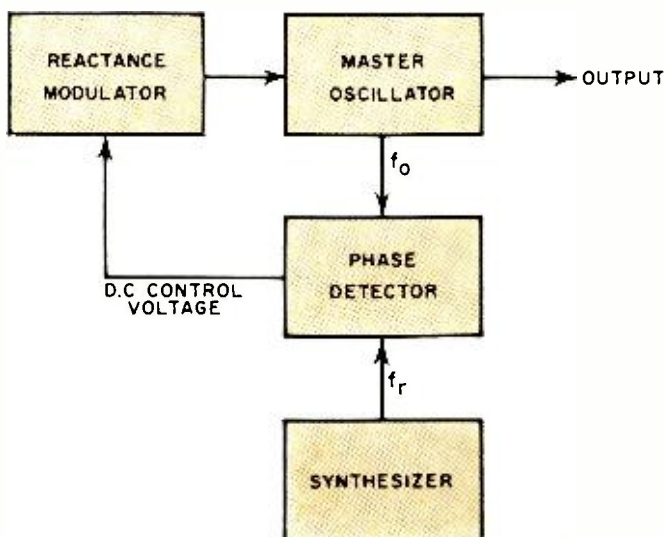

Fig. 5. Multiple crystals are also employed for frequency synthesis.

Fig. 6. Simple block diagram of stabilized master oscillator system.



frequencies is 26.965 mc. To select channel 9 (27.065 mc.), switch 1 is set to position 2 again but switch 2 is set to position 3. This selects frequencies of 15.915 and 11.150 mc. to produce 27.065 mc. at the output.

The bandpass filter at the output of the single mixer gets rid of both original crystal frequencies as well as the difference frequency.

The example, as shown, actually produces two "outlaw" outputs, one at each end of the range, and does not cover channel 23. This comes about because the first CB channel does not start at the beginning of the natural sequence of channels, and because channel 23 is separated from channel 22 by not 10 or 20 kc., but by 30 kc. Equipment using this technique employ added crystals for coverage of channel 23 as well, and usually has disabling contacts on the switches to keep unassigned channels from being selected.

Stabilized Master Oscillator

A technique similar to frequency synthesis in its ability to control thousands of output frequencies with a single crystal is that known as SMO, or stabilized master oscillator.

This technique uses a spectrum generator frequency synthesizer to produce a precisely controlled output frequency, but does not employ the synthesizer's output directly. Instead, the synthesizer output is used only as a reference, to which the output of a free-running master oscillator is locked through a frequency or phase discriminator and a reactance modulator.

Presence of spurious signals in the synthesizer output is not so harmful in the SMO approach, since no path exists for the spurious signals to reach the actual oscillator output.

A block diagram of the SMO is shown in Fig. 6; the master oscillator is tuned (by conventional means) to the approximate output frequency desired. A portion of its output (f_o) is sampled and applied to a phase detector. The reference signal for the phase detector (f_r) comes from the synthesizer. As long as the two signals are identical in frequency and precisely 90 degrees separated in phase, output of the phase detector will be zero and the system runs free.

However, should the master oscillator's frequency begin to drift by so much as a single cycle per second, the phase of its signal will also be changing. This change in phase upsets the balance of the phase detector, producing an output which is positive d.c. voltage for drift in one direction, and negative d.c. voltage for opposite-direction drift.

The phase-detector output is applied to the reactance modulator, which is identical to the frequency-modulator employed in the original FM broadcast systems. The output voltage thus changes the frequency of the master oscillator, via the reactance modulator, and the circuit is so arranged that the change is in a direction which opposes the drift.

This is a negative-feedback system, and some error signal is always present. It is for this reason that *phase* rather than *frequency* is chosen as the controlled element. Phase error can be tolerated, while frequency error cannot.

As long as the oscillator is locked by means of the phase detector, its stability becomes equal to that of the high-precision reference source in the synthesizer. However, since only a single frequency is involved in the locked oscillator itself, no spurious beats can appear in the output.

Because of its complexity, this approach is currently found only in sophisticated military systems. However, these systems can be expected to reach the commercial market in the not too distant future, as the straight synthesizer systems have already arrived commercially.

Other Techniques

Another approach to the problem of maintaining sufficient precision while allowing rapid frequency change has been to construct a highly stable conventional receiver to cover a limited portion of the

(Continued on page 62)

MOUNTS 5 WAYS

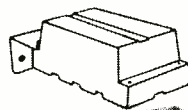

ON OUTSIDE OF HOUSE

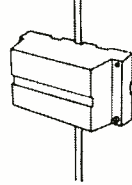

INSIDE OF HOUSE

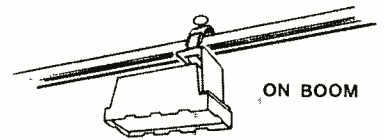

ON BOOM

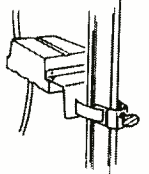

ON MAST

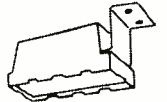

UNDER EAVE

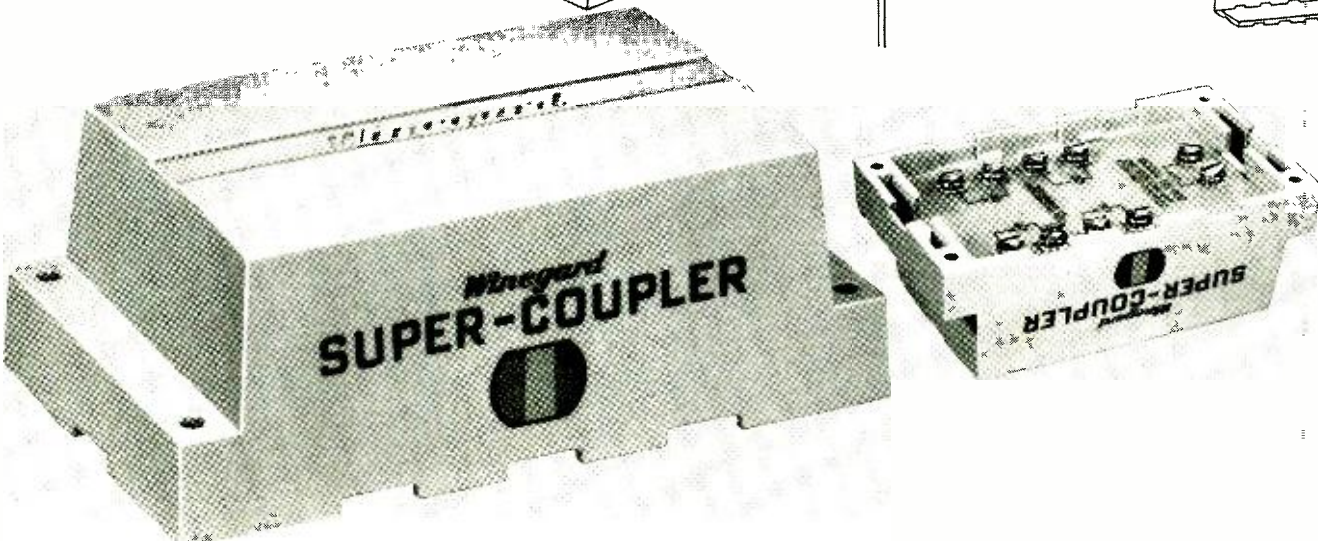

Never before couplers like these! New Winegard Super Color Couplers ...the 2 most efficient TV-FM 2 and 4 set Couplers ever built!

- Constant Isolation between sets... 22db minimum across all channels (2-13 and FM)
- Lowest Loss of Any Coupler... -3.2db maximum
- Best Impedance Match from Antenna to Coupler and Set to Coupler
- Allow Best Possible Reception on Color or Black & White Sets

There is a wide difference in the performance of TV-FM couplers. And now, with the new Winegard 2-set and 4-set Super Color Couplers, there is a greater difference than ever.

For example, no resistors are used for isolation of outputs. No resonant coils are used in the circuit. Instead, our research labs have developed an entirely *new coupler circuit* using three high frequency, ferrite core transformers in a unique "Balanced Bridge" circuit.

What does this do to performance? Well, for one thing, the 2-set Super Coupler provides an isolation figure of 22db minimum across *all* channels (2-13 and FM). Until now, the minimum isolation between sets with 2-set couplers was about 10db or 3 times, and was not constant on all channels. With the new Super Color Couplers, it's 12.8 times—*four times better* than the previous best. In fact, isolation is so good, you can put a dead short across one set of output terminals without affecting the set connected to other output.

LOSS is another key factor in measuring the performance of a coupler. The lowest possible theoretical loss in a 2-set coupler is -3db but no coupler on the market had ever approached this ideal. Now, with Winegard's new 2-set Super Coupler (CC200), the **MAXIMUM** loss is -3.2, nearly perfect and by far the best on the market.

One more very important factor—**IMPEDANCE**. There are two impedance matches to consider... "Forward" from coupler to antenna, and "Backward" from set to coupler. A perfect coupler would have a VSWR of 1.1:1 on both matches. Some couplers have good match one way but, until now, no coupler ever had a good match both ways. Winegard Super Couplers have a near perfect VSWR of 1.2:1 both *forward* and *backward*... and on *all* channels. This far exceeds other couplers on the market.

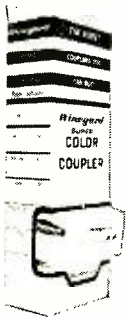

NEW COUPLER
6 PACK DISPENSER

What does all this mean to your customers? Most important, it means that the Super Coupler will not spoil picture resolution by adding smear or halos. *The Super Coupler is especially recommended for color installations* where preservation of picture quality is even more critical than on black & white.

What besides performance? Construction and price. The new Winegard Super Color Couplers have a unique 5-way mount, sleek new weather-proof coupler housing, pre-notched transmission line outlets, 1/4" slotted Hex terminal screws and no-strip terminal connections... the price is only \$4.50 for the CC200 which includes the special inside-outside mount.

Try the new Winegard Super Couplers now and *see* the difference. Ask your distributor for a 6 pack dispenser. Try them on your next six installations. If they aren't the finest you've ever used, take them back for a *full refund*.

CC200 — For VHF and FM Specifications as above.
List \$4.50 includes 5-way mounting bracket and strap.

CC400 — For VHF, UHF and FM (replaces LT-43).

Max. loss -6.23DB (A theoretical loss for perfect 4 way coupler would be -6.0DB); Isolation 12DB min; Response $\pm 1/4$ DB per 6MC; VSWR: Input 1.15:1; Output 1.4:1 Max; Bandpass 20MC-1000MC; Impedance: Input 300ohm, Output 300ohm. List \$5.50 including 5-way mount and strap.

Winegard's Famous CC23 Color Coupler
Finest VHF/FM color coupler on the market next to our new Super Color Couplers. List Price \$3.95.

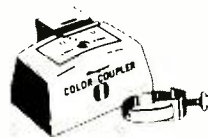

Winegard All New CVU-2 UHF-VHF Coupler Efficiently transfers UHF and VHF signals from antennas to sets. Serves as coupler or splitter for channels 2-83 (UHF-VHF). List \$3.95.

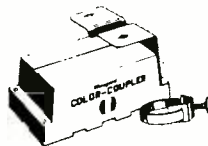

	UHF	VHF/FM
Splitter loss	3.5db	4.3db
Isolation	20 db	12 db
VSWR	1.4:1	2:1



Winegard Co.

ANTENNA SYSTEMS

3003L Kirkwood, Burlington, Iowa

CIRCLE NO. 237 ON READER SERVICE PAGE



JOHN FRYE

New trends in the development of service equipment point the way to a bright future for the technician.

SERVICE SHOP OF THE FUTURE

ANYONE in Mac's Service Shop would have to be blind and deaf not to suspect Christmas was coming. Every screen lighting up on the service bench seemed to display a ho-ho-hoing version of the Jolly Old Elf or a commercial offering help with your Christmas shopping. From the speakers of the radios and TV sets on the checkout bench there came a muted blending of "Silver Bells," "White Christmas," and all the other hardy lyric perennials that bloom afresh this time of year.

Matilda had, as Barney put it, "gone completely ape" in decorating the front office. Wreaths of holly, sprigs of mistletoe, and candy canes ran riot over the walls and counter. A large aluminum tree turned slowly on a rotating stand in one corner while its reflecting branches splintered the beam of a color-changing spotlight into hundreds of twinkling, shifting pinpoints of brilliant color.

It even smelled like Christmas. Taking advantage of the dwindling stream of customers as closing time approached, Matilda was preparing some hot chocolate, and the sweet aroma drifted through the store. When she entered the service department a little later carrying a tray with three cups of the steaming confection and a great stack of vanilla wafers on it, service work came to an abrupt halt. The office girl perched on a stool, and Mac and Barney leaned against the service bench on either side of her. All three surrendered themselves completely to enjoyment of the collation, the rest, and the unspoken companionship.

Finally, after he had eaten at least half the vanilla wafers, Barney sighed contentedly and put his empty cup back on the tray. "Something about the Christmas season always makes me hungry," he confessed.

"Everything makes you hungry!" Matilda scoffed. "Now Christmas always gives me a feeling of happy anticipation. I have the tingly feeling something pleasant is just around the corner. How does Christmas make you feel, Mac?"

"I guess it brings out the Janus in me," Mac answered. "Like the two-faced Roman god, I find myself looking backward and trying to peer into the future. All afternoon I've been humming 'Jingle Bells' and trying to imagine what servicing is going to be like twenty or twenty-five years from now."

Barney wheeled around and pushed a little portable TV chassis in front of Mac. He propped it up so the tube face was pointed toward the older man's face, and then snapped out the room lights. Flickering reflections from the revolving Christmas tree seemed to crawl about inside the darkened face of the picture tube.

"Gaze deep into the crystal ball, O, Master, and tell us what you see," Barney intoned.

Going along with the gag, Mac waved his hands slowly across the face of the picture tube and peered intently into its depths. "I see many bright colors, but everything is blurry and out of focus," he said. "Ah, now it is becoming clearer. The color is coming from the screens of TV receivers on the service bench. All of them are color sets, even the small portables; and the color is much brighter and clearer and

sharper than we are accustomed to seeing. The pictures look like those projected on a screen from color slides. In fact, the whole receiver looks exactly like a framed picture. Obviously the sets are intended to hang on the wall. The picture tubes are different from anything we know, for the frame around them is only four or five inches deep."

"Where's the chassis?" Barney wanted to know.

"It's in a small compartment, about two inches by four inches, in the bottom part of the frame," Mac answered. "Obviously it's a solid-state microminiature affair. And I see no wires. Power is furnished by tiny long-life powerful batteries far superior to anything we know now."

"How about the instruments on the service bench?" Barney asked. "Are they any different?"

"Much different. For example, the signal generator is a crystal-synthesizing affair that can produce any desired frequency from a few cps to many megacycles by simply having the proper buttons pushed. The accuracy of the output is measured in cycles even at the highest frequency range.

"Right next to it is a frequency meter of the type that actually counts the cycles electronically occurring in a precisely measured interval of time and then displays the result in cps with a digital readout. Readings are automatically taken at very short intervals; so any drifting or moving back and forth of the measured frequency is immediately apparent as a change in the readout display. In this shop of the future the working day is very short; so there's no place for time-wasting interpolating or guessing. The technician demands and gets quick and accurate information."

"I suppose he still has to measure voltage, current, and resistance," Barney hazarded. "Do you see anything in the future that resembles our present v.o.m.'s or v.t.v.m.'s?"

"Yes, the technician uses a v.o.m. with an extremely rugged but sensitive meter movement that has a built-in solid-state amplifier. It is absolutely burnout-proof; yet its sensitivity is such that it loads the circuit being tested much less than does a modern v.t.v.m. This v.o.m. automatically selects the proper range for displaying the voltage, current, or resistance being measured; and the proper scale is automatically illuminated. A technician of the future would feel as 'put upon' if he were forced to use a present-day v.o.m. with a manual range selector as a modern gal taught to drive with an automatic transmission would feel if she had to go back to using a clutch and a straight stick.

"Now there's something interesting!" Mac exclaimed, cupping his hands on either side of the little picture tube. "The technician is connecting a tape recorder to the input terminals of the TV receiver. By golly, it's a video recorder! Selected portions of the test tape provide a color-bar display, a cross-hatch or dot design, a test pattern, and several other signals useful in color-set adjustment that cannot be produced by present-day generators. The test tape really provides the technician with a standard signal, one that stays precisely the same day after day. We know how useful such a signal is to work with.

"His scope connects through a coax lead to a fitting on

the chassis. Then a rotary switch connects the scope's input terminals to various portions of the printed circuitry. This arrangement, in connection with the signals provided by the test tape, enables him to determine very quickly what portions of the circuit are operating normally and which ones are not. When a defect is found, that whole portion of the circuit is unplugged and a new one installed."

"How about me?" Matilda asked. "Do I use any different equipment?"

"Yes indeedly!" Mac replied. "You will become much more than the office girl. You will be the keeper of our entire service library. This library will be stored in a sort of computer about the size of a filing cabinet. Inside this, on microfilm, will be stored complete service data on every piece of electronic gear we expect to service. When we put a 'Super Silicon Six' receiver on the bench, you will punch a button or so on this little monster and the diagram, voltage data, and other pertinent information will be displayed on a large screen just above the service bench.

"Along with this basic information will be production changes, factory service notes, and hints and kinks applying to that particular model which you have gleaned from various sources and fed into the computer's memory. What's more, as soon as we have repaired the Super Silicon Six, we'll give you the symptoms and the discovered cause of the trouble and you will feed this information into the computer.

"The computer will give proper weight to all this information so that when we have another Super Silicon Six to repair we'll simply give you the symptoms and the model number. You will punch the proper buttons on the monster, and it will promptly disgorge the various causes of these symptoms in the order of their likelihood! By constantly feeding the memory of the computer with all this information, you will make it more and more valuable to us. Like a meerschaum pipe, it will improve with age."

"I don't know about all that," Matilda said a little dubiously. "It sounds to me as though I'll be spending all my time feeding 'the monster,' as you call it. I'll be working harder so you two can take it easier."

Mac laughed and turned the shop lights back on. "I guess that's enough of a seance for this evening," he said. "It's about time we closed up shop and went home. Actually, as Barney knows, my soothsaying was little more than a projection of modern trends in service equipment. The instruments I mentioned have all been invented or are being developed. You won't find many of them in the service shops, I grant you; but that is chiefly a matter of cost. If we could afford them, all of us would be

using crystal-synthesizing signal generators, counter-type frequency meters, video tape recorders, and automatic v.o.m.'s. But instruments have a habit of moving from the research laboratories into the service shops. That happened to the cathode-ray oscilloscope, the vacuum-tube voltmeter, the square-wave generator, the sweep generator, and many other instruments we now take for granted."

"The idea of that computer sends me," Barney confessed. "Trying to keep track of all the weaknesses of a zillion different models of TV sets, radios, tape recorders, hi-fi jobs, and record players puts quite a strain on even my giant intellect. It would be a great relief to know the little monster was remembering everything for me."

"That was probably the most far-fetched of all my imaginings," Mac said as he shrugged his way into his overcoat, "but actually computers are going to be doing a lot of 'remembering' and 'evaluating' jobs in twenty years when the cost of these units has been drastically reduced. Computers will be doing everything else; they may as well help us service TV receivers. Let's go, you two."

NEW NASA CENTER TO OPEN

THE National Aeronautics and Space Administration's new Electronic Research Center in Cambridge, Mass., was formally activated on September 1, 1964, when Dr. Winston E. Koek took the oath as director.

The center is being established to provide NASA with a greater electronics competence needed for the continued success of the nation's space program. Working with industry and universities throughout the country, the center is expected to advance a research program providing improved electronics techniques and systems for space exploration. The center's efforts will be in basic studies and research in the fields of instrumentation, communications, data processing, navigation, guidance, and control.

Design and construction of the center is scheduled to begin in the latter part of this year, with completion in four to five years. Total personnel complement of the center is expected to reach 2100 by 1970.

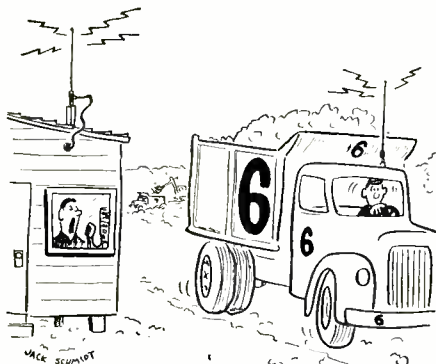

"Unit Six... Unit Six... Where are you?"

Announcing

THE NEW

AEC 77A

50,000

VOLT

TRANSISTOR

IGNITION SYSTEM



- ✓ Features new General Motors Delco transistors with patented "surface passivated ambient control".
- ✓ Improved circuitry uses reverse biasing rectifiers, allows operation beyond 230° — solves heat problem.
- ✓ Gives higher voltage ratios to 180 volts, allowing higher zener voltage — maximum output from coil.
- ✓ Improved circuitry provides faster transistor turn-off — means less heat build-up inside transistors.
- ✓ U.S. Pat. 3089067 on every transistor proves beyond any doubt that each one is new and exclusive.
- ✓ High-voltage spark has up to 15 milliamperes output — nearly twice that of electronic magnetos.

The NEW AEC 77A 50,000-volt transistor ignition system with GM Delco Type 2N2210A transistors guarantees twice the output of any electronic magneto, at half the cost. Guaranteed to outperform all other ignition systems in existence, regardless of price. New performance carries with it greater power, new reliability, new dependability, new FIVE-YEAR GUARANTEE.

AEC 77A's constant high-voltage output guarantees more complete combustion... releases full engine power, increases gas mileage by 15%, keeps plugs and points clean beyond 50,000 miles, fires fouled plugs, makes engine run smoother, increases top speeds, eliminates 4 out of 5 tune-ups, gives you that "tuned-up" performance for thousands upon thousands of miles usage.

Every AEC 77A delivers full voltage at 2,000 rpm as against 18,000 volts of other ignitions. AEC 77A continues to deliver full voltage beyond 7,500 rpm, while other ignitions fail to deliver any voltage. At cranking speed, AEC 77A delivers 20,000 volts as against 8,000 volts of other ignitions, guarantees instant starting in any type weather.

Completely waterproof and shockproof—every system tested under actual operational load with 4 fouled and four operating spark plugs. Quality components in every AEC 77A, are supplied by General Motors (Delco transistors type 2N1358A), Motorola (zener diodes type 1N2836B), Prestolite (400:1 ignition coil), Mallory, Sprague, IRC and others.

Installs easily in only 20 minutes by anyone.

COMPLETE FACTORY WIRED SYSTEMS

- AEC 77A with 400:1 coil, 6/12 volt \$39.95
- AEC 77A for Positive ground British cars, 6/12 volt \$39.95
- AEC 77A 400:1 Coil only, 6/12 volt \$11.95
- Ballast resistor, var. .3 to .9-250 watt \$ 1.95
- AEC K5 Complete do-it-yourself Kit, Negative ground only \$32.95

AUTOMOTIVE ELECTRONICS CO.
387 PARK AVE. SO., NEW YORK, N. Y. 10016

NAME.....
ADDRESS.....
CITY..... ZONE..... STATE.....
 AEC 77A For Negative ground 6/12 v.....\$39.95
 AEC 77AP For Positive ground 6/12 v.....\$39.95
 Kit \$32.95 400:1 Coil \$11.95 Ballast \$1.95
 FREE BROCHURE ON AEC 77A SYSTEMS. EW-12

CIRCLE NO. 161 ON READER SERVICE PAGE

R FOR "DOCTORS
OF SERVICING"



For handy guidebook to better servicing, write Channel Master Corp., Ellenville, N.Y.

Where there's a contact... or a relay...

Service with Contact Shield! Protective! Corrective! It not only cleans and safeguards contacts better on TV, radio, and hi-fi sets; on all relay-operated electrical equipment, regular protective maintenance with this versatile cleaner prevents sticky relays—while corrective servicing unsticks them... in seconds. Promotes greater conductivity, keeps relays working smoother, longer. Contact Shield—the professional service man's cleaner.

APPLICATIONS INCLUDE:

- Bowling Alley Automatic Pin Spotters
- Vending Machines
- Slot Machines
- IBM Computers and other data processing equipment
- Industrial Equipment using relays, such as welding machines, etc.
- Pinball Machines
- Telephone Switchboards

Substituting Transistors

(Continued from page 41)

The bias resistors (Figs. 5D and 5E) are changed in value to accommodate the larger base-to-emitter drop of silicon.

Note that because the collector current is higher in this power circuit, a base-emitter voltage of 0.3 volt was used for the germanium circuit in calculating the voltages and currents.

These calculations are, of course, approximations and the higher leakage of the germanium transistor was taken into account in the original resistance values. Thus the probability is that the calculated bias resistor for the silicon replacement is slightly on the low side. Also, if the transistor used has a higher gain than the original design, a higher bias resistance is needed. If the gain is lower, a lower bias resistor is required. A simple check of voltage in any class. A circuit will determine if the quiescent current is being obtained.

Fig. 6 indicates the voltage measurements which will show if the circuit is properly biased. Most class A amplifiers will be biased for a collector-to-emitter voltage drop, V_{CE} , of a couple of volts to 10 volts. A small-signal circuit will be at the lower end of this range and a large-signal circuit at the higher end. It is easy to estimate the proper value by taking the sum of the resistance drops in the collector and emitter circuits using the desired value of emitter current, and subtracting from the supply voltage, V_{CC} , as follows:

$$V_{CE} = V_{CC} - (V_{R_{collector}} + V_{R_{emitter}})$$

Measure the voltage V_{CE} in the circuit by placing a voltmeter across the transistor's collector and emitter. If it is higher than the estimated value, then you do not have enough transistor base current, so lower the value of R_1 slightly. This is easily done by shunting R_1 with another resistor of large value, say, 1 megohm. If the voltage measures too low, it means that there is too much base current, so raise the value of R_1 .

In practically all cases, the voltage rating of the equivalent silicon transistor substitute will be higher than the germanium type, so there is no cause of concern in the matter of breakdown.

For additional details, see "Selecting High-Frequency Transistors" in the September, 1964 issue. ▲

Fig. 6. Measurement of V_{CE} can be used to check bias current.

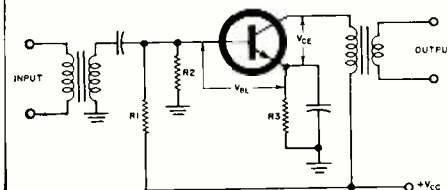

**NEED A
110 VOLT
A.C. OUTLET?
In CAR, BOAT or TRUCK,
YOU HAVE IT WITH A**

terado POWER INVERTER

Actually gives you 110 volt, 60 cycle A.C. from your 6 to 12 volt D.C. battery! Plug inverter into cigarette lighter, and operate lights, electric shavers, record players, electric tools, portable TV, radios, testing equipment, etc. Frequency stable within one cycle.

Models from 15 to 600 watts, priced as low as **\$12.95** LIST

See Your Electronic Parts Dealer or Jobber, or Write:

terado CORPORATION
1058 Raymond Ave.
St. Paul 8, Minn.
In Canada, Atlas Radio Corp. Ltd. — Toronto, Ont.
CIRCLE NO. 228 ON READER SERVICE PAGE

SUB CARRIER DETECTOR

for the reception of background music programs (continuous music without commercials) now being transmitted as hidden programs on the FM broadcast band from coast to coast. Use with any FM tuner. Detector plugs into existing multiplex output of tuner or easily wired into discriminator.

kits with pre-tuned coils, no alignment necessary \$45.00
self powered detectors \$75.00

Complete crystal controlled sub-carrier receivers with usable sensitivity of 1 micro volt kit \$169.00, wired unit \$219.00.

MUSIC ASSOCIATED

Sound Systems since 1950
65 Glenwood Road,
Upper Montclair, New Jersey
phone 744-3387, area code 201

when it's time to think of college
you should read this
FREE CAREER BOOKLET
about electronics at

MSOE



**MILWAUKEE MS-220
SCHOOL OF ENGINEERING**

Dept. EW-1264, 1025 N. Milwaukee Street
Milwaukee, Wisconsin 53201

Tell me about an engineering career through residence study in:

Electrical fields Mechanical fields

Name.....Age.....

Address.....

City, State.....

Which Stereo Receiver Is Your Best Value?

BRAND	IHF POWER	TUNER	CIRCUIT	PRICE
A	70 Watts	AM-FM FM Stereo	Transistor	\$369.95
B	80 Watts	AM-FM FM Stereo	Tubes	\$374.50
C	100 Watts	AM-FM FM Stereo	Transistor	\$619.95
D	70 Watts	FM Stereo	Tubes	\$429.90
E	66 Watts	AM-FM FM Stereo	Transistor	\$195.00
F	60 Watts	FM Stereo	Tubes	\$354.45
G	60 Watts	AM-FM FM Stereo	Tubes	\$273.90
H	100 Watts	AM-FM FM Stereo	Transistor	\$579.90
I	70 Watts	AM-FM FM Stereo	Tubes	\$269.95

**IF YOU CHOOSE E GO DIRECT TO THE COUPON
& COLLECT \$75 TO \$425 SAVINGS!**

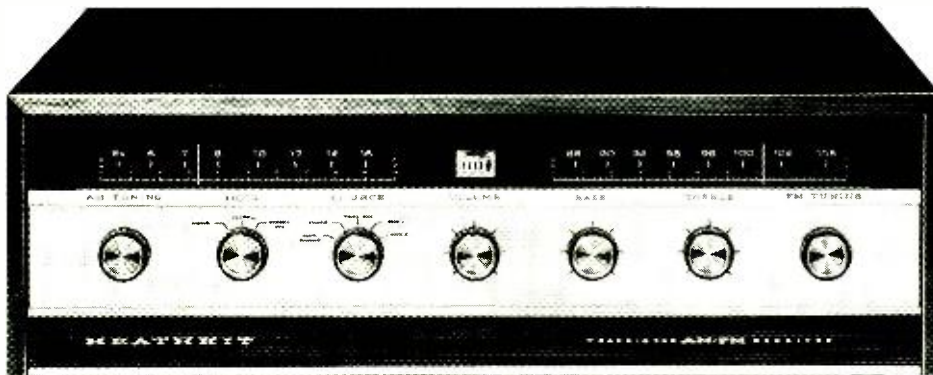

“E” is the Heathkit AR-13A All-Transistor, All-Mode Stereo Receiver. It’s the first all-transistor stereo receiver kit. It costs from \$75 to \$425 less than the finest stereo receivers on the market today. This alone makes the AR-13 unique. But dollar savings are only one reason why it’s your best value.

Even if you can afford to buy the costliest model, you can’t buy better performance. Start with the AR-13A’s 43-transistor, 18-diode circuit. It’s your assurance of cool, instant, “hum-free” operation; long, trouble-free life; and the quick, clean, unmodified response of “transistor sound” . . . characteristics unobtainable in tube types.

Next, there’s wide-band AM, FM, FM Stereo tuning for distortion-free reception to delight the most critical ear. It has two preamps. And its two power amplifiers provide 66 watts of IHF Music Power, 40 watts of continuous sine-wave power. And it’s all housed inside one luxurious, compact walnut cabinet . . . just add two speakers for a complete stereo system.

There are plenty of operating conveniences, too. Like automatic switching to stereo; automatic stereo indicator; filtered tape recorder outputs for direct “beat-free” stereo recording; dual-tandem controls for

simultaneous adjustment of volume, bass, and treble of both channels; 3 stereo inputs; and a separate control for balancing both channels. The AM tuner features a high-gain RF stage and a high Q rod antenna. The FM tuner has a built-in line cord antenna plus external antenna connectors.

In addition, there’s a local-distance switch to prevent overloading in strong signal areas; a squelch control; AFC for drift-free reception; plus flywheel tuning, tuning meter, and lighted AM & FM slide-rule dials for fast, easy station selection. The secondary controls are concealed under the hinged lower front gold aluminum panel to prevent accidental system setting changes. Both of the AM and FM “front-ends” and the AM-FM I.F. strip are pre-assembled and prealigned to simplify construction.

Compare its impressive specifications. Then go direct to the coupon, and order the AR-13A. Now sit back and relax . . . you’ve just saved \$75 to \$425 without compromising!

Kit AR-13A, 34 lbs. \$195.00

SPECIFICATIONS—AMPLIFIER: Power output per channel (Heath Rating): 20 watts / 8 ohm load. (IHF Music Power Output): 33 watts / 8 ohm load. **Power response:** ±1 db from 15 cps to 30 kc @ rated output. **Harmonic distortion:** (at rated output) Less than 1% @ 20 cps; less than 0.3% @ 1

kc; less than 1% @ 20 kc. **Intermodulation distortion:** (at rated output) Less than 1%, +0 & 6,000 cps signal mixed 4:1. **Hum & noise:** Max. phono, 50 db b-l-o-w rated output, Aux. input, +5 db b-l-o-w rated output. **Channel separation:** 40 db. **Input sensitivity:** Mag. phono, 6 MV. **Outputs:** 4, 8, & 16 ohm and low impedance tape recorder outputs. **Controls:** 5-position Selector; 3-position Mode; Dual Tandem Volume; Bass & Treble Controls; Balance Control; Phase Switch; Input Level Controls; Push-Pull ON/OFF Switch. **FM: Tuning range:** 88 mc to 108 mc. **IF frequency:** 10.7 mc. **Frequency response:** ±3 db, 20 to 15,000 cps. **Capture ratio:** 10 db. **Antenna:** 300 ohm balanced (internal for local reception). **Quieting sensitivity:** 3; uv for 30 db of quieting. **Image rejection:** 30 db. **IF rejection:** 70 db. **Harmonic distortion:** Less than 1%. **STEREO MULTIPLEX:** Channel separation: (SCA Filter On) 30 db, 50 to 2,000 cps. **19 KC & 38 KC suppression:** 45 db down. **SCA rejection:** 35 db down from rated output. **AM: Tuning range:** 535 to 1620 kc. **IF frequency:** 455 kc. **Sensitivity:** 30 uv @ 600 kc; 9 uv @ 1000 kc. **Image rejection:** 40 db. **IF rejection:** 55 db @ 1000 cps. **Harmonic distortion:** Less than 2% with 1000 uv input, 400 cps with 30% modulation. **Hum and noise:** 40 db. **Overall dimensions:** 17" L x 5 1/2" H x 14 1/2" D.

FREE CATALOG
Send for your Free copy today! Fully describes over 250 exciting Heathkits at savings of 50% or more! Choose from the world's largest selection of quality instruments in easy-to-assemble kit form!

HEATHKIT

HEATH COMPANY, Dept. 15-12-1
Benton Harbor, Mich. 49023

Enclosed is \$195.00 plus freight. Please send Model AR-13A Stereo Receiver.

Please send Free Heathkit Catalog.

Name _____

Address _____

City _____ State _____ Zip _____

HF-173

CUT HOLES FAST



GREENLEE CHASSIS PUNCHES

Make accurate, finished holes in 1½ minutes or less in metal, hard rubber and plastics. No tedious sawing or filing—a few turns of the wrench does the job. All standard sizes . . . round, square, key, or "D" shapes for sockets, switches, meters, etc. At your electronic parts dealer. Literature on request.

GREENLEE TOOL CO. 
2027 Columbia Ave., Rockford, Illinois
CIRCLE NO. 184 ON READER SERVICE PAGE

Get Your First Class Commercial F. C. C. LICENSE QUICKLY!

Career opportunities in *communications electronics* are almost unlimited. Prepare now. Let Grantham train you — by correspondence, or by classroom and laboratory instruction. Get your *first class commercial* F.C.C. license in as little as 3 months, or at a slower pace if you prefer. Then, continue in more-advanced electronics training if you wish. Diploma awarded. Our catalog gives full details.

Learn how our training can prepare you for your F.C.C. license; write or telephone the School at any one of the teaching divisions listed below, and ask for "Catalog 46."

Grantham School of Electronics

1505 N. Western Av., Los Angeles, Cal. 90027
(Phone: HO 9-7878)

408 Marion Street, Seattle, Wash. 98104
(Phone: MA 2-7227)

3123 Gillham Road, Kansas City, Mo. 64109
(Phone: JE 1-6320)

818-18th St., NW, Washington, D.C. 20006
(Phone: 298-7460)

RADIO & TV NEWS

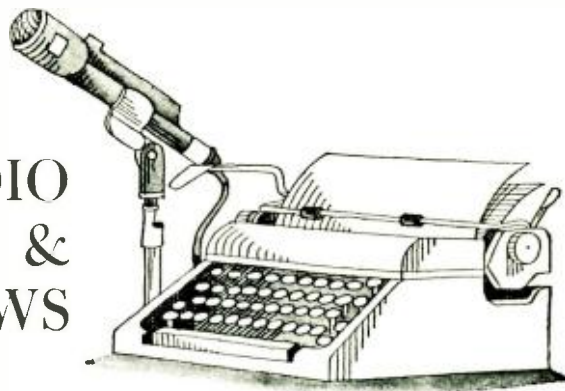

NORMALLY, one thinks of earth satellites as a means of relaying information between continent-spaced ground stations. However, there are some mundane things, of a non-electronic nature, being done with these man-made space objects.

According to reports from France, simultaneous photographs of Echo 1 taken both in France and Algeria are enabling the French to accurately locate future satellite telemetry and tracking stations being built across Europe and Africa by the European Space Research Organization (ESRO). Echo 1, probably seen by more people than any other man-made space object, is losing the smooth shape that permitted reflection of radio waves, but is still brilliant enough in the night sky to serve triangulation purposes.

At the 15th International Astronautical Congress recently held in Warsaw, Poland, a technical paper was presented to show that any satellite emitting a known frequency radio carrier can be used as an accurate triangulation tool.

Here, use is made of the Doppler shift principle. If a radio receiver is located at a known position and a mobile receiver placed at some remote spot, the difference in instantaneous Doppler shift at both stations can be used to accurately triangulate these two. It becomes possible to mount the receiver in a vehicle and pinpoint as many as five to six locations a day.

Depending on the amount of equipment employed and the type of terrain involved, an entire country could be accurately mapped at low cost.

Ultra-Ultrasonic

Most of us think of ultrasonics as sound waves somewhat higher in frequency than human hearing, usually being somewhere in the neighborhood of several tens of kilocycles.

Scientists at *Westinghouse Research Labs.* recently disclosed a technique whereby it now becomes possible to generate ultrasonic sound waves up to frequencies approximating 9000 mc, with the possibility that even higher frequencies may be generated in the future.

Usually, as the ultrasonic frequency

goes up, the transducer becomes thinner. A point is soon reached where the transducer crystal cannot deliver any power without shattering. At this point, the crystal is so thin that it becomes very difficult to handle without fragmenting.

To replace these brittle crystals, *Westinghouse* scientists have successfully "grown" ultra-thin films of crystalline cadmium sulphide, built up atom by atom in an orderly, near-perfect fashion. The films, only 10 to 100 millionths of an inch thick, are grown inside a vacuum chamber. They are deposited from hot vapors in such a way that the required numbers of the two kinds of atoms in the compound cadmium sulphide stack themselves up in perfect order to form what is felt to be a nearly continuous single crystal without gaps.

These thin-film ultrasonic transducers are used in the study of certain basic materials. They are plated on the surface of the material under study and excited. The lifetime of the sound waves and the velocity with which they travel yield basic data on the physical structure of the material being studied.

Improved Ultrasonic Testing

Speaking of ultrasonics, readers using this tool to determine flaws in solid structures will be interested to know that a new approach to ultrasonic testing has been made by the Watervliet Arsenal of the U.S. Army.

The chief difference between this new approach and former techniques is that this new method uses separate transmitter and receiver transducers that permit "through" transmission rather than the commonly used reflection principle.

This more exacting "shadow" method has proved more accurate than pulse echo observations and can record a flaw as small as 3/16-in. in depth. The new method is not affected by surface roughness, angle of and flaw orientation, or other variables that are detrimental to the reflection system.

The new approach is used for testing cannon barrels where both transducers are drawn from one end of the barrel to the other. Readout is on a cylindrical recorder. ▲

Regardless Of What You Pay For Other Color TV

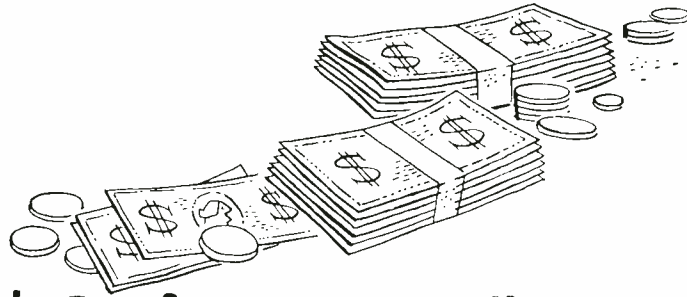

It Can't Perform As Well As This One...

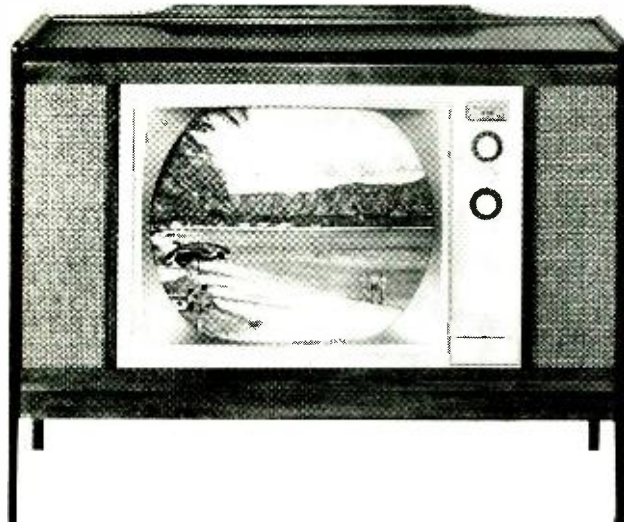

And Yet A Heathkit® Set Costs As Little As \$399!

Exclusive Heath Features For Unequalled Performance! That's right. No matter how many of your hard-earned dollars you pay for another brand of color TV, *none* can equal the performance of the Heathkit All-Channel, High Fidelity 21" Color TV! Why? *All* color sets require minor periodic adjustments to maintain peak picture performance. The Heathkit GR-53A is the *only* set with a "built-in service center" that provides the facilities for perfect picture adjustments. Heath's simple-to-follow instructions & detailed color photos show you exactly what to look for and how to achieve it . . . quickly, easily! You become the expert! Result? Beautiful, true-to-life color pictures day in and day out . . . and *no* costly color TV service calls for simple picture alignment!

And since you service & maintain the set yourself, a costly service contract isn't required! Heath warrants the picture tube for 1 year; all other parts for 90 days.

No Trade-In Required!

Keep your present set as a handy "second" set for the den, bedroom, children's room, etc.

Quick & Easy To Assemble!

No special skills or knowledge required. All critical assemblies are factory-built and tested. Simple step-by-step instructions take you from parts to picture in just 25 hours!

Convenient Time-Pay Plan!

Only 10% down, and the rest in easy monthly installments. Get *free* catalog for full details.

Finest Components, Most-Advanced Circuitry

With the Heathkit GR-53A you're assured of the finest parts and most advanced color TV

circuitry that money can buy . . . at up to \$200 savings. You enjoy rock-steady pictures with no overlap or color fringing.

But Don't Take Our Word For It!

See the special articles on the Heathkit GR-53A in the May issue of *Popular Electronics*, June issue of *Radio-TV Experimenter*, February issue of *Popular Mechanics*, April issue of *Science & Mechanics*, and the August issue of *Radio-Electronics!*

Now Compare The Features . . . And The Price!

In addition to the ones already mentioned, there's the high definition 70" 21" color tube with anti-glare bonded safety glass; 24,000 volt regulated picture power; 27 tube, 8 diode circuit; deluxe Standard-Kollsman VHF tuner with push-to-tune fine tuning for individual channels and transistorized UHF tuner for all-channel (2-83) reception; automatic color control and gated AGC for peak performance; line thermistor for longer tube life; two hi-fi outputs plus tone control; transformer operation; chassis & tube mounting on sturdy one-piece metal support for easy set-up and servicing; plus a low price of only \$399.

Use The Coupon & Order Yours Now!

And be sure to check the appropriate box to get your Free new 1965 Heathkit Catalog with complete descriptions & specifications of the GR-53A as well as over 250 easy-to-build kits!

Kit GR-53A, chassis, tubes, mask, UHF & VHF tuners, mounting kit, and special 6" x 9" speaker, 127 lbs. \$399.00

The Only Color TV You Can Install 3 Ways!

1. In New Heathkit Deluxe Walnut Cabinet (Illust. above), model GRA-53-7, 85 lbs. \$115.00
2. In Heathkit walnut-finished hardboard cabinet (Illust. below), model GRA-53-6, 52 lbs. . . . \$49.00
3. In a wall, bookshelf, or custom cabinet!



FREE! 1965 Heathkit Catalog!

HEATHKIT

HEATH COMPANY, Dept. 15-12-2
Benton Harbor, Michigan 49023

Enclosed is \$ _____, plus shipping.
Please send Model(s) _____.

Please send FREE 1965 Heathkit Catalog.

Name _____
(Please Print)

Address _____

City _____ State _____ Zip _____

CL-193

Prices & specifications subject to change without notice.

where space is small
and reliability
essential...

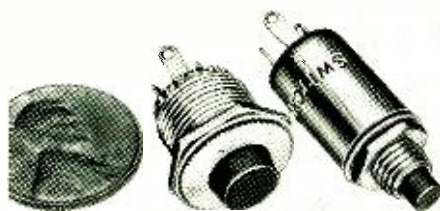

SWITCHCRAFT BUTTON SWITCHES

Unusually small completely metal enclosed push-button switches are not much bigger than a 1/2" threaded bushing—yet they feature a wide variety of circuits coupled with smooth, non-sticking action. Non-locking, red or black buttons. Behind panel mounting (left), or front-of-panel mounting (right). Which one is right for you?

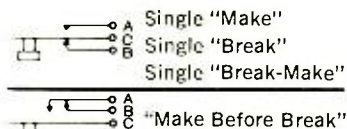

Write for Catalog S-301

SWITCHCRAFT[®]

5577 Elston Ave., Chicago, Illinois 60630
Canada: Atlas Radio Corp., Ltd., 50 Wingold Ave., Toronto, Ontario

CIRCLE NO. 224 ON READER SERVICE PAGE

RADIOTELEPHONE

LICENSE MANUAL

\$5.75

(foreign \$6.25)
Book #030



— helps you prepare for all U.S.A. commercial operator's license exams

Here are complete study-guide questions and answers in a single volume. Helps you understand every subject needed to obtain an operator's license.

RADIO HANDBOOK — largest comprehensive reference source on radio ever published. More "How-to-build" data than any book in the field. Gives simplified theory... latest design data. Book = 166.... \$9.50 (foreign, \$10.50)

The leading book on Transistor Communications Equipment.

TRANSISTOR RADIO HANDBOOK by: Donald L. Stoner, W6TNS, and Lester A. Earnshaw, ZL1AAX. Simplified circuit theory, plus practical construction projects. Book = 044..... \$5.00 (foreign, \$5.50)

SURPLUS RADIO CONVERSION MANUALS — practical conversions of popular surplus equipment. Send stamped envelope for full data.

ORDER FROM YOUR FAVORITE ELECTRONIC PARTS DISTRIBUTOR.
If he cannot supply, send us his name and remittance, and we will supply.



EDITORS and ENGINEERS, Ltd.

Summerland 2, California 93067

Dealers, electronic distributors, order from us. Bookstores, libraries, newsdealers, order from Baker & Taylor Co., Hillside, N.J., or Momence, Ill. Export (except Canada), order from H. M. Snyder Co., 440 Park Ave. South, New York 10016.

CIRCLE NO. 177 ON READER SERVICE PAGE

Receiver Frequency Control

(Continued from page 54)

spectrum and to use crystal-controlled converters to widen coverage. Unlike the digital approach, this technique allows continuous tuning—but like straight crystal control, becomes prohibitive when exceptionally wide spectrum coverage is desired. Typical commercial applications of this technique include Collins' "51-" series of receivers, using up to 30 crystals to provide coverage from 0.5 to 30.5 megacycles.

By a judicious mixture of this approach and the frequency synthesizer technique, British engineers have put into production a receiver which performs in the same manner but employs only a single crystal for all transfer references.

A block diagram of this receiver, the Model RA17 from *Racal Engineering Ltd.*, Bracknell, Berks, England, is shown in Fig. 7. The basic operation is similar to the spectrum-generator approach diagrammed in Fig. 4, but using different frequencies and circuit constants.

In the RA17, the incoming r.f. signal in the range from 3 to 30 mc. is first mixed with the output of a variable oscillator which covers the range 40.5 to 69.5 mc. Stability of this oscillator is of no particular importance, as long as it remains within 150 kc. of its original setting. Output of this first mixer becomes a 40-mc. inverted signal, which is applied to an i.f. amplifier having a passband 1300 kc. wide.

The variable oscillator output is, at the same time, mixed with the harmonics of a high-precision 1-mc. crystal oscillator to produce a variable-frequency output spectrum ranging up to nearly 40 mc. Output of this second mixer passes through a 37.5-mc. filter having a bandwidth of ± 150 kc. Thus the frequency of the single signal present at the output of this filter lies between 37.35 and 37.65 mc.

The signal slice appearing at the output of the 40-mc. i.f. amplifier is then mixed with this 37.5-mc. signal from the filter to produce an output covering the range 2 to 3 mc. This 2- to 3-mc. spectrum then goes to a conventional receiver, covering only this limited range

with calibration accuracy of 200 cps.

To clarify its operation, here is an example of how it works. Suppose it is desired to tune across that part of the class-D Citizens Band from 27 to 27.255 mc.

The first step would be to set the "Megacycles" dial on the RA17 to "27", which would tune the variable oscillator to approximately 67.5 mc. In the first mixer the incoming signals between 27 and 27.255 mc. would mix with the 67.5 mc. to produce output frequencies from 40.245 to 40.5 mc. The second mixer would mix the 67.5-mc. v.f.o. signal with the 30th harmonic of the 1-mc. crystal to produce a 37.5-mc. output for the filter.

The 40-mc. range signals would be amplified in the first i.f. strip, then mixed with the 37.5-mc. filter output to produce signals in the range 2.745 to 3 mc., which would be passed on to the final tunable receiver.

Should the v.f.o.'s frequency drift up to 67.6 mc., the first i.f. signal-frequency range would move to 40.345 to 40.6, but at the same time the output of the 37.5-mc. filter would move up to 37.6 mc. When the third-mixer action was complete, output frequency range would still be 2.745 to 3 mc. Thus accuracy of setting the v.f.o. is not essential.

Since the signal is inverted in the first mixer and is never re-inverted, the final receiver tunes "backward", i.e., 3 mc. is the low end of the signal band and 2 mc. marks the high end. Since this is true on all frequency ranges, the dial is merely calibrated in reverse and final operation is not affected in the least.

In addition to the techniques described here, several other less unusual approaches have been taken. For coverage of restricted portions of the spectrum, such as for some types of commercial communications, aircraft, and amateur use, designers have employed conventional circuits and techniques but have improved accuracy and stability by using construction methods previously reserved for transmitter frequency control.

An understanding of these new techniques will go a long way toward providing knowledge of what makes a modern communications system operate. ▲

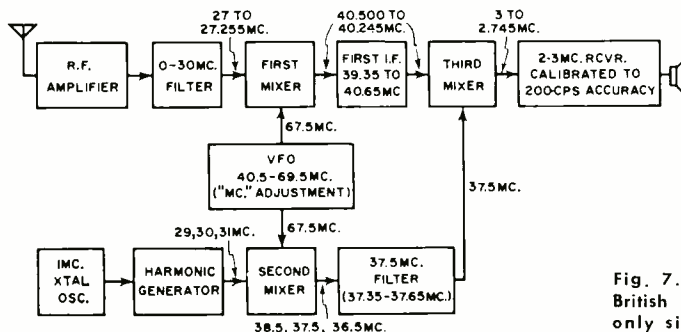
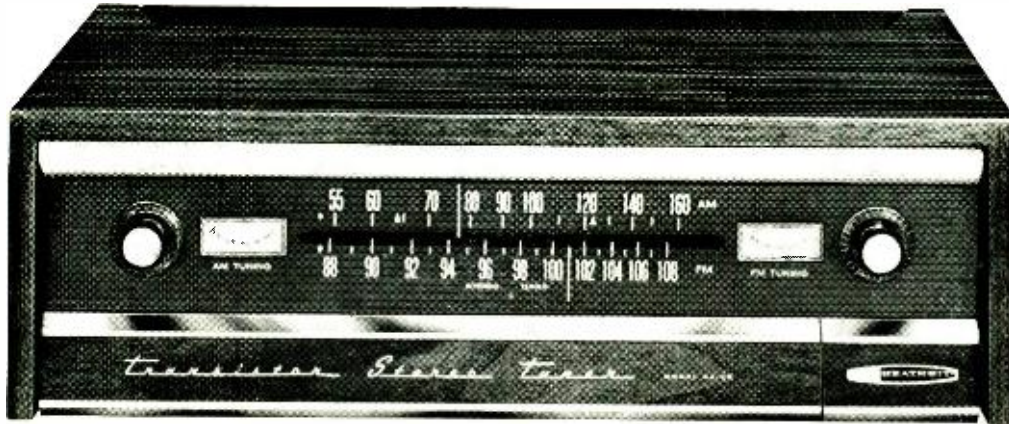
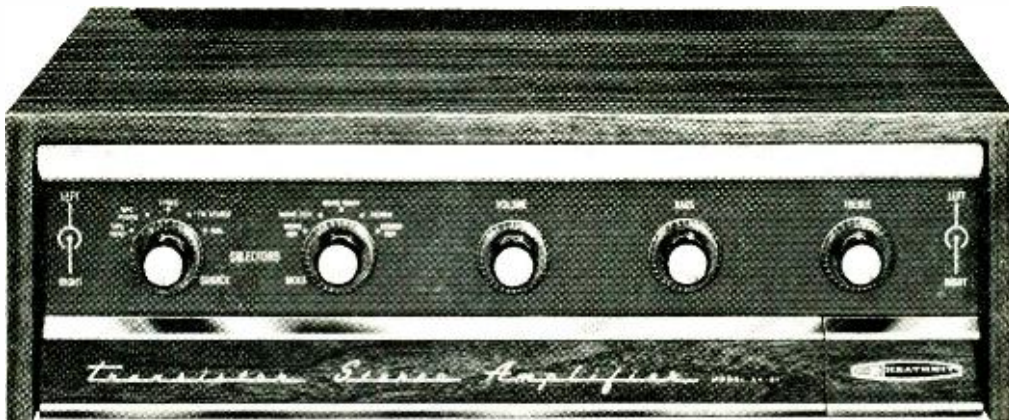

Fig. 7. Diagram of British receiver using only single crystal.

For The Stereophile With An Eye...



As Appreciative As His Ear...



New Heathkit® Deluxe Transistor Stereo!

Luxurious New Walnut Cabinet Styling!

Do you consider appearance as carefully as performance when choosing stereo components? If you do, then you'll delight in the *new look* of Heathkit Deluxe Transistor Stereo! Sleek, richly warm walnut cabinets. Clean, uncluttered charcoal gray upper front panels. Soft, refracted charcoal gray upper front panels. Soft, refracted panel lighting. Hinged, lower front walnut panels to neatly conceal all secondary controls and avoid accidental system setting changes. Beautiful enough to capture the spotlight in any room!

And The Sound?

As modern and beautiful as the new styling. Transistor sound with its broad, clean, unmodified response... no compromising! Add cool, instant operation, simplicity of assembly and the low Heath prices... and you have the best value in transistor stereo today — bar none!

Under These Beautiful Cabinets...

you'll find the most advanced solid-state circuitry. The magnificent Heathkit AJ-43 Stereo Tuner features 25 transistors and 9 diodes... wide-band AM, FM & FM Stereo to satisfy any listening wish... *automatic* switching to stereo plus an automatic stereo indicator light that signals when stereo is received... filtered left & right channel outputs for direct, beat-free stereo recording... separate AM & FM tuning meters... automatic frequency control to lock in de-

sired station for rock-steady, drift-free reception... automatic gain control that eliminates "blasting" or "fading" of incoming signals, keeps volume constant... adjustable FM squelch to let you tune across the dial *without* annoying between-station noise... stereo phase control for maximum separation, minimum distortion... and a factory-built & aligned FM "front-end" tuner and 5-stage FM I.F. circuit board for quick, easy assembly!

Matching Heathkit AA-21 Stereo Amplifier!

This superb unit boasts a 26 transistor, 10 diode circuit that produces 70 watts continuous, 100 watts IHF music power at ± 1 db from 13 to 25,000 cps. And you enjoy complete freedom from microphonics, effortless transient response, and cool instant operation... characteristics unobtainable in tube-types.

In addition, there are complete controls, plus all inputs and outputs to handle any program source & most speaker impedances. Circuit safety is assured with 5 fast-acting, bi-metal circuit breakers... no fuses to replace ever! Transformerless output circuit and multiple feedback loops provide fine fidelity and low distortion levels.

With its encapsulated, epoxy-covered circuit modules and five stable circuit boards, the AA-21's assembly is fast, simple and fun... requires *no* special skills or knowledge!

Please Your Ear, Your Eye & Your Sense Of Value!

Choose this matched Heathkit Transistor Stereo pair now for better performance and appearance at lower cost!

Kit AJ-43C, tuner, 19 lbs.....\$129.95

Kit AA-21C, amplifier, 29 lbs.....\$149.95



FREE 1965 HEATHKIT CATALOG
See these and over 250 other exciting Heathkits available in easy-to-build kit form. Save 50% or more by doing the easy assembly yourself! Send for your free catalog today!

HEATHKIT

HEATH COMPANY, Dept. 15-12-3
Benton Harbor, Michigan 49023
In Canada: Daysiram, Ltd., Cooksville, Ontario

Enclosed is \$ _____, plus shipping.
Please send Kit _____

Please send FREE 1965 Heathkit Catalog.

Name _____
(Please Print)

Address _____

City _____ State _____ Zip _____

Prices & specifications subject to change without notice HF-177

TEST EQUIPMENT

PRODUCT REPORT

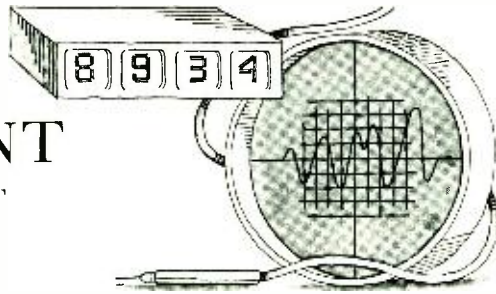

Mercury Model 1400 In-Circuit Capacitor Tester

For copy of manufacturer's brochure, circle No. 62 on coupon (page 15).



THE Mercury Model 1400 is a valuable service aid for in-circuit testing of all types of capacitors, from the smallest ceramic types to large electrolytics. The tester will check for open or shorted capacitors without the necessity of removing them from the circuit. Capacitance values are measured in-circuit for all popular electrolytic capacitors.

An important feature of the electrolytic test is that the low test voltage employed protects low-voltage electrolytics used in transistor radios. Many of these are rated as low as 3 volts d.c., and the Model 1400 is able to test these safely with no chance of damage.

The indicator tube used is a new EM84 type with a bar-shaped fluorescent screen. Directly above the tube there are printed instructions describing its pattern for various capacitor defects.

In testing a capacitor for shorts, a 2.9-volt, 60-cps signal is applied to it through an isolating resistor. The capacitor under test forms a simple voltage divider with the resistor. If the capacitor is not shorted, then enough of the test

signal reaches the detector in the tester and the eye indicator tube is kept open. This holds true even when there is a shunt path of very low resistance.

For the opens test, the capacitor is placed at the end of a tuned line connected to the tester's 20-mc. oscillator. As long as the capacitor under test is not open, the oscillator continues to run and the eye is held open. A leaky or shorted capacitor kills the oscillator and closes the eye indicator tube.

In order to check electrolytics, the same 2.9-volt test signal mentioned above is used except that now the isolating resistor is a front-panel calibrated potentiometer. The pot is rotated until the eye just closes. The scale pointer then indicates the value of the electrolytic over a range of about 2 to 450 μ f.

The power supply for the tester is line-isolated for safety. The unit employs an all-metal case with convenient carrying handle and storage compartment for power and test leads. The Model 1400 is available at a price of \$29.50. ▲

Sencore MX129 FM-Stereo Multiplex Generator

For copy of manufacturer's brochure, circle No. 63 on coupon (page 15).

THE Sencore MX129 is a crystal-controlled, transistorized FM multiplex generator and analyzer. It provides a

manufacturer, service technician, or experimenter with all signals required for analyzing, troubleshooting, and aligning

the stereo portion of FM multiplex receivers.

The MX129 generates a composite multiplex signal the same as that normally transmitted from an FM station during a stereo program. It consists of right- and left-channel information properly combined, a crystal-controlled 19-kc. pilot and, when desired, a 67-kc. SCA signal. The composite signal is available from a front-panel jack and also modulates an FM oscillator for injection into the antenna terminals of a receiver.

In addition, the unit contains a monitoring voltmeter which is calibrated in peak-to-peak volts and decibels. A jack marked "Ext. Meter" is provided for connecting the meter to stereo speakers or at other points after detection; thus no other equipment is required for checking channel separation or alignment.

Full control of left- and right-channel signal selection and signal level is offered by separate signal and level controls for each channel. Each channel can be fed with a choice of two internally generated signals, 60 cps or 1000 cps, or can be fed with an external signal. Jacks are provided on the front panel for the external signals. The signal level of each channel in peak-to-peak volts can be monitored on the panel meter. (See diagram.)

The 19-kc. pilot carrier, which is added to the composite signal, is adjustable and its level control is calibrated from zero to 10 percent of modulation. The pilot can be generated separately for 19-kc. amplifier peaking in a receiver by merely turning the left- and right-level controls to zero.

A 67-kc. SCA signal is available at the SCA jack and also modulates the r.f. carrier. This signal is required for 67-kc. trap adjustment in new stereo receivers. A separate switch selects either the SCA signal or the 1000-cps internal signal.

The panel meter selector switch has five positions: left level, right level, composite level, 3 volts peak-to-peak external, and 30 volts peak-to-peak external. The external-volts scale of the meter is also calibrated in db.

The r.f. output is factory-tuned to 100

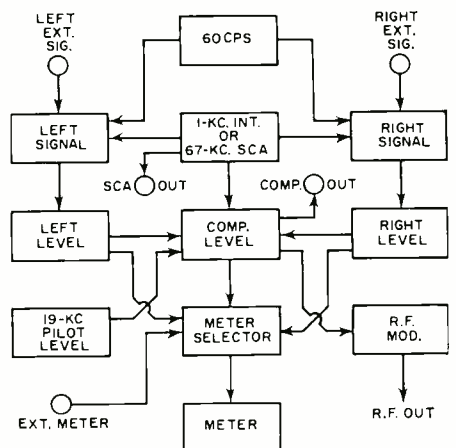

World's Best Buy In Electronic Organs!

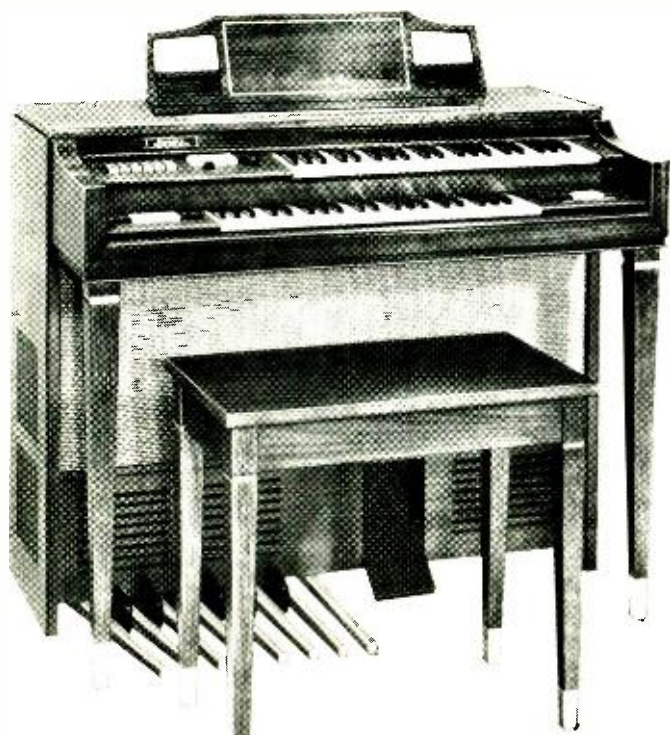

GD-983
\$849⁰⁰
 (including bench)
 \$125 dn.,
 as low as \$27 mo.

**Full Features...
 No Extras To Buy...
 Saves Hundreds of Dollars
 New Heathkit®/Thomas
 "Coronado" Transistor Organ!**

Every Organ Feature You've Ever Dreamed Of! Just look what you can create on this beautiful instrument! *17 True Organ Voices* ... Diapason 16' & 8', Bass Clarinet 16', Trumpet 16', English Horn 8', Violin 8', Oboe 8', Bourdon 16', Flute 8', Flute D'Amour 4', Quint 5-1/3', Saxophone 8', French Horn 8', Cello 8', and Chimes—all at the simple touch of a tab! *2 Separate Speaker Systems* ... a built-in 2-speed rotating Leslie plus two-12" Main speakers. With the Leslie system you create the beauty of full "theatre" organ, or a randomness of sound adaptable for religious music. And by playing through both systems at once, you produce an exciting "stereo" effect. *28 Notes Of Chimes* ... worth \$500 to \$2000 as an "extra" on other organs. Creates hundreds of chime variations. *Color-Tone Attack, Repeat & Sustain Percussion* ... the only organ to give you all 3 to create an infinite number of beautiful musical effects. You can vary the rate of repeat percussion & you can select short or medium Sustain. *2 Full 44-Note Keyboards, Manual Balance* ... to adjust relative volume & to accentuate either manual. *13 Note Heel & Toe Pedalboard, Pedal Sustain* ... for

special rhythm effects. *Pedal Volume Control, Vibrato Switch* ... for warmth & beauty. *Expression Pedal* ... to adjust volume from softest whisper to full majesty. *Reverb* ... to add concert-hall realism. *Treble Accent Tab* ... adds new clarity & brightness to solo work. *Headphone Outlet* ... play any time without disturbing others. *All-Transistor 75-Watt EIA Peak Music Power Amplifier, Pre-Tuned Tone Generator* ... to help you easily tune the organ, *no special "musical" ear needed!* *Transistor Tone Generator Boards* ... warranted for 5 years! *Luxurious Hardwood Cabinets & Bench* handcrafted with walnut finish!

No Extras, Nothing More To Buy! Everything you need for complete playing versatility is included. There are *no* speakers, amplifiers or other "hidden necessities" to add as with other organ kits. It's *all* there at *one* price ... even the bench!

Saves Hundreds Of Dollars! Save more than \$400 over the factory assembled version. And you could pay as much as \$1000 more for other brands and still *not* enjoy as many features!

It's Truly A Professional Organist's Dream With A Beginner's Simplicity! And yet you don't have to be an electronics wizard to build it, nor a professional organist to play it. Famous Heath-"Engi-nuity" has reduced assembly to simple steps that require *no* special talents, tools or knowledge. And the famous Thomas "Musical Fun Book" is included to start you playing many favorites fast! A special, recorded 48-lesson course is also available that lets you learn at your leisure! Regular \$50 value ... only \$19.95!

Pay As You Play! Only \$125 dn., as little as \$27 a month. Get *free* catalog for full details—now!

Kit GD-983, organ & matching bench, 290 lbs. ... \$125 dn., as low as \$27 mo. ... \$849.00

HEAR IT YOURSELF!

Convince yourself by sending for a 7", 33 1/3" demonstration record! Order No. GDA-983-2 for Deluxe GD-983 organ, GDA-232-5 for low-cost GD-232A organ. Each record 50c. Do it now!



HEATH COMPANY, Dept. 15-12-4
 Benton Harbor, Michigan 49023
 In Canada: Daystrom, Ltd., Cooksville, Ontario
 Enclosed is \$_____. Please send model_____.
 Please send Free 1965 Heathkit Catalog.

Name _____
 (Please Print)

Address _____

City _____ State _____ Zip _____

Prices & specifications subject to change without notice

CL-197

**World's Lowest Cost
 2 Manual Organ
 Heathkit/Thomas
 "Largo"**



- 10 true organ voices • Variable Repeat Percussion for additional effects • Two 37-note keyboards • 13-note heel & toe bass pedals • 20-watt peak power amplifier • Walnut cabinet • Transistorized plug-in tone generators ... warranted for five full years • Expression pedal.

Kit GD-232A, organ only, 158 lbs.
\$349.95

Olson

FREE

Fill in coupon for a FREE One Year Subscription to **OLSON ELECTRONICS' Fantastic Value Packed Catalog**—Unheard of **LOW, LOW PRICES** on Brand Name Speakers, Changers, Tubes, Tools, Stereo Amps, Tuners, CB, Hi-Fi's, and thousands of other Electronic Values. Credit plan available.

NAME _____
 ADDRESS _____
 CITY _____ ZONE _____ STATE _____

If you have a friend interested in electronics send his name and address for a FREE subscription also.

OLSON ELECTRONICS, INC.

328 S. Forge Street Akron, Ohio 44308

CIRCLE NO. 203 ON READER SERVICE PAGE

NEW! and NOW!

IRRADIATED

Polyolefin Shrinkable Tubing
PENNTUBE[†] V

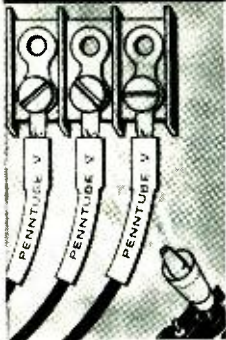

from
**PENNSYLVANIA
 FLUOROCARBON
 COMPANY**

2:1 shrink ratio.
 Meets
 all applicable
 specifications.

Write for product data
 sheet and free sample
NOW!

**P PENNSYLVANIA
 FLUOROCARBON CO., INC.**
 Holley Street & Madison Ave.,
 Clifton Heights, Pa.
 Phone: (215) MADison 2-2300
 TWX: 215-623-1577

Export Dept. Room 5710 Empire State Bldg. N.Y. 1, N.Y.

One source for:

TEFLON* TFE
 Shrinkable
 (Penntube-I-E)

*Du Pont Res. T.M.

TEFLON FEP
 Shrinkable
 (Penntube-II-SMT)

IRRADIATED
 Polyolefin Shrinkable
 (Penntube V)

†Penna. Fluorocarbon Res. T.M.

CIRCLE NO. 134 ON READER SERVICE PAGE



me., but can be adjusted by a tuning tool through the front panel from 90 to 105 mc. If interference is experienced from a local station, the r.f. may be adjusted to a clear spot on the band.

In troubleshooting a stereo receiver, the following three steps will generally pinpoint the defective circuit:

1. Feed the r.f. output from the MX129, modulated with a 1000-cps mono signal, into the antenna terminals of the receiver and balance the outputs to the speakers using the external meter. (A mono signal is produced by selecting 1000 cps on the left and right selector switches and adjusting their respective level controls to the same voltage.) If no signal can be obtained from either speaker, proceed to step 2.

2. Feed the mono signal from the "Comp. Out." into the receiver at the detector output and balance the speakers. If there is still no signal from either speaker, the trouble would be something associated with both channels; "B+," for example. If the speakers can be balanced at this point, the trouble must be in the tuner, i.f., or detector.

3. After the receiver has been bal-

anced, a channel-separation measurement should be made. With the mono signal still applied, turn the 19-kc. pilot signal up to 10% modulation. Measure the level in decibels at the left speaker, then switch off the left channel in the MX129. The tone should come from the right speaker only. If there is a tone from the left speaker, measure its level on the meter. Subtract this reading from the first for the exact amount of separation in the receiver. If the amount of separation is inadequate, the adapter portion of the receiver should be realigned using the manufacturer's instructions. The generator will provide all the signals that are necessary for the realignment.

The MX129 is housed in an all-steel case with a removable cover. A compartment is provided for the attached cables and other accessories. Internally, its 19 transistors, 9 diodes, and 76-kc. crystal are mounted on a 6"x8 3/4" printed wiring board. Removal of four screws permits folding back the board, providing easy access to all components and circuitry. Generator weight is a scant 7 1/2 pounds. Price is \$169.50. ▲

Bird Model 6154 R.F. Wattmeter

For copy of manufacturer's brochure, circle No. 64 on coupon (page 15).

ONE of the most important parameters of transmitter performance is r.f. output power. In addition to determining economy and range of broadcasting operations, power output measurements are often demanded by the FCC for compliance with regulations. To make accurate and meaningful measurements, the transmitter or the coaxial transmission line must be terminated in the proper characteristic impedance—mostly 50 ohms—by a non-radiating r.f. dummy load which maintains its value over the frequency range of interest and

is able to absorb the full power output. Power can then be measured by rectifying all or a known fraction of the r.f. voltage across this resistor and calibrating the meter scale in watts ($P = E^2/R$, and R is a known constant).

The new Bird Model 6154 Termaline® r.f. absorption wattmeter-load was designed for transmitter maintenance and repair at mobile and base stations and at service shops. It has an extended frequency range from 25-1000 mc., covering the 25-50 mc., 150-174 mc., 450-470 mc., and 950-mc. bands in one unit with-

ELECTRONICS WORLD

“Until just recently, I have been somewhat skeptical about low priced transistor amplifiers. However, after testing and listening to the Heath AA-22, I feel it is time to revise my opinion. This remarkable amplifier can easily hold its own against any amplifier — tube or transistor — anywhere near its price range.”

JULIAN D. HIRSCH, Hi Fi/Stereo Review, Nov. '64

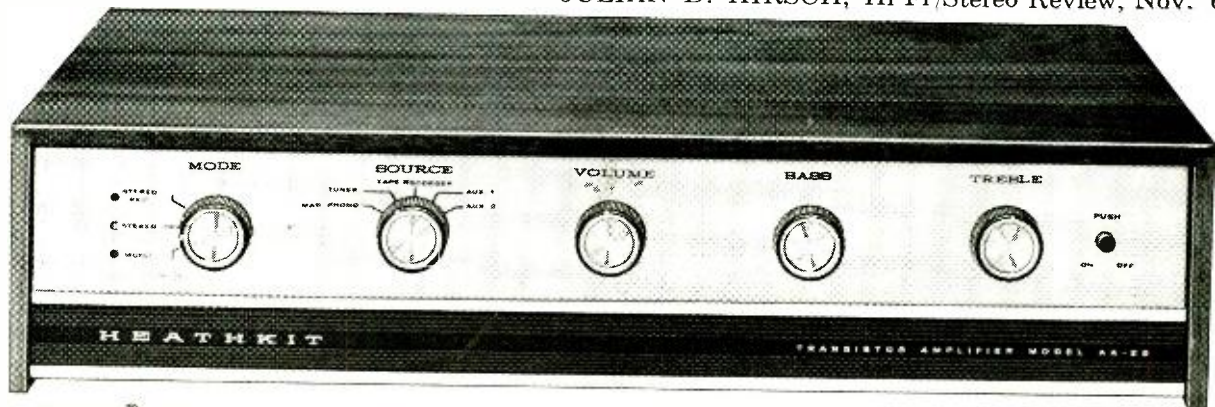

Heathkit® 40-Watt Transistor Stereo Amplifier \$99⁹⁵!

Mr. Hirsch Went On To Say: “It is the embodiment of the so-called ‘transistor sound’ — clean, sharply defined and transparent. It has the unstrained effortless quality that is sometimes found in very powerful tube amplifiers, or in certain expensive transistor amplifiers.” “The AA-22 is almost unique among amplifiers at or near its price, since it delivers more than its rated power over the entire range from 20 to 20,000 cps” . . . “The power response curve of this amplifier is one of the flattest I have ever measured” . . . “Its RIAA phono equalization was one of the most precise I have ever measured” . . . “Intermodulation distortion was about 0.5% up to 10 watts, and only 1% at 38 watts per channel, with both channels driven” . . . “The hum and noise of the amplifier were inaudible” . . . “Hi Fi/Stereo Review’s kit builder reports that the AA-22 kit was above average in ‘buildability’” . . . “In testing the AA-22, I most appreciated not having to handle it with kid

gloves. I operated it at full power for long periods, and frequently overdrove it mercilessly, without damage to the transistors, and with no change in its performance measurements” . . . “One of the best things about the Heath AA-22 is its price, \$99.95 in kit form, complete with cabinet.”

Let’s Look Closer! The AA-22 provides 40 watts continuous, 66 watts IHF music power at ±1 db from 15 to 30,000 cps. Features 5 stereo inputs to handle mag. phono, stereo-mono tuners, tape recorders, & 2 auxiliary sources. There are 4, 8 & 16 ohm speaker outputs plus tape recorder outputs; a 5-position selector switch; 3 position mode switch; dual-tandem control; bass & treble controls.

Get Full Details Free! Simply use coupon below. Or better yet, order both the AA-22 Amplifier & its matching AJ-33 tuner now! Kit AA-22, Amplifier, 23 lbs. \$99.95

“WILL GET ANY STATION THAT CAN POSSIBLY BE PULLED IN”

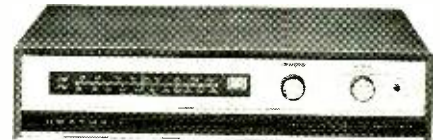

Matching AM/FM/FM Stereo Tuner
The above quote comes from July '64 issue of *Radio-Electronics*.

The matching AJ-33 tuner features a built-in stereo demodulator; AGC for steady volume; AFC for drift-free reception; stereo indicator light; stereo phase control for maximum separation, minimum distortion; filtered stereo outputs; tuning meter; flywheel tuning; voltage regulated power supply; illuminated slide-rule dial; and pre-built, prealigned FM “front-end” tuner and AM-FM I.F. circuit board for fast, easy assembly.

Kit AJ-33A, Tuner, 17 lbs. \$99.95



FREE 1965 CATALOG!

See these and over 250 other exciting Heathkits available in easy-to-build kit form. Save 50% or more by doing the easy assembly yourself! Send for your free catalog today!

HEATH COMPANY, Dept. 15-12-5
Benton Harbor, Michigan 49023
In Canada: Daystrom, Ltd., Cooksville, Ontario

Enclosed is \$ _____, plus shipping. Please send Kit(s) _____
 Please send Free 1965 Heathkit Catalog.

Name _____ (Please Print)

Address _____

City _____ State _____ Zip _____

Prices & specifications subject to change without notice.

HF-179



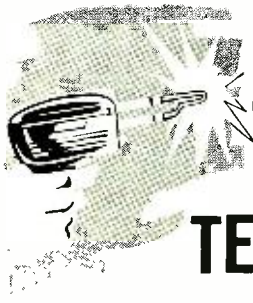

hallicrafters quality is the BIG NEWS in TEST INSTRUMENT KITS

... and hallicrafters engineered quality means outstanding specifications and performance ... plus simplified construction!



NEW "Fail-Proof" soldering terminal strips simplify making of positive connections.

NEW assembly ease. Mechanical parts are riveted to the chassis at the factory.



CAPACITANCE DECADE Kit HD-1

Ideal for experimental and service work requiring precision capacitors. Sixteen commercial slide switches give total variability in 100 pf steps. Uses silve mica capacitors and long lasting stable defilm capacitors. Range .0001 to 1.0 mfd in four decades. Price \$14.95

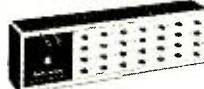

RESISTOR DECADE Kit HD-2

Use to substitute known-value precision resistors in a circuit. Resistors are one-watt, 10%. Twenty-eight commercial slide switches give total variability in 1-ohm steps. Range: 1 ohm to 10 ohms in seven decades. Price \$14.95

CONDENSER TESTER Kit HC-1

Handy service bench instrument for checking unknown condenser and resistor values under operating conditions. Has precision tuning eye for easy operation. Four capacitance ranges: 10 mmf to 2,000 mfd. Three resistance ranges: 0.5 ohm to 5 megohms. Price \$29.95



R.F. GENERATOR Kit HG-1

Generates frequencies from 50 kc. to 55 Mc. in six steps. Calibrated harmonics in two steps from 55 Mc. to 220 Mc. Low frequency range exceptionally stable. Accuracy 1 1/2% of the reading. R.F. output .1-volt. Bandswitch assembly pre-wired and calibrated. Price \$29.95

5-INCH OSCILLOSCOPE Kit HO-1

A perfect scope for servicing color TV sets. Has full 5 Mc. bandwidth. Tube is 5 UPI. One-volt peak-to-peak source attenuator permits voltage measurements over range of 10,000 to 1. Retrace blanking amplifier provided. Phasing is continuously variable from 0 to 140°. Has two axis (beam) modulation. Price \$84.95



VACUUM TUBE VOLT MILLIAMMETER Kit HM-1

Has an exclusive built-in milliammeter circuit, available at the turn of a switch. Illuminated meter and separate front panel On-Off switch. Has seven AC, DC voltage ranges, from 1.5 to 1500; seven ohmmeter ranges, 0 to 1,000 megohms; and six milliammeter ranges, 1.5 to 500. Price \$29.95

BATTERY ELIMINATOR Kit HP-1

Reliable source of 6- or 12-volt DC power for servicing car radios, including transistor and "hybrid." AC ripple less than .25%; exceptionally low. Voltage ranges 0-8 volts and 0-16 volts. Also use as battery charger. Has voltage and current panel meters. Price \$49.95



Look for this display



at your Authorized Hallicrafters Kit Headquarters!



hallicrafters

Master Kits

For FREE Catalog, write Dept. 14-L, 5th & Kostner Aves., Chicago 24, Ill.

CIRCLE NO. 186 ON READER SERVICE PAGE

B.S. Degree in 36 months

Small professionally-oriented college. Four-quarter year permits completion of B.S. Degree in three years. Summer attendance optional. *Engineering:* Electrical (electronics or power option), Mechanical, Civil, Chemical, Aeronautical. *Business Administration:* General Business, Accounting, Motor Transport Administration. One-year Drafting-Design Certificate program. Graduate placement outstanding. Founded 1884. Rich heritage. Excellent faculty. Small classes. 200-acre campus. Well equipped labs. New library. Residence halls. Modest costs. Enter Jan., March, June, Sept. For Catalog and View Book, write Director of Admissions today.



TRI-STATE COLLEGE

16124 College Avenue • Angola, Indiana

ATTENTION CLASSIFIED ADVERTISERS

Be sure to get YOUR ad in the 1965 COMMUNICATIONS HANDBOOK and 1965 ELECTRONIC EXPERIMENTER'S HANDBOOKS. Don't miss this great opportunity to reach a buying audience that will respond for an entire year.

1965 COMMUNICATIONS HANDBOOK 75¢ Word
Spring 1965 ELEC. EXP. HANDBOOK 75¢ Word
Fall 1965 ELEC. EXP. HANDBOOK 75¢ Word
SPECIAL COMBINATION RATE FOR ALL \$1.55 Word
COMBINATION RATE FOR COMMUNICATIONS AND Spring ELEC. EXP. HANDBOOKS ONLY \$1.10 Word

CLOSING DATE FOR COMBINATION RATES:
Nov. 25, 1964

Send Order and Payment Today to:
Martin Lincoln, Class. Adv. Mgr.
Ziff-Davis Publishing Co.
1 Park Avenue
New York, New York 10016.



out charts or calibration adjustments. The usefulness of this lightweight portable instrument is further increased by four full-scale power ranges in place of the usual two: 0-5, 0-15, 0-50, and 0-150 watts. This permits up-scale measurements of low-output transmitter, circuit adjustments prior to final full-power application, in addition to continuous readings up to 150 watts. The load resistor, which is surrounded by a special coolant, is so well matched to the 50-ohm transmission line that v.s.w.r. (voltage standing-wave ratio) remains below 1.1, i.e., reflected power is less than 1/4 percent to 1000 mc. Selected crystals insure full-scale measurement accuracies of 5% to 500 mc. and 10% to 1000 mc.

The coaxial load resistor, mounted within a finned radiator, is detachable from the meter housing for more convenient reading. The voltmeter circuit consists of two capacitive dividers, one for the X1 and the other for the X10 range, two sockets for the plug-in crystal, an r.f. filter circuit (R1 or R2 and C1), and a 30-microampere meter. Switch S1 and meter-shunt resistor R3 effect a 3:1 sensitivity change.

The Model 6154 accurately indicates carrier power with c.w., FM, AM, and TV modulation envelopes. It weighs only 8 lbs. and measures 6 3/4" x 4" x 12 1/4". The input connector is a female type N, and an adapter to u.h.f. (SO-239) is available for \$2.25. Price is \$265. ▲

By changing the location of the crystal diode, a different amount of r.f. energy is picked up. As a result the sensitivity of the meter is altered.

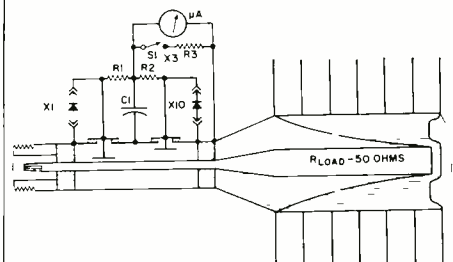

ELECTRONICS WORLD

Portable TV Sets

(Continued from page 30)

both the second anode voltage (8 kv.) and the voltage used to focus the CRT; and an additional winding on this transformer supplies the horizontal frequency pulse for use by the horizontal sweep a.f.c. and the keyed a.g.c. systems.

Although the "B+" for the portable TV sets is approximately 12 volts, either from a battery or a.c.-powered d.c. source, there are many cases where a much higher voltage is required. Such a case is the video amplifier that must accept approximately 1 volt of video from the detector and amplify it to approximately 40 to 50 volts for use by the CRT.

The video amplifier shown in Fig. 5, used in the *Realtone* Model TR-6867 (6-inch) TV set is typical of the video amplifiers found in most sets.

The 1-volt video signal is applied to the *p-n-p* transistor, and the relatively high emitter voltage is generated by taking the signal developed across the horizontal yoke (approx. 90-v.) and rectifying it with a silicon diode. The 15-kc. pulses are then filtered and used as the d.c. source.

Future Developments

What of the future? With the rapid strides now being made in the fabrication of integrated circuits, it may not be too far in the future before we see an almost fully integrated TV set in which a series of tiny monolithic chips, thin-film devices, and hybrid circuits, combined with a new approach to CRT design, may lead to a pocket portable TV set. The limiting factor here would be the size of picture that the public would buy in any worthwhile quantities. The introduction of integrated circuits would make not only for a smaller set but would improve the circuit reliability to the point where service would be minimal.

The integrated circuits would be so arranged that each circuit section (video i.f., sound i.f., sweep sections, etc.) would be on a transistor-like header plugged into a miniature socket. If one of the circuits should fail, then a tube-tester-like device could be used to check the individual circuits, the faulty one isolated and thrown away (integrated circuits cannot be repaired at any reasonable cost) and a new one inserted in the stage.

With the use of integrated circuits, complex and physically bulky circuits would be a thing of the past. Then it would be possible to make small-screen portable color sets. Cathode-ray tubes may undergo drastic electrical and mechanical changes and miniature CRT's of the future may not even look like present ones with a screen at one end and the electron gun at the other. With the continued research into microminiaturization presently going on in other areas of electronics, the consumer market will also profit. ▲

Fig. 5. The video amplifier used in the *Realtone* set is typical of most other sets. "B—" is the rectified horizontal pulse.

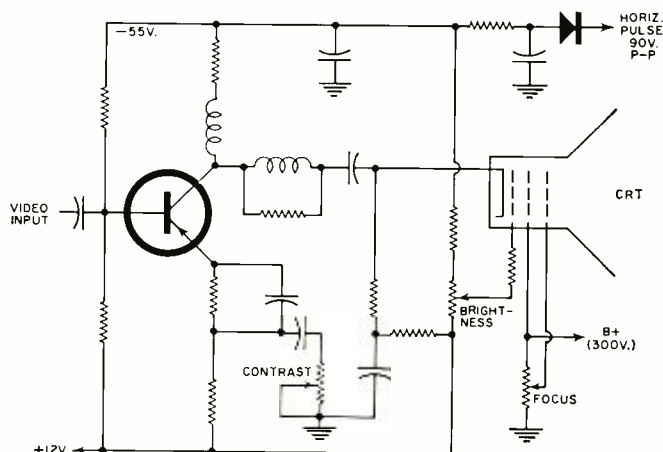

December, 1964

SOLDERING TIPS FOR HI-FI KIT BUILDERS

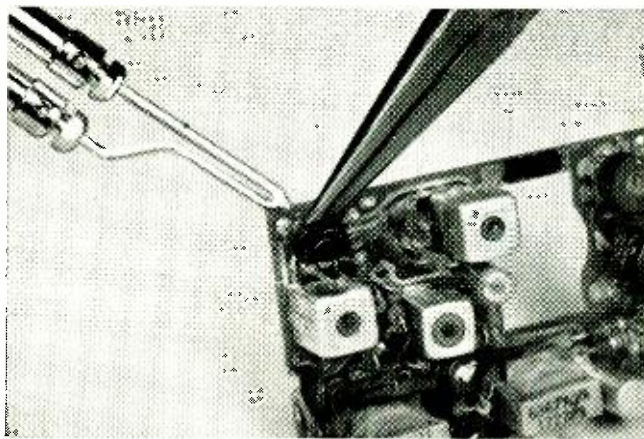

AVOID TOO MUCH HEAT

High heat can damage components. Use low heat for soldering, and a pair of long-nose pliers to hold the wire. Pliers act as a heat sink and prevent overheating.



USE A DUAL HEAT GUN

A Weller Dual Heat Gun has 2 trigger positions. One provides low heat for electronic connections; the other gives high heat when needed. You switch instantly to the right temperature for the job.

The greatest time-saver in hi-fi kit building is a Weller Dual Heat Gun. Tip heats instantly . . . no waiting. Spotlight illuminates your work. Long reach tip gets into tight spots and permits soldering with pinpoint accuracy.

A Weller "Expert" Kit includes 100/140 watt dual heat gun, 3 soldering tips, tip-changing wrench, flux brush, soldering aid and solder, in a plastic carrying case. Model 8200PK—\$8.95 list. Weller Electric Corp., Easton, Pa.

Weller

WORLD LEADER IN SOLDERING TECHNOLOGY

CIRCLE NO. 235 ON READER SERVICE PAGE

69

**STEREO/Hi-Fi
DIRECTORY..**
COMPLETE
BUYERS' GUIDE

**Get
your
own
copy!
It's only
\$1...**

The 1965 STEREO/Hi-Fi DIRECTORY is so valuable, even your best friend won't be able to wrest your copy away!

In 180 photo-packed pages, you get authoritative prices and performance data on over 2,000 components from 170 manufacturers!

This all-new *Buyer's Guide* gives you vital statistics on speakers, tuners, receivers, turntables, changers, cartridges—on every hi-fi component manufactured today! Use it to compare similar items, dollar-for-dollar, feature-for-feature, before you buy, and avoid excessive prices, disappointment, and costly mistakes!

The 1965 STEREO/Hi-Fi DIRECTORY also contains...an up-to-the-minute listing of every hi-fi dealer in the country...and a complete run-down of all the FM stereo multiplex stations in the U.S. and Canada!

But most important—if you want to get top value on every hi-fi component you buy during the next twelve months...

**SEND JUST \$1 NOW FOR YOUR COPY OF
THE 1965 STEREO/Hi-Fi DIRECTORY**

---FILL IN AND MAIL THIS COUPON RIGHT NOW!--

Ziff-Davis Service Division, Dept. SH
589 Broadway, New York, N.Y. 10012

Please send me a copy of the 1965 STEREO/Hi-Fi
DIRECTORY. My dollar, plus 15¢ for shipping and
handling, (25¢ outside U.S.) is enclosed.

name please print EW-124

address

city state zip code

New SCR Developments

(Continued from page 27)

transient-susceptible one. This makes the SCR comparable in self-healing properties to the ignitron, selenium rectifier, and other older self-protecting devices.

As a sidelight, controlled-avalanche SCR's can be used in place of high-voltage, high-current zener diodes and as protection devices for other circuits in certain cases.

Transient Immunity

A closely related problem of SCR's is transient turn-on. A voltage much lower than the forward anode breakover voltage of the SCR could turn the SCR on if the rise time of the applied forward voltage was short enough. This is called the " dv/dt " problem. As an SCR turns on in a short time and produces a transient, it can easily turn on other SCR's on the same power line. The effects of this on a production line could range from amusing to disastrous. The traditional means of eliminating dv/dt turn-on was to isolate the various circuits with transformers or to use inductance to limit the rate of rise of applied current. Thyrite and other varistors were also used.

The new SCR's are virtually dv/dt -proof. The rate of rise of anode voltage must be faster than 200 volts per microsecond before dv/dt turn-on can occur. Transients on industrial lines simply are not usually that fast. The exact manufacturing techniques required to make an SCR dv/dt -proof are not easily explained and are proprietary with certain companies.

Taken together, controlled avalanche and dv/dt immunity make the SCR more transient-immune and self-protecting. These are essential features of any industrial high-current control system.

These techniques are expensive and, at present, are available only on premium devices where this type of protection is mandatory for the intended application. Generally, 117-volt circuits are immune from either problem due to the "softness" of most 117-volt lines. As a result, controlled-avalanche and high dv/dt devices are confined to applications requiring 220-volt or higher line voltages.

Gate Turn-Off SCR's

The conventional SCR is turned on by a positive current pulse at its gate. The only way it can be turned off is by removing or reversing the anode voltage. In many cases, this is either inconvenient or impractical. There are a number of applications for a gate-controlled switch which can turn the load current off as well as on simply by applying a negative current pulse to the gate.

Small (250 ma. or less) gate-controlled $p-n-p-n$ devices have been available for some time. These devices behave like a conventional SCR during turn-on and conduction and as a linear charge controlled amplifier in the turn-off mode. A charge (current pulse) introduced at the gate electrode cancels the charge caused by the load current and the device turns off.

A new type of power SCR is based on the operation of these low-current switches. Gate-controlled switches that can switch 5 amps at 400 volts have recently become available. A positive gate pulse turns them on and a negative gate pulse turns them off. They will also turn off when the supply voltage is removed, just like an ordinary SCR.

Quite a substantial pulse of current is required for turn-off in the present models. Turn-off current gain is around ten. Actually, this low current gain in no way limits the utility of this SCR, for considerable power gain is achieved during turn-off. The turn-off voltage only has to be 3 volts or so, but will directly switch 400 volts. Also, the turn-off signal has to exist for only a small part of a millisecond. The usual method of turn-off is to discharge a capacitor into the gate, as the required high-current pulse is easily provided in this way. The gate may also be turned off by direct connection to a low-impedance negative voltage using a transistor, four-layer diode, or other switch.

There are quite a few possibilities for this device which heretofore had no high-voltage counterpart. Two typical circuits are shown in Fig. 3. Small gate pulses will operate the SCR as a d.c. latching switch. Pulse it to turn on, pulse it to turn off. A 2-kw. load may be controlled with two small, low-energy gate pulses. A second possibility is to use the gate controlled SCR in a voltage-variable power supply. By varying the ratio of on-time to off-time, various amounts of load power can be provided. This is done in a rapid off-on-off-on-off sequence. Filtering this output waveshape retains only the d.c. component, providing a smooth, continuously variable output. As this SCR operates in the switching mode, the efficiency of this design is very high and can approach 100 percent. The heat produced is substantially less than that produced in vacuum-tube or transistor dissipation-type regulators. A small differential amplifier will adjust the output to hold the voltage constant for varying load, making the supply a regulated one.

The fabrication of a gate turn-off SCR is much more difficult than an ordinary SCR. Because of this, they are not, at present, low-cost devices and probably never can approach the price of the economy SCR's. But, the circuit simplification and the new circuit possibilities can reduce over-all equipment cost using

the gate-controlled SCR, thus justifying the higher cost of this component.

Bilateral SCR's

All regular SCR's are unilateral—they only work in one current direction. To operate off the a.c. line, SCR's must be used in pairs or the line must be inverted with diodes. Other alternatives are half-wave, half-range operation and mechanical switching of an ordinary diode to provide full-range control.

Bilateral SCR's eliminate this problem. They simply go in series with the a.c. line and the a.c. load. They work in either current direction and turn off automatically every a.c. zero. There are two newly introduced devices that accomplish bilateral a.c. control at substantial power levels.

Transitron's "Biswitch" is a gateless bilateral SCR. It is turned on by avalanche breakdown. This is done by applying a 400-volt spike to the "Biswitch" to turn it on. An autotransformer steps up a small trigger pulse to trigger the Biswitch. As the Biswitch is turned off during triggering, very little trigger energy is required, giving a very high turn-on gain. Fig. 4A shows a dimmer circuit using a Biswitch. With proper heat-sinking, it can control 600 watts of light or motor load.

General Electric's "Triac" is a bilateral gate controlled SCR. Using this device, a full-range dimmer or power-tool control can be built using only four parts. The circuitry cost, using a Triac or Biswitch, is about the same. The Triac is more expensive, but requires no trigger transformer. A Triac dimmer is shown in Fig. 4B.

For more information on new SCR's, such as the ones discussed in this article, their circuits, and their capabilities, consult manufacturers' data sheets and design-information supplements. ▲

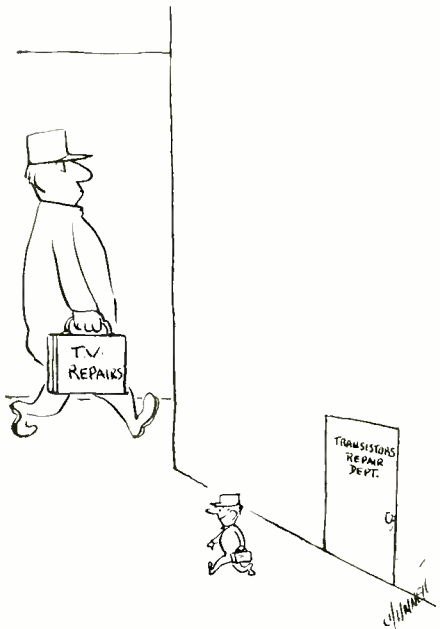

December, 1964

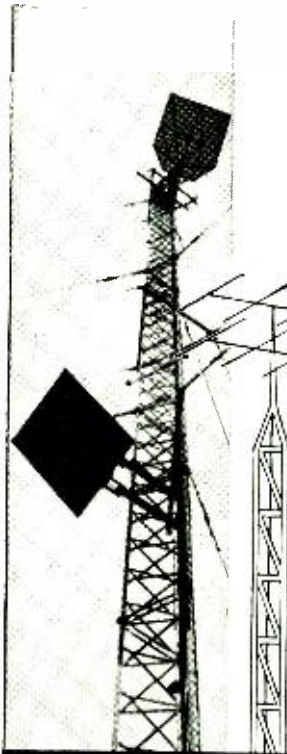

The most Famous Name in
TOWERS of ALL KINDS!

Here are the advantages you get
when you insist on **ROHN TOWERS**

LARGEST FULL RANGE OF TOWERS—you can get anything from home TV and amateur radio towers to heavy-duty communication and micro-wave towers. Included are 500 foot self-supporting towers, 1,000 foot guyed towers, "fold-over" and crank-up towers. Regardless of your needs, ROHN can supply it.

UNQUESTIONED LEADERSHIP IN DESIGN AND MANUFACTURE—you get the latest in advanced tower engineering. All communication towers are engineered to EIA specifications, and are proved by thousands of installations. No other manufacturer can surpass the quality and fine reputation of ROHN.

QUALITY MATERIALS AND WORKMANSHIP—Only highest quality steel is used which fully meets the specifications for the job. ROHN towers are hot-dipped galvanized **after fabrication**—a feature ROHN pioneered!

SERVICE WHEREVER YOU WANT IT—ROHN representatives are world-wide. Complete erection service for communication systems, broadcasting, micro-wave, and other needs is available; also competent engineering service to help you.

Settle for the BEST in TOWERS—ROHN—today the world's largest, exclusive manufacturer of towers of all kinds!

Also available: Rohn Lighting Kits, Microwave Passive Reflectors, Tower Installation Service and Engineering Assistance. Representatives World-Wide to Serve You.

For your needs, contact your local ROHN salesman, distributor or dealer; or write direct for information.

SEND THE HANDY COUPON INDICATING YOUR NEEDS

ROHN
Manufacturing
Co.
BOX 2000
PEORIA, ILLINOIS

Send me complete literature on the following ROHN Products:

- | | |
|---|--|
| <input type="checkbox"/> Home TV Towers | <input type="checkbox"/> Amateur Towers |
| <input type="checkbox"/> Communication Towers | <input type="checkbox"/> AM-FM Broadcasting Towers |
| <input type="checkbox"/> Micro-Wave Towers | <input type="checkbox"/> Government |

Name

Firm

Address

City State

"World's Largest EXCLUSIVE Manufacturer of Towers; designers, engineers, and installers of complete communication tower systems."

CIRCLE NO. 210 ON READER SERVICE PAGE

SEND **ELECTRONICS WORLD**
EVERY MONTH



name

address

city zip

state

Check one: 3 years for \$12

2 years for \$9 1 year for \$5

In the U.S., and possessions.

Payment enclosed Bill me

Foreign rates: Canada and Pan American Union countries, add 50¢ per year; all other foreign countries, add \$1.00 per year.

New Renewal

Mail to:
ELECTRONICS WORLD
Dept. 0029, 1255 Portland Place,
Boulder, Colorado 80301

LAFAYETTE RADIO ELECTRONICS

FREE!

1965 CATALOG No. 650

Over 500 Pages! *Featuring Everything in Electronics for*
HOME • INDUSTRY • LABORATORY
from the "World's Hi-Fi & Electronics Center"

- Stereo Hi-Fi—All Famous Brands Plus Lafayette's Own Top-Rated Components
- Citizens Band—Transceivers, Walkie-Talkies and Accessories
- Tape Recorders
- Test Equipment
- Radios, TV's, and Accessories
- P.A. Equipment; Intercoms
- Cameras; Optical Goods
- Marine Equipment; Auto Accessories
- Musical Instruments; Tools; Books and MUCH MORE

BUY ON TIME—
 Use Lafayette's famous Easy-Pay Credit plan . . . up to 24 Months to Pay

See the Largest Selection in Our 44-Year History



199⁵⁰

New LR-800 70-Watt Complete AM-FM Stereo Multiplex Receiver features a tuned nuvistor "front-end" and an FM "Stereo-Search" multiplex indicator. Excellent sensitivity, frequency response, and low distortion specs. Imported, 99-0005WX.



93⁹⁵

New LT-325 AM/FM Multiplex Tuner combines simplicity, flexibility, and superb styling. 20-Tube performance provides a great variety of features, including a new audible tone "Stereo Search System." Imported, 99-0001WX.



49⁹⁵

Model LA-224 24-Watt Stereo Amplifier combines high performance, beautiful styling and low price to give you a truly brilliant stereo performer. Full control facilities for integration with all hi-fi music sources. Imported, 99-0017WX.

HEADQUARTERS FOR THE HI-FI ENTHUSIAST

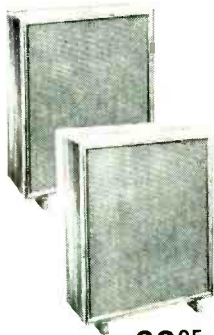

39⁹⁵
2 for 78.50

Model SK-300 "Decor-ette V" Slim 5-Speaker System utilizes the 5 most important speakers you may ever own. Four 6½" woofers and one 2½" cone-type tweeter designed to give optimum performance in a ¼" thin oil walnut enclosure. Response from 50 to 18,000 cycles. Imported, 99-0008WX.

Lafayette 2-Station Transistorized Intercom features inter-unit tone calling, push-button operation and beautiful styling. A single 66 foot plug-in connecting cord allows for fast and simple hookup. Powered by one inexpensive 9-volt battery. AC power supply/battery charger available. Imported, 99-4526.



9⁹⁵

Model RK-142 Deluxe Portable Tape Recorder perfect for the home, school, or office. Records and plays ½ track monaural at two speeds. Specially designed lever type motion switch gives fool-proof operation. Complete with dynamic microphone, connecting cables, and empty 7" reel. Imported, 99-1512WX.



59⁹⁵

Mail The Coupon TODAY For Your FREE LAFAYETTE 1965 Catalog

LAFAYETTE is HEADQUARTERS

For CB and AMATEUR EQUIPMENT

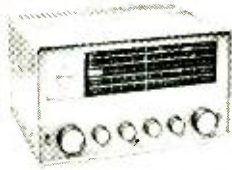

64⁵⁰

Deluxe Model HA-63 Short-wave Receiver is an excellent choice for the beginning shortwave listener or novice amateur. Covers 550 KC to 30mc in 4 bands and features electrical band-spread on all frequencies. 7 Tube circuitry gives outstanding selectivity and sensitivity. Imported, 99-2534WX



22⁹⁵

"Explor-Air"™ 4-band short wave receiver kit—an ideal way of introducing yourself or your children to the fascinating world of electronics and shortwave listening. Detailed step-by-step instruction book makes this kit a pleasure to build. 19-0905. Cabinet available for 2.85. 19-0906



59⁹⁵

Three New Deluxe Lafayette Receivers for monitoring police, fire department, aircraft, civil defense, or commercial communications. 10-Tube performance features high sensitivity, variable squelch, and fully tuned RF stage. Imported. Model HA-50 30-50Mc 99-2525WX Model HA-55 108-136Mc 99-2527WX Model HA-52 152-174Mc 99-2526WX

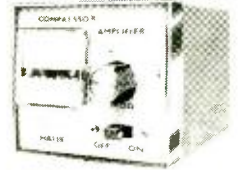

25⁹⁵

The New Model HA-115 audio compressor amplifier instantly and automatically increases the "talking power" of your citizens band transceiver by increasing the average modulation of the transmitter section. Works with all popular CB units. 42-0117.



25⁹⁵

2 for 49.95

HE-29C 9-Transistor Walkie-Talkie provides two-way communications up to 1.5 miles. Powered by six penlight batteries with life expectancy of 55 hours. An AC power supply is also available. Specify channel. Imported, 99-3020CL.



19⁹⁵

2 for 38.75

Model HA-85 6-Transistor "Walkie-Talkie" transmits and receives up to 1 mile. Ideal for sports, boating, construction and recreation. Complete with leather case, earphone, batteries, and crystals for the channel of your choice. Imported, 99-3013CL.



10⁹⁵

2 for 21.00

The HA-70A—a wired pocket-size 3-transistor walkie-talkie with countless exciting short range applications. Complete with crystal, carrying case, and 9-volt battery. Imported, 99-3011L.



6⁹⁵

Lafayette Stainless Steel CB Mobile Antenna—an outstanding buy with outstanding features. Chrome plated swivel ball mount base permits mounting on any surface. Lug terminals for easy hook-up to coaxial cable. Imported, 99-3034WX.

EXCLUSIVE LAFAYETTE WIRED TEST EQUIPMENT



9⁹⁵

New! 20,000 Ohms-Per-Volt Multitester at Lafayette's low, low price. Has every needed range for testing appliances, radio, etc. 40 microampere meter movement and 1% precision resistor for accurate readings. Imported, 99-5008. Pigskin carrying case available for 1.75, 99-5009.



26⁹⁵

Lafayette VTVM with all the ranges and accuracy you need for audio, radio and TV applications. Giant 6½" full-view meter accurately measures AC peak-to-peak, AC RMS, DC voltage, and resistance. Leather case and accessory RF probe available. 38-0101

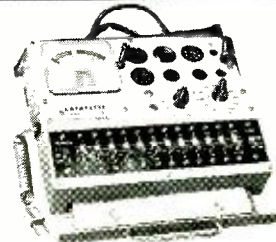

19⁹⁵

Lafayette Tube Checker packed with features at a price you can afford. Accurately checks over 1600 tubes including new compactrons and nuvistors. Handy, easy to read slide out tube chart. Imported, 99-5011.

SEND TODAY FOR YOUR FREE 1965 CATALOG

LAFAYETTE RADIO ELECTRONICS

Mail Order and L. I. Sales Center

111 Jericho Turnpike, Syosset, L. I., New York

New! New York City Store:
71 West 45th St.

New York, N. Y.
100 Sixth Ave.

Brooklyn, N. Y.
2265 Bedford Ave.

Jamaica, N. Y. 105-08 Liberty Ave. Bronx, N. Y. 542 E. Fordham Rd. Scarsdale, N. Y. 691 Central (Park) Ave. Paramus, N. J. 182 Route 17

Newark, N. J. 24 Central Ave. Plainfield, N. J. 139 W. 2 St. Boston, Mass. 584 Commonwealth Ave. Natick, Mass. 1400 Worcester St.

LAFAYETTE RADIO ELECTRONICS

Dept. RL-4 P.O. Box 10

Syosset, L. I., N. Y. 11791

Send me the FREE 1965 Lafayette Catalog 650

\$..... enclosed; send me.....
(Prices do not include shipping charges).

Name.....

Address.....

City..... State..... Zip.....

LAFAYETTE ...Headquarters For Citizens Band Equipment

NEW! LAFAYETTE 23-CHANNEL CRYSTAL-CONTROLLED DUAL CONVERSION 5-WATT CB TRANSCEIVER WITH ADVANCED "RANGE-BOOST" CIRCUIT

- 13 Tubes, 8 Diodes
- Low Noise Nuistor RF & Mixer
- 5 Double-tuned IF Transformers

Model HB-400 **Only 169⁵⁰**

- Frequency Synthesis For 23 Channel Crystal Controlled Transmit & Receive ■ No Extra Crystals Needed ■ Dual Conversion Receiver with 3/10 uv Sensitivity ■ Delta Tuning ■ Variable Squelch, Variable Noise Limiter ■ Illuminated "S" and RF Output Meter ■ Push-to-Talk Ceramic Mike ■ "Range-Boost" provides high average Modulation—increases Effective Range ■ Built-in Dual Power Supply, 117VAC, 12VDC ■ "Vari-Tilt" Mobile Bracket For Easy Installation ■ Plug-in Facilities for Lafayette Selective Call Unit ■ Compact, 12"Wx10"Dx5"H



Double Side Band Full Carrier

NEW! LAFAYETTE ALL-TRANSISTOR DUAL CONVERSION 5-WATT CB TRANSCEIVER FEATURING AUTHENTIC MECHANICAL FILTER



Includes .003% Tolerance Crystals for Frequency Stability!

Small, Compact—Only 3" High!

- 100% Solid-State . . . Full 5-Watt Performance!
- 11 Rugged Silicon Mesa Transistors Used in Critical Areas
- Small, Compact—Only 3" High!
- Low Battery Drain—Less Than 350 ma on Receive, 850 ma on Transmit!

MODEL HB-500 **Only 139⁵⁰**

- 12 Crystal-Controlled Transmit & Receive Positions
- 23 Channel Tunable Receiver with Spotting Switch
- 15 Transistors, 5 diodes with Printed Circuit Construction ■ Dual Conversion Receiver with 5/10 μ V Sensitivity ■ Mechanical Filter For Razor-Sharp Selectivity ■ Variable Squelch, Automatic Noise Limiter, "S" meter ■ Dependable Sealed Relay Switching ■ Fits Anywhere—Only 11 $\frac{1}{2}$ "Wx6 $\frac{1}{8}$ "Dx3"H ■ For 12VDC (optional 117VAC Transistorized power Supply available)
- Supplied With Crystals for Channel 12, special Mobile bracket, Push-to-Talk Dynamic Mike and Mobile power cable.

NEW! LAFAYETTE DELUXE 8-CHANNEL DUAL CONVERSION 5-WATT CB TRANSCEIVER SUCCESSOR TO THE FAMOUS LAFAYETTE HE-20C

Model HB-200 **ONLY 109⁵⁰**

- 9 Tubes plus 3 Silicon Diodes plus 2 Crystal Diodes for 17-Tube Performance ■ Super Sensitivity—1 Microvolt or Less ■ 8 Crystal Receive Positions plus 8 Crystal Transmit Positions plus 23-Channel Tunable Receive
- Push-to-Talk Microphone ■ Dependable Relay Switching ■ Illuminated Meter with 3-Position Switch ■ Adjustable Squelch and Automatic Noise Limiter ■ Spotting Switch ■ Built-in 117 Volt AC Power Supply with 12 Volt DC Mobile Transistorized Power Supply ■ Plug-in facilities for Lafayette Selective Call Unit ■ With Bracket Handle, Push-to-Talk Ceramic Mike, Pair of Transmit and Receive Crystals for Channel 15 plus Crystal for Dual Conversion.



MADE IN U.S.A.

FREE!

Lafayette 516 Pg. 1965 Catalog No. 650. Write:
Lafayette Radio Electronics Corp., Dept. RL-4, P.O. Box 10, Syosset, L.I., N.Y. 11791

ORGAN KIT USES DIODE SWITCHING

Diodes replace mechanical contacts and act as variable resistors in percussion circuitry in Heathkit organ.

FOLLOWING the successful introduction of a low-cost transistor organ kit two years ago, the *Heath Co.* has recently announced a new, more sophisticated model. Designated as the "Heathkit" GD-983, the new model is a kit version of the *Thomas* "Coronado" BL-3.

Until now, when an electronic organ offered an array of electronic equivalents of 16-, 8-, and 4-foot pipe-organ registers, a minimum of one mechanical switch or contact had been required for each register on each key. Such switches require precise initial adjustment for proper sequence as well as periodic maintenance. Even when properly adjusted, such switches may cause transient noises such as "popping" and clicks.

In the new organ, where more than one register is used, the traditional multiple mechanical switches have been replaced with miniature silicon diodes. In contrast to other electronic organs, where a depressed key actually performs the switching of multiple signals, the GD-983 uses a single contact on each key which merely applies a forward biasing voltage to a group of diodes. The signals from the conducting groups of diodes are fed to their respective passive filters, and selected by means of the usual tab voicing switches.

In this particular model, four different registers of stops are offered on the upper or swell keyboard which has 44 keys. Thus there are 176 diodes used in the switching. The benefits of this electronic method of switching are many. In addition to the elimination of the cumbersome mechanical contact method and its problems, there is the complete absence of transient noises due to the "variable-resistor" effect of the rise and decay times of the diodes in going from non-conducting to conducting states. This same microsecond time lag not only precludes transient noises, but also adds to the realism of the organ by making its attack action similar to that of a pipe organ. The reliability of solid-state techniques is firmly established and therefore this important characteristic accrues to the benefit of the owner in terms of long, trouble-free operation.

In addition to the switching diodes, each key has a blocking diode to prevent feedthrough of a signal *via* associated wiring, and a sustain diode which charges a capacitor for the desired decay time. In total, there are 264 diodes em-



ployed in the keyer circuit board. This may sound like a formidable do-it-yourself project, but it isn't since this particular circuit board is supplied factory-assembled and tested, ready to install.

The pedal clavier is also diode switched, and has its own sustain circuitry.

There are 12 tone generator circuit boards, each one consisting of an oscillator, and three bistable frequency dividers.

The percussion section is also quite unique. The user may (1) percuss swell flute voices, while the string, woodwind, reed, and diapason voices sound normally; (2) percuss the swell string, woodwind, reed, and diapason voices while the flute voices sound normally; (3) percuss all voices on the swell manual; (4) percuss voices of the great manual; and (5) percuss voices of both manuals. The repeat percussion adds a strumming effect to create the sounds of mandolin, banjo, and marimba. A variable control adjusts the rate of repeat as desired.

Playing features include 17 organ voices, two 44-note keyboards, a built-in two-speed *Leslie* speaker plus a 2-unit main speaker system. 28 notes of chimes, 13-note heel and toe pedalboard, reverb, vibrato, color-tone attack, repeat and sustain percussion, stereo chorus control, treble accent, manual balance, pedal volume, expression pedal, headset outlet, 75-watt EIA peak power amplifier, and walnut-finished hardwood cabinet and matching bench. The complete kit sells for \$849. ▲

ARE YOUR RECORDS IN GOOD SHAPE?

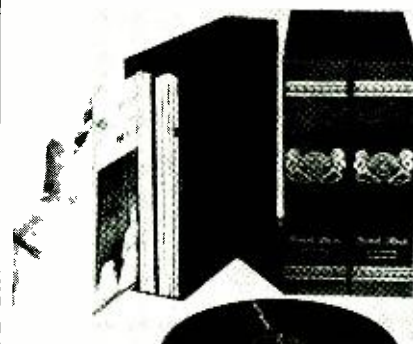

HI-FILE RECORD CASES

These handy record cases hold your albums safely and neatly on your bookshelf. They're the perfect answer to your record storage problems!

so attractive: rich library binding of simulated leather, tooled in 16K gold. They make handsome additions to any shelf. And there are six colors to choose from: black, brown, maroon, red, blue and green.

no chance of warping or breakage: albums are held in a vertical position, thus preventing damage.

albums stay clean and neat: each case is dustproof, holds twenty of your 12" LP's in their original jackets, with a divider for separating records by artist or category.

handy size: 13" high, 12½" wide and 3½" deep, so they can accommodate your multiple-record albums, as well.

albums are easily accessible: open back enables you to read titles on the spine of albums for fast selection.

Ziff-Davis Publishing Co., Dept. SD
1 Park Ave, New York 16, N.Y. EW 124

Please send me _____ Hi-File record cases, at \$3.50 each, 3 for \$10. Color choice, check box.

black brown maroon
 red blue green

I enclose _____.

Name _____

Address _____

City _____ Zone _____ State _____
Shipped prepaid Fully guaranteed

SCIENCE/ ENGINEERING

ASSOCIATE & BACHELOR OF SCIENCE PROGRAMS

Get into fastest-growing fields of Physics, Mathematics, Engineering (Nuclear, Electronic, Electrical); also Engineering Technology (Nuclear, Electronic), Optional four-quarter, all-year schedule allows finishing four-year B.S. degree programs in 3 yrs.; A.S. degree in 2 yrs. A.A. degree in Electronics Technology in 1½ yrs. Send for Catalog W-12. Winter Quarter starts Jan. 4th.

NORTHRIDGE COLLEGE OF SCIENCE & ENGINEERING
18758 Bryant St., Northridge, Calif.



BARGAIN
HUNTING?

FREE! GIANT
SENSATIONAL
ELECTRONICS
CATALOG

HENSHAW TV SUPPLY

3617 TROOST KANSAS CITY, MO.

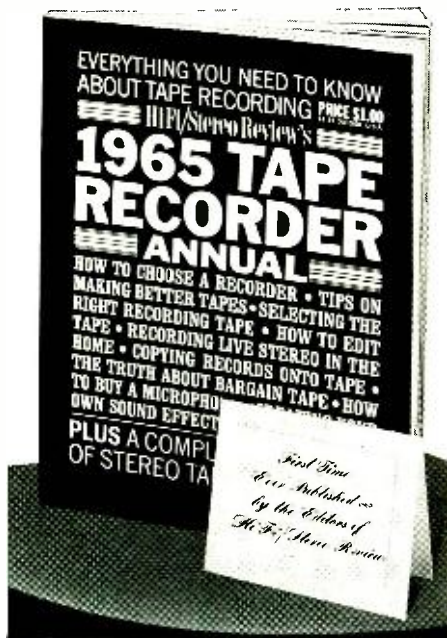

Know-it-all.

It's easy to be an authority on tape when you have a copy of *Hi Fi/Stereo Review's 1965 TAPE RECORDER ANNUAL* handy. Look at the photo above. The special articles listed on the cover of this 132-page factbook are just a few of the **23 complete features!** You get expert tips by the dozens, on equipment — making better tapes—editing—copying—sound on **everything** you need to know about tape recording. Plus...

... a complete directory of stereo tape recorders! Over 100 photos—complete data on 230 models from thirty-three different manufacturers! All the model numbers, specifications, dimensions and prices! All the important information you need to compare the latest tape recorders, and select the finest one in your price range.

Published for the first time (by the editors of *Hi Fi/Stereo Review*), the **1965 TAPE RECORDER ANNUAL** is an indispensable guide for everyone who wants better performance and greater versatility from his tape recorder. If you fit this description...

SEND JUST \$1 NOW FOR YOUR COPY of the 1965 TAPE RECORDER ANNUAL

—FILL IN AND MAIL THIS COUPON TODAY!—

ZIFF-DAVIS SERVICE DIVISION • Dept. TR
589 Broadway • New York, N.Y. 10012

Please send me a copy of the 1965 TAPE RECORDER ANNUAL. My dollar (plus 15¢ for shipping and handling; 25¢ outside U.S.A.) is enclosed.

name please print

address EW-124

city state zip code

(PAYMENT MUST BE ENCLOSED WITH ORDER.)

FM-Stereo Demodulator

(Continued from page 35)

stereo multiplex generator to the input of the adapter.

20. Attach the a.c. v.t.v.m. to the right output.

21. Set the stereo multiplex generator to the left channel only. Adjust *L4* for null on v.t.v.m. (only slight retouching of *L4* is necessary). Record separation (right channel).

22. Measure left-channel separation. Left- and right-channel separations should be within 3 db. (A slight compromise in *L4* adjustment may be necessary to provide equal channel separations.)

23. Connect FM tuner to demodulator input.

24. Connect the stereo multiplex generator output to the external modulation terminal of the FM signal generator; frequency modulate a 98-mc. signal 30% with a 1000 cps L=R signal.

25. Set the FM generator for full limiting in the tuner. The indicator light will then be lit.

26. Attach the a.c. v.t.v.m. to the right output.

27. Set the stereo multiplex generator to the left channel only and adjust *L4* for null on v.t.v.m. (only slight adjustment is required). Record separation (right channel).

28. Measure separation in left channel. (A slight compromise in *L4* adjustment may be necessary for equal right- and left-channel separations.)

29. Decrease the threshold potentiometer to its maximum counterclockwise position. The indicator lamp will then be extinguished.

30. Set the FM signal generator output for acceptable tuner quieting. Slowly advance the threshold potentiometer clockwise until the indicator lamp lights. The demodulator will then automatically switch to stereo operation at or above this signal level.

The performance of the demodulator was tested by means of the setup shown in Fig. 3. A portion of the results obtained are listed below.

Channel separation of stereo demodulator (channel separation adjusted at 500 mv., 1 kc.): At a signal level of 500 mv. r.m.s. channel separation was 34.2 db at 100 cps, 43.7 db at 1 kc., 26 db at 10 kc., and 20.2 db at 15 kc. At a signal level of 200 mv. r.m.s. at 100 cps the channel separation was 22.7 db, at 1 kc. it was 25 db, at 10 kc. it was 20.1 db, and at 15 kc. it was 16.4 db.

Harmonic distortion (signal level=500 mv., 10% pilot): was 1.1% at 100 cps, 0.9% at 1 kc., 1.3% at 10 kc., and 1.9% at 15 kc.

The output subcarrier residual with a modulator input level of 500 mv. was

0.62 mv. and at 200 mv. it was 0.29 mv.

High-Gain Tuner Modifications

Although the multiplex circuit described in this article operates satisfactorily with tuners requiring a minimum of eight microvolts (antenna input) for limiting, problems may be encountered with higher gain tuners, that is, tuners requiring less than three microvolts for limiting. When such tuners are used, the noise immunity, SCA rejection, and input-impedance characteristics of the original circuit should be modified. The required changes can be readily attained by the addition of a stage and replacement of the single-tuned transformer (*L6*) in the threshold amplifier with a double-tuned transformer. This consists of two single-tuned windings (*TRW*

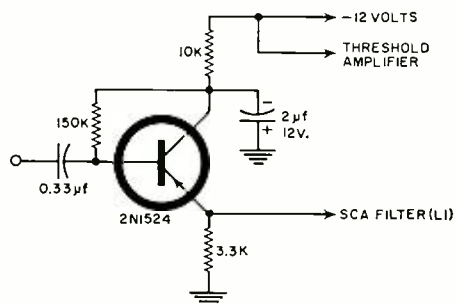

Fig. 4. Added stage for high-gain tuners.

type 17558 primary and *TRW* type 17557 secondary) coupled together with a 10-pf. capacitor. The double-tuned transformer achieves the desired noise immunity and increases the selectivity of the 19-kc. circuit.

The additional stage is located at the input of the adapter, as shown in Fig. 4. With the emitter-follower mode used, this stage supplies the required increase in input impedance. The additional stage is directly coupled to the pilot separator by means of the SCA filter. In this manner, the high impedance of the SCA filter at resonance is used to the fullest extent and, as a result, the increase in SCA rejection can be realized without a change in the filter. ▲



"I don't give a hoot about Greenwich Mean Time! Right now it's Boston Bean Time and they're getting cold."

GET IN WHEN YOU'RE OUT...

Stevens-Robertson's "Sales Dynamics," a sparkling and different approach to sales development, brings you face to face with those prospects you have been unable to reach... can increase the productivity of your sales force 200% to 500%. "Sales Dynamics" creates warm and lasting relationships with your important accounts.

"Sales Dynamics" gets you in— keeps you in. The unique qualities of this highly effective new method of building sales and relationships are attested to by Board Chairmen, Presidents, Vice-Presidents, Sales and Advertising Managers, Merchandising Managers, leading advertising agencies from all over America, including N. W. Ayer, U. S. Steel, The American Tobacco Co., The Pillsbury Co., Kaiser Aluminum, Ford Motor Co., Foote, Cone, & Belding, Printers' Ink, General Motors Corp., Traffic Management Magazine, Manufacturer's Hanover Trust, T. Mellon & Sons, National Biscuit Co.

Tall tale and hard to believe? Let us bring you face to face with the facts... black on white facts... Read-it-yourself facts. Write, Wire, or better still, call Circle 7-4552.

STEVENS-ROBERTSON
CORPORATION

250 WEST 57TH ST.,
NEW YORK, N.Y.

*"I DON'T PAINT PICTURES...
BUT I'M AN ARTIST AT
BUILDING SALES."*



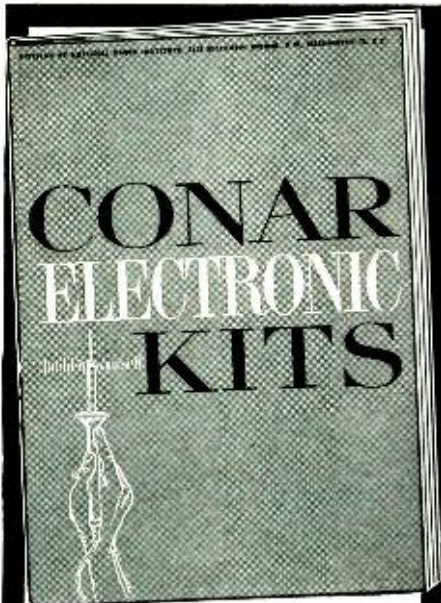

Your copy
is waiting...

The do-it-yourselfer's newest catalog

Here's your new catalog of quality electronic kits and assembled equipment . . . your shopping guide for TV set kits, transistor radios, voltmeters, scopes, tube testers, ham gear, PA systems, and a host of other carefully engineered products. Every item in the Conar catalog is backed by a no-loopholes, money-back guarantee. It's not the biggest catalog, but once you shop its pages you'll agree it's among the best. For years of pleasurable performance, for fun and pride in assembly, mail the coupon. Discover why Conar, a division of National Radio Institute, is just about the fastest growing name in the kit and equipment business.

CONAR

MAIL NOW!

CONAR

NB4C

3939 Wisconsin Avenue, Washington, D.C. 20016
Please send me your new catalog.

Name _____

Address _____

City _____

State _____

Z-Code _____

CIRCLE NO. 245 ON READER SERVICE PAGE 78

Early Vacuum Tubes

(Continued from page 43)

filament were screened in a glass tube. It contains a small square of mica which can be interposed between the plate and the filament. When the plate was screened by the mica from the negative leg of the filament, it was found that the current stopped.

Much of a general nature was learned through these experimental years. Possibly the most important general characteristic of all the Edison-effect lamps was the unilateral conductivity of these lamps. Rectification of alternating current at low frequencies had been accomplished in the laboratories utilizing this unilateral conductivity characteristic.

By 1896 Fleming had about concluded his Edison-effect experiments and these lamps were placed in a cupboard for storage, as no practical use had been discovered for them.

Fleming Valves

In 1899 Fleming became a technical advisor to Marconi. In 1900 he started to assist Marconi in preparations that were to lead to the establishment of transatlantic wireless telegraph communications.

In 1900 the most troublesome part of any wireless equipment was the detector. In those days the only detector of wireless signals was of the contact type, such as coherers and the like, which were mechanically very unstable and subject to burn-out from the local transmitter. Because of these difficulties, Marconi developed the magnetic detector which eliminated the mechanical difficulties and the burn-out but left much to be desired as to sensitivity. The wireless receiver was the weak link in the system and Fleming was given the job of improving it.

In October 1904, while thinking about this problem of wireless detection, Fleming recalled the experiments with the Edison-effect lamps and their ability to rectify low-frequency currents. Would they rectify the high-frequency current encountered in wireless reception?

Concerning this last question Fleming wrote: "I asked my assistant, Mr. G. B. Dyke, to put up the arrangements for creating feeble high-frequency currents in a circuit, and I took out of a cupboard one of my old experimental bulbs. The experiment was at once a great success and I found I could use a galvanometer to detect feeble oscillations . . .".

Fleming in this case had used the rectified energy of the incoming signal as his sole source of power. No plate battery or other local source of power was used to augment the strength of the received signal.

The lamp which Fleming used is shown in Fig. 2. It is preserved in the Science Museum in London. With this lamp was found the first practical wireless use for the Edison effect.

Fleming named the Edison-effect lamp used to detect wireless signals an "oscillation valve." His patent covers the application of the Edison-effect lamp to this particular use and to the circuits relating thereto, and not to the lamp itself.

After the successful experiments with the lamps, Fleming had the *Edison and Swan United Electric Light Co.* make up a number of "oscillation valves" for experimental purposes. Some of these are shown in the bottom row of Fig. 1 and in Fig. 5.

On June 15, 1905 Fleming sent to Marconi five of these experimental "oscillation valves" for trial. Marconi began using these valves at once, to the exclusion of all other detector types. Many more valves were supplied by Fleming in 1905 and in 1906. In 1907 the *British Marconi Company* began to manufacture these valves for its own use.

The *British Marconi Company* continued to use the Fleming "oscillation valves" in its receivers for many years. A 1912 *Marconi* receiver with its duplicate "oscillation valves" is shown in Fig. 4.

From these simple beginnings, the giant electron tube industry has grown. ▲

TIME SIGNAL CHANGED

THE transmitting clocks of radio stations belonging to the National Bureau of Standards (WWV, WWVH, and WWVB) and the U.S. Navy (NBA, NPG, NPM, NPN, and NSS) were retarded by 100 milliseconds at zero hours Universal Time, on September 1, 1964.

The adjustment became necessary because of changes in speed of rotation of the earth as determined by astronomical observation. Such adjustments are made by international agreement, according to a plan whereby the times of emissions of time signals are synchronized to about 1 millisecond. The last previous adjustment in the phase of time signal pulses was made on the first of April, 1964.

Countries participating in the coordination are: Argentina, Australia, Canada, Czechoslovakia, France, Italy, Japan, South Africa, Switzerland, United Kingdom, and the U.S. ▲



ELECTRONICS WORLD

NEW PRODUCTS & LITERATURE

Additional information on the items covered in this section is available from the manufacturers. Each item is identified by a code number. To obtain further details, simply fill in the coupon appearing on page 15.

COMPONENTS • TOOLS • TEST EQUIPMENT • HI-FI • AUDIO • CB • HAM • COMMUNICATIONS

MODULAR ROTARY SWITCHES

1 Oak Manufacturing Co. is now offering its "Moduline" rotary switches which will be available in 2 million different variations. Using the modular principle, OEM engineers can specify one of these semi-custom switches which can be assembled and shipped seven days after receipt of the order.

To assist the engineer in specifying the switch, the company has developed a unique catalogue



and easy-to-use order card. Engineering drawings are eliminated since the design characteristics of a switch are designated by a series of eight numbers (16 digits) which are selected from the catalogue and written on the order card.

Using prefabricated, precision components, the company can assemble switches following the design configurations indicated on the order card.

TEMPERATURE CONTROLLER

2 Viking Industries, Inc. is now offering the Model 9505 digital set temperature controller which features the repeatability of a digital system and the accuracy and stability of a proportional control, according to the company.

The new unit is capable of controlling 1500 watts of 115-volt, 60 cycle power. The controller is adjustable in 1°C steps from -65°C to +200°C and has an absolute accuracy of $\pm 1^\circ\text{C}$ and sensitivity of 0.1°C. The unit measures 5 1/4" x 4" x 3 3/4".

LABORATORY POTENTIOMETER

3 Trimpot Division of Bourns, Inc. has developed a dial-readout precision potentiometer designed especially for laboratory applications.

The Model 3660 "Labpot" is designed for rapid setting of precise voltages, or reading of the required voltages to achieve null in a bridge circuit application. Similarly, it may be used for the introduction of known resistance values in a circuit.

The standard model is available in three resistances (1000, 10,000 and 100,000 ohms) but many special values can be supplied on request. Resistance tolerance is $\pm 1\%$ and resolution is 0.028% to 0.010%.

HIGH-POWER SCR'S

4 Westinghouse Semiconductor Division has introduced a new line of high power silicon controlled rectifiers (JEDEC 2N3130 series). These devices feature a radically new concept in power semiconductor design. These techniques include the use of compression bonding encapsulation (CBE) and an integral heat sink design. The CBE construction eliminates solder joints by the use of high pressure contacts to maintain electrical and thermal contact between the SCR wafer and the base. This construction is completely free from thermal fatigue. The integral heat sink eliminates the ease to sink thermal impedance found in conventional semiconductors.

Maximum current rating is 400 amperes r.m.s. or a half-wave average rating of 250 amperes. Forward blocking voltages from 50 to 1000 volts are available.

R.F. MILLIVOLTMETER PROBE

5 Porter Electronic Laboratories has announced a new and improved probe for its 626 r.f. millivoltmeter. The v.s.w.r. is improved to less than 1.2 to 2000 mc. Frequency accuracy is 5% from 10 to 20 kc., 3% from 20 kc. to 100 mc., 5% from 100 to 300 mc., 10% from 30 to 1000 mc., and 20% from 1000 to 2000 mc.

The probe has a maximum input of 500 volts d.c., 10 volts a.c.

THIN-FILM RESISTORS

6 Metavac, Inc. is now offering a wide variety of rod and disc thin film resistors for application in the microwave and other high-frequency fields. They can be used as coaxial terminations, r.f. pads, dummy loads, coupling loops, attenuators, and impedance-matching devices.

These resistors are offered in ranges of 1 to 500 ohms with power ratings from 1/8 watt to 15 watts. Precision tolerance grades of 5% and 2% are standard. Featuring an unusually low temperature coefficient, excellent value stability to 200°C., and having the property of being non-inductive, these film resistors are offered with soft-soldered tin-plated electrodes to facilitate all conventional circuit soldering techniques.

NARROW DECADE COUNTERS

7 Allegany Instrument Company has available a new series of narrow decade counters with pre-set capabilities for start-stop counting functions. The Series F111 units are available with counting rates of 200 kc., 1 mc., and 10 mc. Models are available in four configurations, including built-in single pre-set for start or stop functions after a pre-set number of pulses, and dual pre-set for combination start and stop.

The units mount on 1-inch centers. They are completely solid-state, employing silicon transistors in a binary circuit for counting logic. Glass epoxy circuit boards are used, with output

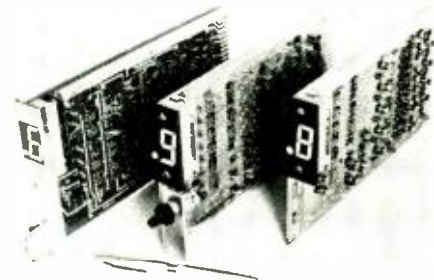

connections for 10-line coincidence, 1-2-4-8 binary, staircase, and pulse output to drive other decades.

The in-plane, segmented type numerical display is 3/4" high. Bright, 100,000-hour-life incandescent lamps are used for high visibility and wide-angle viewing.

25- TO 450-WATT SOLDERING GUN

8 Wen Products, Inc. has developed the Model 450 "All" soldering gun which makes possible heat volume ranges from 25 to 450 watts in one small, lightweight gun. By changing tips, which can be done in seconds, the gun is ready for

heavy, medium, or light duty applications.

The gun features automatic thermal regulation which automatically adjusts the heat power to the right level for the job. The fine point tip is for use in the 25 to 100 watt range, the medium duty tip is for the 100 to 200 watt range, while the heavy-duty tip is for 200 to 450 watt applications.

The instrument measures 5 3/8" long x 2 1/2" wide x 5 3/8" high. It has a 6 foot line cord terminated by a molded plug. It operates on 120 volts a.c. Weight of the gun is 35 ounces plus 3 ounces for the cord.

PHOTOCONDUCTIVE CELLS

9 Chairex Corporation has announced a new, smaller, more rugged photoconductive cell offering up to 2 watts of power dissipation. The new "5M" series is offered in eight types of cadmium sulphide and cadmium selenide sensitive materials in a hermetically sealed metal case only .190 inch in diameter.

The units have voltage ratings up to 300 volts and light resistance down to 250 ohms at 2 foot-candles.

DIFFERENTIAL VOLTMMETER

10 Hewlett-Packard Company has recently introduced the Model 711A a.c./d.c. differential voltmeter/d.c. standard which combines six functions in a single, compact solid-state instrument.

The Model 711A is a d.c. differential voltmeter of 0.03% accuracy which may also be used di-

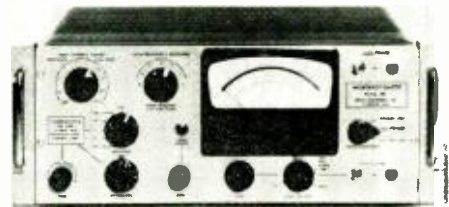

rectly as an electronic d.c. voltmeter; the input impedance is constant and greater than 1000 megohms, regardless of null condition.

As an a.c. measuring instrument, the unit introduces a shunt capacitance of less than 5 pf. at the "touch and read" point in the measured circuit. The shunt resistance is 1 megohm. As an a.c. differential voltmeter, its specified accuracy is 0.1% of reading $\pm 0.01\%$ of full scale, from 0.1 volt to 1000 volts.

A built-in recorder output is driven by a d.c. amplifier which may be used separately, with a maximum gain of 60 db and output of 1 volt into 2000 ohms or more.

L.F. WAVE & SPECTRUM ANALYZER

11 Quan-Tech Laboratories, Inc. has developed a new low-frequency wave and spectrum analyzer which the company claims provides measurement capabilities normally associated with much more elaborate and costly equipment.

Useful as a standard wave analyzer for harmonic and Fourier analysis of complex waveforms, the Model 304 has three selectable flat-topped bandwidths (1, 10, 100 cycles) that also make it ideal for spectral density analysis of random signals. Used with a scope, X-Y plotter, or strip chart recorder, it becomes a spectrum analyzer of wide performance characteristics.

Frequency range is 1 cycle to 5000 cycles with an accuracy of $\pm 1\%$ or one cycle and a dynamic sensitivity of from 30 av. to 100 v. full scale.

DO YOU SAVE YOUR COPIES OF Electronics World



Make sure they're kept neat and always handy for instant reference—with a handsome file that's designed to hold a full year's copies!

- washable Kivar cover has a leather-like appearance
- available in maroon backing with black sides or black with maroon
- 24-karat solid gold leaf embossed lettering for magazine's name
- attractively priced at only \$2.95 each, 3 for \$8.00, 6 for \$15.00
- files are shipped to you prepaid and are fully guaranteed

NOTE: these special-quantity prices apply for any combination of titles, so you can have them for all your favorite magazines.

Order several today—for all the Ziff-Davis magazines: Popular Photography, Modern Bride, HiFi/Stereo Review, Electronics World, Popular Electronics, Flying, Car and Driver, Popular Boating, Amazing, and Fantastic, and for your other favorite publications, as well. (Ziff-Davis magazine files available in colors of your choice as noted in coupon. Those for other publications will be shipped in standard colors available.)

Jesse Jones Box Corp., Dept. EW Box 5120
Philadelphia 41, Pa.

Please send me: (Fill in title, quantity and check appropriate column for color desired)

MAGAZINE TITLE	QUANTITY	BLACK BACKING/ MAROON SIDES	MAROON BACKING/ BLACK SIDES
Electronics World	_____	_____	_____
_____	_____	_____	_____

\$2.95 each, 3 for \$8.00 or 6 for \$15.00—
shipped prepaid—fully guaranteed

Total amount enclosed _____

Name _____

Address _____

City _____ Zone _____ State _____

Typical applications include use in vibration analysis, geophysical measurements, medical, oceanography as well as general spectrum and wave analysis.

MINIATURE ELECTRIC DRILL

12 Jensen Tools has introduced a tiny, battery powered drill which has been designed for many types of light-duty drilling and grinding. The Model 9 accommodates drills up to 1/8" diameter. Although designed primarily for light-duty drilling of aluminum, plastics, gold, silver, and platinum, it is capable of drilling through 1/4" solid brass. Starting torque exceeds 5-inch-ounces at 6 volts.

The drill operates from any d.c. source from 4 to 12 volts, depending on the power required. Normal operating current is less than 1 amp at 6 volts. The motor is "TV" suppressed.

MICROPHOTOMETER

13 Grace Electronics, Inc. is currently marketing a d.c. microphotometer, Model 380, for making micro-microlumen light measurements with exceptionally short rise time and high stability. A variety of detachable probes is available including visible, infrared, and ultraviolet, all of which use multiplier phototubes as transducers. Rise time is 0.5 msec. on most ranges and 1 msec. on the 1 millimicroampere range. Seven

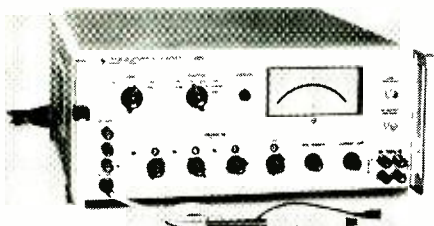

switchable low-pass filters are incorporated to permit reducing the speed if fast rise time is not desired.

The unit is permanently calibrated in microamperes within 1.5% and has nine ranges from 10⁻⁵ ampere to 10⁻⁹ ampere. A 6-inch meter and a 3-ma. recorder jack are the outputs. The d.c. amplifier drift is less than 2% in four days.

U.H.F. CONVERTER

14 Gavin Instruments, Inc. is now marketing a deluxe model u.h.f. converter which has been trademarked "Venus."

The new unit features a high built-in amplifier and special solid-state circuitry for peak all-channel reception, even in problem areas. The converter has a special fine-tuning control for smooth, simple operation.

The converter is housed in a decorator cabinet in soft gold with tawny brown accent.

SCHEMATIC MARKING SET

15 The Datak Corporation is now offering "instant lettering," a dry transfer electronic schematic drafting material. Each kit contains sheets of all the commonly used schematic symbols. Line widths and symbol sizes have been designed to fit in with standard industrial and military drawing procedures.

A new adhesive, especially compounded for the kit, adheres well to all tracing papers, vellums, and Mylar sheets. The transferred symbols will not rub off in normal handling. In use, a ball-point pen rubbed over the symbol releases it from the carrier sheet and adheres to the working surface.

OSCILLOSCOPE PLUG-IN

16 Fairchild Camera and Instrument Corporation's Scientific Instrument Dept. has developed a new plug-in that permits a standard high-frequency oscilloscope to handle signals of 100 mc. with a pulse rise time of 3.5 nanoseconds.

Designated the Type 79-02A, the new unit will fit all Fairchild 765 and 765H series oscilloscopes. It features dual-trace performance with 10 mv./cm. sensitivity.

Applications for this new 100-mc. plug-in include radar and computer analysis, semiconductor studies, and pulse analysis among other of the advancing technologies.

HEAVY-DUTY RELAYS

17 Milwaukee Relays is now offering the new "900" series relays for heavy-duty applications in motor control, elevator control, heater loads, welder controls, and other power switching applications.

The 900 is a 10-ounce relay with a maximum coil resistance of 64,000 ohms and a contact rating of 25 amps at 115 volts a.c. non-inductive or 1 h.p. at 115/230 volts a.c., single-phase.

Coil terminal breakage had been eliminated by having the coil terminal terminate on the base which acts as a back-up support. Electrical shock hazards are reduced by maintaining the position of the flexible lead conductor with a guide built into the armature. Extra dissipation and long life are assured by heat heavy stationary contacts.

Engineering sheet 51F649 provides full details on the "900" series.

DIGITAL DEVIATION OHMMETER

18 Non-Linear Systems, Inc. is now marketing the Model 2033 digital deviation ohmmeter which automatically measures resistance directly in terms of percent deviation from some standard resistance value, or alternatively, absolute resistance values.

The unit is useful in resistor or integrated circuit production, reliability studies, research, quality control, and environmental testing. In automatic systems applications, its direct readout of percent deviation eliminates expensive digital arithmetic computation equipment.

Specifications include direct readout in percent deviation from +99.99% to -99.99% in steps of 0.01%, automatic polarity indication, wide range of 10 ohms to 10 megohms, high over-all accuracy of ±0.05%, and a high measurement speed of 330 msec. per reading.

BINARY DECODING READOUT

19 Cal-Glo Company has available a projection-type, binary-to-decimal readout, employing the standard 8-4-2-1 binary code, known as the "Shelly" BDR-100 readout.

The unit is designed especially for readout applications which require a binary-to-message conversion such as computers, counters, and other electronic and electrical equipment. It will accept



four-line parallel binary coded decimal information, decodes it into twelve messages, and displays the desired message on the front viewing screen in clear, distinct characters.

The circuit contains no moving parts and features silicon semiconductor for reliable operation over extreme temperature ranges. The readout weighs less than 3 ounces.

SUB-NOANOSECOND PULSER

20 General Applied Science Laboratories, Inc. has available a new sub-nanosecond pulser which provides 2 amps of current into 50 ohms with less than 0.3 nsec. rise time. Designated the Model 2303, this compact, remotely programmable pulser is useful in checking semiconductors, switching circuits, magnetic devices, and in nuclear applications where precise amplitude control is necessary.

The instrument employs a mercury-wetted,

long-life switch in a specially designed coaxial cavity, providing reliable operation almost indefinitely. A unit tuning control on the mercury switch cavity provides slight adjustment of the leading edge overshoot.

BIDIRECTIONAL COUNTER

21 Anadex Instruments Inc. has announced the availability of a solid-state, bidirectional electronic counter featuring an internal power supply for powering remote pickup heads.

The Model CF-400R is capable of accepting add/subtract information from two different sources, from the same source on separate lines,



or from quadrature signals. It is available with 4, 5, or 6 wide-angle "Nixie" displays plus polarity sign.

The counter measures 13 3/4" h. x 13" d. x 19" w. Power requirements are 105-125 v. r.m.s., 50 to 60 cps, 25 watts.

MOTOR-SPEED CONTROL

22 Modulonics Inc. is now offering "Select-A-Speed," a low-cost version of its industrial controllers. This unit provides motor-speed control through a full range, from top speed to "almost stopped" without loss of torque, eliminating danger to tool or control unit.

The best cutting speed is dialed by means of a front-panel control. Powered by 117-volt a.c., the control delivers a full 700 watts of continuous power to the tool.

COMPACT X-Y RECORDER

23 F. L. Moseley Co. has announced a new low-cost, ultra-compact basic systems X-Y recorder, the Model 7050A.

The new unit is adaptable to almost any system requiring high-accuracy X-Y readout at minimum cost. It features all solid-state circuitry with

servo amplifiers having single-ended inputs. Both electrical and mechanical damping are used for optimum performance.

Any desired single input span from 100 mv. full scale to 100 volts full scale, each axis, is available although 1-v. full scale is standard. Accuracy is 0.1 percent full scale.

The unit measures 10 1/2" x 13" x 4 1/2" and weighs about 10 pounds.

DISPLAY STORAGE TUBE

24 Westinghouse Electronic Tube Division is now offering a high-resolution, rugged-construction display storage tube, the type WX-5047, which gives air-to-air radar an air-to-ground capability.

The tube is designed for use in systems that require controllable persistence, signal integration, high writing speed, or display brightness greater than that available from conventional CRT's.

At a writing speed of 100,000 inches per second, the tube has stored resolution of 90 lines per inch when saturated brightness is 50% as measured by the shrinking raster method. Minimum saturation brightness is 1200 footlamberts. The tube is electrostatically focused and deflected and has a single writing gun. Over-all length is 14 3/8", usable diameter is 4".

ELECTRONIC MARKING KIT

25 Chart-Pak, Inc. is now offering an electronic marking kit for engineers, draftsmen, and product designers in the electronic and electrical industries.

Hundreds of frequently used titles, words, codes, letters, and numerals are preprinted on dry transfer sheets to facilitate labeling and marking on control panels, drawings and schematics, printed-circuit terminal boards, and electrical and mechanical components.

The kit, which is offered in black, white, red, or blue, contains thirty 3"x6" sheets, each with a separate backing sheet that is chemically treated to prevent accidental transfers. All sheets are

bound into a hard-cover looseleaf binder. Contents are alphabetically arranged and each sheet is numbered for quick reference.

PC TRIMMING POTS

26 Clarostat Mfg. Co., Inc. is now offering its Series 63M-1 and 63M-2 trimming pots which have been specifically designed for application on printed-circuit boards. When seated on a PC card, over-all height is 1 3/8", permitting extremely close board-to-board spacing.

Electrical specifications include a .25-watt dissipation rating at 70 C and metal-to-metal and carbon-to-carbon contacts to provide higher reliability, extended life, and extremely low noise. Mounting terminals are gold plated and located for 0.1" grid configuration per industry standards. Mechanical and electrical rotation is 295 (± 3).

Units are available in a resistance range from 100 ohms to 1 megohm. Working voltage is 350 volts a.c. between end terminals.

SOLID TANTALUM CAPACITOR

27 Cornell-Dubilier Electronics Division has announced the availability of a new dipped solid tantalum capacitor, Type TDR.

The capacitor combines the advantages of high-density packaging, radial leads for direct placement in PC boards, high volumetric efficiency, a broad range of ratings (from .47 µf. to 330 µf.), maximum environmental protection, and dual operating temperature ranges: -55 C to +85° without voltage deration, or +125 C with specified voltage deration.

HI-FI — AUDIO PRODUCTS

AM/FM-STEREO TUNER

28 Latayette Radio Electronics Corporation is now marketing a new AM/FM-sterEO tuner as the Model LT-325.

The unit features a "Stereo Search" circuit which produces an audible signal in both channels when a stereo station is tuned in. Tuner

Back Issues Available

Use this coupon to order back issues of
ELECTRONICS WORLD

We have a limited supply of back issues that can be ordered on a first-come, first-served basis. Just fill in the coupon below, enclose your remittance in the amount of 65¢ each and mail.

(Issues prior to 1963 not available.)

ZIFF-DAVIS SERVICE DIVISION
Dept. BCEW, 589 Broadway
New York 12, New York

Please send the following back issues of ELECTRONICS WORLD. I am enclosing _____ to cover the cost of the magazine, shipping and handling.

Month _____ Year _____
Month _____ Year _____
Month _____ Year _____

Name _____

Address _____

City _____ Zone _____ State _____

No charge or C.O.D. orders please. EW

Everything you ever wanted in a CB transceiver!

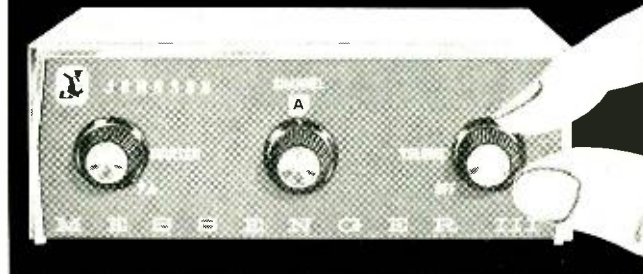

Newest! Most Versatile! Most Power Out!

The 11 channel "Messenger III" will change every idea you ever had about what a Citizens Band unit should offer! Tiny, all transistor, it's really quiet, really hot! Interchangeable for base or mobile—use it as a full 5-watt battery powered portable pack set or a 3-watt PA system. The "Messenger III", with an aerospace transistor developed for the "Relay" communications satellite, delivers *more* power output with maximum legal input! Double conversion receiver with high 1st I.F. provides excellent spurious and image rejection. Set-and-forget "Volume" and "Squelch" controls make it possible for the first time to work "close-in" or at extended range with initial settings. Furnished with dynamic microphone—full line of accessories available for selective calling, portable field pack, or public address use!

Cat. No. 242-150.....\$189.95 Net



E. F. JOHNSON COMPANY

© 1110 Tenth Ave. S.W. • Waseca, Minnesota

Please send full details on the "Messenger" CB line.

NAME _____

ADDRESS _____

CITY _____ STATE _____

WRITE TODAY
for details on the
"Messenger" CB
line—or see your
distributor!

CIRCLE NO. 191 ON READER SERVICE PAGE

MOVING?

ATTACH
LABEL
HERE

If you've recently changed your address or plan to in the near future, be sure to notify us at once. Place magazine address label here and print your new address below.

NEW ADDRESS:

NAME _____ PLEASE PRINT
ADDRESS _____
CITY _____ ZONE _____ STATE _____

MAIL COPIES TO NEW ADDRESS STARTING
WITH _____ ISSUE.

If you have any questions about your subscription be sure to include your magazine address label when writing us.

Mail to: **ELECTRONICS WORLD,**
1255 Portland Place, Boulder,
Colorado 80301

Your Postmaster Suggests:

Always Include

Your (ZIP CODE) Number

in your

Return Address

EARN Electronics DEGREE

You can earn an A.S.E.E. degree at home. College level HOME STUDY courses taught so you can understand them. Continue your education, earn more in the highly paid electronics industry. Missiles, computers, transistors, automation, complete electronics. Over 27,000 graduates now employed. Resident school available at our Chicago campus—Founded 1934. Send for free catalog.

American Institute of Engineering & Technology
1141 West Fullerton Parkway, Chicago 14, Ill.

LOW-COST BUSINESS AIDS FOR RADIO-TV SERVICE

Order books, invoice forms, job ticket books, service call books, cash books and statement books for use with your rubber stamp. Customer file systems, book-keeping systems, many others. Write for FREE 32 PAGE CATALOG now.

OELRICH PUBLICATIONS
6556 Higgins Rd., Chicago, Ill. 60656

INSTANTSPARK

QUALITY TRANSISTORIZED IGNITION MADE BY
NATIONALLY-ADVERTISED MANUFACTURER
Dependable—Guaranteed \$16.95 Postpaid
• Pays for itself • High-quality transistors
• 10-minute installation • Full zener protection
• All U.S. components • Completely epoxy-sealed
Similar units sell for \$29.95 or more.
Fits all 6V and 12V negative-ground systems. Parts
and circuits available. Send for list.
Send check or money order to:
INSTANTSPARK, P.O. Box 5144
Sherman Oaks, California



sensitivity is 2 μ v. for 20 db signal-to-noise ratio.

Frequency response is from 15 to 15,000 cps \pm 1 db and channel separation is better than 38 db @ 400 cps. The unit incorporates a variable a.f.c. and multiplex noise filter. A built-in ferrite loop antenna is used for AM reception and a 300-ohm antenna input is provided for FM reception.

The instrument is housed in a dark beige cabinet which measures 14 $\frac{3}{4}$ " wide x 5 $\frac{3}{8}$ " high x 9 $\frac{1}{2}$ " with legs.

"CONFERENCE" RECORDER

29 StenOtape Div. of American Gelsco Electronics, Inc. has recently introduced a fully transistorized portable tape recorder designed especially for dictation and transcription and conference applications.

The 4-10 is a 3-speed machine that will operate for 10 hours from one patented self-loading reel of tape. It comes complete with a remote-control hand microphone.

The unit has a digital counter for easy spot reference, a built-in handle for portability, vu meter, and built-in clear plastic dust cover and latch. The machine will operate with the dust cover closed. Available accessories include a foot pedal and finger-tip control, conference microphones, telephone pickups, earphones and headsets, mixers, and a 12-volt auto adapter.

FM-STEREO CAR RADIO

30 Delco Radio Division has developed a transistorized stereo adapter which is designed to be plugged into the 1965 Chevrolet AM-FM radios with no modification of the radio receiver. It will be offered as a factory option or can be installed later by the dealer.

The "Impala," "Belair," and "Biscayne" models use four speakers for stereo reception. The two front speakers are located under the instrument panel in the cowl kickpads and the two rear seat speakers are mounted at the outboard ends of the package shell just behind the back seat.

The adapter is fully transistorized, containing 11 silicon transistors, one germanium power transistor, and six diodes. The audio amplifier for the additional stereo channel is contained within the adapter unit. Automatic switching to receive both mono and stereo programs is provided. An indicator light shows when a program is being received in stereo.

TRANSISTORIZED STEREO RECEIVER

31 Harman-Kardon is now offering a new all-transistor series of FM-stereo receivers which includes the Models SR900, SR600, and SR300.

Designated as the "Stratophonic" series, the SR900 is the top of the line. It features HIF

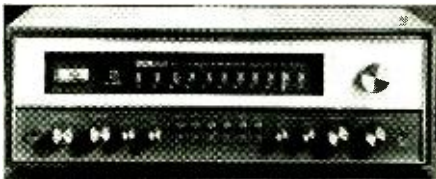

music power output of 75 watts (37.5 watts per channel) at 4 ohms; frequency response 2 to 100,000 cps \pm 1 db at 1 watt and 5 to 60,000 cps at full rated power. Harmonic distortion is less than 0.2% and hum and noise suppression is 95 db. The multiplex separation is 40 db.

The receiver features convenient fingertip rocker switches for contour, tape monitor, hi and lo cut, tone-control defeat, and FM interchannel muting. Other front-panel controls include

lighted push-button "on-off" switch, separate channel treble and bass, program selector, volume, speaker-system selector, speaker balance control, and headphone jack.

The SR900 measures 16 $\frac{1}{4}$ " wide x 5" high x 11 $\frac{3}{4}$ " deep. The walnut enclosure is optional equipment.

WIDE-RANGE SPEAKER SYSTEM

32 Neshaminy Electronic Corp. has introduced a new wide-range speaker system for stereo and mono hi-fi applications.

Known as the Z-700, the new speaker features a pair of "JansZen" 130 push-pull electrostatic radiators which reproduce middle and upper frequencies with unmeasurable distortion to 30,000 cps. Bass is reproduced by the Model 350C dynamic woofer. The woofer has been specifically designed to function in small, totally enclosed cabinets. Its heavily weighted, high-compliance cone is capable of $\frac{5}{8}$ " excursions without break-up or doubling, down to 30 cps.

The totally enclosed, fiberglass-filled cabinet is finished on all four sides. It measures 15" h. x 26" w. x 13 $\frac{3}{4}$ " d. and is available in either lacquered or oiled walnut cabinet finishes.

TRACKING-ERROR INDICATOR

33 Alard Products has developed a device which indicates visually the amount of tracking error in record players and positions the tonearm for optimum performance.

Tradenamed "Tru-Trak," the unit consists of a pointer assembly that attaches to the cartridge and a calibrated scale that fits over the turntable spindle. As the tonearm is moved across the turn-



table, the pointer indicates the tracking variations of the tonearm. By changing the mounting position of the tonearm, an increase or decrease in tracking error is readily apparent.

The device is made from Lucite and fits standard cartridge mountings.

NEW SPEAKER DESIGN

34 Utah Electronics has just introduced a new speaker which features cloth roll suspension for smoother bass response and dual cones for reproduction to 20,000 cps.

The PASJC-WCR features embossed transformer mounting facilities (for transformers up to 2 $\frac{3}{8}$ " mounting centers), shallow construction (only 3" deep), internal dust cap for positive protection of the close tolerance voice-coil gap, and screw terminals.

Specifications include a 10-oz. barium ferrite magnet, a 1" voice coil, a peak power rating of 30 watts, and frequency response 30-20,000 cps.

FM-STEREO RECEIVER

35 Bogen Communications Division is now marketing the RT6000, a 60-watt (30 watts per channel HIF music) solid-state FM-stereo receiver.

The FM section has a sensitivity of 2 μ v. for 20 db of quieting at 300 ohms and distortion of less than 0.5% at 100% modulation. Stereo separation is measured as 25 db at 50 cps, 35 db at 1000 cps, and 20 db at 10,000 cps. Response is \pm 1 db from

15 to 50,000 cps. Noise and hum level is rated at -65 db.

The receiver has a brushed gold front panel which features simplified controls and tuning meter for precise program selection. Provision is made for phono, tape head, tape monitor, or auxiliary inputs. Outputs include speakers, tape, or headphones.

A stereo minder indicator automatically switches from mono to stereo when the station broadcasts in stereo and indicates the change visually. The unit measures 16" wide x 14" deep x 4 7/8" high (including knobs).

INTEGRATED STEREO AMPLIFIER

36 Whitecrest Industries, Inc. is now offering an integrated stereo control amplifier which provides 100 watts peak power output (both channels) and 60 watts music power output (IHF, both channels).

Frequency response is 10-20,000 cps \pm 1 db and sensitivity (for rated output) is 300 mv. (high-level inputs), 3.5 mv. (phono), and 2 mv.



(tape). Output impedances are 4, 8, and 16 ohms.

Each channel has individual bass and treble controls. A separate loudness contour control provides the proper compensation for low-level listening.

The chassis measures 5 3/4" h. x 15" w. x 9 1/2" d. A grained oiled-walnut cabinet is available at additional cost.

SOLID-STATE INTERCOM LINE

37 Rauland-Borg Corporation has just introduced a new solid-state, all-transistor intercom line, the "Amplical" 7400 series.

The new line offers a wide variety of flexible

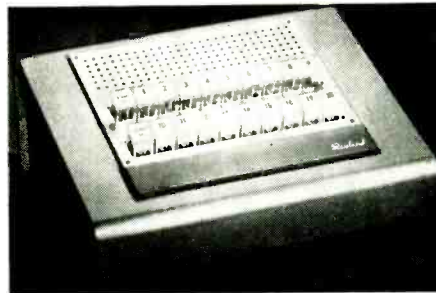

systems permitting communication with up to 18 remote points. The circuit features instant operation and virtually no heat. The intercom is activated by a "talk-listen" bar and features an adjustable volume level. There is a central power supply for the system with plug-in junction boxes.

The intercoms are housed in ultra-modern enclosures which are acoustically treated. Three types of remote stations and complete accessory equipment are available.

66-WATT STEREO AMPLIFIER

38 H. H. Scott, Inc. has added the Model 233, a 66-watt stereo amplifier to its line of component hi-fi equipment.

The amplifier features new decorator styling.



speaker switch and front-panel headphone outlet for private listening with the speakers silenced, a powered center-channel output for an extension or center-channel speaker without any additional amplifiers, and heavy-duty output transformers for good bass response even with inefficient speaker systems.

CB-HAM-COMMUNICATIONS

LIMITER-AMPLIFIER

39 Kahn Research Laboratories, Inc. has developed a new, low-cost limiter-amplifier which meets or better FAA operational specification R543-D.

The Model LIM-63-1A utilizes two compactrons and one rugged octal tube. It features a fast attack time. The instrument covers a range of 300 to 3000 cps and meters compression and output level. Precision step attenuators on both the input and output circuits are included. Input and output impedances are 600 ohms with a 25-ohm microphone input provided.

The unit requires 3 1/2" of standard 19" rack space.

PLUG-IN R.F. TUNING UNIT

40 Defense Electronics, Inc. is now offering a new plug-in r.f. tuning unit, Model TMH-55B, with a tuning range of 250-500 mc. and has a.f.c. applied to the second local oscillator in either v.f.o. or crystal-controlled mode.

Designed for use with the modular TMR-5A telemetry receiver, the compact unit covers both standard U.S. and European telemetry bands. When used with the TMH-B5 tuning unit, con-

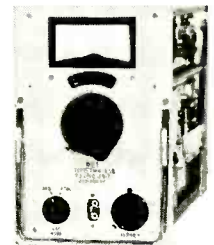

MONEY-MAKING OPPORTUNITY WITH A NEW TYPE OF BUSINESS

NOW . . . NuTone, America's largest manufacturer of Built-In Music Systems . . . offers you a fine opportunity to own and operate a profitable business in your locality.

You can start in full or spare time without previous experience. You need not worry about large inventory stocks . . . because NuTone's network of wholesalers can furnish everything you need at extra special discounts available to you.

The modernization market is booming . . . and Built-In Music Systems are in big demand. Thousands of new homes have NuTone Built-

In Home Entertainment Systems . . . you can supply an even larger market through the existing homes in your area.

Home owners are surprised at the moderate cost . . . and are pleased to learn that they can have a complete music and intercom system installed in the homes they now own.

You can start this business at a minimum investment . . . and expand it to a large staff of sales and installation specialists. We offer you complete details . . . just mail coupon to . . .

Mr. Dickinson, Product Manager, Electronics Division, NuTone, Inc., Cincinnati 27, Ohio.

BUILT-IN MUSIC and INTERCOM
INSIDE and OUTSIDE the HOME!



YOU CAN BE FIRST TO START THIS BUSINESS IN YOUR COMMUNITY



FREE FACTS COUPON
INTERCOM-RADIO BUSINESS

NAME _____
ADDRESS _____
CITY _____ STATE _____



MODEL SS724

NEW SOLID STATE Crown RECORDER — THAT'S PRICED AT ONLY \$895

COMPARE PERFORMANCE

Quarter-Track Record/Play Data			
ips	db	cps	s/n
7½	±2	50 — 25,000	54db
3¾	±2	50 — 15,000	45db
1⅞	±3	30 — 10,000	45db

COMPARE VERSATILITY

Incorporates the **Crown** use-tested solid state control center, featuring plug-in circuitry modules for quick adaptation to a variety of specific uses in home, commercial and laboratory recording. Audio circuitry, ±1/4 db from 10-100,000 cps. Third head permits playback while recording. Complete pushbutton control. And, many other features.

**INVEST
IN CROWN
QUALITY**

THE HALLMARK
OF CROWN —
SUPERLATIVE
CRAFTSMANSHIP
THROUGHOUT!

**INDIVIDUAL PERFORMANCE
RECORD SUPPLIED
WITH EACH CROWN**

WRITE DEPT. EW-12

**Crown
INTERNATIONAL**
1718 Mishawaka Rd. • Elkhart, Ind.

CIRCLE NO. 174 ON READER SERVICE PAGE 84

tinuous frequency coverage from 55 to 500 mc. is provided.

Front-panel switching allows the a.f.c., applied to the second local oscillator, to be used with either a standard or narrow-band FM demodulator. No a.f.c. setup adjustments are required with this unit.

Featuring automatic frequency control, the new unit has stability of -0.005% crystal controlled and approximately 0.001%°C in continuous mode in the 260-180 mc. range. Spurious response is more than 60 db below fundamental frequency response. Noise figure is 10 db maximum, 9 db nominal.

IGNITION NOISE SUPPRESSOR

41 RCA Mobile Communications Department has introduced a transistorized universal noise clipper that can be used with a 50-mc. two-way radio to suppress ignition and other impulse noises at mobile or base stations.

According to the company, the plug-in unit operates effectively with any 50-mc. receiver ir-



respective of age, make, or model and automatically screens out ignition noise from its own vehicle as well as those nearby.

The clipper requires no modification of receiver circuits and is inserted in series with the antenna connection to the receiver. It measures 10½" x 3" x 4" and may be mounted externally with mobile and desk units or in a rack.

COMMUNICATIONS RECEIVER

42 Hammarlund Manufacturing Company is now offering the Model HQ-88 "drift free" receiver for operation on all the popular amateur bands (10 through 160 meters) as well as MARS, CB, WWV, and marine band. According to the company, the crystal front-end design reduces thermal drift after a short warm-up to no more than 50 cycles.

The unit features highly selective circuits with skirt ratios of better than 3 to 1, and separate AM and SSB detectors. Sensitivity is a measurable 0.75 µv for a 10 db AM signal-to-noise ratio, and better than 0.4 µv for SSB and c.w.

RADAR VIEWING CONSOLE

43 Bendix Marine has developed a completely waterproof radar viewing console especially for pleasure and commercial craft requiring a

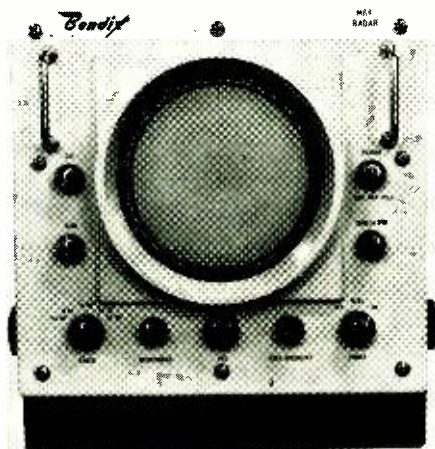

radar installation on an exposed flying bridge or in an open cockpit.

The Model MR-1W is available in either 16- or 32-mile ranges, operating from 12, 32, 110 volts d.c. or 115-volt a.c. electric systems.

Power line connections from the below decks installed transmitter-receiver unit to the console are through watertight stuffing glands. The slotted waveguide antenna, transmitter-receiver unit, and power supply are identical to the firm's MR-1 radars.

The console case, chassis, and controls are especially ruggedized to withstand exposure to the elements and rough service.

MANUFACTURERS' LITERATURE

CONNECTOR CHART

44 Deutch Electronic Components Division is offering a wall chart for determining specifications on the company's line of DM, DS, MDS, DD, MDR, DA, DTK, BTK, and hermetic connectors.

Information is given on connector shell sizes from 3 to 61 with applicable contact patterns. The chart includes data on contact current rating, coupling mechanism air leakage, temperature, and standard finishes.

TEST EQUIPMENT

45 Simpson Electric Company's bulletin No. 2066 contains 16 pages of specifications and prices on the firm's complete line of test equipment for electronic, electrical, and temperature work.

Listings include volt-ohm-milliammeters, v.o.m. adapters, hand-sized testers, scopes, and accessories.

IRON CORE COMPONENTS

46 United Transformer Corporation announces the release of two new catalogues on iron core components. Volume I (52 pages) covers transformers, inductors, and magamps; Volume II (24 pages) features electric wave filters and high "Q" coils.

Also included in each catalogue is a cross index for locating desired components for a given application and an explanation of MHL specs.

ELECTRONICS CATALOGUE

47 Lafayette Radio Electronics Corp. has announced publication of its 1965 electronics catalogue for home, industry, and laboratory. The 516-page listing includes hi fi and tape recording equipment, component parts, and test instruments and gives specifications and prices for the products of over 200 manufacturers.

POWER SUPPLIES

48 Acme Electric Corporation describes the performance features of 36 standard, regulated d.c. power supplies in a new catalogue just issued. The 4-page listing (175-BM2) is illustrated and gives mechanical as well as electrical characteristics of the devices.

R.F. SHIELDING PRODUCTS

49 Emerson & Cuming, Inc. is making available a new 4-page pamphlet describing its line of "Ecoshield" products. Materials covered include surface coatings, adhesives, caulking compounds, and lubricants.

References are provided to technical bulletins where these are available.

PROPERTIES OF GLASSY MATERIALS

50 Corning Glass Works, Electronic Products Division is offering a revised edition of its reference booklet on the various properties of glassy materials. Aimed at designers, engineers, and other technical personnel, the brochure provides data on electrical, thermal, chemical, optical, and mechanical characteristics, including volume resistivity, dielectric constant, thermal conductivity, chemical durability, luminescence, and photo-sensitivity, among others.

In addition, the 8-page booklet contains an ap-

pendix of less familiar definitions and a chart which shows the electromagnetic spectrum.

R.F. COAXIAL FILTERS

51 Bird Electronic Corporation has published a 10-page illustrated brochure listing 80 representative r.f. coaxial low-pass, bandpass, and high-pass models with cut-off frequencies from 30 to 2700 mc.

Typical performance curves and electrical and mechanical data are given.

COMPONENT CATALOGUE

52 U.S. Sencor, the solid-state division of Nuclear Corporation of America, is currently distributing a new short-form catalogue covering its line of zener diodes, temperature-compensated reference elements, tantalum capacitors, and other devices.

PIEZOELECTRIC CERAMIC FILTERS

53 Clevite Corporation's Piezoelectric Division is making available a technical paper which presents characteristics of piezoelectric ceramic ladder filters and their application to electronic circuits.

A general treatment of ceramic properties and basic filter elements is included, along with 20 line drawings.

SCREWDRIVER SPECS

54 Xcelite Incorporated has issued a new catalogue sheet (N764) containing a photo and description of a compact "Allen" hex-type screwdriver set designed to simplify work on products with "Allen" hex recess-set screws and cap screws.

Specifications for the screwdriver handle, interchangeable blades, and extension shaft are given.

ELECTRONIC KITS

55 Heath Company, a subsidiary of Daystrom, has just announced the availability of its 1965 "Heathkit" catalogue, covering over 250 electronic kits. The 108-page booklet, with 16 color pages, offers a complete line of products in the stereo/hi-fi components area, ham and CB communications field, and electronic service equipment area.

With this catalogue, the company is introducing many new products, including an electronic organ and a color-TV receiver.

ELECTRONICS CATALOGUE

56 Allied Radio Corporation is now distributing its 1965 catalogue presenting the latest in hi-fi components, CB and ham-radio units, recorders and accessories, test equipment, radios and phonographs, tubes, parts, tools, and technical books.

The 4-color, 490-page listing also includes over 100 items from the company's "Knight-Kit" line.

TANTALUM CAPACITORS

57 Cornell-Dubilier Electronics has just released a 4-page brochure covering the company's line of tantalum capacitors which exceed military specifications. The bulletin (208.00) contains photographs and a cross-reference to competitive types and military styles including tantalum foils, wet anode, and solid anode types.

HAM/CB CATALOGUE

58 World Radio Laboratories has just published its Catalog No. 24, containing specifications and prices on ham and CB gear and accessories. Illustrated with charts and photographs, the 84-page catalogue also includes sections on hi-fi equipment and various component parts.

COLOR-TV COMPONENTS

59 Triad Distributor Division of Litton Industries has issued a 10-page replacement guide for color-TV components for the receivers of 21 U.S. manufacturers.

The brochure lists the proper replacement flyback, yoke, vertical output and power transformers, and chokes for more than 1200 individual color-TV sets.



ME? BUILD A WHAT? An Artisan electronic organ, naturally. It's not necessary to be a genius either. We'll admit it's just difficult enough to be a challenge. There's transistorized circuitry in your favor with Artisan, plus simplified instructions. What do you have when you finish? An instrument we modestly call magnificent, with the nearest thing to the tonal qualities of a pipe organ. Right in your own home. What about price? You'll keep 50% of the cost of a ready-built organ. And you may buy a module at a time, literally "play as you pay". Get the complete Artisan story now. Write Dept. EW.



a division of Electronic Organ Arts, Inc.
2476 North Lake Avenue/Altadena, California

CIRCLE NO. 156 ON READER SERVICE PAGE

BOOST
YOUR
INCOME



FREE BOOKLET TELLS YOU HOW

HAVE
LESS
COMPETITION!

A proven formula for success is to get in on the ground floor of a booming business. Mobile radio is a booming business. All around, you can see two-way mobile-radio antenna towers springing up—each one a possible new client for you. Most of this work is done on a contract basis with payment 12 months a year. There's little competition . . . few fussy customers to satisfy . . . a welcome change from AM/FM and TV repair! It's not too late to make a start toward bigger money!

MAIL COUPON TODAY!

LAMPKIN LABORATORIES, INC.
MFM Division, Bradenton, Florida

At no obligation to me, please send free booklet and information on Lampkin meters.

Name _____

Address _____

City _____ State _____

Lampkin 105-B Frequency Meter, 0.1 to 175 MC and up. Price \$260.00, net.

Type 205-A FM Modulation Meter, Range 25 to 500 MC. Price \$270.00, net.

THE PPM METER—AN ACCESSORY FOR THE TYPE 105-B. ACCURACY 0.0001%—FOR SPLIT-CHANNEL FREQUENCY CHECKS ABOVE 50 MC. PRICE, \$147.00.

LAMPKIN LABORATORIES, INC.

MFM DIVISION
BRADENTON, FLA.

GREAT NEW CHRISTMAS GIFT

Solve Electronics Problems Fast With Special New Slide Rule

Professional, high quality instrument . . . specifically designed for electronic engineers and technicians . . . made to our rigid specs by Pickett & Eckel. Has special scales for solving reactance and resonance frequency problems. Accurately and quickly locates decimal points. Carries widely used formulas and conversion factors not found on any other slide rule. Comes complete with top-grain leather carrying case, illustrated instruction manual, 90 day consultation service — all for just \$14.95. Carries lifetime guarantee against defects in material and workmanship.

SEND COUPON TODAY

TO: CLEVELAND INSTITUTE OF ELECTRONICS

1776 E. 17th St., Dept. EW-104, Cleveland, Ohio 44114

Please send me your electronics slide rule.

I am enclosing \$14.95. (If not fully satisfied after 10 day trial, CIE will refund payment.)

Please send additional descriptive literature.

Name _____ (Please Print)

Address _____

City _____ State _____ Zip _____

Tuner covers 26-54 and 83-174 MC in eight overlapping bands with good sensitivity. Ideal for use with amplifier or Hi-Fi to listen to Aircraft, CB, Fire, Police and other signals in the VHF bands.

355A AM/FM TUNER \$49.95

Order today or send for free catalog on full line of converters and receivers for every application.

KUHN ELECTRONICS
CINCINNATI 17, OHIO

GET INTO

ELECTRONICS



V.T.I. training leads to success as technicians, field engineers, specialists in communications, guided missiles, computers, cyber and automation. Basic & advanced courses in theory & laboratory. Electronic Engineering Technology and Electronic Technology curricula both available. Assoc. degree in 20 mos. B.S. also obtainable. G.I. approved. Graduates in all branches of electronics with major companies. Start February, September. Dorms, campus. High school graduate or equivalent. Write for catalog.

VALPARAISO TECHNICAL INSTITUTE
Dept. RD, Valparaiso, Indiana

1964 INDEX

VOLUMES 71-72

As a service to our readers we are again presenting a complete listing of all feature articles which appeared in **ELECTRONICS WORLD** during 1964. We suggest you keep this for reference.

COMMUNICATIONS

A.G.C. for Receiver Audio (Lanterman)	Apr.	78
Business Radio Report (Sands)	Jan.	51
Citizens Radio Rules Tightened	Oct.	78
Comments on the New CB Rules (Buckwalter)	Nov.	42
Communicating in a High-Noise Environment (Devaney)	Nov.	39
Designing the I.F. Circuit (Tartas)	Sept.	46
Design Trends in Receiver Frequency Control (Kyle)	Dec.	52
DSB and the Citizens Bander (Packham)	Aug.	38
Microphones for Communications (Conhaim)	Apr.	51
Mixing Magic (Frye)	July	54
Modulation Circuits for Solid-State CB Transmitters (Rheinfelder)	Feb.	28
New Citizens Band Circuits (Buckwalter)	Jan.	32
New Citizens Band Circuits (Buckwalter)	Mar.	46
New Citizens Band Circuits (Buckwalter)	May	46
New Citizens Band Circuits (Buckwalter)	July	34
New Citizens Band Circuit (Buckwalter)	Oct.	54
New Facilities for WWVB and WWVL	Jan.	39
New FCC Rules Now in Effect (Sands)	May	30
New Look in Microwaves (Sands)	Aug.	60
Noise Figures of V.H.F. Amateur Converters (Connelly, W6QID)	Sept.	34
Plumbing the Microwave Circuit (Apperson, Jr.)	June	23
Precision of U.S. Frequency Standard	July	78
Single-Frequency Receiver (Kincaid)	Apr.	44
State-Police Microwave (Lincoln)	Feb.	48
Transistorized Six-Meter Converter (Hejhall)	Feb.	46
Transistors versus Tubes for Two-Way Radio (Rice)	Nov.	48
Understanding Frequency-control Crystals (Conhaim)	May	36
Unijunction C.W. Monitor (Cleary)	Apr.	62
Which Channel Is It? (Sands)	Feb.	40
Why Not U.H.F. Two-Way Radio? (Rice)	Mar.	42

COMPONENTS

Capacitors—An Infinite Variety (Frye)	Apr.	56
Confused Fuse (Edwards)	Jan.	100
Constant-Voltage Transformer Operation (Jaski)	Apr.	40
High-Power Photocell (Cain)	Mar.	44
Inexpensive D.C.-Variable Inductor (Turner)	Feb.	79
New Look in Transformers (Collins)	Mar.	36
Rating Unknown Power Transformers (Duguid)	July	24
Shielded Cables (Buchsbaum)	Nov.	36
Using Slug-Tuned Coils (Tartas)	Apr.	48
Using Hook-up Wire (Tartas)	Dec.	36

CONSTRUCTION

Enlarger-Phototimer	Oct.	102
Light Dimmer & Power-Tool Control		

(Lancaster)	July	46
Motor-Speed Control	Nov.	102
Positive-Ground Transistor Ignition System (Thornton)	Jan.	85
SCR Automotive Ignition System (Ward)	Nov.	44
Simple Photoelectric Amplifier (Turner)	Nov.	104
Simplified Solid-State Color Organ (Lancaster)	Jan.	50
Transistor-Photocell Color Organ (Blechman)	July	41
Twin-T Oscillators for Electronic Musical Instruments (Maynard)	June	36
Updated Transistor Ignition System (Saatjian)	May	51

HIGH-FIDELITY & AUDIO

Adding VU Meter to Tape Recorder (Hogan)	Oct.	104
Audio-Compression Preamplifier (Wright)	Nov.	32
Audio Level Clippers & Limiters (Haskett)	Feb.	51
Design of a High-Quality Transistor Power Amplifier (Furst)	Feb.	34
Distortion in Phono Cartridges (Kogen)	Aug.	28
High-Fidelity Measurements—Science or Chaos? (Villichur)	Aug.	33
Integrated Amplifier-Speaker (Gilmore)	Mar.	32
Loudspeakers for Transistor Amplifiers (Brociner)	Jan.	42
Microphone Sensitivity Rating (Ramsey)	May	31
Mono Use of Stereo Phones (Trauffer)	May	79
New High-Quality Transistor Amplifier (Mergner)	May	42
Noiseless Remote Switching (Martel)	Mar.	60
Quieting Audio Switching Transients (Ives)	Nov.	51
Remote Volume Control (Martel)	July	62
R.F. Pickup in Audio Amplifiers	July	65
SCA Background-Music Demultiplexer (Kuntz)	Sept.	44
Self-Protecting Transistor Hi-Fi Amplifier (Kramer & Japenga)	June	32
Tape-Recorder Equalization Curves (Burststein)	July	38
Transistorized FM-Stereo Demodulator (Englund, Plus & Hansen)	Dec.	34
Transistors for Hi-Fi (Meyers, Jr. & Kahn)	Apr.	42
Transistors for Music (Furst & Zide)	Mar.	48
Transistors vs Tubes for Hi-Fi (Mergner)	Jan.	45
Transistors vs Tubes for Hi-Fi (Chou)	Feb.	36
"Transistor Williamson" Stereo Power Amplifier (Sueker)	Oct.	42

EW LAB TESTED

Audio Dynamics ADC-16 Speaker System	Feb.	92
Burgess Test Tape	Apr.	20
Dual 1009 Automatic Turntable	Mar.	18
Eico Model 2036 Stereo Amplifier	Aug.	12
Eico Model 2200 FM-Stereo Tuner	Nov.	24
Electro-Voice "Coronet I" Speaker System	Mar.	18

THE 1965 PHOTOGRAPHY ANNUAL

\$1.25

24 BIG FULL COLOR PAGES

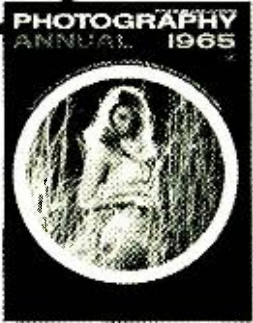

Enjoy the 1965 PHOTOGRAPHY ANNUAL—a superb showcase of color and black-and-white photos by outstanding photographers the world over!

Enjoy, too, the convenience of having this year's edition delivered to your home—immediately! But you'll have to send for your copy right now—the supply is going fast!

Fill in and mail the special order form below—TODAY! (Note: Payment must be enclosed at this low price.)

PARTIAL CONTENTS include these Portfolios:

- ★ War Pictures by the late renowned photographer, **Robert Capa**.
- ★ Preview of a new glamor book by **Sam Haskins**, author of *Five Girls*.
- ★ Abstract color by **Wynn Bullock**.
- ★ **DALI**—the surrealist as **Philippe Halsman** sees him.
- ★ Unusual Nudes by **Masaya Nakamura**.
- ★ The Wonderful World of Children by **Michael Pierce**.

PLUS Int'l. Portfolio, more color pages, etc.

GET THE DELUXE GOLD-EMBOSSED LEATHERFLEX EDITION—only \$2.50 prepaid.



FILL IN, DETACH & MAIL THIS ORDER FORM TODAY!

ZIFF-DAVIS SERVICE DIVISION • Dept. PA
589 Broadway • New York, N.Y. 10012
Please send my copy of the 1965 PHOTOGRAPHY ANNUAL as I've indicated below:

- Send me the regular edition. My \$1.25, plus 15c for shipping and handling (25c outside U.S.), is enclosed.
- Send me the Deluxe Leatherflex-Bound edition, postpaid. My \$2.50 is enclosed. (Add 50c outside U.S.) Allow two extra weeks for delivery.

EW-124

NAME _____

ADDRESS _____

CITY _____

STATE _____

ZIP CODE _____

(PAYMENT MUST BE ENCLOSED WITH ORDER.)

Electro-Voice EV-2 Speaker System	Aug.	14
Electro-Voice Model 664 Microphone	Feb.	22
Electro-Voice 717 Microphone	Jan.	20
Electro-Voice "Sonocaster" Speaker	Dec.	20
Fisher 500-C FM-Stereo Receiver	Feb.	20
Fisher SA-1000 Stereo Amplifier	May	18
"Knight-Kit" KG-870 Amplifier	Nov.	22
"Knight" KN-990 Record Changer	July	14
Lahti U-2 Speaker System	Sept.	16
Harman-Kardon CA-65 P.A. Amplifier	Jan.	18
RCA SK-46 Microphone	Sept.	18
Scott 310E FM-Stereo Tuner	Apr.	20
Scott 340B FM-Stereo Receiver	June	18
Shure Model 570 Microphone	June	20
Shure Model 578 Microphone	July	14
Sonotone "Velocitone Mark IV" Cartridge	May	18
Shure V-15 Phono Cartridge	Oct.	28
Uher 8000 Tape Recorder	Dec.	18
Vernon 47/26 Tape Recorder	Oct.	26

INDUSTRIAL ELECTRONICS

Advances in Photosensitive Devices (Collins)	Dec.	49
Advances in Ultrasonics (Part 1) (Glickstein)	Feb.	25
Advances in Ultrasonics (Part 2) (Glickstein)	Mar.	39
Automated Ships	Nov.	55
Battery Charger Uses an SCR (Dale)	Sept.	79
Binary Computer Codes and ASCII (Bukstein)	July	28
Bootstrap Circuits (Deboo)	July	66
Capacitance Transducer Systems (Silver)	Sept.	38
Computer Input-Output Equipment (Bukstein)	Nov.	52
Computer Logic Fundamentals (Lukens)	June	46
Data Flow in Digital Computers (Bukstein)	Aug.	36
Diversify or Specialize (Frye)	Jan.	58
Electronic Scanning Simplifies Telemetry (Sands)	July	36
Electronic Sirens (Kyle)	Apr.	32
Electronic Time-Delay Relays (Frenzel, Jr.)	Dec.	44
High-Speed Electronic Printer (Edwards)	Dec.	46
Integrated Circuits (Solomon)	Sept.	27
Light Dimmers for Home and Industry (Wolff)	May	25
Liquid Temperature Controller (Scott)	May	46
Magnetic Core Memories (Rusch)	Apr.	37
Magnetic Modulators (Silver)	June	65
Magnetostrictive Delay Lines (Collins)	Jan.	48
Measuring the "Sonic Boom" (Kyle)	Oct.	58
Optical Scanners: Machines that Read (Gilmore)	Oct.	33
"Radicans" at the DEW Line (Stocklin)	May	48
Recharging Cadmium Cells (Frye)	Oct.	68
Technical Institute (Baird)	Mar.	79
Temperature Sensitive Devices (Collins)	Oct.	50
Transducers for Industrial Instrumentation (Shiver)	July	49
Understanding Telemetry (Buchsbaum)	Apr.	25
Vibration Instrumentation (Silver)	Nov.	56
OUTER SPACE		
Advanced Research for Communications Satellites (Mackey, Jr.)	June	64
Advanced Research for Meteorological Satellites (Neil)	June	61
Floating Spacecraft Tracking Stations (LaCoste)	Aug.	17
Goddard's Technical Manpower (Hutchison)	June	62
Guest Editorial (NASA Goddard Space Flight Center) (Goett)	June	50
Manned Space Flight	June	56
Radio Telescopes: Past, Present & Future (Giddis & Maggi)	July	19
Satellites in Space (Vaccaro)	June	51
Satellite Tracking, Telemetry, and Communications (Mengel)	June	58
Spacecraft Technology and Electronics Packaging	June	54
What is Goddard?	June	52
World's Largest Radar Telescope	Feb.	45

send for NEW FREE CRYSTAL CATALOG with NEW TRANSISTOR OSCILLATOR CIRCUITS

Citizen Band Class "D" Crystals \$2.95 EACH

3rd overtone — .005% tolerance — to meet all FCC requirements. Hermetically sealed HC6/U holders. 1/2" pin spacing. .050 pins. (Add 15c per crystal for .093 pins).

TEXAS HC6/U

All 23 megacycle frequencies in stock: 26.963, 26.975, 26.985, 27.005, 27.015, 27.025, 27.035, 27.055, 27.065, 27.075, 27.085, 27.105, 27.115, 27.125, 27.135, 27.155, 27.165, 27.175, 27.185, 27.205, 27.215, 27.225, 27.235, 27.255.

Matched crystal sets for ALL CB units (Specify equipment make and model numbers) \$5.90 per set

RADIO CONTROL CRYSTALS

in HC6/U HOLDERS—SIX FREQUENCIES
In stock for immediate delivery (frequencies listed in megacycles; tolerance .005%, 1/4" pin spacing, .050 pin diameter. .008 pins available, add 15c per crystal.) Specify frequency.
26.963, 27.045, 27.075, 27.145, 27.195, 27.255 \$2.95 EACH
(add 5c per crystal for postage and handling)

HERMETICALLY SEALED PRECISION GROUND CUSTOM MADE NON-OVEN CRYSTALS

1000KC to 1600KC (Fund. Freq.)	Prices on Request
1601KC to 2000KC (Fund. Freq.)	\$5.00 ea.
2001KC to 2500KC (Fund. Freq.)	4.00 ea.
2501KC to 5000KC (Fund. Freq.)	3.50 ea.
5001KC to 7000KC (Fund. Freq.)	3.90 ea.
7001KC to 10,000KC (Fund. Freq.)	3.25 ea.
10,001KC to 15,000KC (Fund. Freq.)	3.75 ea.
15MC to 20MC (Fund. Freq.)	5.00 ea.

ORDER FROM CLOSER PLANT

TEXAS CRYSTALS

DEPT. R-124
1000 Crystal Drive
FORT MYERS, FLORIDA
Phone 813 WE 6-2109

Division of

AND
4117 W. Jefferson Blvd.
LOS ANGELES, CALIF.
Phone 213-731-2258

CIRCLE NO. 229 ON READER SERVICE PAGE

AUTOMATIC TRANSISTORIZED BATTERY CHARGER

- CHARGES 6, 8 or 12 V. BATTERIES
- FULL 6 AMP RATE
- HEAVY GAUGE ALUMINUM CASE
- BUILT-IN AUTOMATIC RESET CIRCUIT BREAKER



\$2070
Dlr. Net

Guaranteed for 5 Years

Ask your electronic or automotive distributor for

WEP MODEL NO. **BC2**

MANUFACTURED BY
WORKMAN
SARASOTA, FLORIDA

CIRCLE NO. 238 ON READER SERVICE PAGE

FREE

NEW 1965 GIANT CATALOG

100'S OF BARGAINS NOT IN ANY OTHER CATALOG

100's of new items listed for first time

EVERYTHING IN HI-FI AND STEREO

TOP VALUES IN POWER & HAND TOOLS

100's of pages packed with savings

NO MONEY DOWN PLUS REVOLVING CHARGE ACCOUNT

Satisfaction GUARANTEED or your money back!

SAVE UP TO 50% ON CHOICE KITS

BURSTEIN-APPLEBEE CO.

BURSTEIN-APPLEBEE CO. Dept. 49,
1012-14 McGee St., Kansas City 6, Mo.

Rush me the FREE 1965 B-A Catalog.

NAME _____

ADDRESS _____

CITY _____ STATE _____

CIRCLE NO. 163 ON READER SERVICE PAGE

FOR 38 YEARS THE
OUTSTANDING
**MONEY
SAVING**
BUYING GUIDE FOR:

• Stereo & Hi-Fi Systems and Components • Tape Recorders • Electronic Parts, Tubes, Books • Phonos & Records • Ham Gear • Test Instruments and Kits • Cameras and Film • Public Address • Citizens Band • Transistor & FM-AM Radios.

RUSH COUPON TODAY

NOMOGRAMS

Capacitance Nomogram (Gross)	Dec. 31
CB Range Nomogram (Karlin)	Jan. 29
Delta-Y Transformation Nomogram (Teubner)	Feb. 31
Meter Reading Conversion Nomograms (Jones)	Aug. 24
Mid-Frequency Amplifier-Gain Nomogram (Jones)	June 31
Phase-Shift Nomogram (Brindley)	Nov. 31
Power & Resistor Charts (Jones)	Sept. 33
Resistor Power-Rating Nomogram (Kyle)	Apr. 29
Tape-Winding Nomogram (Blechman)	Oct. 38
Voltage-Divider Nomogram (Moffat)	Mar. 29

TELEVISION & RADIO

Antennas and Grounds (Frye)	Mar. 56
Automatic Degausser for Color TV (Buchsbaum)	Sept. 53
Cable TV: On the Move (Tepfer)	Jan. 40
First-Hand Report on TV Tape Recorder for Home Use (Snitzer)	June 26
For Men Only (Frye)	June 70
Fraudulent Technician—A Minority (Frye)	May 56
Harnessing the Antenna (Jones)	Apr. 46
Helical Video Recorder for Television (Roizen)	Oct. 47
Hidden TV Test Signals (Solomon)	Apr. 34
Hum from Crossed Connections (Risse)	Feb. 86
Ignition Noise Problems (Frye)	Aug. 52
Japanese Color-TV Has Simple Controls	Mar. 68
"Latter-Day" Enemies (Frye)	Nov. 63
Maintaining TV Color Balance	July 61
New Circuits for FM Portables	May 64
New TV Designs for 1964 (Buchsbaum)	Mar. 51
New Pay-TV System to Start in July	July 30
9-Inch Color-TV Set	Nov. 110
Non-Ignition Noise Sources (Frye)	Sept. 58
Portable TV Sets (Solomon)	Dec. 28
Radio & TV Interference (Part 1) (Haskett & Blount)	May 39
Radio & TV Interference (Part 2) (Haskett & Blount)	June 40
Reducing U.H.F. TV Interference	Sept. 69
Repairing Miniature I.F. Transformers (McKinney)	June 85
Results of EW Tests on U.H.F. Converters	July 31
Service Shop of the Future (Frye)	Dec. 56
Showmanship in Servicing (Frye)	Feb. 56
Simplified Mexican Color TV (Solomon)	July 48
Stabilizing Vertical Height	Sept. 89
Television Servicing—Soviet Style (Hannah)	Jan. 78
U.H.F. Converters: Circuits & Design (Solomon)	Feb. 41
U.H.F. Receiving Antennas	Apr. 80
U.H.F. Tuners for 1964 TV Sets (Buchsbaum)	June 28
Unique Color-TV Tubes and Systems (Solomon)	Jan. 34

TEST EQUIPMENT & MEASUREMENTS

Additional Notes on Audio Sweep Generator (Manus)	Nov. 112
Automatic Electronic Testing (Gilmore)	Jan. 25
Capacitor Value Checker (Mangieri)	July 44
Clip-On D.C. Current Probe (Bergh, Kan & Forge)	Sept. 41
Construct a Milliwatt Meter (Blair)	Sept. 82
Converting Meter Scales (Apperson)	Mar. 74
Design of Simple "Q" Meter (Sandrock)	Sept. 84
Diode Curve-Tracer & Analyzer (Kyle)	June 44
Electronic Switch for Your Oscilloscope (Bammel)	Feb. 38
Electronic Tachometers (Kyle)	May 34
Engine Temperature Indicator (Davis)	Apr. 36
4.5-mc. Detector Alignment Probe	Nov. 66
Frequency & Time Standards (Hudson)	Aug. 20
High-Stability Crystal Frequency Standards (Math)	Aug. 44

PUT ZIP in your mail

Include ZIP CODE NUMBERS IN ALL ADDRESSES

POSTMASTER



the value wheel,
the free-wheeling
feature,
the Webster
"Free-wheeler"



"550 FREE WHEELER"

THE "FREE-WHEELER" DIVIDEND PACKAGE...

"550" transistorized C-B radio179.50
Universal mounting bracket N/C
Webster Model A-66 base-loaded mobile antenna with universal cowl mounting bracket and complete with 15' RG-58/U and fitting 28.35
84 page Road Atlas and Travel Guide with protective cover 2.95
Clip Board with magnetic hold-on. Clings to any iron or steel surface	.. 1.50
Owners operating manual N/C
Station log card w/10-code on rear	.35
Auto Compass w/visi-dome dial, clear markings, aircraft-type compensators, universal mounting bracket 5.95
Model 6200 Noise Suppression System	24.90
Total value243.50
Your cost189.50

THE "CLOVERLEAF" PACKAGE...

Same as above except that Model 6200 Noise Suppression System is omitted ...Total value218.60
Your cost184.50

To bring the "550", finest, feature-filled transistorized radio to the discerning C-B user in true, clear focus, WEBSTER offers an incentive in the form of an exceptional dividend, "the value wheel" comprised of such essential (and high quality) accessories as antenna and noise suppression kit in addition to other functional items—car compass, magnetic clip board, 84 page road atlas, 10-code card. (All illustrated above). Anyone who purchases a "550" radio can have these items, (valued at 64.00) for an additional 10.00—a 54.00 saving!

THE "550"... A BRIEF SKETCH...

Handsome styled, book-size C-B radio with 11-crystal controlled channels, replaces vacuum tubes entirely with transistors and diodes. WEBSTER has applied advanced solid-state circuit concepts to achieve performance that is wholly outstanding in every respect. There are no compromises. "550's" transmitter is full-powered to the 5 watts allowable by F.C.C. It incorporates special high-level modulation techniques (pat. appd. for) that give 100% capability. Speech response is "shaped" for exceptional crispness and clarity.

The all-solid-state superhet receiver is highly sensitive, is particularly well suited for weak signal reception with 10 db signal-plus-noise/noise ratio at **one-half microvolt!** And it provides 60 db rejection to adjacent channel signals!

Here are just a few of the dozens of functional features: Speaker on front panel . . . plenty of reserve audio power. Quiet, no-carrier operation is offered by an adjustable "squelch" . . . and there is a highly effective series-gate noise limiter with OFF switch. "550" uses no vibrators, operates direct from 12V car battery. Fixed station service is possible using separately available 117V AC supply. All "550's" are pre-wired to accept tone signaling units. Universal, cradle-type mounting bracket is standard equipment.

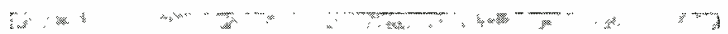

Please rush full information on "550" and "Free-wheeler" dividend deal.

NAME _____
NUMBER STREET _____
CITY _____ ZONE STATE _____



317 ROEBLING ROAD,
SOUTH SAN FRANCISCO, CALIF.

SELLING THAT RECORDER? BUYING A RECEIVER?



ELECTRONICS WORLD runs a Hot Line into the 201,000 electronics professionals who buy the magazine each month. And, for only 35¢ a word, a personal classified ad will help you make your connection.

ELECTRONICS WORLD has the largest audience of its kind in the world, and this creates an ideal market place for you. Actually, when you get together with your co-professionals, you may find that many are near neighbors. Yet your mutual needs may be met only through the medium of our classified columns.

Take advantage of our special personal rate of 35¢ a word (including name and address)

NO MINIMUM REQUIRED

a saving of 25¢ a word from our commercial rate of 60¢.

A small investment can bring quick results, and complete data is printed in the Classified Advertising Section. Write your ad and mail it today, with your payment to:

MARTIN LINCOLN
Classified Advertising Manager
ELECTRONICS WORLD
One Park Ave., N. Y., N. Y. 10016

FEBRUARY ISSUE CLOSING DEC. 4th

How Big is Your Volt? (Jones)	June	42	Ferris 24-D CB "Microvalter"	Mar.	63
How Capacitors Change V.T.V.M. Readings (Duguid)	Oct.	53	General Atomics K-12-R Monitor Oscilloscope	July	58
How Linear is Your Sweep?	Oct.	91	General Radia Type 1396-A Tone-Burst Generator	Aug.	69
Kelvin Color Temperature	June	73	Heathkit HO-13 Spectrum Monitor	Aug.	68
Low "Q" Resonance (Tusinski)	Nov.	90	Hewlett-Packard 208A Test Oscillator	June	82
Measuring Filament Voltage	Aug.	65	Hewlett-Packard 214A Pulse Generator	Apr.	74
Miniature Regulated Power Supply (Shields)	Feb.	74	Houston Instrument VM-77B A.C. V.T.V.M.	June	82
Miniature Voltage Regulators (Burgess)	Feb.	82	Idalee Model 100 A.C. Decade Voltage Source	May	72
Multi-Output Zener Voltage Regulator (Reed)	Feb.	94	Keithley 409 Picoammeter	May	74
New Approach to High-Frequency Measurements (Ferrous)	Aug.	41	"Knight-Kit" Ten-2 CB Checker	Feb.	64
Piano Tuning—The Electronic Way (Van Veen)	Sept.	56	Mar-Con DRT-100 Techometer	June	83
Precise Measurement of Radio Frequencies (Johnson)	Aug.	47	Mercury Model 1400 In-Circuit Capacitor Tester	Dec.	64
Printed Board Repair (McKinney)	May	69	Panco Resistance Calibrator	Jan.	68
R.F. Response Measurement (Tusinski)	Feb.	37	H.F. Parks Lab. ID-1017 Diode Tester	Nov.	70
SCR Tester (Hopkins)	Jan.	56	RCA WR-50A R.F. Signal Generator	Mar.	62
Simple Dwell Meter (Penn)	June	43	Scientific Columbus MMA-1 Gaussmeter Adapter	Apr.	72
Simple Square-Wave/Pulse Adapter (Shields)	Mar.	77	Seco Model 98 Tube Tester	Feb.	68
Simple Transistor Tester (Content & Morse)	May	50	Seco Model 980 Color-Bar Generator	Nov.	68
Simple Transistor Tests (McKinney)	Aug.	63	Secore CG126 Color-Bar Generator	Jan.	64
Tone-Modulated Frequency Calibrator (Ives)	Oct.	56	Secore MX129 FM-Stereo Multiplex Generator	Dec.	64
Transistorized Audio Sweep Generator (Douglas)	Aug.	71	Secore PS127 Oscilloscope	Oct.	94
Transistorized Color-TV Pattern Generator (Stewart)	Nov.	96	Sennheiser Model ZP-2 Audio Impedance Tester	July	58
Units and Standards of Electrical Measure (Harris)	Aug.	29	Tequipo Model 4 Transistor Tester	July	59
Unusual D.C. to D.C. Supply (Winklepleck)	May	62	Texas Crystals TC-3 Alignment Generator	Nov.	72
Voltage Regulator Design (Frenzel, Jr.)	May	52	Waters Model 343 Frequency Meter	Sept.	76
Wide-Range Wow & Flutter Meter (DiElsi)	June	76	Western Reserve Electronics Model 300 Digital V.O.M.	Oct.	92

PRODUCT REPORTS

A & M Instrument Model 1300 Universal Lab Standard	Feb.	66
Ballantine 365 D.C. Volt-Ammeter	Mar.	64
B & K Model 360 V.O.M.	Jan.	64
B&K Model 445 CRT Tester- Rejuvenator	Apr.	72
Bird Model 6154 R.F. Wattmeter	Dec.	66
Boonton 8900B Peak-Power Calibrator	May	72
Budelman 17A4 CB Frequency Meter	Aug.	68
C-W Engineering MX-4 Stereo Signal Generator	Sept.	74
Eico 369 TV/FM Sweep-Marker Generator	Sept.	74
EMC Model 801 R-C Bridge and Capacitor Checker	Oct.	94

PHOTO CREDITS

Page	Credit
18	Mortel Electronics Sales, Inc.
20	Electro-Voice, Inc.
28	Sony
32 (top)	International Business Machines Corp.
32 (bottom left), 33 (bottom right)	Radio Corporation of America
32 (bottom right)	Sperry Gyroscope Corporation
33 (top left)	International Telephone and Telegraph Corp.
33 (top right)	Honeywell, Inc.
33 (bottom left), 38 (Fig. 4)	Collins Radio Company
42	Science Museum of London
43	Marconi Company, Ltd.
44 (top left)	Amperite Co., Inc.
44 (center & right)	Electro-Seal Corporation
46	Century Electronics & Instruments, Inc.
49 (center)	Clairex Corporation
49 (bottom)	Eastman Kodak Company
64	Mercury Electronics Corporation
66	Secore
68	Bird Electronic Corporation
75	Heath Company

TUBES & SEMICONDUCTORS

Early Vacuum Tubes (Watson)	Dec.	42
4- and 5-Layer Semiconductor Diodes (Lancaster)	Oct.	61
Gate Turnoff Controlled Rectifier (Pippen)	Aug.	46
Innovations in Receiving Tubes (Collins)	Sept.	54
New SCR Developments (Lancaster)	Dec.	25
Selecting High-Frequency Transistors (Hejhall & Thorpe)	Sept.	50
Semiconductors for Power Supplies (Gutzwiller)	Nov.	27
Substituting Silicon for Germanium Transistors (Hamlin)	Dec.	39
Traveling-Wave Tubes (Jarrett)	Mar.	25
Tubes Clue to Air Crashes (Halliday)	Jan.	83
Unijunction Transistor (Pippen)	Jan.	46
Using Zener Diodes (Math)	Nov.	88

NIGHT-LIGHT CONTROL

THE G-E-X6 cadmium sulfide photo-conductive cell can be used up to 250 volts peak a.c. or d.c. in a variety of applications. In the circuit shown, when the cell is illuminated, it effectively short-circuits the coil. As the ambient light decreases, the cell resistance goes up, causing more current to flow through the coil winding until the magnetic field within the coil form is sufficient to close the G-E-X7 reed switch. This turns on the 15-watt lamp. ▲

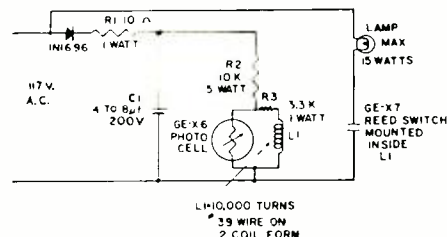

ELECTRONICS MARKET PLACE

COMMERCIAL RATE: For firms or individuals offering commercial products or services. 60¢ per word (including name and address). Minimum order \$6.00. Payment must accompany copy except when ads are placed by accredited advertising agencies. Frequency discount: 5% for 6 months; 10% for 12 months paid in advance.
READER RATE: For individuals with a personal item to buy or sell. 35¢ per word (including name and address). No Minimum! Payment must accompany copy.
GENERAL INFORMATION: First word in all ads set in bold caps at no extra charge. Additional words may be set in bold caps at 10¢ extra per word. All copy subject to publisher's approval. **Closing Date:** 5th of the 2nd preceding month (for example, March issue closes January 5th). Send order and remittance to: Martin Lincoln, ELECTRONICS WORLD, One Park Avenue, New York, New York 10016

FOR SALE

TRANSISTOR Ignition coils, components, kits. Advice Free. Anderson Engineering. Wrentham 5, Mass.

JUST starting in TV service? Write for free 32 page catalog of service order books, invoices, job tickets, phone message books, statements and file systems. Oelrich Publications, 6556 W. Higgins Rd. Chicago, Ill. 60656.

GOVERNMENT Surplus Receivers, Transmitters, Snooperscopes, Parabolic Reflectors, Picture Catalog 10¢. Meshna, Nahant, Mass.

TRANSISTORIZED Products importers catalog. \$1.00. Intercontinental. CPO 1717, Tokyo, Japan.

DIAGRAMS for repairing Radios \$1.00. Television \$2.50. Give make model. Diagram Service, Box 1151 E, Manchester, Connecticut 06042.

INVESTIGATORS, free brochure, latest subminiature electronic surveillance equipment. Ace Electronics, 11500-J NW 7th Ave., Miami 50, Fla.

CANADIANS—Giant Surplus Bargain Packed Catalogs. Electronics. Hi-Fi, Shortwave, Amateur, Citizens Radio. Rush \$1.00 (Refunded). ETCO. Dept. Z, 464 McGill, Montreal, Canada.

RESISTORS precision carbon-deposit. Guaranteed 1% accuracy. 1/2 watt 8¢. 1 watt 12¢ 2 watt 15¢. Rock Distributing Co., 902 Corwin Road, Rochester 10, N.Y.

CONVERT any television to sensitive, big-screen oscilloscope. Only minor changes required. No electronic experience necessary. Illustrated plans, \$2.00. Relco, Box 10563, Houston 18, Texas.

COMPLETE KNIFE catalog 25¢. Hunting, Pocket, Utility. Heartstone. Dept. 2D, Seneca Falls, New York.

TV CAMERAS, transmitters, converters, etc. Lowest factory prices. Catalog 10¢. Vanguard, 190-48 99th Ave., Hollis, N.Y. 11423.

SALVAGE CIRCUIT BOARDS packed with dozens of transistors, diodes, miniature transformers, capacitors, etc. Assortment "A" \$5.00, "B" \$4.00, "C" \$3.00, all different, postpaid. ENGINEERING ASSOCIATES, 434 Paterson Road, Dayton, Ohio 45419

WEBBER Labs. Transistorized converter kit \$5.00. Two models using car radio 30-50Mc or 100-200Mc, one Mc spread. Easily constructed. Webber, 40 Morris, Lynn, Mass.

TAPE RECORDER & TELEVISION SALE. Latest models, \$10.00 above cost. Arkay Sales, 22-02 Riverside Ave., Medford, Mass. 02155.

\$100.00 WEEKLY Spare Time selling Banshee TS-30 Transistor Ignition Systems and Coils. Big Demand. Free money making Brochure. Slep Electronics, Drawer, 1782D-EW Ellenton, Fla. 33532.

DIAGRAMS Radios \$1.00 Televisions \$1.50. Schematics, 618 Fourth Street, Newark, N.J. 07107.

ANSA Fone Schematic \$2.00. Jerry Reeves, 1815 4th Street, SeaBrook, New Jersey, 08303.

PHOTO Facsimile Transceivers TT-1F/TXC-1 with Power Units PP-86E/TXC-1, used, like new, tested, ready to use. Best offer. Dale McLaughlin, RFD 7, Frederick, Maryland 21701.

METERS—SURPLUS, new, used, panel and portable. Send for list. Hanchett, Box 1898, Riverside, Calif.

NEW supersensitive transistor locators detect buried gold, silver, coins. Kits, assembled models. \$19.95 up. Underwater models available. Free catalog. Relco-A22, Box 10563, Houston 18, Texas.

CONVERT Television to Oscilloscope and Signal Tracer. Plans \$1.00. Reagan, 1119 W. Maine, Enid, Okla.

CATALOG of over 200 different slide rules, calculating aids. Send 10¢. Dyna-Slide, 600 South Michigan, Chicago, Ill. 60605.

ANTIQUÉ EDISON Cylinder Phonographs. Released From Storage. Display Price sheet sent. Tracy Storage, 114 State, Brewer, Maine.

FLIP-FLOPS: Transistorized circuit mounted on a printed circuit board with plug-in connector. Operation up to 10,000 cps in set-reset or trigger mode. Can be used in counters, shift registers, and memories with no additional circuitry. \$3.87 complete. Send for free literature. KOMTRON, Box 275, Little Falls, N.J. 07424.

HICKOK TV-FM Alignment Generator, Model 695, with manual. Like new. Built-in bias supply and voltmeter. \$95. Charles Caringella, Box 1025, Ontario, Calif.

RESISTORS, NEWEST TYPE METAL OXIDE FILM, 1/8, 1/4, 1/2, 1 watt \$.07-\$.12 each, 18-470,000 ohms RESISTOR KITS, COPPER CIRCUIT BOARD, CAPACITORS, BATTERY MOTORS, HIGH BARRIER TERMINAL BLOCKS, etc. Write: FARNSWORTH ELECTRONIC COMPONENTS, 88 Berkeley St., Rochester, New York 14607.

FREE catalog: Wholesale electronic parts and equipment. Western Components, Box 2581, El Cajon, Calif.

REPAIRS AND SERVICES

TV Tuners Rebuilt and Aligned per manufacturers specification. Only \$9.50. Any Make UHF or VHF. We ship COD Ninety day written guarantee. Ship complete with tubes or write for free mailing kit and dealer brochure. JW Electronics. Box 51B. Bloomington, Indiana.

TELEVISION Tuners—Rebuilt, Air Tested \$9.00 Plus Shipping. Guaranteed. Texas Tuners, Box 222, Robert Lee, Texas 76945.

RCA TEST Equipment, Authorized Repair & Calibration Center, Nationwide. Edwin Bohr/Electronics, Box 4457, Chattanooga, Tennessee 37415.

RECORDS

DISCOUNT Records, All Labels—Free Lists. Write Cliff House, Box 42-H, Utica, N.Y.

"AMERICA'S MEN IN SPACE" Recorded Story of Project Mercury on a 12" HiFi LP. Contains countdown, blastoff, conversations between Astronauts in orbit. Narration and background by Col. "Shorty" Powers. From official NASA tapes. From Blastoff to recovery "YOU ARE THERE." MONO CMS 1000—\$3.98. STEREO CMS 71000—\$4.98 Postage Free. CMS RECORDS, INC. 14 Warren St., New York, N.Y. 10007.

MICRO SINCE 1957 MICRO

EVERY DEAL A FAIR DEAL

LARGE, SELECT STOCK! DEPENDABLE, FAST SERVICE!

● Every tube tested in our own laboratory for mutual conductance and life test.

● We guarantee FREE replacement for one year of any tube purchased from us which fails to function efficiently under any of its operating conditions. Prompt refunds on any defective merchandise.

● Advertised tubes not necessarily new, but may be electrically perfect factory seconds or used tubes—each clearly so marked.

SPECIAL PURPOSE
and INDUSTRIAL
TUBES

AT SPECIAL SAVINGS!

Type	Price	Type	Price
872A	\$6.95	0A2	\$.60
884	.80	0A3	.70
885	.75	0A4	.75
954	.20	0B2	.45
955	.30	0B3	.65
957	.20	0C3	.30
2050	.90	0D3	.40
2051	.90	20Z1	.55
5643	.75	5E5	1.95
5654	.75	4X150A	
5686	1.50	New	18.00
5687	.75	5R4Y	1.15
5703	1.50	6Z4WA	1.15
5725	.90	210	8.00
5726	.40	30FTL	35.00
5743	.90	116B	18.95
5763	.80	5Z9	.30
5814A	.75	759TL	32.00
5879	.90	80Z	1.00
5881	1.95	81A	New 3.95
6146	2.45	02B	7.00
6159	2.75	132	3.00
6201	1.00	832A	3.50
6900	1.95	865A	2.95

EXTRA SPECIALS:

6 1/2 volt VIB 80¢

6 1/2 volt New VIB \$1.49

50 watt 25K Sprague Resistors 30¢

Surplus Tubes

37¢

per ea.

\$35

PER HUNDRED ASSTD

for ANY TUBE LISTED

MICRO

ELECTRON TUBE CO.

P.O. Box 55 Park Sta. Paterson 3, N. J. **WRITE DEPT. EW-12 FOR OUR FREE COMPLETE LIST OF TUBES & SPECIAL PURPOSE TUBES**

Not Connected With Any Other Mail Order Tube Co | ALL TUBES SENT POSTAGE PAID. Please send 35c handling for orders under \$5. Send 25¢ dep. on C.O.D. orders. Send approx. postage on Canadian and foreign orders.

Life Lite
**RECHARGEABLE
 FLASHLIGHTS
 NEVER NEED BATTERIES**

Just plug into any 110 AC outlet to recharge.



SPORTSMAN
 In handsome calf grain carrying hoister that clips on belt. Equipped with powerful magnet.

COMPACT and POWERFUL!
 Throw a brilliant beam of light up to 200 yards.

ONLY \$12.95 EACH

MOTORIST
 With Auto Charge Adapter for recharging in auto cigarette lighter outlet and powerful Alnico magnet for attaching under dash.

WARRANTY
 FULLY WARRANTED FOR ONE YEAR (except for bulb and lens). If any defect develops under normal use of this product within one year from the date of its purchase, return the product to the manufacturer and the necessary repairs or replacement of parts will be made AT NO CHARGE TO YOU other than a handling and shipping charge of 50c.

CONSUMER SERVICE COMPANY
 160 Mercer Street, New York, N. Y. 10012

Enclosed is \$_____ Please send the following:
 Sportsman Motorist at \$12.95 ea. plus .75 ea. for postage and handling. (N. Y. C. residents please add 4% sales tax). Foreign orders \$1.15 additional.

Name _____
 Address _____ (PLEASE PRINT)
 City _____ State _____ Zip Code _____

Sorry—No charges or C.O.D. orders. EW 124

TAPE AND RECORDERS

RENT Stereo Tapes—over 2,500 Different—all major labels—free brochure. Stereo-Parti, 1616—E. W. Terrace Way, Santa Rosa, California.

SAVE 30-60% Stereo music on tape. Free bargain catalog blank tape/recorders/Norelco speakers. Saxitone, 1776 Columbia Road, Washington, D.C.

RENT 4-TRACK STEREO TAPES—When you narrow it down it has to be TRIMOR—Goodbye to partial satisfaction—Service and Dependability our keynote—ALL LABELS and TITLES—No Deposit—Postpaid both ways (48 States). Write for FREE BROCHURE and TAPE CATALOG. TRIMOR Company, Dept. TR, P.O. Box 748, Flushing, New York 11352.

TAPE-MATES MAKES AVAILABLE TO YOU—ALL 4-TRACK STEREO TAPES—ALL LABELS—POSTPAID TO YOUR DOOR—AT TREMENDOUS SAVINGS. FOR FREE BROCHURE WRITE TAPE-MATES CLUB, 5280-E W. PICO BLVD., LOS ANGELES, CALIF. 90019.

BEFORE renting Stereo Tapes try us. Postpaid both ways—no deposit—immediate delivery. Quality—Dependability—Service—Satisfaction—prevail here. If you've been dissatisfied in the past, your initial order will prove this is no idle boast. Free Catalog. Gold Coast Tape Library, Box 2262, Palm Village Station, Hialeah, Fla. 33012.

SCOTCH recording tape at big discounts. 1200' Mylar—7" reel 99c. Brookline Electronics, 2831 West 23rd St., Brooklyn, New York 11224.

FREE! Tape Recording Handbook. Sarkes Tarzian's Galaxy tape. Pofe, 1716-EW Northfield, Muncie, Indiana.

SOUND EFFECTS—Quarter-track stereophonic, \$4.25. Unique gift! SOUNTAGE; Box 176, Levittown, N.Y. 11756.

NEW! Tape automatic shutoff \$3.95. Also large reel adapters. Leroi Electronics, Marengo, Ill. 60152.

EQUIPMENT

HEAR Aircraft, Tower Emergencies, weather. Portable 9 Transistor AM-FM-VHF Aircraft receiver. Beautiful Black with Gold Trim. \$26.50. Free Details. Transco, Box 13482, North County Station, St. Louis 38, Mo.

WALKIE-TALKIES—Communicate with friends, business associates, up to 5 miles. Service, construction, business, boating, hunting, Fire Dept., Police. Free Details. Sheirr Electronics Lab, Dept. G, 1182 Kenniston Ave., Los Angeles, Calif. 90019

LABORATORY Test Equipment Bought, Sold, Swapped. Hewlett Packard, Tektronix, General Radio, Etc. Large Inventory. Special Sale. Hewlett Packard VTVM 400A \$65.00. Rex-84 Cortlandt St., N.Y.

FREE electronics catalog. Tremendous bargains. Electronics Department C-109E, Hewlett, New York 11557.

HIGH FIDELITY

LOW. LOW quotes: all components and recorders. Hi-Fi, Roslyn 9, Penna.

Hi-Fi Components. Tape Recorders, at guaranteed "We Will Not Be Undersold" prices. 15-day money-back guarantee. Two-year warranty. No Catalog. Quotations Free. Hi-Fidelity Center, 1797 (L) 1st Avenue, N.Y., N.Y. 10028

Hi-Fi components, tape recorders, sleep learn equipment. tapes. Unusual Values. Free Catalog. Dressner, 1523 Jericho Turnpike, New Hyde Park 10, N.Y.

FREE! Send for money saving stereo catalog #E12W and lowest quotations on your individual component, tape recorder or system requirements. Electronic Values, Inc. 200 West 20th Street, N.Y., N.Y. 10011.

FREE \$1.00 Value "Miracle" Record cleaning cloth w/ every quotation on HiFi EQUIPMENT. Our "ROCK BOTTOM" prices on NAME BRAND amplifiers—tuners—taperecorders—speakers—FRANCHISED—59 YEARS IN BUSINESS. Write for this month's specials—NOW! Rabsons 57th St., Inc., Dept. 569, 119 W. 57th St., New York, New York 10019.

PRINTING

1965 DESK Calendars, your name, call, address, Three \$1.00. Morgan Printing, 443 Euclid, Akron, Ohio 44307-3.

BOOK PRINTING. Lowest cost. Paperbacks or hard covers. Catalog free. Addams Printers, 30 W. Washington, Chicago, Ill. 60602.

"TAB", SILICON 750MA" DIODES Factory Tested

NEWEST TYPE! LOW LEAKAGE

Piv Rms 50 35 05	Piv Rms 100 70	Piv Rms 200 140	Piv Rms 300 210
400 280	500 350	600 420	700 490
800 560	900 630	1000 700	1100 770
.20	.24	.32	.40
.48	.55	.70	.75

ALL TESTS AC & DC & FWD & LOAD!

1700 piv 1200 RMS @ 750 Ma \$1.20 @ 10 for \$10
 Same 1100 piv 770 RMS \$75 @ 16 for \$11

"TAB" ★ SCR'S ★ TRANSISTORS ★ DIODES!!!
 Full Leads Factory Tested & Gtd! U.S.A. Mfg.
 PNP 50Watt 15Amp HiPower T036 Pckt:
 2N441, 442, 277, 278, DS501 up to
 50 volts VCB0 \$1.25 @ 5 for \$5
 2N278, 443, 174 up to 80v 53 @ 2 for \$5.
 PNP 10Watt 3A-2N155, 156, 235, 242, 254,
 255, 256, 257, 201, 251, 252 @ 1 for \$1
 PNP Signal IF, RF, OSC, T05, 0V5, c25 @ 6 for \$1
 PNP 2N671 1Watt c50 @ 3 for \$1
 Silicon Pwr T05 & T018, Pckt c25 @ 5 for \$1
 T035, T03 Pckt Mica Mtg. \$1.25 for \$1
 Power Heat Sink Finned 80 Sfr. 1.25 for \$5
 3Amp T03 Pwr Transistors Untested @ 10 for \$1
 Silicon Diodes up to one watt @ 5 for \$1
 Silicon Diodes 35Amp Studs Untested @ 3 for \$5
 Silicon Diodes epoxy 750MA Untested @ 25 for \$1

2N1088 4 \$1, 1049 3 \$1, 1010 2 \$1, 1011 \$1
 2N338, 539, 540 3 Amp 2 for \$1
 Zenor 50 60V Auto Ignition @ 1 for \$1
 150V Auto Ignition Transistor @ 3 for \$5
 Klt Zeners 100 Mw to 10W 3-cent @ 3 for \$1

SILICON POWER DIODES STUDS & P.F.*

DC AMPS	50Piv 35Rms	100Piv 70Rms	150Piv 105Rms	200Piv 140Rms
3	.12	.18	.22	.30
12	.40	.60	.70	.85
15	.45	.70	.80	.85
35	.85	1.10	1.40	1.60
100	1.75	2.15	2.50	3.10
240	4.50	5.70	6.90	8.40

D.C. AMPS	300Piv 210Rms	400Piv 280Rms	500Piv 350Rms	600Piv 420Rms
3	.40	.45	.50	.60
12	1.00	1.25	1.40	1.55
15	1.00	1.30	Query	Query
35	2.25	2.50	Query	Query
100	3.75	4.60	5.65	8.00
240	16.50	24.50	Query	Query

★ SILICON CONTROLLED RECTIFIERS:

PRV	7A	15A	25A	35A	50A
25	.50	.85	1.20	2.50	2.40
50	.85	1.20	1.40	3.00	2.70
100	1.35	1.80	2.20	4.00	3.25
150	2.65	2.00	2.70	5.00	4.45
200	1.85	2.50	3.00	6.00	4.50

Silicon Diodes 3&6 Amp Studs Untested 12 for \$1
 Class Diodes 1N34 48 60 64 Untested 20 for \$1

"TAB" TERMS: Money Back Guarantee!
 Our 18th year. \$2 Min. order
 F.O.B. N.Y.C. Add shipz charges
 or 10% C.O.D. 25% Drop. Prices
 shown subject to change.
 111-WQ Liberty St., N. Y. 6, N. Y.
 Send 25c Phone: Rect. 2-6245 for Catalog

CIRCLE NO. 225 ON READER SERVICE PAGE

GET IT from GOODHEART!

ALL-BAND 5SB RCVR BARGAIN: Halflanders R-15/
 ABR-7. 550 kc to 15 mc. 4000 watts. Voice, CW,
 MW; 2 BE's; 2 IE's; 8 meter; 155 kc XT; 6 se-
 lect choices. Pwr required 270 w. 110 ma dc. 0.3
 A, 1.3 A, 3.3 A, 8.2 A, 15 A, 25 A, 50 A, 100 A, 200 A.
 checked, aligned, clean, 100% gtd. 4-45
 Los Ang. 149.50
 Same w/ 60 cy pwr sply, ready to use... 179.50
 (Add \$20 for 5SB Product Detector installed.)

TIME PAY PLAN: Any purchase totaling 10%
 \$100.00 or more down payment only.

ARC-5 Q-5'er Receiver 100-550 kc w 85 kc IE's. Use
 as 2nd converter for above or other rx's. Checked
 electrically w/ lots of test. data. w/ spline
 knob. 0 lbs for Los Ang. \$25.00
 (Add \$1 for extra-clean selected unit) 14.95

AN APR-4 RECEIVING SET: Time 0R to 1000 mc. In-
 cludes: EN-16, 17, 18 APR-4; plug; hand-
 book; checked, grid OK. for Los Angeles... 179.50

Add \$40 for EN-10, 975-2200 mc; add \$125 for
 EN-51, 2175-10 mc; add \$100 for AM, FM version of
 the rx; w 60 cy pwr sply; add \$125 for RFP
 Panelater w 3" CR 30 mc 5 m. 57.50

LM FREQ. METER 125 kc to 20 mc is common. Inter-
 face meter & signal source. MW or AM accuracy
 100%. XT built. Clean, checked. 100% 57.50
 Add \$10 for test. data. 100% gtd. 4-45
 Add \$22 for LM sply w plugs, data, or \$10 for LMD.
 converters for LM w parts, data, included.

TS-323 UR, 20-100 mc, 500 W (CERTIFIED FM I,
 Crystal Unit) W handbook supplement giving
 supplementary xt check points & instruct. to
 5% closely approach crystal accuracy. W/
 schematic, instruct, pwr sply data, clean, w/
 checked, 100% grid for Los Ang... 199.50

TEKTRONIX SCOPES grid OK & rigorous, w/ book
 sweep cable: 514A: DC to 10 mc sens-10 mix cm; 395.00
 sweep cable: 514B: 500 Hz to 10 mc; 450.00

= 514AD is same plus Video Delay Line... 450.00
 = 513: HV accel. for pulses... 495.00
 = 515D 3" scope adds very slow sweeps... 395.00
 = 512 3" scope adds very slow sweeps... 450.00

= 524D TV Station & General Purpose... 550.00
 = 531 w "TR" preamp; hand owners... 695.00

HEWLETT-PACKARD GOODIES grid OK & w/ book:
 = 100D standby Low-Freq. Oscillator... 295.00
 = 202A Low-Freq. Funct. osc generator... 295.00
 = 410A all-purpose VTVM up to 700 mc... 150.00

= 520A Decade Scale changes 10 mc to 100
 mc w/ 100 Hz to 1000 Hz. If Schmitt Trigger added, 295.00
 = 400D ac VTVM plus Ind. Contr. = 210A dc
 ac converter enables mc & dc VTVM used
 down to as low as 1 mv full scale. As pair 265.00
 = 650A oscil. Trcv to 10 mc... 295.00

For L&N Galvanometers, other Bridges, Voltage Di-
 viders, and Gen. Ratio Trans, see Sept. ad. For
 LINE VOLTAGE REGULATORS see Oct. ad. OR WRITE
 FOR DATA! We have the widest assortment of D-
 STRAIGHT material of this nature in the U.S.A.

R. E. GOODHEART CO. INC.
 Box 1220-A, Beverly Hills, Calif. 90213
 Phones: Area 213, office 272-5707, CHARGES 275-5342

CIRCLE NO. 243 ON READER SERVICE PAGE

Rectifiers & Transistors

750 ma. Silicon Diodes "Epoxy" or "Top Hat" PIV PIV
 50 5¢ 600 25¢ 25 6¢ 300 30¢
 100 7¢ +700 30¢ 50 8¢ 400 35¢
 200 10¢ +800 38¢ 100 14¢ 500 45¢
 400 15¢ +900 48¢ 150 18¢ 600 55¢
 500 20¢ +Top hat only 200 25¢ All tests
 Full Leads, Tested, Guaranteed, American made.
 10 watt Silicon Zener studs, 5v-100v., any voltage\$1.25 ea.
 10 watt Silicon diffused stud power regulators & double anode clippers, 10v-120v, any voltage\$1.49 ea.
 1 Watt Zener Diode 6v-200v75¢ ea.
Hi-Voltage—Silicon epoxy diode, 2 1/2"x3/8"x1/2", mounting holes, 8" glass insulated leads, original factory package.
HOFFMAN—3000 piv—200 ma. (orig. cost \$15.00)\$1.95 ea.
HOFFMAN—6000 piv (3000 piv tap)—200 ma. (orig. cost \$30.00)\$4.50 ea.
 Thermistor, glass bead, 1200 ohms, 600°F, factory packed by Victory Engr., 32A3, long leads2 for \$1.00
20 Watt Germanium (internal heat sink)
 2n10386 for \$1.00 2n10424 for \$1.00
 2n10394 for \$1.00 2n10433 for \$1.00
 2n10403 for \$1.00 2n10442 for \$1.00
 2n10412 for \$1.00 2n104570¢
150 Watt Germanium Hi-Freq Power
 100 volts, 10 amp 2n1046\$1.50 ea.
 100 volts, 20 amp 2n1907\$1.95 ea.
150 Watt Germanium Power
 2n2503/\$1.00 2n45780¢
 2n2512/\$1.00 2n45890¢
 2n45670¢ 2n1021\$1.00
 2n702—100mc, Silicon 40¢, 2n703—150mc, Silicon—60¢
 Germanium switching transistors, 150 mw, long leads, tested 6 pnp—\$1.00, 6 npn—\$1.00
 Small-signal transistors, flat case, short printed circuit board leads, new assorted, tested 15/\$1.00
 Nickel-Cadmium Battery—6 1/2 oz.—6"x2"x1/2"—5 amp-hrs.\$1.25 ea.

SILICON CONTROLLED RECTIFIERS

PRV	7	16	25	PRV	7	16	25
25	.30	.60	.90	200	1.50	2.10	2.60
50	.60	.90	1.10	300	2.30	2.70	3.10
100	1.00	1.50	1.80	400	2.70	3.10	3.85
150	1.30	1.80	2.30	500	2.45	3.95	4.45
ALL TESTS STUD TYPE	600	3.70	4.70	4.90			

Money back guarantee, \$2.00 min. order, include postage. Catalogue 25c.

Electronic Components Co.
 Box 2902 Baton Rouge, La. 70821

CIRCLE NO. 13 8 ON READER SERVICE PAGE

PHOTOGRAPHS

PHOTOGRAPHERS ATTENTION! Photographs and transparencies wanted—To \$500.00 each. Valuable information—Free. Write Intraphoto-EW, Box 74607, Hollywood 90004.

AIRCRAFT RADIO

WANTED Aircraft Radio Sets—Collins: 51R3-51X—51Y—51V—51Z, Bendix: T-21; R21; DFA-70; RA-18C; MK-7; GSA-1, Test Sets: ARC—Boonton—Collins—Hewlett-Packard. Highest prices paid. J. Lee, Box 105, New Haven, Conn.

PHOTOGRAPHY—FILM, EQUIPMENT, SERVICES

MEDICAL FILM—Adults only—"Childbirth" one reel, 8mm \$7.50; 16mm \$14.95. International W, Greenvale, Long Island, New York.

SCIENCE Bargains—Request Free Giant Catalog "CJ"—148 pages—Astronomical Telescopes, Microscopes, Lenses, Binoculars, Kits, Parts, War surplus bargains. Edmund Scientific Co., Barrington, New Jersey.

INVENTIONS WANTED

INVENTORS. We will develop, help sell your idea or invention, patented or unpatented. Our national manufacturer clients are urgently seeking new items for outright cash sale or royalties. Financial assistance available. 10 years proven performance. For free information, write Dept. 42, Wall Street Invention Brokerage, 79 Wall Street, New York 5, N.Y.

SITUATIONS WANTED

GLASSBLOWER experience on TV tube refill. Write Box 584, Crestview, Fla.

BARGAINS

Write for a copy of our Complete Bargain Brochure

Collins 5KW, 10 Chan. Autotune XMTR A-1, A-2, A-3 \$Low

Boonton 207G Univerter\$ 300.00
 Collins R-388/51J3 ReceiversP.U.R.
 Boonton 160A "Q" MTR625.00
 Boonton 160A "Q" MTR\$350.00

4 Band Tuning Units for AP4 Receivers, Slide Rule Dial, Type CV-253, 38-1100 MC Like New189.50

Low Frequency Rev. RHL-2 14 KC—600 KC175.00
 HP 235A Audio Generator375.00
 HP 608B Sig. Gen. 10MC-400Mc, like new595.00
 G.R. Unit Oscill's 1211B 5 to 50mc, New210.00
 HP 630AR Sig. Gen. 10cy to 10mc, Excellent300.00
 HP 475B Tunable Bolometer, New99.00
 HP 212A Pulse Generator, Excellent325.00
 HP 205 AF Audio Generator, Excellent295.00
 TS 418/C Sig. Gen. 10mc to 100mc, Like new495.00
 Measurements Corp. 31 Intermodulation Monitor, New150.00
 Empire Devices Broadband X-tal mixer type CM-107C, 1120mc to 1700mc, Excellent90.00

Waveguides
 HP X370C, New30.00
 HP S370C, New62.50
 Close-out 100 ft of RG-11A/U, PL-259 each end, New3.50
 SPECIAL PRD 1100A 3db Attenuator9.99
 PRD 300 Adaptor, New22.50
 PRD 130B 6db Attenuator25.00
 AN/URM 14 Mike Simulator0
 AN/URM-1 100 kc Pig Counter290.00
 AN/URM 25 Sig. Gen. 10Kc-50Mc0
 HP 683C 2 to 4 KMC Sweep Oscillator1800.00
 TS-47A/APR Sig. Generator375.00
 TS-147/D 8 Band Test Set675.00
 BC-1032B Panadapter 5.25 mc IF125.00
 Ballentine 300 VTM99.00
 Hewlett Packard 430B Power Mtr.120.00
 TS-268D/U Extra Rectifier Test Set17.50
 TS-375A/U VTM65.00
 TS-911 Analyzer for THF175.00
 TMC Type EFR Receiver0
 Measurements 80 Sig Gen.0
 Dumont 256D Scopes90.00
 Dumont 324 Scopes245.00
 SP-600 JX-540 Kc-54mc/s450.00
 R-300 Digital Job 300-32mc/s320.00
 CR-13 225 to 400mc/s375.00
 Tektronix 514AD160.00
 HP 100 VTM160.00
 HP 525B210.00
 HP 200B Freq Mtr.150.00
 HP 200D Audio Gen.95.00
 Bird 63A VHF Wattmeter150.00

SPACE ELECTRONICS 4178 Park Ave. Bronx, N. Y. (212) CY 9-0300

CIRCLE NO. 221 ON READER SERVICE PAGE

CLASSIFIED ADVERTISING ORDER FORM

Please refer to heading on first page of this section for complete data concerning terms, frequency discounts, closing dates, etc.

1	2	3	4	5
6	7	8	9	10
11	12	13	14	15
16	17	18	19	20
21	22	23	24	25
26	27	28	29	30
31	32	33	34	35

Words @ .35 Reader Rate } = \$ _____
 @ .60 Commercial Rate }
 Insert _____ time(s) Total Enclosed \$ _____

NAME _____

ADDRESS _____

CITY _____

ZONE _____

STATE _____

SIGNATURE _____

WORD COUNT: Include name and address. Name of city (Des Moines) or of state (New York) counts as one word each. Zone or Zip Code numbers not counted. (Publisher reserves right to omit Zip Code if space does not permit.) Count each abbreviation, initial, single figure or group of figures or letters as a word. Symbols such as 35mm, COD, PO, AC, etc., count as one word. Hyphenated words count as two words. EW-1264

1965 COMMUNICATIONS HANDBOOK

Spring 1965 ELECTRONIC EXPERIMENTER'S HANDBOOK

Fall 1965 ELECTRONIC EXPERIMENTER'S HANDBOOK

THE BIGGEST CLASSIFIED ADVERTISING COMBINATION BUY OF THE YEAR IS NOW OPEN TO YOU!

Don't Miss These Three Great Opportunities To Expose Your Ad To A Buying Audience That Will Respond For An Entire Year.

1965 Communications Handbook . . \$0.75 Word
 Spring 1965 Elec. Exp. Handbook . . 0.75 Word
 Fall 1965 Elec. Exp. Handbook . . . 0.75 Word
 Special Combination Rate for All . . . 1.55 Word
 Combination Rate for Communications and Spring Elec. Exp. Handbooks ONLY \$1.10 Word

CLOSING DATE FOR COMBINATION RATES: November 25, 1964

Send Order and Payment Today to:

Martin Lincoln, Classified Adv. Manager
 Ziff-Davis Publishing Company
 One Park Avenue
 New York, New York 10016

SILICON RECTIFIER SALE

IMMEDIATE
FULLY GUAR'NT'D
AMERICAN MADE



DELIVERY
NEWEST TYPE
FULLY TESTED

750 MA-SILICON "TOP-HAT" DIODES LOW LEAKAGE FULL LEAD LENGTH

PIV/RMS 50/35 .05 ea	PIV/RMS 100/70 .09 ea	PIV/RMS 200/140 .12 ea	PIV/RMS 300/210 .16 ea
PIV/RMS 400/280 .20 ea	PIV/RMS 500/350 .24 ea	PIV/RMS 600/420 .32 ea	PIV/RMS 700/490 .40 ea
PIV/RMS 800/560 .48 ea	PIV/RMS 900/630 .55 ea	PIV/RMS 1000/700 .70 ea	PIV/RMS 1100/770 .75 ea

ALL TESTS AC & DC & FWD & LOAD SILICON POWER DIODE STUDS

D.C. AMPS	50 PIV 35 RMS	100 PIV 70 RMS	150 PIV 105 RMS	200 PIV 140 RMS
.3	.12	.18	.22	.30
.12	.45	.65	.75	.90
.35	.90	1.15	1.50	1.70
.50	1.60	1.90	2.30	2.80
1.00	1.75	2.15	2.55	3.15

D.C. AMPS	300 PIV 210 RMS	400 PIV 280 RMS	500 PIV 350 RMS	600 PIV 450 RMS
.3	.40	.45	.55	.65
.12	1.10	1.55	1.50	3.00
.35	2.35	2.55	3.00	3.50
.50	3.50	4.20	5.25	7.00
1.00	3.75	4.60	5.65	8.00

"SCR" SILICON CONTROLLED RECTIFIERS "SCR"

PRV	7 AMP	16 AMP	25 AMP	PRV	7 AMP	16 AMP	25 AMP
25	.50	.85	1.20	250	2.30	2.65	3.10
50	.85	1.20	1.40	300	2.60	3.00	3.40
100	1.35	1.80	2.20	100	3.00	3.40	4.15
150	1.60	2.10	2.65	500	3.75	4.25	4.75
200	1.75	2.40	2.90	600	4.00	5.00	5.25

SPECIALS

240 Amp 200 Piv Sil. Power Rect **\$7.50 ea.**

2 Amp 1000 Piv Sil. Power Rect **75¢ ea.**
10 for \$7.00

100 Different Asst Precision Resistors **\$1.50**
1/2-1-2 Watt 1/2%-1% Tol.

Type IN34 Diode .07 ea **\$5.00**
100 for

Type IN91 Germanium Diode **\$1.00**
10 for

Filament Transformer **50¢ ea.**
Pri-120V Sec 6.3V at 1 Amp

Money Back guarantee. \$2.00 min. order. Orders F.O.B. NYC. Include check or money order. Shpg. charges plus. C.O.D. orders 25% down.

Warren Electronic Components

230 MERCER ST. N.Y. 10012 N.Y. OR-3-2620

CIRCLE NO. 259 ON READER SERVICE PAGE

ARR-2 RECEIVER 231-258 MC w 11 tubes, Schematic & Conversion Data for C.B., 2 & 3 Meters, Used, Good **\$ 4.95**
L & N KELVIN-VARLEY PRECISION VOLTAGE DIVIDER 20,000 ohms 0.1% Ratio 1:10, 1:100, 0.01% with Galvanometer. See our Ad Electronics World Sept. 64. Good condition. Lab checked out **49.50**
HIGH VOLTAGE PROBE—Rated 30KV for VOM or VTVM. 500 Meg Resistor. Large Quality probe lists for over \$12.00. Brand new **2.95**
R-237B/VR MOBILE FM RECEIVER 30-40MC 6vdc Vibrator Power Supply—Easily converted to 12vdc. Used, Good, with schematic **26.95**
T-193B/VRC FM MOBILE XMTR 30-40MC 6vdc dynamotor. Easily converted to 6M. With 7 tubes & schematic. Used, Good **12.95**

SEND MONEY ORDER OR CHECK WITH ORDER MIN. \$2.50 PLEASE INCLUDE POSTAGE—Excess promptly refunded. MINIMUM C.O.D. ORDER \$10.00 with 25% DEPOSIT

WRITE FOR BUL. 41. LOADS OF BARGAINS
R. W. ELECTRONICS, INC.
2430 So. Michigan Ave. Dept. 1273
Chicago, Illinois 60616 Phone 225-1281

WANTED

QUICKSILVER. Platinum. Silver. Gold. Ores Analyzed. Free Circular. Mercury Terminal. Norwood, Mass.

CASH Paid! Sell your surplus electronic tubes. Want unused. Clean radio and TV receiving, transmitting special purpose. Magnetrans. Klystrons, broadcast types. Want military and commercial lab test equipment. Want commercial Ham Receivers and Transmitters. For a Fair Deal write: Barry Electronics, 512 Broadway, New York, New York 10012 (Walker 5-7000).

URGENT, NEED IMMEDIATELY. Very high prices paid. Freight prepaid. AN/GRC; PRC; APR; ARC; ALT; URM; UPM; TS—We also buy all military and commercial test, radar, and communication equipment. CALL COLLECT. IT COSTS YOU NOTHING TO HEAR OUR HIGH OFFER. SPACE ELECTRONICS, 4178 PARK AVENUE, BRONX, N.Y. (212) CY 9-0300.

(WANTED) CASH Given: Used Electronic Parts and Equipment. Radio Research, P.O. Box 311, Kenmore Square, Boston 15, Mass.

GOVERNMENT SURPLUS

JEEPS — \$62.50. Transmitters — \$6.18, Typewriters — \$4.15. Walkie-Talkies, Oscilloscopes, Multimeters. Typical Surplus Prices. Exciting Details Free. Enterprises, Box 402-B8, Jamaica 30, N.Y.

JEEPS \$64.50... Boats \$6.18... Typewriters \$4.15... Airplanes, Electronics Equipment, 100,000 Bargains Typically like These Direct From Government in Your Area. For Complete Directory and Surplus Catalog Send Only \$1.00. Surplus Service, Box 820-K, Holland, Michigan.

MUSICAL INSTRUMENTS

ACCORDIONS. GUITARS, BAND INSTRUMENTS! Save 1/2. Famous makes. free home trial. Easy terms. Trades. Free Discount catalogs. Mention instrument. International Music Mart, Dept. EW. 5535 Belmont, Chicago.

MAGAZINES

ELECTRON is A Brand New Electronics Hobbyist Magazine. Free Sample Copy, Electron, Box 796, Montreal, Canada.

BOOKS

AUTHORS! Learn how to have your book published, promoted, distributed. FREE booklet "ZD," Vantage, 120 West 31 St., New York 1.

PUBLISH your book! Join our successful authors: publicity advertising promotion, beautiful books. All subjects invited. Send for free appraisal and detailed booklet, Carlton Press, Dept. ZDL. 84 Fifth Avenue, N.Y.C. 11.

1,000,000 BOOKS! Bargains! Catalog—dime. TreasureSite, 6990 Aberdeen, Upper Darby, Pa. 19082.

TECHNICAL manuals for surplus electronics. Stamp for list. Books, Box 184, Riverdale, Md.

BOOKS 2000 Subjects Catalogs 10¢. Myers Book Service, Marquand, Mo. 63655.

COINS

TWENTY page #27 Retail price list of USA and Canadian coins 10¢. Our retail selling prices on thousands of coins and coin collectors supplies. Bryson Incorporated, 612-2 White, Toledo 5, Ohio.

STAMPS

FREE! 25 Egypt, 10¢ handling. Approvals, Bellet P-E-G, Hazel Park, Michigan 48030.

HELP WANTED

EARN Extra money selling advertising book matches. Free Samples furnished. Matchcorp, Dept. MD-124, Chicago 32, Ill.

GREGORY ELECTRONICS RECONDITIONED FM 2-WAY RADIO SAVINGS

THIS IS A PARTIAL LIST—
WRITE FOR NEW FALL '64
E-X-P-A-N-D-E-D CATALOG

Extra Special Purchase Reconditioned General Electric Voice Commander

Personal FM
Transmitter-Receiver
132 to 172 MC. 1 W
9.5" x 5.3" x 1.7"

The General Electric VOICE COMMANDER 1 Personal Transmitter-Receiver is a high performance, completely self-contained two-way FM Radio. Extremely compact and light-weight, the VOICE COMMANDER is simple to operate and easily hand carried.

Except for the final stages of the transmitter, the VOICE COMMANDER is completely transistorized.

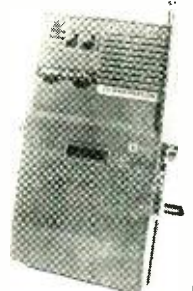

PRICE, including Brand New rechargeable Nickel Cadmium Battery Pack

\$178

If crystals and tuning is desired, add \$40.00.

We also have the proper chargers for these units, GE Model #4EP27A10, Price: \$18.

Additional nickel cadmium Battery Packs are required, they are available at a price of \$25.00 each.



MOTOROLA 450-470mc

T44A6. 6/12 volts, complete with all accessories, less crystals and antenna.



\$108

Same unit less accessories. \$78
T44A6A, 6/12 volts, complete with all accessories, less crystals and antenna. **\$128**
Same unit less accessories. \$98

RCA 25-54mc CMF40

6 12v 40 watts. Vibrator power supply. Fully narrow banded. Complete with all accessories, less crystals and antenna. **\$178**



(Same unit without accessories, \$148.)
Same unit tuned to your frequency including brand new antenna, ready for installation. \$218

We Buy Late Model Equipment for Cash
—Write; Wire or Phone!



GREGORY ELECTRONICS CORPORATION

249 Rt. 46 • Phone 773-7550
Saddle Brook, N.J. • Area Code 201

CIRCLE NO. 185 ON READER SERVICE PAGE

NOW!!! LOW COST AC POWER IN YOUR CAR!!!
12 V DC to 115 V AC (50 W) TRANSISTORIZED
POWER SUPPLY KIT
\$9.95 per Kit

w/ Instructions, schematic, etc. has many uses, easy to wire. Approx. size of alum. box 3X3X3" (Factory wired; complete ready to use—\$16.95 ea.)
 (Not recy. for phone)

SILICON CONT. RECT.		COMPANION RECTIFIERS	
TESTED			
PRV	AMP	3/4 AMP	1 1/2 AMP
70	1.90	1.90	.20
140	1.30	2.25	.25
200	1.50	2.40	.30
250	1.90	2.60	.40
300	2.15	2.85	.45
350	2.40	3.10	.50
400	2.75	—	.55
450	3.10	—	.60
500	—	—	.65
600	3.85	—	.70
700	—	—	.75
800	—	—	.80
900	—	—	.85
1000	—	—	.90

METERS	
SQUARE	ROUND
1 1/2"	2"
0-1MA	0-200 VAC
0-2MA	0-500 VAC
0-100 MV	0-200 MA DC
0-500 MMA	0-200 MMA
0-100 MMA	0-100 MMA
AC Volts 0-2; 3; 5; 10; 25; or 50	0-150 VAC 3"
DC-MA 0-250; 150 or 100	0-1 MA (Arbitrary Scale)
AC MA 0-150	0-150 VDC Weston (dual scale)
DC Volts 0-25; 200; 300 or 500	0-150 VDC
0-30 VDC	0-20 MA DC
0-5 MA DC	0-5A AC (marked 1-50)

MONTHLY SPECIALS
 Solenoid Guardian No. 16AC 115 VAC—2 lb. pull 1.79 ea. 12 for 20.00
 Spectrum Analyzer Vectron SA-20 w/s Band Plug-In Model #20-S \$225.00
 Dumont #322 Scope dual beam DC or AC coupled excellent condition with manual \$369.00
 SCR 70PRV-7 Amps. tested \$75.00
 Switch DPST Rust proof 6A-125V new 12 for \$4.50
 Germanium Diodes, Computer type—\$8./100
 Micro Switches V-31 SPDT \$4.52/19
 Micro Switches ISMI SPDT \$4.17/15
 Transformer 110V PRI 1100 VCT—400 MA \$3.95

ASSORTED RELAYS—QUANTITIES
WRITE FOR PRICES.
 All Shipments FOB NYC

ADVANCE ELECTRONICS
 79 Cortlandt St., New York 7, N.Y. RE 2-0270

REAL ESTATE

WIN Government Oil Leases. Opportunities with Security wealth. Mineral Enterprises, 383A Elsie Street, San Francisco, Calif. 94110.

FLORIDA Water Wonderland—Homesites. Cottagesites, Mobilesites, Established area. \$390 full price, \$5.00 month. Swimming, fishing, boating. Write, Lake Weir, 38be, Silver Springs, Fla. Ad 6-1070 (F-1)

EDUCATIONAL OPPORTUNITIES

LEARN While Asleep, hypnotize with your recorder, phonograph. Astonishing details, sensational catalog free! Sleep-Learning Association, Box 24-ZD, Olympia, Washington.

LEARN while asleep. Remarkable, scientific. 92% effective. Details free. ASR Foundation, Box 721, Dept. e.g., Lexington, Kentucky.

EMPLOYMENT INFORMATION

FOREIGN—U.S.A. Hot listings. All-year jobs now hiring. Transportation. Family relocation. Stamped returnable envelope. Global, Box 286-W, Oroville, Calif.

FOREIGN Employment. Construction, other work projects. Good paying overseas jobs with extras, travel expenses. Write only: Foreign Service Bureau, Dept. D, Bradenton Beach, Florida.

FOREIGN U.S. employment, Big construction projects. All trades. Salaries up to \$1,600 monthly with travel expenses, extras. Write only: Foreign U.S. Employment Bureau, Dept. D-8, The State Building, Portland, Maine.

MISCELLANEOUS

SAVE \$200 to \$2,000 on European automobiles delivered at low, low factory tax-free prices by using our direct shipment plan. Delivery guaranteed, references available. Tourist and Military deliveries available in Europe. Information on all models and makes Eurauto, Postbus 333, Rotterdam, Holland.

FREE Song "Hit" copy. Postcard: Nordyke Publishers, 6000-3 Sunset, Hollywood, Calif. 90028.

CIGARETTES—Makes 20 plain or filter-tip for 9c. Factory-Fresh pipe tobaccos. Mild tropical flavored Philippine cigars. Facts free. Moberly, Box 805, Owensboro, Kentucky.

WINEMAKERS: Free catalog of equipment. Semplex, Box 7208, Minneapolis, Minn. 55412.

BUSINESS OPPORTUNITIES

INVESTIGATE Accidents—Earn \$750 to \$1,000 monthly. Men urgently needed. Car furnished. Business expenses paid. No selling. No college education necessary. Pick own job location. Investigate full time. Or earn \$6.44 hour spare time. Write for Free Literature. No obligation. Universal, C2-12, 6801 Hillcrest, Dallas 5, Texas.

I Made \$40,000.00 Year by Mail Order! Helped others make money! Start with \$10.00—Free Proof. Torrey, Box 3566-N, Oklahoma City 6, Oklahoma.

AMAZING Mail Order Profits using proven methods. Research. 3207-H Southern Hills, Springfield, Mo.

HOW And Where to Raise Capital. Details Free. Financial. Box 785-H, Springfield, Mo. 65801.

HIGHLY WEEKLY EARNINGS! Address-mail letters featuring real merchandise. Get \$10 with every order—keep \$8 profit. Supplies furnished. Free particulars. Modern Merchandising, Box 357, Oceanside, N.Y.

FREE REPORT: "609 Unusual, Successful Businesses." Box 122-ZDA, Wheeling, Ill.

SELL CB Equipment—Dealerships available to aggressive people who can sell Citizens Band Radio full or part time. Knox Electronic, Dept. 194, Galesburg, Ill. 61401.

MONEYMAKING Mailorder opportunities. Details free. Litton, P.O. Box 332D, Randallston, Md.

FREE Book "990 Successful, Little-Known Businesses." Work home! Plymouth-717P, Brooklyn 4, New York.

DETECTIVES

DETECTIVE Opportunities. Experience unnecessary. Write. Wazgner, 125 W. 86th, New York 10024.

FREE Catalog
 OF THE WORLD'S FINEST
 GOVT. SURPLUS
 ELECTRONIC BARGAINS

TELEPHONE—TELETYPE—TELEGRAPH:
 Model 14 AT Teletype—Used: \$69.95
 Paper Tape: 3/8" 900 Ft Roll: 25¢—30 f/\$3—60 f/\$5
 Telegraph Repeater WE-61824A New: 34.95
 TP-7 Portable Repeater New: 12.95
 TG-30 Telegraph Repeater—Used: \$14.95 New: 19.95
 TG-31 Telegraph Repeater New: 16.95
 PE-250 Telephone Ringer Used: 4.95
 EE-8 Field Telephone Used: 12.95
 BD-71 Switchboard—6 line Used: 9.95
 BD-72 Switchboard—12 Line Used: 18.95
 BD-89 Switchboard—20 Mag. & 40 CB lines Used: 59.50
 BD-95 Switchboard—Cordless New: 24.95

MICROPHONES:
 T-30 Throat Microphone—Used: 3 f/\$1.00 New: \$.75
 T-45 Lip Microphone—Used—Each: .75
 RS-38 Microphone Button only New: 1.50
 T-17 Microphone Carbon—Re-Cond: 6.95
 T-26 Microphone Carbon—Used \$1.00—New: 1.75
 T-24/M Microphone Carbon—New: 4.95

HANDSETS:
 TS-9 Butterfly Switch—Used \$2.95. Re-Cond: \$ 3.95
 TS-13 Butterfly Switch w/PL-55/PL-68 Used: 4.95
 H-22/U Butterfly Switch w/PL-55/PL-68 Used: 4.95
 D170312 Sound Powered New: 7.95

HEADSETS:
 HS-33 Headset: with chamois cushions New: \$ 7.95
 with rubber cushions New: 6.95
 HS-23 Headset: with chamois cushions New: 6.95
 with rubber cushions New: 5.95
 Chamois Cushions only 1.50
 Rubber Cushions only 1.00
 HB-7 Headband only for HS-33/23 New: 3.00
 ANBH-1 Element only, for HS-33 New: 3.00
 H-63 Headset with Boom Microphone Used: 3.95
 HS-30 Headset—Hearing Aid Type Used: .75

CODE EQUIPMENT:
 TG-34 Keyer—Code Practice Used: \$24.95
 TG-10 Keyer—Code Practice Used: 14.95
 V0-3 Code Oscillator Used: 12.95
 MX-333/66 Code Tape Puller New: 12.95
 Blank Paper Tape: 3/8" 900 Ft. Roll 25¢ ea. 30/\$3.60/\$5
 Address Dept. EW • Prices F.O.B. Lima, O. •
 25% Deposit on C.O.D.'s • Minimum Order \$5.00
 SEND FOR BIG FREE CATALOG!

FAIR RADIO SALES
 2133 ELIDA RD. • Box 1105 • LIMA, OHIO
 CIRCLE NO. 181 ON READER SERVICE PAGE

TUBES

One Year Guaranteed

21 PICTURE TUBES 1395 1 Yr Guar

all purpose ELECTRONIC CLEANER 79¢

DIODES/RECTIFIERS 39¢ per pack

SENSATIONAL KIT VALUE!

29¢

CORNELL ELECTRONICS CO.
 Dept. EW 12 4217 University Ave., San Diego, Calif. 9 2 1 0 5

CIRCLE NO. 172 ON READER SERVICE PAGE

www.americanradiohistory.com

ELECTRONICS WORLD

**ELECTRONICS WORLD DECEMBER 1964
ADVERTISERS INDEX**

READER SERVICE NO.	ADVERTISER	PAGE NO.	READER SERVICE NO.	ADVERTISER	PAGE NO.
152	Advance Electronics	96	198	Micro Electron Tube Co.	91
	American Institute of Engineering & Technology	82		Milwaukee School of Engineering	58
248	Amperex Electronic Corporation	THIRD COVER		Minnesota Mining & Mfg. Co.	1
156	Artisan Organs	85		Music Associated	58
161	Automotive Electronics Co.	57		National Radio Institute	SECOND COVER
137	Bogen Communications Division	22		Northridge College of Science & Engineering	75
163	Burstein-Applebee Co.	88	242	Nortronics	4
	Capitol Radio Engineering Institute, The	5	258	NuTone, Inc.	83
	Channel Master Corp.	58		Oelrich Publications	82
	Cleveland Institute of Electronics	7, 86	203	Olson Electronics, Inc.	66
245	Conar	78	134	Pennsylvania Fluorocarbon Co., Inc.	66
170	Concertone	21	206	Poly Paks	97
171	Concord Electronics Corporation	6		RCA Electronic Components and Devices	FOURTH COVER
172	Cornell Electronics Co.	96		RCA Institutes, Inc.	8, 9, 10, 11
174	Crown International	84		R. W. Electronics, Inc.	95
178	EICO Electronic Instrument Co., Inc.	24	210	Rohn Manufacturing Co.	71
177	Editors and Engineers, Ltd.	62	214	Sarkes Tarzian, Inc.	14
180	Electro-Voice, Inc.	20	200	Scott, Inc., H. H.	19
138	Electronic Components Co.	94	217	Shure Brothers, Inc.	13
181	Fair Radio Sales	96	221	Space Electronics	94
246	Finney Company, The	16, 17		Stevens-Robertson Corporation	77
183	G & G Radio Supply Co.	98	224	Switchcraft, Inc.	62
243	Goodheart Co. Inc., R. E.	93		Sylvania	23
	Grantham School of Electronics	60	225	"TAB"	93
184	Greenlee Tool Co.	60	228	Terado Corporation	58
185	Gregory Electronics Corporation	95	229	Texas Crystals	87
186	Hallicrafters	68		Tri-State College	68
187	Heath Company	59, 61, 63, 65, 67	233	United Radio Co.	92
	Henshaw TV Supply	75		Valparaiso Technical Institute	86
	Instantspark	82	252	Viking of Minneapolis, Inc.	12
189	International Crystal Mfg. Co., Inc.	2	259	Warren Electronic Components	95
191	Johnson Company, E. F.	81	251	Webster Manufacturing	89
	Kuhn Electronics	86	235	Weller Electric Corp.	69
194	Lafayette Radio Electronics	72, 73, 74	237	Winegard Co.	55
128	Lampkin Laboratories, Inc.	85	238	Workman Electronic Products, Inc.	87
	Classified Advertising	91, 92, 93, 94, 95, 96			

CHRISTMAS SALE



FREE
\$25⁰⁰
YULE GIFT

OF RADIO & TV PARTS
ADD 25¢ for handling

— PLUS —

SECOND GIFT

BOTH 'GIFTS' FREE WITH \$10 ORDERS **CHOOSE \$1 ITEM ANY FREE**

EVERY ITEM CARRIES RMA GUARANTEE!

FACTORY TESTED SEMI-KON-DUCTORS

- 5-30-MC TRANSISTORS, like 2N247, pnp\$1
- 30 TRANSISTORS: audio, switching, rf untested ..\$1
- 15 TEXAS SWITCHING TRANSISTORS, pnp-n-npn ..\$1
- 25 TOP HAT RECTIFIERS, 750 mil untested.....\$1
- 1 RHEEM 2N1613 3-WATT 100MC PLANAR\$1
- 25 GERMANIUM DIODES, 1N34, 1N48 untested ..\$1
- 3-50 W. TRANSISTORS, TO36, untested.....\$1
- 25 "GLASS" TINY SILICON diodes, axial, untested..\$1
- 10-10 W. POWER TRANSISTORS, TO3, untested..\$1

YULETIDE TRANSISTOR JUMBOPAK TRANSISTORS
100 Power, Audio, RF, Switching untested **250**

- 4 GE 2N170 TYPE TRANSISTORS, npn, rf.\$1
- 20 WATT NPN SILICON MESA 2N1648 transistors ..\$1
- 2 25 AMP SILICON STUD RECTIFIERS\$1
- 6 TRANSISTOR RADIO SET OSC—i.f.'s DRIVER, PP \$1
- 15 UPRIGHT SILICON DIODES, worth \$40\$1
- 5 GENERAL ELECTRIC 2N107 type, pnp transistors..\$1
- 25 SEMI-KON-DUCTORS, or equal, TO3 case\$1
- 5 SUN BATTERIES TO 1 1/2" sizes, lite sensitive ..\$1
- 3 CBS 20-WATT TRANSSTRS, pnp, stud, 2N1320\$1
- 2 2N341 NPN SILICON TRANSISTORS, 1 watt\$1
- 15 NPN TRANSISTORS, asst. types and cases\$1
- 15 PNP TRANSISTORS, asst. types and cases\$1
- 10 FAMOUS CK722 TRANSISTORS, pnp\$1
- 3 CBS 35W TRANSISTORS, 2N1434, pnp, stud\$1
- 4 CK721 TRANSISTORS in new aluminum case pnp ..\$1
- 4 SUBMINIATURE 2N131 TRANSSTRS, rf-if, pnp ..\$1
- 2 TRANSITRON 1N429 ZENER REFERENCES\$1
- 6 ZENER DIODES, upright styles, assorted\$1
- 2 2N964 EPITAXIAL MESA, 500 MC, PNP, TO-18 ..\$1
- 3 2N1264 UHF TRANSISTORS, 300 mc TO 5 case ..\$1
- 3 TEXAS 20W TRANSSTRS, 2N1038, heatsink, TO5 ..\$1
- 6 2N112 TYPE IF, OSC TRANSSTRS, TO22 untested ..\$1
- 4 SYLVANIA 2N35 NPN, transistors, TO22\$1
- 3-1-WATT ZENER DIODES, axial leads, 6V\$1
- 1-85-WATT 2N424 SILICON NPN MESA transistor ..\$1
- 10 PHILCO UHF TRANSISTORS, like 5B-100\$1
- 2 RHEEM 4 W. 2N497, 2N498\$1
- 10 2 AMP POWER RECTIFIER STUDS\$1

TRANSITRON SCR's BRAND NEW	PRV	7 AMP		15 AMP		25 AMP	
		50	1.00	1.25	1.50	2.25	2.75
SILICON CONTROLLED RECTIFIERS	100	1.50	1.95	2.25	2.75	3.25	3.75
	200	1.75	2.25	2.75	3.25	3.75	4.25
	250	2.25	2.95	3.25	3.75	4.25	4.75
	300	2.60	3.19	3.50	4.00	4.50	5.00
	350	2.95	3.50	4.25	4.75	5.25	5.75
	400	3.25	3.95	4.50	5.00	5.50	6.00

WORLD'S MOST POPULAR \$1 PARTS PAKS

- 10 RCA PHONO PLUG 'n' JACK SETS, tuners-amps ..\$1
- 60 HI-Q RESISTORS, 1/2, 1, 2W to 1 meg, 5% too ..\$1
- 50 COILS & CHOKES, rf-if, osc, peaking, etc.\$1
- \$25 RADIO 'n' TV SURPRISE, wide variety\$1
- 10 TRANSISTOR ELECTROLYTICS, 10 to 100 mf\$1
- 50 RADIO & TV KNOBS, assorted colors, styles\$1
- 50 MICA CAPACITORS, to .01mf, silvers too\$1
- 30 POWER RESISTORS, to 50W, to 24 Kohms\$1
- 10 PANEL SWITCHES, rotary, mica, slide, power ..\$1
- 60 TUBE SOCKETS, receptacles, audio, plugs, etc. ..\$1
- 60 TUBULAR CONDENSERS to .5mf to 1KV\$1
- 50 ONE WATTERS, resistors, asstd. values, 5% too..\$1

3-TRANSISTOR SUBMINIATURE AMPLIFIER
• Only 3"x2"x3/4" • Wired **1.95**
• Printed Circuit • W Transistors

- 1 INFRARED PARABOLIC REFLECTORS & FILTER ..\$1
- 1 INFRARED PHOTO DETECTOR TRANSDUCER ..\$1
- 4 TRANSISTOR TRANSFORMERS, assorted, worth \$25 ..\$1
- 40 WORLD'S SMALLEST RESIST., 5% too, 1/10W ..\$1
- 60 CERAMIC CONDENSERS, discs, npn's to .05mf ..\$1
- 40 TEXAS PRECISION RESISTORS, assorted\$1
- 10 Logic Transistor Transformers, asstd.\$1
- 10 ELECTROLYTICS FP & tubulars, to 500mf\$1
- 3 UTC SUBOUNCER TR'NSTOR TR'SFORMERS, asst. ..\$1
- 30 SPRAGUE MYLAR condensers, asst. values, volts..\$1
- 75 ASST. HALF WATT RESISTORS, 5% too\$1
- 35 TWO WATTERS, resistors, 5% too\$1

POLY PAKS
TERMS: send check, money order, add postage—avg. wt. per pak 1 lb. Pated. net 30 days. PDKs 25¢
☐ FREE—Winter Catalog
P.O. BOX 942W
SO. LYNNFIELD, MASS.
"PAK-KING" OF THE WORLD

SCR-625 MINE DETECTOR

Complete portable outfit in original packing, with all accessories. **\$32.50**
Brand New

TS-239A/UP OSCILLOSCOPE, for bench-testing all types of radar and communications electronic equipment. Comprises calibrating voltage generator, timing marker generator and trigger generator. Excellent Condition **\$99.50**

AN/ARN-6 RADIO COMPASS DF RECEIVER 100 to 1750 Kc in 4 bands. Built-in vibrator power supply for 24V DC. Complete with tubes, exc. Used **\$29.50**

BC-610 TRANSMITTER 2-8 Mc Complete. Excellent Used, clean P.U.R.

LM FREQUENCY METER

Crystal calibrated modulated, Heterodyne, 100 Kc to 25,000 Kc, with Calibration Book **\$79.50**
Complete, like new
LM Frequency Meter as above, completely checked out, with tubes and crystal, less calibration book. Exc. Used, clean **\$34.50**

BC-221 FREQUENCY METER

Equipped with original Calibration charts, 125 Kc to 20,000 Kc with crystal check points in all ranges. Excel. Used with original Calibration Book, Crystal, and all tables. CHECKED OUT!
Unmodulated **\$89.50** Modulated P.U.R.
AC Power Supply for BC221, checked out... **\$24.50**
BC-221 1000 Kc Crystal Brand New **\$8.95**
BC-221 FREQ. METER CASE, aluminum, with volt. supply. Shock mounted. BRAND NEW **\$2.95**

LORAN APN-4 FINE QUALITY

Determine exact geographic position of your boat or plane. Indicator and receiver complete with all tubes and crystal.

INDICATOR ID-6B/APN-4, and RECEIVER R-9B/APN-4, complete with tubes. Exc. Used. **\$69.50**

NEW! APN-4A Receiver-Indicator as above, changed to operate same as APN-4B for improved performance. NEW **\$88.50**
Shock Mount for above **\$2.95**

INVERTER POWER SUPPLY for above APN-4. INPUT: 24 V DC. OUTPUT: 115 V AC, 800 cycles. Like New **\$22.50**

12-Volt Inverter Power Supply for above APN-4. Like New. P.U.R.
We carry a complete line of replacement parts and accessories for above.

LORAN R-65/APN-9 RECEIVER & INDICATOR

Used in ships and aircraft. Determines position by radio signals from known xmitters. Accurate to within 1% of distance. Complete with tubes and crystal. IN LIKE NEW Condition **\$79.50**

Used, with all parts, less tubes, crystal and visor. Special **\$29.50**

INVERTER POWER SUPPLY for above APN-9. INPUT: 24 V DC. OUTPUT: 115 V AC, 800 cy. Like New **\$22.50**

12-V. Power Supply for APN-9, like New P.U.R. Shock Mount for above **\$2.95**
Circuit diagram and connecting plugs available.
We carry a complete line of replacement parts and accessories for above.

APN-12 3-INCH SCOPE

Has vertical and horizontal sweep with focus and intensity controls. coaxial antenna changeover motor. Complete with 11 tubes and 3P1 CR Tube. For 115 V, 400 cycle AC and 24 V DC. Circuit diagram included. LIKE NEW **\$14.95**

TS100AP SCOPE, exc. used, like new, with all tubes, crystals and CR tube P.U.R.
As above, BRAND NEW **\$69.50**

BC-929 3-inch Scope, with all tubes, BRAND NEW **\$14.95**
Conversion instructions, with diagram, for 100 V AC operation **\$.65**

EE-8 FIELD PHONES

Checked out, perfect working order. Complete with all parts. Excellent Condition.
LIKE NEW! Each **\$14.50**

TG-34A CODE KEYS

Self-contained automatic unit, reproduces code practice signals recorded on paper tape. By use of built-in speaker, provides code-practice signals to one or more persons at speeds from 5 to 25 WPM.

Like New, Tested **\$29.50**

Set of 15 Reels Army Code Practice Lessons, BRAND NEW, original packing P.U.R.

ASK FOR OUR LATEST FREE BULLETIN OF BARGAINS IN MILITARY SURPLUS ELECTRONIC EQUIPMENT!

IMPORTERS—EXPORTERS of ELECTRONIC EQUIPMENT

We specialize in the export of military surplus electronic equipment:

- All at LOWEST PREVAILING PRICES.
- In addition to items shown on this page, we have in stock or can obtain for export and domestic customers, military electronic equipment made for World War II, Korean War, and later. We maintain one of the largest stocks of Government Electronic Surplus Equipment in America!
- IF YOU DON'T SEE WHAT YOU WANT HERE. WRITE US YOUR NEEDS, WE'LL QUOTE ON ANY GOVT SURPLUS EQUIPMENT YOU SEE ADVERTISED ANYWHERE. Write or call today for our low LOW PRICE, and SPEEDY DELIVERY FROM STOCK!
- All packing and shipping is made directly from our own warehouse in NYC to give you substantial savings in handling costs!

WE BUY FOR CASH your surplus Military Electronic Equipment WRITE—WIRE—PHONE

ARC-5 T-23 TRANSMITTER 100-150 Mc., includes tubes: 2-832A, 2-1025, BRAND NEW, with Tubes **\$26.50**
Used, with Tubes **\$12.50**—Used, less tubes **\$3.95**
ARC-5 R-28 RECEIVER 2-meter superhet, 100 to 150 Mc., in 4 crystal channels. Complete with 10 tubes. Excellent Used. Like New **\$24.50**
Like New **\$29.50**

AN/APR-4Y FM & AM RADIO RECEIVER
High precision lab instrument, suitable for monitoring and measuring frequency and relative signal strength of signals from 38 to 4000 Mc., in 5 tuning unit ranges. For 110 V 60 cycle AC operation, built-in power supply. LIKE NEW. SPECIAL **\$79.50**

TN-14, TN-17, TN-18, TN-19 and TN-41 Tuning Units for above in stock. P.U.R.

SCR-522 2-METER TRANSMITTER-RECEIVER

Terrific buy! VHF Transmitter-Receiver, 100-150 Mc., 4 channels. Xtal-controlled. Amplitude modulated voice. Complete with all 18 tubes, top rack and metal case. LIKE NEW!
SPECIALLY PRICED **P.U.R.**
\$32.50

SCR522 as above, exc. used

AN/ART-13 100-WATT XMTR

11 CHANNELS
200-1500 Kc
2 to 18.1 Mc

\$79.50
EXC. USED

complete with Tubes

Famous Collins Autotune Aircraft Transmitter. All CW, MCW. Quick change to any of ten preset channels or manual tuning. Speech amplifier/clipper uses carbon or magnetic mike. Highly stable, highly accurate VFO. Built in Xtal controlled calibrator. "PRT" is modulate 813 in final up to 90% class "B." A Real "HOT" Ham buy at our low price!
AN/ART-13 XMTR, as above, in LIKE NEW condition, with all tubes and crystal **\$89.50**

0-16 Low Freq. Osc. Coil for ART-13 **7.95**
24V Dynamotor for ART-13 **11.95**
We carry a complete line of spare parts for above.

Type	Input	Output	Exc. Used	BRAND NEW
DM-32A	28V 1.1A	250V .05A	2.45	4.45
DM-33A	28V 5A	575V .16A		
	28V 7A	540V .25A	4.45	7.50
DM-34D	12V 2A	220V .080A	4.15	5.50
DM-35	12V	625V .225A		19.50
DM-36	28V 1.4A	220V .080A	1.95	2.95
DM-42	28V 23A	515/1030/2/8 MA 215/260		12.50
DM-53A	28V 1.4A	220V .080A	3.75	5.45

PE-73C 28V 20A 1000V .350A 8.95 \$10.95
PE-86 28V 1.25A 250V .050A 2.75 3.85
PE10C Dynamotor 12/24V input. Brand New **7.95**
DM-37 DYNAMOTOR, Input 25.5 V DC @ 0.2 A. Out. 825 V DC @ 225 MA. BRAND NEW Each **\$3.25**

SCHEMATIC DIAGRAMS For most equipment on this page, each 65¢

Please include 25¢ Deposit with order—Balance C.O.D., or Remittance in Full. 50¢ Handling Charges on all orders under \$5.00. All shipments F.O.B. Our Warehouse, N.Y.C. All Merchandise subject to Prior Sale and Price Change.

G & G RADIO SUPPLY CO.

Telephone: CO 7-6053
77 Leonard St. New York 13, N. Y.

Printed in U.S.A.
CIRCLE NO. 183 ON READER SERVICE PAGE

FAMOUS BC-645 TRANSCEIVER

15 Tubes 435 to 500 MC

Can be modified for 2-way communication. Voice or code, on ham band 430-450 mc, citizens radio 460-470 mc. Fixed and mobile 430-460 mc. television experimental 470-500 mc. 15 tubes (tubes alone worth more than sale price): 4-7F7, 4-7HT, 2-7EB, 2-6F6, 2-955 and 1 WE-605. Brand covers 400 to 490 mc. Brand new BC-645 with tubes, less power supply in factory carton. Shipping weight 25 lbs. SPECIAL! **\$19.50**

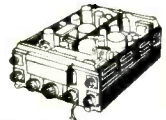

PE-101C Dynamotor, 12/24V input... **\$7.95**
UHF Antenna Assembly... **2.45**
Complete Set of 10 Plugs... **5.50**
Control Box... **2.25**

SPECIAL "PACKAGE" OFFER:
BC-645 Transceiver, Dynamotor and all accessories above, COMPLETE, BRAND NEW, While Stocks Last **\$29.50**

BC-344 RECEIVER, 150-1500 Kc, continuous tuning, 4-band, for 115 V, 60 Cycle AC. Excellent used, perfect working order, complete with tubes. **\$79.50**

BC-342 RECEIVER, 1.5 to 18 Mc. AC Only. Like New, complete with all tubes **\$79.50**

BC-348 SUPERHET RECEIVER 200 to 500 Kc and 1.5 to 1800 Mc. Voice Tone. CW. Self-contained dynamotor for 24 V DC. Exec. Used. Checked out. Like New. **\$89.50**
AC Power Supply **\$14.50**

BC-683 FM RECEIVER, 27 to 38.9 Mc., Complete with all tubes, exc. used. Checked out, in working order **\$49.50**

BC-603 FM RECEIVER, 35-50 Mc. Complete with all tubes, checked out. Like New **\$49.50**
Original Tech. Manual for above **\$ 3.15**

AC Power Supply for above, wired **\$12.95**
12-Volt Multiple Dynamotor Power Supply NEW **\$ 5.50**

BC1206-C BEACON RECEIVER

195 to 420 Kc. made by Satchel - Carlson. Works on 24-28 volts DC. 135 Kc. IF. Complete with 5 tubes. Size 4" x 4" x 6". Wt. 4 lbs. LIKE NEW **\$10.95**
USED, less tubes **\$4.95**

234-258 MC RECEIVER AN/ARR-2

BRAND NEW 11-tube UHF Tunable Receiver with schematic. Only a few at this low price. Complete with tubes. Exc. used **\$8.95**

ARB CRV 46151 NAVY AIRCRAFT RADIO RECEIVER 100 to 9000 KC 4 bands 100-200 550-1000 3-6 Mc. 6-4,650 Mc. 6-tube super with local and remote tuner, band change. Complete with tubes and dynamotor. Like new **\$39.50**
As Above, brand new **\$59.50**
Power Supply, 110 V AC wired **\$ 8.95**

ARC-3 RECEIVER!

Complete with All tubes Exc. Used. **\$21.50**
Like New **\$33.50**
Crystal-controlled 17-tube superhet, tunes from 100 to 156 MC. AM., on any 8 preselected channels. 28-volt DC power input. Tubes: 1-9002, 6-6AK5, 1-12SH7, 1-12SH7, 1-9001, 1-12H6, 2-12SN7, 1-12SL7, 1-12AG.
110 V A.C. Power Supply Kit for above 15.00
Factory Wired and Tested **19.95**

ARC-3 TRANSMITTER

Companion unit for above, tunes 100 to 156 MC on any 8 pre-selected channels, 9 tubes, crystal controlled, provides tone and voice modulation. 28 V DC power input. Complete with all tubes. 2-6G, Exc. Used **\$18.95**
Like New Condition Only **\$28.50**
ARC-3 PUSHBUTTON CONTROL BOX **\$5.95**

SCR-274 COMMAND EQUIPMENT

All Complete with Tubes	Type	Description	Used	Like New	BRAND NEW
	BC-453	Receiver			
		190-550 KC.	\$14.95	\$18.95	P.U.R.
	BC-454	Receiver 3-6 Mc.	\$15.95	\$19.50	P.U.R.
	BC-455	Receiver 6-9 Mc.	\$13.95	\$19.50	P.U.R.
	BC-946	Receiver 550-1500 Kc	Complete with all tubes, Brand New, in original packing		P.U.R.
		1.5 to 3 MC. Receiver Brand New			P.U.R.

110 Volt AC Power Supply Kit for all 274-N and ARC-5 Receivers. Complete with metal case, instructions, tested, ready to operate **\$8.95**
Factory wired, tested, ready to operate **\$12.50**
SPLINED TUNING KNOB for 274-N and ARC-5 RECEIVERS. Fits BC-453, BC-454 and others. Only **49¢**

2.1 to 3 Mc Transmitter, Brand New **\$12.95**
BC-457 TRANSMITTER—4.5-3 Mc. complete with all tubes and crystal, BRAND NEW **\$10.75**
Like New **\$7.95**
BC-458 TRANSMITTER—5.3 to 7 Mc. Complete with all tubes and crystal, BRAND NEW **\$12.95**
Like New **\$7.95**
BC-696 TRANSMITTER 3-4 Mc. Complete with all tubes and crystal. Like New **\$11.95**
BC-456 Modulator. USED **3.45** NEW **5.95**
ALL ACCESSORIES AVAILABLE FOR ABOVE

MICROPHONES Checked Out, Perfect

T-11 Carbon Hand Mike **3.15**
Exc. Used **\$4.45** Like New **\$7.95**
R5-38 Navy Type Carbon Hand Mike. Exc. Used **\$3.95** Like New **\$5.75**

HEADPHONES Checked Out, Perfect

Model	Description	Exc. Used	BRAND NEW
HS-23	High Impedance	\$2.79	\$4.95
HS-33	Low Impedance	3.15	5.95
HS-30	Low Imp. (leather wt.)	.90	1.65
H-16 U	High Imp. (2 units)	3.75	7.95

TELEPHONICS—600 ohm Low Impedance HEADSETS, BRAND NEW, PER PAIR **\$3.95**
CD-307A Cords, with PL55 plug and JK26 Jack Earphone Cushions for above—pair **.50**



How to replace top quality tubes with identical top quality tubes

Most of the quality TV sets you are presently servicing were designed around special Frame Grid tubes originated by Amperex. More and more tube types originated by Amperex are going into the sets you'll be handling in the future.

Amperex Frame Grid tubes provide 55% higher gain-bandwidth, simplify TV circuitry and speed up your servicing because their extraordinary uniformity virtually eliminates need for realignment when you replace tubes.

Amperex Frame Grid Tubes currently used by the major TV set makers include:

2ER5	2GK5	2HA5	3EH7	3GK5	3HA5	4EH7	4EJ7	4ES8	4GK5	4HA5	5GJ7
6EH7	6EJ7	6ER5	6ES8	6FY5	6GJ7	6GK5	6HA5	6HG8	7HG8	8GJ7	

If your distributor does not yet have all the Amperex types you need, please be patient—in some areas the demand keeps gaining on the supply.

Amperex Electronic Corporation, Hicksville, Long Island, New York 11802.



CIRCLE NO. 248 ON READER SERVICE PAGE

www.americanradiohistory.com

RCA Calibration Center's Resistance Standard — accuracy 0.0002%.

RCA Frequency Standard being used to calibrate an oscillator

Recertifying Calibration Tubes on the RCA Static Characteristic Standard.

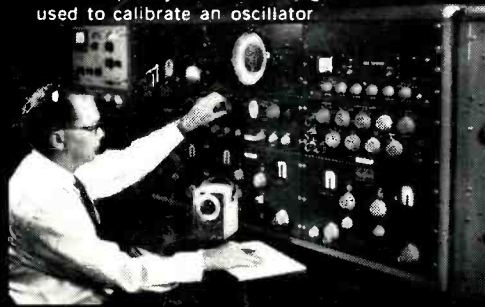
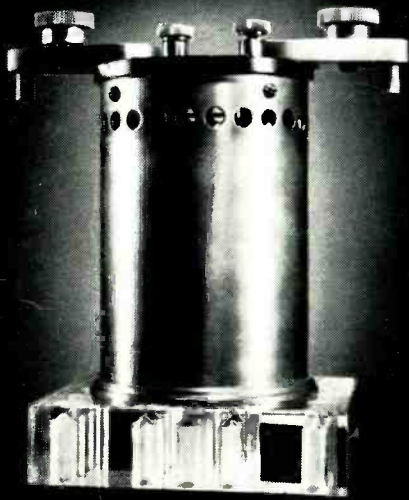

Calibrating portable Standard Cell on the RCA Primary Voltage Standard.

Voltmeter being calibrated on the RCA AC Voltage and Current Standard.

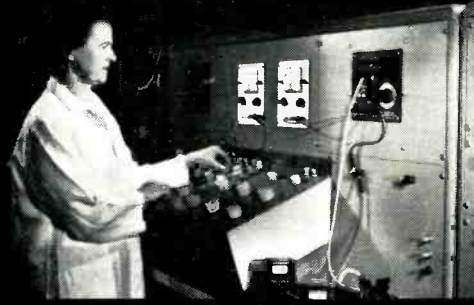

RCA ELECTRON TUBE RELIABILITY BEGINS HERE

DEPENDABLE PERFORMANCE



IS THE END RESULT

No reliability program for receiving tubes can be better than the test instruments and equipments it employs.

That's why RCA maintains the extensive Calibration Center in its Harrison, N. J., tube manufacturing plant (see photos above). The Center's responsibility: to assure that all measuring instruments and equipments, used in tube development from initial design through volume production, are accurate within rigidly specified limits. Here is how this is accomplished:

1 The Calibration Center's own equipments are calibrated by standards (voltage, resistance, capacitance, frequency) whose values are regularly checked against standards of the National Bureau of Standards.

2 Measuring instruments used in all research, design, development and application laboratories are calibrated directly from the Center's equipments.

3 Sets of Calibration Tubes, selected to cover every type and family of tubes, are measured in the Calibration Center and used by the Center's personnel to periodically verify the accuracy of all factory tube-testing equipments.

4 Sets of Control Tubes, evaluated under the supervision of the Calibration Center, constantly monitor the repeatability of factory tube-testing equipments.

Our Harrison Calibration Center is another example of the effort we make to assure the specified and dependable performance of every receiving tube that bears the emblem of RCA... performance that benefits you through customer satisfaction.

**SEE YOUR
AUTHORIZED RCA DISTRIBUTOR
FOR TOP-QUALITY
RCA RECEIVING TUBES**

RCA ELECTRONIC COMPONENTS AND DEVICES, HARRISON, N. J.



The Most Trusted Name in Electronics