

Electronics World

NOVEMBER, 1961

50 CENTS

**ADVANCES IN
MEDICAL ELECTRONICS**

**LISTENING TO STEREO
WITH HEADPHONES**

**SWR INDICATOR
FOR CB TESTS**

**TRANSISTOR
BIAS CIRCUIT DESIGN**

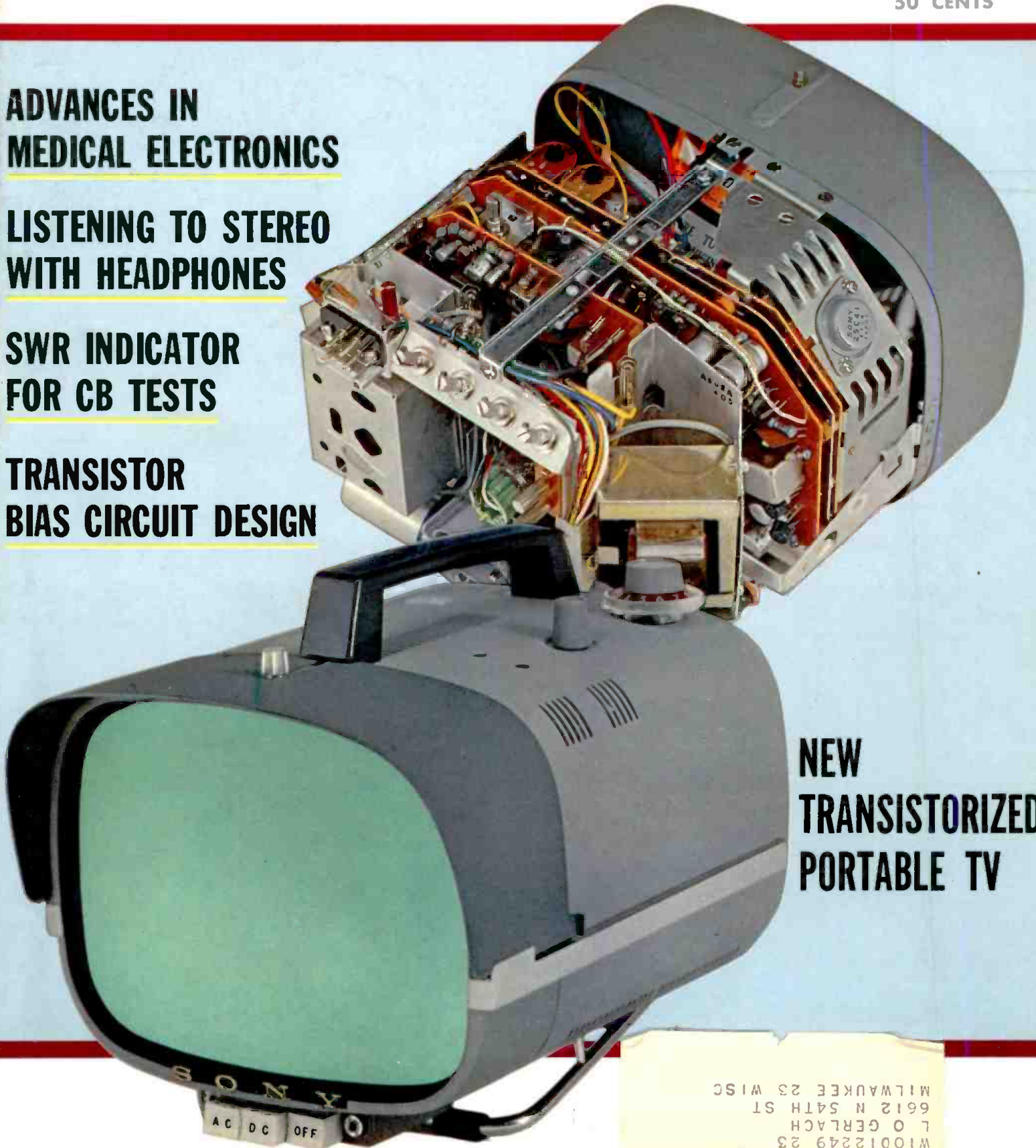

**NEW
TRANSISTORIZED
PORTABLE TV**

W10012249 23
L O GERLACH
6612 N 54TH ST
MILWAUKEE 23 WISC

"STRIP" and "STRAP"

...your 2 key words to profit protection

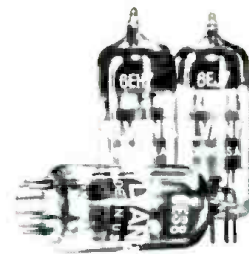

"Strip" is the new BIKINI CATHODE construction. "Strap" is the new FRAME GRID design. Both . . . developed by Sylvania . . . are creating new excitement, bringing new performance standards to TV sets.

BIKINI CATHODE—a precast film-strip of active materials is bonded, by a special Sylvania technique, *only* to the 2 flat surfaces of the cathode sleeve. Results: eliminates stray emission from the sides of the cathode for improved cutoff and noise characteristics, enhances tube-to-tube uniformity, minimizes grid-to-cathode arcing.

STRAP FRAME GRID—grid lateral wires are solidly supported by a sturdy, ladderlike construction enabling use of ultra-fine wire and tight spacing between grid and cathode. Results: reduces possibility of grid-cathode shorts, decreases microphonism and noise, provides unusually high Gm . . . higher performance than ever before available in tubes for TV sets.

Sylvania 4EH7 and 4EJ7, 6EH7, 6EJ7 and 6ES8 now feature the advantages offered by BIKINI "strip" CATHODES and STRAP FRAME GRIDS. So, when the time comes for replacement of those tube types, protect your service profits by installing SYLVANIA. At your distributor's now!

Electronic Tubes Division, Sylvania Electric Products Inc., 1740 Broadway, New York 19, N. Y.

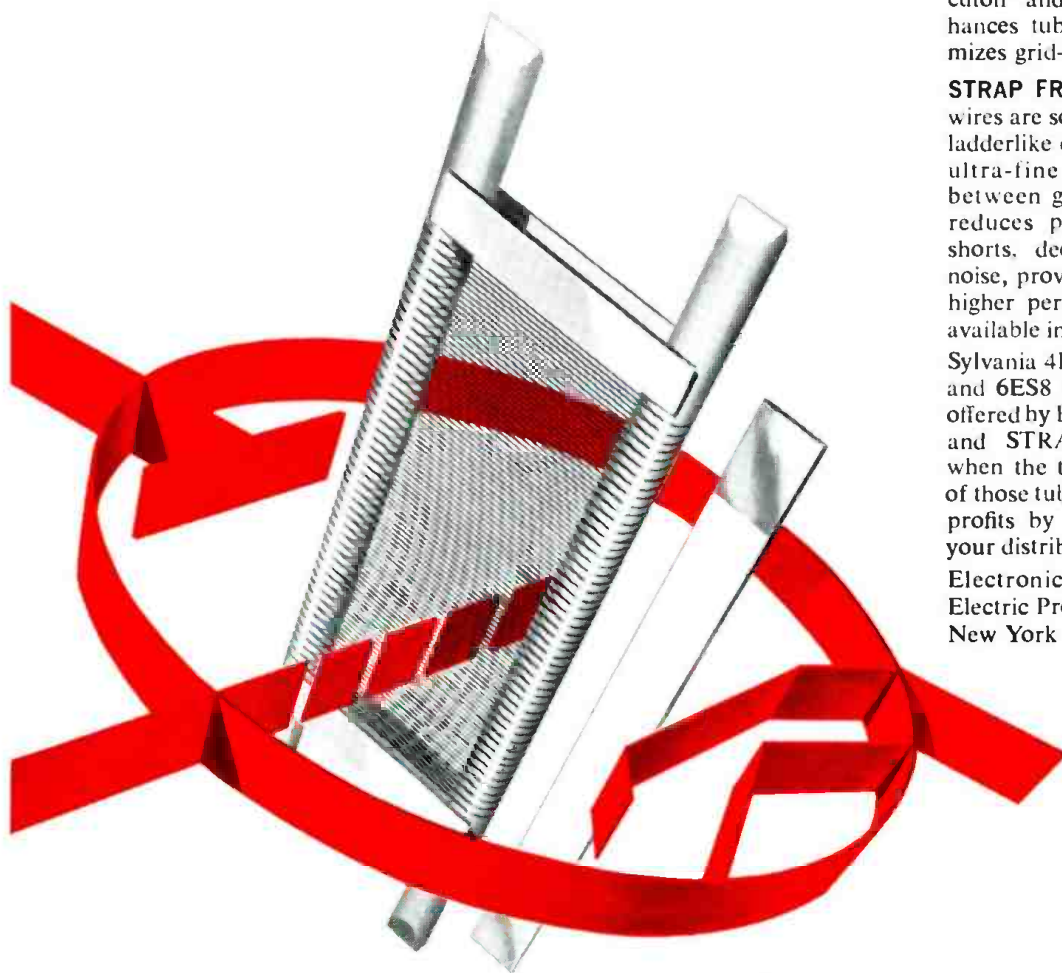

SYLVANIA

SUBSIDIARY OF

GENERAL TELEPHONE & ELECTRONICS



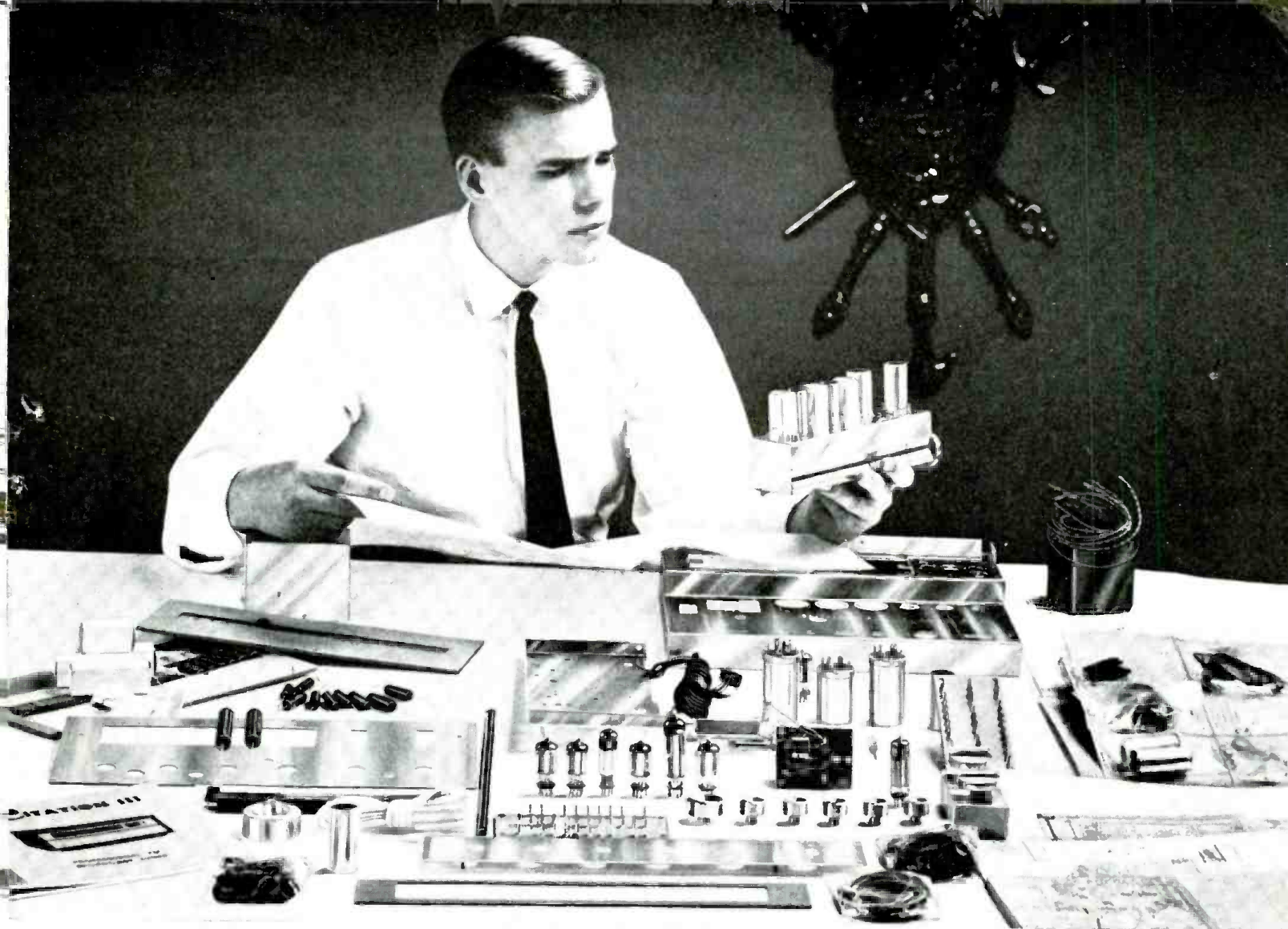

Can You Afford 15 Hours to Build The World's Best FM/Multiplex Tuner?

Fifteen hours. That's all it takes to build the world's best FM/Multiplex tuner.

Citation has the "specs" to back the claim but numbers alone can't tell the story. On its real measure, *the way it sounds*, Citation III is unsurpassed. And with good reason.

After years of intensive listening tests, Stew Hegeman, director of engineering of the Citation Kit Division, discovered that the performance of any instrument in the audible range is strongly influenced by its response in the non-audible range. Consistent with this basic design philosophy—the Citation III has a *frequency response three octaves above and below the normal range of hearing*. The result: unmeasurable distortion and the incomparable "Citation Sound."

The qualities that make Citation III the world's best FM tuner also make it the world's best FM/Multiplex tuner. The multiplex section has been engineered to provide wideband response, exceptional sensitivity and absolute oscillator stability. It mounts right on the chassis and the front panel accommodates the adapter controls.

What makes Citation III even *more* remarkable is that it can be built in 15 hours without reliance upon external equipment.

To meet the special requirements of Citation III, a new FM cartridge was developed which embodies every critical tuner element in one compact unit. It is completely assembled at the factory, totally shielded and perfectly aligned. With the cartridge as a standard and the two D'Arsonval tuning meters, the

problem of IF alignment and oscillator adjustment are eliminated.

Citation III is the *only* kit to employ military-type construction. Rigid terminal boards are provided for mounting components. Once mounted, components are suspended tightly between turret lugs. Lead length is sharply defined. Overall stability of the instrument is thus assured. Other special aids include packaging of small hardware in separate plastic envelopes and mounting of resistors and condensers on special component cards.

For complete information on all Citation kits, including reprints of independent laboratory test reports, write Dept. EW-11, Citation Kit Division, Harman-Kardon, Inc., Plainview, N. Y.

The Citation III FM tuner-kit, \$149.95; wired, \$229.95. The Citation III MA multiplex adapter—factory wired only, \$89.95. The Citation III X integrated multiplex tuner-kit, \$239.90; factory wired, \$319.90. All prices slightly higher in the West.

The
Citation
III



Build the Very Best **CITATION KITS** by

harman kardon

WORTH SHOUTING ABOUT!

NEW IMPROVED
MIGHTY MITE

Reaching New Peaks in
Performance, Portability and Price

MIGHTY MITE II

They're shouting from the hill tops. Technicians, engineers and test labs all say that the original Mighty Mite finds the tubes that large expensive testers miss. And now . . . here is the new improved Mighty Mite! Designed for the present and far into the future. Tests all of your present tubes plus the new RCA Nuvistors and Novars, GE Compactrons and Sylvania 10 pin tubes.

A complete tube tester that is smaller than a portable typewriter yet outperforms testers costing hundreds of dollars. A real money maker for the serviceman and a trusty companion for engineers, maintenance men and experimenters.

Even though the Mighty Mite weighs less than 8 pounds, new circuitry by Sencore enables you to use a meter to check grid leakage as high as 100 megohms and gas conditions that cause as little as one half microamp of grid current to flow. Then too, it checks for emission at operating levels and shorts or leakage up to 120,000 ohms between all elements. This analytical "stethoscope" approach finds troublesome tubes even when large mutual conductance testers fail. And it does all this by merely setting four controls labeled A, B, C, & D.

Check these plus Sencore features: Meter glows in dark for easy reading behind TV set • Stainless steel mirror in ad-

justable cover for TV adjustments • Rugged, all steel carrying case and easy grip handle • Smallest complete tester made, less than one foot square. Mighty Mite II will test every standard radio and TV tube that you encounter, nearly 2000 in all, including foreign, five star, auto radio tubes (without damage) plus the new GE Compactrons, RCA Nuvistors and Novars and Sylvania 10 pin tubes.

Mighty Mite II also has larger, easy-to-read type in the set-up booklet to insure faster testing. Why don't you join the thousands of servicemen, engineers, and technicians who now own a Mighty Mite tube tester? Tube substitution is becoming impossible and costly with nearly 2000 tubes in use today. Ask your authorized Sencore Distributor for the New Improved Mighty Mite. Size: 10 1/4" x 9 1/4" x 3 1/2" Wt. 8 lbs.

MODEL TC114

Sencore Sam says . . . "They all agree . . . the Mighty Mite is the real answer for the man on the go."



SENCORE

ADDISON, ILLINOIS

67⁵⁰
DEALER NET

Remember . . . there is
only one Mighty Mite

CONTENTS

INDUSTRIAL

Transistor Bias Circuit Design	Gene L. Jackson	42
Recent Developments in Electronics		44
Computer Registers and Accumulators	Ed Bukstein	54

TEST EQUIPMENT

The "Trans-Select" Audio Generator	Stanley E. Bammel	46
Product Test Report (RCA Model WV-120A Power-Line Monitor, Eico Model 260 A.C. Volt-Watt Meter) EW Lab Tested		104

HI-FI AND AUDIO

N. Y. Hi-Fi Show & FM Multiplex (Editorial)	W. A. Stocklin	6
Product Test Report (University "Medallion XII" Speaker System, Fisher Model X-1000 Stereo Amplifier) EW Lab Tested		20
Stereo FM Multiplex Adapter Circuits	Milton S. Snitzer	37
Listening to Stereo with Headphones	Steven Hahn	48
Phasing the Stereo System	Ralph Glasgal	52
Servicing Tape-Recorder Oscillators	Herman Burstein	58
Impedance Matching in Public-Address Systems— Part 3 Constant Voltage Method	Mortimer S. Sumberg	61
British Audio Trends	Patrick Halliday	76
Record & Reel Revue	Bert Whyte	81
Squelch Circuit for Wireless Intercom	L. M. Dezettel	91

GENERAL

Advances in Medical Electronics	Walter H. Buchsbaum	33
A Personal, Portable TV (Cover Story)		38
Parallel-Resistor Chart	Jim Kyle	41
New Motorola Color CRT		66
Aluminum Dials and Nameplates	Herbert Friedman	94
Card Index File for EW Articles	Raymond B. Rawlinson	107
Voltage Quiz	Joe Terra	109

COMMUNICATIONS

Standing-Wave Indicator for CB Testing	Harold Reed	51
Citizens Band Crystal Checker	Harold Reed	57

MONTHLY FEATURES

Letters from Our Readers		12
Mac's Service Shop	John T. Frye	60
Service Industry News		97
Technical Books		112
Electronic Terminology	Margaret LeFevre	117
New Products and Literature for Electronics Technicians		122
(For information on Next Month's Features, see page 4)		

Publisher
PHILLIP T. HEFFERNAN

Editor
WM. A. STOCKLIN, B. S.

Technical Editor
MILTON S. SNITZER, W2QYI

Service Editor
SIDNEY C. SILVER

Associate Editor
P. B. HOEFER

Editorial Consultant
OLIVER READ, D.Sc., W4TWV

Industrial Consultant
WALTER H. BUCHSBAUM

Art Editor
MILTON BERWIN

Art and Drafting Dept.
J. A. GOLANEK

Advertising Sales Manager
LAWRENCE SPORN

Advertising Service Manager
ARDYS C. MORAN



ZIFF-DAVIS PUBLISHING COMPANY
Editorial and Executive Office
One Park Avenue
New York 16, New York
ORegon 9-7200

MIDWESTERN and CIRCULATION
OFFICE
434 South Wabash Avenue
Chicago 5, Illinois
WAbash 2-4911
Midwestern Advertising Manager
Gilbert J. Jorgenson

WESTERN OFFICE
9025 Wilshire Boulevard
Beverly Hills, California
CRestview 4-0265
Western Advertising Manager
Bud Dean

FOREIGN ADVERTISING
REPRESENTATIVE
D. A. Goodall Ltd., London, England

November, 1961

PREPARE NOW FOR A
SECURE AND PROFITABLE CAREER
IN ONE OF THESE GROWING FIELDS
OF ELECTRONICS



Learn with proven home study courses from the Philco Technological Center. Get practical knowledge with courses developed by specialists in electronics and training... men who know the kind of knowledge you need.

Choose from five courses:

1. Semiconductors—Transistor Principles and Practices. Learn theory, construction, applications of all types of transistors.
2. Introduction to Analog Computers—Covers theories and fundamentals of analog computers.
3. Analog Computer Systems (Advanced Level)—Covers the analog system concepts and methods.
4. Automatic Digital Computers—Digital computer theory, maintenance, installation, basic programming.
5. Programming for Digital Computers—Covers encoding, set-up and operation.

**MAIL COUPON TODAY
FOR FREE INFORMATION**

Technological Center
P.O. Box 4730
Philadelphia 34, Penna.

E-5

I'm interested in Semiconductors Analog computers Digital computers Computer programming. Please send free information to:

Name _____
Address _____
City _____ Zone _____
State _____

PHILCO

P.O. Box 4730, Philadelphia 34, Pa.

Electronics World



**COMING
NEXT MONTH**

THE SILICON SOLAR CELL

A perpetual primary power source for the space age, this device makes possible direct, instantaneous, and efficient conversion of the sun's energy into useful electrical power.

RELIABILITY—SPACE AGE REQUIREMENT

As much time is often spent to improve reliability as to produce the equipment. Definitions and illustrations of the language of reliability engineers and technicians is included.

TESTING TAPE RECORDER

A summary of the various tests used to check the operation and performance of tape recorders.

DOUBLE-CHAMBER SPEAKER ENCLOSURE

Construction details on an experimental enclosure that will extend the bass response of almost any good 8-inch loudspeaker down to a usable 35 cps.

U.H.F. NUVISTOR TUNER

A newly developed RCA nuvistor makes possible a front end with high gain and low noise, plus greater reliability than can be obtained with conventional u.h.f. triodes.

INDUSTRIAL X-RAY APPARATUS

Many tests on materials can be made in

no other way or no better way than by radiographic examination. The variety of methods and equipment are covered, along with details on how such equipment works.

ELECTRICALLY OPERATED SWITCHES

This category ranges broadly from the simple circuit breaker to types used in "electronic brains." Among the devices used are relays, vacuum tubes, thyristors, and transistors. The various types and their characteristics are covered in this article, along with details on their application.

TRANSISTORIZED CB CONVERTER

A printed-circuit, two-transistor converter for the car's broadcast receiver permits CB signals to be picked up.

MODULATED 10-KC. CALIBRATION OSCILLATOR

Construction of an accurate oscillator that will provide tone-modulated check points on communications receivers.

All these and many more interesting and informative articles will be yours in the December issue of ELECTRONICS WORLD... on sale November 16th

ZIFF-DAVIS PUBLISHING COMPANY

William B. Ziff
Chairman of the Board (1946-1953)

William Ziff
President

W. Bradford Briggs
Executive Vice President

Hershel B. Sarbin
Vice President and General Manager

M. T. Birmingham, Jr.
Vice President and Treasurer

Robert P. Breeding
Circulation Director

Charles Housman
Financial Vice President

Member
Audit Bureau of
Circulations



Net Paid Circulation 235,895

Radio & TV News • Radio News • Radio-Electronic Engineering Trademarks Reg. U.S. Pat. Off.
Copyright © 1961 by Ziff-Davis Publishing Company. All rights reserved.

SUBSCRIPTION SERVICE: All subscription correspondence should be addressed to Electronics World, Circulation Department, 434 South Wabash Avenue, Chicago 5, Illinois. Please allow at least six weeks for change of address. Include your old address, as well as new—enclosing if possible an address label from a recent issue.

EDITORIAL CONTRIBUTIONS must be accompanied by return postage and will be handled with reasonable care; however publisher assumes no responsibility for return or safety of art work, photographs, or manuscripts.

ELECTRONICS WORLD

GET YOUR First Class Commercial F.C.C. LICENSE IN 12 WEEKS!

Is the course proven?

A high percentage of our fulltime resident students get their 1st class licenses within 12 weeks from the time they start the course. Intensive FCC license training is our specialty – not just a sideline.

Is the course complete?

The Grantham course covers all the required subject matter completely. Even though it is planned primarily to lead directly to a first class FCC license, it does this by TEACHING you electronics.

Is the course “padded”?

The streamlined Grantham course is designed specifically to prepare you to pass certain FCC examinations. All of the instruction is presented with the FCC examinations in mind. If your main objective is an FCC license and a thorough understanding of basic electronics, you want a course that is right to the point – not a course which is “padded” to extend the length of time you’re in school. The study of higher mathematics or receiver repair work is fine if your plans for the future include them, but they are not necessary to obtain an FCC license.

Is it a “coaching service”?

Some schools and individuals offer a “coaching service” in FCC license preparation. The weakness of the “coaching service” method is that it presumes the student already has a knowledge of technical radio. On the other hand, the Grantham course “begins at the beginning” and progresses in logical order from one point to another. Every subject is covered simply and in detail. The emphasis is on making the subject easy to understand. With each lesson, you receive an FCC type test so you can discover daily just which points you do not understand and clear them up as you go along.

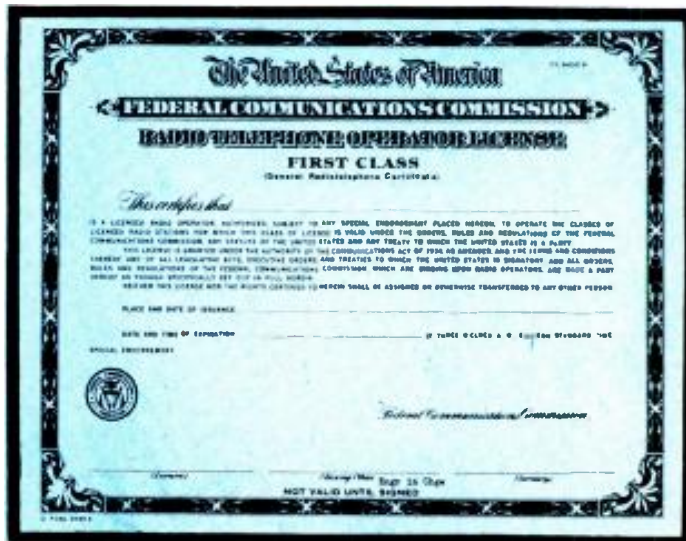

Is the course guaranteed?

The now famous Grantham Guarantee protects your investment. When such “insurance” is available at no extra cost, why accept less?

Is it a “memory course”?

No doubt you’ve heard rumors about “memory courses” and “cram courses” offering “all the exact FCC questions.” Ask anyone who has an FCC license if the necessary material can be memorized. Even if you had the exact exam questions and answers, it would be much more difficult to memorize this “meaningless” material than to learn to understand the subject. Choose the school that teaches you to thoroughly understand – choose Grantham School of Electronics.

THE GRANTHAM FCC License Course in Communications Electronics is available by CORRESPONDENCE or in RESIDENT classes.

Grantham Schools

Accredited by the National Home Study Council

LOS ANGELES

1505 N. Western Ave.
Los Angeles 27, Calif.
(Phone: HO 7-7727)

SEATTLE

408 Marion Street
Seattle 4, Wash.
(Phone: MA 2-7227)

KANSAS CITY

3123 Gillham Road
Kansas City 9, Mo.
(Phone: JE 1-6320)

WASHINGTON

821 - 19th Street, N.W.
Washington 6, O. C.
(Phone: ST 3-3614)

MAIL COUPON NOW — NO SALESMAN WILL CALL →

(Mail in envelope or paste on postal card)

To: **GRANTHAM SCHOOL OF ELECTRONICS**

1505 N. Western • 408 Marion • 3123 Gillham Rd. • 821-19th NW
Los Angeles • Seattle • Kansas City • Washington

Please send me your free booklet telling how I can get my commercial F.C.C. license quickly. I understand there is no obligation and no salesman will call.

Name _____ Age _____

Address _____

City _____ State _____

I am interested in: Resident Classes
 Home Study

16-S

NOW

Ready for FM-MPX Stereo!

Magnecord 748

(3¼ or 7½ IPS)

Olympian

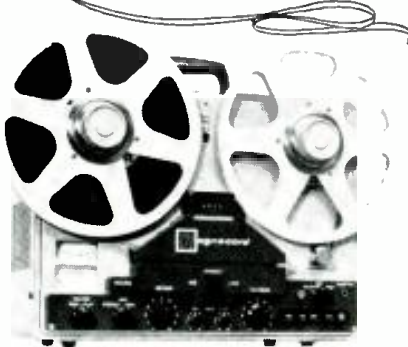

TOPS!/// the only word that adequately describes the new Magnecord Olympian — the latest of an illustrious line of tape recorders. As the proud owner of a distinguished 748, you will indeed be king of the wonderful world of hi-fi or stereo.

Capture all the intricate tonal shadings of your favorite FM music and preserve your valuable records—stereo or mono—for all time with the Olympian... it's different... it's best... it's ready for FM-Multiplex Stereo.

SOLD ONLY THROUGH FRANCHISED MAGNECORD DEALERS

For the dealer nearest you... write



Magnecord

SALES DEPARTMENT

MIDWESTERN INSTRUMENTS, INC.

manufacturers of electronic data acquisition instruments

P. O. BOX 7509

TULSA 18, OKLAHOMA



... for the Record

By **W. A. STOCKLIN**
Editor

N.Y. HI-FI SHOW & FM MULTIPLEX

WE have just returned from a preview of the sixth annual New York High-Fidelity Show sponsored by the Institute of High Fidelity Manufacturers, Inc. There is no doubt that this is the largest such public event in the country and, according to official figures, over thirty thousand visitors attended the four-day session. They had an opportunity of seeing and hearing over six-million-dollars worth of the most up-to-date designs of high-fidelity component equipment.

This show and the one run on the West Coast, alternating between Los Angeles and San Francisco, are really much more than just showcases for the display of electronic equipment. The field of high-fidelity and music reproduction in general is unique in that almost all interested individuals have many questions to ask and some problems to be solved before complete satisfaction is obtained. Nowhere else in the world is there such a congregation of key hi-fi personnel, including many company presidents, owners, chief engineers, and technical people, who can answer these questions and solve these problems.

The high-fidelity industry is a relatively small and young industry. Therefore, many of the original pioneers, who over the past years have devoted their entire efforts to quality sound reproduction, can be found in attendance. Many individuals no doubt find great enjoyment in being able to talk personally with such men as Rudy Bozak, Avery Fisher, Dave Hasler of *Dynaco*, Saul Marantz, Hermon Scott, George Silber of *Rek-O-Kut*, Walter Stanton of *Pickering*, Ed Villechur of *Acoustic Research*, Paul Weathers, and many others. Most of these individuals started out as engineers and, although at present most of them operate their own companies, they are still actively engaged in designing and improving high-fidelity equipment.

The highlight of the show was, without a doubt, stereo FM multiplex. WDHA of Dover, New Jersey, actually transmitted FM multiplex direct from the New York Trade Show Building and its programs were carried via closed-circuit transmission lines from room to room. In addition, there were on-the-air stereo FM multiplex broadcasts from WQXR, New York; WLIR, Garden City, Long Island; as well as WDHA. There are at present over fifteen cities throughout the country that have stations on the air but for those in the New York area, this was their first opportunity of hearing this new form of musical entertainment.

We are fortunate in that we had heard stereo FM multiplex previously. We had heard it in Los Angeles, Chicago, and now in New York. In general, we were favorably impressed with what we heard. There were programs of excellent quality, with good separation and with no more distortion than normally encountered on monophonic transmissions. We do know that on some occasions across the country, transmissions have not been as good as expected, and that some of the FM stations have had trouble with their transmitting equipment. This is certainly no criticism nor a reflection on the stations themselves. Stereo FM multiplex is a new medium and like anything that is new, problems do exist at the beginning, but there is no doubt in our mind that these can be solved and eventually all FM stereo transmissions will be superb.

Unfortunately, there is an economic conflict prevailing behind the broadcast scene. We have heard comments from several FM broadcasters threatening to eliminate all stereo transmissions unless they are financed through commercial advertising by manufacturers of high-fidelity equipment. We can fully appreciate that the economic situation in any industry or business is an important factor and one that should be considered at all times. There certainly would be no criticism should a station decide that such an endeavor would be economically unsound in the first place and not go on the air with stereo at all. But once a station is committed to the installation and operation of such equipment, we feel that they should not take it upon themselves to discontinue such programs. There is negligible cost in continuing FM stereo transmission and there is definitely no deterioration of the monophonic programs. Also, there is no disservice to listeners of stereo programs who have mono equipment. There is, in fact, no reason to discontinue such programs. After all, every station when accepting an FCC license to broadcast, in essence promises to serve his community and the best interests of its listeners.

At present, few of the listening public have multiplex equipment. Once this situation changes and more multiplex equipment is in the hands of the public, FM stations will be forced by popular demand to supply the programs desired. For those stations which continue to keep the good will of their listeners from the beginning, rewards will accrue in the form of greater loyalty on the part of listeners and, in time, advertising will provide more support. ▲

how to get a Commercial FCC LICENSE

An FCC License, Or Your Money Back!

Completion of the Master Course (both Sections) will prepare you for a First Class Commercial Radio Telephone License with a Radar Endorsement. Should you fail to pass the FCC examination for this license after successfully completing the Master Course, you will receive a full refund of all tuition payments. This guarantee is valid for the entire period of your enrollment agreement.

Get This Handy Pocket Electronics Data Guide Folder

Free



Puts all the commonly used conversion factors, formulas, tables, and color codes at your fingertips. Yours absolutely free if you mail the coupon today. No further obligation.

**TO GET THIS FREE GIFT
MAIL COUPON TODAY**

Cleveland Institute Training Results in Job Offers Like These...

ELECTRONICS TECHNICIANS:

RCA has positions for technicians, field engineers & instructor technicians to install, maintain, and teach military radar, communications, and fire control equipment. Company benefits.

RADIO OPERATORS & TECHNICIANS

American Airlines—Chicago, Detroit, St. Louis, Cincinnati and Cleveland — has openings for radio operators and radar mechanics. Operators must have a 2nd class FCC license and ability to type 40 wpm. Many company benefits.

CLEVELAND INSTITUTE OF ELECTRONICS

1776 E. 17th St.
RN59

Desk RN59

Cleveland 14, Ohio

November, 1961



good training
doesn't cost . . .
it pays!

get all three FREE!

Increase Your Technical Knowledge

Get a government license plus an understanding of such electronic applications as computers . . . industrial electronics . . . radar . . . communications . . . and many more.

Sorry—Not For Beginners

Please inquire only if you really want to get ahead and to add to what you have already learned in school, in the service, or on the job. Some previous schooling or experience in electronics, electricity, or related fields is necessary for success in Cleveland Institute programs.

Accredited by the National Home Study Council

Cleveland Institute of Electronics

Desk RN59 1776 E. 17th St. Cleveland 14, Ohio

Please send Free Career Information prepared to help me get ahead in Electronics. I have had training or experience in Electronics as indicated below.



- Military
- Radio-TV Servicing
- Manufacturing
- Amateur Radio

In what kind of work are you now engaged?

Name _____ Age _____

Address _____

City _____ Zone _____ State _____

- Broadcasting
- Home Experimenting
- Telephone Company
- Other _____

In what branch of Electronics are you interested?

RN59

Meet...and beat...the fringe-area challenge with the new **CHANNEL MASTER**

Channel Master's world-famous Antenna Development Laboratory has done it again! By using a brand new concept in antenna design...

PROPORTIONAL ENERGY ABSORPTION...

Channel Master meets the fringe area challenge with the most powerful TV antenna ever produced...the Crossfire!

Proportional Energy Absorption works like this!

Each Crossfire element has a predetermined impedance, at each frequency, which determines its degree of energy absorption. This impedance, governed by the taper and spacing of the dipoles, decreases with the distance from the feed point. Each successive element therefore absorbs a larger percentage of the available energy.

Since the amount of available energy decreases as it progresses along the length of the antenna, each element, by absorbing a *larger* percentage, absorbs approximately the *same amount* of energy as the other elements in the array.

This means that the Crossfire...unlike other antennas...has a large group of driven dipoles actively working to increase gain *on every channel*...on both low and high bands.

More working elements provide more picture power! This is the key to the remarkable performance of the Crossfire.

Revolutionary New Dual Dipole System

Each parasite reverses phase of high band current on the adjacent low band dipole, so that it operates as three driven half-wave high band elements.

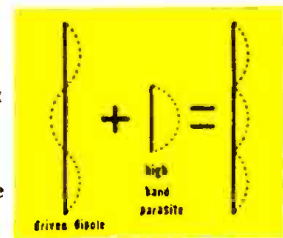

... And the Crossfire is Gold!

The Crossfire's performance is matched only by its beauty. Channel Master's exclusive E*P*C Process gives the antenna a lustrous golden coating that enriches its appearance and protects it for years against corrosion.

Channel Master's E*P*C Process is *not* anodizing! The disadvantage of anodizing is that the anodized film is an electrical insulator, and must be removed by *abrasion* wherever metal-to-metal contact is required. Therefore, anodized antennas have no surface protection on the very parts that need it most!

THERE'S A CROSSFIRE TO MEET EVERY RECEPTION PROBLEM!

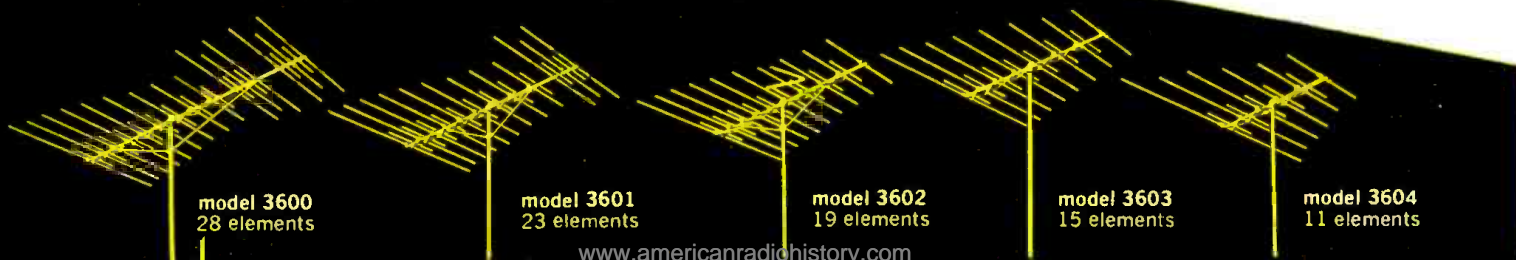

model 3600
28 elements

model 3601
23 elements

model 3602
19 elements

model 3603
15 elements

model 3604
11 elements

GOLDEN Crossfire

Transposed Feed Line Means Cleaner Gain!

Extremely high front-to-back ratios are accomplished by a Transposed Feed Line, from which the Crossfire gets its name. This feed line is transposed between each successive pair of elements. As a result, the radiations from each pair of adjacent elements are self-cancelling because they are 180° out of phase. This carefully engineered system is so efficient that the Crossfire needs no parasitic reflector element.

Because of these high front-to-back ratios, the Crossfire provides *cleaner* gain than any other all-channel antenna. It pulls in the signal you want while rejecting unwanted interference of every type (auto ignition systems, electrical noise, other TV signals, etc.) from both side and rear. See unre-touched photo of actual horizontal polar pattern.

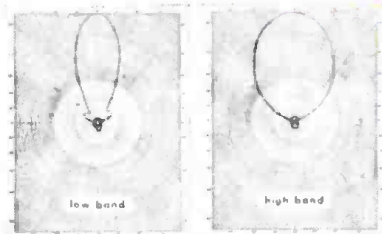
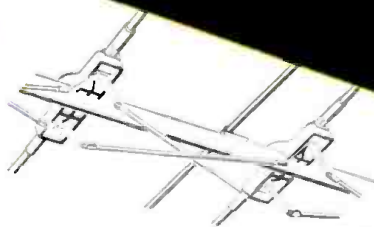

The Crossfire is the only antenna you can sell with full confidence that it will outperform anything your customer is now using!

For still more power...add the new

CHANNEL MASTER JETRON

Antenna-mounted transistorized signal amplifier and set coupler
Most effective...most dependable...lowest noise figure!

model 0020

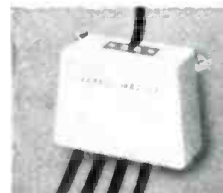
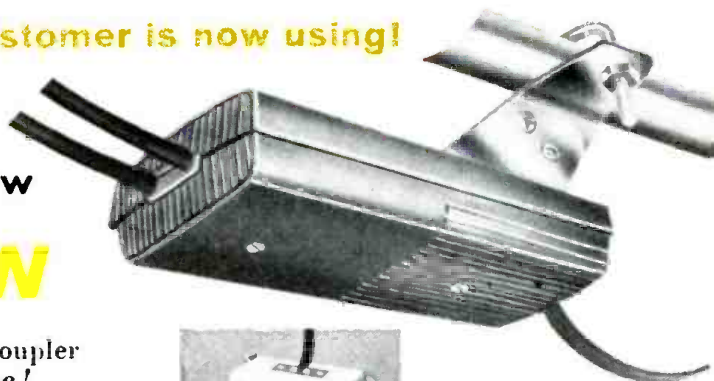

Power supply (with built-in 4-set coupler) is conveniently located in the home. Compact, only 5" x 3 3/4" x 1 3/4".

• Patent Pending

Copyright © 1961 Channel Master Corp.

model 3605
7 elements



YOU ARE NOW LOOKING AT 20 DIFFERENT MICROPHONES

MODULAR MICROPHONES!*

Another exclusive concept that makes UNIVERSITY microphones better.

20 microphones? Yes—for any **one** of University's MODULAR MICROPHONES can provide at least **five** different methods of operation! University has inaugurated a new era in microphone design and construction—**professional** microphones offering **total interchangeability** with every conceivable type of adapter! This permits long-term savings as well as improved versatility, for you can add suitable adapters as your microphone requirements change—**without buying additional microphones**. You need never compromise quality to meet a price.

And it works as simply as this: equipped with a minimum of basic University MODULAR MICROPHONES, any one of University's interchangeable adapters may be chosen to complete the microphone assembly you require...with or without switches, for cables with and without quick-disconnect plugs, for screw-on or slide-on floor and desk-stand operation. And you can make **instant** impedance changes without tools, rewiring or soldering!

*TRADEMARK

For the complete story on University's new line of omni-directional, cardioid and lavalier MODULAR MICROPHONES, send for the free 16-page brochure. Write: Desk S-11M University Loudspeakers, Inc., 80 S. Kensico Ave., White Plains, New York.

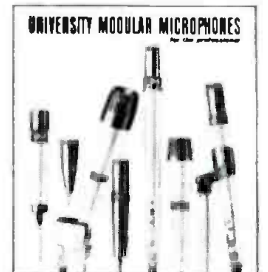

ELECTRONICS WORLD



"a CREI home study program helped me become an electronics engineer"

—Robert T. Blanks

Engineer, Research & Study Division
Vitro Laboratories, Silver Spring, Md.
Division of Vitro Corporation of America

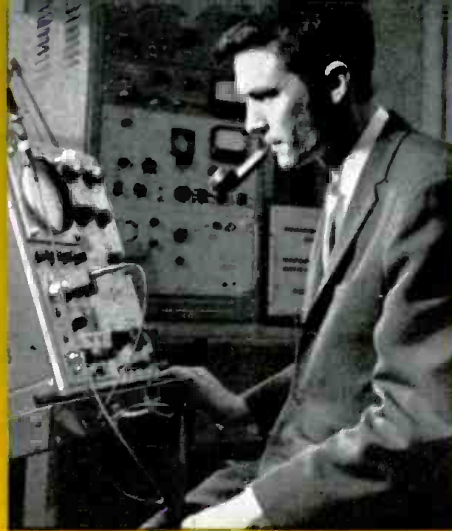

"THROUGH A CREI HOME STUDY PROGRAM I learned the practical theory and technology I needed to become a fully-qualified engineer—not a 'handbook' engineer, either—and I did it while I was on the job," says Robert T. Blanks. Today thousands of electronics personnel—engineering technicians, engineers, administrators, executives—attribute present high salaries and positions to home study of CREI Programs in Electronic Engineering Technology.



DEMAND FOR CREI-PREPARED MEN today far exceeds the supply—has exceeded the supply for many years. Designed to prepare you for responsible positions in electronics, CREI Home Study Programs are the product of 34 years of experience, include the latest advancements in the field. CREI's curricula was among the first accredited by the Engineers' Council for Professional Development. Here Blanks discusses CREI with Director Wayne G. Shaffer of Vitro Labs.



WHEN YOU ENROLL IN A CREI Home Study Program, you join more than 20,500 students working in electronics in all 50 states and most countries of the free world. One CREI Program helped Robert Blanks become an Electronics Engineer. Another helped Robert I. Trunnell become an Electronics Technician. While John H. Scofield—a Mathematician—is enrolled in still a different CREI Program relating mathematics to electronics. All work at Vitro Laboratories.



YOUR LIVING IS BETTER when you prepare for—and get—desired promotions through CREI Home Study. CREI alumnus Blanks is understandably proud of his home in a comfortable neighborhood. The positions of CREI-prepared men in such companies as Pan American Airways, Federal Electric Corporation, The Martin Company, Northwest Telephone Company, Mackay Radio, Florida Power and Light and many others attest to the high calibre of CREI Programs.



YOUR WHOLE FAMILY BENEFITS. Engineer Blanks' growing family pitched in to provide free time for his CREI Home Study. Now they share his success. We invite you to check the thoroughness and completeness of CREI Home Study Programs in Electronic Engineering Technology in the catalog provided on request. For those who can attend, CREI maintains a Residence School in Washington, D. C. also offering ECPD Accredited Technical Institute Curricula.

INDUSTRY-RECOGNIZED CREI HOME STUDY PROGRAMS PREPARE YOU FOR INCREASED RESPONSIBILITIES, HIGHER-PAYING POSITIONS IN ELECTRONICS.

REQUIREMENTS FOR ENROLLMENT

Pre-requisite is a high school education or equivalent plus basic electronics training and/or practical electronics experience. (Electronics experience and/or training not necessary for Residence School.) If you qualify, send for the latest CREI catalog at no cost. Veterans may apply under the G.I. Bill. If you're doubtful about your qualifications, let us check them for you. Mail coupon or send your qualifications to: The Capitol Radio Engineering Institute, Dept. 1111-H, 3224 Sixteenth St., N.W., Washington 10, D. C.



MAIL COUPON TODAY FOR FREE 58-PAGE BOOK

THE CAPITOL RADIO ENGINEERING INSTITUTE

ECPD Accredited Technical Institute Curricula—Founded 1927
Dept. 1111H, 3224 Sixteenth St., N.W., Washington 10, D. C.



Please send me details of CREI Home Study Programs and Free Book, "Your Future in Electronics and Nuclear Engineering Technology." My qualifications are noted to obtain immediate service.

- CHECK FIELD OF GREATEST INTEREST:**
- Servo and Computer Engineering Technology
 - Electronic Engineering Technology
 - Aero & Navigational Engineering Technology
 - Automation and Industrial Electronic Engineering Technology
 - Nuclear Engineering Technology

Name.....Age.....
 Address.....
 City..... Zone..... State.....
 Employed by.....
 Type of present work.....
 Education: Years High School..... Other.....
 Electronics Experience.....
 Check: Home Study Residence School G.I. Bill

Quality you
can count on
**EVERY
SINGLE TIME!**

AEROVOX CERAMIC CAPACITORS

- Bypass-Coupling
- General Purpose
- Hi-Voltage
- Temperature Compensating

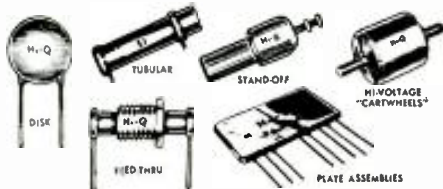

Top quality components to assure top quality performance every single time! That's the whole story "in a nut shell" when it comes to Aerovox ceramic capacitors.

Your Aerovox Distributor offers you a complete line of rugged, dependable ceramic capacitors in every case style for your every replacement need. Choose from a wide selection of disk types for bypass-coupling, general purpose, hi-voltage, and temperature compensating applications.

Top quality Aerovox tubular types are available from general purpose to hi-voltage to temperature compensating units. Vibrator-buffer capacitors are also available for use as replacements where original equipment uses ceramic buffers. And for those special applications you have feedthru, standoff, and high-voltage cartwheels, as well as plate assemblies, in all sizes and values.

save time...boost profits...

BUY 'EM BY THE KIT

Disk ceramic kits AK-200 and AK-201HS, containing fastest moving values in special metal drawers, are available now. The drawers may be stacked when additional kits are purchased. Pay only for the capacitors and the handy file drawers are yours free.

Yes, your local Aerovox Distributor is your one-stop source of supply. Call on him for all your capacitor needs...it pays to use Aerovox!



AEROVOX CORPORATION
DISTRIBUTOR DIVISION NEW BEDFORD, MASS.

LETTERS

FROM OUR READERS

ADD A.F.C. TO TV SETS

To the Editor:

I have just finished reading the article "Add A. F. C. to TV Sets" in the July issue of your magazine. I do not see how the circuit given for adding a.f.c. can possibly work on any TV except very old ones with split-sound system.

All the TV's that I have seen made for the last seven or eight years have used an intercarrier sound system where the discriminator is tuned to 4.5 mc. No matter where the fine tuning is set, the sound section still receives a 4.5-mc. signal. In other words, in a properly operating set, the discriminator is tuned precisely regardless of the setting of the fine-tuning control so there can be no correction voltage taken off the discriminator since there is just no such voltage there.

IRVIN B. REA
Mt. Morris, New York

When we ran Author Wilson's "Add A.F.C. to TV Sets," we were aware that, in intercarrier receivers, the signal to the sound detector is held to 4.5 mc. even when the front-end oscillator is substantially mistuned. Nevertheless, we also knew that his unit, which we tried, works anyhow. Here's why:

Level of the detector-derived d.c. voltage used for control depends, not on frequency shift of the intercarrier signal, but on changes in its amplitude. The latter, in turn, depends on the relative amplitudes of the two i.f. signals, audio and video, that are heterodyned to produce it. Fortunately, this relationship, which does vary with the tuning condition, is linear enough to make the d.c. voltage usable for oscillator correction.—Editors.

* * *

ELECTRONIC AIR PURIFIERS

To the Editors:

Thank you for the fine article about electronic air purifiers in your July issue. The author is to be congratulated on his cautious attitude toward the claims for health benefits from negative ionization.

By contrast, another publication went rather overboard recently in accepting as reportable fact the most extravagant "findings" of investigators on the effects of ionization.

This sort of thing heightens one's appreciation of *ELECTRONICS WORLD*, a publication of considerable integrity.

WARNER CLEMENTS
Beverly Hills, California

To the Editors:

In your July issue of *ELECTRONICS WORLD*, Mr. Walter H. Buchsbaum presented a very informative article on the mechanism by which dust and pollen is

removed from the air by an electrostatic precipitator. Because of the increase in air pollution of our city air resulting in lung cancer and other types of respiratory diseases, the subject of air purification and air purifiers is of increasing interest to laymen as well as to public officials. The subject of air precipitation is complex, involving particle size of dirt, ionization, odor, and killing of microorganisms. It is for this reason that I wish to amplify and correct some of the misconceptions that have crept into this article.

Industrial air may contain as many as 50,000 dirt particles per cubic foot ranging in size from 0.2 microns to over 100 microns. A regular filter will remove 50 to 80 per-cent of the dirt by weight but still permit 99% of the total number of particles through. This is because most of the particles are below 1.0 micron in size. An electrostatic precipitator such as the "Precipitron" will remove 85 to 95 per-cent of all the airborne particles. This can be achieved by an electrostatic precipitator only if the air flow is controlled, there is a proper amount of ionization, and the spacing, size and voltage of the collecting plates are all properly designed. An improper design would give poorer cleaning efficiency as well as could generate considerable amounts of ozone and oxides of nitrogen which are toxic in excessive amounts.

Negative ions have been used for the alleviation of certain respiratory conditions for nearly 60 years. As stated by Mr. Buchsbaum, many patients appear to be relieved. These tests were conducted under well-controlled conditions. The number of ions was constantly monitored, the patients were not aware that they were part of a test, and the examining doctor did not know the polarity of the air until after the tests. It must be admitted that some of the earlier and even recent investigators did not have such controls.

Ultraviolet radiation from germicidal lamps such as the "Sterilamp" would not ionize oxygen or nitrogen of the air. However, ultraviolet radiation has a sufficient amount of energy to remove electrons from dirt particles and many metals so that some ions are always observed with such a lamp. In fact it has been stated in the literature that it is possible that some of the beneficial results of ultraviolet lamps on man could have been a result of the ions generated by the lamps.

As far as is known, all bacteria and viruses can be destroyed by ultraviolet radiation. The quantity of bactericidal radiation necessary to destroy most of the common pathogenic bacteria has been accurately determined many years

New TRANSISTOR RADIO ANALYST

makes it Easy and Profitable to Service all Transistor Radios



Model 960

TRANSISTOR RADIO ANALYST

with Exclusive DYNA-TRACE
Single-Point Probe—and Built-in
Metered Power Supply and VTVM

Complete Transistor Radio Service Shop in One Instrument

Signal-Generator, Power Supply,
Milliammeter, VTVM, Battery Tester,
Ohmmeter, and Both In-Circuit and
Out-of-Circuit Transistor Tester—
All in One

Check all circuits - Pinpoint any trouble ... in minutes

Now you can profit from transistor radio servicing! This amazing new B&K "960" ANALYST gives you *everything* in one complete easy-to-use instrument. Makes transistor radio servicing *quick and easy*. Nothing else is needed except the transistor radios themselves waiting to be serviced. Brings you new customers for service, parts, and batteries. Makes this new business *yours*.

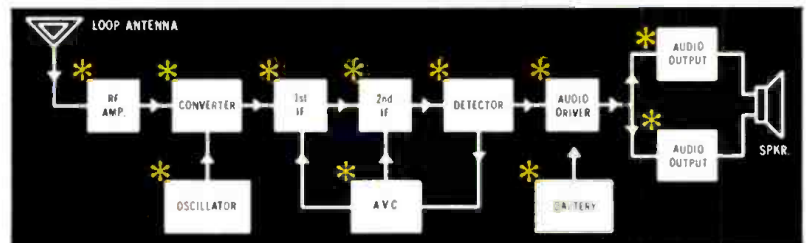

EASILY TROUBLE-SHOOT ANY STAGE BY UNIQUE POINT-TO-POINT SIGNAL INJECTION

The ANALYST gives you a complete signal-generating source for point-to-point signal injection. Easily enables you to trouble-shoot any transistor radio—check all circuits stage-by-stage—isolate and pinpoint the exact trouble in minutes.

Supplies modulated signals, with adjustable control, to check r.f., i.f., converter, and detector. Supplies audio signal to check audio driver and audio output. Provides unmodulated signal to test local oscillator. Provides separate audio low-impedance output for signal injection into loudspeaker voice coils to check speaker performance.

BUILT-IN METERED POWER SUPPLY FOR EASY SERVICING

Makes it easy to operate radio under test, while you inject your own signals. Provides from 1 to 12 volts in 1½ volt steps. Supplies all bias taps that may be required.

SIMPLIFIES IN-CIRCUIT TRANSISTOR TEST WITH NEW DYNA-TRACE SINGLE-POINT PROBE

Unique single-point probe needs only the one contact to transistor under test. No longer are three wires required to connect to emitter, base, and collector. Gives fast, positive meter indication. Saves time. Makes trouble-shooting simple and easy.

BUILT-IN VTVM

Includes high-input-impedance vacuum-tube voltmeter, which is so necessary for transistor radio servicing.

TESTS ALL TRANSISTORS OUT-OF-CIRCUIT

Meter has "Good-Bad" scale for *both* leakage and beta. Also has direct-reading Beta scale, calibrated 0-150. Assures quick, accurate test. Also automatically determines whether transistor is NPN or PNP. Meter is protected against accidental overload and burn-out.

Model 960. Net, \$99⁹⁵

Solve Every Service Problem and Profit
with a Modern B&K Service Shop. See Your
B&K Distributor or Write for Catalog AP18-N



B & K MANUFACTURING CO.
1801 W. BELLE PLAINE AVE • CHICAGO 13, ILL.
Canada: Atlas Radio Corp., 50 Wingold, Toronto 19, Ont.
Export: Empire Exporters, 277 Broadway, New York 7, U.S.A.



on the
CITIZENS BAND-
LESS SIGNAL LOSS WITH



polyfoam[®]

As serious operators are fast discovering, AMPHENOL Polyfoam cable is the very best choice for citizens band antenna systems. Compared to RG-8/U, AMPHENOL's 621-111 Polyfoam equivalent has up to 35% less signal loss. For the low power citizens band, Polyfoam's low loss is a vital factor in increased signal strength.

Polyfoam has other advantages. It's lightweight and easy to handle. It assembles quickly to coaxial terminations such as AMPHENOL 83-1SP. And its cost is surprisingly low. You can buy all this in low-loss AMPHENOL Polyfoam 621-111 for a mere 3¢ more a foot than RG-8/U!

Insist upon genuine AMPHENOL Polyfoam cable, available through your Authorized AMPHENOL Distributor.



AMPHENOL DISTRIBUTOR DIVISION
BROADVIEW, ILLINOIS
Amphenol-Borg Electronics Corporation

ago and the values are in the literature. The lamps are used in operating rooms, air ducts, TB wards, pharmaceutical houses, and food establishments. Lamps have been shown to inactivate such viruses as Asian flu, polio, hepatitis, encephalomyocarditis, mumps, measles, bacteriophage, and plant viruses. The bactericidal radiation, photon per photon, is 500 to 1000 times more effective than ultraviolet from the sun which everybody knows is germicidal. This radiation does not "cook" the bacteria as would infrared radiation but actually inactivates some of the enzymes, disrupts some of the nucleoproteins that carry the hereditary characteristics of the organisms and there is evidence that the cell wall is injured. All of these destructive processes may go on at the same time. One can calculate the amount of ultraviolet energy to destroy 50, 75, or 100 per-cent of the organisms. As an example, a 15-watt germicidal lamp emits about 3.5 watts of germicidal energy. The intensity of this energy would be 11,000 microwatts/cm.² on the surface of the lamp. Most organisms coming in contact with such a lamp would be destroyed in 0.5 second. At a distance of one inch from this lamp, the intensity would be such that most organisms would be destroyed in less than 2 seconds. The number of organisms destroyed by smaller germicidal lamps would depend upon the exposure time and radiation intensity.

Everybody would agree that the "Precipitron" is very effective in removing dirt from the air. However, there is great need for small units as well. Some of the present small units are more effective in killing bacteria, ionizing, deodorizing, or removing dirt than others. The layman cannot properly make an evaluation of these units. If realistic standards were proposed as an example by a scientific society on what constitutes a purifier, it would not be necessary to "search for the truth" and many more purifiers would be sold.

R. NAGY, Ph.D.
 Advisory Engineer
 Research Department
 Westinghouse Electric Corp.
 Bloomfield, New Jersey

Our article indicated that a properly designed purifier would do a good job but that the very widely available, inexpensive "electronic air purifiers" would not fulfill many of the extravagant claims made for them.—Editors.

ELECTRONIC OVERLOAD RELAY

To the Editors:

The parts list for the circuit of the electronic overload relay shown on page 39 of your August issue indicates that S₁ should be a normally open push-button. The proper type of switch for this circuit is actually a normally closed push-button.

LEONARD TURKENKOPF
 Brooklyn, New York

Reader Turkenkopf is, of course, correct since with a normally open push-button the plate voltage would not be applied to the thyatron.—Editors. ▲

GET YOUR ELECTRONICS-TV-RADIO HOME TRAINING FROM N.T.S. RESIDENT SCHOOL

BREAK THROUGH TO HIGHER PAY, GREATER JOB SECURITY

START NOW! Break through the Earning Barrier that stops "half-trained" men. N.T.S. "All-Phase" Training prepares you . . . at home in spare time . . . for a high-paying CAREER as a MASTER TECHNICIAN in Electronics — TV — Radio. One Master Course at One Low Tuition trains you for unlimited opportunities in All Phases: Servicing, Communications, Preparation for F.C.C. License, Broadcasting, Manufacturing, Automation, Radar and Micro-Waves, Missile and Rocket Projects.

A MORE REWARDING JOB . . . a secure future . . . a richer, fuller life can be yours! As an N.T.S.

MASTER TECHNICIAN you can go straight to the top in industry . . . or open your own profitable business.

Over 1 City Block of Modern School Facilities, Laboratories and Shops Housing Over 1,000 Students.

50,000 Graduates — all over the World — since 1905

BETTER . . . MORE COMPLETE . . . LOWER COST . . . WITH NATIONAL SCHOOLS' SHOP-METHOD HOME TRAINING!

BETTER . . . Training that is proved and tested in N.T.S. Resident School shops and laboratories, by a School that is the **OLDEST** and **LARGEST** of its kind in the world.

MORE COMPLETE . . . You learn **ALL PHASES** OF Television — Radio — Electronics.

LOWER COST . . . Other schools make several courses out of the material in our **ONE MASTER COURSE . . .** and you pay more for less training than you get in our course at **ONE LOW TUITION!**

NATIONAL TECHNICAL SCHOOLS
WORLD-WIDE TRAINING SINCE 1905

THE SCHOOL BEHIND YOUR HOME-STUDY TRAINING

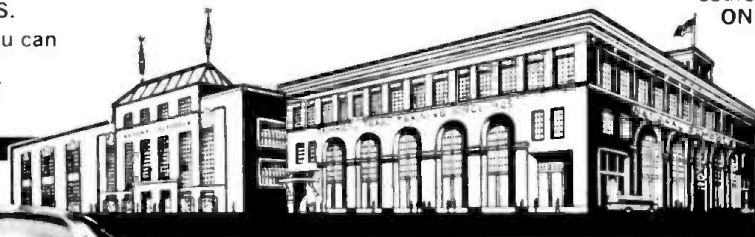

In these modern School Headquarters your Home Training is: Classroom-Developed, Lab-Studio Planned, Shop-Tested, Industry-Approved, Home Study-Designed.

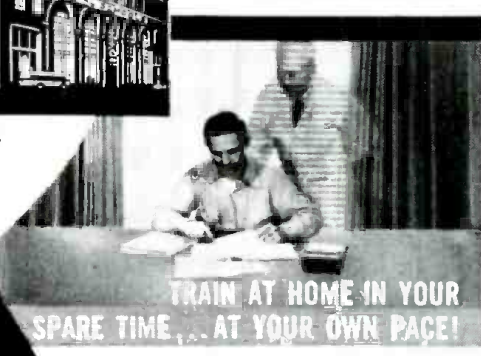
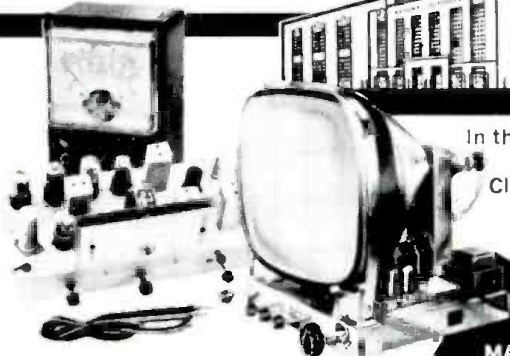

TRAIN AT HOME IN YOUR SPARE TIME . . . AT YOUR OWN PACE!

19 BIG KITS YOURS TO KEEP

- Friendly Instruction and Guidance
- Graduate Advisory Service
- Unlimited Consultation
- Diploma Recognized by Industry
- **EVERYTHING YOU NEED FOR SUCCESS**

N.T.S. IS NOT JUST A MAILING ADDRESS ON A COUPON

N.T.S. is a real school . . . a world famous training center since 1905. Thousands of men from all over the world come to train in our shops, labs, studios and classrooms.

You learn quickly and easily the N.T.S. Shop-Tested way. You get lessons, manuals, job projects, personal consultation from instructors as you progress. You build a Short-Wave, Long-Wave Superhet Receiver plus a large screen TV set from the ground up with parts we send you at no additional cost. You also get a Professional Multitester for your practical job projects. The Multitester will become one of your most valuable instruments in spare time work while training, and afterwards, too. Many students pay for their entire tuition with spare time work. You can, too . . . we show you how.

SEND FOR INFORMATION NOW . . . TODAY!
IT COSTS YOU NOTHING TO INVESTIGATE

After you graduate you can open your own TV-Radio repair business or go into high paying jobs like these: Communications Technicians, Hi-Fi, Stereo and Sound Recording Specialists, TV-Radio Broadcasting Technician, Technician in Computers & Missiles, Electronics Field Technician, Specialist in Micro-Waves and Servomechanisms, Expert Trouble Shooter, All-Phase Master Technician, TV-Radio Sales, Service and Repair.

RESIDENT TRAINING AT LOS ANGELES
If you wish to take your Electronics-TV-Radio training in our famous Resident School in Los Angeles — the oldest and largest school of its kind in the world — write for special Resident School catalog and information, or check special box in coupon.

MAIL COUPON NOW FOR FREE BOOK & ACTUAL LESSON

No obligation.
No salesman will call.



NATIONAL TECHNICAL SCHOOLS
WORLD-WIDE TRAINING SINCE 1905

Mail Now To
National Technical Schools, Dept. PH-111
4000 S. Figueroa St., Los Angeles 37, Calif.
Please rush FREE Electronics-TV-Radio "Opportunity" Book and Actual Lesson.

Name _____ Age _____
Address _____
City _____ Zone _____ State _____

Check here if interested ONLY in Resident Training at Los Angeles.
VETERANS: Give date of discharge _____



ACCREDITED MEMBER

NATIONAL TECHNICAL SCHOOLS

WORLD-WIDE TRAINING SINCE 1905

4000 SO. FIGUEROA ST., LOS ANGELES 37, CALIF., U. S. A.

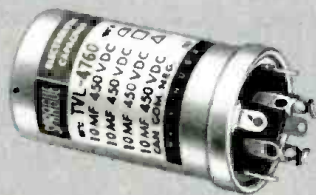

TVL TWIST-LOK® CAPACITORS

These 'lytics take on the toughest TV and radio duty, give maximum trouble-free service, *without HUMMMM!* They are dependable at extremely high and low temperatures. Cathodes are etched to meet the needs of high ripple currents, high surge voltages.

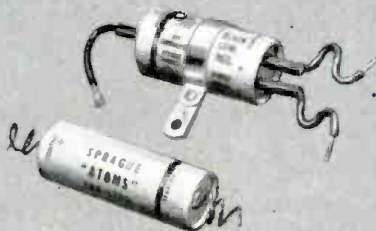

TVA ATOM® CAPACITORS

Atom tubulars are service favorites because they fit anywhere, work anywhere. They're the *only* small size 85 C (185 F) capacitors in ratings up to 450 WVDC. They have low leakage current, long shelf life, and withstand high ripple currents, high surge voltages.



TE LITTL-LYTIC® CAPACITORS

The very best ultra-miniature replacements for transistor circuits, offering unusual reliability through all-welded construction. No pressure joints to cause "open" or intermittent circuits. Long shelf life—extremely important in sets used only part of the year.

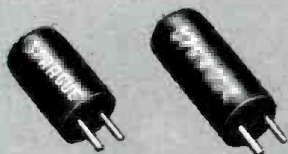

VL VERTI-LYTIC* CAPACITORS

These single-ended molded tubulars are the ideal replacement for units of this type found on printed wiring boards. Keyed terminals assure fast manual mounting and correct polarity. Resin end fill protects against drying of electrolyte or entrance of external moisture.



PCL PRINT-LOK® CAPACITORS

The printed circuit version of the Twist-Lok. Universal base replaces any of the printed circuit 'lytics in use today. No makeshift mounting adapters to damage capacitor or add extra height... no possibility of high resistance contacts.

EVERY 'LYTIC YOU NEED...

- every value
- every rating
- every style

Shown here are the more popular of Sprague's big family of Electrolytic Capacitors, the broadest in the industry. Other types include Metal-encased Screwbase; Plastic-encased High-MF; Metal-encased Octal-base; Ultra-low leakage Photoflash. All are listed and described in Sprague's NEW Catalog C-614. Get your copy from any Sprague distributor, or write Sprague Products Company, 51 Marshall Street, North Adams, Massachusetts.

*TRADEMARK



WORLD'S LARGEST CAPACITOR MANUFACTURER



Special Training Equipment Included

Pick the field of your choice—and train at home with the leader—NRI. In addition to Industrial Electronics and FCC License training explained at the right, NRI offers comprehensive courses in Radio-TV Servicing and Radio-TV Communications. Except for the FCC course, all NRI courses include—at no extra cost—special training equipment for actual practice at home, building circuits and working experiments. Makes theory you learn come to life in an interesting, easy-to-grasp manner.

Multiplexing, FM Stereo Broadcasting Included

NRI training keeps up with the times. New, additional profit opportunities exist for the Technician who understands the latest technical advances. Course material now covers FM Stereo Broadcasting, tells you about Multiplexing equipment, other recent developments.

Learn More to Earn More

Act now. The catalog NRI sends you gives more facts about the field of your choice, shows equipment you get and keep. No obligation. Cost of NRI training is low. Monthly payments. 60-Day Trial Plan. Mail postage-free card today. **NATIONAL RADIO INSTITUTE, Washington 16, D.C.**

**Send for
64-Page
CATALOG
FREE**

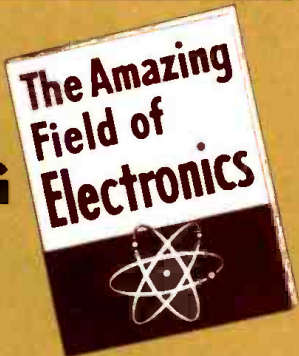

NRI—Oldest and Largest Radio Television School Now Offers NEW HOME STUDY TRAINING IN INDUSTRIAL ELECTRONICS & MILITARY ELECTRONICS

This is the age of Electronics. Rapidly expanding uses for Electronic Equipment in industry, business, the military demands more trained men. Prepare now for a career as an Electronic Technician to assure advancement or to profit from your hobby. NRI now offers a complete course in **ELECTRONICS—Principles, Practices, Maintenance.** Computers, telemetry, automation, avionics are changing our world, yet all employ the same basic principles . . . and that is what this NRI course stresses with illustrated lessons and special training equipment. Mail card below.



NEW HOME STUDY TRAINING FOR YOUR FCC LICENSE



An FCC Commercial License combined with NRI time-tested training can be the keys to a better future for you with higher pay, interesting work, more rapid advancement as the rewards. Prepare at home *quickly* for your FCC examinations through NRI's new, low-cost, special training. Like other NRI-trained men, you can be monitoring TV shows, radio broadcasts, operating shipboard and aviation radio, or holding down other important jobs. Get full details—mail the card below.

FOR MORE INFORMATION-TURN PAGE

Cut Out and Mail—No Stamp Needed



Send me your Electronic, Radio-TV catalog without cost or obligation. I am interested in the course checked below: (No representative will call. Please PRINT.)

- INDUSTRIAL ELECTRONICS
- COMMUNICATIONS
- FCC LICENSE
- SERVICING X

Name _____ Age _____

Address _____

City _____ Zone _____ State _____

ACCREDITED MEMBER NATIONAL HOME STUDY COUNCIL

ELECTRONICS NEEDS

4 TO 7

QUALIFIED TECHNICIANS

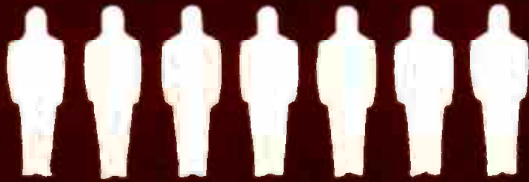

FOR EVERY ENGINEER



Join The Thousands Who Trained For Advancement With NRI

Thousands of NRI graduates throughout the U. S. and Canada are proof that it is practical to train at home. NRI graduates are in every kind of Electronics work: inspectors, maintenance men, lab technicians, testers, broadcasting and mobile communications operators, Radio-TV service technicians, or in essential military and government posts. Catalog tells more about what NRI graduates do and earn. Mail postage free card.

Choose from 4 Courses

1 INDUSTRIAL ELECTRONICS
Learn Principles, Practices, Maintenance of Electronic equipment used today by business, industry, military, government. Covers computers, servos, telemetry, multiplexing, many other subjects.

2 FCC LICENSE
Every communications station must have one or more FCC-licensed operators. New NRI course is designed to prepare you for your First Class FCC exams. You learn quickly, training at home in your spare time.

3 COMMUNICATIONS
Training for men who want to operate and maintain radio and TV stations; police, marine, aviation, mobile radio, etc. Includes FM Stereo broadcasting. Course also prepares you for your FCC license exam.

4 SERVICING
Learn to service and maintain AM-FM Radios, TV sets, Stereo Hi-Fi, PA systems, etc. A profitable, interesting field for a spare-time or full-time business of your own.



"THE FINEST JOB I EVER HAD" is what Thomas Bilak, Jr., Cayuga, N. Y., says of his position with The G. E. Advanced Electronic Center at Cornell University. He writes, "Thanks to NRI, I have a job which I enjoy and which also pays well."



BUILDING ELECTRONIC CIRCUITS on specially-designed plug-in type chassis, is the work of Robert H. Laurens, Hammonton, N. J. He is an Electronic Technician working on the "Univac" computer. Laurens says, "My NRI training helped me to pass the test to obtain this position."



"I OWE MY SUCCESS TO NRI" says Cecil E. Wallace, Dallas, Texas. He holds a First Class FCC Radio-telephone License and works as a Recording Engineer with KRLD-TV.



MARINE RADIO OPERATOR is the job of E. P. Searcy, Jr., of New Orleans, La. He works for Alcoa Steamship Company, has also worked as a TV transmitter engineer. He says, "I can recommend NRI training very highly."



FROM FACTORY LABORER TO HIS OWN BUSINESS that rang up sales of \$158,000 in one year. That's the success William F. Kline of Cincinnati, Ohio, has had since taking NRI training. "The course got me started on the road," he says.

SEE OTHER SIDE

FIRST CLASS
PERMIT
NO. 20-R
(Sec. 34.9, P.L.&R.)
Washington, D.C.

BUSINESS REPLY MAIL
NO POSTAGE STAMP NECESSARY IF MAILED IN THE UNITED STATES

POSTAGE WILL BE PAID BY



National Radio Institute
3939 Wisconsin Avenue
Washington 16, D.C.

NRI IS OLDEST—LARGEST SCHOOL OF ITS KIND

Training men to succeed by home study has been the National Radio Institute's only business for over 45 years. NRI is America's oldest and largest Electronics home-study school. Don't delay. Cut out and mail POSTAGE-FREE CARD.



MAIL POSTAGE-FREE CARD

FREE!

LAFAYETTE

**340 PAGE 1962
ELECTRONICS CATALOG**

*"America's Hi-Fi &
Electronics Shopping Center"*

Yours free for the asking — the biggest, best and most comprehensive catalog in the 41-year history of Lafayette Radio. Audiophile, Experimenter, Hobbyist, Technician, Engineer, Student, Serviceman, Dealer — you'll find what you want in this latest Lafayette catalog.



CATALOG # 620



**COMPLETELY WIRED,
FULL SIZE TUBE TESTER
TE-15.....19.95**



**10,000
OHMS-PER-VOLT
MULTITESTER
TE-10.....9.95**



**TRANSISTORIZED
PORTABLE TAPE RECORDER
RK-125.....29.95**

**SUPERHETERODYNE
COMMUNICATIONS RECEIVER
KT-200, Kit.....64.50
HE-10, Wired.....79.95**



**FM STEREO
MULTIPLEX TUNER
LT-700.....124.50**



**9-TRANSISTOR
CITIZENS BAND
"WALKIE TALKIE"
HE-29A each 39.95
2-for 78.88**

LARGEST STOCK SELECTION. Stereophonic Hi-Fi equipment, Citizens Band, Ham and Amateur equipment, Radio & TV parts, Optics, Industrial Supplies, and much more, including all the favorite name brands.

LAFAYETTE EXCLUSIVES. Featured are the famous Lafayette Kits . . . dollar for dollar the best value for your money today. You'll also see hundreds of Lafayette specials . . . available only from Lafayette. And, as always, **SATISFACTION GUARANTEED OR MONEY REFUNDED.**

LOWEST PRICES. You'll save money too with Lafayette's low, low prices. The lowest prices are always in the Lafayette catalog.

24-HOUR SERVICE. Quick, courteous service is your guarantee at Lafayette. Most orders are fully processed within 24 hours after receipt in the mail Order Division.

NEW EASY-PAY PLAN.
Now, **NO MONEY DOWN . . .**
up to 24 months to pay.

LAFAYETTE'S

**NEW MAIL ORDER HEADQUARTERS
111 JERICO TURNPIKE
(2 Blocks West of South Oyster Bay Rd.)
SYOSSET, LONG ISLAND, NEW YORK**

**Watch for Opening
Fall, 1961**



**LAFAYETTE RADIO, DEPT. RK1-1
P.O. BOX 10, SYOSSET, L. I., N. Y.**

- Rush my **FREE Lafayette 1962 Catalog 620**
 Please send me # _____, shipping charges collect.
I am enclosing \$ _____



340 PAGES

Name _____
Address _____
City _____ Zone _____ State _____

Product Test Report

PREPARED BY HIRSCH-HOUCK LABORATORIES

University "Medallion XII" Speaker System
Fisher X-1000 Integrated Stereo Amplifier
RCA WV-120A Power-Line Monitor
Eico Model 260 A.C. Volt-Watt Meter

University "Medallion XII" Speaker System

For copy of manufacturer's brochure, circle No. 57 on coupon (page 136).

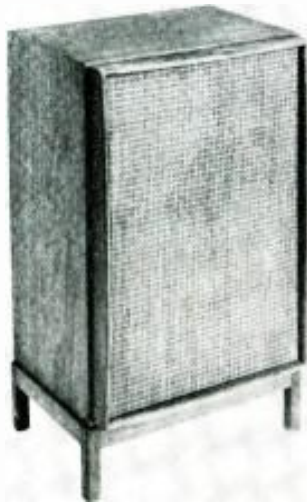

THE University "Medallion XII" is a compact floor-model speaker system, measuring 24½" high x 17" wide x 13" deep. It is a three-way system, with a 12" high-compliance woofer, an 8" mid-range speaker, and a "Sphericon" super tweeter. The crossover frequencies are 600 and 4000 cps. The nominal input impedance is 8 ohms, although a 16-ohm amplifier tap may be used.

The enclosure incorporates what University calls "radiation resistance loading." This is essentially a ducted-port enclosure, with a cylindrical duct. The "Medallion XII" offers an interesting solution to the problem of adjusting speaker levels. The mid-range speaker has a two-position switch, marked "Normal" and "Max. Presence." In the latter position the mid-range level is elevated to give greater projection of program material into the listening room. The super tweeter has a level control marked "Brilliance." Both controls are on the front of the unit, on the speaker board itself. Once they have been correctly set, the speaker grille, in its wooden frame (available in several styles) is snapped in place and the controls are secure from accidental displacement. The only access to the system when the grille is in place is through the two input terminals on the back of the cabinet. The cabinet may be operated on its side or bottom and a matching base

is available in a variety of finishes.

The "Sphericon" super tweeter is a tiny unit with a phenolic diaphragm and a plastic horn and diffuser. It is mounted forward of the speaker board by an inch or two. The instructions suggest that the tweeter level be advanced only enough to just make the listener aware of the presence of highs. We did so, ending with the level control near the center of its rotation. The presence switch was left in "Normal" position. The frequency response was measured indoors, at eight different microphone positions and two speaker locations in the room. Tone-burst photos were taken to illustrate transient response at typical points in the spectrum. The harmonic distortion was measured at low frequencies, with 1-watt input to the speaker.

The average of the eight response curves shows a good, smooth wide-range response from about 100 to 15,000 cps. There were no significant peaks or holes, even at the crossover frequencies. If the middles and highs had been brought up somewhat, which could have been done, the response curve would have been even flatter. The settings used, however, produced the most pleasing and bal-

anced sound. Below 100 cps there is a substantial peak of about 10 db at 80 to 90 cps, below which the response falls to -13 db (referred to the average mid-range level) at 28 cps. The harmonic distortion remains very low at the lowest frequencies, however, which indicates that the speaker can be "pushed" harder to extend the low end without overload or break-up. It must be pointed out that these response curves do not necessarily show the performance of the speaker in all environments, but do suggest its behavior in a room of usual proportions.

The tone-burst photos, at 900 and 2800 cps, show very good transient response. There is little overhang following the burst and only a slight overshoot at the beginning of the 2800 cps burst.

In listening tests, the "Medallion XII" proved to be a pleasantly balanced, smooth-sounding speaker. Many persons will prefer somewhat more high-frequency response, which is available by increasing the brilliance control. The bottom end sounds slightly heavy, probably due to the peak, but the true bass response extends all the way down and can be felt as well as heard.

The "Medallion XII" packs a lot of performance into an attractively styled compact cabinet. With its brilliance and presence controls the user can, to a large extent, tailor its sound to his taste.

The system is available unfinished at \$134.95 and in various furniture finishes at \$139.95. Front-grille frames and bases are available separately.

(Manufacturer's comments: We note that your high-frequency measurements extend only to 15 kc. Our measurements on the high-frequency response of this system indicate that, with the "Brilliance" control fully clockwise, response extends to 22 kc., within less than 3 db. Also, customers appreciate the interchangeable grilles which permit modifying the style of the cabinet in the event that the purchaser's tastes or room decor change subsequent to purchase.) ▲

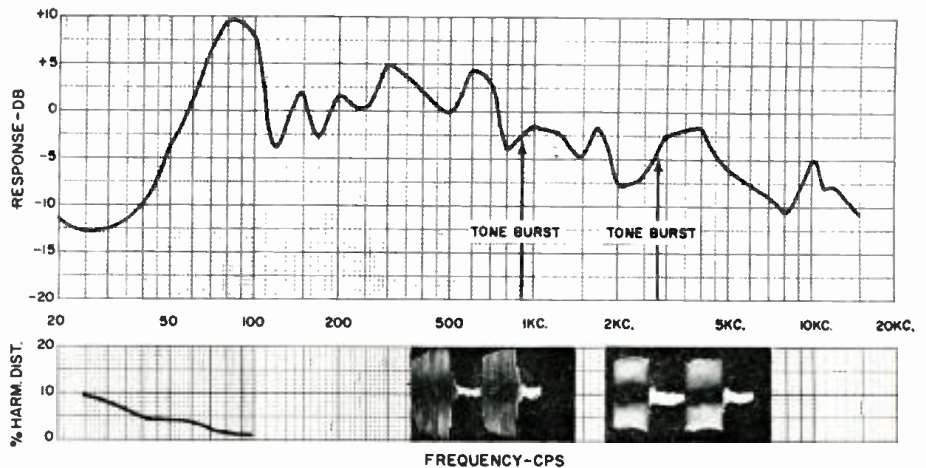

Fisher X-1000 Integrated Stereo Amplifier

For copy of manufacturer's brochure, circle No. 58 on coupon (page 136).

THE Fisher X-1000 is an integrated stereo amplifier with an unusually high power rating—50 watts r.m.s. per

channel or 110 watts total IIFM music-power output rating. It features, in addition to the normal complement of

**TWENTY-FIVE THOUSAND DOLLARS IN RESEARCH TIME
... NOTHING LIKE IT ON THE MARKET!**

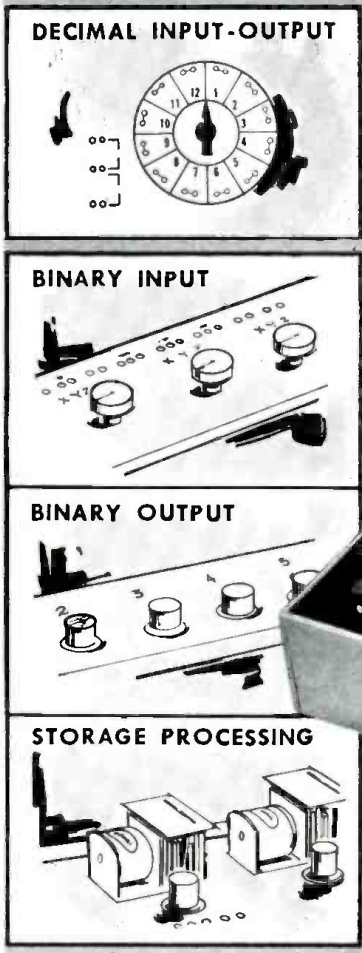

Minivac[®] 601

**scientific exploration... education...
experimentation at the 24" console
of this amazing computer**



MINIVAC 601 is a unique digital computer — the small brother of huge electronic brains that are the newest tools of science and industry. MINIVAC has memory — it thinks... it can even play games. It prepares teenagers and adults for the world of tomorrow.

Created as a private project by Dr. Claude E. Shannon, now Donner Professor of Science, MIT, and developed by the SDC staff, MINIVAC 601 is built of professional components to professional standards.

It opens the way to exciting experimentation with circuits that solve problems and make decisions. It enables you to duplicate control systems like those used in advanced missiles. You may program it to demonstrate data processing techniques used in business. Hundreds of experiments are contained in the booklets. But this is only the beginning. The only limit to MINIVAC's accomplishments is the imagination of the machine's master.

\$8500

A complete set of 6 instruction manuals included. "Getting Acquainted with MINIVAC 601", "What is a Digital Computer?", "How Computers Make Logical Decisions", "How Computers Do Arithmetic", "How Computers Work for Man", and "MINIVAC Games".



SCIENTIFIC DEVELOPMENT CORPORATION

Department of Electronics

372 Main St., Watertown 72, Massachusetts

Scientific Development Corp., Department of Electronics
372 Main Street, Watertown, Massachusetts

Gentlemen:

Please send free brochure giving complete information on Minivac 601... what it is... what it does... how it operates.

Name

Address

City..... Zone..... State.....

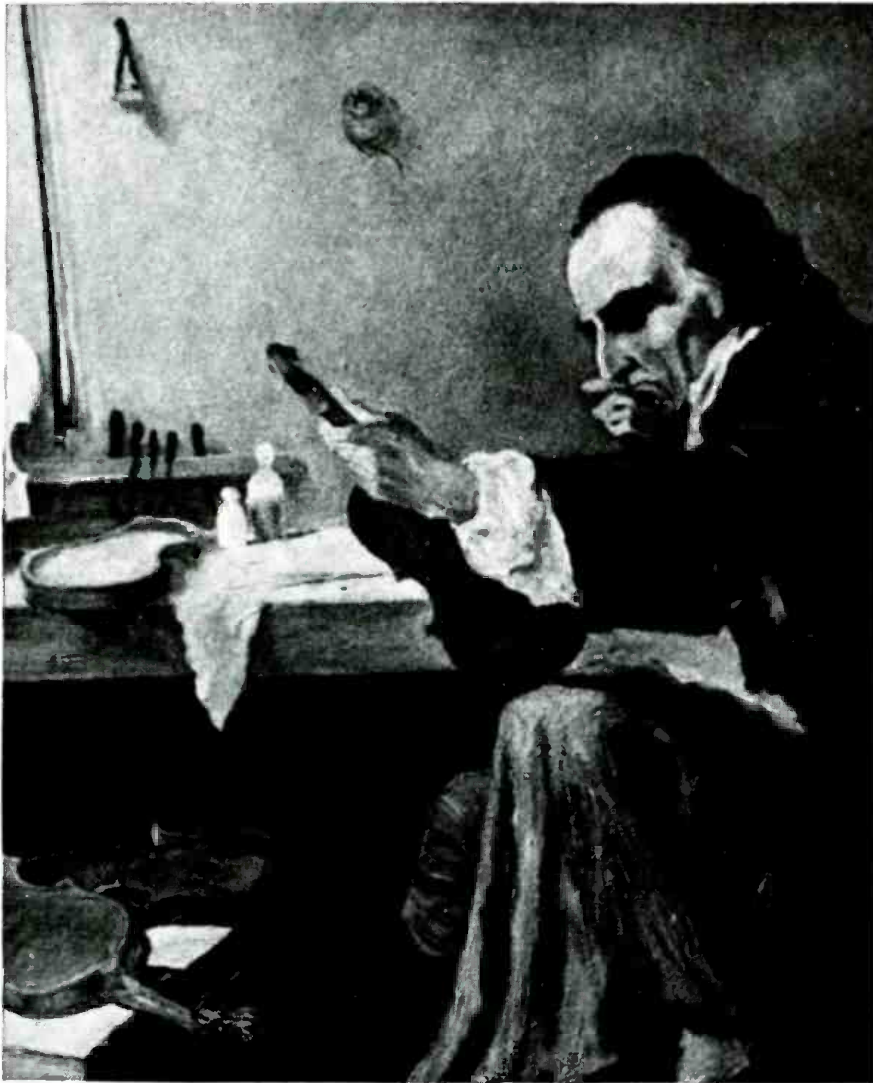

Like the violins of Cremona...



STILL THE FINEST

Since its introduction, the Swiss-made Thorens TD-124 transcription turntable . . . like the violins of Amati, Guarnieri, and Stradivari . . . has been accorded the accolade of critics as a superlative contribution to musical enjoyment. It is even more so, today, when by a word to your hi-fi dealer you can mate the almost microscopic precision of the TD-124 with the flawless performance of the Ortofon arm and cartridge. At your dealer or the N. Y. Hi-Fi Show Room of ELPA Marketing Industries—sole U.S. Representatives for Thorens and Ortofon products. 1.10

Guaranteed for one full year. Sold only through carefully selected franchised dealers.

THORENS

A Division of
ELPA Marketing Industries, Inc.
New Hyde Park, New York



FAMOUS SWISS HI-FI COMPONENTS • MUSIC BOXES • SPRING-POWERED SHAVERS • LIGHTERS

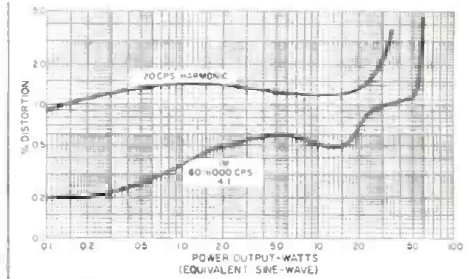

controls, several less common functions which will be described later.

Each power amplifier section of the X-1000 uses a pair of 6L34/6CA7's, operating with fixed bias. There is a d.c. balance adjustment which varies the bias differentially on each pair of output tubes. The phase-inverter stage has a balancing adjustment to supply symmetrical drive to the output tubes. Ahead of this is an EF86 gain stage, to the cathode of which the over-all negative feedback is applied. Up to this point the amplifiers are quite conventional in appearance, but in the earlier stages they depart from run-of-the-mill circuitry.

For example, the tone controls are of the feedback type, with absolutely no effect on mid-frequency gain. They are driven from cathode-followers and isolated from the main power amplifier by a gain stage. The rumble and scratch filters, unlike many such circuits, have sharp cut-off points and 12 db/octave slopes, and cut out the required portions of the spectrum with a minimum of interference to the program material. They use feedback around multi-section RC filters to obtain the desired characteristics and the results are most satisfactory.

The phono equalization is also by means of feedback circuits around a two-stage amplifier. There are two independently selected phono inputs, one of which is RIAA equalized and the other of which offers a choice of RIAA or the old Columbia LP characteristic. Each phono preamp has its own front-panel level control, which enables the master loudness control to be set up for proper Fletcher-Munson compensation. The phono preamps also have playback equalization for tape heads, for both 7½ and 3¾ ips, as well as a flat-gain position for a microphone input.

Other inputs include a tuner and two auxiliary high-level inputs. One of the latter has level-set controls on the rear of the amplifier, performing the same function as the front-panel level controls for the low-level inputs. The X-1000 has the usual tape monitor facilities, for listening to the program from a three-head tape recorder while it is being recorded. As with most such arrangements, none of the tone controls, volume controls, or filters is effective on the output to the tape recorder. However, when listening to a previously recorded tape, switching the input to "Aux. 1" connects the tape playback amplifier so as to have full use of the amplifier's control facilities, even if the recorder is connected to the "Tape Mon." jacks. This is a somewhat more flexible arrangement than is usual in

STOP AND SHOP



Look for this convenient display at your Electronic Parts Distributor (listed in the column at right). A full assortment of famous Wen power tools awaits your inspection. Step up to Wen quality—factory guaranteed to perform to professional standards.

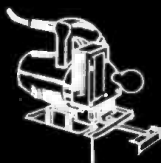

**FAMOUS
"ALL SAW"**

Best selling power saw in the business! A souped-up UL "Industrially Rated" 1/2 HP saw—equally great for 6" logs and delicate pattern work. Cuts virtually any material quickly, cleanly. Complete with 7 blades, rip guide, circle cutter. \$44.95.



**PROFESSIONAL
SOLDER GUNS**

The standard of the Electronic Industry for 10 years! No one—not even Wen—has been able to improve the Wen design. Quick heat, slim sturdy plastic housings. From feather-light 100 watts to 250 watt heavy duty. Guns and kits \$5.95 to \$15.95.



**UNIVERSAL
SABRE SAW**

Lightweight and extremely versatile! Easily cuts 2 x 4's and fine scrollwork . . . any shape. Cuts wood, steel, wallboard, plastic, leather—anything normally cut with any saw. Powerful UL Approved motor. \$26.95.

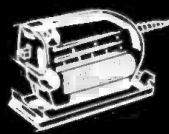

**WORLD'S
FINEST
SANDERS**

Choose from 3 models—all straight-line fine-finish types . . . all with plenty of power. Perfect for re-finishing and new wood work. Never a scratch to mar a good surface. 14,400 strokes per minute by sanding surfaces up to 20 sq. in. \$13.95 to \$19.95.



**2-SPEED
DOUBLE-DUTY
DRILL**

No other drill like it! Big 3/4" geared chuck—2 speeds. Change from 1000 RPM (heavy duty) to 3000 RPM (delicate work) in seconds. 2 ball thrust bearings . . . oversize oilite bearings. Drill, polish, sand, grind, wire brush, mix paint—you name it. Most versatile tool in your workshop. \$29.95.

**WEN PRODUCTS,
INC.**

5810 Northwest Highway, Chicago 31, Ill.

- ALA., Opelika, Southern Electronics Corp.
- CALIF., Buena Park, Ford Electronics
- Burbank, Electronic City, Inc.
- Downey, Master Electronic Supply, Inc.
- Hollywood, Hollywood Radio & Electronics, Inc.
- Yale Radio Electric Co.
- Inglewood, Acorn Radio & Electronics
- Long Beach, Larry Lynde
- Los Angeles, Hollman Electronics-Parts Sales
- Figart's Radio Supply Co.
- Radio Products Sales, Inc.
- Shelley Radio Co., Inc.
- North Hollywood Arrow Sales, Inc.
- Honig Distributing Co.
- Oakland, Brill Audio Products
- Osland, Warsco Sales Co.
- Paramount, Elwin W. Ley Co.
- Pasadena, Dow Radio, Inc.
- Riverside, Electronic Emporium Corp.
- Sacramento, Lombard's Electronics
- Radio Television Products, Co.
- San Carlos, Fortune Electronics
- San Diego, Southland Electronics Inc.
- San Francisco, Market Radio Supply Co.
- West Coast Radio & Electronics
- San Jose, Dealer Electronic Corp.
- Schad Electronic Supply, Inc.
- Santa Ana, Arrow Electronics, Inc.
- Seaside, Mat's Electronics Supply
- Temple City, G. & M. Wholesale Electronics
- Torrance, Torrance Electronics
- West Covina, West Covina Wholesale Electronics
- COLO., Denver, Fisteil's Electronic Supply Co.
- Mountain States Electric Supply
- CONN., Hartford, Del Padre Supply of Hartford
- D. C., Washington, Electronic Wholesalers, Inc.
- FLA., Pensacola, Grice Electronics, Inc.
- Tallahassee, Peard Electronic Supply, Inc.
- GA., Atlanta, Southeastern Radio Parts Co.
- Macon, Peard Electronic Supply, Inc.
- ILL., Aurora, Nationwide—W. J. Electronics
- Berwyn, Nationwide—W. J. Electronics
- B-B & W, Inc.
- Champaign, York Radio and Television
- Chicago, Allied Radio Corp.
- Arthur Nagel, Inc.
- Bowman Electronic Supply Co.
- Nationwide—W. J. Electronics
- Phico Dist., Inc.
- Forest Park, Allied Radio Corp.
- Kankakee, York Radio and Television
- Oak Park, Melvin Electronics, Inc.
- Skokie, E. & H. Electrical Distributors
- Springfield, York Radio and Television
- Waukegan, Nationwide—W. J. Electronics
- IND., Evansville, Geo. C. Mittle Co.
- Gary, Allied Radio of Indiana
- Nationwide—W. J. Electronics
- Hammond, Tri-City Electric Co., Inc.
- Nationwide—W. J. Electronics
- Indianapolis, Graham Electronics Supply
- Radio Distributing Co.
- Van Sickle Radio Supply Co.
- IA., Fort Madison, York Radio and Television
- Sioux City, Duke's Radio Co.
- Moltislad Distributing Co.
- Dittum's York Radio and Television
- LA., Baton Rouge, Davis Electronics Supplies
- Lafayette, Electro Technical Labs
- Lake Charles, Wholesale Radio Equipment, Inc.
- New Orleans, Walther Bros. Co., Inc.
- Radio Parts Inc.
- Shreveport, Koelmay Sales Co., Inc.
- MASS., Lawrence, Alco Electronics
- MD., Baltimore, Revacto of Maryland, Inc.
- Silver Spring, Silver Spring Electronic Supply
- MICH., Detroit, Electronic Parts Co.
- MISS., Greenville, Delta Electronics Supplies, Inc.
- Pascagoula, Mays Electronics Supply
- MO., Hannibal, York Radio and Television
- Jefferson City, York Radio and Television
- Joplin, Russell Belden Electric Co.
- Kansas City, Walters Radio Supply, Inc.
- NEBR., Omaha, Omaha Electronics Co.
- N. H., Laconia, Lacia Electric Co.
- Nashua, Gate City Electric Co.
- N. Y., Albany, Seiden Sound, Inc.
- Binghamton, Stack Electronics, Inc.
- Bronx, W. Bergman Co., Inc.
- Buffalo, W. Bergman Co., Inc.
- Radio Equipment Corp.
- Hempstead, Standard Parts Corp.
- Rochester, Rochester Radio Supply Co.
- Syracuse, Morris Electronics of Syracuse, Inc.
- Utica, Associated Electronics Supply
- OHIO, Akron, The Sun Radio Co.
- Chillicothe, Buckeye Electronics Distributors, Inc.
- Columbus, Buckeye Electronics Distributors, Inc.
- Whitehead Radio Co.
- Coshocton, Wagner's Supply
- Dayton, Srepro, Inc.
- Stotts-Freedman Co.
- East Liverpool, United Electronics, Inc.
- Lancaster, Buckeye Electronics Distributors, Inc.
- Lima, Hutch & Son
- Mansfield, Wholesaling, Inc.
- Toledo, Lifetime Electronics
- Mainline Dist., Inc.
- Warren Radio Co.
- Warren, Rem Electronics
- Youngstown, Armes Electronics
- Glen Electronics
- PA., Butler, E and E Supply, Inc.
- Erie, Warren Radio, Inc.
- Harrisburg, Radio Distributing Co.
- Philadelphia, Radio Electric Service Co.
- Pittsburgh, Lafayette Radio Electronics
- M. Left Parts Co.
- Radio Parts Co.
- Tarentum, Huston TV Parts
- Wayne, High Fidelity House
- TEXAS, Austin, Service Electronic Supply
- UTAH, Salt Lake City, Manwill Supply Co.
- VA., Portsmouth, Distributors, Inc.
- WASH., Seattle, F. B. Connelly Co.
- Seattle Radio Supply, Inc.
- W. VA., Beckley, Chemistry Electronic Dist., Inc.
- WIS., Appleton, Valley Radio Distributors
- Fond du Lac, Harris Radio Corp.
- Madison, Radio Distributors
- Satterfield Electronics, Inc.
- Manitowish, Harris Radio Corp.
- Milwaukee, Allied Radio of Wisconsin
- Radio Parts Co.
- Electronic Enterprises, Inc.
- Portage, Satterfield Electronics, Inc.
- West Allis, Marsh Radio Supply
- Wisconsin Rapids, Satterfield Electronics, Inc.

VERY BIG ON RESPONSE

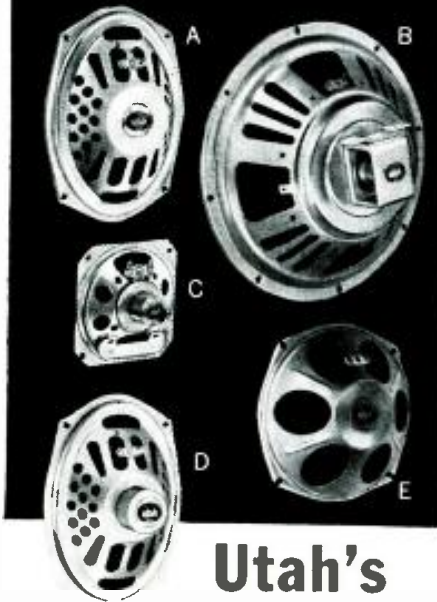

Utah's famous micro-gap replacement SPEAKERS

Better response — better sound reproduction than original equipment! Better customer response, too, when you install Utah Micro-Gap replacement speakers. Single-packed in custom-fitted cartons. Illustrated above:

A SP69NF 6x9" Oval Inverted Auto Speaker **B** SP12J 12" Round Speaker **C** SP4A 4" Square Outdoor Speaker **D** SP69G 6x9" Oval Auto Speaker **E** SP8NF 7½" Inverted Pin Cushion Speaker.

Write for illustrated literature



stereophonic amplifiers of this type.

The "Mono-Stereo" mode switch on the front panel has seven positions: "Bal. R" and "Bal. L" which respectively connect the paralleled channel A and channel B inputs to the right-channel speaker only and to the left-channel speaker only; "Stereo"; "Reverse" (which interchanges the two channels); "Mono Phono," which connects the two inputs in parallel and is effective on all inputs; and "A" and "B" which connect the selected channel input to both speakers. A system of colored lights on the panel indicates the mode of operation, although we found this more confusing than helpful. A row of slide switches controls the rumble filter, scratch filter, reverses phase of one channel, and inserts a three-head tape recorder in the signal path.

Three other front-panel controls are noteworthy. A center-channel volume control, with switch, controls the level of a mixed signal to be supplied to a separate amplifier for driving a middle speaker. This can be of value if the speakers are spaced too widely or if excessive separation of the program occurs on the record. A center-channel speaker can be driven directly, without an external amplifier, in which case this control acts as an "on-off" switch rather than a level control.

A pair of concentric controls labeled "Space Expander" and "Dimension" complete the picture. The former duplicates the level control of the Fisher reverberation unit, for which input and output

jacks are provided. The latter is what is usually called a "blend" control, which mixes the two channels in varying degrees to produce anything from full stereo to mono reproduction.

It can be seen that there is a certain amount of duplication of function in the X-1000, particularly in the matter of blending and filling a center "hole." In most cases only one of the several possibilities would be used, but they are all there to suit any taste.

We tested the Fisher X-1000 with both channels loaded and driven simultaneously, and using steady-stage r.m.s. power measurements. This is a much more severe test than the usual music-power rating of one channel at a time, but one which we feel is more realistic. As the distortion curves show, the X-1000 acquitted itself well. At 2% IM distortion each channel delivered 57 watts, or a total of 114 watts. At any power likely to be encountered in home use, the IM distortion was less than a few tenths of a per-cent. The 20-cycle harmonic distortion was somewhat higher, but the amplifier still delivered 30 watts per channel at 20 cps for only 2% distortion.

The tone control and filter response curves, taken at a low level, illustrate the complete lack of interaction between controls and the nearly ideal filter curves. The sensitivity of the X-1000 is high, only 1 millivolt at the phono input being needed to drive it to 10 watts output; 75 millivolts at a high-level in-

(Continued on page 104)

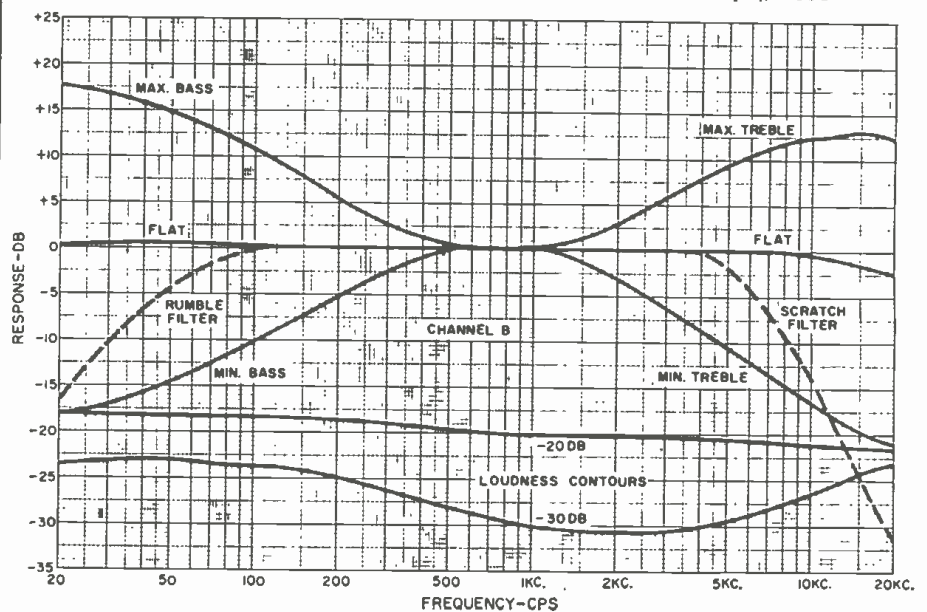

LET THE TOP AUTHORITIES HELP YOU SUCCEED IN ELECTRONICS ...THROUGH RIDER BOOKS

LATEST RELEASES

BASIC MATHEMATICS, Norman H. Crowhurst. 4 volume 'pictured-text' course makes it easier than ever before possible to learn all the math you will need to know to speed your progress in electronics. Here's what the CHARLESTON EVENING POST say about "If the next volumes are anything like the first, then the series is something that has been needed for much too long a time." Treats all the various branches of mathematics in one continuous development of mathematics. Thus arithmetic, algebra, geometry, trigonometry, calculus—heretofore considered unrelated in specialized areas of mathematics are treated together at progressively rising levels. Available now—Volume I, Arithmetic As An Outgrowth of Learning to Count, \$3.90. Volume II, Introducing Algebra, Geometry, Trigonometry As Ways of Thinking in Mathematics, \$3.90. Volume III, Developing Algebra, Geometry, Trigonometry, Calculus as Working Methods in Mathematics, \$3.90. Volume IV, (available April 1962) Developing Algebra, Geometry, Trigonometry, Calculus as Analytical Methods in Mathematics, \$3.90.

BASIC RADIO, M. Tepper. 6 volume 'pictured-text' course enables you to understand the fundamentals of radio communication. No previous knowledge of electricity is required—the course teaches it. Basic Radio will enable you to read schematics, recognize circuits used in radio equipment, understand electricity and magnetism, circuit components, vacuum tubes, power supply, oscillators and amplifiers and their use in radio receivers. You are made thoroughly familiar with semi-conductors and transistors; transmitters, antenna and transmission lines. 6 vols., soft covers, \$13.85; 6 vols., cloth, \$14.85.

HOW TO AVOID LAWSUITS IN TV-RADIO-APPLIANCE SALES & SERVICE, Leo Parker. • When can a serviceman collect for repairs? • When is a service guarantee enforceable? • When can a serviceman demand cash payment? • When does a lien protect a serviceman? • How can a knowledge of contract law earn profits? • How valid are written contracts? • What are the insurance laws? • These are just a few of the vital questions that are answered in this book written by an experienced lawyer. It covers many situations that you may face if you sell equipment, enter a home to service it or receive equipment for servicing in your shop. #283, \$1.00.

FM STEREO MULTIPLEXING, Norman H. Crowhurst. Covers the most timely, exciting area of audio. Of great value to the service-technician, student and anyone who intends to buy new FM stereo equipment or convert his present system to FM Stereo. It tells you how FM Stereo works. It shows you and explains the typical receiver circuits in the equipment available on the market. The information on conversion of monaural FM tuners into stereo units is complete. It includes antenna installation, matching different adapters to different tuners; matching adapters or tuner to a stereo system. Several chapters are devoted to servicing, alignment, performance checks and general trouble-shooting procedures. #282, \$1.50.

FAMOUS 'PICTURE-BOOK' COURSES ON ELECTRICITY, ELECTRONICS, SERVO

BASIC ELECTRICITY • BASIC ELECTRONICS • BASIC SYNCHROS & SERVO-MECHANISMS, Van Valkenburgh, Nooker & Neville, Inc.

BASIC ELECTRICITY, 5 volume picture-book course—civilian version of the extremely successful illustrated training course used by the U. S. Navy to turn out trained technicians in record time. "... The discussions are so lucid that almost anyone could learn, even by home study..." — NATIONAL SCIENCE TEACHERS ASSOCIATION. 5 vols., soft covers, \$11.25; 5 vols., cloth, \$12.75. **BASIC ELECTRONICS STANDARD 5 VOL. COURSE**. Available as heretofore. The 5-volume civilian version of the U. S. Navy course. "... a better and quicker way to teach and learn..." — FT. GORDON BOMBER. Set of vols. I to V in soft covers, \$11.25; all 5 vols. in cloth binding, \$12.75.

*all books soft cover unless noted

BASIC ELECTRONICS VOLUME 6 ONLY. For the great many tens of thousands who have completed the 5-volume course, the 6th volume on semi-conductors, transistors and FM is a book which you should own. "... highly recommended; the section on transistors alone is worth the price of admission." — POPULAR ELECTRONICS. Soft cover, \$2.90; cloth, \$3.95.

BASIC ELECTRONICS EXPANDED COURSE. The integrated expanded course consists of 6 volumes including the 5 volume standard course, plus the 6th volume which expands into the areas of semi-conductors, transistors, and frequency modulation. Set of vols. I to VI, soft covers, \$13.85; 6 vols., cloth, \$14.85.

BASIC SYNCHROS & SERVOMECHANISMS. "... Lavish use is made of illustrations... and the accompanying text is concise and simply worded." LIBRARY JOURNAL. 2 vols., soft covers, \$5.50; both vols. in one cloth binding, \$6.95.

FREQUENCY MODULATION

PRINCIPLES OF FREQUENCY MODULATION, B. S. Camies. "The well-rounded expertly presented text." — NEW TECHNICAL BOOKS, \$3.50.

FM LIMITERS AND DETECTORS, A. Schure, Ph.D., '90. **STEREOPHONIC SOUND (2nd ed.)** Norman H. Crowhurst, \$2.90.

FM TRANSMISSION & RECEPTION (2nd ed.) Rider & Ustian, cloth, \$7.50.

FREQUENCY MODULATION, A. Schure, Ph.D., \$9.00.

TRANSISTORS

FUNDAMENTALS OF TRANSISTORS (2nd ed. rev. & enlarged), Leonard M. Krugman, P. E. "Few who are interested in transistors can afford to be without it." — WIRELESS ENGINEER, \$3.50; hard cover, \$4.50.

BASIC TRANSISTORS "Pictured-Text Course", Alex. Schure, Ph.D. "... readily understandable without an instructor and suitable for individual as well as classroom study." — PRODUCT ENGINEERING. Soft cover, \$3.95; cloth, \$5.50.

PRINCIPLES OF TRANSISTOR CIRCUITS, S. W. Amos, B.Sc., \$3.90.

FUNDAMENTALS OF TRANSISTOR PHYSICS, I. Gottlieb, B.S., \$3.90.

INTERNATIONAL TRANSISTOR SUBSTITUTION GUIDEBOOK (4500 direct substitutions), Keats Pullen, Jr. "Possible substitutions deemed 'doubtful' that is they work only in some cases, were omitted... thus, substitution guide is a 'safe' guide." — INDUSTRIAL ELECTRONIC ENGINEERING & MAINTENANCE, \$1.50.

TRANSISTOR ENGINEERING REFERENCE HANDBOOK, H. E. Marrows, cloth, \$9.95.

SEMI-CONDUCTORS & TRANSISTORS (Electronic Technology Series), A. Schure, Ph.D., \$2.90.

COMPUTERS

BASICS OF DIGITAL COMPUTERS, John S. Murphy (3 volume 'pictured-text' course). "Provides a quick and thorough insight into the ABC's of digital computers." — OFFICE AUTOMATION NEWS BULLETIN. 3 vols., soft covers, \$8.40; cloth, \$9.50.

BASICS OF ANALOG COMPUTERS, T. D. Trautt & A. E. Rogers. ("Pictured-Text" Course). "First comprehensive work on analog computers capable of explaining to almost anyone the basic principles involved, as well as their practical applications." — DESIGN NEWS, Cloth, \$12.50.

DESIGN OF TRANSISTORIZED CIRCUITS FOR DIGITAL COMPUTERS, Abraham I. Pressman, M.S. "... by far the most comprehensive coverage on this subject to date... useful to circuit designers in the computer field." — Reviewed for the PROCEEDINGS OF I.R.E. by William B. Cagle, Bell Telephone Labs., Whippany, N. J. Cloth, \$9.95.

SPACE AGE TECHNOLOGY

BASICS OF MISSILE GUIDANCE & SPACE TECHNIQUES, Marvin Hobbs, P.E. ("Pictured-Text" Course). "Tells the missile guidance story to the electronics man." — RADIO ELECTRONICS, 2 vols., soft cover, \$7.80; cloth, \$9.00.

BASICS OF GYROSCOPES, Carl Machover, E.E. ("Pictured-Text" Course). "Dramatic and forceful, yet extremely lucid approach... very useful."

INDIAN & EASTERN ENGINEERS, 2 vols., soft covers, \$6.90; cloth, \$7.75.

FUNDAMENTALS OF RADIO TELEMETRY, Marvin Tepper. "... will make important telemetry fundamentals crystal clear to the engineer or layman new to the subject." — POPULAR ELECTRONICS, \$2.95.

EFFECTS OF NUCLEAR RADIATION ON MEN & MATERIALS, T. C. Helvey, Ph.D. "... a very lucid and right to the point explanation of the effect of nuclear radiation on men and materials." — THE NAVY NEWS REVIEW, \$1.80.

FUNDAMENTALS OF NUCLEAR ENERGY AND POWER REACTORS, Henry Jacobowitz. "If you want a basic understanding of the atom reactor principles this is the book for you." — POPULAR ELECTRONICS, \$2.95.

INTRODUCTION TO ATOMIC ENERGY, William Atkinson. "Lucid discussion of the fundamentals of atomic energy." — SCIENCE REVIEW, William Atkinson, \$1.35.

TELEVISION

BASIC TELEVISION (Pictured-Text Course), Alex Schure, Ph.D. "... the most understandable presentation of the basic theory operation and circuitry of black and white television ever published." — ELECTRONICS & COMMUNICATIONS, 5 vols., soft cover, \$11.25; cloth, \$12.75.

VIDEO TAPE RECORDING, Julian Bernstein. "A fine overall survey in a field that is becoming increasingly important to the TV industry." — BROADCASTING, cloth, \$8.95.

TELEVISION—HOW IT WORKS (2nd ed.), J. Richard Johnson. "Comprehensive and definitive." — ELECTRONIC TECHNICIAN, \$4.60; cloth, \$5.50.

REPAIRING TELEVISION RECEIVERS, Cyrus Glickstein, \$4.40.

HOW TO TROUBLESHOOT A TV RECEIVER (2nd ed.), J. Richard Johnson. "... How to find the cause of trouble in a television receiver in the shortest time." — ELECTRONIC ENGINEERING, \$2.90.

VITAL AREAS OF ELECTRONICS

MAGNETIC AMPLIFIERS—Principles & Applications, Paul Mall. "... a good first book on the subject for technicians and students." — RADIO ELECTRONICS, \$2.45.

INTRODUCTION TO PRINTED CIRCUITS, R. L. Swiggert. "nicely illustrated, clearly explained, this book is well recommended." — ELECTRONIC TECHNICIAN, \$2.70.

BASIC AUDIO, Norman H. Crowhurst. ("Pictured-Text" Course). "... effectively a complete course in basic audio theory." — POPULAR ELECTRONICS, 3 vols., soft covers, \$8.70; cloth, \$9.95.

BASICS OF PHOTOTUBES & PHOTOCELLS, David Mark. "Students, technicians and engineers should find this book of value..." — INDUSTRIAL SCIENCE & ENGINEERING, \$2.90.

BASICS OF FRACTIONAL HORSEPOWER MOTORS & REPAIR (Pictured-Text Course), Gerald Schweitzer. "Practical, easy-to-understand explanation on the principles of operation of various motors." — DESIGN NEWS, Soft cover, \$3.90; cloth, \$4.90.

BASIC PULSES, I. Gottlieb, P.E. "... highly pictured approach... makes this easy reading." — PRODUCT ENGINEERING. Soft cover, \$3.50; cloth, \$4.75.

METALLIC RECTIFIERS & CRYSTAL DIODES, Theodore Conti. "... comprehensive but basic approach..." — ELECTRICAL EQUIPMENT, \$3.50.

HOW TO READ SCHEMATIC DIAGRAMS, D. Mark. "... a worthwhile acquisition for anyone who is beginning to feel his way in electronics." — ELECTRONICS ILLUSTRATED, \$3.50.

BASIC ULTRASONICS, Cyrus Glickstein. ("Pictured-Text" Course). "An excellent introduction to ultrasonics... heartily recommended." — PROCEEDINGS OF THE I.R.E. Soft cover, \$3.50; cloth, \$4.60.

UNDERSTANDING MICROWAVES (a revised reprint), Victor Young Ph.D. "It is not an easy task to write a good book on microwaves without resorting to deep math. This author has done it." — RADIO ELECTRONICS, \$3.50.

SHORTWAVE PROPAGATION, Stanley Leinwell. "Just right for amateur interested in ionospheric propagation to physicists and engineer..." — QST, \$3.90.

Visit your electronic parts distributor, book store, or order direct from publisher. Free catalog of all Rider titles. Write Dept. EW-11



JOHN F. RIDER PUBLISHER INC., 116 West 14th Street, New York 11, N. Y., a division of Hayden Publishing Company, Inc.

Here's the SPECIALIZED

Let these 2 Ghirardi manuals teach you to
**REPAIR ANY TELEVISION
OR RADIO RECEIVER ever made!**



A. A. GHIRARDI

SAVE \$2.00!

Make your service library complete! Get both these famous Ghirardi books at a saving of \$2.00 under the regular price. See MONEY-SAVING COMBINATION OFFER in coupon.

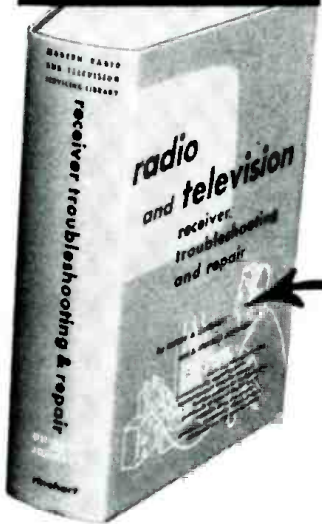

Let these two famous training books teach you to handle all types of AM, FM and TV service jobs by approved *professional* methods—and watch your efficiency and earnings soar! Almost 1500 pages and over 800 clear pictures and diagrams explain EVERY troubleshooting and repair operation as clearly as A-B-C. No needless mathematics. No involved theory. You get straight-from-the-shoulder training of the type that teaches you to do the best work in the

shortest time. Each book is co-authored by A. A. Ghirardi whose radio-electronics training guides have, for more than 25 years, been more widely used for military, school and home study training than any other books of their types. Books are sold separately at prices indicated—or you save \$2.00 by buying them both. Use coupon or order from Dept. RN-111, Technical Div., Holt, Rinehart and Winston, Inc., 383 Madison Ave., New York 17, N.Y.

RADIO & TV CIRCUITRY and OPERATION

Learn about circuits . . . and watch service headaches disappear

You can repair ANY radio, TV or other electronic equipment lots easier, faster and better when you're fully familiar with its circuits and know just why and how each one works . . . and that's exactly the kind of specialized training you get in Ghirardi's 669-page RADIO & TV CIRCUITRY AND OPERATION training guide. First it gives

a complete understanding of basic modern circuits and their variations. Finally it shows what troubles to look for and how to eliminate useless service testing and guesswork. Throughout, it gives you the above-average training that takes the "headaches" out of trouble-shooting—the kind that fits you for the best-paid servicing jobs. Contains 417 clear illustrations.

Sold separately for \$9.00—or see MONEY-SAVING COMBINATION OFFER.

RADIO & TV TROUBLESHOOTING & REPAIR

Complete training in modern service methods

RADIO & TV TROUBLESHOOTING AND REPAIR is a complete 822-page guide to *professional* service methods . . . the kind that help you handle jobs faster, more profitably. For beginners, this giant book with its 417 clear illustrations is an easily understood course in locating troubles fast and fixing them right. For experienced servicemen, it

is an ideal way to develop better methods and shortcuts; or to find fast answers to problems. You learn troubleshooting of all types from "static" tests to dynamic signal tracing methods. Step-by-step charts demonstrate exactly what to look for and how to look. A big television section is a down-to-earth guide to all types of TV service procedures. Read it 10 days at our risk!

Sold separately for \$10.00 or save \$2.00 on MONEY-SAVING COMBINATION OFFER.

Cut Radio Television Test Time IN HALF!



In modern electronic work it's what you know about using instruments that really counts!

This big 316-page BASIC ELECTRONIC TEST PROCEDURES manual with its more than 190 illustrations, pattern photos and procedure diagrams teaches you to test any circuit, equipment or component in a fraction of the usual time. In brief, it is a complete course in professional instrument testing techniques! Covers different ways of doing jobs. For instance, you learn to check for distortion by the scope, rejection filter, harmonic distortion meter, wave analyzer or oscillator methods. You learn to measure resistance with a current meter, a voltmeter, waltmeter, ohmmeter, or via the bridge method—and so on through all types of testing.

Includes: Current checks; measuring Power, Capacitance, Resistance, AF, RF, Phase, Distortion & Modulation; testing Tubes and Semiconductors; testing Amplifiers; checking Sensitivity, RF Gain, Fidelity, AVC Voltage, etc. Even includes industrial electronic test procedures. Everything is really complete—and written so you can understand it! Price \$8.00.

Order BASIC ELECTRONIC TEST PROCEDURES in coupon.

Here's what you need to know about SEMICONDUCTORS!

Diodes—Transistors—Thermistors—Varistors—
Rectifiers—Zener Diodes—Photo Cells
Parametric and Magnetic Devices, etc.

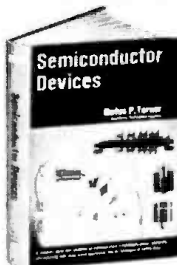

PLUS details on using, testing and measuring semiconductors.

This down-to-earth 278-page book brings you a practical working knowledge of semiconductors of all commonly used types. It answers your questions. It equips you with the complete know-how of types, construction, circuit applications, testing and use.

SEMICONDUCATORS by Rufus Turner has been specifically written for electronic technicians, servicemen and experimenters who find it increasingly important to have more than just a casual knowledge of these little devices that are literally revolutionizing electronic circuitry and design.

Over 250 illustrations demonstrate semiconductor circuitry and features. Methods of testing and measuring semiconductors are spelled out in detail.

Price only \$6.95. Check SEMICONDUCTOR DEVICES in coupon to order.

DON'T THROW OLD RADIOS AWAY!



Here's the data you need to fix old sets in a jiffy!

Just look up the how-to-do-it data on that old radio you want to fix.

Four times out of 5, this giant, 313-pound, 744-page Ghirardi RADIO TROUBLESHOOTER'S HANDBOOK tells what is likely to be causing the trouble . . . shows how to fix it. No useless testing. No wasted time. Using it, even beginners can easily fix old sets which might otherwise be thrown away because service information is lacking. With a few simple repairs, most of these old sets can be made to operate perfectly for years to come.

Covers every model made by 202 mfrs. from 1925 to 1942

THE ONLY GUIDE OF ITS KIND!

Cuts service time in half!

Included are common trouble symptoms and their remedies for over 4,800 models of old home, auto radios and record changers: Airline, Apex, Arvin, Atwater Kent, Belmont, Bosh, Brunswick, Clarion, Crosley, Emerson, Fada, G-E, Kolster, Majestic, Motorola, Philco, Pilot, RCA, Silvertone, Spartan, Stromberg and dozens more. Includes hundreds of pages of invaluable tube and component data, service short cuts, etc.

Specify RADIO TROUBLESHOOTER'S HANDBOOK in coupon. Price only \$10.00. 10-day trial.

USE COUPON FOR **10-day Free Trial!**

TRAINING YOU NEED

in its most complete
economical and
easily understood form

TRAIN AT HOME FOR TV-RADIO-ELECTRONICS . . . at rock-bottom cost!

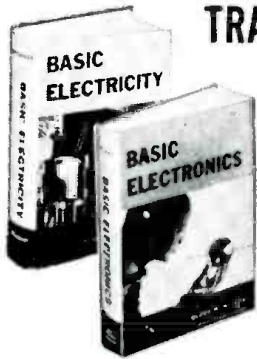

Now! Get your basic training from these two easily understood, low cost books!

Here is complete basic electrical-electronic training specifically written for beginners—priced at a fraction of what you might expect. 785 pages and almost 700 pictures, diagrams and charts in these two big books bring you top notch training that can pave your way to a fascinating electronic career. Every detail is fully and clearly explained. Nothing is omitted—nothing is condensed. In every respect, the material in these books compares more than favorably with "courses" costing many times as much!

BASIC ELECTRICITY—Fundamental electrical principles are the basis of all Electronics—and this 396-page manual gives you a complete working knowledge of them all! Covers everything from electromagnetism to phone principles, circuits, wiring, illumination, reactance, impedance, power factor, instruments, controls, measurements, and all types of components and equipment. Includes set-up diagrams, practical examples and problem solutions. Price \$6.25 separately. See Money-Saving Offer!

BASIC ELECTRONICS—This big 389-page guide takes up where Basic Electricity leaves off. Shows how electrical principles are applied in Electronics and gives you a sound grasp of electronic theory, methods, circuits and equipment. Over 375 illustrations explain details clearly. The ideal basic training to help you build a profitable future in TV, radio, communications, hi-fi, industrial electronics and related fields! Price \$6.25 separately.

ONLY \$11.00 FOR THIS COMPLETE HOME TRAINING!

Save \$1.50! See special Money-Saving Offer in Coupon!

Here's everything you need to know about

SCOPES!

Complete data on using the handiest instrument of all!

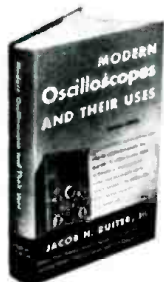

'Scope experts get the big pay jobs!

Men who know how to use oscilloscopes on all types of jobs don't guess about trouble-shooting and tough realignment problems! They locate troubles in a jiffy, adjust them quickly and accurately—and this famous 346-page manual teaches you the methods they use. **MODERN OSCILLOSCOPES AND THEIR USES** gets right down to earth in telling you all about these versatile instruments and exactly how to use them. Particular attention is paid to AM, FM, and TV realignment procedures. Every detail of testing with 'scopes is explained from connecting the 'scope and setting its controls to adjusting components in the chassis being tested. Illustrated instructions teach you to analyze patterns. Even includes data on quantitative measurements (as used in color TV servicing) and use of 'scopes in lab, industrial electronics and atomic work. 370 illustrations. Price \$8.00.

Specify **MODERN OSCILLOSCOPES AND THEIR USES** in coupon to order.



SHORT CUT TO TV REPAIRS!

Just turn the dial of the pocket-size PIX-O-FIX TROUBLE FINDER GUIDE! When the picture in the PIX-O-FIX window matches the image on the TV screen—presto!—you've got your clue. PIX-O-FIX shows the likely causes of the trouble—indicates the re-

ceiver section involved—then gives clear repair instructions. Two PIX-O-FIX units Nos. 1 and 2 cover 48 different TV troubles. Together, they're a comprehensive guide to quick "picture analysis" servicing of any TV. Price only \$3.00 for the two.

Get your COMMERCIAL OPERATOR'S LICENSE!

Train for radio's most fascinating, best paid jobs!



This famous book makes it easy to train for your FCC commercial license as an operator aboard ship, in aviation, broadcasting, telecasting, etc. **LICENSE MANUAL FOR RADIO OPERATORS** is a quick, easily understood guide that covers ALL

EIGHT FCC examination elements—not just some of them. Reviews almost 2200 exam questions. Covers everything you'll need to know to pass your examination for 1st or 2nd class radio-phone license with flying colors! Price \$6.75.

REPAIR ANY ELECTRICAL APPLIANCE!

Save on repair bills! . . . Earn in your Spare Time!

This 370-page **ELECTRICAL APPLIANCE SERVICE MANUAL** helps you service practically any home electrical appliance. Includes standard and automatic washers, irons, toasters, ranges, cleaners, mixers, razors, clocks, motors, and many more.

Troubleshooting charts quickly help you locate troubles. Easy instructions guide you in making repairs. Tells how to make your own low-cost test tools. Includes appliance refinishing methods. An ideal guide for fixing your own appliances or for building a profitable repair business! \$6.25.



ORDER NOW

TRY ANY BOOK 10 DAYS FREE!

Dept. RN-111, Technical Division, Holt, Rinehart & Winston, Inc.,
383 Madison Ave., New York 17, N. Y. 623900

Send books checked for 10 day FREE examination at prices indicated plus postage. SAVE! Send cash with order and we pay postage. Same 10 day return privilege with money refunded.

Check here for **MONEY-SAVING SERVICE COMBINATION** on Ghirardi's Radio & TV CIRCUIRY & OPERATION and Radio & TV TROUBLESHOOTING and REPAIR. Price only \$17.00 for both (plus postage). Regular price \$19.00—you save \$2.00! (#709006)

Check here for **MONEY-SAVING Basic Training COMBINATION** ON BASIC ELECTRICITY and BASIC ELECTRONICS. Price only \$11.00 plus postage for both big books. Regular price—\$12.50—you save \$1.50! (#709196)

Check here to order **INDIVIDUAL BOOKS**

- | | |
|--|--|
| <input type="checkbox"/> Radio & TV CIRCUIRY & OPERATION (#708214) \$ 9.00 | <input type="checkbox"/> Basic Electronics (#708974) \$ 6.25 |
| <input type="checkbox"/> Radio & TV Receiver TROUBLE-SHOOTING and REPAIR (#708578) . . 10.00 | <input type="checkbox"/> Modern Oscilloscopes & Their Uses (#708818) 8.00 |
| <input type="checkbox"/> Basic Electronic Test Procedures (#708933) 8.00 | <input type="checkbox"/> PIX-O-FIX TV Trouble Finder Guides, Nos. 1 and 2 (#708412) . . . 3.00 |
| <input type="checkbox"/> Semiconductor Devices (#709003) . 6.95 | <input type="checkbox"/> License Manual for Radio Operators (#708537) 6.75 |
| <input type="checkbox"/> Radio Troubleshooter's Handbook (#708297) 10.00 | <input type="checkbox"/> Electrical Appliance Service Manual (#708172) 6.25 |
| <input type="checkbox"/> Basic Electricity (#708859) 6.25 | <input type="checkbox"/> Handbook of TV Troubles (#708453) 7.50 |

Add 50¢ to price of each book. Cash with order, but money refunded if books are returned in 10 days.

Name _____
Address _____
City, Zone, State _____
(Above offers expire July 15, 1962)

Master Guide to TIME-SAVING TV SERVICE



Almost regardless of set make or model this remarkable new 302-page **HANDBOOK OF TV TROUBLES** helps you track down TV troubles from the symptoms they produce in the set itself: screen intermittently dark; "blooming"; abnormal contrast; "snow"; poor detail; sync troubles; sound troubles—and all the many other symptoms that indicate something is wrong. Just turn to the "Quick Trouble-Finder Guide" inside the cover. Look up the symptoms exhibited by the set you're working on. The **HANDBOOK** then tells you just what

LOOK! LISTEN! Then follow this easy guide!

to do and how to do it. Outlines time-saving shortcuts. Eliminates guesswork. More than 150 test patterns, wave form and circuit illustrations explain test results, details and procedures. Printed in large type and bound in sturdy varnished covers for use at the bench. All methods presented have been bench-tested by the author through actual shop-work! Price \$7.50.

Order **HANDBOOK OF TV TROUBLES** in coupon.

November, 1961



Only
General
Electric
gives
you
this:

New Orthonetic Stereo Cartridge

*Purest musical response ever—
even beyond 20,000 cycles!*

Compared with four other leading brands, the General Electric Orthonetic Cartridge gives flattest, widest frequency response of all . . .

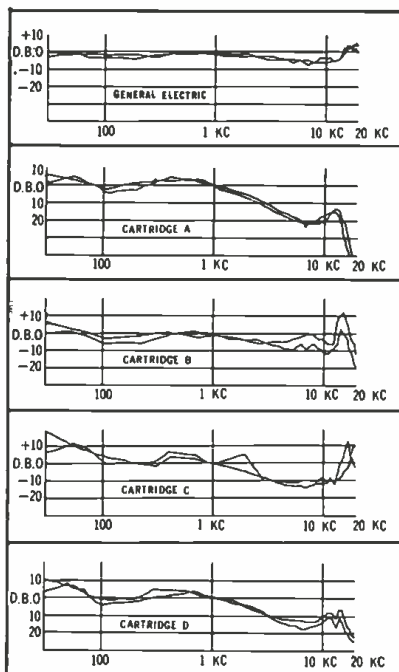

Audio Products Department

GENERAL ELECTRIC
Decatur, Ill.

Giant breakthrough in musical reproduction! General Electric's new ORTHONETIC Cartridge gives precise, undistorted reproduction of every note on your high-fidelity records—even at frequencies above the normal range of human hearing!

Even the most subtle overtones come through . . . Ordinary cartridges fall off sharply in frequency response above 15,000 cycles per second. They shave off the higher overtones that give orchestral instruments their characteristic color.

To prevent the loss of the higher harmonics, General Electric engineers developed a revolutionary new suspension and damping system. This exclusive system ensures that all harmonic frequencies are

reproduced without loss, and in their proper relationship to the fundamental.

This means that every instrument has its true coloration; even the most sensitive ear can listen without the fatigue caused by musical distortion.

Tracks at pressures as low as one gram prolongs record life . . . The mass of the moving system of the ORTHONETIC is less than one-thousandth of a gram. This minimal mass permits the stylus to trace faithfully record-groove patterns that require it to stop and start as frequently as 40,000 times per second! The low tracking pressure also minimizes wear on your valuable records.

Specifications for General Electric VR1000-5

.5 mil Diamond Stereo Cartridge (Also available with .7 mil diamond stylus, for record changers that track from 3-7 grams vertical force). **Application:** Professional-type turntable and tone arm, or any quality changer that tracks below 4 grams vertical force. **Recommended Tracking Force:** 1-3 grams. **Lateral Compliance:** 6×10^{-4} cms/dyne. **Vertical Compliance:** 9×10^{-4} cms/dyne. **Frequency Response:** 20 —20,000 cycles per second ± 3 db. **Recommended Load Resistance Each Channel for Flat Response:** 47K ohms. **Output:** 1 millivolt per cm/sec. minimum. **Separation between Channels:** 25-30 db per channel at 1000 cycles. **Channel balance at 1000 cycles** 2 db or better. **Resistance:** 1100 ohms per channel, nominal. **Inductance:** 400 mh, per channel, nominal. **Shielding:** Triple mu-metal. **Mounting Centers:** Standard $\frac{1}{2}$ " mounting centers. All measurements taken from RCA Victor stereophonic test record number 12-5-71.

exclusive in PHOTOFACT

the world's finest electronic service data

the famous Howard W. Sams **STANDARD NOTATION SCHEMATIC!**

as easy to read as a road map...makes circuit tracing and parts identification simple, quick, accurate...saves you hours each day for more profitable servicing...

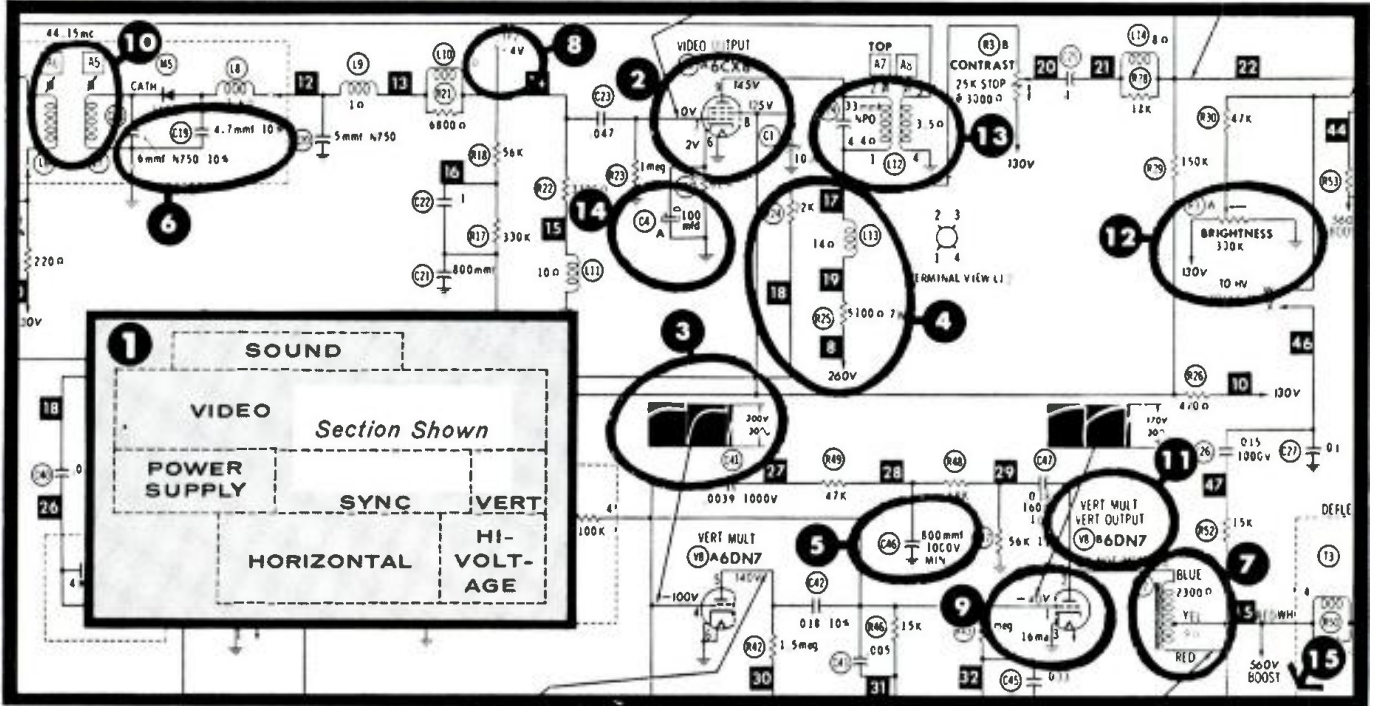

THIS AMAZING FEATURE-PACKED SCHEMATIC GIVES YOU ALL THE RIGHT ANSWERS AT A GLANCE!

- 1** Uniform schematic layout. Each receiver circuit can be located quickly, since layout is always the same, regardless of receiver make.
- 2** Voltages are shown at all tube pins and test points for speed and convenience—no time-wasting separate reference charts to fumble through.
- 3** Shows actual photos of waveforms at key check points for quick comparison with those obtained on your own scope.
- 4** "CircuitTrace" numbers on schematic are keyed to actual photos of printed boards, for easy location of specific circuit points.
- 5** Component item numbers are keyed to chassis photos for parts location, and to parts list to enable you to quickly determine proper replacement.
- 6** Special capacitor and resistor ratings are shown on the schematic; valuable where tolerances are a factor in replacement parts consideration.
- 7** Coil and transformer color codes or terminal identifications are given to speed tracing of connections.
- 8** Test points are shown for speedy reference in measuring and servicing.
- 9** Special currents (B+ supply, horizontal output cathode, vertical output cathode, etc.) are given, to isolate improperly operating circuits or components.
- 10** Alignment points are identified on the schematic and photos, and are keyed in with the alignment procedures for rapid, error-free adjustments.
- 11** Tube functions are shown on schematic and Tube Placement Charts to help you quickly isolate troubles.
- 12** Complete identification of controls and switches quickly shows their functions without needless circuit tracing. Arrows indicate direction of rotation to help you understand circuit operation.
- 13** Coil resistances over 1-ohm are shown—a great help in determining shorted turns, opens, etc.—avoids misleading continuity tests
- 14** Polarity and section identification of electrolytic capacitors are easily determined from the schematic—saves valuable time in identifying component sections
- 15** Fuse ratings are shown on schematics and Tube Placement Charts for quick replacement, handy for in-home service work.

The Standard Notation Schematic is just one of dozens of great features in PHOTOFACT for fastest, easiest, more profitable servicing. See your Sams Distributor for full details on an Easy Buy Library or Standing Order Purchase!

COMING IN PHOTOFACT!
FREE BONUS 20-LESSON Second-Class Radiotelephone License Course!

Will help you pass the exam for an FCC License...so you can upgrade your career in electronics and become an expert in communications! Begins in January 1962 (Photofact Set No. 561) as a bonus with your subscription to PHOTOFACT. Be sure your distributor has your subscription!

FREE!

VALUABLE PHOTOFACT INDEX!

Your guide to over 50,000 TV, Radio, Electronic listings—covering virtually every model produced since 1946. Helps you locate the proper PHOTOFACT Folder you need to solve any service problem in any model. Send coupon today for your FREE copy of the latest PHOTOFACT Index!

HOWARD W. SAM'S & CO., INC.

Howard W. Sams & Co., Inc., Dept. 5-L1
 1724 E. 38th St., Indianapolis 6, Ind.

Send FREE Photofact Cumulative Index

Send full information on: Easy Buy Plan Standing Order Subscription "Peet" Program

Shop Name _____

Attn: _____

Address _____

City _____ Zone _____ State _____

Why the WINEGARD ELECTRONIC MOST EFFECTIVE TV ANTENNA...

**DESIGNED TOGETHER
TO WORK TOGETHER... WINEGARD
POWERTRON ANTENNA AND
BUILT-IN AMPLIFIER!**

TRANSISTORIZED!



MODEL SP-55X

"By FAR world's most powerful all-channel antenna"

WHY? BECAUSE...



IT CAPTURES MORE SIGNAL than any other all-channel antenna ever made. Patented design, electro-lens director system, dual "TAPERED T" driven elements, 30 precision-tuned elements in all.



IT'S THE ONLY TRUE ELECTRONIC ANTENNA. Only the Winegard Powertron is built with the amplifier as part of the driven element—not an "add-on" attachment.



IT ELIMINATES ALL SIGNAL LOSS that normally occurs between the driven element and the amplifier due to transmission and coupling mis-match.



IT BOOSTS WEAK SIGNALS UP OUT OF THE SNOW far better than any other antenna or antenna-amplifier combination made.



FOR VIVID COLOR, HIGH DEFINITION BLACK AND WHITE AND LONG DISTANCE RECEPTION, nothing can compare to the Super Powertron. Thousands have been installed all over the country and our files are full of testimonials from grateful TV viewers and Service-Technicians alike.



WINEGARD IS THE ONLY MANUFACTURER THAT MAKES BOTH ANTENNAS AND RF AMPLIFIERS. Because of this you can feel confident of getting the very best. But don't take our word for it—let your eyes and ears and field strength meter tell the story.



MODEL P-55
Powertron — transistorized, 14 elements.



MODEL P-55X
Powertron with Pack — Transistorized, 21 elements.



MODEL SP-55X
Super Powertron — transistorized, 30 elements.

POWERTRON is by far WORLD'S

Not 60%...Not 70%...but over 95% efficient

OUTFEATURES—OUTPERFORMS ORDINARY ANTENNAS WITH "ADD-ON" TYPE SIGNAL BOOSTERS!

THIS IS BETTER —



Exclusive amplified "Tapered T" driven element for perfect match and lowest possible signal-to-noise ratio. Only Powertron has it.

THAN THIS —



Not an after-thought "add on" signal booster hung on an ordinary antenna — not an old fashioned mast mounted booster.



ONLY POWERTRON HAS BOTH 300 OHM TWIN LEAD OR 75 OHM COAX TERMINALS ON BUILT-IN AMPLIFIER.



ONLY POWERTRON GIVES YOU YOUR CHOICE OF TRANSISTORS OR TUBES (TUBE MODELS 300 OHM ONLY).

POWERTRON HAS COMPLETELY AC POWER SUPPLY



Transistorized Model has rectifier and filter in power supply — not in amplifier, where servicing is difficult. No batteries. Costs 27¢ to operate for full year. Battery types require \$5 to \$9 in batteries a year to operate continuously at maximum efficiency.



ONLY POWERTRON HAS RANGE CONTROL SWITCH TO PREVENT OVER-DRIVING TV SETS ON EXTRA STRONG CHANNELS.



ONLY POWERTRON HAS AC PLUG-IN OUTLET FOR TV SET BUILT INTO THE POWER SUPPLY.

POWERTRON IS 100% CORROSION-PROOFED — ANTENNA IS GOLD ANODIZED, ALL HARDWARE IRRIDIZED, AMPLIFIER HOUSING OF HIGH IMPACT PLASTIC.

ONLY THE POWERTRON CAN DO ALL THIS!

1. Powertron will drive up to 10 TV sets and each set will have a better picture than an ordinary antenna will deliver to one set.
2. Powertron will drive a TV signal through one-half mile of lead-in with signal to spare—permits you unprecedented flexibility for remote installations.
3. Powertron will virtually eliminate snow and interference even on an old TV set.
4. Powertron will deliver superlative color reception far better than a non-electronic antenna.
5. Powertron brings in stations beyond the reach of non-electronic antennas—delivers greatest reception distance.



AND WINEGARD POWERTRON is the only antenna presold to your customers—nationally advertised in the biggest consumer advertising campaign yet! So stock up now—take advantage of the demand Winegard is building for you.

Write for free technical bulletins.



Winegard

ANTENNA SYSTEMS

Winegard Co., 3003-11 Kirkwood, Burlington, Iowa

EICO®... UNCOMPROMISING ENGINEERING

BEST BUYS IN SERVICE INSTRUMENTS: everything from Scopes to Probes



DC-5 MC
5" Scope #460
Kit \$79.95
Wired \$129.50
Also Avail.—5" Push-Pull Scope #425
Kit \$44.95 Wired \$79.95



Peak-To-Peak
VTVM #232
& Uni-Probe®
Kit \$29.95
Wired \$49.95
VTVM #221
Kit \$25.95
Wired \$39.95

Pat. #2,790,051



Dynamic Conductance
Tube & Transistor Tester #666
Kit \$69.95 Wired \$109.95
Complete with steel cover & handle

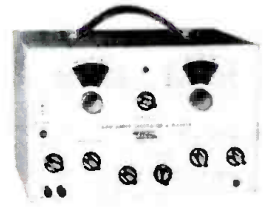

TV-FM Sweep Generator
& Marker #368
KIT \$69.95 Wired \$119.95

BEST BUYS FOR INDUSTRIAL TESTING: everything from Bridges to Supplies

NEW Metered
Variable
Auto-Transformer
AC Bench
Supplies:
#1073 (3 amp.)
Kit \$35.95
Wired \$47.95
#1078 (7 1/2 amp.)
Kit \$42.95
Wired \$54.95



NEW Extra-Low-
Ripple 6 &
12 Volt
Battery
Eliminator
& Charger #1064
Kit \$43.95
Wired \$52.95



NEW AC
Volt-Watt
Meter #260
Kit \$49.95
Wired \$79.95



1350 Combinations!
Series/Parallel R-C
Combination Box #1140
U.S. Pat. No. 2954518
Kit \$13.95 Wired \$19.95



BEST BUYS IN STEREO & MONO HI-FI: everything from Tape Decks to Speakers

TRANS-
TURIZED
Stereo/
Mono
4-Track
Tape
Deck
Wired
Model
RP100W
\$399.95
Semi-Kit
Model
RP100K
Electronics in Kit form \$299.95

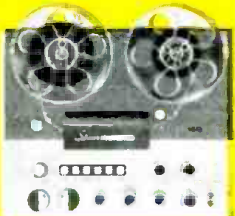

An original, exclusive EICO product
designed and manufactured in the
U.S.A. (Patents Pending)



NEW FM-AM Stereo Tuner ST96
Kit \$89.95 Wired \$129.95 Inc. FET

NEW FM-Multiplex
Autodaptor MK99
Kit \$39.95 Wired \$64.95
Designed for all EICO
FM equipment (MF790,
MF792, ST96) and any
other Component quality,
wide-band FM tuners
having multiplex outputs



NEW 70-Watt Integrated
Stereo Amplifier ST70
Kit \$94.95 Wired \$149.95

NEW 40-Watt Integrated
Stereo Amplifier ST40
Kit \$79.95 Wired \$129.95



Bookshelf Speaker System HFS1
Kit \$39.95 Wired \$47.95

BEST BUYS IN "HAM" GEAR: from Transmitters to Code Oscillators



NEW 60-Watt CW Transmitter #723
Kit \$49.95 Wired \$79.95



90-Watt CW Transmitter #720
U.S. Pat. No. D-184776
Kit \$79.95 Wired \$119.95



Universal Modulator Driver #730
Kit \$49.95 Wired \$79.95
Cover E-5 \$4.50

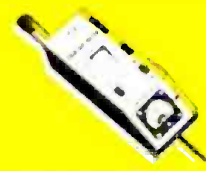

Grid Dip Meter #710
Kit \$29.95 Wired \$49.95

Over 2 MILLION EICO instruments in use. Compare EICO side-by-side critically with products selling for 2 or 3 times more. Buy your EICO right "off the shelf" from 1500 neighborhood dealers coast to coast, most of whom offer budget terms.

BEST BUYS IN CITIZENS TRANSCEIVERS AND TRANSISTOR RADIOS



Over 80 unique
products to
choose from!

EICO, 3300 N. Blvd., L.I.C. 1, N.Y. EW-11

Send free 32-page catalog & Distributor's name.

Send Free Schematic of Model No. _____

Send new 36-page GUIDEBOOK TO HI-FI for which I enclose 25c for postage & handling.

Name _____

Address _____

City _____ Zone _____ State _____



Citizens Band Transceivers
From: Kit \$59.95 Wired \$89.95
Superhet; prealigned xmitter
osc; match different antennas
by variable "pi" network.
Single & multi-channel models.



NEW Walkie-Talkie
Citizens Band
Transceiver #740
Kit \$54.95
Wired \$79.95.
Carrying Case \$3.95.
Complete with rechargeable
leakproof battery & charger.
Operates 2500 hours on the battery.
U.S.-made by EICO.



Transistor Portable Radio RA6
KIT \$29.95 Wired \$49.95 Incl. FET

Listen to the EICO Hour, WABC-FM, N. Y. 95.5 MC, Mon.-Fri., 7:15-8 P.M. © 1961 Electronic Instrument Co. Inc., 3300 N. Blvd., L.I.C. 1, N.Y. Add 5% in the West

A survey of some unusual ways that electronics is being teamed with medicine to give a better understanding of life processes.

Advances in MEDICAL ELECTRONICS

By WALTER H. BUCHSBAUM / Industrial Consultant, *ELECTRONICS WORLD*

EVERY taxpayer is well aware of the vast size of our annual defense budget and most of our readers also realize that a large portion of these expenditures go for military electronics. We have noted how some electronic techniques, developed for the defense effort, have eventually been used in commerce and industry. The host of novel applications of electronics to medical problems is far more thrilling because of their implication in matters concerning our health and vitality.

When we consider the electronic industry potential for human betterment, the prospect is staggering. The author has recently studied the field of medical electronics and has been convinced that, in this area alone, the application of electronic equipment has enormous possibilities. The benefits electronics can bring to bio-medicine may be greater by far than any previous medical discovery. We use the term "bio-medicine" because of the close interrelation between biology and medical research.

Electronics has been applied to medicine for many years in the form of such familiar equipment as the x-ray machine, the electrocardiograph, and the diathermy machine. Recently many doctors have installed ultrasonic vibration machines for deep massage of bruises, contusions, and simple bursitis.

Commonly used electronic devices which are found in practically every hospital are closed-circuit TV and audio systems for internal paging and instruction, along with radiation counters, timers, and similar devices.

In this article we will concentrate on the advances in the application of electronics in bio-medical research laboratories because this is where tomorrow's commonplace equipment originates. From the wealth of material and the wide variety of different electronic tech-

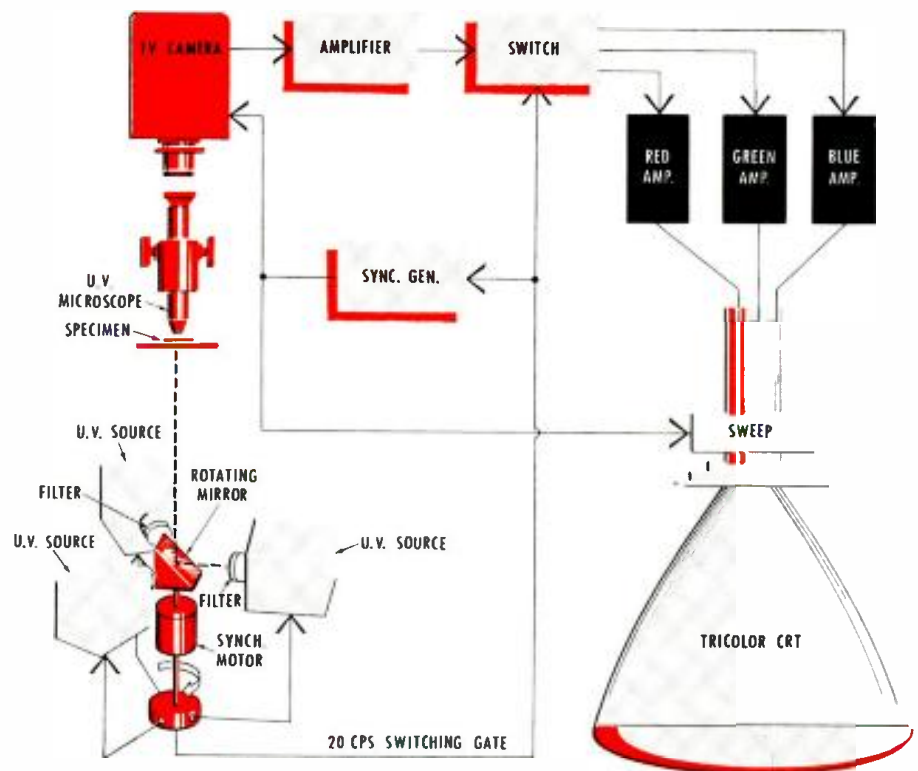

Fig. 1. Simplified block diagram of microscopy system using ultraviolet illumination combined with a color-television display.

niques perfected in the past few years we have selected a few examples which appear to be headed for use in the immediate future and which offer completely new tools in medical research.

Ultraviolet Microscopy

Many cells, bacteria, and other microorganisms are transparent to visible light and must be stained for microscopic investigation. This stain often disrupts the normal cell activity or else colors only the outside. A completely new insight into living cells and their structure will be possible by use of a new technique which replaces visible light with ultra-

violet radiation and combines a microscope with a color-TV system to view the results.

Fig. 1 is a simplified block diagram of the ultraviolet microscopy system developed at the Medical Electronics Center of Rockefeller Institute. By combining the talents of a medical man, Dr. Aterman, a biophysicist, Mr. Berkely, and an electronics expert, Dr. Zworykin, this novel technique has been developed which promises to open broad avenues to understanding life processes.

Three different wavelengths of ultraviolet radiation are selected by the variable filters placed in front of the three

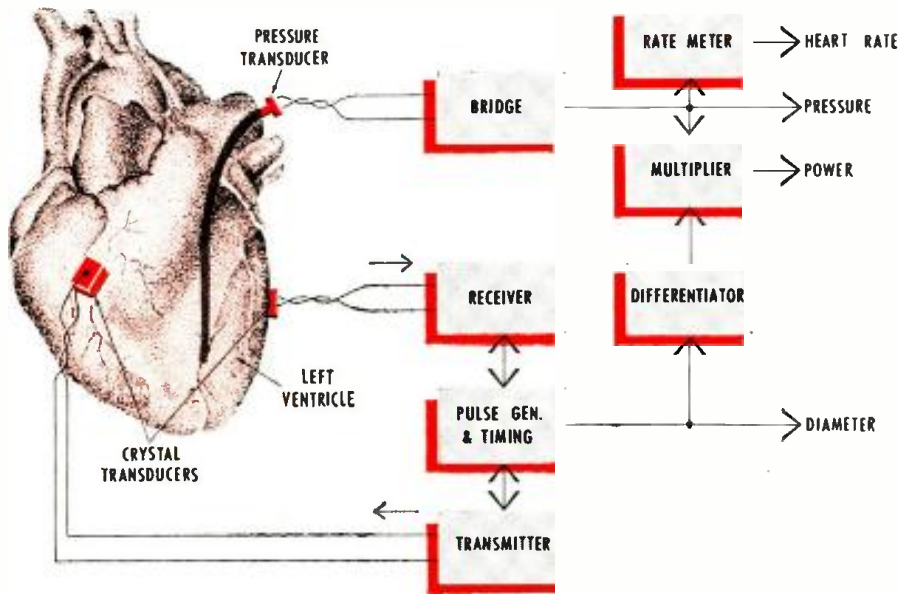

Fig. 2. Instrumentation setup utilized to determine heart operating parameters.

mercury xenon lights which serve as the ultraviolet sources. These wavelengths are reflected in sequence through the specimen by the rotating mirror; the specimen is magnified by the microscope. Instead of the observer's eye the image orthicon in the TV camera does the "looking." The microscope and orthicon are both selected to operate well into the ultraviolet spectrum, which means that all lenses must be quartz.

The video signal is amplified and then switched, in synchronism with the three ultraviolet light sources which are sequenced by the rotating mirror so that during one-twentieth of a second only one wavelength, corresponding to red, green, or blue, is seen. (Note: Because of light leakage from one ultraviolet source to another, the lights are switched by a commutator-like assembly rotated by a synchronous motor. This assembly also supplies a 20-cps switching gate for the electronics circuitry.) This is the same system as was used in the field-sequential color-TV system which pre-

ceded the present simultaneous system. Three separate amplifiers then drive a 21-inch tricolor tube. The result is a color picture of the specimen where the primary colors correspond to the three different ultraviolet wavelengths.

Many of the cells and microorganisms which are transparent to visible light, absorb or reflect the much shorter wavelengths of the ultraviolet spectrum. Different parts of these cells sometimes absorb or reflect different wavelengths so that it is often possible to see internal portions of cells in a different color. Where the microscope under visible light may show only vague shadows or nothing at all, ultraviolet illumination and subsequent translation into a color TV picture reveal a wealth of detail.

At the present time the research team which pioneered this new technique is primarily interested in advancing and perfecting it.

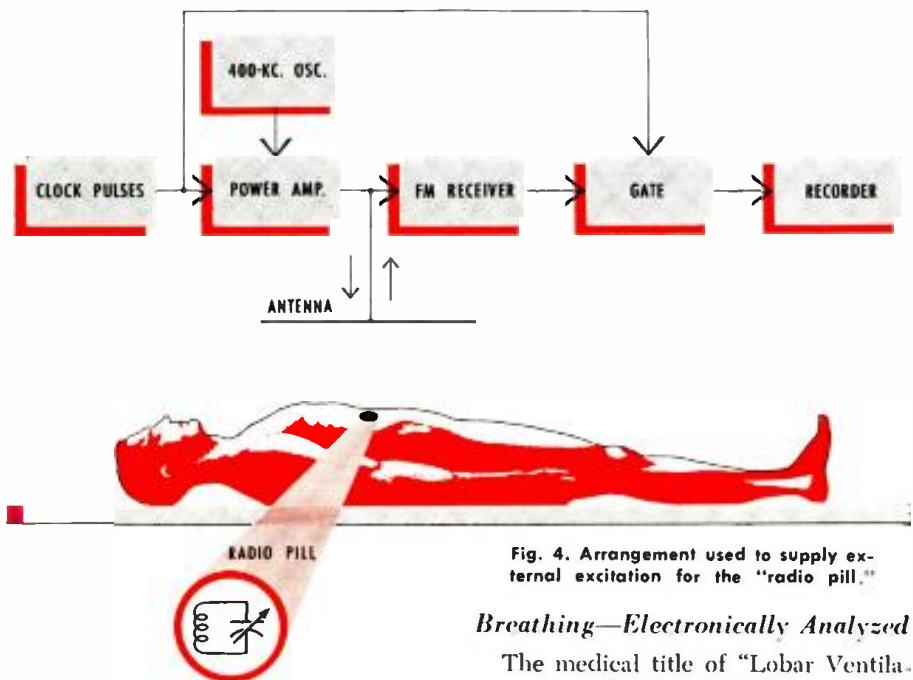
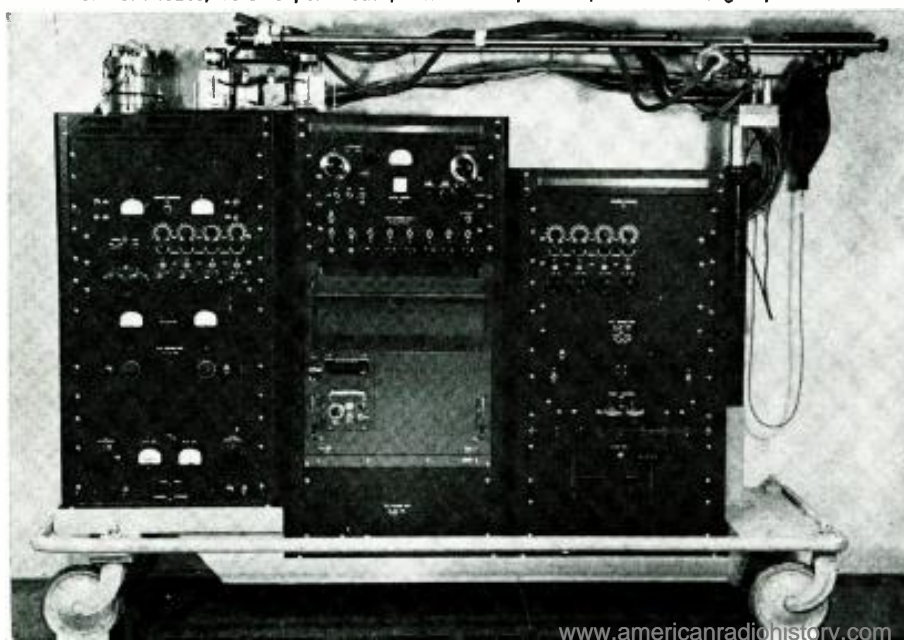

Fig. 4. Arrangement used to supply external excitation for the "radio pill."

Fig. 3. Respiratory gas analyzer employing an 8-channel recorder to indicate percent of carbon dioxide and nitrogen in upper and lower lobes of lungs, flow rate of both lobes, volume per breath, differential pressure, and relative gas pressure.



Breathing—Electronically Analyzed

The medical title of "Lobar Ventilation in Man" by Drs. C. J. Martin and A. C. Young, covers a brief paper which is one part of a much larger effort to apply electronics to the study of the respiratory process. At the University of Washington Medical School, the electronics group has developed the "Respiratory Gas Analyzer" shown in Fig. 3. This unit, affectionately dubbed "The Monster," can be wheeled to any convenient location and provides a wealth of information about the patient's breathing.

In the lower center rack an 8-channel recorder indicates the percentage of carbon dioxide and nitrogen from the upper and lower lobes of one lung, the total volume of inhalation per breath, the flow of air from both lobes, and the pressure of the two lobes with respect to each other. Usually the patient breathes into a mouthpiece while walking a tread-

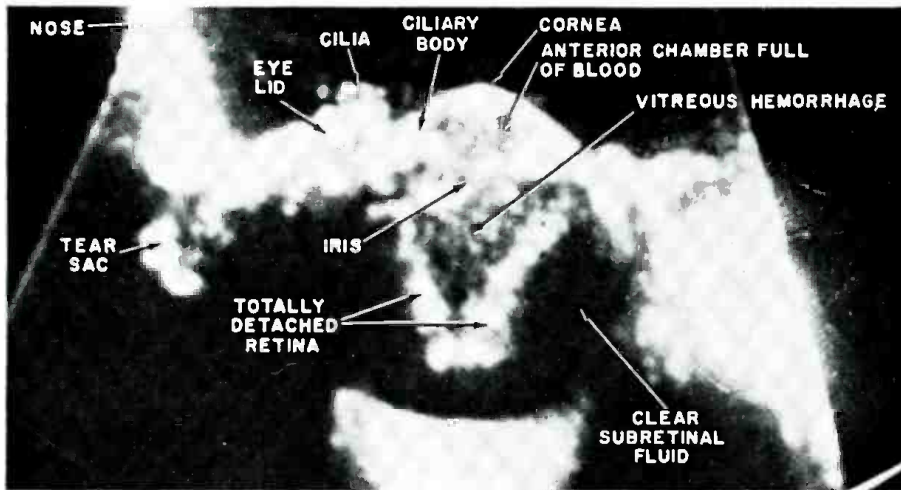

Fig. 5. An actual sonogram of a human eye. The view that is shown is from above.

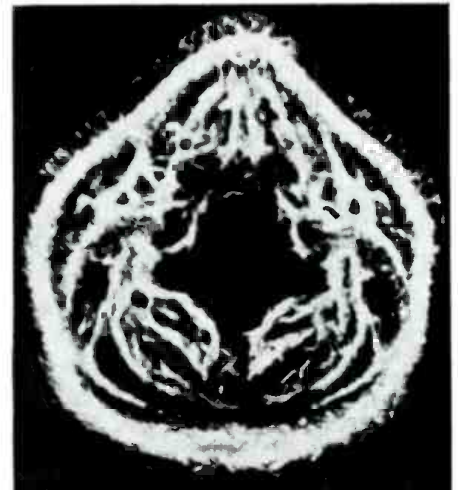

Fig. 7. Cross-section of a human neck.

mill, standing still, or in some other medically significant position. From the resulting data the doctor can determine lung defects with hitherto unknown accuracy and detail.

Heart-Measuring Techniques

The original electrocardiograph primarily indicates irregularities in the heartbeat, but today's techniques allow exact measurements of the flow of blood through the aorta, dimensioning of the heart and its chambers, and a much more detailed study of each heartbeat. For many of these measurements the chest must be opened, but the blood vessels and the heart itself remain undisturbed.

A group of researchers at the University of Washington have given a paper which briefly outlines some of these techniques. One simple method of measuring the expansion of the heart is to tie a thin rubber tube, filled with mercury, around the heart and record the change in resistance as the tube is stretched. A balanced resistance bridge and a pen recorder are all the electronic instrumentation needed.

Sonar can be used to measure the thickness of the heart by placing small crystal transducers at opposite sides of the heart or blood vessel and exciting one with some pulsed ultrasonic energy. The travel time of sound in tissue is about 1500 meters per second thus it takes about 16 μ sec. to traverse 25 mm. of tissue. A sonar or radar-type of pulse generator and time-delay measuring system is required for body-tissue evaluation. In addition to the heart and aorta, successful measurements of liver and spleen have also been made by this technique. The Doppler effect, using ultrasonic signals, can be employed to measure the flow of blood without cutting into the blood vessel.

A still more sophisticated system has been devised for determining the effective power of the heart itself. It uses both an ultrasonic dimensioning arrange-

ment of the heart and a catheter carrying a thermistor inserted into the bloodstream. The latter measures the heat carried away by the bloodstream as an indication of the velocity of the blood flow. It is also possible to utilize a pressure transducer, mounted at the end of a catheter which is inserted into the heart's left ventricle, to indicate the blood pressure in the heart itself. This pressure measurement may be made at the same time that the ultrasonic dimensioning measurement is made. A simplified version of the instrumentation for this procedure is shown in Fig. 2. Outputs of the two systems are measured by a pulse-timing circuit and a resistance bridge, followed by a simple analogue computer which feeds a multichannel recorder. From this doctors can read heart rate, change in diameter, pressure, and effective heart power.

Radio-Transmitter Pills

Several years ago headlines were made by a small radio transmitter capsule which could be swallowed by the patient and which would then radio in-

ternal pressure data to external receivers. This original capsule contained a battery and a transistor oscillator and was about 1 cm. in diameter. Battery life limited the use of this "pill" to about 8 to 30 hours maximum.

A refinement of this technique has been described by Drs. Zworykin and Farrar and Mr. Berkely of the Medical Electronics Center of the Rockefeller Institute. In this novel arrangement the "pill" is much smaller and contains only a resonant circuit in which the capacitor is formed by a pressure-sensing transducer. As shown in Fig. 4, an external antenna is placed over or around the patient and excited 3000 times a second with short 400-ke. bursts. The energy received by the "pill" causes the resonant circuit to "ring" on after the burst and this "ringing" takes place at the resonant frequency of the "pill." These frequencies are amplified and detected by the FM receiver after each burst of transmitted energy and, after the "pill" has been calibrated, precise internal pressure indications can be obtained.

One of the advantages of this method

Fig. 6. Ultrasonic scanning technique used to map a cross-section of the eye.

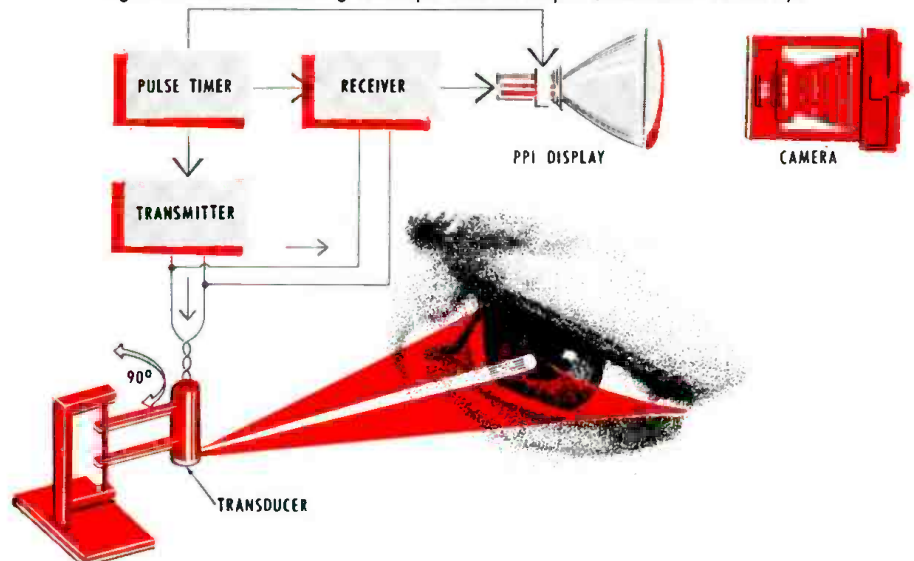

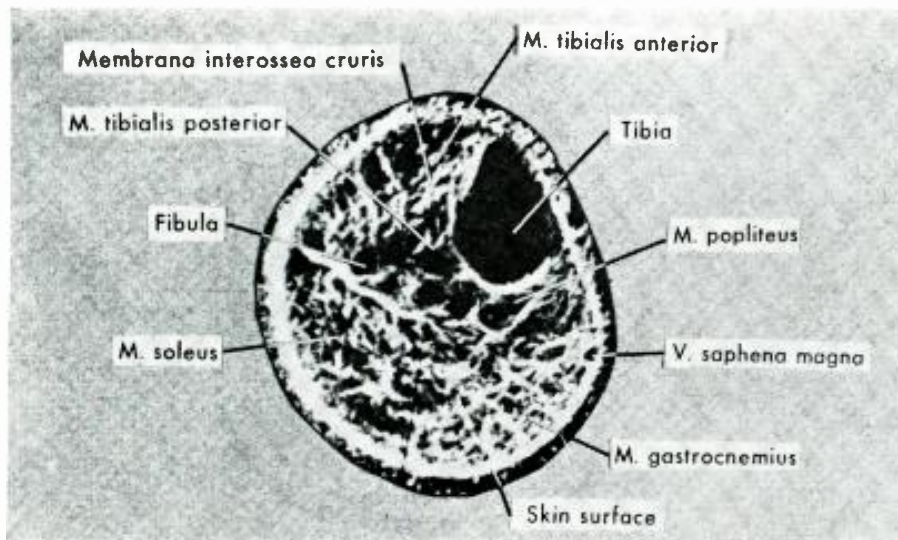
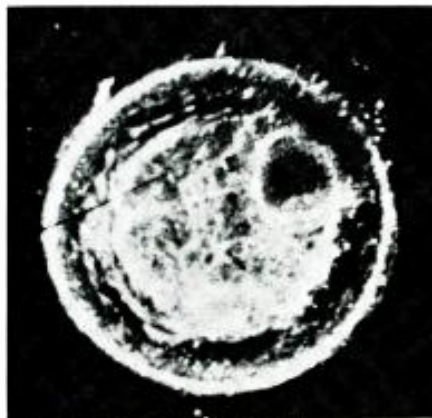

Fig. 8. Sonogram showing a cross-section of a normal human lower leg.

Fig. 9. Leg showing nephrotic edema. ▶

Fig. 10. The "Cytoanalyzer" automatically inspects cervical smears. ▼



is that the "pill" can remain in the patient for several days, permitting observation under natural conditions. Applications to organs other than the gastrointestinal tract are planned for future experiments.

Sonar in Medical Research

One of the most gratifying applications of an important technique of submarine detection is in the exploration of the human body. Our readers are familiar with the principles of sonar where sound waves are sent out in water and the echoes then indicate submerged objects. Various methods of pulsing, scanning, and displaying these sound waves are used to detect submarines, map ocean floors, and even communicate under water. In medicine the frequencies are much higher, transducers and the sonar beams themselves are much smaller, and different scanning techniques may be used, but the principles involved are the same as in sonar.

Because the body contains so much liquid, transmission of ultrasonic signals

proceeds fairly well in muscles and blood vessels. Bones and cartilage transmit poorly and tend to reflect the ultrasonic signals. Based on this phenomenon, a number of investigators have used this method to "look through" human organs. A good example of the results obtainable with ultrasonic radiation is contained in papers presented by Dr. G. Baum who has explored the human eye. He can diagnose detachment of the retina where conventional methods indicate blindness due to glaucoma. The method used to scan the eye ultrasonically is illustrated in Fig. 6. The transducer is coupled to the body through a water bath, not shown. For display, Dr. Baum uses a portion of an AN/APS-23, an airborne radar indicator, and then photographs the screen to obtain a permanent record.

A typical "sonogram" of a human eye, together with a description of the anatomical parts, is shown in Fig. 5. The frequency used for these experiments is 15 mc. and the transducer is a specially cut crystal with an epoxy lens capable of providing beam diameters smaller than one millimeter. The transducer itself moves the beam in a sector scan, just like a radar antenna, while the entire transducer structure is moved over a 90-degree arc in front of the eye to "look into" all corners. The total picture is only seen by the camera which integrates the

many sector scans over the entire 90-degree rotation period.

Drs. Howry and Holmes at the University of Colorado Medical School have applied the same sonar technique to other areas of soft tissue and have obtained extremely good results. By submerging the patient in a tub and rotating the transducer while the scanning goes on, they have been able to get cross-section views of the neck, as shown in Fig. 7, as well as many other hitherto impossible insights. As mentioned before, bone reflects the sound energy and in Fig. 7 the portion of the spine shows as the black area in the center. Arteries and veins are apparent by their black, blood-filled centers and the surrounding white walls.

A cross-section of a normal lower human leg is shown in Fig. 8 with the various parts labeled. Here again the two bones, the tibia and the fibula, appear as black areas while muscle fibers, skin, and veins show as a pattern of white. To demonstrate the value of this technique, the cross-section view of Fig. 9 illustrates the difference between the healthy leg of Fig. 8 and one showing the effects of nephrotic edema. Between the skin and the main muscles there is an area of black which is the edema fluid. Only a sonogram could show the extent and location of the disease so clearly.

Sonograms of the liver, breast, and other organs have been used to investigate cirrhosis, cancer, and many other diseases which manifest themselves only in the soft tissue and are difficult to observe with x-rays. Further improvement of the sonar method will eventually give medicine a tool perhaps even more powerful than the x-ray machine.

Infrared Techniques in Medicine

Infrared techniques which made possible the "Snooper scope" and the "Sidewinder" missile are also used beneficially in medical electronics. Among the many different applications is the "Pupillometer" which measures the contraction and dilation of the pupil of the human eye. Since the fine infrared beam scans the eye without being seen by it, it is possible to observe the effects of different light levels, drugs, or other stimulation on the patient. When the equipment is put into use, the patient's face is carefully aligned to the optical system which, itself, is accurate to within a thousandth of an inch.

Other applications of infrared to the human eye include a technique for looking through opacities of the cornea such as those occurring in cataracts and glaucoma. Infrared is also used in a number of studies of the effects of burns and in body heat experiments.

Communications & Computers

Many different approaches to the use
(Continued on page 70)

STEREO FM MULTIPLEX ADAPTER CIRCUITS

By **MILTON S. SNITZER**
Technical Editor, **ELECTRONICS WORLD**

Schematic diagrams and circuit descriptions of two new commercially available FM multiplex adapters.

CROSBY Model MX-101 self-powered adapter (below) consists of four tubes (including rectifier) and a matched pair of crystal diodes. Under-emphasized signals from an FM tuner are applied to V_{11} via the input jack. This tube section is a composite signal amplifier from which three separate outputs are taken. The upper output is applied through a low-pass filter (70-mhy. coil and .001- μ f. capacitor) to the pair of 22,000-ohm matrixing resistors in the crystal-diode circuit. Information in this circuit consists of the $L+R$ main-channel signals. The center output of V_{11} is applied through bandpass networks (two 44.3-mhy. coils and associated capacitors) to the crystal diodes. Signals in this circuit are the $L-R$ side-

bands in the 23- to 53-kc. stereo subchannel. Starecast-music information (around 67 kc. and higher) is rejected by the bandpass networks. The lower output of V_{11} is applied through a voltage divider to V_{21} , the function of which is to amplify the 19-kc. pilot subcarrier that is transmitted by the FM station that is broadcasting a stereo program. This 19-kc. signal is then applied to the input tank circuit of V_{21} , the oscillator stage. The purpose of the pilot subcarrier is to lock the adapter oscillator into frequency and phase with itself. The oscillator is a Hartley circuit with a special film capacitor (.0066 μ f.) used across the tank for stability. The output tank circuit of V_{21} is tuned to 38 kc., double the input frequency, and this signal is injected through a .005- μ f. capacitor into the crystal detectors. Detected output from the crystals consists of a positive $L-R$ signal and a negative $L-R$ signal. When these signals are combined with the $L+R$ signal in the matrixing resistors, the resulting output is a separate left signal and a separate right signal. De-emphasis also takes place in the detector circuit. A front-panel "Dimension" control adjusts the proportion of sum and difference signals so as to change the apparent stereo separation. The left and right signals are then applied through noise filters (that may be switched in or out as required) to the inputs of V_{21} and V_{22} . These cathode-followers deliver output voltages to the stereo amplifier. The power supply consists of a conventional full-wave rectifier (V_{12}) with a multi-section RC filter.

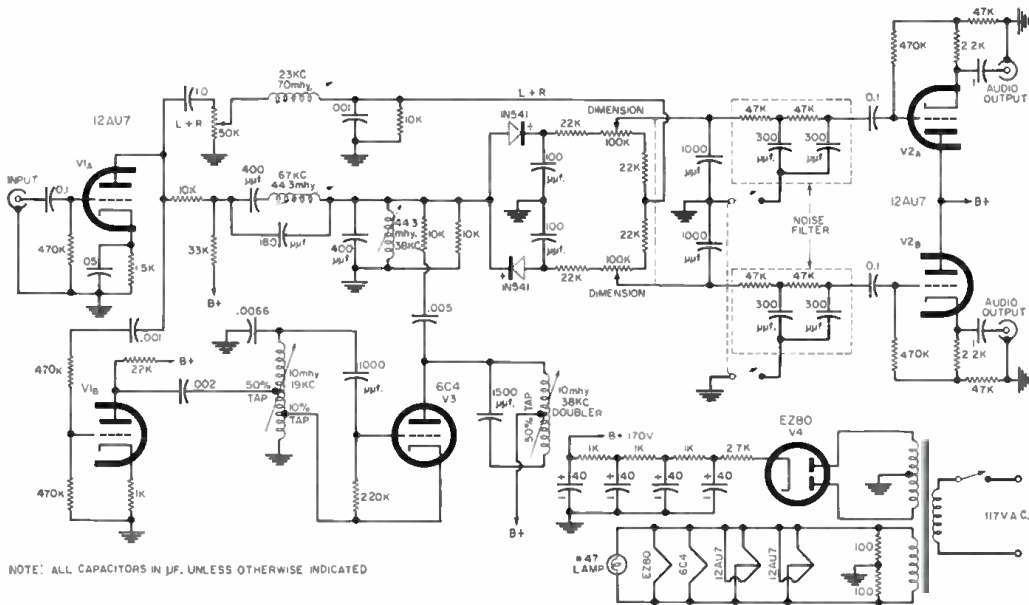

BOGEN Model PX-60 self-powered adapter (right) uses four tubes (with rectifier) and a crystal detector. Detected output from the FM tuner is amplified by V_{11} and coupled to V_{21} . Two cathode outputs are taken from this tube section; one is the sum-signal ($L+R$) channel via a 19-kc. low-pass filter, the other is the difference-signal ($L-R$) channel via a bandpass filter and starecast-music trap. Plate output from V_{21} consists of the 19-kc. pilot subcarrier which locks in oscillator V_{22} . The oscillator output frequency is doubled by the 38-kc. tank, and this signal is applied to the crystal detector along with the difference-channel information. Output of the crystal consists of the detected $L-R$ signal which is then applied to paraphase amplifier V_{23} . Positive and negative $L-R$ signals are then matrixed with the $L+R$ sum signal, resulting in separate left and right signals being applied to both sections of V_{24} , a pair of cathode-followers. Outputs from the cathode-followers may then be applied to the stereo amplifier. For mono use, the adapter circuits are bypassed by the slide switch. A conventional full-wave rectifier (V_{12}) is employed for $+B$.

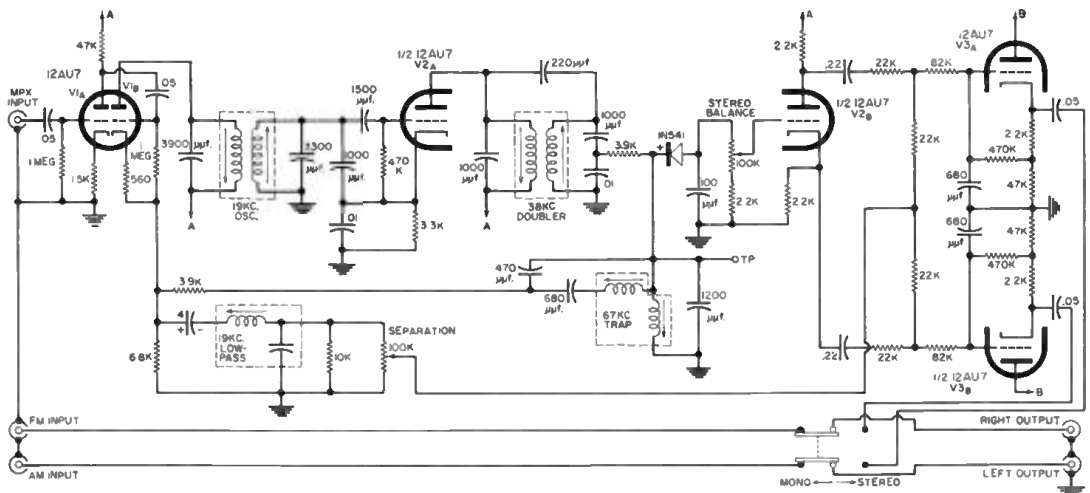



The third transistorized, battery-powered set to go on sale, Sony's 8-301W enters set-of-the-future sweepstakes.

THE ADVENT of a transistorized, independently powered TV receiver no longer rates as a revolutionary development, with the *Philco* "Safari" and the *Motorola* "Astronaut" already on the record. However, such sets being far from commonplace, Japan's first entry in the domestic set-of-the-future sweepstakes, the *Sony* 8-301W, is still important news.

The entire receiver is scarcely larger than the 8½-inch, direct-view, rectangular tube on which it displays its pictures: width and height are about 8 inches, depth 10 inches without the battery pack that plugs into the rear and 12 inches with it. A built-in, monopole antenna telescopes out of the rear. Three push-buttons under the CRT, labeled "AC," "DC," and "Off," establish the various modes of operation when used singly or in combination.

Consumer controls at the top rear are for vertical and horizontal sync, brightness, and gain. Although the latter will be used as a conventional contrast control, it isn't and will give somewhat different action, as we shall see later. Also topside are the channel-selector switch concentric with the fine-tuning control and the volume control. An oval speaker fires out of the bottom.

On the back are connectors for external a.c., external d.c. (12 volts), and jacks for 75- or 300-ohm antennas. Flanking the push-buttons at the front are two earphone jacks, one of which cuts out the speaker. Included accessories are a zip-on carrying case, an a.c. cord, a length of 300-ohm line terminating in a plug matched to the receiver input, an earphone, and spare fuses. An optional kit permits operation

from the cigarette-lighter socket of any 12-volt automotive system.

Weighing a little over 13 pounds, more than 17 with the power pack added, the set is reasonably portable if not featherweight. The lead-acid storage batteries will run the receiver for three hours. The ratio between discharge and charge time is 1 to 3. The batteries should always be kept upright although they are called leakproof. Charging is accomplished by depressing the "AC" and "Off" buttons simultaneously while the set is plugged into the line. Some trickle charging occurs during a.c. operation if "AC" and "DC" buttons are both pushed in.

Performance

The manufacturer rates the 8-301W at 30 microvolts sensitivity for a usable picture. In practice, sensitivity appeared quite commendable. In a medium-fringe area outside New York City, we were able to get usable to fairly good reception on all channels with the built-in monopole. In-city reception left nothing to be desired, with useful results obtained even inside a moving auto.

In fact, not even picture wash-out was serious in the shade of the car's interior on a sunny day. However, you can forget about daytime, outdoor use in such places as your favorite bathing beach. Indoor pictures were sharp, clear, bright, and viewable by a number of people at a reasonable distance.

Adjustment was somewhat more critical than on modern, tube sets, and some re-setting was required during the warm-up period. Set too high, the "Gain" control results in horizontal

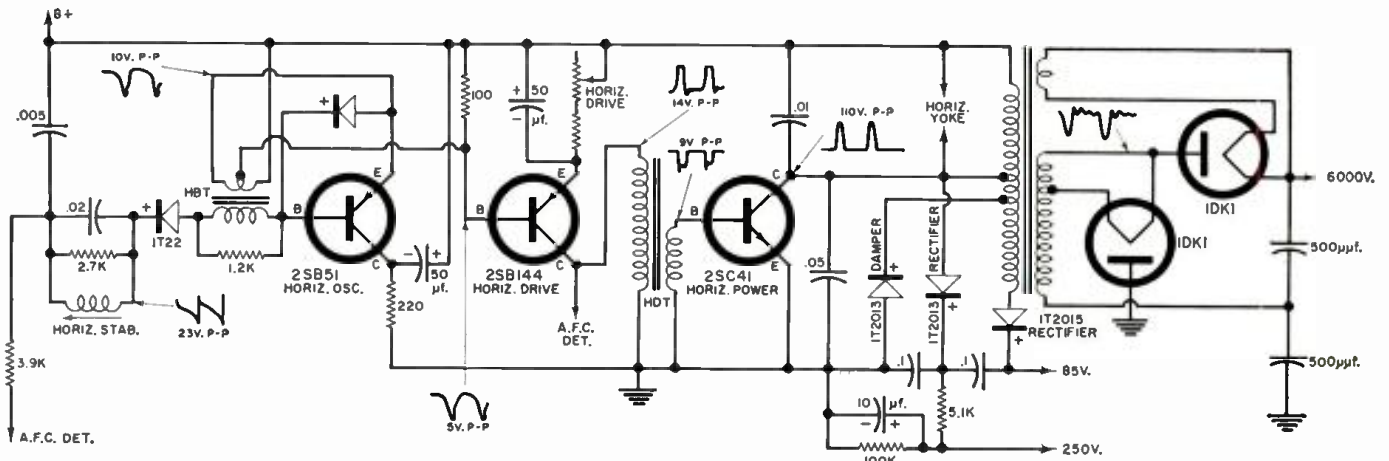

Fig. 1. Horizontal oscillator, sweep, and high-voltage sections highlight similarities and differences with respect to tube TV.

pulling and other signs of overload; set too low, it lets the picture fall out of sync. Between these points, however, it has a broad range of adjustment that was found to be quite adequate.

Circuitry

The set uses 23 transistors and 18 diodes. Included in the latter are 4 silicon rectifiers that form the power supply's full-wave bridge. This is fed by the power transformer's 15-volt secondary during recharge or line-voltage operation. A resonant filter minimizes both ripple and component size: following an input electrolytic, a 15-millihenry choke is shunted by another capacitor to resonate near 120 cps.

The antenna input includes a matching transformer for 300 ohms and a 1000-ohm potentiometer before the r.f. stage. The pot, which prevents overload of the sensitive tuner, is one-half the user-operated "Gain" control. It is ganged to another pot in the a.g.c. line.

The compact, disc-turret tuner is an incremental-inductance affair with 14 positions. The two spare spots are to take care of future developments, such as increased u.h.f. activity. Three 2SA161 *p-n-p* transistors serve as r.f. amplifier, oscillator, and mixer. This special, high-gain type is a germanium mesa unit with an *alpha* cut-off of 500 mc.

The four-stage 20-mc. i.f. strip uses 2SA124 *p-n-p* transistors in a generally conventional configuration. A noteworthy

departure is a semiconductor diode that effectively shunts the secondary of the input i.f. transformer. This helps to lower "Q" and prevent overloading of the strip. The i.f. output is fed to two detector diodes, one for video and one for a.g.c. The latter connects to the base of an a.g.c. amplifier (*n-p-n* type). The other half of the dual "Gain" control, a 10,000-ohm potentiometer section, is in this amplifier's collector circuit. Emitter output is applied to the bases of the 1st and 2nd i.f. transistors.

The video detector is followed by a two-stage amplifier before the picture tube is reached. A take-off trap in the first (video driver) stage feeds the sound i.f. strip. The video-output transistor, a high-gain, *n-p-n* 2SC15, has been specially designed. It operates with a collector potential of 85 volts d.c. or slightly more, whose source will be discussed later. Its emitter circuit includes what is called a "contrast" control—which is a service adjustment not made available to the user and which does not function in the way we would expect from its name. Set at the factory, it need be re-adjusted only if the video-output transistor must be replaced, as follows: with gain adjusted so that signal-input to the base of this stage is 1 volt p-p, the "Contrast" control is manipulated to produce an output of 55 volts, p-p, which is enough to drive the picture tube. In effect, it is a compensating adjustment for differences in transistor characteristics.

Output is applied to the sync circuits as well as to the

Fig. 2. Removal of cabinet shell reveals compact internal layout. Note the three, vertically mounted, printed boards.

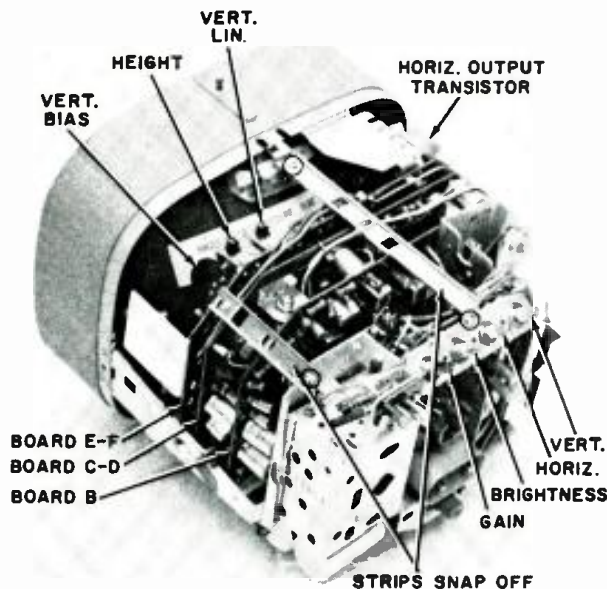
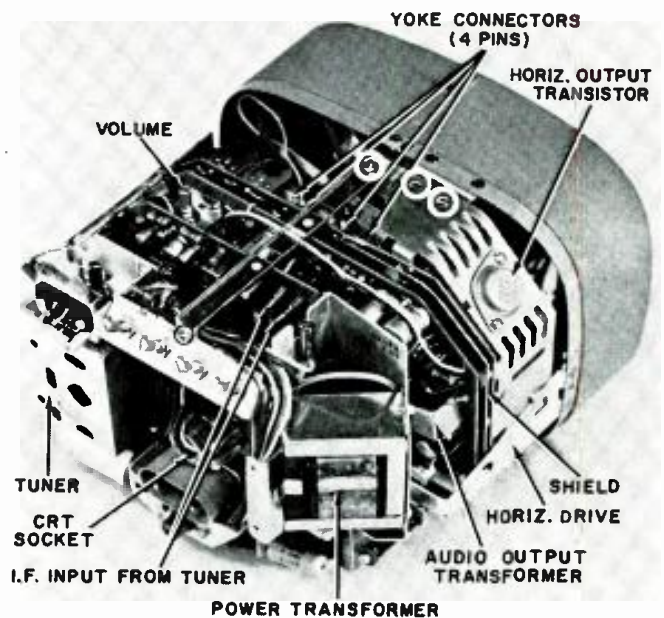

Fig. 3. Many components not visible in Fig. 2 are shown in this view. The shield is placed between boards C-D, E-F.



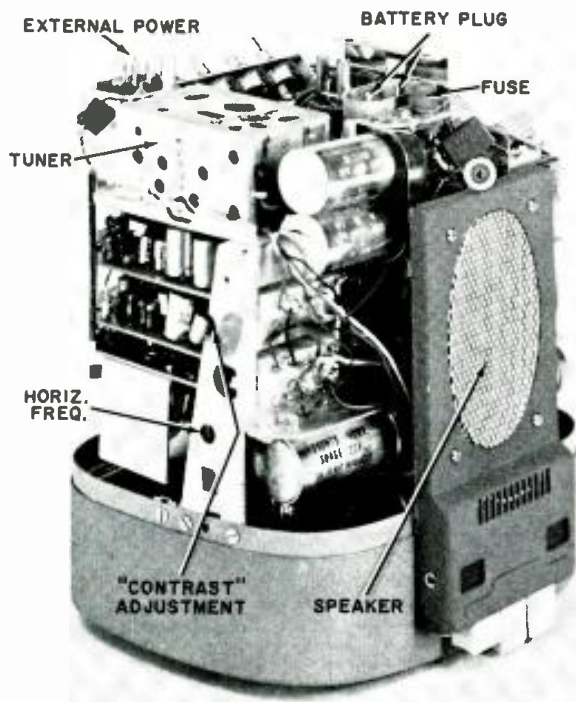

Fig. 4. Set resting on its face to show speaker at bottom. This is convenient position for slipping off outer shell.

cathode of the picture tube. The latter is a newly developed, 90°, rectangular tube, using electrostatic focus, whose type number is 210HB4. It uses a straight gun with no ion trap. Sony reports the gun construction is of a special type, under patent, but is not yet ready to divulge more specific details. Although this assembly fits into a CRT neck whose diameter is only one inch, operating voltages are not unexpected. 250 volts are applied to G_2 , between 85 and 100 to G_1 , which includes the brightness control, and the second anode takes 6000 volts. The filament connects to the normal 12-volt supply. The screen is aluminized.

The sound section consists of two i.f. stages, the second of which also limits, followed by two semiconductor diodes in a modified Foster-Secley configuration. Detector output is applied to an a.f. driver and a push-pull pair of output transistors in an arrangement familiar to anyone who has worked on transistorized radios.

As to the sync section, a clamping diode at the base input of the first (amplifier) transistor serves as the separator. Output then goes to a phase splitter, which feeds the vertical section and a twin-diode a.f.c. detector. Output from the latter is applied to the horizontal section.

A closer look at the horizontal and high-voltage circuit (Fig. 1) will help us get the feel of the similarities and differences found in a transistor TV set as compared to the more familiar tube circuits. Not shown are a pair of pots controlling horizontal frequency. One, externally available, is for fine adjustments. The other is simply for centering the control range of the former. The first stage is a blocking oscillator distinguished by a pair of diodes not found in the tube version of this familiar circuit. Their principal purpose is to suppress peaks of excessive amplitude that might damage the transistor. A stabilizing coil is also evident.

The driver stage includes a drive control. Since transistor characteristics do not change as much with age as is the case with tubes, this is not an ordinary service adjustment. As is the case with the "Contrast" control, it is only to be used for compensation following transistor replacement. Finally, the output transistor is another special type. This silicon mesa unit, rated at 50 watts, is shown mounted on its heat sink in Fig. 3. It feeds the flyback transformer directly.

Not unexpectedly, the latter has several taps and windings.

A damper diode shunts one. Two other semiconductor diodes connected to different taps provide rectified output at two different levels for requirements above 12 volts. One provides the 250 volts already noted for one CRT electrode. The other yields output in the order of 85-100 volts for the picture tube, the video-output stage, and the neon lamp that indicates channels and shows that the receiver is on. Two subminiature high-voltage diodes, type 1DK1 (the only two tubes aside from the CRT), act as a doubler to provide 6000 volts.

The vertical section uses three transistors: a blocking oscillator (diode-protected), a driver, and a power-output stage that couples directly to the vertical coils in the yoke, without a transformer. In addition to a hold control available to the user, screwdriver-adjusted height and linearity controls at the top of the chassis (Fig. 2) are available through openings in the top of the cabinet. However, the nearby vertical bias control in Fig. 2 can only be reached when the set is taken out of its cabinet. This is another compensating adjustment used only after transistor replacement.

Dis-assembly and Layout

How does one get inside the set for service? It's easy once you know how. Remove the sun shade by loosening the knurled nut that holds it. A single screw underneath, circled in Fig. 4, is next. Then the only two slotted screws at the rear are taken out, permitting removal of the two horizontal,

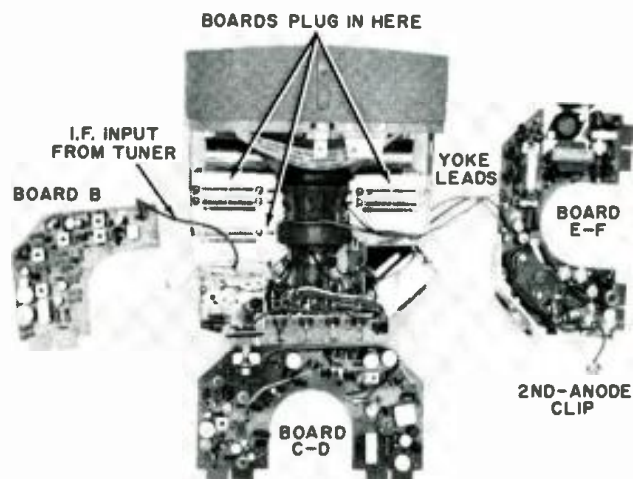

Fig. 5. The three printed chassis boards may be unplugged. This permits easy access to components on and off boards.

metal strips, one on either side of the cabinet, and one of which is visible on the cover. Underneath each strip, toward the front, is another screw. These two also come out.

While we have the strips off, we may as well note that they cover some adjustments that now become available. These include the coarse horizontal frequency and "Contrast" adjustments on the right side from the front, shown in Fig. 4, and the horizontal drive adjustment on the left side, visible in Fig. 3.

Only four more screws of the seven remaining on the back need come out now. They all look alike, but the two mounting the 300-ohm input socket remain untouched, as well as the one directly underneath the vertical-hold control. After external knobs are pulled off, the set may be slipped out of its shell.

If you don't know any better, what you now see (Figs. 2, 3 and 4) will be quite discouraging; accessibility on this marvel of compactness seems impossible. However the set

(Continued on page 96)

*Useful nomogram for technicians,
experimenters, and servicemen
simplifies parallel-R, series-C problems.*

By JIM KYLE

PARALLEL-RESISTOR CHART

TECHNICIANS, experimenters, and servicemen often find it necessary to determine the resistance of two or more resistors in parallel. While this can be done by using the classic sum-of-the-reciprocals formula: $1/R_T = 1/R_1 + 1/R_2 + \dots + 1/R_n$, the arithmetic involved frequently becomes cumbersome.

The more widely used formula $R_T = (R_1 \times R_2)/(R_1 + R_2)$ suffers the same drawback, when applied to standard resistance values, as anyone who has tried multiplying 39 by 18 and dividing the product by 57 knows.

This chart was designed to give a rapid answer to such calculations. In addition, it can be used to determine the value resistor which must be added in parallel with an existing component to reduce the total resistance to a specified amount—a procedure which becomes complex when standard formulas are employed.

Using the Chart

To use the chart, draw a straight line from the value of R_1 to the value of R_2 . This line will cross the R_T scale at the value of total resistance. Note that all values have been normalized to the range from 1 to 10 to make the chart universal. You can multiply or divide the values given by 10, 100, 1000, etc. as needed.

For example, the total resistance obtained by paralleling a 39-ohm resistor with an 18-ohm resistor is 12.3 ohms, as shown by the dashed line on the nomogram.

If you want to find out what size resistor to use to reduce an existing resistor's value to some specified amount, draw a line from the existing value on R_1 through the desired final value on the R_T scale and read the value of the resistor that is to be added from the R_2 scale.

In addition to its uses with parallel resistors, the chart can be used without change to determine series-capacitor problems, since the same formulas apply. Simply replace the "R" symbols mentally with "C" and proceed as described above. ▲

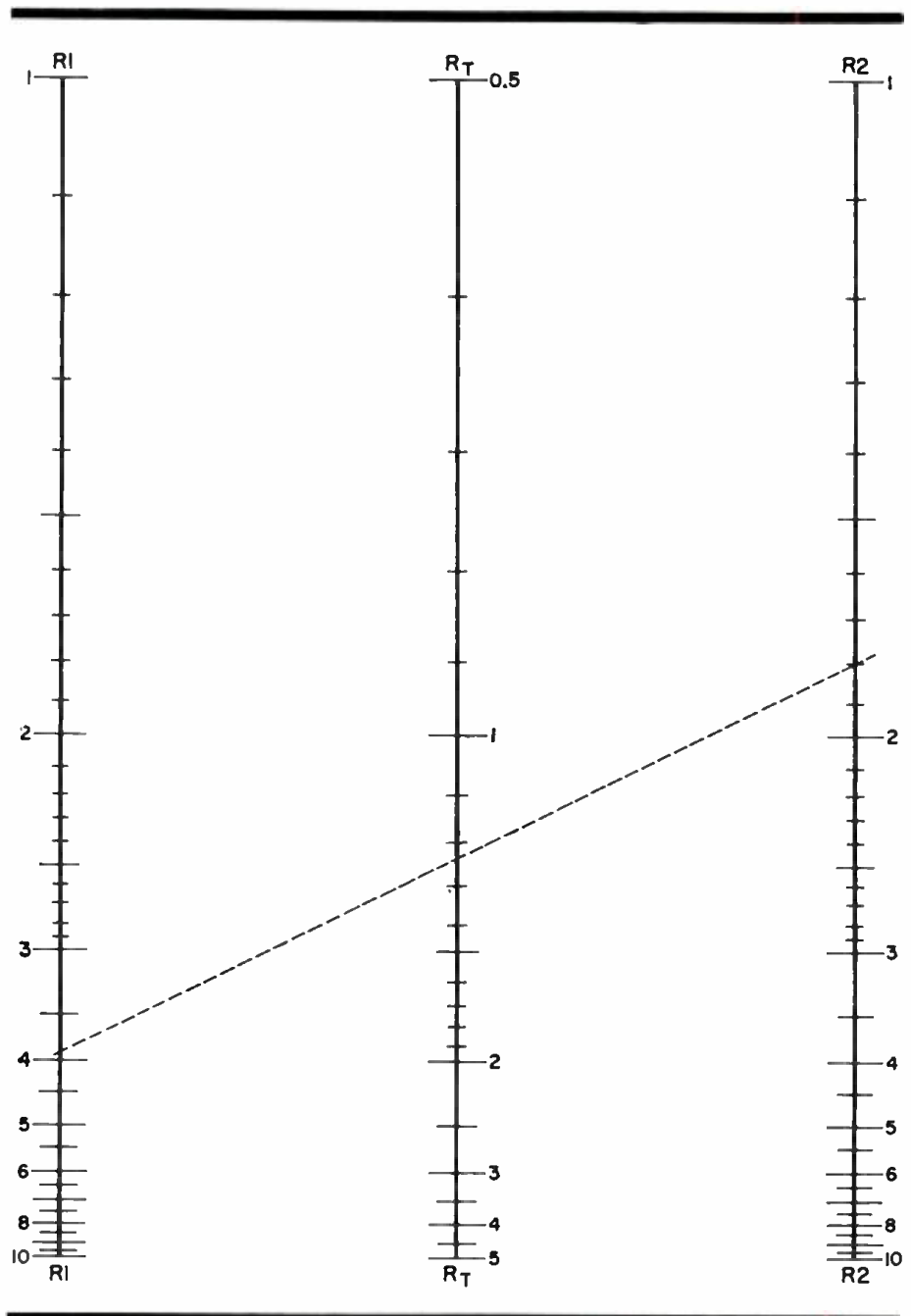

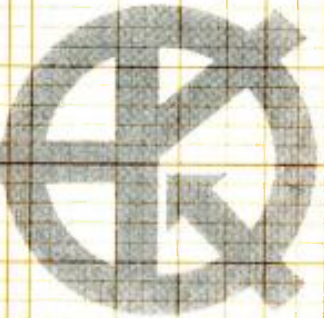

TRANSISTOR BIAS CIRCUIT DESIGN

By GENE L. JACKSON / General Dynamics / Fort Worth

Simplified design procedure to establish d.c. operating conditions that uses only Ohm's Law and basic ratios.

THERE are many published approaches to the design of transistor bias circuits as anyone who has studied engineering texts or other publications on this level can attest. While there is no denying that these approaches are very important in this age of technical design, the author believes that there are easier methods—particularly for the technician or casual designer.

Many of these mathematical approaches fall apart because of their dependence on other mathematical equations, such as those for a current stability factor or other variables. The current stability formula used is probably not exact and other factors are not considered. It is not surprising, then, when the results are not as expected after several pages of calculations. Other methods go into much detail and attempt to account for all variables. They usually work quite well if the designer has all of the necessary information available at his fingertips, but seldom is he this fortunate. This is partly because different manufacturers supply different kinds and types of information about their semiconductor products.

Ohm's-Law Method

The method of circuit design to be described uses only Ohm's Law, simple ratios, and common sense. This discussion will be concerned with the bias or d.c. operating conditions of transistor amplifiers and a.c. circuit analysis will not be attempted here.

Fig. 1 is a schematic of a *p-n-p* transistor amplifier used in a common-emitter configuration with transformer coupling on the output. The necessary forward bias is developed by the voltage divider consisting of R_1 and R_2 . The d.c. emitter current divides between the collector and base circuit according to the ratio I_C/I_B or the value of h_{FE} which is called the d.c. forward-current transfer ratio. This value is given in most transistor data sheets.

R_E is the emitter resistor used for stability. It also represents a certain amount of negative current feedback. The amount of bias stability is determined mainly by the ratio of R_1 to R_E , therefore the value of R_1 depends greatly on R_E . The larger R_E , the better the

current stability will be. Unfortunately, this limits the maximum output signal and the amount of emitter current that can flow, therefore the choice of R_E must be a compromise affected by the value of the emitter current desired, the load impedance, and other factors pertaining to the particular circuit application.

Example of Method

To further illustrate the problems of bias circuit design, a popular *n-p-n* transistor will be used to design a rather common type of transistor amplifier. This circuit is shown in Fig. 2.

A type 2N333 small-signal silicon *n-p-n* transistor is used in this example. Probably the first consideration is the

value of E_{CC} . This will be determined by the type of application, perhaps by the battery or power supply available, and by the maximum collector voltage allowed. The data sheet for the 2N333 transistor lists the maximum allowable collector-to-base voltage as 45 volts. For this example, let E_{CC} be equal to 40 volts.

Next the value of emitter current will be chosen. The maximum value of emitter current allowed for this transistor is 25 ma. If the signal-to-noise ratio is important, as when the transistor is used as a low-level preamplifier, the emitter current is kept to a low level for more favorable signal-to-noise ratio. If maximum power is wanted, a larger emitter current is necessary. Before deciding on a value for emitter current, the graph of h_{FE} versus collector current, shown in Fig. 3, should be studied. From this it can be seen that at a temperature of 25 degrees C, the transistor can be operated effectively between 1 and 5 ma. (A higher collector current can be used if desired.) If an emitter operating point of 3 ma. is chosen, the result should be satisfactory for most applications.

When the emitter resistor is bypassed with C_2 , the emitter can be considered to be at a constant d.c. potential as the a.c. signal variations will be filtered out. If the d.c. voltage drop across R_E has been determined, the value of R_E can be calculated. The larger the percentage of E_{CC} dropped across the emitter resistor, the more stable the amplifier is with respect to changes in temperature and its associated effects. However, it must be remembered that efficiency will decrease and that the voltage drop across R_E will be lost, as far as voltage available for a.c. signal amplification is concerned. Usually the voltage across R_E will be 10 to 40 per-cent of the supply voltage. Compromising again, let E_{RE} be equal to 20 per-cent of E_{CC} , or 8 volts.

If the emitter current is 3 ma, and the drop across R_E is 8 volts, then R_E can be calculated as follows: $R_E = E_{RE}/I_E$ or $R_E = 8 \text{ volts} / 3 \text{ ma.} = 2667 \text{ ohms}$. Thus the closest EIA value of 2700 ohms will be used. The actual drop across R_E is then: $E_{RE} = 2700 \text{ ohms} \times 3 \text{ ma.} = 8.1 \text{ volts}$. This leaves 31.9 volts across the transistor itself and the load resistor R_L .

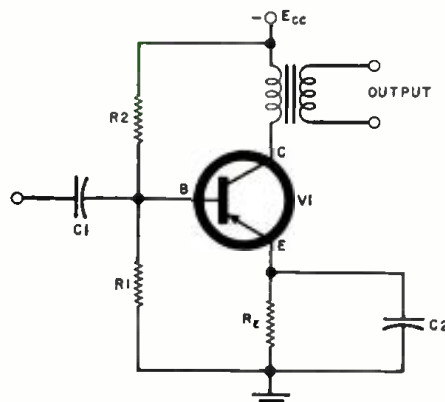
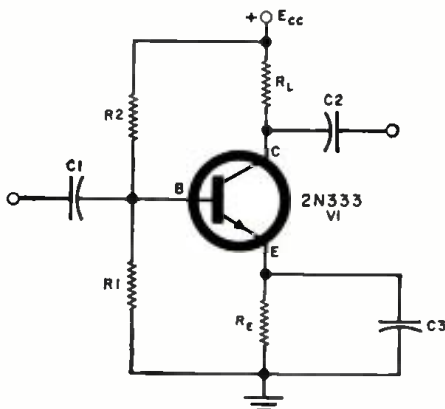

Fig. 1. Schematic of "p-n-p" transistor amplifier in common-emitter configuration.

Fig. 2. Popular "n-p-n" transistor is used in circuit illustrating design technique.



Under ideal operating conditions, the voltage drop across the transistor itself and R_1 would be equal with no signal input. This would allow the collector voltage to increase and decrease an equal amount with signal input, with minimum distortion. However, as I_c will increase if the operating temperature increases, certain precautions must be taken. As I_c increases, E_{RE} increases and the voltage drop across the transistor decreases. Therefore, the voltage drop across the transistor will be made a little larger than E_{RE} as a safeguard against increases in I_{CBO} and h_{FE} .

If E_{RE} plus the voltage drop across the transistor is 31.9 volts or approximately .80 of E_{CC} , E_{RE} can be assigned an arbitrary value of .35 E_{CC} . This leaves the voltage across the transistor at approximately .45 E_{CC} and E_{RE} at 14 volts.

The voltage drop across the transistor is 31.9 volts minus 14 volts or 17.9 volts. This gives us the necessary relationships. Because I_c is approximately the same value as I_E : $I_c = 3$ ma., $R_1 = E_{RE}/I_c$, or $R_1 = 14$ volts/3 ma. or 4667 ohms. The nearest EIA value would be 4700 ohms.

There can be an increase of I_c due to changes in I_{CBO} , h_{FE} , or R_{EB} (emitter-to-base resistance) of approximately (17.9 v.—14 v.)/ R_1 without having an adverse effect on the circuit. With R_1 equal to 4700 ohms, the allowable increase in I_c is 3.9 v./4700 ohms or .83 ma. With the low values of I_{CBO} for a 2N333, this should be sufficient protection against any possible changes in bias operating point.

Next the value of the base voltage is determined. The base must be slightly more positive than the emitter in an $n-p-n$ transistor. How much more positive can be determined by the graph of V_{BE} versus I_c in Fig. 4. At a temperature of 25 degrees C and a collector current of 3 ma., V_{BE} is seen to be approximately .68 volt, therefore the base d.c. voltage with respect to ground is 8.1 volts plus .68 volt or 8.78 volts.

Stability Factor

Because the values of R_1 and R_2 will largely determine the current stability factor, they must be considered at this point. One stability equation is: $S_I = 1/(R_E/R_1 + R_E/R_2 + 1 + h_{FE})$, where S_I is the current stability factor and h_{FE} is the d.c. forward current transfer ratio for a common-base amplifier.

As R_1 is usually much smaller than R_2 , the ratio R_E/R_1 is the factor that largely determines the current stability of the circuit. If an S_I of 5 is wanted, it can be closely approached by making R_1 about six times larger than R_E . Thus $6R_E = 16,200$ ohms. Selecting the closest 10% standard value, let $R_1 = 15,000$ ohms. R_2 can now be calculated. With 8.78 volts across R_1 , the current through R_1 is: $I_{R1} = 8.78$ volts/15,000 ohms or approximately .585 ma.

Again using Fig. 3, at 25 degrees C, with a collector current of 3 ma., h_{FE} is equal to 28. By knowing the value of h_{FE} and the collector current (collector current is approximately equal to the emitter current), we can calculate I_B . h_{FE} is

equal to the d.c. collector current divided by the d.c. base current or $I_B = I_c/h_{FE}$ or 3 ma./28, which is about .107 ma.

Because I_{R2} is equal to $I_{R1} + I_B$, $I_{R2} = .585$ ma. + .107 ma. = .692 ma. The voltage across R_2 is: $E_{R2} = E_{CC} - E_{RE}$ or 31.22 volts. Next R_2 is calculated. Since $R_2 = E_{R2}/I_{R2}$, it is equal to 31.22 volts/.692 ma. or approximately 45,000 ohms. Picking the nearest standard EIA value, R_2 would be 47,000 ohms.

To check on these values the current stability factor can be calculated thus: $S_I = 1/(R_E/R_1 + R_E/R_2 + 1 + h_{FE})$ and $h_{FE} = -h_{FE}/(1 + h_{FE})$ or $-28/29$ or -0.964 . $S_I = 1/(2700/15,000 + 2700/45,000 + 0.036)$ or 3.7.

This is a better (a lower value) than

the current stability goal of 5. Therefore R_1 and R_2 can be made larger if a larger stability factor can be tolerated. Remember, for every value of R_E there are an infinite number of values for R_1 and R_2 . As the values of R_1 and R_2 are made smaller, the S_I improves but the current drain from E_{CC} increases, as well as the shunting effect on the a.c. signal input. Therefore, the values of R_1 and R_2 are again compromises. For this design, let R_1 and R_2 have the calculated values.

Other Parameters

This completes the design of the amplifier as far as the bias circuitry is concerned. It should be remembered that several parameters such as I_E and R_{EB} were chosen instead of calculated. This is necessary no matter what design procedure is followed. There is no one value for these components. For any reasonable value of R_E , there are many possible values of R_1 and R_2 .

As in all transistor design procedures, the non-conformity of transistors is the greatest stumbling block. Because of the technical problems associated with production of all semiconductor devices, parameters cannot be held constant. For instance, the value of h_{FE} (a.c. forward-current transfer ratio) in a 2N333 will vary from 18 to 40 as shown on one data sheet. h_{FE} has a similar range.

In our particular problem, we assumed a value of h_{FE} equal to 28. However, if h_{FE} is not this average value, we will have to make some changes because of a different base current, I_B , for the same I_c . If after constructing this circuit, I_c is found to be different from the design value, R_2 may be changed to give the correct forward bias. If more I_c is wanted, R_2 should be made smaller. For smaller I_c , make R_2 larger. Do not change the value of R_1 because this will more directly affect S_I and may require a major re-design of the circuit.

If it is deemed necessary to know the exact value of h_{FE} of a particular transistor at a particular collector current and operating temperature, the circuit of Fig. 5 may be used.

After R_E and R_1 have been calculated, a large variable resistor R_B can be connected as shown and set to give the correct collector current. Caution must be observed not to start with a minimum value of R_B as sufficient current may result in permanent damage to the transistor. The amount of base current can now be read on the meter, M_2 . This value of I_B can then be used to calculate R_1 and R_2 . If necessary, h_{FE} can be determined from the ratio I_c/I_B .

Germanium transistors have a much larger I_{CBO} than silicon units so that greater precautions must be taken to stabilize germanium transistors than for those made of silicon. Generally speaking, the stability factor for germanium transistors must be smaller and the operating temperature must be limited to a lower value. Also, the value of I_{CBO} , which flows between the base and collector, may become so large that it cannot be ignored when calculating the resistor values used in the amplifier bias circuitry. ▲

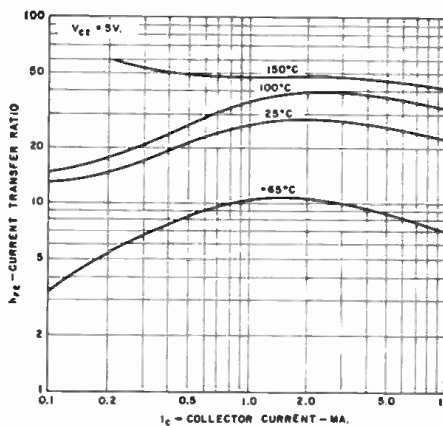

Fig. 3. Characteristics of transistor used.

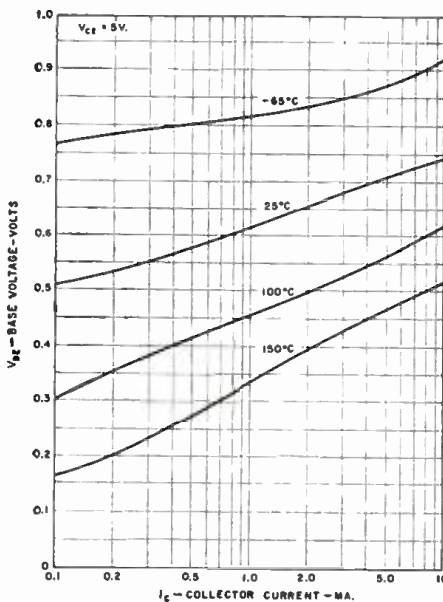
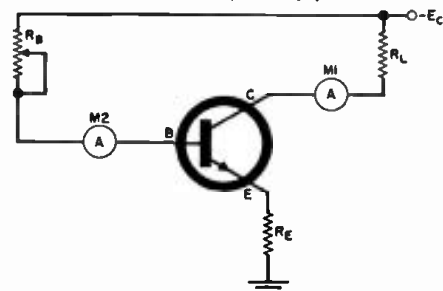

Fig. 4. Current-voltage characteristics.

Fig. 5. Circuit used in order to obtain the exact values of operating parameters.



Clip-on Ear Transducer

An earful of essential medical information is provided by the "clothespin" type transducer clipped to the ear of this hospital patient. The device is used with a new Minneapolis-Honeywell medical electronics system that automatically monitors the condition of a dozen or more critically ill and post-operative patients. It measures diastolic and systolic blood pressures and pulse rate by shining a light through the patient's ear onto a photocell. Also monitored and recorded via two additional transducers attached to the assembly shown are body temperature and respiration. An alarm is sounded automatically if high or low limits for any of the five variables is exceeded.

Gaseous Optical Maser

This version of a gaseous optical maser, or laser, emits a continuous needle-sharp beam of coherent infrared energy through the circular window at the near end. Simplified, straightforward design of this assembly, developed by Raytheon Co., marks a significant step toward practical c.w. lasers needed for space communications and advanced military systems. The device is similar in principle to the gas maser developed by Bell Telephone Laboratories.

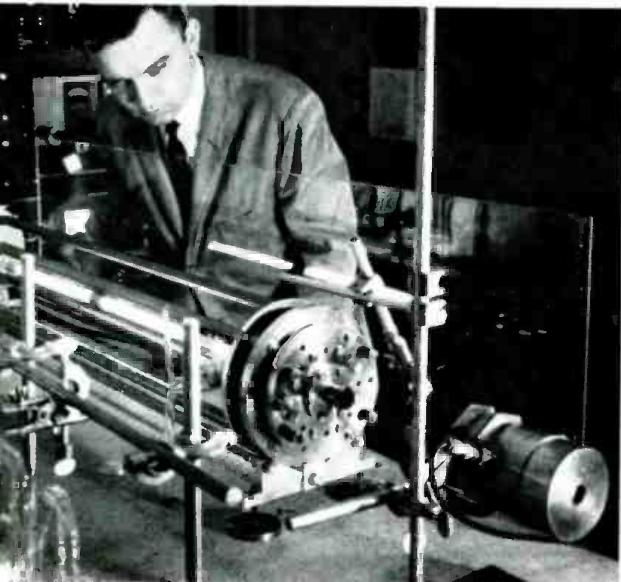

RECENT DEVELOPMENTS IN ELECTRONICS



Ultra-fast Computer-Centers Link

This IBM computer center in New York City is linked to another in Poughkeepsie, N.Y., (68 miles away) by a communications system that transmits information at a rate of 15,000 characters per second, more than 1000 times faster than human speech. The link uses a special magnetic tape transmission unit (left), telephone cable, and a microwave radio network.

Millionth Nuvistor Tube

A rack containing six thimble-size RCA nuvistor electron tubes, including the company's millionth unit, is being lowered into an exhaust and sealing machine. Over 60 electronic firms have "nuvistorized" military and industrial products now in development or production.

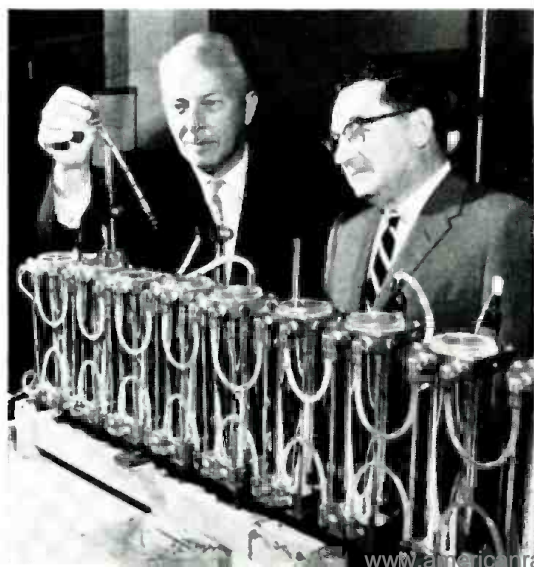

White-hot Thermoelectric Generator

The Minneapolis-Honeywell technician at right is heating up to 2400 degrees F a new all-ceramic thermoelectric generator capable of converting white-hot temperatures into usable electricity. The generator—believed to be the first ever made of heat-resistant ceramics—is being tested by the Army for space-age uses. It is said to open the way to obtaining electricity from such "waste heat" as a rocket's exhaust, which would destroy presently available thermoelectric generators. Here, as shown on the voltmeter, the device converts the 2400-degree heat of an electric furnace into almost 100 volts of electricity.

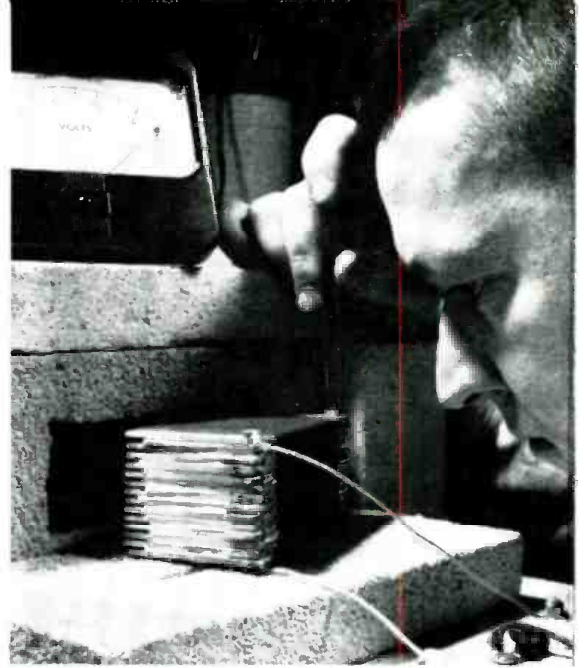

Electronic Flight Simulator

The electronic "heart" of the flight and tactics simulator of the F-105D fighter-bomber is adjusted for precise operation by a technician at ACF Electronics. More than 150 miles of wiring and nearly 400,000 parts make up the training device that exactly reproduces the responses of the aircraft and is described by the company as the most advanced electronic flight simulator ever ordered by the Air Force.

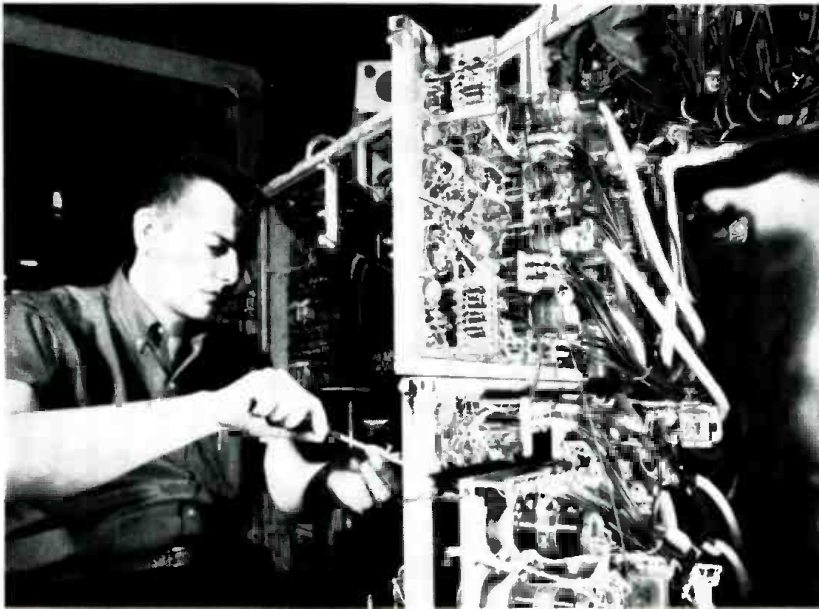

Computer-Controlled Resistor Production Line

Engineering associates at Western Electric Co.'s North Carolina plant are inspecting the computer-controlled terminating machine in the automated production line for manufacturing deposited-carbon resistors. The gold cathode in the bottom of the bell jar being inspected is used to sputter a layer of gold on the ends of the carbon-coated resistor core. The gold termination forms a contact on each end of the resistor, to which the succeeding machine in the line attaches caps and wire leads.

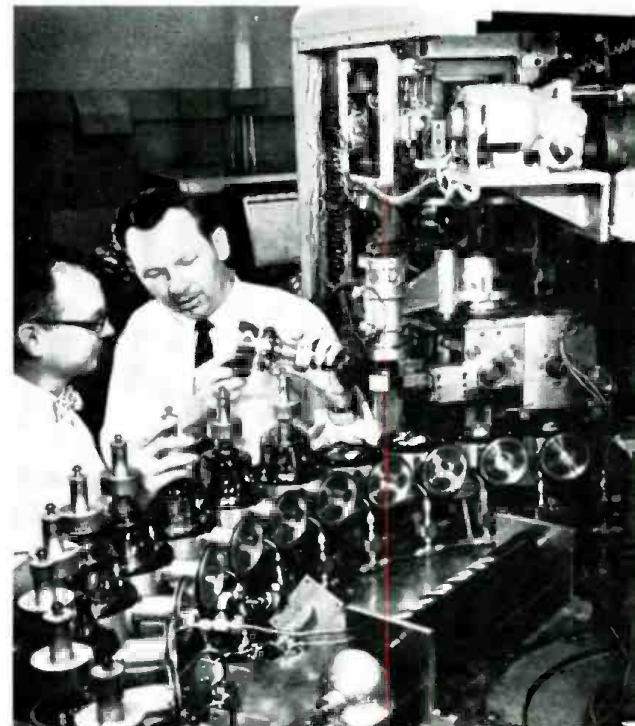

Battery-Powered Electromagnet

A battery-operated electromagnet, developed in Union Carbide laboratories, is used in a demonstration of the company's standard flashlight batteries. Two D-size cells power the candy-striped 7" diameter magnet which is supporting the automobile. When the technician removes the batteries, the car drops to the ground. The same two batteries are then used to operate a flashlight. The electromagnet, which can hold the car for about 25 minutes, draws 1.2 amps from the batteries.



THE "TRANS-SELECT" AUDIO GENERATOR



Fig. 1. Frequency switches (S₁-S₅) may be used in combination.

By STANLEY E. BAMMEL

It's small, light, battery-powered, and can be built at reasonable cost; yet it yields clean output and good level from 10 to over 100,000 cps.

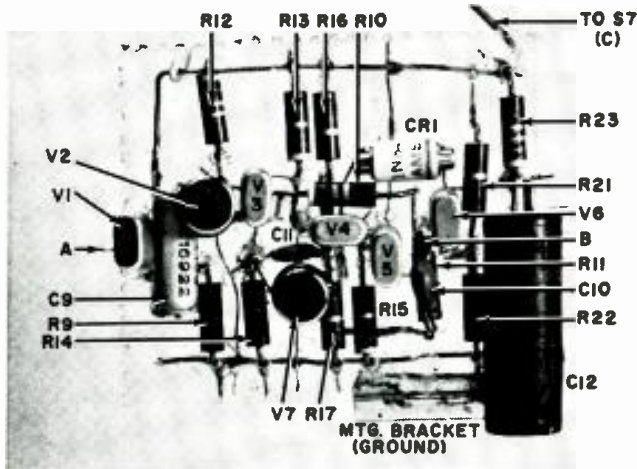

Fig. 2. Most of the components mount on this polystyrene board.

BULKY, tube-equipped instruments, drawing considerable current and dependent on power lines, are often inconvenient to use. Transistors, with their promise of miniaturization, low power requirement, and the flexibility of battery operation, often tempt the designer or constructor.

However, transistors may pose problems of their own. In the case of this audio generator, for example, the problem of providing a constant output without introducing distortion and temperature instability had to be faced and resolved. Also, the use of transistors often increases equipment cost. That is hardly the case here. With reasonably careful shopping, total cost for this audio generator, using new parts, should not exceed \$20. This is not high for the features provided.

The instrument produces clean sine waves over a wide range. It gets its name in part from the fact that transistors are used instead of tubes, and in part from the means by which output frequency is determined. Instead of continuously variable tuning, a binary method of switching selects discrete frequencies. Four switches are used to select four basic frequencies as follows: 10, 20, 40, and 80 cps. However, the switches add up. For example, throwing the 10-cps and 20-cps switches simultaneously will give an output of 30 cps. Thus all frequencies from 10 to 150 cps are available in steps of 10 cycles or in various combinations of two or more.

In addition, a 4-position range switch

multiplies this basic range by 1, 10, 100, or 1000. Theoretically this provides output from 10 cps to 150 kc. Due to high-frequency circuit losses, however, the top end reaches only to about 110 kc., still providing a wide range. Output amplitude is up to half a volt (r.m.s.).

The Circuit

The bridged-T oscillator used, a basic version of which is shown in Fig. 3, is essentially an amplifier with both positive and negative feedback. The regenerative loop tends to produce and sustain oscillation at any frequency. The degenerative loop has the opposite effect, but is frequency-selective because it includes the bridged-T network. The latter acts as a filter for the chosen frequency of oscillation, at which negative feedback is suppressed. Thus the positive feedback is bucked at all frequencies but the one desired.

Fig. 3. Basic circuit: feedback paths cause oscillation and choose frequency.

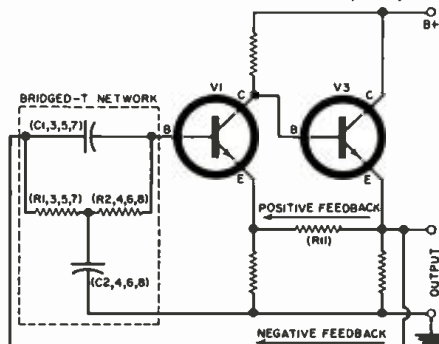

The complete circuit is shown in Fig. 4. Positive feedback is obtained through R_{11} and C_{11} in parallel. The latter compensates for high-frequency circuit losses, as does C_{11} . The bridged-T network components include R_1 through R_7 and C_1 through C_7 . The particular resistors used depend on the basic frequency chosen, while the capacitors depend on the selected multiplier range.

V_1 , in the grounded-collector or emitter-follower configuration, provides the high input impedance necessary to avoid loading down the network. This high impedance also tends to minimize variation in circuit gain at different frequencies, helping to simplify the problem of providing constant amplitude. This stage is biased at its base, through the network, from the emitter of V_3 . V_3 , another emitter-follower, is biased through R_{11} . The latter provides a considerable amount of negative d.c. feedback to stabilize the d.c. circuit.

Collector output from V_3 , a conventional grounded-emitter amplifier, is fed to the emitter of V_1 , a grounded-base stage. The latter, which may at first seem superfluous, serves more than one purpose. It permits direct coupling to V_1 . It can have a higher emitter-collector voltage than could V_3 alone; thus a greater undistorted output voltage is obtainable. But its most important function is that it facilitates amplitude control. As will be explained later, a point in the circuit is needed for control where signal level is low. This point is the junction between the collector of V_3 and the emitter of V_1 .

Fig. 4. Although seven transistors are called for by the circuit, they are low-cost types.

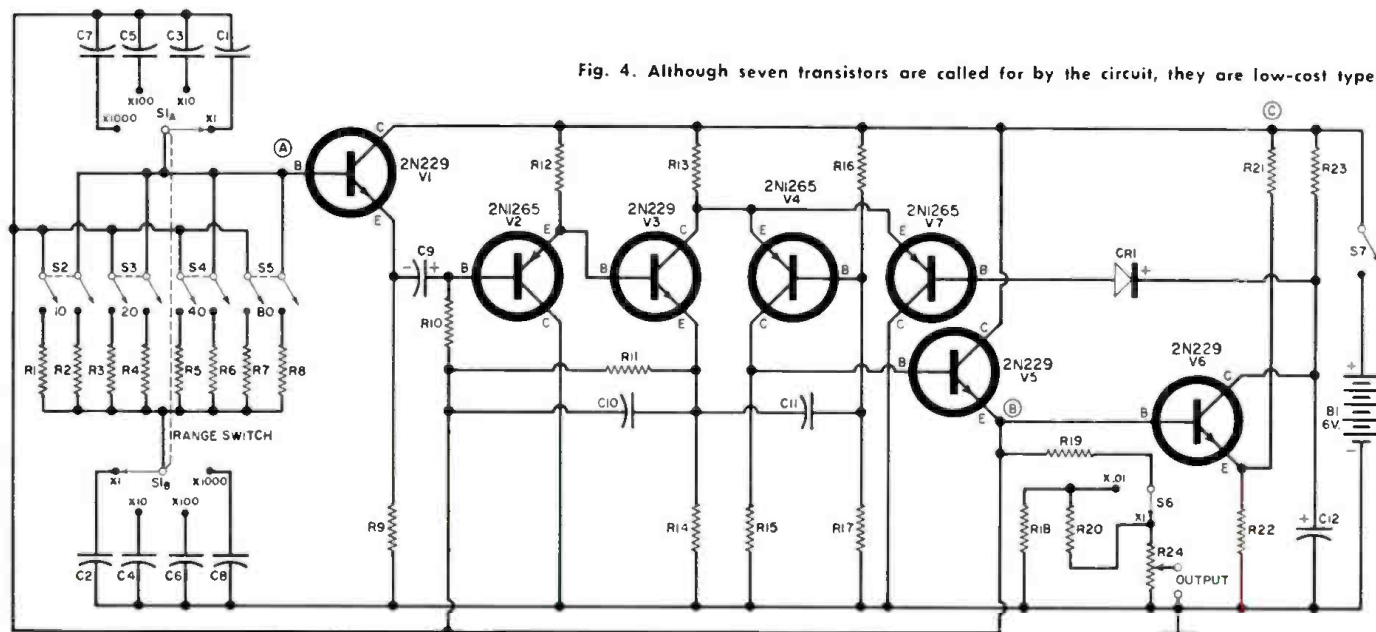

R_1, R_2 —110,000 ohm, $\frac{1}{2}$ w. res. (see text)
 R_3, R_4 —55,000 ohm, $\frac{1}{2}$ w. res. (see text)
 R_5, R_6 —27,500 ohm, $\frac{1}{2}$ w. res. (see text)
 R_7, R_8 —13,750 ohm, $\frac{1}{2}$ w. res. (see text)
 R_9 —15,000 ohm, $\frac{1}{2}$ w. res.
 $R_{10}, R_{11}, R_{12}, R_{13}$ —47,000 ohm, $\frac{1}{2}$ w. res.
 R_{14}, R_{15} —2200 ohm, $\frac{1}{2}$ w. res.
 R_{16}, R_{17}, R_{18} —470 ohm, $\frac{1}{2}$ w. res.
 R_{19}, R_{20} —4700 ohm, $\frac{1}{2}$ w. res.
 R_{21}, R_{22} —1000 ohm, $\frac{1}{2}$ w. res.
 R_{23} —1500 ohm, $\frac{1}{2}$ w. res.

R_{24} —1800 ohm, $\frac{1}{2}$ w. res.
 R_{25} —500 ohm linear taper pot
 C_1, C_2 —.05 μ f. tubular capacitor (see text)
 C_3 —.5 μ f. tubular capacitor (see text)
 C_4, C_5 —.005 μ f. tubular capacitor (see text)
 C_6, C_7 —500 μ f. mica capacitor (see text)
 C_8 —50 μ f. mica capacitor (see text)
 C_9 —10 μ f., 3 v. elec. capacitor
 C_{10}, C_{11} —220 μ f. disc or mica capacitor (see text)
 C_{12} —68 μ f. disc or mica capacitor (see text)

C_{13} —25 μ f., 6 v. elec. capacitor
 CR_1 —1N60, 1N295 or other diode
 S_1 —D.p. 4-pos. rotary switch
 S_2, S_3, S_4, S_5 —D.p.s.t. slide switch
 S_6 —S.p.s.t. slide switch
 S_7 —S.p.s.t. slide switch
 B_1 —Four 1.5-volt pralite cells in series
 V_1, V_2, V_3, V_4 —"u-p-n" transistor (2N229 or other general-purpose type)
 V_5, V_6, V_7 —"p-n-p" transistor (2N1265 or other general-purpose type)

Output stage V_6 , an emitter-follower, provides isolation and a low output impedance so that neither the external load nor the feedback circuits will load down the gain. With switch S_6 in the X1 position, as shown, potentiometer R_{23} may be roughly calibrated from 0 to .5 volt. Throwing S_6 to the X.01 position attenuates output about 40 db, so that R_{23} may be set from 0 to 5 mv.

Transistors V_6 and V_7 , in conjunction with diode CR_1 , provide automatic amplitude control as follows: V_6 is normally biased to cut-off. When signal amplitude from V_5 exceeds a certain level, V_6 begins to conduct on negative peaks, with the current it passes being in proportion to the excess amplitude. This current is filtered by C_{12} , goes through CR_1 , and biases V_7 . The emitter of V_7 is connected back to the previously mentioned junction of V_6 and V_5 , at which point V_7 grounds out some of the signal. How much of the signal is dropped through V_7 depends on the bias current to the latter from V_6 and CR_1 . Thus circuit gain is automatically reduced to keep amplitude at the proper level.

Ordinarily the nonlinearity of the diode and V_7 in the control loop would introduce distortion. However, since the amplitude of signal at the point in question, the collector of V_7 , is quite low, the effect is negligible. With this arrangement, amplitude control is excellent. If the generator is properly calibrated, output will not vary more than $\pm .5$ db.

Construction

The author's version was built into

an LMB chassis box 3" x 4" x 6". Outside and inside of the completed instrument can be seen in Figs. 1 and 5. Wherever possible, the terminals on the controls were used to mount parts. Other parts, except for batteries, were mounted on a polystyrene board about 2" x 2½", which may be seen edge-on to the right in Fig. 5. Board layout is shown in Fig. 2. In general, physical construction should present few problems. Probably the best procedure is to build the unit with everything in its place except for the frequency-determining components (R_1 through R_8 and

C_1 through C_8), the latter to be installed permanently after values are found.

Calibration & Adjustment

To achieve good accuracy and to maintain constant amplitude at different frequencies, care must be exercised in choosing certain component values. A review of how such values relate to performance is in order before procedure is described. Two characteristics are involved.

For the amplitude to remain constant at different frequencies, the pairs of re-

(Continued on page 72)

Fig. 5. Note used of matched pairs for critical resistor and capacitor values.

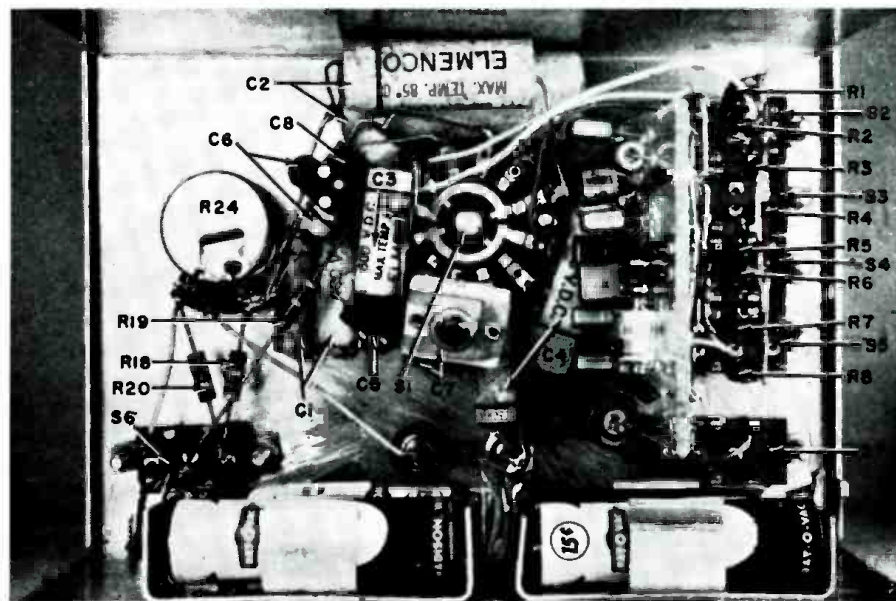

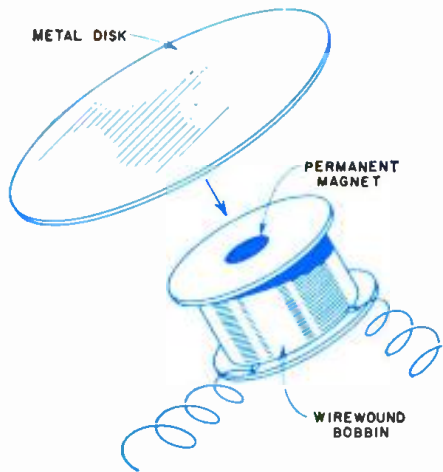

Fig. 1. The magnetic headphone.

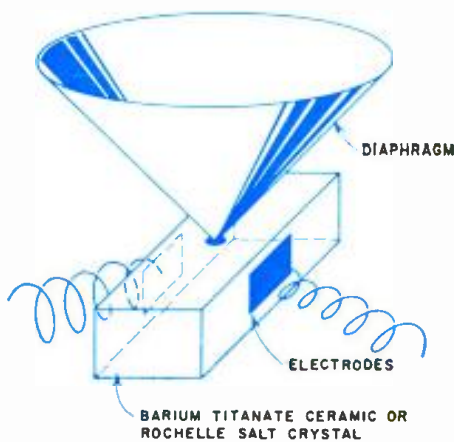

Fig. 2. Crystal or ceramic headphone.



Fig. 3. The dynamic headphone.

ONE OF the most enjoyable ways to listen to stereo programs is through stereo headphones instead of a dual-speaker system. While it is true that such listening has not enjoyed great popularity in the past, mainly because of the limited response of early units, major advances in recent years have widened the frequency response to the 30-cycle region at the bottom and to well beyond 16,000 cps at

the top and headphones are at last coming into their own.

Headphone listening has a number of advantages over speaker listening. The first advantage is economic—a good pair of stereo headphones costs considerably less than a pair of good speakers. For example, the least expensive stereo headphone sells for about two dollars while the most expensive pair goes for around 80 dollars. The second advantage is that since headphones are such sensitive devices, they require only a few milliwatts of audio power to drive them. Consequently, audio amplifiers are not driven into overload regions and, as a result, even low-power and economy amplifiers give excellent results when used with headphones.

In addition, the use of headphones completely eliminates the vexing problems of room acoustics which are encountered when speakers are used. Thus, such matters as room resonances, unwanted reverberation, excessive mixing of the stereo signal, and doubling do not enter the picture in headphone listening.

Of course, headphone listening isn't entirely without drawbacks. Headphones will allow you to listen to program sources at the highest volume level you desire, but even the best designed headphones cause some physical discom-

fort after a while. In addition, a first-rate speaker system is capable of a somewhat wider reproduction range than the best headphones available today. Then, too, headphone listening tends to be "anti-social" since it is hard to share your enjoyment with a group. Headphones limit your "mobility" while listening to the length of the connecting cable.

Types of Stereo Headphones

Virtually all modern headphones fall into one of three generic groups: magnetic, crystal, or dynamic. In all the units we checked, only one was found to fall outside these categories—it being a variable-reluctance device.

Magnetic Headphones: The magnetic headphone consists of a permanent magnet and a bobbin or spool wound with fine wire. See Fig. 1. Some magnetic headphones contain two of these bobbins in each earphone cup, while the less expensive ones usually contain a single bobbin. The permanent magnet is inserted through the center of the bobbin and the entire fixture is mounted in a plastic case. A thin metal disk or diaphragm, about 2" or 3" in diameter, is placed on top of the magnet-bobbin combination so that it just barely touches the magnet and the outside rim of the plastic housing.

When an audio signal is impressed across the bobbin coil, it reinforces or



Listening to Stereo

By STEVEN HAHN / Round Hill Associates

This method has advantages of freedom from room acoustics problems.

opposes the magnetic field produced by the permanent magnet. Thus, the strength of the magnetic field will vary in direct proportion to the audio signal impressed across the bobbin coil. This causes the metal diaphragm to move back and forth, thereby setting up sound waves.

An unusual twist to this principle is employed in a stethoscope-type magnetic headset. In this unit, the magnetic driving system rests approximately on your collarbone and the sound is actually piped through $\frac{1}{4}$ " plastic tubing into your ears—just like a stethoscope. However, the manufacturer has arranged the plastic piping in such a manner that one leg is somewhat shorter than the other. This means that the sound from one channel will reach your ear before the sound from the other channel. As a result, a very slight amount of acoustic delay (on the order of a few microseconds) is obtained. This delay gives a very slight reverberation effect which, according to the manufacturer, increases intelligibility.

Magnetic headphones are extremely rugged and will withstand a great deal of abuse. They are not expensive—varying in price from \$2.00 to about \$16.00. Their over-all frequency response is about 100 to 8000 cps and they are offered in virtually any impedance up to about 6000 ohms.

Crystal and Ceramic Headphones: The crystal headphone is a device which operates on the piezo-electric principle. See Fig. 2. Actually, such a unit is similar to a crystal phonograph pickup only working in reverse, i.e., converting electrical energy into mechanical energy—sound.

The headphone contains a material which physically vibrates when an electrical voltage is impressed across it. This material is usually a slug of Rochelle salt. Barium titanate ceramic material also exhibits piezo-electric properties and may be used.

In a crystal or ceramic headphone, two electrodes are attached to the piezo-electric material and this material is then mounted in the headphone case. A thin plastic circular or cone diaphragm is then glued to the piezo-electric material and

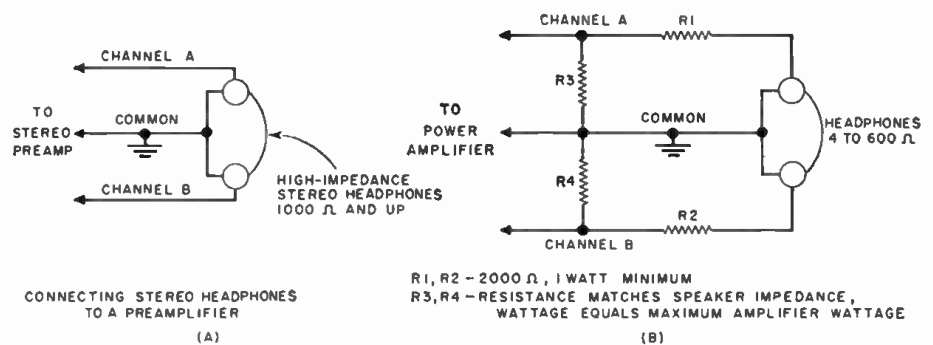

Fig. 4. Methods used to connect stereo headphones to (A) preamp and (B) power amplifier.

supported at the rim by the headphone case. When an audio signal is impressed across the crystal, it physically vibrates in accordance with the signal and sound is heard from the diaphragm.

Crystal or ceramic headphones are capable of extremely wide reproduction, especially at the high-frequency end. However, they are sensitive to vibration and can be permanently damaged if direct current flows through the piezo-electric substance. As a result, these headphones must never be hooked across a d.c. voltage source. This can be easily avoided by using a .1 to .01 μ f. blocking capacitor. Even when headphones are used on audio signals, care should be taken not to impress a high voltage across them, since too much a.c. can permanently damage the sensitive piezo-electric material.

Crystal and ceramic headphones are the most sensitive of the three generic types. They cost from a few dollars to as much as \$30 and they are invariably high-impedance devices—10,000 ohms to 100,000 ohms.

Dynamic Headphone: The dynamic headphone is as rugged as the magnetic type and a well-designed unit is capable of about as wide a frequency response as the crystal type. See Fig. 3. As a matter of fact, a good dynamic headphone excels the crystal in the matter of low-frequency response. In addition, it is difficult to damage a dynamic headphone by impressing large audio signals across it. However, in all fairness, it must also be stated that

the dynamic headphone is usually the highest priced of the three.

A dynamic headphone is really a miniature speaker system: in other words, a coil of wire is attached to a diaphragm—not unlike the cone of a speaker. This coil-diaphragm combination is placed in the air gap of a metal structure using a fixed permanent magnet. As the audio signal is impressed across the coil, the entire diaphragm system moves back and forth in the magnetic field, thereby generating sound. In some ways the dynamic headphone is similar in operation to the magnetic headphone. However, in the magnetic unit, the coil is wound around

➔ **with Headphones**

lower cost, reduced power needs,

Complete headphone directory included.

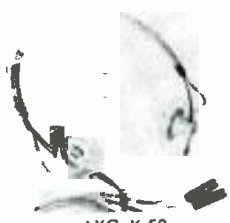

AKG K-50



Lafayette F618



Beyer DT48



Permoflux BDHS28



S. G. Brown "Super-K"



Plastic Mold LT-100



Clevite-Brush BA-200



Radio Shack A91L150



General Phones CLC-B



Rye Sound S-15



Knight KN840



Sargent-Rayment "Binaphone"



Koss SP-3



Sharpe HA-10

the magnet and remains fixed, while the dynamic headphone coil is attached to the diaphragm and moves back and forth with it.

Dynamic headphones are considerably more sensitive than magnetic units although not as sensitive as crystal headphones. Some inexpensive dynamic types can be purchased for a few dollars. However, the better units cost anywhere from \$25 to \$80. Most dynamic phones have impedances that are in the 4 to 16 ohm range.

One manufacturer has actually combined a set of dynamic phones with ceramic units, coaxially mounted in the same set of earpieces. The ceramic units reproduce the higher frequencies via a crossover network, while the dynamic reproducers handle the lower frequencies.

Variable-Reluctance Headphone: In the variable-reluctance headphone a pair of fixed, rectangular permanent magnets

is used in conjunction with a small flat coil to provide the driving force. A thin metal disk or diaphragm, separated from the magnetic structure, completes the magnetic path through an air gap. The permanent magnets are mounted parallel to the disk, and on the face of the coil away from the disk.

Audio current through the coil varies the magnetic flux in the gap and causes the disk to vibrate and produce sound. The operating principle is much the same as that of the magnetic headphone (shown in Fig. 1), although the physical construction is somewhat different. The variable-reluctance headphone gets its name from the changes in reluctance of the magnetic path as the metal disk vibrates. Only one manufacturer currently produces a headset of this type.

Connecting Stereo Headphones

Stereophonic headphones come in a
(Continued on page 108)

Table of presently available stereophonic headphones.

MANUFACTURER	MODEL	PRICE	TYPE	IMPEDANCE
AKG	K-50	\$24.50	Dynamic	400 ohms
BEYER	DT48	\$79.50	Dynamic	5 ohms
BROWN, S.G.	Super-K	\$32.50	Dynamic	52 ohms
CLEVITE-BRUSH	BA-200	\$16.35	Crystal	45,000 ohms
	BA-205	\$22.50	Crystal	100,000 ohms
	BA-206	\$26.15	Crystal	50,000 ohms
	BA-220	\$29.95	Crystal	50,000 ohms
GENERAL PHONES	CLC-B-16	\$29.40	Var.-Reluct.	3.2-16 ohms
KNIGHT	KN840	\$22.95	Dynamic	16-600 ohms
KOSS	SP-3	\$24.95	Dynamic	4 ohms
	F616	\$15.95	Dynamic	4-8 ohms
LAFAYETTE	F618	\$15.95	Dynamic	8 ohms
	MS431	\$ 2.35	Magnetic	6 ohms
	MS432	\$ 2.45	Magnetic	5000 ohms
	MS433	\$ 1.95	Crystal	45,000 ohms
PERMOFLUX	BDHS28	\$45.00	Dynamic	12 ohms
	BDHS17	\$50.00	Dynamic	300 ohms
	HDB16/16	\$40.00	Dynamic	16 ohms
	LT-100	\$30.00*	Dynamic	10 or 300 ohms
PLASTIC MOLD	A91L155	\$ 1.98	Crystal	70,000 ohms
RADIO SHACK	A91L150	\$ 2.49	Dynamic	10 ohms
RYE SOUND	S-15	\$15-\$17*	Dynamic	15,120, 500, 2000, 4000 ohms
	UCL-15	\$12-\$14*	Dynamic	3.2-8000 ohms
SARGENT-RAYMENT	Binaphone	\$24.50	Dynamic	16 ohms
SHARPE, E. J.	HA-10	\$43.50	Dynamic	10 ohms
	ST-M	\$29.95	Cer./Dynamic	8-16 ohms
SUPEREX	ST-S	\$19.95	Dynamic	8 ohms
	ST-48,600, 2000	\$ 2.35	Magnetic	4-8, 600, 2000 ohms
	ST-4000	\$ 2.65	Magnetic	4000 ohms
	HAV-13	\$13.50	Magnetic	128 or 2000 ohms
TELEX	HDP	\$24.38	Dynamic	6 ohms
TRIMM	50-14	\$15.60	Magnetic	4, 300, 1000, 6000 ohms

Approximate price.



Superex ST-M



Telex HDP



Trimm 50-14

Standing-Wave Indicator for CB Testing

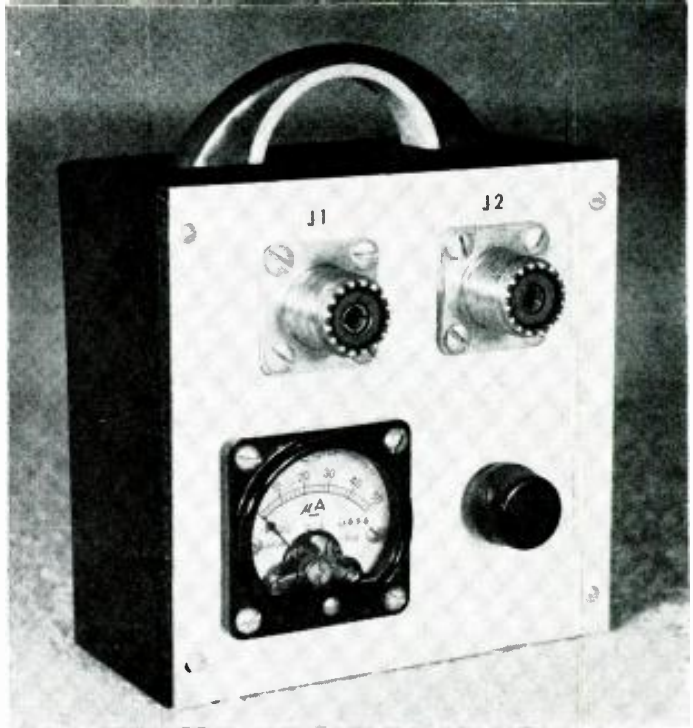
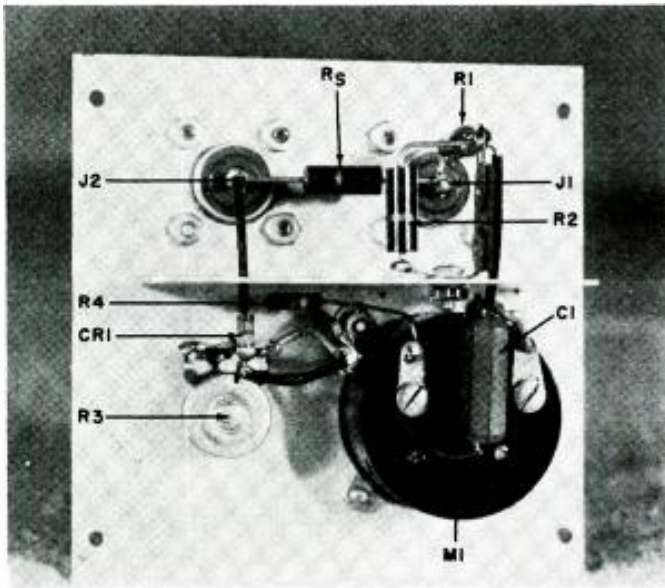

The completed standing-wave indicator constructed by the author. Standard coaxial connectors are used for output and input. A handle was added to the 4" x 4" x 2" metal cabinet for carrying.

Interior view. All parts are attached to front panel. A metal shield divides the bridge circuit from the null-detection circuit. Bridge resistors are placed at right angles to each other as shown.

By HAROLD REED

Construction of compact antenna-matching bridge for most efficient power transfer.

WITH input to a Citizens Band transmitter limited to a relatively low power of 5 watts, it is desirable, for greater signal coverage, to deliver as much r.f. power to the antenna as possible to obtain maximum radiation intensity. This requires good impedance matching in the antenna system. Among other things, antenna impedance will vary with height above ground and its immediate surroundings. When the antenna presents an impedance to the transmission line which is equal to the characteristic impedance of the line, the antenna will absorb all the r.f. power. When the antenna does not match the line, some of the power is reflected back toward the input end of the line. This reflected energy, which sets up standing waves, is wasted power and increases with increasing antenna-line mismatch.

A simple way to check standing-wave-ratio is to use a resistance bridge. The miniature indicator here described employs this method and includes a self-contained null rectifier and meter.

Circuit Details

The basic bridge circuit is shown in Fig. 1. The four resistive arms of the bridge are composed of R_1 , R_2 , R_3 , and R_4 . The resistance values of R_1 and R_2 are not critical but they should be as nearly identical as possible. R_1 is the unknown impedance and is compared against resistor R_2 , which can be termed the standard arm of the bridge. When R_1/R_2 is equal to R_3/R_4 there is no potential difference at the points where the meter is connected, the bridge is

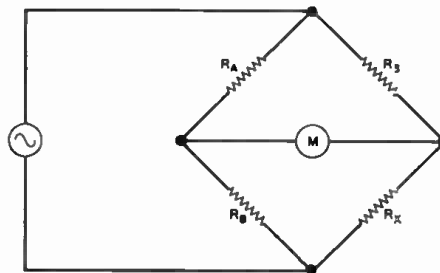

Fig. 1 Basic resistance bridge circuit.

balanced, and the meter reads zero. If R_1 does not match R_2 , the bridge is unbalanced, a potential difference exists at the meter terminals, and the meter deflects.

In the practical application of the bridge in the standing-wave indicator, arm R_1 is replaced by the transmitter end of the antenna transmission line and R_2 is made equal to the rated characteristic impedance of the line. It is convenient to make R_3 and R_4 the same value as R_2 . See Fig. 2. The meter of Fig. 1 is replaced by a crystal diode rectifier—microammeter circuit for null detection. Resistor R_3 provides a high meter-circuit impedance to prevent bridge loading, while R_4 is used for full-scale meter adjustment.

Assembly Details

The standing-wave indicator is assembled in a 4" x 4" x 2" cabinet. All component parts are attached to the front panel. The bridge circuitry is placed on the upper half of the panel

and the rectifier-meter circuit is located on the lower half. A metal shield plate, attached to the panel and secured under the lower coax-connector screws, is inserted between these two sections of the complete circuit. The shield is included to minimize stray coupling between the bridge components and the rectifier-meter circuit. Also, to avoid stray coupling, the bridge arms are separated and placed at right angles to each other. Short, direct lead dress is employed in connecting the component parts.

The indicator is designed to be used (Continued on page 80)

Fig. 2. Complete schematic of indicator.

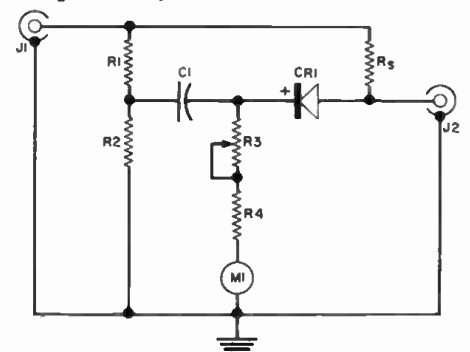

- R_1, R_2, R_3 —51 ohm, 1 w. carbon res. $\pm 5\%$ (Allen-Bradley, see text)
- R_4 —50,000 ohm miniature pot
- R_5 —5600 ohm, $\frac{1}{2}$ w. res.
- C_1 —.003 μ f. mica capacitor
- CR_1 —Crystal diode (Raytheon 1N66 or equiv.)
- M_1 —0-50 d.c. microammeter
- J_1, J_2 —Coax connector (Amphenol 83-1R Type S(-)-239)
- I —4" x 4" x 2" metal cabinet

PHASING THE STEREO SYSTEM

By RALPH GLASGAL

Methods used to detect and to correct for improperly phased recordings and high-fidelity stereo components.

THAT proper phasing of stereo components seems to "faze" professional and amateur audiophiles alike is demonstrated by the continuing availability of out-of-phase records and by persistent reports of out-of-phase hi-fi show demonstrations. Perhaps this is so because phase distortion is the most difficult aural distortion to detect by casual, or hectic, listening methods. The human ear is less sensitive to phase distortion than to frequency or harmonic distortion, especially where only one sound source is involved. Nevertheless, in this era of stereophonic reproduction and low-distortion components, phase distortion must be eliminated from multi-channel systems if the best possible sound reproduction is to be obtained.

This article will survey some of the methods used to detect and compensate for incorrectly phased recordings and components.

What Is Phase?

First, let us define what is meant by "phase" in a multi-channel system. All audio waveforms, no matter how complex, can be reduced to a series of sine waves differing in amplitude, frequency, and phase. Phase in this context refers to the position of each sine-wave component in time relative to all the other sine-wave components. It has been demonstrated by experimenters at *Bell Telephone Laboratories* that the ear is insensitive to the phase of these sine waves. This conclusion applies only to a single waveform issuing from a single sound source. We might call this "internal" or "self" phase. Thus it is necessary to consider only external phase problems and characteristics.

External phase is the time relationship between two waveforms of the same waveshape emanating from two or more separate sound sources. The ear is exceptionally sensitive to external phase shifts. Indeed, the existence of stereo perception is, to a large extent, dependent on the ear's ability to detect even small external phase differences.

Stereo perception depends on a combination of amplitude and time differences between two or more channels. It is the recording engineer's job to capture these amplitude and time differences in a practical and effective manner. It is the function of the reproducing system to transmit these amplitude and time differences with as much fidelity

as possible so as to re-create accurately the stereo image captured by the recording engineer.

The simplest form of phase distortion is a complete change in the polarity of one channel with respect to the other. The aural results of such distortion are reduction of bass response, lack of center-channel presence, and a generally confused sound pattern. The loss of bass response occurs because of acoustic cancellation of completely out-of-phase signals in the listening room. The amplitude of the lower bass frequencies is affected more than that of the higher frequencies because the microphone spacing used to make most stereo recordings is small compared to the wavelengths of the lowest bass frequencies, so that the low bass always arrives at both microphones essentially in-phase. Thus, if the two signals are combined out-of-phase, electronically or acoustically, bass cancellation will occur.

As will be described, it can easily be demonstrated that identical in-phase signals applied to two loudspeakers produce a virtual image midway between them for a listener who is sitting between the two speakers. The reproduction of solo or center orchestral instruments from two side loudspeakers is only possible because of this effect. If the phase of one speaker is reversed, the ephemeral center image is destroyed and the side speakers are heard individ-

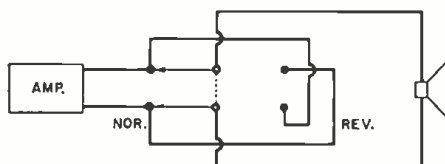

Fig. 1. Simplest phase-reversal switch.

ually. In general, it can be said that any tampering with the phase or timing of one channel of a stereo signal with respect to the other is detrimental.

An inexperienced stereo listener should practice listening to these phase effects so as to recognize them more easily when they appear unbidden later on. A very simple experiment and one which does not require elaborate equipment is performed by feeding the output of a single power amplifier to a set of stereo headphones. Headphones have the virtue of eliminating the effects of room acoustics and of magnifying out-of-phase defects to the point where they become very easily detectable by even

the most inexperienced stereo listener.

Some means of reversing the leads to one earphone should be provided. Any type of program or test tone material can be used. A few minutes of A-B testing, by reversing the phase of the signal to one earphone, will demonstrate the basic character of out-of-phase sound reproduction. It is interesting to note that bass cancellation does not occur when headphones are used. This proves that the bass cancellation occurs acoustically in the listening room and not in the brain. The brain does not interpret phase differences in terms of volume level but in terms of direction, distance, and precedence.

System Phasing

Now that we understand and can recognize the nature of phase distortion, let us consider the phasing of stereophonic recording and reproducing systems. Since phase meters or oscilloscopes are not usually available to the audiophile, we will consider methods that rely only on the ability of a practiced ear to detect phase discrepancies.

First, we must standardize and adjust loudspeakers to produce a strongly in-phase sound pattern that ears can readily detect. This procedure also insures superlative stereo reproduction if applied rigorously. First connect an FM tuner to the input of a power amplifier. Remove the antenna from the tuner, disable its a.f.c., as well as any noise-muting circuit and tune it to an area of the FM band where there are no stations. Use the multiplex output jack if the tuner has one. Connect both loudspeakers to be phased to the single power amplifier. Wide-band noise should be heard from both speakers at equal volume.

If widely dissimilar speakers are involved, balance must be obtained by using different output impedance taps for each speaker or by using a previously phased stereo power amplifier with balancing controls. The object is to manipulate balance controls, speaker position, listener position, tweeter or mid-range level controls, and the phase of one speaker until the noise coming from the individual speakers merge into a single noise source emanating from a point between the two speakers.

Sometimes, if very dissimilar multi-speaker systems are used, particularly ones with complicated crossover networks and eccentric frequency and

phase characteristics, no noise image can be formed and phase reversing makes little difference in the quality of the noise. In such a set of speakers, the phase *versus* frequency relationships are so widely divergent that the speakers cannot be maintained in-phase with each other in more than one region of the audio band at a time. Speakers that cannot produce an effective center noise image are not suitable for use in a stereo system and should either be altered or discarded in this application.

Beware also of tweeters that are not in-phase with their own woofers. Acoustic cancellation can occur near the crossover points and phasing such a speaker with another not similarly afflicted can be an exasperating experience! A tweeter may be phased with its woofer by applying a signal at the crossover frequency from a signal generator or a test record. Correct phasing produces the loudest sound to an ear located equidistant from both sources. If possible, the components of the crossover network should be shorted while this test is being made. If the terminals of both tweeter and woofer are accessible, phase is best accomplished by using a flashlight battery and observing the direction of cone motion when the battery is applied to each pair of terminals in turn.

Once two loudspeakers have been reliably phased they can be used, in turn, to check other stereo components for phasing. The basic method for doing this consists of applying a monophonic signal to the stereo system involved and listening for the characteristic in-phase and out-of-phase sound over the previously standardized loudspeaker system.

Thus a control amplifier or power amplifier-preamp can be phased by putting the controls in the monophonic position and listening to any program source or by applying the same signal to both channel inputs simultaneously. A stereo control and amplifier system may also be checked for phase and balance by momentarily connecting a single loudspeaker from the high tap on one amplifier to the same tap on the other. With the same signal fed to the inputs of both channels, no sound will be heard from the loudspeaker, if both phase and balance are exact. The balance should be adjusted to produce the least sound possible. Whatever residue of sound remains is then due to differences in phase between the two channels. Often, adjustment of tone controls improves balance and introduces phase shift that improves the null. If the channels are completely out-of-phase, the balance control is ineffective and no null can be obtained.

Stereo phonograph cartridges may be phased by playing a monophonic record through a stereo system and listening for the null, as before, or for a center image. Likewise, a tape recorder can be checked for phase by recording the same signal on both channels and listening for the null or center image on the standard system during playback. The null method, while more complex than the center-image method, has the virtue

of being more sensitive to small phase shifts and does not require special listening abilities. The center-image method, however, requires no special wiring and is good enough to detect blatant phase errors.

Microphones can be phased by placing a sound source equidistant from them and listening for a center image on the standard system.

Changing the Phase

There are only a few places in a stereo sound system where phase changes can be made conveniently: at the power amplifier output terminals, stereo cartridge output terminals, tape record or playback head terminals, and microphone output or transformer terminals. Changes at the three latter points affect only the phase of the components involved, whereas reversal of the power amplifier leads changes the phase of the entire system.

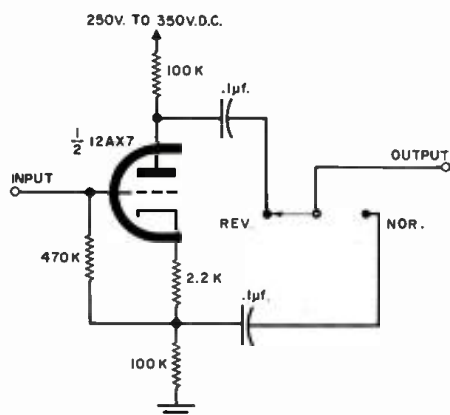

Fig. 2. Phase-reversal circuit that may be employed with the split-load inverter.

The phasing of an FM tuner with a multiplex adapter is a more difficult matter. We can assume, in most cases, that a tuner and adapter of the same make will be designed to produce in-phase outputs but when an adapter of one brand is connected to a tuner of another make, there is a 50 per-cent chance that the outputs will be out-of-phase. Unfortunately, the monophonic signal needed to phase a multiplex system reliably by ear is not easily come by. Broadcast stations almost never transmit monophonic multiplex so phase must be determined by using stereo material that is being broadcast. This is most easily done with a coordinating phase meter but it can be done by ear, using the standard system and a phase-reverse switch for A-B testing.

The audiophile's phase problems do not end when his own equipment is in-phase. It is a rare stereo record collection that does not contain several out-of-phase discs. There are records that are in-phase on one side and out-of-phase on the other. There are also records that shift phase erratically because they were edited from two master stereo tapes, one of which was in-phase and the other one of which was not.

At least for the next few years, the phasing of stereo broadcasts is likely to be haphazard until studios discover and

eliminate the out-of-phase cartridges, microphones, recorders, line amplifiers, modulators, etc. in their own equipment.

Because of the prevalence and continuing availability of out-of-phase program sources, it is desirable to incorporate some means of phase reversal in all stereo systems that do not already have them. Fig. 1 shows the simplest of all phase-reversal circuits. This switch circuit is generally usable only if inserted in the lead between amplifier and speaker. It is a very effective and simple method but has the disadvantage of making the phase change after the signal has been through the blend control or tape recorder outputs. Thus, with only this phase-reversal circuit in a stereo system, it would be impossible to make in-phase recordings from out-of-phase program sources and the blend control would operate as a cancellation control.

Figs. 2 and 3 show electronic phase-reverse circuits which can be used at almost any point in a stereo system. Fig. 2 is a common split-load phase inverter, used to provide phase reversal. It has some disadvantages when used as a phase-reversing device. There is a loss of gain, the output impedance is not as low as it might be (particularly at the plate), and distortion is higher than that obtained with the circuit of Fig. 3. This circuit, also known as an anode-follower, has very low distortion, very low output impedance, and no loss in gain—but it must be fed from a source impedance small compared to 470,000 ohms or the gain in the reverse-phase position will decrease. The circuit

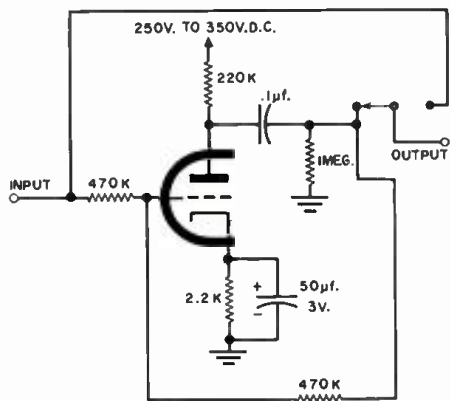
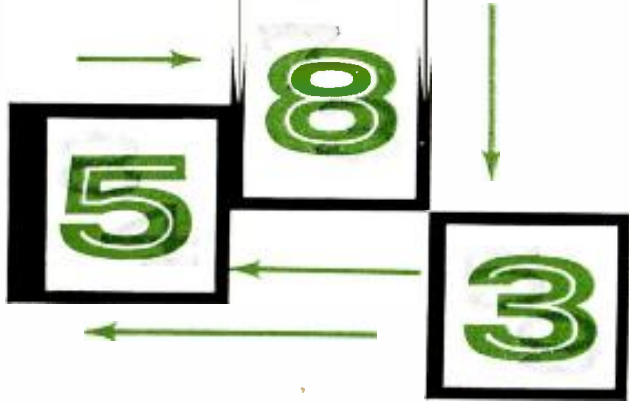

Fig. 3. Phase reversal with anode-follower.

of Fig. 2 is independent of the input source impedance.

Finally, it is necessary to point out that there are some stereo records to which the problems of external phase do not apply. These are recordings made with such widely spaced microphones that no part of the signal heard by one microphone is picked up by the other. Such a recording is completely uncorrelated, produces no center image, has two channels but is not stereophonic, and is entirely unaffected by phase changes in the reproducing system. Such "pseudo-stereo" records are, unfortunately, widely distributed among devotees of audible "ping-pong" matches. ▲



By ED BUKSTEIN

Author, "Digital Counters and Computers"

COMPUTER REGISTERS and ACCUMULATORS

The versatile flip-flop, other roles aside, is involved with storing, transferring, and combining information.

THE flip-flop stage is one of the essential building blocks of the digital computer. Stages of this type may be used for storing information in the form of binary numbers, and for performing mathematical operations on such numbers.

The storage register, as the name implies, is used for storing or holding information. The register consists of stages of the type shown in Fig. 1, each stage storing a single bit of binary information (either 0 or 1). In this circuit, only one of the two triodes can be below cut-off. When V_1 is below cut-off, for example, V_2 must conduct because the plate voltage of V_1 is high enough to drive the grid of V_2 positive with respect to cathode. Likewise, if V_2 is below cut-off, its plate potential will raise the grid of V_1 to the saturation level. Since the circuit is stable in either one of two possible conditions, one of these conditions can represent binary 0 and

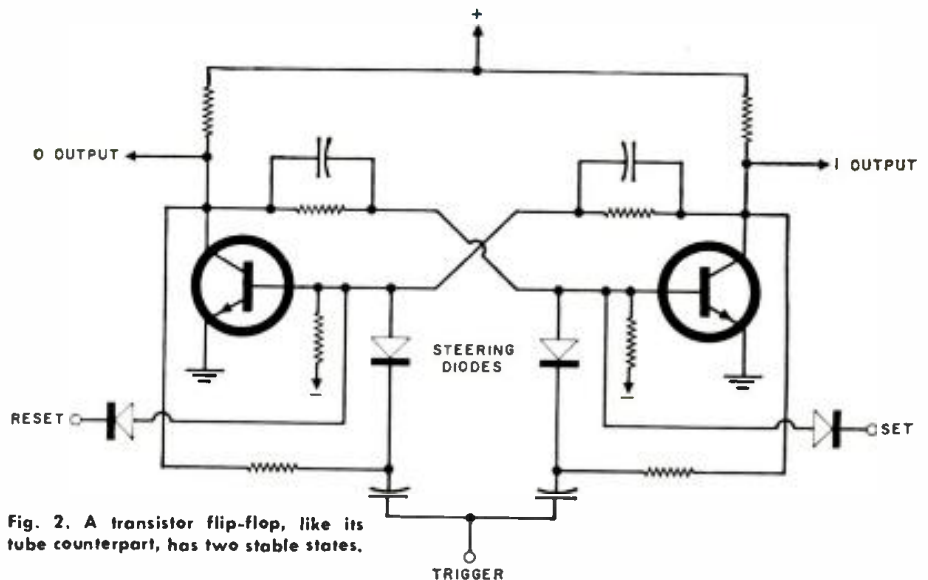

Fig. 2. A transistor flip-flop, like its tube counterpart, has two stable states.

the other can represent binary 1. When triode V_1 in Fig. 1 is below cut-off, the stage represents binary 0; when V_2 is below cut-off, the stage represents binary 1.

As indicated in Fig. 1, the circuit has three input terminals: *set*, *reset*, and *trigger*. The set terminal is used to switch the circuit to the binary 1 condition. This is accomplished by applying a negative pulse to the set terminal, driving triode V_2 below cut-off. If a negative pulse is now applied to the reset terminal, triode V_1 will be driven below cut-off and binary 0 is now stored in the stage.

If a flip-flop stage is already set (V_2 below cut-off), a pulse applied to the set terminal will produce no change in the circuit. Similarly, if a flip-flop stage is already reset (V_1 below cut-off) a pulse applied to the reset terminal will produce no change. By contrast, a pulse applied to the *trigger* terminal will always reverse the stage regardless of its

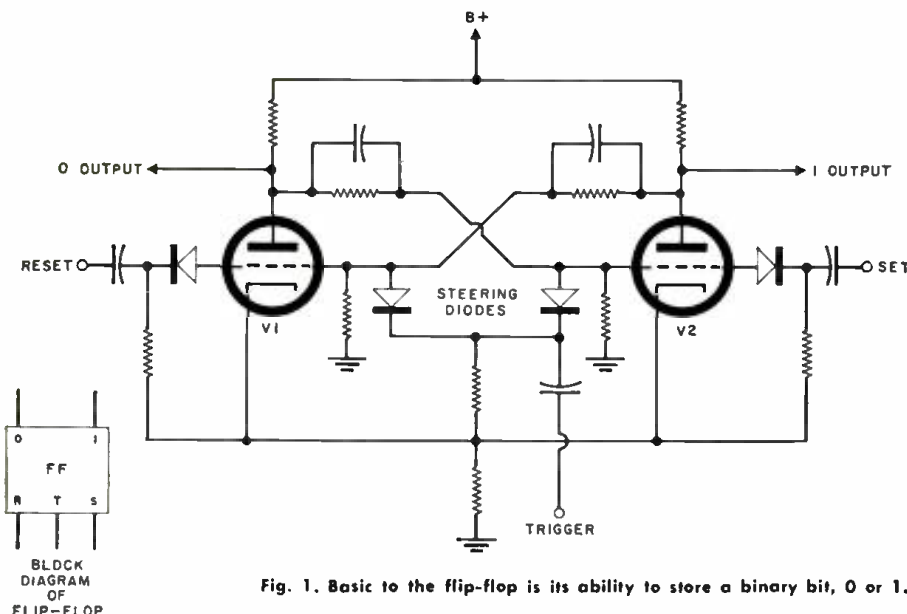

Fig. 1. Basic to the flip-flop is its ability to store a binary bit, 0 or 1.

previous condition. The two diodes in the trigger circuit are effectively connected between grid and cathode of the two triodes. Since, at any given instant, one grid is negative with respect to cathode and the other grid is positive, one of the two diodes is forward biased and the other is reverse biased. The input pulse applied to the trigger terminal passes through the conducting diode only and therefore reaches the grid of the conducting triode only. In this way, the input pulse is *steered* to the conducting triode, driving this triode below cut-off and reversing the condition of the circuit. It is for this reason that the diodes in the trigger circuit are referred to as *steering diodes*.

The flip-flop has two output terminals, one from each plate. Since one triode is at saturation and the other is below cut-off, the voltage level is high at one output terminal and low at the other. When the stage is set to the binary 1 condition, a high level of voltage appears at the "1 output" terminal. When the stage is reset to binary 0, a high level is available at the "0 output" terminal. As indicated in the block diagram in Fig. 1, the three input terminals of the flip-flop are labeled reset, trigger, and set, and the two output terminals are labeled 0 and 1.

A transistor flip-flop circuit is shown in Fig. 2. Since the collector of each

produce a high-level output only when *both* of the following conditions exist:

1. Binary 1 is stored in the flip-flop so that its "1 output" terminal supplies a high level input to one of the *and* terminals.

2. A transfer pulse is applied to the other terminal of the *and* circuit.

If binary 0 is stored in the flip-flop, the "1 output" terminal will be at a low level. Under these conditions, the transfer gate cannot produce a high level output. The reason for the name *transfer gate* now becomes apparent: whichever binary bit is stored in the

This assumes that the high level is more positive than the low level. If desired, however, the *and* circuit can be designed so that the high level is more *negative* than the low level.

A five-stage storage register and associated transfer gates are shown in Fig. 5. (In the computer, many more stages are used so that larger numbers can be stored.) As indicated, a *clear* terminal is available to permit all stages to be reset simultaneously. A pulse applied to the clear terminal therefore has the effect of *erasing* any binary number previously in the register. In Fig. 5, it is assumed that set pulses have been applied to three of the stages so that binary number 11001 is stored in the register. The shaded stages are assumed to be in the binary 1 condition, and the unshaded stages are assumed to be in the 0 condition.

The three stages in the binary 1 condition supply high-level inputs to the associated transfer gates. When a transfer pulse is applied, these three gates produce high level outputs to represent the binary 1's. The other two gates produce low level outputs to represent the binary 0's. Binary number 11001 therefore appears at the output terminals of the transfer gates when the transfer pulse is applied.

The Accumulator

The accumulator is an arithmetic circuit which, as the name suggests, accumulates (adds) binary numbers applied to its input terminals. As indicated in Fig. 6, the accumulator consists of flip-flop stages connected in cascade. In this respect, it is similar to a binary counter except that an independent input terminal is available for each stage of the accumulator. Each time a stage switches from the 1 condi-

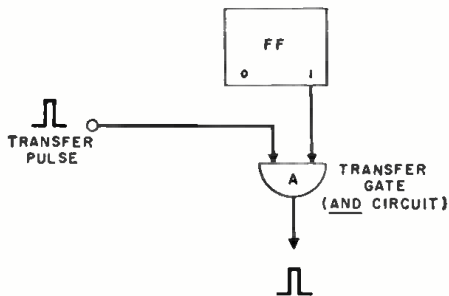

Fig. 3. Transfer gate yields high-level output if flip-flop is in binary-1 state.

transistor is resistively coupled to the base of the opposite transistor, only one of the two transistors can be below cut-off. When the left-hand transistor is below cut-off, for example, its collector voltage is sufficiently high to raise the base of the right-hand transistor to the conducting level. As in the case of the vacuum-tube circuit of Fig. 1, a pulse to the set terminal will cut off the right-hand transistor, a pulse to the reset terminal will cut off the left-hand transistor, and a pulse to the trigger terminal will reverse the stage regardless of its previous condition. A transistor flip-flop fabricated in the form of a plug-in card is shown in Fig. 4.

Information Transfer

The technique of transferring information out of a flip-flop stage is illustrated in Fig. 3. As shown, an *and* circuit is used as a *transfer gate*. (See "Computer Logic Elements," *ELECTRONICS WORLD*, December, 1960, for discussion of *and* circuits.) Since the *and* circuit can produce output only when both of its input terminals are at a high level, the transfer gate will pro-

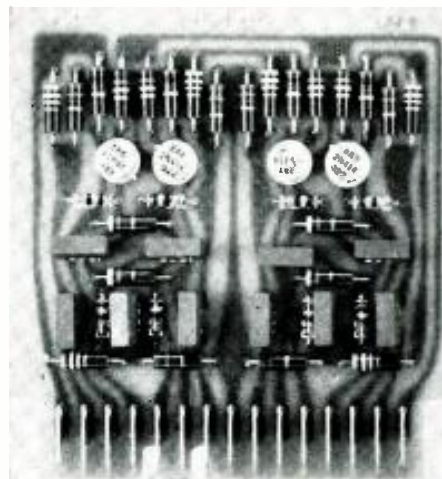

Fig. 4. A transistorized flip-flop fabricated in the form of a plug-in card.

flip-flop appears at the output of the gate. If the flip-flop has a 1 in it, the gate produces a high level output when the transfer pulse is applied; if the flip-flop has a 0 in it, the gate output remains at a low level when the transfer pulse is applied. The gate output is represented as a positive pulse in Fig. 3.

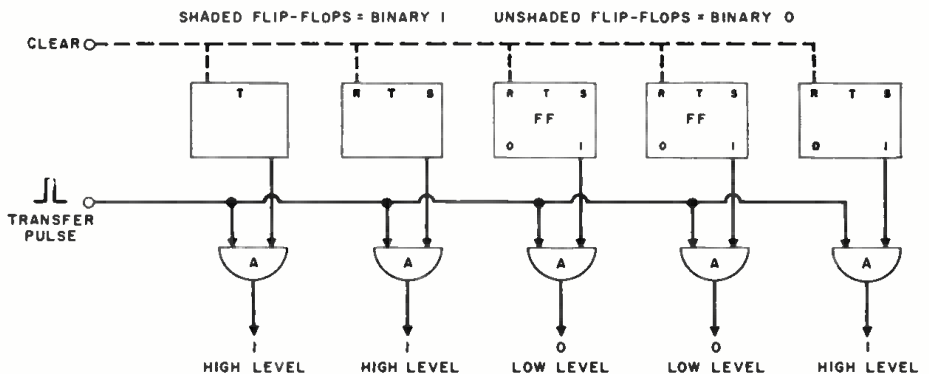
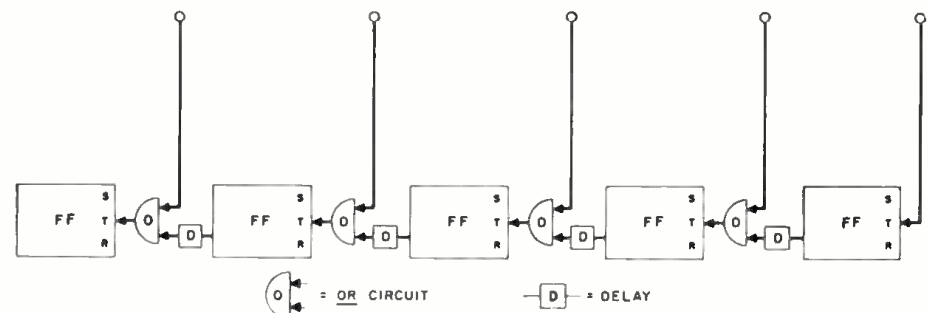

Fig. 5. Binary information in flip-flops appears at output terminals of transfer gates.

Fig. 6. Accumulator resembles binary counter, but each stage has independent input.



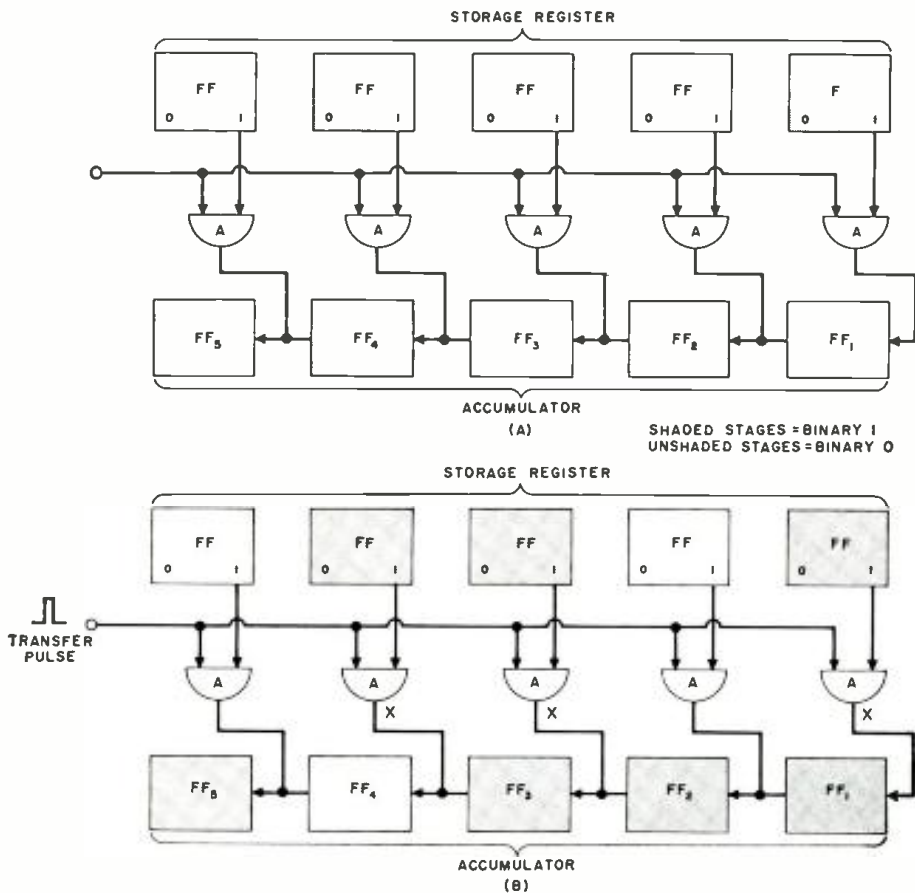
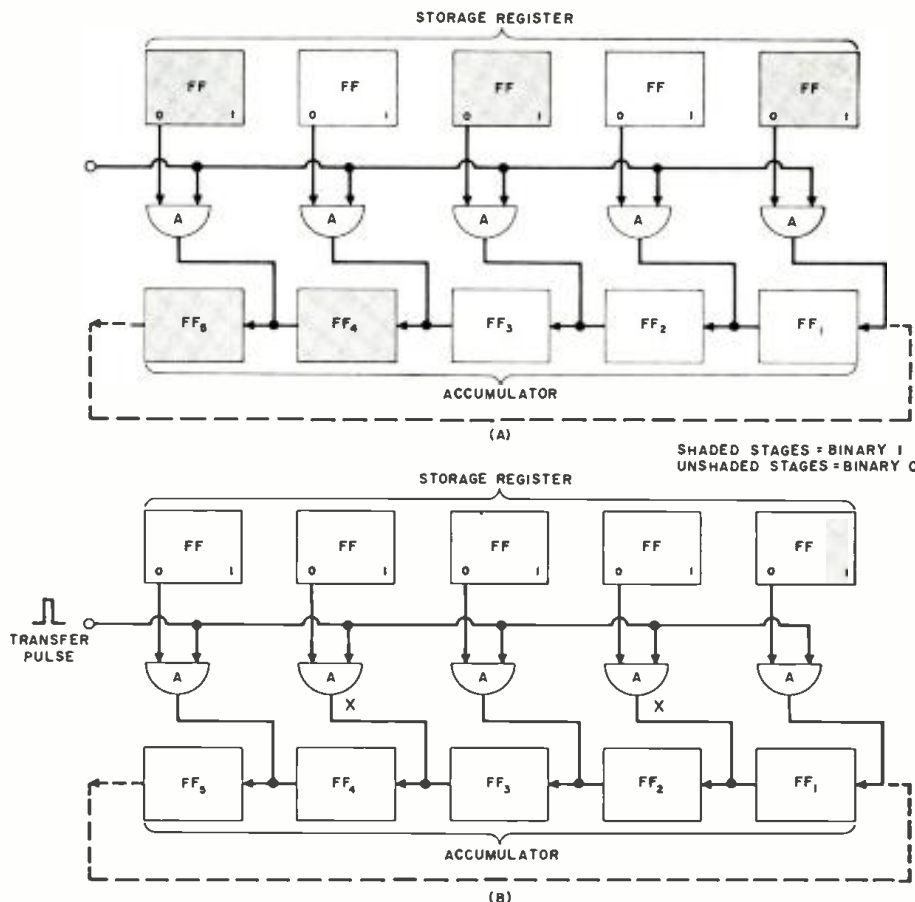

Fig. 7. A storage register and accumulator connected for binary addition. The conditions shown are before (A) and after (B) a transfer pulse has been applied.

Fig. 8. A storage register and accumulator connected for binary subtraction. The conditions shown are before (A) and after (B) a transfer pulse has been applied.



tion to the 0 condition, it generates a pulse of the correct polarity to trigger the following stage. An *or* circuit is used for interstage coupling because a stage may receive an input from either of two sources: from the preceding stage or from its own independent input terminal. Since one of these inputs may attempt to switch the stage to 0 while the other input attempts to switch it to 1, the two inputs must not be allowed to arrive simultaneously. This is the purpose of the delay (usually an RC network) in the interstage coupling.

For simplicity, the *or* circuits and the delays of the accumulator are not shown in Fig. 7. Here, it is assumed that binary number 01010 (equivalent to decimal *ten*) is stored in the accumulator, and that binary 01101 (equivalent to decimal *thirteen*) is in the storage register. These conditions are shown in Fig. 7A. If a transfer pulse is now applied to the circuit, three of the transfer gates will produce high level outputs (labeled "X" in Fig. 7B). These high level outputs are applied to the trigger terminals of the associated stages of the accumulator. The following changes therefore occur in the accumulator:

1. FF₁ receives a high level input and reverses its state to the 1 condition.
2. FF₂ receives no input and remains in the 1 condition.
3. FF₃ receives a high level input and reverses to the 1 condition.
4. FF₄ receives a high level input and reverses to the 0 condition.
5. FF₅ receives a triggering signal from FF₄ (which switched to 0) and therefore reverses to the 1 condition.

After these changes have occurred, binary number 10111 is now in the accumulator. This binary number is equivalent to decimal *twenty-three* and is the sum of the number in the storage register (13) and the number previously in the accumulator (10). The transfer pulse therefore causes the contents of the storage register to be added to the contents of the accumulator.

Problems in subtraction can be performed either directly or indirectly. The indirect method is frequently used in the computer because it permits a reduction in the total amount of circuitry required (the circuits used for addition are also used for subtraction). An example of the indirect method of subtraction is shown below:

- step 1:**
- | |
|----|
| 8 |
| -3 |
- step 2:**
- | |
|----|
| 8 |
| +6 |
- step 3:**
- | |
|-----|
| 8 |
| +6 |
| =14 |
- step 4:**
- | |
|----|
| 4 |
| +1 |
| =5 |

The subtraction problem in step 1 is converted to an addition problem (step 2) by using the *nines complement*. Two numbers that add up to nine are com-

(Continued on page 115)

Citizens Band Crystal Checker

By HAROLD REED

Simple single-transistor device checks crystal activity.
Can also be used with other LC circuits on other bands.

WITH the number of Citizens Band stations increasing daily, technicians and constructors engaged in CB work should be able to make independent tests on crystals. Since these tests cannot be made with the usual gear on hand, there is a need for a small, portable device for this purpose—one that can be constructed inexpensively. The present lower cost of some r.f. transistors and miniature meters makes this possible. The little instrument to be described seems to fill the bill and is easy to build.

The Circuit

A common-emitter transistor oscillator circuit is used. The crystal socket is connected between the collector and base of the transistor and when the crystal to be tested is plugged into the socket, the oscillatory circuit is completed. Tuning from below to above the Class D Citizens Band is provided for by the LC circuit made up of L_1 , C_4 , and C_5 . Output from the oscillator circuit is

coupled to a crystal diode, CR_1 , through capacitor C_3 . The diode rectifies the r.f. signal and this d.c. output is indicated by microammeter M_1 . Meter sensitivity is varied by potentiometer R_4 . Base bias for the transistor is obtained from resistors R_1 and R_2 connected across the battery supply source. A stabilizing resistor, R_3 , is included in the emitter circuit. Battery B_1 supplies the required d.c. voltage for the circuit.

Construction

The crystal checker is built in two $1\frac{5}{8}'' \times 2\frac{1}{8}'' \times 3\frac{1}{4}''$ metal boxes. This was done so that any LC circuit may be tested with any crystal. One box houses all of the circuit components except the LC circuit. All small parts, including the transistor and diode, are attached to a piece of perforated phenolic board which is mounted under the miniature meter terminals. The wire leads of these small parts are simply pulled through the holes in the board and bent over on the other side. All connections and sol-

dering at the rear of the board should be taken care of before the board is mounted.

Wire leads running from the board to component parts not on the board are soldered in just before attaching it to the meter terminals. The leads to the crystal socket are connected last and should be just long enough to permit the box to be opened for battery replacement. The battery, whose life should equal shelf life, is secured by a thin copper band attached by two machine screws to the end of the box. A small pin jack is placed at the other end of the box for plugging in the LC circuit. The meter sensitivity control is connected so that all of its resistance is in the circuit when the control knob is in the extreme counterclockwise position. This control and the slide-type power switch are mounted to the left of the meter.

The other box contains the LC circuit which is tuned by a miniature vernier dial. A miniature pin plug for inserting into the jack on the other box is attached to one end of this box. This plug is not designed for chassis mounting so it was adapted for this purpose by unscrewing the plug cap and drilling a hole in the box just slightly smaller than the size of the remaining part of the plug in which the pins are set. After applying cement, the plug was force-fit into the box hole. It holds securely.

Coil L_1 , 11 turns of #18 enamelled wire, is self supporting. It has a diameter of $\frac{3}{8}$ inch and is spread to a length of $\frac{3}{4}$ inch. This length may vary with different units depending on circuit lead

(Continued on page 78)

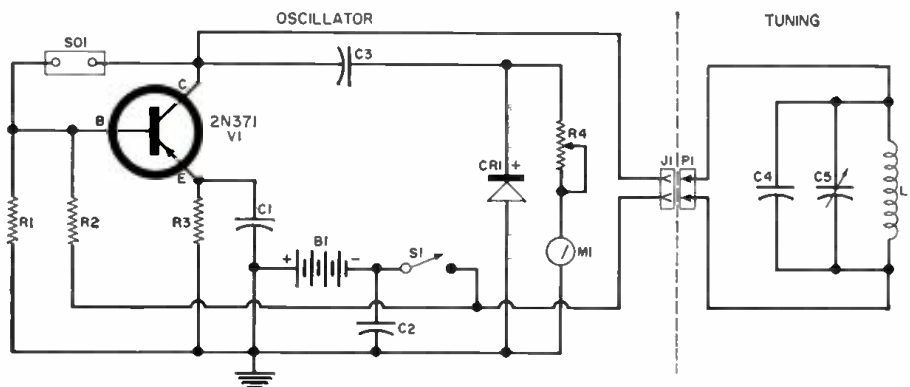

- R_1 —3900 ohm, $\frac{1}{2}$ w. res.
- R_2 —270,000 ohm, $\frac{1}{2}$ w. res.
- R_3 —1200 ohm, $\frac{1}{2}$ w. res.
- R_4 —500,000 ohm miniature pot
- C_1, C_2 —0.01 μ f. mica capacitor
- C_3 —18 μ f. ceramic capacitor
- C_4 —17 μ f. mica capacitor
- C_5 —3-15 μ f. midret variable capacitor (Bud 21850 or equiv.)
- L_1 —11 t. ± 18 en. self-supporting coil, $\frac{3}{8}''$ dia., $\frac{3}{4}''$ long
- CR_1 —Crystal diode (Sylvania 1N56A)
- M_1 —0-50 μ a. meter
- S_1 —S.p.s.t. slide switch
- SO_1 —Crystal socket (National CS-7)
- J_1 —Two-pin miniature jack
- P_1 —Two-pin miniature plug
- B_1 —9-volt battery (Burgess P6M or equiv.)
- V_1 —“p-n-p” transistor (RCA 2N371)
- 2—Chassis boxes $1\frac{5}{8}'' \times 2\frac{1}{8}'' \times 3\frac{1}{4}''$

Front view of two sections of checker. LC unit at right is plugged into oscillator section at the left. The crystal being checked is plugged into oscillator section.

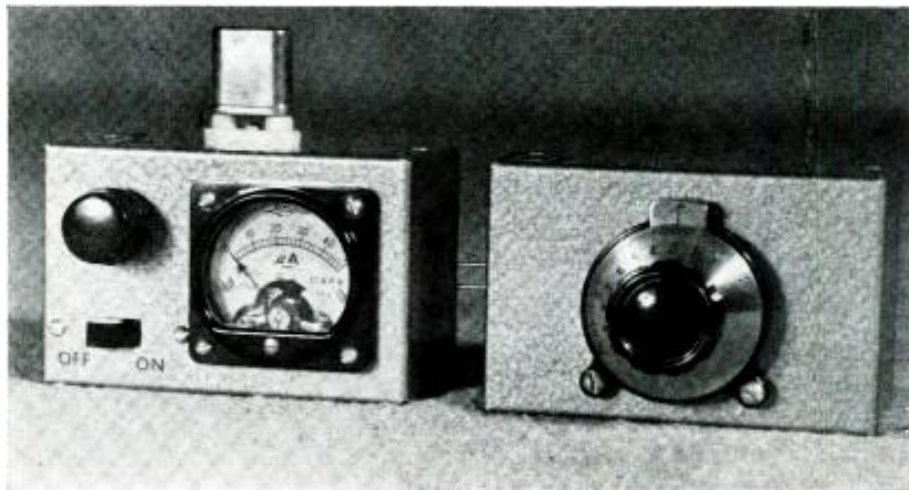

Complete schematic diagram of the CB crystal checker. SO_1 is the crystal socket. J_1 is the miniature jack on the oscillator box, and P_1 is mating plug on the tuning-circuit box.

TRY this quiz. Name a possible cause for each of these symptoms in a tape recorder brought to you for servicing: (1) low output at normal recording level; (2) excessive distortion; (3) severe treble loss; (4) excessive treble response; (5) excessive noise produced in recording; and (6) erase head doesn't do its job well.

What is more natural than to answer that the above symptoms indicate defective tubes, resistors, or capacitors associated with the voltage amplification stages; defective components in the power supply; defective record or erase head; magnetized heads? Yet if for each symptom you said, "something to do with the tape oscillator," you would be right every time.

The tape amplifier is much like other audio amplifiers in many respects. To this extent the service technician can get by on his knowledge of standard audio servicing procedures. But the tape amplifier is unique in that it incorporates a bias-erase oscillator. Here is the source of problems that can arise to vex the technician who hasn't yet learned the ins and outs of tape machines. The chances of a "sick" tape recorder experiencing a speedy recovery at your hands are increased if you know the tape oscillator well—what it is supposed to do, how it operates, how it is coupled to the rest of the amplifier circuit, what to expect of it in terms of frequency and waveform, and the special problems that are apt to arise, such as drift and stray pickup.

Functions

The purpose of the tape oscillator is to (1) send bias current through the record head, thereby reducing distortion and increasing the amount of signal

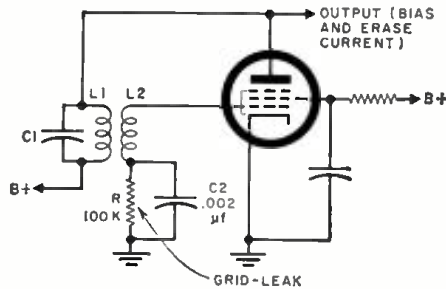

Fig. 1. Typical single-ended tape oscillator.

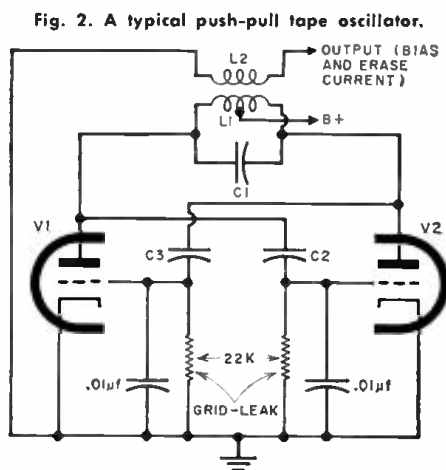

Fig. 2. A typical push-pull tape oscillator.

recorded on the tape and (2) energize the erase head.

The amount of bias current fed to the record head is quite critical and should be very close to the value specified by the manufacturer of the tape recorder or of the head. Deviations of 10% or even less from the optimum value are serious. If bias current exceeds optimum, distortion is reduced, but treble response deteriorates. If bias current is below optimum, treble response goes up, but so does distortion.

To check the amount of bias current flowing through the record head, place a 100-ohm resistor in series with the ground lead of the head and measure

the voltage across the resistor. Calculate the bias current by Ohm's Law: current equals voltage divided by resistance (100 ohms in this case). Optimum bias current in home tape machines ranges between .3 ma. and 1 ma.

In the case of the erase head, oscillator current flowing through it can vary over a moderate range without upsetting matters. The amount of current can be checked in the same way as for the record head. Typical erase currents used in home machines range from 10 to 50 ma. The manufacturer's service data should be checked for exact values.

Operation

Tape oscillators are sometimes single-ended affairs, as in Fig. 1 or, for minimum distortion, push-pull types as shown in Fig. 2.

For a basic understanding of how a tape oscillator works, consider the arrangement of Fig. 1. Oscillation is due to positive feedback between plate and grid. Assume a random increase in tube current so that the plate is negative-going. L_2 of the oscillator coil is connected so that a negative-going voltage across L_1 results in a positive voltage on the grid of the tube, causing further increase in tube current. Eventually, however, the current increase must slow down, causing the magnetic field of L_1 to collapse, thereby reversing the voltage across L_2 . So the grid goes negative, abetting the decrease in tube current. But the decrease in tube current also cannot continue indefinitely. As the decrease approaches an end, there is another collapse in the magnetic field around L_1 and another reversal of the voltage at the grid. Once more the grid is positive and promotes an increase in tube current . . . and so forth.

The oscillator frequency is essentially governed by the value of L_1 - C_1 , which determines how long it takes for the magnetic field around L_1 to build up and to collapse. The collapsing magnetic field helps the capacitor to charge; the

Servicing Tape-Recorder Oscillators

By HERMAN BURSTEIN

The audio technician must understand this circuit to keep the tape recorder in top-notch working condition.



discharging capacitor helps the magnetic field to build up.

R and C_2 in Fig. 1 provide negative grid-leak bias so that the tube will work on the proper portion of its operating curve. To maintain a stable level of oscillation, the time-constant of R and C_2 should be at least five times as great as the time required for one cycle of oscillation. For example, if the oscillation frequency is 50,000 cycles per second—20 μ sec. for 1 cycle—the time-constant should be at least 100 μ sec. for stable operation. Should R or C_2 substantially decrease in value, bias current can fluctuate and adversely affect recording results.

Feedback must be great enough to maintain oscillation yet small enough to permit the tube to operate within the linear portion of its characteristic curve; otherwise there will be excessive harmonic distortion and, consequently, noise produced in recording. In Fig. 1, the amount of feedback is controlled by using a suitable turns ratio between L_1 and L_2 and by the degree of coupling between them. Shorted turns in one winding or the other can result in distorted operation or in no operation at all.

Turning to Fig. 2, we note that positive feedback takes place *via* capacitors rather than through transformer coupling. The feedback is from the plate of V_1 to the grid of V_2 and from the plate of V_2 to the grid of V_1 . Reduction of distortion (even-harmonic) depends upon symmetry of operation which, in turn, depends upon symmetry of component values.

In many home tape recorders the same tube functions as an oscillator when recording and as the audio output tube in playback. Fig. 3 is a typical circuit of this kind. At audio frequencies, L_1 of the oscillator transformer provides a low-impedance path between the audio transformer primary and "B+." At the oscillator frequency, capacitor C_2 provides a low-impedance path between the plate of the tube and the oscillator tank circuit, L_1-C_1 .

Coupling the Oscillator

Oscillator current is usually fed to the record and erase heads *via* coupling capacitors, as shown in Fig. 4. The values of these capacitors determine the amount of current going through the heads. A change in their value will upset operation, particularly in the case of the record head. When there is too much distortion, improper treble response (too much or too little), or inadequate erasure, it is wise to check whether the capacitances are those specified by the tape recorder manufacturer.

Some tape machines, particularly the more expensive ones, employ a variable capacitor instead of a fixed one, so that bias current can be precisely adjusted to its optimum value. Sometimes a variable resistor is employed instead of a variable capacitor to control bias current to the record head.

Waveform

The bias waveform should be as close

to a perfect sine wave as possible. One can check for obvious distortion by connecting an oscilloscope across the record head when the tape machine is in the record mode, but without an audio input signal.

If appreciable noise is generated in the record mode although there is no signal input and the input gain control is all the way down, it pays to check components in the oscillator circuit. Significant distortion can be due to a defective tube or to capacitors or resistors that have changed values. In the case of a push-pull oscillator, substantial lack of symmetry between the two triodes, in terms of their mutual conductance, or the capacitors and resistors in the circuit of each triode may be causing distortion. It is also possible that distortion is due to excessive loading by the erase head. The erase head may be drawing too much current because of shorted turns; or because the coupling capacitor to that head is shorted or too large in value.

Frequency

To avoid noticeable beats between the bias frequency and the harmonics of the upper audio frequencies, the oscillator frequency should be at least four to five times the highest audio frequency that the tape machine is capable of recording. This dictates a bias frequency upward of 50,000 cycles for quality results; preferably, the frequency should be closer to 75,000 cycles.

On the other hand, the erase head tends to lose efficiency as oscillator frequency rises. There is increasing impedance to current flow because of the erase head's inductance. And the self-capacitance of the head's winding causes an increasing portion of the current to

be shunted to ground. Poor erasure can sometimes be traced to an excessively high oscillator frequency.

Between these conflicting requirements of the record head and of the erase head there is an optimum oscillator frequency, which is the one recommended by the manufacturer of the tape machine. To check the oscillator frequency, note the number of cycles on an oscilloscope connected to the record or erase head; then connect the scope to a signal generator and adjust the latter until the same number of cycles is obtained again. The dial reading on the signal generator indicates the frequency of the tape oscillator. Bias signals and generator signals may also be applied to vertical and horizontal scope inputs simultaneously and the frequency may be checked by means of the resulting Lissajous figures.

Drift

Oscillator frequency and output tend to change somewhat during warm-up, with a resulting change in the amount of bias current supplied to the record head, which in turn affects distortion and treble response. Drift of this kind may last 15 minutes or more. Therefore it is advisable to allow a generous warm-up period if checks or adjustments of bias current are to be made. By the same token, the operator of a tape machine is well advised to allow a warm-up period before making a tape recording.

The capacitor in the oscillator tank circuit is sometimes of the negative-coefficient type in order to minimize frequency drift. If it becomes necessary to replace such a capacitor, it is important to replace it with one of the same type. Or it is sometimes possible to correct a serious case of drift by substituting a negative-coefficient type for a standard capacitor.

Variation in the amount of bias current reaching the record head may be due to an erase head that overheats, thereby changing the load on the oscillator. Reducing the amount of oscillator current going to the erase head may be the cure, provided that the reduction does not materially affect the efficiency of the head.

Stray Pickup

The oscillator frequency is high enough to have the properties of a radio wave. Hence the oscillator frequency can be broadcast into unwanted places to work mischief. The same thing can happen through stray capacitance. Care must be taken with respect to the location and lead dress of oscillator components, as well as of circuits susceptible to stray pickup, chiefly the early tape amplifier stages. When service work is done on these circuits, the original lead dress should be carefully observed, assuming that all was well in the beginning.

Should appreciable stray pickup occur in the record-level circuit, a false indication of recording level will result, leading to an under-recorded tape and therefore too low a signal-to-noise ratio.

(Continued on page 116)

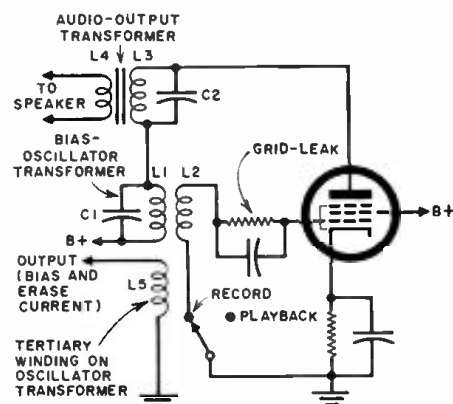

Fig. 3. Circuit showing use of audio-output tube as an oscillator in the record mode.

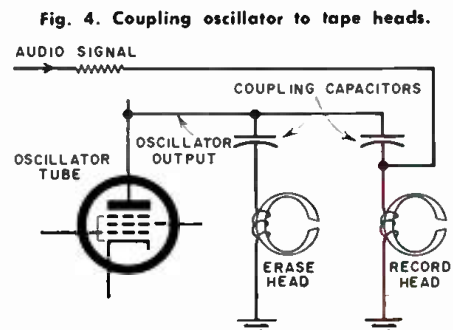

Fig. 4. Coupling oscillator to tape heads.



Senior Citizen Service

THE CALENDAR indicated it was the first of November; but summer, like an aging actress, could not resist taking one last curtain call before leaving the stage for good. The rays of the sun, in spite of the disadvantage of their inclination, still managed to drive the mercury up into the low 80's; and the doors of Mac's Service Shop stood wide open.

There was, though, something incongruous, almost oppressive, about the untimely warmth. As Barney, the Number Two Man of the service shop, put it when he returned tardily from his lunch hour, "It kinda feels as though Nature has a fever out there today."

"I was wondering if only I had that feeling!" Mac exclaimed with relief. "But don't try to distract me. How come you took such a long lunch hour?"

"Well," Barney said glibly, "you might say I did it for you. After lunch I called CQ on twenty meters with my ham rig and raised a fellow down in Ormond Beach, Florida. After we had exchanged the usual stuff about handles, QTH's, rigs, beam antennas, reception reports, and the weather, he asked what I did for a living. When I told him, he came right back and said he operated a small radio and TV shop down there. With that, naturally, we were off and running. This guy, Bud, is a pretty bright boy. He not only works at radio and TV service; he thinks about it, too, and he has some doggoned good ideas. In fact, he was coming up with so many interesting comments that I decided I could do us more good listening to him than I could pushing a solder-gun."

"I've got to hand it to you," Mac said, shaking his head admiringly. "Your Irish tongue always comes up with a good story. But you darned well better come up with some examples of those fine ideas you were allegedly drinking in; otherwise you can work a half hour late tonight."

"Fair enough," Barney agreed. "First off, I asked if the humid weather and the nearness of the ocean caused any peculiar service problems. He said he was confident they did. Coil windings in particular took a beating from the salt-

bearing moisture. Open windings and shorted turns were a very common occurrence in transformers, yoke windings, peaking coils, etc. Moisture also got into paper capacitors and caused them to become leaky and short-circuited more often than happened in drier inland localities. He was sure these troubles were unusual in their frequency because his experience revealed tubes *were not* the most common cause of set failure in his area. From his reading, he knew tube failures carried off the booby prize in most other places. I asked if the same conditions adversely affected printed circuits, and he said they didn't. Printed circuits seem to stand up just as well in the humid atmosphere as they do in drier climates."

"This is interesting, in an academic sort of way," Mac admitted; "but I've not heard anything yet of much use to us here in the Midwest."

"Be patient; I'm coming to the goodies," Barney retorted. "But don't forget you're always telling me a really good technician is interested in everything electronic, no matter if the information is of immediate benefit to him or not."

"I said it, it's true, and I withdraw my comment," Mac admitted cheerfully.

"Well, then," a mollified Barney continued, "Bud says the main thing that makes his service work different from that of most other service technicians is the average age of the people he serves. According to him, Ormond Beach is second only to the St. Pete area as a retirement center. A very high percentage of his customers are what Bud calls 'Senior Citizens.' Not once did he say 'old codgers,' 'old folks,' or anything like that. I very definitely got the feeling he not only respects these senior citizens but actually likes them."

"Is that so hard to believe?" Mac asked drily. "If a man doesn't like older folks, he must already despise his parents and is surely going to hate himself one of these days."

"Yeah! How about that? I never thought of it just that way," Barney admitted. "Anyway Bud says these retired

people insist on having the set repaired in the home. There are several reasons for this: first, they do not want to take a chance of having a large bill run up against them without their knowing it. When the work is being done right under their eyes, they feel they are in control of the situation. Secondly, most of them are a little lonely and really enjoy talking to a stranger. In fact, Bud says in working for senior citizens you must learn to work and to listen at the same time. At first it may seem a little difficult to be puzzling out the cause of a missing boost voltage while your ear is being bent with an account of how the customer's son was a real 'electrical' genius as a boy—you know: how he got KDKA loud and clear the very first time he adjusted the catwhisker on his homemade crystal set—but once you get used to it, it's not too hard."

"How about grandchildren?" Mac asked.

"They and pets come under the heading of sacred cows in the home of a senior citizen," Barney explained. "Quite often visiting grandchildren are encountered in the home, and rarely do the doting grandparents exercise as much control over them as parents would, but you must shoo them out of your tube caddy very gently. Be cross with them, and you might as well kick the dog or yell at the parakeet. In either case, your name is mud with that customer."

"Does he think these older people are more critical, more difficult to please?"

"In a way, yes. You see the TV set occupies a much more important place in their lives than it does in the lives of younger, more active people. That TV set often takes the place of an afternoon at the track, the country club dance, nine holes of golf, an evening of nightclubbing, or a day at the beach. In other words, it is their most important, if not their only, source of entertainment. Lavishing, as they do, so much attention on the set, these people are much more annoyed by imperfect reception than are more casual watchers. But by the same token they recognize and appreciate little improvements in performance that would escape people who only watch TV when they can't find something more exciting to do. There is satisfaction in working for a truly critical and appreciative customer—as we both know."

"Well, I know it, and I'm pleased and mildly surprised to learn you do. How does he find his senior citizens when it comes to paying for work? Did he mention that?"

"Yes, very emphatically. He says they are excellent pay. When the job is done, they have the money ready for you. There is none of this 'I'll-see-you-pay-day' jazz. He says senior citizens usually budget their money very closely. They have to. Most of them live on Social Security checks or other limited retirement income, and they have a horror of slipping into debt. They know how hard it is to get out when most of their income is already assigned to meeting current obligations."

(Continued on page 110)

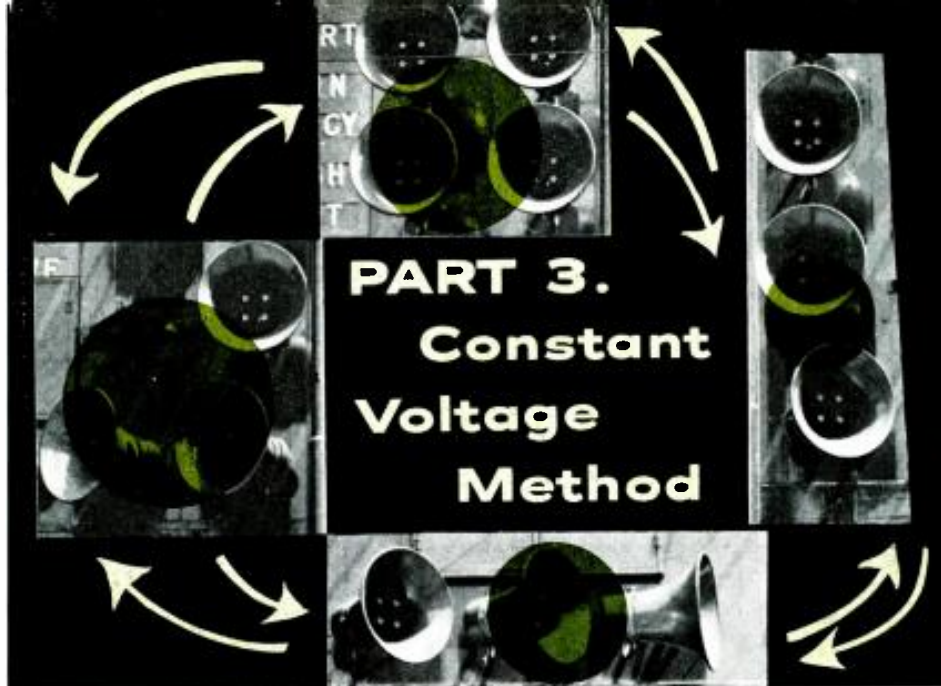

IMPEDANCE MATCHING IN PUBLIC-ADDRESS SYSTEMS

By **MORTIMER S. SUMBERG**, Director of Sales
Bogen-Presto Div., The Sieglar Corp.

Even inexperienced sound-system installers can match amplifier and speakers perfectly with speed and confidence—and by the use of only simple arithmetic.

IN THE preceding articles we reviewed the techniques for providing a proper impedance match between an amplifier and its loudspeaker load by means of a high-impedance transmission line. Although this method enjoys many advantages and makes possible the installation of complex sound systems, the advantages are frequently offset by certain inherent disadvantages. Not the least of these is the complex computations required for large sound systems. More important, however, is the high voltage developed across lines by amplifiers of even moderate output power.

As an example, a 100-watt amplifier will develop 224 volts when delivering rated power to a speaker load from a 500-ohm output tap. This is, obviously, of serious concern to those responsible for protecting personnel and property from both shock and fire hazards.

In order to comply with the recommendations of *Underwriters' Laboratories*, the Committee on Sound Systems of the EIA proposed that the industry utilize a system of impedance and voltage selection which is based on a recommended nominal distribution-line voltage at rated output. This system

was adopted years ago by most amplifier manufacturers and has been called the "constant-voltage" system.

Although specifically recommending 70 volts (more exactly 70.7 volts), the Committee suggested other possible voltage values including 25, 35, 50, 100, and 140 volts.

School and p.a. systems have used 25-volt and 70-volt outputs; 140-volt output has been used for higher power systems covering large areas. The constant-voltage system presents still another important advantage over the constant-impedance system (*i.e.*, employing high-impedance transmission lines) which can best be illustrated by the following example.

Assume a system is installed in a small factory using a 30-watt amplifier with its 500-ohm output tap connected to a number of line-matching transformers and speakers. After several years of service the factory is expanded to a size which requires 100 watts of power. If a 100-watt amplifier with a 500-ohm output tap is substituted for the 30-watt unit, connections to every existing transformer will have to be changed to a higher impedance tap on the primary (to provide the correct

loudspeaker driving level as previously). If this is not within the range of the transformer, it will have to be replaced. Needless to say, this involves considerable labor and component cost.

Had the constant-voltage system been employed in the first place, virtually no problem would exist when the sound system is expanded. A 30-watt amplifier with a 70-volt output tap would have been selected and constant-voltage transformers would have been installed at each loudspeaker to provide the proper level. Expansion of the system would then require only the replacement of the original 30-watt amplifier by a 100-watt amplifier, also having a 70-volt output tap. The same line-matching transformers would be used and there would be no need to make any change in the wiring to them. The 100-watt amplifier would drive a loudspeaker to 4 watts if the latter were originally connected to the 30-watt amplifier so as to draw 4 watts. Expansion of the system would entail the addition of loudspeakers, each with a constant-voltage transformer and a loudspeaker transmission line.

It will be noted that involved computations are completely eliminated by

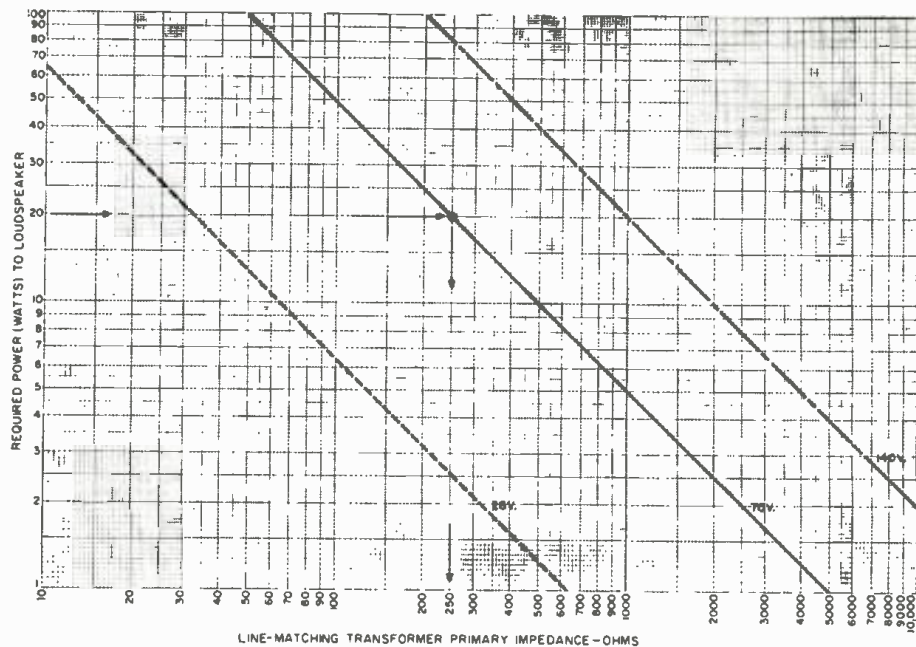
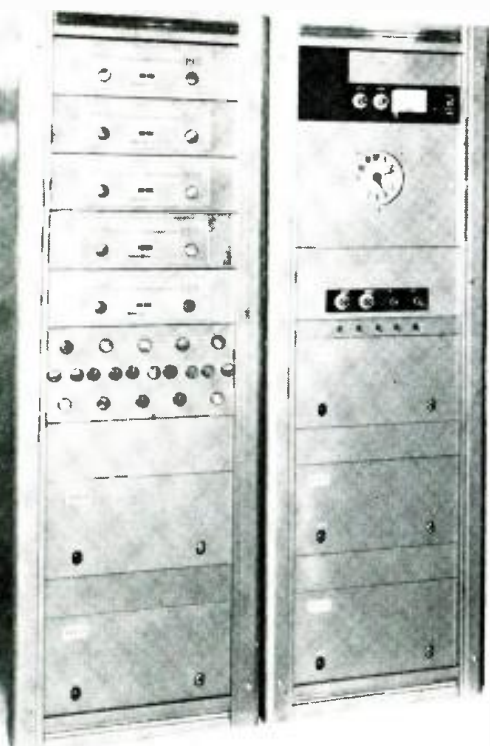

Fig. 16. Primary impedance versus loudspeaker power in constant-voltage systems.

Five-channel sound system that provides radio programs to guest rooms in modern hotel. The built-in clock turns the system on in the morning and off in the late evening.

This versatile four-channel sound system is installed in one of our large hospitals.

the use of the constant-voltage system since the loudspeaker-matching transformer is selected as simply as a light bulb—by wattage.

There is frequently some misunderstanding as to the exact meaning of the expression "constant voltage." Stated simply, this implies that the amplifier has a 70-volt output tap. It does not mean that the voltage at this tap will always be 70 volts. When the system is operating at levels well below the rated output of the amplifier, the voltage may be less. The 70 volts will appear across the output tap when the amplifier is terminated by its rated load impedance and is supplying power to the load equal to the rating of the amplifier power. In order to simplify still further the few calculations which are required to set up a constant-voltage system, it may be considered that the amplifier is always delivering its full output and that 70 volts appears across the output tap.

Constant-Voltage Xformer Matching

A typical impedance-matching problem was solved in Fig. 13 (Part 2) by means of a high-impedance transmission line and matching transformers. Computations of a nature which all but the most experienced sound men would consider involved were required to determine the kind of matching transformers to install, the proper primary taps to which connections would be made, and the most convenient amplifier output tap impedance from which the transmission line would originate.

To demonstrate the ease with which

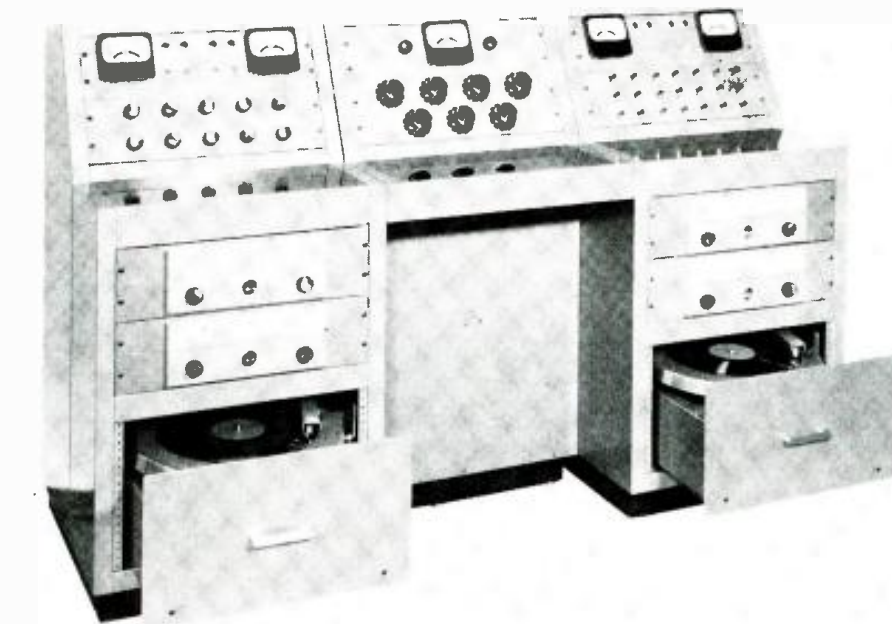

this same system can be set up by means of the constant-voltage method, the identical requirements will be assumed. To begin with, a total of five loudspeakers is needed and these will be driven to levels of 20, 10, 5, 4, and 1 watt respectively. Since the total power requirement is 40 watts, we select a 40-watt amplifier, as we did previously—but now we make certain that it provides a 70-volt output tap. A constant-voltage transformer with a 20-watt tap—designed to work with a 70-volt line—is installed at Loudspeaker No. 1, as shown in Fig. 17. When the amplifier is operating at its rated out-

put, 20 watts will be delivered to this speaker. For Loudspeaker No. 2 we install a similar transformer—but one with a 10-watt tap. The same simple procedure is followed with the three remaining loudspeakers, in each case selecting a transformer no larger in power-handling capacity than is required.

Returning to the system shown in Fig. 13, consider the problem of re-matching which would be posed if a new section were added to the building and the sound technician were called in to install two more trumpets—each operating at a 30-watt level. A 100-watt

amplifier would have to be substituted for the 40-watt amplifier, of course; but the job would not end there. Connections at each line-matching transformer would have to be changed so that the loudspeakers continued to draw the same amount of power. For example, a 1250-ohm primary tap would now be used on T_1 instead of the 500-ohm tap originally required. (If the 250-ohm output tap on the 100-watt amplifier were decided on, the 1250-ohm transformer tap would represent an upward mismatch of 5:1. This transformer would therefore draw one-fifth of the amplifier rated power—20 watts.) In addition to the recalculations and the labor of reconnecting the transmission line to the five matching transformers, it is quite probable that several of the latter will have to be replaced with others which provide the correct primary tap impedance. In other words, if T_1 did not also provide a 1250-ohm primary tap, it would have to be replaced by one which did.

The addition of two 30-watt trumpets to the constant-voltage system in Fig. 17 presents no problem at all and dramatically points out the remarkable ease with which otherwise complex matching problems are handled. The two trumpets will add 60 watts to the existing power requirements (40 watts) and bring the total to 100 watts. Accordingly, a 100-watt amplifier will replace the original 40-watt amplifier and the same transmission line—with connections at the five constant-voltage transformers remaining as before—will be terminated at the 70-volt output tap. In addition, a transmission line will be run to the two trumpets and tied to constant-voltage transformers which will provide 30-watt taps. In like manner, the sound system could be further expanded by installing additional loudspeakers, transformers, and a larger amplifier—without making any changes whatsoever in the original hook-up.

Matching with Available Transformers

It frequently happens that constant-impedance transformers (*i.e.*, primary taps marked in impedance values) must be used with a constant-voltage amplifier. This situation would arise if constant-voltage transformers were not immediately available or if the installer preferred to turn over his stock of the other type. To determine the correct primary impedance tap which will deliver the desired amount of power to the loudspeaker when the transformer is connected to a 70-volt transmission line, the following formula may be applied: *Correct transformer primary impedance tap = 5000/watts desired in loudspeaker.* The mathematician states this same relationship as follows: $Z = E^2/P$.

In the above formula, the factor 5000

represents the square of 70 volts (E^2). If a 140-volt output tap is used, as might be the case with a large amplifier, this factor (E^2) becomes 20,000. With the 25-volt output tap found on many school console amplifiers, the factor 625 applies. For those who prefer to work with graphs, Fig. 16 is offered.

To illustrate the use of the graph, let us suppose that while installing the system of Fig. 17 it is discovered that a suitable constant-voltage transformer (T_1) for Loudspeaker No. 1 is unavailable but that several constant-impedance transformers are at hand. Our problem is to determine the primary impedance value of a transformer which will deliver 20 watts to the loudspeaker. Since a 70-volt output tap is used, the

formula is applied in the following way:

$$Z = E^2/P = 5000/20 = 250 \text{ ohms}$$

Obviously, the transformer must not only provide a 250-ohm primary tap, it must also have a secondary tap to match the voice-coil impedance—and be rated to pass 20 watts of power. Referring to Fig. 16, we can check the above impedance value by finding the point on the solid line (for 70-volt systems) which is intersected by the horizontal line representing 20 watts. Dropping this point vertically, we discover that it corresponds to 250 ohms.

The above formula and graph may be used in the same manner to ascertain the impedance value of an amplifier's constant-voltage output tap. The impedance of the 70-volt tap on a 20-watt

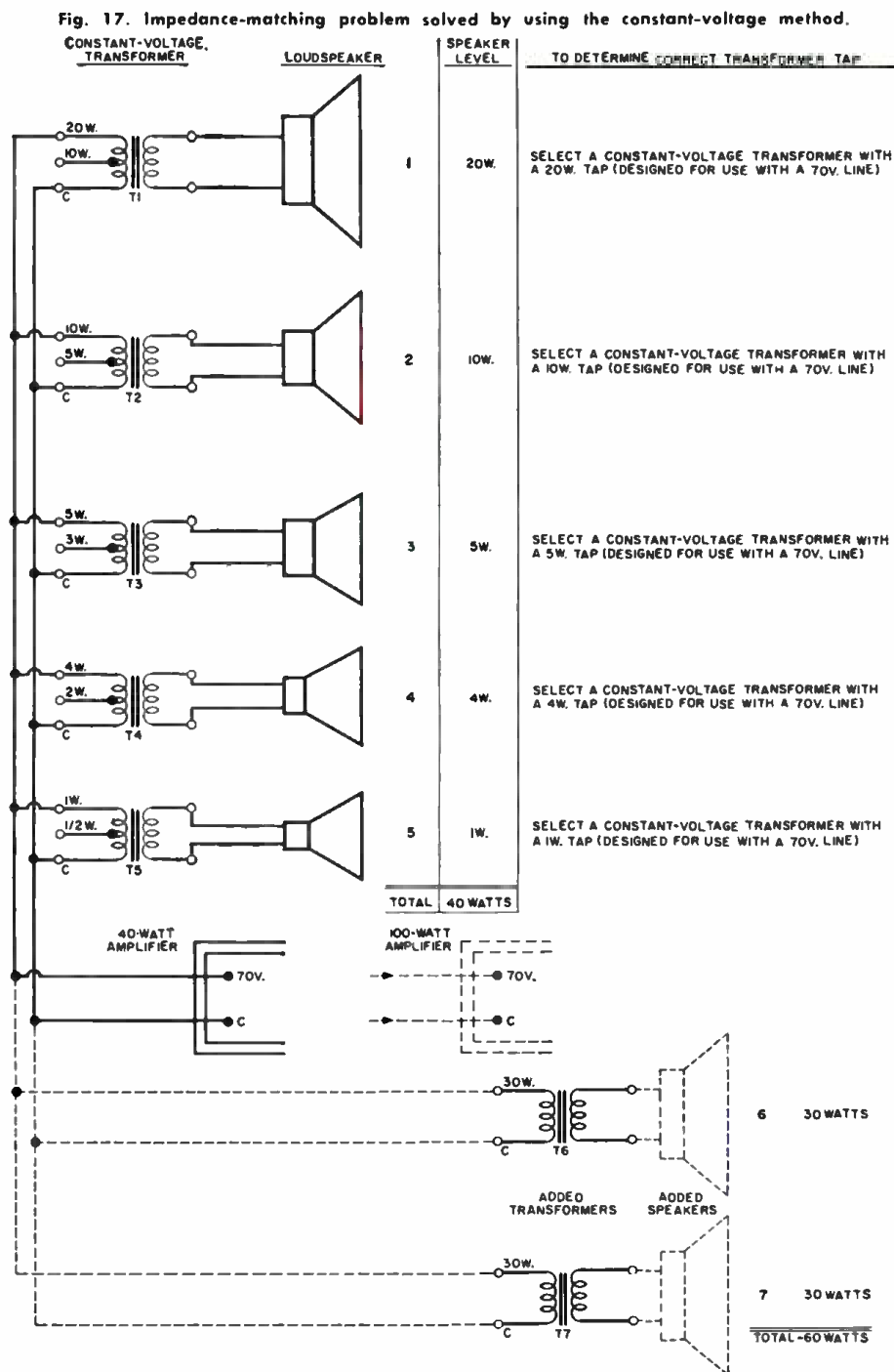

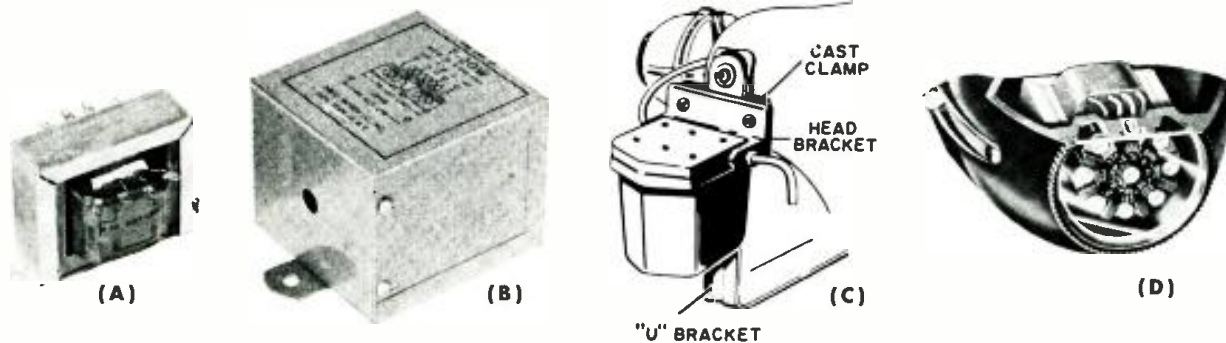

Fig. 18. Typical line-matching transformers. (A) Standard type. (B) Weatherproof type. (C) Weatherproof transformer in multipurpose housing, shown here mounted on speaker. (D) Transformer built into driver unit of speaker trumpet.

amplifier is equal to 250 ohms. Similarly, the 140-volt output tap on a 100-watt amplifier is equivalent to 200 ohms (the dot-dash line in the graph is used in this instance).

Line-Matching Transformers

Line-matching transformers, of the constant-voltage and constant-impedance types, are produced in a wide variety of designs so that selection of a specific component presents little difficulty. When purchasing a line-matching transformer, the following considerations have to be examined: (1) required primary impedance or voltage tap; (2) required secondary-impedance tap to match loudspeaker voice coil; (3) power-handling capability; (4) required frequency response. (Costly transformers with the ability to pass a wide range of frequencies are available if a wide-range loudspeaker is being used to reproduce a wide-range signal. For most commercial and industrial sound installations, a frequency response of 100 to 7000 cps is entirely adequate and permits the use of moderately priced matching transformers.); (5) location of transformer and mounting requirements. (Transformers are available for indoor use and, at somewhat higher prices, for outdoor use. Electrically these transformers are identical and the outdoor type may be used if cost is no object. The indoor transformer will not stand up well, however, if it is exposed outdoors to the effects of salt spray, rain, and extremes of temperature for long periods.)

Fig. 18 shows several typical line-matching transformers which are intended for use in a wide range of applications. The two audio transformers in Figs. 18A and 18B are electrically identical. The enclosed component is an outdoor type which usually is located adjacent to a speaker or trumpet, whereas the open-frame indoor transformer is designed to attach directly to a cone loudspeaker frame.

The construction of the weatherproof transformer in Fig. 18C permits an out-

door reflex trumpet to be attached directly to the transformer housing, thereby eliminating the necessity for having to attach the trumpet and transformer separately to a wall or pole. In Fig. 18D, we have a unique arrangement whereby a line-matching transformer is built into a driver unit housing which attaches to a reflex trumpet. The transformer is rated at 50 watts, passes wide-frequency audio signals and affords a number of power taps (for a 70-volt line) and impedance taps (to match a

high-impedance transmission line). In installations where reflex trumpets are mounted at the top of poles or at other relatively inaccessible points, the use of this combination eliminates the need for mounting the trumpet and line-matching transformer separately—a time consuming and possibly dangerous job which must be handled in the shortest possible time.

Most of the line-matching transformers are wound with solder terminal lugs. Connections to these should be made with considerable care since the application of excessive heat from the soldering iron may cause the connecting lead between the lug and the transformer coil to open. Similar care should be exercised when soldering the short leads between the transformer secondary and the loudspeaker voice coil.

Control of Speaker Levels

Although the relative amounts of power delivered to various loudspeakers can be established by selection of the matching transformers or by the arrangement of voice coils, it is sometimes necessary to vary the sound level from one or several speakers in the system without influencing the operation of the others. There are several ways of accomplishing this.

The simplest technique consists of wiring the available primary taps of the line-matching transformer to a selector switch, as shown in Fig. 19. The selection of power taps in a 2:1 ratio is reasonable since this represents approximately the smallest important change in sound level that can be discerned by the average listener.

Other methods of loudspeaker-level control employ the selection or change of resistance networks to vary the amount of power loss between the amplifier and loudspeaker. The most common of these is the continuously variable "L" pad shown in Fig. 20. In Fig. 20A, an 8-ohm "L" pad is employed in the transformer secondary circuit whereas in Fig. 20B, a 500-ohm "L" pad

(Continued on page 111)

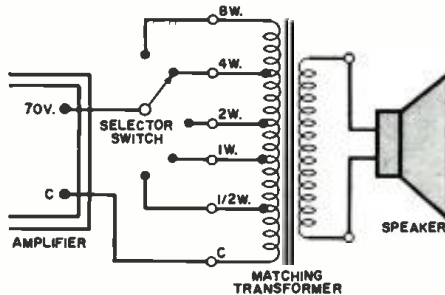
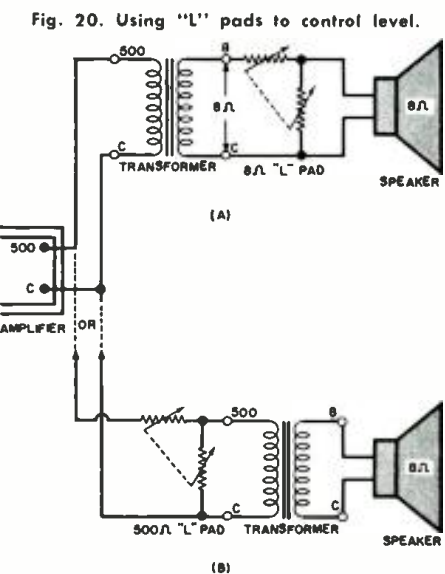

Fig. 19. Power-tap selector controls level.



"L" PAD DUAL GANGED VARIABLE ELEMENTS
PADS ARE AVAILABLE IN THE FOLLOWING IMPEDANCE VALUES (Ω)

4	200	3000
8	250	4000
16	500	5000
50	1000	
100	2000	

(c)

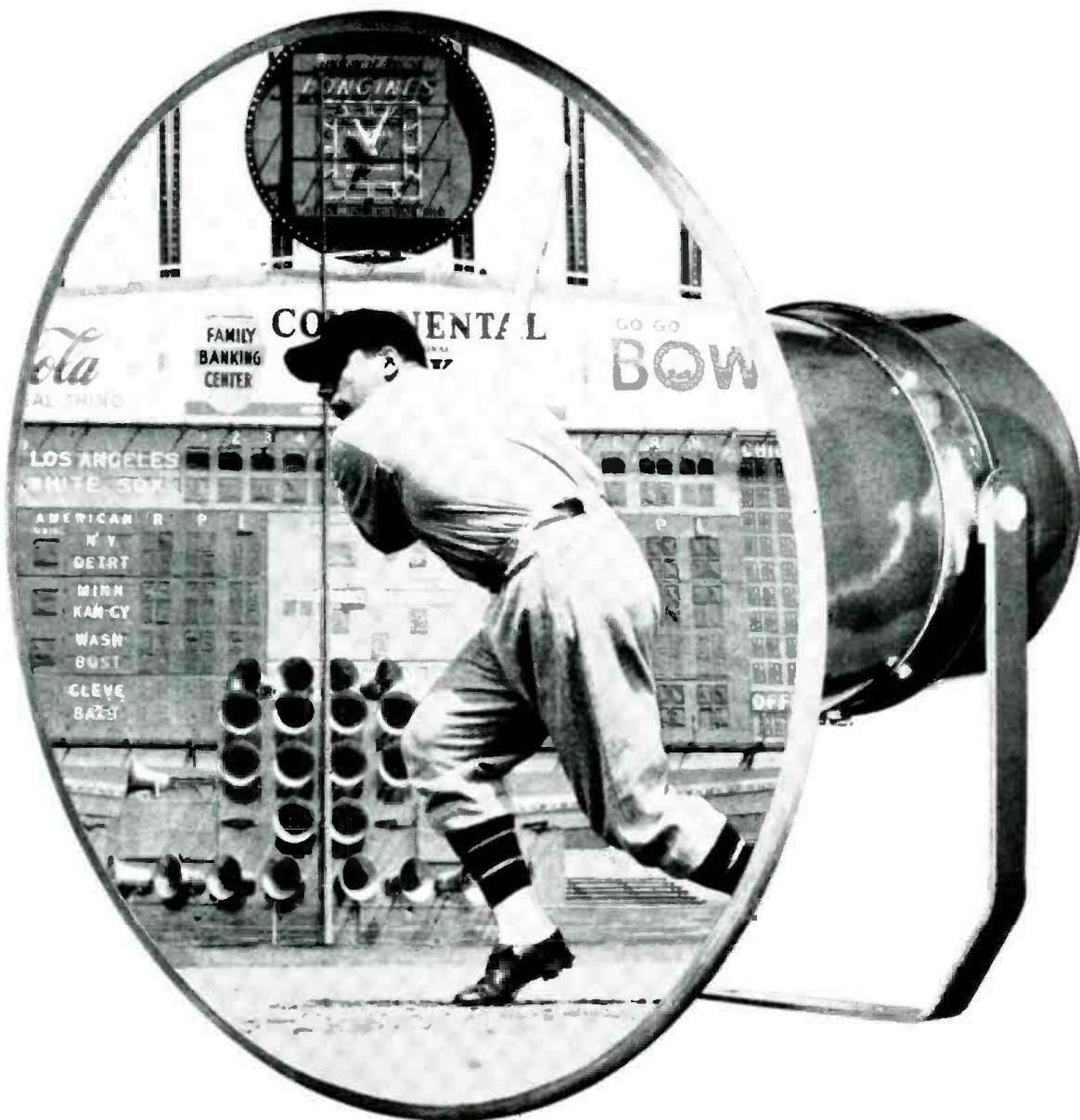

play ball!

Heard better at Comiskey Park with University 4A4 P. A. loudspeakers*

And why was University chosen to be the voice of the Chicago White Sox explosive scoreboard? For the same reasons that have made University Loudspeakers the choice of more P. A. users than any other brand in the world: proven dependability, greater value, superior performance.

University 4A4 Superpower Projectors are excellent examples of University quality. During World War II, the military needed an extremely compact, lightweight, high power unit capable of penetrating the terrific noise levels found under combat conditions. The first 4A4 fulfilled exacting military specifications—to perfection. As a result of University's ever-expanding R & D program, today's 100-watt Model 4A4—and its big brother, the B-12P—are actually far superior. You will find them at leading sports stadiums, race tracks, airports . . . in church towers for the transmission of chimes and organ music . . . and in many civil defense installations. They are simple to install, fool-proof in operation, and immune to weather conditions of every kind. Perhaps they could be the answer to your P. A. needs?

But whether you need superpower projectors, top quality drivers, trumpets, paging or weather-proof high fidelity speakers . . . portable super-hailers, explosion-proof or underwater speakers—check University first. Most P. A. users do.

Write today for complete 4A4 specifications and P. A. catalog.
Desk S-11, University Loudspeakers, Inc., White Plains, N. Y.

*Integrated in a Dukane Sound System, installed by Rich Sound Engineers, Chicago, Illinois.



A Division of Ling-Temco-Vought, Inc.

CITIZEN BAND

CLASS "D"

CRYSTALS

All 22 Frequencies in Stock



3rd overtone. .005% tolerance—to meet all FCC requirements. Hermetically sealed HC6/U holders, 1/2" pin spacing—.050 pins. (.093 pins available, add 15c per crystal.) **2⁹⁵** each

We can supply matched sets for all CB units at \$5.90 per set. Specify transmitting frequency and make and model number of equipment.

Following frequencies in stock (frequencies listed in megacycles): 26.965, 26.975, 26.985, 27.005, 27.015, 27.025, 27.035, 27.055, 27.065, 27.075, 27.085, 27.105, 27.115, 27.125, 27.135, 27.155, 27.165, 27.175, 27.185, 27.205, 27.215, 27.225.

RADIO CONTROL CRYSTALS in HC6/U holders in stock for immediate delivery—all channels. Pin diameter .050, **\$2.95** ea. .093 pin spacing, add

15c. SEALED OVERTONE CRYSTALS Supplied in metal HC6/U holders.

Pin spacing .486, diameter .050
15 to 30 MC .005 tolerance **\$3.85** ea.
30 to 45 MC .005 tolerance **\$4.10** ea.
45 to 60 MC .005 tolerance **\$4.30** ea.

QUARTZ CRYSTALS

for every service

All crystals made from Grade "A" imported quartz—ground and etched to exact frequencies. Unconditionally guaranteed! Supplied in:
FT-243 holders pin spacing 1/2" pin diameter .093
CR1A/AR holders pin spacing 1/2" pin diameter .125
MC-7 holders pin spacing 3/4" pin diameter .125
FT-171 holder pin spacing 3/4" banana pins

MADE TO ORDER CRYSTALS

1001 KC to 2600 KC: .005% tolerance **\$4.50** ea
2601 KC to 9000 KC: .005% tolerance **\$2.50** ea
9001 KC to 11,000 KC: .005% tol. **\$3.00** ea
Specify holder wanted

ANY AMATEUR, NOVICE, TECHNICIAN BAND CRYSTALS

80 meters 3701-3749 KC .01% tolerance
40 meters 7152-7198 KC
15 meters 7034-7082 KC
6 meters 8335-8650 KC within 1 KC) **1.50** ea.

MARINE FREQUENCY CRYSTALS—All marine frequencies from 2000-3200 KC .005 tolerance **\$2.50** ea. (supplied in either FT-243, MC-7 or FT-171 holders)

STOCK CRYSTALS in FT-243 holders from 5675 KC to 8650 KC in 25 KC steps 75c each or 3 for **\$2.00**
FT-241 Lattice Crystals in all frequencies from 370 KC to 540 KC (all except 455 KC and 500 KC) 50c ea. Pin spacing 1/2" Pin diameter .093

Matched pairs—15 cycles **\$2.50** per pair
200 KC Crystals **\$2.00** ea.
455 KC Crystals **\$1.25** ea.
500 KC Crystals **\$1.25** ea.
100 KC Frequency Standard Crystals in HC6/U holders **\$4.50** ea.

Socket for FT-243 crystal 15c ea.
Dual socket for FT-243 crystals 15c ea.
Sockets for MC-7 and FT-171 crystals 25c ea.
Ceramic socket for HC6/U crystals 20c ea.

FREE! Write for Catalog #961 with oscillator circuits.

ASK YOUR PARTS DEALER FOR TEXAS CRYSTALS

See big red display... if he doesn't stock them, send us his name and order direct from our factory.

NOW! Engineering samples and small quantities for prototypes now made either at Chicago or at Ft. Myers Plant. 24 Hour Service!
IN CHICAGO, Phone Gladstone 3-3555

ORDER FROM OUR NEW FLORIDA PLANT

Use coupon below for 1st Class shipment
TEXAS CRYSTALS
Dept. R-91, 1000 Crystal Drive, Fort Myers, Fla.
For Fastest Service, Phone WE 6-2100

FILL OUT AND ATTACH THIS COUPON TO YOUR ORDER FOR SHIPMENT VIA 1ST CLASS MAIL AT NO EXTRA COST!

NAME.....

ADDRESS.....

CITY.....ZONE.....STATE.....

TERMS: All items subject to prior sale and change of price without notice. All crystal orders must be accompanied by check, cash or M. O. with **PAYMENT IN FULL.** Dept. R-91

New Motorola Color CRT

This rectangular picture tube, lighter and shorter, provides more viewing area and is easier to make.

ANNOUNCEMENT of Motorola's version of the three-gun shadow-mask, color picture tube (see our October issue, page 100) has aroused considerable industry interest. The manufacturer has since released additional details about the display device.

Requiring the same 25,000 volts for its second anode that is used by existing types, it makes no additional demands on the high-voltage circuit. Aside from this, deflection angle of the 23-inch rectangular tube is 92 degrees as compared to 70 degrees for the 21-inch round type. This difference largely accounts for the significant reduction in CRT depth: from 25.25 inches to 20.25. While image size is about the same, restoring information lost in the missing corners of the round tube adds 22 square inches of viewing area to the complete picture: an increase from 261 to 283 square inches. Using less glass, a costly ingredient, the squared-off design weighs only 30 pounds as compared to 33.5 for types in current use.

Convergence problems become considerably more stringent, due both to the increased scan angle and the need to maintain three-gun tracking in the extreme corners added to the rectangular version. This can be met by elaborating convergence circuitry—indeed, has been met in the working receiver using the new CRT that was put on display by Motorola. The associated deflection yoke is also a new design. The chassis employed was adapted from that for a color set the manufacturer marketed some years ago.

Significance of the development, as this manufacturer sees it, lies in its belief that receiver appearance rather than price has been the chief impediment to widespread acceptance of color TV. With consumers accustomed to the trim styling and compactness of modern monochrome sets, made possible by wide-angle, squared-off picture tubes, they balk at the "bulky, boxy look" of current models, like the table receiver to the right in the accompanying photograph. Extra height is needed to accommodate the wasted, masked-off portion of the CRT, and extra depth is needed for the front-to-back length.

By contrast, note the trim console in which the rectangular version is housed to the left. To make a point, the latter cabinet is one used for a recent, popular, monochrome set in the Motorola line. Samples of the new and old tubes, shown atop their housings, suggest the depth difference. The cup for the base of the CRT that protrudes from the rear of the console, of course, is deeper than it would be for a black-and-white tube; but the flat appearance that is expected today has not been changed because depth of the cabinet itself is unaltered.

With no facilities for CRT production and no plans to acquire them, Motorola has produced working models in cooperation with an established tube manufacturer. Since fabrication is based on techniques for monochrome devices, largely obviating the heavy investment for all-new equipment needed to make round color tubes, it is hoped several CRT makers will show interest. ▲

The new (left) and old (right) picture tubes, together with associated cabinets.

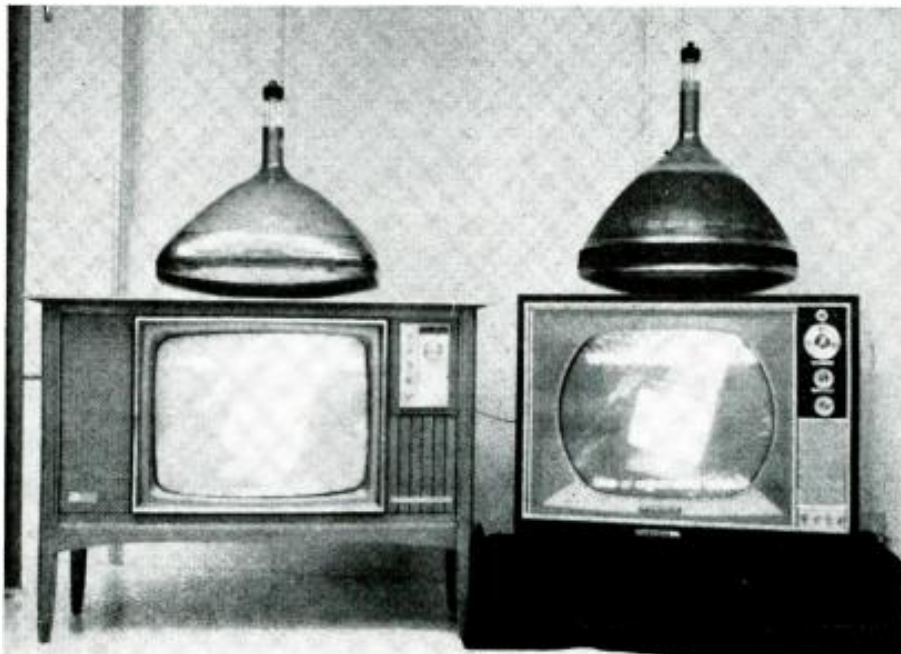

THE A. E. S. *Gigolo*

ONE OF THE MOST SOUGHT AFTER PRODUCTS IN THE HIGH FIDELITY INDUSTRY

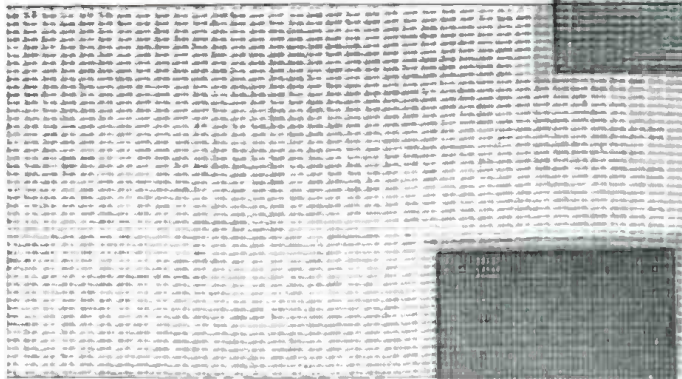
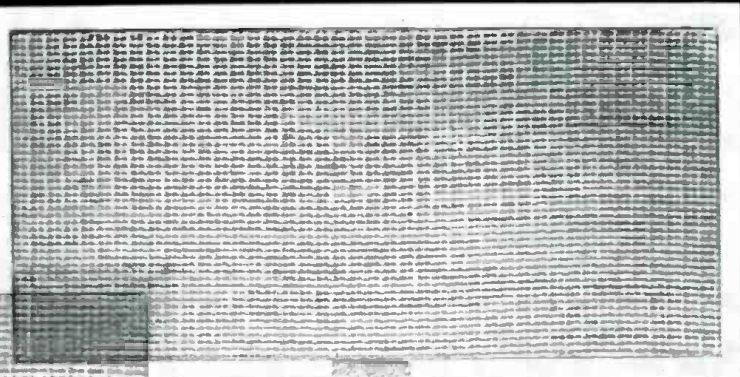
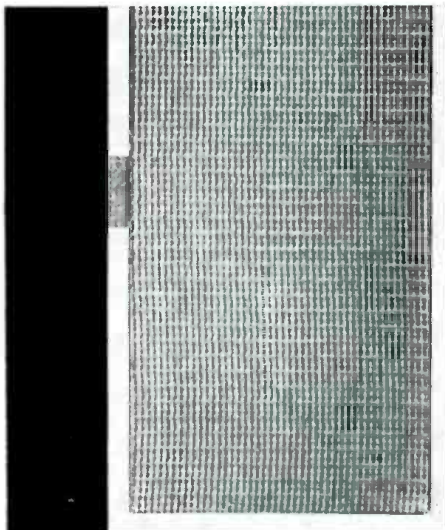

At our present rate of sales and production, A. E. S. will sell nearly 100,000 Gigolos this year.

Imagine, now you can own a speaker with this quality for only \$15.00.

TRY IT — WE GUARANTEE IT
100,000 PEOPLE CANNOT BE WRONG

DESCRIPTION:

The Gigolo is constructed with a resonant resistant all wood product of at least 3/4" thickness throughout. Its outside dimensions are 24" long, 12" high, 9 1/2" deep. The heavy construction and the fine workmanship suggest a value far exceeding its low, low price. All units sold on 100% MONEY BACK GUARANTEE.

Price \$15.00. Unfinished only.
F.O.B. Factory

SPECIFICATIONS:

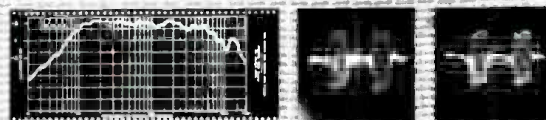

Frequency response	500	Tone bursts	3500'
Maximum frequency response			19-21000 cps
Frequency response	±8 db		5-18000 cps
Harmonic distortion		less than 3%	70-21 kc
Impedance curve	within ±0	200% of 8 ohms	
			20-20000 cps
Flux density			11000 gauss
Frequency response curve run at continuous 10 watts.			

Power handling capacity, the Gigolo may be used with small economy amplifiers of very low wattage, as well as with the highest power component amplifier with satisfactory results.

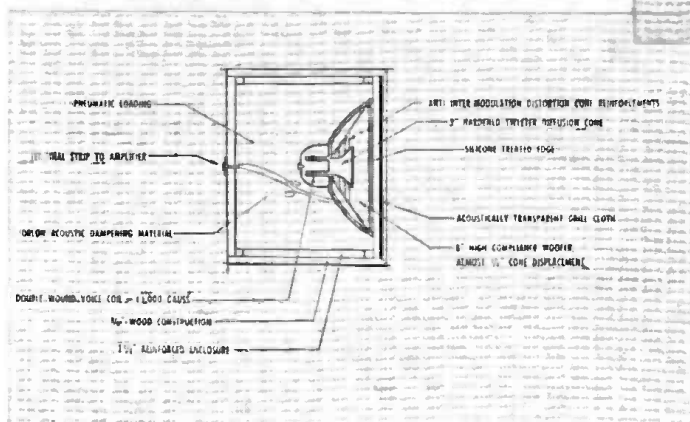

A.E.S., Inc.
3338 Payne Avenue, Cleveland, Ohio

Gentlemen please ship _____ GIGOLOS.

I understand these units are guaranteed and if I am not satisfied I may return for a full refund of sales price, \$15.00 each.

Name _____

Address _____

City and State _____

Enclosed find check _____ money order _____

Looking
for
better TV
perform-
ance
in these
areas?

HOME TV

ETV

CCTV

MATV

CATV

BLONDER

HOME TV
AND UHF

Blonder-Tongue offers the most complete line of products to improve home TV reception—VHF or UHF. Examine Blonder-Tongue UHF converters—the model 99R for prime areas; the model BTU-2S for weak signal areas—and the BT-70 for translator and MPATI area conversions. They're the biggest selling UHF converters in America today because for 10 years they have proved themselves best in action in every UHF area. Consider the transistor home TV signal booster — the AB-4 (mast-mounted) and IT-3 (indoor use). Both are complete home TV amplifier and distribution systems supplying signal to as many as 4 TV/FM sets. Both represent unique engineering achievements from the industry's most experienced manufacturer in transistor RF circuit design. 6 different home boosters—including the only UHF booster plus a host of TV and antenna couplers round out the home TV line.



ETV

Only Blonder-Tongue offers a complete line for ETV in which each unit is matched and integrated to bring out the best performance of the other units in the system. With B-T products a school can be equipped to receive educational programs from ground TV stations, from strato-vision, or programs originating from a closed circuit TV camera. Important products include: Lock-Jax, an obsolescence-proof video/RF system that permits any room to be used as a TV studio or TV outlet; a variety of amplifiers, converters, splitters, tapoffs to provide multi-classroom reception.

CCTV

For CCTV there are: Port-A-Studios, portable studio consoles capable of originating complete TV channels; Film Chains to convert 16mm film into video or RF signals; manual and remote controlled transistor TV cameras; direct-view or projection monitors; complete video distribution equipment and accessories to provide flexibility, ease of operation.



TONGUE

MATV

6 broadband amplifiers (transistor and tubed); 11 single channel amplifiers—6 crystal-controlled converters and the most sensibly engineered line of accessories (tapoffs; matching transformers; splitters; traps; filters; mixers etc.)—the most complete product line available today. Each product is engineered to do a specific job best—each matched and integrated to bring out the best in each other. With Blonder-Tongue equipment, there are no compromises — no design to cover the waterfront! Very simply, you can select the amplifier, converter or accessory that's best suited to the job, paying for only the performance features the job requires. Blonder-Tongue master TV products are the heart of installations in the nation's leading motels, hotels, apartments, schools, etc.



CATV

Here's where Blonder-Tongue and its Canadian division, Benco, team up to provide a wide range of products—matched and integrated to bring the finest reception to entire communities via a system that is initially low in cost and that provides long-term maintenance—free performance. The Blonder-Tongue MCSc single-channel amplifier for VHF or FM and the Benco T-AMP-2, a cable powered transistor community system are typical products in the line.

* A word about Blonder-Tongue Services—our application engineering department offers *Free System Layout*. Field engineering is available at minimum cost.



Rely
on the
world's
only
matched &
integrated
line

BLONDER TONGUE

Available through distributors. Write for complete short-form catalog. Blonder-Tongue, 9 Alling St., Newark, N. J. Canadian Div.: Benco Television Associates, Toronto, Ont. Export: Morhan Export Corp., New York 13.

FREE CAREER BOOKLET

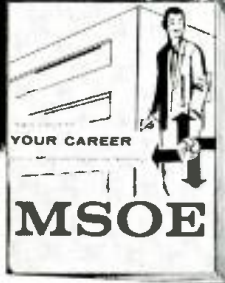

to guide you to a successful future in

ELECTRONICS RADIO-TV COMPUTERS ELECTRICAL ENGINEERING

This interesting pictorial booklet tells you how you can prepare for a dynamic career as an Electrical Engineer or Engineering Technician in many exciting, growing fields:

**MISSILES • RADAR • RESEARCH
ELECTRICAL POWER • ROCKETRY
AUTOMATION • AVIONICS
SALES • DEVELOPMENT**

Get all the facts about job opportunities, length of study, courses offered, degrees you can earn, scholarships, part-time work — as well as pictures of the Milwaukee School of Engineering's educational and recreational facilities. No obligation — it's yours free.

MILWAUKEE SCHOOL OF ENGINEERING

MAIL COUPON TODAY!

MILWAUKEE SCHOOL OF ENGINEERING
Dept. EW-1161, 1025 N Milwaukee St. MS-113
Milwaukee, Wisconsin

Please send FREE "Your Career" booklet
I'm interested in Electronics Radio-TV
 Computers Electrical Engineering
 Mechanical Engineering
(PLEASE PRINT)

Name..... Age.....

Address.....

City.....Zone.....State.....

I'm eligible for veterans education benefits.

Discharge date.....

Advances in Medical Electronics

(Continued from page 36)

of communications techniques and various computer applications are now under study. It is a logical step to combine some of the electronic instrumentation methods already described with a data processing and computing system. For example, several electronic respiration analyzers could be connected to a central station in the hospital and indicate, remotely and instantaneously, how each patient is doing. An automatic alarm could be added to alert the attending nurse or doctor when a patient's condition deteriorates.

A computer could also be used to find the right diagnosis after the results of a series of tests and detailed patient characteristics have been entered. Statistical probability would be computed to indicate the most likely disease and, possibly, the best treatment based on comprehensive statistics gathered over a period of years and covering a large number of cases.

A more immediate application of TV scanning techniques, combined with data processing, is the "Cytoanalyzer" shown in Fig. 10, which automatically inspects microscopic slides of cervical smears for cancer. Developed by *Airborne Instruments Labs.* in conjunction with the Sloan-Kettering Institute, this unit eliminates the time-consuming and painstaking microscopic examination of large numbers of slides involved in routine cancer checks. The "Cytoanalyzer" measures the light absorption of each of about 10,000 cell nuclei per slide and enters the result on IBM punch cards. This method provides effective screening of large numbers of definitely negative slides and will bring out any suspicious samples for further detailed study.

While we cannot visualize the day when a patient will simply drop a coin in the slot and let an automatic medical computer give him a complete physical examination, provide a punched card diagnosis, hand out a prescription and neatly wrapped medicine bottle, we can see that computers will play an ever-increasing role in the practice of medicine. Just as in industry the computing device can assume the burden of routine statistics, medical administration, and general medical data processing to remove such details from the overworked doctor's shoulders and leave him free for more important tasks.

Exploring the Brain

You have probably read of the electroencephalograph which measures brain waves. This is a very useful instrument which, together with mapping and recording devices, can help locate tumors

NOW MULTIPLEX!

What do you need to get stereo on your present FM radio? How much will it cost? Which manufacturers produce FM stereo adapters and tuners? Find the answers in the



IN ADDITION...

The 1962 edition of the STEREO/HI-FI DIRECTORY is the complete buyers' guide to over 1300 component listings! Get specifications, prices, and performance data on:

- tape recorders and players
- speakers and cabinets
- A.M. FM tuners and receivers
- phonograph equipment
- accessories—cabinets, antennas, microphones

Now on sale—pick up your copy at your favorite newsstand or electronics parts store. Or mail the coupon below and a copy will be sent you. Only \$1.00.

Ziff-Davis Book Division
One Park Avenue
New York 16, N. Y.

Please send me a copy of the 1962 STEREO AND HI-FI DIRECTORY. I enclose \$1.00, the cost of the DIRECTORY, plus 10¢ to cover mailing and handling charges. (Canada and foreign, \$1.25 plus 10¢ postage.)

NAME.....

ADDRESS.....

CITY.....ZONE.....STATE.....

Department EF 2032

and other brain troubles. To probe still more deeply into the mysteries of the human brain, researchers now use micro-miniature electrodes to stimulate selected sections of the brain and record electrical activity of brain tissues.

The Mayo Clinic in Rochester, Minn. has done extensive research in this area and has found, for example, that electrode currents vary with the patient's smelling activities, with his body movements, eye actions, and his state of "awakeness," with different sections of the brain reacting to various stimuli. Carried out on patients suffering from epilepsy, schizophrenia, and other mental disturbances, this method has yielded invaluable data not only about the particular patient, but about brain functions in general.

Conclusion

In all fairness to the many devoted researchers in the field of bio-medicine we must point out that many teams, at different hospitals and laboratories, often work on the same problem, interchanging their knowledge at conventions and through technical publications. We would have to devote an entire article to names were we to give due credit to all those working on the particular projects mentioned here.

In order to develop any of the electronic bio-medical techniques described, research teams are often made up of specialists not only in medicine and biology but in optics, electronics, and similar fields. Because research institutes always operate on limited budgets, electronics people have, in some instances, volunteered their services on a part-time basis. We know, for example, of a group of engineers in Buffalo who have selflessly given of their spare time to design and build the specialized electronic equipment needed in an ultra-sensitive blood-flow meter. This device is able to measure blood flow in unopened arteries which are part of the heart's own blood supply. The 1- μ v. sensitivity of this device has made possible new studies of hardening of the arteries and certain heart defects.

Another group of engineers, all working for Illinois Bell Telephone Company, teamed up with a local hospital to design a transistorized, self-contained electronic cardiometer. This instrument can be carried by the patient under his clothing for a long as 72 hours and records accurately the number of heart beats.

The continued devotion of dedicated researchers and the application of the latest techniques of electronics to bio-medical problems holds out the promise of continued progress in this field. As we gain a greater understanding of the life processes and are better able to deal with the many ills to which the body is heir, life expectancy should increase and better health result. ▲

November, 1961



For the 1 family in 17 that demands Recording-Studio Quality from their tape recorder...

People actively engaged in the musical arts—amateurs as well as professionals—are finding the Continental '400' the practical solution to the problems of complexity and cost posed by professional recording equipment.

Guild-crafted by Philips of the Netherlands—styled by the Continental's top designers, the Continental '400' is simple to use yet amazingly versatile. The 3-speed, 4-track '400' offers professional quality recording and playback, both stereo and mono, at moderate cost for home use.



the *Norelco*[®]
CONTINENTAL '400'
world's most advanced,
most versatile, portable
stereo/mono tape recorder

Completely self-contained with dual recording and playback preamps, dual power amplifiers, stereo-dynamic microphone and two stereo-matched wide-range Norelco loudspeakers.

VERSATILITY: 4-track stereo recording and playback, as well as 4-track monophonic recording and playback, at any of its 3 speeds.

FREQUENCY RESPONSE: at 7½ ips, 50-18,000 cps; at 3¾ ips, 50-14,000 cps; at 1½ ips, 60-7000 cps.

PROFESSIONAL EXTRAS (at no extra cost): mixing, monitoring and sound-on-sound facilities.

SIGNAL-TO-NOISE-RATIO: 48 db or better.

WOW AND FLUTTER: less than .15% at 7½ ips.

CROSSTALK: 55 db. **HEAD GAP:** .00012".

NORTH AMERICAN PHILIPS COMPANY, INC. High Fidelity Products Division, 230 Ouffy Avenue, Hicksville, L.I., N.Y.



Plus EVERY NEW SUPPLEMENT FOR NEXT 12 MONTHS!

Our bigger, better catalogs offer the widest line of electronic parts and equipment in the world! Stereo, Hi-Fi, Ham Radio, Test Equipment, Pre-Recorded Tapes, Tape Recorders, Records, Parts—plus 30 pages of Kits! 340 pages—over 100,000 items! No Money Down credit terms. Every item backed by a money-back guarantee of satisfaction.

RADIO SHACK Corp. Boston, Mass.

RADIO SHACK Corp
730 Commonwealth Ave., Boston 17, Mass.

Send Radio Shack's famous electronics catalogs for one year—FREE and POSTPAID.

Your Name _____ 6116

Your State _____

City and Zone _____

For a Friend _____ 61161

Address _____

City and Zone _____ State _____

Now... Tomorrow and for years to come!

**Sonar
CITIZENS BAND
RADIO**

- 8 Channels, crystal controlled transmitter and receiver
- Tunable receiver for 22 channels
- Transmitter 100% Class B modulated
- Adjustable squelch
- Automatic noise limiter
- R. F. Power indicator
- 1 Year guarantee
- Easy to install. Ideal for home, boat, car or business. Weighs only 9 lbs. . . 4³/₄ x 9¹/₂ x 11¹/₄
- FCC Type accepted*

with 1 pair of crystals, microphone and power cables

\$179⁵⁰



**Sonar
RADIO CORPORATION**
3050 West 21st Street • Brooklyn 24, N. Y.
Please send me complete information on Model "E" CB Radio.

NAME _____
ADDRESS _____
CITY _____
STATE _____

with 1 pair of crystals, microphone and power cables

TAPE RECORDERS



**HI-FI COMPONENTS
SLEEP LEARN KITS**

UNUSUAL VALUES FREE 1962 Catalog DRESSNER 1523RA Jericho Tpke. New Hyde Park, N.Y.

MERITAPE. Low cost. High quality recording tape, in boxes or cans.



Save 30% on 4-track Stereo Music on Tape!
Empty 3 in. plastic reels 7¢ ea.

**BARGAIN PRICES!
SEND FOR OUR FREE**

Tape Recorder/Blank/Pre-recorded Tape Catalog
SAXITONE TAPE SALES
(Div. of Commissioned Electronics Co., Inc.)
1776 Columbia Road Washington, D.C.

**IF YOU BELIEVE THAT ALL RECORDING TAPES ARE THE SAME ...
READ THESE FACTS ABOUT SOUNDCRAFT TAPES!**



IT'S SOUNDCRAFT

IN THE GREAT MOTION PICTURES

The course of the motion picture industry was revolutionized by the application of magnetic stripes on film... a Soundcraft achievement which has made possible the stereophonic sound tracks of the great MGM (Camera 65), Cinemascope and Todd-A O productions. For this contribution, Soundcraft received the coveted Academy Award "Oscar"—first and only tape manufacturer ever so honored. Soundcraft achievement never stops.

SOUNDCRAFT WAS

FIRST

TO OFFER YOU:

- Mylar* base tapes for longer life, longer play
- Plasticizer-free oxide to prevent chipping or flaking
- Micropolished tape surface to preserve the "highs" and minimize recorder head wear
- FA-4 frequency adjusted formulation to capture the full dynamic range of sounds

Buy the best—buy Soundcraft Tapes

*DU PONT T.M.
PHOTO FROM METRO-GOLDWYN-MAYER, WILLIAM WILDER'S PRESENTATION OF "BEN HUR," WINNER OF 11 ACADEMY AWARDS.

REEVES **SOUNDCRAFT** CORP Main Office: Great Pasture Road, Danbury, Connecticut

"Trans-Select" Generator

(Continued from page 47)

sistors in the bridged-T network (R_1 & R_2 , R_3 & R_4 , etc.) must be matched in value. For the amplitude to remain constant on the different ranges, certain combinations of capacitors must have a proper relationship to each other. Note that the ratio between the value of C_1 (.05 μ f.) and C_2 (.5 μ f.) is 1:10. This same ratio must be maintained between C_1 & C_3 , C_3 & C_4 , and C_2 & C_4 . Increasing the value of the odd-numbered capacitors in this group decreases amplitude on the range or ranges involved, while decreasing the value increases amplitude. Increasing the value of even-numbered capacitors increases amplitude, and conversely.

So much for output *amplitude* which, as has been noted, depends on certain relative values. The individual values of components in the frequency-selective network affect *frequency*. Increasing the value of a component, whether resistor or capacitor, will decrease frequency, while reducing its value will raise the frequency.

As to obtaining the needed values, it is not necessary to use components of high precision. One way of adjusting the value of a component, for example, is simply to try several different units whose tolerance includes the exact value desired until the right one is found. Other simple methods include the following: if a resistor or capacitor is somewhat low, adding a small resistor in series or a small capacitor in parallel can produce the desired increase. To reduce these components if too high, a larger resistor in parallel or larger capacitor in series can achieve the desired result. With such methods and a reliable means of checking frequency, there is no need for an unusually precise means of determining resistance or capacitance.

The best way to measure frequency is with an oscilloscope, using Lissajous figures. Full details of the method, available in many reference sources, will not be presented here. Generally, a 60-cps sine-wave signal, available from line voltage, is applied to the horizontal channel of the scope. This position is provided internally on many instruments. The output of the generator to be calibrated is fed into the vertical channel. When generator frequency is an integral multiple or submultiple of 60 cps, a reasonably stable pattern will result. For example, when generator output is exactly 10 cps, a figure with six horizontal peaks but only one vertical peak will result. Other integral ratios may be used. In any case, generator frequency is the number of vertical peaks divided by the number of horizontal peaks and multiplied by 60. For the four basic, switch-selected frequencies, the ratios for the number of vertical peaks to the number of horizontal peaks is as follows: for 10 cps, 1:6; for 20 cps, 1:3; for 40 cps, 2:3, and for 80 cps, 4:3.

This method is practical for measur-

ing frequency and correspondingly "adjusting" component values, using the general principles already described, only on the two lowest ranges of the generator. Frequency checks on the higher ranges can be made, in each case, with reference to the next lowest range. This is accomplished as follows: Set the scope to display a single cycle of signal on the lower range, using the smallest possible amount of synchronizing voltage. Then switch the generator to the next highest range and adjust values to obtain exactly 10 cycles in the display.

In the author's unit, the sequence of adjustment began with the selection of the pair of matched resistors for R_1 and R_2 , obtaining the closest possible values. Precision resistors could be used at this starting point, but ohmmeter accuracy should be satisfactory. Then install C_1 and C_2 , and "adjust" their values (as described) for 80 cps.

Next switch out R_1 & R_2 , with S_1 , and install the other resistors, one pair at a time, individually adjusting each pair for the proper frequency if necessary. If there is a slight mismatch in any pair, adjust for amplitude as well. When this procedure is completed for the first position of range switch S_1 , install the pair of capacitors, C_3 & C_4 , for the next higher range, adjusting them for proper output amplitude and frequency. Then proceed in order to the two highest ranges, adjusting each range to ten times the one below it.

Accuracy can be just as good as your patience in making the adjustments. In the author's version, this was better than 5 per-cent except for the high end of the highest range. Evidence of the recommended adjustment procedure can be seen in Fig. 5, where two components are identified for such part numbers as C_1 , C_2 , and others.

The transistors and diode specified are about the least expensive types on the market. Virtually any general-purpose transistors and diodes should work as well, if they are more readily available. C_{10} and C_{11} , as mentioned, extend the upper frequency limit and maintain amplitude at this limit. Their values may have to be altered somewhat for different transistors, even of the type recommended.

Modifications

To meet different requirements and situations, the frequency-determining components could be dealt with in other ways. The generator could be designed to operate at a single frequency only, simplifying the number and choice of components. On the other hand, there could be a continuously variable frequency control in place of the switched frequencies. In this case, a dual potentiometer would take the place of switches S_1 to S_5 , and the resistor pairs associated with them. Switch S_1 , along with its associated pairs of capacitors could be retained for multiplying the basic, continuous range. The only precaution in this arrangement is that potentiometer resistance be adjusted to fall between the approximate limits of 5000 and 100,000 ohms. ▲

Build Your Own Superb Scott Kits

Have fun . . . save money . . . get the best! Now you can build your own world-famous Scott components . . . and you can make substantial savings compared to the costs of the nearest equivalent factory assembled units.

H. H. Scott kits feature the same engineering, same high performance, same features and parts as do the factory wired components. Tuners have exclusive Scott Wide-Band design with factory aligned silver-plated front ends. Amplifiers use H. H. Scott's superb conservatively rated transformers.

Scott kits are fun to build, too. The wires are pre-cut to exact length and pre-stripped. Instruction books are in full color to help you see exactly what you're doing. Mechanical parts are factory-riveted to the chassis.

For a genuine H. H. Scott system at a real saving, choose from these fine kits:

LT-110 FM Multiplex Stereo Tuner Pre-wired and aligned front end and multiplex sections; Wide-Band design; 2.2 uv sensitivity (IHF); \$159.95*

LK-48 48-Watt Stereo Complete Amplifier Kit A truly superior amplifier with power enough to drive even the most inefficient speaker systems. Only \$119.95*

LK-72 72-Watt Stereo Complete Amplifier Kit Fabulous Scott features never before available in a kit: derived center channel controls; tape monitor; \$159.95*

LT-10 FM Tuner Kit Unique Ez-A-Line alignment system. Sensitivity 2.2 uv (IHF). \$99.95*

LC-21 Stereo Pre-Amplifier Kit Exceptional versatility. 16 front panel controls; frequency response for optional laboratory applications 8 to 50,000 cps! \$99.95*

LK-150 150-Watt Stereo Power Amplifier Kit Conservative design, massive transformers unsurpassed performance. \$169.95*

**slightly higher West of Rockies.*



LT-110 FM Multiplex Stereo Tuner Kit

Rush me complete details on money-saving Scottkits.

FREE!

Colorful and detailed 20-page "Guide to Custom Stereo" including complete technical information on Scottkits.

Name
 Address
 City Zone State

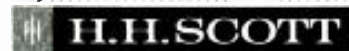

H. H. Scott, Inc., Dept. 160-11
 111 Powdermill Rd., Maynard, Mass.

Export: Morhan Exporting Corp.,
 458 Broadway, NYC

Full Color Giant Fold-Out Charts Still Available!

Here's a complete series of colorful, authoritative fold-out wall-charts (originally appearing in the pages of ELECTRONICS WORLD)—yours for only 15¢ each. All in full-color—each suitable for framing.

- 2. Hi-Fi Crossover Network Design Charts:** Tells how to build speaker nets for any crossover frequency. Complete coil-winding data, capacitor values given.
- 4. Bass-Reflex Design Charts:** Complete data on building own bass-reflex enclosures for any speaker, including ducted-port enclosures.
- 5. Radio Amateur Great Circle Chart:** For Hams and short-wave listeners—gives complete listing and map of amateur prefixes by calls and countries.

IMPORTANT: ORDER BY NUMBER! OUR SUPPLY OF THESE FOLD-OUT CHARTS LIMITED. OFFERED ONLY ON A FIRST COME, FIRST SERVED BASIS.

Send 15¢ per selection to ELECTRONICS WORLD

Box 378, Church Street Station

New York 8, New York

*Do your
Christmas shopping
the easy, economical
satisfying way
with the
1962 HEATHKIT®
Catalog*

World's biggest kit catalog—offers over 250 kit selections.

The big, new 100-page Heathkit catalog is the world's shopping center for kit builders. It offers over 40 completely new kits and a variety of products priced from \$7.95 up. Heathgift certificates are available in any dollar amount you wish.

New easy terms; order now—pay later!

Heathkit's new relaxed terms are the easiest ever. Now, no down payment is necessary . . . and take as long as 18 months to pay. See the order blank in the 1962 Heathkit catalog or write for application forms today.

Heathkits give a world of pleasure—at half the price!

With Heathgifts you provide more than just a remembrance. You open an exciting, challenging, satisfying new world of pleasure—that lasts a lifetime. What's more, you give the highest quality electronic equipment, but pay up to 50% less than the cost of ready-made units.



**New "value-packed"
FM Tuner in charcoal gray and ivory**

Performs in the true Heathkit quality tradition. Loaded with such features as flywheel tuning and slide rule dial, AFC control, assembled prealigned front end for easy kit completion. 9 tube function, ± 20 -20,000 cps. A honey for looks! Features multiplex jack for use with the Heathkit AC-11 Multiplex Converter to provide FM stereo.

Kit AJ-31 FM Tuner (shown) . . . 8 lbs. \$39.95
Kit AC-11 Multiplex Converter . . . 4 lbs. \$32.50

New HEATHGIFTS



**New Test Instruments
for the technician or serious amateur**

The IM-21 AC VTVM has clean design. Extended freq. response 1 db 10 cps to 500 kc. 10 megohm input imp.; 10 voltage ranges; -50 to +50 calibrated db scale.

Versatile IO-21 "general purpose" 3" oscilloscope perfect for industrial, medical and general use. Push-pull vert. and horiz. amplifiers; 20 to 100,000 cps sweep; automatic sync.

Kit IM-21 AC VTVM . . . 4 lbs \$33.95
Kit IO-21 3" Oscilloscope . . . 14 lbs \$49.95

**Deluxe
9 transistor
Walkie-Talkie
keeps you in touch
anytime, anywhere**



Units at twice the price can't compare! Operating range of 1 to 3 miles; meets FCC regulations. Crystal controlled superhet receiver; squelch noise limiter circuit; push-to-talk switch; rugged, 2-tone alum. case. Use for private reception, as wireless mike or for paging. 75 hours on 9 volt battery. Collapsible 35" whip antenna.

Kit GW-21 ... 3 lbs. \$44.95



**A Handsome Radio for every
room in the house**

Choose from 3 spanking new ivory and beige radios. Low cost AM set provides hours of pleasure. Economical FM table radio is noise-free; has preassembled tuner. AM Clock-Radio has Telechron unit, sleep switch, radio alarm, pillow speaker jack.

Kit GR-121 AM Clock-Radio, 8 lbs. \$29.95
Kit GR-11 FM Table Radio, 7 lbs. \$27.50
Kit GR-10 AM Table Radio, 7 lbs. \$19.95

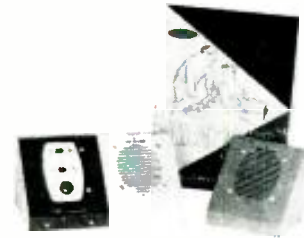

**Learn as you build—an
Educational Kit on Transistors**

Teaches basic fundamentals of transistors while performing interesting experiments! Text is written in simple easy-to-understand language. Final product is highly useful two-station intercom. Textbook provides a storehouse of valuable reference material. Designed for youngsters and adults alike. All components and materials furnished.

**Kit EK-3 Basic Transistors ...
4 lbs. \$16.95**

make it a merrier Christmas for anyone!



**New
Accessories**

to make a "Ham" happy

Ham accessories that sing performance, price, features! Spectacular, compact tunnel diode "dip" meter does everything a "grid dip" can do. New rugged VFO covers 80 thru 2 meters. New "Q" multiplier has 2 peak I. F. positions. Exceptional values!

Kit HG-10 VFO ... 12 lbs. \$34.95
**Kit HM-10 "Tunnel Dipper" ...
3 lbs. \$34.95**
**Kit HD-11 "Q" Multiplier ...
2 lbs. \$14.95**



**Safe
cruising
for the Boating Enthusiast**

Compare for price, for quality! See why the 3-band "Mariner" gives you so much. Includes consolan, beacon, broadcast and marine phone bands. 10 transistor, 1 diode circuit. Functionally styled with "sense" antenna, waterproofed 4" x 6" speaker. Preassembled tuner. Bearing accuracy of $\pm 3^\circ$.

**Kit MR-11 3-band "Mariner" ...
12 lbs. \$109.95**



**Short Wave Radios put the
world at your fingertips**

Hours of fascinating broadcast, amateur radio, and short wave pleasure await you in the GR-91. Covers 500 kc to 30 mc in 4-bands. Illuminated 7" slide-rule dial & meter. Versatile controls for top reception. "Velvet touch" tuning. Easy circuit board assembly. Beige & Aqua color.

Kit GR-91 SWL Radio ... 9 lbs. \$39.95



**New Wireless Intercom
saves time, saves steps**

No home, office or factory should be without this transistorized all-master intercom system. Imagine, only 3c a month to operate. No wires between units, just plug in. Any station calls other stations. Easy to build. In beautiful two-tone beige.

Kit GD-51 Intercom ... 4 lbs. \$22.95
Kit GD-51-2 (pair) ... 8 lbs. \$45.90

HEATH COMPANY
Benton Harbor 15, Michigan



Yes, send me my free 1962 Heathkit catalog

NAME _____

ADDRESS _____

CITY _____ ZONE _____ STATE _____

Order direct by mail or see your Heathkit dealer.

Ship Parcel Post Express C.O.D. Best Way

Ordering instructions: Fill out the order blank. Include charges for parcel post according to weights shown. Express orders shipped delivery charges collect. All prices F. O. B. Benton Harbor, Mich. A 20% deposit is required on all C.O.D. orders. Prices subject to change without notice. Dealer and export prices slightly higher.

ITEM	MODEL NO.	PRICE

Free Catalog!



Send in today for your free 100-page catalog. Over 250 kits (more than 40 are new) in this most complete catalog of kits. Every piece is top quality ... save up to 50%. Get a catalog now and receive 1962 Heathkit supplements.

This Christmas Give a Heathgift ... from the World's Shopping Center for Electronic Kits

British Audio Trends

By PATRICK HALLIDAY

Rundown on some of the interesting products and the displays at London's 1961 International Audio Festival.

THE LATEST in audio equipment was seen and heard recently at the 1961 International Audio Festival in London, supported by more than seventy British, American, European, and Japanese firms. Prominent among the exhibits was an increasing number of high-fidelity tape recorders, ranging from the miniature, pocket-sized transistorized models by *Fi-Cord* (only 9 $\frac{5}{8}$ " x 5" x 2 $\frac{3}{4}$ ", but claiming a 50-20,000 cps \pm 3 db response) to the larger professional recorders by *Ampex* and *E.M.I.*

A new low-distortion moving-coil loudspeaker system with a particularly clean bass response was shown by *Leak*—the firm which first pioneered 0.1 per-cent distortion amplifiers. The new loudspeaker and enclosure is relatively small—26" x 15" x 12"—and combines 13" and 3" units with a half-section crossover network. The 13" speaker incorporates a new "sandwich" cone which is $\frac{3}{8}$ " thick and provides an extremely stiff cone which, it is claimed, behaves as the theoretical ideal of a rigid piston and avoids the flexing of the cone at large amplitudes; it has no greater weight than conventional cones of paper, plastics, or aluminum. The term "sandwich" is derived from the layer construction of the diaphragm, with a skin material denser and stronger than the inner part.

The demonstration of stereo sound using two of these sandwich speakers was certainly impressive, although your reporter would like to hear the system under better listening conditions before



fully endorsing this reputable maker's claim that the stiff cone represents the "greatest advance" since the development of the Rice-Kellogg moving-coil speaker! A single enclosure and speaker is priced in Britain around the \$110 mark.

Another British maker well-known on both sides of the Atlantic is *Lowther* who has always championed the use of a single high-efficiency speaker driver unit in connection with compound horn enclosures; this year the *Lowther* range of enclosures has been extended with a re-designed "Acousta-Twin" enclosure. For stereo, only a single enclosure is used, placed in the center of the wall, offering the widest expansion of sound facing the normal listening area. It is

designed to reverse the accepted Blumlein principle for stereo, that is, the placing of two microphones at a central point and angled to collect sound from a given area; the sound pattern from the "Acousta-Twin" is designed to be of the same order, with the concentration of sound in the central area, intended to give the feeling of the original.

Lowther also showed the only all-transistor hi-fi amplifier noted at this year's show and then only in prototype form. It is a direct-coupled amplifier using a symmetrical push-pull circuit with two 6C26 power transistors in the transformerless output stage; no direct current flows through the 16-ohm voice coil. Power rating of this amplifier is only 5 watts (continuous sine-wave power). Although this may seem low by conventional audio standards, it should be remembered that the unit is designed for use with this firm's horn-loaded speakers which have an unusually high electrical/acoustical conversion efficiency.

The *Quad* wide-range electrostatic loudspeaker has been in continuous production since 1957, yet continues to attract keen interest—indeed on the day this writer visited the Festival, it was one of the few demonstrations for which one had to queue. Although other makers have from time to time demonstrated speakers using the push-pull electrostatic principle, the *Quad* model remains the only wide-range speaker of this type on the British market.

A new, compact integrated 10 + 10 watt stereo control unit and amplifier in a 4" x 14" x 13 $\frac{3}{4}$ " cabinet has been introduced during the past year by "*His Master's Voice*"—one of the brand names of the *E.M.I.* organization, long prominent in the audio field. An unusual feature is the small cathode-ray tube included for balancing and speaker phasing and with a built-in calibration signal. Independent control of each channel is provided by means of dual concentric knobs. Like many other British amplifiers, the "Ultra-Linear"-type output stage in each channel uses two EL84 tubes. The complete unit, termed the "Stereoscope," is priced in Britain at under \$190.

Long popular in Britain for ensuring groove cleanliness has been the "Dust-bug" device which can be mounted either with a special arm or on the pickup arm. It consists of nylon bristle sweeping the groove in advance of the

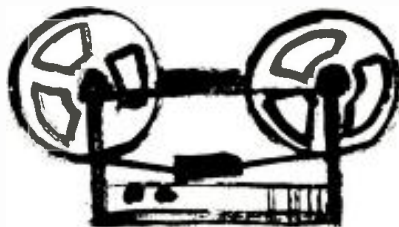

stylus to remove dust which is then trapped on a pad which also discharges surface static electricity. An accessory seen for the first time at this year's Festival is the *S.M.E.* "bias adjuster" for fitting to their pickup arms so as to correct the force developed by friction between stylus and record. Because of the offset of the arm, this force tends to swing the arm toward the record center. The new device has no springs but incorporates a small weight suspended by nylon thread and acting on a lever attached to the bearing assembly.

The *M.S.S. Recording Company* has announced a new form of transistor sine-wave oscillator capable of delivering 1-watt output at frequencies from 1 to 100 kc. with an efficiency better than 75 per-cent. A conventional a.f. transistor of the type often found in the output stage of broadcast portable receivers is used in this circuit—full details



of which have not yet been disclosed, pending patent application. In the audio field this circuit should be of interest for erase and bias currents in portable tape recorders, and may have applications in communications and industrial electronics.

Noted among the overseas exhibits was the Japanese *Sony* "Radio Microphone"—a lightweight transistorized FM transmitter used on 27 mc. in conjunction with a tube superhet receiver. Among the many high-quality microphones were a number of *Shure* and *A.K.G.* units.

Not shown at the Festival was one of Britain's main audio talking points—the controversial Gough loudspeaker enclosure. This new cabinet enclosure, which costs under \$15 to construct, has set audiophiles arguing and manufacturers busy issuing comments on the more sweeping claims put forward in some circles. The enclosure, announced late in 1960, was invented by Jabez Gough, a radio dealer in South Wales. The inventor, who developed the design empirically, considers that it conforms to no known earlier design; he claims that it differs from recognized design principles by being open at both ends, need not be constructed of particularly heavy materials, and does not contain interior padding. Gough himself makes no attempt to explain how the enclosure works. ▲

ELECTRONICS WORLD

INTERNATIONAL'S **Executive** MODEL 100



citizens band transceiver

A precision engineered transceiver for Citizens Band licensees seeking outstanding design and performance. Dual conversion superheterodyne receiver. Push-to-talk operation. Three way power supply for 6, 12 vdc and 115 vac. Full five watts plate input. Certified FCC tolerance $\pm .005\%$. Size $5\frac{1}{2}'' \times 8\frac{1}{2}'' \times 9''$ deep.

Complete with 1 transmit crystal, 1 receive crystal, new style ceramic microphone and coil cord..... **\$199.50**

Advanced engineering featured in the Executive Model 100

- NEW crystal filter minimizes adjacent channel interference.
- NEW built-in calibration circuit
- NEW International NR squelch.
- NEW 12 position crystal control transmit channel selector.
- NEW front panel microphone jack.
- NEW provision for connecting external speaker and S/meter.

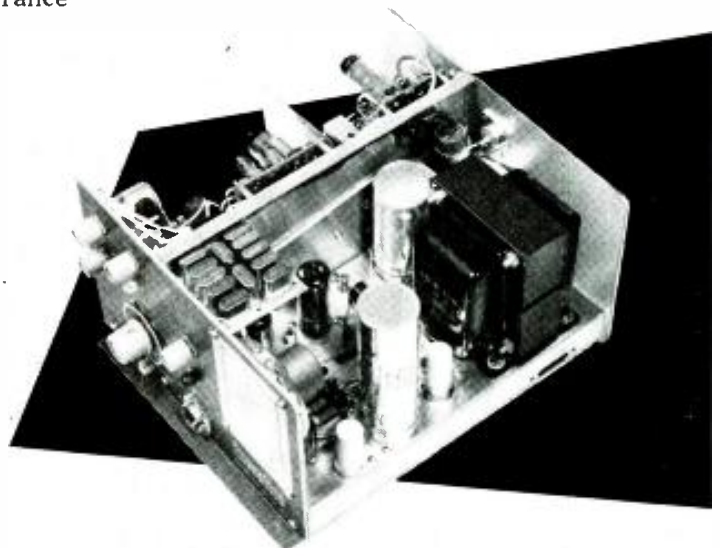

FREE INTERNATIONAL'S 1962 CATALOG

Your buying guide for precision radio crystals and quality electronic equipment. Complete data on International's Citizens Band transceivers and accessories.

Send for it TODAY!

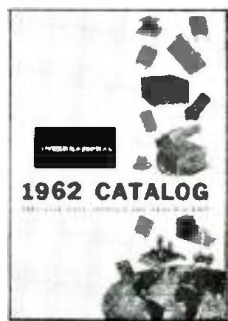

International Crystal Mfg. Co., Inc.
18 North Lee, Oklahoma City, Okla.

Rush FREE 1962 Catalog EW2

Name _____
Please print

Address _____

City _____ Zone _____ State _____

INTERNATIONAL Crystal Manufacturing Co., Inc. • 18 North Lee • Oklahoma City, Okla.

GET IT from GOODHEART!

Receivers and Panadapter

BC-453-B: 190-550 kc w/85 kc IF's. This rcvr is ideal as a tuner. IF to double-conversion. Other rcvrs having 455 kc IF's. Checked, aligned, grtd 100% OK, not as-is junk. W/all needed tech. data, pwr sply data, etc. fob Los Ang. \$12.95

Same, in handsome cabinet w/ply, spkr, etc., ready to use, is our QX-535. \$37.50

RBS: Navy's Pride 2-20 mc 14-tube superhet has voice filter for low noise, ear-saving AGC, high sens., & select. IF is 1255 kc. Checked, aligned, w pwr sply, cords, tech data, ready to use. \$39.50 fob Charleston, S.C. or Los Angeles

R-45/ARR-7 brand new, 12-tube superhet .55-43 mc in 6 bands, 5-meter, 455 kc IF's, xtl filter, 6 sel. positions, etc. Not and complete. It can be made still better by double-converting into the BC-453 or QX-535. Pwr sply includes DC for the automatic tuning motor. FOB San Antonio \$179.50

AN APR-4 rcvr is the 11-tube 30 mc IF etc. for its plug-in tuning units: has 5-meter, 60 cy pwr sply, pan., video & audio outputs, etc. Pan output is ideal to feed 30 mc to the R-45/ARR-7. Checked and aligned. fob Los Angeles \$69.50

Plug-in tuning units for above convert RF to 30 mc: TN-16, 38-94 mc, \$25.00. TN-17, 74-320 mc, \$25.00. TN-18, 300-1000 mc, \$35.00. TN-19, 975-2200 mc, \$39.50. TN-5, 217-500 mc, \$17.50. Power Plug for rcvr: \$2.00. Tech. Handbook: \$7.50.

Panadapter RBY, brand new, 455 kc input, has 115 v 60 cy pwr sply, fob Los Ang. \$79.50

Bendix 2-way Radios

SCR-522: 100-156 mc AM, 19 tubes, 832A RF Po. Very clean, satisfaction grtd. fob your choice of Buick, Oldsmobile, or Buick. (Add \$3.00 for complete tech data, includes conversions, xtl data, putting xmt on 6 & 10, etc. Add \$49.50 fob San Diego for RA-62-C, the 115 v 60 cy pwr sply made for ground use of SCR-522.)

MRT-9A1: Licensable hand-carry, 144-174 mc FM, deviation 15 kc. Rcvr sens. 1 uv, minim. Po 1 W. Complete w/antenna, handset, & v. vhrpack, xtls, less than 10 lbs. w/xtl. w/xtl. w/xtl. \$179.50 w/ instructions. NEW, fob Los Angeles.

Bargains in Surplus Transmitters

TQ: 115-156 mc, 45 W carrier emission can be 100% AM by voice or 85% AM by 1 kc tone, keying up to 40 wpm. Includes modul. & pwr sply 115 v 60 cy w/10 lbs. peak. w/xtl. w/xtl. w/xtl. \$149.50 checked, 829B final. Exc. condition, checked out operating OK. FOB Los Angeles

TDZ: 225-400 mc AM, 30 W Po, 10 chan. Autotune xtl. w/modul & pwr sply 110 v 220 v 440 v. 50/60 cy 1 ph. NEW, fob San Diego \$149.50

Surplus Test Scopes Ready to Use

TS-34 AP has internal sweeps 10-50,000 cy, video flat 40 cy, 100 cy, 1000 cy. Timing triggered by signal to be seen. 2" tube plus lens gives 5" pic. Checked OK, w case & large instruct. \$39.50 sheet, fob Los Angeles

TS-239A/UP: Freq. range 10 cy to 5 mc. Sine waves

observable 10 cy to 2 mc, pulses, 15 to 5000 usec. Sweep speeds 15 to 50,000 usec/inch. Timing markers 2, 1, 10, 100 & 500 usec. Puts out triggers 300, 800, 2000 cy. Unique grid is light-projected on the 3BP1, no parallax. Variable sweep delay. Accurate voltage calibration. Clean, checked operating. fob Los Angeles \$149.50 (Add 20.00 for photocopy of the Handbook.)

Surplus Tuning-Fork Oscillators

400 cy \pm .001% Am, Time Prod. \$125.00 Sealed fork, new, w ckt dwgs \$29.95

Same in complete osc. module w tubes, needs 150 vdc & 6.3 vac, w ckt dwgs \$69.50

AF ampl.: use also as bench B-c & hfr sply \$19.95

400 cy \pm .005% Philamon module w tube, new, w ckt dwg, needs 28 vdc 1.2 amp \$17.50

Same except Varo 622B rated 0.1% to be extra conservative; w ckt dwg. \$19.95

500 cy \pm .05% Philamon module w tube, new, w ckt dwg, needs 28 vdc 1.2 amp. \$49.50

1000, 500, 250, 125, 62.5 cy \pm .02% from new module w tubes, counters & Am. Time Prod. =2003 fork. Needs 250 vdc & 6.3 vac. W ckt dwgs \$49.50

Surplus Pulse & Signal Generators

Meas. Corp. Mod. 79B pulse generator 50-100,000 pps + pulses 1-40 usec wd + sync pips delayed 1/2 period. Can pulse-modulate an RF source and can be synced to a sine source, new, w book, 40 lbs fob Harrisburg, Pa. \$97.50

The following are all overhauled, certified, fob Los Angeles, have microvolt-calibrated outputs, variable internal modulation, w instruct. & fittings:

LP Signal Generator, 91.2 kc to 50 mc, \$197.50

LX-2 or =804 Sig. Gen., 71.2-330 mc, \$179.50

Meas. Corp. Mod. 84, 300-1000 mc, \$249.50

TS-47 APR, 40-500 mc w useful harmonics to 3000 mc, dial accuracy 1%. Uncalibrated attenuator 0.387-1000 uv. CW, AM 50%, at 1 kc, or pulsed at 500 cy. Grtd OK. fob Los Ang. \$79.50

Boonton =203B Univertor extends the range of any VHF microwave, (75 mc to 50 GHz, Zo) to cover 100 kc to 25 mc. Certified OK. \$129.50

Not \$420.00, but (fob Los Angeles) only

Surplus Brush Recorders

Portable BL-202 (RD-2321-001) 2-pen, ink, chart 5.25, 125 mm sec., sensitiv. 1.1 mm/v. certified like new fob Los Angeles \$295.00

Same but ink or electric writing (BL-222, RD-2322-001), w pwr sply for elect. wrtg. \$325.00

BL-206 6-pen, ink, 2 1/2-125 mm/sec. \$750.00

Write us for other Brush models, for DC amplifiers, for Esterline-Angus recorders, etc.

Miscellaneous Surplus Bargains

Boonton =170-A Q-Meter \$99.50

Hewlett-Packard =330B Distortion Analyzer \$225.00

Navy =60007 C R Leakage Insul Resist Turns Ratio bridge, accuracy 5% \$37.50

DC pwr sply, 230 v 60 cy 3 ph to 15/30 v at 130/65 A cont., w vernier, new, fob Topoka \$99.50

Leads & Northrup Voltage Divider, 15K ohms, 2 decades and slide-wire dial, certified OK \$79.50

Write for data on Airborne Magnetometer AN ASQ-3. Write for current stock in LINE VOLTAGE REGULATORS.

Write for your needs in schematics, conversion information, and tech. manuals on surplus electronic equipment.

Time Pay Plan: Send us your list of material, we will quote terms.

R. E. GOODHEART CO.

P. O. Box 1220-A Beverly Hills, Calif.

CB Crystal Checker

(Continued from page 57)

lengths, etc. The coil should be expanded or compressed until capacitor C_3 covers the band.

It is not necessary to follow the author's layout. If the device is to be used solely as a Citizens Band crystal checker, the complete circuit may be built into a single box of slightly larger size. The only precaution to be taken is to keep the leads as short as possible.

Using the Tester

To check crystal activity, plug the LC tuning section into the crystal oscillator box. Set the meter sensitivity control to its extreme counterclockwise position to protect the meter. Plug the crystal to be checked into the socket. Throw power switch S_1 on. Vary tuning capacitor C_3 by means of the vernier dial. If the crystal is good there should be some indication of rectified r.f. output on the meter. The meter sensitivity control may then be advanced for a more convenient meter deflection while adjusting the tuning dial for maximum meter indication.

In the author's unit the meter deflected to full scale with the sensitivity

control advanced to about three-quarters of its maximum rotation when checking crystals of frequencies at either end of the band—26.965 and 27.255 mc. The activity of different crystals may be compared by setting the sensitivity control for a given meter reading and then adjusting the tuning dial for maximum meter indication as different crystals of the same frequency are plugged in.

In transmitter construction work an LC circuit can be pre-checked with any given crystal. The LC circuit need not be mounted in a box but can be connected to an extra pin plug. This plug can then be inserted into the oscillator box jack and the LC circuit can then be tailored for optimum results with the crystal in the socket. Keep the leads to the plug as short as possible.

The crystal checker may also be set up for testing crystals and LC circuits of other services such as in amateur radio work. Output from the tester can be picked up on a communications receiver for checking frequency.

The constructor may calibrate the tuning dial in terms of frequency or Citizens Band channels if desired.

Since the current drain is quite small and the tester will not normally be in continuous use, battery life will be extremely long. ▲

Inside view showing small parts mounted on phenolic board. Sensitivity control and power switch are hidden by battery. Two unconnected leads go to the crystal socket.

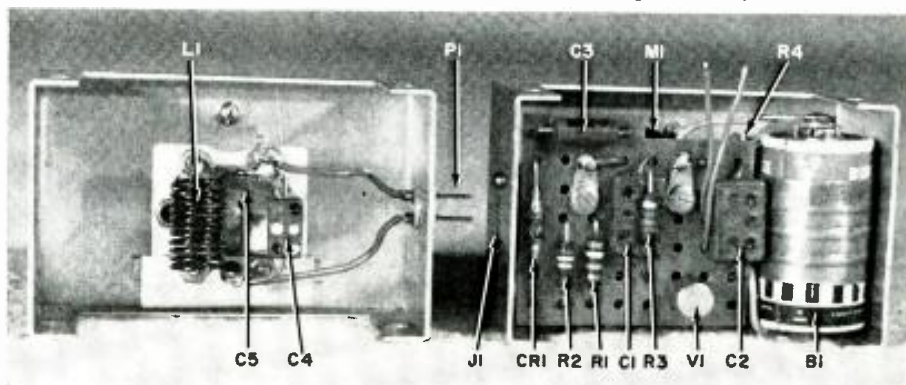

SIMPLE CHECK FOR TV ANTENNA LEAD-IN WIRE

By HERB BROWN

A SUSPECTED break in an antenna lead-in, especially if intermittent, is not easy to confirm. It can be anywhere along a line that is not accessible along most of its length. However, if you own a capacitor checker, you can test this easily.

Because the pair of wires act as capacitor plates, every two-conductor cable has capacitance whose value depends on the line length. If a break exists in either side of the line, the capacitor seen at one end of the line ends at the point of the break. Many 300-ohm, twin-lead types are rated at 4.1 μf . per foot, although some go as high as 5 μf . If you encounter an unusual type, check this rating in a catalogue or the manufacturer's fact sheet.

Disconnect the lead from the TV set and connect the clips of your checker to the bare ends of the wire. Starting at the low end of the lowest range, rotate the

instrument's "value" knob until you get a reading. Divide this figure, in μf ., by 4.1 or other applicable figure for a reading in feet. For example, a reading of 220 μf . indicates 50 feet of unbroken line. Suppose you know (a visual estimate will do) that the lead-in is about 50 feet long. You have confirmed continuity all the way up. But suppose the wire is about 100 feet long. Your reading has not only revealed a break; it has located it at the middle of the line.

An erratic reading on the tester's eye tube or other indicator exposes an intermittent. To check for this possibility, try to agitate the line if the wind isn't helping you. A final note: the antenna element to which the wire connects may be folded dipole, which tends to place a short across the wire. If your checker doesn't give a usable reading and this is the case, disconnect the wire at the antenna end too before re-testing. ▲

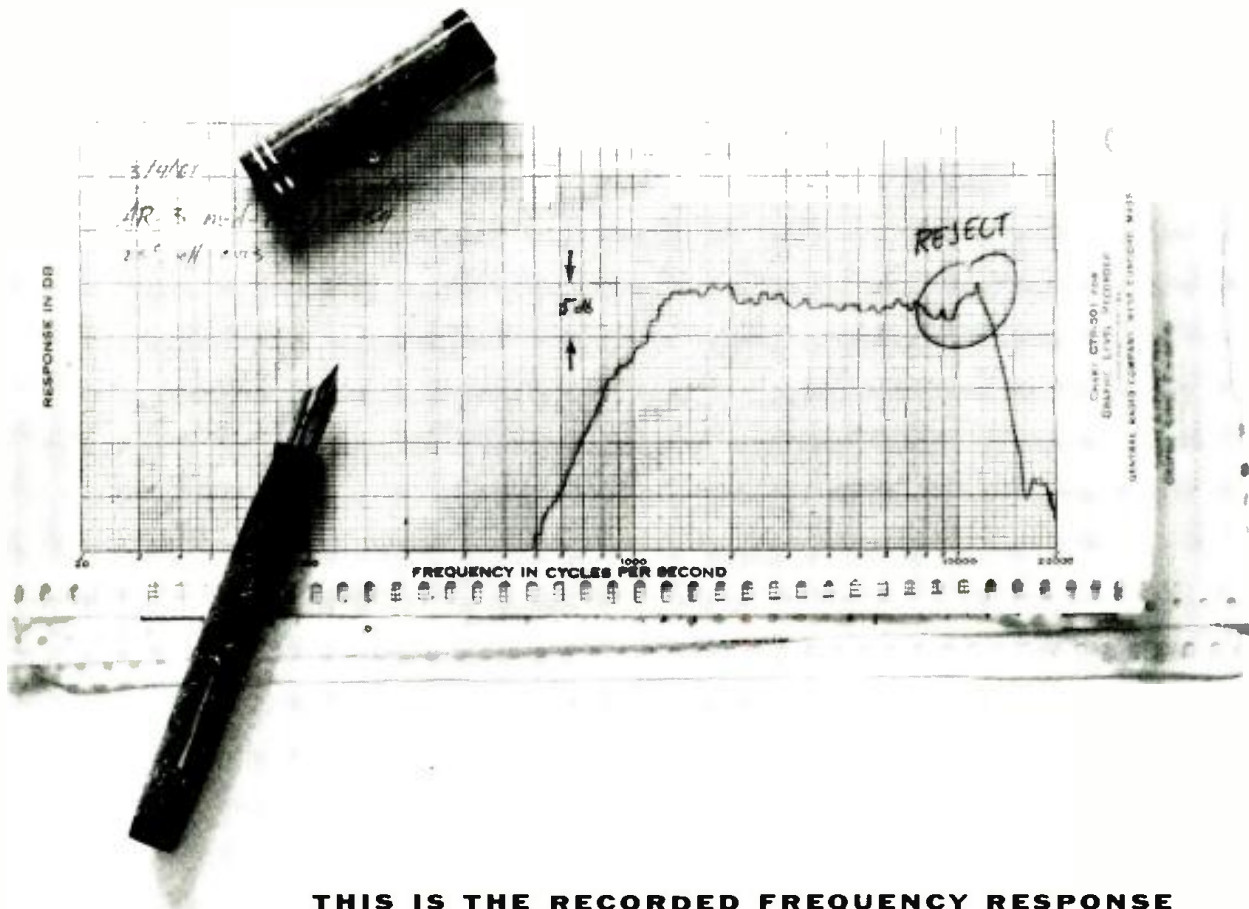

THIS IS THE RECORDED FREQUENCY RESPONSE CURVE OF A REJECTED AR-3 MID-RANGE TWEETER

Although this curve does not depart from the ideal by more than 2 decibels at any point, the sharp peak at 11,500 cycles is evidence of transient distortion.

The frequency response of all AR-3 tweeters and AR-2a super-tweeters is recorded and examined critically before installation. One out of fifteen never makes it to the cabinet.

AR speakers are priced from \$89 to \$225. They may be heard at AR Music Rooms, on the west balcony of Grand Central Terminal in New York City, and at 52 Brattle Street in Cambridge, Massachusetts. No sales are made or initiated at these showrooms.

Literature, including a list of AR dealers in your area, is available for the asking.

ACOUSTIC RESEARCH, INC., 24 Thorndike Street, Cambridge 41, Massachusetts

NOW ANYONE CAN MAKE AS FINE AN AMPLIFIER AS FISHER

with this new Fisher StrataKit!



Introducing a totally new approach to stereo kit design

■ When the KX-200 Control Amplifier, first of the new line of Fisher StrataKits, became available a few weeks ago, the entire concept of high-fidelity components in kit form entered a new, exciting phase. For the first time, a kit is backed by a name with the tradition, acceptance and stature of Fisher.

Before Fisher could stake its reputation on a product completed by the purchaser, two requirements had to be unconditionally satisfied. First, the performance of a Fisher kit had to meet the same guaranteed Fisher laboratory standards no matter who assembled it—Fisher laboratory technicians or a totally unskilled and inexperienced builder. Second, constructing the kit had to be a pleasure, not a problem.

Fisher engineers have responded to both of these unusual challenges brilliantly, as will be evident to any builder of the KX-200 StrataKit. He will own the finest 80-watt Stereophonic Master Control Amplifier Fisher knows how to make.

The StrataKit method of kit construction permits assembly by easy, error-proof stages (strata), each stage corresponding to a particular page in the Instruction Manual and to a separate transparent packet of parts, separately identified. Major components come already mounted on the chassis, and wires are pre-cut for every stage—meaning every page!

Errors of omission, if any, can thus be checked stage-by-stage and page-by-page—before proceeding to the next stage. There are no surprises with a Fisher StrataKit, only the pleasure of accomplishment and of effortless learning.

Outstanding features of the Fisher KX-200 StrataKit:

80 watts IHFM music power—more than with any other control-amplifier kit. Harmonic distortion 0.24%. Hum and noise 93 db below full output.

Built-in D'Arsonval laboratory-type calibration meter—a Fisher exclusive. Permits precise adjustment for peak performance; assures optimum results from the start and in the years ahead.

Level control facilities for a center-channel speaker without the need for an additional amplifier—unlike any other kit now available.

Architectural brass-finish control panel to match all other standard Fisher-built components and to fit standard Fisher component cabinets.

Price \$169.50*

Coming Soon: The Fisher High-Sensitivity, Wide-Band, Stereo-FM Tuner StrataKit.

*Walnut or Mahogany cabinet, \$24.95 extra; metal cabinet, \$15.95 extra; prices slightly higher in the Far West.

USE THIS COUPON FOR FURTHER INFORMATION

Fisher Radio Corp.

21-51 44th Drive, Long Island City 1, N. Y.

Please send me the following FREE Fisher literature:

Complete details and specifications on the Fisher KX-200 StrataKit.

The 1962 Fisher Handbook, a 40-page illustrated reference guide and component catalogue for custom stereo installations.

Name _____

Address _____

City _____ Zone _____ State _____

EW11K1

EXPORT: Telesco International Corp., 171 Madison Ave., N.Y. 16, N.Y. In Canada: Tri-Tel Associates, Ltd.

Standing-Wave Indicator

(Continued from page 51)

with 52-ohm coaxial cable since this is most commonly used in Citizens Band service. If some type 72-ohm cable is to be used, the indicator can be employed with this cable simply by changing R_1 to 72 ohms. (This 72-ohm resistor may be selected from a group of standard 68- or 75-ohm carbon types, as suggested below for the 52-ohm types.) Ideally, special non-inductive resistors should be used but the carbon types listed serve very well for this purpose. The standard value of 51 ohms is near the value wanted and is close enough for all practical purposes. Some 51-ohm resistors, measuring slightly on the high side, may be used if the constructor wishes to hand pick these units. The supplier here cooperated in this respect. Most any diode can be used with this bridge.

Using the Indicator

For test purposes it is convenient to use an extra 51-ohm resistor soldered to a mating coax connector. To test the indicator, plug this test resistor into the connector marked J_1 . Connect the output from a Citizens Band transmitter to connector J_2 . Very loose coupling to the transmitter tank should be employed in order to protect the meter. The meter sensitivity control, R_2 , should be set to its extreme counterclockwise position. This control, however, does not reduce the rectified current to the meter to zero. It simply serves as a fine adjustment in setting the meter to full scale. After full-scale indication is obtained on the meter, the coax connections are reversed, that is, transmitter output goes to J_1 and the test resistor connects to J_2 . The meter should now read near zero. (Even when trying the unit with unselected 51-ohm resistors, the meter read down to 0.5 μ a. when a test resistor was plugged into J_2 , and 3 μ a. with the test resistor terminating 25 feet of RG-58/U transmission line.)

In making antenna impedance matching tests, this same procedure is followed except the antenna coax line is used in place of the test resistor. The better the antenna-line impedance matching, the lower will be the reading on the meter. When the meter reads zero, a 1:1 s.w.r. exists, which would indicate perfect matching.

Although unnecessary for straight impedance matching measurements as just described, the constructor may calibrate the instrument, if desired, by plugging carbon load resistors of various values into connector J_2 and plotting the meter reading against the resistance ratio R_2/R_1 or R_1/R_2 , the larger value in each case being placed in the numerator and where R_1 is the load resistor. As an example, the meter reading obtained with R_1 one-half or twice the value of R_2 would be calibrated as a 2:1 standing-wave ratio. For each load resistor used, the indicator must first be adjusted for full-scale meter reading as previously described. ▲

THOSE of you who read this column undoubtedly read other record reviews in other magazines. I know I do, because I am interested in what my peers have to say and their evaluations of recordings on which I have formed my own opinions. Without being specific, it is apparent that some critics concern themselves primarily with the purely musical aspects of a recording. Still others add some technical evaluation, and some go a few steps farther in this direction.

For the most part, there is generally some expression and opinion on sound quality. Unfortunately, such information as "nice recording" and "good sound" doesn't convey a great deal to the reader who is more than casually interested in the sound qualities of a recording. I do not say this as a rebuke to my colleagues but merely to point out that such reporting isn't sufficiently differential for the more technically minded.

More often than not, when there is more involvement with the technical aspects of a recording, it is amazing to note the wide diversity of opinion. One critic will lambast a certain recording for its poor sound and, in another publication, this same recording will be acclaimed a sonic masterpiece. How come? Why this disparity?

There are variables of course . . . differing playback equipment, a variety of acoustical environments, perhaps even differences in auditory response. There is always the question of maintenance . . . is one part of the system worn or out of balance, etc.? Admitting to these variables, it would still seem that a recording which is really good should receive favorable reviews in general.

This is a complex problem and I do not pretend that I have the answer, but all the foregoing is in preface to a situation I recently encountered. Perhaps it will afford a little insight into these technical inconsistencies. At the very least, it will give you an idea of some of the odd-ball things with which we must cope and why a critic's hair turns gray!

As you are probably aware, there are quite a number of recordings on the market that appear on mono LP, then on stereo disc, and then on stereo tape. It is always interesting to compare the stereo disc with the stereo tape of a certain performance. There are expected differences, of course, and sometimes differences which are totally unexpected. For our purposes here, we will dismiss the most obvious differences.

Now I have a neat little setup whereby I can play back stereo discs and stereo tapes and get an instantaneous A-B comparison. I was thus engaged with a certain recording of a Beethoven symphony. I cued up the disc and the tape so that they would sync together (not an easy job, but it can be done with the right equipment), started them rolling, and began to punch the compare button.

As I have said, there were the expected differences, but there was something else. It was slight, but an abso-



RECORD & REEL REVUE

By **BERT WHYTE**

lutely definite variation in pitch! This was a stopper. The human ear is more sensitive to pitch than most people realize and it is actually capable of separating very minute increments of tone. OK, so we have a difference in pitch. The question now is whether the tape or the disc is off pitch. Or, more to the immediate point, is it the tape and disc themselves, or the turntable or tape machine which is out of kilter?

Thus began an arduous series of tests. First I checked the available voltage and current—which was right on the nose and stable. The turntable I was using has a built-in strobe with variable drive and she was as steady as a rock, both with the record alone and with tonearm in place (you would be surprised how a good strobe shows up the drag on the record surface imposed by even a one-gram pressure!).

The tape machine was checked with a timing tape, then aligned and given a frequency check just for the heck of it. All was OK. Next step was to play back on the turntable an acetate I had cut on a professional *Scully* lathe, which contained a 440-cycle tone derived from a signal generator. While it was playing, I struck a 440-cycle tuning fork and beat it against the tone on the record. Again all checked OK.

I followed the same procedure with the tape machine, beating the fork against a tone on the tape and with the same results. Conclusion? In view of the accuracy of the playback drive systems of both tape and disc, it would seem that either the disc or the tape itself was the pitch offender.

Now we must enter another world of variables . . . somewhere along the processing line, between the master recording and the finished product, somebody or something "goofed." Perhaps a tape playback machine wasn't checked out that particular day and, although they are mechanical marvels, a lathe might have been slightly out of whack, or perhaps one of the tape duplicating slaves was off.

Let us consider the possibilities in dimensional stability of the final product. Here the nod must go to the disc, because vinyl is relatively inert and expansion and contraction are so minute as to be disregarded. Tape, on the other hand, is subject to a certain degree of

stretch, especially after repeated play, but this too can largely be ignored. It is true we are splitting hairs here . . . the erudite critic blessed with perfect pitch can put on the "D Minor" symphony and tell you right off whether or not it is on pitch. However, for his slightly less gifted peers and in the interests of accuracy, one solution might be to incorporate on a production tape or disc, at some appropriate spot, a 440-cycle "A" which could function as a standard with which he could compare a standard "A" tuning fork.

Big question . . . this is but one of the phenomena likely to be encountered. There may be others which, in the long run, contribute to the diversity of opinion on sound quality in a given recording. The final arbiter is your own ear. Given reasonably good equipment which you keep in top shape, if you think a certain disc or tape sounds good—a view contrary to what some of the critics say—I say a pox on the critics . . . enjoy yourself!

ALBENIZ

IBERIA (Orchestral Version)

RAVEL

RIHAPSODIE ESPAGNOLE

Paris Conservatoire Orchestra conducted by Jean Morel, Victor Stereo LSC-6094, Price \$11.95, Two discs.

The Ravel is an adequately performed "filler" in this album, the real treasure being the "Iberia" orchestration. Originally scored for piano, the various sections have been set in orchestral form by Enrique Arbos and Carlos Surinach and their tonal colorings are the very essence of the Spanish musical idiom. One has but to listen to this music for a few bars and it is instantly recognizable as a Spanish utterance.

The twelve sections are widely varied in mood and expression. Perhaps the most famous is the "Feast Day in Seville," which is a masterpiece of massive sonorities.

Morel is a very perceptive interpreter and his reading sounds completely authentic. He intrudes none of his personality but lets the music speak for itself. Above all, he pays strict attention to the indicated tempi and elicits some surprisingly brilliant playing from the not-always-too-reliable Paris Conservatoire Orchestra.

(Continued on page 86)

RCA Training Can Be The Smartest Investment You Ever Made!



If you're considering a future in electronics, investigate the courses offered by RCA Institutes Home Study School. In the rapidly expanding world of electronics, good basic training in Electronic Theory and Practice is most important. And you can be sure of the very finest when you enroll at RCA Institutes.

Founded in 1909, RCA Institutes is one of the largest technical schools in the United States de-

voted exclusively to electronics. The very name "RCA" means dependability, integrity and scientific advance.

The courses offered by RCA Institutes are many and varied. A complete program of integrated courses for beginners and advanced students is available. They include: Electronic Fundamentals, Transistors, Television Servicing, Color Television, Electronics for Automation. Each one

is especially tailored to your needs, designed to prepare you for a profitable future in the ever-expanding world of electronics. And once you become an RCA Institutes graduate, you are assured of top recognition by leading companies everywhere.

Investigate the superb facilities for technical instruction at the RCA Institutes today. It can be the smartest move you ever made.

HOME STUDY COURSES

*in Radio and Electronic Fundamentals
TV Servicing · Color TV · Transistors
Electronics for Automation*

New Voluntary Tuition Plan. All RCA Institutes Home Study courses are available under the Voluntary Tuition Plan. This plan affords you the most economical possible method of home study training. You pay for lessons only as you order them. If, for any reason, you should wish to interrupt your training, you can do so and you will not owe a cent until you resume the course. No other obligations! No installment payments required.

RCA Personal Instruction. With RCA Home Study training you set your own pace in keeping with your own ability, finances, and time. RCA Institutes allows you ample time to complete the course. Your lesson assignments are individually graded by technically trained personnel, and helpful comments are added where required. You get theory, experiment, and service practice beginning with the very first lesson. All lessons are profusely illustrated. You get a complete training package throughout the entire course.



You Get Prime Quality Equipment. All kits furnished with the course are complete in every respect, and the equipment is top grade. You keep all the equipment furnished to you for actual use on the job... and you never have to take apart one piece to build another.

RESIDENT SCHOOLS

*in Los Angeles and New York City—
You can study electronics in the city of your choice.*

No Previous Technical Training Required For Admission. You Are Eligible Even If You Haven't Completed High School. RCA Institutes Resident Schools in Los Angeles and New York City offer training that will prepare you to work in rewarding positions on research and production projects in fields such as automation, transistors, communications, technical writing, television, computers, and other industrial and advanced electronics applications. If you did not complete high school, RCA will prepare you for such training with

courses specially designed to provide the basic math and physics required for a career in electronics.

Free Placement Service. RCA Institutes graduates are now employed in important jobs at military installations such as Cape Canaveral, with important companies such as IBM, Bell Telephone Labs, General Electric, RCA, and in radio and TV stations all over the country. Many other graduates have opened their own businesses. A recent New York Resident School class had 92.06% of the graduates who used the Free Placement Service accepted by important electronics companies... *and had their jobs waiting for them on the day they graduated!*



Coeducational Day and Evening Courses. Day and Evening Courses are available at Resident Schools in New York City and Los Angeles. You can prepare for a career in electronics while continuing your normal full-time or part-time employment. Regular classes start four times each year.

SEND POSTCARD FOR FREE ILLUSTRATED BOOK TODAY! SPECIFY HOME STUDY OR NEW YORK OR LOS ANGELES RESIDENT SCHOOL

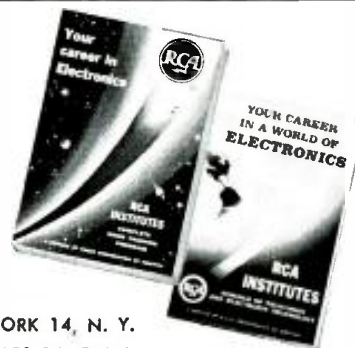

RCA INSTITUTES, INC. A SERVICE OF RADIO CORPORATION OF AMERICA, 350 WEST 4TH ST., NEW YORK 14, N. Y.
PACIFIC ELECTRIC BLDG., 610 S. MAIN ST., LOS ANGELES 14, CALIF.



The Most Trusted Name in Electronics

SCIENTISTS... ENGINEERS!

8,165 Reasons Why You Need This

APPLIED MATH

1-VOLUME

"LIBRARY"

NOW... this mammoth, 1,215-page International Dictionary of Applied Mathematics puts at your fingertips 8,165 essential methods, terms and applications. Even includes definitions and procedures from pure mathematics to help you better understand applied math problems. Completely covers THIRTY-TWO math-related fields of science and engineering!

CONCISE, YET COMPREHENSIVE... Lists range from a few clear lines to as many as seven pages. Includes equations and derivations. Totally cross-indexed; key words and phrases in boldface type.

Prepared by World-Famous Experts
Authoritative selection, meticulous presentation, by leading U.S. and foreign specialists. Every scientist and engineer, every student, teacher and researcher will find the right answers quickly, easily, in this huge volume.

COVERS ALL THESE FIELDS: Acoustical Eng.; Acoustics; Astronomy; Auto-Control; Diff. Geometry; Electromag. Theory; Mechanics; Network Topology; Nucl. Sci.; Optics; Quant. Mech.; Relativity; Spectroscopy & Interpretation; Strength of Materials; Chem. & Phys. Thermodynamics; Vector Anal.; Aerodynamics & Hydrodynamics; Atom Struct.; Chem. Elasticity; Gen. Math.; Molecular Struct.; Nucl. Eng.; Numerical Anal.; Prob. & Statistics; Relat. Quantum Mech.; Sig. St. Phys.; Chem.; Stat. Mech.; Stat. Anal. & Design; Eng. Thermodynamics; Tensor Anal.; Visco-Elasticity & Plasticity.

EXTRA FEATURE:
FOREIGN-LANGUAGE DEFINITIONS
Helpfully lists all foreign terms with their English equivalents.
German, Russian, French and Spanish.

Authorities Praise Book
"Real dictionary, not just pseudo-learned collection sometimes encountered... very convenient and valuable reference."

AMERICAN SCIENTIST Magazine
"English equivalents of German, Russian, French and Spanish terms should prove invaluable. The typography is excellent, well displayed."

CECIL B. READ, Univ. of Wichita
"Prodigious wealth of information in a single volume of moderate cost."

JOURNAL OF OPTICAL SOC. OF AMERICA

FREE EXAMINATION

Send No Money

Coupon below brings you a permanently bound, 1,215-page copy of the International Dictionary of Applied Mathematics—yours to use FREE for 10 days. If you're not delighted, return it and owe nothing! Otherwise, take 4 MONTHS to pay (as noted in coupon)—send TODAY to: **D. VAN NOSTRAND COMPANY, INC., Dept. 3711, 120 Alexander St., Princeton, N.J.** Established 1818.

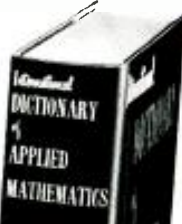

D. VAN NOSTRAND COMPANY, INC., Dept. 3711, 120 Alexander St., Princeton, New Jersey

Please send me the *International Dictionary of Applied Mathematics* for 10 DAY'S FREE USE. If not delighted, I'll return it and owe nothing. Otherwise, I will remit \$5.00 (plus small shipping charge), and \$5.00 a month for 4 months. Total price: \$25.00.

Name..... (Please print plainly)

Address.....

City..... Zone... State.....

SAVE! Send full \$25.00 payment with order and all shipping charges will be prepaid. Same return-for-refund privilege. (In Canada: 25 Hollinger Rd., Toronto 16. Price slightly higher.)
Foreign, APO—please send full payment of \$25
TAX DEDUCTIBLE — if used in your work!

This is generally a good, clean sounding recording with but a few of the triple forte peaks a little on the "blurred" side. The stereo is good in both depth and direction, although the depth has been achieved somewhat at the expense of orchestral detail and "presence." Nice wide dynamic and frequency response. These are delightful listening—a refreshing change from the usual symphonic diet and I recommend this album to your attention.

SEA SHANTIES

Men of the Robert Shaw Chorale conducted by Robert Shaw. Victor Stereo LSC2551. Price \$5.98.

This is one of the saltiest albums to appear in a long time. If you have a friend who is a sailing bug and he invites you to crew for him, I can't think of a gift he would appreciate more than this.

When I was very young and foolish (maybe romantic is a better word), I had an experience few men can share today... I made two voyages in four-masted sailing ships. These were the *Herbert Rawding* and the *Constellation*. The *Rawding* rots in some forgotten harbor and the *Constellation* tore her vitals out on a reef near Bermuda. When she went down she took with her several thousand cases of *Johnny Walker* and other assorted goodies. One of these days, if she is not too deep, I'm going to strap on my scuba and give the old girl another look.

The crews of these ships were one part wet-nosed kids like myself and the other part ancient "shellbacks"—many of whom had rounded the Horn on such great old ships as the *Grace Harwar* and the *Pamir and Ponape*.

It was from these utterly fascinating characters that I first heard sea shanties (or chanties, if you prefer), many of which are on this album. So I listened to this with more than a little nostalgia. Needless to say, although the cracked and whiskey-baritones of my old shipmates may have been more authentic, the superbly trained voices of the Robert Shaw Chorale are much more pleasant to the ear.

They sing all the great favorites, from the immortal "Blow the Man Down" to the haunting "Shenandoah" and the lusty "What Shall We Do with the Drunken Sailor?". One of the most beautiful—and done here with wonderfully rich blending and sonority—is "Lowlands."

The recording is exceptionally clean with the voices projected well forward and the presence outstanding. The various choirs are perceived with fine directionality and the acoustics are handled well, to afford a nice rounded spaciousness and depth.

So, tell the boatswain to pipe all hands to "splice the mainbrace" (have a drink, in landlubber parlance) to toast a wonderful album.

WAGNER FOR BAND

Eastman Wind Ensemble conducted by Frederick Fennell. Mercury Stereo SR90276. Price \$5.98.

As might be expected when Fennell's spirited group turns its attention to

Ask By Name For GENUINE

"NO NOISE" PRODUCTS

your assurance of brand name quality

No-Noise VOLUME CONTROL and Contact Restorer
• Cleans • Lubricates • Protects
Not a Carbon Tet Solution
2 Oz. Bottle \$1.00
6 Oz. Spray Can \$2.25
Net to Servicemen



No-Noise TUNER-TONIC with PERMA-FILM
• Cleans, lubricates, restores all tuners, including water type.
• Non-toxic, non-inflammable
• Economical—a little does a lot.
6 oz. Aerosol Can \$3.25
Net to Servicemen

FREE with each can of ELECTRONIC CHEMICAL products —
5" PLASTIC EXTENDER
Push Button Assembly For Pin Point Applications—Does Not Cause Shorts
Electronic Chemical new formula
EC-44
Lubricates, conditions, cleans all electrical contacts. Economical—little does a lot!
6 oz. spray can \$3.50

ELECTRONIC CHEMICAL CORP.
813 Communipaw Avenue Jersey City 4, N. J.

MOBILE RADIOS

SAMPLE OFFERING: 12V 30W or 60W mobile units. Reconditioned General Electric type MC series.

Formerly used by N.J. State Police and serviced by N.J. Bell Telephone.

Can be tuned and crystallized to frequencies within 30-50 mc band.

Complete with accessories less antenno and crystals **\$98** each

Complete with accessories including antenno, crystals, fully narrow banded and tuned to your frequency **\$198** each

Prices are FOB our warehouse and all equipment subject to prior sale

ALSO AVAILABLE: Many reconditioned RCA, GE and Motorola units in 30-50mc, 150-170mc and 450-470mc bands. Guaranteed prompt, efficient, courteous service. For more information and catalogue...

write or wire Department EW
Gregory Electronics Corp.
112 Route 46 Saddle Brook, N.J.
phone PR 3-7550

GREGORY ELECTRONICS CORPORATION

Headquarters for reconditioned 2-way mobile radios

something as rich in sonority as the music of Wagner, the result is slightly overwhelming.

Although scoring what is essentially an orchestral piece for band is not altogether favored by Fennell, once set on the path he comes up with some fabulous sounds. In excerpts from "Lohengrin," "Rheingold," and "Parsifal" he leads his bright youngsters in readings of great power and vitality. The album opens with the "Prelude" to Act 3 and the "Bridal Chorus" from "Lohengrin." Then we are treated to some huge brass and percussion in a great outpouring for the "Entry of the Gods into Valhalla," the "Cathedral Procession" from "Lohengrin," a really rousing Overture to "Rienzi," and the "Good Friday Spell."

The sound throughout is very clean and of great dynamic compass. The stereo was well handled as to depth and direction, with the superb acoustics of Eastman Theatre lending their customary aid to the recording.

The only disappointment was in the "Valhalla" wherein I thought *Mercury*

would come up with some stupendous sound to challenge what *London* did in their memorable recording of the complete opera. But this is but one point and the rest is more than worth the price of the album.

Now that Fennell has broken the ice with this recording, I hope we can look forward to many other great transcriptions for band which have lain fallow for many years.

BEETHOVEN
PIANO CONCERTO #1
SONATA FOR PIANO #31

Andor Foldes, pianist, with Bamberger Symphoniker conducted by Ferdinand Leitner. Deutsche Grammophon Stereo 138636SLPM. Price \$5.98.

This album is a bit of a surprise, since Foldes is much better known for his interpretations of the moderns—most especially Bartok. Still, I suppose every pianist wants to do Beethoven. While Foldes' performance will not cause Richter or Rubenstein any sleepless

nights, one can be fair and say that if it is not a performance on that lofty scale, it is at least an honest reading, making no pretensions and Foldes plays it straight.

Technique this fellow has and superb phrasing is the best of it. Now, if he could manage a bit more warmth and be a little less stiff, his reading would go up the ladder a great many rungs. He gets a fine, sympathetic, and knowing accompaniment from Leitner, who has always been a first-class Beethoven man.

Soundwise, this is a departure from the usual M/S stereo of *Deutsche Grammophon*. The sound has much more pronounced directionality and much more presence and orchestral detail, yet they have managed to retain their good depth effects and fine acoustic handling. The piano is nicely centered and stable too. All of which leads me to believe that this is either a new and unusual modification of the M/S technique or an American-style three-channel recording.

Everything is fairly clean with the

NEXT BEST THING TO THE
WINEGARD ELECTRONIC
POWERTRON TV ANTENNA

NEW TRANSISTOR TV-FM
WINEGARD
**TENNA-
BOOST**

MOUNTS ON ANY ANTENNA

MOUNTS ON
ANTENNA



Model
MA-300

\$34⁹⁵
only LIST

INSTALL IT... FORGET IT!

ALL ELECTRIC, ALL-AC POWER SUPPLY costs less than 27c a year to operate. Many exclusive features.

No costly, nuisance batteries!



Built-in two set coupler.



Exclusive Gain Control Switch



AC outlet on power supply.

19 DB GAIN! CUTS SNOW...BOOSTS SIGNAL!

Now you can make any TV or FM antenna work better by magnifying signals with the new Winegard transistor Tenna-Boost.

Tenna-Boost has up to 19 DB gain, no peaks and valleys. Ultra low noise. Linear frequency response. VSWR input better than 1.5:1 across all frequencies. Output VSWR 1.8:1 or better. This fine frequency response plus the very low VSWR make Tenna-Boost excellent for color.

Winegard's exclusive input band-pass filter eliminates interference from citizen's band, Hams, garage door openers, etc. Only TV and FM signals are amplified.

All metal parts are anodized, irridized or stainless steel. Completely weather-proof, trouble-free. Install it... forget it.

There's a big difference in antenna amplifiers! Ask your distributor or write for technical bulletin.

FOR THE ULTIMATE IN TV RECEPTION

Winegard Transistorized Electronic Powertron TV Antennas. 3 Models to Choose From.



Winegard

ANTENNA SYSTEMS

3009-10 Kirkwood • Burlington, Iowa

BUILD THE FINEST
Professional Quality
 CUSTOMIZED
TV KIT

On Easy "Pay As You Wire" Terms
 Only \$15 for the Starting Package!

The
"PROFESSIONAL"
 Series—designed for
 the perfectionist seeking
 the finest in TV performance.
 Easy to assemble. No technical
 knowledge required. An ideal
 "Learning" Kit with a Complete
 Course of Study is available.



Also available:
**WIRED
 CHASSIS**
 for custom
 installations
 with a choice
 of vertical or horizontal
 controls and the newest
 23", 24" or 27"
 CRT.



Beautiful Cabinets —
 designed to enhance sound quality and blend with
 modern decor. For TV or combination TV and Hi-Fi.

A few of the Professional Quality Features:
 Choice of push-pull 10-watt audio or output to
 your Hi-Fi system... D.C. restoration...
 Ultra-linear sweep circuits... Standard Coil
 Guided Grid Turret Tuner... Super-sensitiv-
 ity for fringe areas... Complete line of Acces-
 sories for Custom Installations.

Choice of 23", 24" or 27" CRT. Prices range
 from \$119 to \$199.

U.S. Armed Services and over 4000 schools and
 colleges have selected Transvision Receivers for
 educational television.

Interested in Electronics?

Learn the basic principles of elec-
 tronics from the Course available with the Kit.

ASSEMBLY MANUAL—\$2.00

See how easy it is to assemble the Transvision
 Kit. Cost of Manual refunded on purchase of Kit.



New Rochelle, N.Y.
 NE 6-6000

START NOW — MAIL THIS COUPON

TRANSVISION Electronics, Inc., New Rochelle, N.Y. Dept. EW

Send FREE 8-page Catalog... I enclose \$2 for Assembly
 Manual, refundable on purchase of Kit.

I enclose \$15 for Starting Pkg. on pay-as-you-wire plan.
 (Complete Kits range from \$119 to \$199.)

Name _____

Address _____

City _____ Zone _____ State _____

first strings sounding a little coarse and
 wiry at times. Good dynamics were a
 feature, but most surprising of all, sur-
 faces were a little "ticky"—something
Deutsche Grammophon has rarely been
 guilty of in their recordings.

DELIBES

SYLVIA (Excerpts)

COPPELIA (Excerpts)

Paris Conservatoire Orchestra conducted
 by Hugo Rignold. Victor Stereo LSC2 185.
 Price \$5.98.

Those who are real balletomanes will
 probably want to get the superb com-
 plete editions from either *London* or
Mercury. Those who want just the meat
 of these ballets, with most of the famil-
 iar numbers, will find this an attractive
 album.

That urbane and affable chap, Hugo
 Rignold, is an old hand with ballet and
 affords a completely satisfying perform-
 ance. The orchestra plays very well for
 him and between them they manage to
 impart a really balletic feeling to the
 works.

The sound is big and bright, with good
 stereo direction and depth and no au-
 dible distortions. Nothing world-shaking
 here, but a highly listenable disc all the
 same.

LALO

CELLO CONCERTO IN D MINOR

SAINT-SAENS

CELLO CONCERTO IN A MINOR

BRUCH

KOL NIDREI

Pierre Fournier, cellist, with Orchestre
 Lamoureux, Paris, conducted by Jean
 Martinon. Deutsche Grammophon Stereo
 138669SLPM. Price \$5.98.

Fournier is, of course, one of our ma-
 jor talents on the cello and here he gives
 fresh evidence to support his reputation.
 His work on this disc is exemplary, but
 if one must choose the best among the
 works, I would pick the Saint-Saens.
 Here his bowing is magic, such wonder-
 fully modeled phrasing and rich sonor-
 ous tone are a delight to the ear.

Martinon is effective as usual, al-
 though I question some of the balances
 at times. This may, however, be less
 Martinon and more the engineer's fault.
 I may be wrong but this sounds as if
 it were recorded at the Salle Pleyel in
 Paris, a hall for which I have no great
 love. It is a difficult place to record, es-
 pecially for stereo and what seems to
 have happened here is that the over-all
 sound is slightly coarse and the balance
 between cello and orchestra is variable.
 At times the cello covers the orchestra
 and at other times the orchestra covers
 the cello.

Again in this disc I feel a departure
 from the usual M/S technique has been
 made and the result is greater presence,
 more directionality, and more "close-up"
 sound which, if the DGG boys can bring
 under full control, should give us some
 fine records in the months to come.

On The Lighter Side

POP CONCERT IN SOUND

Richard Hayman and his Orchestra. Mer-
 cury Stereo PPS6010. Price \$1.98.

This recording will send the purists
 howling for cover. What Hayman has

done is take snippets of familiar classi-
 cal pieces like "Ritual Fire Dance,"
 "Sabre Dance," "March Militaire,"
 "Danse Macabre," etc. and score them
 for a light pop orchestra and in the
 fullest type of ping-pong stereo imagin-
 able.

I can hear the composers moaning
 now, but for those folks who can take
 or leave their classical music and whose
 taste doesn't encompass the usual con-
 cert-hall versions, this may be just the
 ticket.

One can't deny the arrangements are
 clever (Hayman makes lots of the Bos-
 ton Pops arrangements) and the stereo
 speaks very strongly for itself with
 ultra-close-up of big, bright sound that
 also has depth via the echo-chamber
 route. Plenty of blustery brass and per-
 cussion here—all nice and clean, so turn
 up the volume control.

JEWELS OF THE SEA

Les Baxter and his Orchestra. Capitol
 Mono TI537. Price \$4.98.

If you are familiar with Baxter's other
 record excursions into exotically and
 colorfully scored lush and romantic type
 music, here is more of same.

This is all original writing and here
 he has produced a sort of tone-poem of
 the sea in twelve sections, depicting the
 various moods of the sea. The sections
 are all titled such as "Sunken City,"
 "Sea Nymph," "Dawn Under the Sea,"
 etc. OK, so a lot of this is pure corn,
 but there is a crackerjack orchestra
 playing the undeniably colorful orches-
 trations and, from a strictly sonic view-
 point, this is first rate.

All is nicely balanced and clean, with
 excellent string and woodwind sound
 and, of course, a plethora of Baxter's
 beloved percussion, mostly of the high,
 tinkly variety. As good as it is here,
 stereo is practically mandatory for this
 type of music and I wish *Capitol* would
 send me the stereo version instead of
 the mono.

THE ROMANTIC APPROACH

Stan Kenton and his Orchestra. Capitol
 Mono T1533. Price \$4.98.

Stan has essayed just about every
 style in his constant experimenting with
 new sonorities. Here he is on a romantic
 kick, playing all the evergreen romantic
 ballads like "When Your Lover Has
 Gone," "All the Things You Are," "Once
 in a While," and others of similar per-
 suasion. But how they are played and
 with what an orchestra! Dig this if you
 will... 5 trumpets, 4 trombones, 5
 saxes, 4 mellophoniums (designed for
 Kenton), tuba, drums, bongoes, bass,
 and Stan's piano.

The numbers are mostly slow beat
 stuff you could dance to, but when that
 brass armamentarium lets loose in some
 of Stan's massive outpourings, the walls
 shake. The over-all sound is clean ex-
 cept that when the tuba, mellophoniums,
 and trombones are playing in unison in
 some of the lower registers, there is a
 coarsening of the sound due to the nat-
 ural intermodulation that occurs among
 these instruments when they play in this
 fashion.

Frankly, I prefer the crisp, clean

NOW! A FULL LINE OF FAMOUS **REALISTIC** ELECTRONIC KITS AT RADIO SHACK

- Easy to assemble—enjoy the pride of craftsmanship with very little effort.
- Save up to 42%! Put your savings into quality.
- Look like professionally assembled equipment and last as long.
- Widest assortment of designs to choose from

Radio Shack's whole new family of audio and test equipment kits employs the most advanced designs and engineering concepts known today! They meet the most exacting requirements in performance and appearance. They're easy and fun to build! Critical areas are pre-wired, factory-aligned. Even a novice can follow the simplified assembly manuals. And they're easy to own on No Money Down credit terms. Every kit backed by a money-back guarantee. We show here six kits newly introduced in our exciting 1962 Catalog.

Plug 'n Talk Intercom Kit—Beautifully styled by Realistic! New completely wireless 2-station Intercom System—easy to build yourself. Operates over 1 mile! 3-position switch: talk, listen, permanent. "B" speaker for good voice reception. Rear panel squelch control. Front panel volume. Use it in kitchen, bedroom, sickroom—ideal as a baby-sitter. 117-V power line circuit operates anywhere. 90LX844—\$29.50

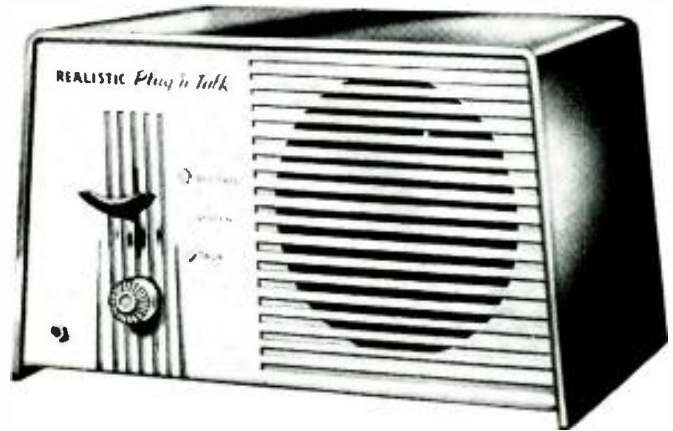

Realistic "Novatherm" Kit—the one and only professional-type electronic thermometer for the home! Compact, supremely accurate! Use in refrigerator, freezer, fish aquarium, lab. At flip of switch reads 2 temperatures in 2 different locations. Instantaneous readings from -20°F . to 120°F . Portable, uses 13c battery. Has "accessory probe"—use in freezer, liquid, even acid. Thermister type. Meter—0-200, a D'Arsonval movement. All 1% resistors. 94LX095—\$19.95

Radio Shack's 1962 Line of Kits Includes All These:

- Stereophonic Preamplifier Kit
- Stereo 140W Basic Amplifier Kit
- 40 Watt Stereo Amplifier Kit
- Complete Stereo System Kits
- Universal Multiplex Adapter Kit
- Hi-Fi 12 Watt Amplifier Kit
- FM Adapter Kit
- Stereo Balance Meter Kit
- Wireless Intercom Kits
- Deluxe Signal Generator Kit
- Deluxe VTVM Kit
- Standard VTVM Kit
- Ultra-Modern Tube Tester Kit
- 500W Variable AC Supply Kit
- VOM Kit with $4\frac{1}{2}$ " Meter
- Signal Generator Kit
- AC VTVM Preamplifier Kit
- Electronic Photo Relay Kit
- "Novatherm" Thermometer Kit
- 5-Tube Teakwood Radio Kit
- 2-Transistor Home Radio Kit
- 6-Transistor Portable Radio Kit
- Transistor Experimental Lab Kit

See complete specifications of these fine kits in Free Catalog



Teak AM Radio Kit. 5 tube superhet circuit. Handsome teakwood case. 90LX637—\$12.95



6 - Transistor Radio Kit. Major parts pre-mounted. Easy to do and save! 90L636—\$16.95



30 - in - 1 Transistor Experimenter Kit. Build 30 different circuits! 98LX375—\$18.95



Stereo Balance Indicator Kit. Top quality! Gold anodized case. Easy to build. 91L547—\$5.95



Send today for **FREE** 1962 Catalog

Gentlemen:

Please send me your giant new 340-page Electronics Catalog of over 100,000 items and every exciting supplement for one full year—all FREE and POST-PAID.

Your Name -61L6D

Your Address

City and Zone

State

For a Friend 61L6D1

Address

City and Zone

State

Mail coupon to

RADIO SHACK Corp.
730 Commonwealth Ave.
Boston 17, Massachusetts

**BOOST
YOUR
INCOME**



**FREE
BOOKLET
TELLS YOU
HOW**

**HAVE
LESS
COMPETITION!**

A proven formula for success is to get in on the ground floor of a booming business. Mobile radio is a booming business. All around, you can see two-way mobile-radio antenna towers springing up—each one a possible new client for you. Most of this work is done on a contract basis with payment 12 months a year. There's little competition . . . few fussy customers to satisfy . . . a welcome change from AM/FM and TV repair! It's not too late to make a start toward bigger money!



Lampkin 105-B Frequency Meter. 0.1 to 175 MC and up. Price \$260.00, net.
Type 205-A FM Modulation Meter. Range 25 to 500 MC. Price \$270.00, net.

NEW: THE PPM METER—AN ACCESSORY FOR THE TYPE 105-B. ACCURACY 0.0001%—FOR SPLIT-CHANNEL FREQUENCY CHECKS ABOVE 50 MC. PRICE, \$147.00.

LAMPKIN LABORATORIES, INC. MFM DIVISION BRADENTON, FLA.

MAIL COUPON TODAY!

LAMPKIN LABORATORIES, INC.
MFM Division, Bradenton, Florida

At no obligation to me, please send free booklet and information on Lampkin meters.

Name _____
Address _____
City _____ State _____

power-drivin' Keaton of the "Intermission Riff" days, but it doesn't seem as if we are ever going to get any more sound like that. Once again, this would have benefited greatly by stereo and should be the version to buy if you are so equipped.

TAPE TOPICS

About the only new thing to report on in the tape world isn't strictly tape. *Westrex* has marketed a combination transistorized radio with a unique playback system. This uses the cartridge concept, the cartridge itself being a gray plastic affair, quite large by other cartridge standards—measuring roughly 3" x 4" x 2½" thick. A belt of red vinyl, about 1 inch wide, is looped around the playback slot after the cartridge. Twelve individual selections are recorded on the belt and each is individually selectable, *via* a sort of cueing wheel.

Now here is the kicker . . . the recordings on the belt are reproduced by a tiny needle! Yessir, you can drop this needle onto any of the 12 channels and out of the speaker comes some fairly respectable sound. The amount of needle scratch I heard was negligible. You can play the belt through in automatic sequence, which will give you about an hour and a half of music or you can play what you wish *via* the selector wheel.

Is there any future for this sort of thing? I dunno. I can't see why a needle should have any advantages, other than cost, over a conventional magnetic head. There would seem to be a wear factor and the size of the cartridge would appear to be a stumbling block. On the other hand, who knows what the engineers can come up with after further refinement?

**HAYDN
SYMPHONY #101 IN D
MOZART
SYMPHONY #10**

Vienna Philharmonic Orchestra conducted by Herbert von Karajan. Victor Stereo FTC2080. Price \$8.95.

Herr von Karajan here and with results if not quite as salutary as other discs, at least worth listening to. His approach to the Haydn I thought a shade too pedantic and a bit stiff, while the Mozart he whipped up the tempi here and there and inflicted a few other mannerisms which keep it out of the top bracket.

Oddly enough, the small deficiencies in sound noted elsewhere have been cleared up on this tape. There is no stridence at all here—all is bright and clean, with beautiful woodwind sound. Reverb hasn't increased much but enough to lend some depth. Direction here was excellent and over-all balances well handled. The increase in orchestral detail and the very definite central image leads me to believe that they are now employing American 3-channel techniques in Vienna, which is all to the good, especially as one might anticipate its application to some forthcoming operas. ▲

Amazing "New Fun" AND VERSATILITY . . .
with your Hi-Fi, Tape Recorder or Record Player. Send 10c for Audio Accessory Catalog A-401W.
SWITCHCRAFT, INC.
5577 N. Elston Ave., Chicago 30, Ill.

TV PICTURE TUBES All Aluminized Glass Types **BUY DIRECT AND SAVE**
• 12LP4—\$8.95 • 17BP4—\$9.95 • 21AL/ATP4—\$16.75 • 24DP4—\$24.50 • 27EP4—\$39.95
All Types Available
These tubes are made from reprocessed glass. All materials including Electron gun are brand new. All Prices with old tube F.O.B. Chicago

PICTURE TUBE OUTLET FREE . . . Write for complete Picture Tube list.
2922 MILWAUKEE • Chicago 18

**FAST, DEPENDABLE
TUNER
REPAIR SERVICE**

It just makes sense that a manufacturer of tuners should be better-qualified, better-equipped to offer the most dependable tuner repair and overhaul service.

Sarkes Tarzian, Inc., pioneer in the tuner business, maintains a complete, well-equipped Factory Service Dept.—assisted by Engineering personnel—and staffed by specialized technicians who handle ONLY tuner repairs . . . on ALL makes and models.

Tarzian-made tuners received one day will be fixed and shipped out the next. Cost is only \$8.50 and \$15 for UV combinations. That includes ALL parts and labor, and a 6-month guarantee against defective workmanship and parts failure due to normal usage. Replacements available at low cost on tuners beyond practical repair.

Tarzian-made tuners are identified by this stamping. When inquiring about service on other tuners, always give tube complement . . . shaft length . . . filament . . . voltage . . . series or shunt heater . . . IF frequency . . . chassis identification. All tuners repaired on approved, open accounts. Check with your local distributor for Sarkes Tarzian replacement tuners, replacement parts, or repair service.

ALL MAKES
ONLY \$8.50 INCLUDING ALL PARTS and LABOR
24-HOUR SERVICE 6-MONTH WARRANTY
Tuners Repaired on Approved, Open Accounts

SERVICE MANAGER • TUNER DIVISION • DEPT. 1
SARKES TARZIAN INC.
east hills de dr. • bloomington, indiana
edison 7-7251
TELEPHONE: 362-1234 • 362-5678 • 362-9012

Squelch Circuit for Wireless Intercom

By L. M. DEZETTEL / Allied Radio Corp.

An unusual circuit that provides for speaker muting between calls and keeps out triggering transients.

EARLY models of the wireless intercom, using house wiring for signal transmission, were subject to considerable noise and hum pickup. Annoying "hash" in these units often led the user to reduce speaker volume to the point where he would miss incoming calls.

This deficiency has been largely overcome with the signal-operated squelch to be described. With the addition of this circuit, only receipt of a desired signal "opens up" the intercom's audio stages for amplification. During standby periods, the speaker remains silent. The system herein described is used by Allied Radio in its "Knight-Kit" wireless intercom. It is designed to provide speaker muting between calls and render the unit insensitive to sharp transients which tend to falsely trigger the squelch.

Basic Circuit

A block diagram of the intercom is shown in Fig. 1. It can be considered a radio-frequency transceiver. When the selector on the front panel is thrown to the "Talk" position, the loudspeaker functions as a microphone and voice currents are built up in the three-stage amplifier V_2 , V_3 , and V_4 . Audio power modulates the oscillator V_1 . The radio-

The circuit, just described, is subject to all manner of interference: from sparking of electric motors and a variety of other transient disturbances existing along the power line.

The Squelch Circuit

The heart of the squelch circuit is V_2 , a tube which has a dual function. When the intercom is on "Talk," it acts as a conventional mike preamp stage to amplify the low-level output of the speaker (operating as a microphone). On "Listen," however, the received signal is adequate to drive the circuit without an assist from a preamp stage—and the tube is freed for squelch purposes. All necessary connections are made as the selector switch is thrown from the "Talk" to the "Listen" position.

A schematic of the stages involved in the squelch action is shown in Fig. 2. The output of the detector, audio with a d.c. component, appears at the top of the volume control where a split-up occurs. Audio proceeds to the grid of V_3 for amplification, while d.c. (rectified carrier at several volts negative) is applied to the grid of the squelch tube V_2 . The resting plate current of V_2 drops under the biasing effect of the signal. The direct result is a rise in V_2 plate

currents which happen to occur at frequencies on, or near, 180 kc. The effect of this interference is to open and close the squelch with an audible burst of noise in the loudspeaker. Fig. 2 shows the method of preventing this. A 470,000-ohm resistor and a .1- μ f. capacitor in the screen circuit form an RC time-constant circuit which grounds noise transients. The values were chosen to provide enough delay to reduce impulse-type noise which is, characteristically, of short duration. The desired signal experiences little significant loss in the RC network.

Performance

In operation, the circuit performs well under weak-signal conditions one of the more important criteria for judging squelch action. With approximately 58 μ v. of r.f. signal on the line, the squelch opens up the controlled audio stage for usable signal reception. In the absence of the carrier there is about a 50-db reduction in loudspeaker output, a figure that cuts objectionable pickup below the level of audibility. The sensitivity of the circuit eliminates the need for a squelch-adjusting pot, usually found in older units, for determining the muting threshold. ▲

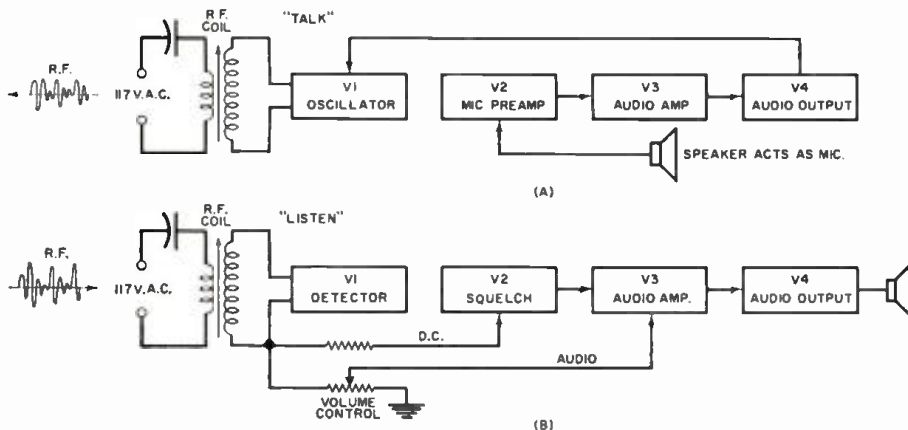

Fig. 1. Block diagrams illustrating circuits used on "talk" (A) and "listen" (B).

frequency output of the oscillator is nominally 180 kc, although it may be retuned and shifted if more than one intercom system is to be used on the same power line. The modulated r.f. is impressed on the line through a link on the r.f. oscillator coil.

Switched to "Listen," the circuit performs as a receiver. The oscillator is now a diode detector formed by the control grid and cathode of the tube. The plate and screen are de-energized and grounded by the switch. The rectified carrier is applied to the volume control and is available for amplification.

voltage of approximately .5 to 25 volts.

The screen of V_2 is tied to the plate of V_1 through a 470,000-ohm resistor. This coupling causes the screen voltage to rise correspondingly and V_2 is now capable of normal amplification. Audio impressed on its grid by the volume control is able to proceed through the circuit and drive the loudspeaker.

The squelch tube can be considered a switch in the screen circuit of V_2 —its operation keyed by signal action. This, however, is not the complete solution to the muting problem since the circuit is still susceptible to power-line tran-

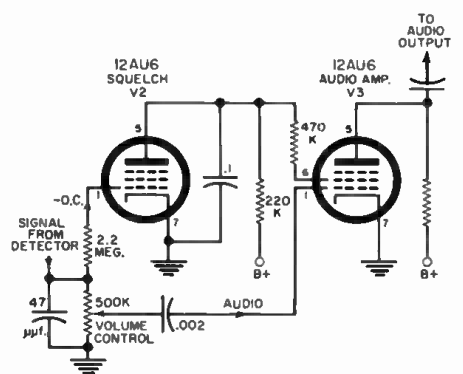
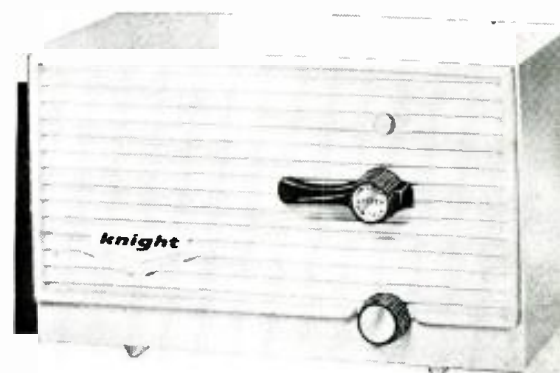

Fig. 2. Simplified schematic diagram of squelch tube and controlled amplifier. The intercom that incorporates the squelch.



LAFAYETTE is America's Citizens Band Headquarters

Complete Portable Communications for Everyone



HE-29A

**PORTABLE—
POCKET SIZE**
Only
6 3/4 x 3 1/4 x 1 1/2"



Ship
to
Shore



On the
Farm



Construction
Work

**NO LICENSES,
TESTS OR
AGE LIMITS**

LAFAYETTE 9 TRANSISTOR CITIZENS BAND "WALKIE TALKIE"

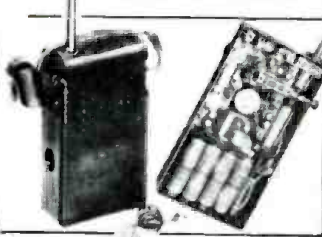

Complete with Leather
Carrying Case, Earphone,
Antenna, Batteries, and Crystal

39.95
2 for 78.88
NO MONEY DOWN

- Completely Wired—Ready to Operate
 - Fully Transistorized—9 Transistors plus 1 Diode
 - Uses Inexpensive Penlight Batteries
 - No License, Tests or Age Limits
 - Comes with Leather Carrying Case, Earphone, Antenna, Batteries and Crystals
- As simple and easy to use as the telephone—and twice as handy. Receives and transmits up to 1.5 miles under average conditions. Weighs only 18-oz. and slips into your pocket. Push-to-talk button operates built-in speaker as sensitive microphone.

LAFAYETTE HE-20A Deluxe CITIZENS BAND TRANSCEIVER

ONLY
109⁵⁰
NO MONEY DOWN

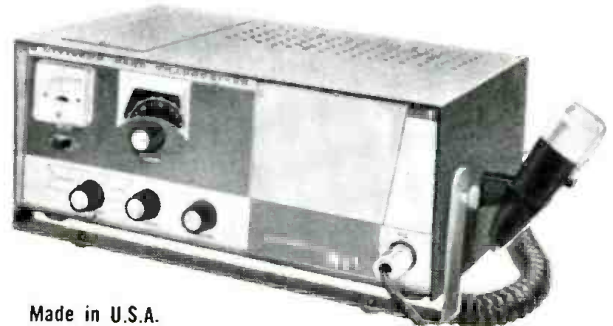

Made in U.S.A.

Now With Added Deluxe Features—

- Pi-Network for Greater Power Output
 - Calibrated "S" Meter
 - 14 Tube Performance, 3 Diodes
 - Built-in 12 Volt Power Supply for Mobile Use
 - Complete with Matched Crystals for Channel 9
- A highly efficient 2-way communications system operating over a distance of up to 20 miles or more depending on terrain. Features

4 crystal-controlled transmit positions and 4 crystal-controlled receive positions. Tuneable superhet receiver covers all 23 assigned channels. Other highlights include dependable push-to-talk ceramic mike & relay, adjustable squelch control, automatic series gate noise limiter and illuminated dial.

LAFAYETTE HE-15A

Made in U.S.A.



SUPERHET

Citizens Band TRANSCEIVER

- Completely Wired—Not A Kit
- 5 Crystal-Controlled Transmitting Positions
- Tuneable Receiver Over Full 23 Channels
- High Output Ceramic Microphone
- Complete with Transmitting Crystal for Channel 9

A compact, precision transmitter and receiver covering up to a 20 mile or more radius, depending upon conditions. The HE-15A features an effective full-wave variable noise limiter, planetary vernier tuning, RF and microphone jack, on front panel. 12 tube performance from 4 dual-function tubes, 2 single-function tubes, 2 rectifiers.

HE-19 Telescoping Whip Antenna	Net 3.95
HE-16 Power Supply for 12 Volts	Net 10.95
HE-18 Power Supply for 6 Volts	Net 10.95

ONLY
59⁵⁰
NO MONEY DOWN

NOT A KIT

LAFAYETTE All-in-One CITIZENS BAND MOBILE ANTENNA

6.95

HE-800WX

- Chrome Swivel Base
- Stainless Steel Spring
- 102 1/2" Stainless Steel Whip for Optimum 11-Meter Performance

Chrome swivel ball mount base designed for mounting on any surface. Stainless steel spring holds rod in properly adjusted position and prevents rod damage from shocks and blows. Stainless steel whip for maximum resiliency and strength.



NEW! LAFAYETTE RADIO FIELD INDICATOR

6.95

- Continuously Indicates Transmitter Output
 - Rugged 200 ua Meter Movement
 - Requires No Electricity, Batteries or Transmitter Connection
- Check the performance of marine, mobile or fixed transmitter. Features a 200 ua meter movement with variable sensitivity control. Earphones can be plugged in for an aural check of output. Antenna extends from 3 1/4" to 10 3/4". Magnet on bottom plate allows easy mounting on car dash or metal surfaces. Size, less antenna, 3 1/8"W, 2 3/4"H, 2"D.

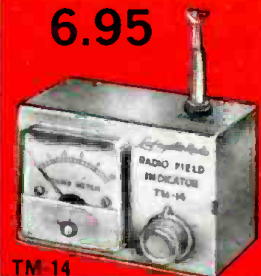

TM-14

LAFAYETTE RADIO

SEND MAIL ORDER TO LAFAYETTE RADIO
111 JERICHO TURNPIKE
SYOSSET, LONG ISLAND, NEW YORK

PLEASE INCLUDE SHIPPING CHARGES WITH ORDER.

OTHER LOCATIONS	NEW YORK, N. Y. 100 6th Avenue	NEWARK, N. J. 24 Central Avenue	PARAMUS, N. J. 182 Route 17
JAMAICA, N. Y. 165-08 Liberty Avenue	BRONX, N. Y. 542 E. Fordham Rd.	BOSTON, MASS. 110 Federal Street	PLAINFIELD, N. J. 139 W. 2nd Street

LAFAYETTE

Engineered To Professional Standards
... Designed For The Home ... Dedicated To Music

STEREO HIGH-FIDELITY COMPONENTS



NEW! LAFAYETTE LT-700 **Criterion**™ FM STEREO MULTIPLEX TUNER

Ready for Stereo and no Adapter Needed... opening a new era in stereo, the new Lafayette Criterion FM Stereo Multiplex Tuner is entirely self contained with its own built-in multiplex facilities. Capable of achieving the highest Laboratory Standards, its exceptional selectivity and sensitivity together with drift-free AFC performance insures effective reception of even the weakest multiplex or monaural FM signals.

Made in U.S.A.

FACTORY WIRED & TESTED **124.50**



Made in U.S.A.

KT-250A 50 WATT INTEGRATED STEREO AMPLIFIER

KT-250A **74.50**
in Kit Form

LA-250A **99.50**
Completely Wired

- Separate Bass & Treble Controls
- 3rd Channel Output
- Response: 15-40,000 cps \pm .5db (at normal listening level)
- 50-Watts Monophonically—25 Watts Each Stereo Channel

Pacesetter quality, performance and design. Features include: unique "Blend" control for continuously variable channel separation—from full monaural to full stereo, 4-position Selector, Mode, Loudness and Phase switches. Individual bias and balance controls. Harmonic distortion, less than 0.25%. IM distortion, less than .5%. Hum and noise 77db below full output.



Made in U.S.A.

KT-600A **Criterion**™ PROFESSIONAL STEREO CONTROL CENTER

KT-600A **79.50** LA-600A **134.50**
in Kit Form Completely Wired

- "Null" Balancing System
- Response 5-40,000 cps \pm 1 db
- Bridge Control Provides Variable 3rd Channel Output
- Tape Head Playback Equalization for 4-Track Stereo
- Variable Cross Channel Signal Feed Eliminates Hole-In-The-Middle Effects

Sensitivity 2.2 mv for 1 volt out. Dual low impedance "plate follower" outputs 1500 ohms. Less than .03% IM distortion; less than .1% harmonic distortion. Hum and noise 80 db below 2 volts.

New LT-200 MULTIPLEX ADAPTER

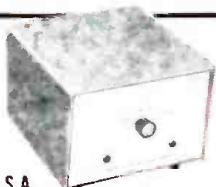

Made in U.S.A.

FACTORY WIRED
& TESTED
47.50

Now enjoy stereo with all the fidelity and convenience that only FM can provide by adding this brilliant new multiplex adapter to your tuner. Performs beautifully with virtually any late model wide band tuner equipped with a multiplex output. Front panel selector switch provides for On-Off, Mono-FM and Stereo FM, while pilot lights indicate when power is on and when adapter is operating stereophonically. Complete with enclosure and all necessary audio cables.

KT-550

Criterion™

100-WATT
BASIC STEREO
AMPLIFIER

Made in U.S.A.

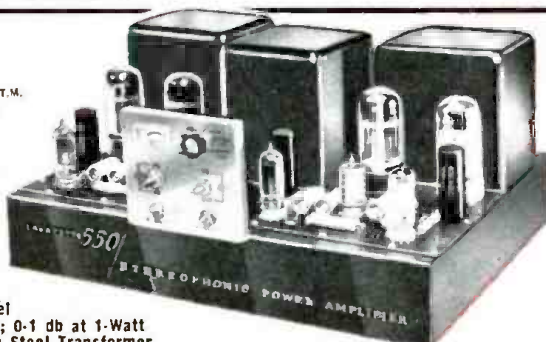

- Rated at 50-Watts per Channel
- Response from 2-100,000 cps; 0-1 db at 1-Watt
- Massive Gain Oriented Silicon Steel Transformer
- Multiple Feedback Loop Design (over 50 db)
- Metered Calibration Control Panel
- Absolutely Stable Under Any Conditions of Load

A new "Laboratory Standard" dual 50-watt amplifier guaranteed to outperform any basic stereo amplifier on the market. Advanced engineering techniques plus the finest components ensure flawless performance. Distortion levels, so low they are unmeasurable. Hum and noise better than 90 db below 50-watts. Complete with metal enclosure.

LA-550 **134.50**
in Kit Form

KT-550 **184.50**
Completely Wired

Lafayette's NEW Easy-Pay Plan.
NO MONEY DOWN

FREE!

YOURS FOR THE ASKING ~

LAFAYETTE RADIO, DEPT. RK-2-1
P.O. BOX 10, SYOSSET, L. I., N. Y.



Send FREE 1962 Catalog featuring the complete line of Lafayette Stereo Components.

\$ Enclosed for Stock No.

Name _____

Address _____

City _____ Zone _____ State _____

ALUMINUM DIALS AND NAMEPLATES

By HERBERT FRIEDMAN

Small lithographic plates may be employed for custom dials and nameplates to dress up prototype and experimental models of electronic equipment.

MANY a fine piece of prototype amateur, experimental, or even custom-shop equipment is marred by a poorly made dial or nameplate—reflecting very little credit on the builder who has expended so much time and effort in constructing the instrument itself.

Admittedly, if there is no commercial nameplate meeting the requirements, the easy and usual recourse is to a grease pencil, "Labelon," or "Eveready" tape. Yet, if we consider how commercial nameplates are made, it becomes apparent that a process exists whereby quality dials and nameplates can be made without difficulty right on the workbench.

Commercial nameplates—be they of anodized aluminum, etched aluminum, or just plain paper—are generally made through either screen or offset printing. For our purpose only the offset process will be considered.

In the offset process a lithographic (litho) plate is prepared on which the characters or background are represented with ink (or special resist). The ink is transferred by a "transfer blanket" to the material used as a nameplate.

It is the litho plate, usually made of aluminum or zinc, which gives us the basis for "custom-made" aluminum nameplates. Basically, a litho plate is a piece of aluminum coated with a photo-

sensitive diazo compound. When a litho plate is exposed to light through a negative and then developed, the diazo areas which are not exposed are dissolved and removed by the developer. The exposed diazo compound remaining on the plate has the ability to absorb ink. Normally, the plate is inked, locked in an offset press, and then used to print nameplates.

If a fast-drying ink is combined with the developer, the litho plate is developed and inked simultaneously. When the ink is dry, the litho plate itself can be used as a dial or nameplate. The inked litho plate appears as the usual nameplate—aluminum characters with a color background or colored characters with an aluminum background. The plate, being the approximate weight of foil, can be trimmed with scissors, shears, or a paper cutter.

The processing of a litho plate is not

similar to nor as difficult as the processing of photographic printing paper. The processing of a litho plate is performed under subdued room illumination. As for developing-inking, a small quantity of developing ink is poured on the exposed litho plate and rubbed in with a damp sponge. That is all there is to it. The process is quick and inexpensive. In less than five minutes an entire 8"x10" plate of nameplates can be made at a cost of under three dollars.

While a negative is necessary for the preparation of a litho plate, the usual photographic negative is not needed. The original dial or nameplate drawing can be used as the negative. In this instance a reverse nameplate is produced. Fig. 1 is the original drawing of an instrument dial. By using the drawing as a negative, a completed dial appears as in Fig. 2. For sharp characters, the drawing must be prepared on a very thin material since the amount of "spill" of the exposing light source is a direct function of the thickness of the drawing base. A .0025 matt-surface, polyester drafting film will give the sharpest reproduction.

The artwork can be prepared in many ways. Fig. 4 shows an instrument dial lettered with *LeRoy* (*LeRoy* or *Letter-guide* produce the neatest lettering). Maximum density is achieved in the lettering by using an acetate drawing ink.

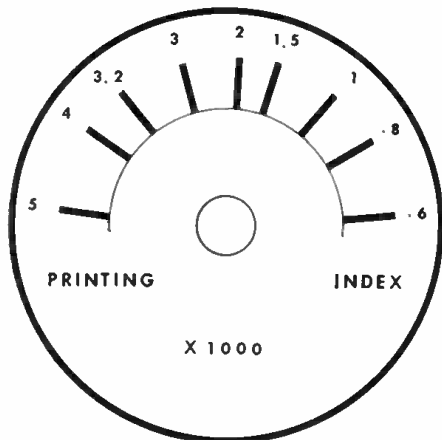

Fig. 1. The desired dial drawing, prepared by combination of adhesive letters and ink.

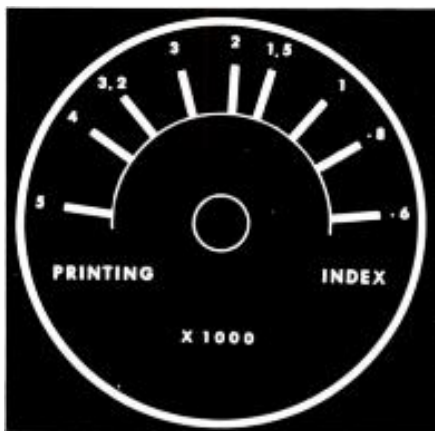

Fig. 2. The use of the drawing as a negative produces this negative dial directly.

Fig. 3. Print-quality nameplates are made by using adhesive letters and lines.

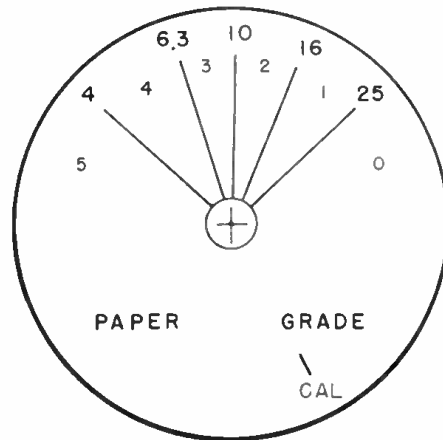

Fig. 4. Dials may be made with *LeRoy* lettering. Intermediate negative produces positive.

It is very important in working directly from the drawing that the characters be a dense black. If the inking of the drawing varies from light to dense black, this disparity will be even more pronounced on the nameplate.

If print-quality characters are desired, the letters and lines can be done with adhesive characters similar to *Artype*. In this instance the characters are arranged as desired and then pressed against the polyester film. The completed drawing appears "professional" and produces quality of the type illustrated in Fig. 3. For complex dials, adhesive characters can be combined with inking—in which case the adhesive characters should be applied after the inking. The dial shown in Fig. 1 is such a combination.

When the drawing is completed it is placed face up on a litho plate and locked in a printing frame or covered with a piece of weighted glass. The plate is then exposed for two minutes by a No. 2 photoflood placed 12 inches from the drawing. After exposure, developing ink is rubbed over the plate until the desired density is obtained. A water rinse removes the excess ink and the nameplate is completed.

For positive dials, Fig. 1, an intermediate negative must be used. A lithographic film is necessary for maximum contrast, however a high-contrast film such as Contrast Process Ortho will give adequate results. If you are unable to make your own negatives, the local litho supplies dealer can recommend a negative processor.

The nameplate can be mounted either with screws or contact adhesive although the latter will give the easiest and firmest mounting, particularly on curved surfaces.

While it is possible to assemble the necessary supplies from various sources, much time and effort can be saved by purchasing a Nameplate and Panel Kit. These kits sell for around seven dollars and contain the required supplies: 8x10 litho plates, developing ink, three sets of adhesive letters, printing glass, and mounting adhesive. Such kits are available from some of the larger electronic parts dealers, *Allied Radio* for one, and from the *Kcil Engineering Co.*, 4356 Duncan Ave., St. Louis 10, Mo. ▲



"He said he would take the set out and clean it off when we paid the bill."

Introducing the perfect mate for any TV/FM antenna

NEW TRANSISTOR JERROLD® POWERMATE

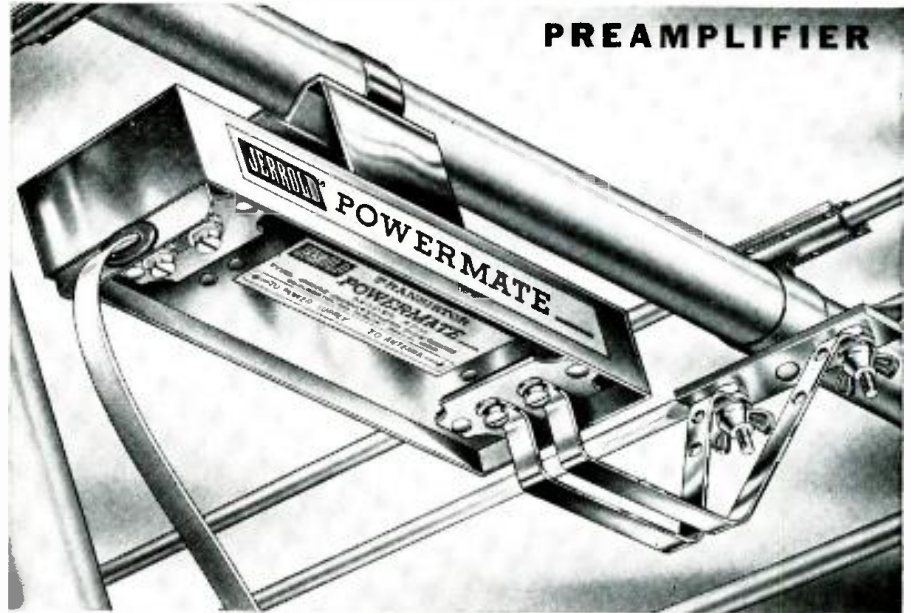

**mounts on boom, mast, wall, window...
offers highest gain, lowest noise figure**

Here's the preamplifier for every TV antenna in your area, whether new or up for years! The exclusive universal bracket of the new JERROLD Transistor POWERMATE permits mounting directly on the antenna boom (for greatest boost before download losses) or at *any* other point—along the mast, on the wall or windowsill, behind the set—anywhere your best judgment dictates.

And look at this gain: An average of 13.9db at Channel 13 and 18.25db at Channel 2—by far the highest in the business! This remarkable gain gives any antenna system the lowest System Noise Figure obtainable—the key to better pictures.

See your distributor today, or write for special bulletin describing System Noise Figure.

Only \$39.95 list, complete with power supply

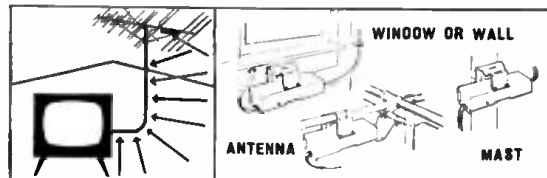

MOUNT IT AND FORGET IT

On the antenna or anywhere along the download, POWERMATE is up for good. Same 300-ohm lead that carries signal also carries 15 volts ac to POWERMATE. No tubes, no batteries to replace.

REMOTE A-C POWER SUPPLY

installs on or near receiver, draws less current than an electric clock. No polarity nuisance when attaching to lead, no danger of damaging the transistor.

JERROLD® ELECTRONICS CORPORATION
Distributor Sales Division, Dept. IDS 183
The Jerrord Building, Philadelphia 32, Pa.

Jerrord Electronics (Canada) Ltd., Toronto, Ontario
Export Representative: CBS International, New York 22, N.Y.

AMERICA'S LEADING MANUFACTURER OF TV-FM RECEPTION AIDS AND MASTER-ANTENNA-SYSTEM PRODUCTS

how often
could you
have used...



an Xcelite "Seizer"?

Handy as an extra hand or helper. Clamps lightly or tightly ... for moments or minutes.

two-position snap-lock

slim, serrated jaws

Outreaches, out-holds needle-nose pliers. Hardly a spot too small for it. Approx. 6" long. Dozens of uses: Holds and positions wires for soldering ... retrieves small parts from inaccessible places ... it's a heat sink. Two-position snap-lock won't slip, yet releases with a twist of the fingers. All stainless steel—precision machined and tempered for smooth action and years of service.

2 Models: No. 43H curved nose and No. 42H straight—Ask your distributor to show you Xcelite Seizers today.



XCELITE, INC. • ORCHARD PARK, N. Y.
Canada: Charles W. Pointon, Ltd., Toronto, Ont.

Personal, Portable TV

(Continued from page 40)

opens out with little more difficulty than a road map (and goes back together easier than some). Most of the circuitry is on three plug-in printed boards that fit around the neck of the tube. To free the boards, you must remove the two metal strips that support them at the top (Fig. 2). The shorter strip is released by removing the one screw (circled) that holds it. The longer strip is held by the two screws circled in Figs. 2 and 3. Two other screws, circled in Fig. 3, must also be removed to free the heat sink for the horizontal output transistor, which is attached to one of the boards.

With the boards removed (Fig. 5) you can reach anything on or off them with ease. Most connections to and from the boards are made through the keyed, multiple, plug-in sockets visible on the chassis. A few others are made through clearly identified leads that can also be unplugged (Fig. 5). Board B includes the video i.f. and detector section. Sound, video-amplifier, and sync circuits are on board C-D. Vertical and horizontal sweep circuits fill board E-F. Component sides are shown in Fig. 5. Component, voltage, and connector markings are indicated on the wiring side.

How about the availability of replacement parts, service, and service data? Sony is making the same effort to provide these that it has done with its radios. The set comes with a 90-day warranty on labor and a year on parts. A network of manufacturer installations will provide service and/or parts, but service data, in preparation at this writing, will be available to independents.

Most parts will take domestic replacements. The manufacturer obligingly provides on request a list of domestic equivalents for most of the transistors used. For some of the special types however, such as certain transistors used in the sweep circuits and the tuner, there are no such equivalents. This also applies to the picture tube. Anxious to avoid replacement problems, Sony is introducing the TV set in one part of the country at a time, as it can be sure that replacements and service will be available.

The set's schematic is generously marked with waveforms, and amplitude designations are indicated. Obviously, the scope is going to be a major troubleshooting instrument when service is needed.

Although service techniques will differ from those used on tube-TV receivers, they should not be radically different from the methods required on the two other transistor sets already on the market. For that matter, the techniques probably will not differ much from those that will be useful for other transistorized TV receivers not yet born. Such sets are inevitable in the future. The service technician, as he has done in the past, will doubtless take these innovations in stride. ▲

PURCHASING A HI-FI SYSTEM?

TIME PAYMENTS AVAILABLE
Up to 2 years to pay!

Send Us
Your List Of
Components
For A
Package
Quotation

YOU CAN BUY
WITH CONFIDENCE
AT AIREX

All merchandise is
brand new, factory
fresh & guaranteed.

Free Hi-Fi Catalog

**AIREX
RADIO
CORPORATION**

85-R Cortlandt St., N.Y. 7, WO 4-1820

- Jim Lansing*
- Altec Lansing
- Electrovoice
- Hartley*
- University
- Acoustic Research
- Janszen • Jensen
- Wharfedale
- USL Citizen Band
- Gonset • Mallinckroft
- Texas Crystals
- International Crystals
- Concertone • Viking
- Bell • G.E.
- Weathers
- Harman—Kardon
- Eico • Pilot
- Sherwood*
- ESL
- Frazier
- Dual Changer
- Bogen • RCA
- Dynakit • Fisher
- H. M. Scott
- Thorens*
- TEC. Amps & Tuners
- DeWald • National
- Superscope
- Sony • Roberts
- Challenger
- Wallensak
- Garrard • Norelco
- Miracord
- Glaser-Steers
- Rek-O-Kut
- Polytronics
- Tandberg*
- Fairchild • Conrac
- Pickering • Sonar
- Audio Tape
- Magnecord*
- Rockford Cabinets

*Fair Traded

**YOU
SAVE
MONEY!**

RUSH US YOUR
LIST OF HI-FI
COMPONENTS
FOR A SPECIAL
QUOTATION
WRITE FOR FREE
AUDIO DISCOUNT
CATALOG A-15

New low prices on amplifiers, tuners, tape recorders, speakers, etc.

KEY ELECTRONICS CO.
120 LIBERTY STREET
NEW YORK 6, N.Y.

IF LICENSING itself has not swept the country from coast to coast, it cannot be said that all legislation pertaining to the service industry has experienced the same sort of slow going. Laws requiring the proper labelling of picture tubes with respect to whether they are all new or have been rebuilt, for example, are now in force in three states, although pressure for legislation of this type developed many years after the first license bill was proposed. Ohio and Pennsylvania are the two recent states to get on this bandwagon. Legal requirements and obligations of service dealers who sell replacement tubes are essentially the same as in New York State, where a similar law went into effect over a year ago. For further details, see this column in our issue of November 1960, page 106.

In Ohio and Pennsylvania, the labelling laws were supported by the statewide service associations. There is good reason for the fact that industry groups are having less trouble getting such regulations than has been the case with licensing: another powerful interest is also promoting labelling. The big glass manufacturers who produce the CRT shells have a stake in the matter. Three states out of 50 doesn't sound like an important trend—until we consider that these three account for 21 per-cent of the total U.S. population and 23 per-cent of all replacement picture tubes sold in the nation.

California Apprentice Program

On another front, the apprentice training and journeyman program fostered by the California State Electronics Association is well under way. State certificates are being issued to service technicians in that part of the country right now. Since CSEA's own complete program operates in addition to the official one, many of these men are also receiving association certificates designating them as master technicians or in other categories. State journeyman certificates are being issued to men who have passed the CSEA apprentice training program, another CSEA-nurtured project.

The apprenticeship program starts out with trainees who are placed in the shops of association members at half of journeyman pay. Training standards and requirements have been worked out in cooperation with local educators, who function on the Trade Apprenticeship Committee. A carefully planned course in theory and manipulative skills, involving classroom and lab work, is coordinated with the shop activity.

One of the goals the proponents hope to realize from their plan is the stabilization of industry wages. (Apprentices advance from the half-pay start to full journeyman wage at stated intervals.)



Euphonics
Euphonics
Euphonics

Euphonics
Euphonics
Euphonics

EXCLUSIVE

Turret action ceramic cartridges

Stereo
Monaural

— Euphonics —

American Made
Immediate Delivery

Euphonics — corporation

Tel: 7-3496 Box 2746
Río Piedras, Puerto Rico U.S.A.

- § Turret action eliminates magnetic hum.
- § Turret action eliminates twisting lead wires.
- § Turret action completely decouples unused needle.
- § Replaces all ceramic stereo cartridges.
- § Replaces most ceramic monaural cartridges.
- § High compliance insures low stylus and record wear.

FREE Catalog of The WORLD'S FINEST GOV'T SURPLUS ELECTRONIC BARGAINS



**AM-142/AIC
MIXER AMPLIFIER**

Used in large aircraft inter-communication systems as a booster. 500 ohm input; 500 ohm output. Operates from 24 VDC with one 28A7 Dual Tube. Size: 3 x 5 x 2". Wt.: 2 lbs. Price—Used... **\$1.95**



**75 MC MARKER BEACON
RECEIVER**

fixed freq. Used in aircraft to receive modulated radio signals, aural and visual indication. From these indications the pilot can accurately check his position with respect to the Radio Range Station. When the signal is being received the tone can be heard in the headset, and the signal lamp on the instrument panel will light. Complete with tubes: 5 6AJ5, 2 6AL5W, 2 28D7W. Has crystal controlled oscillator and 6.9 MC I.F. Operates from 24 VDC. Size: 10 x 5 x 6". Wt.: 8 lbs. Price—Used... **\$4.95**



**AIRCRAFT AMPLIFIER
AM-26/AIC**

Audio Amplifier used in aircraft for inter-communication. Carbon Microphone input. High and low impedance output with volume control. Normally requires DM-32 Dynamotor for operation with 24 Volt DC input and 250 VDC 60 MA output. Complete with tubes: 2 12J5 & 2 12A6. (For conversion to 9 Watt Amplifier, see Surplus Conversion Manual #21. Size: 9 1/2 x 5 1/2 x 5 1/2". Wt.: 6 1/2 lbs. Price—Used... **\$3.95**

HUGE SELECTION:

Hundreds and hundreds of quality surplus items—Receivers, Transmitters, FM Equipment, Telephones, Headsets, Mics., Generators, Motors, Amplifiers, Dynamotors, Power Supplies, Antennas, Transformers, Motors, Test Equipment, Inverters, Cable—Etc. Etc. Previously advertised items still available. Write us your needs. We probably can supply!

SEND FOR FREE CATALOG!

FAIR RADIO SALES
2133 ELIDA RD. • P.O. Box 1105 • LIMA, OHIO

www.americanradiohistory.com

97

**MAKE YOUR
REK-O-KUT
STEREOTABLE
AND TONE ARM
FULLY
AUTOMATIC!
WITH AUTO-POISE***



In all the world, there is no finer record reproducing instrument than the REK-O-KUT Stereotable and Tonearm. Now—REK-O-KUT offers fully automatic operation of Stereotables and Tonearms, with an easily attached accessory called Auto-Poise. Auto-Poise maintains true Stereotable quality because it disconnects completely from the turntable and tonearm during play. You enjoy the faultless tracking of the REK-O-KUT Stereo Tonearm, adjusted for minimum pressure and perfect balance, plus a Stereotable with an impressively lower noise level than that of any other record playing device. Only in this way can you enjoy flawless record reproduction with the convenience of automatic operation. Literature on request.

MODEL APK
Auto Poise only
\$49.95
net

SAVE \$10.00
MODEL AP 320
Auto-Poise with S-320
Stereo Tonearm
\$74.95 net

Model AP-320 Illustrated
Pat. Pending

**REK-O-KUT
STEREOTABLES**

Rek-O-Kut Company, Inc.,
38-19 108th St., Corona 68, New York
44-26

Another benefit that should be noted, not entirely divorced from the wage issue, is some relaxation of the manpower problem. While "tube pullers" of questionable qualification will probably always be available in sufficient numbers, there is now and will continue to be a real shortage of properly trained men to function in the service industry and other areas of electronics. The California approach is bound to encourage more people to enter the industry on a legitimate basis.

Decisions in Indiana

Three affiliates of the Indiana Electronic Service Association recently elected to join NATESA. This trend within IESA began more than two years ago, when ITTA of Indianapolis, a leading affiliate, decided to enter the national. The new groups include FESA-Fort Wayne, RTSEA of Anderson, and TVB of Elkhart. While some groups within the state body are still reluctant to take the step, this increases pressure for state-wide association with NATESA.

Meanwhile ITTA was having other problems in its own back yard, Indianapolis, with the launching of a new, local service company that is promoting itself by offering free TV tube testing in the home. Principals behind the new organization were reported to be six ITTA members, otherwise in good standing, who are trying it out as a sideline.

Considering the past record of such service companies, a group of ITTA members has drawn up charges against the six, on the grounds that such an operation is detrimental to the policies and aims of the association. The six contend that they should not be held responsible for what others may have done. As far as they are concerned, they intend to run a clean, legitimate business offering a service that appeals to a certain type of customer. Taken up at a recent meeting, the matter generated so much discussion that other, pressing business was put aside. Finally, the charges were dropped for the time being, but it is not likely that the matter will rest there. One of the claims made by the six is that they are acting in behalf of all Indianapolis service dealers to combat the effect of drug-store checkers and other, questionable, "free-test" operators.

Thus we have another issue, disruptive of unity, that can easily spread to other parts of the country. How ITTA finally resolves the matter will be of interest to all service people.

Service Income Shifts

That the problem of the drug-store checker cannot be ignored altogether is reflected in a letter to "TSA News," the Delaware Valley organ, sent in by a member. He is primarily concerned with the reasons for his own ultimate decision to join an association, but the ground he covers in the process has other interest. His moment of revelation came last January when his accountant told him that he had made less last year than in preceding years.

KEEP CANDEE HANDEE!

ARC RECEIVERS SPECIAL!
R-19 ARC AIRCRAFT RECEIVER: 28 V., 118-148 Mc. Mfg. by ARC. An A-1 unit in excel. cond. Removed from aircraft. WITH DYNAMOTOR. **\$59.95**
WITHOUT DYNAMOTOR. Only **49.95**
R-22 ARC RECEIVER: FB for light planes! Mfg. by ARC. Excel. cond. 28 V., 510-1600 Kc. **\$49.95**

MANY \$\$\$\$ for 4 U!
We are in urgent need of GRC-9, PRC-6, R-8, R-10, ELECTRONIC TEST EQUIP. NEXT—all types, all conditions! Tell us what you have—today!

APN-1 FM TRANSCEIVER
420-160 Mc. Compl. with tubes. Exc. 1 . . . **\$2.95**
Approx. ship. wt. per unit 25 lbs. TWO for 5.00

APX-6 TRANSPONDER
A midsize warehouse of parts! Blowers, three weather-tight controls, LED status cavity, oval 200 tubes, etc. Includes 3E29 tube. Good . . . **\$9.95**
cond. A STEAL AT ONLY **Weight 40 lbs.**
Conversion Manual **\$1.50**

R-4A/ARR-2 RECEIVER
231-258 Mc. 11 tubes. 11P tuning receiver. See Aug 50 '49 Magazine for conversion. Excellent cond. TWO for **\$5.00**. Each . . . **\$2.95**

A TRIO OF HEADSET BARGAINS!
HS-23: HI Impedance, Leather covered headset. Brand new. Great buy. Only . . . **\$4.95**
HS-33: Low Impedance, Leather covered headset. Brand new. A J. J. Candee Special **5.95**
Hi FI Headset: 15,000 cycles! Brand new with diamond cushions. It's terrific! Only **8.95**
CD-307A Headset Extension Cord: Approximately 5 ft. length. Only . . . **49c**

COMMAND GEAR
This is the fabulous one! 190-550 kc. The receiver you've been looking for . . . **\$9.95**
at only
BC-454: 3-6 Mc. **9.95**
BC-455: 6-9.1 Mc. **9.95**
MD-7 MODULATOR: Special! **3.95**
T-18 ARC-5 Xmt'r 2-1.4 mc. Excel. cond. . . **4.95**
T-19 ARC-5 Xmt'r 3-1 mc. Excel. cond. . . . **7.95**
T-20 ARC-5 Xmt'r 4-5.3 mc. Excel. cond. . . **4.95**
T-21 ARC-5 Xmt'r 5-1.7 mc. Excel. cond. . . **4.95**

NAVIGATION Special
TYPE AN/ARN-6 RADIO COMPASS RECEIVER: R-101/AIN-6. Excellent cond. **\$9.95**
LOOP: AS 313-B. Excellent cond. Only . . . **37.50**
INDICATOR: ID 91B AIN-6. Excellent cond. **9.95**
MOUNTS: MT-273 or MT-274. Excellent. Each **14.95**
Cords and Connectors also available.

All items FOB Burbank or Tucson, subject to prior sale. In Calif. or Ariz. add 4%. Min. order \$3.95.

J. J. CANDEE CO. Dept. EW
509 No. Victory Blvd., Burbank, Calif.
Phone: Victoria 9-2411
ARIZONA DIVISION: 244 So. Park Avenue,
Tucson, Ariz.
Phone Number: 624-2014

**SAY YOU SAW IT IN
ELECTRONICS WORLD**

BC-221 FREQUENCY METER.	Like New Condition Only \$69.50
85kc IF Transformers	ARC-12, New 79c ea. 3 for
BC-603 FM Receiver	20-27.3 Mc. 14.95
B-603 FM Receiver	20-27.3 Mc. Brand New 18.95
BC-923 A FM Receiver	27-38.0 Mc. Brand New 29.95
ART-13 Transmitter	with tubes & meters, used 49.50
BC-604 MF Transmitter	with tubes, Brand New 4.95
Antenna Mast Base	& 3-31P Mast Sections 2.95
BC-191 Transmitter	with tubes, Excellent condition 14.95
GE Computer Tester	with VOM, Selsyns, W.W. pnt., switches, and a load of other parts. . . 12.95
Servo Amplifier Assembly	has 2-6AQ5's and 6J6, Only 3.00
ID-6/APN-4 Indicator	less tubes 2.95
B-442 Antenna Relay	with Meter & Vacuum Capacitor 1.95
ARR-2 Receiver,	11 tubes with CB conversion 4.95
ARC-3 AM Receiver	100-150 Mc. 12.95
ARC-3 AM Transmitter	100-150 Mc. 14.95
1-130A Signal Generator,	100-150 Mc. 7.95
1-95B Field Strength Meter,	100-150 Mc. 7.95
MD-7 Modulator with tubes,	Swinging Chokes, 0-20 Hertz, 525 to 75 MA, 3KV bottled, New . . . 5.95
Swinging Chokes, 0-20 Hertz,	525 to 75 MA, 3KV bottled, New 4.95

Send Money Order or Check with Order
Write for Bulletin No. 33—LOADS OF BARGAINS!
R W ELECTRONICS
2430 S. Michigan Avenue • Dept. EW11
Phone: CALumet 5-1281 Chicago 16, Ill.

This was quite a blow to the reader, an established operator who had considered his position secure for years and who knew he was just as busy as ever.

After a session with his records, he came up with some hair-raising figures. The anticipated rise in overhead was not a serious factor. However, tube sales were found to have dropped 60 per-cent, battery sales 45 per-cent, and accessories 54 per-cent. Although this man's volume of sets handled had gone up (radios by 13 per-cent, TV sets by 18 per-cent), losses in the areas noted were enough to account for the serious drop in profits.

Checking further, he soon discovered that his experience was not unique. Other shops in the area confirmed that the same thing was happening to them. His distributor salesmen also acknowledged the trend. Believing that the reasons for his decreased income involve problems that can only be handled by group action, he elected to join TSA.

Service of Air Purifiers

One of the measures perennially suggested to counteract dwindling profits is diversification into service of products other than TV. To a certain extent, such activity will be inevitable as new electronic devices for the consumer reach the market. The electronic air purifiers that seem to be capturing the public's fancy are a case in point. This equipment is being sold without the growth of correlated service establishments. Nor need there be such growth.

Herman Shore, president of TSADV, has written a letter to the *Philco* people expressing appreciation for their cooperation with independents with respect to service on the "Ionitron" purifiers. The TV service dealer is the "natural" inheritor of work on such devices. He will do himself no harm by getting familiar with the equipment before he finds one on his bench. Our July 1961 issue, incidentally, carried a helpful article.

FTC Wholesale-Retail Stand

At their otherwise successful "Tele-rama" and convention in Atlantic City, New Jersey, members of the Tri-State Service Council heard unpleasant news about a long-term industry problem. For years, service dealers have been hoping to get the Federal Trade Commission to take action against wholesalers and distributors who have sold freely to the public at the same prices they charge legitimate dealers. Basis of the complaints is the fact that unfair competition is involved. An FTC letter, addressed to complaining service dealer Leon Skalish, says there is nothing to stop a distributor from engaging in this practice. Furthermore, a distributor is "under no legal obligation to sell to dealers at prices which will enable them (dealers) to compete with their supplier on sales to consumers. In a case where the distributor sells to consumers at prices which his dealers cannot meet, the distributor is simply making use of his lawful competitive advantage." ▲



CROWN

Professional Tape Recorder

NEW!

"1000" Series

The World's Finest
Recorder in the \$1000 Class

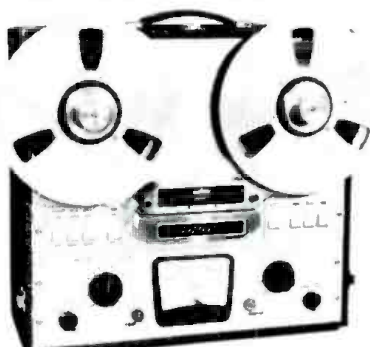

The Ultimate in Performance

Those seeking the best
are buying CROWN

"The New Standard in the Industry"

Foreign Dealers Wanted
Write Dept. EW-11

CROWN INTERNATIONAL

Division of
INTERNATIONAL RADIO & ELECTRONICS CORP.
ELKHART, INDIANA

MAKE YOUR INTEREST IN ELECTRONICS *PAY OFF*

Get
Into . . .

The HIGH PAY — PRESTIGE Field of TECHNICAL WRITING

HERE'S WHAT YOU GET . . .

- 50 Meaty Lessons
- Over 110 pages on Electronics
- Covers ALL Military Specifications
- Real, practical writing projects
- Full consultation privileges
- Many manuals, charts and diagrams
- Low tuition terms
- Employment Assistance
- Close, personal supervision
- AND MUCH, MUCH MORE . . .

ELECTRONICS WRITERS NEEDED NOW—ATWS will train you at home at low cost for a profitable career in TECHNICAL WRITING. Thousands needed in all areas. Get in on the ground floor of this fascinating new field. ATWS offers training specifically designed for the needs of industry. Course includes everything you need to become a top-notch Tech Writer.

YOU ARE JUST A STEP AWAY FROM TOP PAY—Yes, with your present interest in Electronics, you're just a step from the BIG MONEY. Technical Writing is one of the highest paying fields NOT requiring college training. It's tailor-made for YOU—but you must ACT NOW.

THIS COUPON CAN BE YOUR PASSPORT TO SUCCESS
Fill in your name and address and rush coupon for full information. We will prove to you that we can train you without interfering with your present income or job.

CAREER BOOK AND SAMPLE LESSON

American Technical Writing Schools, Inc. Dept. EW-111
5504 Hollywood Blvd., Hollywood 28, Calif.
Please RUSH full particulars.

Name _____ Age _____

Street _____

City _____ Zone _____ State _____

BOTH
FREE

NO SALESMAN WILL CALL ON YOU

TRAINING  AMBITIOUS
MEN FOR INDUSTRY

American Technical Writing Schools, Inc.
5504 Hollywood Blvd.
Hollywood 28, Calif.

Free

ALLIED

444-PAGE ELECTRONICS CATALOG

WORLD'S BIGGEST • MOST COMPLETE

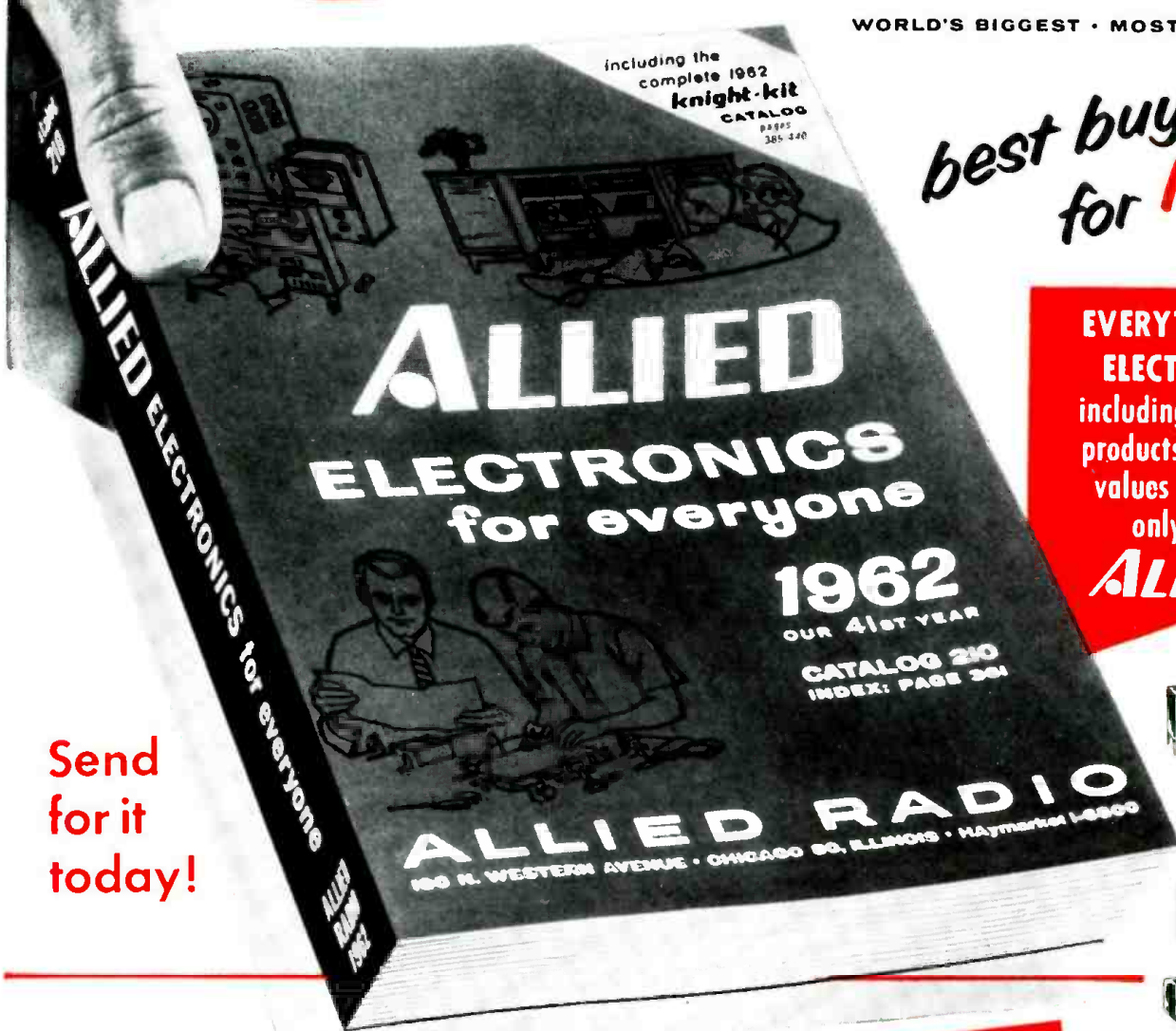

*best buys
for 1962*

**EVERYTHING IN
ELECTRONICS
including exclusive
products & special
values available
only from
ALLIED**

**Send
for it
today!**



**SAVE
MOST
ON EVERYTHING IN ELECTRONICS**

- New Stereo Hi-Fi Systems—Everything in Hi-Fi Components
- New Multiplex Stereo FM • All-Transistor Stereo Hi-Fi
- Money-Saving Build-Your-Own KNIGHT-KITS® for Every Need
- Best Buys in Tape Recorders, Tape, and Supplies
- Citizens Band 2-Way Radios • Short-Wave Receivers
- Amateur Receivers, Transmitters, and Station Gear
- Latest Public Address Systems, Paging and Intercom Equipment
- TV Tubes, Antennas, Accessories • Batteries, Wire and Cable
- Test and Laboratory Instruments • Tools, Hardware
- Huge Listings of Parts, Tubes, Transistors, Technical Books

**NEW Multiplex Stereo FM
All-Transistor Stereo Hi-Fi**

exclusive money-saving KNIGHT® products

SAVE MOST on famous KNIGHT Stereo Hi-Fi—comparable to the best in quality, styling and performance, yet priced far lower. Select super-value KNIGHT components or complete systems (including latest Multiplex Stereo and All-Transistor hi-fi) and save most. KNIGHT products are acclaimed by all those who recognize integrity in design and manufacture and who appreciate value.

NO MONEY DOWN
new on Allied's new Credit Fund Plan
Now—enjoy 50% more buying power—up to 24 months to pay—see our 1962 Catalog for simple details.

SEND FOR 444-PAGE CATALOG TODAY!

Satisfaction Guaranteed or Your Money Back

ALLIED

ELECTRONICS WORLD

BIG PLUS!

in your 1962
ALLIED
CATALOG

includes complete catalog featuring over 90 exciting

knight-kits 
A PRODUCT OF ALLIED RADIO

NEW for '62 and simply great!
available only from **ALLIED**

new
HI-FI KITS

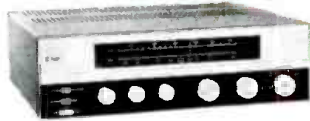

All-In-One FM-AM Tuner-Amplifier Kit with latest built-in MULTIPLEX Stereo FM, less case..... \$129.95



MULTIPLEX Self-Powered Adapter Kit, for Stereo FM reception..... \$19.95



Deluxe Stereo FM-AM Tuner Kit with latest built-in MULTIPLEX Stereo FM..... \$99.95

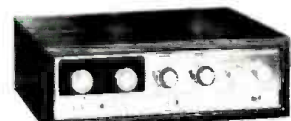

ALL-TRANSISTOR 50-Watt Stereo Amplifier Kit, less case..... \$79.95

new
HOBBYIST KITS

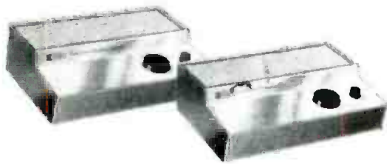

ALL-TRANSISTOR Wireless Intercom System Kit (2 units)..... \$45.90



TRANSISTORIZED Electronic Tachometer Kit. \$24.95



Amazing 100-In-1 Electronic Science Lab Kit..... \$29.95



ALL-TRANSISTOR 2-Band AM-Shortwave DX'er Radio Receiver Kit..... \$19.95

building a Knight-Kit is the most satisfying do-it-yourself experience in the world!

5 BIG REASONS WHY:

- **Convenience Designed**—makes you a kit-building expert—even the very first time!
- **Wonderful to Build**—you'll marvel at the sheer ease of assembly with the exclusive "show-how" manual guiding you like a good instructor.
- **You Own the Best**—you'll enjoy with pride a true custom-built product, professional in its engineering and performance.
- **You Save So Much**—because you buy direct from Allied at our money-saving volume prices—and because you do the easy assembly yourself.
- **Easiest to Buy**—NO MONEY DOWN on Allied's new Credit Fund Plan—easiest terms ever!

MONEY BACK GUARANTEE: Buy any Knight-Kit. Build it! Use it! You must be satisfied or you get your money back!

see more than 90 KNIGHT-KITS

- 21 HIGH-FIDELITY KITS
- 25 HOBBYIST KITS
- 31 INSTRUMENT KITS
- 14 AMATEUR & CITIZENS BAND KITS

KNIGHT-KITS are also available in Canada

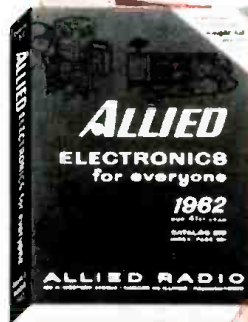

Send for it today!

new

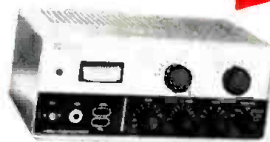

Phone and CW 60-Watt Ham Transmitter Kit..... \$49.95



Mutual Conductance Tube Tester Kit..... \$99.50

- World's Largest Stocks • Lowest Money-Saving Prices
 - Fastest Shipment • Expert Help • Easiest-Pay Terms
 - Satisfaction Guaranteed or Your Money Back
- send for the world's biggest electronics catalog!

Free

ALLIED RADIO, Dept. 199-L1
100 N. Western Ave., Chicago 80, Ill.

Send FREE 1962 ALLIED 444-page Catalog

Name _____
PLEASE PRINT

Address _____

City _____ Zone _____ State _____

RADIO  World's Largest Electronic Supply House

SURPLUS

SILICON RECTIFIERS. All rectifiers listed at maximum peak inverse voltage ratings; approximate forward voltage drop, 1.5 volts.

1N1446	.750 amp.	100 volts	.60
1N1447	.750 amp.	200 volts	.70
1N1448	.750 amp.	300 volts	.80
1N1449	.750 amp.	400 volts	.95
1N1551	1 amp.	100 volts	.80
1N1552	1 amp.	200 volts	.95
1N1553	1 amp.	300 volts	1.10
1N1450	5 amp.	100 volts	1.00
1N1451	5 amp.	200 volts	1.25
1N1452	5 amp.	300 volts	1.50
1N1453	5 amp.	400 volts	2.00
1N1454	25 amp.	100 volts	3.00
1N1455	25 amp.	200 volts	3.50
1N1456	25 amp.	300 volts	4.50
1N1458	35 amp.	100 volts	3.50
1N1459	35 amp.	200 volts	4.00
1N05P7	50 amp.	50 volts	6.00
1N1462	50 amp.	100 volts	7.00
1N1466	75 amp.	100 volts	10.00
1N1467	75 amp.	200 volts	11.00
1N1468	75 amp.	300 volts	12.50
1N05V7	150 amp.	50 volts	16.50
1N1474	150 amp.	100 volts	17.00

X-BAND POWER LEVEL TEST SET, TS-36/AP

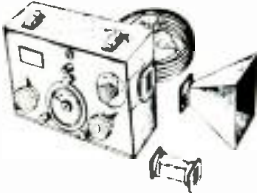

Brand new, in original packing, with accessories. Measures 10 to 30 dbm. 8700-9500 mc.

PRICE \$14.95 each

Brand new power unit, PE162C. Lightweight; approx. 56 lbs. Output 7 volts DC at 3.5 amp and 550 volt DC, 200 mil. Governor controlled with filter. Driven by Jacobsen single cylinder 2 cycle 1 h.p. engine. Units are complete with set of tools, spare parts and manuals. Dim.: 16" x 18 1/2" long, 10 7/8" wide, 18 1/2" high, 10 7/8" high. Over-sens. packaged.

Shipping weight: 90 lbs.

PRICE \$39.95 each



SELENIUM RECTIFIER

full wave
input 12-24-36 volt
will handle approx. 1 1/2 amp D.C.
1 1/8" dia. x 3 1/4" long



PRICE \$1.00 ea.

POWER TRANSFORMER

output 12-24-36 volts
input 100 volts, 50 cycle, single phase
will handle 2 1/2 amps.
steel case hermetically sealed
3 1/2" long x 2 3/4" wide x 4 1/4" high;
weight: 3 1/4 lbs.



PRICE \$2.95 ea.



MINOR SWITCH

10 position, 3 pole with stepper
coil and reset coil 0-12 volt, D.C.,
off-normal non-bridging wiper
approx. dimensions 3 1/2" long x 1 1/2"
high x 1 1/8" wide; weight: 1 lb.

PRICE \$9.95 ea.

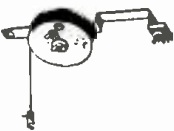

ANTENNA WIRE

150 ft. stranded copper on
windup reel complete

PRICE \$2.95 ea.



12 FT. TELEPHONE SWITCH CORD

3 conductor wire with a
JK-33 and a U-31 GT plug

PRICE \$1.49 ea.



COAX CABLE RG59A/U

50 ft. roll
complete with coax fittings

PRICE \$2.49 ea.

**NO C.O.D.'S
REMIT FULL AMOUNT
WITH ORDER.**

C & H SALES CO.

2176 E. Colorado St. - Pasadena 8, Calif.

Product Test Report

(Continued from page 24)

put produced the same output. Hum levels were lower than Fisher specs, being better than 82 db below 10 watts on high-level inputs and 70 db below 10 watts on phono inputs.

The X-1000 is a rather large, heavy unit, some 16-7/16" wide and 14-3/8" deep and weighing 44 pounds. Its 4-13/16" high panel, finished in brushed gold, matches the Fisher 202-R tuner. The X-1000, selling for \$339.50, is capable of driving any speaker system and has all the flexibility required for any conceivable home music system. It is a worthy companion to the company's 202-R tuner.

RCA WV-120A Power-Line Monitor

For copy of manufacturer's brochure, circle No. 59 on coupon (page 136).

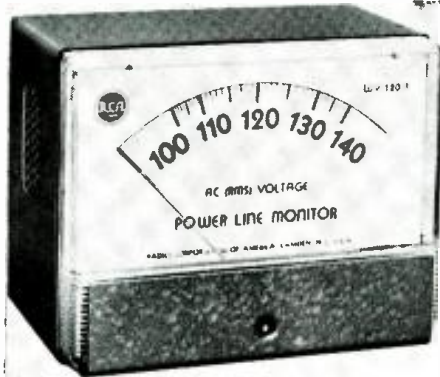

THE RCA WV-120A is a conveniently packaged, expanded-scale a.c. line voltmeter which, when plugged into an a.c. outlet, continuously monitors the value of the line voltage. The instrument is designed for radio-TV service shops, laboratories, and industries where it is necessary to know the line voltage at all times. It is especially useful with variable autotransformers to allow exact voltage adjustment.

The scale of the meter, reading from 100 to 140 volts, has large numbers and a red pointer so that it is possible to take an approximate reading from practically across the room. The meter movement is a moving-vane type that indicates r.m.s. values of line voltage directly, even if the input waveform is distorted.

In using the meter it is important to allow at least a 5-minute warm-up. The meter-movement coil and the series-dropping and calibrating resistors dissipate about 6 watts. If a reading is taken with the instrument cold, it is apt to be several volts too high. After about 5 minutes, though, the reading stabilizes at its correct value.

We checked two samples of the unit against a 1/2% expanded-scale laboratory-type a.c. line

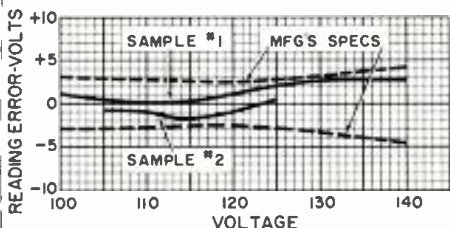

INJECTORALL

THE NEEDLE DOES THE JOB!



TUNER CLEANER AND LUBRICANT
with...
INJECTOR NEEDLE

The leak-proof steel Injectorall Needle lubricates where you need it... you can reach hard-to-get at Wafers without pulling Tuners apart, or even removing Chassis.

The BEST CLEANER on the market today!

INJECTORALL CO. Brooklyn 14, New York

F. M. RECEIVERS

Bargain Prices

\$9.95 to \$44.95

Write for Detailed List EW

Denson Electronics Corp.

Box 85, Rockville, Conn.

- ARC-5 Transmitter—2.1-3 Mc—NEW... \$11.95
- Field Phones #FE-8, w/leather case. Used—OK... \$23.95 (Pair)
- BC-733 DMF Receiver, 10-Tubes—Dynamotor. C.G. Article 2 or 6 Meter Conversion—2X22 Excell. 20 Lbs. \$5.95
- 115 VOLT 60 CYCLE TRANSFORMERS
- Sec. #1—2.5V-23 A.C.T. | Sec. #005-0-005-205 MI- | 5X5X4 - dual 1/2 Shell | Wire Load. 5.95
- Sec. #2—2.5V-23 A.C.T. | Cased. Term's, 4x4 1/2x4 1/2 13 Lbs. 5.95
- Sec. #1—12VCT - 35A. | 8X8X1 1/2 - 15 Lbs. 9.95
- Cased—Lugs 9.95
- Sec. #1 - 0.3V - 22A. | Sec. #2 - 0.3V - 7A. | 36,000 Volt In-put with 1 pr. Socket-15 lbs. 12.95
- Sec. #3 - 0.0V - 2A. | Sec. #1 - 5.0V - 2A. | 4X4-5X3 - 15 Lbs. Cased—Term's 4.95
- Sec. #1 - 1750V - 5MHS. | Sec. #2 - 6.3V - 0A. | Sec. #1 - 170V - 1.0A. | Sec. #2 - 170V - 1.0A. | 5X5X4 - 15 Lbs. 7.95
- Sec. #3 - 2.5V - 1.75A. | Sec. #4 - 0.3V - 10A. | Silent Diodes & Voltage Dumpers make this an unusually versatile unit. Open Frame—Small 9.95
- Sec. #1 - 2.5V - 1.75A. | 18X35-1 Lbs. —Cased 3.95
- Sec. #1 - 12.0VCT - 8A. | Open Frame—Small 9.95
- Gasoline Engine Generator, Variable output 0-21VDC, 50 amps, Ammeter, Voltmeter, Battery or Manual Start, Gas Tank, 17X12X12—10 lbs. Used—OK \$9.95
- Battery is 2201—115VOLT Supply—Input 115VDC (Open the coil) Output 100VAC—3500+1 1X2X2 1 Lb. 1.49
- Silicon Diode-Sylvania—400 PIV -500Ma—New, Gid 6 for 3.00 + 12 for 15.00
- Marker Beacon Recvcr. 75-85 MC-BC 1293-28VDC New \$9.95
- Panel Meter, 30 MH DC, Marked 300 amps, Westinghouse—New 1.49
- RCA Geiger Counter W/15A, List Price 750.00, 10 Geiger Tubes Brand New w/Phones, Case, etc., 10 lbs. 99.50
- Noise Cancelling carbon Mikes, w/cables—4.4, 68—Hand Held Press to Lip—Surplus Price 15.00—New—Now Only 3.95
- Geiger Muller Counter Tube—for Beta-Gamma-Mica Window BS-0—w/specs—Unused 4.95
- Desk Telephone w/Dial—Complete—Standard. 8.95 Like New
- REX RADIO, 84 Cortlandt St., N.Y. 7, N.Y.

voltmeter; our results are shown by the curves (page 104). The manufacturer rates the accuracy of the instrument as $\pm 2\%$ at 120 volts and $\pm 3\%$ at 100 volts and 140 volts. These specs, converted to a reading error in volts, are shown dashed in the figure. Note that both of the samples

checked were well within the accuracy specified; one of the samples reading about .8% high and the other reading about .9% low at 120 volts. The instrument has convenient mounting holes so that it can be hung on a wall in the service shop. The price of the WV-120A is \$14.95. .E.W.

Eico Model 260 A.C. Volt-Watt Meter

For copy of manufacturer's brochure, circle No. 60 on coupon (page 136).

ANOTHER unit in the new Eico line of professional and industrial test equipment is the Model 260 a.c. volt-watt meter. This instrument will be of great value to those who are interested in making accurate audio measurements of frequency response, power response, and audio voltage levels at values ranging from a few millivolts out of a stereo cartridge up to as much as 1000 volts or less across the secondary winding

of a power transformer in a hi-fi amplifier. Some eleven wide-band voltage ranges are available, from 10 mv. full-scale to 1000 v. full-scale. Readings may be made directly in volts or in db. According to the manufacturer, the voltmeter is flat from 10 cps to 150 kc. with the response falling to -3 db at 500 kc. The input impedance is high (2 megohms shunted by 15 μ f.) to prevent circuit loading. The accuracy of the

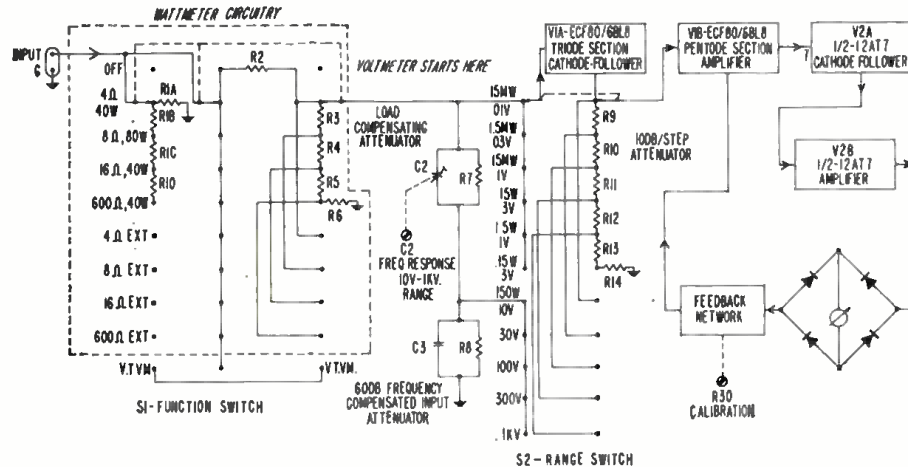

**PROOF OF SUPERIORITY
NO OTHER MICROPHONE
CAN MATCH!**

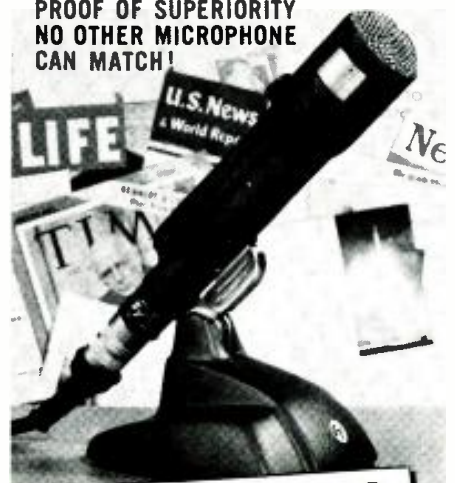

**LEADING NEWSWEEKLY
MAGAZINES PICTURE E-V
MORE OFTEN THAN THE NEXT
FOUR BRANDS COMBINED!**

Write now for catalog of
microphones preferred by top radio, TV,
newsreel and sound engineers!



ELECTRO-VOICE, INC.
Commercial Products
Div., Dept. 1111N
Buchanan, Michigan





PERSONAL Messenger

- No license required—may be used at once!
- Meets FCC requirements for use with licensed Citizens' Band stations, too!

This is the new "Personal Messenger"—a superbly engineered 2-way crystal-controlled transceiver so compact it fits in your hand—so flexible it can be used in thousands of applications! 11 transistors and 4 diodes—superheterodyne receiver with exclusive tuned R.F. amplifier gives you twice the sensitivity and more than 40% more range than units with conventional circuitry! Powerful two-stage transmitter delivers more power output than similar units with the same rated input! Unmatched audio intelligibility and razor-sharp voice reproduction—automatic noise limiter—automatic volume control—positive squelch control—elastic hand strap—operates on penlight or rechargeable nickel-cadmium batteries. **\$109.50**

ILLUSTRATED AT LEFT—The Viking "Messenger"—maximum legal power Citizens' Band crystal-controlled transceiver. Excellent receiver sensitivity and selectivity—highly efficient transmitter punches your signal home! Built-in squelch—AVC—ANL. With tubes, push-to-talk microphone and crystals for 1 channel. **FROM \$134.95**

 Delivery or fleet operation	 Your own personal use	 Construction or Business
--	--	---

FREE
Color Brochure



WRITE TODAY

E. F. JOHNSON COMPANY
2511 Tenth Avenue S. W. • Waseca, Minnesota
• Please rush me your full color brochure.

NAME _____
ADDRESS _____
CITY _____ STATE _____

Manufacturers of the world's most widely used personal communications transmitters

CARD INDEX FILE FOR EW ARTICLES

By **RAYMOND B. RAWLINSON**

MANY readers of **ELECTRONICS WORLD** have copies extending back several years. They have at their fingertips an immense volume of information on electronics and associated subjects. The ability to locate an article on a specific subject, however, is difficult despite the fact that an index is published each December covering feature articles which appeared during the year.

The writer's solution to this may be of interest to others. It is a card index file. The desired information is typed on conveniently sized 3" x 5" cards. Complete indexing takes not more than 20 or 30 minutes a month at most. The information included on the cards is: title of article, month and year of publication, page number. Most titles are self-explanatory but, if not, a brief word of explanation is included. Five single-spaced entries with double spacing between entries will fit on the standard card.

The following headings were set up ten years ago:

- | | |
|-------------------------|---------------------------------|
| 1. Amplifiers (audio) | 2. Antennas |
| 3. Audio (general) | 4. Binaural |
| 5. Business | 6. Computers |
| 7. Electronic Controls | 8. FM |
| 9. Ham Radio | 10. Marine Radio |
| 11. Misc. | 12. Mobile Equipment |
| 13. Musical Instruments | 14. Noise Suppressors |
| 15. Phono | 16. Photography |
| 17. Radio Receivers | 18. Radio Servicing |
| 19. Recording | 20. Rectifiers & Power Supplies |
| 21. Safety | 22. Speaker Enclosures |
| 23. Speaker Networks | 24. TV Receivers |
| 25. TV Servicing | 26. Test Equipment |
| | 27. Transistors |

No attempt is made to justify such a list. Each reader will undoubtedly have his own ideas about whether it should be expanded, compressed, or revised. Time has shown that "Noise Suppressors" and "Speaker Networks" have not had enough coverage to warrant separate headings. "Binaural" has now become "Stereo." The biggest error was in the "Transistor" category. The transistor is no longer a curiosity. It is now involved in all phases of electronics. This listing should be broken down into a number of subheadings. Expanding the categories makes it easier to locate specific information while fewer listings makes the monthly typing chore easier.

The writer's stack of cards is now 3 inches thick. Metal boxes are made for the 3" x 5" size cards and solve storage and protection problems nicely, although the cards have been kept for years with nothing more than a rubber band looped loosely around them.

The index has been a real convenience and time-saver and is recommended to other readers on that basis. ▲

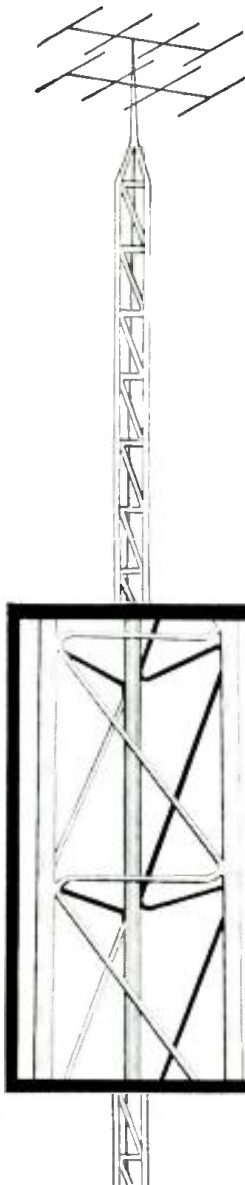

THE MOST FAMOUS LINE OF TOWERS IN THE WORLD ARE ROHN!

Here are the features that make them the largest selling and most accepted tower for television, radio, industrial and communications uses:

- **ZIG-ZAG CONSTRUCTION**—proven zig-zag design means sturdiness and dependability that is truly outstanding. Tower sections are completely assembled and electric welded throughout for maximum strength and greater economy in erection.
- **HOT DIPPED GALVANIZED AFTER FABRICATION**—Entire tower sections are completely zinc coated after fabrication for the finest outer protection possible. Being galvanized after fabrication means no uncoated bolt holes, weld spots or seam to rust. All ROHN Towers last for longer and have less maintenance than competitive towers because of this feature.
- **HIGHEST QUALITY MATERIAL USED**—only highest quality laboratory-certified steel tubing is used (not pipe). Quality steel plus heavy gauges combine to give far greater strength than competitive towers.
- **COMPLETE LINE FOR WHATEVER YOUR NEEDS**—Fully self-supporting towers are available to 170 feet or lower; heavy duty guyed towers available up to 500 feet. Whatever your needs, check ROHN.
- **UNEXCELLED ENGINEERING**—all ROHN Towers are engineered to meet the most rigid requirements as outlined by all major communications equipment manufacturers and electronic industry associations.
- **UNIVERSAL ACCEPTANCE**—Hundreds of thousands of Rohn Towers are in use all over the world. They have withstood the "test of time"—the only true test as to the superiority of a tower. So why settle for less than the BEST? Insist on the largest selling tower in the world—ROHN.

For your needs and for all allied tower accessories, contact your local ROHN salesman or write direct for full information.

SEND THE HANDY COUPON INDICATING YOUR NEEDS

ROHN
Manufacturing Company
BOX 2000
PEORIA, ILLINOIS

ROHN Manufacturing Company
Box 2000
Peoria, Illinois

Send me complete literature on the following ROHN Products:

<input type="checkbox"/> TV Towers	<input type="checkbox"/> Amateur Towers
<input type="checkbox"/> Communication Towers	<input type="checkbox"/> ROHN Accessories

Name _____
Firm _____
Address _____
City _____ State _____

MAIL ORDER HI-FI

You can now purchase all your Hi-Fi from one reliable source and be assured of perfect delivery. We deliver most hi-fi components, recorders & tape within 24 hours. SEND US YOUR LIST OF HI-FI REQUIREMENTS FOR OUR WHOLESALE QUOTATION AND FREE CATALOG. WE WILL NOT BE UNDERSOLD. Write us for proof of this statement.

CARSTON
125-7D E. 88 St. New York 28, N.Y.

OUT OF SPACE?

You bet we'd be... if we were to tell you all about AUDION'S "Out of this World Hi-Fi Values"

Write for free Catalog

audion
25-W Oxford Road
Massapequa, New York

ENGINEERING DEGREE IN SCIENCE MATH 27 or 36 MOS.

B.S. degree - 36 mos. • B.E. degree - 27 mos.
Accelerated year-round program prepares for early employment in fields of Science and Engineering. Regular 4-year program for B.S. Degree completed in 36 months, special engineering degree program in 27. Classes start - January, March, June, July, September. Quality education. Graduates employed from coast to coast. Government approved for veteran training. Students from 50 states, 40 countries, 20 buildings, dorms, gym, Campus. Save time and money. Earn board while studying. Write for catalog and complete information.

9111 E. Washington Blvd., Fort Wayne 2, Indiana

INDIANA TECHNICAL COLLEGE

TV-RADIO Servicemen or Beginners

SEND FOR

Coyne's

7-Volume Job Training Set
on 7-Day FREE TRIAL

The First Practical
TV-RADIO-ELECTRONICS
Shop Library



Answers ALL
Servicing Problems QUICKLY . . .

Makes You Worth More On The Job!
Examine Coyne's all-new 7-Volume TV-RADIO-ELECTRONICS Reference Set for 7 days at our expense! Be convinced it gives you the way to easier TV-Radio repair—time saving, practical working knowledge that helps you get the BIG money! See how to install, service and align ALL radio and TV sets, even color-TV, UHF, FM and transistorized equipment. New photo-instruction method is quick and easy to understand. No complicated math or theory—just practical facts you can put to use immediately right in the shop, or for ready reference at home. Over 3000 pages; 1200 diagrams; 10,000 facts!

Like An Electronics Expert At Your Side!

VOL. 1—EVERYTHING ON TV-RADIO PRINCIPLES! 300 pages of practical explanations; hundreds of illustrations

VOL. 2—EVERYTHING ON TV-RADIO-FM RECEIVERS! 403 pages; fully illustrated

VOL. 3—EVERYTHING ON TV-RADIO CIRCUITS! 336 pages; hundreds of illustrations, circuit diagrams.

VOL. 4—EVERYTHING ON SERVICING INSTRUMENTS! How they work, how to use them. 368 pages; illustrated.

VOL. 5—EVERYTHING ON TV TROUBLESHOOTING! Covers all types of sets. 437 pages; illustrations, diagrams.

VOL. 6—TV CYCLOPEDIA! Quick and concise answers to TV problems in alphabetical order, including UHF. Color TV and Transistors; 868 pages.

VOL. 7—TRANSISTOR CIRCUIT HANDBOOK! Practical Reference covering Transistor Applications; over 200 Circuit Diagrams; 410 pages.

DIAGRAM BOOK FREE!

For prompt action, we'll also send you this big book, "150 Radio-Television Picture Patterns and Diagrams Explained" ABSOLUTELY FREE just for examining Coyne's 7-Volume Shop Library on 7-Day FREE TRIAL! Shows how to cut servicing time by reading picture-patterns, plus schematic diagrams for many TV and radio sets.



SEND NO MONEY

Just mail coupon for 7-Volume TV-Radio Set on 7-Day FREE TRIAL! We'll include the DIAGRAM BOOK FREE. If you keep the set, pay only \$3 in 7 days and \$3 per month until \$27.25 plus postage is paid. Cash price only \$24.95. Or return set at our expense in 7 days and owe nothing. Either way, the FREE BOOK is yours to keep. Offer is limited, so mail the coupon TODAY!

FREE BOOK—FREE TRIAL COUPON

Educational Book Publishing Division
COYNE ELECTRICAL SCHOOL
1455 W. Congress Parkway, Dept. B1-EW, Chicago 7, Ill.
Yes! Send me COYNE'S 7-Volume Applied Practical TV-RADIO-ELECTRONICS Set for 7-Days FREE TRIAL per your offer. Include "Patterns & Diagrams" book FREE!

Name Age
Address
City Zone State
Check here if you want Set sent C.O.D. Coyne pays postage on C.O.D. and cash orders 7-Day Money-Back Guarantee.

Stereo with Headphones

(Continued from page 50)

wide range of impedances. Crystal headphones are usually of the high-impedance type (10,000 ohms and up), magnetic headphones tend to cover the medium-impedance range (around 2000 ohms), while dynamic units favor the low-impedance range (4 to 16 ohms). The impedance ranges cited are only generally valid and there are, for example, high-impedance dynamic headphones, low-impedance magnetic headphones, etc. In addition, the impedance of any of these headphones can, of course, be changed through the use of a suitable transformer.

Headphone impedance is of primary importance when the units are connected to associated amplifying equipment. Devices which have low impedance (600 ohms or less) load the circuit to which they are connected while the loading encountered with high-impedance devices will be negligible.

Stereophonic headphones can be hooked directly to the output of a stereo preamplifier-tone-control system. See Fig. 4A. These circuits are usually terminated in a high-impedance network or in a cathode-follower configuration which has a nominal impedance of approximately 1000 ohms. Any type of headphone will work with such a unit as long as the impedance of the headphone is 1000 ohms or higher so that the circuit is not unduly loaded.

Headphones may, of course, be connected directly to the output taps of the power amplifier (see Fig. 4B). If only headphones are used while listening, the power amplifier should be loaded down with a resistor whose value is equal to the impedance of the speaker normally used in the installation. This resistor should have a wattage rating equal to the maximum wattage rating of the amplifier.

In addition, as mentioned before, headphones are very sensitive devices and may reproduce equipment hum and noise quite loudly even when the volume control is set at minimum. This is caused by the fact that the headphone does not load down the circuit and actually reproduces the very small amount of hum and noise which occur in the circuit after the volume control. Also, it may be found that when the volume control is turned ever so slightly clockwise, excessively high signal will immediately result. To overcome this condition, a 1-watt resistor of approximately 2000 ohms is inserted in each leg of the headphone circuit. When connecting headphones to power amplifiers in this manner, headphone impedance should match the power-amplifier impedance. However, considerable leeway is permissible here and a

MICRO

ELECTRON TUBE

FABULOUS LOW PRICES!

LARGE SELECT STOCKS!

DEPENDABLE, FAST SERVICE!

- Each and every tube is tested in our own laboratory for mutual conductance and life test.
- We guarantee FREE replacement for one year of any tube purchased from us which fails to function efficiently under any or all operating conditions. Prompt refunds are made on any defective merchandise.
- The advertised tubes are not necessarily new, but may be electrically perfect factory seconds or used tubes—each is clearly so marked.

37¢ ea. \$35 PER HUNDRED ASSTD.

6A2	5K8	6DH6	6SF5	7Z4	19BG6G
6X2	5Y3GT	6HJ6	6SF7	12A8	19J6
1A7GT	5Y4G	6HJ6	6S7	12A05	19T8
1B7GT	6AR5	6HJ7	6S7	12A76	24A
1M4G	6AB8	6DL7GT	6SL7GT	12A77	25AV5
1M5GT	6AB9	6H9G	6S7GT	12A8	25B06
1L4	6AC7	6H9GT	6S7	12A87	25D86
1L4	6A4	6B07	6S7	12AV6	25L6GT
1N5GT	6AG5	6BY5G	6F4	12AV7	25W4GT
1Q5GT	6B07	6DZ6	6H9	12AX4GT	25Z5
1R5	6A8GT	6BZ7	6H9	12BX7	25Z6
1R5	6A8G	6C1	6V6	12AZ7	26
1T9	6AK6	6C1	6W6GT	12B4	25A5
1U4	6AL5	6C6	6H9GT	12BA6	35B5
1U5	6AL7	6CB6	6K4	12BA7	35C3
1V2	6AM6	6ED6G	6X5	12BE6	35L6GT
1X2	6AM6	6CFR	6X6	12BF6	35W4
2A3	6AQ5	6CZ7	6Y6G	12BH7	35Y4
2A4A	6AQ6	6C6	7A4/XXL	12BQ6	35Z5GT
3BC5	6RQ7GT	6CM6	7A5	12BR7	3T
3BN6	6RQ7	7A6	7A6	12BY7	3H/44
3C5	6AS5	6C9T	7A7	12CA5	43
3C8	6AT6	6E6	7A8	12J5	43
3CP6	6AT8	6C16	7D4	12K7	43
3CS8	6AU4GT	6E6	7B5	12L6	60A8
3LP4	6AUSGT	6D06	7B6	12Q7	50B5
3Q4	6A6	6F6	7B7	12SA7	50E
3R4	6A6G	6G6	7B8	12S07	50L4GT
3V4	6A9GT	6J4	7C4	12S17	50R5
4B07A	6AV6	6J5	7C5	12SK7	58
4B7	6AV6	6J7	7C6	12SN7GT	5T
5A4	6A4GT	6K6GT	7C7	12SQ7	5B
5A7B	6A4SGT	6M7	7E6	12VG7	7A
5AV6	6B	6R6	7E7	12WG7	7B
5AW4	6B4G	6L7	7F7	12X4	7B
5B7	6B5	6M7	7F8	12Z3	7T
5B8	6B6	6Q7	7H7	14A7/12B7	7B
5U4G	6B6	6S7	7N7	14B6	80
5U8	6B6S	6S0T	7Q7	12Q7	80, 6Z4
5V4G	6B6	6R7	7A/XXFM	19	11Z73
5V6GT	6D6G	6C7	7Y4	19AU4GT	11Z76

SEND FOR OUR FREE COMPLETE LIST OF TUBES & SPECIAL PURPOSE TUBES

ALL TUBES SENT POSTAGE PAID. Please send 25¢ handling for orders under \$5. Send 25¢ deposit on C.O.D. orders. Send approximate postage on Canadian and foreign orders.

MICRO ELECTRON TUBE CO.
P.O. Box 55 Park Station, Paterson 3, N. J.

LEARN
TRANSISTOR, COMPUTER OR
RADAR ELECTRONICS
AT HOME!

Prepare now for a profitable career in one of these growing fields. Learn theory and practical application of all makes and types with proven home study courses from the Philco Technological Center.

For FREE information write:
PHILCO
TECHNOLOGICAL CENTER
P.O. Box 4730, Dept. W-2, Philadelphia 34, Pa.

600-ohm headphone will certainly work off an 8-ohm tap.

One point to remember, whether the headphones are used with a preamplifier or with a power amplifier, try to avoid passing d.c. through the headphones. Thus, when making these hookups, be sure that the phones are isolated from d.c. paths by means of a coupling capacitor or by the output transformer.

In conclusion, the final choice of the type of headphone—as is so often the case with high-fidelity equipment—is primarily dependent upon what the listener likes and is willing to pay for. In any event, no matter what type of headphones you choose, you can anticipate a unique listening experience—in many ways totally different from what you are used to with loudspeaker systems. ▲

VOLTAGE QUIZ

By JOE TERRA

Match the words in the first column with the definitions in the second column, then check your answers on page 134.

- | | |
|---------------------|--|
| 1. Inverse peak | A. Voltage supplied by the damper tube to attain greater saw-tooth output. |
| 2. Boost | B. In a thyatron, the value of voltage which causes tube to fire. |
| 3. Working | C. Negative grid bias at and beyond which plate current ceases to flow. |
| 4. Line | D. E_c plus E_{b1}/μ . |
| 5. Ripple | E. Voltage variation due to thermal agitation or shot effect. |
| 6. Critical-grid | F. Reverse voltage that a gas or vapor rectifier can stand without breakdown. |
| 7. Inverse | G. Effective voltage value existing across a rectifier tube during that half-cycle in which current does not flow. |
| 8. Sparking | H. Wall-outlet voltage generally between 115 and 120 volts. |
| 9. Primary | I. Maximum voltage which can be applied to electrolytic capacitors for a period not to exceed 30 seconds. |
| 10. Cut-off | J. Voltage applied to the input terminals of a transformer. |
| 11. Surge | K. The alternating components of a unidirectional voltage. |
| 12. Signal | L. Used in TV receivers to insure uniform rate of movement of the beam across and down the face of the picture tube. |
| 13. Equivalent-grid | M. Modulating voltage of a transmitter or a detected voltage in a receiver. |
| 14. Saw-tooth | N. The starting potential of a cold-cathode gas tube. |
| 15. Fluctuation | O. Voltage rating of a fixed capacitor. |

FREE TO YOU
and your friends
**RADIO SHACK'S 1962
ELECTRONICS CATALOGS**

Plus
EVERY NEW
SUPPLEMENT
FOR NEXT
12 MONTHS



Our bigger, better catalogs offer the widest line of electronic parts and equipment in the world! Stereo, Hi-Fi, Ham Radio, Test Equipment, Pre-Recorded Tapes, Tape Recorders, Records, Parts—plus 30 pages of Kits! 340 pages—over 100,000 items! No Money Down credit terms. Every item backed by a money-back guarantee of satisfaction.

Radio Shack Corp., Boston, Mass.

RADIO SHACK Corp.
730 Commonwealth Ave., Boston 17, Mass.
Send Radio Shack's famous electronics catalogs for one year—FREE and POSTPAID.

Your Name _____ 61L6B
Your Address _____
City and Zone _____ State _____
For a Friend _____ 61L6B1
Address _____
City and Zone _____ State _____



Transistor Manual

An industry classic, now in its 5th edition. 320 fact-filled pages on theory, construction techniques, signal characteristics, hi-fi and radio circuits, transistor radio servicing techniques, feedback and servo amplifiers, switching characteristics, unijunction transistor circuits, complete specs and JEDEC listings, introductions to silicon controlled rectifiers and tunnel diodes. \$1.00.

Tunnel Diode Manual

This is the most comprehensive presentation of theory, circuits, applications and specifications available today for tunnel diodes. Complete ratings and characteristics, tunnel diode specifications, chapters on tunnel diode amplifiers, oscillators, switches, logic circuits and tunnel diode test circuits. Also a bibliography of basic tunnel diode source material. Just \$1.00.

Get your copies today from your Authorized G-E Semiconductor Distributor. Or mail the coupon directly to the factory.



Bring your Semiconductor Library up to date!



Latest G-E Semiconductor Full Line Bulletin — Free. Here are the latest ratings and specifications for every semiconductor device in General Electric's famous line. Transistors, rectifiers, tunnel diodes, silicon controlled rectifiers, rectifier stacks . . . 14 pages, arranged for quick and easy reference. Free.

GENERAL ELECTRIC

General Electric Co., Semiconductor Products Department, Section 58K103, Electronics Park, Syracuse, New York.

Please send me the following publications for my reference library:

- G-E Transistor Manual. I enclose \$1.00 (no stamps, please)
 G-E Tunnel Diode Manual. I enclose \$1.00
 1961 G-E Semiconductor Full Line Bulletin. Free.

Name _____
Address _____
City _____ Zone _____ State _____

STEP UP TO A STANTON

... before you decide on a new stereo pickup - do yourself - your family - your friends this service: Listen to your favorite stereo or mono record, reproduced with all of the leading stereo pickups. Check stylus pressure and tracking (for record wear) and, most of all - the quality of music reproduction. Only in this way can you really know the worth of the STANTON Stereo Fluxvalve* - with its wonderfully practical, easily replaceable V-GUARD stylus.

*Covered under U.S. Patent No. 2,917,590

SERIES: 380-381-198-199
from \$29.85

Send for your complimentary copy of Tech-Specs - a handy guide for planning a stereo high fidelity system... write Dept. F-111



FOR THOSE WHO CAN HEAR THE DIFFERENCE



Pickering

PICKERING & CO., INC., PLAINVIEW, NEW YORK

Mac's Service Shop

(Continued from page 60)

"OK, you win," Mae conceded. "You don't have to make up that half hour. Your conversation with Bud has obviously turned your attention to a very important subject: how we, as service technicians, can best serve the interests of our senior citizens."

"Here in the United States we now have better than 16,500,000 people over 65 years of age, and the number is growing at the rate of more than 1000 a day. These figures are pretty impressive in themselves, but consider this: 929,000 of those people are over 85! This compares with 91,000 in 1920, or an increase of better than 920 per-cent in thirty years. If you want to think of a person as becoming 'old' at 65, quite obviously he has a fair chance of staying in this category for at least 20 years."

"These people must be clothed, fed, housed, doctored, and entertained. That means they are very important customers in a wide variety of businesses and professions. Even a casual look at national advertising shows most business men and their advertising agencies are already keenly aware of this fact. But I think this over-65 group is especially important to the radio and TV service technician. I say this because I'm convinced the most avid TV watchers are found at both ends of the life span: children and oldsters. Both groups have a great deal of leisure time; both must

find a large part of their diversion in the home. TV watching provides a method of escape from the boredom that would otherwise result from such a combination of leisure and restricted movement. They depend on TV for entertainment; we depend on TV to earn a living. They need us; we need them."

"I'm with you all the way," Barney chimed in. "And when you get right down to it, the service the senior citizens demand is not much more than any customer has a right to expect."

"There is one other thing they want that is a little extra," Mac said slowly. "It is an 'extra' that does not cost the service technician much to give, but it has a lot to do with his success in dealing with these senior citizens. They want to be treated as real people, not as over-age children. They want to be listened to with genuine interest instead of amused tolerance. The technician who can provide good service *plus* a little sympathetic understanding can easily win for himself a loyal following among this Golden Years crowd. I use the word 'loyal' advisedly. Elderly people do not like change for its own sake as younger people do. When they find a technician they like, they will stick with him year after year."

"I simply gotta get you and Bud together on the air. I never heard two guys sound so much alike."

"People who think right frequently think alike," Mac retorted. "You just listen to Bud and me and we'll make a thinking man's technician out of you yet!"

TOSHIBA ELECTRON TUBES

Japan's leading electronics producer offers world industry a full range of high quality tubes. Toshiba's two research laboratories have kept pace with rapid electronic advances, and now the most sophisticated superhigh frequency tube as well as the simplest receiving tube are available in quantity as original equipment or direct replacement.

Two modern Toshiba plants offer a wide range of electron tubes for commercial and industrial applications such as rectifier tubes for high frequency induction heating and cathode ray tubes. Toshiba produces semiconductors, too, with an industry-leading output of 4 million units monthly.

With Toshiba, you have all the business advantages of Japan's fast-growing industry plus the knowledge that you are dealing with one of the world's leading names in electronics. Detailed specifications will be sent on request. Address Toshiba, Tokyo, Japan.

Toshiba

Tokyo Shibaura Electric Co., Ltd.

Tokyo, Japan



for communications



for industrial use



for broadcast



for radio and TV receiving

Impedance Matching for P.A.

(Continued from page 64)

is used between the amplifier and the line-matching transformer.

When the "L" pad is in the full "on" position it generally is designed so that the series arm is zero resistance and the shunt arm is open-circuited. The insertion loss is then zero. As the control is turned toward "off" position, the series arm approaches the value of the rated impedance and the shunt arm approaches zero resistance. In this way the pad-speaker combination presents approximately a constant impedance back to the line, causing a minimum amount of interaction. Though the "L" pad varies to a very slight degree the impedance presented to the amplifier output, this is ignored in practice.

The "T" pad is a similar component, having three ganged variable elements (see Fig. 21) wired into the speaker line in such a manner as to present a

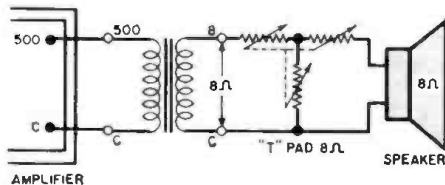

Fig. 21. Using "T" pad to control level.

constant impedance to the amplifier as well as to the speaker at all times. The "T" pad sells at a somewhat higher price and is not therefore used as widely as is the "L" pad.

In selecting an "L" or "T" pad, careful consideration must be given to the dissipation rating of the component as established by the manufacturer. For example, if a loudspeaker is wired through a line-matching transformer to be driven to a 4-watt level, an "L" or "T" pad should likewise be rated at 4 watts so that it can safely dissipate the power not used by the loudspeaker. Pads are made to absorb up to 30 watts of audio power. The smallest acceptable rating is always chosen, of course, to keep the cost down. Pads may be selected for use with 4-, 8-, or 16-ohm voice coils (when wired in the line-matching transformer secondary circuit) or with 250- and 5000-ohm values (for wiring between the line-matching transformer primary and amplifier).

Although this discussion has involved many words and a fair amount of space in three issues, the job of impedance matching speakers in public-address systems is neither difficult nor impossible. With a little practical experience plus a firm grasp of the theory behind impedance matching, any competent audio technician can handle this interesting and profitable work. ▲



YOU NEED THIS...

FREE GIANT ALL NEW 1962 BA CATALOG



SAVE UP TO
50% ON B-A
SELECTED
KITS

TOP VALUES
IN POWER
AND HAND
TOOLS

HI-FI AND
STEREO
SYSTEMS &
COMPONENTS

30 PAGES
OF BARGAINS
NOT IN ANY
OTHER CATALOG

**RUSH COUPON
TODAY!**

BURSTEIN-APPLEBEE CO. Dept. EW
1012-14 McGee St., Kansas City 6, Mo.

Rush me New 1962 B-A Catalog No. 621

NAME _____

ADDRESS _____

CITY _____

STATE _____



JESSE JONES BOX CORP.

Dept. EW

(Established 1843)

Box 5120, Philadelphia 41, Pa.

Keep them neat... clean...
ready for instant reference!

Now you can keep a year's copies of ELECTRONICS WORLD in a rich-looking leatherette file that makes it easy to locate any issue for ready reference.

Specially designed for ELECTRONICS WORLD, this handy file—with its distinctive, washable Kivar cover and 16-carat gold leaf lettering—not only looks good but keeps every issue neat, clean and orderly.

So don't risk tearing and soiling your copies of ELECTRONICS WORLD—always a ready source of valuable information. Order several of these ELECTRONICS WORLD volume files today. They are \$2.50 each, postpaid—3 for \$7.00, or 6 for \$13.00. Satisfaction guaranteed, or your money back. Order direct from:

NEW SAMS BOOKS

NEW & REVISED—2nd EDITION
OF THE HOWARD W. SAMS

Transistor Substitution Handbook



- ★ OVER 7500 DIRECT SUBSTITUTIONS
- ★ OVER 1000 NEW SUBSTITUTIONS

Includes biasing diagrams, polarity identifications and manufacturers for over 3100 transistor types... PLUS over 7500 direct substitutions!

Completely revised for maximum help in selecting suitable transistor replacements. Special section shows 700 American replacements for Japanese transistors. PLUS a semiconductor diode and rectifier guide showing over 600 substitutions. Explains why substitution is possible; when it is appropriate and when not; precautions to observe. Covers all types of transistors. U.S. and foreign, for \$1.50 every type of use. 96 pages; 5 1/2 x 8 1/2". Only \$1.50

Electronics Math Simplified

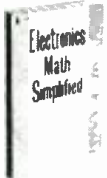

Now—Alan Andrews provides a simplified approach to an understanding of the advanced arithmetic, algebra, and trigonometry required for a solid background in basic electronics. Gives step-by-step examples relating to problems dealing with resistance, capacitance, inductance, wire measurements, frequency, tube characteristics, transformers, modulation, meters, antennas, etc. Includes practical exercises, with answers in special Appendix. Invaluable to anyone studying for second and first-class FCC phone licenses. Ideal for home study or classroom. 224 pages, 5 1/2 x 8 1/2". Only \$4.95

BASIC ELECTRONICS SERIES:

Detector & Rectifier Circuits



Latest volume in Capt. T. M. Adams' unique series which shows dynamic circuit diagrams in four colors demonstrating exactly what happens during each moment of circuit operation. Accompanying text describes each "moving" circuit action as shown in the diagrams. Eight chapters: Rectification & Detection; Half-Wave Rectifier Circuits; Full-Wave Rectifier Circuits; Diode Detector Circuits; Diode Detector with AVC; Grid-Leak Detectors; Discriminator Circuits; Ratio Detector Circuits. 128 pages, 5 1/2 x 8 1/2". Only \$2.95

Industrial Electronics Measurement & Control



Ed Bukstein describes the electronic devices most commonly used for industrial measurement and control. Explains techniques for measuring: pressure; illumination and color; temperature, humidity; liquid level, time and speed; frequency, dimensions, rate of flow, etc. Describes methods for electronically controlling: time delay, temperature; motor speed; weld current; positioning; illumination; tension; etc. Covers devices such as Bourdon tubes, servomotors, radiation pyrometers, binary counters, ratemeters, radioactivity gauges, anemometers, etc. Provides a ready and valuable reference source for industrial engineers, technicians, and maintenance personnel. 192 pages, 5 1/2 x 8 1/2". Only \$3.95

HOWARD W. SAMS & CO., INC.

Order from your Sams Distributor today, or mail to Howard W. Sams & Co., Inc. Dept. L-11 1720 E. 38th St., Indianapolis 6, Ind.

Send me the following books:

- Transistor Substit. Handbook Vol. 2 (SSH-2)
- Electronics Math Simplified (MAT-1)
- Detector & Rectifier Circuits (BED-1)
- Indust. Electronics Measure, & Control (IND-1)

Send \$_____ enclosed. Send Free Book List

Name _____

Address _____

City _____ Zone _____ State _____

IN CANADA: A. C. Simmonds & Sons, Ltd., Toronto 7 (outside U.S.A. priced slightly higher)



"UNDERSTANDING CAPACITORS AND THEIR USES" by William F. Mullin. Published by Howard W. Sams & Co., Inc., Indianapolis. 91 pages. Price \$1.95.

Written by a man who is intimately connected with the capacitor field, this volume is a nice amalgam of design theory and practical application data on this vital electronic component.

The text is divided into six chapters dealing with capacitor theory, construction, application, replacement, and testing. The material is presented in a practical format which makes it suitable for technicians, students, and those concerned with specifying capacitors for electronic circuits.

* * *

"MOST-OFTEN-NEEDED 1962 TV SERVICING INFORMATION" compiled by M. N. Beitman. Published by Supreme Publications, Highland Park, Ill. 192 pages. Price \$3.00.

This is Vol. TV-19 in this publisher's series of service data manuals and covers TV sets made by Admiral, Emerson, General Electric, Magnavox, Montgomery Ward, Motorola, Philco, RCA, Sylvaria, Westinghouse, and Zenith.

Like its predecessors, this volume includes chassis views, tube location diagrams, complete schematics, alignment data, adjustment of the various controls, plus special circuit hints, as suggested by the manufacturer.

* * *

"TWO-WAY MOBILE RADIO MAINTENANCE" by Jack Darr. Published by Howard W. Sams & Co., Inc., Indianapolis. 250 pages. Price \$4.95.

This volume has been prepared expressly for the field service engineer who plans, maintains, and installs all types of two-way mobile radio systems.

Included in the nine chapters are specific instructions for tuning up the system, test procedures and equipment for locating troubles, record keeping as required by the FCC, installation procedures, remote controls, noise eliminations, towers, receivers, and transmitters.

Since this volume was written by a man specializing in this type of service work, the suggestions and procedures are characterized by a down-to-earth practicality.

* * *

"SERVICING TRANSISTOR RADIOS" by Sams Staff. Published by Howard W. Sams & Co., Inc., Indianapolis. 160 pages. Price \$2.95. Vol. 9.

This latest volume in the publisher's series on the servicing of transistorized receivers covers 47 models produced during 1960 including sets by Admiral, Cadrad, Channel Master, Columbia, Coronado, Crown, Emerson, General Electric, Linmark, Magnavox, Nec, Norelco, Olympic, Philco, RCA Victor, Robin, Silvertone, Sylvaria, Toshiba, and Tru-tone.

Like the earlier volumes in this serv-



NEED AN
A.C. OUTLET?
IN CAR,
BOAT OR TRUCK,
YOU HAVE IT WITH A

terado POWER CONVERTER

Actually gives you 110 volt, 60 cycle A.C. from your 6 or 12 volt D.C. battery! Plug converter into cigarette lighter, and operate lights, electric shavers, record players, electric tools, portable TV, radios, testing equipment, etc.

Models from 15 to 300 watts, priced as low as **\$12.95** LIST

See Your Electronic Parts Dealer or Jobber, or Write.

terado COMPANY

1058 RAYMOND AVE.
ST. PAUL 8, MINN.

In Canada, ATLAS RADIO CORP. LTD. — Toronto, Ont.

Guaranteed! Crystals!
BUY NOW AND SAVE!!

OVERTONES: 10 to 30 Meg. Tol. .005%	\$2.50
AMATEUR & NOVICE Fundamental Tol. .005%	\$2.50
HC-6 Herm. Sealed	\$2.50
HC-6—6 Meters (5th Overtone)	\$3.75
MARINE FREQ. HC-6 (Herm. Sealed) Tol. .005%	\$3.50

ALL MARINE FREQ.—FT-243, DC-34 Hold Tol. .005	\$2.00
POLICE, C.A.P., CD, MARS, Tol. .01%	\$1.89
CITIZENS BAND—11 METERS—.005% TOL.	
26.965 to 27.225 MC, 3rd Over. Herm. Seal. or FT-243	\$2.50
13.4825 to 13.6125 MC, 2nd Harm. Herm. Seal. or FT-243	\$2.50
6741.25 to 6806.25 Kc, 4th Harm. FT-243 only	\$2.00

SPECIAL! STOCK CRYSTALS

FT-243 Holders 5700 KC to 8700 KC in steps of 25 KC's

79¢ ea.

SEND FOR FREE CATALOG

DC-34 Hold. 1690 KC to 4440 KC steps of 10 KC, ea. 79c

NOVICE BAND FT-243 Fund. ea. \$1.19

80 Met. 3701-3748—Steps of 1 KC. FT-243	
40 Met. 7150-7198—Steps of 1 KC. FT-243	
Dbl. to 40 Met. 3576-3599. Steps of 1 KC. FT-243	
15 Met. 9276-9312—7034-7093 Steps of 1 KC. FT-243	
FT-243—2 Meters (Steps of 1 KC)	\$1.19
FT-243—6 Meters (Steps of 1 KC)	\$1.19
FT-243—From 3000-4000	\$1.19
FT-243—From 1005-2999 (Steps of 5 KC)	\$2.39
FT-243—.005% Tol. From 3000-8750	\$2.39
FT-243—.01% Tol. From 3000-8750	\$1.89
FT-241 SSB Low Xtals 370 to 540 KC (Steps of 1.852 and 1.380)	\$.69
FT-241 SSB Matched Pairs	\$2.39
FT-241—AN/TRC-1-721.167 KC-1040-625 (Steps of 1.042 KC—Except 1000 KC)	\$.96

Include 5c per crystal postage. (U.S. only). Calif. add 4% tax. No C.O.D. Prices subject to chg. Incl. 2nd choice, sub. may be needed. Min. Order \$2.50

Open Friday Evenings until 9 P.M.

"The House of Crystals"

U. S. CRYSTALS, Inc.

1342 S. La Brea Ave. Los Angeles 19, Cal.

ice series, this book features schematics, dial-cord stringing arrangements, cabinet and chassis photos, alignment instructions, parts lists, and replacement data.

* * *

"BASIC ELECTRICITY" by C. E. Matson. Published by *McKnight & McKnight Publishing Co.*, Bloomington, Illinois. 123 pages. Price \$1.70.

This manual covers 30 instruction units for use by teachers giving courses in electricity. Each of the instruction units combines information, job, and operation sheets and can be used at either a junior or senior high-school level.

The projects are graded and presented in logical progression. Six appendices include aids for the instructor in planning and conducting such a course in basic electricity.

* * *

"SOUND AND TELEVISION BROADCASTING" by K. R. Sturley. Published for "Wireless World" by *Iliffe Books Limited*, Dorset House, Stamford Street, London SE1, England. 373 pages. Price 46 s. 4 d. postpaid.

Although prepared as a training manual for *BBC* engineering recruits, the material included by Dr. Sturley (head of the *BBC* Engineering Training Department) is of interest to all those involved in sound and television broadcasting.

The text covers fundamental principles, sound studios and recording, TV studios, telecine and telerecording, re-

note TV broadcasts, the r.f. transmission of sound and video programs, line interconnection systems, etc. Although the techniques and equipment covered are those used in Great Britain much of this material will find a ready audience among broadcast engineering personnel in the U.S.

* * *

"TROUBLESHOOTING AMATEUR RADIO EQUIPMENT" by Howard S. Pyle, W7OE. Published by *Howard W. Sams & Co., Inc.*, Indianapolis. 128 pages. Price \$2.50.

Author Pyle, who is a familiar byliner of ham articles in this magazine, has come up with a thoroughly practical handbook on ham radio maintenance.

The seven chapters and three appendices include receiver troubles, transmitter troubles, the antenna system, accessory equipment, preventive maintenance, mobile equipment, component color codes, schematic symbols, as well as complete schematics of nine popular transmitters and receivers.

As a practicing ham for more than 50 years and a former assistant U.S. Radio Inspector and FCC license examiner, there is little about ham radio that Mr. Pyle doesn't know. His enthusiasm in sharing his knowledge and experience makes this a "natural" for the tyro and "Old-Timer" alike.

* * *

"ABC'S OF MODEL RADIO CONTROL" by Allan Lytel. Published by *Howard W. Sams & Co., Inc.*, Indianapolis. 96 pages. Price \$1.95.

Relieve that "HEAD" ache!



Call your dealer to replace with **Nortronics** Magnetic Recording Heads found in most original equipment. See what a difference a **Nortronics** Replacement Head or 4-Track Stereo Conversion can make.

World's largest manufacturer of laminated heads... the heart of your tape recorder.
Send 25¢ for Tape Recording Manual



Nortronics CO., INC.
"Music sounds best on tape—
tape sounds best on Nortronics Heads!"

1023 South Sixth St., Minneapolis 4, Minn.

HERE'S THE *General* IDEA FOR CHRISTMAS
Give the **BEST** in citizen's band

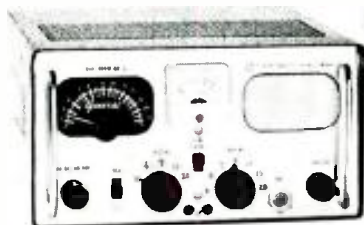

Model MC4 Commercial Citizens Band Transceiver. 15 watt construction. 6 channel transmitter plus external transmit socket for multi-channel operation. 22 channel variable plus 4 fixed crystal receive channels. 6V-12V-115V operation. Net \$199.95.

Model 615 Multi Function In-line Bridge. A single instrument that measures Standing Wave Ratio, Field Strength and True Watts. Complete with internal dummy load. A must for every Citizen's Band Station. Net. \$39.95.

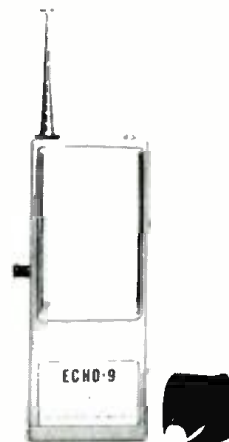
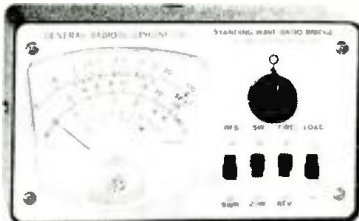

ECHO 9 — FIELDMASTER. 9 transistor pocket-talkie, every hunter's dream! Ready to operate. Net \$59.95.

FOR COMPLETE SPECIFICATIONS AND SCHEMATICS SEE YOUR DEALER OR WRITE:

GENERAL RADIOTELEPHONE COMPANY
Department E-11 • 2806 West Burbank Blvd. Burbank, California

Under present rules part 19.32 the FCC does not provide for more than (5) watt input in the Citizens Radio Service (26.965 — 27.225 MC Band).

Schober

captures
magnificent
pipe organ
tone
in a
tiny
electronic
tube

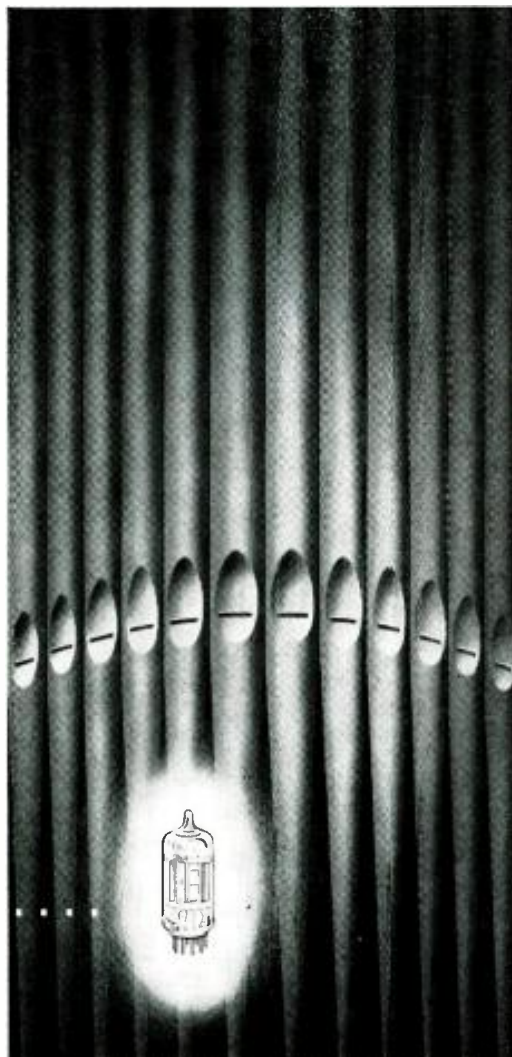

Here is magnificent Pipe Organ tone: tremendous tonal color range; two 61-note pipe-organ keyboards; hand-rubbed cabinetry in the finish of your choice. Taken together they comprise a superlative electronic instrument comparable to organs selling for \$2,500 to \$6,000.

Yet, when you assemble the Schober of your choice, you save more than half the normal cost and create a superb instrument to bring the delightful gift of music to your family.

Matched kits and printed circuitry make it possible.

Work requiring knowledge and experience is eliminated. All that remains is the pride and pleasure of watching a fine musical instrument take shape under your own hands. The Schober organ you assemble will equal or surpass any factory-built organ for quality, reliability and circuitry.

And the Schober Electronic Organ is so easy to play!

From the very first day even novices will transform simple tunes into deeply satisfying musical experiences — because unlike a piano whose tone dies away almost as soon as the keys are struck, organ tones continue to sing out as long as the key is held down. Then, by simply moving your right foot, you change the volume so that the sound becomes rich and alive.

The coupon brings you full details on how you can start building the Schober of your choice with an investment of as little as \$18.95. In addition, you may have an exciting 10" LP record demonstrating Schober's full range of tones and voices. The \$2 charge for the record is refunded when you order your starting kit. No salesman will call.

MAIL THIS COUPON TODAY

THE Schober Organ CORPORATION
Dept. RN-15, 43 WEST 61ST STREET, NEW YORK 23, N.Y.

The Schober Organ Corp., Dept. RN-15
43 West 61st Street, New York 23, N.Y.

Please send me FREE full-color booklet and other literature on the Schober organ.

Please send me the Hi-Fi demonstration record. I enclose \$2 which is refundable when I order my first kit.

name _____

address _____

city _____ zone _____ state _____



Since model enthusiasts come in all ages, interests, and vocations, this basic text on the radio-control of various types of models should find a vast, ready-made audience.

Basic R/C systems and their operation, applications of radio controls, equipment, servicing and troubleshooting, FCC regulations, etc. are all covered in layman's language with a healthy boost from the excellent photos, diagrams, and illustrations with which the text is supplied.

* * *

"FUNDAMENTALS OF UHF" by Allan Lytel. Published by John F. Rider Publisher, Inc., New York. 150 pages. Price \$3.90.

This text covers that portion of the spectrum from 300 to 3000 mc. and deals with antennas, transmission lines, wave propagation, generators, communications equipment, test equipment, and techniques.

In addition, the FCC rules and regulations covering the use of these frequencies are included, making this a self-contained source book for those actively engaged in the field.

Written at an intermediate level and featuring numerous diagrams, photographs, charts and graphs, this book is suitable for both student and practicing engineer.

* * *

"BASIC MATHEMATICS" by Norman H. Crowhurst. Published by John F. Rider Publisher, Inc., New York. 136 pages. Price \$3.90.

This is the second in the projected four-volume series covering basic mathematics. This book introduces algebra, geometry, and trigonometry to the student and covers simple, simultaneous and quadratic equations; powers and roots; imaginary numbers; simple mechanics, including resonance; proportion and ratio; simple trigonometry calculations; and properties of triangles and circles.

The step-by-step presentation in "pictured-text" form poses a problem, then discusses the nature of the problem and explains how one or more methods of solution are tied to the problem.

* * *

"FIRST-CLASS RADIOTELEPHONE LICENSE HANDBOOK" by Edward M. Noll. Published by Howard W. Sams & Co., Inc., Indianapolis. 304 pages. Price \$4.95.

This handbook is designed to assist those preparing for their first-class tickets, for broadcast station engineers, and for technicians. It includes questions and answers based on Element IV of the FCC license exam and a complete discussion of frequency assignments, duties and license requirements, broadcast microphones, record and tape machines, studio and control-room facilities, remote facilities, AM broadcast transmitters, AM broadcast antennas and lines, FM transmitters, transmitter monitor and test equipment, proof-of-performance measurements, television broadcasting, audio and power circuits, transmitters and antennas, laws and test procedures, and TV and FM broadcasting. ▲

Registers & Accumulators

(Continued from page 56)

plements of each other: 4 and 5, 7 and 2, 1 and 8, etc. The 6 in step 2 is therefore the complement of the 3 in step 1. After the addition has been performed (step 3) the left-hand digit is added to the right-hand digit (step 4). This is known as an *end-around carry*. The result obtained in step 4 is the answer to the original problem in step 1.

A circuit for subtracting binary numbers by the indirect method is shown in Fig. 8A. This is similar to Fig. 7 except that the "0 output" instead of the "1 output" terminals are connected to the transfer gates. As a result, the stages in the 0 condition supply high level inputs to the transfer gates. This effectively complements the binary number in the storage register because the complement of a binary number is obtained by changing the 1's to 0's and the 0's to 1's.

When a transfer pulse is applied, Fig. 8B, the transfer gates labeled "X" produce high level outputs. These outputs, representing the complement of the number in the storage register, are applied to the corresponding stages of the accumulator. These changes now occur:

1. FF_2 switches from the 0 condition to the 1 condition.

2. FF_1 switches from the 1 condition to the 0 condition, generating a trigger pulse for FF_3 .

3. FF_3 switches from the 1 condition to the 0 condition, generating a trigger pulse which is fed back to FF_1 (end-around carry).

4. FF_1 switches from the 0 condition to the 1 condition.

After these changes have occurred, the binary number in the accumulator is 00011 (decimal 3). This is the *difference* of the number in the storage register (10101 = decimal 21) and the number previously in the accumulator (11000 = decimal 24).

Multiplication can be performed as a series of repeated additions, and division can be accomplished by repeated subtractions. Modifications of the circuits in Figs. 7 and 8 can therefore be used for performing the operations of multiplication and division. ▲



"He fixed his first printed-circuit job."

SEND

ELECTRONICS WORLD

EVERY
MONTH

Electronics World



name _____

address _____

city _____ zone _____ state _____

Check one:

3 years for \$12 2 years for \$9
 1 year for \$5

In the U. S., its possessions, and Canada:

Payment enclosed Bill me

Foreign rates: Pan American Union countries, add .50 per year; all other foreign countries, add \$1.00 per year.

Mail to: **ELECTRONICS WORLD**
Dept. EW 1161H, 434 S. Wabash Ave.
Chicago 5, Ill.

Up in the air over your next project? Make it...

hallicrafters great new "SKY BUDDY" short wave PLUS AM receiver kit!

You're "airborne" fast with this outstanding new HALLI-KIT, precision-engineered in the most respected communications laboratories in the world—Hallicrafters.

- AM plus 2 short wave bands (2-5.5 mc. and 5.7-16.4 mc.) covering aircraft, ships, foreign stations, amateurs, etc.
- Transformer-type power supply. Superheterodyne circuit with superb sensitivity and planetary drive for sharp, selective tuning.
- Built-in speaker and headphone jack, with function switch. Separate switch for voice or code reception.



S-119K "Sky Buddy" Kit
ONLY \$39.95

P.S. For another \$10.00, you can buy it factory wired and tested.

Sold only through authorized
Hallicrafters distributors and dealers.



Send for Hallicrafters'

"GUIDE TO

SHORT WAVE LISTENING"



We've just published a new miniature book that tells you the entire story of Short Wave—64 pages of facts on how it works, what you can hear, where and when to listen, antennas, tuning information, etc. Send 35¢ to Hallicrafters, Dept. 21, Chicago 11, Ill.



automatic turntable

M
I
R
A
C
O
R
D

the new Miracord is both

Here's the best of two worlds in one exciting package . . . the all-new Miracord automatic turntable and record changer. Enjoy perfect record reproduction only a professional turntable and tone arm offers . . . or the convenience of uninterrupted music, hours on end. Choose either model: the **STUDIO H** with hysteresis synchronous motor—**\$99.50**; or the **STUDIO** with heavy-duty, shaded 4-pole motor — **\$79.95**.



record changer

For complete information write:

BENJAMIN
ELECTRONIC SOUND CORP.
Dept. EW-11/61—97-03 43d Ave., Corona 68, N.Y.

Servicing Recorder Oscillators

(Continued from page 59)

There is often a small capacitor at the input to the record-level circuit in order to shunt the oscillator frequency to ground. Sometimes, as in Fig. 5, there is

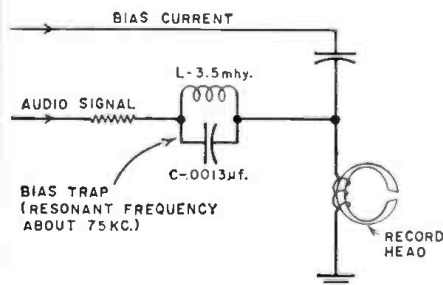

Fig. 5. Use of a bias trap to prevent oscillator output from getting into record amplifier.

a bias trap between the record head and earlier stages in order to prevent bias current from getting into these prior stages. These components should be checked if there is significant stray pickup.

If there is stray pickup of the oscillator frequency at an early stage of the record amplifier, it may be amplified along with the audio signal, resulting in excessive bias current applied to the record head, with a reduction in treble response. Such stray pickup can also cause oscillation or blocking of the record amplifier.

Stereo Load Resistors

In a stereo tape machine, the oscillator must feed two sets of record and erase heads. But when the machine is used for mono recording, oscillator current is removed from one set of heads and fed into a substitute load, usually a resistor.

If the load resistor departs appreciably from its design value, the oscillator current supplied to the one set of active heads will be either too much or too little, causing a substantial change in treble response and in distortion. Accordingly, if one channel or the other exhibits an appreciable change in treble response when shifting between the stereo mode and the mono mode of recording, the substitute load resistor should be checked. ▲



"There's something I must tell you, Thelma... Your set has a bad 6SN7."

**SILICON
RECTIFIERS**
Factory Direct



**750 MA
TOP HATS**
Mfg. Prices

PIV/RMS 50/35 15 ea.	PIV/RMS 100/70 .25 ea.	PIV/RMS 200/140 .30 ea.	PIV/RMS 300/210 .40 ea.
PIV/RMS 400/280 .45 ea.	PIV/RMS 500/350 .65 ea.	PIV/RMS 600/420 .75 ea.	PIV/RMS 700/490 .90 ea.
PIV/RMS 800/560 1.95 ea.	PIV/RMS 900/630 1.15 ea.	PIV/RMS 1000/700 1.55 ea.	PIV/RMS 1100/770 1.75 ea.

General Purpose 400PIV at 300MA
Special 2 for .75 25 for \$7.50

LOW PRICES

100 Different prec. res., 1/2 W, 1 W, 2 W
of 1/2 % . 1 % Tolerance only 1.90/c

General Electric 1N91 Power Junction
Diode 10 for \$1.50

Top Hat Silicon Diode 25PIV/17RMS
500MA 20 for \$2.00

Hughes 1N67A Crystal Diode Glass
Special 10 for \$1.50

Int. Rect. Selenium PIV440/RMS160
DS Current 10MA 10 for \$2.00

All material guaranteed. \$2.00 min. order. Orders
F.O.B. NYC. Include check or money order. Ship-
charges plus. C.O.D. orders 25% down.

WARREN DIST. CO.

NYC 7, NY 87 Chamber St. WO 2-5727

AVAILABLE AT LAST COMPLETE CONSTRUCTION MANUAL NATIONALLY FAMOUS VIDEOLA

TV CRAFT KIT BY TECH-MASTER
Detailed Schematics—Diagrams—Illustrations
Ideal for Students And Home Projects
Cost Of Manual Refunded With Kit Purchase
Send \$3.75 (check-cash-money order) to:
TV Construction Manual—Dept. EW11
Tech-Master
75 Front St., Brooklyn 1, N.Y.

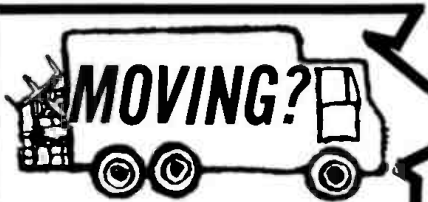

If you've recently changed your address, or plan to in the near future, be sure to notify us at once. We'll make the necessary changes on your mailing plate, and see to it that your subscription continues without interruption. Right now — print the information requested in the spaces below and mail it to: **ELECTRONICS WORLD, 434 So. Wabash Ave., Chicago 5, Illinois.**

Name *Please PRINT!*

*Account No.

Old Address

City State

New Address

City Zone State

Mail copies to new address starting with _____ issue.

*(Your Account Number appears directly above your name on the mailing label.)

ELECTRONIC TERMINOLOGY

By **MARGARET LeFEVRE**

(Answer on page 134)

ACROSS

1. People in general.
5. In push-pull amplifiers a _____ of tubes is used.
9. A ham's apparatus.
10. Debt discharged (abbr.).
12. River in Italy.
14. To own (code spelling).
15. Type of transmission (abbr.).
16. "Worked All Countries."
17. Bow of flame formed between two electrodes connected to an electric current.
19. A lady ham.
20. It goes with "hi."
21. Near (code spelling).
23. To vibrate.
29. "Listening" sets.
30. Bands of frequencies on either side of the carrier wave.
34. Chemical symbol for thoron.
35. That thing.
36. Chemical symbol for silicon.
37. Frequency changing device.
40. While.
41. Lower than r.f. (abbr.).
43. Last stage.
45. This type of emission is steady, unmodulated pure carrier.
46. Vim.
48. Bovine quadrupeds.
49. Landing ship dock (abbr.).
50. River in Germany.
51. An instrument for transforming air-pressure waves of sound into electric currents or voltages.

DOWN

1. To adapt to the use of solid-state devices.
2. That man.
3. For example.
6. An exclamation.
7. Climbing plant.
8. Electro-magnetic switches.
10. Sound system (abbr.).
11. Battery current (abbr.).
12. The final (abbr.).
13. Companion of "either."
16. Sagacious.
18. Center (code spelling).
20. Large wooded areas.
22. Hinder the flow of an electric current.
24. Volume measure (abbr.).
25. That is to say (abbr.).
26. Arm or branch.
27. Fifty-five (Rom. numerals).
28. Digraph in Latin names.
31. Beginning (abbr.).
32. It indicates frequency.
33. Three-element tube.
37. Same as 37 across.
38. Radar is used to location of objects.
39. Single thing.
42. Tube element (abbr.).
44. Indefinite article.
45. Inquire.
47. Chemical symbol for fusible metal alloy used in all radio construction.
49. Fifty-one (Rom. numerals).

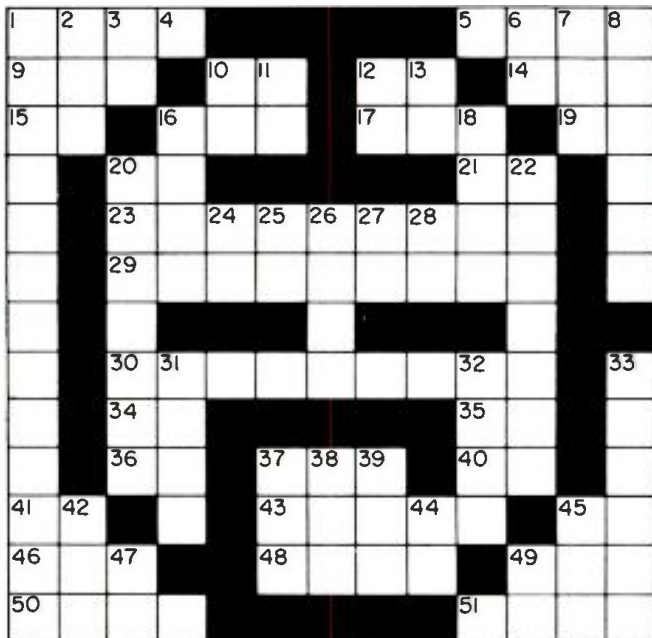

Surprise!

WALTER ASHE TRADES HIGHER

(he always has since 1922)

You always save money dealing with Walter Ashe Radio . . . because we always offer you more for your used transmitters, receiver or other surplus amateur gear* Find out for yourself . . . tell us what you have to trade and what you want. We guarantee you'll be genuinely surprised by the Walter Ashe deal! Use the coupon below . . . mail it today!



DO YOU HAVE OUR NEW 144 PAGE AMATEUR CATALOG? ...IT'S FREE

Check the coupon... get the amateur's most complete catalog of the newest in equipment, parts and supplies... everything you need!

*Made Since 1945

Catalogs mailed only to U.S. and Canada.

Phone: Chestnut 1-1125

WALTER ASHE RADIO CO.
Dept. R-11-61
1123 Pine St.
St. Louis 1, Mo.

WALTER ASHE RADIO COMPANY

Dept. R-11-61, 1123 Pine Street, St. Louis, Missouri

I am interested in _____

What is the Ashe "Surprise" allowance on _____

Name _____

Address _____

City _____ Zone _____ State _____

Send New Catalog Send Recanditioned Bulletin

CITIZEN'S BAND RADIO **CBD-5**

5 Channel, crystal controlled - Dual voltage



12 Volts DC/115 Volts AC... 3.2 Amps full standby current
... Transistor power supply... Highly sensitive, selective, superheterodyne receiver with RF stage... 2 IF stages... Automatic noise limiter... Adjustable quieting squelch... Full 5 watt transmitter... Dual tuned pi-network output circuit... Universal mounting bracket included.

Five Channel • CBD-5 w/1 pair crystals \$179.50

ALSO AVAILABLE

Single Channel • CBD-1 w/1 pair crystals \$159.50

PEARCE-SIMPSON, INC.

A Leader in Creative Electronics

2295 N. W. 14th ST., MIAMI 35, FLORIDA

DEALER INQUIRIES INVITED

EXAMINE ANY OF THESE TESTERS BEFORE YOU BUY!!

Yes, we offer to ship at our risk
one or more of the testers
described on these pages.

SUPERIOR'S NEW MODEL 770-A

VOLT-OHM MILLIAMMETER

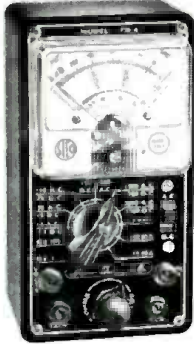

FEATURES:

- Compact—measures 3 1/8" x 5 1/8" x 2 1/4"
- Uses "Full View" 2% accurate 850 Microampere D'Arsonval type meter
- Housed in round-cornered, molded case.

SPECIFICATIONS:

- 6 A.C. VOLTAGE RANGES: 0-15/30/150/300/1500/3000 Volts.
- 6 D.C. VOLTAGE RANGES: 0-7.5/15/75/150/750/1500 Volts.
- 2 RESISTANCE RANGES: 0-10,000 Ohms, 0-1 Megohm.
- 3 D.C. CURRENT RANGES: 0-15/150 Ma., 0-1.5 Amps.
- 3 DECIBEL RANGES: -6 db to +18 db, +14 db to +38 db, +34 db to +58 db.

The Model 770-A comes complete with test leads and operating instructions. Price is \$15.85. Terms: \$3.85 after 10 day trial then \$1.00 monthly for 3 months.

SUPERIOR'S NEW MODEL 77

VACUUM TUBE VOLTMETER

WITH NEW 6" FULL VIEW METER

Compare it to any peak-to-peak V.T.V.M. made by any other manufacturer at any price!



SPECIFICATIONS:

- DC VOLTS—0 to 3/15/75/150/300/750/1500 volts at 11 megohms input resistance.
- AC VOLTS (RMS)—0 to 3/15/75/150/300/750/1500 volts.
- AC VOLTS (Peak to Peak)—0 to 8/40/200/400/800/2000 volts.
- ELECTRONIC OHMMETER—0 to 1000 ohms/10,000 ohms/100,000 ohms/1 megohm/10 megohms/100 megohms/1,000 megohms.
- DECIBELS—10 db to +18 db, +10 db to +38 db, +30 db to +58 db. All based on 0 db = .006 watts (6 mw) into a 500 ohm line (1.73V).
- ZERO CENTER METER—For discriminator alignment with full scale range of 0 to 1.5/7.5/37.5/75/150/375/750 volts at 11 megohms input resistance.

Model 77 comes complete with operating instructions, probe and test leads and carrying case. Price is \$12.50. Terms: \$12.50 after 10 day trial then \$6.00 monthly for 5 months.

SUPERIOR'S NEW MODEL 70 UTILITY TESTER

FOR REPAIRING ALL ELECTRICAL APPLIANCES MOTORS ★ AUTOMOBILES



UTILITY TESTER INCLUDED FREE
64 page condensed course in electricity. Profusely illustrated. Written in simple, easy-to-understand style.

As an electrical trouble shooter the Model 70:

- Will test Toasters, Irons, Broilers, Heating Pads, Clocks, Fans, Vacuum Cleaners, Refrigerators, Lamps, Fluorescents, Switches, Thermostats, etc.
- Measures A.C. and D.C. Voltages, A.C. and D.C. Current, Resistances, Leakage, etc.
- Incorporates a sensitive direct-reading resistance range which will measure all resistances commonly used in electrical appliances, motors, etc.
- Leakage detecting circuit will indicate continuity from zero ohms to 5 megohms (5,000,000 ohms).

As an Automotive Tester the Model 70 will test:

- Both 6 Volt and 12 Volt Storage Batteries • Generators • Starters • Distributors • Ignition Coils • Regulators • Relays • Circuit Breakers • Cigarette Lighters • Stop Lights • Condensers • Directional Signal Systems • All Lamps and Bulbs • Fuses • Heating Systems • Horns • Also will locate poor grounds, breaks in wiring, poor connections, etc.

Model 70 comes complete with 64 page book and test leads. Price is \$15.85. Terms: \$3.85 after 10 day trial then \$1.00 monthly for 3 months.

SUPERIOR'S NEW MODEL 79

SUPER-METER

WITH NEW 6" FULL VIEW METER



SPECIFICATIONS:

- D.C. VOLTS: 0 to 7.5/15/75/150/750/1,500.
- A.C. VOLTS: 0 to 15/30/150/300/1,500/3,000.
- D.C. CURRENT: 0 to 1.5/15/150 Ma. 0 to 1.5/15 Amperes.
- RESISTANCE: 0 to 1,000/100,000 Ohms. 0 to 10 Megohms.
- CAPACITY: .001 to 1 Mfd. 1 to 50 Mfd.
- REACTANCE: 50 to 2,500 Ohms. 2,500 Ohms to 2.5 Megohms.
- INDUCTANCE: 15 to 7 Henries. 7 to 7,000 Henries.
- DECIBELS: -6 to +18, +14 to +38, +34 to +58.

The following components are all tested for QUALITY at appropriate test potentials. Two separate BAD-GOOD scales on the meter are used for direct readings.

- All Electrolytic Condensers from 1 MFD to 1000 MFD.
- All Selenium Rectifiers.
- All Germanium Diodes.
- All Silicon Rectifiers.
- All Silicon Diodes.

Model 79 comes complete with operating instructions, test leads and carrying case. Price is \$38.50. Terms: \$8.50 after 10 day trial then \$6.00 monthly for 5 months.

SUPERIOR'S NEW MODEL 80

20,000 OHMS PER VOLT ALLMETER



6 INCH FULL-VIEW METER provides large easy-to-read calibrations. No squinting or guessing when you use Model 80.

MIRRORED SCALE permits fine accurate measurements where fractional readings are important.

SPECIFICATIONS:

- 7 D.C. VOLTAGE RANGES: (At a sensitivity of 20,000 Ohms per Volt) 0 to 15/75/150/300/750/1500/7500 Volts.
- 6 A.C. VOLTAGE RANGES: (At a sensitivity of 5,000 Ohms per Volt) 0 to 15/75/150/300/750/1500 Volts.
- 3 RESISTANCE RANGES: 0 to 2,000/200,000 Ohms. 0-20 Megohms.
- 2 CAPACITY RANGES: .00025 Mfd. to 3 Mfd., .05 Mfd. to 30 Mfd.
- 2 D.C. CURRENT RANGES: 0-75 Microamperes, 0 to 7.5/75/750 Milli-amperes, 0 to 15 Amperes.
- 3 DECIBEL RANGES: -6 db to +18 db, +14 db to +38 db, +34 db to +58 db.

NOTE: The line cord is used only for capacity measurements. Resistance ranges operate on self-contained batteries.

Model 80 Allmeter comes complete with operating instructions, test leads and portable carrying case. Price is \$12.50. Terms: \$12.50 after 10 day trial then \$6.00 monthly for 5 months.

DID YOU EVER?

- ▶ Order merchandise by mail, including deposit or payment in full, then wait and write... wait and write?
- ▶ Purchase anything on time and sign a lengthy complex contract written in small difficult-to-read type?
- ▶ Purchase an item by mail or in a retail store then experience frustrating delay and red tape when you applied for a refund?

Obviously prompt shipment and attention to orders is an essential requirement in our business... We ship at our risk!

NO

CONTRACT TO SIGN
CO-MAKERS
EMPLOYER
NOTIFICATION

The simple order authorization included in this offer is *all* you sign. We ask only that you promise to pay for or return the goods we ship in good faith.

EXAMINE ANY ITEM YOU SELECT
IN THE PRIVACY OF YOUR OWN HOME

Then if completely satisfied pay on the interest-free terms plainly specified. When we say interest-free we mean not one penny added for "interest" for "finance" for "credit-checking" or for "carrying charges." The net price of each tester is plainly marked in our ads—that is all you pay except for parcel post or other transportation charges we may prepay.

SUPERIOR'S NEW MODEL 82A
MULTI-SOCKET TYPE

TUBE TESTER

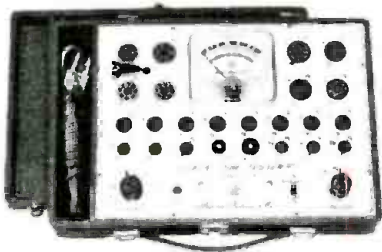

SPECIFICATIONS:

- Tests over 1000 tube types.
- Tests OZ4 and other gas-filled tubes.
- Employs new 4" meter with sealed air-damping chamber resulting in accurate vibrationless readings.
- Use of 22 sockets permits testing all popular tube types and prevents possible obsolescence.
- Dual Scale meter permits testing of low current tubes.
- 7 and 9 pin straighteners mounted on panel.
- All sections of multi-element tubes tested simultaneously.
- Ultra-sensitive leakage test circuit will indicate leakage up to 5 megohms.

Model 82A comes housed in handsome, portable case.
Price is \$36.50. Terms: \$6.50 after 10 day trial then \$6.00 monthly for 5 months.

SUPERIOR'S NEW MODEL TW-11

STANDARD PROFESSIONAL TUBE TESTER



- Uses the new self-cleaning Lever Action Switches for individual element testing. Because all elements are numbered according to pin-number in the RMA base numbering system, the user can instantly identify which element is under test.
- Free-moving built-in roll chart provides complete data for all tubes. All tube listings printed in large-easy-to-read type.
- NOISE TEST: Phono-jack on front panel for plugging in either phones or external amplifier will detect microphonic tubes or noise due to faulty elements and loose internal connections.
- SEPARATE SCALE FOR LOW-CURRENT TUBES—Previously, on emission type tube testers, it has been standard practice to use one scale for all tubes. As a result, the calibration for low-current types has been restricted to a small portion of the scale. The extra scale used here greatly simplifies testing of low-current types.

The Model TW-11 comes housed in a handsome, portable, saddle-stitched Texon case. Price is \$17.50. Terms: \$11.50 after 10 day trial then \$6.00 monthly for 6 months.

SUPERIOR'S NEW MODEL 83A

C.R.T. TESTER

Tests and Rejuvenates
ALL PICTURE TUBES

ALL BLACK AND WHITE TUBES
From 50 degree to 110 degree types—from 8" to 30" types.

ALL COLOR TUBES
Test ALL picture tubes—in the carton—out of the carton—in the set!

Model 83A provides separate filament operating voltages for the older 6.3 types and the newer 8.4 types.

Model 83A properly tests the red, green and blue sections of color tubes individually—for each section of a color tube contains its own filament, plate, grid and cathode.

Model 83A will detect tubes which are apparently good but require rejuvenation. Such tubes will provide a picture seemingly good but lacking in proper definition, contrast and focus.

Rejuvenation of picture tubes is not simply a matter of applying a high voltage to the filament. Such voltages improperly applied can strip the cathode of the oxide coating essential for proper emission. The Model 83A applies a selective low voltage uniformly to assure increased life with no danger of cathode damage.

Model 83-A comes housed in handsome portable Saddle-stitched Texon case—complete with socket for all black and white tubes and all color tubes. Price is \$38.50. Terms: \$8.50 after 10 day trial then \$6.00 monthly for 5 months.

SUPERIOR'S NEW MODEL 85

TRANS-CONDUCTANCE TYPE TUBE TESTER

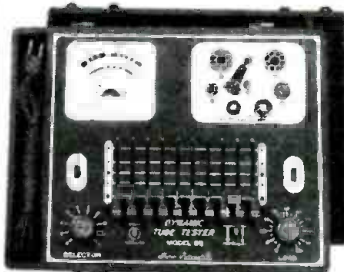

- Employs latest improved TRANS-CONDUCTANCE circuit. Test tubes under "dynamic" (simulated) operating conditions. An in-phase signal is impressed on the input section of a tube and the resultant plate current change is measured as a function of tube quality. This provides the most suitable method of simulating the manner in which tubes actually operate in radio, TV receivers, amplifiers and other circuits. Amplification factor, plate resistance and cathode emission are all correlated in one meter reading.
- SYMBOL REFERENCES: Model 85 employs time-saving symbols (●, ▲, ■) in place of difficult-to-remember letters previously used. Repeated time-studies proved to us that use of these scientifically selected symbols speeded up the element switching step. As the tube manufacturers increase the release of new tube types, this time-saving feature becomes necessary; and advantageous.
- "FREE-POINT" LEVER TYPE ELEMENT SWITCH ASSEMBLY marked according to RETMA basing, permits application of test voltages to any of the elements of a tube.
- FREE FIVE (5) YEAR CHART DATA SERVICE. Revised up-to-date subsequent charts will be mailed to all Model 85 purchasers at no charge for a period of five years after date of purchase.

Model 85 comes complete, housed in a handsome portable cabinet with slip-on cover. Price is \$32.50. Terms: \$12.50 after 10 day trial then \$8.00 monthly for 5 months.

SUPERIOR'S NEW MODEL TV-50A

GENOMETER 7 Signal Generators in One!



- ✓ R.F. Signal Generator for A.M.
- ✓ R.F. Signal Generator for F.M.
- ✓ Audio Frequency Generator
- ✓ Bar Generator
- ✓ Cross Hatch Generator
- ✓ Color Dot Pattern Generator
- ✓ Marker Generator

A versatile all-inclusive GENERATOR which provides ALL the outputs for servicing:

A.M. Radio • F.M. Radio • Amplifiers • Black and White TV • Color TV

The Model TV-50A comes absolutely complete with shielded leads and operating instructions. Price is \$47.50. Terms: \$11.50 after 10 day trial then \$6.00 monthly for 6 months.

SUPERIOR'S NEW MODEL 88

TESTS ALL TRANSISTORS AND TRANSISTOR RADIOS

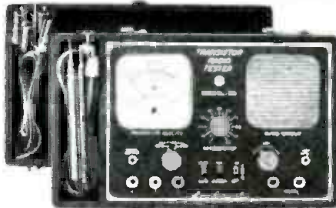

AS A TRANSISTOR RADIO TESTER

An R.F. Signal source, modulated by an audio tone is injected into the transistor receiver from the antenna through the R.F. stage, past the mixer into the I.F. Amplifier and detector stages and on to the audio amplifier. This injected signal is then followed and traced through the receiver by means of a built-in High Gain Transistorized Signal Tracer until the cause of trouble is located and pinpointed.

AS A TRANSISTOR TESTER

The Model 88 will test all transistors including NPN and PNP, silicon, germanium and the new Gallium Arsenide types, without referring to characteristic data sheets. The time-saving advantage of this technique is self-evident. A further benefit of this service is that it will enable you to test new transistors as they are released!

Model 88 comes housed in a handsome portable case. Complete with a set of CHIP-on Cables for Transistor Testing; an R.F. Diode Testing; an R.F. & I.F. Tracing; an Audio Probe for Amplifier Tracing and a Signal Injector Cable. Complete—nothing else to buy! Price is \$38.50. Terms: \$8.50 after 10 day trial then \$6.00 monthly for 5 months.

SEND POSTCARD TODAY

(NO POSTAGE
NECESSARY)

Try any of the instruments on this or the facing page for 10 days before you buy. If completely satisfied then send down payment and pay balance as indicated on coupon. No interest or Finance Charges Added! If not completely satisfied return unit to us, no explanation necessary.

MOSS ELECTRONIC, INC., DEPT D-916 3849 TENTH AVENUE, NEW YORK 34, N.Y.

November, 1961

121

SENSITIVE photo meters which are subjected to extreme shock, and provide a high degree of accuracy.

November, 1961

Multiple high voltage gear which is between the twin-lead so as not to cut the stranding. One quick jerk on the pliers strips off all insulation neatly. The tool can also be used as end-cutting resistor pliers.

23 Superior Manufacturing and Instrument Corp. is in production on a new controls analyzer for the complete checking of servo-mechanisms and feedback controls systems.

The Model 440 incorporates a novel brushless rotating transducer. Carrier frequencies of 5000 cps are easily accommodated in the standard unit, while considerably higher frequencies are available on special order. The Model 440 in-

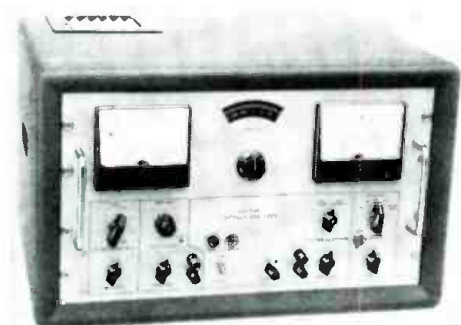

November, 1961

HERSHAW RADIO SUPPLY
3619 TROOST KANSAS CITY, MO.

TRIPSTATE COLLEGE
16111 College Ave., Angola, Indiana

123

The new ideas in communications are born at . . .

hallicrafters
Chicago 24, Illinois

Export Sales: International Div.,
Raytheon Mfg. Co., Waltham, Mass.

Canada: Gould Sales Co.
Montreal, P.Q.



FREE to you and your friends
RADIO SHACK'S 1962
ELECTRONICS CATALOGS

Plus EVERY NEW SUPPLEMENT
FOR NEXT 12 MONTHS!

Our bigger, better catalogs offer the widest line of electronic parts and equipment in the world! Stereo, Hi-Fi, Ham Radio, Test Equipment, Pre-Recorded Tapes, Tape Recorders, Records, Parts—plus 30 pages of Kits! 340 pages—over 100,000 items! No Money Down credit terms. Every item backed by a money-back guarantee of satisfaction.

RADIO SHACK Corp. Boston, Mass.

RADIO SHACK Corp.
730 Commonwealth Ave., Boston 17, Mass.

Send Radio Shack's famous electronics catalogs for one year—FREE and POSTPAID.

Your Name _____ 61L6A

Your State _____

City and Zone _____

For a Friend _____ 61L6A1

Address _____

City and Zone _____ State _____

125

Olson

FREE **10 OLSON STORES Plus MAIL ORDER**

Visit your local Olson Stores at . . .

AKRON, OHIO
69 W. State Street

BUFFALO, N.Y.
711 Main Street

7-TUBE, 14 WATT STEREO \$29.95
AMPLIFIER
WITH 6 SPEAKERS AS SHOWN \$45.95
IDEAL FOR CUSTOM INSTALLATION

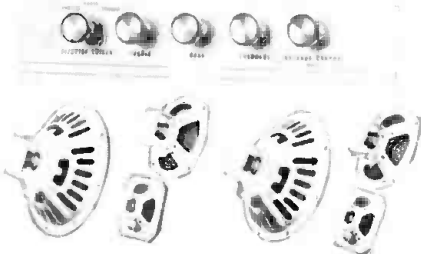
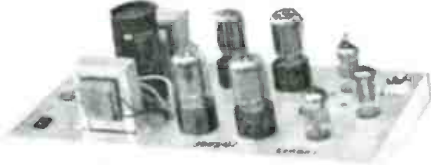

PUSH PULL OUTPUT ON EACH CHANNEL

McGee offers \$100,000 worth of stereo amplifiers at a fraction of their original cost. 14 watts (7 watts per channel) 7 tubes. Push Pull output on each channel matches any 8 ohm hi-fidelity speaker. Response 35 to 15000 cps. Full tone control circuits. Separate gated base and treble tone controls, balance control, loudness control, plus input selector switch for any crystal phono cartridge, or radio tuner. Controls are mounted on a 3 1/4" x 15" gold escutcheon plate. A 30" lead plugs the control system into the amplifier for easy custom installation. Amplifier size 12 1/2" long, 4 1/2" tall and 7 1/2" wide. Operates on 110 volts 60 Cycle a. c. Ship. wt. 8 lbs. Shipped complete with instructions. Stock no. M-1400. McGee sale price \$29.95 with tubes, less speakers. Price with 6 speakers as illustrated \$45.95. The 6 speakers included are 2 10 inch heavy alloy V woofers, 2 matched 6" mid-range and 2 matched 4" alloy V tweeters. Stock No. M-1400-6S. VW 4 speed record changer with Astatic 13TX diamond needle stereo cartridge \$24.95 extra.

DECCA 2-TRACK STEREO TAPE SALE

PEPE FOUNTAIN—King of the clarinet recorded in New Orleans. I GOT RHYTHM. JA-DA. CHINA BOY. AVALON. SHINE. TIGER RAG. DON'T BE THAT WAY. POOR BUTTERFLY. SOMEDAY SWEETHEART. 'S WONDERFUL. Coral 2 track stereo tape regularly \$9.95. from McGee at \$3.95. Stock No. 5733.

WRITE FOR MCGEE'S 1962 172 PAGE CATALOG
McGEE RADIO CO.
1901 McGee St., Kansas City 8, Missouri

This suspension-type meter makes use of a short, very thin, narrow band kept tightly suspended on special spring terminals to support the coil and its moving counter parts. There are no pivots, no jewels, no hairsprings, and no rolling friction.

The new line is available in case sizes including 2 1/2", 3 1/2", 4 1/2", 6", 7", and 8".

POWER SUPPLIES & MODULES

17 Technipower, Inc., has developed a new line of power supplies and modules designed for a wide variety of component-type applications in



laboratories, test equipment, and finished products.

Available in rack-mounted configurations, both metered and unmetered, one, two, or three isolated outputs may be provided on a single rack panel. The units feature regulation of $\pm 0.5\%$ versus line and load, and ripple of less than 1 mv. r.m.s. The units are suitable for use in

cludes a self-contained response channel, obviating the need for an oscilloscope.

LINEAR CONVERTER

24 Neshaminy Electronic Corporation has introduced a wide-range, highly linear voltage-to-frequency converter as the "Volcan."

The all solid-state circuit converts a given voltage into a corresponding frequency with better than .1 per cent linearity and with a stability approaching that of a good crystal oscillator. Virtually the only variable in the circuit is temperature drift which is held to .2 per cent per degree C from zero to 50 degrees C without the need for temperature stabilization.

PANEL INSTRUMENTS

25 Weston Instruments Division has added the Model 1931 to its series of rectangular a.c. and d.c. meters.

The new 3 1/2" instrument is available as an ammeter, milli-ammeter, microammeter, or voltmeter with optional 1 or 2 per cent accuracy. Instruments of 1 per cent accuracy feature a knife-edge pointer and mirror scale; models of 2 per cent accuracy are equipped with a lance-type pointer and conventional scale. Front covers are available in either clear plastic or Bakelite.

TRANSISTORIZED POWER SUPPLIES

26 Amoux Electronics Division is now in production on a new line of rack-mounted, low-voltage, transistorized a.c. to d.c. power supplies for applications involving equipment operation and secondary battery charges.

There are four basic production categories: 15 volts d.c., 5-amp output; 4.5 volts d.c., 10-amp output; 30 volts d.c., 5-amp output; and 4.5 volts

Advance BEST BUYS OF THE MONTH!

ASTRO COMPASS

The Astro Compass is a precision instrument measuring 8 1/4" high x 5 1/4". Furnished in Carrying Case. Designed to provide accurately (a) True heading of aircraft or boat, (b) True bearing of a distant object, (c) The relative bearing of distant objects.

Of special interest to Astronomers, Yachtsmen, & Experimenters.

\$14.50 ea.

Brand New w/instruction booklet.

G-R VARIACS

115 VAC Input 0-135 VAC Output

1 1/2 Amp	\$5.50	5 Amp	10.95
2 Amp	7.50	10 Amp	22.95
3 Amp	8.95	20 Amp	39.95
7 1/2 Amp motor driven Powerstat . . . \$35.00			

VIBRATOR POWER SUPPLIES

OUTPUT 117 VAC. 60 CYC. 100 WATTS-FILTERED

Input 210-240 VDC	24.95
Input 32-40 VDC	24.95

TRANSFORMERS

Primary 115 VAC. 60 cycles

Sec. 460 VCT. 50 MA. 6.3 V. 2.5 A	\$3.25
Sec. 1250 VCT. 200 MA. 2 X 10 VCT.	
1 A; 3 X 5 VCT. 1.2 A; 5 V. 2 A	6.95
Sec. 1050 VCT. 200 MA. 6.3 VCT. 3 A;	
6.3 VCT. 4 A; 5 VCT. 3 A	5.95
Sec. 800 VCT. 200 MA. 6.3 V. 6 A; 5 V. 3 A	5.75
Sec. 2200 VCT. 212 MA	11.95
Sec. 12-6 VCT. 2.5 A; 15-6 V. 1 A	2.45
Sec. 6.3 @ Ba-6.3 @ Ba-6.3 @ 10a	

CHOKES

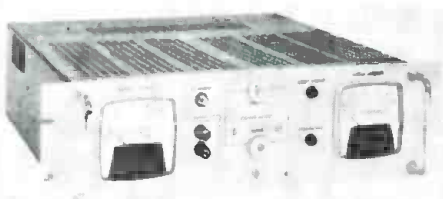

d.c., 10-amp output for battery charging. All types operate from 115-volt, 60-cps power lines. The supplies, designed for the standard 19" relay rack, occupy 5 1/2" of vertical space.

LOW-VOLTAGE DISC CAPACITORS

27 Centralab is now marketing a new line of low-voltage disc capacitors designed especially for transistor circuitry in both original equipment and replacement applications.

Capacities range from .005 μ l. to .1 μ l. $\pm 20\%$. Working voltage is 50 volts d.c. Initial leakage resistance is over 7500 megohms, while leakage resistance after humidity testing is over 1000 megohms. Power factor is 2% maximum at 1 kilocycle.

The Type CK capacitors are 5/32" thick with diameters ranging from 3/8" to 3/4", depending on capacity.

MULTI-TRACE CRT

28 Sylvania Electric Products Inc. has introduced a multi-trace cathode-ray tube with three independently controlled electron guns capable of producing three displays simultaneously.

Designated Type SC-3061, the 10-inch tube is available in a variety of phosphors, is electrostatically focused and deflected, and features an astigmatism control electrode. Deflection factors at 5 kv. anode voltage are approximately 130 v./in. horizontal and 70 v./in. vertical. The useful horizontal scan of each parallel trace is approx-

TRU-VAC 1-yr. guaranteed Radio & TV Tubes

FREE UP TO 100 1-YR. GUARANTEED TRU-VAC TUBES TO QUANTITY BUYERS!

Now quantity buyers get a FREE assortment of individually-boxed, regular stock TRU-VAC tubes with each order.

PLACE YOUR ORDER TODAY! GET UP TO 100 TUBES FREE! Here's how this FREE offer works!

15 FREE TUBES	With Order of \$25
25 FREE TUBES	With Order of \$50
50 FREE TUBES	With Order of \$100
100 FREE TUBES	With Order of \$500

LOOK! 1,000 USED TV'S \$16.95 As 15

Sensational Offer! "Self Service" TUBE CHECKERS \$37.95 FOB Our Warehouse

Let your customers test their own tubes! These reliable, reconditioned 22-socket tube checkers will return your investment in one week or less with little or no effort on your part! Handsome, field-tested console models COMPLETE WITH KEY FOR BOTTOM DOOR AND NEON-LIGHTED HEAD!

BRAND NEW 1-YEAR GUARANTEED TV PICTURE TUBES

6W4GT	30c	6W4GT	30c
1R5	304	6AC7	6B6G
0Y4	354	6AF4	6B6G
0Z4	3V4	6AG5	6B6G
1A7GT	4B07A	6AH4GT	6A5S
1B3CT	4B58	6AH6	6AT6
1MSGT	4BZ7	6AK5	6AU4GT
1L4	4CB6	6AL5	6AV5GT
1L6	5AB8	6AN8	6A8B
1NSGT	5AN8	6AN8	6AV5GT
1S5	5AT8	6AQ5	6AV6
1T4	5AV8	6AQ6	6AW8
1U4	5AZ4	6A07	6AXGT
1U5	5BR8	6AR5	6AXSGT
1V2	5C0B	6AU6	6BK5
1V2	5J6	6B8	6BK7
2A4	5R4	6B8A	6BL7CT
2B4	5T8	6B8C	6BN6
2C5	5U4	6B8C	6B0GT
3A5	5U8	6BD6	6B07
3A5	5V4C	6BE6	6RR8
3AU6	5V6GT	6BF5	6R5B
3BC5	5X8		
3BN6	5Y3		
3BZ6	6A6		
3CB6	6AB4		

Factory Used or Factory Second Tubes! TRU-VAC will replace FREE any tube that becomes defective in use within 1 year from date of purchase!

ALL TUBES INDIVIDUALLY BOXED! CODE DATED & BRANDED "TRU-VAC"

Below Listed prices do not include tax and additional \$5.00 deposit on tube sizes to 20" on 21" and 24" tubes—\$7.50. Deposit refunded immediately when unit is returned prepaid. Atomized tubes—\$4.00 extra. Picture tubes shipped only to continental USA and Canada—All times P.O.B., Harrison, N.J.

BRAND NEW 1-YEAR GUARANTEED TV PICTURE TUBES

Below Listed prices do not include tax and additional \$5.00 deposit on tube sizes to 20" on 21" and 24" tubes—\$7.50. Deposit refunded immediately when unit is returned prepaid. Atomized tubes—\$4.00 extra. Picture tubes shipped only to continental USA and Canada—All times P.O.B., Harrison, N.J.

ATTENTION QUANTITY USERS! Big Discounts Are Yours... Call or Write For Our Tube "Private Label" Special! Attention Branding Dept. Mgmt. Money cheerfully refunded Within Five (5) Days, If Not Completely Satisfied!

TRU-VAC PAYS YOUR POSTAGE—on orders of \$5 or more in USA and Territories. Send approximate postage on foreign orders. Any order less than \$5 requires 25¢ handling charge, send 25¢ on U.O.D.'s. All orders subject to prior sale, complying with Federal regulations, the following statement appears in all TRU-VAC advertising: Tubes in this ad may be FACTORY SECOND or USED tubes and are clearly marked.

TRU-VAC
Harrison Avenue • Box 107 • Harrison, N. J. HUmboldt 4-9770



imately 8½" while traces are 138" apart on a common vertical line.

DUAL-GUN SCOPE

29 Packard Bell Electronics has introduced a dual-gun d.c. to 5 mc, oscilloscope which weighs 22 pounds. With only two types of vacuum tubes and the CRT the scope is designed for easy maintenance and repair. Identical amplifiers on each vertical input provide identical traces over the full screen face with no phase shift.

A preamplifier is built into the lower vertical amplifier, increasing the sensitivity from 100 mv./cm. to 1 mv./cm. Sweep range is from 1 μsec./cm. to 1 sec./cm. Both internal and external triggers are provided.

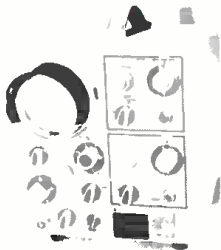

HI-FI—AUDIO PRODUCTS

MINIATURE RECORDERS

30 International Telephone and Telegraph Corp. is handling the U.S. distribution of the "Minilon" line of wire and tape recorders.

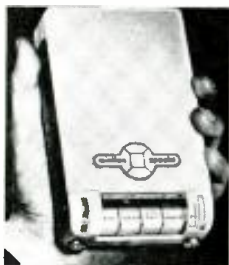

Included in the new line are three portable recorder models and a number of accessories which make them adaptable to special needs. The "Special" is a long-play wire recorder, capable of transcribing up to five hours of continuous conversation; the "Attache"

offers features aimed at general business and commercial dictating requirements, while the "Hi-Fi" is a precision-engineered, hi-fi instrument for professional use.

All models are battery-powered and fully transistorized, weighing as little as 1 lb., 12 oz.

STEREO & MONO TAPE HEADS

31 Sonotone Corporation has announced that its record/reproduce and erase heads, produced for original equipment manufacturers, are now available for distributor and service replacement.

Two series are represented in this new replacement line: the RH-2 series for mono taping with matching EH-2 erase heads if desired, and the RH-1 series for stereo recording, also with matching EH-1 erase heads.

All of these new models can be obtained singly or with matching erase heads as required by the user.

STEREO TAPE SYSTEM

32 Penton Electronics Corporation has developed a compact, lightweight, completely self-contained stereo tape recorder and playback system which can record from any source, add to existing recordings, as well as play stereo quarter-track and half-track tapes.

The "880" design incorporates two hand-wired amplifiers and preamps, two full-range speaker

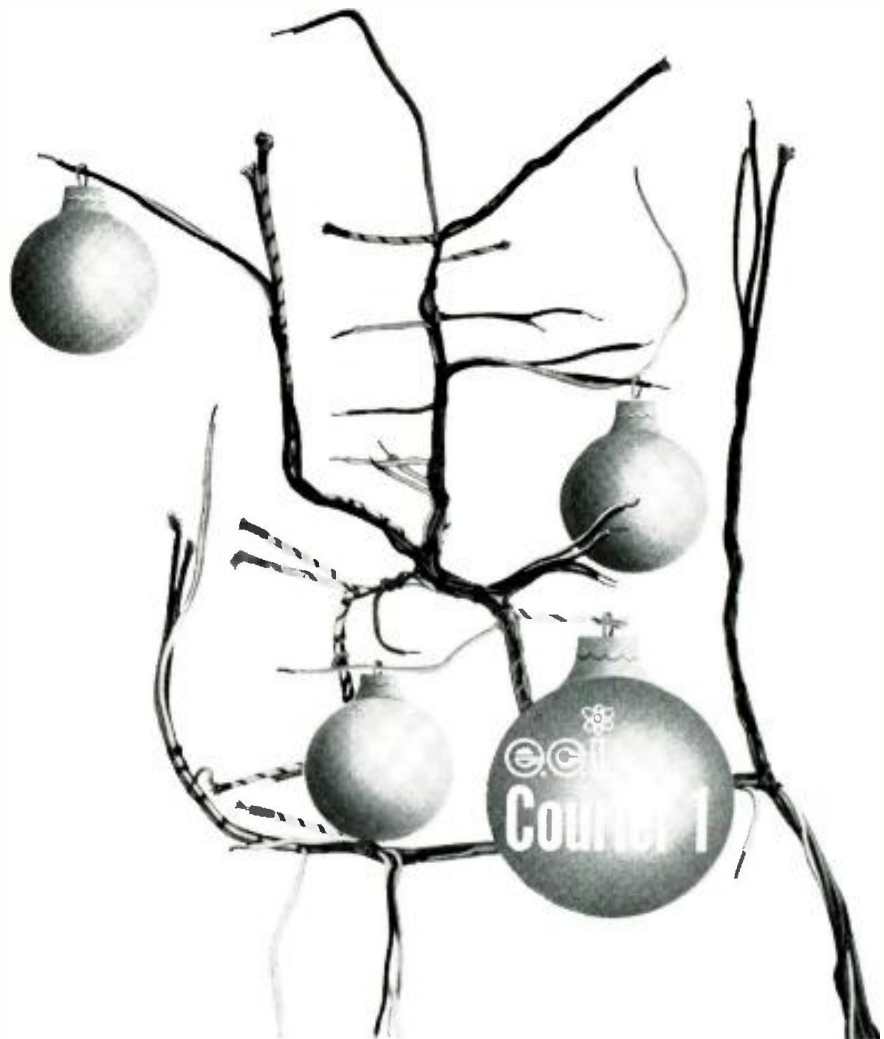

CB TREE? It's actually the e.c.i. Courier 1 hand wired harness that ties together its five individual segments into a unified chassis for simple installation, use and maintenance. And that's only part of the e.c.i. Courier 1 quality story. Think of every conceivable feature you need and want in a CB transceiver that will still get out more than 3 watts . . . e.c.i. Courier 1 has them. See for yourself.



write for free brochure

\$189.50

Slightly higher west of Rockies

- TRIPLE CONVERSION
- 12 CHANNEL TRANSMITTING
- FIXED & TUNABLE DRIFT-FREE RECEIVING
- BUILT-IN NOISE LIMITER & SQUELCH
- ELECTRONIC SWITCHING (no relays)
- FULLY MODULATED (100%)
- BUILT-IN "S" & "RF" METER
- LOWEST NOISE FRONT END
- MOBILE OR BASE (117 V. and 12 V.)
- ENTIRE UNIT SLIDES OUT ON TRACKS



electronics communications, inc. 325 no. macquesten pkwy. mt. vernon, n.y.

MOVING?

Make sure you notify our subscription department about any change of address. Be sure to include your postal zone number as well as both old and new addresses. Please allow four weeks' time for processing.

ELECTRONICS WORLD

434 South Wabash Avenue
Chicago 5, Illinois

GET INTO

ELECTRONICS



V.T.I. training leads to success as technicians, field engineers, specialists in communications, guided missiles, computers, radar and automation. Basic and advanced courses in theory and laboratory. Associate degree in electronics in 24 months. B.S. in electronic engineering obtainable. FCC accredited. G.I. approved. Graduates in all branches of electronics with major companies. Start February, September. Dorms, campus. High school graduate or equivalent. Catalog.

VALPARAISO TECHNICAL INSTITUTE
Dept. RD, Valparaiso, Indiana

ANNUAL DOUBLE BONUS MONTH

FREE!

BONUS #1

\$\$\$50.00\$\$\$

ADD 25¢ FOR HANDLING

WORTH OF RADIO-TV PARTS
(Over 300 Pieces in our Famous Variety Gift Paks)

BONUS #2

PLUS \$1 POLY PAK®
ANY OF YOUR CHOICE LISTED BELOW

BOTH FREE with every \$15 ORDER

- 60 Radio 'N' TV Knobs Ass't. colors, sizes, shapes; some worth \$1 ea. \$1
- 1 1/2 LBS. HARDWARE Nuts, bolts, etc. \$1
- 40 Two-Watt Resistors Incl. 1 1/2, 100 Ass't. values. \$1
- 2000 OHM PHONE With cord & plug, ear loop, Worth \$1
- CRYSTAL PHONE Sensitized w/ear & plug. \$1
- 525 SURPRISE PAK Variety of radio-TV, hobby parts. \$1
- 10 RCA Plug 'N' Jack Sets for amps, etc. \$1
- 40 TUBE SOCKETS 1 to 12 pin types. Worth \$1
- 6 HOBBY TRANSISTORS PNP's, and NPN's. \$1
- 10 "POLY" BOXES Snap top covers. \$1
- 60 Plugs & Receptacles Incl. power, audio, battery, etc. Worth \$1
- 100 Ceramic Condensers Incl. disc, tub. \$1
- 10 Germanium Diodes Glass sealed, like 1N31. \$1
- 100 Half Watt Resistors Ass't. values, 1/2, 100, Worth \$1
- 35 POWER RESISTORS Ass't. to 50W to 10,000 ohms. Worth \$1
- 60 MICA CONDENSERS Incl. silver, tub. and to 100V. Worth \$1
- 10 Electrolytic Cond. Incl. can & paper types. Duals (out) Worth \$1
- 60 Tubular Condensers Papers, molded, oiled, cemented to 100V in can. Worth \$1
- 35 SILVER MICAS Epoxy, mica made. Worth \$1
- 300-FT. HOOKUP WIRE Ass't. colors, insula- tion, sizes. Worth \$1
- 70 TERMINAL STRIPS 1 to 10 tie points. Worth \$1
- 60 COILS & CHOKES I.F., ant. asp., slug-tuned, I.F. Worth \$1
- 70 One-Watt Resistors Incl. precision, W, W, 1/2, 100, Worth \$1
- RCA INVERTER 110V to 110VAC Comes less tubes. \$1
- 3 Sylvania Transistors Popular makes. \$1
- 30 ALLEN BRADLEY RESISTORS, world's finest, 5W, 100, 1/2, 100, 2W's. \$1
- TWO 9V BATTERIES Same as Burgess 20B. 100% fresh stock. \$1
- 30 Transistor "Things" Disc. condensers, 0.05 mfd. 30 to 100VDC. \$1
- "TINIEST" RESISTORS Body only 4/10" long, 5 values, 1/4W. \$1
- 000 to 999 TIMER Veeber Root; long shaft; for call, motors. \$1
- 65 Condenser Special Incl. disc, mica, mdf, mdf, mica. Worth \$1
- 15 ROTARY SWITCHES Ass't. gauges, con- tacts. Worth \$1
- 50 DISC CONDENSERS Ass't. 500 to 50 to 100V. Worth \$1
- 4 Output Transformers 50LB, etc. Open frame types. Worth \$1
- 6 NPN TRANSISTORS Worth \$1 ea. 100's \$1
- 10 115 VAC SWITCHES Toggle type, SPST, DPDT, etc. A shop must. \$1
- 60 Insulated Resistors III, 1/2, 1W, to 1 meg. 1/2V AC. \$1
- 10 PANEL SWITCHES Micros, power, rotary types. Exc. variety. \$1
- 65 RESISTOR SPECIAL Carbon, precision, W.W., to 50W, 1/2, 100, Worth \$1
- 20 VOLUME CONTROLS 2 cond. rubber w/ 1 mfd. switch. Worth \$1
- 15 AC-DC LINE CORDS 2 cond. rubber w/ 7 molded plugs, short \$1
- 30 PRINTED CIRCUITS Resistor & condenser networks \$1
- CRYSTAL MIKE, mini 1 1/2" sq. 100. \$1
- HEAVY DUTY line cords, all rubber, 18-ft. lengths. \$1
- 2 SUN BATTERIES Lite sensitive cells, 2x1" size. \$1
- 10 Transistor Sockets PNP resistors and mini tubes \$1
- 6 PNP TRANSISTORS Worth \$1, 100's of uses. \$1
- 3 Power Transistors For all types of audio use. \$1
- 4 SILICON RECTIFIERS 500 mAs, top hat type. \$1
- Selenium Rectifiers 115 VAC, 65 mill rect., 1/2 wave. \$1
- 25 PILOT LITES 1/2" & screw types; 1.5 to 6V. \$1
- 5 MICRO SWITCHES Rated 115 VAC, SPST cont. \$1
- 25 RELAY SURPRISE Guaranteed satisfac- tion. \$1
- 50 Precision Resistors WW & carbo-ilm; val; 50 ohms to 1 meg. 1/2, 1, 2W, 1/2, 100. \$1
- 4 BRAND NEW 1U4's Tubes by Sylvania. 0.05c boxes. \$1
- "TINIEST" IFS Transformer; for trans- form. 1/2" sq. 450 \$1
- GIANT SOLAR DISC "Sun Battery," 1 1/2" dia. Generates own voltage. \$1
- 6 CORD SETS Vt rubber, 6-ft. long; 2- cond., #18; black. \$1
- 6 ROLLS OF TAPE Incl. friction & poly vinyl. \$1
- 50 HI-Q CONDENSERS Incl. Finest made, Formium bottles. \$1

FREE GIANT BARGAIN CATALOG WRITE FOR YOURS!

CLIP 'N MAIL! USE AS ORD-GRAM

LEKTRON 243 EVERETT AVE. CHELSEA 50, MASS. Write for free catalog.



systems, two microphones, and a push-button-controlled tape transport mechanism all housed in a molded fiber case measuring 14" x 7 1/2" x 14 1/2".

The unit comes complete with microphones, connecting cables, a reel of blank tape, and a take-up reel.

FM/MULTIPLEX ADAPTER

33 Stromberg-Carlson is now marketing a miniature, all-transistorized FM multiplex adapter that adapts any quality FM tuner to receive stereo multiplex broadcasts.

The new unit, which can be installed in a matter of minutes, measures 3" x 5" x 1 1/2". Since it generates virtually no heat, this separate modular component can be placed anywhere on the chassis.

The adapter features stereo separation of more than 20 db, automatic electronic balancing which eliminates manual controls, automatic adjustment of various input signal levels, and a.l.c.

STEREO AMPLIFIER

34 Magnatone Amplifier and Guitar Division has recently introduced an extensive line of hi-fi amplifiers, several models of which in-



corporate the Hammond reverberation unit as well as the firm's patented stereo vibrato.

The Model 180 shown in the photo has 14 tubes, two output channels totaling 50 watts output, two custom-designed extended-range hi-fi 12" speakers, two matched 5" x 7" oval mid-range speakers with high frequency diffusers, two separate input channels, stereo input jack, a two-position switch, jacks for two separate remote speakers, and the patented stereo vibrato circuit.

The line offers units with outputs of from 5 to 50 watts.

CB-HAM-COMMUNICATIONS

CB ANTENNA LINE

35 Clear Beam Antenna Corporation is now offering a new series of economy CB antennas. The Model G-P-1 ground-plane features a unique design with a 1" diameter driven element and drooping radials to give improved impedance matching with coaxial lead cable. The Model C-B-Y-3 is a three-element yagi for 27 mc. with full .10 and .15 wavelength spacing.

AUTOMATIC SIGNAL DEVICE

36 Aquatronic Industries has developed a portable, easy-to-operate distress-signal transmitter for boats which is being marketed as the "Res-Q-Matic."

Designed to transmit an SOS signal on 2182

kc., the unit has a self-contained power source and is activated in an emergency at sea simply by extending the antenna assembly.

The unit is five inches in diameter and twenty inches high with the antenna collapsed for storage. It comes complete with its own stowage and carrying case. Colored a brilliant "distress-orange" to provide maximum visibility, the transmitter is designed to float. Its effective range allows its signal to be heard and fixed on inland and coastal waters.

CB TRANSCEIVER

37 Monarch Electronics International, Inc. has announced the availability of a pocket-sized transceiver for the CB service.



Designed to operate with a range of a mile or more, output power is 100 mw. The transmitter is a crystal-controlled v.t. oscillator while the receiver is a crystal-controlled superheterodyne.

Its nine-transistor circuit is powered by seven standard pen-light cells. The rugged case is of black impact plastic and measures 6 3/4" x 2 1/2" x 1 3/8". The transceiver comes complete with leather case and shoulder strap, belt clamp, earphone and earphone case, batteries, and crystals.

V.H.F. NAV/COM SYSTEM

38 Aircraft Radio Corporation has introduced a new crystal-controlled, lightweight, local-control v.h.f. Nav/Com system for light planes as the Model 317A.

The new system, designed to TSO Category B requirements, offers broad receiving and transmitting coverage of VOR, LOC, and communication frequencies. It transmits on 360 channels and receives on 380 channels. All crystals are supplied with the original equipment, with no modifications required later. Transmission range is from 118 to 135.95 mc. in 50-ke. steps. It receives VOR and LOC from 108 to 117.9 mc. plus 180 communication channels from 118 to 126.95 mc. in 50-ke. steps.

PORTABLE CB UNIT

39 Polygram Industries Inc. has recently introduced a portable two-way unit for use in CB service.



The completely transistorized transmitter-receiver, designated the "C1-200," operates in pairs or with existing mobile and base equipment. Power is supplied from standard 9-volt dry batteries or rechargeable nickel-cadmium batteries.

The unit measures 1 1/4" x 2 3/4" x 5 1/2" and weighs 9 ounces. The circuit features a press-to-talk switch and an eight-section telescoping antenna.

NEW HAM RECEIVER

40 National Radio Co., Inc. has added the Model NC-190 receiver to its line of short-wave, military, and amateur receiving equipment.

The new unit features an exclusive dial selector which provides calibrated bandspread for the popular international broadcast bands as well as excellent amateur bandspread. Dual conversion on all bands above 1 mc. eliminates the possibility of unwanted image signals in all tuning ranges. Three selectivity positions are provided: 600 cycles, 3 kc., and 5 kc.

The unit is housed in a steel chassis and a dune-tone blue cabinet with steel panel.

MONITOR RECEIVERS

41 Outercom Electronics, Inc. is now offering a split-channel monitor receiver which provides clear, strong reception of two-way radio communications even under the most congested signal conditions.

Available in two models, the MR 30-X and the MR 50-X, the units can be installed wherever standard 117-volt a.c. is available. A built-in whip antenna provides adequate reception in most areas, with terminals provided for an external antenna if required.

The Model MR 30-X is designed for 25-74 mc, while the MR 50-X covers 147-171 mc. The standard model is single channel but an optional fea-



ture is a four-way switch that permits selection of 2, 3, or 4 pre-selected two-way radio channels with a spread of 1% of channel frequency.

FM SIGNAL GENERATOR

42 Microdot Inc. is now offering an FM signal generator which has been specifically designed for checking out command receivers in the 400-550 mc. band.

The Model 112 features direct six-place digital readout of frequency, accurate to within 1 kc.



Continuous frequency coverage is provided by a single tuning control and .0002% accuracy prevails throughout the frequency range. Frequency stability is .0005% per hour.

The instrument can be used for frequency search, receiver alignment, bandwidth testing, discriminator measurements, sensitivity measurements, and check out of command receivers as well as for impedance and filter attenuation measurements.

MANUFACTURERS' LITERATURE

INDUSTRIAL RELAY DATA

43 General Electric Company has issued a 12-page bulletin which describes a new 10-amp, 300-volt industrial relay designed to cut control-panel space requirements. The publication (Bulletin GEV-7329) discusses the elimination of the need for a wiring trough, includes a photo with call-outs which explain how the new relay is designed to make wiring and installations easier, and incorporates text material explaining features and advantages. Ordering information and outline drawings are included.

ELECTRONIC CHEMICALS

44 Injectorall Co. is offering a six-page catalogue covering an extensive line of chemicals for the electronics industry.

FREE TO YOU and your friends
RADIO SHACK'S 1962 ELECTRONICS CATALOGS

Plus
EVERY NEW
SUPPLEMENT
FOR NEXT
12 MONTHS



Our bigger, better catalogs offer the widest line of electronic parts and equipment in the world! Stereo, Hi-Fi, Ham Radio, Test Equipment, Pre-Recorded Tapes, Tape Recorders, Records, Parts—plus 30 pages of Kits! 340 pages—over 100,000 items! No Money Down credit terms. Every item backed by a money-back guarantee of satisfaction.

Radio Shack Corp., Boston, Mass.

RADIO SHACK Corp.
730 Commonwealth Ave., Boston 17, Mass.
Send Radio Shack's famous electronics catalogs for one year—FREE and POSTPAID.

Your Name _____ 61L6C

Your Address _____

City and Zone _____ State _____

For a Friend _____

Address _____ 61L6C1

City and Zone _____ State _____

Just Out



New SUPREME 1962 TV Manual

AMAZING BARGAIN

The new 1962 TV manual is the bargain of the year. Covers all important sets of every make in one giant volume. Your price for this mammoth manual is only \$3. This super-value defies all competition. Other annual volumes at only \$3 each. Factory service material simplifies repairs. Includes all data required for quicker TV servicing. Practically shows you how to find each fault and make needed repair. More pages, more diagrams, more service data per dollar of cost.

TELEVISION SERVICING COURSE

Let this new course help you in TV servicing. Amazing bargain, complete, only \$3. full price for all lessons. Giant in size, mammoth in scope, topics just like a \$200.00 correspondence course. Lessons on picture faults, all circuits, tuners, sync., short-cuts, alignment facts, hints, UHF, antenna problems, trouble-shooting, test equipment, and advanced video analysis. Special, only **\$3**

SIMPLIFIED RADIO SERVICING (Introduction to TV)

Explains how to use comparison method to find most radio faults in minutes. Many practical tests without any equipment. Also several sections on use of instruments. Introduction to TV. Schematics, charts, trouble-shooting hints. Job sheets cover all sets. New edition, only... **\$1.50**

RADIO VOLUMES



RADIO DIAGRAMS

Your best source for all needed RADIO diagrams and service data. Covers everything from most recent 1961 radios to pre-war old-timers: home radios, stereo, combinations, transistor portables, FM, auto sets. Only \$2 for many volumes. Every manual has large schematics, all needed alignment facts, printed boards, voltages, trimmers, dial stringing, and hints. Volumes are big, 8 1/2 x 11 inches, about 190 pages. See coupon at right for list of SUPREME popular radio service manuals ▶

COVERS ALL POPULAR SETS

Here is your service data for faster, easier TV repairs. Lowest priced. Best by comparison. Supreme TV manuals have all needed service material on every popular TV set. Helpful, practical, factory-prepared data that will really make TV servicing easy for you. Benefit and save with these amazing values in service manuals. Only \$3 per large volume. Used by 184,000 wise servicemen for faster repairs. Join them: begin to make TV repairs easily and quickly.

SIMPLIFIES TV REPAIRS

These giant TV manuals have complete circuits, needed alignment facts, printed boards, servicing hints, production changes, voltage charts, waveforms, and double-page schematics. Here are your authentic service instructions to help you do expert work quicker, and priced at only \$3 per large annual manual. Repair any TV model ever made by having in your shop all 15 volumes as listed in coupon. Your special price for all, only \$42. Or try the new 1962 TV manual to see what amazing bargain you get for \$3. Send no-risk trial coupon today.



The repair of any TV set is simple with Supreme Television service manuals. Every set is covered in a practical manner to simplify trouble-shooting and repair. With this help find toughest faults in a jiffy. Most \$3 TV volumes cover a whole year. Buy Supreme Manuals only once each year instead of spending dollars almost every week.

NO-RISK TRIAL ORDER COUPON

SUPREME PUBLICATIONS, 1760 Balsam Rd., Highland Park, ILL.

<input type="checkbox"/> 1961 <input type="checkbox"/> 1960 <input type="checkbox"/> 1959 <input type="checkbox"/> 1958 <input type="checkbox"/> 1957 <input type="checkbox"/> 1956 <input type="checkbox"/> 1955 <input type="checkbox"/> 1954 <input type="checkbox"/> 1953 <input type="checkbox"/> 1952 <input type="checkbox"/> 1951 <input type="checkbox"/> 1950 <input type="checkbox"/> 1949 <input type="checkbox"/> 1948 <input type="checkbox"/> 1947 <input type="checkbox"/> 1946 <input type="checkbox"/> 1942 <input type="checkbox"/> 1941 <input type="checkbox"/> 1940 <input type="checkbox"/> 1926-1938 Manual, \$2.50 <input type="checkbox"/> Simplified Servicing, \$1.50	Popular RADIO Diagram Manuals at only \$2.50 each..... These annual RADIO volumes specially priced at only \$2.50 each..... THIS GROUP ONLY \$2 EACH 1926-1938 Manual, \$2.50 Simplified Servicing, \$1.50	Rush today TV manuals checked <input checked="" type="checkbox"/> below and Radio manuals at left. Satisfaction guaranteed. <input type="checkbox"/> New 1962 Television Servicing Manual, only... \$3. <input type="checkbox"/> 1961 TV Manual, \$3. <input type="checkbox"/> 1960 TV Manual, \$3. <input type="checkbox"/> Additional 1959 TV, \$3. <input type="checkbox"/> Early 1959 TV, \$3. <input type="checkbox"/> 1958 TV Manual, \$3. <input type="checkbox"/> Additional 1957 TV, \$3. <input type="checkbox"/> Early 1957 TV, \$3. <input type="checkbox"/> 1956 TV Manual, \$3. <input type="checkbox"/> Additional 1955 TV, \$3. <input type="checkbox"/> Early 1955 TV, \$3. <input type="checkbox"/> 1954 TV, \$3. <input type="checkbox"/> 1953 TV, \$3. <input type="checkbox"/> 1952 TV, \$3. <input type="checkbox"/> 1951 TV, \$3. <input type="checkbox"/> Master Index to all Manuals, 25c <input type="checkbox"/> New Television Servicing Course, complete... \$3. <input type="checkbox"/> I am enclosing \$..... Send postpaid. <input type="checkbox"/> Send C.O.D. I am enclosing \$..... deposit. Name: Address:
---	---	---

Supreme Publications
Sold by All Leading Parts Jobbers
Supreme Publications are accurate, easy-to-follow, complete, lowest in price.



UNIVAC

FIELD ENGINEERS

For Univac Missile-Guidance Computers & Tactical Data Systems

Field engineers are now being selected for maintenance assignments on ultra-reliable Univac missile-guidance computers and other military electronic data processing systems.

Openings involve maintenance of the Univac ICBM guidance computer, first of its size to be completely transistorized.

Applicants must have at least 2 years of formal education in Electronics with 3 or more years in maintenance or maintenance-instruction. Experience should be associated with complex electronic equipment such as TV, radar, sonar or digital computing systems.

Before assignment, you receive 2 to 6 months training at full pay in our St. Paul, Minnesota, laboratories. Benefits include company paid life insurance, hospitalization, medical and surgical benefits, relocation expenses and living allowances at field sites.

Openings also for qualified instructors with backgrounds similar to above.

Send complete resume of education and experience to:

R. K. PATTERSON, Dept. CC-11



Division of Sperry Rand Corporation
2750 West 7th St., St. Paul 16, Minn.

Included in the two-color catalogue are photos and descriptions of cements, lubricating oils, yoke remover spray, glues, dial-cord compounds, circuit freezer, cleaners and polishes of various types, among other items.

SILICONE MOLDING FACILITIES

45 Dow Corning Corporation has established a new customer service facility to render complete and comprehensive engineering service to end users and fabricators of parts made from silicone molding compounds. The company has prepared a well-illustrated 8-page brochure describing this new service and facilities which it is offering to interested persons on request.

MOLDED WAFER CAPACITOR

46 AMP Incorporated has published a two-page product information bulletin which describes a new silicone rubber molded wafer capacitor. In addition to covering this new item in detail, the bulletin also describes other of the thousands of capacitors produced by the company. Representative specifications are given on the line.

PRECISION WIREWOUNDS

47 Kelvin Electric Company is currently offering copies of its Bulletin O-1 which provides electrical and mechanical specifications on its complete line of stable, encapsulated precision wirewound resistors. The single-page data sheet lists general specifications and details on both axial-lead and radial-lug types.

CLOSED-CIRCUIT TV DATA

48 Kin Tel Division has just published an 8-page, 2-color catalogue covering general applications of closed-circuit television systems. The booklet includes photographs of actual installations, block diagrams of systems for various applications, and a general discussion of the uses for such CCTV equipment.

HI-FI AUDIO TUBES

49 General Electric Company is now offering copies of its Bulletin E1D-2622 entitled "High-Fidelity Audio Tubes." This 12-page brochure describes the extent and features of the firm's growing line of audio tubes designed especially for hi-fi. Included are specifications on the current line of 26 amplifier, preamplifier, and rectifier tubes as well as information on design features and manufacturing processes.

R.M.S. VOLTMETER

50 John Fluke Mfg. Co., Inc. has announced the availability of a technical data bulletin describing its new true r.m.s. voltmeter. This instrument, which measures virtually all waveforms over a broad (10 cps to 7 mc.) bandwidth and provides 100 μ v. sensitivity, is pictured and described in considerable detail.

P.A. AMPLIFIERS/SYSTEMS

51 Harman-Kardon, Inc. has issued a four-page folder describing and illustrating its "Commander" series of p.a. amplifiers and systems. The catalogue details the features and applications of 12-, 35-, and 100-watt amplifiers, a phonograph top common to all units, locking panel covers, and a combination mixer-preamp.

QUARTZ CRYSTAL DATA

52 Texas Crystals has announced the availability of its new catalogue and price list No. 961 which includes diagrams of oscillator circuits, a history of the manufacture and use of quartz crystals, as well as details on crystals for CB use, low-frequency crystals, lam units, plated and pressure-type crystals, special prototype models, and a list of the company's representatives.

STEREO BROCHURE

53 Electronic Instrument Co., Inc. is now offering copies of its 4-page, 2-color illustrated brochure entitled "Why Stereo?". The booklet contains pictures and diagrams to make the entire stereo concept clear and simple.

COLUMBIA GEMS!

COLUMBIA'S CLASSIFIED CORNER

- TC5 SET: Complete, 12 V. Recondit. . . \$150.00
 - TC5 SET: Complete, 110 VAC . . . 199.50
 - ARC-27 TRANSCEIVER: Excel. This month only . . . 295.00
 - RT-66/GRC or RT-681/GRC: Excel. Ea. 150.00
 - PP-109 12 V. POWER SUPPLY: Excel. cond. . . 99.50
 - PP-112 24 V. POWER SUPPLY: Excel. cond. . . 99.50
 - PRC-6 HANDIE TALKIE: Comp. w/look Excel. Ea. . . 125.00
 - TCK TRANSMITTER: Comp. w/power supply. Excel. . . 99.50
 - BC-312 RECEIVER: Excel. cond. . . 89.50
 - GC-668 TRANSMITTER-REC-VER: Excel. 89.50
 - PE-110 VOLT POWER SUP. For above. B units. Excel. . . 49.50
- SPARES!** Complete spares for GRC, PRC, HANDIE-TALKIES, SCR Equip., 75 Equip. etc. WHAT DO YOU NEED?
R101A/ARN-6 COMPASS RECEIVER: Excel. Cond. . . \$79.50
SA 142/GSA-6 SWITCH BOX: With CN147/DU Carl Excel. . . 3.95
GN-58 GENERATOR: Excellent. New low price! . . . 35.00
GN-175 BAG: For above Generator. Only 1.00

APR-4 TUNING UNITS

- TN-18: 300-1000 Mc. Like New, Each . . . \$35.00
- TN-19: 972-2000 Mc. Like New, Each . . . 49.50

APR-1 TUNING UNITS

- TN-1: 30-50 Mc. Excellent condition. Only 19.95
- TN-2: 80-300 Mc. Excellent condition. Only 19.95
- TN-3: 300-1000 Mc. Excellent cond. Only 19.95

SOLA CONSTANT VOLTAGE TRANSFORMERS

- INPUT: 95-190 VAC 50/60 cyc. Out 115 V @ 7.5 A. Full . . . \$89.50
- W. rating: Just
- PRIMARY: 95 V. Output 115 V. @ 8.7 amps. 100 W. 50/60 cycles. Like new. Only . . . 49.50

DRIG. CASE FOR BC-611 HANDIE-TALKIE

- Leads switch top and bottom. . . \$4.95
- PP-109 THERMAL RELAY: 227598-10 Brand new Ea. . . 1.00

FACSIMILE TRANSMISSION MODULATOR: Model M1-108/EX. Permits transmission of facsimile signals via air or wire. BRAND NEW . . . \$99.50

RT-82/APX-6 TRANSCEIVER. 1215 Mc.

- Less tubes . . . excellent condition . . . \$3.95

WIRE RECORDER

Manufactured by Air King Products. This is a complete wire recorder with amplifier for voice and music with a 24V DC @ 2.5 AMPS. input. This unit has 2 carbon microphone inputs and one 600 ohm audio output. 14" long, 8" wide, 8" high. Excel. cond . . . \$9.95

BC-375 100 W. TRANSMITTER

- Ideal for domestic use, as well as export marine and motel. Proper tuning unit. CW or MCW. Excellent cond. . . \$14.95
- ABOVE, but in good condition . . . \$9.95
- PE-73 DYNAMOTOR FOR ABOVE: Input 24 V. Output 100 V. @ 300 mths. W/altering base. Like new . . . \$7.95
- TUNING UNITS: For BC-375 Each . . . \$1.95

RA-105 POWER SUPPLY

- 115 VAC 60 cyc. in. but. Multiple outputs: 115 V @ 1.5 A, 295 V @ 0.3 A, 0 V @ 10 amps. 0.2 VAC @ 10 amps. Uses 3 3U1 tubes, 1 2X2 and 1 2X5 With tubes. Good cond. Only \$9.95.

HEAVY DUTY 12V BATTERY

- Thomas A. Edison dry cell 12V @ 7.5 A H. Ideal for portable radio work A CO. LUMBIA EXTRA. Spec brand new . . . \$29.95

MOBILE RADIO-TELEPHONE

150-170 Mc. single channel, crystal control. FM, 0 V. Input. 25 W. Consists of transmitter, receiver, and antenna, connecting cable and other accessories. Mfg. by West Coast Elect. Good condition. Only \$24.95

RA-91 DRY DISC RECTIFIER

This unit is excellent for battery charging and general purpose use. 115 V AC input. This unit will deliver a charging rate of from 2 to 1.5 amperes into a 6 to 18 V battery with 21 lead 14 cell unit. Unit has input and output circuit breakers, 1.1 ampere. Fine and coarse voltage adjustment. Heavy duty transformer, filter reactor and 4 selenium rectifier stacks. Brand new \$39.95

WRITE IN for new Bargain Bulletin!
All orders FOB Los Angeles. 25% deposit required. All items subject to price change. NOTE MINIMUM ORDER \$3.00. WRITE TO DEPT. R.

COLUMBIA ELECTRONICS

4365 WEST PICO BLVD. LOS ANGELES 19, CALIF.

Detect Police Radar Traps Before They Detect You Plans \$1.00 • Kits \$19.95 Wired Units \$29.95

RADAR KING

Both S and K Band Operation Sets and wired units shipped with S band antennas unless otherwise specified. Extra antennas \$4.50 each

WARDELL SMITH. ELECTRONIC DESIGNS
63 Glenwood Road
pat. pending Upper Montclair, New Jersey est. 1924

Now you can build almost any kind of electronic device!



Send for FREE 7-day Trial Examination of this Valuable Book!

PARTIAL CONTENTS:

DIODE VACUUM TUBES. Emission—Diode Operation—Diode Characteristics—Rectification Power—Supply Filters—Detection (AM and FM).

TRIODE VACUUM TUBES. Triode Operation—The Triode Test Circuit—Control—Grid Effect—Triode Characteristics—Plate Characteristic Curves—Plate Resistance—Transconductance—Amplification Factor—Interelectrode Capacitance.

TRIODE AMPLIFIERS. Load Lines—Operating Point—Cathode Bias—Cathode Load Lines—Signal Amplification—Signal Inversion—Voltage Gain—Computing Voltage Gain—Cathode Bypass Capacitor—Distortion—Summary.

MULTIELEMENT TUBES. Miller Effect—Tetrodes—Tetrode Plate Characteristic Curves—Output Signal vs. Secondary Emission—Pen-

todes—Suppressor Grid—Pentode Plate Characteristic Curves—Tetrode and Pentode Characteristics—A. C. Plate Resistance—Transconductance—Amplification Factor—The Pentode Voltage Amplifier—Operating Point—Cathode Bias—Cathode Bypass Capacitor—Distortion—Beam-Power Vacuum Tubes—Audio Output Stages.

CIRCUIT CONSTRUCTION HINTS. Checking Components—Fixed Resistors—Potentiometers—Capacitors—Transformers and Coils—Vacuum Tubes—Where to Buy—Test Equipment—Multimeter—Vacuum Tube Voltmeter—Oscilloscope—Signal Generators—Other Test Equipment—Tools—Tools You Will Need—Soldering—Chassis Construction.

BASIC VACUUM TUBE CIRCUITS.

Here are the ABC's of 50 vacuum-tube circuits for electronics experimentation and project construction— all fully diagramed, complete with parts list.

How many times have you wanted a diagram of a basic vacuum-tube circuit which you could use as a guide in building hi-fi components, receivers, transmitters, intercom systems, test equipment and other electronic gear? At last, in one book, you can find all the basic diagrams, schematics, and other vital information on vacuum tubes and their circuits essential for such projects!

Beginning with the Edison effect (the birth of the diode), Julian M. Sienkiewicz, Managing Editor of Popular Electronics, leads you right up to the multi-element vacuum tubes used in everyday circuits. Vacuum-tube circuit design is described in understandable, down-to-earth language. Plate resistance, transconductance, gain, load lines, characteristic curves and the like will no longer be mysterious terms but useful tools for your work or hobby.

You'll Become An Expert On All Types Of Vacuum Tubes

The first four chapters are devoted to the operation of diodes, triodes, tetrodes, and pentode and beam-power tubes. Chapter five covers construction practices, tools, and test equipment, along with workshop hints that will be a real boon to all who want to get the most out of their equipment. Chapter six contains a collection of fifty vacuum-tube circuits that gives you a basic library of useful circuits for quick and trouble-free reference.

One hundred vacuum-tube schematics, plate-characteristic curves, simplified diagrams, test circuits and other selected illustrations supplement the informative text to make this book one of the most useful and invaluable manuals for your electronic experiments and hobby projects.

192 pages, 100 illustrations \$4.95

ZIFF-DAVIS PUBLISHING COMPANY

ELECTRONICS BOOK SERVICE
One Park Avenue
New York 16, N. Y.



Please send me VACUUM-TUBE CIRCUITS FOR THE ELECTRONIC EXPERIMENTER for a free 7-day trial examination. I understand that if I am not completely satisfied, I may return the book and owe you nothing. Otherwise, I will remit \$4.95 plus small charge for postage, packaging and handling.

Name _____
(please print)

Address _____

City _____ Zone _____ State _____

EF 566

SAVE MONEY! Enclose \$4.95 in check or money order, and we will pay for postage, packing and handling. Same return privilege and prompt refund guaranteed!

LORAN APN-4

FINE QUALITY NAVIGATIONAL EQUIPMENT

Determines exact geographic position of your boat or plane. Indicator and receiver complete with all tubes and crystal.

INDICATOR 10-6B/APN-4, and RECEIVER \$49.50
R-9B APN-4, complete with tubes, Exc. Used \$88.50

INVERTER POWER SUPPLY for Loran, Model 10-11 type
 -Dynamometer DIV. INPUT: 24 V DC @ 60 Cycles
 115 V AC @ 11.5 Amps, 800 cycles. Complete with
 non-commutating diodes. BRAND NEW \$49.50

12-Volt Inverter Power Supply, Like New \$19.50
 Shock Mount for above.

We carry a complete line of spare parts for above.

LORAN APN/4

OSCILLOSCOPE

Easily converted for use on radio-TV service bench.

LIKE NEW! Supplied with 5" Scope, type 5CPI only \$14.50

LORAN R-65 APN-9 RECEIVER & INDICATOR

Determines position of your boat or plane from height. Complete with tubes and crystal. Exc. Used \$79.50

FAMOUS BC-645 TRANSCIEVER

15 Tubes 435 to 500 Mc

Can be modified for 2-way communication, voice or code, on ham band 420-450 mc. citizens radio 460-470 mc. Fixed and mobile 470-460 mc. television experimental 470-500 mc. Same as above less meter. Worth more than sale price.

7T 4-7H7, 7E6, 6X4, 6AR5, 6AV6, 6BE6, 6BD6, 6CA5, 6CA6, 6CA7, 6CA8, 6CA9, 6CA10, 6CA11, 6CA12, 6CA13, 6CA14, 6CA15, 6CA16, 6CA17, 6CA18, 6CA19, 6CA20, 6CA21, 6CA22, 6CA23, 6CA24, 6CA25, 6CA26, 6CA27, 6CA28, 6CA29, 6CA30, 6CA31, 6CA32, 6CA33, 6CA34, 6CA35, 6CA36, 6CA37, 6CA38, 6CA39, 6CA40, 6CA41, 6CA42, 6CA43, 6CA44, 6CA45, 6CA46, 6CA47, 6CA48, 6CA49, 6CA50, 6CA51, 6CA52, 6CA53, 6CA54, 6CA55, 6CA56, 6CA57, 6CA58, 6CA59, 6CA60, 6CA61, 6CA62, 6CA63, 6CA64, 6CA65, 6CA66, 6CA67, 6CA68, 6CA69, 6CA70, 6CA71, 6CA72, 6CA73, 6CA74, 6CA75, 6CA76, 6CA77, 6CA78, 6CA79, 6CA80, 6CA81, 6CA82, 6CA83, 6CA84, 6CA85, 6CA86, 6CA87, 6CA88, 6CA89, 6CA90, 6CA91, 6CA92, 6CA93, 6CA94, 6CA95, 6CA96, 6CA97, 6CA98, 6CA99, 6CA100, 6CA101, 6CA102, 6CA103, 6CA104, 6CA105, 6CA106, 6CA107, 6CA108, 6CA109, 6CA110, 6CA111, 6CA112, 6CA113, 6CA114, 6CA115, 6CA116, 6CA117, 6CA118, 6CA119, 6CA120, 6CA121, 6CA122, 6CA123, 6CA124, 6CA125, 6CA126, 6CA127, 6CA128, 6CA129, 6CA130, 6CA131, 6CA132, 6CA133, 6CA134, 6CA135, 6CA136, 6CA137, 6CA138, 6CA139, 6CA140, 6CA141, 6CA142, 6CA143, 6CA144, 6CA145, 6CA146, 6CA147, 6CA148, 6CA149, 6CA150, 6CA151, 6CA152, 6CA153, 6CA154, 6CA155, 6CA156, 6CA157, 6CA158, 6CA159, 6CA160, 6CA161, 6CA162, 6CA163, 6CA164, 6CA165, 6CA166, 6CA167, 6CA168, 6CA169, 6CA170, 6CA171, 6CA172, 6CA173, 6CA174, 6CA175, 6CA176, 6CA177, 6CA178, 6CA179, 6CA180, 6CA181, 6CA182, 6CA183, 6CA184, 6CA185, 6CA186, 6CA187, 6CA188, 6CA189, 6CA190, 6CA191, 6CA192, 6CA193, 6CA194, 6CA195, 6CA196, 6CA197, 6CA198, 6CA199, 6CA200, 6CA201, 6CA202, 6CA203, 6CA204, 6CA205, 6CA206, 6CA207, 6CA208, 6CA209, 6CA210, 6CA211, 6CA212, 6CA213, 6CA214, 6CA215, 6CA216, 6CA217, 6CA218, 6CA219, 6CA220, 6CA221, 6CA222, 6CA223, 6CA224, 6CA225, 6CA226, 6CA227, 6CA228, 6CA229, 6CA230, 6CA231, 6CA232, 6CA233, 6CA234, 6CA235, 6CA236, 6CA237, 6CA238, 6CA239, 6CA240, 6CA241, 6CA242, 6CA243, 6CA244, 6CA245, 6CA246, 6CA247, 6CA248, 6CA249, 6CA250, 6CA251, 6CA252, 6CA253, 6CA254, 6CA255, 6CA256, 6CA257, 6CA258, 6CA259, 6CA260, 6CA261, 6CA262, 6CA263, 6CA264, 6CA265, 6CA266, 6CA267, 6CA268, 6CA269, 6CA270, 6CA271, 6CA272, 6CA273, 6CA274, 6CA275, 6CA276, 6CA277, 6CA278, 6CA279, 6CA280, 6CA281, 6CA282, 6CA283, 6CA284, 6CA285, 6CA286, 6CA287, 6CA288, 6CA289, 6CA290, 6CA291, 6CA292, 6CA293, 6CA294, 6CA295, 6CA296, 6CA297, 6CA298, 6CA299, 6CA300, 6CA301, 6CA302, 6CA303, 6CA304, 6CA305, 6CA306, 6CA307, 6CA308, 6CA309, 6CA310, 6CA311, 6CA312, 6CA313, 6CA314, 6CA315, 6CA316, 6CA317, 6CA318, 6CA319, 6CA320, 6CA321, 6CA322, 6CA323, 6CA324, 6CA325, 6CA326, 6CA327, 6CA328, 6CA329, 6CA330, 6CA331, 6CA332, 6CA333, 6CA334, 6CA335, 6CA336, 6CA337, 6CA338, 6CA339, 6CA340, 6CA341, 6CA342, 6CA343, 6CA344, 6CA345, 6CA346, 6CA347, 6CA348, 6CA349, 6CA350, 6CA351, 6CA352, 6CA353, 6CA354, 6CA355, 6CA356, 6CA357, 6CA358, 6CA359, 6CA360, 6CA361, 6CA362, 6CA363, 6CA364, 6CA365, 6CA366, 6CA367, 6CA368, 6CA369, 6CA370, 6CA371, 6CA372, 6CA373, 6CA374, 6CA375, 6CA376, 6CA377, 6CA378, 6CA379, 6CA380, 6CA381, 6CA382, 6CA383, 6CA384, 6CA385, 6CA386, 6CA387, 6CA388, 6CA389, 6CA390, 6CA391, 6CA392, 6CA393, 6CA394, 6CA395, 6CA396, 6CA397, 6CA398, 6CA399, 6CA400, 6CA401, 6CA402, 6CA403, 6CA404, 6CA405, 6CA406, 6CA407, 6CA408, 6CA409, 6CA410, 6CA411, 6CA412, 6CA413, 6CA414, 6CA415, 6CA416, 6CA417, 6CA418, 6CA419, 6CA420, 6CA421, 6CA422, 6CA423, 6CA424, 6CA425, 6CA426, 6CA427, 6CA428, 6CA429, 6CA430, 6CA431, 6CA432, 6CA433, 6CA434, 6CA435, 6CA436, 6CA437, 6CA438, 6CA439, 6CA440, 6CA441, 6CA442, 6CA443, 6CA444, 6CA445, 6CA446, 6CA447, 6CA448, 6CA449, 6CA450, 6CA451, 6CA452, 6CA453, 6CA454, 6CA455, 6CA456, 6CA457, 6CA458, 6CA459, 6CA460, 6CA461, 6CA462, 6CA463, 6CA464, 6CA465, 6CA466, 6CA467, 6CA468, 6CA469, 6CA470, 6CA471, 6CA472, 6CA473, 6CA474, 6CA475, 6CA476, 6CA477, 6CA478, 6CA479, 6CA480, 6CA481, 6CA482, 6CA483, 6CA484, 6CA485, 6CA486, 6CA487, 6CA488, 6CA489, 6CA490, 6CA491, 6CA492, 6CA493, 6CA494, 6CA495, 6CA496, 6CA497, 6CA498, 6CA499, 6CA500, 6CA501, 6CA502, 6CA503, 6CA504, 6CA505, 6CA506, 6CA507, 6CA508, 6CA509, 6CA510, 6CA511, 6CA512, 6CA513, 6CA514, 6CA515, 6CA516, 6CA517, 6CA518, 6CA519, 6CA520, 6CA521, 6CA522, 6CA523, 6CA524, 6CA525, 6CA526, 6CA527, 6CA528, 6CA529, 6CA530, 6CA531, 6CA532, 6CA533, 6CA534, 6CA535, 6CA536, 6CA537, 6CA538, 6CA539, 6CA540, 6CA541, 6CA542, 6CA543, 6CA544, 6CA545, 6CA546, 6CA547, 6CA548, 6CA549, 6CA550, 6CA551, 6CA552, 6CA553, 6CA554, 6CA555, 6CA556, 6CA557, 6CA558, 6CA559, 6CA560, 6CA561, 6CA562, 6CA563, 6CA564, 6CA565, 6CA566, 6CA567, 6CA568, 6CA569, 6CA570, 6CA571, 6CA572, 6CA573, 6CA574, 6CA575, 6CA576, 6CA577, 6CA578, 6CA579, 6CA580, 6CA581, 6CA582, 6CA583, 6CA584, 6CA585, 6CA586, 6CA587, 6CA588, 6CA589, 6CA590, 6CA591, 6CA592, 6CA593, 6CA594, 6CA595, 6CA596, 6CA597, 6CA598, 6CA599, 6CA600, 6CA601, 6CA602, 6CA603, 6CA604, 6CA605, 6CA606, 6CA607, 6CA608, 6CA609, 6CA610, 6CA611, 6CA612, 6CA613, 6CA614, 6CA615, 6CA616, 6CA617, 6CA618, 6CA619, 6CA620, 6CA621, 6CA622, 6CA623, 6CA624, 6CA625, 6CA626, 6CA627, 6CA628, 6CA629, 6CA630, 6CA631, 6CA632, 6CA633, 6CA634, 6CA635, 6CA636, 6CA637, 6CA638, 6CA639, 6CA640, 6CA641, 6CA642, 6CA643, 6CA644, 6CA645, 6CA646, 6CA647, 6CA648, 6CA649, 6CA650, 6CA651, 6CA652, 6CA653, 6CA654, 6CA655, 6CA656, 6CA657, 6CA658, 6CA659, 6CA660, 6CA661, 6CA662, 6CA663, 6CA664, 6CA665, 6CA666, 6CA667, 6CA668, 6CA669, 6CA670, 6CA671, 6CA672, 6CA673, 6CA674, 6CA675, 6CA676, 6CA677, 6CA678, 6CA679, 6CA680, 6CA681, 6CA682, 6CA683, 6CA684, 6CA685, 6CA686, 6CA687, 6CA688, 6CA689, 6CA690, 6CA691, 6CA692, 6CA693, 6CA694, 6CA695, 6CA696, 6CA697, 6CA698, 6CA699, 6CA700, 6CA701, 6CA702, 6CA703, 6CA704, 6CA705, 6CA706, 6CA707, 6CA708, 6CA709, 6CA710, 6CA711, 6CA712, 6CA713, 6CA714, 6CA715, 6CA716, 6CA717, 6CA718, 6CA719, 6CA720, 6CA721, 6CA722, 6CA723, 6CA724, 6CA725, 6CA726, 6CA727, 6CA728, 6CA729, 6CA730, 6CA731, 6CA732, 6CA733, 6CA734, 6CA735, 6CA736, 6CA737, 6CA738, 6CA739, 6CA740, 6CA741, 6CA742, 6CA743, 6CA744, 6CA745, 6CA746, 6CA747, 6CA748, 6CA749, 6CA750, 6CA751, 6CA752, 6CA753, 6CA754, 6CA755, 6CA756, 6CA757, 6CA758, 6CA759, 6CA760, 6CA761, 6CA762, 6CA763, 6CA764, 6CA765, 6CA766, 6CA767, 6CA768, 6CA769, 6CA770, 6CA771, 6CA772, 6CA773, 6CA774, 6CA775, 6CA776, 6CA777, 6CA778, 6CA779, 6CA780, 6CA781, 6CA782, 6CA783, 6CA784, 6CA785, 6CA786, 6CA787, 6CA788, 6CA789, 6CA790, 6CA791, 6CA792, 6CA793, 6CA794, 6CA795, 6CA796, 6CA797, 6CA798, 6CA799, 6CA800, 6CA801, 6CA802, 6CA803, 6CA804, 6CA805, 6CA806, 6CA807, 6CA808, 6CA809, 6CA810, 6CA811, 6CA812, 6CA813, 6CA814, 6CA815, 6CA816, 6CA817, 6CA818, 6CA819, 6CA820, 6CA821, 6CA822, 6CA823, 6CA824, 6CA825, 6CA826, 6CA827, 6CA828, 6CA829, 6CA830, 6CA831, 6CA832, 6CA833, 6CA834, 6CA835, 6CA836, 6CA837, 6CA838, 6CA839, 6CA840, 6CA841, 6CA842, 6CA843, 6CA844, 6CA845, 6CA846, 6CA847, 6CA848, 6CA849, 6CA850, 6CA851, 6CA852, 6CA853, 6CA854, 6CA855, 6CA856, 6CA857, 6CA858, 6CA859, 6CA860, 6CA861, 6CA862, 6CA863, 6CA864, 6CA865, 6CA866, 6CA867, 6CA868, 6CA869, 6CA870, 6CA871, 6CA872, 6CA873, 6CA874, 6CA875, 6CA876, 6CA877, 6CA878, 6CA879, 6CA880, 6CA881, 6CA882, 6CA883, 6CA884, 6CA885, 6CA886, 6CA887, 6CA888, 6CA889, 6CA890, 6CA891, 6CA892, 6CA893, 6CA894, 6CA895, 6CA896, 6CA897, 6CA898, 6CA899, 6CA900, 6CA901, 6CA902, 6CA903, 6CA904, 6CA905, 6CA906, 6CA907, 6CA908, 6CA909, 6CA910, 6CA911, 6CA912, 6CA913, 6CA914, 6CA915, 6CA916, 6CA917, 6CA918, 6CA919, 6CA920, 6CA921, 6CA922, 6CA923, 6CA924, 6CA925, 6CA926, 6CA927, 6CA928, 6CA929, 6CA930, 6CA931, 6CA932, 6CA933, 6CA934, 6CA935, 6CA936, 6CA937, 6CA938, 6CA939, 6CA940, 6CA941, 6CA942, 6CA943, 6CA944, 6CA945, 6CA946, 6CA947, 6CA948, 6CA949, 6CA950, 6CA951, 6CA952, 6CA953, 6CA954, 6CA955, 6CA956, 6CA957, 6CA958, 6CA959, 6CA960, 6CA961, 6CA962, 6CA963, 6CA964, 6CA965, 6CA966, 6CA967, 6CA968, 6CA969, 6CA970, 6CA971, 6CA972, 6CA973, 6CA974, 6CA975, 6CA976, 6CA977, 6CA978, 6CA979, 6CA980, 6CA981, 6CA982, 6CA983, 6CA984, 6CA985, 6CA986, 6CA987, 6CA988, 6CA989, 6CA990, 6CA991, 6CA992, 6CA993, 6CA994, 6CA995, 6CA996, 6CA997, 6CA998, 6CA999, 6CA1000, 6CA1001, 6CA1002, 6CA1003, 6CA1004, 6CA1005, 6CA1006, 6CA1007, 6CA1008, 6CA1009, 6CA1010, 6CA1011, 6CA1012, 6CA1013, 6CA1014, 6CA1015, 6CA1016, 6CA1017, 6CA1018, 6CA1019, 6CA1020, 6CA1021, 6CA1022, 6CA1023, 6CA1024, 6CA1025, 6CA1026, 6CA1027, 6CA1028, 6CA1029, 6CA1030, 6CA1031, 6CA1032, 6CA1033, 6CA1034, 6CA1035, 6CA1036, 6CA1037, 6CA1038, 6CA1039, 6CA1040, 6CA1041, 6CA1042, 6CA1043, 6CA1044, 6CA1045, 6CA1046, 6CA1047, 6CA1048, 6CA1049, 6CA1050, 6CA1051, 6CA1052, 6CA1053, 6CA1054, 6CA1055, 6CA1056, 6CA1057, 6CA1058, 6CA1059, 6CA1060, 6CA1061, 6CA1062, 6CA1063, 6CA1064, 6CA1065, 6CA1066, 6CA1067, 6CA1068, 6CA1069, 6CA1070, 6CA1071, 6CA1072, 6CA1073, 6CA1074, 6CA1075, 6CA1076, 6CA1077, 6CA1078, 6CA1079, 6CA1080, 6CA1081, 6CA1082, 6CA1083, 6CA1084, 6CA1085, 6CA1086, 6CA1087, 6CA1088, 6CA1089, 6CA1090, 6CA1091, 6CA1092, 6CA1093, 6CA1094, 6CA1095, 6CA1096, 6CA1097, 6CA1098, 6CA1099, 6CA1100, 6CA1101, 6CA1102, 6CA1103, 6CA1104, 6CA1105, 6CA1106, 6CA1107, 6CA1108, 6CA1109, 6CA1110, 6CA1111, 6CA1112, 6CA1113, 6CA1114, 6CA1115, 6CA1116, 6CA1117, 6CA1118, 6CA1119, 6CA1120, 6CA1121, 6CA1122, 6CA1123, 6CA1124, 6CA1125, 6CA1126, 6CA1127, 6CA1128, 6CA1129, 6CA1130, 6CA1131, 6CA1132, 6CA1133, 6CA1134, 6CA1135, 6CA1136, 6CA1137, 6CA1138, 6CA1139, 6CA1140, 6CA1141, 6CA1142, 6CA1143, 6CA1144, 6CA1145, 6CA1146, 6CA1147, 6CA1148, 6CA1149, 6CA1150, 6CA1151, 6CA1152, 6CA1153, 6CA1154, 6CA1155, 6CA1156, 6CA1157, 6CA1158, 6CA1159, 6CA1160, 6CA1161, 6CA1162, 6CA1163, 6CA1164, 6CA1165, 6CA1166, 6CA1167, 6CA1168, 6CA1169, 6CA1170, 6CA1171, 6CA1172, 6CA1173, 6CA1174, 6CA1175, 6CA1176, 6CA1177, 6CA1178, 6CA1179, 6CA1180, 6CA1181, 6CA1182, 6CA1183, 6CA1184, 6CA1185, 6CA1186, 6CA1187, 6CA1188, 6CA1189, 6CA1190, 6CA1191, 6CA1192, 6CA1193, 6CA1194, 6CA1195, 6CA1196, 6CA1197, 6CA1198, 6CA1199, 6CA1200, 6CA1201, 6CA1202, 6CA1203, 6CA1204, 6CA1205, 6CA1206, 6CA1207, 6CA1208, 6CA1209, 6CA1210, 6CA1211, 6CA1212, 6CA1213, 6CA1214, 6CA1215, 6CA1216, 6CA1217, 6CA1218, 6CA1219, 6CA1220, 6CA1221, 6CA1222, 6CA1223, 6CA1224, 6CA1225, 6CA1226, 6CA1227, 6CA1228, 6CA1229, 6CA1230, 6CA1231, 6CA1232, 6CA1233, 6CA1234, 6CA1235, 6CA1236, 6CA1237, 6CA1238, 6CA1239, 6CA1240, 6CA1241, 6CA1242, 6CA1243, 6CA1244, 6CA1245, 6CA1246, 6CA1247, 6CA1248, 6CA1249, 6CA1250, 6CA1251, 6CA1252, 6CA1253, 6CA1254, 6CA1255, 6CA1256, 6CA1257, 6CA1258, 6CA1259, 6CA1260, 6CA1261, 6CA1262, 6CA1263, 6CA1264, 6CA1265, 6CA1266, 6CA1267, 6CA1268, 6CA1269, 6CA1270, 6CA1271, 6CA1272, 6CA1273, 6CA1274, 6CA1275, 6CA1276, 6CA1277, 6CA1278, 6CA1279, 6CA1280, 6CA1281, 6CA1282, 6CA1283, 6CA1284, 6CA1285, 6CA1286, 6CA1287, 6CA1288, 6CA1289, 6CA1290, 6CA1291, 6CA1292, 6CA1293, 6CA1294, 6CA1295, 6CA1296, 6CA1297, 6CA1298, 6CA1299, 6CA1300, 6CA1301, 6CA1302, 6CA1303, 6CA1304, 6CA1305, 6CA1306, 6CA1307, 6CA1308, 6CA1309, 6CA1310, 6CA1311, 6CA1312, 6CA1313, 6CA1314, 6CA1315, 6CA1316, 6CA1317, 6CA1318, 6CA1319, 6CA1320, 6CA1321, 6CA1322, 6CA1323, 6CA1324, 6CA1325, 6CA1326, 6CA1327, 6CA1328, 6CA1329, 6CA1330, 6CA1331, 6CA1332, 6CA1333, 6CA1334, 6CA1335, 6CA1336, 6CA1337, 6CA1338, 6CA1339, 6CA1340, 6CA1341, 6CA1342, 6CA1343, 6CA1344, 6CA1345, 6CA1346, 6CA1347, 6CA1348, 6CA1349, 6CA1350, 6CA1351, 6CA1352, 6CA1353, 6CA1354, 6CA1355, 6CA1356, 6CA1357, 6CA1358, 6CA1359, 6CA1360, 6CA1361, 6CA1362, 6CA1363, 6CA1364, 6CA1365, 6CA1366, 6CA1367, 6CA1368, 6CA1369, 6CA1370, 6CA1371, 6CA1372, 6CA1373, 6CA1374, 6CA1375, 6CA1376, 6CA1377, 6CA1378, 6CA1379, 6CA1380, 6CA1381, 6CA1382, 6CA1383, 6CA1384, 6CA1385, 6CA1386, 6CA1387, 6CA1388, 6CA1389, 6CA1390, 6CA1391, 6CA1392, 6CA1393, 6CA1394, 6CA1395, 6CA1396, 6CA1397, 6CA1398, 6CA1399, 6CA1400, 6CA1401, 6CA1402, 6CA1403, 6CA1404, 6CA1405, 6CA1406, 6CA1407, 6CA1408, 6CA1409, 6CA1410, 6CA1411, 6CA1412, 6CA1413, 6CA1414, 6CA1415, 6CA1416, 6CA1417, 6CA1418, 6CA1419, 6CA1420, 6CA1421, 6CA1422, 6CA1423, 6CA1424, 6CA1425, 6CA1426, 6CA1427, 6CA1428, 6CA1429, 6CA1430, 6CA1431, 6CA1432, 6CA1433, 6CA1434, 6CA1435, 6CA1436, 6CA1437, 6CA1438, 6CA1439, 6CA1440, 6CA1441, 6CA1442, 6CA1443, 6CA1444, 6CA1445, 6CA1446, 6CA1447, 6CA1448, 6CA1449, 6CA1450, 6CA1451, 6CA1452, 6CA1453, 6CA1454, 6CA1455, 6CA1456, 6CA1457, 6CA1458, 6CA1459, 6CA1460, 6CA1461, 6CA1462, 6CA1463, 6CA1464, 6CA1465, 6CA1466, 6CA1467, 6CA1468, 6CA1469, 6CA1470, 6CA1471, 6CA1472, 6CA1473, 6CA1474, 6CA1475, 6CA1476, 6CA1477, 6CA1478, 6CA1479, 6CA1480, 6CA1481, 6CA1482, 6CA1483, 6CA1484, 6CA1485, 6CA1486, 6CA1487, 6CA1488, 6CA1489, 6CA1490, 6CA1491, 6CA1492, 6CA1493, 6CA1494, 6CA1495, 6CA1496, 6CA1497, 6CA1498, 6CA1499, 6CA1500, 6CA1501, 6CA1502, 6CA1503, 6CA1504, 6CA1505, 6CA1506, 6CA1507, 6CA1508, 6CA1509, 6CA1510, 6CA1511, 6CA1512, 6CA1513, 6CA1514, 6CA1515, 6CA1516, 6CA1517, 6CA1518, 6CA1519, 6CA1520, 6CA1521, 6CA1522, 6CA1523, 6CA1524, 6CA1525, 6CA1526, 6CA1527, 6CA1528, 6CA1529, 6CA1530, 6CA1531, 6CA1532, 6CA1533, 6CA1534, 6CA1535, 6CA1536, 6CA1537, 6CA1538, 6CA1539, 6CA1540, 6CA1541, 6CA1542, 6CA1543, 6CA1544, 6CA1545, 6CA1546, 6CA1547, 6CA1548, 6CA1549, 6CA1550, 6CA1551, 6CA1552, 6CA1553, 6CA1554, 6CA1555, 6CA1556, 6CA1557, 6CA1558, 6CA1559, 6CA1560, 6CA1561, 6CA1562, 6CA1563, 6CA1564, 6CA1565, 6CA1566, 6CA1567, 6CA1568, 6CA1569, 6CA1570, 6CA1571, 6CA1572, 6CA1573, 6CA1574, 6CA1575, 6CA1576, 6CA1577, 6CA1578, 6CA1579, 6CA1580, 6CA1581, 6CA1582, 6CA1583, 6CA1584, 6CA1585, 6CA1586, 6CA1587, 6CA1588, 6CA1589, 6CA1590, 6CA1591, 6CA1592, 6CA1593, 6CA1594, 6CA1595, 6CA1596, 6CA1597, 6CA1598, 6CA1599, 6CA1600, 6CA1601, 6CA1602, 6CA1603, 6CA1604,

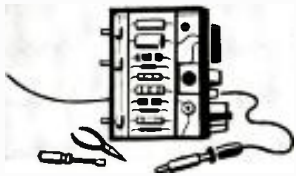

ELECTRONICS MARKET PLACE

RATE: 60¢ per word. Minimum 10 words. January issue closes November 1st. Send order and remittance to: ELECTRONICS WORLD, One Park Ave., N. Y. C. 16, N. Y.

FOR SALE

TV Tuners—Rebuilt or Exchanged \$9.95 complete—all types—fast, guaranteed service. Send tuner with all parts to: L. A. Tuner Exchange, 46 1 West Jefferson Blvd., Los Angeles 16, California.

TUBES—TV, Radio, Transmitting And Industrial Types At Sensibly Low Prices. New, Guaranteed, 1st Quality, Top Name Brands Only. Write For Free Catalog or Call WALKER 5-7000, Barry Electronics Corp., 512 Broadway, New York 12N, N. Y.

DIAGRAMS for repairing radios \$1.00. Television \$2.00. Give make, model. Diagram Service, Box 672-E, Hartford 1, Conn.

GOVERNMENT Surplus Receivers, Transmitters, Snooperscopes, Parabolic Reflectors, Pictures Catalog 10¢. Meshna, Maiden 48, Mass.

GOVERNMENT Sells Surplus—Electronics: Oscilloscopes; Transceivers; Test Equipment; Radar; Sonar; Walkie-Talkie; Boats; Jeeps; Aircrafts; Misc.—Send for "U.S. Depot Directory & Procedures"—\$1.00—Brody, Box 425(RT), Nanuet, New York.

PROFESSIONAL Electronic Projects—Organs, Timers, Computers, Industrial, etc.—\$1 up. List Free. Parks, Box 1665 Lake City, Seattle 55, Wash.

BEFORE You Buy Receiving Tubes or Hi-Fi Components send now for your giant Free Zalytron current catalog featuring nationally known Zalytron First Quality TV Radio Tubes, Hi-Fi Stereo Systems, Kts. Parts, etc. All priced to Save You Plenty Why Pay More? Zalytron Tube Corp. 220 W. 42nd St., NYC.

"SURPLUS Electronics, Optics, Free Catalog, Thermo-electric Devices, Inc. 302 Massachusetts Ave., Cambridge, Mass."

SURPLUS Aircraft Radio Units and Electronic Parts, Instruments, Controls, Power Supplies, Resistors, Capacitors, Many Others, Free List, Echols Electronics, Box 5522, Arlington 5, Virginia.

FREE Confidential Bargain Sheets Electronic Components—Lowest Prices Guaranteed—Knapp—3174 1/2 8th Ave. S.W., Largo, Florida.

WRITE for stereo component prices, no catalogues. We ship anywhere in the U.S. (We say: "If you can beat our Prices, You're lying.") Masterpiece, 1801 Kings Highway, Brooklyn. In business 16 years—Custom made Cabinets for TV, Stereo, Bars & Hi-Fi.

CIRCUITS—FM Booster, 3-Inch Scope, \$1 each. List. Ko-Lab, Box 62, Lake Jackson, Texas.

INFRA-Red!!! Snooperscopes, Optics, Lamps, Parts. World's largest stock Infra-red components. Write for Free Infra-red Catalog. McNeal Electric & Equipment, Dept. 11, 4736 Olive, St. Louis 8, Mo.

COMMUNICATIONS Test Equipment: Motorola Frequency & Deviation Meter \$375.00; Measurements Model 80R; Like New, Don Clark Communications, 99 N.W. Main Street, Blackfoot, Idaho.

HOFFMAN Silicon Solar Cells type 12C Min. output current 23ma. Min. power 9mw. Size .788x.394x.025". Temperature range 65 C to -175 C. Cells unmounted without leads. Reg. Net \$2.40, Only 50¢ ea. 3 For \$1.25, 6 For \$2.25. All New, Po. tag Paid, Satisfaction Guaranteed! Min. order \$1.00. Cash, Check or Mo. No COD. Write, Wire or Phone Clark Electronics, 190 West Santa Clara Street, San Jose 13, California Cy 76874.

TRANSISTORIZED police radar detector kits. Free Diagram and literature. Deekit Co., Box 7263, Houston 8, Texas.

ELECTRIC Engraver permanently engraves tools, any metal. \$2.00 postpaid. Relco, Box 10563, Houston 18, Texas.

SUPERSENSITIVE directional microphone picks up a whisper at great distances. Hears through ordinary walls. Used by investigators. Easily built for about \$6.00. Plans \$2.00. Dee Company, Box 7263, Houston 8, Texas.

TUBES, 60—10 off. 1st quality. Brand new and guaranteed. Top name brands. Edison Tubes Co., Menlo Park, New Jersey.

SEND for flyers listing Transmitters, Receivers, Teletype converters, Tubes, components. Spera Electronics, 37-10 33 St. L.I.C. N.Y.

INVESTIGATORS, Write for Free Brochure on Latest Subminiature Electronic Listening Devices Dept. 2B Ace Electronics, 11500 NW 7th Ave., Miami 50, Fla.

ELECTRONICS ENGINEERING & INSTRUCTION

USED Correspondence Courses and Books sold and rented. Money back guarantee. Catalog free. (Courses Bought.) Lee Mountain, Pisgah, Alabarra.

November, 1961

ENGINEERING Education for the Space Age. Northrop Institute of Technology is a privately endowed, non-profit college of engineering offering a complete Bachelor of Science Degree Program and Two-Year accredited technical institute curricula. Students from 50 states, many foreign countries. Outstandingly successful graduates employed in aeronautics, electronics, and space technology. Write today for catalog—no obligation. Northrop Institute of Technology, 1183 West Arbor Vitae Street, Inglewood 1, California.

ELECTRONICS! Associate degree—29 months. Technicians, field engineers, specialists in communications, missiles, computers, radar, automation. Start September, February. Valparaiso Technical Institute, Dept. N, Valparaiso, Indiana.

EARN \$150 Week Mechanical, Electronics Drafting. Send \$2 first Lesson, \$25 Complete Home Study Course, Prior, Inc., Dept. 123, 23-09 169 Street, White-stone 57, New York.

WANTED

QUICKSILVER, Platinum, Silver, Gold, Ores Analyzed. Free Circular. Mercury Terminal, Norwood, Massachusetts.

CASH Paid! Sell your surplus electronic tubes. Want unused, Clean radio and TV receiving, transmitting special purpose, Magnetrons, Klystrons, broadcast types. Want military and commercial lab test equipment such as G.R.H.P., AN UPM prefix. Also want commercial Ham Receivers and Transmitters. For a Fair Deal write: Barry Electronics Corp., 512 Broadway, New York 12, N. Y. (Walker 5-7000).

INVENTIONS wanted for immediate promotion! Patented, unpatented Outright cash; royalties! Casco, Dept. 88 Mills Building, Washington 6, D.C.

TRIGGER W91VJ We Buy Shortwave Equipment For Cash. 7361 W. North, River Forest, Ill. Phone PR 1-8616. Chicago TU-9-6429.

WANTED used CRT rebuilding equipment. Alpha TV, 8440 Bird Rd. Miami 55, Fla.

TAPE & RECORDERS

TAPE Recorders, Hi-Fi Components, Sleep Learning Equipment, Tapes, Unusual Values, Free Catalog, Dressner, 1523 EW Jericho Turnpike, New Hyde Park, N.Y.

RENT Stereo Tapes—over 2,000 Different—all major labels—free catalog. Stereo-Parti, 811-G, Centinela Ave., Inglewood 3, California.

DON'T Buy Hi-Fi components, kits, tape, tape recorders until you get our low, low return mail quotes. "We Guarantee Not To Be Undersold." Wholesale catalog free. Easy time payment plan, 10% down—up to 24 mos. to pay. Hi-Fidelity Center, 220NC E. 23 St., New York 10, N. Y.

SELF-Hypnosis. New concept teaches you quickly by tape or LP-record. Free literature. McKinley Publishers, Dept. T6, Box 3038, San Bernardino, California.

AMPEX, Bozak, Citation, Concertone, Crown, Magnecord, Presto, Norelco, Tandberg, Sherwood, Thorens, Scott, Shure, others. . . . Trades. Boynton Studio, Dept. RT, 10 Pennsylvania Ave., Tuckahoe, New York.

4TR Stereo Tapes—we buy, sell, rent and trade! Free Catalog listing bargain closeouts. Columbia, 9651 Foxbury Way, Rivera, California.

HIGH-FIDELITY



PROMPT Delivery, We Will Not Be Undersold. Amplifiers, Tape Recorders, Tuners, Etc. No Catalogs, Air Mail Quotes, Compare. L. M. Brown Sales Corp., Dept. W, 239 E. 24 St., N. Y. 10, N. Y.

DISGUSTED with "Hi" Hi-Fi Prices? Unusual Discounts On Your High Fidelity Requirements. Write. Key Electronics, 120 Liberty St., New York 6, N. Y. Cloverdale 8-4288.

RECORDERS, Components. Free wholesale catalogue. Carston 125-R, East 88, N.Y.C. 28.

PRICES? The Best! Factory-sealed Hi-Fi Components? Yes! Send for free catalog. Audion, 25T Oxford Road, Massapequa, N.Y.

WANT to buy good equipment and accessories? Place a low-cost classified ad in this space.

HIFI Tuners, Amplifiers, Speakers, Walkie Talkies, Radios, Telescopes, Microscopes, Cameras, Top Quality Imports, Low Prices, Free Catalog, GM Photoelectronics, 623 Gay, Knoxville, Tennessee.

REPAIRS and SERVICING

KIT Repairing—Kit trouble send to us for expert repair. We service all makes and models of Kits: Hi-Fi, Test Equipment, Receivers, Transmitters, Etc. Terms: Ship equipment to us prepaid, returned to you C.O.D. plus shipping charges. K. T. Electronic Service, 1626 19th St. Parkersburg, West Virginia.

GOVERNMENT SURPLUS

JEEPS \$278, Airplanes \$159, Boats \$7.88, generators \$2.68, typewriters \$8.79. are typical government surplus sale prices. Buy 10,001 items wholesale, direct. Full details. 627 locations, procedure, only \$1.00. Surplus. Box 789-C9Z, York, Penna.

PATENTS

PATENT Searches, \$6.00. For free: Invention Record, and "Information Inventor's Need." Write: Miss Heyward, 1029 Vermont Avenue, N.W., Washington 5, D.C.

SHOPPING GUIDE Classified

A HANDBY GUIDE TO PRODUCTS, NOT NECESSARILY ELECTRONIC, BUT OF WIDE GENERAL INTEREST.

PHOTOGRAPHY—FILM, EQUIPMENT, SERVICES

SCIENCE Bargains—Request Free Giant Catalog "CJ"—144 pages—Astronomical Telescopes, Microscopes, Lenses, Binoculars, Kits, Parts. War surplus bargains. Edmund Scientific Co., Barrington, New Jersey.

STAMPS & COINS

TERRIFIC Stamp Bargain! Israel-Iceland-San Marino-plus triangle set—Plus Antigua-Borneo-Virgin-Scouts-Congo-Russia-Plus large stamp book—all four offers free—Send 10¢ for mailing cost. Empire Stamp Corporation, Dept. 2Z, Toronto, Canada.

SELLING entire personal stamp collection. All foreign. Good condition. Assorted packets of 50—25¢ and self-addressed, stamped envelope. Electronics World, Box 573, One Park Avenue, New York 16, N.Y.

HELP WANTED

HIGH Paying Jobs in Foreign Lands! Send \$2.00 for complete scoop! Foreign Opportunities, Box 172, Columbus 16, Ohio.

EARN Extra money selling advertising book matches. Free Samples furnished. Matchcorp, Dept. MD-111 Chicago 32, Ill.

EDUCATIONAL OPPORTUNITIES

LEARN While Asleep, hypnotize with your recorder, phonograph. Astonishing details, sensational catalog free! Sleep-Learning Association, Box 24-ZD, Olympia, Washington.

COMPLETE Your High School at home in spare time with 64-year-old school. Texts furnished. No classes. Diploma. Information booklet free. American School, Dept. X836, Drexel at 58th, Chicago 37, Illinois.

USED Correspondence Courses and Books sold and rented. Money back guarantee. Catalog Free (Courses Bought.) Lee Mountain, Pisgah, Alabama.

BUSINESS OPPORTUNITIES

FREE Book "990 Successful, Little-Known Businesses." Work home! Plymouth-455R, Brooklyn 4, New York.

MAKE \$25-\$50 Week, clipping newspaper items for publishers. Some clippings worth \$5.00 each. Particulars free. National, 81-DG, Knickerbocker Station, New York.

SECOND Income From Oil Can End Your Toil! Free Book and Oilfield Maps! National Petroleum, Pan-American Building—PP, Miami 32, Florida.

BECOME a telephoneman, experience unnecessary, details free. Occupations Unlimited, 1100 Reeve, Santa Clara, Calif.

MISCELLANEOUS

TECHNICAL writing, rewriting, editing: Sally Richards, 1488 Simpson, St. Paul, Minnesota.

Now! An ash tray that smokers can't miss. Beautiful, new light-up ash tray adds a fashionable touch to home or office. Tray-Lite is not only an unusual conversation piece, but also a functional aid that housewives appreciate. Made of translucent styrene plastic, Tray-Lite's base is full 6"x 5 1/4"x 3" and contains a soft glow night light cleverly subdued to blend with the most fastidious decor. Tray-Lite sheds just the right amount of light for comfortable Television viewing. At the same time, it acts as a handy, always visible ash tray. Available in yellow, Pink, Ivory and Beige with Ebony-Black glass tray. Send \$2.50 postpaid. House of Brand, 3458 Fish Avenue, Bronx 69, New York.

WRITERS!—Free Sample copy of Pink Sheets listing top-notch USA markets for short stories, articles, books and plays available to you upon request. Write today! Literary Agent Mead, 915 Broadway, New York 10, N.Y.

CONVERT any television to sensitive, big screen oscilloscope. Only minor changes necessary. Plans \$2.00. Relco, Box 10563, Houston 18, Texas.

REACTANCE REMINDER

By JIM KYLE

AUDIOPHILES, service technicians, and home experimenters alike frequently need to know the reactance of a capacitor at a specific frequency. Some make use of the reactance formula, some use a chart, and still others prefer to consult a reactance table. One of the fastest methods, though, is by use of the figure 159.

This figure is the reactance, in ohms, of a 1- μ f. capacitor at a frequency of 1000 cycles. Since reactance decreases with an increase in either capacitance or frequency, it is only a few seconds' mental work to obtain reactance for any capacitance or frequency. Simply multiply the capacitance (in microfarads) by the frequency (in kilocycles) and divide this product into 159.

For example, using this technique, let's find the reactance of a .1- μ f. capacitor at 5 kc. Multiplying 5 by .1 gives 0.5 and dividing this into 159 yields 318 ohms. The more cumbersome reactance formula comes out with 318.1 ohms—less than one-half ohm difference. ▲

CANADIAN STUDENTS AND EXPERIMENTERS

LATEST CATALOGUE DESIGNED FOR ELECTRONIC, ELECTRICAL AND PHYSICS CLASS USE. CONTAINS SHORT HISTORY ON THE EVOLUTION OF POWER AND MEANS OF TRANSMISSION, THEORY, TERMS, SYMBOLS AND DEFINITIONS — PLUS MOST USED TUBES, TRANSISTORS AND COMPONENTS.



ELECTRO SONIC SUPPLY COMPANY LIMITED

543 YONGE STREET, TORONTO 5, ONTARIO, CANADA

Rush FREE Esco Catalogue No. 612

NAME (Please Print)

ADDRESS

CITY

ZONE

PROVINCE

(CANADIAN INQUIRIES ONLY PLEASE)

PHOTO CREDITS

Page	Credit
20, 64 (right)	University Loudspeakers, Inc.
24	Fisher Radio Corp.
34 (Fig. 3)	University of Washington
35 (Fig. 5)	Dr. G. Baum
35 (Fig. 7), 36 (Figs. B & 9)	Drs. Holmes & Honory, University of Colorado
36 (Fig. 10)	Airborne Instrument Labs.
44 (top), 45 (top)	Minneapolis-Honeywell
44 (center left)	Raytheon Co.
44 (center right)	IBM
44 (bottom), 104	Radio Corp. of America
45 (center)	ACF Electronics
45 (bottom left)	Union Carbide
45 (bottom right)	Western Electric Company
55	Packard Bell Computer Corp.
61	DuKane Corp.
62, 64 (left)	Bogen-Presto
66	Motorola Inc.
105, 106	Electronic Instrument Co., Inc.

ANSWERS TO QUIZ

(Appearing on page 109)

1. F	6. B	11. I
2. A	7. G	12. M
3. O	8. N	13. D
4. H	9. J	14. L
5. K	10. C	15. E

Answer to Puzzle

Appearing on page 117



MODEL 704 STEREO FM/AM RADIO with Automatic Frequency Control \$49.95* Also available as Model 604 FM Radio \$39.95*

MODEL SC-4 GRANCO FM STEREO COMPANION \$29.95* for use with Models 704 and 604

STEREO FM RADIO

Only Granco brings the magnificent new sound of stereophonic FM radio into your home—today! Fine Granco FM/AM radio with AFC... and matching speaker-amplifier Stereo Companion for total listening pleasure never before possible. Hear Granco stereophonic FM radio now—at fine dealers everywhere.

Write for free booklet "THE WONDERFUL WORLD OF STEREO FM"



GRANCO America's Leading Specialist in Stereophonic FM
A Product of Emerson Radio



Dept. E W, 680 FIFTH AVENUE, N.Y. 19

*Suggested list. Prices slightly higher in some areas.

RAD-TEL Tube Values Defy Comparison!

RAD-TEL'S
Quality
**BRAND NEW
TUBES!**

1 YEAR GUARANTEE

UP TO
75% OFF



Mr. Serviceman: Do yourself a favor! The COMPARISON tells the story of RAD-TEL'S "MONEY-SAVING" SALE OF VALUES. Dependable ONE-DAY SERVICE. RAD-TEL SELLS ONLY NEW TUBES.

EACH TUBE INDIVIDUALLY & ATTRACTIVELY BOXED

Qty.	Type	Price	Qty.	Type	Price	Qty.	Type	Price
—	6AU7	.61	—	6I6	.67	—	12D4	.69
—	6AU8	.87	—	6J7	.62	—	12DB5	.69
—	6AV6	.41	—	6K6	.63	—	12DE8	.75
—	6AW8	.90	—	6L6	1.06	—	12DL8	.85
—	6AX4	.66	—	6N7	.98	—	12DM7	.67
—	6AX5	.74	—	6S4	.51	—	12DQ6	1.04
—	6AX7	.64	—	6S8	.76	—	12DS7	.79
—	6AX8	.92	—	6SA7GT	.76	—	12DT5	.76
—	6BA6	.50	—	6SG7GT	.41	—	12DT7	.79
—	6BA7	.84	—	6SH7GT	.49	—	12DT8	.79
—	6BA8	.88	—	6SJ7	.88	—	12DW8	.89
—	6BC5	.61	—	6SK7GT	.74	—	12DZ6	.56
—	6BC7	.94	—	6SL7GT	.80	—	12EG6	.54
—	6BC8	.97	—	6SN7GT	.65	—	12EK6	.56
—	6BD5	1.25	—	6SQ7	.73	—	12EL6	.50
—	6BD6	.57	—	6T4	.99	—	12EM6	.79
—	6BE6	.55	—	6T8	.85	—	12EN6	.78

—	6BF5	.90	—	6U8	.83	—	12EZ6	.53
—	6BF6	.44	—	6V6GT	.54	—	12F8	.66
—	6BG6	1.66	—	6V8	.86	—	12FA6	.79
—	6BH6	.65	—	6W4	.60	—	12FM6	.43
—	6BH8	.87	—	6W6	.71	—	12FR8	.91
—	6BJ6	.62	—	6X4	.39	—	12FX8	.85
—	6BJ7	.79	—	6X5GT	.53	—	12GC6	1.06
—	6BK7	.85	—	6X8	.80	—	12J8	.84
—	6BL7	1.00	—	6Y6G	.65	—	12K5	.65
—	6BN4	.57	—	7A8	.68	—	12L6	.58
—	6BN6	.74	—	7AU7	.61	—	12S8	.62
—	6BQ5	.65	—	7B6	.69	—	12SA7	.92
—	6BQ6	1.05	—	7EY6	.73	—	12SF5	.50
—	6BQ7	1.00	—	7F8	.90	—	12SF7	.69
—	6BR8	.78	—	7Y4	.69	—	12SH7	.49
—	6BS8	.90	—	8AU8	.83	—	12SJ7	.67
—	6BU8	.70	—	8AW8	.93	—	12SK7	.74

—	6BX7	1.02	—	8BH8	.90	—	12SL7	.80
—	6BY5	1.15	—	8BN8	.75	—	12SN7	.67
—	6BY6	.54	—	8BQ5	.60	—	12SQ7	.78
—	6BY8	.66	—	8CG7	.62	—	12U7	.62
—	6BZ6	.55	—	8CM7	.68	—	12V6	.53
—	6BZ7	1.01	—	8CN7	.97	—	12W6	.69
—	6BZ8	1.09	—	8CS7	.74	—	12X4	.38
—	6C4	.43	—	8CX8	.93	—	17AX4	.67
—	6C8	.90	—	8EB8	.94	—	17BQ6	1.09
—	6CB6	.55	—	8SN7	.66	—	17D4	.69
—	6CD6	1.42	—	9CL8	.79	—	17DQ6	1.06
—	6CE5	.57	—	11CY7	.75	—	17L6	.58
—	6CF6	.64	—	12A4	.60	—	17W6	.70
—	6CG7	.61	—	12AB5	.55	—	18FW6	.49
—	6CG8	.77	—	12AC6	.49	—	18FX6	.53
—	6CK4	.70	—	12AD6	.57	—	18FY6	.50
—	6CL8	.79	—	12AE6	.43	—	19AU4	.83

—	6CM6	.64	—	12AE7	.94	—	19BG6	1.39
—	6CM7	.66	—	12AF3	.73	—	19T8	.80
—	6CM8	.90	—	12AF6	.49	—	19Y8	.79
—	6CN7	.65	—	12AJ6	.46	—	21EX6	1.49
—	6CQ8	.84	—	12AL5	.45	—	25AV5	.83
—	6CR6	.51	—	12AL8	.95	—	25AX4	.70
—	6CS6	.57	—	12AQ5	.60	—	25BK5	.91
—	6CS7	.69	—	12AT6	.43	—	25BQ6	1.11
—	6CU5	.58	—	12AT7	.76	—	25C5	.53
—	6CU6	1.08	—	12AU6	.51	—	25CA5	.59
—	6CY5	.70	—	12AU7	.60	—	25CD6	1.44
—	6CY7	.71	—	12AV6	.41	—	25CU6	1.11
—	6DA4	.68	—	12AV7	.75	—	25DN6	1.42
—	6DB5	.69	—	12AX4	.67	—	25EH5	.55
—	6DB6	.51	—	12AX7	.63	—	25L6	.57
—	6DE6	.58	—	12AY7	1.44	—	25W4	.68
—	6DG6	.59	—	12AZ7	.86	—	25Z6	.66
—	6DK6	.59	—	12B4	.63	—	32E75	.55

—	6DN6	1.55	—	12BA6	.50	—	32L7	.90
—	6DQ6	1.10	—	12BA7	.84	—	35B5	.60
—	6DT6	.53	—	12BQ6	.50	—	35C5	.51
—	6DT8	.79	—	12BE6	.53	—	35L6	.57
—	6EA8	.79	—	12BF6	.44	—	35W4	.42
—	6EB5	.72	—	12BH7	.77	—	35Z5	.60
—	6EB8	.94	—	12BK5	1.00	—	36AM3	.36
—	6EM5	.76	—	12BL6	.56	—	50B5	.60
—	6EM7	.82	—	12BQ6	1.06	—	50C5	.53
—	6EU8	.79	—	12BY7	.77	—	50EH5	.55
—	6EW6	.57	—	12BZ7	.75	—	50L6	.61
—	6EY6	.75	—	12C5	.56	—	57G3	1.00
—	6F5GT	.39	—	12CN5	.56	—	70L7	.97
—	6F6	.69	—	12CR6	.54	—	70Z5	.69
—	6GK6	.79	—	12CU5	.58	—	84/6Z4	.46
—	6GN8	.94	—	12CU6	1.06	—	807	.70
—	6H6	.58	—	12CX6	.54	—	117Z3	.61
—	6J5GT	.51	—			—		

Qty.	Type	Price	Qty.	Type	Price	Qty.	Type	Price	Qty.	Type	Price	Qty.	Type	Price
—	DC3	.80	—	2AF4	.96	—	3Q5	.80	—	5AV8	1.01	—	5Y4	.59
—	DZ4	.79	—	2D21	1.20	—	3S4	.61	—	5BC8	.79	—	6A8G	1.20
—	1AX2	.62	—	2EN5	.45	—	3V4	.58	—	5BE8	.83	—	6AB4	.46
—	1B3	.79	—	3A3	.76	—	4AU6	.54	—	5BK7	.82	—	6AC5	1.05
—	1DN5	.55	—	3A4	.60	—	4BA6	.51	—	5BQ7	.97	—	6AC7	.96
—	1G3	.79	—	3AF4	1.02	—	4BC5	.58	—	5BR8	.79	—	6AF3	.73
—	1H5	.54	—	3AL5	.42	—	4BC8	.96	—	5BT8	.83	—	6AF4	.97
—	1J3	.79	—	3AU6	.51	—	4BN6	.75	—	5CG8	.76	—	6AC5	.68
—	1K3	.79	—	3AV6	.41	—	4BQ7	1.01	—	5CL8	.76	—	6AH4	.81
—	1L4	.68	—	3BA6	.51	—	4BS8	.98	—	5CM8	.90	—	6AH6	.99
—	1LC5	.59	—	3BC5	.54	—	4BU8	.71	—	5CQ8	.84	—	6AK5	.95
—	1LD5	.69	—	3BE6	.52	—	4BZ6	.58	—	5CZ5	.72	—	6AL5	.47
—	1LG5	.69	—	3BN6	.76	—	4BZ7	.96	—	5EA8	.80	—	6AL7	1.43
—	1LN5	.59	—	3BU8	.78	—	4CS6	.61	—	5EU8	.80	—	6AM4	1.50
—	1R5	.62	—	3BY6	.55	—	4OE6	.62	—	5J6	.68	—	6AM8	.78
—	1S2A	.76	—	3BZ6	.55	—	4DK6	.60	—	5T4	.79	—	6AQ5	.53
—	1S4	.59	—	3CB6	.54	—	4DT6	.55	—	5T8	.81	—	6AR5	.55
—	1S5	.51	—	3CF6	.60	—	4EW6	.58	—	5U4	.60	—	6AS5	.60
—	1T4	.58	—	3CS6	.52	—	5AM8	.79	—	5U8	.81	—	6AS6	.80
—	1U4	.57	—	3DG4	.85	—	5AN8	.86	—	5V3	.90	—	6AT6	.43
—	1U5	.50	—	3DK6	.60	—	5AQ5	.52	—	5V6	.56	—	6AT8	.79
—	1V2	.50	—	3DT6	.50	—	5AS8	.86	—	5X8	.78	—	6AU4	.82
—	1X2B	.82	—	3Q4	.63	—	5AT8	.80	—	5Y3	.46	—	6AU6	.52

• NOT AFFILIATED WITH ANY OTHER MAIL ORDER TUBE COMPANY •



SEND FOR FREE TROUBLE SHOOTER
GUIDE AND NEW TUBE & PARTS CATALOG

RAD-TEL TUBE CO.

DEPT EW-1161 55 CHAMBERS STREET, NEWARK 5, N. J.

TERMS: 25% deposit must accompany all orders, balance COD. Orders under \$5: add \$1 handling charge plus postage. Orders over \$5: plus postage. Approx. 8 tubes per 1 lb. Subject to prior sale. Prices subject to change. No COD's outside continental USA.

ADVERTISERS' INDEX NOVEMBER, 1961

Advertisers listed below have additional information available on their products in the form of catalogues and bulletins. To obtain more detailed data, simply circle the proper code number in the coupon below and mail it to the address indicated. We will direct your inquiry to the manufacturer for processing.

CODE NO.	ADVERTISER	PAGE	CODE NO.	ADVERTISER	PAGE	CODE NO.	ADVERTISER	PAGE
100	A.E.S., Inc.	67	141	Halicrafters	115, 125	179	Radio Shack Corp.	125
101	Acoustic Research, Inc.	79	142	Harmon-Kardon, Inc.	1	180	Radio Shack Corp.	129
102	Advance Electronics	124	143	Heath Company	74, 75	181	Reeves Soundcraft Corp.	72
103	Aerovox Corporation	12	144	Henshaw Radio Supply	123	182	Rek-O-Kut Company, Inc.	98
104	Airex Radio Corporation	96	145	Holt, Rinehart & Winston, Inc.	26, 27		Remington Rand Univac	130
105	Allied Radio	100, 101, 102, 103	146	Indiana Technical College	107	183	Rex Radio Supply Co.	104
106	American Technical Writing Schools, Inc.	99	147	Injectorall Co.	104	184	Rider Publisher, Inc., John F.	25
107	Amphenol-Borg Electronics Corp.	14	148	International Crystal Mfg. Co., Inc.	77	185	Robins Industries	106
108	Ashe Radio Company, Walter	117	149	International Radio & Electronics Corp.	99	186	Rohn Manufacturing Company	107
109	Audion	107	150	Jerrold Electronics Corp.	95	187	Sams & Co., Inc., Howard W.	29
110	B & K Manufacturing Co.	13	151	Johnson Company, E. F.	105	188	Sams & Co., Inc., Howard W.	112
111	Benjamin Electronic Sound Corp.	116	152	Key Electronics	96	189	Sarkes Tarzian, Inc.	90
112	Blonder-Tongue	68, 69	153	Lafayette Radio	19, 92, 93	190	Schober Organ Corporation, The	114
113	Burstein-Applebee Co.	111	154	Lampkin Laboratories, Inc.	90	191	Scientific Development Corp.	21
114	C & H Sales Co.	104	155	Lektron	128	192	Scott, Inc., H. H.	73
115	Candee Co., J. J.	98	156	McGee Radio Co.	126	193	Sencore	2
116	Capitol Radio Engineering Institute, The	11	157	Magnecord Sales Department	6	194	Smith, Electronics Designs, Wardell	130
117	Carston	107	158	Micro Electron Tube Co.	108	195	Sonar Radio Corporation	72
118	Channel Master	8, 9	159	Milwaukee School of Engineering	70	196	Sprague Electric Co.	16
119	Cleveland Institute of Electronics	7	160	Moss Electronic, Inc.	118, 119, 120, 121	197	Standard Trans Vision, Inc.	106
120	Columbia Electronics	130		National Radio Institute	17, 18	198	Supreme Publications	129
121	Commissioned Electronics Co.	72		National Radio Institute	124	199	Switchcraft, Inc.	90
122	Coyne Electrical School	108	161	National Technical Schools	15		Sylvania Electric Products	SECOND COVER
123	Denson Electronics Corp.	104	162	North American Philips Co., Inc.	71	200	Tech-Master	116
124	Dressner	72	163	Nortronics Co., Inc., The	113	201	Terado Company	112
125	E.C.I. Electronics Communications, Inc.	127	164	Oelrich Publications	123	202	Texas Crystals	66
126	EICO	32	165	Olson Electronics	124	203	Thorens	22
127	Electro-Voice, Inc.	105	166	Peak Electronics Company	106	204	Tokyo Shibaura Electric Co., Ltd.	110
128	Electronic Chemical Corp.	86	167	Pearce-Simpson, Inc.	117	205	Transvision Electronic, Inc.	88
	Electronics Book Service	131	168	Philco Technological Center	4	206	Tri-State College	123
129	Electro Sonic Supply Co.	134	169	Philco Technological Center	108	207	Triplett Electrical Instrument Company, The	THIRD COVER
130	Euphonics Corporation	97	170	Pickering & Co., Inc.	110	208	Tru-Vac	126
131	Fair Radio Sales	97	171	Picture Tube Outlet	90	209	U. S. Crystals, Inc.	112
132	Fisher Radio Corporation	80	172	Pomije Electronics	123	210	University Loudspeakers, Inc.	10
133	G & G Radio Supply Co.	132	173	RCA Institutes, Inc.	82, 83, 84, 85	211	University Loudspeakers, Inc.	65
134	General Electric	28	174	R W Electronics	98	212	Utah Electronics Corp.	24
135	General Electric	109	175	Rad-Tel Tube Co.	135	213	Valparaiso Technical Institute	127
136	General RadioTelephone Company	113		Radio Corporation of America	FOURTH COVER	214	Van Nostrand Company, Inc., D.	86
137	Goodheart Co., R. E.	78	176	Radio Shack Corp.	71	215	Warren Distributing Co.	116
138	Granco	134	177	Radio Shack Corp.	89	216	Wen Products, Inc.	23
139	Grantham School of Electronics	5	178	Radio Shack Corp.	109	217	Winegard Antenna Systems	30, 31, 87
140	Gregory Electronics	86				218	Xcelite, Inc.	96

The coupon below can also be used to obtain additional information on the new product items shown on pages 122 through 134 as well as on the ads as listed above.

VOID AFTER NOV. 30, 1961	NAME _____ STREET NO. _____ CITY _____ ZONE _____ STATE _____																																																																																																																																											
	<table border="1"> <tr><td>100</td><td>101</td><td>102</td><td>103</td><td>104</td><td>105</td><td>106</td><td>107</td><td>108</td><td>109</td><td>110</td><td>111</td><td>112</td><td>113</td><td>114</td><td>115</td><td>116</td><td>117</td><td>118</td><td>119</td></tr> <tr><td>120</td><td>121</td><td>122</td><td>123</td><td>124</td><td>125</td><td>126</td><td>127</td><td>128</td><td>129</td><td>130</td><td>131</td><td>132</td><td>133</td><td>134</td><td>135</td><td>136</td><td>137</td><td>138</td><td>139</td></tr> <tr><td>140</td><td>141</td><td>142</td><td>143</td><td>144</td><td>145</td><td>146</td><td>147</td><td>148</td><td>149</td><td>150</td><td>151</td><td>152</td><td>153</td><td>154</td><td>155</td><td>156</td><td>157</td><td>158</td><td>159</td></tr> <tr><td>160</td><td>161</td><td>162</td><td>163</td><td>164</td><td>165</td><td>166</td><td>167</td><td>168</td><td>169</td><td>170</td><td>171</td><td>172</td><td>173</td><td>174</td><td>175</td><td>176</td><td>177</td><td>178</td><td>179</td></tr> <tr><td>180</td><td>181</td><td>182</td><td>183</td><td>184</td><td>185</td><td>186</td><td>187</td><td>188</td><td>189</td><td>190</td><td>191</td><td>192</td><td>193</td><td>194</td><td>195</td><td>196</td><td>197</td><td>198</td><td>199</td></tr> <tr><td>200</td><td>201</td><td>202</td><td>203</td><td>204</td><td>205</td><td>206</td><td>207</td><td>208</td><td>209</td><td>210</td><td>211</td><td>212</td><td>213</td><td>214</td><td>215</td><td>216</td><td>217</td><td>218</td><td>219</td></tr> <tr><td>220</td><td>221</td><td>222</td><td>223</td><td>224</td><td>225</td><td>226</td><td>227</td><td>228</td><td>229</td><td>230</td><td>231</td><td>232</td><td>233</td><td>234</td><td>235</td><td>236</td><td>237</td><td>238</td><td>239</td></tr> </table>	100	101	102	103	104	105	106	107	108	109	110	111	112	113	114	115	116	117	118	119	120	121	122	123	124	125	126	127	128	129	130	131	132	133	134	135	136	137	138	139	140	141	142	143	144	145	146	147	148	149	150	151	152	153	154	155	156	157	158	159	160	161	162	163	164	165	166	167	168	169	170	171	172	173	174	175	176	177	178	179	180	181	182	183	184	185	186	187	188	189	190	191	192	193	194	195	196	197	198	199	200	201	202	203	204	205	206	207	208	209	210	211	212	213	214	215	216	217	218	219	220	221	222	223	224	225	226	227	228	229	230	231	232	233	234	235	236	237	238
100	101	102	103	104	105	106	107	108	109	110	111	112	113	114	115	116	117	118	119																																																																																																																									
120	121	122	123	124	125	126	127	128	129	130	131	132	133	134	135	136	137	138	139																																																																																																																									
140	141	142	143	144	145	146	147	148	149	150	151	152	153	154	155	156	157	158	159																																																																																																																									
160	161	162	163	164	165	166	167	168	169	170	171	172	173	174	175	176	177	178	179																																																																																																																									
180	181	182	183	184	185	186	187	188	189	190	191	192	193	194	195	196	197	198	199																																																																																																																									
200	201	202	203	204	205	206	207	208	209	210	211	212	213	214	215	216	217	218	219																																																																																																																									
220	221	222	223	224	225	226	227	228	229	230	231	232	233	234	235	236	237	238	239																																																																																																																									
ADVERTISED PRODUCTS (SEE INDEX ABOVE)	<table border="1"> <tr><td>1</td><td>2</td><td>3</td><td>4</td><td>5</td><td>6</td><td>7</td><td>8</td><td>9</td><td>10</td><td>11</td><td>12</td><td>13</td><td>14</td><td>15</td><td>16</td><td>17</td><td>18</td><td>19</td><td>20</td></tr> <tr><td>21</td><td>22</td><td>23</td><td>24</td><td>25</td><td>26</td><td>27</td><td>28</td><td>29</td><td>30</td><td>31</td><td>32</td><td>33</td><td>34</td><td>35</td><td>36</td><td>37</td><td>38</td><td>39</td><td>40</td></tr> <tr><td>41</td><td>42</td><td>43</td><td>44</td><td>45</td><td>46</td><td>47</td><td>48</td><td>49</td><td>50</td><td>51</td><td>52</td><td>53</td><td>54</td><td>55</td><td>56</td><td>57</td><td>58</td><td>59</td><td>60</td></tr> </table>	1	2	3	4	5	6	7	8	9	10	11	12	13	14	15	16	17	18	19	20	21	22	23	24	25	26	27	28	29	30	31	32	33	34	35	36	37	38	39	40	41	42	43	44	45	46	47	48	49	50	51	52	53	54	55	56	57	58	59	60																																																																															
1	2	3	4	5	6	7	8	9	10	11	12	13	14	15	16	17	18	19	20																																																																																																																									
21	22	23	24	25	26	27	28	29	30	31	32	33	34	35	36	37	38	39	40																																																																																																																									
41	42	43	44	45	46	47	48	49	50	51	52	53	54	55	56	57	58	59	60																																																																																																																									
NEW PRODUCTS & LITERATURE	<table border="1"> <tr><td>1</td><td>2</td><td>3</td><td>4</td><td>5</td><td>6</td><td>7</td><td>8</td><td>9</td><td>10</td><td>11</td><td>12</td><td>13</td><td>14</td><td>15</td><td>16</td><td>17</td><td>18</td><td>19</td><td>20</td></tr> <tr><td>21</td><td>22</td><td>23</td><td>24</td><td>25</td><td>26</td><td>27</td><td>28</td><td>29</td><td>30</td><td>31</td><td>32</td><td>33</td><td>34</td><td>35</td><td>36</td><td>37</td><td>38</td><td>39</td><td>40</td></tr> <tr><td>41</td><td>42</td><td>43</td><td>44</td><td>45</td><td>46</td><td>47</td><td>48</td><td>49</td><td>50</td><td>51</td><td>52</td><td>53</td><td>54</td><td>55</td><td>56</td><td>57</td><td>58</td><td>59</td><td>60</td></tr> </table>	1	2	3	4	5	6	7	8	9	10	11	12	13	14	15	16	17	18	19	20	21	22	23	24	25	26	27	28	29	30	31	32	33	34	35	36	37	38	39	40	41	42	43	44	45	46	47	48	49	50	51	52	53	54	55	56	57	58	59	60																																																																															
1	2	3	4	5	6	7	8	9	10	11	12	13	14	15	16	17	18	19	20																																																																																																																									
21	22	23	24	25	26	27	28	29	30	31	32	33	34	35	36	37	38	39	40																																																																																																																									
41	42	43	44	45	46	47	48	49	50	51	52	53	54	55	56	57	58	59	60																																																																																																																									
MAIL TO ELECTRONICS WORLD P.O. BOX 212 VILLAGE STATION NEW YORK 14, N.Y.	INDICATE NUMBER OF ITEMS REQUESTED <input type="checkbox"/>																																																																																																																																											

 Make sure that your name and address are printed clearly.

ELECTRONICS WORLD READER SERVICE COUPON

TRIPLETT

ACTUAL SIZE

USES UNLIMITED:

- Field Engineers
- Application Engineers
- Electrical, Radio, TV, and Appliance Servicemen
- Electrical Contractors
- Factory Maintenance Men
- Electronic Technicians
- Home Owners, Hobbyists



MODEL 310

complete
VOLT-OHM-
MILLIAMMETER



World's Largest Selling POCKET SIZE V-O-M

FEATURES:

- 1 Hand size and lightweight, but with the features of a full-size V-O-M.
- 2 20,000 ohms per volt DC; 5,000 AC.
- 3 EXCLUSIVE SINGLE SELECTOR SWITCH speeds circuit and range settings. The first miniature V-O-M with this exclusive feature for quick, fool-proof selection of all ranges.

SELF-SHIELDED Bar-Ring instrument; permits checking in strong magnetic fields • Fitting interchangeable test prod tip into top of tester makes it the common probe, thereby freeing one hand • UNBREAKABLE plastic meter window • BANANA-TYPE JACKS—positive connection and long life.

■ Price—only \$37.50; leather case \$3.20.

Available For Immediate Delivery From Your Triplet Distributor's Stock



MODEL 100

The most comprehensive test set in the Triplet line is Model 100 V-O-M Clamp-On-Ammeter Kit, now available at distributors. The world's most versatile instrument—a complete accurate V-O-M plus a clamp-on-ammeter with which you can take measurements without stripping the wires. Handsome, triple-purpose carton holds and displays all the components: Model 310 miniaturized V-O-M, Model 10 Clamp-On-Ammeter, Model 101 Line Separator, No. 311 Extension leads, and a leather carrying case, which neatly accommodates all the components. Model 101 literally makes it possible to separate the two sides of the line when using Model 10. Extension leads permit use of Model 10 at a distance from the V-O-M. Complete Model 100 is only

\$64.50

THE TRIPLETT ELECTRICAL INSTRUMENT COMPANY, BLUFFTON, OHIO

MANUFACTURERS OF PANEL AND PORTABLE INSTRUMENTS; ELECTRICAL AND ELECTRONIC TEST EQUIPMENT

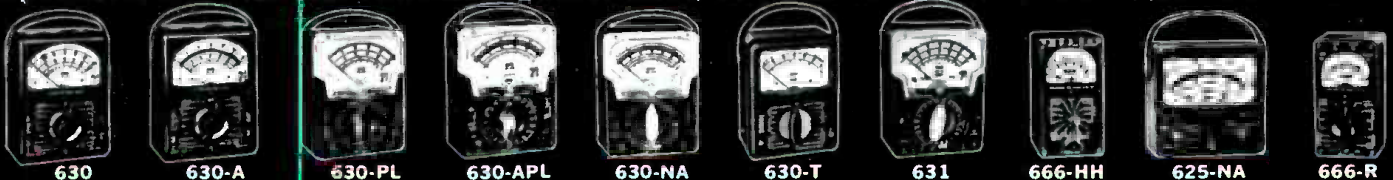

FOR EVERY PURPOSE—THE WORLD'S MOST COMPLETE LINE OF V-O-M'S



HOW SILVERAMA BECOMES "SILVER"

High-Vacuum Aluminizing Assures Sharpest TV Picture Possible

Here RCA Silverama picture tubes become "silver" at the aluminizing station on our Marion, Indiana, production line. In a burst of light, aluminum is vaporized in a high vacuum and is deposited over the entire inner surface of the tube. Then the operator, with an RCA-designed electronic gauge, checks to be sure the aluminum film is of proper thickness. If it is not, the tube is rejected.

Such extra care in manufacture is an important reason why the Silverama you install today is free from "picture-spoiling" dark centers caused by an excess of aluminum deposited on the tube face. This extra care is the reason, too, why Silverama delivers

the brightest, sharpest picture your customers' sets can produce. Obviously, Silverama picture tube service is the surest way toward satisfied customers, repeat business, favorable word-of-mouth advertising for you—plus freedom from call backs and costly in-warranty failures.

Equally important is the fact that RCA is a picture tube manufacturer. This means that your customers can take advantage of the latest innovations in picture tube design and manufacture when they buy RCA Silverama. It is made with a precision electron gun, the finest parts and materials, plus a reused envelope.



Final checkout before shipment. Here Silverama tubes receive final focus check before being shipped to customers.



Packing for final shipment. Before it can go into this box, RCA has made certain this Silverama is the best picture tube modern science and technology can produce.

RCA ELECTRON TUBE DIVISION, HARRISON, N. J.



The Most Trusted Name in Television