

ELECTRONICS WORLD

DECEMBER, 1959

Formerly

**RADIO
& TV NEWS**

50 CENTS

- APPLICATIONS OF DIELECTRIC HEATING
- HOW TO BALANCE STEREO SYSTEMS
- LET'S LEGALIZE HAM PHONE PATCHES
- BUILD A "STROBOLYZER"



**PHOSPHORS AND THEIR USES
(SEE PAGES 50 & 51)**

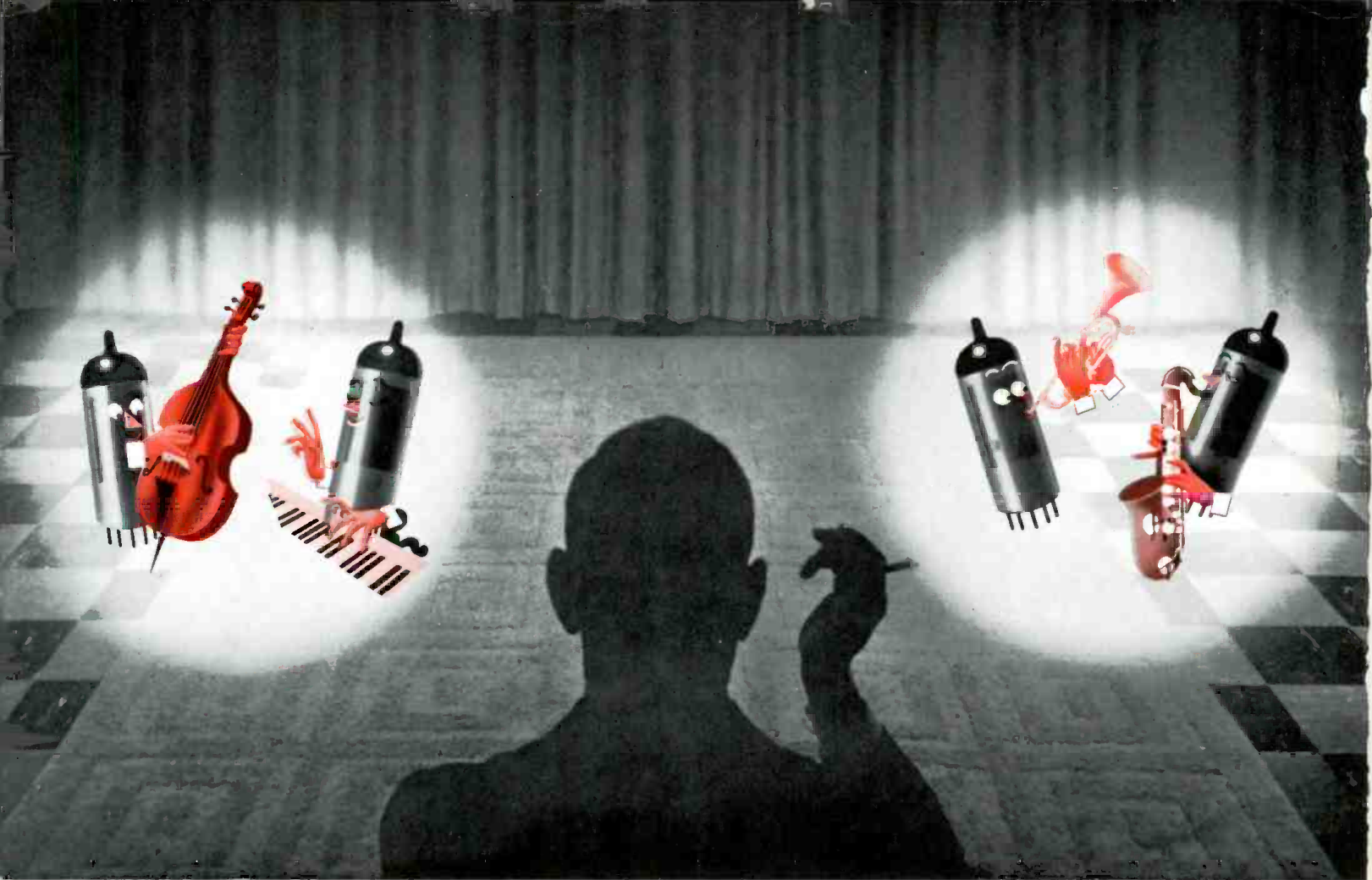

Amperex[®] tubes are making music in the world's finest **STEREO** systems...

AMPEREX 'preferred' tube types have proven themselves in the world's finest *monophonic* amplifiers. Now AMPEREX is paving the way with tubes for the world's finest *Stereophonic* systems. Developed in the research laboratories of Philips of the Netherlands, and applications-engineered by Amperex for the American electronics industry, these ultra-advanced tubes have proven their reliability and unique design advantages in late model amplifiers and tuners of the world's leading high fidelity manufacturers. Sold by franchised dealers everywhere... available for off-the-shelf deliveries in any quantity.

Detailed data and applications engineering assistance available from Semiconductor and Special Purpose Tube Division, Amperex Electronic Corp., 230 Duffy Avenue, Hicksville, Long Island, N. Y.



ask Amperex

about hi-fi tubes for hi-fi stereo circuitry

POWER AMPLIFIER TYPES

6CA7/EL34—Exceptionally linear, high-power output pentode with low-voltage drive requirements. Up to 100 watts in push-pull.
EL84/6BQ5—Unique AF power pentode combining high gain and linearity with 9-pin miniature construction. Up to 17 watts in push-pull.
EL86/6CW5—Low voltage, high current version of

the type EL84/6BQ5. Up to 20 watts in push-pull.
ECL82/6BM8—Triode-pentode. Up to 8 watts in push-pull.
UCL82/50B8—Series string (100 ma. 50v) version of ECL82/6BM8.
PCL82/16A8—Series string (300 ma. 16v) version of ECL82/6BM8.

VOLTAGE AMPLIFIER TYPES

EF86/6267—High-gain pentode with exceptionally low hum, noise and microphonics.* Particularly suitable for pre-amplifier and input stages. Similar to the 2739 and the 5879.
ECC81/12A7—Medium-gain dual triode with low hum, noise and microphonics. Replaces the 12A7 without circuit changes.
ECC82/12AU7—Low-gain dual triode with low hum,

noise and microphonics. Replaces the 12AU7 without circuit changes.

ECC83/12AX7—High-gain dual triode with low hum, noise and microphonics. Replaces the 12AX7 without circuit changes.

ECF80/6BL8—High-gain triode-pentode with low hum, noise and microphonics.

RF AMPLIFIER TYPES

6DJ8/ECC88—Frame grid, sharp cut-off twin triode. Particularly suitable for cascade circuits, RF & IF amplifiers, mixer & phase inverter stages. Features high transconductance and low noise.
***6ES8**—Similar to 6DJ8/ECC88. Has remote cut-off characteristics.
***6ER5**—Frame grid shielded triode with remote cut-off characteristics. Suitable for RF amplifiers in TV & FM tuners. Features high transconductance

and low noise.
†**ECC85/6AQ8**—High gain dual triode for FM tuners with shield between sections for reducing oscillator radiation.

EBF89/6DC8—Duo diode-pentode with remote cut-off characteristics. Suitable for RF & IF amplifiers.

ECF80/6BL8—High gain triode-pentode for RF amplifiers.

RECTIFIER TYPES

EZ80/6V4—Indirectly heated, full-wave rectifier with 6.3 v, 0.6 amp. heater, 90 ma. output capacity and 9-pin miniature construction.
EZ81/6CA4—Indirectly heated, full-wave rectifier with 6.3 v, 1 amp heater, 150 ma. output capacity and 9-pin miniature construction.

G234/5AR4—Indirectly heated, full-wave rectifier with 5 v, 1.9 amp heater and 250 ma. output capacity. Octal base. Replaces the 5U4G without circuit changes with the advantage of lower tube voltage drop because of the unipotential cathode.

Also Available: INDICATOR TUBE TYPES

EM84/6FG6—Indicating pattern is a varying length bar. For use in broadcast receivers and tape recorders.

DM70/1M3—Subminiature type with "exclamation mark" indicating pattern. Features low filament consumption (25 ma.).

GERMANIUM DIODES

1N542—Matched pair. Replaces 6AL5 in FM detector circuits.

1N87A—High RF rectification efficiency diode. Suitable for AM detector circuits.

*300, 450 & 600 ma series string versions available.
†300, 150 & 100 ma series string versions available.

ELECTRONICS WORLD

DECEMBER, 1959
VOL. 62 ■ NO. 6

Publisher
OLIVER READ, D. Sc., W1ET1

Editor
WM. A. STOCKLIN, B. S.

Technical Editor
MILTON S. SNITZER, W2QY1

Service Editor
SIDNEY C. SILVER

Associate Editor
P. B. HOEFER

Assistant Editor
J. JUSTER

Industrial Consultant
WALTER H. BUCHSBAUM

Art Editor
MILTON BERWIN

Art and Drafting Dept.
J. A. GOLANEK
A. J. LICHOTA, JR.
K. W. PAUL, JR.

Advertising Director
JOHN A. RONAN, JR.

Advertising Manager
GEORGE E. MORRISSEY

Midwest Adv. Manager
W. ROBERT WOLFE

Western Adv. Manager
DON CENA



ZIFF-DAVIS PUBLISHING COMPANY
William Ziff, President; W. Bradford Briggs, Executive Vice-President; Michael Michaelson, Vice-President and Circulation Director; Hershel B. Sarbin, Vice-President; J. L. O'Donnell, Treasurer.

Editorial and Executive Offices
One Park Avenue
New York 16, N. Y. OR. 9-7200



Member
Audit Bureau of
Circulations

MEMBER
INSTITUTE OF



BRANCH OFFICES: Midwestern Office,
434 S. Wabash Ave., Chicago 5, Ill.;
Western Office, 215 W. 7th St., Los
Angeles 14, Calif., James R. Pierce,
manager.

FOREIGN ADVERTISING REPRESENTA-
TIVES: D. A. Goodall Ltd., London;
Albert Mithado & Co., Antwerp and
Dusseldorf.

First in radio-television-audio-electronics

CONTENTS

ELECTRONICS—GENERAL

For the Record (Editorial).....	W. A. Stocklin	8
Spot News.....	Washington Correspondent	28
Dielectric Heating.....	M. Rothstein & Walter H. Buchsbaum	37
Electronic Countermeasures—The Art of Jamming.....	D. J. Blattner	47
Phosphors and Their Uses.....	David F. Fortney	50
Cover Story.....		51
Recent Developments in Electronics.....		60
Resuscitation For Electric Shock.....		68
Calendar of Events.....		83
EIA Asks Investigation of Transistor Imports.....		99
ELECTRONICS WORLD Annual Index (Vols. 61 & 62).....		140

HIGH FIDELITY AND AUDIO

Decorating With Music.....		41
Balancing Your Stereo System.....	Herman Burstein	44
Technique for Tuning Electronic Organs.....	William H. Meyer, Jr.	62
Improving the Mullard 520 Hi-Fi Amplifier.....	Edward A. Laurent	66
Delayed Audio A.V.C. Output Limiter.....	Ronald L. Ives	82
Hi-Fi—Audio Product Review.....		88
Certified Record Revue.....	Bert Whyte	120
Sound on Tape.....	Bert Whyte	137

TELEVISION-RADIO

Mac's Service Shop.....	John T. Frye	52
In Case of Fire.....	Ernest W. Fair	53
Fix Those Printed-Board Defects.....	Chester S. Lawrence	54
Tube Faults & Test Techniques.....	Sherman H. Hubelbank	56
Financing a Service Business.....	William Leonard	65
Transistor Radio Circuits (Part 2).....		94
Tuner for Transistor TV.....		106
Service Industry News.....		112
Quadrature FM Detectors: Function and Failure.....	Ken Bramham	118
Service Notes.....		124

AMATEUR AND COMMUNICATIONS

Hand-Held Citizens Band Transceiver.....	J. M. Price & J. P. Overley	42
Let's Legalize Ham Phone Patches.....	C. D. Ehinger, K9IVY	70
License Not Needed for Citizens Radio Adjustments.....		84

ELECTRONIC CONSTRUCTION

The "Strobolyzer"—A High-Intensity Stroboscopic Analyzer.....	F. G. Fender	57
---	--------------	----

DEPARTMENTS

Letters from Our Readers.....	14	Manufacturers' Literature.....	108
Within the Industry.....	22	Technical Books.....	116
What's New in Radio.....	130		

Net Paid Circulation 242,396

Radio & TV News • Radio News • Television News Trademarks Reg. U. S. Pat. Off.
Copyright © 1959 by Ziff-Davis Publishing Company. All rights reserved.

SUBSCRIPTION SERVICE: Form 3579 and all subscription correspondence should be addressed to Circulation Department, 434 South Wabash Avenue, Chicago 5, Illinois. Please allow at least four weeks for change of address. Include your old address as well as new—enclosing if possible an address label from a recent issue.

CONTRIBUTIONS: Contributors are advised to retain a copy of their manuscripts and illustrations. Contributions should be mailed to the New York Editorial Office and must be accompanied by return postage. Contributions will be handled with reasonable care, but this magazine assumes no responsibility for their safety. Any copy accepted is subject to whatever adaptations and revisions are necessary to meet the requirements of this publication. Payment covers all author's, contributor's, and contestant's rights, title, and interest in and to the material accepted and will be made at our current rates upon acceptance. All photos and drawings will be considered as part of the material purchased.

ELECTRONICS WORLD

**MEN 17-55
GET FREE
FACTS**

Let DeVRY Tech prepare you in spare time
to be an

Electronics Technician

**WORK OVER 300 PRACTICAL PROJECTS
AT HOME WITH THESE PARTS**

**Train for a Good-Paying
Job or your own Business
in One or More Branches of
Electronics!**

**Radar • Communications • Radio • Television
Hi-Fi Stereo Sound • Computers • Broadcasting
Your Own Service Shop • Guided Missile Control
Industrial and Automation Electronics**

It's a fact! In almost any location where good Television-Radio-Electronics technicians are found, you'll see DeVry-trained men earning GOOD PAY . . . holding EXCITING JOBS . . . facing a REAL FUTURE. Many DeVry-trained men have good jobs in modern plants, broadcast studios, laboratories, to name a few; others have profitable service shops of their own.

What's so important, many of these now-skilled men had NO PREVIOUS TECHNICAL EXPERIENCE OR ADVANCED EDUCATION when they first contacted DeVry Tech. At home in their spare time, they learned basic principles using clearly-written texts and MOTION PICTURE TRAINING FILMS. They developed practical skill working with many shipments of Electronic parts . . . and soon became technicians the proved DeVry way. What these men have done, YOU should be able to do, too. NOW is the time to act, for the Electronics field is growing steadily larger. This means wonderful opportunities ahead for those who start preparing now. Take that all-important first step by mailing the coupon below.

PREPARE IN CHICAGO OR TORONTO TRAINING CENTERS

DeVry's great training centers at Chicago and Toronto also are noted for preparing men thoroughly. Students learn quickly—using much actual Electronic equipment under the guidance of friendly, experienced instructors.

HOME MOVIES MAKE "HIDDEN ACTIONS" CRYSTAL CLEAR

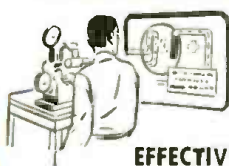

On the wall of your own room, you see radio waves travel through the air . . . circuits "come alive" . . . hidden actions shown . . . through the magic of DeVry's home training movies. What a wonderful aid to your progress!

**EFFECTIVE EMPLOYMENT
SERVICE HELPS YOU START**

DeVry's long-established contacts with employers of trained technicians can be valuable to YOU when you are one of our graduates. And we'll also show you how to start your own profitable Television-Radio servicing business, if that's your aim.

Draft Age?

DeVry has important information for men who face military service. Ask for details.

2 FREE Booklets. Act Now!

"One of North America's
Foremost Electronics Training
Centers"



DEVRY TECHNICAL INSTITUTE
4141 Belmont Avenue • Chicago 41, Illinois

Accredited Member of National Home Study Council

**SEND THIS
COUPON
TODAY!**



**You Build This 5-Inch Color
OSCILLOSCOPE**



After working scores of practical projects, you build and keep this 5-inch wide band Oscilloscope—a "must" for profitable servicing.

**Also Build This Quality
VACUUM TUBE VOLTMETER**

Another valuable test instrument which you build and keep. Helps you earn spare time income while you learn.

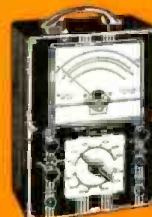

2 Practical Projects

1. 21-INCH TV SET, complete with instructions and all parts, including picture tube. Tops for instructional value!
2. HI-FI STEREO SOUND SYSTEM. Bring "3-D" sound into your home and learn important principles as well, when you build this DeVry-quality system.

DEVRY TECHNICAL INSTITUTE, Dept. EW-12-P
4141 Belmont Avenue, Chicago 41, Ill.

Please give me your two free booklets, "Pocket Guide to Real Earnings," and "Electronics in Space Travel," also include details on how to prepare for a career in one or more branches of Electronics.

Name _____ Age _____
Please Print
Street _____ Apt. _____
City _____ Zone _____ State _____

Check here if you face military service.
Canadian residents write DeVry Tech of Canada, Ltd.,
626 Roselawn Ave., Toronto 12, Ont.

2068

DIRECT-DRIVE and 6CD6-GA



Here's how you can get better service from the 6CD6-GA!

Have you had difficulties with 6CD6-GA's operating in direct-drive circuits? If so, this message is most important to you. Here's a simple way to "lick" the problem.

In horizontal-output circuits utilizing transformer or auto-transformer coupling to the deflecting yoke the damper tube is usually connected across a portion of the flyback transformer, and acts to reduce "ringing" after each flyback pulse.

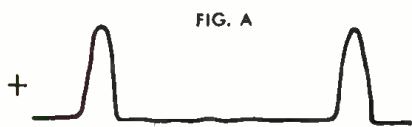

Waveform of flyback pulse at the plate of horizontal-output tube in a typical transformer-coupled circuit.

In most direct-drive circuits, those in which the horizontal coils of the deflecting yoke are connected in series with the horizontal-output transformer, the damper tube is not connected across any portion of the high-voltage transformer. Therefore, high-amplitude "ringing" voltage may be present. Should the negative peaks of the "ringing" voltage exceed the maximum plate-voltage rating of the horizontal-output tube, the tube may be damaged. Thus, premature failure of a horizontal-output tube may occur because of improper conditions.

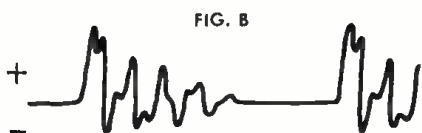

Waveform at the plate of horizontal-output tube in a typical direct-drive circuit.

Possibilities of premature failure of the popular 6CD6-GA when used in direct-drive circuits can be reduced by lowering the negative peaks of the flyback pulse. This is done very simply as shown below in Fig. C. Add a 5,000-ohm 5-watt resistor in series with "C". ("C" is part of the existing circuit, usually about 33μf).

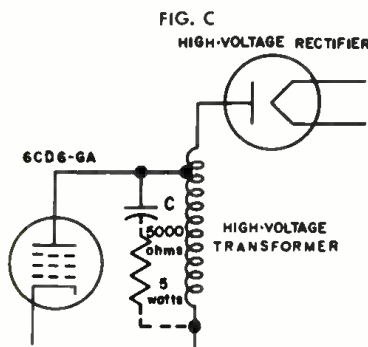

Typical direct-drive circuit, with 5,000-ohm 5-watt resistor to be added shown in broken line. To provide adequate ventilation and H-V insulation, the resistor should be spaced away from other parts, wires, shields, etc.

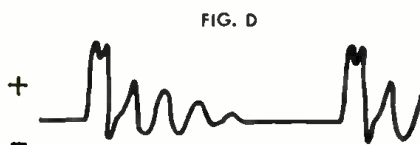

Waveform at the plate of horizontal-output tube in a typical direct-drive circuit with added 5,000-ohm 5-watt resistor. The resistor lowers the "Q" of the transformer to reduce the amplitude of the "ringing" voltage.

CORRECT HORIZONTAL ADJUSTMENTS ARE IMPORTANT!

Incorrect setting of the horizontal-drive and linearity controls can cause excessive cathode current. To assure long life of the 6CD6-GA, measure its cathode current, and adjust drive and linearity controls for lowest current consistent with linearity. To measure cathode current in the RCA Victor KCS-68 and KCS-81, and other chassis utilizing similar direct-drive horizontal-output circuits, simply remove the B+ fuse and connect a dc milliammeter across the fuse holder, as shown in Fig. E.

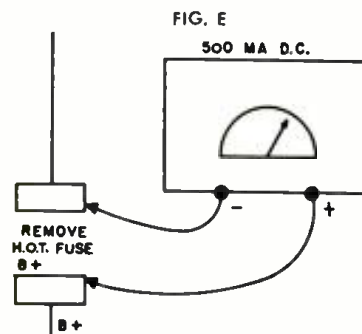

VOLTAGES ARE IMPORTANT, TOO!

Check screen-grid, cathode, and control-grid voltages. If the control-grid voltage is low, check waveform and amplitude of the sawtooth driving voltage at the control grid. Make horizontal-oscillator circuit adjustments, if necessary. Check B+ and line voltages.

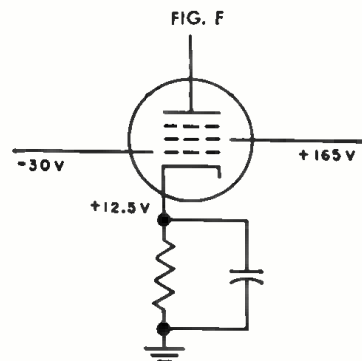

Typical operating voltages of a 6CD6-GA horizontal-output tube in the direct-drive circuits used in the RCA Victor KCS-68 and KCS-81 chassis, measured to chassis ground, with an RCA VoltOhmyst®.

RCA-6CD6-GA TUBES ARE DYNAMICALLY CHECKED IN DIRECT-DRIVE CIRCUITS!

To insure top performance and long life, production samples of RCA-6CD6-GA tubes are factory-checked in direct-drive circuits under typical operating conditions. Keep your profits up by keeping 6CD6-GA callbacks down. Check and adjust horizontal circuits. And, if you replace a 6CD6-GA, always replace with RCA!

Do you have your copy of the RCA Triple Index? Ask your RCA Tube Distributor about this useful servicing aid today.



ANOTHER WAY RCA HELPS YOU IMPROVE YOUR BUSINESS

RADIO CORPORATION OF AMERICA

Electron Tube Division

Harrison, N. J.

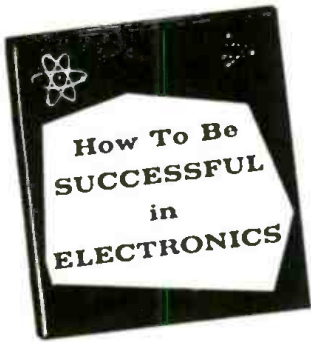

FREE

tells how

Get your FCC Commercial License —or your money back

The Master Course in Electronics will provide you with the mental tools of the electronics technician and prepare you for a First Class FCC License (Commercial) with a radar endorsement. When you successfully complete the Master Course, if you fail to pass the FCC examination, you will receive a full refund of all tuition payments.

EFFECTIVE JOB FINDING SERVICE HELPS CIRE TRAINEES GET BETTER JOBS

"License and \$25 raise due to Cleveland Institute training"

"I sat for and passed the FCC exam for my second class license. This meant a promotion to Senior Radio Technician with the Wyoming Highway Department, a \$25 a month raise and a District of my own for all maintenance on the State's two-way communication system. I wish to sincerely thank you and the school for the wonderful radio knowledge you have passed on to me. I highly recommend the school to all acquaintances who might possibly be interested in radio. I am truly convinced I could never have passed the FCC exam without your wonderful help and consideration for anyone wishing to help themselves."

CHARLES C. ROBERSON
Cheyenne, Wyoming

HERE'S PROOF FCC LICENSES ARE OFTEN SECURED IN A FEW HOURS WITH OUR COACHING

Name and Address	License	Time
John H. Johnson, Boise City, Okla.	1st	20 weeks
Prentice Harrison, Lewes, Delaware	1st	27 weeks
Herbert W. Clay, Phoenix, Arizona	2nd	22 weeks
Thomas J. Bingham, Finley, North Dakota	2nd	9 weeks
William F. Masterson, Key West, Fla.	2nd	24 weeks

EMPLOYERS MAKE JOB OFFERS LIKE THESE TO OUR GRADUATES EVERY MONTH

Employers Make Job Offers Like These To Our Graduates Every Month

Broadcast Station in Illinois: "We are in need of an engineer with a first class phone license, preferably a student of Cleveland Institute of Radio Electronics; 40 hour week plus 8 hours overtime."

West Coast Manufacturer: "We are currently in need of men with electronics training or experience in radar maintenance. We would appreciate your referral of interested persons to us."

Your FCC Ticket is recognized by employers as proof of your technical ability.

Accredited by
National Home Study
Council

Cleveland Institute of Electronics

Desk RN-36, 4900 Euclid Bldg., Cleveland 3, Ohio

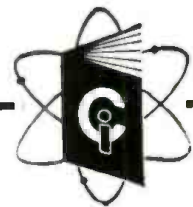

Please send Free Booklets prepared to help me get ahead in Electronics. I have had training or experience in Electronics as indicated below:

<input type="checkbox"/> Military	<input type="checkbox"/> Amateur Radio	<input type="checkbox"/> Telephone Company
<input type="checkbox"/> Radio-TV Servicing	<input type="checkbox"/> Broadcasting	<input type="checkbox"/> Other
<input type="checkbox"/> Manufacturing	<input type="checkbox"/> Home Experimenting	

In what kind of work are you now engaged?

In what branch of Electronics are you interested?

Name Age Address

City Zone State

RN-36

ONLY the ACRO Stereo pre-amplifier gives you these years ahead design features!

CHECK THESE EXTRAS that no other kit gives:

- | | |
|---------------------------------------|---|
| 1. Selective Rumble & Scratch Filters | 5. Input Level Controls |
| 2. 3rd Channel Output | 6. Exclusive Panel Light Matrix |
| 3. Exclusive Mike Dub Switch | 7. Lowest Hum with D.C. Filament Supply |
| 4. Phasing Switch | Plus many other features |



ACRO'S STEREO PRE-AMPLIFIER

EASY TO ASSEMBLE KIT

Unequaled Versatility; Logical planning; Pre-assembled, tested, printed circuit board makes construction simple. A PERFECT MATE FOR ACRO'S STEREO 20 AND ULTRA LINEAR II AMPLIFIERS.

SPECIFICATIONS

INPUTS each channel

- Magnetic (Turntable & Changer) Equalized 78, LP, RIAA
- Crystal/ceramic (switched in mag. input) Sensitivity for 1.5V out Low Level 5 MV. High Level 30 MV.
- Tape Head Equalized NARTB Sensitivity 2 MV
- FM ● AM ● FM Multiplex ● Tape Head
- Microphone (switched into one channel for announcing, faded in or out with balance control)

OUTPUTS 2 Ampl., 2 Tape, 3rd Channel

INPUT SELECTOR (8 position) 78, LP, RIAA1, RIAA2, Tape Head, FM-AM, FM Multiplex & Aux.

OUTPUT SELECTOR 7 MODES (Check-A, Check-B, Stereo, Stereo Reverse, Monaural A-B, Monaural A, Monaural B.) 6 panel light Matrix provides selection Mode at a glance.

CONTROLS Gauged Volume/Loudness, Balance, Individual Bass & Treble for each channel

SWITCHED EXTRAS effective each channel. Filters, scratch and rumble ● loudness ● phasing ● tape input/monitor ● mike dub

AC OUTLETS 2 switched 2 direct

TUBES (4) Type 7199 low noise pentode/triode

DIMENSIONS 4-1/2H x 13-3/4L x 6-3/8D

PRICE: Kit \$69.50 Self powered kit \$79.50

Write today for free folder

ACRO PRODUCTS COMPANY KIT DIV.

410 SHURS LANE, Dept. EW 12
Philadelphia 28, Pa.

ACRO, THE FIRST NAME IN AUDIO!

...for the Record

By **W. A. STOCKLIN**
Editor



FOR most of us 1959 has been a pretty good year all-around and while there are, undoubtedly, many items which we would like to find in our Christmas stockings our annual letter to "Santa Claus" will probably be considerably shorter this year than at holidays of the recent past.

On the whole, the electronics industry has stabilized after last year's set-back and a host of new and interesting items are being offered the discriminating buyer. For the stereophile the manufacturers of high-fidelity equipment are making units incorporating convenience and operating features reflecting unusual ingenuity and engineering skill. The television fan has a wide choice of receivers, both black-and-white and color, ranging in size from the battery-operated portable to the "home entertainment center" whose cabinetry covers the better part of a living room wall.

The upsurge of Fall and Winter television programming offers a variety of "Specials" and "Spectaculars" in color as well as black-and-white, making the investment in a color set a worthwhile expenditure.

For the service technician the new sets incorporate designs which enable the receivers to be serviced with a minimum of time and trouble as manufacturers heed pleas from the field for chassis accessibility and more and handier test points.

The average citizen is having his fun with two-way radio and it is our guess that many Christmas trees this year will shelter mysterious packages containing sleek new CB transceivers—a gift the whole family can enjoy.

Lovers of good music have a wealth of new FM-AM tuners and stereo and/or mono discs from which to select works to suit every taste—and the list of new and unusual offerings is growing daily. Record companies are producing a higher percentage of "off beat" discs than ever before—balancing out the bread-and-butter "warhorses" which formerly made up the bulk of their catalogues. New artists and conductors are being heard as A & R men move farther afield to capture the music of ensembles in remote areas of the world—now possible thanks to the abundance of high-quality tape recording equipment available today.

All of us at ELECTRONICS WORLD join in the wish that Santa will be generous with our readers and bring each his heart's desire. For our part, we promise to bring you all the best in our field in the coming year to keep you abreast of your job, your hobby and/or your special interests. The editorial staff, your art and drafting departments, and our authors join me in wishing you a

*Merry
Christmas*

FREE

ALLIED'S 1960

ELECTRONIC SUPPLY CATALOG

*it's value-packed...
send for it!*

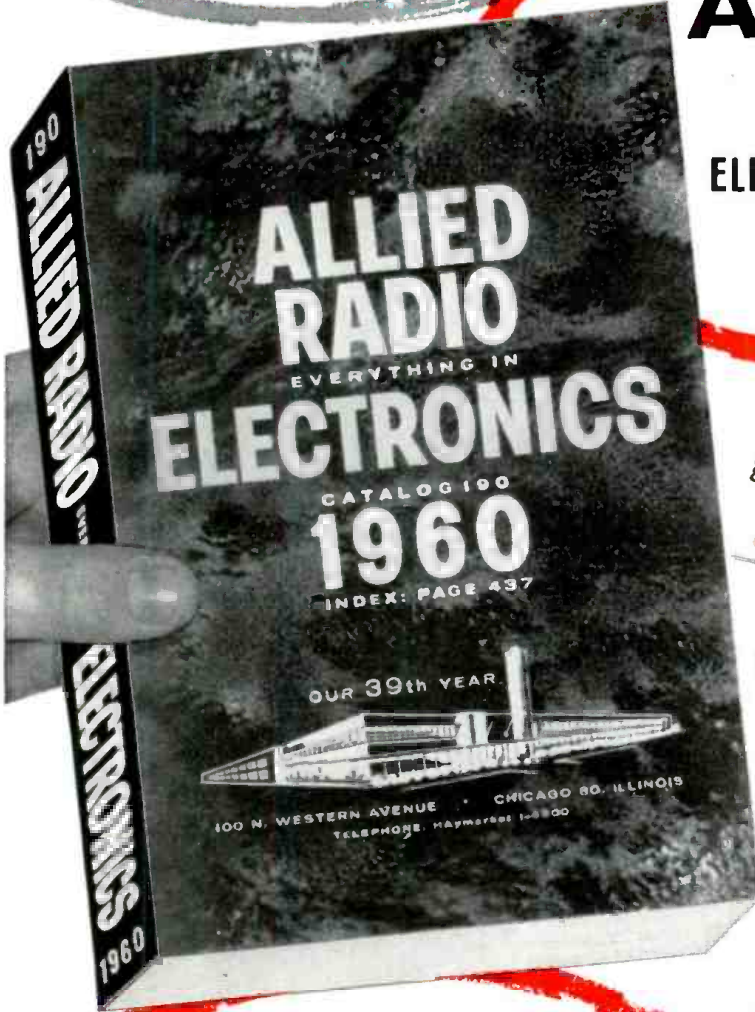

*your complete money-saving
guide to everything in electronics*

WORLD'S LARGEST STOCKS

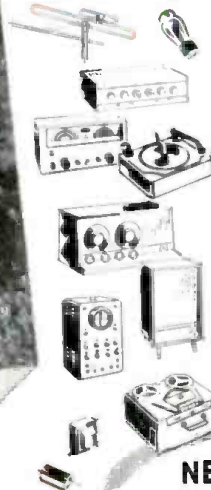

- Latest Stereo Hi-Fi Systems— Everything in Hi-Fi Components
- Money-Saving, Build-Your-Own KNIGHT-KITS for Every Need
- Values in Recorders and Supplies
- Latest Public Address Systems, Paging and Intercom Equipment
- Amateur Receivers, Transmitters and Station Gear
- Test and Laboratory Instruments
- TV Tubes, Antennas, Accessories
- Huge Listings of Parts, Tubes, Transistors, Tools, Books

*featuring
these **ALLIED** exclusives:*

MONEY-SAVING KNIGHT-KITS®—the very best in build-your-own electronic equipment—designed to save you up to 50%. "Convenience Engineered" for easiest assembly; the only kits covered by Money-Back Guarantee. Complete selection of Stereo hi-fi kits, Hobbyist kits, Test Instrument and Amateur kits. KNIGHT-KITS are an exclusive ALLIED product.

KNIGHT® **STEREO HI-FI**—truly "honored for value"—the best you can buy, yet far lower in cost. Select super-value KNIGHT components or complete systems and save most. Also see the world's largest selection of famous name hi-fi components and money-saving ALLIED-recommended complete systems.

NEW LOW EASY PAY TERMS

Only \$5 down (or less) on orders up to \$200. Up to 24 months to pay. Fast handling—no red tape.

Get every buying advantage at ALLIED: lowest money-saving prices, fastest shipment, expert personal help, guaranteed satisfaction...

*send for the leading
electronic supply guide*

FREE

ALLIED RADIO



our 39th year

World's Largest Electronic Supply House

ALLIED RADIO CORP., Dept. 1-M9
100 N. Western Ave., Chicago 80, Ill.

Send FREE 1960 ALLIED Catalog.

Name _____

Address _____

City _____ Zone _____ State _____

TV Technician Bing Longton says . . .

“We Can’t Gamble With Customer

Bing Longton, co-owner of Longton Bros. TV in Wyandotte, Michigan, has had an active interest in electronics since his childhood. A graduate of Detroit’s Electronics Institute, Bing and his brother started their own TV sales and service business in 1948. In slightly more than 10 years, business has expanded greatly.

The Longton business philosophy has always been that every customer deserves the utmost in service. This, coupled with a keen interest in new developments which allow better service, has enabled Longton Bros. TV to become one of the most successful TV service organizations in the Detroit area.

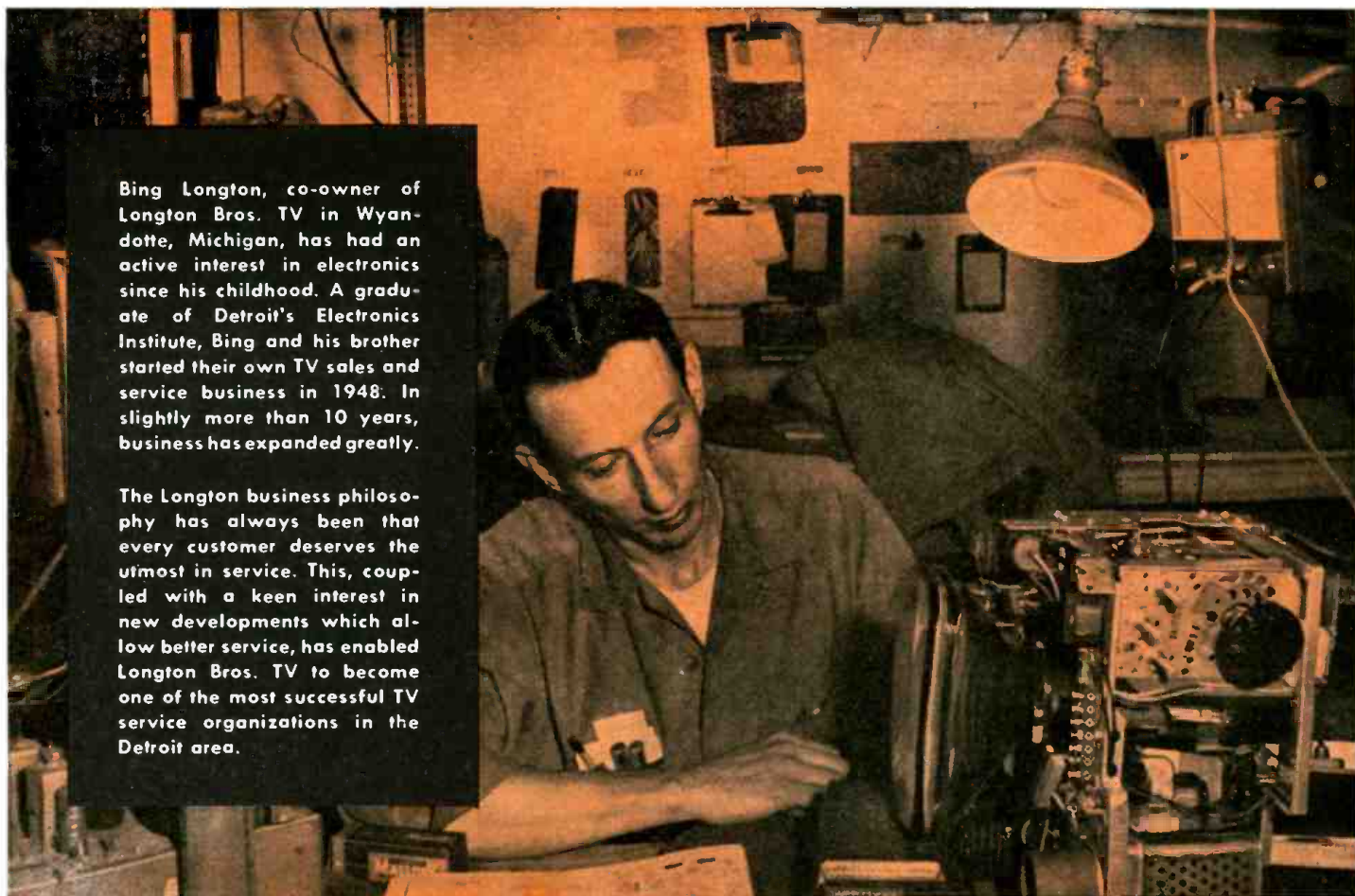

Put an end to call-backs with these quality Mallory products . . .



GEMS

5 rugged, moistureproof, Mallory “Gem” tubular capacitors in an easy-to-use dispenser that keeps your stock fresh and clean—easy to find—no more kinks in lead wires. They’re your best bet for outstanding service in buffer, by-pass or coupling applications.



RMC DISCAPS[®]

Are a product of the world’s largest producer of ceramic disc capacitors. Long the original equipment standard, Mallory RMC Discaps are now available for replacement. They come in a handy 3” x 5” file card package . . . easy to stock, simple to use.

®A registered trade mark of Radio Materials Company, a division of P. R. Mallory & Co. Inc.



FP ELECTROLYTICS

The Mallory FP—the original 85°C. capacitor—now has improved shock-resistant construction and leakproof seal. Its etched cathode construction—standard in all FP’s—assures hum-free performance. High ripple current ratings fit the toughest filter circuits.

Satisfaction . . . We Use Mallory Components for Replacement”

“Customers demand quality repair service, and at Longton TV the customer is *king*. We figure the best way to keep him happy . . . and protect our own profits, too . . . is to prevent complaints before they happen. So we give him the best in service and the best in replacement parts—that means MALLORY components. We’ve used them ever since we started in business, because we know

we can always depend on MALLORY.”

Whether you need capacitors, controls, resistors, silicon rectifiers or batteries, you get the highest quality components at sensible prices. The Mallory line is the widest in the industry, and Mallory “service-engineering” assures you fewer call-backs and more satisfied customers. See your Mallory distributor for a full selection of the parts you need.

Get TC capacitors at your distributor from this handy merchandise display.

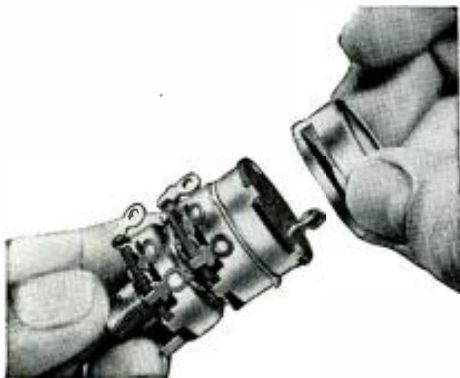

STA-LOC* CONTROLS

New Sta-Loc design enables your distributor to custom build, in just 30 seconds, any of 38,000 combinations—eliminates waiting for out-of-stock controls. You can replace the line switch by itself, without unsoldering control connections.



GOLD LABEL* VIBRATORS

On critical auto radio servicing, use the Mallory Gold Label Vibrator. It gives longer, trouble-free service life. Mallory Gold Label Vibrators feature Mallory exclusive buttonless contact design.

*Trade Mark



TC TUBULAR ELECTROLYTICS

Economically priced electrolytic filter capacitors with a reputation for doing an excellent job. They have been proved in performance and are backed by years of Mallory experience. Also special TCX type available for -55°C .



SELL THE ANTENNA LINE THAT HELPS YOU SELL!

Cash in on...

Winegard's

...the Industry's Greatest

SEE the big-name TV stars such as ★ Ward Bond of "Wagon Train" ★ Walter Brennan of "The Real McCoy's" and other TV stars promoting Winegard Color'Ceptors!

SEE Winegard's advertising in a non-stop, big-space schedule in LIFE, Better Homes & Gardens, others, ALL YEAR LONG!



GET FREE PROFIT-MAKING SALES AIDS

GET Winegard's new "PROMOTION BUCKS"! Given to you free with every Color'Ceptor you buy. You use them for getting your own choice of the finest sales promotion aids anyone has ever offered — knock-out sales helps that hitch your business to the giant national sweep of Winegard's BIG TV SHOW TIME!

SEND THIS COUPON TODAY!

WINEGARD CO.
3003-12 Scotten, Burlington, Iowa

- RUSH full color brochure showing Winegard's new antenna dealer sales aids . . . and tell me how I can get them free!
- Send literature on Winegard's complete line of FM and TV antennas.

FIRM NAME _____

ADDRESS _____

Sell the Winegard Color'Ceptor, the only antenna that's GUARANTEED to give your customers the BEST reception — In the rare event, a customer of yours is not satisfied — Winegard will refund the list price of the antenna and YOU KEEP YOUR FULL PROFIT.

Talk to your Distributor or send coupon for the whole story.

FEATURE THE LEADER AND BE ONE!



Winegard Co.

3003-12 Scotten, Burlington, Iowa

As Advertised in



Year-round big-space national advertising featuring big name TV stars.

OUT WHERE THE SALES BEGIN



Color'Ceptor full-color mailing piece and full-color postcards for your direct mail program.



Special window decals.



DEALER'S NAME & ADDRESS GO HERE

Giant 6 foot 3-color metal road sign imprinted with your name.



For best TV reception Winegard Gold Antennas

Big gold balloons for the kiddies.

Unlimited 50-50 co-op on local newspaper and radio advertising.

BIG TV SHOW TIME!

All-Out Antenna Profit Drive!

INSIDE YOUR STORE



Colorful window streamers.



"Antenna Specialists" Shirt Emblems.

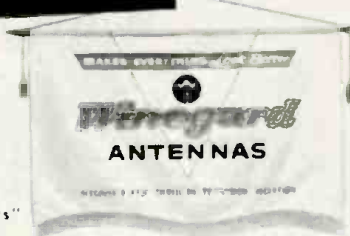

Attractive silk wall banners.



Antenna check-up sheets.



Gold anodized sample to hand out on service calls.



Illuminated plastic window sign.

New Color'Ceptor display with gold anodized mast.



OUTSIDE YOUR STORE

Eye-catching metal flange sign.



Special truck decals.



Hanging store front sign imprinted with your name.

ALL THESE SALES AIDS FREE - Ask Your Distributor



NEW! . . . MULTI-CHANNEL 2-WAY RADIO

Low Cost **G-12**
Citizens Communicator

A complete 4-channel radio station . . . for virtually unlimited business or personal use in vehicle, office, boat, plane

Operates on new 11-meter Citizens Band. Easy to obtain station license . . . no code, no exams. U.S. Citizens required only to complete simple F.C.C. form.

HUNDREDS OF USES!

units may operate together as a system. Examples: Industrials . . . buildings . . . yards . . . warehouses . . . aviation . . . branch businesses . . . fixed station to car or truck. Also for farm . . . ranch . . . mining . . . construction . . . sports . . . fishing . . . boating . . . hunting . . . sporting events . . . outdoors.

RUGGED . . . DEPENDABLE . . .

Full feature Citizens Band Radio. No tuning . . . has quartz crystal-controlled channels for highest stability, reliability. Easy, press-to-talk operation . . . has front panel channel selector, noise limiter, superhet receiver with RF stage, adjustable squelch, transmitter tuning indicator, built-in speaker. Is fully FCC type accepted.

Employs latest electronic design techniques. Compact! Only 4½" H, 7" W, by 10" D. Weighs 11 lbs. Has gimbal mount, built-in 12VDC/117VAC universal power supply for fixed or mobile service.

149⁹⁵
per unit

WITH P-T-T MICROPHONE
AND TRANSMITTER/RECEIVER CRYSTALS
FOR ONE CHANNEL.

Send coupon for FREE Citizens Band Booklet . . .

GONSET DIVISION Dept. EW
Young Spring & Wire Corp.
801 South Main Street, Burbank, Calif.

Gentlemen: Rush complete details on your Citizens' Band radio, and free booklet

NAME _____

ADDRESS _____

CITY _____

ZONE _____

STATE _____

GONSET

Division of Young Spring & Wire Corporation

801 SOUTH MAIN ST., BURBANK, CALIFORNIA



OUR SERVICE FEATURES

To the Editors:

We are new to the TV servicing business. In fact, we have only been in it for three months. We have purchased your magazine and wish to comment that since it contains so many wonderful TV servicing aids it has become an important tool in our business. It is just as important to us as a TV schematic.

GEORGE E. MOLSON, Manager
Eastern Electronics
Albany, New York

Thanks to Reader Molson for his kind words. We wish him much luck in his new venture. Although it is sometimes difficult, we try to satisfy both the beginner and the "old timer" in servicing.—Editors.

* * * CODED STEREO

To the Editors:

In your 1958 edition of the HI-FI ANNUAL & AUDIO HANDBOOK, there was an article reprinted from RADIO & TV NEWS on coded stereo by Norman Crowhurst. When the article originally appeared, Mr. Crowhurst offered construction information for the system at a nominal fee of \$1.00.

I have been in touch with the author recently but, unfortunately, his supply of this material is exhausted, and he is no longer able to supply the data.

If any of your readers has this data and would be willing to sell it or lend it so that I might copy and return it to them, I would gladly pay for the service.

WALTER J. BEBENEK
78 Rivercrest Road
Toronto 9, Ontario
Canada

We are sorry that we cannot help this reader directly, but if anyone can, we are sure he would appreciate it.—Editors.

* * * CAREER OPPORTUNITIES

To the Editors:

I wonder who compiled the salary figures in your article "Career Opportunities in Electronics" which appeared in your September issue. I live in the St. Louis area, which has its fair share of electronic industries, yet graduate engineers cannot command the salaries you quoted, let alone technicians. In only one branch of electronics are the salaries as quoted in your article, and that is the radio-broadcast field. This is due to many years of unionization and not the law of supply and demand.

Also, the false lure of the dollar bill is insufficient inducement to attract people to engineering and scientific

fields. I don't believe it will carry them through the long, hard hours of math and theory necessary to master electronics. I believe the prerequisites are genuine, natural curiosity, and an insatiable desire to learn, originally cultivated by subtle teaching in our preparatory schools and beyond.

I urge you to do the public a favor and print both sides of the picture.

EUGENE R. POWELL
East St. Louis, Illinois

Many statistical sources were used in compiling figures for the . . . career opportunities in electronics. These included the official wage scales of several large concerns in different parts of the country, data provided by the Bureau of Labor Statistics in Washington, civil service schedules, and other sources. While these figures are representative on a nation-wide basis, there are naturally many specific areas in the country where the situation is different.

However, we agree with Reader Powell that the "lure of the dollar bill" is insufficient inducement to attract worthwhile people, that a genuine interest in the field is at least as important.—Editors.

* * * OUR AUGUST EDITORIAL

To the Editors:

I was very pleased to read your editorial in the August issue on "Stiff Competition Ahead for the Parts Industry."

This is a problem which concerns us in the vacuum-tube field a great deal, and I thought you did a fine job in pointing it out to the industry in general.

C. E. ATKINS
Manager of Engineering
Electronic Tube Div.
Tung-Sol Electric Inc.
Bloomfield, New Jersey

The editorial in part discussed the future competition from imported components and what American manufacturers will have to do to cope with it.—Editors.

* * * INDEPENDENT SERVICE

To the Editors:

Anyone can ascertain from Bill Leonard's articles and others written by people in the same position the problems that the independent service organization faces. Even though I must admit to being one of those people who does his own TV and radio repair, I understand your position and sympathize with it.

I feel that one of the ways you can get the incompetents out of your busi-

**WE'RE MAKING IT EASIER THAN EVER TO BECOME A WELL PAID
RADIO-TELEVISION SERVICE TECHNICIAN**

**NOW - Just \$6 Starts You Training in
RADIO-TELEVISION**

the SPRAYBERRY "Learn-by-Doing" Way . . .

**25 BIG, COMPLETE KITS
of PARTS & EQUIPMENT**

To help you learn fast the practical side of Radio-Television, we send you expertly engineered training kits to test and assemble for interesting, valuable shop-bench practice!

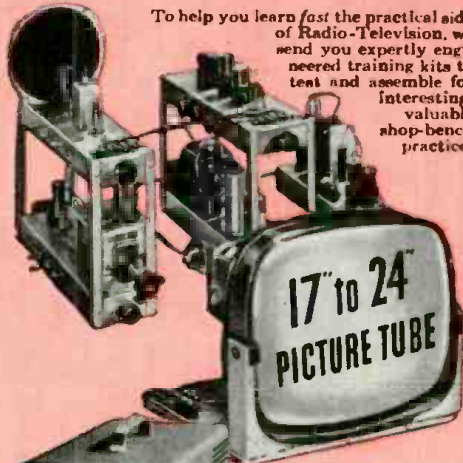

• The new Sprayberry Training Television Receiver, built and tested in 5 sections.

• Now offered . . . this fine modern oscilloscope.

• You build this powerful two-band superheterodyne radio receiver.

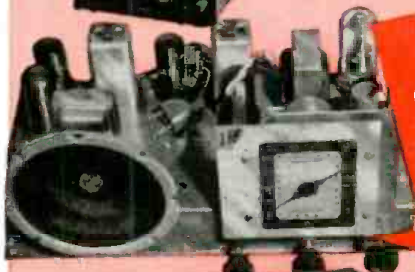

**Big New
CATALOG
AND
Sample Lesson
FREE!**



You build the new Sprayberry tester—a complete 18-range Volt-Ohm-Milliammeter test meter.

★ ★ ★ ★ This great industry is begging for trained men . . . to step into good paying jobs or a profitable business of their own! Our new plan opens the doors of Radio-Television wide to every ambitious man who is ready to act at once!

Men by the thousands . . . trained Radio-Television Service Technicians . . . are needed at once! Perhaps you've thought about entering this interesting, top paying field, but lack of ready money held you back. Now—just \$6 enrolls you for America's finest, most up to date home study training in Radio-Television! Unbelievable? No, the explanation is simple! We believe Radio-Television *must* have the additional men it needs as quickly as possible. We are willing to do our part by making Sprayberry Training available for less money down and on easier terms than ever before. This is your big opportunity to get the training you need . . . to step into a fine job or your own Radio-Television Service Business.

Complete Facts Free—Act Now; Offer Limited

Only a limited number of students may be accepted on this liberal and unusual basis. We urge you to act at once . . . mail the coupon below and get complete details plus our big new catalog and an actual sample lesson—all free. No obligation . . . no salesman will bother you.

HOME STUDY TRAINING IN SPARE TIME

Under world-famous 27-year old Sprayberry Plan, you learn entirely at home in spare time. You keep on with your present job and income. You train as fast or as slowly as you wish. You get valuable kits of parts and equipment for priceless shop-bench practice. And everything you receive, lessons and equipment alike, is all yours to keep.

LET US PROVE HOW EASILY YOU CAN LEARN!

Radio-Television needs YOU! And Sprayberry is ready to train you on better, easier terms, than any ambitious man can afford. Just \$6 starts you! Mail coupon today . . . let the facts speak for themselves. You have everything to gain. Let us prove the kind of opportunity that's in store for you!

SPRAYBERRY Academy of Radio-Television
1512 Jarvis Avenue, Dept. 25-E, Chicago 26, Illinois

Mail This Coupon Now—No Salesman Will Call

Sprayberry Academy of Radio-Television
Dept. 25-E, 1512 W. Jarvis Ave., Chicago 26, Ill.

Please rush all information on your ALL-NEW Radio-Television Training Plan. I understand this does not obligate me and that no salesman will call upon me. Include New Catalog and Sample Lesson FREE.

NAME _____ Age _____

ADDRESS _____

CITY _____ ZONE _____ STATE _____

MASTER RECEIVING-PICTURE TUBE SUBSTITUTION GUIDEBOOK by H. Middleton. The popular Receiving Tube Substitution Guidebook* and all four supplements has been reset, expanded and brought up to date in one master book. The original Tube Substitution Guidebooks were considered the most handy and important work books for technicians, engineers and hobbyists—the new Master book is even more valuable. In one Master Book that is easy-to-use the entire range of all radio and television receiving and picture tubes and their substitutions are at your fingertips.

- 5100 Radio and Television Receiving Tube and 825 Picture Tube substitutions are listed in numerical sequence with accompanying wiring instructions showing the original and substitute tube socket illustrations. • features European-American and American-European cross index listing 325 American to European substitutions; 320 European to American tube substitutions.
- special section on ruggedized tubes.

This book is an indispensable tool to any person who designs, assembles or repairs radio, TV or electronic equipment. This book pays for itself almost immediately. A major portion of the first printing has been sold out, you must act now to reserve your copy. Satisfaction guaranteed. #244 — 8½" x 11", only \$7.45.

*For a short time, the original RECEIVING TUBE SUBSTITUTION GUIDE, its three SUPPLEMENTS plus a fourth SUPPLEMENT (ready soon) will be available.

R-L-C COMPONENTS HANDBOOK—David Mark.

An extremely comprehensive coverage of the fundamental components used in radio and electronic equipment. It starts and finishes with the practical approach to the functioning and utility of electronic components without which no electronic device could function. Most component failures can be avoided by properly utilizing basic principles. Resistors, capacitors, inductors, and transformers—are covered. Voltage, temperature, resistance, current, and numerous other electrical characteristics and ratings are explained as well as coding techniques physical details. #227, \$3.50

Completely rewritten—and up-to-date!

HOW TO USE METERS (2nd edition) by John F. Rider & Sol D. Prensny. Engineers, laboratory and service-technicians—everyone who uses meters in their daily work—will find this revised, expanded and modernized version of the fabulously popular original text absolutely indispensable.

Everything that is new in meter instrumentation will be found in this book. For example, in addition to full coverage of the many types of conventional d-c, high frequency a-c and modulated type VTVM, the digital voltmeter is also discussed in full detail. Also covered are the ultra-high impedance electrometer vacuum tube voltmeter; transistor voltmeter and industrial transducers for voltmeters.

Explains in detail the construction and operation of all types of electrical meters to use for making different kinds of measurements in electronic and electrical equipment and industrial applications. Also explains how to make measurements... namely, where to connect the meters. A section is devoted to multi-phase circuit measurements. #144, \$3.90.

FUNDAMENTALS OF RADIO TELEMETRY by Marvin Tepper.

Telemetry makes possible the collection of data on which the improvement of existing rockets, missiles and aircraft is based. This exciting book explains its purpose and explores its techniques. #225, \$2.95.

BASICS OF MISSILE GUIDANCE & SPACE TECHNIQUES by Marvin Hobbs. You can learn and easily understand the fundamentals of the important electronic areas that will contribute to the conquest of space with this two-volume 'picture-book' course. #229, 2 vol., soft covers, \$7.80; #229-H, 2 vols. in one cloth binding, \$9.00.

NOW AVAILABLE

ENCYCLOPEDIA ON CATHODE-RAY OSCILLOSCOPES & THEIR USES (2nd edition) by John F. Rider & Seymour Uslan. The second edition of the extremely useful book—has been expanded to include the new types of oscilloscopes and their applications. It is completely up-to-date!

Whatever your field—geophysics, aviation, automotive, medical research, television, audio, computers, automatic control or any other branch of industrial and communication electronics—you'll find the cathode-ray oscilloscope today's basic instrument.

This 23 chapter (1300 pages) volume covers all construction and operating details of the tube-gun-deflection electrodes—screen; all the circuits used in oscilloscopes with explanations of circuit functions; specifications and schematics of American and foreign oscilloscopes; adjustment and application in all areas of use.

It covers the latest in special purpose cathode-ray tubes, new data on probes, related information on scope photography, pulse measurements, square wave testing #133, 1300 pp., 8½ x 11", \$21.95.

RIDER ANNOUNCES NEW RECEIVING-PICTURE TUBE SUBSTITUTION GUIDEBOOK

... the answer to all tube substitution problems

SHORTWAVE PROPAGATION by Stanley Leinwoll (Radio Frequency and Propagation Mgr.—Radio Free Europe). Of special interest to those concerned with radio communications, this text provides a modern, up-to-the-minute analysis of shortwave propagation. #241, \$3.90.

There are now 33 titles (more to come) in the famous Electronic Technology Series, Edited by Alexander Schure, Ph.D. Have you read these latest releases?

MAGNETISM AND ELECTROMAGNETISM Thorough study of magnetism at the elementary level. Magnetic theory and principles covered at great length. #166-20, \$1.80.

ADVANCED MAGNETISM & ELECTROMAGNETISM. A companion volume to Magnetism & Electromagnetism, this text explores in depth advanced theories of magnetism and magnetic devices. #166-26, \$2.50.

R-F AMPLIFIERS

Excellent discussion of the operation of amplifiers in the r-f portion of the radio frequency spectrum. Design and theory of a wide range of r-f voltage and power amplifiers are covered. #166-27, \$2.40

5 FABULOUS 'PICTURE-BOOK' COURSES

You can learn any electronic subject easily, rapidly at low cost with these 'picture-book' courses.

BASIC ELECTRICITY by Van Valkenburgh, Nooger & Neville, Inc., #169, soft cover, 5 vols., \$10.00; #169H, all 5 vols. in single cloth binding, \$11.50.

BASIC ELECTRONICS by Van Valkenburgh, Nooger & Neville, Inc., #170, soft cover, 5 vols., \$10.00; #170H, all 5 vols. in single cloth binding, \$11.50.

BASIC TELEVISION by Alexander Schure, Ph.D., #198, 5 vols., soft cover, \$10.00; #198H, all 5 vols. in single cloth binding, \$11.50.

BASICS OF DIGITAL COMPUTERS by John S. Murphy, #196, 3 vols., soft cover, \$7.50; #196H, all 3 vols. in single cloth binding, \$8.50.

BASIC AUDIO by Norman Crowhurst, #201, 3 vols., soft covers, \$8.70; #201-H, 3 vols. in one cloth binding, \$9.95.

learn code faster, easier than ever before—

RIDER SOUND-n-SIGHT CODE COURSE

by Lewis Robins & Reed Harris

- applies REINFORCED LEARNING—a psychological principle proved successful by the Armed Forces.
- uses LP records to teach you to hear signal pattern correctly and identify it—how to transmit.
- uses identification cards to teach you the correct letter associated with each signal pattern.
- uses instruction book to speed your progress. ... plus an imaginary instructor (in complete and novice courses) provides correct answers to speed code learning. Many people have learned to receive 5 words per minute within 9½ hours. Eliminates code plateau barrier!

3 INDIVIDUAL COURSES—THERE'S ONE FOR YOU

COMPLETE COURSE (0-20 words per minute)—Six 10" LP records (192 minutes of recording, 46 recordings), 47 cards, book. #REC-020, \$15.95.

NOVICE COURSE (0-8 words per minute)—Three 10" LP records (96 minutes of recording, 28 recordings), 47 cards, book. #REC-08, \$9.50.

ADVANCED COURSE (9-20 words per minute)—Three 10" LP records (96 minutes of recording, 28 recordings), book. #REC-920, \$8.95.

Records prepared in collaboration with the N. Y. Institute of Technology and mfd. by Decca Records. Satisfaction Guaranteed

Other Rider books that add to amateur radio enjoyment are: Getting Started In Amateur Radio; Building The Amateur Radio Station; Radio Operator's License Q & A Manual (6th edition) How To Read Schematics.

Write for Free 1960 Catalog

At your jobber or book store, or order direct, Dept. EW-12



ness is to advocate state laws requiring examination and licensing of anyone wishing to engage in service work. Some states are thinking of requiring repairmen to have a valid commercial license from the FCC, and while I feel this is probably a little too much to be required of service personnel, undoubtedly some form of examination is necessary.

As for destroying the "slave" service organizations, I think the independent service associations represent the best means of accomplishing this. The slave service company, generally speaking, represents only a small portion of the over-all revenue of the parent company. If these companies were forced to choose between giving up their slave service organizations and loss of a much more significant portion of their total revenues, they would probably let the service business go.

Good luck and continuing success in your fight for better service by independent service companies.

EUGENE F. LUCAS
Duluth, Minnesota

We are always glad to have our readers let us know of their reactions to the material that we use. Most of the points made have already been covered and will continue to appear in the various departments and articles of our publication.—Editors. —30—

READER SURVEY ON OUR TEST RECORD

WE HAVE just completed a reader survey of a large sampling of purchasers of our stereo-monophonic test record. The editors were extremely gratified to learn that about 95 per-cent of those replying found the record well planned, well executed, and well worth the nominal charge made.

Most of those who did not reply favorably complained that the record arrived either badly warped or broken. To remedy this, we took immediate steps to improve the packaging of the disc in order to minimize the possibility of warping or breakage. Some purchasers felt that the surfaces were somewhat noisy. This may have been due to the rather low level at which the disc was recorded in order to get a good 15-ke. signal on the 7-inch disc. Actually the best grade of virgin vinyl was used so that the surface noise should be no greater than any other high-quality disc. A few complained that their record changers would not track the grooves properly. We actually tried several changers out and had no difficulty, especially with the units adjusted for manual playing. One suggestion is to temporarily increase the tracking pressure by placing a coin on top of the pickup head while playing the record.

Finally, some of the purchasers felt that, although the instruction sheet was adequate, some additional information on the use of the test record would have been helpful. We would like to remind you that an article "Making & Using a Stereo Test Record" on page 56 of our May, 1959 issue contains just this type of information. We strongly suggest that this article be reviewed for additional help in the methods of using the test disc. —30—

JOHN F. RIDER PUBLISHER, INC. 116 West 14th Street, New York 11, N. Y.
Canada: Chas. W. Pointon, Ltd., 66 Racine Rd., Rexdale, Ont.
Europe & British Isles: Chapman & Hall Ltd., 37 Essex St., London (India: Asia Publishing House, Bombay and other cities)



LET RCA TRAIN YOU IN ELECTRONICS

RCA Institutes celebrates Fifty Years of Electronic Training by introducing its newest Home Study Course . . .

ELECTRONICS FOR AUTOMATION

. . . Now you have *four* comprehensive courses for your electronic training . . . from basic electronic theory to the more advanced principles of color TV and Automation.

Electronic Fundamentals



Electronics for Automation

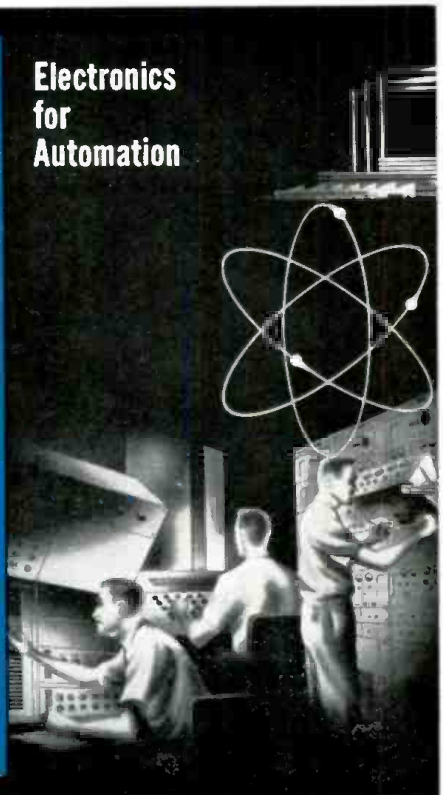

Television Servicing

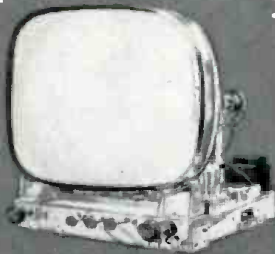

Color Television

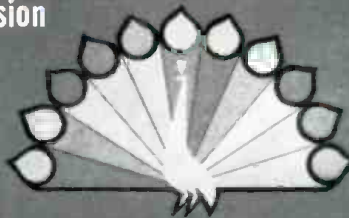

Send for our 64 page Home Study Catalog

FREE!

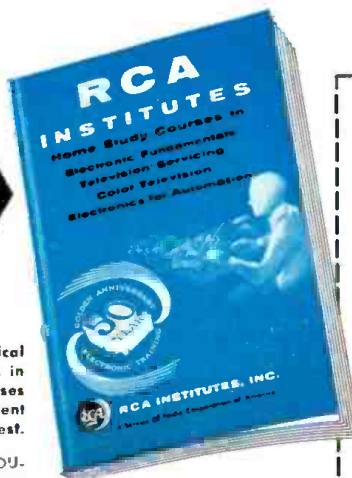

RESIDENT SCHOOL offers Technical Institute and Vocational Courses in Electronics. Day and Evening classes start 4 times each year. Resident School Catalog sent free on request.

ANOTHER WAY RCA SERVES EDUCATION THROUGH ELECTRONICS.

December, 1959

Practical work with the very first lesson. Pay-as-you-learn. You need pay for only one study group at a time.

RCA INSTITUTES, Inc. Home Study School, Dept. EW-129

A Service of Radio Corporation of America

350 West Fourth Street, New York 14, N. Y.

Without obligation, send me the FREE catalog of Home Study Courses. No salesman will call.

Name Please print

Address

City..... Zone..... State.....

Korean Vets! Enter Discharge Date.....

CANADIANS — Take advantage of these same RCA courses at no additional cost. No postage, no customs, no delay. Send coupon to: RCA Victor Company, Ltd., 5001 Cote de Liesse Rd., Montreal 9, Quebec

To save time, paste coupon on postcard.

CBS LABORATORIES LEADER IN RESEARCH AND DEVELOPMENT

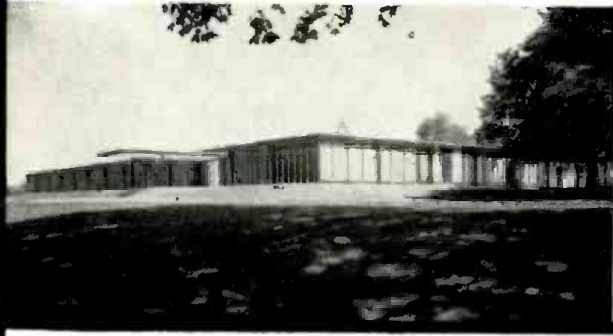

Pioneered in the creation of a practical color television system
 Put on the air the world's first color TV broadcast
 Developed airborne, guidance and electronic countermeasure systems
 Produced revolutionary color television microscope
 Co-operated with CBS Electronics in engineering improved electron guns and screens for color TV
 Designed closed-circuit color TV for medical use
 Also a leader in acoustics, recording, solid state physics, semiconductor, vacuum tube and advanced electronic systems research and development

CBS Laboratories, Stamford, Conn.

CBS ELECTRONICS LEADER IN TUBE QUALITY AND DEVELOPMENT

Producers of receiving tubes top-rated by leading radio and TV set makers
 Manufactured first practical color picture tube, CBS-Colortron
 Introduced first Bantam GT receiving tubes
 Originated first Bantam Jr. subminiature tubes
 Pioneered the first rectangular picture tube
 Designed first receiving tubes rated for Continuous Television Service

CBS Electronics, Danvers, Mass.



CBS DIVISIONS WORK TOGETHER FOR YOU...

The CBS family habit of being first helps guarantee you the quality of performance that only leadership can deliver. This leadership is your further assurance that:

- CBS tube quality cuts your call-backs.
- CBS tube quality insures your customers of dependable performance.
- CBS tube quality guarantees profits for you.

Ask for the leader with the top-rated name your customers know and trust. Ask first for CBS.



CBS ELECTRONICS

Danvers, Massachusetts
 Electronic manufacturing division of
 Columbia Broadcasting System, Inc.

*Receiving, industrial and
 picture tubes • transistors and diodes •
 audio components • and phonographs*

Learn Radio-TV Electronics

*by Practicing
at Home in
Spare Time*

**Without Extra
Charge You Get**

special NRI kits developed to give actual experience with Radio-TV equipment. You build, test, experiment with receiver or broadcasting circuits. All equipment yours to keep.



Have High Pay, Prestige, Good Future as a Skilled Radio-TV Electronic Technician

People look up to and depend on the Technician, more than ever before. Offices, plants, homes everywhere are obliged to buy his knowledge and services. His opportunities are great and are increasing. Become a Radio-TV Electronic Technician. At home, and in your spare time, you can learn to do this interesting, satisfying work—qualify for important pay. To ambitious men everywhere here in the fast growing Radio-TV Electronic field is rich promise of fascinating jobs, satisfaction and prestige as well as increasing personal prosperity.

Increasing Opportunities in Growing Field

A steady stream of new Electronic products is increasing the job and promotion opportunities for Radio-Television Electronic Technicians. Right now, a solid, proven field of opportunity for good pay is servicing the tens of millions of Television and Radio sets now in use. Color TV, Hi-Fi is growing. The hundreds of Radio and TV Stations on the air offer interesting jobs for Operators and Technicians.

More Money Soon—Make \$10 to \$15 a Week Extra Fixing Sets in Spare Time

NRI students find it easy and profitable to start fixing sets for friends and neighbors a few months after enrolling. Picking up \$10, \$15 and more a week gives substantial extra spending money. Many who start in spare time soon build full time Radio-Television sales and service businesses—enjoy security.

Act Now—See What NRI Can Do for You

NRI has devoted over 40 years to developing simplified practical training methods. You train at home in spare time. Get practical experience, learn-by-doing.
NATIONAL RADIO INSTITUTE
Washington 16, D.C.



NRI Has Trained Thousands for Successful Careers in Radio-TV



Studio Engr., Station KATV
"I am now Studio Engineer at Television Station KATV. Before enrolling, I was held back by limitation of a sixth grade education." **BILLY SANCHEZ**, Pine Bluff, Ark.

Has All the Work He Can Do
"I have repaired more than 2,000 TV and Radio sets a year. NRI training certainly proved to be a good foundation." **H. R. GORDON**, Milledgeville, Georgia.

Has Good Part Time Business
"Early in my training I started servicing sets. Now have completely equipped shop. NRI is the backbone of my progress." **E. A. BREDA**, Tacoma, Washington.

▶▶▶▶ **SEE OTHER SIDE** ▶▶▶▶

Cut Out and Mail This Card—No Stamp Needed

Sample Lesson and Catalog Both Sent FREE

OLDEST & LARGEST HOME STUDY RADIO-TV SCHOOL
National Radio Institute
Dept. F, Washington 16, D.C.

Please send me sample lesson of your Radio-Television Training and Catalog FREE. (No salesman will call.)

Name..... Age.....

Address.....

City..... Zone..... State.....

ACCREDITED MEMBER NATIONAL HOME STUDY COUNCIL

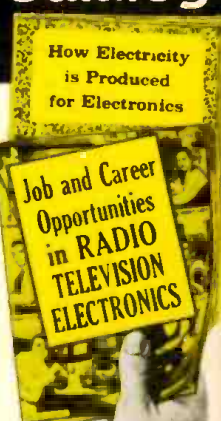

How Electricity
is Produced
for Electronics

NRI SUPPLIES LEARN-BY-DOING KITS WITHOUT EXTRA CHARGE
Technical Know-How Pays Off in Interesting, Important Work



YOU BUILD AC-DC Superhet Receiver

NRI Servicing Course includes all needed parts. By introducing defects you get actual servicing experience practicing with this modern receiver. Learn-by-doing.



YOU BUILD This 17 Inch Television Receiver

As part of your NRI course you can get all components, tubes, including 17" picture tube, to build this latest style Television receiver; get actual practice on TV circuits.

YOU BUILD Broadcasting Transmitter

As part of NRI Communications Course you build this low power Transmitter, learn commercial broadcasting operators' methods, procedures. Train for your FCC Commercial Operator's License.

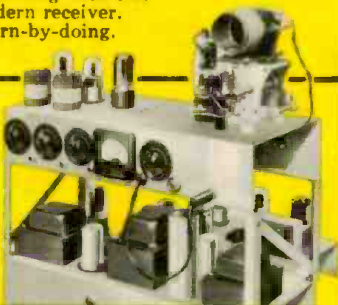

YOU BUILD Vacuum Tube Voltmeter

Use it to earn extra cash fixing neighbors' sets; bring to life theory you learn from NRI's easy-to-understand texts.



For Higher Pay, Better Jobs
Be a Radio-TV Electronic Technician



Servicing Needs More Trained Men

Portable TV, Hi-Fi, Transistor Radios, Color TV are making new demands for trained Technicians. Good opportunities for spare time earnings or a business of your own.



J. E. Smith, Founder

Train at Home the NRI Way Famous for Over 40 Years

NRI is America's oldest and largest home study Radio-Television school. The more than 40 years' experience training men for success, the outstanding record and reputation of this school—benefits you in many ways. NRI methods are tested, proven. Successful graduates are everywhere, from coast to coast, in small towns and big cities. You train in your own home, keep your present job while learning. Many successful NRI men did not finish high school. Let us send you an actual lesson, judge for yourself how easy it is to learn.

Broadcasting Offers Satisfying Careers

4000 TV and Radio stations offer interesting positions. Govt. Radio, Aviation, Police, Two-Way Communications are growing fields. Trained Radio-TV Operators have a bright future.

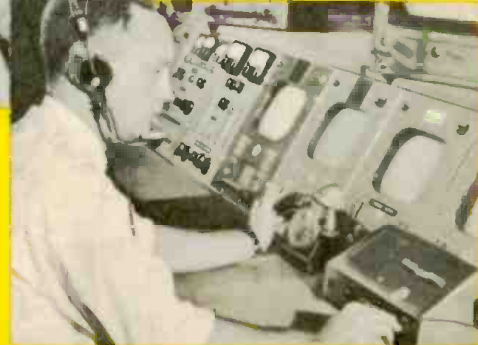

No Experience Necessary—NRI Sends Many Kits for Practical Experience

You don't have to know anything about electricity or Radio to understand and succeed with NRI Course. Clearly written, well-illustrated NRI lessons teach Radio-TV Electronic principles. You get NRI kits for actual experience. All equipment is yours to keep. You learn-by-doing. Mailing the postage-free card may be one of the most important acts of your life. Do it now. Reasonable tuition. Low monthly payments available. Address: NATIONAL RADIO INSTITUTE, Washington 16, D. C.

NRI Graduates Do Important Work



Now Quality Control Chief
 "Had no other training in Radio before enrolling, obtained job working on TV amplifiers before finishing course. Now Quality Control Chief." T. R. FAVAZZO, Norwich, N. Y.

NRI Course Easy to Understand
 "I opened my own shop before receiving my diploma. I have had to hire extra help. I am independent in my own business." D. P. CRESSEY, Stockton, Cal.

Works on Color-TV
 "NRI changed my whole life. If I had not taken the course, probably would still be a fireman, struggling along. Now Control Supervisor at WRCA-TV." J. F. MELINE, New York, N. Y.

FIRST CLASS
 Permit No. 20-R
 (Sec. 34.9, P. L. & R.)
 Washington, D.C.

BUSINESS REPLY CARD
 No Postage Stamp Necessary if Mailed in the United States

POSTAGE WILL BE PAID BY
NATIONAL RADIO INSTITUTE
 3939 Wisconsin Avenue
 Washington 16, D.C.

SAMPLE LESSON
64-page CATALOG
both FREE

SEE OTHER SIDE

General Electric's all-new VR-22 Stereo Cartridge

try it in your own home

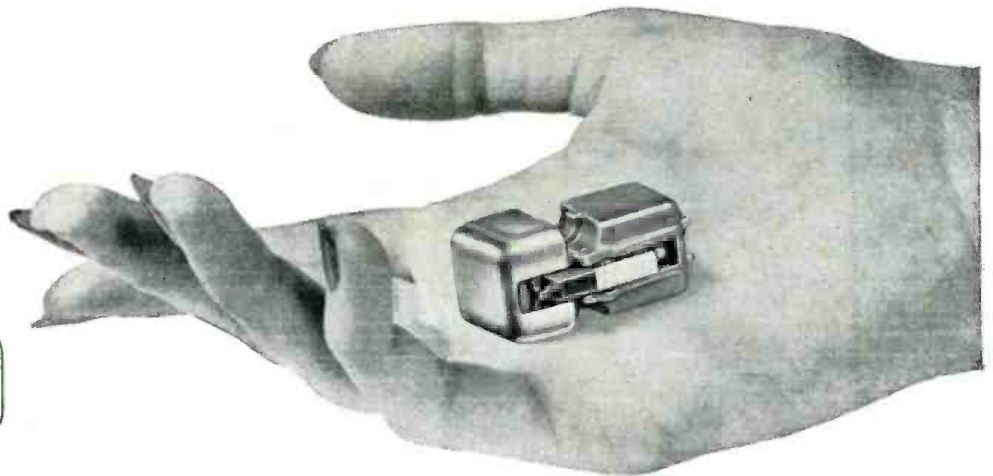

money-back guarantee!

We believe that once you hear General Electric's all-new VR-22 in the privacy of your own home, on your own equipment, you'll want to have this superb stereo cartridge for your very own.

We're so sure of it, in fact, that we are making you an offer virtually without precedent in the Hi-Fi field: Try the VR-22 at home for 10 days. If you don't agree that this is *the* stereo cartridge for you, bring it back and the full purchase price will be cheerfully refunded. You have nothing to lose and a whole new world of enjoyment to gain! See your participating General Electric Hi-Fi dealer.

The VR-22 is outstanding in all four critical areas of stereo cartridge performance: *Channel separation—Response—Freedom from hum—Compliance.*

VR-22-5 with .5 mil diamond stylus for professional quality tone arms, **\$27.95***. VR-22-7 with .7 mil diamond stylus for professional arms and record changers, **\$24.95***. TM-2G Tone Arm—designed for use with General Electric stereo cartridges as an integrated pickup system, **\$29.95***. General Electric Co., Audio Components Products Section, Auburn, N. Y.

*Manufacturer's suggested resale prices.

Acclaimed
by the
experts!



Oliver P. Ferrell
Editor
Hi-Fi Review
as quoted
in issue
of Aug. 1959

"... the VR-227 is a top performer. The frequency response is as flat as any cartridge tested to date. Channel-to-channel separation in the vital area between 700 cycles and 8000 cycles was equal to the very best stereo cartridges now offered the public."



Wm. A. Stocklin
Editor
Electronics World
as quoted
in issue
of Sept. 1959

"... listening tests did not show up any flaws. Frequency response from 30 to 15,000 cps (limits of our test) was within 2.25 db of flat. Provides about the best channel separation available of any checked with the exception of [cartridge selling for \$65.00] in the frequency range from about 5000 to 9000 cps."



C. G. McProud
Editor
Audio
as quoted
in issue
of Sept. 1959

"... is even better than its predecessor with respect to output, channel separation and extended frequency response and the two channels balance within ± 2 db to 15,000 cycles. The shielding has been improved and the grounding of the shield and the method of shorting the two 'ground' terminals are well thought out."

GENERAL  ELECTRIC

NOW! A down-to-earth guide to MODERN TEST PROCEDURES

Alternate Test Methods • Cautions • Correct Instrument Usage • Readings • Connections and Control Settings • Test Techniques • Time-Saving Methods ... and all the rest!



Almost anyone can repair TVs, radios and other electronic equipment AFTER the trouble has been located. The trick is to know how to spot troubles in the first place—and that means knowing how to use instruments fast and accurately. Actually, it's amazing what you can do with only a few instruments—providing you know how to use different kinds for the same job; how to select the right ones; where to use them; how to connect them into circuits; how to set controls; how to read them; and how to follow professional test procedures every step of the way. And that's exactly what this new 316-page book with its more than 190 how-to-do-it pictures, procedure sketches and pattern designs teaches you.

IT'S WHAT YOU KNOW ABOUT USING INSTRUMENTS THAT COUNTS!

BASIC ELECTRONIC TEST PROCEDURES by Rufus Turner helps you learn to troubleshoot any circuit, equipment or component in half the usual time. Covers different methods of doing specific jobs. For instance, you learn to check distortion by the scope, rejection filter, harmonic-distortion meter, wave analyzer or audio oscillator methods. You learn to make resistance measurements with a current-meter, a volt-ammeter, a volt-meter, an ohmmeter, or via the bridge method . . . and so on.

Subjects include current checks; power, capacitance, inductance, resistance, A.F. R.F. phase, distortion, and modulation measurements; tube and semi-conductor testing; audio amplifier tests; sensitivity, RF gain, fidelity, AVC voltage, operating voltage checks, etc.; visual alignment techniques—even transmitter and industrial electronic measurement procedures. Price only \$6.50.

CONSIDER OSCILLOSCOPES for instance!

Simplified explanations of modern oscilloscope techniques show how to use your 'scope as a volt-meter, current meter, variable frequency oscillator, etc., or for making RF, phase or AM measurements; for distortion and deflection checking; square wave testing; visual AM and FM alignment and for many other jobs. Every detail is explained—from making connections, to adjusting controls and analyzing patterns.

STILL ANOTHER BIG FEATURE is the book's usefulness in acquainting you with industrial electronic test techniques—including testing non-electronic phenomena such as strain, pressure, etc.

PRACTICE 10 DAYS . . . FREE!

Dept. RN-129, RINEHART & CO., INC.
232 Madison Ave., New York 16, N. Y.

Send BASIC ELECTRONIC TEST PROCEDURES for 10-day FREE EXAMINATION. If I decide to keep book, I will then send you \$6.50 plus a few cents postage in full payment. If not, I will return book postpaid and owe you nothing. (SAVE! Send \$6.50 with your order and Rinehart pays the postage. Same 10-day guarantee with your money promptly refunded if you're not more than satisfied with book.)

NAME.....

ADDRESS.....

CITY, ZONE, STATE.....

OUTSIDE U.S.A.—Cash with order only. Price \$7.00. Money back if book is returned in 10 days.

Within the Industry

ARTHUR JAMES WARNER has been appointed manager of research and engineering of *Aerovox Corporation*, New Bedford, Mass.



Mr. Warner graduated from London University in 1936 and from this date to 1957 he worked on problems in the materials and components field for various subsidiaries of the *International Telephone and Telegraph Corporation* both in Europe and the United States. His most recent appointment in the United States was that of a technical director of *Federal Telecommunication Laboratories*.

Mr. Warner returned to this county as a consultant in the electrical-electronic field and began his services with the capacitor firm in August, 1959.

ELECTRONIC INDUSTRY ASSOCIATION's sponsored quarter-hour TV film entitled, "The Mighty Electron" has been released by the National Association of Manufacturers for broadcasting in its "Industry On Parade" series over 270 TV stations throughout the United States and 42 stations overseas.

The film covers all major facets of the electronic industry including military, consumer goods, and industrial uses of electronics. It also covers TV in education, as exemplified by the Hagerstown, Md. experiment; electronics in medicine as viewed at Walter Reed Army Medical Center in Washington, D. C.; and the vital role of electronics in space exploration.

As the telecasts are on a "public service" basis, the date of showing is at the discretion of the telecaster. However, the films are customarily shown at the same time each week and, in some instances, are repeated.

WALTER WARE SLOCUM has been named president of *International Resistance Company*. He succeeds Charles Weyl, who now becomes chairman of the board of directors.



Mr. Slocum was formerly associated with *Daystrom, Inc.* where he headed several divisions at various times and was also vice-president in charge of operations. Before joining the firm he was president of his own firm of management consultants, *W. W. Slocum and Company*, for ten years.

A graduate mechanical engineer holding a degree from the University of Pennsylvania, Mr. Slocum is a reg-

istered professional engineer in fourteen states. He is a member of numerous business and professional organizations, including American Society of Mechanical Engineers, American Society of Naval Engineers, and Sigma Tau, the honorary professional fraternity.

JAMES J. LAMB is the recipient of the Merit Award of the American Radio Relay League for 1959. The award was presented for Mr. Lamb's significant contributions to the welfare of amateur radio.

An engraved gold plaque mounted on walnut is inscribed: "For his contribution to amateur communication techniques, especially in the development of methods for achieving high selectivity and noise reduction in radio reception."

ALLEN SNYDER has been named advertising and sales promotion manager, semiconductor products division, *Motorola Inc.*



In his new position Mr. Snyder will direct the advertising and sales promotion program for the division's complete line of products.

Mr. Snyder was formerly supervisor of promotional services with the firm's communication and industrial electronics division. Prior to joining the company, he had seven years of editorial and sales promotion experience with the *Minneapolis-Honeywell Regulator Co.*, *Putnam Publishing Co.*, and *Cherry-Burrell Corporation*.

JOHN H. SKEHAN, JR. has been appointed manager of sales training for *Sylvania Electric Tubes*, a division of *Sylvania Electric Products Inc.* . . .

FRED M. FARWELL has assumed the newly created corporate staff position of vice-president, marketing, *RCA* . . .

RICHARD E. KRAFVE has been elected executive vice-president of the *Raytheon Company* . . . *CBS Electronics* has named **GEORGE A. WILDE** semiconductor sales engineer . . . **STANLEY ROSENBERG** has been elected chairman of the board and chief financial officer of *Telectro Industries Corp.* . . . **MURRAY WILNER** has been appointed director of purchasing of *Crosby Electronics, Inc.* . . . *Shure Brothers, Inc.* has announced the appointment of **ROBERT W. CARR** as manager of the microphone development department . . . **JOHN F. PARYZEK** is now director of public relations at *Designers for Industry* . . . *Amplex Corporation* has announced the appointment of five new vice-presidents: **JOHN JIPP**, **NEAL K. McNAUGHTEN**, **HERBERT**

NOW!
at a price
you can afford!

MAKE MORE MONEY in TELEVISION RADIO-ELECTRONICS

**BETTER...MORE COMPLETE...LOWER COST...
WITH NATIONAL SCHOOLS SHOP-METHOD
HOME TRAINING!**

BETTER... Training that is proved and tested in Resident School shops and laboratories, by a School that is the **OLDEST** and **LARGEST** of its kind in the world.

MORE COMPLETE... You learn **ALL PHASES** of *Television-Radio-Electronics*.

LOWER COST... Other schools make several courses out of the material in our **ONE MASTER COURSE**... and you pay more for less training than you get in *our course* at **ONE LOW TUITION!**

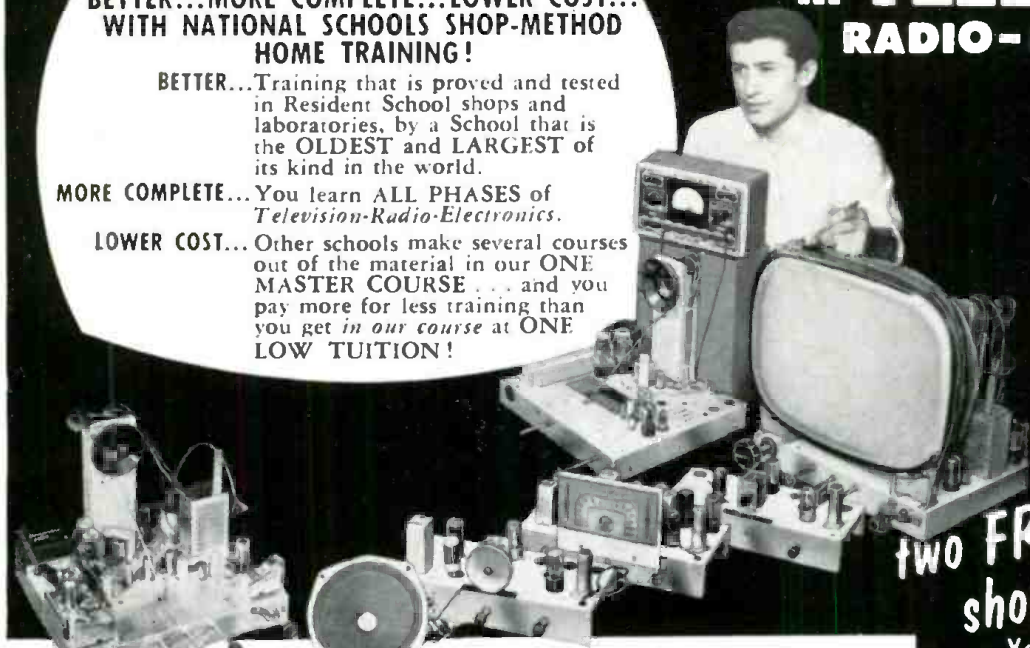

These **FREE** books will show you how!

You get all information by mail... You make your own decision... at home! **NO SALESMAN WILL CALL**

TOP PAY... UNLIMITED OPPORTUNITIES LIFETIME SECURITY CAN BE YOURS!

You are needed in the Television, Radio, and Electronics industry! Trained technicians are in growing demand at excellent pay—in **ALL PHASES**, including Servicing, Manufacturing, Broadcasting and Communications, Automation, Radar, Government Missile Projects.

NATIONAL SCHOOLS SHOP-METHOD HOME TRAINING, with newly added lessons and equipment, trains you in your spare time at home, for these unlimited opportunities, including many technical jobs leading to supervisory positions.

YOU LEARN BY BUILDING EQUIPMENT WITH KITS AND PARTS WE SEND YOU. Your National Schools course includes thorough *Practical* training—**YOU LEARN BY DOING!** We send you complete standard equipment of professional quality for building various experimental and test units. You advance step by step, perform more than 100 experiments, and you build a complete TV set from the ground up, that is yours to keep! A big, new TV picture tube is included at no extra charge.

EARN AS YOU LEARN. We'll show you how to earn extra money right from the start. Many of our students pay for their course—and more—while studying. So can you!

LESSONS AND INSTRUCTION MATERIAL ARE UP-TO-DATE, PRACTICAL, INTERESTING. Every National Schools Shop-Method lesson is made easy to understand by numerous illustrations and diagrams. All instruction material has been developed and tested in our own Resident School Shops, Laboratories and Studios.

SEND FOR INFORMATION TODAY... it can mean the difference between **SUCCESS** and failure for you! Send for your **FREE BOOK** "Your Future in Television-Radio-Electronics" and **FREE Sample Lesson.** Do it **TODAY**, while you are thinking about your future. It doesn't cost you anything to investigate!

GET THE BENEFITS OF OUR OVER 50 YEARS EXPERIENCE

Approved for
GI Training



NATIONAL SCHOOLS

Los Angeles 37, Calif.

YOU GET...

- 19 Big Kits—**YOURS TO KEEP!**
- Friendly Instruction and Guidance
- Job Placement Service
- Unlimited Consultation
- Diploma—Recognized by Industry
- **EVERYTHING YOU NEED FOR SUCCESS!**

**SHOP-METHOD HOME TRAINING
COVERS ALL PHASES OF INDUSTRY**

1. Television, including Color TV
2. Radio AM & FM
3. Electronics for Guided Missiles
4. Sound Recording and Hi-Fidelity
5. FCC License
6. Automation and Computers
7. Radar & Micro-Waves
8. Broadcasting and Communications

NATIONAL TECHNICAL SCHOOLS

WORLD-WIDE TRAINING SINCE 1905

MAIL NOW TO

NATIONAL SCHOOLS, Dept RH-129
4000 S. FIGUEROA ST. LOS ANGELES 37, CALIF.

Rush free TV-Radio "Opportunity" Book and sample lesson. No salesman will call.

NAME _____ AGE _____

ADDRESS _____

CITY _____ ZONE _____ STATE _____

Check if interested **ONLY** in Resident School training at Los Angeles

VETERANS: Give date of Discharge _____

RESIDENT TRAINING AT LOS ANGELES

If you wish to take your training in our Resident School at Los Angeles, the world's TV capital, start **NOW** in our big, modern Shops, Labs and Radio-TV Studios. Here you work with latest Electronic equipment - - professionally installed - - finest, most complete facilities offered by any school. Expert, friendly instructors. Personal attention. Graduate Employment Service. Help in finding home near school - - and part time job while you learn. Check box in coupon for full information.

ELECTRONIC TECHNICIANS
AND INSTRUCTORS—

*You Can
Realize
Your Full
Professional
Potential
with
Burroughs*



Advance your career in the most critical field of tomorrow: integrated DATA PROCESSING for military weapons systems at BURROUGHS, Military Field Service Division. Participate in challenging work on important long range ATLAS and SAGE programs.

You can qualify as TECHNICIAN if you are a graduate of an accredited technical school and/or have military training in radar or communications equipment, plus at least 2 years' experience in electronics. You will receive 8 to 22 weeks of classroom training in Data Processing Systems at full salary. Current field assignments include far-West and Western areas after your training is completed.... You can qualify as INSTRUCTOR if you have a knowledge of electronics theory and some related teaching experience. Work involves the training of technical personnel in the installation, maintenance and repair of electronic and/or electro-mechanical equipment.

The above positions carry these exceptional benefits: 1) Advancement based on individual performance. 2) Starting salary commensurate with experience and ability. 3) Merit review program. 4) Outstanding group insurance and retirement plan. 5) Generous educational assistance program. Inquiries are invited from qualified candidates. Please write Mr. R. F. Johnson, Dept. 2378, Burroughs Corporation, Military Field Service Division, Burroughs Drive, Radnor, Pa. (a suburb of Philadelphia).



Burroughs Corporation
"NEW DIMENSIONS/in computation for military systems"

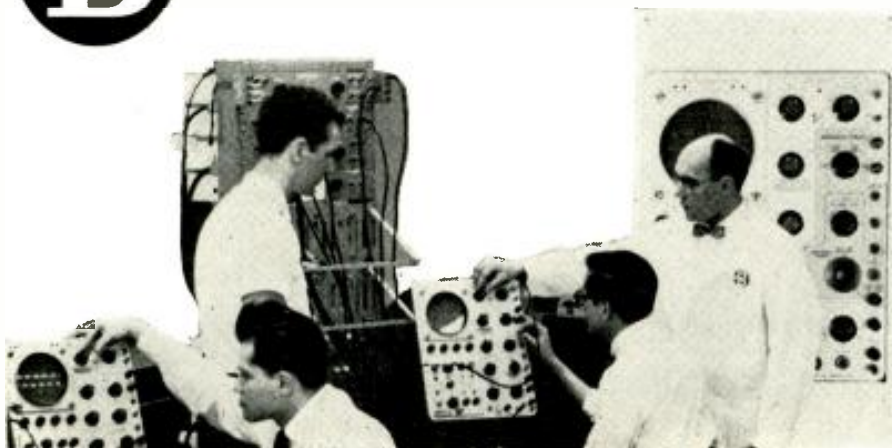

L. BROWN, JOHN M. LESLIE, JR., and WALTER T. SELSTED . . . DR. ROBERT C. LANGFORD, chief engineer for research and development, *Weston Instruments Division of Daystrom, Inc.* has been elected chairman of the newly formed instrumentation division of the American Institute of Electrical Engineers in New York . . . **WILLIS DITMANSON** has been named national parts and service manager for *Motorola Communications & Electronics, Inc.* . . . **JOHN B. O'DONNELL** is now distributor sales manager of the *Solu Electric Co.* . . . The semiconductor division of *Sylvania Electric Products Inc.* has announced the appointment of **DONALD E. SMITH** to the newly created position of product sales manager.

* * *

GEORGE HILDEBRAND has been appointed administrator, micromodule and rectifier sales. *RCA* semiconductor and materials division.



Mr. Hildebrand joined the firm as an engineering trainee in 1949 and a year later became an applications engineer with the tube department. In 1952 he was appointed a field engineer in the eastern equipment sales district and in 1955 was named equipment sales manager of the tube department in Montreal, Canada.

Mr. Hildebrand was transferred to the semiconductor and material division in 1957 as a field engineer and since 1958 has been coordinator of field engineering.

* * *

CHICAGO-STANDARD TRANSFORMER CORP. has established an Eastern warehouse at 431-435 Greenwich St., New York City . . . **CLEVITE TRANSISTOR PRODUCTS**, division of the *Clevite Corp.*, has established a New York district office at 338 Northern Blvd., Great Neck, Long Island . . . **SYLVANIA ELECTRIC PRODUCTS INC.** has announced plans for construction of a 32,000 square-foot computer component manufacturing plant on a 26-acre site in Santa Cruz, Calif. . . . **HUDSON RADIO & TV CORP.** will open five new high-fidelity centers in each of the stores owned by *Masters, Inc.* In addition, an expansion program is planned involving the firm's industrial division . . . **RCA** will build a 100,000 square-foot addition to its Devcens plant in Moorestown, N. J. . . . **TRANSISTOR DEVICES INC.** and **INSTRUMENT MASTERS INC.** are now located at 626 Schuyler Ave., Kearney, N. J. . . . **MAGNAVOX COMPANY** has started construction of its new multi-million dollar research center at Torrance, Calif. . . . **RCA** is planning a major expansion of transistor and rectifier manufacturing facilities which calls for the construction of a 120,000 square-foot plant in Mountaintop, Pa.

* * *

S. R. MILHALIC, *General Electric Company*, has been re-appointed chairman of the service committee of the Electronic Industries Association. E. W. (Continued on page 102)

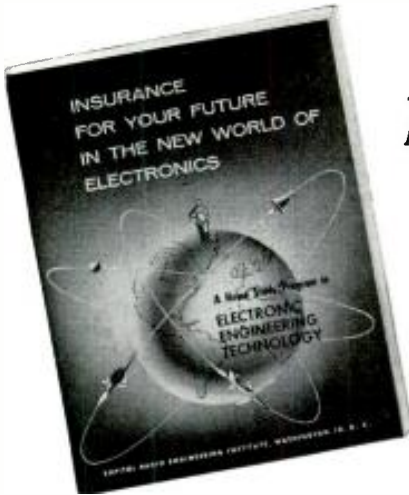

The data that
**Launched Thousands
of Careers**
is yours **FREE** } tells how
**you can be
successful in
ELECTRONICS**

Automation . . . Instrumentation . . . Industrial Electronics
. . . Aeronautical Electronics . . . Guided Missiles . . . Radar
. . . Servomechanisms . . . Computers . . . Astronautics . . .
Telemetering . . . Communications . . . Manufacturing

Send for your Free Copy today!

This is a brand new edition of the book which has launched thousands of men on good-paying careers in electronics.

It brings you completely up to date—answers important questions on newest career developments in electronics, including Automation, Instrumentation, Industrial Electronics, Aeronautical Electronics, Guided Missiles, Radar, Servomechanisms, Computers, Astronautics, Telemetering, Communications and Manufacturing.

This book, "Insurance for Your Future in the New World of Electronics," also shows you how CREI Home Study leads the way to greater earnings in the booming electronics world.

However, CREI does not promise you a "snap." With accredited technical school curricula such as CREI offers, you must study to convert your ambition into technical knowledge which you can sell in the fabulous field of Electronics. Since its founding in 1927, CREI has provided thousands of professional electronics men with technical education. During World War II, CREI trained thousands for the Armed Services. Leading firms recommend CREI home study courses for their own personnel. Among them: United Air Lines, Canadian Broadcasting Corporation, National Broadcasting Co., Florida Power and Light Co., The Martin Co., Columbia Broadcasting System, All-America Cables and Radio, Inc., Gates Radio Co., Canadair, Ltd., Federal Electric Corp., and U. S. Information Agency (Voice of America).

CREI courses are prepared by recognized experts, in a practical, easily understood manner, and constantly revised to meet the new electronic challenges of our time. You get the benefit of time-tested study assignments under the personal supervision of a CREI staff instructor. Your studies are accomplished on your own time, during hours selected by you, and controlled by your own willpower. This complete education is the reason that graduates find their CREI diplomas keys to success in even the most advanced of electronic applications. CREI alumni hold top positions in America's leading firms. At your

service is the CREI Placement Bureau, which maintains constant contact with electronic industry, and cooperates with employers and graduates in making satisfactory placements. This free service is available to students, as well as graduates. Fill out the coupon below *completely* and mail it now. We'll promptly send you your free copy of "Insurance for Your Future in the New World of Electronics." The rest—your future—is up to you!

**ELECTRONIC
TECHNICIANS**

Lowing Peninsula Co. has openings for 1st class electronic technicians to work directly with engineering in development of new products. Only those with CREI or equal training and 3 years minimum commercial experience will be considered. Top salaries to qualified applicants. Call Mr. McQueeney, A. 4-4733 for appointment. LTO SCIENTIFIC Co., Inc. 855 COMMERCIAL ST. PALO ALTO

**ENGINEERING
AIDES
AND
TECHNICIANS**

Immediate Positions Available

C.R.E.I. or other forms of electronic training desirable.

Experienced in reading schematics, breadboard construction of electronic circuits and chassis preparation.

**EMERSON
RESEARCH
LABORATORIES**

CREI ALSO OFFERS residence courses in Washington, D. C. . . . at the same high technical level. Day and evening classes start at regular intervals. Qualified residence school graduates earn degree as "Associate in Applied Science." If you have had a high school education, and experience in electronics—you can qualify for a CREI home study course. (Electronics experience is not required for admission to CREI Residence School.) Check and mail coupon if you prefer residence or home study information . . . or write Capitol Radio Engineering Institute, Dept. 1112F1, 3224-16th St., N.W., Wash. 10, D. C.

INDUSTRY CALLS FOR CREI BY NAME . . . SO SHOULD YOU!

Here you see actual help wanted ads—one from a San Francisco newspaper, another seen in Washington. They are just two of many which specify, "CREI or equal" education. This shows that industry approves CREI education, even insists on it. Experience has taught many, many companies that CREI students are taught what industry needs and wants them to know. Let this be your cue when you choose your educational program.

BRAND-NEW COURSE ADDED . . . AUTOMATION AND INDUSTRIAL ELECTRONICS ENGINEERING TECHNOLOGY. Complete course, covers all electronic phases of automation, Special emphasis on theory, functioning, and applications of servomechanisms and computers. Also noteworthy: Lessons on machine control, instrumentation, data-processing, and telemetry.

MAIL TODAY FOR YOUR FREE 54-PAGE BOOK

CAPITOL RADIO ENGINEERING INSTITUTE
 ECPD Accredited Technical Institute Curricula—Founded 1927
 Dept. 1112F 3224 Sixteenth St., N.W., Washington 10, D. C.

Please send me your course outline and FREE 54-page Book, "Insurance for Your Future in the New World of Electronics" . . . describing opportunities and CREI Home Study courses in Practical Electronic Engineering Technology.

CHECK FIELD OF GREATEST INTEREST

Radar, Servo and Computer Engineering Technology

Electronic Engineering Technology

Television Engineering Technology

Communications Engineering Technology

Aeronautical Electronic Engineering Technology

Automation and Industrial Electronics Engineering Technology

B³

Name Age

Street

City Zone State

Check: Home Study Residence School Korean Veteran

To obtain fast, immediate service, and to avoid delay, it is necessary that the following information be filled in:

Employed By

Type of Present Work

Education: Yrs. High School

Other

Electronics Experience

How far can you
go in electronics...
without a degree?



At the SAGE display console, Dick Brani reads 1957 magazine story about his IBM career.

Two years ago, when Richard F. Brani was first asked to review his field engineering progress at IBM, he'd been recently promoted to computer instructor. Now, he has a new and more crucial responsibility: Group Manager of 20 field engineers who keep a SAGE computer operating at its peak, bulwarking America's air defenses. Here's his story.

GIVEN IMPORTANT ASSIGNMENT. "In my first four years with IBM, my field engineering career has taken several giant steps forward—despite my lack of a college degree," reports Dick Brani. "When I joined the Company, my special training consisted of graduation from a technical school, an F.C.C. license, and some Army engineering training. Now, I have a responsible management job in the SAGE Project, my knowledge of electronics has grown tremendously, and my future looks as promising as I could wish it.

"How did I make this progress? IBM believes that—after comprehensive training—technicians like me can handle assignments generally performed by graduate engineers. And IBM has been proved right. Hundreds of technicians are now functioning successfully as IBM field engineers."

20 WEEKS' COMPUTER TRAINING. Dick Brani joined IBM in the fall of 1955. He was immediately enrolled in a 20 weeks' computer units training program. "You learn how the different units of large-scale computers like SAGE operate . . . how the computer itself can help diagnose and locate trouble . . . and how to make fast, precise repairs," he says. "Once assigned to a SAGE Site, field engineers may also attend classes—during regular working hours, by the way—to keep up with advanced developments in electronics. Our site, for example, recently had a course on the new, increased-capacity SAGE 'memory'."

ADVANCES RAPIDLY IN FOUR YEARS. "I know of few other companies that offer technicians better or more valuable training than IBM," Dick Brani says. "This training can prove an 'open sesame' to engineering and management opportunities not usually available to men lacking college degrees."

After his training, Dick Brani's abilities won him a position as instructor in IBM's education program. For two years, he taught courses in computer units and systems. Then, a little over a year ago, he was promoted to Group Manager of 20 field engineers assigned to install—and maintain—a SAGE computer at a new site. "I'm responsible for the successful operation of the computer. I have to check out repairs my men do, schedule maintenance activities and supervise all new engineering changes."



Introducing a new field engineer to SAGE operations.



Dick Brani (right) discusses the new SAGE "memory" with a field engineer.

WHAT IS SAGE? SAGE is a vital part of America's air defense system. At the core of the SAGE system is a network of fast, extremely reliable electronic computers. In each sector of our nation, a SAGE computer is constantly in operation, 24 hours a day, helping the Air Force prevent surprise aerial attacks. Here's how SAGE works: The computer receives radar data from many observation points. It checks this information against known air traffic for the sector and presents to the Air Force a pictorial display of the air situation. If need be, the computer can guide a BOMARC missile to a target for certain interception.

COUNSELING TO DEVELOP STRONG LEADERS. "My most challenging duty as a SAGE Group Manager? Helping the men in my group advance and develop," replies Dick Brani. "One way I do this is by periodically rotating my men so that they become familiar with all phases of large-scale computer operation. But the most effective way is through counseling—just sitting down with a man and discussing his progress, his prospects, his career goals. IBM encourages frequent and intensive counseling. By this method the Company finds and develops the strong leaders it needs to stay at the head of its field."

SAGE PROGRAM STILL GROWING. "My future? I can advance to still more important responsibilities in SAGE field engineering," says Dick Brani. "SAGE has grown tremendously since its inception a few years ago, and it's still growing rapidly. Or, I can move into major spots in education, personnel, management, development engineering—or nearly any activity you can name. My future at IBM is limited only by my ability as an individual."

* * *

If you have a minimum of 3 years' technical schooling after high school—or equivalent experience—you may be eligible for 20 weeks' training as a computer units field engineer. While training, you receive full pay plus living allowance. Your starting salary will be determined by the extent of your education and experience.

WRITE TODAY TO: Mr. N. H. Hoyer, Dept. 650L
Military Products Division
IBM Corporation
Kingston, N.Y.

You'll receive a prompt reply. Personal interviews arranged in all areas of the United States.

IBM®

INTERNATIONAL BUSINESS MACHINES CORPORATION



**Latest Information
on the Electronic Industry**

Spot News

By ELECTRONICS WORLD'S
WASHINGTON EDITOR

HUMAN HEARTBEAT NOW ANALYZED BY HIGH-SPEED COMPUTER—The National Bureau of Standards has developed a method for using high-speed computers to analyze and compare heartbeat information. Using an analogue-digital converter, electrical signals associated with heartbeats can be converted from continuous waveforms to digital form on magnetic tape and then fed to the computer. Cardiac cycles of about 1000 patients may be recorded on one reel. The electrocardiogram used here is composed of a series of three continuous waveforms, substantially repetitive with each heartbeat. These waveforms, as obtained from electrodes placed on the head, chest, and ankle, are not suitable for use in a digital computer until they have been changed from their analogue (continuous wave) to digital form. When ready for conversion the analogue tape recording contains 10 or 12 heartbeats on three FM channels, and the patient's identification on one voice channel. Wide-deviation FM has been chosen for recording because the frequencies to be studied fall between direct current and 200 cycles. A technician monitors the three signals displayed simultaneously on an oscilloscope and selects the cardiac cycle for conversion to digital form.

NEARLY 1000 ILLEGAL TV BOOSTERS FOUND OPERATING IN WEST—A report filed recently by the FCC's Broadcast Bureau chief has revealed that close to 1000 unauthorized television boosters are now operating in the mountainous areas of a number of Western states. In Montana, over 150 illegal boosters have been spotted. Practically all of the installations were described as low-power projects which simply receive one v.h.f. signal and re-transmit it to another v.h.f. channel. Just how to resolve such signal "bootlegging" has been puzzling the Commission for quite a spell. A number in Congress have suggested that the FCC should legalize boosters; others have violently opposed such approval. The Commission hopes to have an answer before Congress reconvenes in January.

UNPARALLELED MILITARY-ELECTRONICS PROGRESS HERALDED IN HOUSE REPORT—The ten-fold increase in electronic developments since World War II will be matched by another ten-fold increase within the next years: so forecast military-science specialists appearing before recent sessions of the House of Representatives' Committee on Science and Astronautics. We are now in a fantastic era, they said, pointing out that vacuum-tube circuits are being microminiaturized to one-tenth, one-hundredth, and even one-thousandth of their original size and volume—reductions affording a tremendous saving to the military in bulk and weight and in power requirements.

ALL PLANES MAY SOON BE REQUIRED TO CARRY WEATHER RADAR—Because of the excellent safety record of air carriers using weather radar, the Federal Aviation Agency has issued a proposed rule-making that will require all planes to be equipped with approved types of radar systems. At present there is no such regulation on the books.

NEW BUILT-IN SONAR DETECTORS TO BE PRODUCED FOR SUBMARINES—A new sonar detection system which combines sophisticated searching, electronic control of underwater firepower, and advanced communications techniques is now under development at Raytheon. Submarines carrying this new system will be able to locate their targets—both submarines and surface craft—from much longer distances, reducing the chances of enemy detection. The entire system will be an integral part of the hull. In the past sonars were fitted into existing hulls. The built-in approach will make it possible not only to package complex electronic gear into a relatively tight space, but locate it in the most favorable position in the sub.

NEW FACTS ON SOLAR X-RAYS REVEALED BY ROCKETS—New facts about x-rays from the sun which penetrate into the earth's upper atmosphere were revealed by Navy Scientists in announcing results of the recently completed "Project Sunflare II". The solar flare study, conducted by the U.S. Naval Research Laboratory, Washington, D.C., determined the existence of x-rays tens of thousands of volts greater than detected in previous experiments. X-rays with energies as high as 80,000 volts were detected above the absorbing atmosphere of the earth. These findings indicate possible temperatures in the solar atmosphere of 100-million degrees C.

—30—

THE WHOLE MULTI-MILLION DOLLAR MARKET HAS HEARD THAT

ASTATIC PLUG-IN CARTRIDGES

ARE THE ONLY COMPLETE LINE THAT MEETS EVERY SALES OPPORTUNITY

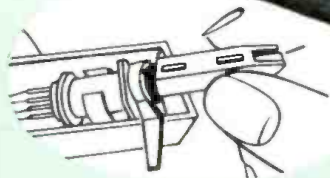

AS EASY AS CHANGING A LIGHT BULB
... NO INSTALLATION OR SERVICE PROBLEMS

You've had the message by now—that millions of plug-in phono cartridges have already been sold . . . that Astatic Plug ins represent a tremendous multi-million dollar replacement market . . . and that **THE ONLY COMPLETE, SINGLE SOURCE PLUG-IN LINE ON THE MARKET IS ASTATIC'S!**

So why not use the message? Act now to cash in on this RICH and SKY-ROCKETING MARKET. Get into the plug-in business and get into it all the way—never missing a single sale—with **THE COMPLETE ASTATIC PLUG-IN LINE.**

EASY, AUTOMATIC SALES WITH
ASTATIC MERCHANDISING PACKAGE

You sell from this plastic display-merchandiser which is pilfer-proof, holds an assortment of a dozen cartridges. Information under each cartridge tells the customer which model he needs. Colorful, attractive window card—free of charge—tells 'em you've got 'em!

CALL YOUR DISTRIBUTOR OR WRITE FOR FULL DETAILS



THE

Astatic

ASTATIC

CORPORATION, CONNEAUT, OHIO

IN CANADA: CANADIAN ASTATIC LIMITED,
TORONTO, ONTARIO
EXPORT SALES: ROBURN AGENCIES INC.,
431 GREENWICH ST., N. Y. 13, N. Y., U. S. A.

KNOWN THE WORLD OVER



GO BY BRAND
—GO BUY ASTATIC



A MODEL FOR EVERY APPLICATION — STEREO OR MONAURAL — DIAMOND OR SAPPHIRE TIP

DAVE GARROWAY
"Today"
NBC-TV



JOHN PAYNE
"Restless Gun"
ABC-TV



GALE STORM
"The Gale Storm Show"
ABC-TV



BOB CUMMINGS
"Love That Bob"
ABC-TV



"4 STARS" for the CHANNEL MASTER® T-W

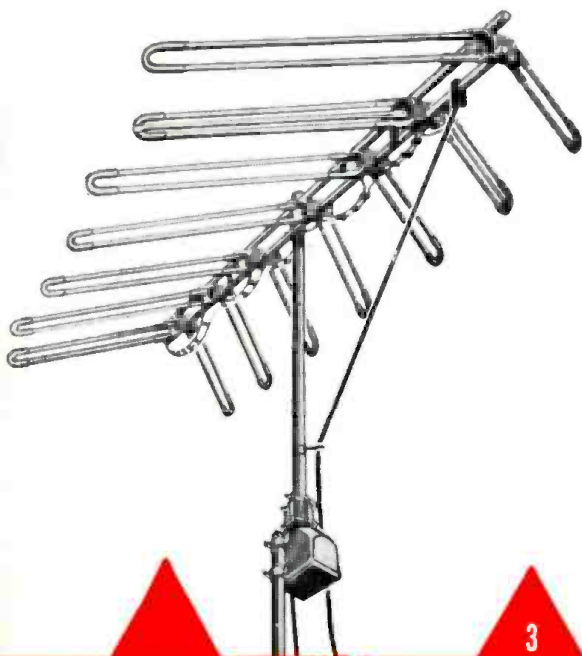

"4 STARS" — recognized symbol for superb performance.

"4 STARS" — going all-out to help you sell more antennas.

Who doesn't recognize these top-rated TV stars? Their audience numbers millions. And hard-hitting commercials are telling these millions... over and over again... to replace their old, worn-out antennas with the powerful Channel Master T-W.

On network TV... in the top farm publications... in best-selling mass magazines... Channel Master is using the power of *all-out National Advertising* to help you do a bigger, MORE PROFITABLE, antenna installation business.

That's why it makes good sense for you to promote and install the Channel Master T-W... the one antenna that has never been equalled for brilliant performance and rugged construction.

FULL
NETWORK
TV

3
TOP
FARM
PUBLICATIONS

2
BEST-SELLING
GENERAL
MAGAZINES

NEW
DISPLAY
POSTERS

FOUR TOP SHOWS
2 MAJOR TV
NETWORKS
210 TV STATIONS

The Progressive Farmer
Successful Farming
Farm Journal

The Saturday
Evening Post
Coronet



Available from your Channel Master distributor.

CHANNEL MASTER works wonders in Sight and Sound

CHANNEL MASTER advertising works 'Round the Clock

...to make friends
and customers
for the full line of
Channel Master products.

Aluminum and Steel Mastings



2-way couplers



TV Wire

Insulators, mounts, and hardware



Transistor radios

Electron Tubes



Stereo turntable



Minstrel Speakers



Indoor and outdoor antennas

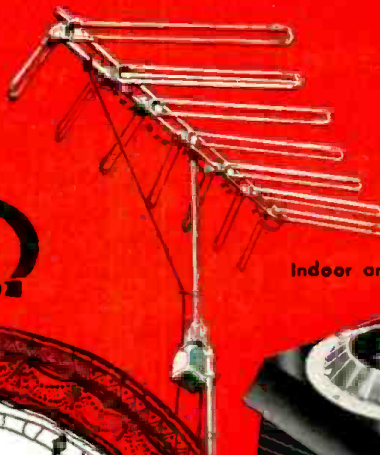

Automatic and Compass rotators



AM/FM Tuner



High Fidelity Amplifiers

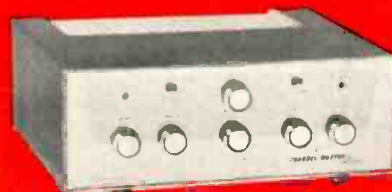

Get the
profit story.
Call your
Channel Master
distributor today.

CHANNEL MASTER CORP ELLENVILLE, N. Y.

"TUBE INVENTORY DOWN 30%,

...from using General Electric's **PROFIT*** Program. That's the dollar-saving, income-building record of Chicago partners Robert Knudsen and Harold Russell!

* Programmed Replenishment OF Inventory Turnover

"We're moving more tubes than ever, with a stock one-third less. Inventory turnover is that much higher, which shows in increased profits." The two busy partners of Tel-Rad TV Sales-with-Service, 5839 Belmont Ave., Chicago, name this as their principal benefit from General Electric's new **PROFIT*** Program.

Another big saving – space! The compactness of the General Electric Inventory Rack means that a service dealer can do away with 50 to 60 feet of shelving. Furthermore, the attractive, organized display of tubes gives the shop a modern and professional-looking appearance.

Knudsen and Russell add, "Now our tube stock's geared to our needs. And it stays that way – plenty of fast-selling types, a minimum of slow movers. The distributor's weekly re-order visit takes care of everything." No stock-taking or clerical work by the partners is involved. This saves them time for profitable repairwork.

You too can increase turnover and boost income with General Electric's new **PROFIT*** Program. Available with the purchase of tubes from your G-E tube distributor. See him today! *Distributor Sales, Electronic Components Division, General Electric Company, Owensboro, Kentucky.*

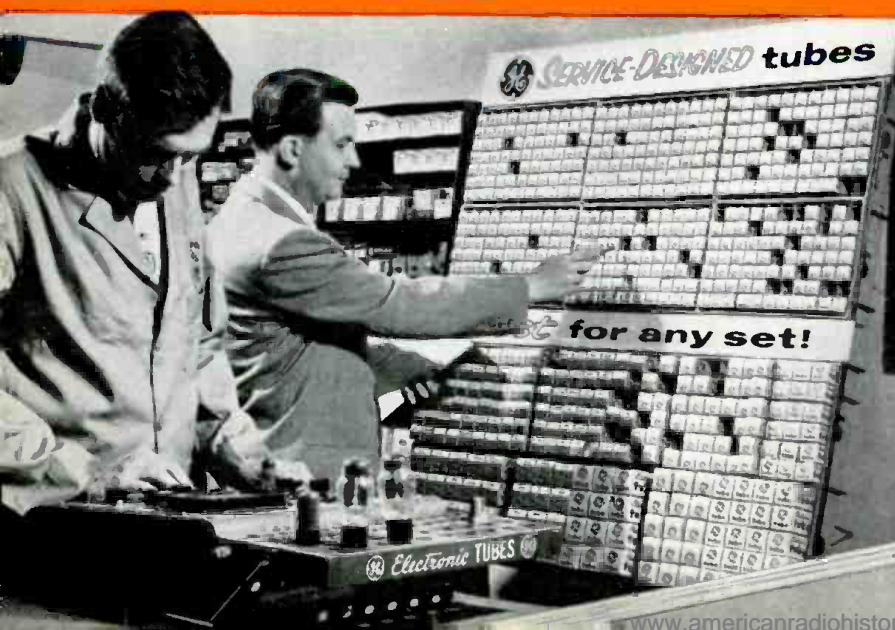

TEL-RAD'S SERVICE WORK

doesn't stop while tube stocks are being checked. Here Richard Schlueter (facing rack in picture at left), salesman for Melvin Electronics, General Electric tube distributor, inspects the **PROFIT*** tube inventory for types to re-order. Schlueter does this job weekly, handling all routine and paperwork – thus saving valuable time for Knudsen and Russell.

OUR SALES ON THE INCREASE!"



Progress Is Our Most Important Product

GENERAL  **ELECTRIC**

2-111-223



WHAT'S NEW?

WHAT'S EXCITING AND DIFFERENT

FOR STEREO IN 1960

University's three new ultra-compact systems... offering superb performance and elegant styling at moderate cost...ideal for stereo application

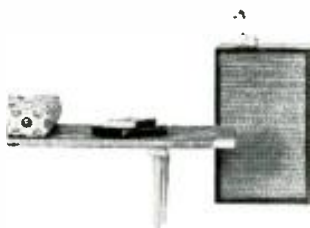

MODEL RRL-12 12" 3-Speaker RRL System
Featuring the sensational new Sphericon Super Tweeter for sweet, smooth highs to inaudibility. From **\$114.95** net.



MODEL RRL-8 8" 3-Speaker RRL System
The impossible becomes reality! An 8" system with full bass response down to below 30 cps! From **\$95.50** net.



MODEL S-80 8" 2-Way High Efficiency System
Excellent wide-range response from a system only 9 1/4" deep. From **\$59.95** net.

University's 'Tridimensional' TMS-2... the most sensational advance in stereophonic reproduction...now in Early American styling



Containing two complete 3-way multi-speaker systems in one compact enclosure, the 'Tridimensional' TMS-2 projects frequencies of both channels to the rear and side walls of the room. Thus, one large wall area becomes channel A; another channel B... exactly as if you had a series of widely distributed speakers for each channel.



Early American model in hand-rubbed fruitwood finished maple, **\$279.95** net.

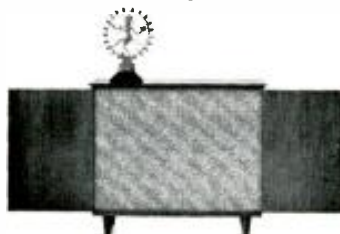

Contemporary model in mahogany, **\$258**; in blond or walnut, **\$263** net.

University's newly engineered 8" high fidelity speakers especially designed for 'big system' performance from the smallest enclosures



MODEL UC-82 8" 2-Way Diffaxial
Excellent low cost wide-range speaker with unlimited versatility. Use monophonically, as matched stereo pair in minimum size enclosures, as second channel speaker, or as stereo add-on. Response: 45-14,000 cps. **\$16.95** net.



MODEL C-8HC 8" High Compliance Woofer
Features special low resonance cone with treated cloth surround, extra deep dual voice coil and heavy die-cast basket. Remarkable response range extends from 20 cps to 3000 cps in suitable enclosure. **\$39.95** net.

SEE AND HEAR THEM AT YOUR DEALER NOW!

... or write for new edition of "An informative guide to high fidelity stereo and monophonic speaker systems and components." Desk S-7, University Loudspeakers, Inc., White Plains, N. Y.



In **STEREO**

and Mono Hi-Fi... the experts say
your best buy is

EICO

"The overall design of the HF-81 is conservative, honest and functional. It is a good value considered purely on its own merits, and a better one when its price is considered as well."

— Hirsch-Houck Labs (HIGH FIDELITY Magazine)

- Advanced engineering • Finest quality components
- "Beginner-Tested," easy step-by-step instructions
- LIFETIME service & calibration guarantee at nominal cost
- IN STOCK — compare, then take home any EICO equipment — right "off the shelf" — from 1500 neighborhood EICO dealers.



Stereo Amplifier-Preamplifier HF81

HF81 Stereo Amplifier-Preamplifier selects, amplifies, controls any stereo source & feeds it thru self-contained dual 14W amplifiers to a pair of speakers. Provides 28W monophonically. Ganged level controls, separate balance control, independent bass & treble controls for each channel. Identical Williamson-type, push-pull EL84 power amplifiers. "Excellent" — SATURDAY REVIEW; HI-FI MUSIC AT HOME. "Outstanding quality... extremely versatile." — ELECTRONICS WORLD LAB-TESTED. Kit \$69.95. Wired \$109.95. Includes cover.

HF85 Stereo Preamplifier is a complete, master stereo preamplifier-control unit, self-powered for flexibility & to avoid power-supply problems. Distortion borders on unmeasurable even at high output levels. Level, bass, & treble controls independent for each channel or ganged for both channels. Inputs for phono, tape head, mike, AM, FM, & FM-multiplex. One each auxiliary A & B input in each channel. Switched-in loudness compensator. "Extreme flexibility... a bargain." — HI-FI REVIEW. Kit \$39.95. Wired \$64.95. Includes cover.

New HF87 70-Watt Stereo Power Amplifier: Dual 35W power amplifiers of the highest quality. Uses top-quality output transformers for undistorted response across the entire audio range at full power to provide utmost clarity on full orchestra & organ. IM distortion 1% at 70W, harmonic distortion less than 1% from 20 to 20,000 cps within 1 db of 70W. Ultra-linear connected EL34 output stages & surge-protected silicon diode rectifier power supply. Selector switch chooses mono or stereo service; 4, 8, 16, and 32 ohm speaker taps, input level controls; basic sensitivity 0.38 volts. Without exaggeration, one of the very finest stereo amplifiers available regardess of price. Use with self-powered stereo preamplifier-control unit (HF85 recommended). Kit \$74.95. Wired \$114.95.

HF86 28W Stereo Power Amplifier Kit \$43.95. Wired \$74.95.

FM Tuner HFT90: Prewired, prealigned, temperature-compensated "front end" is drift-free. Prewired exclusive precision eye-tronic® traveling tuning indicator. Sensitivity: 1.5 uv for 20 db quieting; 2.5 uv for 30 db quieting, full limiting

from 25 uv. IF bandwidth 260 kc at 6 db points. Both cathode follower & FM-multiplex stereo outputs, prevent obsolescence. Very low distortion. "One of the best buys in high fidelity kits." — AUDIOCRAFT. Kit \$39.95. Wired \$65.95. Cover \$3.95. *Less cover, F.E.T. Incl.

New AM Tuner HFT94. Matches HFT90. Selects "hi-fi" wide (20c - 9kc @ -3 db) or weak-station narrow (20c - 5kc @ -3 db) bandpass. Tuned RF stage for high selectivity & sensitivity; precision eye-tronic® tuning. Kit \$39.95. Wired \$65.95 Incl. Cover & F.E.T.

New FM/AM Tuner HFT92 combines the renowned EICO HFT90 FM Tuner with excellent AM tuning facilities. Kit \$59.95. Wired \$94.95. Includes cover & F.E.T.

New AF-4 Stereo Amplifier provides clean 4W per channel or 8W total output. Inputs for ceramic/crystal stereo pick-ups, AM-FM stereo, FM-multi stereo. 6-position stereo/mono selector. Clutch-concentric level & tone controls. Use with a pair of HFS-5 Speaker Systems for good quality, low-cost stereo. Kit \$38.95. Wired \$64.95.

HF12 Mono Integrated Amplifier provides complete "front-end" facilities and true high fidelity performance. Inputs for phono, tape head, TV, tuner and crystal/ceramic cartridge. Preferred variable crossover, feedback type tone control circuit. Highly stable Williamson-type power amplifier circuit. Power output: 12W continuous, 25W peak. Kit \$34.95. Wired \$57.95. Includes cover.

New HFS3 3-Way Speaker System Semi-Kit complete with factory-built 3/4" veneered plywood (4 sides) cabinet. Bellows-suspension, full-inch excursion 12" woofer (22 cps res.), 8" mid-range speaker with high internal damping cone for smooth response, 3 1/2" cone tweeter. 2 1/4 cu. ft. ducted-port enclosure. System Q of 1/2 for smoothest frequency & best transient response. 32-14,000 cps clean, useful response, 16 ohms impedance. HWD: 26 1/2", 13 3/8", 14 3/8". Unfinished birch \$72.50. Walnut, mahogany or teak \$87.50.

New HFS5 2-Way Speaker System Semi-Kit complete with factory-built 3/4" veneered plywood (4 sides) cabinet. Bellows-suspension, 5/8" excursion,



Stereo Preamplifier HF85



**70W Stereo Power Amplifier HF87
28W Stereo Power Amplifier HF86**

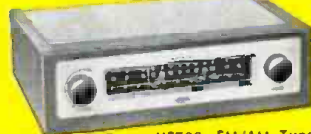

**FM Tuner HFT90 FM/AM Tuner
AM Tuner HFT94 HFT92**



Stereo Integrated Amplifier AF4



**12W Mono Integrated Amplifier HF12
Other Mono Integrated Amplifiers:
50, 30, & 20W (use 2 for stereo)**



**2-Way Bookshelf
Speaker System HFS1
3-Way Speaker System HFS3
2-Way Speaker System HFS5**

8" woofer (45 cps res.), & 3 1/2" cone tweeter. 1 1/4 cu. ft. ducted-port enclosure. System Q of 1/2 for smoothest frequency & best transient response. 45-14,000 cps clean, useful response. HWD: 24", 12 1/2", 10 1/2". Unfinished birch \$47.50. Walnut, mahogany or teak \$59.50. **HFS1 Bookshelf Speaker System** complete with factory-built cabinet. Jensen 8" woofer, matching Jensen compression-driver exponential horn tweeter. Smooth clean bass; crisp extended highs. 70-12,000 cps range. 8 ohms. HWD: 23" x 11" x 9". Price \$39.95.

HFS2 Omni-Directional Speaker System (not illus.) HWD: 36", 15 1/4", 11 1/2". "Eminently musical" — HIGH FIDELITY. "Fine for stereo" — MODERN HI-FI. Completely factory-built. Mahogany or walnut \$139.95. Blond \$144.95.

IMPORTANT NOTE: All EICO kits built according to our instructions, and all EICO factory-assembled equipment, conform to the high standards and specifications as published in EICO literature and advertisements. All EICO factory-assembled equipment is completely and meticulously hand-wired throughout — no printed circuitry; each factory-assembled unit is 100% final-tested throughout for each feature and function — no "spot" or "partial" checking. In EICO's final-test techniques, nothing is left to chance.

Fill out coupon on next page for FREE CATALOG. Ask your dealer about EICO's exclusive STEREO RECORD BONUS

Over 1 MILLION EICO Instruments in use throughout the world.

Add 5% in the West.

Copyright 1959 by Electronic Instr. Co., Inc. 33-00 N. Blvd., L. I. C. 3, N. Y.

The specs prove it...your best buy is



B
TV-FM SWEEP GENERATOR
AND MARKER #368
KIT \$69.95 WIRED \$119.95

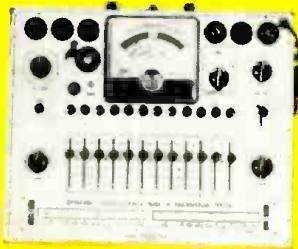

A
DYNAMIC CONDUCTANCE
TUBE & TRANSISTOR
TESTER #666
KIT \$69.95 WIRED \$109.95
Complete with steel cover & handle

C
RF SIGNAL GENERATOR #324
KIT \$26.95 WIRED \$39.95



D
PEAK-TO-PEAK
VTVM #232 &
UNIPROBE (pat. pend)
KIT \$29.95
WIRED \$49.95

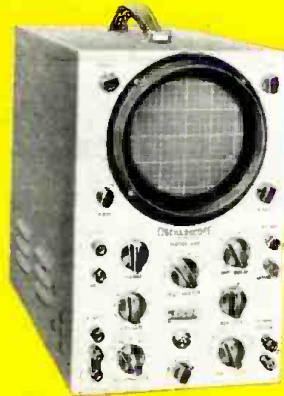

E
COLOR & MONOCHROME
DC TO 5 MC LAB & TV
5" OSCILLOSCOPE #460
KIT \$79.95 WIRED \$129.50
5" PUSH-PULL
Oscilloscope #425:
Kit \$44.95 Wired \$79.95

A Tests all receiving tubes (picture tubes with adapter), n-p-n and p-n-p transistors. Composite indication of Gm, Gp & peak emission. Simultaneous selection of any one of 4 combinations of 3 plate voltages, 3 screen voltages, 3 ranges of continuously variable grid voltage (with 5% accurate pot.). Sensitive 200 ua meter. 10 six-position lever switches: freepoint connection of each tube pin. 10 pushbuttons: rapid insert of any tube element in leakage test circuit. Direct reading of inter-element leakage in ohms. New gear-driven rollchart. **CRA Adapter \$4.50.**

B Entirely electronic sweep circuit with accurately-biased inductor for excellent linearity. Extremely flat RF output. Exceptional tuning accuracy. Hum and leakage eliminated. 5 fund. sweep ranges: 3-216 mc. Variable marker range: 2-75 mc

in 3 fund. bands, 60-225 mc on harmonic band. 4.5 xtal marker osc., xtal supplied. Ext. marker provision. Attenuators: Marker Size, RF Fine, RF Coarse (4-step decade). Narrow range phasing control for accurate alignment.

C 150 kc to 435 mc with ONE generator in 6 fund. bands and 1 harmonic band! $\pm 1.5\%$ freq. accuracy. Colpitts RF osc. directly plate-modulated by R-follower for improved mod. Variable depth of int. mod. 0-50% by 400 cps Colpitts osc. Variable gain ext. mod. amplifier: only 3.0 v needed for 30% mod. Turret-mounted, slug-tuned coils for max. accuracy. Fine and Coarse (3-step) RF attenuators. RF output 100,000 uv, AF output to 10 v.

D Uni-Probe — exclusive with EICO — only 1 probe performs all functions: half-turn of probe tip selects DC or AC-Ohms. Calibration without re-

moving from cabinet. Measure directly p-p voltage of complex & sine waves: 0-4, 14, 42, 140, 420, 1400, 4200. DC/RMS sine volts: 0-1.5, 5, 15, 50, 150, 500, 1500 (up to 30,000 v. with HVP probe, & 250 mc with PRF probe). Ohms: 0.2 ohms to 1000 megs. $4\frac{1}{2}$ " meter, can't-burn-out circuit. 7 non-skip ranges on every function. Zero center.

E Features DC amplifiers! Flat from DC to 4.5 mc, usable to 10 mc. Vert. Sens.: 25 mv/in.; input Z 3 megs; direct-coupled & push-pull throughout. 4-step freq.-compensated attenuator up to 1000:1. Sweep: perfectly linear 10 cps — 100 kc (ext. cap. for range to 1 cps). Pre-set TV V & H positions. Auto sync. lim. & ampl. Direct or cap. coupling; bal. or unbal. inputs; edge-ill engraved lucite screen with dimmer control; plus many more outstanding features.

FREE CATALOG shows you HOW TO SAVE 50% on 65 models of top quality professional test equipment. MAIL COUPON NOW!



New Transistor
Portable Radio RA-6
Kit \$29.95
Wired \$49.95
Incl. F.E.T.; less 9V batt.
Prealigned RF, IF
xfrms; push-pull
audio; 6" spkr.

PAT. PEND.



NEW Power & Bias
Supply for
Transistorized
Eqt. #1020
Kit \$19.95
Wired \$27.95



NEW Tube &
CRT Fil.
Tester #612
Kit \$3.95
Wired \$5.95
Fast-checks
radio/TV tubes,
pilot lamps, etc.



Series/Parallel
R-C Combination
Box #1140
Kit \$13.95
Wired \$19.95



Tube Tester #625
Kit \$34.95
Wired \$49.95
• tests 600 mil
series string type
tubes
• illuminated
roll-chart
Pix Tube Test
Adapter \$4.50



6V & 12V Battery
Eliminator
& Charger #1050
Kit \$29.95
Wired \$38.95
Extra-filtered for
transistor equip.
#1060 Kit \$38.95
Wired \$47.95



20,000 Ohms/Volt
V-O-M #565
Kit \$24.95
Wired \$29.95
1000 Ohms/Volt
V-O-M #536
Kit \$12.90
Wired \$14.90



33-00 Northern Blvd. L. I. C. 1, N. Y.

Add 5% in the West. © 1959

TURN PAGE FOR MORE EICO VALUES

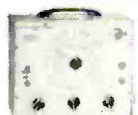

R-C Bridge & R-C-L
Comparator #950B
Kit \$19.95
Wired \$29.95
Reads 0.5 ohms-
500 megs,
10 mmfd-5000 mfd,
power factor



VTVM Probes Kit Wired
Peak-to-Peak \$4.95 \$6.95
RF \$3.75 \$4.95
High Voltage Probe-1 \$6.95
High Voltage Probe-2 \$4.95
Scope Probes
Demodulator \$3.75 \$5.75
Direct \$2.75 \$3.95
Low Capacity \$3.75 \$5.75

EICO
33-00 Northern Blvd.
L. I. C. 1, N. Y.

R-12

Show me HOW TO SAVE 50% on Test Instruments
 Hi-Fi Ham Gear. Send free Stereo Hi-Fi
Guide. Send me FREE Catalog, name of neighborhood
dealer.

Name

Address

City Zone State

SEE OUR OTHER ADVERTISEMENT ON PAGE 98

By **M. ROTHSTEIN**
Director of Engineering, The Thermatron Company
and
WALTER H. BUCHSBAUM

Giant plastic radomes whose seams are bonded by means of dielectric heating principles are symbolized below.

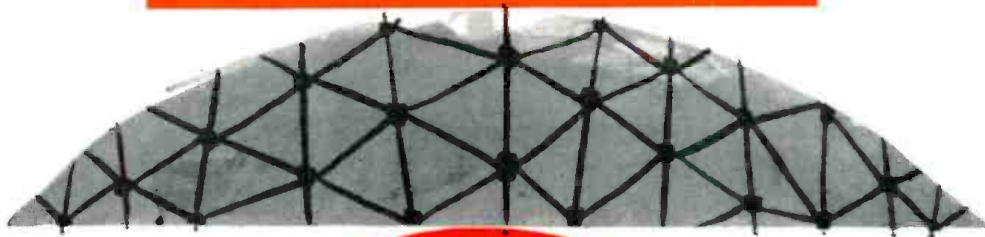

DIELECTRIC HEATING

Plastics and plywood are sealed and bonded by electronics in an important industrial process that is discussed here.

CHILDREN frolicking in their plastic pools take their existence for granted and the chic young lady sporting a new vinyl jacket cannot be expected to notice the lack of threads in her finery. But the radar technician working over his gear inside a large plastic radome in the midst of an Arctic storm may be concerned about the strength of the seams that hold the radome together. He may not know that these seams were "welded" by the same type of r.f. used by his radar to detect distant targets.

The proud boat owner may enjoy the molded, lightweight bottom made of epoxy Fiberglas laminations without knowing that these materials, too, may be formed, cured, and glued by radio-frequency energy. So many articles in daily use are made of various plastics that we have come to accept their unique qualities without wondering how they are made and what

makes some of these qualities possible. The chemical industry developed the plastic materials but, surprisingly enough, the electronics industry usually provides the means of shaping, sewing, glueing, etc.

Today, practically all automobiles use plastic upholstery and all of the sewing, quilting, embossing, and processing of these materials is done with r.f. energy. In other parts of the automobile r.f. energy is used to seal waterproof wiring, form door panels, and mold the rubber or vinyl trim.

Overlooked because of the more spectacular applications of electronics, the dielectric heating industry may receive less publicity than space communications but, in terms of dollars, equipment, and useful products involved, it turns out to be one of the major new industries. This is especially true because of the constantly increasing application of plastic materials,

which are usually most economically and efficiently processed by r.f. energy. Plywood is bonded and cured almost exclusively by r.f. heating. This method permits the heat to be concentrated in the laminating glue while the entire wood and glue sandwich is tightly compressed. A typical plywood processing unit is shown in Fig. 1. Related materials, such as Masonite and various types of wallboard, may also be manufactured with r.f. energy as the heat source.

The general public accepts the myriad plastic items with their perfect patterns, seams, and seals, without realizing that they are all made possible by a new and growing industry, the dielectric heating field. To the electronically minded reader, however, this important application of the principles of radio and electricity will be of great interest. Many familiar circuits and components are used to



◀ Fig. 1. Curing and bonding plywood with r.f.

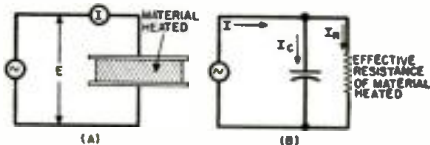

Fig. 5. The equivalent electrical circuit.

achieve unusual effects. Just how the r.f. energy is generated, how it is put to work, what some of the limitations and problems are, and what potential this field holds for service-minded readers—those are the topics to be covered in the following paragraphs.

Dielectric Heating Principles

Unlike induction heating (see May 1959 issue), dielectric heating works, as the name implies, in insulators or dielectric material rather than in metals. While induction heating employs a coil to apply the r.f. to produce heating, dielectric heating is a capacitive effect.

Most of our readers are familiar with capacitors in one form or another and while they may have noticed that power transformers get hot, capacitors generally remain cool, at least they don't generate any heat by themselves. Most of our readers also know that, while good capacitors operate without heating, a leaky capacitor generally gets quite hot. This is due to the losses introduced when the dielectric material deteriorates. These same losses are put to work in dielectric heating in the following manner:

First, we must go back to the basic structure of an atom. A positively charged nucleus is surrounded by electrons in orbit around the nucleus. The electrons are negatively charged and, if a strong positive electric force is applied, it is possible to remove one or

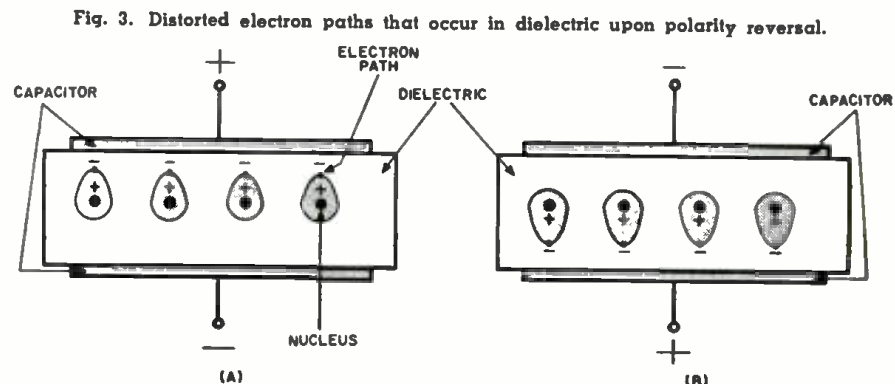

Fig. 3. Distorted electron paths that occur in dielectric upon polarity reversal.

more electrons from their orbits. In vacuum tubes the cathode is heated and the positive plate voltage pulls electrons from atoms making up the cathode. An insulator or dielectric material is different from a metal or conductor in that it has no free electrons and therefore cannot support current flow. In the dielectric material each electron is closely held by its nucleus and, unless the material breaks down, no current can flow in it.

Now look at Figs. 3A and 3B. Here, in a simplified form, we show what happens to electrons in a dielectric when a voltage is applied across the

in any given material. Table 1 shows a comparison among a number of different common materials and their relative susceptibility to dielectric heating.

Naturally, the thickness of the material, the size of the capacitor plates, and the desired temperature also have an effect on the choice of frequency and power. In general, however, the type of material determines the basic frequency range. Most dielectric heating is done between 5 and 100 megacycles.

Dielectric Heating Uses

As stated at the beginning of this article, probably the most universal application of dielectric heating is in the plastics industry and there it is generally referred to as "heat sealing." But every one of our readers who likes cigarettes with a controlled moisture content, enjoys one of the benefits of dielectric heating. Back in 1936, r.f. heating was first used to eliminate the excess moisture from tobacco without removing it from the hoghead.

Almost all flexible plastics belong to the "thermoplastic" family, meaning that they become soft under heat as distinguished from the "thermosetting" plastics, such as Bakelite or epoxy, which are soft only the first time they are heated. The most widely used thermoplastic materials are the family of vinyl, rubber, nylon, orlon, saran, etc. These materials make up the bulk of the raincoats, seatcovers, plastic bags, wading pools, inflated toys, shower caps, and all the thousand and one items which, in everyday life, are called "plastic".

In addition to these familiar consumer items, dielectric heating is also used in many industrial processes. Whenever heat in a dielectric is desired, this method is applied. Typical examples here are the manufacture of foam rubber where the curing and vulcanizing is done by r.f. heating. Curing of epoxy in laminations is another of the many industrial uses.

Still another, more recent, use of dielectric heating is the baking of



Fig. 4. Continuous baking of foundry cores.

two plates of a capacitor. The electrons are attracted to the positively charged plate and repelled by the negatively charged one. This distortion of the electron's orbit requires the application of energy, in other words, work is done. If the polarity of the two capacitor plates changes rapidly, the resultant distortion of the electron orbits can be compared to a vibration of the electrons and the energy expended here is turned into heat. The amount of heat generated depends basically on the resistance the dielectric material offers to the alternating charges. In the induction heating process, the eddy current losses determine the heat in the metal and in dielectric heating the dielectric losses raise the temperature of the material. These losses are shown symbolically in the diagram of Fig. 5 and increase generally with frequency

Fig. 2. Power supply of 5-kw. generator.

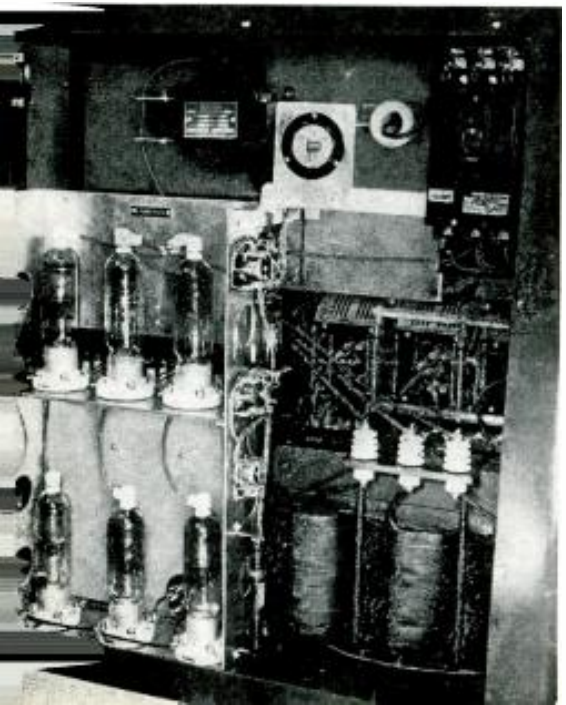

foundry cores as shown in Fig. 4. Here the electric field is not applied to each individual core, but rather a whole group of sand forms, with plastic binders added, is passed through the electric field while the moisture is baked out and the plastic material heats up to bind the sand particles together. The introduction of this method of baking foundry cores has made really substantial economies possible and proven a real boon to the foundry industry.

Heating by means of r.f. energy is also used in such an unlikely place as textile mills. Here, as shown in Fig. 6, frozen wool bales are thawed out between two vertical capacitor plates. Still other uses include the curing of foam rubber pieces on a conveyor belt arrangement.

Dielectric ovens are widely used to determine the water content of certain materials such as grains, to cure glues, bake chemicals, dry building material, preheat printed wiring boards prior to punching, and a host of other similar applications.

Heat Sealing for Plastics

To the average consumer the most conspicuous application of dielectric heating is still in the threadless, airtight, and waterproof seams of the many plastic items of daily use. A major portion of the industry's effort is concentrated in this field and provides a good place to examine the dielectric heating process.

First, we need a source of r.f. energy, in other words, an oscillator capable of delivering the required power.



Fig. 6. Warming frozen wool bales.

Basically, this oscillator is pretty much like any other c.w. power oscillator, whether used in a ham transmitter, radio station, or radar device. A typical oscillator circuit, as used in a 3-kw. *Thermatron* heat-sealing machine, is shown in Fig. 7. Two triodes in parallel form the oscillator and the load capacitor, in series with a control capacitor C_5 , is part of the series tank circuit L_1 and C_6 , which can be adjusted to vary the effective voltage at the load. One of the features of most dielectric units, which is quite different from the transmitter used in communications, is the power supply. The source is a single-

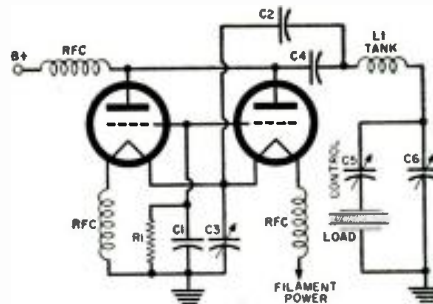

Fig. 7. Simplified 3-kw. oscillator.

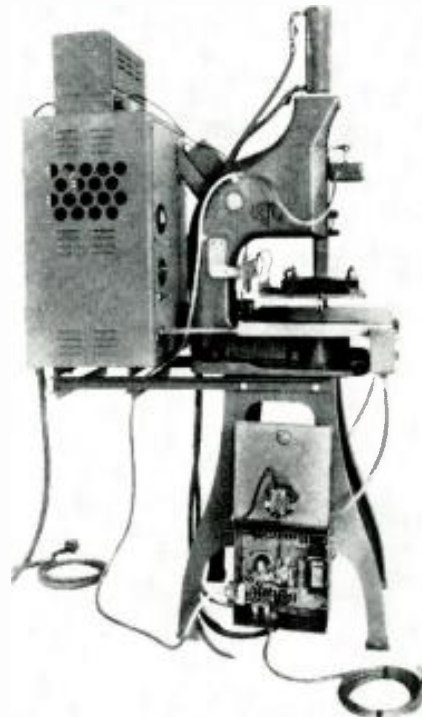

Fig. 8. 3-kw. generator and sealing press.

or three-phase 60-cps line, depending on the total power required, but no attempt is made to filter the output of the power rectifiers. This means that 120- or 360-cps modulation is superimposed on the r.f. voltage, a fact that is worth remembering when interference due to dielectric heating equipment is encountered.

The 3-kw. *Thermatron* unit shown in Fig. 8 is used to heat-seal any one of a variety of plastic items. One of this machine's outstanding features is an automatic arc suppression system. Occasional flaws in the plastic or burrs on the plates may cause arc-over between the two plates and this would short out the oscillator. To avoid this, a small d.c. voltage, about 50 volts, is applied across the two plates and when an arc occurs, this voltage drops. This voltage goes to the grid of a thyratron tube which cuts the power oscillator off instantly. In other words, as soon as an arc-over occurs, the power is shut off and remains off until the faulty condition is corrected. Other controls shut the r.f. power off when the two plates are apart or when the main safety switches are off.

The equipment shown in Fig. 8 operates at 27 mc. and is capable of sealing an area of 11.2 square inches in

less than 4 seconds with adequate pressure. Another typical machine is the 5-kw. generator made by *Erdco Engineering Corp.* Its r.f. portion is shown in Fig. 9 while Fig. 2 pictures the power supply and rectifier circuit. A much bigger unit, the *Allis-Chalmers* 20-kw. generator is shown in Fig. 10. Its transmitter tube is air-cooled by the blower motor visible just below the main unit.

While for the electronics-minded reader the main feature of dielectric heating is always the r.f. generator, the other portions of the unit are, of course, equally important to the actual manufacturing process. In heat sealing, the pressure applied to the two capacitor plates which make up the die, is of great importance. These two pieces must be squeezed together at the instant the plastic becomes soft due to the heat. Furthermore, they must stop just the right distance apart to give a strong seal. In some applications a so-called tear seal is used which allows the edges of the seal to be almost cut apart. After the seal is made, the excess plastic is torn off easily along the "tear" line, as shown in Fig. 13. Fig. 13 shows a typical die cross section for such a tear seal with the plastic in position.

Fig. 12 illustrates a small air-operated, hand-held sealing press. The r.f. power is supplied by one of the smaller generators and when the trigger switch is pressed the top part of the die is depressed, r.f. power is applied, and the seal is made. The presence of r.f. energy is indicated by the two small neon bulbs at the right of the lower die. In contrast to this small die is the set-

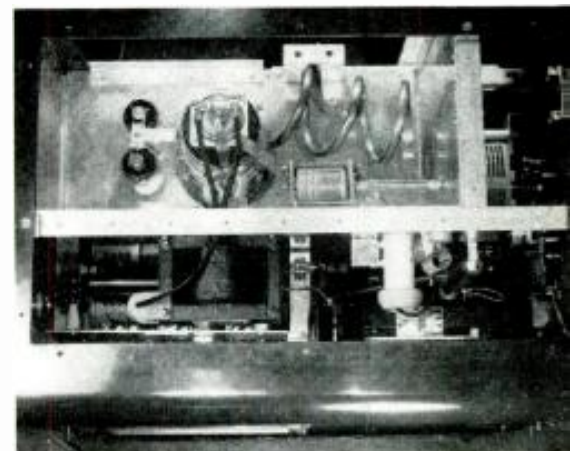

Fig. 9. Top view, r.f. section of unit.

up shown in Fig. 11 which is used for heat sealing children's wading pools. Here the r.f. generator is mounted below and behind the main portion of the machine. The large center disc is rotated to bring each section of the seam under the top die portion until the entire circle of the inflatable ring is sealed to the center piece.

The Interference Problem

When one considers the frequency and power ranges used in dielectric heating, the magnitude of the interference problem becomes awesome.

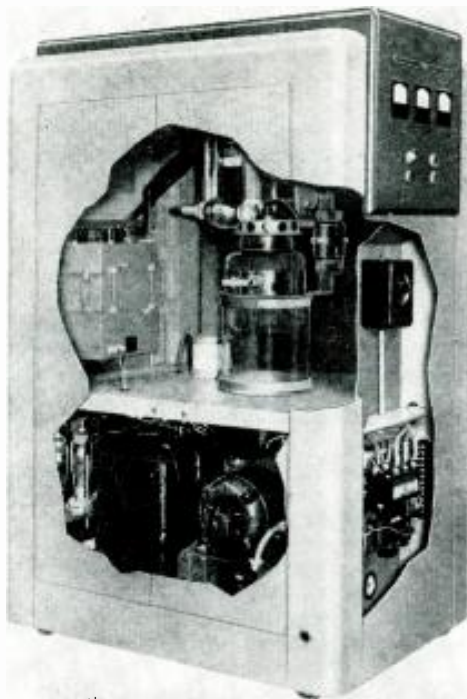

Fig. 10. Cut-away of 20-kw. generator.

the case of dielectric ovens and other devices where the active portions of the electronic circuit are enclosed. Regarding the r.f. generator, it always includes r.f. power-line filters and shielded and grounded chassis and case to minimize radiation from the r.f. source.

Maintenance and Service

Because of the highly reliable components used and their conservative circuit design, the electronic portions of most dielectric heating units have a very good performance record. Most of the defects encountered seem to be in the mechanical elements of the equipment. Such parts as blower fan belts, air hose to the press, valves, etc. seem to be the most frequent sources of trouble. Tube replacement is usually done by the local plant maintenance people, but for more difficult electronic service work most equipment manufacturers offer their own factory service, usually preceded by telephone consultations. *The Thermatron Company* reports that in several instances its customers have turned to local TV service technicians for help rather than wait for the factory representative. In each such instance the technician was able to cure the trouble with the help of the instruction manual and occasional phone calls to the factory.

As mentioned before, the dies which form the capacitor plates in heat sealing can be formed and shaped to fit a variety of different patterns. These dies are usually made of brass because

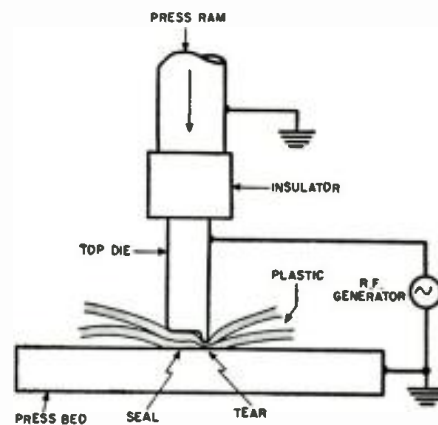

Fig. 13. A tear-sealing operation.

this is a good conductor and easy to work. Very often new dies are designed and built right in the user's plant. Occasionally this results in difficulties when certain dimensions are exceeded. For example, the length of any die cannot be more than $\frac{1}{4}$ of a wavelength. This means that for very large dies the oscillator frequency is usually reduced. Another limiting factor is the total capacitance of the die area. If this is too great, the oscillator frequency can be lowered to the point where the feedback network is no longer sufficient and oscillator efficiency drops rapidly. Most of the manufacturer's manuals contain detailed information on the maximum sizes of the dies and their capacitance.

Future of Dielectric Heating

Miraculous as dielectric heating may seem to the layman, it is an efficient and ready tool for the industrial engineer. The variety of present-day applications is sure to be increased as articles of dielectric material continue to invade the home, office, and factory. We have, in recent years, seen a startling growth, for example, in contour-packaged goods, ranging from golf balls to hand tools, from candy to precision ball bearings. The sealing of the inexpensive plastic wrapping is done by dielectric heating. Just as this application has brought a new method of packaging into being, so will other applications of dielectric heating result in additional consumer products. In the chemical industry, especially, dielectric heating is still a great unexplored field offering new opportunities for growth and advancement to firms and men engaged in this work. —30—



Fig. 11. Wading pool heat sealing press.

Transmitters with up to 75 kw. of power, ranging in frequency up to 100 mc. or more could certainly wreak havoc with the communication and air navigation services. For this reason the FCC has set up strict rules to limit the amount of radiated power. According to these rules no machine may radiate more than 10 microvolts-per-meter at a distance of one mile irrespective of frequency, harmonics, or duration. To make sure that this limit is not exceeded manufacturers using r.f. generators must have a certificate of compliance granted by a competent engineering firm which is equipped to make these measurements.

While the r.f. generator itself is usually well shielded, the dies must often be in an accessible place and then they radiate quite a bit. The best method of shielding such machines is to house the entire unit in a suitable enclosure. In most plants, as shown in the photo of Fig. 6, the plates of the capacitor, at least, are housed in a screened room. This is unnecessary in



Fig. 12. Two-kw., 40-mc. manual sealer.

Table 1. Relative susceptibility to dielectric heating of a variety of materials.

MATERIAL	EXCEL- LENT	GOOD	POOR	LITTLE EFFECT	MATERIAL	EXCEL- LENT	GOOD	POOR	LITTLE EFFECT
Acetate Film		x			Polyvinyl Acetate		x		
Butyrate Film		x			Polyvinyl Chloride (Plastisol)	x			
Epoxy		x			Resorcinol Formal- dehyde Resin		x		
Kel-F			x		Rubber	x			
Micalex			x		Saran	x			
Melamine Formal- dehyde Resin			x		Silicone Materials				x
Nylon, Dacron, Or- lon, Dynel (Mylar)	x				Teflon				x
Plexiglass, Lucite	x				Urea Formaldehyde Resins		x		
Polyester Resins	x				Vinyl Film	x			
Polyethylene				x	Vinyl Foam	x			
Polystyrene, styrene				x	Water	x			
Polyurethane				x	Wood	x			
Foam	x								

Teen-Age Bed-Sitting Room

Fabric over heavy felt hung on the walls and a thick carpet practically soundproof this contemporary room for a teenager. The mobile cabinet houses stereo components and wheels easily to bedside. Speakers are in the chest of drawers and on a table opposite. The mobile unit can be rolled to other parts of the house where it operates with other speakers. (Designed by Daren Pierce.)



decorating with music

Five imaginative model rooms designed by members of American Institute of Decorators for 1959 New York High Fidelity Music Show.



Country Living Room

A relaxed and informal room for listening and reading combining American contemporary and French traditional styles. Music and books are easily accessible. High fidelity components for the stereo music system are installed in book shelves hidden by doors mounted with book bindings. When the doors are closed, the equipment is concealed. The speakers are recessed below each book shelf. The music system includes a tape recorder as well as a turntable. (Designed by Phyllis Horton.)



Provincial Music Room

Contemporary oiled walnut wood finishes on cabinets to house up-to-the-minute stereo high fidelity components are used in a background of old world provincial charm. Speakers are located in individual cabinets which can be moved or repositioned. Entire music system is concealed when not in use. (Designed by David Eugene Bell.)



Eighteenth Century Collector's Study

Study for couple interested in collecting antiques and in the fine arts. The coffee table houses the stereo components. Loudspeakers are located in cabinets under triangular book cases. (Designed by Hector Grant.)

Contemporary Living Room

Handsome stereo components open to view in a glass case along with sculpture and paintings are the main design elements. Corner speakers, covered with fabric, have hard-surface walls in order to extend speaker horns. (Designed by Joseph Freitag.)





Hand-Held Citizens Band Transceiver

By J. M. PRICE and J. P. OVERLEY
Radio Mfg. Engineers Inc.

Completely transistorized unit with just under 100 mw. input power may be used without any license or permit.

WHILE currently available Citizens Band equipment leaves little to be desired, there are two areas of needful improvement. These are true mobility and relief from the exasperating, but necessary, time-consuming licensing procedures. The RME Model 4303 transceiver to be described provides the answer to both these needs.

Designed for ultimate mobility in short-range communication applications, the Model 4303 features a full superheterodyne receiver and class C modulated transmitter, complete with its own battery power supply, in a package measuring a mere 9½" x 3¾" x 1¾", and tipping the scales at a featherweight ¾ pound. The unit sells for just under \$100.

Unlike other equipment designed for the 27 mc. Citizens Band, this unit is specifically intended for use over relatively short line-of-sight paths in industrial and field applications. In contrast to the by-now-common 5-watt units available, the Model 4303 is a "mighty midget," boasting of its just-under 100 milliwatts. It is, however, this same 100-milliwatt power limitation that provides one of its salient features. Part 15 of the FCC Rules and Regulations provides that a low-power communication device may be used *without* a license when properly certified by the manufacturer. Briefly, the restrictions and certification requirements are: 1. Power input must not exceed 100 milliwatts; 2. Total antenna length must not exceed 60 inches; 3. Spurious radiations must be at least 20 db below carrier; and 4. The carrier must be restricted to the frequency limits specified by Part 15 (26.97 mc.-27.27 mc.).

By happy coincidence, most of the Citizens Band channels fall within the limits specified for low-power communication devices.

Using RCA's latest drift transistor oscillator (it still bears a development number, 3552A) the 100-milliwatt limitation is met well within ratings. To insure compliance with the antenna restriction, RME has used a combina-

tion of hidden antenna connector and oversized telescoping rod making it rather difficult to attach other than the antenna furnished with the unit. When loaded beyond safe or legal limits, the transistor oscillator tends to "suck out" of oscillation.

The Model 4303 receiver in current production utilizes an RCA 2N1225 transistor for r.f. mixer service. The 2N1225 is of the drift type known for excellent performance through the v.h.f. band. Careful alignment can produce a sensitivity on the order of 1 microvolt, well within the manufacturer's published specification of 2 microvolts.

Of interest is the fact that one of the development requirements specified that all components should be commonly available. In the actual unit, all components are "standard" except for the double-duty modulation/audio-output transformer. This has served to reduce the consumer cost of the unit and will, undoubtedly, facilitate speedy servicing because of the ready availability of replacement parts.

Circuit Description

The 2N1225 mixer stage in the superheterodyne receiver is fed from a broadly resonant tuned circuit which is tapped to match the very high whip-antenna impedance to the low impedance of the mixer input. The location of this tap is chosen to provide maximum signal-to-noise ratio. The level of internally generated transistor noise is less than that of ignition interference and man-made static found at most receiving locations. The .05 µf. base-coupling capacitor maintains a low impedance in the input circuit, even at the intermediate frequency, thus minimizing regenerative tendencies in the mixer.

The local oscillator circuit is a frequency-stabilized, common-base circuit designed to minimize detuning effects with variations in supply voltage and temperature. Its output is inductively coupled to the mixer by means of a two-turn link.



The two intermediate frequency amplifier stages operate at 455 kc. and are coupled by means of miniature, single-tuned transformers. Automatic gain control is applied to the first i.f. stage to prevent overloading when operated close to another transceiver. By using drift-type transistors, a relatively high gain may be obtained with complete stability and without the need for neutralization of any kind.

The second detector diode supplies both audio for use in later stages and the a.g.c. current which is filtered and fed back to the first i.f. amplifier. A slight d.c. forward bias is maintained on the diode to increase rectification efficiency and reduce distortion to low signal levels. Additional filtering to remove any 455 kc. component takes place at the detector output and a volume control is included at this point.

A two-stage audio amplifier provides the frequency response correction and gain necessary to drive the two-inch speaker to an output capability of 30 milliwatts, sufficient for all intended applications. The use of smaller-than-usual values of bypass and coupling capacitors in these stages results in high-frequency boost, which corrects for loudspeaker characteristics and gives a crisp, intelligible signal.

The audio section doubles as a speech amplifier and modulator in the transmitting mode. The speaker is employed as a microphone and its 48-ohm voice coil drives the audio input transistor without the need for a matching transformer. The shaped response also helps to improve quality in this mode of operation since a speaker, when used as a microphone, normally exhibits a 6 db-per-octave roll-off above the fundamental resonance of the cone.

A high-frequency drift-type transistor (the 3552A) is used in the crystal-controlled transmitter in a negative-resistance or phase-shift type of

circuit. This configuration is unusual in that r.f. energy from the tuned circuit is fed back to the base *in-phase* with the collector. The tank circuit must be tuned to a frequency slightly below that of crystal resonance for oscillation to occur. Sufficient stabilization is incorporated to insure that under no condition will the d.c. input to this stage exceed the 100-milliwatt limit specified by the FCC. Modulation is applied to the collector because of inherently good linearity of this system and because greater r.f. efficiency can be realized than with other types of modulation.

Switching between the transmitting and receiving modes is accompanied by a 3-pole, double-throw push-button switch. One section changes over the antenna, a second switches the speaker from output to input of the audio amplifier for use as a microphone, and the third section applies battery power to activate either the receiver front-end or the transmitter.

Sufficient decoupling is used in biasing and power-supply leads to insure stability under the varied conditions of operation and each stage employs emitter resistor to stabilize current drain over the range of all normally encountered temperatures. Printed circuit construction permits absolute uniformity of layout so that optimum performance can be realized in production units. Although parts placement is not critical, optimum stability and sensitivity are achieved by using printed circuit boards so that lead inductance and stray capacitance can be accurately controlled.

Applications

Since there is considerable "overlap" in frequencies allocated to both the Citizens Band service and those specified in Part 15 for low-power use, the transceiver is supplied with $\pm .005\%$

crystals centered on Citizens Band channels, thereby permitting its use in conjunction with systems licensed under that service. When used to communicate with stations licensed for Citizens Band service, the standard licensing requirements for CB must be met.

While the manufacturer indicates ranges of coverage on the order of one mile or more, in field tests communication over a three-mile path has been accomplished. Field tests have also indicated a battery cost of approximately two cents per hour or approximately 60 hours of useful life, based on an average use of four hours per day with 25% transmitting time.

While there will undoubtedly be many thousands of these units used by sportsmen in the field, boating enthusiasts, and families needing truly portable wireless intercoms, the big value of the unit promises to be in the industrial field. Applications from the bridge construction field to much-needed communication for highway flagmen are within the capabilities of this unit. Football spotters, band directors, loggers topping trees, parking area patrols, plant security guards, and warehouse shipping clerks will soon be performing their duties accompanied by this handy "wireless telephone."

In field testing these units, two applications fell into the "boon to mankind" category. One of the units was hung around the neck of a lively six-year-old with a penchant for disappearing from family outdoor gatherings. This placed him "on call" at all times. The second, and more practical application, involved adjusting a six-meter beam for maximum front-to-back ratio.

It is not outside the realm of possibility that someday we will see the FCC issuing "calls" to newborn babies as part of their birth certificates! -30-

The receiver portion of the transceiver is a complete superhet, the audio portion of which is used as the transmitter modulator.

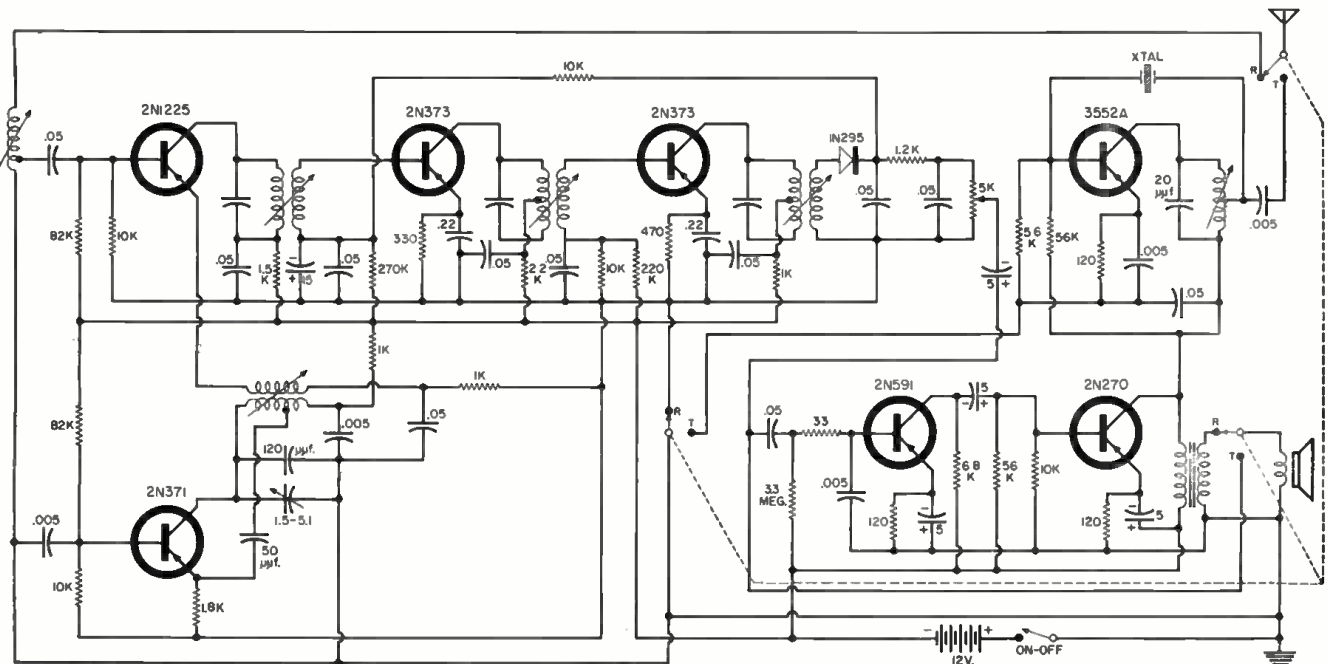

Balancing Your Stereo System

By HERMAN BURSTEIN / For good stereo the acoustic output from both channels must be closely matched. Here's the how and why of it.

CLOSE balance between the two channels of a stereo system—within 2 db or less—is considered by experts to be one of the prime requirements for a successful stereo illusion. While this basic premise may change at times because of room acoustics, the listener's position in the room, or other factors, equality of sound levels nevertheless serves as a fundamental reference point, from which one may depart temporarily to secure a desired effect, but to which one may always return to get his bearings.

Specifically, at an identifiable setting of the balance control,¹ preferably when the knob points to 12 o'clock, equal incoming signals should produce equal acoustic output from the speakers. The signals referred to are those on a stereo disc, on a stereo tape, or emanating from AM-FM radio tuners in a stereo broadcast.²

A helpful analogy is the requirement of flat response in a control amplifier. The bass and treble controls are needed to compensate for tonal char-

acteristics of program material, room acoustics, speaker deficiencies, individual hearing deficiencies, and the Fletcher-Munson characteristic of human hearing (apparent loss of bass, and to some extent of treble, as volume is reduced below the original performance level). Hence, flat *acoustic* response is very often *not* obtained by setting the tone controls to mid-position. However, for purposes of reference, we want to know that response is *electrically* flat at mid-setting of the tone controls. Similarly, it is desirable that a given setting of the balance control should entail balance between channel levels in a stereo system, even though subsequently we may wish to alter the balance.

The following discussion deals with sources of imbalance in a stereo system and with the controls and methods for correcting imbalance.

Sources of Imbalance

Each of the basic elements of an audio chain is a potential source of imbalance. These elements, as shown in Fig. 1, are: 1. program source—disc, tape, or radio signal; 2. signal source—phono cartridge, tape head or tape playback amplifier, or tuner; 3. control amplifier; 4. power amplifier; and 5. speaker.

Differences of several db often exist between the two channels of a stereo disc or stereo tape. The differences referred to are not those in the sound source itself (for example, a greater volume of sound produced by the left side of an orchestra than by the right side), but those due to misadventures in the recording process. Similarly, there are differences in the strength of the signals emanating from the transmitters involved in a stereocast.

Significant imbalances may occur in the signal sources. The two sections of a stereo cartridge or a stereo tape head may differ in output by as much as 6 db. The two sections of a stereo tape playback amplifier may differ by a few db. The sensitivities of an AM tuner and an FM tuner employed for stereo will vary. The resulting imbalance between the two tuners may be mitigated or aggravated by changes in sensitivity of each tuner from one end of the tuning range to the other.

Where matched amplifiers are employed (such as two power amplifiers of the same brand and model or two control amplifiers on a single chassis), small imbalances between channels may exist due to parts tolerances. When unmatched amplifiers are employed, imbalance can become profound. Control amplifiers may range in

¹ A number of stereo amplifiers have individual, concentric gain controls for each channel, with a locking device so that the two may be operated in unison as a master gain control. The present discussion also applies, in essence, to this manner of controlling balance and gain.

² What is said here about AM-FM stereo, as yet the prevalent means of stereo transmission over the air, applies basically to FM multiplex.



sensitivity—input voltage required for 1 volt output—from about 50 millivolts to 300 millivolts, a difference of 16 db. Power amplifiers may range in sensitivity—input voltage required for 10 watts output—from about .1 to 1 volt, a difference of 20 db.

Speakers of identical brand and model may vary a few db in efficiency, depending upon the rigor of manufacturing standards. Speakers of different types can range from about 1% to 20% in efficiency, a difference of 13 db.

While it is probable that imbalances in one direction in some components will offset imbalances in the opposite direction in other components, it would be a rare stroke of luck if the net imbalance for the entire stereo system were reduced to less than 2 db, as is highly desirable. Thus a balancing problem is likely to confront the stereophile who wants optimum performance.

Installations containing a stereo control amplifier or a stereo adapter invariably have a master gain control. Tracking error of this control—variation in level *between* channels as the control is rotated—tends to be a significant source of imbalance. Ideally, tracking error should not exceed 1 db, although in practice it tends to be 3 db or more. The author has come across tracking errors as great as 10 db, that is, perfect balance between channels would exist at one position of the master gain control, while at another position there would be 10 db difference between channel levels.

Correcting Imbalance

To achieve balance, it might seem that one merely has to adjust the balance control found in most stereo control amplifiers and adapters. But the situation is not that simple, for the following reasons:

1. The amount of imbalance between left- and right-channel components, particularly if unmatched amplifiers and/or speakers are used, may be so great that the balance control is inadequate to the task. To some extent this depends upon the design of the control, which may provide from infinite down to 6 or 8 db correction for channel differences.

2. To provide a readily identifiable reference point, it is desirable that balance between components occur at mid-setting of the balance control rather than at a position considerably to either side.

3. It is desirable that balance between components occur at mid-setting of the control so that one may have sufficient reserve in either direction for correcting other imbalances. To illustrate, if balance between components were achieved by turning the balance control almost fully clockwise, there might not be sufficient reserve to compensate for severe inequality between channel levels on a stereo disc or tape.

Accordingly, before resorting to the balance control, it is desirable to achieve balance between components by means of whatever other controls

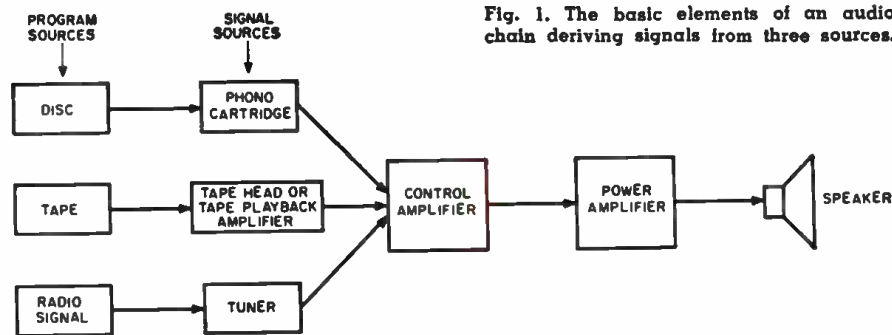

Fig. 1. The basic elements of an audio chain deriving signals from three sources.

are available. It then remains for the balance control to compensate for imbalance due to two factors: (1) inequality between channel levels in the program source (disc, tape, AM-FM stereocast); (2) tracking error of the master gain control.

Depending upon the components employed in a given installation, some or all of the following "other controls" may be available for correcting imbalance:

1. Input level-sets in the control amplifier.

2. Input level-set in the power amplifier. It is virtually universal practice to incorporate a level-set in the power amplifier. But in the case of integrated amplifiers—control amplifier and power amplifier on one chassis—the level-set for the power amplifier section is non-existent as far as the author knows (although it would be useful to have one). If one plans to employ dissimilar speakers for stereo, it may be advisable to purchase power amplifiers separate from control amplifiers, so that the input level-set of the power amplifier can be used to compensate any major difference in speaker efficiencies. If one plans to use integrated amplifiers, it is wise to plan on using matched speakers as well.

3. Speaker L-pads. The difficulty is that a pad may significantly reduce the ability of the power amplifier to damp the speaker and may therefore lead to boomy or muddy sound. Hence its use in high quality installations is questionable.

4. Volume controls in the signal source. These are generally available in the case of tuners and tape playback machines.

Balancing the System

The stereo balancing procedure may be divided into four steps:

1. The first is to set the balance control at mid-position (or in the case of concentric gain controls, to rotate their knobs to the same degree), which is the reference point. Since balance is likely to be upset as the master gain control is rotated, the latter should be turned to normal listening position and this position (ideally about 12 to 2 o'clock) should be noted as a reference point. In sum, when the balance control is at mid-position and the master gain control is at "normal" position, this should denote that equal signals coming into the stereo system from

disc, tape, or radio will emerge as equal sound levels from the speakers, as measured by that quite accurate instrument, the human ear.

2. The next step is to furnish the same signal (not one-half of a stereo signal) to each channel of the signal source, that is, to the stereo cartridge, stereo tape head, or AM-FM tuner pair. In the case of the stereo cartridge, a monophonic disc will present identical signals, equal in frequency content and level, to each section of the pickup. In the case of the stereo tape head, test tapes are available that alternately furnish the same signal to each section of the head or one can improvise a satisfactory source of equal signals for each channel as follows. Obtain a reel of erased tape. Run it from reel to reel with the tape machine in playback position, and hold a bar magnet firmly against the travelling tape. This will cause a substantial amount of noise to appear across the full width of the tape, supplying the same signal to each section of the head. (After the tape has been played for balancing purposes, it is advisable to demagnetize the heads to remove magnetization resulting from the d.c. signal on the tape.)

In the case of an AM and FM tuner pair, the procedure would be to tune each unit to a monophonic program broadcast by the same AM-FM station that transmits stereo material. If there is more than one such AM-FM station, balance should be obtained on the basis of the station to which one listens most frequently. Adjustments for other stations, assuming that balance between the AM and FM tuners changes with station, can be made with the balance control or with the volume control of one of the tuners (the one producing the highest level).

3. The third step is to provide for rapid switching between two conditions: left channel on and right channel off; or left channel off and right channel on. This enables one to compare the acoustic level of each speaker when reproducing the same signal. Some stereo control amplifiers, power amplifiers, and integrated amplifiers incorporate such an A-B switching facility. If not, the listener can install an A-B switch as shown in Fig. 2. Note the use of protective 50-ohm, 10-watt resistors to prevent possible damage to the output transformer when the

Balancing Your Stereo System

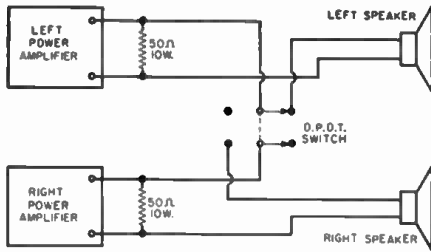

Fig. 2. An A-B switch used for balancing.

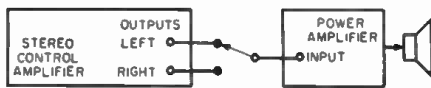

Fig. 3. Balancing of control unit's output.

loudspeaker system is switched off.

For accurate comparison of the speaker sound levels, the listener should be equidistant from the speakers. To minimize error, the speakers should be temporarily positioned next to each other, if possible.

4. The final step is to adjust level-sets (on the control amplifier or power amplifier), volume controls (in the tuner and tape playback machine), and, as a last resort, speaker L-pads in order to achieve acoustic balance while A-B switching between the two speakers. As a general rule, the earlier in the audio chain that the signal is reduced, the lower the distortion. Thus if one has a choice between using the level-set in a control amplifier or the level-set in a power amplifier to achieve balance, it is usually preferable to use the former.

There may be control amplifier level-sets for some signal sources but not for others. The procedure would be to first balance the signal source for which there is no level-set, using the balance control if no other means exist. The resultant setting of the balance control would thenceforth be the reference point. Leaving the balance control in this position, one would then balance the sources for which there are level-sets. To illustrate, a stereo integrated amplifier of one well-known make supplies input level-sets only for a stereo tape amplifier and for the AM and FM (or multiplex) tuners. No level-sets are provided for phono. Since this is an integrated amplifier, no power amplifier level-sets are available. Therefore one would have to achieve balance on the phono signal by means of the balance control (assuming speaker L-pads are not used). Leaving the balance control at this setting, one would then equate the signals from the stereo tape amplifier by means of the available level-sets; and similarly for the signals from the tuners.

Sometimes the only available level-sets are in the power amplifiers. The procedure might then be as follows. First, use these level sets to equate the phono signals, with the balance control at mid-position. Second, equate the

AM and FM tuners by means of their respective volume controls, taking note of the positions which achieve balance. Third, equate the tape machine's signals by means of the latter's volume controls, taking note of the positions which achieve balance. If, instead, the tape signals are taken directly from the stereo tape head, these signals would be balanced by means of the balance control, taking note for future reference of the position where balance is achieved.

Occasionally, no level-sets whatsoever are available. In this case one would have to rely on the balance control for each signal source, taking note in each instance of the position that corresponds to balance. It might be worthwhile, for the source most frequently used (for example phono), to remove the balance control knob, rotate the balance control shaft until balance is achieved on phono, and replace the knob so that it points to 12 o'clock; this is feasible if the knob is secured by means of a set-screw instead of a pressure-fit to a flattened shaft. Thus the easily remembered 12 o'clock setting will denote balance for phono, even though it will not be possible to turn the control equal amounts to the left and right. Balance control positions for the other signal sources can then be determined.

Electrical Balancing

For some purposes it may be desirable to achieve *electrical* balance—which is not necessarily the same as *acoustic* balance—at an intermediate point in the stereo system. Such balance, for example, might be desired at the outputs of the control amplifier or of the power amplifier in order to feed equal signals to a phantom channel. Or it might be desired to insure equality of signals fed to a stereo tape recorder.

One may check for equal signals by means of a pair of balanced meters, which are sold by a number of manufacturers as a single unit specifically for stereo. While the level of a steady signal may readily be gauged in this manner, it is difficult to read the level of program material. To get around this difficulty, one can employ a conventional meter capable of following audio signals, and connect the meter leads to the hot side of each output. The voltage differential between equal signals will be zero and the meter reading will be minimum at the balance point.

A similar null principle is incorporated in at least one stereo control amplifier as follows. The signal of one of the channels is phase inverted 180° and then combined with the signal of the other channel at both output jacks. When the signals are in balance and opposite in phase, minimum sound will be heard from the speakers.

Another stereo control amplifier on

the market uses two "microbeam" indicators (magic-eye tubes with long rectangular bar screens) to facilitate electrical balancing.

In the absence of a meter or other balancing device, electrical balancing can be achieved by ear. This entails connecting *one* power amplifier-speaker combination alternately to the left and right output jacks of the control amplifier, as in Fig. 3. Some stereo control amplifiers provide such a facility. If not, the user must improvise. (If the channel-reverse switch is at the output rather than input end of the control amplifier, then the switching scheme of Fig. 3 is available.)

Balancing for Inequalities

The foregoing balancing procedures assume that the stereo program source (disc, tape, radio) will have equal level in each channel. This, however, may not be true, although it will probably tend to be increasingly true as stereo techniques are improved. Where the two channels of the program source are of unequal level, this should be compensated by turning the balance control from its reference position, meanwhile using the amplifier facilities or the method of Fig. 2 for alternating the sound between the two speakers until the ear is satisfied that balance exists.

Balancing for Tracking Error

After having balanced his system, with the master gain control in a position corresponding to normal listening level (more or less), the stereophile would be well advised to spend some time in experimentally ascertaining what happens to this balance as he varies the master gain control. In this way he can learn how much and in what direction to adjust his balance control to compensate for imbalance produced by the master gain control.

Balancing for Position

The balancing procedures that have been discussed assume that the stereophile will do his listening from a position approximately equidistant from his speaker systems. But if he takes a position much closer to one speaker than the other, he may well desire to adjust the balance control to favor the farther speaker.

On the other hand, it may be reasoned that if one moves away from an equidistant listening point, this corresponds to sitting at the left or right instead of at the center of a concert hall (or other site), and therefore one should not tamper with the balance. This is a matter of personal preference. It can be countered that a listener at the left of a concert hall might be happier if the conductor asked the orchestra members on the right to play a little louder. The balance control affords one the luxury of controlling the orchestra in this manner. —30—



By **D. J. BLATTNER**

RCA Electron Tube Division

Today, in the age of target-seeking missiles, radar and radar countermeasures are even more sophisticated than ever before. Here are some methods that have been and are being employed.

ELECTRONIC countermeasures (ECM), the art of jamming or deceiving an enemy's radio and radar, is both old and new. At the very beginning of World War I, the Germans jammed British radio communications to cover the escape of their warships *Goeben* and *Breslaw* to Turkish waters. In the cause of ECM the World War II allies broadcast Nazi propaganda, distributed Christmas decorations to the German populace, and flew jamming planes over Tokyo. Countermeasures saved 450 U. S. bombers and 4500 American airmen from destruction by radar-controlled German flak, and turned back Japanese torpedo plane attacks in the battle for Leyte Gulf.

Today, in the age of target-seeking missiles, both radar and radar countermeasures are more sophisticated than ever.

Use in Great Britain

The World War II struggles for scientific supremacy involving the then little-known countermeasures devices was called the "Wizard War" by Sir

Winston Churchill, and England needed this "wizardry" during the Battle of Britain to save London and her other cities from chaos and total ruin. Initially, German bombers were navigated by the use of radio beacons. A large number of these beacons, each with its own characteristic transmission, were set up at various points on the continent so that the German navigators could use radio direction finders to fix their positions by the bearings of any two stations. The British countered this scheme by picking up the German signals and rebroadcasting them from England. The false bearings led the German navigators astray and a number of planes were lost in this way. One German bomber actually landed in southwestern England under the impression that it was in France.

At the end of August 1940, however, the Luftwaffe came up with a scheme whereby their bombers flew along a narrow radio beam which was crossed by a second beam over the intended target. The British had anticipated

this plan before it was put into effect and were ready for it. They picked up the beam, carried it over telephone lines for a few miles, and rebroadcast it at a stronger level in a direction which intersected the original beam at a slight angle. This deflection of the beam was not perceptible to the bomber pilot and it placed him far off the target with his bombs. German air crews wandered around England bombing open fields for several months before they realized that their navigation beams were being juggled.

The Germans then tried to disguise their beams. They would cover England with a propaganda broadcast and then narrow its coverage to a thin beam over the intended target. British intelligence soon noted that, in a target area, radios tuned to the propaganda broadcast suddenly grew louder just before an air raid, while radios elsewhere lost their volume. They therefore picked up the Nazi propaganda broadcasts and retransmitted them from omni-directional antennas, making them useless for navigation.

Electronic Countermeasures

THE ART OF JAMMING



The effective use of these and other countermeasures so disrupted the German bombing systems that only one bomb in five fell within a target area. This 80 per-cent reduction in the enemy efficiency was a great victory for the British at a time when all other means of defense had failed or were strained to their limits.

In the fall of 1940 the Germans switched to night bombing in an attempt to reduce their aircraft losses, but the British soon had radar-equipped night fighters in the sky. Partly because their beams provided information on the direction and timing of raids, the Germans lost too many bombers to maintain the aerial blitzkrieg. In May of 1941 the German Air Force broke off the attack on Great Britain, and turned for action to other theaters.

The European Theater

As the Luftwaffe bombers faded from the skies, RAF night raids on the invasion coast and "Festung Europa" grew in intensity. To locate the British bombers from the air, the Nazis began in 1942 to install the 500-megacycle Lichtenstein airborne radars in their night fighters. The success of this equipment, nicknamed "Emil-Emil" by the German pilots, demanded development of a countermeasure. Jamming by a transmitter carried in the bombers was not feasible because the jammer itself would serve as a beacon. It was decided, therefore, to locate a tremendously powerful ground-based jammer on the English coast pointed toward France to blot out the screens of the German night fighters as they chased the homeward-bound bombers.

The U. S. was asked to furnish this transmitter under lend-lease and work was begun on the "Tuba" jammer in 1943. It used a powerful resonant u.h.f. oscillator which generated 50 kilowatts c.w. at any frequency between 350 and 650 megacycles, with noise modulation. The waveguide output led into a horn radiator made of chicken wire, 150 feet long and having a 6- by 18-foot opening. Tuba went into tactical operation early in 1944 and was used to blanket the sky above the Normandy invasion.

As the allies gained aerial supremacy over Europe and the problem of German fighter plane opposition diminished, the Germans built up formidable anti-aircraft installations which used from 4 to 16 guns operating with a Wurzburg fire-control radar system. (At the time of World War II, the Germans called radar "Funkortgerät," or "Funkpeilgerät," or even "Funkmesstechnik mit Impulsmodulation". They now call it "radar".) Over 4000 Wurzburg radar batteries were put into service to defend important targets and their accurate fire produced heavy losses among attacking bombers.

The air forces turned to countermeasures to furnish a "magic carpet" on which the bombers could safely fly

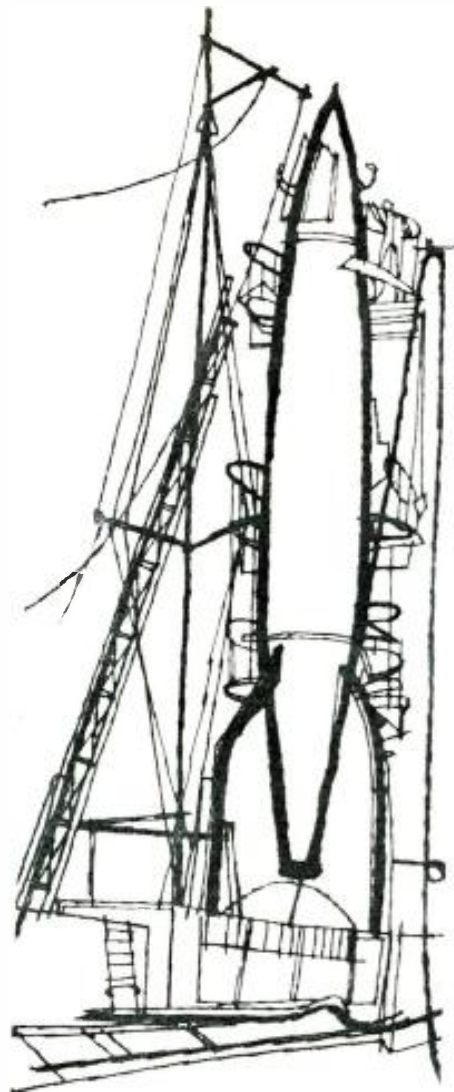

over the German flak. In the summer of 1943, "Carpet" jammers were installed in the aircraft of two 8th Air Force bomber groups. Each jammer radiated six watts of noise-modulated c.w. in a 7-megacycle band. The center frequency could be tuned over a wide range around the 560-megacycle nominal operating frequency of the Wurzburgs.

Because the Wurzburg antenna used a spinning dipole, the jamming signal had to be circularly polarized. This polarization was accomplished with a "Fishhook" antenna using two stubby dipoles at right angles. The two bomber groups initially equipped with Carpet jammers sustained less than half the losses of non-equipped groups. Therefore, the entire 8th Air Force was equipped with these electronic jammers.

The Germans tried to escape the jamming by staggering the frequencies of their radar units but the allies began dropping strips of aluminum foil to produce false echoes on the enemy radar screen. Known as "window" by the British and "chaff" by the Americans, these aluminum strips were dropped by the millions; more than 20,000 tons were dispersed over the German countryside. (The German citizenry gathered this tinsel for Christmas tree decorations.) To be efficient reflectors, the strips had to be close

to a half wavelength long, so a range of lengths was distributed. On a radar screen, an aircraft throwing out chaff seemed to multiply into a whole swarm of targets which stayed behind as the plane flew off. Succeeding aircraft were then hidden from the radar as they flew through the slowly falling cloud of foil. Planes outside the cloud were not hidden, but the material fell so slowly (150 ft./min.) that the area over a target could be cluttered for hours, rendering radar gun directors useless.

To achieve radar vision in a chaff cloud the Germans developed radar circuits which would distinguish between moving and stationary targets, but these circuits were all the more susceptible to the Carpet jamming. Conversely, the use of anti-Carpet devices made the radars more vulnerable to chaff. Thus, the combination of electronic jamming and confusion reflectors produced effective protection against anti-aircraft fire. The Germans found that while 3000 rounds were fired to bring down a bomber protected by ECM, less than 800 rounds were required per kill in the absence of jamming. Thus, the effectiveness of the radar-controlled anti-aircraft defenses was reduced by 75 per-cent. Since 150 bombers were lost to such anti-aircraft fire, it can be estimated that ECM saved 450 planes and 4500 men in Europe.

The Invasion

As the time for the invasion of Europe approached, the impressive radar coastal defense of the Germans became a major topic at planning conferences. At least 50 radar installations, each having at least two radars—early warning and gun laying—were known to exist between Dieppe and the tip of the Cherbourg peninsula.

These sets were adapted to supplement or replace each other and were diversified. For example, the early warning Freyas, which had all operated within 8 megacycles of one another at the beginning of the war, were now dispersed over a band about 100 megacycles wide. It was necessary to put these radars out of effective operation in order to prevent the enemy from finding out where our forces were concentrated. This purpose was accomplished by deception and by jamming as well as by bombing and strafing attacks on the radar installations.

On the night before "D-Day," airplanes carrying jammers cruised up and down the south coast of England jamming the German early warning radars to prevent them from seeing our air squadrons forming over England and approaching the continent. Groups of small craft, equipped with huge reflectors and towing aluminum-painted balloons to make their radar echoes look like those of a major warship, approached the French coast at numerous widely separated points. Chaff was dropped over these groups to give them the radar aspect of vast convoys. A small force of bombers

using jamming and chaff simulated a heavy raid headed into Germany; this succeeded in drawing a number of Nazi night fighters off to the east of the invasion forces. The Germans later attributed much of the success of the invasion to this confusion which prevented them from meeting the launching forces with all the reserves at their disposal.

The Pacific Theater

In the Pacific war, the tremendous distances which our planes and ships had to traverse to strike at the enemy made radar (the Japanese name for radar was "dempa tanchiki"—electric search) defenses extremely important to the Japanese and made countermeasures vital to the U. S. forces. Far-ranging aircraft and submarines, equipped with search receivers, pinpointed Nipponese radar installations from the Solomons to the China coast. Up-to-date maps showing the areas covered by these enemy installations were maintained for use in operational planning. Enemy radar installations were often put out of action by strafing and bombing planes known as "radar busters" which were outfitted to "home" on the radar signals. The enemy operators soon grew chary of having their own radars used as beacons and would cease transmitting when planes flew too close to them.

Because radar operates by reflection of signals while the search receiver picks up the transmitted signal directly, our planes and ships could detect an enemy radar long before it could detect them. Our forces made good use of this advantage in locating Japanese ships in the vast reaches of the Pacific and in spotting aircraft. On one occasion a Navy bomber, escorting a crippled U. S. submarine to its base through murky weather, picked up the signal of a Japanese radar-equipped plane. The bomber immediately headed toward the enemy transmissions, located a Betty bomber, and shot it down 8 miles from the submarine. Similarly, the U. S. submarine *Batfish*, in one action-packed patrol, located and sank three Japanese subs in succession by means of their radar transmissions. (The Japanese were unable to turn the tables and use our radars as beacons because there were no good Japanese search receivers at the frequencies of our radar equipment.)

When the Pacific Air Forces began to bomb the Japanese home islands, they encountered effective searchlight-control and anti-aircraft fire-control radars. To counter these radars, both electronic jamming and confusion reflectors were used, just as in Europe. Instead of chaff, however, 400-foot aluminum foil ribbons were dropped suspended from parachutes. This type of confusion reflector, called "rope", was such an effective countermeasure against the low-frequency radar used by the Japanese that each Superfort carried 600 pounds of "rope" on each mission.

In addition, every plane was equipped with at least one jamming transmitter. During daylight raids, when the bombers flew in massed formations, these jammers complemented one another and safely protected the entire flight. At night, however, the B-29's flew in long streams a mile behind one another. To screen each bomber from all the radars which might be encountered, a few special jamming aircraft carrying many jammers and search receivers flew over the target area parallel to and above the main bomber force. These "Porcupines"—so named because they bristled with antennas—were effective because the low frequency of the Japanese radars made their radiation and reception patterns broad and easy to fill.

In the Navy, ECM was a fleet-wide activity. Every ship from destroyers on up carried intercept and jamming equipment, and even landing craft carried jammers which were pre-set before amphibious operations to protect them from radar-controlled shore batteries. Some vessels also carried transmitters for deflecting German radio-controlled glider bombs.

Shipboard jammers were employed with conspicuous success against Japanese torpedo bombers using radar sights during the battle of Leyte Gulf. When jamming was turned on, the attackers were observed on the radar scope to waver from their course and finally turn back.

Naval ECM was decisive in the classic night action of the war when, in October 1944, a Japanese battleship force tried to pass through Surigao Straits to attack troop transports in Leyte Gulf. Five American battleships blinded the Japanese radar by jamming and then used their own radar-controlled gunfire to sink the enemy.

Communication Countermeasures

While jamming and deceiving enemy radar and navigation systems was an important phase of ECM in World War II, countermeasures against communi-

cations were also of vital importance. Aircraft and Army field radio circuits were monitored and jammed. One outstanding example occurred during the Libyan Desert campaign when the British aircraft radios jammed German v.h.f. tank radio sets: the pilots simply placed their microphones close to the airplane engine and broadcast its noise into the German tank radio receivers. On other occasions German-speaking Americans would break in on Nazi fighter-control radio circuits, giving contradictory orders and urging the pilots to ignore the other (real) instructions. When the Germans switched to female voices, German-speaking WAC's were ready to mimic them. The results were so disruptive that the Germans used a score of voice circuits simultaneously to insure reliable communication with their planes.

The "Cigarette" Signal Corps project for jamming enemy air-to-ground radio also figured extensively in the early defense against the V-2 rocket. The missiles radioed back height and speed data; at the right moment, as determined from this data, the Germans would turn off the rocket motor by radio and let the missile coast to its target. To deflect the missiles, false signals were sent from England to the V-2's, shutting off their power too soon so that they fell short. This countermeasure was so successful that the Germans gave up radio control and switched to gyro control, which we could not jam.

Countermeasures Now

The development of countermeasures systems has continued since the end of World War II to a point where this year the United States is spending over 400 million dollars on ECM—more than the total spent during World War II. Reflecting the state of offensive weapon development, most of the countermeasures are for airborne application. Bombers are defended from radar-controlled interceptors by use of ECM rather than by guns. Complete countermeasure system packages have been developed for the Air Force B-52 and B-58 bombers. One of these planes in each formation carries an ECM pod in place of a bomb load, providing electronic defense for the entire group.

Radar-guided missiles and interceptors continually measure the range and direction of their targets and feed this information to their guidance systems. If the radar can be induced, by ECM, to give false guidance information, the target is protected.

Range data can be obscured by use of a small electronic countermeasure transmitter which sends out a series of pulses at suitably spaced intervals each time that a pulse arrives from the enemy radar. A number of false targets are thus created, each at a different range. If the ECM pulses have the same length, frequency, and pulse repetition rate as the enemy radar, they cannot be distinguished from actual target echoes. If the false echoes

(Continued on page 126)

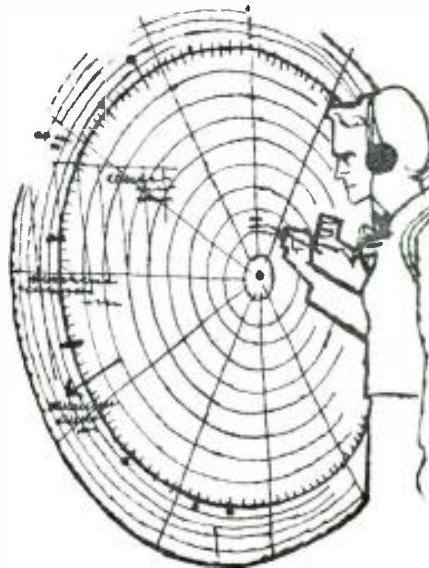

Phosphors and their uses

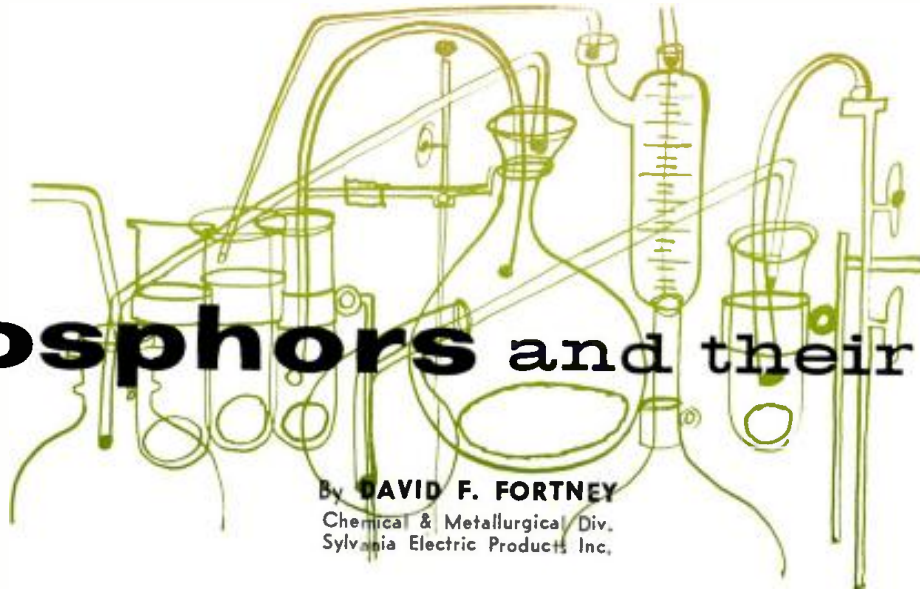

By **DAVID F. FORTNEY**
 Chemical & Metallurgical Div.
 Sylvania Electric Products Inc.

These remarkable fluorescent powders have made possible great advances in lighting and in visual communications.

TWENTY-FIVE years ago the making and use of fluorescent powders called "phosphors" or "light bringers" as well as the phenomenon of luminescence, while long well-known in the laboratory, had little significance to most people. Phosphors had few practical applications beyond the oscilloscope and the x-ray intensifying screen. We lighted our homes, offices, and factories with incandescent lamps. We had no television sets in our living rooms. During these twenty-five years, fluorescent lighting has enjoyed universal acceptance while the TV set is now a standard item of furniture in the American home. Luminescence, in lighting and in the television picture tube, has become as commonplace in our generation as the radio during our parents' time and as the incandescent lamp from the turn of the century to the first World War.

Phosphors, the light producing pow-

ders which make possible these advances in lighting and in visual communication, are inorganic materials which have the special property of absorbing energy in the ultraviolet range (lamp phosphors), from fast-moving electrons (TV picture tubes), or in a changing electric field (electroluminescence). Some of the energy so absorbed raises the electrons to higher energy states within the phosphor activator centers. When these electrons return to lower energy states, the energy is released as radiation of longer wavelength in the visible range of approximately 4000 to 7000 angstroms (400 to 700 millimicrons), or, in some cases, in the region of 3650 angstroms. This latter emission may be used to excite organic "black-light" paints or pigments. Visible emission from phosphors is ordinarily not monochromatic or in a narrow discrete band, but occupies a wide band having a spectral energy dis-

tribution curve of a "mountain peak" shape (see Fig. 1).

In general, lamp phosphors are inorganic silicates, borates, tungstates, and phosphates, usually activated by manganese, antimony, tin, or lead. Those used for TV picture tubes are sulfides of zinc and cadmium activated by silver, while the electroluminescent phosphors are copper-activated zinc sulfides. Barium silicate is a well-known "black-light" phosphor.

The color of a so-called "white" fluorescent lamp is designated by its color temperature, so that basically any lamp whose color falls on or near the so called black body line is considered a "white" lamp.

There has been and there still is considerable confusion for the user because there are so many varieties of "white" lamps. Table 2 helps clarify the situation and emphasizes that one of the most important advantages of

Fig. 1. Energy distribution of fluorescent lamp phosphors.

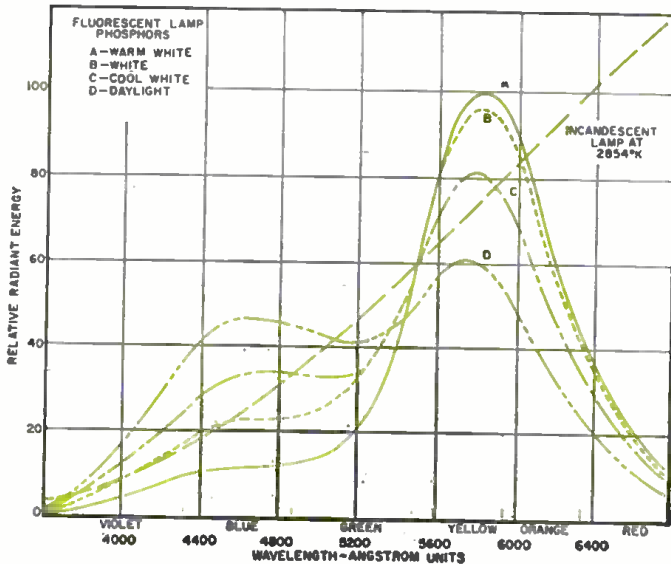
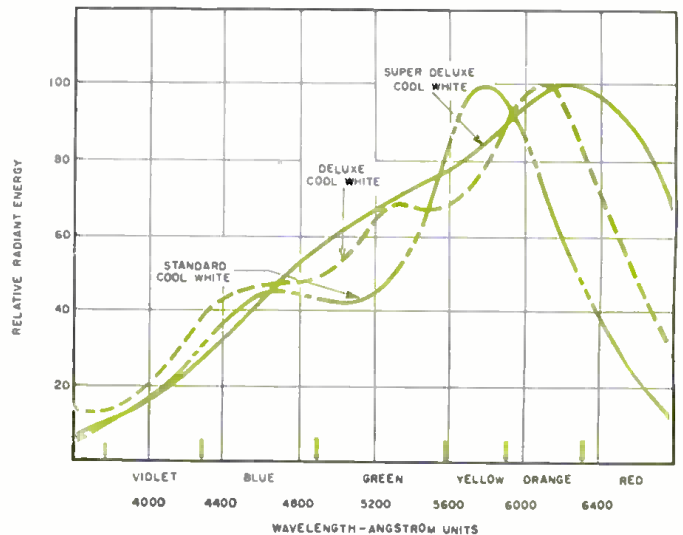

Fig. 2. Energy distribution of various white lamp phosphors.



fluorescent lighting is color control.

At the present time, by far the most popular lamp is the high efficiency "cool white" lamp, although large numbers of the other colors are in use for specialized applications. It should be understood that 4500° "cool white" lamps, for example, all look the same color to the eye, whether "standard," "deluxe" or "super deluxe." The differences arise in the appearance of objects under the various lamps. These differences are shown by a study of the spectral energy distribution curves in Fig. 2, in which the three "cool whites" are compared. The standard lamp is weak in red and green—strong in yellow. The "deluxe" is stronger in red and green. In the "super deluxe" lamp, the red is greatly increased and the colors are better balanced.

In the early days, manganese-activated zinc beryllium orthosilicate was the basic "white" phosphor used by all lamp makers. Actually this material is not a single phosphor, but a family of phosphors. By varying the Zn/Be ratio

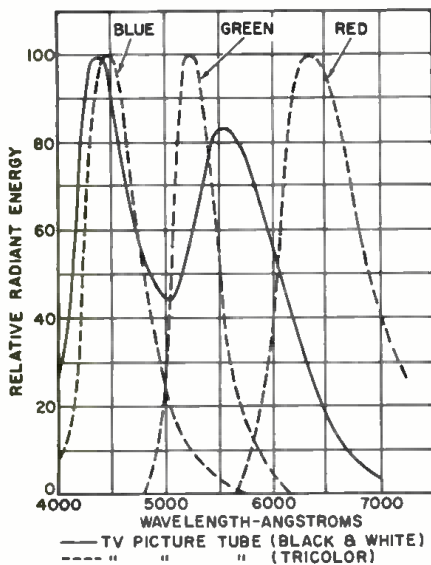

Fig. 3. Radiant energy of CRT phosphors.

and the manganese content, the color could be varied from a brilliant green through white to a pinkish color. Blue-white magnesium tungstate was blended with the silicate to adjust the color as desired.

Other important lamp phosphors which have been used for some years, either as color correction phosphors for white lamps or for the production of colored fluorescent lamps or sign tubing, are given in Table 1.

At present, the blue-white magnesium tungstate has been largely replaced by titanium-activated barium pyrophosphate, and the other blue tungstates by strontium pyrophosphate, tin activated. Both of these important phosphors were developed in Sylvania's laboratories.

Because of the toxic nature of the zinc beryllium silicate, the lamp industry in America and England completely discontinued its use in 1948, although

(Continued on page 98)

COVER STORY

THIS MONTH'S COVER shows a number of piles of Sylvania phosphors employed in the electronics and lighting industries. Under normal illumination these materials look like ordinary white powder. However, when illuminated by ultraviolet or when a thin film of the powder is excited by an electron beam, light of various colors is produced. In photographing our cover, we illuminated the white phosphor piles with four 15-watt ultraviolet lamps in order to produce the colorful effect shown. A yellow filter was used for color correction to remove the bluish cast that would have been produced.

Probably the most common use of phosphors is in the ordinary fluorescent lamp shown at the lower left of the cover. When current passes through the lamp, some ultraviolet radiation is produced. This excites the phosphor that coats the inside surface of the long glass tube. As a result, the phosphor glows brightly and gives off visible light.

The three electron tubes shown on the cover are all RCA types that employ various types of phosphors. The tube at the lower right-hand corner is the 21CYP22 color picture tube. This is the conventional three-gun shadow-mask type that uses a tricolor phosphor-dot screen. The screen is composed of an orderly array of small, closely spaced, phosphor dots arranged in triangular groups, or trios. Each trio consists of a green-emitting dot, a red-emitting dot, and a blue-emitting dot, and is aligned with a corresponding hole in the shadow mask. When the three electron beams in the tube cause these dots to be illuminated in various mixtures and com-

binations, a full-color picture is produced on the screen.

Directly above the color picture tube is a type 7448 display storage tube. This 5-inch tube produces a bright, non-flickering display of stored information for as long as 40 seconds after the image has first been produced. The tube utilizes two electron guns—one for writing and the other for viewing. The writing gun produces a beam that applies the pattern to a thin storage grid located just behind the tube's faceplate. The pattern is in the form of a distribution charge on this grid. Then a high-current, low-velocity beam from the viewing gun transfers the charge pattern on the storage grid to a highly efficient phosphor screen where an intense visible pattern is produced. Because of the high efficiency of the phosphor and the fact that it is continuously excited, rather than intermittently as in ordinary CRT's, a very bright, non-flickering display is produced.

Just to the left of the color picture tube is a small type 7404 image-converter tube. This tube is used with suitable optical systems for viewing an object or specimen irradiated with ultraviolet radiation, as in ultraviolet microscopy. The object to be viewed is focused by optical means on a semi-transparent photo-cathode at one end of the tube. Electrons from this image are electrostatically focused on the fluorescent screen at the other end of the tube by electron-optical methods. The resultant reduced image can then be viewed with an optical magnifier.

These are just a few of the many interesting and important uses to which phosphors can be put.

(Photo by Bruce Pendleton)

- (1) Type 7448 display storage tube.
- (2) The 7404 image-converter tube.
- (3) The 21CYP22 color picture tube.

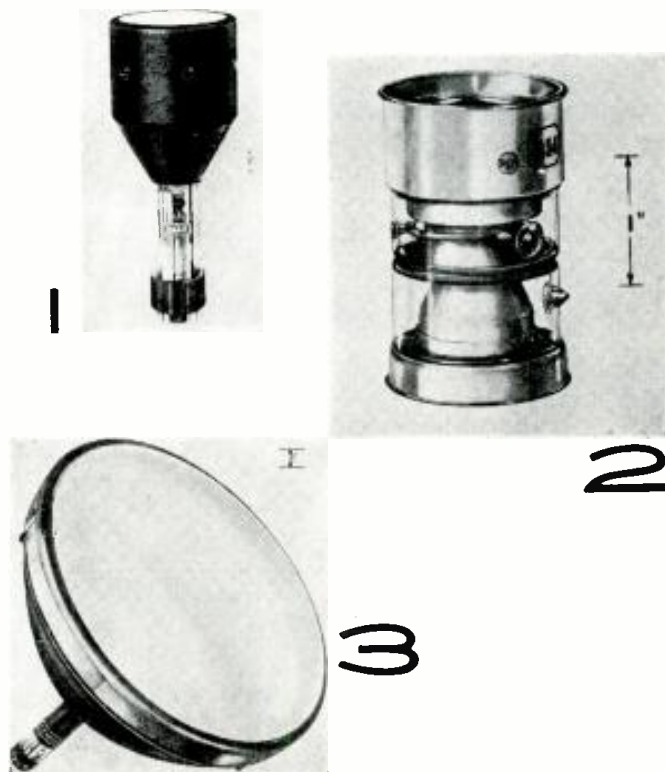

By JOHN T. FRYE



Grasshoppers & Compatibility

"HEY, MAC," Barney called to his boss; "look at the broken resistor I found in the bottom of this TV set a farmer brought in this morning. The set's nearly new; so I suppose the resistor fell into the chassis during production and jarred out later."

"What's wrong with the set?" Mac asked as he walked over to inspect the two pieces of the one-watt resistor Barney was holding.

"Don't know yet, but I think something's wrong with the tuner. There's no picture or sound and yanking the tuner tubes causes no flash of the raster, although pulling the first i.f. tube does cause a flash."

Mac swung the flexible bench light so he could see down alongside the tuner.

"That's it!" he exclaimed. "The grasshopper's empty."

"The grasshopper's empty," Barney mimicked. "Now I ask you: is that any kind of talk for a grown man? We're repairing radio and TV sets, not studying the dietary habits of insects, remember?"

"Don't try to be so smart," Mac admonished as he rapped Barney sharply on top of his curly red head with the alignment tool he was holding in his hand. "Do you see anything odd about this tie-point assembly on the side of the tuner case?"

"Hm-m-m-m, it looks sort of queer. This long, tapering point on the end is shaped differently from the others," Barney observed as he flipped it with his finger. It vibrated with a pronounced "ping."

"That's what technicians call a 'grasshopper,'" Mac explained. "It's a simple but effective circuit breaker used in new RCA black-and-white TV receivers to protect the r.f. circuit inside the tuner if a short occurs in a tube. Let me show you how it works."

Mac got out some service literature and studied it carefully for a few seconds. Then he took an 870-ohm, 1-watt Allen-Bradley resistor from the resistor chest and bent a lead at right angles $\frac{1}{16}$ " from the resistor body. The

other lead was also bent at right angles so that the distance between the two bends was $1\frac{1}{16}$ ". Finally he snipped off the ends of the two leads so only $\frac{1}{4}$ " was left between each end and the adjacent bend.

Next he hooked one end of the resistor through a hole in the top of the odd-shaped tie-point and sprung the point down with his thumb while he hooked the other resistor lead through a tie-point on the opposite end of the strip. Tension produced by the tapered, spring-like tie-point held the resistor firmly in place, making an angle of about thirty degrees with the tie-point strip. The whole thing *did* look a little like a grasshopper poised to jump.

"If an r.f. tube short-circuits," Mac explained, "the heavy current through the resistor heats it until it chars. The spring tension pulls the weakened resistor in two and breaks the circuit, thus saving the tuner coils from damage."

"Hey! That's neat!" Barney applauded; "and the same little old grasshopper could be used to advantage in lots of other places as a cheap, self-indicating, reliable fuse. I can think of a couple of places in my ham rig where I can use that idea. Well, slip on the set and let's see if it plays."

"Aren't you forgetting something?" Mac asked quizzically.

Barney flushed to the roots of his red hair. "I win the ermine-trimmed tube puller!" he said in disgust. "Gimme that r.f. tube and I'll check it."

Sure enough, the tube was shorted. When a new one was put in the tuner, the receiver played perfectly.

"Well, I may as well slap it back in the cabinet," Barney said.

"Wait a minute. I want to show you something else about this set that may come in handy," Mac said as he looked up from the service literature he had been studying. "See this resistor in series with one of the primary leads of the power transformer?"

"Yeah, what's the idea?"

"It's a new negative-temperature-coefficient surge resistor. Cold, it meas-

ures about 120 ohms; but when current passing through it heats it up, the resistance drops to one or two ohms. RCA calls it a 'Tube Guard' because it furnishes a low starting voltage on the receiver circuits and tube heaters, including the picture-tube heater, and allows them to increase gradually to full power. Protecting the tubes from abrupt starting current surges results in a considerable increase in their life. Thermal switches, such as the 'Surgistor,' accomplish the same thing on a stepped instead of a continuously variable basis. What I want to impress on your foggy mind is that this is *one* resistor that must be replaced with an exact duplicate."

"Gotcha!" Barney acknowledged as he started replacing the TV chassis in the cabinet. "I'm sure glad this set was so easy fixed. Extra parts always worry me."

"I just wish this little stinker was as easy to fix," Mac said with a sigh as he turned to a printed-circuit a.c.-d.c. receiver on his end of the bench. "I know there's a break somewhere in the printed circuit in this area that causes it to 'intermit' at just one temperature; but I'll be blamed if I can—hey! Wait a minute! I forgot all about my handy-dandy '5X Flash-Magnifier' that fast-talking salesman sold me Monday. He said all the boys were using it to spot hairline breaks in printed circuits."

As he talked, Mac took an instrument from the cupboard. It was a combination of a flashlight and a pair of magnifying lenses. The lens system was mounted at right angles on the end of the battery case and the bulb was inside the lens case so that when the large end of this case was placed against a surface that surface was in proper focus and was bathed in a "surround" type of illumination. When the lens barrel was turned around, it had to be held about an inch away from an object for that object to be in focus; and the illumination feature was not used. Mac employed it in this fashion to examine closely the area of the board he had found to be sensitive to tapping. Suddenly he held the "Flash-Magnifier" steady and peered intently through the lens. Then he switched off the set, turned on the "Flash-Magnifier" and set the large end of the lens case down on the board.

"Uh-huh!" he said triumphantly; "it looms up like the Grand Canyon through this gadget."

Carefully he scraped the protective coating away from a portion of the circuit, placed a drop of solder on the break, and then gave the repair a shot of plastic spray.

"That jeweler's loupe we've been using to spot breaks works a lot better than the unaided eye," Mac announced; "but this thing has it beat. You don't have to keep your nose right down on the chassis to see; it's a lot easier to keep things in focus; and that light shining on a hairline break from all angles really makes it show up."

(Continued on page 102)

in case of fire

By ERNEST W. FAIR



By itself, insurance is not enough to keep you in business if flames devastate your service shop.

IF FLAMES devastated your service shop, would you be able to keep your business going? Even if you have what is generally considered to be adequate fire-insurance coverage, the odds may not be much better than fifty-fifty that you could get back on your feet.

One of the great delusions of business men everywhere is that fire insurance takes care of "everything," and that they will be back at the old stand, perhaps better than ever, as soon as all insurance claims are settled. Statistics show that 43 out of every 100 firms who lose their records by fire never re-open! If you are a typical service-shop owner, your only set of records is in your place of business. And records are just one area in which protection for the shop owner must go far beyond making certain that he is well covered by insurance. Extensive data has been compiled on the importance of additional precautions. Here are some of the steps that should be taken.

Make sure of your safe. Most old-fashioned safes are nothing but incinerators. Make certain that yours is a modern one of proper construction and that it is not only burglar-proof but heat-proof as well. Some "fireproof" safes are just like some fireproof buildings: the latter may prevent spread of fire, but not its effects.

Insurance recovery calls for proper records. The insurance company, as a matter of good business, must insist on some proof of losses incurred on any premises it has insured before settling a claim. Today it is almost impossible to collect fully on fire insurance without records on which to base a "proof-of-loss" statement.

Besides making certain that the shop's records are in an efficient and modern safe, it is a good plan to store copies of such records in a place of safekeeping like a bank vault. It might be wise to have a copy of your assets and your latest inventory on file in the office of your local insurance broker,

attorney, or accountant. You cannot always depend on records being available after a fire—especially if your only copies are in the shop building.

Protect accounts receivable. The kind of insurance that will guarantee payment of all accounts receivable, should these records be lost in a fire, is unknown today. Some of your customers will cooperate and pay voluntarily under such circumstances. However, a great many will display that all-too-human trait of "getting away with something" when the opportunity presents itself. Maintaining duplicate records of this type may seem a nuisance but it is a fairly simple matter to have an extra copy made at billing time each month; and these extra statements can be kept at another location—such as your safety deposit box at the bank or in your home.

Use microfilm for records. The development of 35-mm microfilm as a means of preserving essential records has grown rapidly during the last couple of years and the cost has gone down. With it, an entire filing cabinet full of records can be stored on a single, small reel of film. While it is not feasible for the shop owner to purchase a unit for his limited use, blue-prints and other reproduction firms in most major cities now offer this service at very moderate cost.

Make sure *everything* is insured. Far too often we temporarily store certain supplies and materials as well as regular equipment in the shop. Such items may *not* be covered by the over-all fire-insurance policy. You may find it difficult to convince an insurance claims adjuster that such out-of-the-ordinary items were actually in the shop at the time a fire occurred. The most businesslike procedure is to keep such materials elsewhere or have them covered by other policies or special "riders" on your regular policy.

Have the best fire-fighting equipment. While you can recover cash for fire losses if you are properly insured, cash itself cannot always compensate

for lost records, irreplaceable inventory, tools and equipment which cannot be duplicated because of production backlogs, or breaks in the continuity of a business.

Any insurance coverage program might well include more than fire insurance. Business-interruption insurance, for example, will help bridge the gap until you can get started again. This type of insurance provides income from the time the doors are closed because of fire until they can be re-opened for business.

Every day you lose while closed because of fire represents a loss of current business in addition to a possible permanent loss of your customers. Even business-interruption insurance will not bring these people back—but it will help cushion the loss.

Plan how to stay in business. The greatest loss you may suffer, as we have noted, often isn't the actual damage done by the fire but the loss of business while a new location is being found or the shop is being rebuilt. If you have a plan for staying in business worked out in advance, the interruption may not be more than a single day after the fire and there will then be practically no customer "shrinkage." One helpful measure in this direction is the maintenance of storage facilities in another location and the stocking of a diversified inventory at that warehouse. There are other steps one can take to insure resumption of business. We come to another.

Secure a local cooperative agreement. It may be difficult to get all shop owners in any one area to agree on anything, but even the most rugged individualist can generally be sold on the idea of participating in a "disaster program" if it is kept as simple as possible and is limited to basic requirements. If a local association is functioning, it can provide an excellent cornerstone for building such a program. Such an agreement can provide for contributing, loaning, and/or sell-

(Continued on page 136)

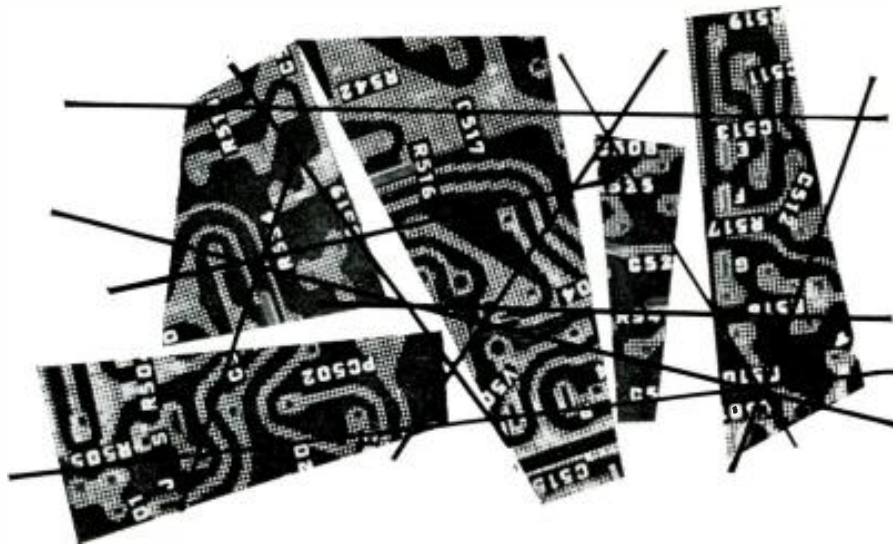

Fix Those Printed-Board Defects

By CHESTER S. LAWRENCE

Practical experience plus recommendations of the manufacturer equal solutions for thorny problems.

THERE IS virtually no type of electronic equipment now in widespread use in which printed boards have not appeared. Yet, still regarding these devices with suspicion, we often find ourselves saying, "Who wants them?" Well, let's face the facts: the boards are less costly to use and take up less room; so we'll be running into them more and more.

The great difficulties encountered in printed-circuit repair fall away once you know how to go about the matter. We found this to be so as the result of considerable, recent experience with a large number of sets using printed wiring. As it happens, this experience was predominantly with the sets of one manufacturer, RCA, but the problems and their solutions are generally applicable to other sets. Perhaps the best way of presenting the relevant experiences is in the form of individual case histories, just the way they happened, with the mistakes as well as the successes, since both types of experience have value.

We were called on the first set just as the World Series was beginning. The complaint on this RCA was vanishing sound. When we arrived, the customer was steaming. The set—and the ball game—were on, but the sound was off. After persuading the customer to let us take a look to see what could be done, we got to work.

Off came the back and on went the cheater cord. When the set went on, we pulled out a 6AQ5, the audio-output tube. This produced a very normal thump from the speaker, telling us the trouble was farther back. Pulling the sound i.f. and ratio-detector tubes brought similar results. While replacing the sound i.f. tube in its socket, we banged a hand against the sound take-off transformer (T_{201} in Figs. 1 and 2) and, for a brief moment, had all the volume anyone, including the down-

stairs neighbors, could possibly want.

Tapping the transformer a few times made the answer obvious. Either the transformer itself was intermittent or its connections to the printed board were broken. Applying a little pressure on one side of the transformer can would make the audio section work perfectly.

Normally, the set would have been pulled right to the shop, but, with the Series on, the customer wouldn't hear of it. He had a one-track mind: "You gotta fix it now," were his only words.

The circuit itself definitely couldn't be fixed in his home. What with a 100-watt soldering gun, close working quarters, no replacement transformer, and a large, irate customer, things could only get worse.

Remembering that the set worked when the transformer can was pushed away from the sound i.f. tube, we wedged an empty matchbook between the can and the tube. The set ran throughout the whole Series and, when we went up the following week to pick up the set for a final shop repair, the customer was grateful to the extent of a generous tip.

Once the set was in the shop, the rest was simple. With a low-wattage iron and some low-temperature solder, the job was completed easily. One of the lugs of T_{201} in Fig. 2 had broken away from the board. Forcing the matchbook between the tube and the transformer had pulled the broken connection together temporarily.

How Not to Repair

One bright morning a few weeks later we were delivering a chassis from the shop. After installing it, hooking up the yoke, high-voltage lead, speaker, and "kine" socket, there was no picture or sound—just a clear light-grey raster. A look inside showed a 6DE6 in the video i.f. section was out. After trying two new tubes, neither of which lit, we decided the fault had to be in the socket connection for the 6DE6 (V_{202} in Fig. 3) to the printed-circuit board. A quick check with the ohmmeter showed that pin 4, the hot side of the filament, was not connected to the board at all.

Resolder a socket contact to the board? Shouldn't be too difficult—after all it isn't going to look good if this goes back to the shop again. So, with the 100-watt gun available on the call, plenty of heat and solder were applied.

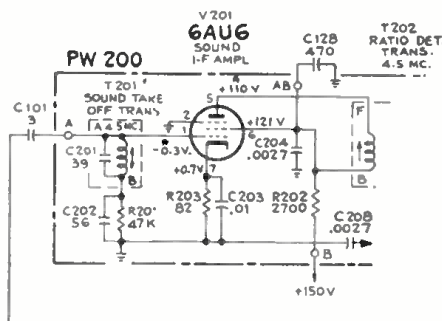

Fig. 1. Poor contact produced intermittent audio output in this RCA circuit.

Fig. 2. One of the terminals of T_{201} had broken away from the printed board.



End result was that pins 2, 3, and 4 were shorted, along with a few other things. Back to the shop we went, where careful use of a low-wattage iron failed to repair the circuit. Because of the damage done by the 100-watt gun, the entire board had to be replaced at a cost of some \$22.00. This experience will not fade from memory for some time.

Now, what *should* have been done? To begin with, this particular soldering gun should never have been used: its wattage rating is just too high. Second, heat should not have been applied for more than a few seconds at a time. The shorter the time an iron is applied to any of these boards, the better. If you don't get a joint to hold right away, give it a chance to cool, and then try once again.

However, even with low heat, the entire approach would have been wrong. In this case, what should have been done was to tack one end of a piece of hook-up wire to pin 4 of the tube socket and the other end to the terminal marked *H* on the circuit board (Fig. 3). This would have eliminated the risk of hurting other wiring on the board—and it's a lot easier to make this kind of connection than it is to resolder a tube socket to a printed-circuit board.

In some vertical chassis, broken connections may be caused by flexing the chassis while handling. Bending a board may place enough strain on it to break a connection or two. Sometimes a board will snap right in half. While this can happen in any set, it is more common in those that use the vertical layout. Remember this and proceed with due caution.

Small-Component Problems

One day in the shop when we were still in the groping stage, we had a little discussion on how to replace a small component like a resistor or capacitor on a printed-circuit board. Each one of us had a different idea on how the job should be done. One of the technicians felt that he should unsolder the component from the circuit, removing it completely, and then install a new part. Another figured, just cut the old part out and tack in a new one. Well, that sounded reasonable, so we tried it and learned another way of how *not* to do things.

Getting the old part out was child's play. Two snips with a pair of diagonal cutters and the job was done. Then it came time to tack the new one on. This wasn't quite so simple. By the time we got things hot enough to do any tacking, there wasn't any solder left on the contact we were soldering to.

Finally someone came up with a radical notion—he got hold of a copy of the manufacturer's instruction manual! Believe it or not, their way was best. First, said RCA's book (Fig. 4A), cut the part in half. We did. Next, with pliers, crush the remaining halves (Fig. 4B) until only the longest possible length of

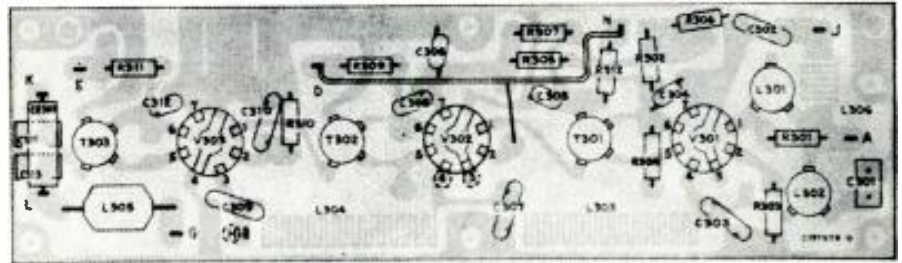

Fig. 3. With connection of pin 4, V_{802} broken, a wire can be run to lug *H*.

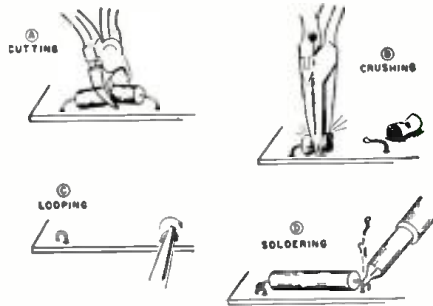
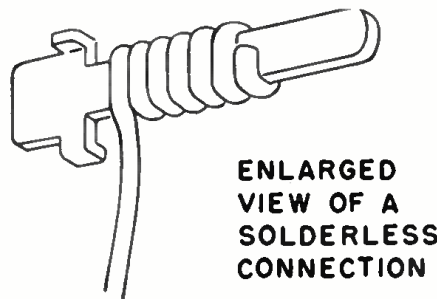

Fig. 4. For replacing a board-mounted component, the manufacturer's suggestion works best: solder new part to loops made from the leads of the old part.



ENLARGED VIEW OF A SOLDERLESS CONNECTION

Fig. 5. If it becomes necessary to unwind a wrap-around, solderless connection, always re-connect it with solder.

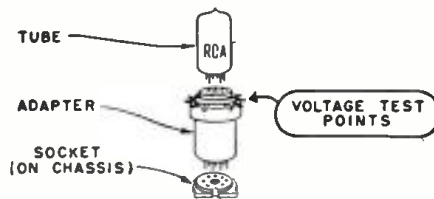
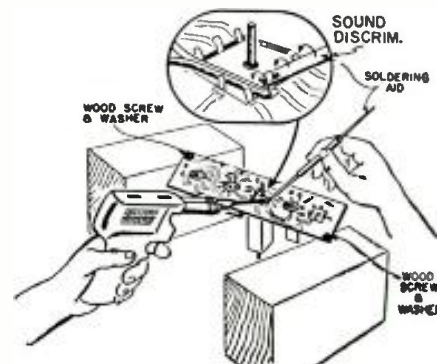

Fig. 6. Where accessibility is a problem, the test adapter inserted in a tube socket will permit convenient measurements without serious disassembly.

Fig. 7. Soldering aid helps manipulate lugs of a transformer can that must be removed. Support for board also helps.



wire. Then bend a loop (Fig. 4C) in the end of each lead. Interwind these with the leads from the new part and resolder, holding a pair of long-nose pliers on each lead between the board and the point being soldered (Fig. 4D). This approach worked, and no one has come up with a better method as yet.

This incident just covered may seem like making much of an obvious point, but the moral is important. Why learn the hard way when you don't have to? Manufacturers' literature has its value.

One time we ran into a set whose picture would go on and off. The raster would stay put, but the video signal wouldn't. Even walking across the room was enough to knock it off. After getting the set on the bench, we started to trace back through the video strip with a scope. Jarring the chassis now and then to induce the intermittent symptom, we finally got to the point where the video signal was disappearing.

You've seen the "wrapped-wire" connections (Fig. 5) on a printed-circuit board? That's where the trouble was. Some technician who had once worked on the set evidently unwound one of the connections at one time or another, probably while making a resistance check. The only trouble was that he just didn't bother *soldering* it when he finished—just wrapped it back around the terminal and gave it a little squeeze with a pair of pliers. Unfortunately, that was the wrong way.

When these connections are made at the factory, they are tightly spun by a machine that wraps the wire around the pin with great force. The result is such an effective and reliable electrical bond between the wire and the terminal that solder is unnecessary. However, *you* cannot duplicate this effect. Any time you open one of these connections, you must solder it or face the equivalent of a cold-solder joint.

Another technique found to be a big help is the use of a set of test sockets. Of course such aids were available and worthwhile before many of us ever saw printed boards, but these tube-socket adapters are particularly handy for some printed sets where tube-socket pins may not be too much in the clear. All you have to do (Fig. 6) is pull the tube, plug in the test socket, and then plug the tube into the adapter.

What technician can forget the first time he had to replace a board-mounted i.f. transformer? It might

(Continued on page 129)

Tube Faults & Test Techniques

By SHERMAN H. HUBELBANK

What has happened inside the defective tube, and what conventional checks can and cannot tell you.

HOW LONG does a tube last? Many factors must be considered in the determination of an answer. Take the case of just one such; if the average receiving tube is not overdriven and not operated continuously at or above maximum ratings, it can be expected to run at least 2000 hours before the filament opens.

Of the other factors affecting life expectancy, some of the more important ones are: circuit function in which the tube is used; deterioration of the cathode (emitter) coating; decrease in emission of impregnated emitters with age, in the case of filament-cathode types; defective seals, which permit air to leak into the envelope and oxidize the emitting surface; appreciable gas content; and internal short circuits or open circuits caused by vibration or excessive voltage.

When a tube has first been put into use, these and other factors are indeed responsible for many tube failures. Nevertheless, studies indicate that there is too much readiness to put the blame on the tube. In one such survey, it was found that one out of every three tubes removed from equipment and discarded was a good tube. Often, instead of installing a new tube, merely replacing the same tube in the same socket would have resulted in better pin contact and improved operation.

There are other reasons for hesitating before discarding a tube. Life tests show that the first 50 hours of use are the ones during which failures occur in relatively large numbers. The outlook for a tube that has survived this critical period is good. Thus it should not necessarily be discarded just because its transconductance is found to be somewhat below that specified in a tube manual, for example, provided that it still seems to be operating satisfactorily in the circuit. The probability of its continued survival for many more hours of satisfactory life is better than that of a new, non-premium replacement. However, if transconductance has fallen well below a specified minimum, the tube is probably nearing the end of its useful life.

Types of Failure

Experience has shown that tube failures may be roughly classified as follows: mechanical defects and gas within the tube, filament (or heater) burn-out, change in tube characteris-

EDITOR'S NOTE: The largest single class of equipment failures, by far, is that in which tubes are involved. Yet, relatively speaking, surprisingly little is known about life expectancy, the factors involved in the development of tube defects, and the how's and why's of testing. Appraisal of tests is particularly important since, if they are to be of value, intelligent interpretation of results is necessary. The author has relied on the U. S. Navy "Handbook of Test Methods and Practices" and other available sources for this information.

tics, physical damage, and intermittent shorts.

Mechanical defects and rise of gas pressure within the tubes are attributed to faulty construction and processing. Some of these defects cannot be detected by standard testing methods until the tubes have been in operation for some time.

The repeated, sudden application of full voltage to an improperly protected filament often results in *filament burn-out*. The excess voltage causes non-uniform initial filament heating. Mechanical stresses, set up by thermal expansion, weaken the filament.

Change in tube characteristics is a broad classification and covers such phenomena as decreasing emission, change in cut-off voltage, changing transconductance, and others. Such changes are usually the result of deterioration of a cathode structure or formation of a cathode interface surface in the tube (see "Lazy Tube Cathodes," December, 1958), or changes in alignment of electrodes.

Physical damage is largely accidental. It includes breakage, bending of pins, and accidental application of excessive voltages. *Intermittent shorts* are caused mainly by foreign matter, such as lint, within the tube assembly.

Tube defects, of which only the most common have been mentioned, account for a high percentage of all equipment failures. For this reason it is good practice when troubleshooting equipment to eliminate immediately any tube known to be faulty—avoiding, however, blind replacement of good tubes by fresh spares.

Some tube defects may be observed visually or in some other simple way. Open filaments in glass-type envelopes can be seen. When the plate current is excessive, the tube may be brighter. Gassy tubes take on a purple glow. Arcing between elements is apparent. Metal-type envelopes can be felt for

the warmth indicating filament operation. Noisy or microphonic tubes can be checked by gentle tapping with a cork mallet or tapper. Other faults cannot be detected with such ease.

Types of Tests

There are three basic types of tube tests: the substitution test, the emission test, and the transconductance (dynamic mutual-conductance) test. Many tube testers also perform a gas test, a short-circuit and noise test, and a cathode-activity test.

The substitution test. Substitution of a tube known to be in good condition is a simple method of determining the quality of a questionable tube. However, tube substitution should be carried out carefully, one at a time, so that the effect of differences of each substituted tube can be noted. However this method of testing ordinarily cannot be used to advantage to locate more than one faulty tube in a circuit.

The emission test. This checks the comparative emission of the cathode or filament. Prescribed voltages are applied to the elements of the tube under test. Essentially, the test is an indication of plate current. A pronounced lower-than-normal emission, or a complete loss of emission, indicates that the tube has reached the end of its useful life. Both multi-grid and diode tubes are tested for this factor.

The transconductance test. The term "transconductance" (also called mutual conductance) expresses the effect of grid voltage upon the plate current of a tube. The condition of most tubes can be more accurately determined in this way than by measuring cathode emission, because this test more closely approximates actual circuit conditions imposed on most tubes.

Transconductance is expressed mathematically as the ratio of a change in plate current to a change (small) in control-grid voltage with all other electrode voltages held constant. Transconductance is measured in units of conductance called "micromhos."

The transconductance indicated by a tube tester is not always the true transconductance of the tube. More often it is an approximate measurement. Therefore, in evaluating tubes on this factor, the readings should not be compared to a tube's specifications to determine quality.

(Continued on page 127)

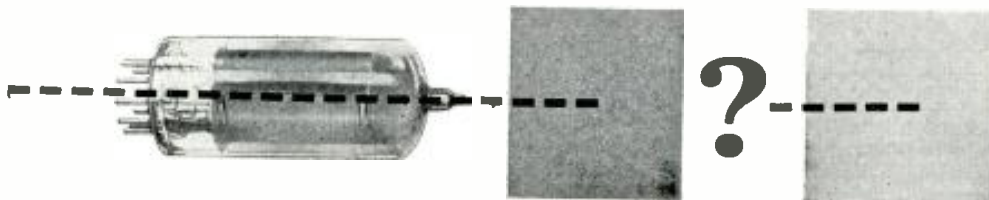

THE electronic stroboscope is becoming more and more popular in the home as well as in the professional workshop. While several circuits have been published, most such articles make it difficult for the reader to fully understand the operation of the instrument or enable him to modify the circuit to meet his own particular requirements.

The following will not only provide a description of a useful and versatile instrument, the "Strobolyzer" (*stroboscopic analyzer*), but will present sufficient theory to enable the reader to fully understand this unit in particular and stroboscopes in general.

Although most people are familiar with the technique of using an ordinary stroboscope or strobosc; a brief review is often helpful. A stroboscope will "stop" any motion which is repetitive in nature. The "stopping" is, of course, accomplished by illuminating an object in a particular position each time it reaches that position. If the repetition rate of the stroboscope is calibrated, making it a strobosc, the speed or repetition rate of the object may be determined. The motion may also be "stopped" if the object is illuminated every other time, or every

third, fourth, etc. time it reaches a given position. If the illumination rate is twice the repetition rate of the moving object, the motion will be "stopped" in two positions. Speed or repetition rate is normally measured by noting the highest illumination rate which will "stop" the object in a single position.

The Strobolyzer has an upper limit of 100 flashes-per-second. This is not a limit to speed measurement, however. By some simple calculations speeds or repetitions over 100-per-second may be measured. As an example, consider a rotating object which is "stopped" at 100-flashes-per-second. The speed could be 100, 200, 300, etc. revolutions-per-second. To determine which it is, we proceed as follows: Assume that the object is rotating at 100 rps. If this is true, each revolution will take $\frac{1}{100}$ th second and one and a half revolutions will take $1.5/100$ th second. If the strobosc is flashed at a rate of $100/1.5$ or $66\frac{2}{3}$ flashes-per-second, the object should be illuminated every one and a half revolutions and thus be "stopped" in two positions. If, however, only one position is seen, then the object must be rotating at some multiple of $66\frac{2}{3}$, that is, 200, 400, etc. revolutions-per-

second. This line of reasoning may be followed in determining the final speed exactly.

Basic Types

Several basic forms are possible in the construction of a stroboscope. A simple one is to cause conduction in a gas-filled tube by the intermittent application of a sufficiently high voltage. The most obvious example of this is a neon sign. While this is not ordinarily thought of as a stroboscope, actually it is an intense light source operating at a rate of 120 flashes-per-second (two times line frequency) and is capable of "stopping" motion. The duration of the "on" period is somewhat long compared to the "off" period and frequency control is not possible. A practical modification might be devised whereby the neon sign transformer is replaced by a d.c. source which is switched at the desired rate. Unfortunately, the problems associated with the rapid switching of high energy levels usually kill this idea. Nevertheless, one form of this type of stroboscope is in common use. The inexpensive automobile ignition timing lights are of this nature. They consist of a gas-filled tube (usually neon) which is built to be wired

The "Strobolyzer"

A High-Intensity Stroboscopic Analyzer

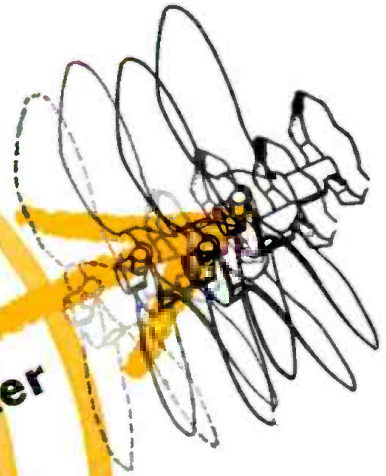

Strobe lamp is mounted on the side of the cabinet of unit.

By F. G. FENDER

Construction of a useful and versatile strobe unit that can be employed to "freeze" motion.

December, 1959

57

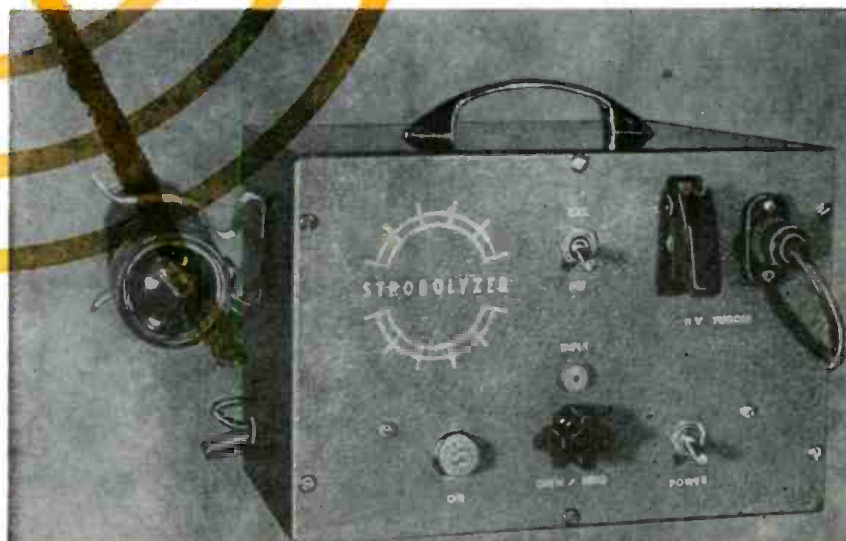

in shunt with the No. 1 cylinder spark-plug. The ignition discharge passes through the gas, causing it to flash at the appropriate time for viewing the timing mark on the flywheel or vibration damper. This represents a triggered stroboscope.

A second possible form of stroboscope utilizes an ordinary incandescent lamp. The illumination from the lamp is passed through a shutter which is opened at the desired rate. The stroboscopic effect produced by a motion-picture projector has been noted by all of us. A stroboscope of this sort may be easily constructed by fastening an opaque disc on a variable-speed motor; a hole or slot is cut in the disc and a light placed behind it. As the disc rotates, the light is effectively "flashed" on and off. While this might seem quite satisfactory, there are several serious disadvantages. First of all, frequency calibration is usually difficult. Second, the "on" period is proportional to the repetition rate; thus it is not possible to "stop" slow motions without blurring. Finally, synchronization with an external signal is very difficult. However, this form is sometimes useful in demonstrating the strobe principle.

The most useful form of stroboscope is the electronic variety. This utilizes a gas-filled tube operating at a potential lower than would ordinarily cause conduction. The potential at which a gas-filled tube will conduct depends on many factors: among which are the type of gas within the tube, the gas pressure, the terminal electrode shape, and the length of the tube. Say, for example, that a tube is so constructed that the voltage applied to its end terminals must be at least 400 v. to cause conduction. This is called the "hold-off" potential. If less than 400 volts is applied, the tube normally will not conduct. It can be made to conduct, though, if the gas within the tube is ionized or partly ionized. One way to accomplish this is the application of a strong r.f. field. Once conducting, the tube will continue to conduct until the potential across it drops to some critical value. This value is called the "extinction" potential and is generally low compared to the hold-off potential. If a capacitor, charged to somewhat less

than the hold-off potential, is placed across a tube which is then ionized by some means, the result is a rapid discharge of the capacitor through the tube. The discharge stops when the voltage reaches the extinction potential. With a properly designed stroboscope a short duration flash of high intensity is thus produced.

If a gas-filled tube is designed for use as a stroboscopic light source, it is called a strobotron. Two methods are generally used to ionize the gas and initiate conduction. One is to insert a third electrode into the tube near one of the end electrodes. The hold-off potential between this third electrode and the adjacent end electrode is small and hence a low potential will ionize the gas. Once the gas is ionized, conduction will take place between the end electrodes. Actually, two additional electrodes are usually incorporated and ionization initiated between them (see Fig. 1). The additional electrodes also function as grids to modify the hold-off potential of the tube.

The 1D21/SN4 and SN4 strobotrons, made by Sylvania, are tubes which incorporate this type of construction.

The second method generally used to initiate conduction involves the establishment of an ionizing potential

external to the tube. The required potential varies from 1000 to 10,000 volts and is applied to a wire wrapped around the outside of the gas-filled tube. The Sylvania SA309 (\$20.00 net) is a strobotron of this type.

Electronic photoflash lamps are frequently of this design and can serve as strobotrons, although ratings for this type of service are difficult to obtain. Hold-off potentials as high as 3000 volts are possible with this type of lamp which is exemplified by the Sylvania R4330 (\$29.10 net).

Choice of Tube

The first decision to be made before building a stroboscope is what strobotron tube to use. All three of the tubes mentioned before are readily available: the SN4, the 1D21/SN4, and the SA309. The first two are identical except for maximum repetition rates. Sixty-flashes-per-second is maximum for the SN4 while the 1D21/SN4 allows 240. They are both triggered by internal electrodes and require a trigger potential of 175 volts. Maximum discharge voltage is 300v. Maximum average current is 50 milliamperes. The light output is orange-red.

The SA309 has a maximum repetition rate of 100 per-second. It is trig-

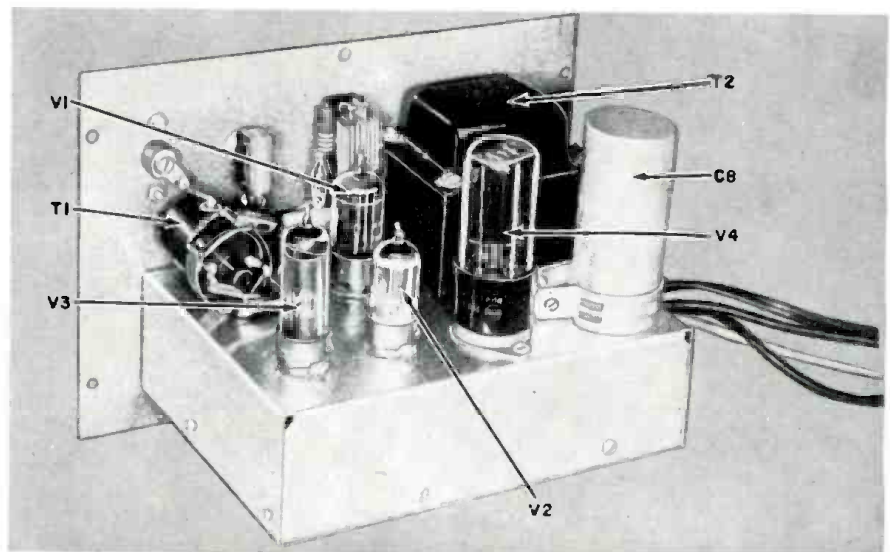

Inside view of the strobe unit showing the placement of tubes and components.

Bottom view of unit along with view of the disassembled strobe lamp housing.

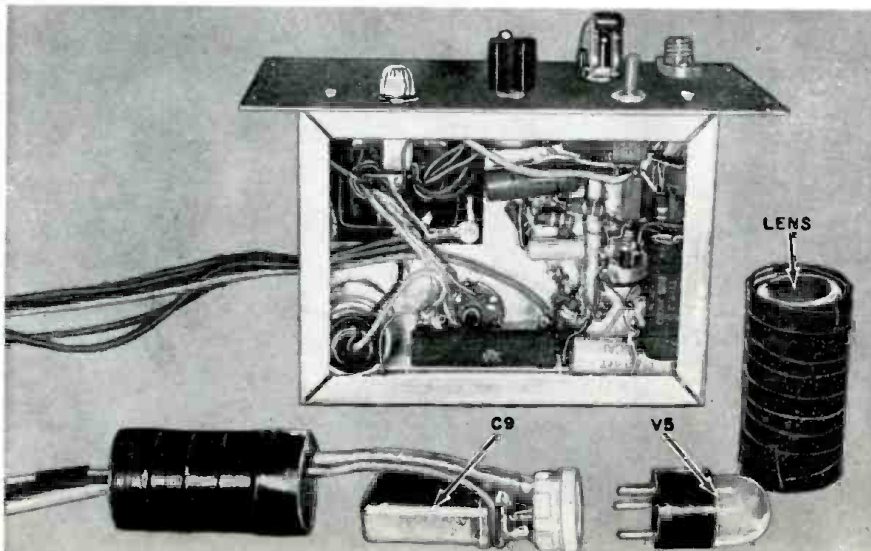
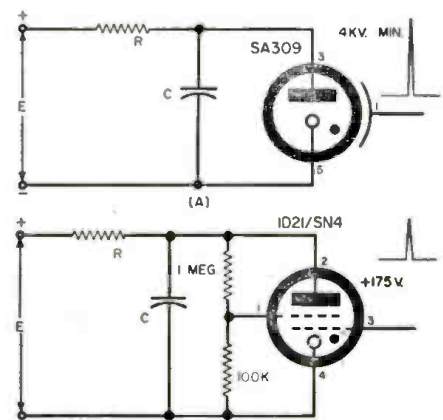

Fig. 1. Basic strobotron circuits.



gered by an external ionizing potential of 4000 volts minimum. Its maximum discharge voltage is 600 v, and maximum average power is 3.5 watts. The light output is blue-white, being very near daylight in color.

The high trigger potential required for the SA309 is enough of a deterrent to make the SN4 or the 1D21/SN4 much more popular. Despite these drawbacks, the author selected the SA309 for his "Strobolyzer." This was done for several reasons. First of all, one of the primary uses for the Strobolyzer was an automobile ignition timing light; the required trigger potential is readily available from the ignition system. Second, a higher light output per flash is possible using the SA309; since it has twice the discharge voltage rating, four times the energy per flash is obtained for the same size capacitor. Next, the color of the light is more pleasant to work with. Finally, the size of the lamp is an advantage.

Size has not been mentioned thus far, but the SN4 and the 1D21/SN4 require a rather large reflector to utilize the full light output. A much smaller reflector is possible using the SA309 since the light output is concentrated over a much smaller area. Actually, the author used no reflector since he mounted the lamp and its energy storing capacitor in an old flashlight case with a focusing lens.

Circuit Used

If the only use for the Strobolyzer had been as an ignition timing light, the circuit would have been much simpler than the one shown in Fig. 2. It would then merely consist of the 600-volt power supply; the series resistor, R_4 ; the energy storing capacitor, C_9 ; and the strobotron lamp with a lead to connect to the engine's No. 1 sparkplug (and a ground lead to the car frame).

It was desired, however, to use the instrument for several other purposes. It must, in addition, serve as an ordinary stroboscope; next, as a stroboscac or calibrated stroboscope; and finally, as a triggered stroboscope capable of accepting relatively low-level input voltages.

The trigger potential was the first problem and an ignition coil was the logical choice. The type used for model aircraft ignition systems was selected because of its small physical size but transformers of the type designed for triggering photoflash units will serve equally well. Excitation was supplied by a 2D21 thyatron to discharge a capacitor through the primary winding. The d.c. voltage for this portion of the circuit and earlier stages was obtained by using a voltage-regulator tube to maintain a reasonably constant 150-volt potential. Bias voltage for the 2D21 is obtained by half-wave-rectifying the filament voltage, using a 1N34 crystal diode. An 0A4 cold-cathode thyatron could be used in place of the 2D21 and would require no bias voltage. It is several times more costly than the 2D21, however. Since it was decided initially that

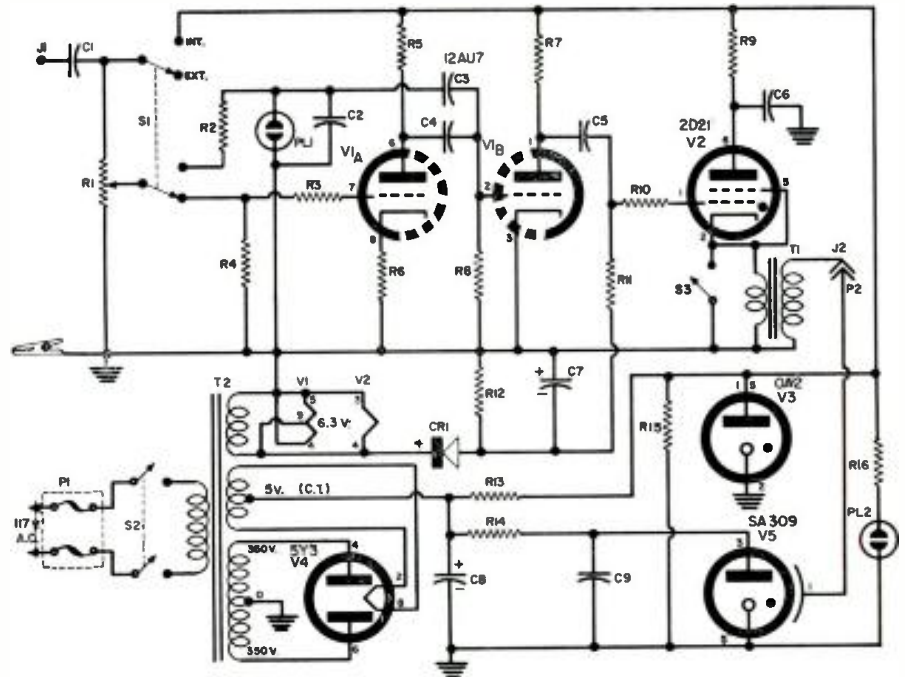

- R_1 —250,000 ohm pot
- R_2 —3.3 megohm, 1 w. res.
- R_3, R_{10}, R_{15} —100,000 ohm, 1 w. res.
- R_4 —1.2 megohm, 1 w. res.
- R_5, R_7 —820,000 ohm, 1 w. res.
- R_6 —4700 ohm, 1 w. res.
- R_8, R_{11} —1 megohm, 1 w. res.
- R_9 —10,000 ohm, 10 w. wirewound res.
- R_{12} —120,000 ohm, 1 w. res.
- R_{13} —35,000 ohm, 25 w. wirewound res.
- R_{14} —10,000 ohm, 25 w. wirewound res.
- R_{16} —150,000 ohm, 1 w. res.
- C_1, C_4 —.1 μ f., 250 v. capacitor
- C_2, C_5 —.005 μ f., 250 v. capacitor
- C_3 —.01 μ f., 250 v. capacitor
- C_6 —.25 μ f., 250 v. capacitor
- C_7 —50 μ f., 25 v. elec. capacitor
- C_8 —8 μ f., 600 v. elec. capacitor
- C_9 —1 μ f., 600 v. oil-filled capacitor
- S_1 —D.p.s.t. toggle switch
- S_2 —D.p.s.t. toggle switch
- S_3 —S.p.s.t. toggle switch
- PL—NE-2 neon bulb

- PL—NE-51 neon bulb
- Pr—1 amp fused plug
- Pr—High-voltage connector (Millen 37001. Mating pair, with J_1 , have single number)
- J_1 —Phone tip jack
- J_2 —High-voltage connector (Millen 37001, see P_2)
- CR—1N34 crystal diode
- T—Model aircraft ignition coil or photoflash trans. (Thordarson 22R44 can be used, 200 v. capacitor discharge primary to 15 kv. peak sec.)
- T₂—Power trans. 350-0-350 v. @ 70 ma.; 5 v. @ 2 amps; 6.3 v. @ 2.5 amps (Stancor PM8408 or Allied 62G043 can be used. Note: if 5-volt winding has no center-tap, make "B+" connections to one side of winding)
- V₁—12AU7 tube
- V₂—2D21 thyatron
- V₃—0A2 tube
- V₄—5Y3 tube
- V₅—Strobotron tube (Sylvania SA309, see text)

Fig. 2. Complete schematic diagram and parts listing for the "Strobolyzer."

frequency calibration for the Strobolyzer would be provided from an external oscillator, all that is required is to insure the proper waveshape for triggering the thyatron. The only requirements for the trigger voltage are that it be large enough to fire the tube (on the order of 6 volts) and have short duration. "Short duration" is required because the trigger voltage must return to zero before the capacitor across the thyatron recharges sufficiently to cause the thyatron to fire again. If this is not the case, double-triggering or even continuous conduction is likely to occur.

The necessary trigger is easily formed by adding a squaring amplifier ahead of the thyatron; the rectangular wave thus produced is passed through a small capacitor into the thyatron grid. The dual-triode squaring circuit is merely a two-stage amplifier which saturates very easily. It is not at all critical. Parts values may vary by as much as 25% and many of the common miniature twin-triodes, such as the 12AX7, 12AT7, or 12AY7, may be substituted for the 12AU7. The circuit provides sufficient gain

to drive the strobotron from a rather low-level input. The required amplitude varies with the waveform. If the input is a square wave, less than 0.1 volt will trigger; if it is a 20-cps sine wave, about 0.3 volt is required. This is adequate to drive the unit from a vibration-sensitive pickup, such as a crystal phono cartridge. In searching for the cause of vibration it is frequently convenient to drive the Strobolyzer from the vibration itself. For example, if one gear in a train is at fault, and the train is viewed in the strobe light, the offending gear will often be "stopped" while the rest rotate or "stop" in several positions. Automobile wheel-balancing devices frequently utilize this type of circuitry wherein the flash is triggered by the vibration of the axle on which the wheel is mounted (on the car or off). A low-pass filter might be required if vibrations over 100 cps are present although reducing the squaring-amplifier gain will usually separate out the harmonics if they are of lower amplitude than the fundamental vibration.

Since many applications do not re-

(Continued on page 114)



◀ **World's Largest Radio Telescope**

Artist's concept of world's largest radio telescope being erected by Navy at Sugar Grove, West Virginia. The \$79-million facility is scheduled to be completed in 1962. It will enable scientists to tune in on radio signals emitted by astral bodies as far as 38 billion light years out in space, 19 times the distance probed by the 200-inch optical telescope at Mt. Palomar, Calif. Instrument's aluminum-mesh reflector will have a 600-foot diameter, dwarfing the 250-foot dish at Jodrell Bank in England, the largest radio telescope now in operation.

400-Watt P.A. System

A new 400-watt amplifier, originally developed for the military by the *Bogen-Presto Co.*, is being demonstrated below by means of a Los Angeles Sheriff's office helicopter. Designed for emergency rescue operations or general disaster work, the amplifier has an effective range of more than one mile and, by the use of transistors, weighs 75 per-cent less than equivalent equipment using vacuum tubes. Special *University* loudspeakers are employed in the system.



Recent Developments in Electronics



◀ **Banking by Electronics**

The document handler at the left is a part of *General Electric's* new computer ERMA, now in use by *Bank of America* in Los Angeles and San Jose. ERMA is the world's first completely automatic operational banking system using magnetic character reading. In operation, magnetic tape heads read arabic numbers printed directly on customer's checks by special magnetic ink. By the end of 1961 there will be 13 such computer centers in California handling two million checking accounts for 460 branches of the bank.

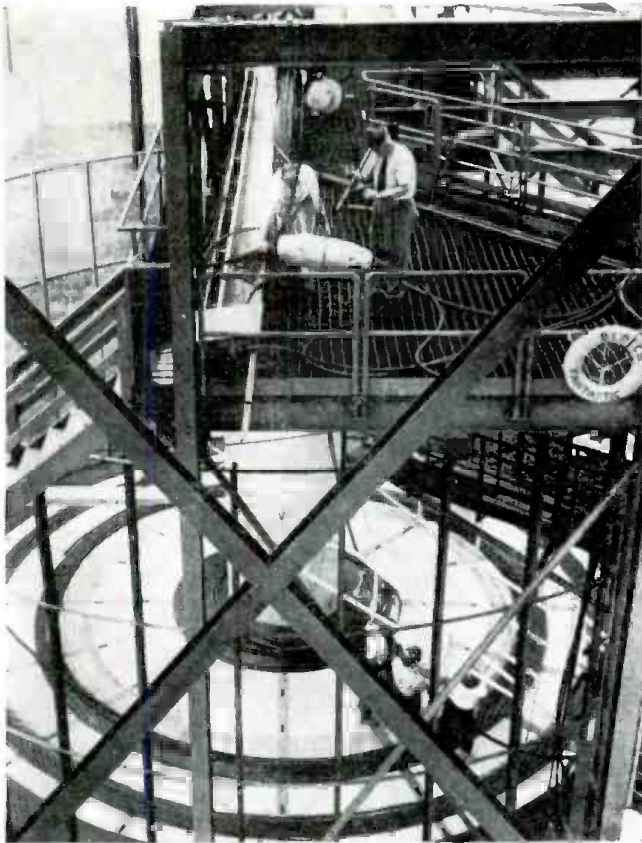

▲ Landlocked Cable-Laying Ship

Simulated undersea cable-laying activities are shown on two levels of the cable ship "Fantastic" at Bell Telephone Laboratories' Chester, N. J. location. On deck, engineers place a cable repeater model in the "highway," ready for launching, while below others work out methods of stowing cable in the "tank." The cable-ship mockup will help engineers develop new shipboard equipment and methods of handling repeaters and cable systems.

125-Foot Radar Antenna ▶

One of the largest radar antennas of its kind in the world (37 3/4 feet high and 125 feet wide) is being installed at Thomasville Aircraft Control and Warning Station in Alabama. Designed to search out and identify missiles and aircraft, the radar will become part of the U. S. Air Force's Continental Aircraft Control and Warning System. The installation's mammoth reflector antenna was built by Blaw-Knox Co. for Sperry Gyroscope Co. The Alabama project is part of contracts totalling \$47-million awarded Sperry for development and production of high-powered air search radar systems.

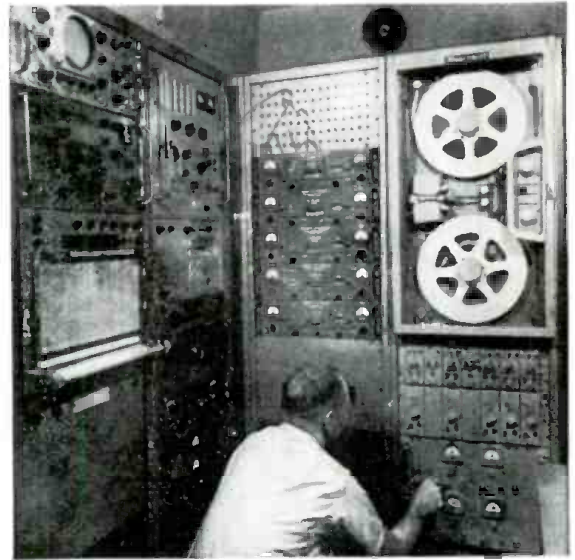
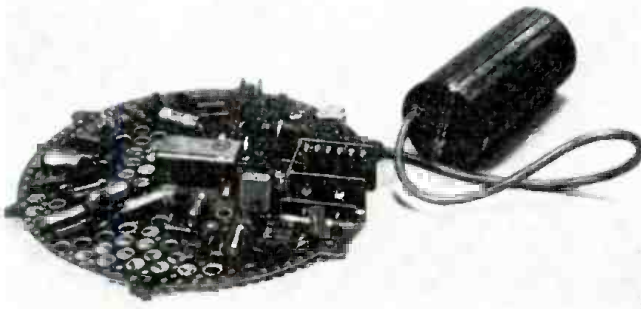

▲ Satellite Tracker

This bank of high-precision equipment lines one of two windowless trailers which provide Redstone Arsenal's Army Ballistic Missile Agency with a mobile means of testing the instrumentation designed to telemeter information from earth satellites and to "listen in" on the satellites once they are launched into space. A Minneapolis-Honeywell recorder-reproducer (right) is used to record 6 channels of information on half-inch magnetic tape.

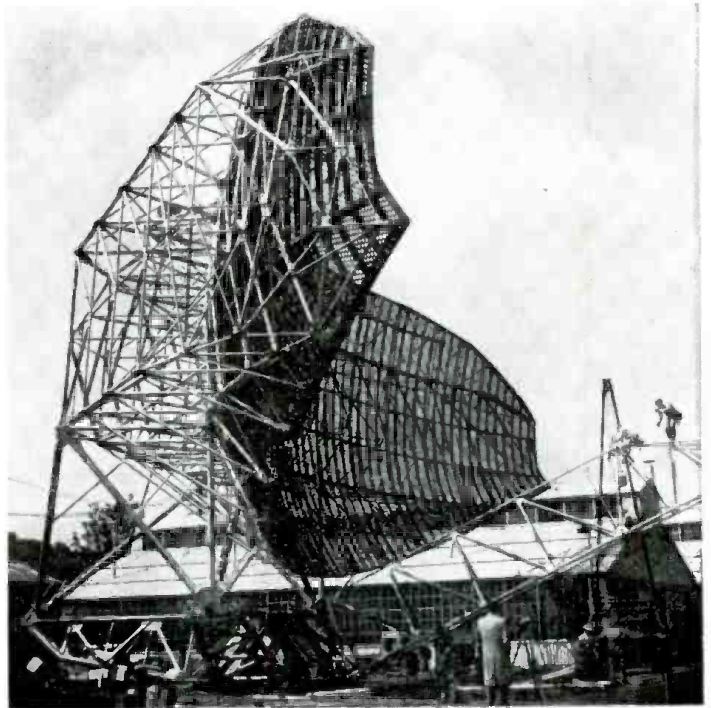

◀ Vanguard Satellite Magnetometer

Pictured at the left is the unencapsulated electronics portion of the minified, transistorized Varian magnetometer which recently made the trip to outer space in a Vanguard satellite. The sensing head at the right encases a coil of wire immersed in hexane. The magnetometer, which weighs only 30 ounces without batteries, is used to measure the earth's magnetic field above and in the highly ionized upper atmosphere. Findings are telemetered to ground stations throughout the world as the satellite continues in its orbit.



Technique for Tuning Electronic Organs

By WILLIAM H. MEYER, JR.

Simple but highly accurate method employs an oscilloscope to check power-line beat notes.

PEOPLE by the thousands are being attracted by the charm and relaxation of the various small electronic organs which are taking their places in living rooms all over the country. Many of these instruments are owned by hi-fi enthusiasts, ham operators, and TV technicians who are fully capable of maintaining and servicing their instruments, using test equipment already on hand. However, the task of tuning an organ is one that is generally beyond the experience of most electronics people and yet it is one that must be done both periodically and at any time that an oscillator component is changed.

Types of Organs

Electronic organs fall into three general categories: (1) electro-mechanical, (2) frequency divider, and (3) separate oscillator types. Electro-mechanical organs such as *Hammond*, *Wurlitzer*, and *Kimball* use rotating discs or vibrating reeds for tone generation. These normally need no tuning and should only be adjusted by factory trained servicemen. Frequency divider organs use 12 master oscillators, tuned for the highest octave. All other notes are obtained by frequency dividers which are synchronized to the master oscillators. This group is represented by *Baldwin*, *Lowery*, *Kinsman*, *Thomas*, and others. The last group uses a separate oscilla-

tor for each note or each key. Representative of this group are *Allen*, *Conn*, and *Gulbransen*. Organs of the last two categories are completely electronic and maintaining perfect pitch will require tuning every six months to a year, as does a piano.

The professional organ serviceman has little trouble tuning an organ as he is equipped with a stroboscopic tuning device or a set of 12 master tuning forks. Tuning by ear is almost out of the question, except for the true expert. But the radio technician is neither an expert in this field nor does he generally own the special equipment required. Even very expensive audio generators are usually guaranteed to no better than 2% accuracy. Yet for a good organ tuning job, an accuracy of better than 0.1% is necessary since the frequency change between keys (half tones) is only 6%.

Simple Tuning Technique

The tuning method to be described here is capable of an accuracy of 0.02% when carefully applied. The only equipment required is an ordinary cathode-ray oscilloscope and a watch or clock with sweep second hand or, preferably, a stopwatch. Briefly, the procedure is as follows: Using the 60-cycle line frequency as a standard, "A" (220 cycles) is tuned. (EDITORS NOTE: In larger cities, such as *New York*, *Chicago*, etc.,

the frequency accuracy of the 60-cycle power line is normally within $\pm .05$ cycle or $\pm .083\%$. Hence, the accuracy of the tuning with respect to absolute pitch will be within this percentage. The tuning accuracy of one note with respect to another, however, will be better than this using the method described below.) Then D is beat against A, G against D, C against G, etc. until each of the 12 notes in one octave has been tuned, beating one against the other in chain-like fashion. Theoretically this is fine but, unfortunately, it is not quite this simple since the tempered scale to which all keyboard instruments are tuned cannot be brought to exact pitch by zero-beating one note against another. The method just described, if not corrected, would create an accumulated error of more than 1% by the time the last note was tuned. This is far beyond the tolerance of a good tuning job.

This difficulty can be completely overcome by the application of a small correction to each zero-beat before the next note is tuned. Mathematically it can be shown that if each note is raised in frequency 0.113% above the zero-beat value, the exact tempered scale pitch will be obtained. This is accomplished by counting and timing the beat-frequency while tuning the oscillator slightly higher than the zero-beat value.

The detailed procedures which follow may at first seem difficult, but after trying them once, it will be found that they are simple and interesting.

1. *Adjust Scope Sweep:* With the scope sync turned off, adjust the sweep for a one-cycle pattern of a 60-cycle signal. A 60-cycle input can be easily obtained by touching the vertical input terminal with the finger. After a steady pattern is obtained, set the sync selector to "Line" and advance the sync gain so as to lock the sync to the

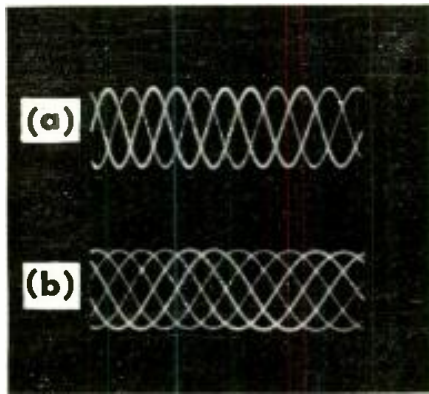
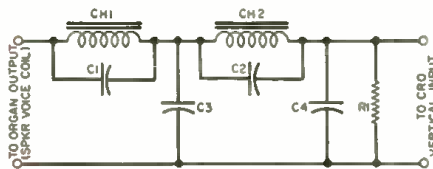

Fig. 1. Patterns for (A) A-220, (B) A-110.



R1—13,000 ohm, 1 w. res.
 C1, C2—.047 μf., 200 v. capacitor
 C3—.05 μf., 200 v. capacitor
 C4—.02 μf., 200 v. capacitor
 CH1, CH2—4.5 hy., 50 ma. filter choke
 (Thoradson 26C42 or equiv.)

Fig. 2. Low-pass filter: cut-off at 275 cps.

line frequency. Advance this control no farther than necessary.

2. *Connect Scope to Organ Output:* The vertical input of the scope should be connected to the organ output. Probably the simplest way to make the connection is at the speaker voice coil. Allow both the organ and the scope to warm up for at least 30 minutes to avoid any drift during the tuning operation.

3. *Locate A-220 cps Key:* Before an organ can be played, at least one stop tablet must be depressed. Stops are often marked in footage—16-foot, 8-foot, and 4-foot being the most common. The footage is an indication of the pitch, or octave, in which the entire manual (keyboard) is voiced. Doubling the footage will halve the frequency. If there is no footage marking on the stop, it may then be assumed to be 8-foot.

Referring to Fig. 3, the location of A-220 is indicated on the manuals of a typical spinet organ, which is the type usually found in the home. Depress the A-220 key and lock it in this position by inserting a sharp-pointed pencil or similar object between the key and the felt pad at the rear of the keyboard.

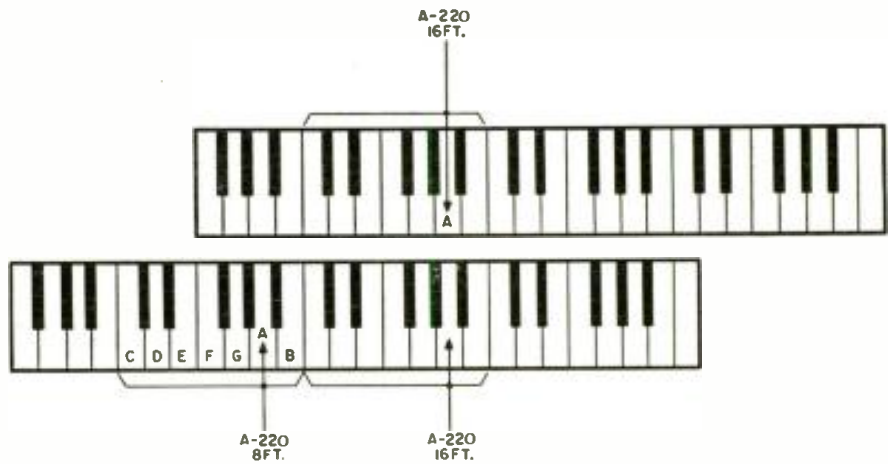

Fig. 3. Frequency location on typical spinet organ manuals. The stop tablets that must be depressed in order to produce the tone A-220 are indicated above.

Push in only one stop for the manual being used—preferably one marked "Flute" so as to obtain a waveshape close to that of a sine wave. Now observe this pattern on the scope, adjusting gain controls to a convenient level, but not disturbing the sweep which was previously locked in at 60 cycles. Keep the horizontal gain low enough so that the entire pattern is visible. If A-220 is exactly in tune the pattern will be stationary. If the pattern is drifting, which it most likely will be, adjust the A oscillator until the drift disappears. This operation tunes A to exactly 220 cycles. As will be explained, the pattern displayed can positively identify A-220 and will guard against

the possibility of tuning an octave higher or lower. The method given here applies only to the frequencies stated.

4. *Checking the Pattern:* Fig. 1A shows the pattern obtained from a 220-cycle pitch and a 60-cycle sweep rate. Notice that there are three overlapping sine waves which can be readily seen by counting the ends of the traces on either the right- or left-hand side of the pattern. Also observe that there are eleven peaks, counting across the top or bottom of the pattern. Thus the frequency ratio displayed is 11 to 3. If this ratio is multiplied by the sweep rate ($11/3 \times 60 = 220$), the frequency of the key can be found. If A-110 were

Fig. 4. Tuning chart employed by author for checking patterns.

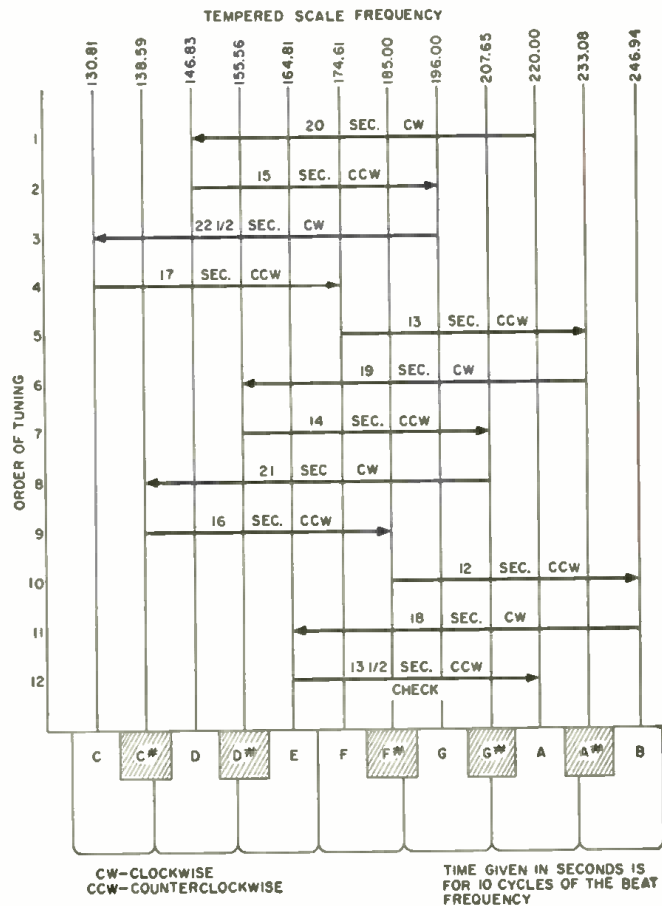

Improving the Mullard 520 Hi-Fi Amplifier

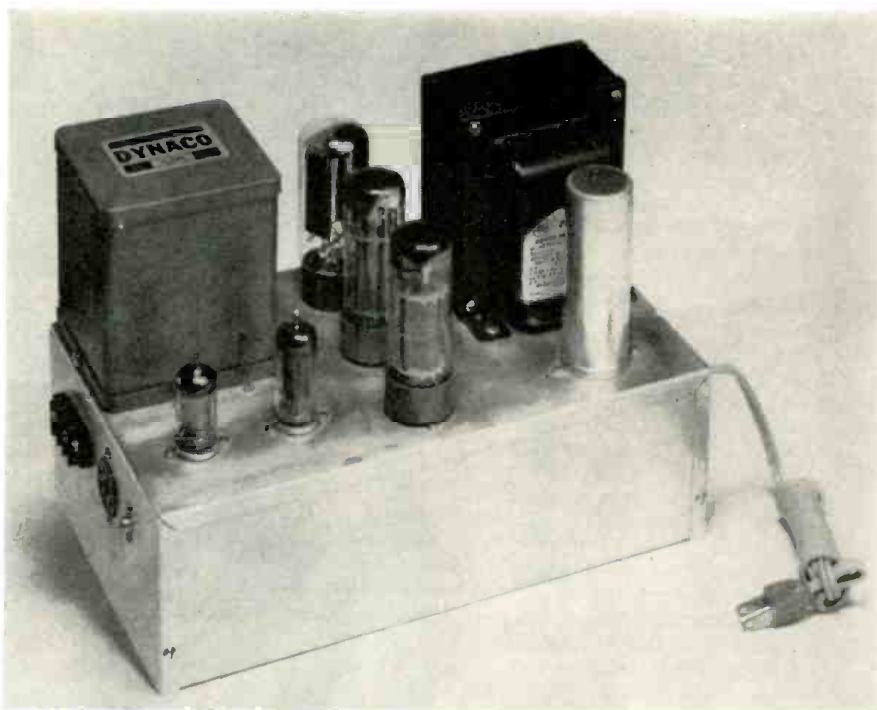
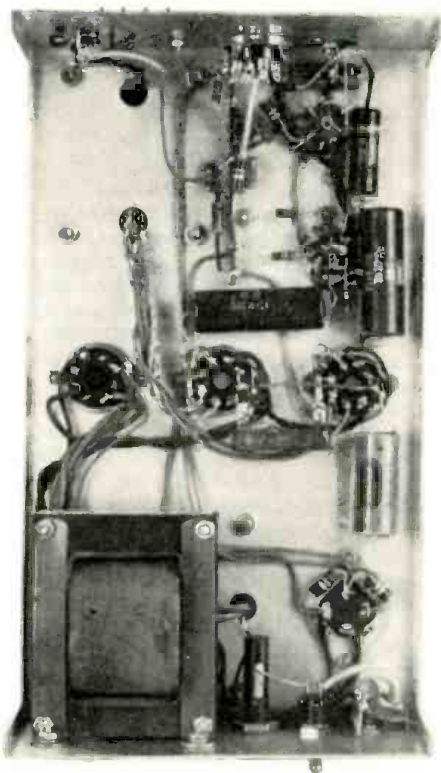

Over-all (above) and under-chassis (left) views of the 35-watt basic power amplifier.

By EDWARD A. LAURENT

Construction details on a conservatively designed power amplifier that delivers 35 watts at 0.3% IM.

omies have been made in the over-all cost—a combination to which no one can object.

Original Circuit

Briefly, the original circuit employs the *Mullard* EF86 audio pentode as a voltage amplifier which is direct-coupled (for minimum phase shift) into a 12AX7/ECC83 dual-triode used in the well-known cathode-coupled phase inverter. The output tubes are the high-power, sensitive *Mullard* EL34's, already recognized as an excellent audio power type. The power supply incorporates the 5AR4/GZ34 rectifier—one of the huskiest types available.

Since the subject is a British amplifier, a few salient facts about the famous "British watt" versus the "American watt" are in order. A watt by any other name is still a watt, in other words, there is no actual difference between them. By way of explanation, the *Mullard* 520 will serve as an example. The original amplifier is rated at 20 watts, but measurement of maximum undistorted output will show that there is actually more than 20 watts of mid-band power available. The reason for this "extra power" is quite simple; the unit uses an output transformer rated at 20 watts and the power handling capabilities of an output transformer at the extremes of the audio band become a limiting factor in rating an amplifier. If the designer, or manufacturer, of an amplifier wishes to be honest about the

ratings, he will quote power output as it is available from one extreme of the full range of audio frequencies to the other. This range, in full-fledged high-fidelity equipment, is generally recognized to be from 20 to 20,000 cps. In amplifiers that utilize output transformers of more limited performance, power rating is sometimes selected at the frequency of maximum power.

The fact of the matter is that, inherent in the design of output transformers, there exists no direct relationship between the amount of mid-band power a transformer can handle and the limit of power it can handle at the extremes. The power handling capability is determined by a number of factors: the type and amount of core material, the winding inductance, the winding technique, etc. The modified amplifier circuit covered by this article employs an output transformer of excellent design, rated at 30 watts. Because of the conservative American rating, the transformer can handle more than 30 watts even at the extremes of the audio band. The amplifier can thus be rated at 30 or more watts when using this transformer. The conclusion to be reached is that many British amplifier manufacturers use the conservative 20-cps figure for power rating; actually there is no mysterious difference in actual audio power between British and American ratings.

The "Improved" Circuit

In typical British fashion, the origi-

WITH the widespread acceptance of the stereo disc many home sound systems are due to expand. For the real audio enthusiast, this means the construction of more equipment to add to his present monophonic system and so the search is on for the latest and best in circuits and performance.

In the power-amplifier department, the search could well end right here: the following is a description of an "Americanized" version of the British *Mullard* 520 circuit which originally appeared in an article in *Wireless World*,¹ was reprinted by *Mullard* in a booklet,² and was the subject of an article "High Fidelity Performance with *Mullard's* 520 Circuit"³ in this magazine. In the version to be described, improvement has been effected in the performance while some econ-

nal amplifier was rated conservatively in the power department; however, on examining performance and in light of modern American standards, it was felt that some improvement could be made in the stability and distortion characteristics of the unit. The amplifier was first built according to the original circuit, but with good quality domestic components of the readily available variety. As stated previously, the most important item, as with any power amplifier—is the output transformer. The output transformer is not the place to effect economies as it is impossible to build an amplifier with top-notch performance around a skimpy transformer. For this "improved" circuit, the Dynaco A-420 output transformer was selected. Its specifications indicate, and its performance proves, that it was just what the doctor ordered.

A power transformer that would supply the approximately correct voltages was used, even though somewhat higher voltages than originally called for will produce higher output and lower distortion while remaining within the tube ratings. As far as the other components are concerned, the type of resistors and capacitors available at parts jobbers were used. All resistors, except R_{10} , R_{11} , R_{12} , R_{13} , were $\pm 10\%$ types. The four exceptions were of $\pm 5\%$ tolerance. An article¹ on this amplifier indicated the use of all premium-type components for construction but, as the editors noted, the cost of such an amplifier was rather high.

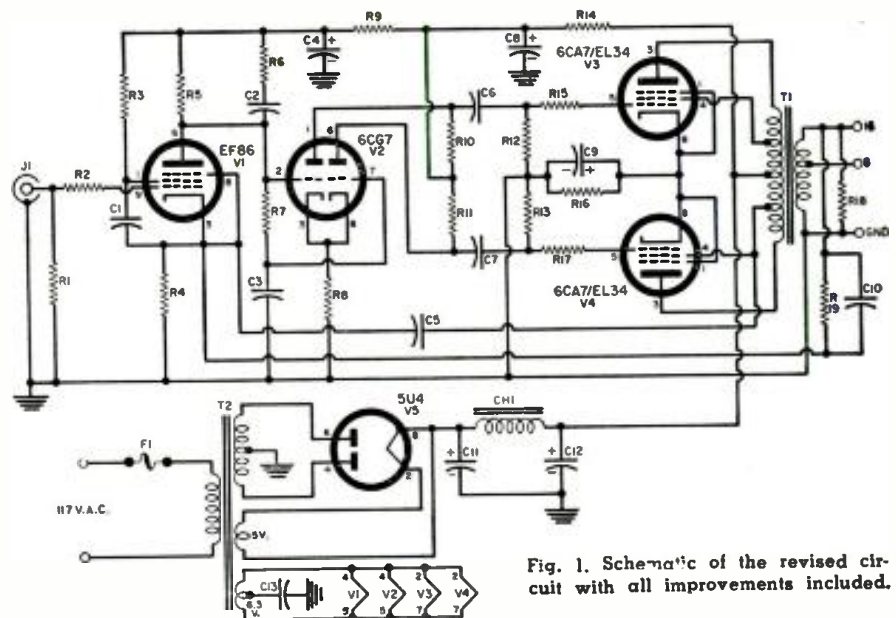

Fig. 1. Schematic of the revised circuit with all improvements included.

- R_1 , R_7 —1 megohm, $\frac{1}{2}$ w. res. $\pm 10\%$
- R_2 —10,000 ohm, $\frac{1}{2}$ w. res. $\pm 10\%$
- R_3 —560,000 ohm, $\frac{1}{2}$ w. res. $\pm 10\%$
- R_4 —1000 ohm, $\frac{1}{2}$ w. res. $\pm 10\%$
- R_5 —82,000 ohm, 1 w. res. $\pm 10\%$
- R_6 —62,000 ohm, $\frac{1}{2}$ w. res. $\pm 10\%$
- R_8 —22,000 ohm, $\frac{1}{2}$ w. res. $\pm 10\%$
- R_9 —100,000 ohm, 1 w. res. $\pm 10\%$
- R_{10} , R_{11} —62,000 ohm, $\frac{1}{2}$ w. res. $\pm 5\%$
- R_{12} , R_{13} —240,000 ohm, $\frac{1}{2}$ w. res. $\pm 5\%$
- R_{14} —18,000 ohm, 1 w. res. $\pm 10\%$
- R_{15} , R_{17} —2200 ohm, $\frac{1}{2}$ w. res. $\pm 10\%$
- R_{16} —250 ohm, 10 w. wirewound res.
- R_{18} —680 ohm, 1 w. res. $\pm 10\%$
- R_{19} —18,000 ohm, $\frac{1}{2}$ w. res. $\pm 10\%$
- C_1 —.05 μ f., 400 v. molded paper capacitor
- C_2 —82 μ f. mica capacitor
- C_3 —.25 μ f., 200 v. molded paper capacitor
- C_4 —12 μ f. mica capacitor
- C_5 —5 μ f., 400 v. molded paper capacitor
- C_6 —100 μ f., 50 v. elec. capacitor
- C_7 —33 μ f. mica capacitor
- C_8 —.02 μ f., 400 v. molded paper capacitor
- C_9 —100 μ f., 50 v. elec. capacitor
- C_{10} —20/20/30/20 μ f., 525 v. elec. capacitor
- C_{11} , C_{12} , C_{13} —20/20/30/20 μ f., 525 v. elec. capacitor

- C_4 —12 μ f. mica capacitor
- C_5 —5 μ f., 400 v. molded paper capacitor
- C_6 —100 μ f., 50 v. elec. capacitor
- C_7 —33 μ f. mica capacitor
- C_8 —.02 μ f., 400 v. molded paper capacitor
- C_9 —100 μ f., 50 v. elec. capacitor
- C_{10} —20/20/30/20 μ f., 525 v. elec. capacitor
- C_{11} , C_{12} , C_{13} —20/20/30/20 μ f., 525 v. elec. capacitor
- F_1 —2 amp fuse
- T_1 —Audio output trans. 6600 ohms c.t. to 8, 16 ohm sec., 30 watts (Dynaco A-420)
- T_2 —Power trans. 400-0-400 v. @ 250 ma.; 5 v. @ 4 amps; 6.3 v. c.t. @ 5 amps (Stancor PC8413 or equiv.)
- V_1 —6267/EF86 tube
- V_2 —6CG7 tube
- V_3 , V_4 —6CA7/EL34 tube
- V_5 —5U4 tube (see text)

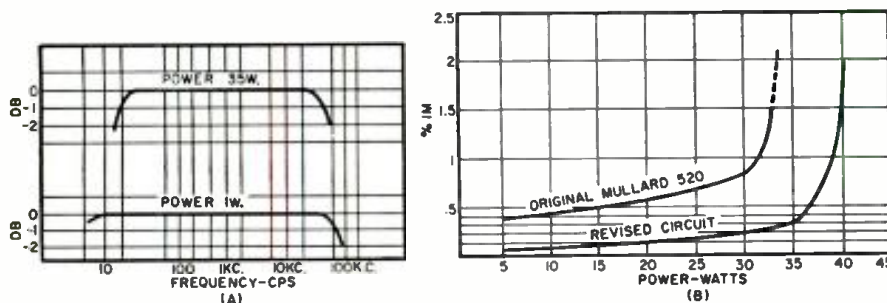

Fig. 2. (A) Power and frequency response, (B) IM distortion of the revised circuit.

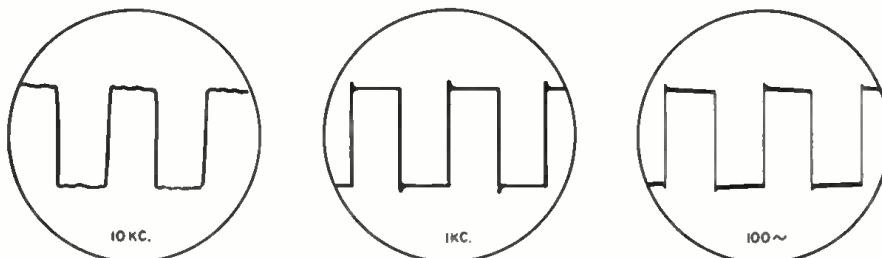

Fig. 3. Square-wave performance of the revised circuit at three test frequencies.

This version uses only components of ratings indicated for good design. The only item "beefed up" at all was the plate resistor of the pentode voltage amplifier since here a unit of higher rating than necessary will help minimize noise. Ordinary molded paper capacitors were used with the exception, of course, of the electrolytics and the very small values which are micas.

Fig. 1 is the schematic diagram of the amplifier as modified. For the original circuit, the reader is referred to page 67 of the April 1956 issue of this magazine or to the other references mentioned previously. Several differences will be noted between the two circuits. First of all, the original version was found to be rather marginal as to stability; capacitive loads

were applied with and without a resistive load. In both cases the amplifier would oscillate with small amounts of capacitance applied. Observation of the square-wave behaviour on an oscilloscope showed overshoot and ringing to an undesirable degree.

Theory indicates, and practice proved, that a lower μ triode would allow a greater degree of stability. The lower μ triode has a lower input capacitance and thus allows better high-frequency operation of the preceding pentode. The output impedance of the tube itself, the triodes, and its associated components is also lower—allowing improved high-frequency performance. An amplifier's high audio-frequency and ultrasonic capabilities are a major factor in the degree of stability and distortion of that amplifier and particularly when, as in this case, it is involved in a feedback loop.

After first attempting to adjust component values for improved stability, a lower μ triode, type 6CG7, was substituted. For those unfamiliar with this type, it is just like a 6SN7 only in a miniature 9-pin bottle. After adjusting resistor values to accommodate this type, adjustment of feedback and compensating capacitors made it evident that a greater degree of stability was available.

The next basic change was the elimination of the separate cathode re-
(Continued on page 128)

RESUSCITATION

For Electric Shock / A Proven Tool for Saving Lives

Thousands of lives have been saved by some of the techniques described and illustrated in this article.

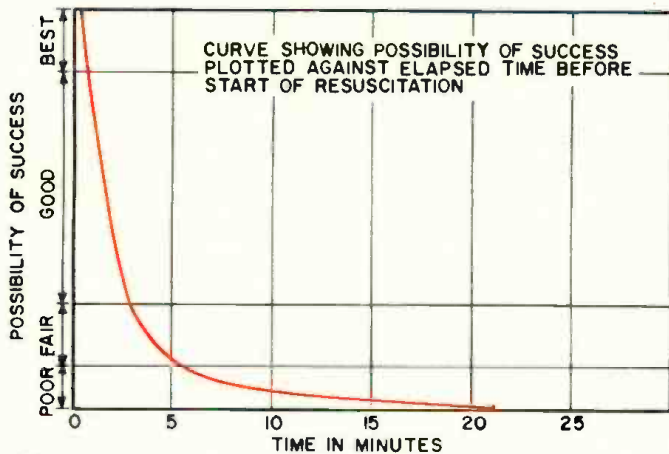

EDITOR'S NOTE: We have run several articles recently on subject of electrical shock. Very little was said, however, as to what to do for the shocked victim. The following material, excerpted from the "Resuscitation Manual," prepared by the Electric Institute, presents some of this information.

In cases where breathing has been suspended by accident causes, the advantages of manual artificial respiration are unchallenged. Records over the years show that thousands of lives have been saved by those who knew to apply it to persons who have stopped breathing because of electric shock. Every year many additional lives are saved by properly trained rescuers. Many thousands of individuals, and society as a whole, owe a debt of eternal gratitude to the hundreds of public-spirited organizations and private companies who have sponsored and promoted artificial respiration training and practice—a proven tool for saving lives.

Conversely, many lives have been lost needlessly because those available did not know how to apply artificial respiration in an emergency.

Effects of Electric Shock

The effect of electric shock on a human being is rather unpredictable and may manifest itself in a number of ways:

a. *Asphyxia*: Electric shock may cause a cessation of respiration (asphyxia). Current passing through the body may temporarily paralyze (or destroy) either the nerves or the area of the brain which controls respiration.

b. *Burns—Contact and Flash*: Contact burns are a common result of electric current passing through the body. The burns are generally found at the points where the current entered and left the body, and vary in severity, the same as thermal burns. The seriousness of these burns may not be immediately evident because their appearance may not indicate the depth to which they have penetrated.

In some accidents there is a flash or electric arc, the rays and heat from which may damage the eyes or result in thermal burns to exposed parts of the body.

c. *Fibrillation*: Electric shock may disturb the natural rhythm of the heart beat. When this happens, the muscles of the heart are thrown into a twitching or trembling state and the action of the individual muscle fibers are no longer coordinated. The pulse disappears and circulation ceases. This condition is known as "ventricular fibrillation" and is serious.

d. *Muscle Spasm*: A series of erratic movements of a limb or limbs may occur due to alternating contractions and relaxations of the muscles. This muscle-spasm action on the muscles of respiration may be a factor in the stoppage of breathing.

Rescue

Because a person may receive electrical shock in many different locations—on the ground, in buildings, on poles, or on steel structures—it is neither possible nor desirable to lay down definite methods of rescue. However, there are certain facts which should be remembered.

1. *Freeing Victim*: Because of the muscle spasm at the time of shock, most victims are thrown clear of contact. However, in some instances (usually low voltage) the

1



2



3



4



5

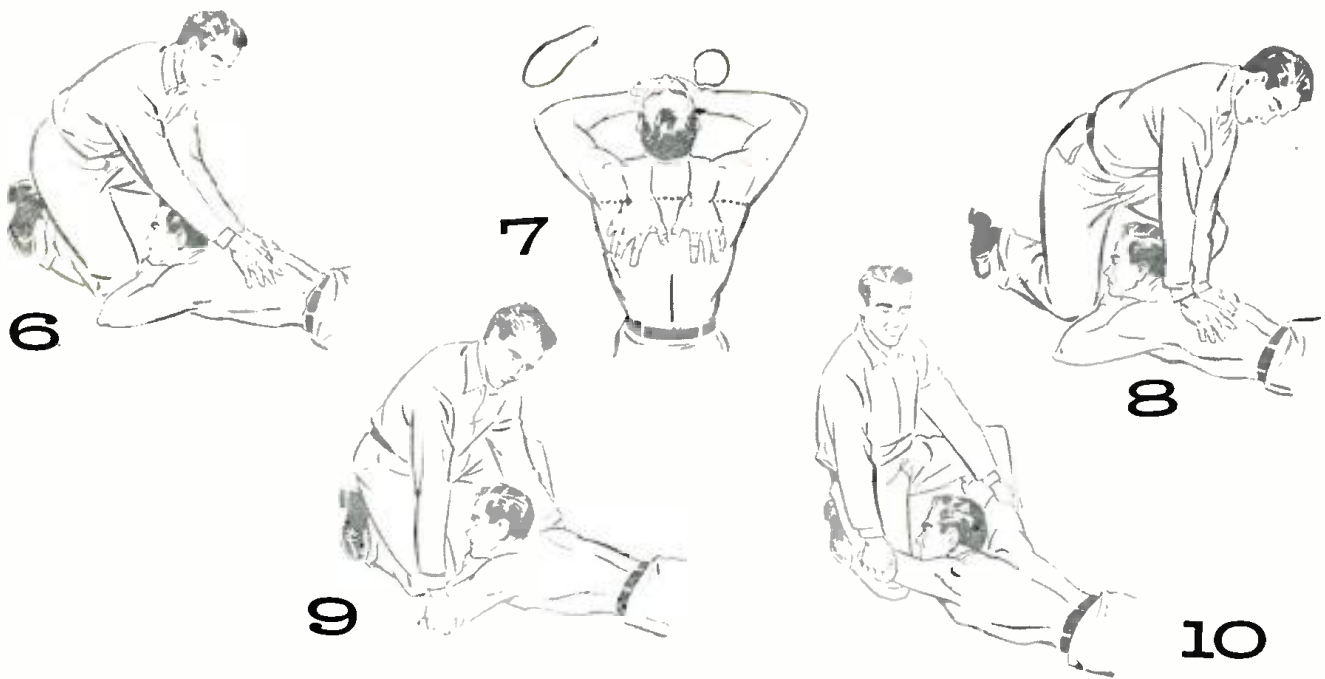

victim is still touching live equipment. In either situation, the rescuer must be extremely careful not to get himself in contact with the live equipment nor to touch the victim while he is still in contact. He should "free" the victim as soon as possible so that artificial respiration can be applied without hazard. This may involve opening switches or cutting wires so that equipment within reach is de-energized, or using rubber gloves or other approved insulation to move the victim out of danger.

2. *Applying Artificial Respiration:* To be successful, artificial respiration must be applied *within the shortest possible time* to a victim who is not breathing. The graph (Fig. 1) shows the possibility of successful revival for each minute of delay.

Normally, the type of resuscitation in which the victim is placed on the ground or floor is the best because the victim can be given additional treatment (stoppage of bleeding, wrapping in blanket to keep warm, etc.) and the "rescuer" can be easily relieved without an interruption of the breathing rhythm or cycle.

In choosing the type of resuscitation to be used, the rescuer must consider the obvious injuries suffered by the victim. Broken ribs, for example, might make inadvisable the use of certain types of resuscitation; burns on the arms or on the face might exclude other types. However, no time should be lost in searching for injuries; artificial respiration should be started *at once*.

There must be no delay to loosen clothing, warm the victim, or move him to a more comfortable position. However, an immediate check of the victim's mouth should be made by a quick pass of the fingers through the mouth to pull the tongue forward and remove false teeth, tobacco, chewing gum, etc. *After* resuscitation is started, the victim's belt, collar, and other clothing may be loosened, providing this doesn't interfere with the resuscitation process. Artificial respiration should be applied with a smooth and steady rhythm, as a person normally breathes this way. However, split-second timing is not necessary.

After Resuscitation Is Started

a. As soon as artificial respiration has been started and while it is being continued, an assistant (if available) should loosen any tight clothing about the victim's neck, chest, or waist. Liquids are not to be given by mouth until the victim is fully conscious.

b. Resuscitation should be carried on at the nearest possible location to where the victim was injured. He should not be moved from this location until he is breathing normally, and then only upon his own volition and while lying down. Should it be necessary, because of ex-

treme weather conditions, to move the victim before he is breathing normally, resuscitation should be carried on while he is being moved.

c. A brief return of normal breathing does not necessarily indicate that resuscitation should be discontinued. Not infrequently the victim, after temporary recovery, stops breathing again. He must be watched and if normal breathing stops, artificial respiration must be resumed at once.

d. Artificial respiration must be continued (four hours or longer, if necessary) until natural breathing is restored or *rigor mortis* (as determined by a doctor) sets in.

e. To avoid strain on the victim's heart when he revives, he should be kept lying down and not be allowed to sit up or stand. If he revives before the doctor arrives, he should be given a stimulant, such as inhalation of ammonia, or a hot drink such as coffee or tea. *The victim should be kept warm.* However, when heating devices are applied to an unconscious person, great care must be taken to prevent possible burns. The heating devices should be tested on one's own body before use and if too hot, should be wrapped in a towel or other suitable insulation or allowed to cool to the proper temperature.

Although there are many methods that have been employed for resuscitation, only two are described here. These are the mouth-to-mouth and back pressure-arm lift methods. Both techniques are highly effective and usually convenient to apply.

Mouth-to-Mouth Method

a. The victim should be laid on his back with his head placed as far back as possible so that his neck is extended. If there is a slope, placing the victim's body with the head slightly downhill is advisable.

b. The operator uses one hand to elevate the victim's jaw so that it juts out by inserting a thumb between the victim's teeth, grasping the lower jaw at midline and lifting it forcefully upward so that the lower teeth are higher than the upper teeth. He then closes the victim's nose with his other hand (Fig. 2). When it is difficult to insert the thumb into a victim's mouth, or when the thumb almost fills the mouth (such as on a child), the operator lifts the jaw forcefully upward with both hands, places his fingers on both sides of the jaw (near the ear lobes), and closes the victim's nose by pinching the nostrils between the thumbs (Fig. 3).

c. After taking a deep breath, the operator places his mouth completely over the victim's mouth with *airtight contact*. The victim's mouth should not be held open too

(Continued on page 134)

Let's Legalize Ham Phone Patches

By C. D. EHINGER, K91VY / **A telephone company president, who is also a radio amateur, suggests here a sound plan for making phone patches legal.**

OUR AUTHOR is a Registered Professional Engineer. He is president of the Citizens Telephone Company, Nappanee Telephone Company, and Argos Telephone Company, all in Indiana. At present he is also serving as president of the Indiana Telephone Association.

AS A working member of the telephone industry, my blood pressure must rise at least 40 points whenever I bump into this "phone patch" proposition. As a comparatively new member of the ham fraternity, exactly the same reaction sets in when I lock horns with the problem from the other side of the fence.

Probably the greatest irritation to me concerning this whole question is the attitude taken by both sides. The telephone industry has somewhat arbitrarily decided to completely ignore the situation and the ham fraternity seems to have decided to seize the bull by the horns and continues to make phone patches on a more-or-less "gray market" basis.

The most discouraging thing about this "phone-patch dilemma" is that there seems to be one very logical solution which will clarify the matter for the telephone industry, hams, and every-and-anyone else concerned—but no one seems willing to take the first step.

Before setting forth my proposal for a way out of the mess, let me attempt to state a few of the issues from both sides. As is usually the case, I probably fail to grasp a good many of the primary problems which present themselves but, in any event, it appears to me that someone should start the ball rolling and stick out his neck. To state the issue from the standpoint of one who has been in the engineering profession, specifically telephone engineering, and management of telephone companies for a period exceeding twenty years, can be done in one short sentence. *Any foreign attachment to*

a telephone line is illegal. Pick up any telephone directory. I believe you will find in the general instructions, at the front of the directory, a paragraph specifically prohibiting the attachment of any device to the lines of the telephone company. In reality, this prohibition means not only a direct electrical "tap" but any means by which communication on the line can be monitored.

The Phone Company's Position

At first glance, such a stand by the telephone companies may seem rather high-handed. But, consider the matter from the standpoint of the telephone company. It has been given a certain area to serve and has been further granted a monopoly on the telephone service in that area. In exchange for this monopoly, the telephone company has surrendered a number of functions which are ordinarily considered "rights" by any other industry. The industry, as a whole, is probably regulated by more governmental agencies than any other business in the United States. No type of service can be offered, or abandoned, or charged to the customer, without some type of approval by the State Service Commission and, in a great number of cases, by the Federal Communications Commission. Add to this the fact that the telephone is the



instrument by which a person may summon the doctor, the fireman, or other aid in case of an emergency, and I believe that it is easy to recognize that the telephone line is not just an easy means for Mrs. Perkins to gah with her daughter but is, rather, a vital part of our emergency system as well as our means of conducting business throughout the country.

It adds up to one thing—the telephone companies are charged with the responsibility of maintaining their equipment and lines in such a manner as to provide the utmost service to the greatest number of people. To accomplish this objective, it is necessary that no “foreign attachments” be allowed on the lines and this viewpoint is shared and upheld by both State and Federal law.

The Amateur's Side

Now, let us consider the matter from the viewpoint of the amateur radio operator. As an aside, and considerably off the subject, I am one of those fellows who deliberately stayed away from ham radio for a good number of years. It appeared that it would be just too much of a “busman’s holiday” after participating in communications on a full-time basis. However, I felt, several years ago, that I might be missing something and decided to have a go at the next session of the FCC examinations for a General license. I surprised myself no end by passing the thing—my experience with c.w. was strictly limited to World War II and I was a “lid” if there ever was one—but I did manage to pass and get my ticket.

Since my operating had been confined to army experience, which involved pre-assigned channels with absolutely no QRM except from the Japanese, I imagine that it is not necessary for me to describe to you my amazement at the bedlam which exists on the ham bands. For the first few weeks, I did not believe that it was possible to become accustomed to the QRM and other interference which exists, but as they say, “you can get used to hanging, if you hang long enough.” I still get a bang out of some of these fellows on the various bands who seem to feel that single-sideband is a brand new development—most of them seem to be amazed when I tell them that the telephone industry has been using single-sideband, suppressed-carrier for over thirty years. The same commentary would apply to those who “look down their noses” at those of us who are still plodding along in engineering and design in the audio field. Such design can often be much more difficult than work in the r.f. field and, in addition, the telephone industry has long been engaged in point-to-point communication by means of 6000 megacycle carrier and is shortly adding the 11,000 mc. band on a commercial basis.

The foregoing comments are far afield from the original subject, yet may serve to acquaint some in the amateur field who are not aware that

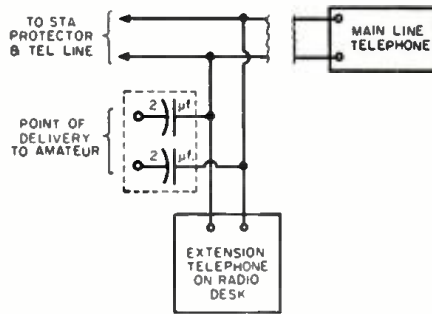

Fig. 1. The basic arrangement employed.

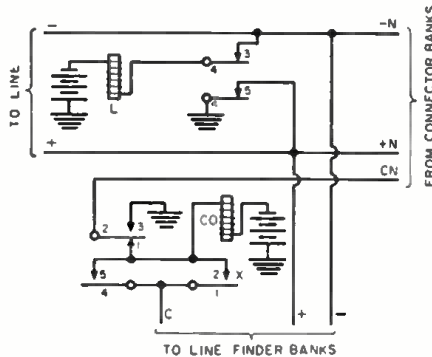

Fig. 2. Simplified schematic of typical telephone central-office line relays.

all communications are considered and are definitely a part of the telephone industry. Most certainly, it has been an extremely embarrassing thing to me to be engaged in a QSO with some other amateur and to be asked if I can “patch him in” to some telephone in this community. My alibi, to date, has been that I do not have a phone patch, which is most certainly the truth as I will not have one until such a time as the patch has become recognized and legalized.

Most amateurs will argue that they are not causing the telephone company to lose toll business. On the whole, I am quite inclined to agree with this general statement. As all of you have done, I have often monitored the bands and followed the course of patching being completed, or the attempt to complete patches. With the general unreliability of such communication, it would certainly be my guess that such patches, or attempts at patches, actually increase toll business for the telephone company. My contention is that the telephone company’s toll business is increased by two factors. The first factor is the case where an actual toll call is involved in the completion of the phone patch. The second factor is

that, in many cases, either the called or calling party will immediately place a toll call, by telephone, to complete the original attempt, or to finish the conversation under the blanket of privacy, or secrecy, which they will have by use of land lines.

A Proposed Solution

I have a proposal which may or may not have merit. In boiling down the entire matter, the fly in the ointment is that, quoting again, “any foreign attachment to a telephone line is illegal.” My solution is simply this: *Let us take steps to remove the phone patch from the “foreign attachment” category.* Actually, in telephone language, just what is a foreign attachment? Wading through all of the miles of legal phraseology usually involved, the definition of “foreign attachment” is “any item not covered or filed in the tariff of the telephone company.” I do not believe that it is all far-fetched to suggest that the ARRL could meet with the USITA, representing the Independent segment of the telephone industry, and the Bell System, representing the Bell components of A.T. & T. I suggest that at such meetings, it should not be too difficult to work out suggested tariff filings which all telephone companies could use to cover the situation.

After all, telephone companies now have tariff filings to allow for the use of telephone lines for such purposes as broadcast, teletypewriters, news wire services, etc. In all such cases, the line is turned over to the subscriber at a certain point for the attachment of additional facilities, usually the property of the subscriber, for further transmissions. It is true that two additional circumstances usually accompany such a situation. The lines in question are always “private lines” and the point of termination is invariably a fixed, definite point. By use of a “private line” any malfunction of the subscriber’s equipment does not jeopardize the telephone service of any other person, or persons, and by use of a fixed terminating point, the subscriber cannot interrupt any service at the distant end, except his own. In addition, there are certain other restrictions on the use of “leased lines.” These restrictions pertain to maximum sending levels, types of transmission, etc.

Even though such a situation is not exactly parallel to a “phone patch,” I am suggesting that it is possible for a

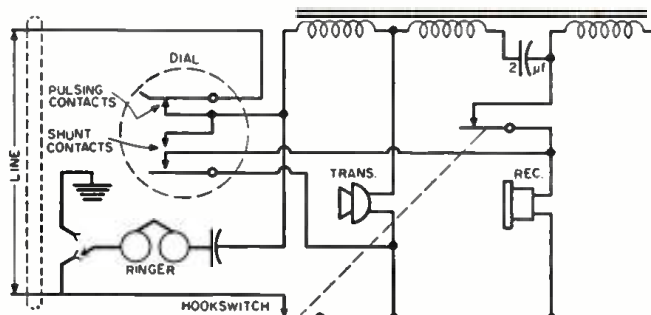

Fig. 3. A simplified schematic diagram of a typical telephone setup, shown in the “off-hook” condition.

telephone company to recognize the phone patch as a valid instrument and to offer such service to any qualified amateur fulfilling certain minimum requirements. I propose that these minimum requirements should be as follows:

1. That the service be offered only to a person holding a valid operating and station license and that all operations be subject to the restrictions of the license.

2. That the telephone line used by the amateur be a "private line."

3. That either the main line or extension telephone be a part of the equipment installed on the radio operating desk.

4. That the equipment to be used by the amateur, for the means of the "phone patch," be subject to inspection and approval by the telephone company.

5. That the "patch" equipment have a means of monitoring the volume level of transmission toward the telephone central office.

6. That the amateur pay a nominal, monthly fee for the service that would be provided.

There are probably many who will feel that these qualifications are too stringent. However, as I have attempted to point out, a telephone line

side of the line. The necessity for these capacitors can be seen from Fig. 2 which is a schematic of the line-terminating equipment which is somewhat generally used throughout the telephone industry. Although this particular set of line equipment is for a dial office, the same general principle applies whether the central office be a common battery or a magneto manual office. Fig. 3 shows a simplified schematic of a telephone instrument. With the telephone handset in the "on hook" position, only the telephone ringer terminates the line.

When the telephone handset is in the "off hook" position, a d.c. shunt through the dial pulsing springs, a part of the induction coil, the transmitter, and the hook-switch contacts, is placed across the line. Relay *L* (at the telephone central office, Fig. 2) is capable of operating with a d.c. shunt (d.c. resistance of telephone instrument plus d.c. resistance of telephone line) of approximately 1000 ohms maximum. Relay *L* operates, placing ground on the *CN* lead, to busy-out the line, and prepares a circuit, through contacts 4 and 5, for the *CO* relay. When the line finder seizes the line, ground is placed on the *C* lead, completing the circuit to the *CO* relay. Relay *CO* operates (contacts 1 and 2 are "x" contacts which operate

incoming transmission to be diverted to the transmitting section of the phone patch while the light arrows indicate that transmission from the radio receiver is diverted only into the telephone line and not back in the direction of the transmitter. For optimum results, it is vital that the balancing network impedance be identical to the impedance of the telephone line. For the purpose of a phone patch, this network can be composed of a 1- μ f. capacitor in series with a 1000-ohm variable resistor. The resistor can then be varied for the best balance. Fig. 5 shows the equivalent circuit of the network which actually takes the form of a Wheatstone bridge.

In a short article, such as this, it is not possible to enumerate all of the pros and cons of the phone patch nor do anything other than touch very lightly upon the actual equipment used. As an example, I have not mentioned the fact that a working system of phone-patch-equipped amateurs represents a substantial "back-up" reserve to our communication network. This could be of vital importance in cases of localized disaster or national emergency and should interest Civil Defense and Armed Forces planners.

I wish to make it amply clear that all views expressed are strictly my own and do not necessarily represent those of any company, industry, or organization. I hope that many of you feel as I do concerning the necessity and desirability of removing the phone patch from the "illegal" category. If enough of you concur in this thinking, it is certainly not beyond the realm of possibility to stir up some action by the ARRL, USITA, and A.T. & T. In the meantime, I hope to be seeing you on the bands, but I won't have a phone patch.

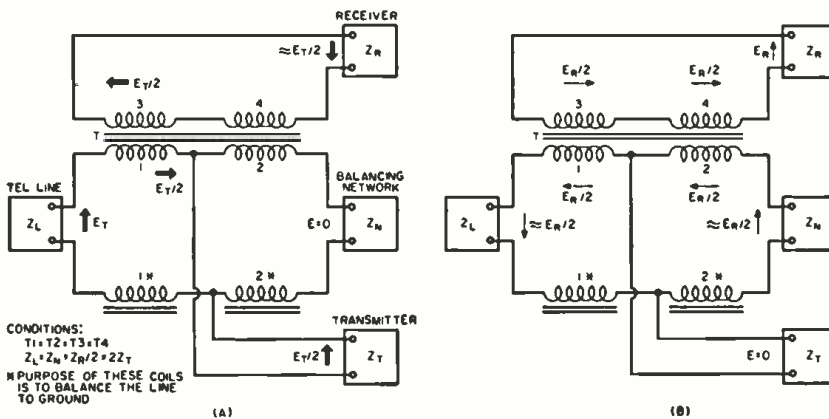

Fig. 4. (A) Distribution of signal from telephone line into hybrid coil. (B) Distribution of the signal from the receiver into the hybrid coil.

is not something to be used as a plaything or a toy. It can be too vital and too urgently needed to allow some irresponsible person to throw a "hay-wire" rig on the line and perhaps jeopardize the lines and/or safety of others. Of course, that is also the reason why I feel that patches should be made only on the amateur's own "private line" into his home. If, by some chance, he does manage to foul it up, then, at least, he is only jeopardizing his own telephone service and not that of others.

Circuit Information

As shown in Fig. 1, the point of delivery of the terminals for the phone patch would be immediately adjacent to or from the same terminal block used for the extension phone. In addition, the patch would be fed through 2- μ f. capacitors placed in series in each

prior to the other contacts of the relay) opening the circuit to the *L* relay, removing ground from the "plus" side of the line, and locking up the relay through contacts 1 and 2. The line is then prepared and ready for pulsing, in the case of a dial office, or for answering by an operator in the case of a manual office. Again, a manual office has a slightly different arrangement than that shown in Fig. 2, however the basic principles are the same as those described above.

Fig. 4 is a simplified diagram of a hybrid coil which is often used in telephone work to transpose from a "2-wire" system to a "4-wire" system. Since amateur radio is basically a 4-wire or 2-channel system, it is necessary that some means be used to transpose from the existing 2-wire telephone line to a 4-wire system. As shown by the heavy arrows, the hybrid coil allows

Fig. 5. Equivalent Wheatstone bridge circuit of the hybrid coil employed.

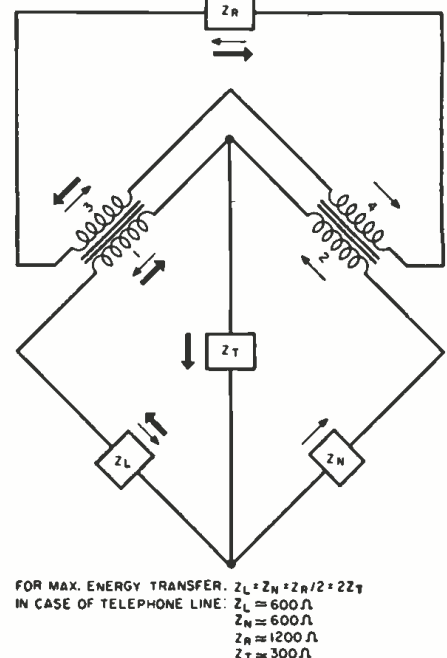

GET *more!* DO *more!* MAKE *more!*

PROFIT PROFESSIONALLY ON EVERY CALL WITH

NEW **B&K** LOW-COST PROFESSIONAL Model 550 DYNA-QUIK DYNAMIC MUTUAL CONDUCTANCE TUBE TESTER



NET \$119⁹⁵

MODEL 550 DYNA-QUIK TUBE TESTER

Tests Each Section of Dual-Section Tubes Separately

Great new value in professional quick-check at small cost. Provides more tube sockets to test more tubes faster. Accurately checks most of the TV and radio tubes usually encountered in everyday service work. Tests each section of dual-section tubes separately. Measures true dynamic mutual conductance. Checks tubes for shorts, grid emission, gas content, and leakage. Completely tests each tube in seconds, checks average TV set in a few minutes, in home or shop. One switch tests everything. Fast, convenient reference listings on socket panel. Patented circuit provides automatic line voltage compensation. 7-pin and 9-pin straighteners on panel. Handsome, luggage-type carrying case. Net, \$119⁹⁵

MODEL 650 DELUXE DYNA-QUIK

Today's Finest Portable Tube and Transistor Tester

Accurately checks over 99% of the tubes most widely used in television receivers, plus popular home and portable radio tubes. Tests over 600 tube types. Lists over 125 most popular tube types, with settings, on socket panels for maximum operating speed. Complete listing in fast, index-type selector. Measures true dynamic mutual conductance. Tests each section of multiple tubes separately for GM, Shorts, Grid Emission, Gas Content and Life. Includes 16 spare sockets and ample filament voltages for future new tube types. Transistor Section checks transistors, diodes, and selenium rectifiers. Luggage-type carrying case. Net, \$169⁹⁵

Every service-technician now can easily check tubes the B&K professional way! Only with a *genuine dynamic mutual conductance tube tester* can you make a complete and accurate test under the actual dynamic operating conditions of the TV set. The compact new "550" is not just an emission checker. *It completely checks more tubes faster—with laboratory accuracy.* And the cost is so amazingly low, it pays its way over and over again! Take a tip from thousands of professional servicemen—use *B&K Dyna-Quik*. There is nothing like it.



Get More for Your Money

—IN SPEED, ACCURACY, AND VALUE



Save Customers

—SAVE CALL-BACKS, SAVE COST



Sell More Tubes

—MAKE MORE MONEY PER CALL



B&K

B & K MANUFACTURING CO.
1801 W. BELLE PLAINE AVE • CHICAGO 13, ILL.

Canada: Atlas Radio Corp., 50 Wingold, Toronto 10, Ont.
Export: Empire Exporters, 277 Broadway, New York 7, U.S.A.

See Your Distributor or Send Now for Bulletin ST24-N

New Transistor Clock Radio Kit

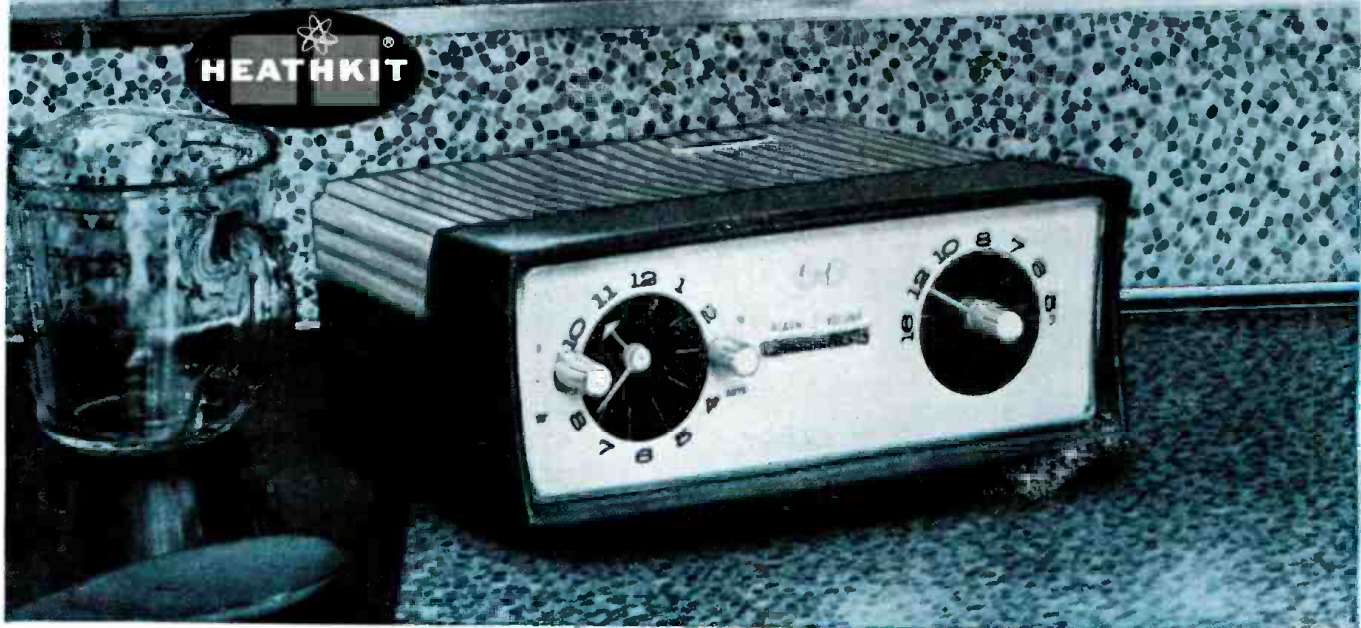

EVERYTHING A CLOCK-RADIO CAN OFFER ... AND PORTABLE TOO!

- Completely portable, all-transistor circuit
- Runs up to 500 hours on standard batteries
- Deluxe features at half the cost
- Easy to assemble

HEATHKIT TCR-1
\$45⁹⁵

"YOUR CUE" TRANSISTOR CLOCK RADIO KIT (TCR-1)

Take all the deluxe features found in the most expensive clock-radios, add the convenience of complete portability, plus a modern 6-transistor battery operated circuit ... then slash the price at least in half, and you have the new Heathkit "Your Cue" Transistor Portable Clock Radio.

Packing every modern clock-radio feature into a compact, beautifully styled modern turquoise and ivory plastic cabinet, "Your Cue" lulls you to sleep, wakes you up, gives you the correct time and provides top quality radio entertainment in and out-of-doors. It can also be used with the Heathkit Transistor Intercom system, opposite page, to provide music or a "selective alarm" system for one or more rooms covered by the intercom system.

An "Alarm-set" hand, hour hand, minute hand and sweep second hand grace the easy-to-read clock dial. All controls are conveniently located and simple to operate. The "lull-to-sleep" control sets the radio for up to an hour's playing time, automatically shutting off the receiver when you are deep in slumber. Other controls set "Your Cue" to wake you to soft music, or conventional "buzzer" alarm. A special earphone jack is provided for private listening or connection to your intercom or music system. At all times crystal-clear portable radio entertainment is yours at the flick of a switch.

The modern 6-transistor circuit features prealigned IF's for ease of assembly. A tuned RF stage and double tuned input to the IF stage assure top performance. The built-in rod-type antenna pulls in far-off stations with outstanding clarity while a large 4" x 6" speaker provides tonal reproduction of unusual quality.

Six easily obtainable penlight-size mercury batteries power the radio receiver up to 500 hours, while the clock operates up to 5 months from a single battery of the same type. Ordinary penlight cells may also be used with reduced battery life.

The handsome two-tone cabinet, measuring only 3½" H. x 8" W. x 7½" D. fits neatly into the optional carrying case for beach use, boating, sporting events, hunting, hiking, or camping.

Wherever you are, you'll find "Your Cue" your constant companion. Shpg. Wt. 5 lbs.



HEATH COMPANY / Benton Harbor, Mich.

 a subsidiary of Daystrom, Inc.

ELECTRONICS WORLD

New Transistor Intercom Kit

**TALK WITH ANY OR ALL FIVE STATIONS
WITH YOUR OWN INTERCOM SYSTEM**

- Battery Power Permits Placement Anywhere
- Versatile Unit has Many Important Uses
- Complete Privacy of Conversations Assured

TRANSISTOR INTERCOM KIT (XI-1 and XIR-1)

A flexible, versatile transistor intercom, has been developed by Heath engineers to enable you to set up your own communications system at an unbelievably low price.

Consisting of a master unit (XI-1) and up to five remote stations (XIR-1), the system is designed for any remote unit to call the master, for any remote station to call any other remote station, or for the master unit to call any single remote unit or any combination of remote units. Complete privacy is assured, since a call to a remote station cannot be interrupted or listened to while the remote unit is in operation unless switched in by the master unit. Used with clock-radio, opposite page, it can serve as a music or "selective alarm" system.

Transistor circuitry means long life, instant operation and minimum battery drain. Eight ordinary, inexpensive "C" flashlight batteries will run a unit for up to 300 hours of normal "on" time. Circuitry is especially designed for crisp, clear intelligible communication and the instant operation feature allows tuning of the units off between calls, extending battery life. Use of battery power does away with power cords, allowing each unit to be placed where most convenient. Only two wires are required between the master unit and each remote station. Beautifully styled, the Heathkit Intercom presents a new approach in design. Both master and remote stations have two-piece cases in ivory and turquoise for a rich, quality appearance. Batteries not included. Shpg. Wt. 6 lbs.

AC POWER SUPPLY (XP-1)

A permanent power supply for 24-hour operation of the XI-1 Intercom on household current. Converts 110 V. AC to well filtered 12-volt DC output, eliminating the need for batteries. Power supply is small, compact and fits in space normally occupied by batteries.

HEATHKIT XP-1..... \$9.95



HEATHKIT XI-1 (Master)

\$27⁹⁵

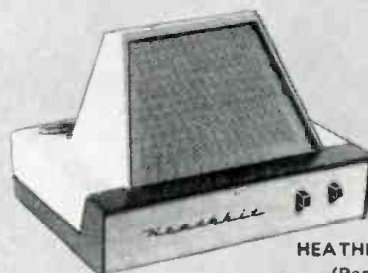

HEATHKIT XIR-1
(Remote)

\$6⁹⁵

Shpg. Wt. 4 lbs.

NEW IMPROVED DESIGN

STEREO-MONO PREAMP KIT (SP-2A, SP-1A)

Get the SP-2A Stereo Preamp kit now, or the SP-1A monophonic version which you can easily convert to stereo whenever you choose by assembling the second channel (C-SP-1A) and plugging it into your SP-1A.

The SP-2A permits stereo, two channel mixing, or either channel monophonic use, and includes a remote balance control.

Six inputs (12 in the stereo version) accommodate tape, magnetic phono and microphone, plus three separate high level inputs. Level controls provided on "mag. phono" and high level inputs. Switch selects NARTB equalization for tape head input, and RIAA, LP or 78 RPM compensation for mag. phono input

HEATHKIT SP-1A (monophonic) Shpg. Wt. 13 lbs..... \$37.95
HEATHKIT, C-SP-1A (not shown) (converts SP-1A to SP-2A) Shpg. Wt. 4 lbs..... \$21.95

New

HEATHKIT SP-2A (stereo)
Shpg. Wt. 15 lbs.

\$56⁹⁵

\$5.70 down. \$6.00 mo.



THE WORLD'S BIGGEST BARGAIN IN A HI-FI AMPLIFIER

55 WATT HI-FI AMPLIFIER KIT (W-7A)

Utilizing advanced design in components and tubes to achieve unprecedented performance with fewer parts, Heathkit has produced the world's first and only "dollar-a-watt" genuine high fidelity amplifier. Meeting full 55-watt hi-fi rating and 50-watt professional standards, the new improved W-7A provides a comfortable margin of distortion-free power for any high fidelity application.

The sleek, modern styling of this unit allows unobtrusive installation anywhere in the home. The clean, open layout of chassis and precut, cabled wiring harness makes the W-7A extremely easy to assemble. Shpg. Wt. 28 lbs.

SPECIFICATIONS—Power output: Hi-Fi rating, 55 watts; Professional rating, 50 watts. Power response: ± 1 db from 20 cps to 20 kc at 55 watts output. Total harmonic distortion: Less than 2% from 30 cps to 15 kc at 55 watts output. Intermodulation distortion: Less than 1% at 62 watts output using 60 cps and 6 kc signal mixed 4:1. Hum and noise: 80 db below 55 watts, unweighted. Damping factor: Switch on front panel for selecting either maximum (20:1) or unity (1:1). Output impedances: 4, 8 and 16 ohms and 70-volt line. Power requirements: 117 volts, 50/60 cycles, 90-160 watts. Dimensions: 8 1/2" D. x 6 1/2" H. x 15" W.

New



HEATHKIT W-7A

\$54⁹⁵

New



HEATHKIT SA-2

\$52⁹⁵

Stereo Amplifiers

**YOUR BEST DOLLAR VALUE
IN STEREO...**

14/14 WATT STEREO AMPLIFIER KIT (SA-2)

Complete control is at your fingertips with this versatile Stereo Amplifier-Preamplifier. Providing 14 watts per stereo channel, or 28 watts total monophonic, the SA-2 offers every modern feature in a master stereo control center at a price to please the budget minded. The unit offers selection of dual channel stereo operation, monophonic operation using both channels simultaneously, or using either channel for monophonic program material independent of the other channel. A 4-position input selector switch provides choice of mag. phono, crystal phono, tuner, and high level auxiliary input for tape recorder, TV, etc. Other features include RIAA equalization on mag. phono, channel reversing function, clutched volume control, ganged dual tone controls, speaker phase reversal switch and two AC outlets. Handsomely styled black and gold vinyl-clad steel cabinet. Shpg. Wt. 23 lbs.

SPECIFICATIONS—Power output: 14 watts per channel, "hi-fi"; 12 watts per channel, "professional"; 16 watts per channel, "utility". Power response: ± 1 db from 20 cps to 20 kc at 14 watts output. Total harmonic distortion: less than 2%. 30 cps to 15 kc at 14 watts output. Intermodulation distortion: less than 1% at 16 watts output using 60 cps and 6 kc signal mixed 4:1. Hum and noise: mag. phono input, 47 db below 14 watts output; tuner and crystal phono, 63 db below 14 watts. Controls: dual clutched volume, ganged bass, ganged treble; 4-position selector; speaker phasing switch. AC receptacle: 1 switched, 1 normal. Inputs: 4 stereo or 8 monophonic. Outputs: 4, 8 and 16 ohms. Dimensions: 4 $\frac{1}{2}$ " H. x 15" W. x 8" D. Power requirements, 117 volts, 50/60 cycle, AC, 150 watts (fused).

New



HEATHKIT SA-3

\$29⁹⁵

ECONOMY STEREO AMPLIFIER KIT (SA-3)

This amazing performer delivers more than enough power for pure, undistorted room-filling stereophonic sound at the lowest possible cost. Featuring 3 watts per stereo channel and 6 watts as a monophonic amplifier, the SA-3 has been proven by exhaustive tests to be more than adequate in volume for every listening taste.

You will find its ease of assembly another plus feature. Heathkit construction manuals, world famous for their clarity and thoroughness, lead you a simple step at a time to successful completion of the kit. Larger than life-size diagrams show you exactly what each part looks like, where it goes, and how it is installed.

The amplifier is tastefully styled in black with gold trimmed control knobs and gold screened front and rear panel. A tremendous buy at this low Heathkit price! Shpg. Wt. 13 lbs.

SPECIFICATIONS—Power output: 3 watts per channel. Power response: ± 1 db from 50 cps, 20 kc at 3 watts out. Total harmonic distortion: less than 3%; 60 cps, 20 kc. Intermodulation distortion: less than 2% @ 3 watts output using 60 cycle & 6 kc signal mixed 4:1. Hum and noise: 65 db below full output. Controls: dual clutched volume; ganged treble, ganged bass; 7-position selector; speaker phasing switch; on-off switch. Inputs (each channel): tuner, crystal or ceramic phono. Outputs (each channel): 4, 8, 16 ohms. Finish: black with gold trim. Dimensions: 12 $\frac{1}{2}$ " W. x 6 $\frac{1}{2}$ " D. x 3 $\frac{1}{2}$ " H.

New



HEATHKIT XR-2P
(6 lbs.)

\$29⁹⁵



HEATHKIT XR-2L
(7 lbs.)

\$34.95

New



HEATHKIT DS-1

\$69⁹⁵

\$7.00 DN., \$7.00 MO.

6-TRANSISTOR PORTABLE RADIOS (XR-2P and XR-2L)

New, improved styling, new vernier tuning, up to 1,000 hours on flashlight batteries... are just a few of the plus features you get with these new transistor portables. Carry them with you wherever you go; to the beach, on trips, boating, etc. These new, improved models bring you the outstanding performance of the preceding models plus brand new styling and the additional convenience of vernier tuning for smooth, effortless station selection. The XR-2P features a mocha and beige high-impact plastic case. The XR-2L has a sun-tan color leather case with an identical beige plastic front. Six Texas Instrument transistors are used for high sensitivity and selectivity. A large 4" x 6" PM speaker with heavy magnet provides excellent tone quality. The roomy chassis makes it unnecessary to crowd components, adding greatly to ease of construction. The six standard size "D" flashlight batteries used for power provide extremely long battery life and can be purchased anywhere. Fun to build, and fun to use... order one today!

- Indicates Depth and Type of Bottom From 0 to 100 Feet
- Detects Submerged Objects (fish, logs, etc.) and Their Depth
- Completely Transistorized... Operates From Flashlight Batteries

TRANSISTOR DEPTH SOUNDER (DS-1)

Weekend boatsman or professional... fisherman or skindiver... here's the depth sounder for you. Depth is indicated by a flashing neon lamp rotating behind a transparent circle in the molded black plastic dial face. A large hood around the dial enables the viewer to easily read the indicator in bright light or sunshine. The transducer uses a barium titanate element mounted in a faired, molded epoxy resin housing with solid brass through-hull fitting and mounting hardware. While designed for permanent mounting on the bottom of the boat, temporary outboard mounting of the transducer is also possible. The completely transistorized circuit operates from 6 flashlight cells and one long-life battery. Comes complete with splash-proof cabinet, hardware and gimbal-type mounting bracket. Shpg. Wt. 10 lbs.

New



Amplifiers & Tuners

A NEW AMPLIFIER AND PREAMP UNIT PRICED WELL WITHIN ANY BUDGET

14-WATT HI-FI AMPLIFIER KIT (EA-3)

This thrilling successor to the famous Heathkit EA-2 is one of the finest investments anyone can make in top quality high fidelity equipment. It delivers a full 14 watts of hi-fi rated power and easily meets professional standards as a 12-watt amplifier.

Rich, full range sound reproduction and low noise and distortion are achieved through careful design using the latest developments in the audio science. Miniature tubes are used throughout, including EL-84 output tubes in a push-pull output circuit with a special-design output transformer. The built-in preamplifier has three separate switch-selected inputs for magnetic phono, crystal phono or tape, and AM-FM tuner. RIAA equalization is featured on the magnetic phono input. Shpg. Wt. 15 lbs.

NOTE THESE OUTSTANDING SPECIFICATIONS—Power output: 14 watts, Hi-Fi; 12 watts, Professional; 16 watts, Utility. Power response: ± 1 db from 20 cps to 20 kc at 14 watts output. Total harmonic distortion: less than 2%, 30 cps to 15 kc at 14 watts output. Intermodulation distortion: less than 1% at 16 watts output using 60 cps and 6 kc signal mixed 4:1. Hum and noise: mag. phono input, 47 db below 14 watts; tuner and crystal phono, 63 db below 14 watts. Output impedances: 4, 8 and 16 ohms.

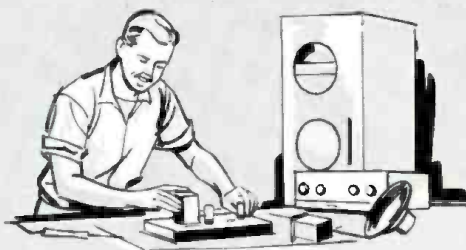

HEATHKIT EA-3

\$29⁹⁵

NEVER BEFORE HAS ANY HI-FI AMPLIFIER OFFERED SO MUCH AT SO LOW A PRICE

"UNIVERSAL" 14-WATT HI-FI AMPLIFIER KIT (UA-2)

Meeting 14-watt "hi-fi" and 12-watt "professional" standards, the UA-2 lives up to its title "universal" performing with equal brilliance in the most demanding monophonic or stereophonic high fidelity systems. Its high quality, remarkable economy and ease of assembly make it one of the finest values in high fidelity equipment. Buy two for stereo. Shpg. Wt. 13 lbs.

SPECIFICATIONS—Power output: Hi-Fi rating, 14 watts; Professional rating, 12 watts. Power response: ± 1 db from 20 cps to 20 kc at 17 watts output. Total harmonic distortion: Less than 2% from 20 cps to 20 kc at 14 watts output. Intermodulation distortion: Less than 1% at 14 watts output using 60 cps and 6 kc signal mixed 4:1. Hum and noise: 73 db below 14 watts. Output impedances: 4, 8 and 16 ohms. Damping factor: Switched for unity or maximum; maximum damping factor 15:1. Input voltage for 14 watt output: .7 volts. Power requirements: 117 volts 50/60 cycles, 55 watts. Dimensions: 10" W. x 6 $\frac{1}{2}$ " D. x 4 $\frac{3}{4}$ " H.



HEATHKIT UA-2

\$22⁹⁵

New

MORE STATIONS AND TRUE FM QUALITY ARE YOURS WITH THIS FINE TUNER KIT

HIGH FIDELITY FM TUNER KIT (FM-4)

This handsomely styled FM tuner features better than 2.5 microvolt sensitivity, automatic frequency control (AFC) with on-off switch, flywheel tuning and prewired, prealigned and pretested tuning unit. Clean chassis layout, prealigned intermediate stage transformers and assembled tuning unit makes construction simple—guarantees top performance. Flywheel tuning and new soft, evenly-lighted dial scale provide smooth, effortless operation. Vinyl-covered case has black, simulated-leather texture with gold design and trim. Multiplex adapter output also provided. Shpg. Wt. 8 lbs.

SPECIFICATIONS—Tuning range: 88 to 108 mc. Quieting sensitivity: 2.5 uv for 20 db of Quieting. IF frequency: 10.7 mc. Image ratio: 45 db. AFC correction factor: 75 kc per volt. AM suppression: 25 db. Frequency response: ± 2 db 20 to 20,000 cps. Harmonic distortion: Less than 1.5%, 1100 uv, 400 cycles 100% modulation. Intermodulation distortion: Less than 1%, 60 cycles and 6 kc mixed 4:1 1100 uv, 30% modulation. Antenna: 300 ohms unbalanced. Output impedance: 600 ohms (cathode follower) Output voltage: nominal .5 volt (with 30% modulation, 20 uv signal). Power requirements: 105-125 volts 50/60 cycle AC at 25 watts. Overall dimensions: 4 $\frac{1}{2}$ " H. x 13 $\frac{1}{2}$ " W. x 5 $\frac{1}{2}$ " D.



HEATHKIT FM-4

\$34⁹⁵

New

HEATH COMPANY/Benton Harbor, Mich.

 a subsidiary of Daystrom, Inc.

New



Tape Recorders

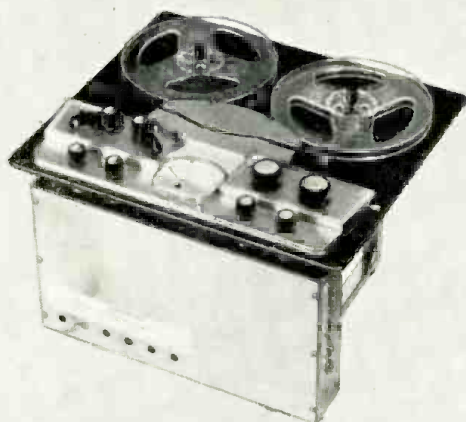

- Choice of 3 Outstanding Models
- Compare With \$350-\$400 Machines
- Preassembled Tape Mechanism
- Choice of Monophonic or Stereo models
- Complete versatility
- Easy to assemble, easy to use

PROFESSIONAL QUALITY TAPE RECORDER KITS (TR-1 Series)

Enjoy the incomparable performance of these professional quality tape recorders at less than half the usual cost. These outstanding kits offer a combination of features found only in much higher priced professional equipment, generally selling for \$350 to \$400. Not the least of these special features is the handsome styling which characterizes the kits... a semi-gloss black panel is set off by a plastic escutcheon in soft gold, which is matched by black control knobs with gold inserts. The mechanical assembly, with fast forward and rewind functions, comes to you completely assembled and adjusted; you build only the tape amplifier. And, you'll find this very easy to accomplish, since the two circuit boards eliminate much of the wiring. Separate record and playback heads and amplifiers allow monitoring from tape while recording and a "pause" control permits instant starting and stopping of tape for accurate cueing and tape editing. A digit counter is provided for convenient selection of any particular recording. Push-pull knob provides instant selection of 3¾ or 7½ IPS tape speed. Safety interlock on record switch reduces possibility of accidental erasure of recorded tapes. Shpg. Wt. 30 lbs.

SPECIFICATIONS—Tape speed: 7.5" and 3.75" per second. **Maximum reel size:** 7". **Frequency response (record-playback):** ±2.5 db, 30 to 12,000 cps at 7.5 IPS; ±2.5 db, 30 to 6,500 cps at 3.75 IPS. **Harmonic distortion:** 1% or less at normal recording level; 3% or less at peak recording level. **Signal-to-noise ratio:** 50 db or better, referred to normal recording level. **Flutter and wow:** 0.3% RMS at 7.5 IPS; 0.35% RMS at 3.75 IPS. **Heads (3):** erase, record, and in-line stereo playback (TR-1C, monophonic playback). **Playback equalization:** NARTB curve, within ±2 db. **Inputs (2):** microphone and line. **Input impedance:** 1 megohm. **Model TR-1D & TR-1E outputs (2):** A and B stereo channels. **Model TR-1C output (1):** monophonic. **Output levels:** approximately 2 volts maximum. **Output impedance:** approximately 600 ohm (cathode followers). **Recording level indicator:** professional type db meter. **Bias erase frequency:** 60 kc. **Timing accuracy:** ±2%. **Power requirements:** 105-125 volts AC, 60 cycles, 35 watts. **Dimensions:** 15½" W. x 13½" D. Total height 10½". **Mounting:** requires minimum of 8½" below and 1½" above mounting surface. May be operated in either horizontal or vertical position.

MODEL TR-1C Monophonic Tape Deck: \$159.95 \$16.00 DWN. Monophonic Record and Playback. \$14.00 MO.

MODEL TR-1D Two Track Stereo Tape Deck: Monophonic Record and Playback, plus Playback of 2-track Pre-recorded Stereo Tapes (stacked). \$169.95 \$17.00 DWN. \$15.00 MO.

MODEL TR-1E Four Track Stereo Tape Deck: Monophonic Record and Playback, plus Playback of 4-track Pre-recorded Stereo Tapes (stacked). \$169.95 \$17.00 DWN. \$15.00 MO.

MODEL C-TR-1C Conversion Kit: Converts TR-1C to TR-1D (see TR-1D description above). Shpg. Wt. 2 lbs. \$19.95

MODEL C-TR-1D Conversion Kit: Converts TR-1D to TR-1E (see TR-1E description above). Shpg. Wt. 2 lbs. \$14.95

MODEL C-TR-1CQ Conversion Kit: Converts TR-1C to TR-1E (see TR-1E description above). Shpg. Wt. 2 lbs. \$19.95

STEREO-MONO TAPE RECORDER KITS (TR-1A Series)

Here are the tape recorders the avid hi-fi fan will find most appealing! Their complete flexibility in installation and many functions make them our most versatile tape recorder kits. This outstanding tape recorder now can be purchased in any one of three versions. You can buy the new two-track (TR-1AH) or four-track (TR-1AQ) versions which record and play back both stereo and monophonic programming, or the two-track monophonic record-playback version (TR-1A) and later convert to either two-track or four-track stereo record-playback models by purchasing the MK-4 or MK-5 conversion kits. The tape deck mechanism is extremely simple to assemble. Long, faithful service is assured by precision bearings and close machining tolerances that hold flutter and wow to less than 0.35%. Power is provided by a four-pole, fan-cooled induction motor. One lever controls all tape handling functions of forward, fast-forward or rewind modes of operation. The deck handles up to 7" tape reels at 7.5 or 3.75 IPS as determined by belt position. The TR-1A series decks may be mounted in either a vertical or horizontal position (mounting brackets included). The TE-1 Tape Electronics kits supplied feature NARTB equalization, separate record and playback gain controls and a safety interlock. Provision is made for mike or line inputs and recording level is indicated on a 6E5 "magic eye" tube. Two circuit boards simplify assembly.

MODEL TR-1A: Monophonic two-track record/playback with fast forward and rewind functions. Includes one TE-4 Tape Electronics kit. Shpg. Wt. 24 lbs. \$99.95 \$10.00 DWN. \$9.00 MO.

TR 1A SPECIFICATIONS—Frequency response: 7.5 IPS ±3 db 50 to 12,000 cps; 3.75 IPS ±3 db 50 to 7,000 cps. **Signal-to-noise ratio:** better than 45 db below full output of 1.25 volts/channel. **Harmonic distortion:** less than 2% at full output. **Bias erase frequency:** 60 kc (push-pull oscillator).

MODEL TR-1AH: Two-track monophonic and stereo record/playback with fast forward and rewind functions. Two TE-4 Tape Electronics kits. Shpg. Wt. 36 lbs. \$149.95 \$15.00 DWN. \$13.00 MO.

TR-1AH SPECIFICATIONS—Frequency response: 7.5 IPS ±3 db 40 to 15,000 cps; 3.75 IPS ±3 db 40 to 10,000 cps. **Signal-to-noise ratio:** 45 db below full output of 1 volt/channel. **Harmonic distortion:** less than 2% at full output. **Bias erase frequency:** 60 kc (push-pull oscillator).

MODEL TR-1AQ: Four-track monophonic and stereo record/playback with fast forward and rewind functions. Two TE-4 Tape Electronics kits. Shpg. Wt. 36 lbs. \$149.95 \$15.00 DWN. \$13.00 MO.

TR-1AQ SPECIFICATIONS—Frequency response: 7.5 IPS ±3 db 40 to 15,000 cps; 3.75 IPS ±3 db 40 to 10,000 cps. **Signal-to-noise ratio:** 40 db below full output of .75 volts/channel. **Harmonic distortion:** less than 2% at full output. **Bias erase:** 60 kc (push-pull oscillator).

HEATH COMPANY/Benton Harbor, Mich.

ED a subsidiary of Daystrom, Inc.

ELECTRONICS WORLD

New "Acoustic Suspension" Hi-Fi Speaker System Kit



HEATHKIT AS-2U (unfinished)

\$69⁹⁵

HEATHKIT AS-2M (mahogany) **\$79.95**
HEATHKIT AS-2B (birch) **EACH**

**NOW—FOR THE FIRST TIME
—EXCLUSIVELY FROM HEATH**

ACOUSTIC SUSPENSION HI-FI SPEAKER SYSTEM KIT (AS-2)

A revolutionary principle in speaker design, the Acoustic Research speaker has been universally accepted as one of the most praiseworthy speaker systems in the world of high fidelity sound reproduction. Heathkit is proud to be the sole kit licensee of this Acoustic Suspension principle from AR, Inc., and now offers for the first time this remarkable speaker system in money-saving, easy-to-build kit form.

The 10" Acoustic Suspension woofer delivers clean, clear extended-range bass response and outstanding high frequency distribution is provided by the specially designed "cross-fired" two-speaker tweeter assembly.

Another first in the Heathkit line is the availability of preassembled and prefinished cabinets. Cabinets are available in prefinished birch (blond) or mahogany, or in unfinished birch suitable for the finish of your choice. Kit assembly consists merely of mounting the speakers, wiring the simple cross-over network and filling the cabinet with the fiberglass included. Shpg. Wt. 32 lbs.

SPECIFICATIONS—Frequency response (at 10 watts input): ± 5 db, 42 to 14,000 cps; 10 db down at 30 and 16,000 cps. Harmonic distortion: below 2% down to 50 cps, below 3% down to 40 cps at 10 watts input in corner room location. Impedance: 8 ohms. Suggested amplifier power: 20 watts minimum. Suggested damping factor: high (5:1 or greater). Efficiency: about 2%. Distribution angle: 90° in horizontal plane. Dimensions: 24" W. x 13 $\frac{1}{2}$ " H. x 11 $\frac{3}{4}$ " D.

New Test Equipment



HEATHKIT FMO-1 Price to be announced

AN INSTRUMENT LONG-AWAITED BY SERVICE TECHNICIANS EVERYWHERE!

HEATHKIT FM TEST OSCILLATOR KIT (FMO-1)

Here in one compact, easy-to-use instrument are provided all the test signals and sweep frequencies required for fast, easy alignment and troubleshooting of RF, IF and detector sections of FM tuners and receivers. An instrument unique in the test equipment field . . . being the only one of its type designed especially for FM service work.

SPECIFICATIONS—Output frequencies: for RF alignment, 90 mc (FM band low end), 100 mc (FM band middle range), 107 mc (FM band high end). Modulation: 400-cycle incidental FM. IF and detector alignment: 10.7 mc sweep. Sweep width markers: 200 kc to over 1 mc, variable. 10.7 mc (crystal), 100 kc sub-markers. Modulation: 400-cycle AM. For other applications: 10.0 mc (crystal) and harmonics, 100 kc, 400-cycle audio. Controls: main frequency selector, modulation switch/concentric level control, marker oscillator switch/concentric level control, sweep width—power switch, output control, AF-RF (source impedance) switch. Power supply: transformer, selenium rectifier. Power requirements: 105-125 V, 50/60 cycles, 12 watts. Cabinet size: 7 $\frac{3}{4}$ " H. x 4 $\frac{1}{2}$ " W. x 4 $\frac{3}{4}$ " D.



HEATHKIT RF-1

\$27⁹⁵

PREASSEMBLED AND ALIGNED BANDSWITCH/COIL ASSEMBLY

RF SIGNAL GENERATOR KIT (RF-1)

Moderately priced, and capable of precision performance the RF-1 provides highly accurate and stable RF signals for trouble-shooting and aligning RF and IF circuits of all kinds. Modulated or unmodulated RF output of at least 100,000 microvolts is available, controlled by both fixed-step and continuously variable controls. A built-in 400 cycle audio generator with 10-volt output provides internal modulation of RF signal and is available separately for audio tests. A preassembled bandswitch and coil assembly, aligned to factory precision standards, eliminates the need for special alignment equipment. Shpg. Wt. 7 lbs.

SPECIFICATIONS—Frequency range: Band A, 100 kc to 320 kc; Band B, 310 kc to 1.1 mc; Band C, 1 mc to 3.2 mc; Band D, 3.1 mc to 11 mc; Band E, 10 mc to 32 mc; Band F, 32 mc to 110 mc. Calibrated harmonics: 110 mc to 220 mc. Accuracy: 2%. Output: impedance, 50 ohms; voltage, in excess of 100,000 uv on all bands. Modulation: internal, 400 cycles approx. 30% depth, external, approx. 3 V across 50 k ohm for 30%. 400 cycles audio output: approx. 10 V open circuit. Tube complement: V1 12AT7 RF oscillator, V2 6AN8 modulator and output. Power requirements: 105-125 V 50/60 cycles AC, 15 watts. Aluminum cabinet dimensions: 6 $\frac{1}{2}$ " W. x 9 $\frac{1}{2}$ " H. x 5" D.

New

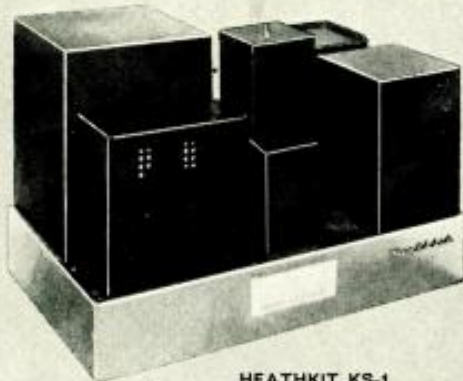

HEATHKIT KS-1

\$169⁹⁵



HEATHKIT KL-1

\$415⁰⁰



HEATHKIT XC-2

\$36⁹⁵



HEATHKIT UT-1

\$28⁹⁵

Ham Radio Gear

TOP POWER WITH ECONOMY AND SAFETY

KILOWATT POWER SUPPLY KIT (KS-1)

The KS-1 is designed as a companion to the "Chippewa" Linear Amplifier and is also suitable for supplying plate power to most other RF amplifiers in the medium to high power class. The KS-1 features an oil-filled, hermetically sealed plate transformer to minimize corona, a swinging choke in the filter circuit for good regulation, and a 60-second time delay relay to permit adequate heating of the mercury vapor rectifiers before application of plate voltage. All components are conservatively rated and well insulated for long life and dependable service. Shpg. Wt. 105 lbs.

SPECIFICATIONS—Maximum DC power output: 1500 watts. Nominal DC voltage output: 3000 or 1500 volts. Maximum DC current output: Average 500 ma, peak 1000 ma. Regulation: 180 to 600 ma (typical linear amplifier), 8%; 0 to 300 ma (typical class C amplifier), 10%; 0 to 500 ma, 15%. Ripple: Less than 1%. Tube complement: (2) 866A mercury vapor rectifiers. Recommended ambient temperature: 50 to 100 degrees F. Circuit: Two half-wave mercury vapor rectifiers in a full wave, single-phase configuration with swinging choke input filtering. Line power requirements: 115 V, 50/60 cycles, 20 amperes; 230 V, 50/60 cycles, 10 amperes. Chassis size: 17 1/2" W. x 12" H. x 13" D.

MOVE TO THE TOP IN TRANSMITTING POWER

"CHIPPEWA" KILOWATT LINEAR AMPLIFIER KIT (KL-1)

The KL-1 operates at maximum legal amateur power inputs in SSB, CW or AM service using any of the popular CW, SSB and AM exciters as a driver. Premium tubes (4—400's) push the "Chippewa" to top performance levels while a centrifugal blower provides more than adequate cooling. Shpg. Wt. 70 lbs.

SPECIFICATIONS—RF section: Driving power required (10 meters): Class AB1 (tuned grid) 10 watts peak; Class C (tuned grid) 40 watts; Class AB1 (swamped grid) 60 watts peak. Power input: Class AB1 (SSB-voice modulation) 2000 watts PEP; Class AB1 (SSB-two tone test) 1300 watts; Class AB1 (AM linear) 1000 watts; Class C (CW) 1000 watts. Power output (20 meters): Class AB1 (SSB-voice modulation) 900 watts PEP; Class AB1 (SSB-two tone test) 550 watts; Class AB1 (AM linear) 300 watts; Class C (CW) 750 watts. Output impedance: 50 to 72 ohms (unbalanced). Input impedance: 50 to 72 ohms (unbalanced). Band coverage: 80, 40, 20, 15 and 10 meters. Panel metering: 0 to 50 ma, grid current; 0 to 100 ma screen current; 0 to 5000 volt plate voltage; 0 to 1000 ma plate current. Tube complement: Final tubes, (2) 4-400A; clamp tube, (1) 6DO6; voltage regulators, (4) OD3, (2) OC3. Power requirements: AC (power supply primary circuit), 250 watts, 115 volt, 50/60 cycles; DC, 3000 to 4000 volts, 450 ma. Cabinet size: 19 1/4" W. x 11 1/2" H. x 16" D.

2-METER CONVERTER KIT (XC-2)

Extends coverage of the Heathkit "Mohawk" Receiver to the 2-meter band. May also be used with receivers tuning a 4 mc segment between the frequencies of 22 and 35 mc when appropriate crystal is used. Shpg. Wt. 7 lbs.

SPECIFICATIONS—Noise figure: 4.5 db; 1 uv signal provides 20 db thermal noise quieting. Sensitivity: approx. .1 uv input will provide a signal better than 6 db over noise level. Gain: approx. 40 db. Pass band: essentially flat 144 to 148 mc; approx. 35 db down at 143 and 149 mc. Image rejection: better than 100 db (tunable). Output impedance: 50 to 75 ohms. Input impedance: 50 to 75 ohms; 300 ohms with balun. Frequency: input, 144 to 148 mc; output, 22 to 26 mc with crystal supplied. Tubes: 6AM4, 6BS8, 6EA8, 12AT7. Crystal: .005% 3rd overtone. Power requirements: 150 volts DC at 50 ma (dropping resistor supplied for 210 VDC RX-1 operation) 6.3 volts AC/DC at 1.375 amps. Size: 9" W. x 5 1/2" H. x 4 1/4" D.

"BEST BUY" UTILITY POWER SUPPLY KIT (UT-1)

This power supply is ideal for converting the Heathkit "Cheyenne" and "Comanche" mobile transmitter and receiver to fixed station operation; or may be used to provide necessary filament and plate voltage for a wide variety of amateur equipment. Features silicon diode rectifiers, high capacity filters for superior dynamic regulation, and line filtering to minimize TVI and reduce receiver line noise. On ICAS basis, provides 150 watts DC plus filament power for 6.3 volt or 12.6 volt filament applications (6.3 VAC., 8 amps. or 12.6 VAC., 4 amps.; 600 VCD., 250 ma or 600 VDC., 200 ma and 300 VDC., 100 ma). Less than 1% ripple; excellent regulation. Housed in attractive green and gray-green cabinet measuring 9" long, 4 3/4" wide, 6" high. Shpg. Wt. 15 lbs.

ELECTRONICS WORLD

New Citizen's Band Transceiver

WIRED OR KIT FORM

HEATHKIT CB-1
\$42⁹⁵
 (kit model)

HEATHKIT W-CB-1
\$60⁹⁵
 (wired model)
 \$6.10 dwn., \$6.00 mo.

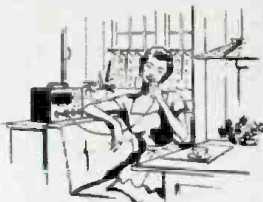
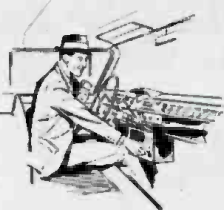

Both models include transceiver, crystal, microphone and two special power cords.

- No Tests to Take—No Operator's License Required
- Any Citizen 18 or Older Can Have Own Station
- Hundreds of Business and Personal Uses

CITIZEN'S BAND TRANSCEIVER KIT (CB-1)

The Heathkit CB-1 Citizen's Band Transceiver is a compact radio transmitter and receiver combination designed to operate on the new 11-meter "Citizen's Band". No tests to take, no special knowledge or operator's license required . . . you need only fill out forms we supply, and mail them to FCC to apply for station license. Operates just like any short wave radio used by police and other communication services. Front panel switch selects both "transmit" and "receive". Two or more Heathkit Transceivers provide you with your own 2-way radiotelephone system for making necessary business and personal contacts with family, friends or associates. A Heathkit accessory power supply makes the CB-1 completely portable for use in cars, trucks, boats, etc., using 6 or 12 volt batteries. With appropriate accessory antenna, the CB-1 can be used for communicating between truck and office, home and automobile, boat and shore, farm-house and field . . . literally hundreds of useful applications. Comes complete with microphone, 2 power cords for mobile or fixed operation, station ID card, call letters, and crystal for one channel and FCC application form. Order power supply and antenna separately. Attractively styled in two-tone "mocha" and "beige". Shpg. Wt. 10 lbs.

SPECIFICATIONS—Receiver type: Superegnerative detector w/rt stage. **Power input:** 5 watts maximum to plate of final RF amplifier (FCC requirement). **Transmitter frequency control:** Taird overtones type quartz crystal operating within 0.005% of marked channel frequency between -20° and +130°F. **Modulation:** AM plate and screen modulation automatically limited to less than 100% (FCC requirements). **Power supply:** Internal 117 V, 50/60 cycles, AC (35 watts). For 6 V battery power, use Model VP-1-6 Vibrator Power Supply (6.5 amps); for 12 V battery power, use VP-1-12 (4 amps). **Total B+ requirements:** 260 volts at 60 ma; total heater requirements, 6.3 volts at 1.8 amps, or 12.6 volts at 0.9 amps. **Power rectifier:** 2 silicon diodes in full wave voltage doubler circuit. **Microphone:** Combination hand-held and desk type, ceramic element, plastic case, with cord and connector. **RF output impedance:** 50 ohms. **Speaker size:** 3 1/2" (round). **Undistorted audio power output:** Approximately 1 watt. **Line cords:** Two supplied, one for AC operation, one for battery operation. Power circuits automatically switched when appropriate line cord is plugged in. **Cabinet dimensions:** 8" H. x 6" D. x 9 1/2" W.

SPECIFY FREQUENCY CHOICE
 (1st and 2nd choice)

CLASS D CITIZEN'S BAND FREQUENCIES

26.965 mc	27.035 mc	27.115 mc	27.185 mc
26.975 mc	27.055 mc	27.125 mc	27.205 mc
26.985 mc	27.065 mc	27.135 mc	27.215 mc
27.005 mc	27.075 mc	27.155 mc	27.225 mc
27.015 mc	27.085 mc	27.165 mc	*27.255 mc
27.025 mc	27.105 mc	27.175 mc	

*This channel shared with Class C Radio Control.

ANTENNAS

CBU-1 "UTILITY" ANTENNA.....\$9.95
 Good coverage, portable antenna for temporary mobile or fixed installations. 45 1/2" base-loaded antenna, 12' connecting cable, mounting bracket and clip. 3 lbs.

CBM-1 "MOBILE" ANTENNA.....\$19.95
 Best coverage mobile installation. Easy to install spring base, 1/4 wave, 9' whip; 15' connecting cable and necessary hardware. 7 lbs.

CBF-1 "FIXED LOCATION" ANTENNA...\$19.95
 Excellent coverage, 1/4 wave "ground plane", 9' elements; 50' connecting cable and mounting bracket. 7 lbs.

WIRED AND KIT FORM

POWER SUPPLIES FOR MOBILE USE

6 volt Vibrator Power Supply for use with 6 volt batteries.

KIT—Model VP-1-6. Shpg. Wt. 4 lbs. \$7.95

WIRED—Model WVP-1-6. Shpg. Wt. 4 lbs. \$11.95

12 volt Vibrator Power Supply for use with 12 volt batteries.

KIT—Model VP-1-12. Shpg. Wt. 4 lbs. \$7.95

WIRED—Model WVP-1-12. Shpg. Wt. 4 lbs. \$11.95



ORDER BLANK

NOTE: all prices and specifications subject to change without notice.

Enclosed find () check () money order. Please ship C.O.D. ()

On Express orders do not include transportation charges—they will be collected by the express agency at time of delivery.

On Parcel Post Orders include postage for weight shown. All prices are NET F.O.B. Benton Harbor, Michigan, and apply to Continental U.S. and Possessions only. 20% Deposit required on all C.O.D. orders.

HEATH COMPANY BENTON HARBOR 15, MICH.

a subsidiary of Daystrom, Inc.

Name _____
 Address _____
 City & Zone _____ State _____

SHIP VIA

- Parcel Post
- Express
- Freight
- Best Way

(PLEASE PRINT)

QUANTITY	ITEM	MODEL NO.	PRICE
<input type="checkbox"/> SEND FREE HEATHKIT CATALOG		POSTAGE	
		TOTAL	

HEATHKITS are also available at your Dealer

see listing on next page

Here's where to buy your HEATHKIT locally . . .

CALIFORNIA

BERKELEY
zacKIT Corporation
CHICO
Dunlap Radio & TV
EL CAJON
Telrad Electronics
FRESNO
Dunlap Radio & TV
LOS ANGELES
Kierulff Sound Corporation
(2 Locations)
MARYSVILLE
Dunlap Radio & TV
MERCEDO
Dunlap Radio & TV
MODESTO
Dunlap Radio & TV
PALO ALTO
Zack Electronics
RIVERSIDE
Kierulff Sound Corporation
SACRAMENTO
Dunlap Radio & TV
SAN DIEGO
Telrad Electronics
SAN FRANCISCO
Zack Electronics
SANTA BARBARA
zacKIT Corporation
STOCKTON
Dunlap Radio & TV
TARZANA
Kierulff Sound Corporation
VISALIA
Dunlap Radio & TV

DELAWARE

WILMINGTON
Radio Electric Service Co.

FLORIDA

COCOA
Thurow Distributors, Inc.
DAYTONA BEACH
Thurow Distributors, Inc.
JACKSONVILLE
Thurow Distributors, Inc.
MIAMI
Thurow Distributors, Inc.
ORLANDO
Thurow Distributors, Inc.
PENSACOLA
Thurow Distributors, Inc.
ST. PETERSBURG
Thurow Distributors, Inc.
TALLAHASSEE
Thurow Distributors, Inc.
TAMPA
Thurow Distributors, Inc.

ILLINOIS

ALTON
Radonics—Alton, Inc.

INDIANA

FORT WAYNE
Ft. Wayne Electronics Supply, Inc.
INDIANAPOLIS
Graham Electronics Supply, Inc.
LAFAYETTE
Lafayette Radio Supply Co., Inc.
MUNCIE
Muncie Electronics Supply, Inc.

IOWA

DES MOINES
Radio Trade Supply Co.
FORT DODGE
Radio Trade Supply Co.
MARSHALLTOWN
Radio Trade Supply Co.
WATERLOO
Radio Trade Supply Co.

LOUISIANA

LAFAYETTE
Sterling Electronics, Inc.

MARYLAND

BALTIMORE
American Distributing Co.
(2 Locations)
The Hi-Fi Shop

SALISBURY
Radio Electric Service Co.

MASSACHUSETTS

BOSTON
Audionics, Incorporated

MICHIGAN

ALLEN PARK
Volta Electronics
DETROIT
High Fidelity Workshop
PONTIAC
High Fidelity Workshop

MINNESOTA

DULUTH
Low Bonn Company
LA CROSSE
Low Bonn Company
MINNEAPOLIS
Hi-Fi Sound
Low Bonn Company
ST. PAUL
Hi-Fi Sound
Low Bonn Company

MISSOURI

ST. LOUIS
Radonics
(2 Locations)
Radonics-West, Inc.
Radonics-Gravois, Inc.

NEW JERSEY

ATLANTIC CITY
Radio Electric Service Co.
CAMDEN
Radio Electric Service Co.
MOUNTAIN SIDE
Federated Purchaser, Inc.
NEWARK
Federated Purchaser, Inc.

NEW YORK

ALBANY
Fort Orange Radio Dist. Co., Inc.
BATH
Rochester Radio Supply Co., Inc.
BELLEROSE
Cross Island Electronics, Inc.
BINGHAMTON
Stack Electronics, Inc.
BROOKLYN
Acme Electronics, Incorporated
ELMIRA
Stack Electronics, Inc.
FARMINGDALE
Gem Elec. Distributors, Inc.
FOREST HILLS
Beam Electronics, Incorporated
GENEVA
Rochester Radio Supply Co., Inc.
HERKIMER
Herkimer Electronics Co., Inc.
HICKSVILLE
Gem Elec. Distributors, Inc.
MINEOLA
Arrow Electronics, Incorporated
MT. VERNON
Oavie Radio Distributing Co., Inc.
NEW YORK
Arrow Electronics, Incorporated
Harvey Radio Company
ROCHESTER
Rochester Radio Supply Co., Inc.
SYRACUSE
Syracuse Radio Supply Co., Inc.
UTICA
Genesee Electronics Company
VALLEY STREAM
Elm Electronics, Inc.
WATERTOWN
Watertown Electronics Company

NO. CAROLINA

CHARLOTTE
Southeastern Radio Supply Co.
FAYETTEVILLE
Southeastern Radio Supply Co.
GREENSBORO
Southeastern Radio Supply Co.
KINSTON
Southeastern Radio Supply Co.
RALEIGH
Southeastern Radio Supply Co.

OHIO

AKRON
Sun Radio Company
CHILLICOTHE
Buckeye Electronics Dist., Inc.
CLEVELAND
Pioneer Electronic Supply Co.
(2 Locations)
COLUMBUS
Buckeye Electronics Dist., Inc.
DAYTON
Ham 'n Hi-Fi, Inc.
LORAIN
Pioneer Electronic Supply Co.
MAPLE HEIGHTS
Pioneer Electronic Supply Co.
NEWARK
Buckeye Electronics Dist., Inc.
SANOUSKY
Pioneer Electronic Supply Co.
SPRINGFIELD
Standard Radio-Springfield, Inc.
TOLEDO
Lifetime Electronics
ZANESVILLE
Buckeye Electronics Dist., Inc.

OREGON

PORTLAND
Eccles Electric Company
SALEM
Cecil Farnes Company

PENNSYLVANIA

ALLENTOWN
Federated Purchaser, Inc.
EASTON
Federated Purchaser, Inc.
ERIE
J. V. Duncombe Co.
(2 Locations)
PHILADELPHIA
Austin Electronics, Inc.
Radio Electric Service Co.
(3 Locations)
PITTSBURGH
House of Audio
WILLOW GROVE
Radio Electric Service Co.
YORK
Radio Electric Service Co.

RHODE ISLAND

PROVIDENCE
Audionics, Incorporated

TEXAS

BEAUMONT
Sterling Radio Products, Inc.
BRYAN
Sterling Radio Products, Inc.
DALLAS
Hillicrest Records & Hi-Fi
HOUSTON
Sound Equipment, Incorporated
Sterling Radio Products, Inc.
LUFKIN
Sterling Radio Products, Inc.

VIRGINIA

ARLINGTON
Key Electronics, Inc.
NEWPORT NEWS
Cain Electronics Company, Inc.
NORFOLK
Cain Electronics Company, Inc.
(2 Locations)
PORTSMOUTH
Cain Electronics Company, Inc.
RICHMOND
Meridian Electronics, Inc.

WASHINGTON

SEATTLE
Seattle Radio Supply, Inc.

WISCONSIN

MAOISON
Hi-Fi Corner
Satterfield Electronics, Inc.
MILWAUKEE
Hi-Fi Center
Netrow's

Delayed Audio A. V. C. Output Limiter

By RONALD L. IVES

Circuit prevents audio peaks
from damaging p.a. speakers.

IN many industrial p.a. systems as well as in a few high-fidelity installations, a number of contingencies, ranging from dropping the microphone to an open in a section of the speaker circuit, causes output power to exceed the power that the speakers can safely handle and sometimes results in damaged speakers or output transformers.

Customarily, this difficulty is partly offset by a clipper in the output of the system, the common methods including a pair of zener diodes or a biased dual-diode. This protects the system load very well indeed, but still exposes the output stage and transformer to overloading and possible damage.

A more satisfactory protection system, which reduces the drive on the amplifier as soon as the output voltage exceeds a specific value, is shown in Fig. 1. This is substantially a delayed audio a.v.c. system—the delay being produced by the neon lamp in series with the rectifier circuit.

Operation of the system is quite simple. A portion of the voltage developed by the amplifier is tapped off by means of the 600-ohm tap on the output transformer and the 25,000-ohm pot across it. This is fed to a neon lamp through an isolating capacitor. Whenever the peak voltage applied to the neon lamp exceeds its firing voltage (about 85 v.), the lamp conducts and a voltage is applied to the rectifier system. This voltage is rectified in the voltage-doubler circuit and filtered and then applied to the grid return of one of the low-level stages of the amplifier.

The rectifier has a short time-constant (.001 second in this case) so that, for a momentary power surge in the amplifier, the input is biased down only momentarily. If, however, recurrent surges occur, these keep the amplifier biased down so that power output cannot exceed a pre-set level.

Fig. 1. Circuit of the output limiter.

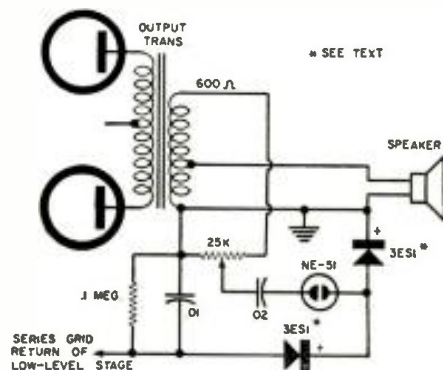

Careful selection of reliable qualified dealers is a slow process . . . so please bear with us if your area has not been covered. Thank you.

New York Service Representative
Empire State Electronic Serv., Inc.
180-14 Union Turnpike
Flushing 66, Long Island, New York



HEATH COMPANY/Benton Harbor, Mich.

a subsidiary of Daystrom, Inc.

The 3ES1 rectifiers used in the author's circuit are made by *International Rectifier* and will handle up to about 400 ma. at 135 volts (r.m.s.). The *Sarkes Tarzian* M500 rectifiers have also been used successfully in the circuit. In the author's original version a 6H6 tube was employed instead of the two crystal rectifiers. Actually, any rectifier that will handle about 100 ma. should be suitable.

With the circuit shown in the schematic, the voltage available at the 600-ohm tap on the output transformer is found from the formula: $E = \sqrt{2} \sqrt{ZW}$ where E = peak voltage available; Z = impedance of transformer winding; and W = watts output.

Quite obviously there is a minimum power level below which this system will not limit, as the voltage available must exceed the firing voltage of the neon lamp or no audio a.v.c. voltage is available. This voltage, commonly about 85 v., is attained when the power level is approximately 6 watts, which is a minimum level. For any higher power level, limiting is adjusted by setting the 25,000-ohm pot.

This limiting system may be extended to lower power levels by substituting a dual-anode zener diode for the neon lamp. This makes limiting possible down into the milliwatt output range, but with the cost of such zener diodes somewhat high at present this system runs into money. -30-

Sun	Mon	Tue	Wed	Thu	Fri	Sat
		1	2	3	4	5
						12
						19
						26

**CALENDAR
of EVENTS**

DECEMBER 1-2

Fourth Midwest Symposium on Circuit Theory. Sponsored by PGCT and Marquette University. Brooks Memorial Union, Marquette University, Milwaukee, Wisc. James D. Graham, College of Engr., Marquette University, 1515 W. Wisconsin Ave., Milwaukee 3, for program details.

DECEMBER 1-3

Eastern Joint Computer Conference. Sponsored by PGEC, AIEE, and ACM. Statler Hotel, Boston, Mass. Information regarding program available from Jean H. Felker, Bell Telephone Labs, Murray Hill, N. J.

DECEMBER 3-4

PGVC Annual Meeting. Sponsored by PGVC of IRE. Colonial Inn & Desert Ranch, St. Petersburg, Fla. Details on program available from J. R. Neubauer, RCA, Building 1-4, Camden 2, New Jersey.

THE BIG NEWS FOR 1960

SYLVANIA 23-INCH TV



*Viewing area 275 square inches. 23-inch picture tube measured diagonally.

Big 23-inch* picture is the sensation of 1960 that *changes the face of television* . . . and Sylvania scoops the industry with the first complete line.

- Square corners of the 23-inch* bonded shield picture tube pioneered by Sylvania presents more of the TV picture as the camera sees it. New squared shape is closer to the 3 x 4 ratio of the true TV camera raster.
- The 23-inch* tube flattens the TV screen. "Bonded shield" face-panel eliminates the dust trap, cuts reflections in half, and improves brightness and contrast.
- ◆ New Super HaloLight® is bigger and better than ever. It's a Sylvania exclusive that adds eye comfort to eye appeal.

SYLVANIA 23 TV OFFERS THE NEWEST AND FINEST FEATURES YOU CAN RECOMMEND**

SYLVANIA
Subsidiary of
GENERAL TELEPHONE & ELECTRONICS



CLIMB THE PROFIT TOWER

in 2-WAY MOBILE-RADIO MAINTENANCE

Mobile radio communications are booming! All around... you can see the vertical radiators going up... each one is a definite lead to more and higher profits for qualified service men.

To learn more about contract fees... labor rates... and upping YOUR profits... mail the coupon below for your free copy of: "HOW TO MAKE MONEY IN MOBILE-RADIO MAINTENANCE."

LAMPKIN INSTRUMENTS ARE THE MOST POPULAR MOBILE-MAINTENANCE METERS.



LAMPKIN 105-B FREQUENCY METER. RANGE 0.1 TO 175 MC AND UP. PRICE \$260.00 NET.



LAMPKIN 205-A FM MODULATION METER. RANGE 25 TO 500 MC. PRICE \$270.00.

MAIL COUPON TODAY

LAMPKIN LABORATORIES, INC. MFM Division, Bradenton, Florida

At no obligation to me, please send

Free booklet Data on Lampkin meters

Name _____

Address _____

City _____ State _____

LAMPKIN LABORATORIES, INC.

MFM Division BRADENTON, FLORIDA

COYNE
TRAINS YOU
IN SPARE TIME
AT HOME

COYNE QUALITY TRAINING AT LOWEST COST

TELEVISION
RADIO-COLOR TV

Only from famous COYNE do you get this modern up-to-the minute TV Home Training. Easy to follow instructions—fully illustrated with 2150 photos and diagrams. Not an old Radio Course with Television tacked on. Includes UHF and COLOR TV. Personal guidance by Coyne Staff. *Practical Job Guides* to help you EARN MONEY QUICKLY IN A TV-RADIO SALES AND SERVICE BUSINESS—part time or full time. COSTS MUCH LESS—pay only for training—no costly "put together kits."

SEND COUPON FOR FREE BOOK

SEND COUPON BELOW for Free Book and full details including EASY PAYMENT PLAN. NO COST OR OBLIGATION—NO SALESMAN WILL CALL.

B. W. COOKE, Jr., Pres. **COYNE** ELECTRICAL SCHOOL FOUNDED 1899

CHARTERED AS AN EDUCATIONAL INSTITUTION NOT FOR PROFIT
1501 W. Congress Pkwy., Dept. 99-H6, Chicago 7, Ill.

COYNE Television Home Training Div. New Coyne Building, Dept. 99-H6
1501 W. Congress Pkwy., Chicago 7, Ill.

Send FREE BOOK and details of your Television Home Training offer.

Name _____
Address _____
City _____ State _____

Special Offer 25¢

Hear these authentic recordings of dramatic events from

"The Amazing World of Short Wave Listening"
narrated by Alex Dreier, Radio-TV "Man on the Go"

- President's voice from outer space!
- Actual capture of a desperate criminal!
- Radio amateur at Little America!
- Ships at sea... aircraft in action!

S-107 receiver **\$94.95**

4 short wave bands plus standard broadcast. Phono and headset jacks, built-in speaker.

MAIL COUPON TODAY!

hallicrafters
DEPT. 20, CHICAGO 11, ILL.

Gentlemen: Please rush by return mail my recording, "The Amazing World of Short Wave Listening." I enclose 25¢.

NAME _____
ADDRESS _____
CITY _____ STATE _____

License Not Needed for Citizens Radio Adjustments

FCC rule change allows xmtr. tests without license if unit meets certain requirements.

ON November 15 the FCC adopted an amendment to the Citizens Radio Service rules to permit unlicensed persons to make on-the-air transmitter adjustments. Before that date, all transmitter adjustments and tests during construction, installation, servicing, or maintenance of a Citizens Radio transmitter had to be performed by or under the supervision of a holder of a commercial radio operator's license. No license had been required for tests made with a dummy antenna, but with an antenna in use and with the transmitter on the air, a license was needed. Now all this is changed for Class D stations provided all of the following conditions are met:

1. The transmitter must be crystal-controlled with a crystal that will maintain the frequency tolerance within .005 per-cent.
2. The transmitter must either be a factory-assembled unit or a kit.
3. The frequency-determining elements of the transmitter (the crystal and the crystal-oscillator components) must be pre-assembled by the manufacturer, pre-tuned to a specific available frequency, and then sealed so that none of these parts can be replaced without breaking the seal.
4. The transmitter must be designed in such a way that none of the normal adjustments and tests may reasonably be expected to result in off-frequency operation, excessive plate input power, overmodulation, excessive harmonics, or other spurious emissions.
5. The manufacturer must certify in writing to the purchaser that the equipment meets the foregoing requirements.

If it is found that the equipment is operating contrary to any of the technical regulations, all adjustments and tests made to restore the unit to proper operation must be carried out by or under the direction of a holder of a commercial radio operator's license. Such person shall be responsible for proper operation at the conclusion of the adjustments and tests.

The Commission feels that the limited exception to the licensed operator requirements will facilitate development and use of Class D stations, but at the same time, the new rules contain adequate safeguards to prevent degrading the service, especially for those persons who wish to use equipment involving some degree of home construction.

page ads in the nation's top magazines tell the story!

The New JERROLD TV-FM RECEPTOR* Ends Rabbit Ears!



the first
really small
really powerful
TV-FM antenna

*the new antenna that
hides while it works!*

Model TVR **\$5⁹⁵** List

- No gadget or unproven gimmick . . . it's guaranteed by Jerrold Electronics Corporation.
- No more rabbit ears cluttering up the top of the TV set!
- Even eliminates outside antennas in many areas!
- Easy to install, slides over line cord of TV or FM set!
- Push button tuning for best reception . . . set it and forget it!
- Absolutely safe . . . uses no electricity!
- Designed for VHF, UHF, Color and FM!
- Handsomely packaged in a self display unit. Priced to sell fast!

JERROLD

Contact your Jerrold Distributor or Write:

*Trade Mark

Patent Pending

ELECTRONICS CORPORATION *Distributor Sales Division*
Dept. PD206 The Jerrold Building • Philadelphia 32, Pa.
Jerrold Electronics (Canada) Limited

Export Representative: CBS International, New York 22, N. Y.

BOGEN

the sound way
to better business

NEW POPULAR-PRICED STEREO LINE FROM THE TOP NAME IN HI FI!

CHALLENGER COMPONENTS BY BOGEN

Now you can offer your budget conscious customers top-quality stereo components at remarkable savings. It's the *Challenger* line by Bogen... and it's true high fidelity at truly low prices. Built to the same exacting engineering standards as the regular Bogen line, these *Challenger* components give you premium features you can sell with pride...sales-closing price tags you can push with profit! Look 'em over at your distributor. Or, mail the coupon.



RC412 Stereo Receiver. An all-in-one stereo amplifier, stereo control center and stereo FM-AM tuner, the RC412 has dual volume controls to permit one-hand balancing of the two channels and built-in provision for a multiplex adapter. Power output: 12 watts (6 per channel). Frequency response: 30 to 15,000 cps ± 1 db. Price: \$169.50. Enclosure and legs: \$8.50.



AC220 Stereo Control Center and Dual 10-Watt Amplifier. An astonishing value, the AC220 features low-noise preamp, low distortion, dual volume controls, loudness switch, channel reversing switch, provision for tape deck and mono-stereo mode selector. Comes complete with enclosure. Price: \$79.95. Leg kit: \$1.85.

TC322 FM-AM Stereo Tuner. (Matches AC220) The sensitive TC322 receives stereo FM-AM, FM or AM broadcasts. It features: AFC, provision for multiplex adapter, automatic volume control, illuminated dial scale, and comes complete with enclosure. Frequency response: FM: 20 to 15,000 cps ± 1 db; AM: 20 to 3,500 cps ± 1.5 db. Price: \$109.50. Leg kit: \$1.85.

BOGEN-PRESTO, DEPT. EW-129, PARAMUS, N. J.
A Division of the Siegler Corporation
Please send me more information on
the new Challenger components.

Name _____
Address _____
City _____ Zone _____ State _____



EICO STEREO AMPLIFIER
Electronic Instrument Co., Inc., 33-00 Northern Blvd., Long Island City 1, N. Y. has announced the addition of a stereophonic amplifier to its *EICO* line of stereo and mono equipment in wired and kit form.

The AF-4 is a dual amplifier containing two highly fed back, single-ended



amplifiers. The input selection, mode of operation, tone and level control facilities are said to insure complete flexibility for either stereo or mono operation. The unit employs a moderate single tone control so that the available gain, released by this type of control, is converted into distortion-reducing negative feedback. Feedback level around each power amplifier is 27 db which results in harmonic and IM distortion figures that fall within the high-fidelity standards range.

There are five front-panel controls: input selector, mode, level, tone, and power "on-off." Five pairs of separate inputs provide for ceramic or crystal stereo cartridges, stereo tape transport with its own preamp, an AM tuner, FM tuner, and FM-multiplex adapter. The input selector switch has positions for feeding FM tuner output to one channel and the AM tuner to the other or the FM tuner to one channel and the FM-multiplex adapter output to the other.

FISHER SPEAKER SYSTEM
Fisher Radio Corporation, 21-21 44th Drive, Long Island City 1, N. Y. has



developed a new speaker system for use with mono and stereo hi-fi audio equipment.

The XP-1 is rated at 30 cps to well beyond the range of audibility. It is of bookshelf size and features a free-piston, three-way system which provides high compliance plus high effici-

ency, according to the manufacturer.

The cabinet includes a 12" woofer, 5" mid-range, and 3" tweeter. The heart of the woofer is a fully encapsulated magnet system which concentrates 100% of the magnetic flux in the air gap. The voice coil is 2" in diameter and is capable of a $\frac{3}{8}$ " excursion. The cone is high-density curvilinear with a bellows-type impregnated cloth surround. Bass response is to 30 cps and below.

The mid-range speaker is essentially flat between 1800 and 5000 cps while the tweeter carries out to 18,000 cps. The crossover network utilizes oil-filled capacitors in a three-stage, equalized-response circuit. Crossover frequencies are at 1800 and 5000 cps.

The system is housed in a rigid enclosure, hermetically sealed with a complete absence of nails or screws. The chamber is filled with Acousti-Glass to eliminate all resonances. The cabinet measures 13 $\frac{1}{4}$ " x 24" x 11 $\frac{3}{4}$ " and is available in mahogany, walnut, cherry, or blonde finishes or unstained birch ready for finishing.

STEREO SWITCH
The Nortronics Company, Inc., 1015 S. Sixth Street, Minneapolis 4, Minn.

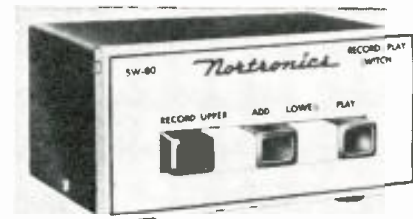

has added a stereo switch to its line of tape recording equipment and accessories.

The SW-80 facilitates the rapid selection of stereo and monophonic recording and playback. It controls the application of erase and record signals to the upper, lower, or both tracks produced by the heads on the tape deck. A switch interlocks to eliminate the possibility of errors during recording.

The new unit is designed primarily for use with a pair of the company's RC-100 recording amplifiers and any tape deck. Full details are available from the manufacturer.

BOGEN STEREO FM/AM TUNER
Bogen-Presto Company, Paramus, N. J. is now in production on a new stereophonic FM/AM tuner, the Model ST442.

The circuit uses nine tubes and three diodes and is designed to receive simulcast stereo FM/AM programs, FM, and AM. With the addition of a spe-

cial adapter, the tuner will also receive multiplex stereo (FM/FM). The unit features a built-in FM antenna and also has provision for external an-



tennas. In addition, the tuner has individual meters for FM and AM. Automatic volume control is provided on each channel as well as automatic frequency control. The circuit features cathode-follower output. Selector controls include stereo FM/AM, FM, AM, Multiplex, and AFC Out. Outputs are AM, FM, and Multiplex.

Frequency response is 20 to 18,000 cps ± 0.5 db on FM and 20 to 4500 cps ± 1.5 db on AM. FM sensitivity is 1.5 μ v., 30 db quieting at 75-ohm input and 30 μ v., 30 db quieting at 300-ohm input.

The enclosure measures 15" x 4 $\frac{3}{4}$ " x 12 $\frac{1}{4}$ ". Additional details are available from the manufacturer or any of the firm's authorized dealers.

NEW FIDELITONE NEEDLE

Fidelitone, Inc. of Chicago has announced the development of a new "Pyramid Point" diamond needle which is claimed to reduce sound distortion from records by as much as 85 percent.

The new stylus tip has a pyramid shape with four sides instead of the conventional cone shape with a round point. The design was based on the cutting stylus with the result that the needle will follow the groove exactly.

The company claims longer life for its "Pyramid Point" diamond needle. Details on this new component are available from the manufacturer on request.

RECORD CLEANING KIT

The Duotone Company, Keyport, N. J. has announced the availability of a new record cleaning kit that is suitable for stereo as well as mono discs.

The kit contains a super-synthesized version of the company's record clean-



er and anti-static spray and two special pads to spread the fluid after spraying. These pads are made of specially fabricated soft textile with long irregular pile. This pile has been scientifically designed to reach deep into the record grooves and lift out the

Individually Selected FOR ABSOLUTE RELIABILITY

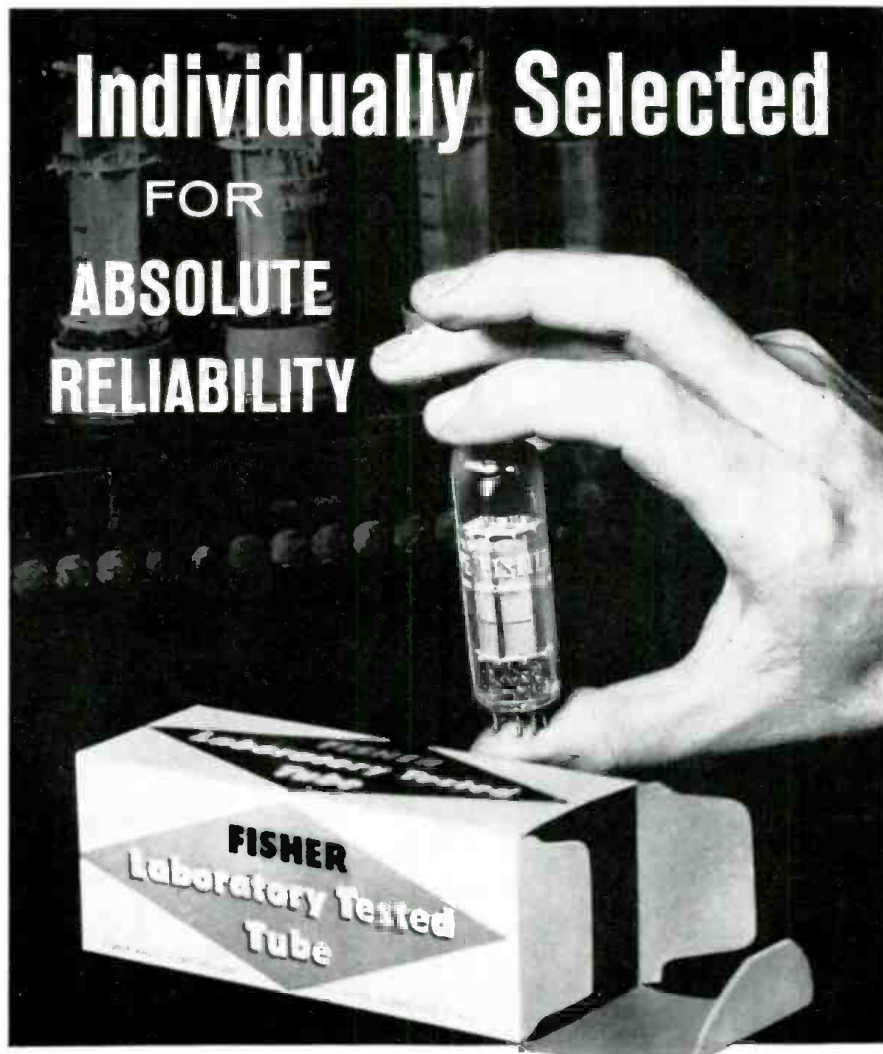

THE FISHER Laboratory Matched Tubes

At FISHER RADIO, the age of mass production is still on the 'outside looking in.' FISHER Laboratory Tested and Matched Tubes are still individually selected, and *guaranteed* to fulfill the maximum requirements of your high fidelity components.

For absolutely minimum hum, noise and distortion — choose FISHER Tubes. For high fidelity performance free of disturbing microphonics and intermittents — choose FISHER Tubes. For perfectly matched power output tubes designed specifically for stereo reproduction — choose FISHER Tubes. You will find no 'variables' — nothing less than the best in every box.

Audio-Fans, Servicemen, Dealers

WRITE TODAY FOR COMPLETE INFORMATION



FISHER RADIO CORPORATION, 21-40 44th Drive, L. I. C. 1, N. Y.

I want to know more about FISHER Laboratory Matched TUBES!

NAME _____

STORE NAME _____
(if a serviceman or dealer)

ADDRESS _____ CITY _____ STATE _____

What the DUAL-1006 combination turntable/changer won't do

won't wear records* — because the tonearm is totally disengaged from the cycling mechanism during play . . . automatically . . . and tracks perfectly at as low as 1½ grams stylus pressure.

DUAL-1006

won't produce rumble or hum* — because totally shielded motor is 100% balanced in both axes, and rigid-equipoise motor suspension prevents noise at the source.

DUAL-1006

won't develop flat-spot idler thump — because all gears and idler disengage automatically after play — no neutral position to worry about.

DUAL-1006

won't wow or flutter* — because heavy armor-gauge turntable is both laminated and concentrically girded to prevent warping and eccentricity.

DUAL-1006

won't chip record edges or enlarge center holes — because Elevator Action changer-spindle uses no pusher arm, no offsets; lifts stack off bottom record before it descends.

DUAL-1006

won't ever become obsolete — because any present (or future) size records from 5" to over 12" can be intermixed, and in any sequence.

DUAL-1006

won't disappoint you — because these are just a few of its wonderful features that result in flawless, reliable performance. See your dealer soon, or write us for the full story.

united  Audio

PRODUCTS OF DISTINCTION
202-4 East 19th St., N. Y. 3, N. Y.

*Comparable to professional equipment, and so vital for stereo reproduction.

cause of crackling noises while at the same time coating the walls of the groove with a thin layer of protective liquid which lasts for months.

NORELCO RECORDER

The High Fidelity Products Division of North American Philips Company, Inc., Hicksville, L. I., New York is now marketing its "Continental 400" 4-track stereo record and playback tape recorder.

Engineered and manufactured by Philips of the Netherlands, the new unit features 4-track stereo and monaural record and playback for tape economy (will also play back 2-track stereo tapes); three speeds (7½, 3¾, and 1⅞ ips) for maximum versatility and economy; and simple piano key controls for ease of operation. The



unit is fully compatible with conventional commercial tapes.

The machine has inputs for recording from microphone, tuners, and phonograph with facilities for mixing microphone with tuners or phono. An output jack for monitoring with stereo headphones is also incorporated into the unit. The unit may also be used as a self-contained phono/p.a. amplifier and speaker system.

The recorder is housed in a high-styled carrying case. The unit consists of tape drive mechanism, two preamps with controls, two 4-watt amplifiers, and a Norelco wide-range speaker. Also furnished is a dynamic, full-frequency stereo (dual-element) microphone. For stereo playback all that is required is a second speaker.

ACRO STEREO PREAMP

The Kit Division of Acro Products Company, 410 Shurs Lane, Philadelphia 28, Pa. is offering an easy-to-as-

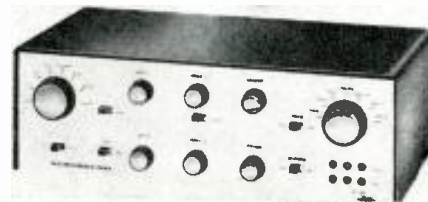

semble stereo preamp which has been designed as a companion unit to the firm's "Stereo 20" and "Ultra Linear II" amplifiers.

Each channel has inputs for magnetic cartridges, crystal/ceramic cartridges, tape head, FM, AM, FM Multiplex, and tape head equalized for NAB

standard, and microphone. Outputs include two amplifier, two tape, and a third channel. The input selector has 8 positions while the output selectors offers 7 operational modes.

Controls include ganged volume-loudness, balance, individual bass and treble for each channel. There are two switched and two direct a.c. outlets. The circuit uses four Type 7199 low-noise pentode/triodes. The unit measures 4½" x 13¾" x 6¾". Both kit and factory assembled versions of this preamp are available.

STEREO "COMPENTROL"

Centralab, 900 E. Keefe Ave., Milwaukee 1, Wis. has announced the availability of a stereo version of its "Compentrol" which is designed to improve the bass and treble response by automatically compensating for the Fletcher-Munson effect. At full volume level, the unit operates with a flat response.

The unit consists of two matched volume controls each with its own printed-circuit tone-compensating circuit. Both controls are operated from the same shaft to assure equal compensation of both stereo circuits. The entire unit takes only slightly more space than the original volume control and requires no circuit alterations.

Two types are available for the replacement of 500,000-ohm and 1-meg-ohm volume controls. For detailed information on installation and method of operation, write the manufacturer direct.

AMPEX "CUSTOM" CONSOLES

Amplex Audio Inc., 1020 Kifer Road, Sunnyvale, Calif. has just introduced its 1960 "Custom" line of stereo high-



fidelity consoles which feature lower price tags and a completely revamped and improved audio control center pre-amp.

A flexible approach gives a choice of four versions with a stereo tape recorder (records in stereo and plays both 2- and 4-track stereo tapes) or with a precision 4-speed stereo record player; or a combination of either plus the company's new stereo AM/FM radio tuner.

All "Custom" versions include the new audio control center preamp and a pair of matched speaker/amplifier systems. Each of the two amplifiers delivers 15 watts of power (30 watts total audio power, 60 watts peak), through correctly enclosed bass and treble sound projectors in each of the two channels.

Any of the series combinations is available in a choice of walnut or teak in contemporary design or in cherry fruitwood in French Provincial style. Write the manufacturer direct for full details on the new "Custom" line.

FULL-RANGE SPEAKER

Lafayette Radio Corp., 165-08 Liberty Ave., Jamaica 33, N. Y. is now offering an 8-inch, full-range duaxial speaker, the Model SK-128.



The speaker consists of an 8-inch woofer and 2-inch tweeter integrally mounted on dual axes. A departure from normal coaxial design is to be found in the eccentric mounting of the tweeter and the use of an elliptical baffle. This new design is said to eliminate interaction between woofer and tweeter and insure over-all response free from intermodulation effects. The treated woofer cone has a unique "Conical Stiffener" which prevents break-up and permits the cone to move as a true piston.

The tweeter is a separate unit complete with voice coil and magnetic field. Special treatment of the cone and cone edge insures an even distribution of highs.

AUDIO CATALOGUES

CARTRIDGE CROSS-REFERENCE

CBS Electronics has made available a new phono cartridge cross-reference chart for dealers. The chart lists both CBS-Ronette and Columbia CD models for exact replacement of the estimated six million cartridges in use in the U. S.

The list of 27 CBS-Ronette units, which replace over 500 types, is included in the catalogue along with exact-size silhouettes for each cartridge for quick identification of model number and a handy table which illustrates and describes various bracket installations.

The 8-page catalogue, Bulletin PF-285, is available free to independent service dealers through their distributors.

EQUIPMENT CABINETS

Bozak of Darien, Conn. is now offering a two-color leaflet illustrating and describing its new line of equipment cabinets.

The new cabinets are designed to match the firm's speaker enclosures to provide a complete harmonizing mono or stereo music-center ensemble.

The equipment cabinets feature two adjustable shelves on the left with space for turntable and changer on the right with record-storage below. Wide front doors and removable backs permit easy installation.

All of the features are covered in detail in the booklet which can be obtained from the company direct or any of its franchised dealers.

Build This Superb *Schober* Organ From Simple Kits and SAVE OVER 50%!

The Beautiful *Schober* CONSOLETTA

— the only small organ with two full 61-note keyboards and 22 stops. Requires only 2' x 3 1/2" floor space! Commercial value approximately \$1600 or more — yet you save over 50% when you build this thrilling instrument!

LET US SEND YOU FREE DETAILS HOW TO ASSEMBLE A *Schober* ELECTRONIC ORGAN IN SPARE TIME!



Give Your Family A Lifetime of Musical Joy With A Magnificent Schober ELECTRONIC Organ!

Now you can build the brilliant, full-range Schober CONSOLETTA or the larger CONCERT MODEL with simple hand tools. No skills are necessary to construct an instrument with one of the finest reputations among electronic organs. No woodworking necessary — consoles come completely assembled and finished. All you do is assemble clearly marked electronic parts guided by clear illustrations and detailed step-by-step instructions. Even teen-agers can assemble the Schober! You build from kits, as fast or as slowly as you please... at home, in spare time — with a small table serving as your entire work shop!

Send For Complete Details On Schober Organs and For Hi-Fi Demonstration Record

The coupon will bring you a handsome 16-page booklet in full color describing Schober organs in detail, plus articles on how easy and rewarding it is to build your own organ and how pleasant and quick it is to learn to play the organ. In addition, we have prepared an exciting 10" hi-fi LP record demonstrating the full range of tones and voices available on the Schober, which you may have for only \$2.00 (refunded when you order a kit). Literature on the Schober is FREE! There is no obligation; no salesman will call.

THE GREAT CONCERT MODEL meets specifications of American Guild of Organists

Pay As You Build Your Organ; Start With As Little As \$18.94!

You may start building your Schober at once with an investment of as little as \$18.94. The musical instrument you assemble is as fine, and technically perfect, as a commercial organ built in a factory — yet you save over 50% on top-quality electronic parts, on high-priced labor, on usual retail store markup! In your own home, with your own hands you build an organ with genuine pipe organ tones in an infinite variety of tone colors to bring into your home the full grandeur of the Emperor of Instruments. You may build the CONSOLETTA for your home, or you may want to build the great CONCERT MODEL for home, church, school or theatre. You save 50% and more in either case.



Mail This Coupon For FREE Literature and Hi-Fi Record Today!

The Schober Organ Corp., Dept. RN-2
2248 Broadway, New York 24, N. Y.

Please send me FREE full-color booklet and other literature on the Schober organs.

Please send me the 10" hi-fi Schober demonstration record. I enclose \$2.00 (refundable on receipt of my first kit order).

Name.....

Address.....

City..... Zone... State.....



SUPERIOR'S NEW MODEL TW-11 STANDARD PROFESSIONAL TUBE TESTER

- ★ Tests all tubes, including 4, 5, 6, 7, Octal, Lock-in, Hearing Aid, Thyatron, Miniatures, Sub-miniatures, Novals, Sub-minars, Proximity fuse types, etc.
- ★ Uses the new self-cleaning Lever Action Switches for individual element testing. Because all elements are numbered according to pin-number in the RMA base numbering system, the user can instantly identify which element is under test. Tubes having tapped filaments and tubes with filaments terminating in more than one pin are truly tested with the Model TW-11 as any of the pins may be placed in the neutral position when necessary.
- ★ The Model TW-11 does not use any combination type sockets. Instead individual sockets are used for each type of tube. Thus it is impossible to damage a tube by inserting it in the wrong socket.
- ★ Free-moving built-in roll chart provides complete data for all tubes. All tube listings printed in large easy-to-read type.
- ★ NOISE TEST: Phono-jack on front panel for plugging in either phones or external amplifier will detect microphonic tubes or noise due to faulty elements and loose internal connections.

Model TW-11—TUBE TESTER . . . Total Price \$47.50—Terms: \$11.50 after 10 day trial, then \$6.00 per month for 6 months if satisfactory. Otherwise return, no explanation necessary!

EXTRAORDINARY FEATURE—SEPARATE SCALE FOR LOW-CURRENT TUBES. Previously, on emission-type tube testers, it has been standard practice to use one scale for all tubes. As a result, the calibration for low-current types has been restricted to a small portion of the scale. The extra scale used here greatly simplifies testing of low-current types.

The Model TW-11 operates on 105-130 Volt 60 Cycles A.C. Comes housed in handsome portable Saddle Stitched Texon case.

\$47⁵⁰ NET



SUPERIOR'S NEW MODEL 83

C.R.T. TESTER

TESTS and REJUVENATES ALL PICTURE TUBES

ALL BLACK AND WHITE TUBES

From 50 degree to 110 degree types—from 8" to 30" types.

- Model 83 is not simply a rehased black and white C.R.T. Tester with a color adapter added. Model 83 employs a new improved circuit designed specifically to test the older type black and white tubes, the newer type black and white tubes and all color picture tubes.
- Model 83 provides separate filament operating voltages for the older 6.3 types and the newer 8.4 types.
- Model 83 employs a 4" air-damped meter with quality and calibrated scales.
- Model 83 properly tests the red, green and blue sections of color tubes individually—for each section of a color tube contains its own filament, plate, grid and cathode.

ALL COLOR TUBES

Test ALL picture tubes—in the carton—out of the carton—in the set!

- Model 83 will detect tubes which are apparently good but require rejuvenation. Such tubes will provide a picture seemingly good but lacking in proper definition, contrast and focus. To test for such malfunction, you simply press the rej. switch of Model 83. If the tube is weakening, the meter reading will indicate the condition.
- Rejuvenation of picture tubes is not simply a matter of applying a high voltage to the filament. Such voltages improperly applied can strip the cathode of the oxide coating essential for proper emission. The Model 83 applies a selective low voltage uniformly to assure increased life with no danger of cathode damage.

Model 83 comes housed in handsome portable Saddle Stitched Texon case—complete with sockets for all black and white tubes and all color tubes.

\$38⁵⁰ NET

Model 83—C.R.T. Tube Tester
Total Price \$38.50
Terms: \$8.50 after 10 day trial, then \$6.00 monthly for 5 months if satisfactory. Otherwise return, no explanation necessary.



GENOMETER

7 Signal Generators in One!

- ✓ R.F. Signal Generator for A.M.
- ✓ R.F. Signal Generator for F.M.
- ✓ Audio Frequency Generator
- ✓ Bar Generator
- ✓ Marker Generator
- ✓ Cross Hatch Generator
- ✓ Color Dot Pattern Generator

A versatile all-inclusive GENERATOR which provides ALL the outputs for servicing:
A.M. Radio • F.M. Radio • Amplifiers • Black and White TV • Color TV

R. F. SIGNAL GENERATOR: The Model TV-50A Genometer provides complete coverage for A.M. and F.M. alignment. Generates Radio Frequencies from 100 Kilocycles to 60 Megacycles on fundamentals and from 60 Megacycles to 180 Megacycles on powerful harmonics.

VARIABLE AUDIO FREQUENCY GENERATOR: In addition to a fixed 400 cycle sine-wave audio, the Model TV-50A Genometer provides a variable 300 cycle to 20,000 cycle peaked wave audio signal.

BAR GENERATOR: The Model TV-50A projects an actual Bar Pattern on any TV Receiver Screen. Pattern will consist of 4 to 16 horizontal bars or 7 to 20 vertical bars.

THE MODEL TV-50A comes absolutely complete with shielded leads and operating instructions.

Model TV-50A—Genometer
Total Price \$47.50
Terms: \$11.50 after 10 day trial, then \$6.00 monthly for 6 months if satisfactory. Otherwise return, no explanation necessary.

CROSS HATCH GENERATOR: The Model TV-50A Genometer will project a cross-hatch pattern on any TV picture tube. The pattern will consist of non-shifting, horizontal and vertical lines interlaced to provide a stable cross-hatch effect.

DOT PATTERN GENERATOR (FOR COLOR TV): Although you will be able to use most of your regular standard equipment for servicing Color TV, the one addition which is a "must" is a Dot Pattern Generator. The Dot Pattern projected on any color TV Receiver tube by the Model TV-50A will enable you to adjust for proper color convergence.

MARKER GENERATOR: The Model TV-50A includes all the most frequently needed marker points. The following markers are provided: 189 Kc., 262.5 Kc., 456 Kc., 600 Kc., 1000 Kc., 1400 Kc., 1600 Kc., 2000 Kc., 2500 Kc., 3579 Kc., 4.5 Mc., 5 Mc., 10.7 Mc., (3579 Kc. is the color burst frequency)

\$47⁵⁰ NET

EXAMINE BEFORE YOU BUY!
USE APPROVAL FORM ON NEXT PAGE

SUPERIOR'S NEW MODEL 77

VACUUM TUBE VOLTMETER

WITH NEW 6" FULL-VIEW METER

Compare it to any peak-to-peak V. T. V. M. made by any other manufacturer at any price

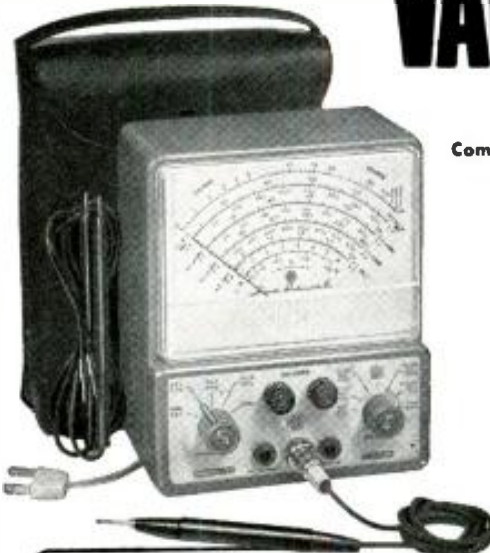

- ✓ Model 77 completely wired and calibrated with accessories (including probe, test leads and portable carrying case) sells for only \$42.50.
- ✓ Model 77 employs a sensitive six inch meter. Extra large meter scale enables us to print all calibrations in large easy-to-read type.
- ✓ Model 77 uses new improved SICO printed circuitry.
- ✓ Model 77 employs a 12AU7 as D.C. amplifier and two 9006's as peak-to-peak voltage rectifiers to assure maximum stability.

- ✓ Model 77 uses a selenium-rectified power supply resulting in less heat and thus reducing possibility of damage or value changes of delicate components.
- ✓ Model 77 meter is virtually burn-out proof. The sensitive 400 microampere meter is isolated from the measuring circuit by a balanced push-pull amplifier.
- ✓ Model 77 uses selected 1% zero temperature coefficient resistors as multipliers. This assures unchanging accurate readings on all ranges.

AS A DC VOLTMETER: The Model 77 is indispensable in Hi-Fi Amplifier servicing and a must for Black and White and color TV Receiver servicing where circuit loading cannot be tolerated

AS AN AC VOLTMETER: Measures RMS values of sine wave, and peak-to-peak value of complex wave. Pedestal voltages that determine the "black" level in TV receivers are easily read

AS AN ELECTRONIC OHMMETER: Because of its wide range of measurement leaky capacitors show up glaringly. Because of its sensitivity and low loading, intermittents are easily found. Isolated and repaired.

Model 77 comes complete with operating instructions, probe and test leads. Use it on the bench—use it on calls. A streamlined carrying case, included at no extra charge, accommodates the tester, instruction book, probe and leads. Operates on 110-120 volt 60 cycle. Only

SPECIFICATIONS

• DC VOLTS — 0 to 3/15/75/150/300/750/1,500 volts at 11 megohms input resistance. • AC VOLTS (RMS) — 0 to 3/15/75/150/300/750/1,500 volts. • AC VOLTS (Peak to Peak) — 0 to 8/40/200/400/800/2,000 volts. • ELECTRONIC OHMMETER — 0 to 1,000 ohms/10,000 ohms/100,000 ohms / 1 megohm / 10 megohms / 100 megohms/1,000 megohms • DECIBELS — 10 db to + 18 db, + 10 db to + 38 db + 30 db to + 58 db. All based on 0 db = .006 watts (6 mw) into a 500 ohm line (1.73V). • ZERO CENTER METER—For discriminator alignment with full scale range of 0 to 1.5/7.5/37.5/75/150/375/750 volts at 11 megohms input resistance.

Model 77—VACUUM TUBE VOLTMETER
 ... Total Price \$42.50—Terms: \$12.50 after 10 day trial, then \$6.00 monthly for 5 months if satisfactory. Otherwise return, no explanation necessary!

\$42⁵⁰ NET

SUPERIOR'S NEW MODEL 79

SUPER-METER — WITH NEW 6" FULL-VIEW METER

A Combination VOLT-OHM MILLIAMMETER.

Plus CAPACITY, REACTANCE, INDUCTANCE AND DECIBEL MEASUREMENTS.

Also Tests SELENIUM AND SILICON RECTIFIERS, SILICON AND GERMANIUM DIODES.



The Model 79 represents 20 years of continuous experience in the design and production of SUPER-METERS, an exclusive SICO development.

In 1938 Superior Instruments Co. designed its first SUPER-METER, Model 1150. In 1940 it followed with Model 1250 and in succeeding years with others including Models 670 and 670-A. All were basically V.O.M.'s with extra services provided to meet changing requirements.

Now, Model 79, the latest SUPER-METER includes not only every circuit improvement perfected in 20 years of specialization, but in addition includes those services which are "musts" for properly servicing the ever increasing number of new components used in all phases of today's electronic production. For example with the Model 79 SUPER-METER you can measure the quality of selenium and silicon rectifiers and all types of diodes—components which have come into common use only within the past five years, and because this latest SUPER-METER necessarily required extra meter scale, SICO used its new full-view 6-inch meter.

Model 79 comes complete with operating instructions and test leads. Use it on the bench—use it on calls. A streamlined carrying case, included at no extra charge accommodates the tester, instruction book and test leads.... Only

Specifications

D.C. VOLTS: 0 to 7.5/15/75/150/750/1,500.
 A.C. VOLTS: 0 to 15/30/150/300/1,500/3,000.
 D.C. CURRENT: 0 to 1.5/15/150 Ma. 0 to 1.5/15 Amperes.
 RESISTANCE: 0 to 1,000/100,000 Ohms. 0 to 10 Megohms.
 CAPACITY: 001 to 1 Mfd. 1 to 50 Mfd.
 REACTANCE: 50 to 2,500 Ohms, 2,500 Ohms to 2.5 Megohms.
 INDUCTANCE: .15 to 7 Henries, 7 to 7,000 Henries.
 DECIBELS: —6 to +18, +14 to +38, +34 to +58.

The following components are all tested for QUALITY at appropriate test potentials. Two separate BAD-GOOD scales on the meter are used for direct readings.

All Electrolytic Condensers from 1 MFD to 1000 MFD.
 All Selenium Rectifiers. All Germanium Diodes.
 All Silicon Rectifiers. All Silicon Diodes.

Model 79—SUPER-METER ... Total Price \$38.50—Terms: \$8.50 after 10 day trial, then \$6.00 per month for 5 months if satisfactory. Otherwise return, no explanation necessary!

\$38⁵⁰ NET

SHIPPED ON APPROVAL NO MONEY WITH ORDER — NO C. O. D.

Try any of the instruments on this or the facing page for 10 days before you buy. If completely satisfied then send down payment and pay balance as indicated on coupon. **No Interest or Finance Charges** Added! If not completely satisfied return unit to us, no explanation necessary.

MOSS ELECTRONIC, INC.

Dept. D-693, 3849 Tenth Ave., New York 34, N. Y.

Please send me the units checked on approval, if completely satisfied I will pay on the terms specified with no interest or finance charges added. Otherwise, I will return after a 10 day trial positively cancelling all further obligations.

- Model TW-11.... Total Price \$42.50 \$11.50 within 10 days. Balance \$6.00 monthly for 6 months.
- Model 83..... Total Price \$38.50 \$8.50 within 10 days. Balance \$6.00 monthly for 5 months.
- Model TV-50A.... Total Price \$47.50 \$11.50 within 10 days. Balance \$6.00 monthly for 6 months.
- Model 77..... Total Price \$42.50 \$12.50 within 10 days. Balance \$6.00 monthly for 5 months.
- Model 79..... Total Price \$38.50 \$8.50 within 10 days. Balance \$6.00 monthly for 5 months.

Name

Address

City Zone.... State.....

All prices net. F.O.B., N.Y.C.

Here is your CHRISTMAS KIT Complete—Low Priced CITIZEN'S BAND Two-Way Transceiver

No examination required for use of this equipment.

Made from parts of finest quality.

Meets F.C.C. Requirements.

Two models to choose from. Both now available in KIT FORM.

Kits are complete, including Cabinet, Pre-punched Chassis, Power Transformer, all components, Mike, Crystal, Easy to follow instructions and schematic. F.C.C. form 505 furnished with each order.

SPECIFICATIONS

Both models have Superheterodyne Receiver with RF Stage. One MV sensitivity, over two watts Audio Transmitter 5 Watts of RF, 100% AM Modulated. 40 to 80 Ohms Antenna Output. Power Transformer operates on 6VDC, 12VDC and 117VAC. All units can be operated as base or mobile.



CUSTOM DISPATCHER

Has noise limiter and adjustable squelch. Crystal controlled Receiver and Transmitter.

• In Kit... **69⁹⁵** A few factory wired and tested Custom Dispatchers ready for prompt delivery at \$89.95.



MODEL 1000 DK

Has Tuneable Receiver. Receives all 22 channels and 10 meter band. Has fixed squelch and noise limiter.

• In Kit... **59⁹⁵** •

Ground plane antenna.....\$17.00
Finest quality mobile antenna with 15' of lead-in.....\$16.00
POWER SUPPLY KIT for those who want to use parts on hand.....\$13.95
Consists of fully shielded 100MA 6V, 12V and 117V transformer, choke, condensers, tube and sockets and vibrator.

All units complete. 15% deposit required with all C.O.D. orders or send cash and take 2% discount. F.O.B. Chickasha.

PROMPT DELIVERY

CHICKASHA ELECTRONICS, Inc.
Chickasha, Oklahoma

Transistor Radio Circuits

Part 2. Covers the mixer and oscillator stages to be found in most automobile radio receivers.

EDITOR'S NOTE: This material on transistor circuits, appearing here and in subsequent issues, is being reproduced with the kind permission of the Delco Radio Division of General Motors Corporation. Although originally prepared and distributed to those servicing Delco auto radio receivers, much of the information is also applicable to other types of transistorized radios and we believe it worthwhile to present this material to our readers.

Mixer Stage

The purpose of the mixer stage is to convert the r.f. signal to a fixed intermediate frequency somewhere between the r.f. signal frequency and the audio frequencies. The resulting i.f. signal output is obtained by mixing two input signals—one from the r.f. stage or antenna and the other from the local oscillator of the receiver. The two frequencies are then present in the collector circuit and the difference frequency of 262 kc. is selected by the i.f. transformer-tuned circuit.

The mixer transistor in Fig. 2 is a 2N149 low-power *n-p-n* unit with good voltage amplifying characteristics. The signal from the r.f. stage is developed across the 3900-ohm base resistor and applied to the base of the transistor. A common-emitter circuit arrangement is used and a positive base voltage is obtained by a voltage divider in the base circuit. This consists of a 3900-ohm resistor and a 39,000-ohm resistor

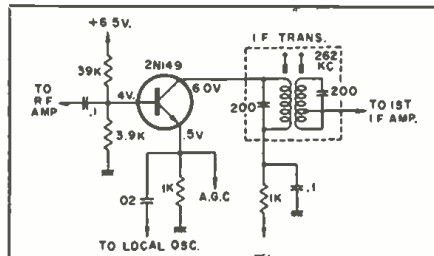

Fig. 2. Typical mixer stage for auto radio.

in series across the 6.5-volt line, which produces a base potential of about .4 volt.

There is a 1000-ohm resistor in the emitter circuit which has a stabilizing influence on collector current. Additional emitter voltage is produced by the local oscillator signal which is coupled to the emitter through a .02- μ f. capacitor. This is an a.c. signal which drives the emitter into conduction on the negative swing and into cut-off on the positive swing, producing a rectified emitter voltage which keeps the mixer transistor operating in a non-linear fashion near the class B point for best detection characteristics. If the oscillator is not oscillating, the emitter voltage in the mixer stage will be lower than the base voltage. The oscillator circuit is discussed later.

Collector current varies at both the

oscillator and r.f. signal rates since both voltages are modulating the base-emitter diode current. The "difference frequency" is then selected by the i.f. transformer tuned to 262 kc. and this becomes the i.f. signal. In most cases, the i.f. signal will then be amplified by two or three successive i.f. stages to produce good receiver sensitivity.

Oscillator Stage

The 2N149 oscillator transistor in Fig. 3 is connected in a tuned-collector circuit arrangement which employs an untuned base winding to provide inductively coupled feedback to sustain oscillation. The tuned tank circuit deter-

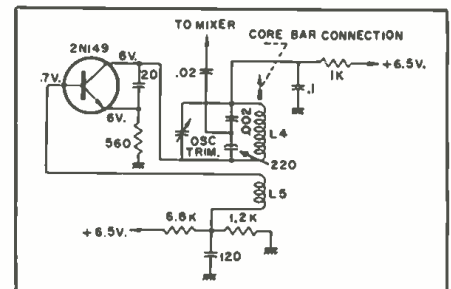

Fig. 3. Oscillator stage using a 2N149.

mines the oscillator frequency, which is always tuned 262 kc. above the incoming station frequency by a powdered iron core which is physically connected to the common core bar.

Forward base-emitter driving current is obtained by the 6800-ohm and 1200-ohm voltage divider resistors in the base circuit and the base current is given an additional "kick" each cycle by the feedback voltage induced in L_5 . Thus, during part of each cycle the induced voltage drives the base more positive which increases base current and causes a surge of collector current to charge the tank capacitors.

During the other half cycle, however, the base voltage reverses, driving the transistor into cut-off and allowing the tank capacitors to discharge and charge again through L_5 in flywheel fashion. The 560-ohm self-bias resistor in the emitter circuit has a degenerative effect since the voltage drop across it causes the emitter to go in a positive direction on the conduction part of the cycle. This prevents excessive collector current and loading of the tank circuit, which assists in maintaining good oscillator stability.

The oscillator voltage is capacity coupled to the mixer stage from a low impedance point of a capacity divider across L_5 , consisting of a 220- μ f. capacitor and a .002- μ f. capacitor in series. This provides proper matching for the emitter connection at the mixer stage, which is also a low-impedance point.

(To be continued)

Even SANTA shops by mail at RADIO SHACK!

Five fabulous bargains for mail-order Santas — typical of what you see month after month when you sign up to receive — FREE — Radio Shack's Bargain Bulletins. See coupon below!



STROMBERG-CARLSON \$99.95 COAXIAL SPEAKER
60% off at Radio Shack!

\$39⁹⁵
\$2 down

SAVE \$60 — 1959 Model RF483 true 2-way 15" coaxial speaker — for stereo, monaural, gifts!

The most extraordinary buy in hi-fi history — and we mean high fidelity! This chrome-and-red fifteen pound S-C master-piece features separately driven 100-watt 25 cps woofer, 115" dispersion tweeter that silks up to 18,000 cps, meticulously designed 3000 cps crossover. Radio Shack — and nobody else but Radio Shack — has this speaker to sell actually below dealer cost! Order one for quality monaural, two for an ultimate stereo system. Either way, you'll be getting a Rolls Royce for the price of a tin lizzie! 6 3/4" deep. 16 ohms. Ship. wt. 15 lbs.

RADIO SHACK'S TRANSISTOR GIFT SENSATION
Portable — built-in speaker, phone jack!

\$9⁹⁵ \$19.95 value

Ours exclusively — smashes all transistor radio prices! Order one for yourself, 2 more for friends, shut-ins, students, office — get all three radios for what you'd expect to pay for one. Excellent reception of every major station in metropolitan areas. Has built-in 2 1/2" speaker, antenna, jack for earphone listening, Conelrad markings. Handsome molded case. Ship. wt. 2 lbs. each. Accessory earphone, battery extra (see coupon).

AMAZING "BASIC-10" CLASSICAL LP OFFER

A library of 10 reg. \$4.98 famous-fidelity, famous-label (in disguise) records — literally a disk-opedia of music — at a history-making low price of less than \$1.10 per record!

- ★ NOT \$2 chain store or supermarket disks!
- ★ EXACTLY the same music, "masters", and vinyl as this maker's reg. \$4.98 label!

ALL 10 RECORDS \$10⁹⁵ \$49.80 value!

A Radio Shack exclusive! The great classics you've always wanted to give (or get) — nearly ten hours of great music — at a price that says order one set for your own collection, one or two others for gifts, for your school, your club! Superb highest-fidelity recordings, every one, pressed for a terminated Record Club offer. Radio Shack bought the entire remaining inventory and agreed not to disclose the maker's name, the artists or the world-renowned orchestras! (Though we've disguised the labels, when you hear these records you'll instantly recognize the virtuoso artists, the top-rated performances!). Included are: Beethoven's Symphony No. 5; Schubert's "Unfinished" Symphony No. 8 and Symphony No. 5; Dvorak's "New World" Symphony; Bizet's Carmen Suite; Grieg's Peer Gynt Suite; Rimsky-Korsakoff's Scheherazade; Franck's Symphony in D minor; Tchaikovsky's 1812 Overture, Capriccio Italien, Piano Concerto No. 1, and Symphony No. 5; and a collection of Strauss Waltzes. Every record is individually factory-sealed and handsomely jacketed. The entire group is in one easy-to-mail package — or break it up for 10 perfect single-record gifts. Ship. wt. 10 lbs.

INTERNATIONALLY ACCLAIMED ELECTROSTAT-3
The REALISTIC masterpiece... the most vainly imitated tweeter in audio history!

Add unbelievably clean transparency and "spaciousness" to your speaker system with the super-high frequency tweeter twice top-rated as the "best" regardless of price! 25,000 cps response compliance speakers. Complete, in cabinet 11 1/2" x 5 7/8" x 4 1/2". Ship. wt. 7 lbs.

\$27⁵⁰ \$2 down

ELECTROSTAT-3 CROSSOVER NETWORK
Designed for Realistic Electrostat-3, but may be used with any 8 or 16 ohm tweeter-woofer combination for perfect balance between speakers. Ship. wt. 2 lbs.

\$6⁹⁵ \$13.95 value

33-FT. CHRISTMAS TREE LIGHTS
Always a sellout! 24-lite set at fabulous savings!

\$17⁹⁵ worth \$5 a string!

2 for \$33⁹⁵

Sparkling decoration for any Christmas tree, wreath or mantle! 24 tiny red, yellow, blue, green and white lamps that twinkle on every 3 seconds. Green lamp-bases and wire, only 11" between bulbs, a full 33 feet long. A Radio Shack exclusive at this low price. Hurry! Ship. wt. 1 1/2 lbs.

New 1960 Radio Shack ELECTRONIC BUYING GUIDE only 35c

50,000 sold! Practically an electronics education in itself. 312 book-size 8 1/2 x 11 rotogravure pages, profusely illustrated, crammed with articles, engineering data, complete specifications for over 40,000 electronic, hi-fi, optical, tool, record, gift items.



RADIO SHACK CORPORATION, Dept. 12F
730 Commonwealth Avenue, Boston 17, Mass. Send:

Monthly Bargain Bulletins — FREE!
 Stromberg-Carlson speaker, 90LX215 @ \$39.95
 Portable transistor radio, 90L601 @ \$9.95 ea.
 Accessory earphone, 91L166 @ 69c
 Battery, 95L030 @ 59c
 "Basic-10" LP Library, 93W1889 @ \$10.95
 Electrostat-3 tweeter @ \$27.50 ea.
 36CX017Y, mah. () 36CX041Y, blond () 36CX059Y, wal.
 Electrostat-3 crossover @ \$6.95
 91L534, 8 ohms () 91L531, 16 ohms
 Christmas lights, 98L278 @ \$1.79
 1960 Electronic Buying Guide @ 35c

Name _____
 Address _____
 City _____ Zone _____ State _____
 Check Money Order C.O.D.

167 WASHINGTON STREET, BOSTON 8, MASS. • 730 COMMONWEALTH AVENUE, BOSTON 17, MASS. • 230-234 CROWN STREET, NEW HAVEN 10, CONN.

knight-kits[®]
A PRODUCT OF ALLIED RADIO

make the Big News...

see them in **ALLIED'S** 1960 catalog
THE 'WORLD'S LEADING ELECTRONIC SUPPLY GUIDE

FREE
send
for it

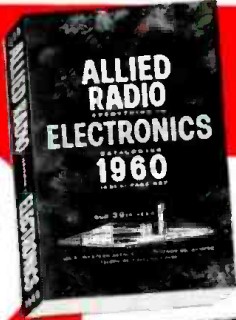

See these and scores of other great **knight-kits**



Y-731 Deluxe FM-AM Stereo Hi-Fi Tuner (Multiplex add-in) . . . \$87.50
only \$5 down



Y-712 Custom Superhet Citizen's Band Transceiver \$79.95
only \$5 down



Y-608 Lab AC VTVM with Automatic Range Selection \$99.50
only \$5 down

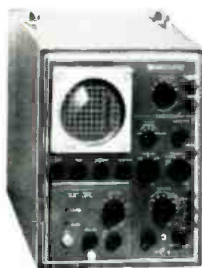

Y-611 Lab DC Scope with Triggered Sweep and Plug-in Vertical Preamps (less Preamps) \$285.00
only \$10 down



Y-773 Super-Value 20-Watt Stereo Hi-Fi Amplifier. \$44.50
only \$2 down



T-400 400-Watt Transmitter (AM and SSB add-ins available) \$395.00
only \$10 down



Y-708 1000 Ohm/Volt Pocket Volt-Ohm-Milliammeter \$9.95



G-30 Amateur Grid Dip Meter (1.5-300 mc) . . . \$22.95
only \$2 down



Y-711 Ammeter-Voltmeter for Cars and Boats \$10.75



there's a money-saving **knight-kit** for every need

SEE PAGE AFTER PAGE OF FASCINATING KITS, INCLUDING:

HI-FI KITS

- Stereo Deluxe Preamp
- 60-Watt Stereo Amplifier
- Stereo Control
- 25-Watt Amplifier
- 18-Watt Amplifier
- 12-Watt Amplifier
- FM-AM Tuner
- FM Tuner
- Speaker Systems
- and others

HOBBYIST KITS

- "Span-Master" Receiver
- "Space-Spanner" Receiver
- "Ranger" Radios
- "Ocean Hopper" Radio
- Clock-Radio
- Radio-Intercom
- 5-Transistor Portable
- 2-Transistor Pocket Set
- 2-Way Intercom
- Electronic Lab Kits
- Photoelectric System,
- and many others

INSTRUMENT KITS

- DC VTVM
- Volt-Ohm-Milliammeters
- 5" Oscilloscopes
- Tube Checkers
- RF Signal Generator
- Signal Tracer
- Audio Generator
- Sweep Generator
- Battery Eliminator
- Capacity Checker
- Transistor Checker
- R/C Tester, plus many others

NEW LOWEST TERMS

Only \$5 down (or less) on orders up to \$200; up to 24 months to pay. Fast handling—no red tape.

sold exclusively by **ALLIED RADIO**

the Best News in electronic kits for 1960

world's easiest-to-build kits

SAVE UP TO 50%

BUILD THE BEST

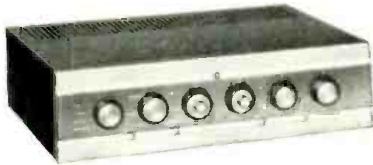

Y-774 Deluxe 40-Watt Stereo Amplifier (with Center Channel) . . \$79.50
only \$5 down

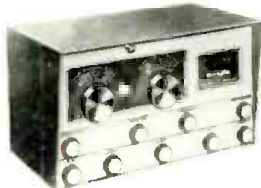

R-100 Amateur Communications Receiver (Hi-gain, with built-in Q-Multiplier) . . \$104.50
only \$5 down



Y-713 Citizen's Band Transceiver . . \$39.95
only \$2 down

SEE THEM HERE

AMATEUR KITS

- 50-Watt Transmitter
- Self-Powered VFO
- 100 kc Crystal Calibrator
- RF "Z" Bridge
- Code Practice Oscillator

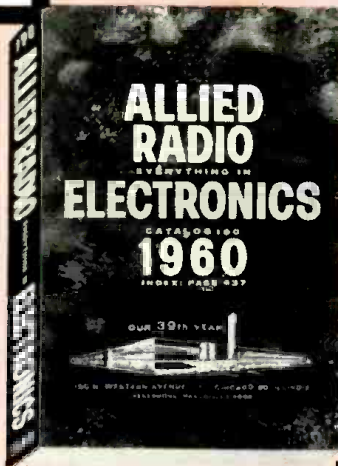

Pioneers in the development of the world's finest electronic kits



our 39th year
THE WORLD'S LARGEST ELECTRONIC SUPPLY HOUSE

BEST...by Design!



with the exclusive **knight-kit**

MONEY-BACK GUARANTEE

KNIGHT-KITS are an exclusive product of Allied Radio. Every KNIGHT-KIT meets or exceeds published specifications, or we refund your money in full.

**BUY ANY KNIGHT-KIT! BUILD IT!
IT MUST PERFORM EXACTLY AS CLAIMED
- OR WE REFUND YOUR MONEY!**

only **knight-kits** have
"CONVENIENCE ENGINEERING"
for easiest building... no previous
electronic experience needed

Exclusive in Knights-Kits, "convenience engineering" means special attention to every detail: resistors are carded and numbered for easy selection... all parts and hardware are packaged in clear plastic bags for easy identification... wire is precut, stripped, tinned and color-coded to save time... special printed circuitry is used to eliminate complex wiring... all parts are top premium quality... you get everything—even the solder! Finally, Knight-Kit instructions are clear as crystal; step-by-step procedure and wall-sized picture diagrams make assembly a marvel of simplicity. Your final reward is proud enjoyment of the superior performance designed into your Knight-Kit.

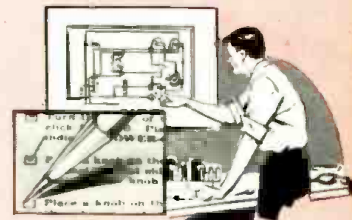

FREE

send for the value-packed

1960 ALLIED CATALOG

Write for the 1960 ALLIED Catalog featuring the complete KNIGHT-KIT line—see the big news in electronic kits—get this leading Buying Guide for everything in Electronics. Send for your **FREE** copy.

ALLIED RADIO CORP., Dept. 161-M9
100 N. Western Ave., Chicago 80, Ill.

Send **FREE** 1960 ALLIED Catalog

Name _____

Address _____

City _____ Zone _____ State _____

...Build the Best
Portable... **EICO**



6-TRANSISTOR RADIO RA-6
Kit \$29.95 Wired \$49.95

INCLUDES F.E.T., LESS 9V BATTERY
Easy creative fun to build... a lifetime of big-set entertainment wherever you go... designed so that even the novice can build it & obtain a handsome professional assembly & outstanding performance. American-made modern super-heterodyne all-transistor circuitry, plus finest quality parts throughout, assure you of highest durability & stability.
• high sensitivity & selectivity • big-set volume & tone quality with 4" x 6" PM speaker & 250 mw push-pull audio output stage • built-in Ferrite rod antenna for good reception in any location • pre-aligned RF & IF transformers • planetary vernier tuning (7:1 reduction) for easy station selection & tuning • high-impedance earphone jack for private listening; eliminates drain of output stage when using earphone • attractive tan leatherette case, retractable handle • compact: 8 1/2" w, 4 1/2" h, 2 1/2" d. Only 3 lbs.

Build the BEST BUYS in
"HAM" gear... **EICO**



90-WATT CW TRANSMITTER #720
Kit \$79.95 Wired \$119.95

"Ideal for veteran or novice" — ELECTRONIC KITS GUIDE. "Top quality" — POPULAR ELECTRONICS. "Well designed" — ELECTRONIC WORLD. 80 thru 10 meters with one-knob band-switching. Full "clean" 90W input, 65W external plate mod. Matches loads 50 to 1000 ohms. May be used as basic exciter unit. TVI shielded. Tubes: 6146, 6CL6, 2-6AQ5, GZ34. Attractive "living room" low-silhouette design. 15" w, 5" h, 9" d.

UNIVERSAL MODULATOR-DRIVER #730

Kit \$49.95
Wired \$79.95
Cover E-5 \$4.50

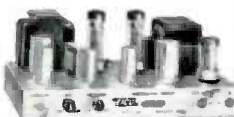

Delivers 50W undistorted audio. Modulates transmitters having r.f. inputs up to 100W. Unique over-modulation indicator. Output transformer matches 500-10,000 ohms. Low-level speech clipping & filtering. Inputs for xtal or dynamic mikes, phone patch, etc. 7 tubes. 6" h, 14" w, 8" d.

GRID DIP METER

Kit \$29.95
Wired \$49.95 #710



Includes complete set of coils for full band coverage. 400 kc-230 mc in 8 overlapping ranges. 500 ua meter. Plug-in coils are pre-wound, pre-calibrated to 0.5% accuracy. Transformer-operated power supply. 2 1/4" h, 2 1/4" w, 6 7/8" l.

Compare—judge for yourself—at your neighborhood EICO distributor. For free catalog on 65 models of EICO test instruments, hi-fi & "ham" gear, fill out coupon on Page 36

EICO ELECTRONIC INSTRUMENT CO., Inc.
33 00 N. Blvd., L. I. C. I., N. Y.
© 1959

Phosphors and Their Uses

(Continued from page 51)

it is still being used in some projection-TV picture tubes. Almost overnight, calcium halophosphate activated by antimony and manganese ("halo" because it contains the halogens, chloride and fluoride) was used exclusively. Like the silicate system, it is not a single phosphor, but a complex family in which some color variations can be made by changes in "mol ratios" or activator concentrations. The primary activator, manganese, gives rise to the emission of a red band, in conjunction with the secondary activator or sensitizer, antimony, emitting in the blue region.

As color rendition became a more important factor in lighting, the calcium silicate phosphor was used as the major component in the deluxe series of phosphors. In 1954, the super deluxe cool white lamp was introduced, which provides the best rendition of color yet obtained with fluorescent lamps. The basic phosphors for this lamp, both developed by *Sylvania*, are calcium strontium orthophosphate activated by tin, subsequently replaced by the brighter calcium zinc orthophosphate: tin activated. In 1956, in response to demands for higher illumination for virtually all seeing tasks, *Sylvania* introduced the VHO (Very High Output) lamp, which produces two and one-half times as much light as conventional lamps of the same dimensions. This important development makes possible the extension of fluorescent lighting into medium and high bay industrial lighting, as well as for outdoor applications such as street lighting, parking lots, etc.

While each lamp contains only a few grams of phosphor, the amount of phosphor required by the industry each year adds up to many tons. The phosphor is applied to the inside of the lamp as a lacquer suspension, from which, after the solvent has evaporated, the lacquer is baked out, leaving the phosphor adhering to the glass in a smooth, uniform coat. The raw materials for phosphors must be of exceptional purity. Accordingly, purifica-

tion procedures are always a vital part of the precipitation of phosphors or phosphor component raw materials. In general these are made as pure as possible, then the desired amount of activator added in the form of a suitable compound. Control of crystal structure and crystal size distribution are also important in many materials used in compounding the phosphate phosphors. Phosphors are usually prepared by the homogeneous dry mixing of the purified constituents in the required proportions, followed by a heat treatment in the range of 1800 to 2000°F. Ofttimes control of the atmosphere is necessary during such "firing" to provide oxidizing, reducing, or inert conditions in the furnace.

Television picture-tube phosphors are largely zinc or zinc cadmium sulfides with a range of activators such as silver to secure the color, brightness, and efficiency desired. (See Fig. 3) The phosphor screen is formed on the inner face of a picture tube by allowing the powder to settle from a water suspension containing a little potassium silicate and barium acetate. Cathode-ray-tube phosphors, as used in industrial and military tubes, are made in a range of colors and persistence characteristics essential for rapidly changing displays or longer time presentations. (Refer to our cover story for additional details.—Editor.)

The newest family of phosphors, electroluminescent phosphors, are used in solid state "cold light" lamps manufactured under the name "Panel-escence" by *Sylvania*.¹ These phosphors are already manufactured in ton quantities for applications such as in automobile instrument panels, night lights, and highway signs. These phosphors are largely zinc sulfide having activators such as lead or copper. "Panel-escence" lamps are made by imbedding the phosphors in a ceramic glaze resulting in years of continuous service at low cost.

As new needs arise in the lighting and electronics industries, the development of suitable phosphors to meet these needs will also continue.

REFERENCES

¹ Martin, A. V. J.: "Electroluminescence—Light of the Future," RADIO & TV NEWS, January, 1958.

Fluorescent Color

deep blue
blue
green
blue
orange-pink
pink

Composition

calcium tungstate
calcium tungstate:lead
calcium magnesium tungstate:lead
zinc orthosilicate:manganese
calcium silicate:lead, manganese
cadmium borate:manganese

(Left) Table 1. Composition of phosphors for colored fluorescents.

(Below) Table 2. Color temperatures for various white fluorescents.

Nominal Color Temperature

3000° K
3500° K
4500° K
6500° K

Deluxe Lamps

Warm White
.....
Cool White

Super Deluxe Lamps

.....
Cool White
.....

High Efficiency Lamps

Warm White
White
Cool White
Daylight

EIA Asks Investigation of Transistor Imports

Electronic Industries Assn. asks if Japanese units are threat to national security.

THE EIA has asked the Office of Civil and Defense Mobilization to investigate growing imports of Japanese transistors and other semiconductor products and determine whether they threaten American security. If the OCDM so finds, EIA asks the agency to take appropriate action to alleviate the threat. The EIA action was taken on recommendation of its Electronic Imports Committee, of which Robert C. Sprague, chairman of the board of the *Sprague Electric Co.*, is chairman, and with the approval of the Association's Board of Directors.

The Association reported that Japanese production of transistors had skyrocketed from 560,000 in 1956 to 26,736,000 in 1958 and 14,967,000 in the first quarter of 1959. Production of diode units also increased almost tenfold from 1956 to 1958. While American production of transistors has also grown rapidly, the rate of increase is far below that of Japan. From 1956 to 1958 domestic production rose from 12,840,000 to 47,051,000 units.

Because Japanese wage rates are less than one-fifth those paid by American electronic manufacturers and a great deal of hand labor is involved in making transistors, the Japanese sell an entertainment type transistor in the United States for 80 cents or less as contrasted to an average price of \$1.35 charged for a comparable American product.

It is the position of EIA that the increasing penetration of the transistor market will have an adverse effect upon the growth of the electronics industry producing transistor products. This will impair the efforts of American producers to provide the capacity to meet existing and potential national security requirements.

It was also pointed out that 33 percent of the dollar value of U. S. transistors made in 1958 was used in military equipment. "This expanding military demand requires continued expansion of American production facilities and research programs," said EIA President D. R. Hull.

Press reports have quoted the Electronic Industries Association of Japan to the effect that Japan plans to double its shipments of transistors to the U.S. in 1959. These reports said that 60 per-cent of Japan's transistors this year is destined for the United States. The Japanese industry organization stated that exports of transistor radios will reach 4,000,000 units in 1959 or twice as many as in 1958. Of 1,928,860 sets exported by Japan last year, 1,233,548 units were shipped to the U. S. —30—

December, 1959

NEW FROM SECO DYNAMIC TRANSISTOR CHECKER



MODEL 100

DYNAMICALLY CHECKS WIDE RANGE OF TRANSISTOR TYPES EITHER "IN OR OUT" OF CIRCUIT!

This new low-cost checker uses an entirely new approach but a proven DYNAMIC principle for checking transistors. safely tests PNP and NPN transistors either "in or out" of the circuit. Covers wide range of types: small signal including "drift" types, medium power; and power types. Provides positive check for "opens," shorts, and gain—condition indicated by means of a visual indicator plus jacks for meter or scope. Also provides GO-NO-GO test at practical currents—and permits matching of similar transistor types. No set-up required—no further leakage tests necessary. Model 100 is compact, lightweight, complete, and ready-to-use . . . helps you cash-in on the big profits in the fast growing transistorized equipment servicing field!

MODEL 100—Wired and factory tested \$19.95 NET

NEW FROM SECO LOW COST, COMPLETE TUBE TESTER



MODEL 78

GRID CIRCUIT and TUBE MERIT TESTER

Complete test coverage of all modern TV tube types as well as all heater type radio tubes including hybrid types, using only 5 sockets. Incorporates patented Seco GRID CIRCUIT TEST plus a reliable CATHODE EMISSION test using new low impedance low test voltage circuit—also checks filament continuity and provides open element test. One easy-to-read meter indicates results for both Grid Circuit and Tube Merit Tests. Two-stage dc amplifier isolates meter from tube under test to protect meter—and makes it possible to achieve a wide range of load currents and test conditions. Complete with portable carrying case, pin straighteners, and flip-chart for quick set-up data.

MODEL 78—Wired and factory tested \$69.50 NET



MODEL 107 TUBE TESTER

outstanding reliability, accuracy

Provides 3 important tests: amplifier types tested for gain by Dynamic Mutual Conductance method—power types tested for cathode current by Cathode Emission method—all types tested for shorts and grid error by Grid Circuit Test developed and patented by Seco. Dynamic Mutual Conductance Test pre-wired to eliminate elaborate set-up. Cathode Emission Test done by free point pin-selector method—will not be obsolete. Completely self-contained in portable carrying case.

MODEL 107—Wired and factory tested \$139.50 NET



MODEL HC-6 IN-CIRCUIT CURRENT CHECKER

positive, on-the-spot check of horizontal output current!

This new, low-cost current checker provides simple means for making a positive on-the-spot check of TV horizontal circuits. Can be placed into the circuit in seconds—no unsoldering of circuit wiring—immediately indicates whether horizontal tube cathode current is within manufacturer's recommended limits. Valuable as a fast, accurate indicating device when adjusting horizontal drive and linearity. Eliminates one of the most common causes of callbacks. Compact, inexpensive, easy to use.

MODEL HC-6—Wired and factory tested \$12.95 NET

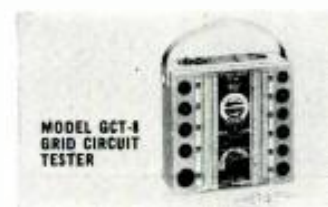

MODEL GCT-8 GRID CIRCUIT TESTER

fast check of critical "control grid" conditions

Model GCT-8 checks "control grid" condition of vacuum tubes faster, more accurately than any other tester! As many as eleven simultaneous checks—automatically! Quickly spots grid errors and leakage—stops guessing, substitution checking, and costly rechecks. Electron-Eye tube indicates faults at a glance. Truly portable. The perfect companion to any tester that employs only conventional gas and shorts test. Carry it on all calls.

MODEL GCT-8 Complete kit . . . \$19.95 NET

MODEL GCT-8 Wired and tested . \$29.95 NET

SEND FOR COMPLETE SECO STORY ON . . .

<input type="checkbox"/> Three Tube Testers <input type="checkbox"/> VTVM <input type="checkbox"/> Dynamic Transistor Checker <input type="checkbox"/> In-Circuit Current Checker <input type="checkbox"/> 100% Accurate Flyback Checker <input type="checkbox"/> Battery Eliminator	<p style="text-align: center;">SECO SECO MANUFACTURING CO. 5015 Penn Ave. So., Minneapolis, Minn.</p> <p>NAME _____</p> <p>ADDRESS _____</p> <p>CITY _____ ZONE _____ STATE _____</p>
---	---

Sold Only Thru Electronics Parts Distributors

SHIPPED ON APPROVAL

NEW

CRT TESTER-REACTIVATOR Model CRT-2

NOW . . . a TESTER-REACTIVATOR really designed to test, repair and reactivate EVERY PICTURE TUBE MADE — whether black and white or color . . . with exclusive features never before found in picture tube testers.



Housed in hand-rubbed oak carrying case — completed with MULTI-HEAD*

Model CRT-2
\$57⁵⁰
Net

TERMS: \$13.50 within 10 days. Balance \$11 monthly for 4 months.

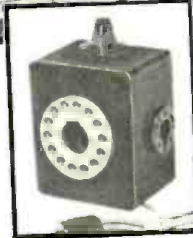

The CRT-2 steps in and solves the limitations and shortcomings of present day CRT Testers. Unlike ordinary CRT testers that keep entering the field with a limited range of operation, the CRT-2 employs a new brilliantly engineered circuit designed to test, repair and reactivate every black and white or color picture tube made. The CRT-2 eliminates the guesswork and risk that until now, has always been present when a picture tube is reactivated. It accomplishes this by providing perfect control of either the 'Boost' or 'Shot' method of reactivation.

THE CRT-2 DOES ALL THIS RIGHT IN THE CARTON, OUT OF THE CARTON OR IN THE SET

TEST

- ✓ for quality of every black and white and color picture tube
- ✓ for all inter-element shorts and leakage up to one megohm
- ✓ for life expectancy

REPAIR

- ✓ Will clear inter-element shorts and leakage
- ✓ Will weld opens between any two elements in the tube gun

REACTIVATE

- ✓ The unique controlled 'SHOT' (high voltage pulse) method of reactivation provided by the CRT-2 will restore picture tubes to new life in instances where it was not possible before. Furthermore the high voltage is applied without danger of stripping the cathode as you always have perfect control of the high voltage pulse.
- ✓ The 'BOOST' method of reactivation also provided by the CRT-2 is used effectively on tubes with a superficially good picture but with poor emission and short life expectancy. It will improve definition, contrast and focus greatly and add longer life to the picture tube.

1. **THE MULTI-HEAD** (patent pending) . . . A SINGLE PLUG IN CABLE AND UNIQUE TEST HEAD — A tremendous advance over the maize of cable and adapters generally found with other testers. Enables you to test, repair and reactivate every type of picture tube with greater convenience than ever before . . . 50 degree to 110 degree types from 8" to 30", whether 12 pin base, 8 pin base, 14 pin base . . . even the very latest 7 pin base. A special color switch on the MULTI-HEAD enables you to test, repair and reactivate each of the red, green and blue color guns separately.
2. **WATCH IT REACTIVATE THE PICTURE TUBE** — You actually see and control the reactivation directly on the meter as it takes place, allowing you for the first time to properly control the reactivation voltage. This eliminates the danger of stripping the cathode of the oxide coating. It enables you to see the speed of reactivation and whether the build-up is lasting. You will see if the cathode contamination is too great and if the picture tube is too far gone to be reactivated.
3. **CONTROLLED "SHOT" WITH HIGHER VOLTAGE FOR BETTER REACTIVATION** — Stronger than any found in other testers . . . high enough to really do the job — yet controlled to avoid damage to the picture tube.
4. **UNIQUE HIGH VOLTAGE PULSE CIRCUIT** — Will burn out inter-element shorts and weld open circuits with complete safety to the picture tube.
5. **VISUAL LIFE TEST** — Enables both you and your customer to see the life-expectancy of any picture tube right on the meter. The fact that your customer can see the results of your tests as you make them virtually eliminates resistance to picture tube replacement when necessary.
6. **TESTS, REPAIRS AND REACTIVATES SPECIAL LOW SCREEN VOLTAGE TUBES** — Many new type picture tubes use special low voltage of approximately 50 volts. The CRT-2 will test, repair and reactivate these types with the same thoroughness as the regular types with complete safety.
7. **SEPARATE FILAMENT VOLTAGES** — Including the very latest 2.35 volt and 8.4 volt types as well as the older 6.3 volt types.
8. **TESTS, REPAIRS AND REACTIVATES 'SF' PICTURE TUBES** — found in the newest Sylvania and Philco TV sets. These picture tubes have different base pin connections than standard picture tubes and there is always an element of risk that the tube may be burned out when tested with ordinary picture tube testers. The CRT-2 is designed to accommodate this new base pin arrangement and will test the tube with no danger of damage.

ADDITIONAL FEATURES

- Employs the time proven dynamic cathode emission test principle • Large 4 1/2" meter with heavily damped movement for smooth action, accuracy and long life
- Provides separate shorts test for each element in the picture tube • Filament continuity is shown on a separate glow indicator • An easy to read instruction manual contains all the latest testing information on old and new type picture tubes • Housed in handsome hand-rubbed oak carrying case with special compartment for MULTI-HEAD and line cord.

* patent pending

IN-CIRCUIT CONDENSER TESTER Model CT-1

Here is an IN-CIRCUIT CONDENSER that DOES THE WHOLE JOB! The CT-1 actually steps in and takes over where all other in-circuit condenser fail. The ingenious application of a dual bridge principle gives the CT-1 a tremendous range of operation . . . and makes it an absolute 'must' for every serviceman.

in-circuit checks:

- ✓ Quality of condensers even with circuit shunt resistance . . . (This includes leakage, shorts, opens, intermittents)
- ✓ Value of all condensers from 200 mmfd. to .5 mfd.
- ✓ Quality of all electrolytic condensers (the ability to hold a charge)
- ✓ Transformer, socket and wiring leakage capacity

out-of-circuit checks:

- ✓ Quality of condensers . . . (This includes leakage, shorts, opens and intermittents)
- ✓ Value of all condensers from 50 mmfd. to .5 mfd.
- ✓ Quality of all electrolytic condensers (the ability to hold a charge)
- ✓ High resistance leakage up to 300 megohms
- ✓ New or unknown condensers . . . transformer, socket, component and wiring leakage capacity

OUTSTANDING FEATURES

- Ultra-sensitive 2 tube drift-free circuitry
- Multi-color direct scale readings for both quality and value . . . in-circuit or out-of-circuit
- Simultaneous readings of circuit capacity and circuit resistance
- Built-in hi-leakage indicator sensitive to over 300 megohms
- Cannot damage circuit components
- Electronic eye balance indicator for every greater accuracy
- Isolated power line
- Housed in sturdy hammertone finish steel case . . . comes complete with test leads

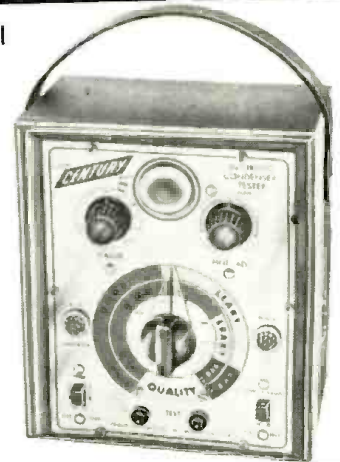

Model CT-1
\$34⁵⁰
Net

TERMS: \$9.50 within 10 days. Balance \$5 monthly for 5 months.

EASY TO BUY IF SATISFIED — see order form on facing page

FOR 10 DAY FREE TRIAL

Convince yourself at no risk that CENTURY instruments are indispensable in your every day work. Send for instruments of your choice without obligation . . . try them for 10 days before your buy . . . only then, when satisfied, pay in easy-to-buy monthly installments — without any financing or carrying charges added.

NOW a Battery Operated Peak-to-Peak **VACUUM TUBE VOLT METER** Model VT-1

WITH LARGE EASY-TO-READ 6" METER —

featuring the sensational new **MULTI-PROBE** * Patent Pending

No extra probes to buy! The versatile MULTI-PROBE does the work of 4 probes

- ① DC Probe ② AC-Ohms Probe ③ Lo-Cap Probe ④ RF Probe

The VT-1 is a tremendous achievement in test equipment. With its unique MULTI-PROBE it will do all the jobs a V.T.V.M. should do without the expense of buying additional probes. No longer do you have to cart around a maize of entangled cables, lose time alternating cables or hunting for a misplaced probe. With just a twist of the MULTI-PROBE tip you can set it to do any one of many time-saving jobs. A special holder on side of case keeps MULTI-PROBE firmly in place ready for use.

FUNCTIONS

DC VOLTMETER . . . Will measure D.C. down to 1.5 volts full scale with minimum circuit loading, and give accurate readings of scale divisions as low as .025 volts . . . Will measure low AGC and oscillator bias voltages from .1 volts or less up to 1500 volts with consistent laboratory accuracy on all ranges . . . Zero center provided for all balancing measurements such as discriminator, ratio detector alignment and hi-fi amplifier balancing.

AC VOLTMETER . . . True Peak-to-Peak measurements as low as 3 volts of any wave form including TV sync, deflection voltages, video pulses, distortion in hi-fi amplifiers, AGC and color TV gating pulses . . . Scale divisions are easily read down to .1 volts . . . Measures RMS at 1/20th the circuit loading of a V.O.M. . . . Unlike most other V.T.V.M.'s there is no loss in accuracy on the lowest AC range.

ELECTRONIC OHMMETER . . . Measures from 0 to 1000 megohms . . . Scale divisions are easily read down to .2 ohms . . . Will measure resistance values from .2 ohms to one billion ohms . . . Will detect high resistance leakage in electrolytic and by-pass condensers.

RF and LO-CAP MEASUREMENTS . . . With these extra VT-1 functions you can measure voltages in extremely high-impedance circuits such as sync and AGC pulses, driving saw tooth voltages, color TV gating pulses, mixer output levels, I.F. stage-by-stage gain and detector inputs.

OUTSTANDING FEATURES

- Completely portable — self powered with long life batteries — permits use everywhere
- New advanced pentode amplifier circuit assures amazingly low battery drain
- Large 6" 100-microampere meter, many times more sensitive than meters used in most V.T.V.M.'s
- Laboratory accuracy performance — 2% of full scale on DC, 5% of full scale on AC
- Simplified multi-color easy-to-read 4-scale meter
- No heat operation assures rigid stability and accuracy
- Immune to power line fluctuations
- Amplifier rectifier circuit with frequency compensated attenuator — a feature found only in costly laboratory instruments
- Meter completely isolated — practically burn-out proof
- Hand-crafted circuitry eliminates the service headaches of printed circuitry
- 1% resistors used for permanent accuracy
- Separate RF ground return for low-loss RF measurement
- Micro-phon type co-axial connector
- Matching cover protects instrument face — snaps on and off instantly.



Housed in hammertone steel-case — complete with MULTI-PROBE

SPECIFICATIONS

- DC Volts — 0 to 1.5/6/30/150/300/600/1500 volts
- AC Volts (RMS and Peak-to-Peak) — 0 to 3/12/60/300/1200 volts
- Ohms — 0 to a billion ohms, 10 ohms center scale — Rx1/10/100/1K/10K/100K/1M
- RF — Peak reading demodulator supplied for use on all DC ranges
- Zero Center — available on all DC volt ranges with zero at mid-scale
- Decibels — from -10 Db to +10, 22, 36/50/62 based on the Dbm unit: 0db-1mW in 600 Ohms
- Impedance — 11 megohms DC, 1 megohm AC, 10 megohms Lo-Cap
- Input Capacity — 130 mmfd. RMS, 250 mmfd. Peak-to-Peak, 25 mmfd. Lo-Cap

Model VT-1
\$58.50 Net

TERMS: \$14.50 within 10 days. Balance \$11 monthly for 4 months.

FAST-CHECK TUBE TESTER Model FC-2

Simply set two controls . . . insert tube . . . and press quality button to test any of over 700 tube types completely, accurately . . . IN JUST SECONDS!

Over 20,000 servicemen are now using the FAST-CHECK in their every day work and are cutting servicing time way down, eliminating unprofitable call-backs and increasing their dollar earnings chose the FAST-CHECK above all other tube testers.

PICTURE TUBE TEST ADAPTER INCLUDED WITH FAST-CHECK

Enables you to check all picture tubes (including the new short-neck 110 degree type) for cathode emission, shorts and life expectancy . . . also to rejuvenate weak picture tubes.

RANGE OF OPERATION

- ✓ Checks quality of over 700 tube types, employing the time proven dynamic cathode emission test. This covers more than 99% of all tubes in use today, including the newest series-string TV tubes, auto 12 plate-volt tubes, 0Z4s, magic eye tubes, gas regulators, special purpose hi-fi tubes and even foreign tubes.
- ✓ Checks for inter-element shorts and leakage.
- ✓ Checks for gas content.
- ✓ Checks for life-expectancy.

SPECIFICATIONS

- No time consuming multiple switching . . . only two settings are required instead of banks of switches on conventional testers
- No annoying roll chart checking . . . tube chart listing over 700 tube types is located inside cover. New listings are added without costly roll chart replacement
- Checks each section of multi-section tubes and if only one section is defective the tube will read "Bad" on the meter scale
- 41 phosphor bronze beryllium tube sockets never need replacement
- 7-pin and 9-pin straighteners line voltage variation
- 12 filament positions
- Special scale on meter for low current tubes, yet rugged — fully no shock hazards
- Long lasting etched aluminum panel
- Separate gas and short jewel indicators
- Line isolated

NOTE: The Fast-Check positively cannot become obsolete . . . circuitry is engineered to accommodate all future tube types as they come out. New tube listings are furnished periodically at no cost.



Housed in hand-rubbed oak carrying case complete with CRT adapter

Model FC-2
\$69.50 Net

TERMS: \$14.50 within 10 days. Balance \$11 monthly for 5 months.

CONVENIENT TIME PAYMENT PLAN — NO FINANCING CHARGES

ALL CENTURY INSTRUMENTS ARE GUARANTEED FOR ONE FULL YEAR

The extremely low prices are made possible because you are buying direct from the manufacturer.

CENTURY ELECTRONICS CO., INC.

CHECK INSTRUMENTS DESIRED

- Model CRT-2 CRT TESTER REACTIVATOR . . . \$57.50 \$13.50 within 10 days. Balance \$11 monthly for 4 months.
- Model CT-1 In-Circuit Condenser Tester . . . \$34.50 \$9.50 within 10 days. Balance \$5 monthly for 5 months.
- Model VT-1 Battery Vacuum Tube Volt Meter . . . \$58.50 \$14.50 within 10 days. Balance \$11 monthly for 4 months.
- Model FC-2 Fast-Check Tube Tester . . . \$69.50 \$14.50 within 10 days. Balance \$11 monthly for 5 months.

Prices Net F.O.B. Mineola, N. Y.

111 Roosevelt Avenue, Dept. 212, Mineola, New York

Please rush the instruments checked for a 10 day free trial. If satisfied I agree to pay the down payment within 10 days and the monthly installments as shown. If not completely satisfied I will return the instruments within 10 days and there is no further obligation. It is understood there will be NO INTEREST or FINANCING charges added.

Name Please print clearly

Address

City State

HARVEY has the latest in

CITIZEN BAND RADIO

The POLY-COMM
A 27 MC Deluxe
Two-Way Citizen
Band
TRANSCEIVER
for Class 'D' Operation



Price:
\$159.50

Here's the model for everyone—at work or play or business—it's the natural choice for any citizen to take advantage of the 22 newly created 27 MC Citizen Band frequencies. Features super sensitive dual conversion 10 tube superhet receiver, which incorporates rapid acting adjustable vacuum tube squelch circuit; plus Delayed A.G.C.—Floating series gate-type noise limiter—Low distortion—Communication tailored frequency response—Has no relays—Better than 3-watts output—Operates on 115V A.C. or 12 volt battery. With slight modification will also operate on 6 volt D.C.



RCA "RADIO-PHONE"
27 MC Citizen Band
Two-way Radio

Designed to provide low-cost 2-way communication facilities for small boat owners, it is ideal for out-boards not equipped with a standard multichannel radio-telephone. Features Single channel Transceiver—Simplified operation—5-watt output—Compact, portable—weighs only 8 lbs.—High sensitivity receiver—Dual power supply.

Price: **\$124.95**

HARVEY has a complete stock of Antennas to meet every 27 MC citizen band requirement.

MAIL ORDERS SHIPPED SAME DAY AS RECEIVED
Include with your payment a generous allowance
for shipping charges—the excess will be
promptly refunded.

HARVEY Estab. 1927
RADIO CO., INC.
103 West 43rd Street, New York 36, N. Y.
JU 2-1500

Mac's Service Shop (Continued from page 52)

"Well, I'm for anything that makes printed circuits easier to service," Barney exclaimed. "Every day we're getting more and more of them into the shop. In fact, most of our bread-and-butter sets, the a.c.-d.c. jobs, are printed circuits. Time was when I could depend on being able to zip through a stack of these in nothing flat. Fixing one of these sets was usually a matter of changing tubes, stringing a dial cord, or replacing filters, shorted output tube plate bypass capacitors, intermittent or open coupling capacitors, or worn-out volume controls. Now and then we got a bad i.f. transformer or oscillator coil just to make life interesting, but even that was quickly solved by substituting a new part. It's not that simple with some printed circuits," he finished with a sigh.

"You can say that again—and probably will," Mac agreed. "Tiny cracks in printed circuits are the very devil to find sometimes. That's why I'm willing to buy anything that promises to speed up the process. We've got to work out techniques for cracking these little monsters as rapidly as we do conventional wired jobs. Gripping about them does no good. We're going to have to work on them, and that's that. I keep hoping manufacturers are going to make them easier to service as time goes on. These two sets here on the end of the bench are beautiful examples of the difference in printed circuit boards," he said as he turned the two little receivers over on their backs.

"Both sets had an intermittent type of noise I finally decided was a defective i.f. transformer," he explained. "It's darned hard to be sure about this, for you can't easily cut the transformer out of the circuit for testing, and a very similar symptom is produced by a crack in the circuit board. Finally, though, I decided to change transformers. Now in Set #1 this was a real undertaking. The four flat leads from the transformer windings were thrust through narrow slots in the circuit board, bent over, and soldered. In addition, heavy flat strips on each side of the shield can were thrust through slots in the board, twisted, and soldered. Getting that transformer loose without wrecking the board was a tedious, nerve-wracking, time-consuming job; and I did not pull it off without loosening some of the foil from the board. Then I had to wait ten days on a new exact-replacement transformer because it was next to impossible to adapt a standard replacement transformer for use.

"Set #2 was a different story altogether. The i.f. transformer fits down over this square hole cut in the board. As you can see, the winding terminals are simply bent over and soldered to leads on the board. All I needed to do to a standard replacement transformer

to make it fit was to solder a grounding lead to the side of the can. Replacing this transformer was no harder than it would have been in a wired set, and the board was not damaged at all by the replacement.

"This is what you might call 'compatible' receiver design. The engineer designed the printed circuit so that standard wired-circuit replacement items could be used without sacrificing a thing in the way of manufacturing convenience or operating efficiency. The transformer leads can be lifted free from the printed circuit so as to isolate it for checking without actually having to remove the transformer. Now that's what I call engineering!"

"Amen!" Barney agreed. "And it's that kind of engineering that makes things easier on the technician's nerves and the customer's pocketbook and creates good will for the manufacturer. I hope we see lots more of it." —30—

Within the Industry (Continued from page 24)

Merriam, *Sylvania Electric Products Inc.* has been named vice-chairman.

The following members were named to the committee in addition to Messrs. Milhalic and Merriam: A. Adler, *Olympic Radio and Television*; R. M. Alston, *Conrac, Inc.*; R. L. Barnard, *Arvin Industries, Inc.*; J. Bennett, *Philco Corp.*; J. P. Brocki, *Bendix Radio Div.*; K. H. Brown, *Westinghouse Electric Corp.*; P. Calorbrisi, *Motorola Inc.*; A. Coumont, *Sprague Electric Co.*; D. R. Creato, *RCA Service Co., Inc.*; C. A. Duffy, *Packard Bell Electronics Corp.*; H. Feldman, *Trav-Ler Radio Corp.*; A. J. Forman, *Caldwell-Clements Manual Corp.*; C. Golenpaul, *Aerovox Corp.*; E. J. Greaney, *Hoffman Electronics Corp.*; C. N. Hofman, *Warwick Mfg. Corp.*; A. N. Jonsson, *Delco Radio Div.*; J. H. Miller, *G-E Co.*; F. B. Ostman, *Federal Electric Corp.*; H. T. Paiste, *Philco Corp.*; W. L. Parkinson, *G-E Co.*; K. W. Pietenpol, *American Television and Radio Co.*; W. D. Renner, *H. W. Sams & Co., Inc.*; J. F. Rider, *John F. Rider Publisher, Inc.*; N. F. Schumacher, *Wells-Gardiner and Co.*; H. Schwalbe, *Columbia Phonographs*; F. E. Smolek, *Zenith Radio Corp.*; and R. J. Yeranko, *The Magnavox Co.* —30—

HEATH WINS DMAA AWARD

CLIFFORD M. Edwards, director of advertising and sales promotion of the Heath Company, Benton Harbor, Mich., has received one of advertising's top honors for the second consecutive year—an award from the Direct Mail Advertising Association, Inc.

This award was presented for the company's mail advertising during the year ended June 1, 1959.

The winning campaigns will be shown in many cities throughout the United States and Canada during the coming year. Portions of each campaign will be shown in a color slide presentation the Association produces for showing to those interested in direct-mail advertising. —30—

LAFAYETTE'S 1960 CATALOG

308 GIANT SIZED PAGES

Our 39th Year

The Complete Catalog Featuring
"The Best Buys In The Business"

FOR THE NEWEST AND FINEST IN
STEREOPHONIC HI-FI EQUIPMENT AND SYSTEMS

- TAPE RECORDERS ● PUBLIC ADDRESS SYSTEMS
- AMATEUR EQUIPMENT ● INDUSTRIAL SUPPLIES
- MINIATURE COMPONENTS ● RADIO & TV TUBES AND PARTS
- EXCLUSIVE LAFAYETTE TRANSISTOR & HI-FI KITS

Send for Lafayette's FREE Catalog—the most complete, up-to-the-minute electronic supply catalog crammed full of everything in electronics at our customary down-to-earth money-saving prices.

CONTAINS HUNDREDS OF EXCLUSIVE LAFAYETTE ITEMS NOT AVAILABLE IN ANY OTHER CATALOG OR FROM ANY OTHER SOURCE — SEND FOR YOUR COPY NOW!

A "must" for the economy-minded hi-fi enthusiast, experimenter, hobbyist, engineer, technician, student, serviceman and dealer.

Leaders in Hi-Fi

The most complete selection and largest stocks of hi-fi components and systems—available for immediate delivery at the lowest possible prices. Save even more on Lafayette endorsed "best-buy" complete systems.

EASY PAY TERMS Available on orders over \$20
Only 10% down—Up to 18 months to pay



FREE



TM-66 STEREO
AUDIO ANALYST
11.95

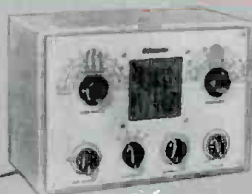

KT-135
4-BAND
RECEIVER
KIT
(Less
Cabinet)
18.50



PK-330
4 SPEED CHANGER
WITH BRAND NEW
GE VR-22 (.7 MIL) DIAMOND
STEREO CARTRIDGE
39.95



PA-56 TRANSISTORIZED
POWER MEGAPHONE
29.50

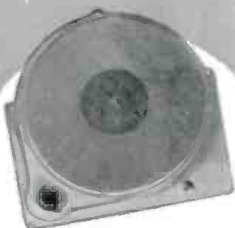

PK-331 33 1/3 RPM
HYSTERESIS TURNTABLE
47.50



PROFESSIONAL
COMMUNICATIONS
RECEIVER
KT-200 KIT 64.50
HE-10 WIRED 79.95



RW-60
20,000
OHM
PER VOLT
MULTITESTER
13.50



SK-128 ULTRA-LINEAR
8" DUALAXIAL SPEAKER
19.50

Lafayette Radio

"Everything in Electronics"

FREE

308 GIANT
SIZED PAGES



CUT
OUT
AND
PASTE
ON
POST
CARD

LAFAYETTE RADIO, Dept. RL-9

P.O. Box 222, Jamaica 31, N. Y.

SEND FOR THE WORLD'S LEADING ELECTRONICS,
RADIO, T.V., INDUSTRIAL, AND HI-FI GUIDE

Send FREE LAFAYETTE Catalog 600

Name

Address

City..... Zone.... State.....

Lafayette Superior Quality Hi-Fi Kits

50 WATT INTEGRATED STEREO AMPLIFIER



KT-250
IN KIT FORM
64.50

LA-250
COMPLETELY WIRED
89.50

- 50 WATTS MONAURALLY—25 WATTS EACH STEREO CHANNEL
- RESPONSE 17-21,000 CPS \pm 1 DB (at normal listening level)
- UNIQUE "BLEND" CONTROL
- PREMIUM EL86 OUTPUT TUBES
- SEPARATE BASS AND TREBLE CONTROLS
- CLUTCH-OPERATED VOLUME CONTROL
- 3RD CHANNEL OUTPUT

A completely new stereo high fidelity amplifier with a high quality of reproduction, versatility of operation, and distinctive styling. A full range of controls enable you to enjoy the utmost in listening pleasure in any situation. Deluxe features include: unique "Blend" control for continuously variable channel separation—from full monaural to full stereo, 4-position Selector, Mode, Loudness and Phase switches. Also provided are outputs for 4, 8 and 16 ohm speakers. Hum-free operation is insured by the use of DC on all pre-amp and tone control tubes. Harmonic distortion, less than 0.25%, IM distortion, less than 1%. Hum and noise, 74 db below full output. Designed with the kit builder in mind, assembly is simple—no special skills or tools required. Complete with deluxe cabinet and legs, all parts, tubes and detailed instruction manual. Shpg. wt., 26 lbs.

KT-250 Stereo Amplifier Kit.....6.45 Down.....Net 64.50
LA-250 Stereo Amplifier, wired.....8.95 Down.....Net 89.50

LAFAYETTE PROFESSIONAL STEREO MASTER AUDIO CONTROL CENTER

Solves Every Stereo/Monaural Control Problem!



KT-600
IN KIT FORM
79.50

LA-600
COMPLETELY WIRED
134.50

- UNIQUE STEREO & MONAURAL CONTROL FEATURES
- AMAZING NEW BRIDGE CIRCUITRY FOR VARIABLE 3d CHANNEL OUTPUT & COSS-CHANNEL FEED
- PRECISE "NULL" BALANCING SYSTEM
- RESPONSE 5-40,000 CPS \pm 1 DB
- 6 CONCENTRIC FRONT PANEL CONTROLS

A REVOLUTIONARY DEVELOPMENT IN STEREO HIGH FIDELITY.

Provides such unusual features as a Bridge Control, for variable cross-channel signal feed for elimination of "ping-pong" (exaggerated separation) effects. Also has full input mixing of monaural program sources, special "null" stereo balancing and calibrating system. 24 equalization positions, all-concentric controls, rumble and scratch filters, loudness switch. Clutch type volume controls for balancing or as 1 Master Volume Control. Has channel reverse, electronic phasing, input level controls. Sensitivity 2.2 millivolts for 1 volt out. Dual low-impedance outputs (plate followers), 1500 ohms. Response 5-40,000 cps \pm 1 db. Less than .03% IM distortion. Uses 7 new 7025 low-noise dual triodes. Size 14" x 4 1/2" x 10 1/2". Shpg. wt., 16 lbs. Complete with printed circuit board, cage, profusely illustrated instructions, all necessary parts. LAFAYETTE KT-600—Stereo Preamplifier kit7.95 Down.....Net 79.50
LAFAYETTE LA-600—Stereo Preamplifier, Wired.....13.45 Down.....Net 134.50

Outstanding Design — Incomparable Performance

LAFAYETTE STEREO/MONAURAL BASIC POWER AMPLIFIER KIT

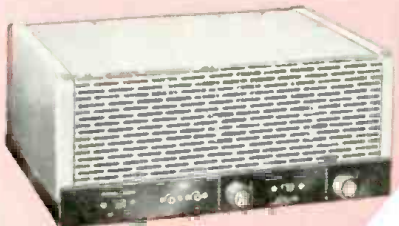

KT-310
IN KIT FORM
47.50

LA-310
COMPLETELY WIRED
72.50

- 36-WATT STEREO AMPLIFIER—18-WATTS EACH CHANNEL
- 2 PRINTED CIRCUIT BOARDS FOR NEAT, SIMPLIFIED WIRING
- EMPLOYS 4 NEW PREMIUM-TYPE 7189 OUTPUT TUBES
- RESPONSE BETTER THAN 35-30,000 CPS \pm 1/2 DB AT 18 WATTS
- LESS THAN 1% HARMONIC OR INTERMODULATION DISTORTION

A superbly-performing basic stereo amplifier, in easy-to-build kit form. Dual inputs are provided, each with individual volume control, and the unit may be used with a stereo preamplifier, for 2-18 watt stereo channels, or, at the flick of a switch, as a fine 36-watt monaural amplifier—or, if desired, it may be used as 2 separate monaural 18-watt amplifiers! CONTROLS include 2 input volume controls, channel Reverse switch [AB-BA], Monaural-Stereo switch, DUAL OUTPUT IMPEDANCES are: 4, 8, 16 and 32 ohms permitting parallel (monaural) operation of 2 speaker systems of up to 16 ohms. INPUT SENSITIVITY is 0.45 volts per channel for full output. TUBES are 2-6AN8, 4-7189; GZ-34 rectifier. SIZE 9-3/16" d (10-9/16" with controls) x 5 1/4" h x 13 1/4" w. Supplied complete with perforated metal cage, all necessary parts and detailed instructions. Shpg. wt., 22 lbs.

KT-310 Stereo Power Amplifier Kit.....4.75 Down.....Net 47.50
LA-310 Stereo Power Amplifier, Wired.....6.95 Down.....Net 72.50

LAFAYETTE STEREO TUNER KIT The Most Flexible Tuner Ever Designed



KT-500
IN KIT FORM
74.50

LT-50
COMPLETELY WIRED
124.50

- Multiplex Output for New Stereo FM
- 11 Tubes (including 4 dual-purpose) + Tuning Eye + Selenium rectifier Provide 17 Tube Performance
- Pre-aligned IF's
- Tuned Cascode FM
- Dual Cathode Follower Output

More than a year of research, planning and engineering went into the making of the Lafayette Stereo Tuner. FM specifications include grounded-grid triode low noise front end with triode mixer, double-tuned dual limiters with Foster-Seeley discriminator, less than 1% harmonic distortion, frequency response 20-20,000 cps \pm 1/2 db, full 200 kc bandwidth and sensitivity of 2 microvolts for 30 db quieting with full limiting at one microvolt. The AM and FM sections are separately tuned, each with a separate 3-gang tuning condenser, separate flywheel tuning and separate volume control for proper balancing when used for stereo programs. Simplified tuning is provided by magic eye. Automatic frequency control "locks in" FM signal permanently. Two separate printed circuit boards make construction and wiring simple, even for such a complex unit. Complete kit includes all parts and metal cover, a step-by-step instruction manual, schematic and pictorial diagrams. Size is 13 1/2" W x 10 1/2" D x 4 1/2" H. Shpg. wt., 22 lbs.
KT-5007.45 Down.....Net 74.50
LT-50 Same as above, completely factory wired and tested.12.45 Down.....Net 124.50

LAFAYETTE RADIO

165-08 LIBERTY AVE., JAMAICA 33, N. Y.

AXtell 1-7000

NEW YORK, N. Y.
100 6th Ave.
Worth 6-5300

BOSTON, MASS.
110 Federal St.
HUBbard 2-7850

BRONX, N. Y.
542 E. Fordham Rd.
Fordham 7-8813

NEWARK, N. J.
24 Central Ave.
Market 2-1661

PLAINFIELD, N. J.
139 W. 2nd St.
PLainfield 6-4718

NEW! Lafayette 50 Watt Complete Stereo Phono System



LA-250



SK-58



GARRARD
RC121/11

WOOD
BASE



NEW
GE VR-22



(OPTIONAL)
LAFAYETTE
ELIOFLEX
SERIES

COMPLETE
STEREO SYSTEM

174⁵⁰

This superb system will add a new dimension in living to your home with all the excitement and realism of a live concert. The new Lafayette LA-250 50-watt stereo amplifier (25 watts each channel) forms the heart of this outstanding stereo hi-fi phonograph music system—the features, versatility and advanced circuitry of this unit are second to none—all the necessary inputs and outputs are provided if you wish to add stereo tape and stereo FM/AM later. A unique blend control allows continuously variable channel separation—from full monaural to full stereo. Also included is the famous Garrard RC121/11 intermix 4-speed automatic record changer with full manual or automatic operation supplied with your choice of stereo cartridges—the new GE VR-22 (.7 mil) diamond stereo cartridge, Pickering 371.7D (.7 mil) diamond stereo cartridge, Shure M7D (.7 mil) diamond stereo cartridge or the new Electro-Voice 31MD7 (.7 mil) diamond stereo cartridge. Supplied with the Lafayette PK-111 wood base cut for the RC121 in your choice of finishes. These outstanding components are coupled with the 2-

COMPONENTS

LAFAYETTE LA-250 50-WATT STEREO AMPLIFIER	89.50
GARRARD RC121/11 STEREO CHANGER	41.65
NEW GE VR-22 (.7 MIL) DIAMOND STEREO CARTRIDGE	24.45
LAFAYETTE PK-111 WOOD CHANGER BASE	3.95
2-LAFAYETTE SK-58 FAMOUS FREE EDGE 12" COAXIAL SPEAKERS at 29.50	59.00

Regular Catalog Price ~~218.55~~

YOUR GUARANTEED BEST STEREO SYSTEM BUY!

YOU SAVE 44.05

famous free-edge Lafayette SK-58 12" Coaxial speakers with built-in crossover network and brilliance level control. System supplied with plugs, cables and simple instructions. Shpg. Wt., 67 lbs.

HI-FI STEREO PHONO SYSTEM with choice of cartridge and mahogany, walnut or blond changer base (please specify).

HF-681. 17.45 Down Net 174.50

Same as HF-681, but with 2-Lafayette Eliofolex Series Bookshelf Enclosures (please specify finish.) Shpg. Wt., 143 lbs.

HF-683. 22.99 Down Net 229.95

STEREO AM-FM-PHONO SYSTEM: Same as HF-681 but including the new Lafayette LT-50 stereo tuner. Shpg. Wt., 85 lbs.

HF-682. 28.75 Down Net 287.50

Unquestionable Economy—Elegant Styling

LAFAYETTE 36-WATT INTEGRATED STEREO AMPLIFIER KIT

NEW!
KT-236
IN KIT FORM
52.50

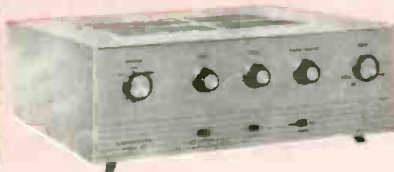

- 36 - WATTS MONAURALLY - 18 - WATTS PER CHANNEL
- FREQUENCY RESPONSE 15-30,000 CPS ± 1 DB
- UNIQUE "BLEND" CONTROL
- CONCENTRIC CLUTCH - OPERATED VOLUME CONTROL
- DUAL CONCENTRIC BASS AND TREBLE CONTROLS.
- 4 - EL84 TUBES IN PUSH PULL.

An outstanding achievement in kit engineering... This exciting new amplifier kit combines dual preamplifiers and dual 18 watt power amplifiers on one compact chassis. It's complete versatility allows connecting both stereo and monophonic sources permanently, with instant selection provided by the turn of a switch. Controls include an amazing new "Blend" control which provides continuously variable channel separation from full monophonic to full stereo, thus insuring the correct degree of stereo separation for individual listening tastes and room acoustics. Additional features are: Concentric clutch-operated volume control for independent or simultaneous level adjustments of both channels; Dual concentric bass and treble controls furnish 4 independent tonal adjustments; Selector Switch provides for Aux, Tuner and Phono. Dual output impedances are: 8 and 16 ohms. Harmonic distortion is less than 0.15% at normal listening level. IM distortion is less than .3%. Hum and noise 70 db below rated output. Complete with cage, legs and detailed instructions. Shpg. wt., 24 lbs.

KT-236 Stereo Amplifier Kit 5.25 Down Net 52.50

DELUXE 70 WATT BASIC AMPLIFIER

KT-400
IN KIT FORM
69.50
LA-70
COMPLETELY WIRED
94.50



- CONSERVATIVELY RATED AT 70 WATTS
- INVERSE FEEDBACK
- VARIABLE DAMPING
- METERED BALANCE AND BIAS ADJUST CONTROLS
- AVAILABLE IN KIT AND WIRED FORM

Here's ultra-stability in a 70 watt basic power amplifier employing highest quality components conservatively rated to insure performance and long life. Features matched pair KT 88's and wire range linear Chicago output transformer, variable damping control, meter for bias and balance and gold finish chassis. Frequency response 10-100,000 cps ± 1 db. Hum and noise 90 db below full output. IM distortion less than 1 1/4% at 70 watts, less than 0.3% below 30 watts. Harmonic distortion less than 2% at 70 watts from 20 to 20,000 cps ± 1 db. Output impedance 4, 8 and 16 ohms. Handsome decorative cage perforated for proper ventilation. Size 14 1/2 x 10 x 7 1/2" including cage and knobs. Shpg wt., 40 lbs.

KT-400—In Kit Form 6.95 Down Net 69.50

LA-70—Completely Wired 9.45 Down Net 94.50

MONEY-BACK GUARANTEE

Lafayette Kits are exclusive products of Lafayette Electronics. Each Lafayette Kit must meet or exceed its published specifications, or your money is refunded in full.

FREE!
1960
CATALOG

CUT OUT
AND PASTE
ON POST
CARD

LAFAYETTE RADIO

P.O. BOX 222
JAMAICA 31, N. Y.
DEPT. RL-9

Name.....
Address.....
City..... Zone..... State.....

SALES • SERVICE
 Complete Your Citizens Band
 Line with the Leading
HY-GAIN BANDERS

COMPLETE
 ANTENNAS
 ENGINEERED & DESIGNED
 FOR TOP

11 METER
 PERFORMANCE

CITIZENS
MOBILE

MODEL CM

Chrome plated, stainless steel telescoping whip extends to 73", down to 23" for easy parking. Weatherproof, polyethylene enclosed, hi-efficiency base loading coil with exclusive Hy-Gain "L" matching net for perfect 50 ohm match. Complete with universal swivel body mount. Drill one hole for mounting.

\$11.95 List

CITIZENS
GROUND PLANE

MODEL COP

Base station antenna kit designed for hi-efficiency point-to-point or base-to-mobile operation, complete with 3/4" to 3/4" OD telescoping aluminum radiator, copper clad steel stranded radials and strain insulators, screw hooks, 1/4" OD 3-ft mast and universal swivel hook mount for flat or peaked roofs. Less feed line.

\$18.95 List

HEAVY DUTY
GROUND PLANE

MODEL GP-1

Commercial duty (100 mph rating) citizens ground plane for hi-efficiency point-to-point or base-to-mobile use, complete with four 3/4" to 3/4" OD telescoping aluminum radials and radiator. Drooping radials adjusted for 50 ohm match. Nylon base insulator and mounting fits masts to 1 1/2" diameter. Complete with #0239 coax receptacle less feed line.

\$32.50 List

CITIZENS
BEAM

MODEL 113-G

3-Element Citizens Beam provides 4.5 db forward gain, multiplying effective power times 2.5 for long range point-to-point use. Commercial duty construction of 3/4" - 3/4" OD aluminum elements and 1 1/2" OD galvanized steel boom. Factory pre-adjusted and gamma matched for perfect 50 ohm match. Boom: 8'. Longest element: 16.5". Positive "U" bolt grip for masts up to 1 1/2" diameter.

\$34.95 List

- Citizens Dipole, Model CD, for transmitter/receiver mounting\$12.95
- Citizens Whip, Model CW, for transmitter/receiver mounting\$ 6.95
- Auto Door Mount, Model ADM, with SO-239 receptacle for mounting CW to top of auto door\$ 4.95
- Model ADT Adapter, connects VHF coax plug type PL259 to automotive type plug\$ 1.95
- Factory Pre-Assembled Coaxial Cable Kits
- Model CC-12, 12 ft.\$ 3.95
- Model CC-25, 25 ft.\$ 5.95
- Model CC-50, 50 ft.\$ 8.95

SEE YOUR HY-GAIN DISTRIBUTOR OR
 WRITE FOR LITERATURE DIRECT TO

Hy-gain antenna products

1135 NO. 22ND • LINCOLN NEBRASKA

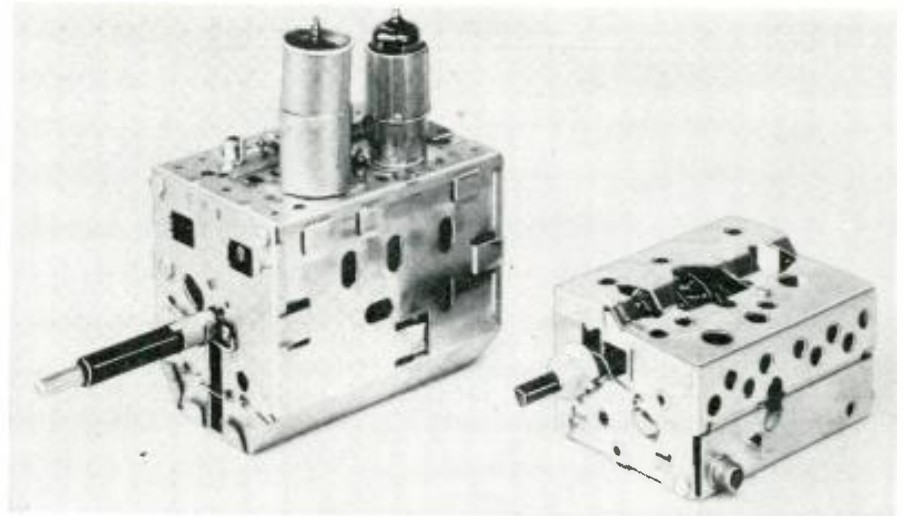

Fig. 1. A conventional TV tuner (left) and the transistorized version (right).

Tuner for Transistor TV

General Instrument's front end, light and small, solves a problem for makers of battery-portable TV.

THE FIRST commercial TV tuner to use transistors instead of tubes, now in production by General Instrument Corp., is available to all manufacturers planning to market battery-portable, fully transistorized TV receivers. It was used in the first such mass-produced receiver in this country (see "You Can Buy This Transistorized TV," page 56, July ELECTRONICS WORLD).

Two years in development, the package is 3 1/2 inches deep (its greatest dimension), only 1 1/4 inches high and weighs in at 9 1/2 ounces—yet it packs 287 separate parts in this small space. See Figs. 1 and 2. Operating from a 12-volt supply, its three transistors are all micro-alloy diffused

(MADT) types, capable of providing performance at v.h.f. TV frequencies and above. The neutralized common-emitter r.f. triode, separate oscillator, and mixer are reported to provide performance comparable to that of conventional tube-using front ends.

High-band gain (channels 7 to 13) is given as 18 to 22 db, with low-band gain ranging from 27 to 35 db. Noise figure for the higher channels ranges from 9 to 12 db and, for the lower channels, this figure is given as 4.5 to 7.5 db. Bandwidth is in the neighborhood of 2 mc. at 3 db down.

To accommodate different design approaches by set makers, the front end may be obtained for use with a negative or positive power supply and with other variations.

Fig. 2. Wiring inductance helps tune this front end's selector networks.

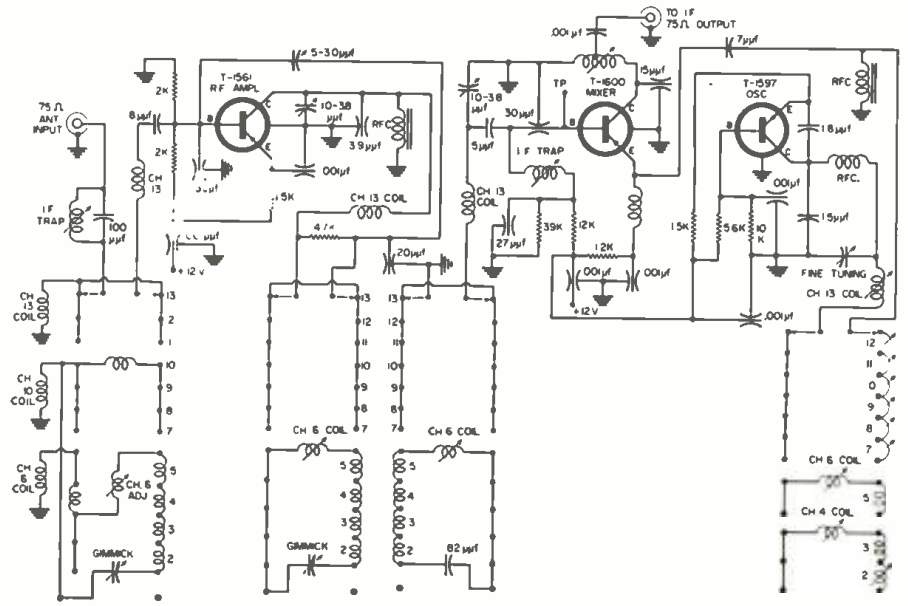

your best buy . . .

TRU-VAC®



REMARKABLE TUBE VALUES AT 1950 PRICES

ALL TUBES INDIVIDUALLY BOXED, CODE DATED AND BRANDED "TRU-VAC"

Typical TRU-VAC® Bargains!

THIS IS A PARTIAL LIST 6SN7GT ----- ALWAYS 30c
Thousands More Always In Stock 6W4GT ----- ALWAYS 30c

OY4	3AU6	6A6	6B8	6CH8	657	7B4	12AT6	12SA7	36
OZ4	3BC5	6AB4	6BA6	6CL6	658GT	7B5	12AT7	12SJ7	38
1A7GT	3BN6	6AC7	6BC5	6CM6	65A7	7B6	12AU6	12SK7	39/44
1B3GT	3BZ6	6AF4	6BC8	6CM7	65D7G1	7B7	12AU7	12SN7GT	41
1C6	3CB6	6AG5	6BD6	6CN7	65F5	7B8	12AV6	12SQ7	42
1C7	3Q4	6AH4GT	6BE6	6CO8	65F7	7C4	12AV7	12V6GT	43
1F4	354	6AH6	6BF5	6CR6	65G7	7C5	12AX4GT	12W6GT	45
1F5	3V4	6AK5	6BG6G	6CS6	65H7	7C6	12AX7	12X4	50A5
1G4	4BQ7A	6AL5	6BH6	6CU5	65J7	7C7	12AZ7	14A7/12B7	50B5
1HS7	4BS8	6AMB	6BJ6	6CU6	65K7	7E5	12B4	14B6	50C5
1L4	4BZ7	6AN8	6BK5	6D6	65L7	7E6	12BA6	14Q7	50L6
1L6	4CB6	6AQ5	6BK7	6DE6	65Q7	7E7	12BA7	19	56
1NSGT	5AM8	6AQ6	6BL7GT	6DG6GT	65R7	7F7	12BD6	19AU4GT	57
1R5	5AN8	6AQ7	6BN6	6DQ6	6T4	7F8	12BE6	19BG6G	58
1S5	5AT8	6AR5	6BQ6GT	6F5	6U8	7G7	12BF6	19J6	71A
1T4	5AV8	6AS5	6BQ7	6F6	6V6GT	7H7	12BH7	19T8	75
1U4	5AZ4	6AT6	6BR8	6H6	6W6GT	7N7	12CQ6	24A	76
1U5	5BR8	6AU4GT	6BS8	6J4	6X4	7O7	12HR7	25Z6GT	77
1V2	5J6	6AUSGT	6BYSG	6J5	6X5GT	757	12BY7	26	78
1X2	5R4	6AU6	6BZ6	6J6	6X8	7X6	12CA5	27	80
2AF4	5U4	6AUB	6BZ7	6J7	6Y6G	7X7	12CN5	35	84/6Z4
2BN4	5U8	6AV5GT	6C4	6K6GT	7A4/XXL	7Y4	12D4	35A5	117Z3
2CY5	5V4G	6AV6	6CB6	6K7	7A5	7Z4	12F5	35B5	
3A4	5V6GT	6AW8	6CD6G	6N7	7A6	12A8	12K7	35C5	
3A5	5X8	6AX4GT	6CF6	6O7	7A7	12AB5	12L6	35W4	
3AL5	5Y3	6AX5GT	6CG7	654	7A8	12AQ5	12Q7	35Z5	

1 YEAR GUARANTEED PICTURE TUBES

Brand New* Allied A-1 Tubes Brand New
Below Listed prices do not include dud. Add Additional \$5.00 Deposit on tube sizes to 20"; on 21" and 24" tubes - \$7.50. Deposit refunded immediately when dud is returned prepaid. Aluminized tubes - \$4.00 extra.

Picture tubes shipped only to continental USA and Canada — All tubes F.O.B. Harrison, N. J.

10BP4	7.99	16HP4	12.19	17CP4	16.99	19AP4	18.39	21ATP4	18.79	21FP4	18.39	21YP4	18.39
12LP4	10.49	16KP4	11.99	17GP4	17.89	20CP4	15.69	21AMP4	17.99	21KP4	18.39	21ZP4	17.49
14B/CP4	11.99	16LP4	12.19	17MP4	16.99	20DP4	15.89	21AU4	18.79	21MP4	22.39	24AP4	39.49
16AD4	16.09	16RP4	11.99	17IP4	16.99	20HP4	17.89	21AVP4	18.79	21YP4	18.39	24CP4	27.79
16DP4	12.19	17AVP4	15.49	17QP4	13.89	21AP4	21.49	21AWP4	17.49	21WP4	17.49	24DP4	29.79
16GP4	16.09	17BP4	13.49	17TP4	16.99	21ALP4	18.79	21EP4	17.39	21XP4	17.49		



\$33 PER HUNDRED

For any used or factory second tube!

ATTENTION!
Get More For Your Money
... Get Quality And Bigger Selection ... Get Truly Remarkable Tube Values When You Buy At TRU-VAC

FREE FUSE CLIP!
Sent With Any Order Of \$5 Or More

GUARANTEE
Only TRU-VAC guarantees to replace free any tube which becomes defective in use within one year of date of purchase.

USED TV CONSOLES GUARANTEED To Work When You Receive Them

10" & 12"	\$29
14" & 16"	\$37
17"	\$45
19"	\$59
20" & 21"	\$70

All sets shipped in two cartons to avoid breakage. Sets shipped express to continental U.S.A. and Canada only. F.O.B. Harrison, New Jersey.

FREE BONUS—RABBIT EARS
\$7.95 Value
FREE with each set purchased

ATTENTION QUANTITY USERS!
Big Discounts Are Yours . . . Call or Write For Our 1000 Tube "Private Label" Special! Attention Branding Dept. MGR.

MONEY CHEERFULLY REFUNDED WITHIN FIVE (5) DAYS, IF NOT COMPLETELY SATISFIED!

TRU-VAC® PAYS YOUR POSTAGE
On orders of \$5 or more in U.S.A. and Territories. Send approximate postage on Canadian and foreign orders. Any order less than \$5 requires 25c handling charge. Send 25% on C.O.D.'s. All orders subject to prior sale.

Complying with Federal regulations, the following statement appears in all Tru-Vac advertising: Tubes appearing in this ad may be FACTORY SECONDS or USED tubes and are clearly marked.

TRU-VAC®

Harrison Avenue Box 107 Harrison, New Jersey
HUMboldt 4-9770

Electric Company

Write Dept. L For FREE LIST Of Other Tube Types and Products Sold By TRU-VAC®

Visit Our Huge Testing Dept. In The Heart Of Harrison, N. J.'s Electronics Industry

COYNE'S New Complete
Pin-Point TROUBLE SHOOTING Series
 Takes Headaches Out Of All Servicing Problems!
 See All 4 Books On 7-Day FREE TRIAL!



Pin-Point
TRANSISTOR TROUBLES
IN 12 MINUTES!

Trouble-shoot every type of circuit in ALL transistorized equipment! 525 pages; hundreds of illustrations; 120 check charts! \$5.95

Pin-Point
RECORD CHANGER TROUBLES
IN 5 MINUTES!

Locate mechanical and electronics troubles fast. Covers all makes. 320 pages; 450 photos; 58 check charts! \$3.95

Pin-Point
TV TROUBLES
IN 10 MINUTES!

Find the exact sound or picture trouble in any TV set from 700 possibilities! 300 pages; 300 diagrams, check charts! \$3.95

Pin-Point
COLOR TV TROUBLES
IN 15 MINUTES!

Covers every type of color TV and picture tube! 550 pages; 362 check charts, diagrams, picture patterns! \$5.95

Simple Check Chart System Saves Time

These amazing practical handbooks with an ENTIRELY NEW METHOD, show you how to find the trouble in ANY tv, record changer or transistor circuit FAST! Index tells you where to look; famous Check-Charts help you pin-point the exact trouble in minutes! These on-the-job books quickly pay for themselves in profitable new business and valuable time saved!

SEND NO MONEY!

Just mail coupon for free trial. After 7 days, send only low price or return books and pay nothing! If you keep all 4 books, send only \$3.00 after 7 days, and \$3.00 a month until \$19.80 plus postage is paid.

VALUABLE FREE GIFT!
 Send for FREE TRIAL OFFER of all 4 Pin-Point books and get FREE book, "Bigger Profits in TV" whether you keep series or not!

FREE TRIAL OFFER...Mail Coupon Now!

Educational Book Publishing Div.
 COYNE ELECTRICAL SCHOOL, Dept. C9-RT
 1501 W. Congress Pkwy., Chicago 7, Ill.

- Rush 4-book PIN-POINT Series for 7-day FREE TRIAL per offer. For individual books, check below.
- RECORD CHANGER (\$3.95 plus postage)
- TRANSISTORS (\$5.95 plus postage)
- TV (\$3.95 plus postage)
- COLOR TV (\$5.95 plus postage)

Name..... Age.....

Address

City..... Zone... State.....

Check here if enclosing full price we pay Postage. 7-day money-back guarantee.

Booklet
catalog
Manufacturers' Literature

RADIO SHACK CATALOGUE

Radio Shack Corporation, Boston, Mass., has announced the publication of its annual electronic parts and equipment catalogue, "1960 Guide to Electronic Buying." It is available at the company's stores or by mail from 730 Commonwealth Ave., Boston, Mass. The price is 35¢ postpaid to individuals and is mailed free to industrial concerns requesting copies on company letterhead.

The 8½" x 11" format is printed entirely in rotogravure and contains paid display advertising, articles written by industry authorities, and a handbook for the engineer and hobbyist.

The catalogue lists some 40,000 items of electronic merchandise, with accompanying illustrations. It includes over 100 pages of high-fidelity, plus products of consumer interest primarily, and some 200 pages of industrial and service items.

CLIP AND INSULATORS

Mueller Electric Company, 1583H East 31st St., Cleveland 14, Ohio, has published its Catalogue No. 220 which describes electric clips and insulators. Copies may be obtained direct from the company.

The eight-page brochure covers the firm's entire line, from miniaturized clips to welding ground clamps.

Also included are such new developments as colored insulators and an alligator clip adapted for telephone or test prod tip.

MOBILE RADIO BROCHURE

Aeronautical Electronics, Inc., P.O. Box 6527, Raleigh, N. C., is offering a four-page folder entitled "Two-Way V.H.F.-FM Mobile Radio System." The folder may be obtained by writing the company direct.

The brochure describes the company's new "Aerotron" Model 6N15, a compact unit featuring new circuits and a 6-, 12-, and 117-volt power supply.

PRINTED CIRCUIT BOOKLET

RCA has released a new, illustrated booklet entitled, "Printed Circuit Servicing Techniques." Prepared jointly by the RCA Service Company and the television division, the 24-page manual is being distributed to independent service technicians, servicing organizations, and the firm's distributors and dealers.

The manual contains detailed instructions, circuits, and other information on servicing printed circuit boards in all types of television and radio receivers, as well as other electronic

equipment. It is divided into six sections and covers the development of the printed board, use of manufacturer's service data, the systematic approach to servicing printed boards, recommended tools, soldering techniques, and replacing components.

The booklet is designed to help the electronic technician develop the basic work habits required to service printed circuit boards in a fast and efficient manner.

TRANSISTOR MANUAL

General Electric Company, semiconductor products department, Charles Building, Liverpool, N. Y., has made available the Fourth Edition of its "Transistor Manual."

Priced at \$1.00, the Manual provides 227-pages of transistor data. Included in the contents are details on basic semiconductor theory, transistor construction techniques, small- and large-signal characteristics, biasing, audio amplifiers, high-fidelity circuits, radio receiver circuits, transistor radio servicing techniques, and transistor specifications, as well as many other chapters of general information.

Write direct to the company for additional details.

PICTURE TUBE WALL CHART

CBS Electronics has made available a comprehensive technical data and replacement guide for television picture tubes.

The handy 23" x 29" wall chart gives mechanical and electrical characteristics for more than 360 picture tubes and lists popular replacement types.

The chart, PF-288, is available to independent service technicians through distributors of the company's receiving and picture tubes.

1960 FLASHER CATALOGUE

Tung-Sol Electric Inc., 1 Summer Avenue, Newark 4, N. J., has announced the publication of its new 1959-60 AF-20 flasher catalogue. It is available from the manufacturer or from any of the company's sales offices.

The 16-page issue contains detailed information on all standard and automotive turn signal flashers, brake light indicators, special flashers, and emergency warning units. A section of the new publication is devoted to the firm's new line of heavy duty flashers.

Designed for engineering, sales, and service use, the catalogue includes extensive application notes, typical circuit diagrams, and complete electrical and mechanical specifications for all of the company's flashers now in use. A full set of line drawings provide ex-

NOT USED, NOT PULLED OUT OF OLD SETS

**RAD-TEL'S
FIRST
QUALITY**
Remember
ALL RAD-TEL
TUBES
GUARANTEED
**ONE
FULL
YEAR**

Brand New TUBES

**BETTER
THAN
70%
OFF!**

WHY GAMBLE ON USED & "PULL-OUT" TUBES?

**BUY *Only* RAD-TEL'S FIRST QUALITY
BRAND NEW TUBES . . . and SAVE!**

EACH TUBE INDIVIDUALLY AND ATTRACTIVELY BOXED!

Qty. Type	Price	Qty. Type	Price	Qty. Type	Price	Qty. Type	Price	Qty. Type	Price	Qty. Type	Price	Qty. Type	Price	Qty. Type	Price
___0Z4M	.79	___4BA6	.51	___6AN4	.95	___6CD6	1.42	___7A8	.68	___12AU7	.60	___12DL8	.85	___17L6	.58
___1AX2	.62	___4BC5	.56	___6AN8	.85	___6CF6	.64	___7B6	.69	___12AV5	.97	___12DM7	.67	___17W6	.70
___1B3GT	.79	___4BC8	.96	___6AQ5	.50	___6CG7	.60	___7Y4	.69	___12AV6	.41	___12DQ6	1.04	___19AU4	.83
___1DN5	.55	___4BE6	.54	___6AR5	.55	___6CG8	.77	___8AU8	.83	___12AV7	.75	___12DS7	.79	___19B66	1.39
___1G3	.73	___4BN6	.75	___6AS5	.60	___6CM7	.66	___8AW8	.93	___12AX4	.67	___12DZ6	.56	___19T8	.80
___1J3	.73	___4BQ7	.96	___6AT6	.43	___6CN7	.65	___8BQ5	.60	___12AX7	.63	___12EL6	.50	___21EX6	1.49
___1K3	.73	___4BS8	.98	___6AT8	.79	___6CR6	.51	___8CG7	.62	___12AZ7	.86	___12EG6	.54	___25AU4	.87
___1L6	1.05	___4BU8	.71	___6AU4	.82	___6CS6	.57	___8CM7	.68	___12B4	.63	___12EK6	.56	___25BQ6	1.11
___1LA6	.69	___4BZ6	.58	___6AU6	.50	___6CU5	.58	___8CN7	.97	___12BA6	.50	___12EZ6	.53	___25C5	.53
___1LC6	.79	___4BZ7	.96	___6AU7	.61	___6CU6	1.08	___8CX8	.93	___12BD6	.50	___12F5	.66	___25CA5	.59
___1LN5	.59	___4CB6	.59	___6AU8	.87	___6CY5	.70	___8EB8	.94	___12BE6	.53	___12F8	.66	___25CD6	1.44
___1R5	.62	___4CS6	.61	___6AV6	.40	___6CY7	.71	___10DA7	.71	___12BF6	.44	___12FM6	.45	___25CU6	1.11
___1S5	.51	___4DE6	.62	___6AW8	.89	___6DA4	.68	___11CY7	.75	___12BH7	.73	___12K5	.65	___25DN6	1.42
___1T4	.58	___4DG6	.60	___6AX4	.65	___6DB5	.69	___12A4	.60	___12BK5	.70	___12SA7M	.86	___25EH5	.55
___1U4	.57	___4DT6	.55	___6AX7	.64	___6DE6	.58	___12AB5	.55	___12BL6	.56	___12SK7GT	.74	___25L6	.57
___1U5	.50	___5AM8	.79	___6BA6	.49	___6DG6	.59	___12AC6	.49	___12BQ6	1.06	___12SN7	.67	___25W4	.68
___1X2B	.82	___5AN8	.86	___6BC5	.54	___6DQ6	1.10	___12AD6	.57	___12BY7	.74	___12SQ7M	.73	___25Z6	.66
___2AF4	.96	___5AQ5	.52	___6BC7	.94	___6DT5	.76	___12AE6	.43	___12BZ7	.75	___12U7	.62	___35C5	.51
___2BN4	.60	___5AT8	.80	___6BC8	.97	___6DT6	.53	___12AF3	.73	___12C5	.56	___12V6GT	.53	___35L6	.57
___2CY5	.71	___5BK7A	.82	___6BD6	.51	___6EU8	.79	___12AF6	.49	___12CA5	.59	___12W6	.69	___35W4	.52
___3AL5	.42	___5BQ7	.97	___6BE6	.55	___6EA8	.79	___12AJ6	.46	___12CN5	.56	___12X4	.38	___35Z5GT	.60
___3AU6	.51	___5BR8	.79	___6BF6	.44	___6EB8	.94	___12AL5	.45	___12CR6	.54	___17AX4	.67	___50B5	.60
___3AV6	.41	___5CG8	.76	___6BG6	1.66	___6H6GT	.58	___12AL8	.95	___12CU5	.58	___17BQ6	1.09	___50C5	.53
___3BA6	.51	___5CL8	.76	___6BH6	.65	___6J5GT	.51	___12AQ5	.52	___12CU6	1.06	___17C5	.58	___50DC4	.37
___3BC5	.54	___5EA8	.80	___6BH8	.87	___6J6	.67	___12AT6	.43	___12CX6	.54	___17CA5	.62	___50EH5	.55
___3BE6	.52	___5EU8	.80	___6BJ6	.62	___6K6	.58	___12AT7	.76	___12DB5	.69	___17D4	.69	___50L6	.61
___3BN4	.63	___5J6	.68	___6BK5	.80	___6S4	.48	___12AU6	.50	___12DE8	.75	___17DQ6	1.06	___117Z3	.61
___3BN6	.76	___5T8	.81	___6BK7	.85	___6SA7GT	.76								
___3BU8	.78	___5U4	.60	___6BL7	1.00	___6SK7GT	.74								
___3BY6	.55	___5U8	.81	___6BN4	.57	___6SL7	.80								
___3BZ6	.55	___5V6	.56	___6BN6	.74	___6SN7	.65								
___3CB6	.54	___5X8	.78	___6BQ5	.65	___6SQ7	.73								
___3CF6	.60	___5Y3	.46	___6BQ6GT	1.05	___6T4	.99								
___3CS6	.52	___6AB4	.46	___6BQ7	.95	___6T8	.80								
___3CY5	.71	___6AC7	.96	___6BR8	.78	___6U8	.78								
___3DE6	.62	___6AF3	.73	___6BS8	.90	___6V6GT	.54								
___3DK6	.60	___6AF4	.97	___6BU8	.70	___6W4	.57								
___3DT6	.50	___6AG5	.65	___6BY6	.54	___6W6	.69								
___3Q5	.80	___6AH6	.99	___6BZ6	.54	___6X4	.39								
___3S4	.61	___6AK5	.95	___6BZ7	.97	___6X5GT	.53								
___3V4	.58	___6AL5	.47	___6C4	.43	___6X8	.77								
___4AUG	.54	___6AM8	.78	___6CB6	.54	___7AU7	.61								

USE THIS AS YOUR ORDER BLANK

Rad-Tel Tube Co. 55 CHAMBERS ST.
NEWARK 5, N. J.

NAME

ADDRESS

RAD-TEL TUBE CO. Est. 1945 55 Chambers Street
Newark 5, N. J. Mitchell 2-3147

NOT AFFILIATED WITH ANY OTHER MAIL ORDER TUBE CO. . . SPEEDY ONE-DAY SERVICE
TERMS: 25% deposit must accompany all orders, balance C.O.D. No handling charge with this ad. Subject to prior sale.
All shipments F.O.B. Newark warehouse. No C.O.D.'s outside continental U.S.A.

**NOT
JUST
BETTER...**



For ALL Radio-TV Replacement Applications

Naturally you want to supply your customers with the best replacement electrolytic capacitors to insure a satisfactory repair job without costly call-backs. That's exactly what you do when you use only Aerovox AFH twist-prong electrolytics. Aerovox offers you all the latest refinements — 85°C operation, improved hermetic sealing, rugged prongs and terminals (including printed-wiring types), and only high purity aluminum foil construction throughout.

But quality alone is only part of the deal. Aerovox offers you the widest selection of exact-duplicate replacements in the entire industry. Your local Aerovox Distributor stocks every rating you need. Call on him today for all your capacitor requirements and at the same time ask for your free copy of the latest Aerovox catalog.

BUY THEM BY THE KIT...

see the AFH "Stack-a-Lytic" kits (AK-400 and AK-401) at your Aerovox Distributor. A selection of 8 or 16 popular replacement units in a FREE metal storage rack with stacking feature.



**AEROVOX
CORPORATION**
DISTRIBUTOR DIVISION
NEW BEDFORD • MASSACHUSETTS

ternal dimensions and mounting variations. Installation notes and servicing instructions are also included as a service aid.

ENTERTAINMENT TRANSISTORS

Sylvania Electric Products Inc. has issued a new booklet, "Entertainment Transistors for Every Design Approach." Copies may be obtained by writing direct to the firm at 1100 Main Street, Buffalo 9, N. Y.

The 32-page booklet contains maximum ratings and electrical characteristics for a wide variety of *p-n-p*, *n-p-n*, and "drift" transistors designed for use in high-fidelity, toys, organs, intercoms, portable, short-wave, and auto radios. Also included are diagrams illustrating the mechanical specifications and connections of all types in the company's transistor line.

NEW EDUCATIONAL AID

Electronic Instrument Co., Inc., 33-00 Northern Blvd., Long Island City 1, N. Y., has prepared a new educational aid now available to all students of electronics. These aids may be obtained through the company's distributors, and are free of charge to students. For the name and address of the distributor in your area, write the company direct.

One part of this educational aid consists of a resistor-capacitor color code, displayed in easy-to-read chart form. The various types of resistors and capacitors are illustrated, with all code markings clearly labeled. Tables giving the values for the color-code markings are included for resistors, ceramic capacitors, and molded mica capacitors.

Illustrated in a separate table are various pieces of hardware with which the student of electronics should be familiar. Different types of machine

screws, hex nuts, spacers, and washers are represented.

The balance of the aid consists of electronic schematic symbols. Each symbol is individually depicted and labeled.

NEW EIA STANDARDS

Electronic Industries Association has issued five new recommended standards. Copies of the standards may be obtained through the EIA Engineering Department, 11 West 42nd Street, New York 36, N. Y. A minimum charge of \$1.00 is made on all orders.

RS-211-A "Dimensional Characteristics of Monophonic and Stereophonic Disc Phonograph Records for Home Use—78, 45, 33½ rpm." A revision of RS-211. 60 cents each.

RS-222 "Structural Standards for Steel Transmitting Antennas, Supporting Steel Towers." \$1.10 each.

RS-223 "Magnetic Recording Instruments for the Home, Wire Size, Speed, Spools." A revision of REC-131-A. 25¢ each.

RS-224 "Magnetic Recording Tapes." A revision of REC-132 and REC-138. 30 cents each.

RS-225 "Rigid Coaxial Transmission Lines and Connectors—50 Ohms." A revision of TR-134. 80 cents each. —30—

ACOUSTIC RESEARCH OPEN HOUSE

ACOUSTIC RESEARCH, INC. (AR) will hold its annual "open house" this year on Friday, November 27. Tours of inspection of the AR plant, which is located at 24 Thorndike St., Cambridge, Mass., will be conducted at 10:00 a.m. and 2:30 p.m. Visitors will have the opportunity to watch production and quality control test procedures, including speaker checks, in AR's anechoic chambers.

Coffee will be served and all visitors are welcome. —30—

The topographical layout of Technical Appliance Corporation's new test range at Earlville just a few miles from the main plant at Sherburne, New York. The test building, dwarfed by the antennas undergoing test, houses latest automatic recording equipment. A transmitter installation some 3000 feet across the valley is used to transmit controlled signals to the receiver location. In addition to short range tests which are conducted on the upper deck, the range is equipped to handle as many as three tests simultaneously between this site and the transmitter building. TACO's expanding test facilities are a result of its diversification program—resulting in broadening in both military and commercial areas.



LORAN R-65/APN-9 RECEIVER & INDICATOR



Used in ships and aircraft. Determines position by radio signals from known transmitters. Accurate to within 1% of distance. Complete with tubes and crystal. Exc. used.

Value \$1200.00. Our Price **\$79.50**

SCR-AR-283 Transmitter-Receiver

Consists of: RECEIVER, 201 to 398 Kc and 2500 to 7850 Kc. TRANSMITTER, 2500 to 7700 Kc. for unmodulated, tone-modulated, or voice. Here's what you get, at this fantastically low price: Receiver complete with 6 tubes, transmitter complete with 4 tubes, dynamotor for 24 V DC operation, 5 coil sets, 2 control boxes, antenna switching relay, operating manual. ALL BRAND NEW—
\$16.95
and All Yours, for only

BC-929 3-INCH SCOPE



Low cost station monitor and/or bench scope. Has Horiz., focus, sweep, intensity controls. Tubes: 2-6SN7, 2-6H6, 1-6X5, 1-6GD, 1-2X2, 3BP1 CR Tube. Voltage req. 110V 400 cy. and 24VDC. Complete with tubes, exc. used **\$9.95**
BRAND NEW **\$12.95**
Conversion instructions for 110V 60 cyc AC **.45c**

WILLARD 6-VOLT MIDGET STORAGE BATTERY



3 Amp. Hour, BRAND NEW, 3 1/2" x 1-13/16" x 2 3/8". Uses Standard Electrolyte Only **\$2.95**

POWER SUPPLY for BC-620, 659, available for 6, 12 or 24 Volts DC. Specify **\$8.95**

SCR-625 MINE DETECTOR

Complete portable outfit in original packing, with all accessories. Brand New **\$22.50**

ASB-5 'SCOPE INDICATOR



BRAND NEW, including all tubes, together with 5 B P 1 Scope Tube. Originally used in Navy Aircraft RADAR equipment. Easily converted for AC operation.
VALUE \$250.00
OUR LOW PRICE **\$15.95**

SCR-522 2-METER RIG!

Terrific buy! VHF Transmitter-receiver, 100-156 Mc. 4 channels. Xtal-controlled. Amplitude modulated voice. They're going fast! Excellent condition. SCR-522 Transmitter-Receiver, complete with all 18 tubes, top rack and metal case. **\$32.32**
RECEIVER only, with all tubes **\$19.50**
TRANSMITTER Only, with all tubes **\$22.25**
Accessories for above available.

LORAN APN-4 FINE QUALITY NAVIGATIONAL EQUIPMENT



Determine exact geographic position of your boat or plane. Indicator and receiver complete with all tubes and crystal.
INDICATOR ID-68/APN-4, and RECEIVER R-98/APN-4, complete with tubes, exc. used **\$49.50**
Receiver-Indicator as above, BRAND NEW **\$69.50**
Inverter for above unit available from stock.

LORAN APN/4 OSCILLOSCOPE



Easily converted for use on radio-TV service bench.
Completely Assembled
LIKE NEW! Supplied with 5" Scope, type SCPI only **\$14.95**
Brand New **\$19.50**

BC-906 FREQ. METER—SPECIAL



Cavity type, 145 to 235 Mc. BRAND NEW, complete with antenna. Manual included. OUR LOW PRICE **\$9.88**

STANDARD TUBES

Removed from Brand New Gov't Equipment

RECEIVING	614	613	612	611	610
155	.35	.35	.35	.35	.35
204	.35	.35	.35	.35	.35
6AG5	.35	.35	.35	.35	.35
12AT7	.45	.45	.45	.45	.45
12X4	.35	.35	.35	.35	.35
6AK5	.35	.35	.35	.35	.35
6C4	.25	.25	.25	.25	.25
6X4	.32	3E29	.425	4X-150	.595
6AL5	.33	807	.95	3BP1	1.49

REMOTE CONTROL RM-52



Direct remote control for radio equipment. Uses 4 flashlight bats. Provides bias for Microphone and sidetone to headset. Hi or Lo Imp. Mike and Phone jacks. Makes good phone patch unit. BRAND NEW **\$2.49**

SCHEMATIC DIAGRAMS For any equipment on this page, each... **65c**

SEND FOR FREE CATALOG, many more Wonderful Surplus Buys!

AN/ART-13 100-WATT XMTR



11 CHANNELS
200-1500 Kc
2 to 18.1 Mc **\$48.50** Complete with Tubes

Famous Collins Autotune Aircraft Transmitter, AM, CW, MCW. Quick change to any of ten pre-set channels or manual tuning. Speech amplifier/clipper uses carbon or magnetic mike. Highly stable, highly accurate VFO. Built in Xtal controlled calibrator. PF811s modulate 813 in final up to 90% class "B." A Real "HOT" Ham buy at our low price! Orig. cost \$1800. **\$48.50**
Exc. Used **7.95**
O-16 Low Freq. Osc. Coil for ART-13 **7.95**
24V Dynamotor for ART-13 **11.95**

BC-733 VHF 10-TUBE AIRCRAFT RECEIVER.

6-channel xtal control. Freq. 108.3 to 110.3 Mc. Dual filter range. Easily converted for tracking Sputniks! **\$7.95**
Exc. used. Complete with tubes **\$8.95**
Brand New complete with tubes **\$8.95**
Dynamotor for above 12 or 24 V.—New **\$5.95**

AN/ARR-5A AIRCRAFT RECEIVER.

11 tube superhet. 3-crystal control UHF for static-free reception. Exc. used with tubes **\$9.95**

TG-34A CODE KEYS

Self-contained automatic unit, reproduces code practice signals recorded on paper tape. By use of built-in speaker, provides code-practice signals to one or more persons at speeds from 5 to 25 WPM. **\$16.88**

DYNAMIC 800M MIKE M-33/AIC.

Low impedance. With mounting bracket for attachment to headsets. A REAL VALUE at **\$3.95**

DYNAMIC HANDMIKE, with "Press-to-Talk" Switch

on handle. Good and solid. BRAND NEW, only **\$2.95**

DYNAMIC HANDMIKE, aircraft, made by Telephonics Corp.

Press-to-talk switch on mike. BRAND NEW **\$4.95**

HI-FI DYNAMIC HEADSET with Cushions

Freq. Range: 40-14000 CPS. No Distortion. BRAND NEW **\$7.85**

MICROPHONES Excellent BRAND

Model	Description	Used	NEW
T-17	Carbon Hand Mike	\$.34	\$5.45
T-30	Carbon Throat Mike	.45	74
T-45	Army and Navy Lip Mike	1.25	
T-24	Carbon Mike	5.98	
TS-9	Handset	3.88	
RS-38	Navy Type	2.89	4.75

HEADPHONES Excellent BRAND

Model	Description	Used	NEW
MS-23	High Impedance	\$2.19	\$4.65
MS-33	Low Impedance	2.89	4.65
MS-30	Low Imp. (leatherwt.)	1.15	1.89
M-16/U	High Imp. (2 units)	3.75	7.95

TELEPHONICS—800 ohm Low Impedance HEADSETS, BRAND NEW, PER PAIR **\$3.25**
CD-307A Cords, with PL55 plug and JK26 Jack **.99**
Earphone Cushions for above—pair **.50**

MOBILE-MARINE DYNAMOTOR

Input 12V DC. Output: 625 V DC @ 225 Ma. for press-to-talk intermittent operation. Sghp. wt. 14 lbs. **\$6.45**

OTHER DYNAMOTOR VALUES: Excellent BRAND

Type	Input	Output	Used	NEW
DA-19-A	28V 11A	400V 400A	4.95	\$4.95
DM-28	28V	224V .07A	2.75	4.75
DM-32A	28V 1.1A	250V .05A	2.45	4.45
DM-33A	28V 5A	575V .16A	1.95	3.75
DM-34D	12V 2A	220V .080A	4.15	5.50
DM-53A	28V 1.1A	220V .080A	3.75	5.45
DM-64A	12V 5.1A	275V .150A	7.95	
PE-73C	28V 20A	1000V .350A	7.95	10.50
PE-85	28V 1.25A	250V .050A	2.75	4.95

Please include 25% deposit with order—Balance C.O.D. or Remittance in Full. 50c Handling Charges on all orders under \$5.00. All shipments O.O. Our Warehouse, N.Y.C. All Merchandise subject to Prior Sale and Price Change.

FM TRANSMITTER-RECEIVER

APN-1. 420 to 460 Mc Aircraft Radio altimeter equipment. Tubes: 4—955, 3—12SJ7, 4—12SH7, 2—12H6, 1—VR150. Complete with all tubes and mount. For 27 V DC. BRAND NEW **\$8.95**
Original operating manual for above **\$1.00**

NAVY AIRCRAFT RADIO RECEIVER

ARB/CRV 46151—190 to 9050 Kc in 4 bands. 6 Tube Superhet communications receiver, with local and remote tuning, band change, Sharp and broad tuning, AVC, CW, Illuminated dial. Complete with tubes and dynamotor, used **\$17.95**
Like New **\$26.50**
POWER SUPPLY for above, 110 V AC, complete, ready to plug in, wired **\$9.75**

ARC-5/R28 RECEIVER

2-meter Superhet, 100 to 156 Mc in 4 crystal channels. Complete with 10 tubes, BRAND NEW **\$24.45**
110V AC Power Sup. Kit for above **\$9.75**

ARC-5/T-23 TRANSMITTER

100-150 Mc Includes 2—82A, 2—1625 Tubes, BRAND NEW **\$21.50**
SPECIAL Limited quantity ARC-5/T23 emitters. OFFER! Excellent Used, less tubes **\$5.95**
MD-7 MODULATOR for T-23, complete with 4 tubes, LIKE NEW **\$9.95**

ARC-5 MARINE RECEIVER-TRANSMITTER

Navy Type Comm. Receiver 1.5 to 3 Mc BRAND NEW with 6 tubes **\$16.95**
Navy Type Comm. Transmitter 2.1-3 Mc BRAND NEW with 4 tubes and Xtal MODULATOR for above, new with tubes **\$5.95**

234-258 MC RECEIVER

AN/ARR-2
BRAND NEW 11-tube UHF Tunable Receiver with automatic. Only a few at this low price! Complete with tubes **\$8.88**

SCR-274 COMMAND EQUIPMENT

ALL COMPLETE WITH TUBES

Type	Description	Used	Like NEW
BC-453	Receiver 190-550 KC	\$14.50	\$16.50
BC-454	Receiver 3-6 Mc	9.45	12.45
BC-455	Receiver 6-9 Mc	10.45	12.45
BC-450	3-Receiver Control Box	1.29	1.75

110 Volt AC Power Supply Kit, for all 274-N and ARC-5 Receivers. Complete with metal case, instructions **\$7.95**
Factory wired, tested, ready to operate **\$11.50**
SPINED TUNING KNOB for 274-N and ARC-5 RECEIVERS, Fits BC-453, BC-454 and others. Only **49c**

BC-457 TRANSMITTER—4-5.3 Mc. complete with all tubes and crystal. BRAND NEW **\$7.85**
BC-458 TRANSMITTER—5.3 to 7 Mc. Complete with all tubes and crystal. BRAND NEW **\$9.75**
BRAND NEW **\$13.95**
BC-459 TRANSMITTER—7-9.1 Mc. complete with all tubes and crystal. BRAND NEW **\$13.95**

ARC-5/T-19 TRANSMITTER—3 to 4 Mc. BRAND NEW complete with all tubes & crystal. BRAND NEW **\$8.85**
BC-451 Transmitter Control Box. 1.25 NEW 5.65
ALL ACCESSORIES EQUIPMENT FOR COMMAND

BC-603 FM RECEIVER

20 to 27.9 Mc. **\$14.95**
Like New **\$16.95**
BRAND NEW **\$16.95**
10-Channel, pushbutton tuning or continuous tuning. Complete with speaker, tubes, squelch. 12 or 24V Dynamotor for Above
Exc. Used \$4.25 Brand New **\$5.50**
BC-683 same as above except 27 to 38.9 Mc. LIKE NEW **\$23.50**
Brand New **\$27.50**

AC POWER SUPPLY FOR BC603, 683
Interchangeable, replaces dynamotor. Has On-Off Switch. NO RECVR. CHANGE NEEDED. Provides 220 VDC @ 80 Ma. 24VAC @ 2 Amps. Complete kit, with easy instructions **\$8.45**
Wired **\$10.49**
Complete 240-page Technical Manual for BC-603, 604 **\$2.95**

BC-604 TRANSMITTER—Companion unit for BC-603 Rcvr above. Complete with tubes only Like NEW **\$7.95**
BRAND NEW **\$12.95**

BC-684 TRANSMITTER—Companion unit for BC-683 Rcvr above. Complete with tubes only Like NEW **\$7.95**
BRAND NEW **\$12.95**

2 VOLT BATTERY "PACKAGE"

1—2V, 20 Amp. Hr. Willard Storage Battery **\$2.79**
1—2V, 7 prong Synchronous Plug-In Vibrator **1.49**
1—Quart Bottle Electrolyte (for 2 cells) **1.45**
ALL BRAND NEW! combination Price **\$5.45**

NEW IMPORTANT SAMS BOOKS



"Printed Circuit Diagnosis Made Easy"



Helps you become an expert in servicing printed circuit boards. Practical, simplified approach saves time troubleshooting all types of printed circuits. Explains correct way to interpret and use various styles of data shown in service literature. Describes best procedures to follow when only a schematic diagram is available.

Sample problems illustrate each phase of printed circuit troubleshooting. A "must" book for your service library. Illustrated; 96 pages; 5 1/2 x 8 1/2". Only..... **\$100**

"Radio Receiver Servicing"

ALL-NEW EDITION



Latest enlarged edition of John T. Frye's famous best-seller. Includes new chapter on how to service transistor radios and printed circuits. The most understandable and valuable guide to radio servicing; based on the author's 25 years of practical experience. Includes a separate chapter on each type of trouble, such as the dead set; tubes light but no sound; noisy sets; weak sets; sets unable to separate stations, etc.

208 pages; 5 1/2 x 8 1/2". Only..... **\$295**

"Howard W. Sams Handbook of Electronic Tables and Formulas"

FOR ELECTRONIC TECHNICIANS



Specially prepared for electronic technicians, junior engineers and students. A valuable compilation of tables, charts, formulas and laws useful to all who work in electronics. Five comprehensive sections include: Formulas and Laws of Electronics; Constants, Standards, Symbols, Codes; Service and Installation Data; Mathematical Tables and Formulas; Miscellaneous. Features full-color frequency spectrum chart based on latest 1959 FCC allocations.

134 pages; 5 1/2 x 8 1/2"; hard-cover. Only **\$295**

"Television Tube Location Guide" Vol. 9



Latest volume in this invaluable series. Gives tube location data for TV sets produced in 1958-1959. Shows position and function of tubes in over 250 receiver models—just find the trouble and replace defective tubes without removing chassis! Shows major component placement; signal path; pin orientation on socket;

series string filaments; fuse location. Includes tube failure check charts. 96 pages; 5 1/2 x 8 1/2"; comb binding. Only..... **\$125**

HOWARD W. SAMS & CO., INC.

Order from your Sams Distributor today, or mail to Howard W. Sams & Co., Inc., Dept. M-19 2201 E. 46th St., Indianapolis 6, Ind.

Send me the following books:

- "Printed Circuit Diagnosis Made Easy" (PC-1)
 "Radio Receiver Servicing" (RS-2)
 "Handbook of Electronic Tables" (HTF-1)
 "Television Tube Location Guide" Vol. 9 (TGL-9)

\$..... enclosed. Send Free Book List

Name.....

Address.....

City..... Zone..... State.....

(outside U.S.A. priced slightly higher)

Service Industry



News

THE BOARD of Directors of the Electronics Industries Association recently appropriated funds to enable its Service Committee to conduct a long-range program for aiding service technicians in non-technical business management and customer relations. The Service Committee, under Chairman Steven R. Mihalic of the *General Electric Co.*, had proposed the development of business-training and customer-relations aids after consultations with numerous association leaders.

The EIA move appears to be in step with the thinking of service dealers in all sections of the country. Service associations in particular have recognized that the lack of basic business training and management "know-how" is the major reason that many shops continue to operate on sub-marginal incomes.

Moving along similar lines, the Television Service Association of Michigan is embarked on a long-range business-training program for its members in the Greater Detroit and adjacent areas. The association has invited all set manufacturers as well as set and parts distributors in its area to cooperate in the development of the organization's program. In discussing the program for the 1959-60 season, a spokesman for the association said:

"It is our aim to present basic management facts and business operating procedures that are of immediate practical value to dealers who operate even in the smallest-size businesses. While general management information is interesting, in most cases dealers are unable to make practical use of it in an activity as individualistic as that of an electronic service business.

"Take any group of one-man shops, for instance. While every one of them will be set up to handle TV service, their supplementary activities will be as varied as the electronic industry itself. The service activities of some of them may spill over into the appliance field.

"Another important factor is the steady trend among small shops to handle the sale of high-quality TV sets. One of the leading set manufacturers has focused his attention on distribution through small, self-servicing dealers. While these small shops cannot hope to match advertising dollars with the mass merchandisers and discount houses, they possess individual and effective promotional advantages that will produce sales in competition with the large-scale advertisers. How to make the most effective use of the promotional advantages of a small TV sales-servicing type business will be

thoroughly covered in our program.

"The TSA business-management series will cover such things as methods for determining the costs of providing service, how to build a workable system of customer relations into a small business, how to use the few advertising dollars available to a small shop to best advantage, how to make the shop and business location an effective and inexpensive advertising tool, and a host of other subjects vital to the profitable operation of an independent electronic service business."

NATESA Chides Manufacturers

In a recent letter, Frank J. Moch, executive director of NATESA, took issue with set manufacturers over the opinions expressed by some manufacturing executives about two of the resolutions adopted at the last NATESA convention. One of these resolutions condemned those set manufacturers who provide direct factory or factory-controlled service on their products. The NATESA resolution urged "All service people to exercise selective buying and channel their buying power to those companies that are non-competitive."

The second resolution belittled by manufacturing executives was a request to set producers to adopt a system of permanent TV receiver identification as an aid in combatting the epidemic of store burglaries that has been plaguing dealers everywhere.

In his reply, Mr. Moch said: "We believe the reaction of the companies (to the NATESA resolutions) is based upon archaic and disorganized thinking. Too many of these companies still look upon the service industry as it was in the radio service days.

"It is true that independent service people have not always taken adequate steps to protect their interests. This has been due to several reasons. Among them is the obvious one that associations, especially at the national level, due to federal law, cannot preach boycott and thus must use the less dramatic medium of trying to urge support of cooperating companies. This is often complicated by companies, though not engaged in retail service, going off with sales campaigns and other activities that are not acceptable to independent service.

"Unfortunately, too, though captive and factory service will eventually destroy not only independent service but independent parts distributors and independent parts manufacturers, reps and others, few of these other factors have chipped in.

"In spite of these factors, however,

we doubt the statement that selective buying has not affected sales on a regional basis. Recorded facts prove otherwise."

With respect to the criticism of the set identification resolution, Mr. Moch said: "On the subject of proper identification, a lot of set producers again demonstrate their utter disregard for the welfare of their dealers and set purchasers. Almost every device of reasonably high cost carries a permanent serial number. In our industry this is omitted or a very slipshod paper label is pasted on simply to avoid the cost of an indenting operation. In other words, to enable the manufacturer to save a few pennies, he puts the dealer and set buyer in a position where they cannot recover stolen property."

New Florida Associations

The Television Service Dealers Association of St. Petersburg, Fla., was recently formed in the Peninsula State. Its purpose is to help to upgrade serious and sincere service dealers to improve their business and professional standing through mutual cooperation. Mr. Bud Fox was elected president of the newly formed association.

Across the state, service dealers in St. Lucie County were recently granted a charter for their association, to be known as St. Lucie-TESA. Officers elected to head the organization include: James W. Sowinski of the *Fort Pierce TV Center*, president; Leonard A. Appel of *Bonded TV*, secretary; John Forget of *Forget's TV*, vice-president; and William Montallos of *Community TV*, treasurer. Elected to serve with the officers on the Board of Directors were: Fred Gardner of *Gardner's TV*; James B. Rock of *Telerex TV & Radio*, and Cy Broder of *Broder TV Clinic*.

TESA-Buffalo PR Campaign

The Television and Electronic Service Association of Greater Buffalo is conducting an institutional campaign designed to impress TV set owners with the value of doing business with reputable service firms. The association is using cooperative advertising in newspapers and other media to put over its message. TV set owners are urged to clip the newspaper ads for future reference when service is needed.

The campaign stresses the "Triple Guarantee" in the service they offer. This is detailed as follows: (1) guarantee by the company that services the set; (2) guarantee by the Television and Electronic Service Association of Greater Buffalo which stands behind the work of each of its members; and (3) guarantee of parts by the manufacturer.

Members of the association participating in the campaign include *Jerry's TV*; *National TV*; *University TV*; *Tele-Sound TV*; *South Buffalo TV*; *Ideal TV*; *Depew TV*; *Winton TV*; *A & B Electric TV* and *Parkdale TV*. The address of the association is TESA-Buffalo, Station E, Box 28, Buffalo 11, New York.

-50-

Service Technicians! YOU EARN MORE... YOU RATE with the public when you own the PHOTOFACT® service data library!

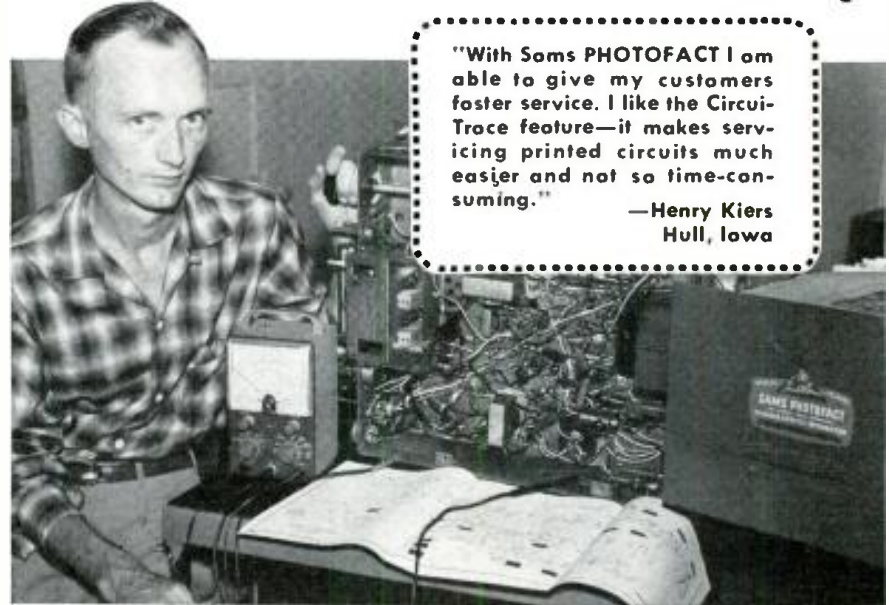

"With Sams PHOTOFACT I am able to give my customers faster service. I like the Circuit-Trace feature—it makes servicing printed circuits much easier and not so time-consuming."

—Henry Kiers
Hull, Iowa

YES, if you are one of the thousands of owners of a complete PHOTOFACT Service Data Library, you are enjoying maximum earnings. It's inevitable, because no matter how expert you are, you can always *save more time on any job, get more jobs done daily—EARN MORE, DAY IN AND DAY OUT...*

Moreover—as the owner of a complete PHOTOFACT Library, you know your customers' sets *best*. You can actually show each customer you have the PHOTOFACT Folder covering his very own set. Result: You command public respect and acceptance which paves the way to more business and earnings for you...

HOW TO STAY AHEAD...

Today, the truly successful Service Technicians are those who own the complete PHOTOFACT Library, who can meet and solve any repair problem—faster and more profitably. And these men *keep ahead* because they're on a Standing Order Subscription with their Distributors to receive all new PHOTOFACTS as they are released monthly.

For PHOTOFACT Library Easy-Buy Plan details and Standing Order Subscription, see your Sams Distributor today, or write to Howard W. Sams...

"PEET"
PROGRAM

BIG NEW PLUS!

get the details

If you now own a PHOTOFACT Library, you can apply for membership in the powerful new "PEET" program, designed to build prestige and business for the Service Technician who qualifies. Ask your Sams Distributor about "PEET" or mail coupon today!

HOWARD W. SAMS & CO., INC.
2203 E. 46th St., Indianapolis 6, Ind.

Send me full details on the new "PEET" Program. Include full information on the Easy-Buy Plan and Free File Cabinet deal.

I'm a Service Technician: full-time; part-time

My Distributor is: _____

Shop Name _____

Attn: _____

Address _____

City _____ Zone _____ State _____

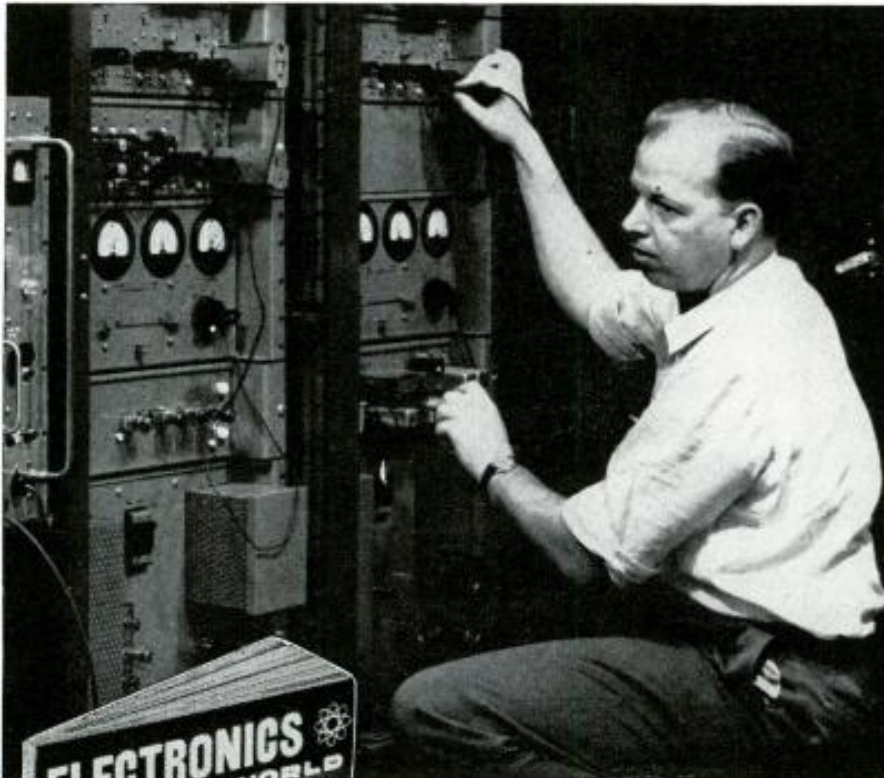

Photo courtesy National Co., Inc.



IF THIS MAN IS ON YOUR CHRISTMAS LIST —

A subscription to **ELECTRONICS WORLD** will make a perfect gift for him, and every other man with a stake in electronics.

If he makes his living in electronics or is an advanced hobbyist who loves Hi-Fi, Radio, TV, Audio, R/C, ham radio and communications, he'll be delighted to get **ELECTRONICS WORLD** as a gift. For **ELECTRONICS WORLD** offers the best

technical coverage in the field. It provides men in electronics with tips and techniques on repairing, installing and maintaining radio and TV sets and circuits, latest Hi-Fi developments, newest ham techniques, fresh audio ideas, test equipment, and current industry news. There is no more thoughtful Christmas gift, or flattering one, than a subscription to **ELECTRONICS WORLD**, the first and most authoritative magazine in the field. Each of your gift subscriptions will be announced by an attractive card, inscribed with your name. What's more, you can enter or extend your own subscription to **ELECTRONICS WORLD** at the special Christmas gift subscription rates, too!

Check the special Christmas gift order form, bound in this issue, for low gift rates. Then fill in the names and addresses of your friends, and mail it today!

WRAP UP YOUR CHRISTMAS GIVING NOW! DO IT EASILY, AND APPROPRIATELY, WITH **ELECTRONICS WORLD**



ELECTRONICS WORLD • 434 S. WABASH AVE. • CHICAGO 5, ILL.

The "Strobolyzer" (Continued from page 59)

quire frequency calibration, but merely a repetitive light source, a simple oscillator was incorporated in the Strobolyzer. A gas-tube relaxation oscillator was chosen because it requires a minimum of parts. For a given tube the frequency can be controlled by a series resistor, the capacitor, or the charging potential.

The NE-2 miniature neon lamp was chosen as the gas tube because of its small size. When using this tube the most convenient method of frequency variation is *via* the charging potential. A series resistor might seem practical, but the required resistances are large and such potentiometers are not readily available. If the series resistance is too small, the lamp will not extinguish due to its low current-carrying capacity and the small region in which it exhibits the required negative resistance characteristic. The short-time stability of this circuit was found adequate. Another gas tube, such as an OB2 voltage regulator would be even better from the standpoint of frequency stability.

If a calibrated frequency is desired, the multivibrator circuit of Fig. 3 could be incorporated. A good square wave is developed on both plates and the output may be coupled to the thyatron grid through a small capacitor. The circuit is similar to many covered in the literature, but is slightly modified to provide a frequency variation ratio of about 7 to 1. This is nearly twice that of most circuits. The frequency of oscillation is linear with the change in potential, E , to within 1% and the stability is excellent. Recalibration is eventually necessary and R_2 and R_3 are provided for this purpose. They should be set at about half value for the initial scale calibration of R_1 .

Construction

Construction of the Strobolyzer is apparent from the photographs hence only a few points will be noted. The Strobolyzer is housed in a 6" x 9" x 5"

Fig. 3. Wide-range multivibrator circuit.

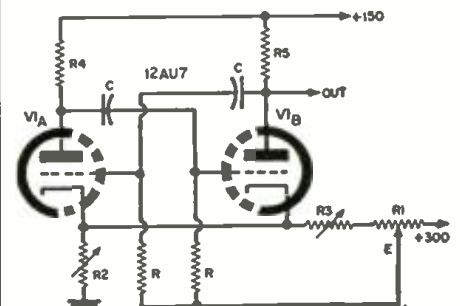

R_1 —100,000 ohm pot
 R_2 —25,000 ohm wirewound pot
 R_3 —10,000 ohm pot
 R_4, R_5 —47,000 ohm, 1 w. res.
 V_1 —12AU7 tube

Note: For range 8 to 60 cps: $C = .006 \mu\text{f.}$;
 $R = 3.3 \text{ meg.}$ For range 30 to 210 cps:
 $C = .006 \mu\text{f.}$; $R = 1 \text{ meg.}$

utility cabinet; a 5" x 7" x 2" chassis is bolted to the front panel and mounts most of the components. Panel labels are decals of the type available from most radio parts jobbers. Simple point-to-point wiring was used, two additional terminal strips being required to handle all of the components. All of the wiring to the lamp is Belden test-prod wire which was chosen because of its flexibility and its freedom from tangling. The wire carrying the trigger potential is rated at 10,000 volts (Belden 8898). All of the components are generously de-rated to permit continuous operation in the confined cabinet space.

No connectors were required except for the trigger potential. This goes through a Millen 37001 high-voltage connector. The other wires are brought out through a rubber grommet in the side of the case. Fusing is provided by means of a fused plug.

The mount for the lamp case is formed from a holder for brooms and tools available at hardware stores. Two strips of metal were formed and bolted to the back panel to provide storage for the cables. The whole unit thus becomes quite easy to transport or store.

The lamp itself, along with its energy-storing capacitor, is housed in an old flashlight case which is wrapped with high-dielectric plastic electrical tape for an extra measure of insulation. The lamp plugs into a standard six-pin tube socket with the even-numbered pins removed to prevent arcing. By placing the energy-storing capacitor in the lamp housing, the leads between the capacitor and lamp are made very short, keeping discharge resistance at a minimum. A cylinder of sponge rubber, removed from an old vibrator, was placed around the lamp and its socket to provide resistance to mechanical shock.

Most of the circuitry has been discussed, but a few additional notes are required.

First, the "internal-external" switch (S₁) is for the selection of the trigger source. When on "ext." the dual-triode serves as a squaring amplifier, as described, and R₁ is its gain control. When on "int." the neon relaxation oscillator is energized, with R₂ serving as a variable potential source. The first half of the dual-triode is not used in this instance.

The pilot light is arranged to indicate the presence of "B+" voltage since a rather light bleeder is utilized. An additional safety feature is provided by switch S₂ which shorts the primary of the ignition coil when the trigger potential is not required. The switch is enclosed by a safety cover.

Once you have built and used a Strobolyzer or other form of stroboscope, more and more applications become apparent. Some things give unexpected results when viewed in the stroboscopic light. Turn your strobe towards the stream of water from a faucet—you'll be surprised at what you will see!

Now Completely SELF-CONTAINED

For Testing & Rejuvenating
BLACK AND WHITE and **COLOR** including **110° TUBES**

NEW CRT 440

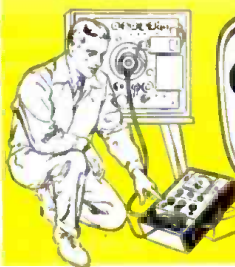

CATHODE REJUVENATOR TESTER

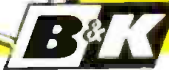

TESTS AND REJUVENATES

all black & white and color picture tubes at correct filament voltage from 1 to 12 V.

TESTS AND REJUVENATES

110° tubes with 2.34, 2.68, 6.3 and 8.4 volt filaments.

TESTS AND REJUVENATES

color picture tubes. Checks each color gun separately same as black & white tubes.

Used by Thousands of Professional Servicemen
MAKES NEW PICTURE TUBE SALES EASIER

Gives you more value than ever—all-in-one. Quickly checks and corrects most TV picture tube troubles in a few minutes right in the home without removing tube from set. Gives new useful life to weak or inoperative tubes. Checks leakage. Restores emission and brightness. Repairs inter-element shorts and open circuits. Life test checks gas content and predicts remaining useful life of picture tube. Completely self-contained in leatherette-covered carrying case. Net, \$69.95

ACCESSORIES for USE ONLY with FORMER B&K Models 400 and 350 CRT

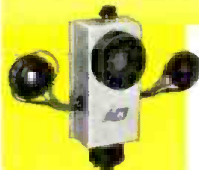

Model C40 Adapter. For use only with all previous B&K Model 400 and 350 CRT's. Tests and rejuvenates TV color picture tubes and 6.3 volt 110° picture tubes. Net, \$9.95



Model CR48 Adapter. For use only with all previous B&K Model 400 and 350 CRT's. Tests and rejuvenates 110° picture tubes with 2.34, 2.68, and 8.4 volt filaments. Net, \$4.95

See your B&K Distributor
 or Send now for Bulletin ST24-N



B & K MANUFACTURING CO.

1801 W. BELLE PLAINE AVE • CHICAGO 13, ILL.
 Canada: Atlas Radio Corp., 50 Wingold, Toronto 10, Ont.
 Export: Empire Exporters, 277 Broadway, New York 7, U.S.A.

INSIST ON PROVED BRAND NAMES

insist on the GENUINE

"NO NOISE"
 big **3**

Beware Of Cheap Substitutes!

NO-NOISE VOLUME CONTROL and CONTACT RESTORER

• Cleans • Protects • Lubricates
 NOT A CARBON TET SOLUTION
 2 Oz. Bottle \$1.00 6 Oz. Spray Can \$2.25

NET to Servicemen



NO-NOISE TUNER-TONIC
 With PERMA-FILM

• Economical—a little does a lot.
 • Cleans, lubricates, restores all tuners, including water type.
 • Non-toxic, non-inflammatory.
 • Use for TV, radio and FM
 6 Oz. Aerosol Can \$3.25
 NET to Servicemen



NOW AVAILABLE

FREE

AT YOUR JOBBERS

5" **PLASTIC EXTENDER**

With Push Button Assembly For PIN-POINT APPLICATIONS! Does Not Cause Shorts

NO-NOISE RUBBER COAT SPRAY
 • Insulates • Waterproofs • Protects
 6 Oz. Spray Can \$3.25
 NET to Servicemen

ELECTRONIC-CHEMICAL CORP. 813 Communipaw Avenue Jersey City 4, N. J.

prepare for your career in

ELECTRICAL ENGINEERING ELECTRONICS COMPUTERS RADIO-TV

At MSOE, you can equip yourself for a career in many exciting, growing fields: **MISSILES**
RADAR • AUTOMATION
RESEARCH • DEVELOPMENT
ELECTRICAL POWER
AVIONICS • ROCKETRY

When you graduate from the Milwaukee School of Engineering, you are prepared for a dynamic career as an Electrical Engineer or Engineering Technician. Under a faculty of specialists, you gain a sound technical education in modern, completely equipped laboratories and classrooms. As a result, MSOE graduates are in great demand and highly accepted by industries nationally.

At MSOE you will meet men from all walks of life and all parts of the country — some fresh out of high school or prep school, others in their twenties—veterans and non-veterans.

You can start school in any one of four quarters and begin specializing immediately. Engineering technicians graduate in 2 years with an Associate in Applied Science degree. For a Bachelor of Science degree in Engineering, you attend 4 years. A 3-month preparatory course also is available.



FREE CAREER BOOKLET!
If you're interested in any phase of electronics, radio or television, be sure to look into the programs of study offered by the Milwaukee School of Engineering. Just mail the coupon.

MILWAUKEE SCHOOL OF ENGINEERING

Dept. EW-1259, 1025 N. Milwaukee St.
Milwaukee, Wisconsin

Please send FREE Career Booklet. I'm interested in Electrical Engineering;
 Electronics Computers
 Electrical Power Radio-TV
 Mechanical Engineering

PLEASE PRINT

Name.....Age.....

Address.....

City.....Zone.....State.....

I'm eligible for veterans education benefits.

MS-123



"BASIC AUDIO" by Norman H. Crowhurst. Published by John F. Rider, Publisher, Inc., New York. Three Volumes, \$2.90 each. Soft cover.

This series is another of the publisher's "picture-book courses" designed specifically with the "do-it-yourself" student in mind.

Volume 1 covers the nature of sound, acoustics, microphones, loudspeakers, baffles and horns, other types of speakers, impedance matching, dividing networks and crossovers, and resonance. Volume 2 treats audio amplification, transistorized circuits, interstage coupling, noise and distortion, frequency response, power amplification, push-pull, phase-splitting circuits, and audio transformers while the final volume in the series covers feedback fundamentals, feedback applications, power supplies, shielding, audio transmission lines, audio oscillators, recording, electro-acoustics, and stereophonic sound.

Most readers of this magazine are thoroughly familiar with the author's style and his faculty for presenting audio material interestingly and clearly. The text material is accompanied by illustrative material on each page wherein the subject under discussion is further amplified by the visual presentation.

Those with a knowledge of basic electricity should be able to derive considerable satisfaction from a progressive perusal of this "course."

"VACUUM-TUBE AND SEMICONDUCTOR ELECTRONICS" by Jacob Millman. Published by McGraw-Hill Book Company, Inc., New York. 632 pages. Price \$10.00.

Dr. Millman, professor of electrical engineering at Columbia University has prepared this book as a text for the first year of an undergraduate electrical engineering course at the university. The author feels that the study of semiconductors should be integrated with that of vacuum tubes rather than treated as a separate field and this balanced consideration of the two components is adhered to throughout the text.

The text is divided into 19 chapters and 9 appendices. Subject matter includes the motion of charged particles in electric and magnetic fields, the applications of the motion of particles in applied fields, metals and semiconductors, vacuum-diode and semiconductor-diode characteristics, photo-electric devices, vacuum-triode characteristics, triode linear equivalent circuits, transistor characteristics and linear equivalent circuits, multi-electrode vacuum

tubes and high-frequency transistors, electrical discharges in gases, commercial gas tubes, rectifiers, untuned voltage amplifiers, audio power amplifiers, feedback amplifiers, sinusoidal oscillators, and power supplies.

Because the "audience" for which this text was prepared is the student in a professional engineering course, the author has made no concessions with regard to mathematics and prerequisite basic material. Those who will derive the most benefit from this book are those with a solid engineering background or a thorough understanding of basic electronics plus a healthy working knowledge of mathematical procedures.

"VIDEO SPEED SERVICING" by Samuel L. Marshall. Published by Howard W. Sams & Co., Inc., Indianapolis, Ind. 160 pages. Price \$2.95. Soft cover. Vol. 3.

This is a third volume in this time-saving series for service technicians. The method involves a listing of the symptom, the section affected, the cause of the trouble, and the repair procedure. A schematic of the circuit or part of the circuit involved is included. Each of these "capsule cures" carry information on the manufacturer and the chassis number.

Sixteen manufacturers and literally hundreds of models are covered in this volume. The index lists each set by manufacturer and number with the sets of one manufacturer all grouped together in case model numbers are not readily available.

One of the notable achievements is the clear and concise way that the repair procedures have been covered. In most instances the instructions consist of the terse statement "Replace C..." etc. For the practicing technician the saving of time represented by the elimination of excess verbiage and unnecessary "padding" is inestimable.

This book is by a "pro" for "pros" and should be welcomed by the service fraternity with open arms.

"SCIENTIFIC RUSSIAN" by George E. Condyannis. Published by John Wiley & Sons, Inc., New York. 225 pages. Price \$3.50.

At the outset let it be stated that this reviewer doesn't read or speak the Russian language hence is somewhat handicapped in evaluating the worth of this volume. It was designed, however, to meet the needs of those whose work involves scientific and technical Russian—a need not generally met by standard language primers.

The book is based on a course that the author offered at MIT. It is his contention that given this book plus a Russian dictionary the student can find his way through a scientific treatise with sufficient understanding to cope with all but the most esoteric points.

The text material is divided into 12 "lessons" and covers pronunciation and spelling, general remarks on structure, noun-adjective system, verb system, verbs, pronouns and word order, word building, details on nouns, details regarding adjectives, details on verbs and more details on verbs, and numbers.

Without actually trying out the system suggested, it seems to be a simple and easy method of "doing it yourself" which would be helped, of course, by an opportunity to practice pronunciation with another Russian-speaker. Since this book is primarily for the U. S. scientist reading Russian texts, this shouldn't be a handicap.

"PRINCIPLES OF ELECTRONICS" by M. R. Gavin & J. E. Houldin. Published by *D. Van Nostrand Company, Inc.*, Princeton, N. J. 342 pages. Price \$5.75.

This volume is an extension of the British series on physical sciences, written for the advanced student or candidate for graduate membership in a professional society. There are no concessions to the unprepared or those with a weak foundation in mathematics and basic engineering. Those who use this text are advised to read the authors' Preface in which they explain the notation used in the text, which is based on the British Standards Institution rather than the more familiar American Standards Association (ASA) symbols.

The text is divided into twenty chapters dealing with electron motion, electron emission, and electronics in matter as prefatory data before leading into diode currents; triodes and transistors; voltage, power, and transistor amplifiers; feedback; transients in amplifiers; direct-coupled amplifiers; oscillators; electrons and fields; special tubes for v.h.f.; rectification; and modulation and detection. -30-

Nipco FOR HIGH PROFIT

1. EXCELLENT FACTORY MANAGEMENT
2. STRICT INSPECTIONS GIVEN TO THE PRODUCTS

Write today FOR FURTHER DETAILS

TRADE-SHOW



MODEL: 60 TM
Superheterodyne 6 transistors, 1 diode and 1 thermistor, 535-1605 KC, 0.5mV/M with enclosed ferristic bar antenna, 80 milliwatts. (Maximum: 120mW), 455KC, 2 1/4" permanent dynamic, 4 1/4" x 2 1/2" x 1 1/8", With Cowhide leather carrying case and earphone.



MODEL: 59 TM
Superheterodyne 6 transistors, 1 diode and 1 thermistor, 535-1605 KC, 0.5mV/M with enclosed ferristic bar antenna, 80 milliwatts, (Maximum: 120mW), 455KC, 2 1/4" permanent dynamic, 4 1/2" x 2 1/4" x 1 1/8", with Cowhide leather carrying case and earphone.

MODEL: 400 T
Superheterodyne 7 transistors, 1 diode and 1 thermistor, 535-1605 KC, 11.5mV/M, 455 KC, 3" permanent dynamic, 5 3/4" x 3 1/4" x 2", with Cowhide leather carrying case, earphone and rod antenna.

NIPCO MFG. CO., LTD.
36, 1-chome, Okachimachi, Taito-ku, Tokyo, Japan

PERFECT GIFT FOR ANYONE . . . INTERNATIONAL'S
KB-1 CITIZEN BANDER KIT!



FOR BUSINESS

Ideal for office intercom and service trucks.

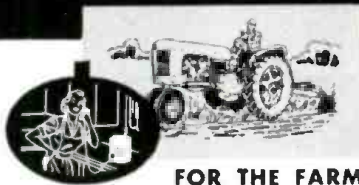

FOR THE FARM

Solution to fast communication from the farm home to the field.



FOR THE HOME

Saves steps from kitchen to den or workshop . . . from living room to sick room.



FOR SPORTS

Ship to shore, base camp to scene of the hunt, adds enjoyment to sports!

ORDER BY MAIL! Terms F. O. B. Oklahoma City, or C. O. D. with 1/3 down payment.

International
CRYSTAL MFG. CO., INC.
18 N. LEE • OKLAHOMA CITY, OKLA.

complete kit
for 115 V A.C.
\$90.00
only



FREE! Gift wrapping on all orders received by Dec. 15.

Quadrature FM Detectors: Function and Failure

By KEN BRAMHAM

This circuit develops audio in a way of its own
—and also develops distinctive trouble symptoms.

REJECTION of amplitude modulation, detection of frequency modulation, and amplification are the requirements of a TV receiver sound circuit. Because of the nature of the 4.5 mc. i.f. signal formed by a beat between sound and picture carriers (a strong video AM signal is also present), good rejection of AM signals is essential. While unrejected AM in a straight FM receiver is usually noise heard after detection as "hash" in the higher audio range, unrejected AM in a modern TV receiver is mostly video signal and is heard predominantly as sharp 60-cycle buzz. As this buzz is made up of rectangular sync pulses, strong frequency components over a wide range are present, making normal limiting methods somewhat less effective than is the case with ordinary FM radio reception.

Early intercarrier TV receivers required one or two limiter stages preceding the FM discriminator and at least one stage of audio amplification prior to the power-output stage. The AM rejection properties of the frequently used ratio detector reduced the number of limiting stages needed, while other designs featured use of the video amplifier for one stage of sound i.f. amplification and reflexing of the i.f. pentode as an audio amplifier to reduce the number of stages and components still further. Quadrature cir-

cuits provide, in one stage, good AM rejection, linear FM detection, plus a high-level output signal requiring no additional voltage amplification before the output stage.

The excellent AM rejection provided by quadrature circuits is achieved by use of tubes having very sharp cut-off and saturation characteristics. Examination of the plate current vs grid voltage curve for a type 6BN6 tube (Fig. 1) shows that a change in plate current from zero to saturation is produced by a swing of less than .5 volt on the grid, any signal exceeding this level being effectively limited. It is also apparent from Fig. 1 that the plate output, after limiting, is essentially a square wave, with almost instantaneous changes from zero to maximum current. The effect of this grid (G_1) can thus be considered as that of a switch for turning plate current on or off, with virtually no intermediate condition of conduction between these two extremes.

While the operation charted in Fig. 1 illustrates the effect of signal on the G_1 grid with other voltages being held constant, there is another grid (G_2 , shown schematically in Fig. 2 in the position of the suppressor grid, although it is not one such) whose action is similar to that of G_1 . We may think of these two grids as being switches in series with each other and also in

series with the plate circuit. Thus if either of these switches is off, no plate current will flow: for the tube to conduct, both must be in the "on" position. Furthermore, each of these switches or grids is capable of opening or closing in response to its input signals.

In addition to gated-beam tubes, like the 6BN6, there are other pentodes, such as the 6DT6, that have cut-off and saturation characteristics satisfactory for use in quadrature detectors. Since the exact circuit for the stage may vary somewhat depending on the tube type used and other factors, Fig. 2 should be regarded as a generalized circuit covering such detectors as a group. The sound i.f. signal is applied to control grid G_1 . The cathode bias resistor is adjusted so that the "on" and "off" conditions will produce plate-current pulses in the desired polarity for detection. In some actual circuits, the cathode resistor is made variable to be used as a service adjustment.

Some of the energy introduced by the input signal at G_1 is transferred to G_2 and its resonant LC circuit. The latter is so tuned that, when energized, it will produce an oscillation at the sound i.f. center frequency (4.5 mc.) that is approximately 90 degrees out-of-phase (lagging) with a 4.5-mc. signal introduced at G_1 . This oscillatory voltage also acts as a switching potential.

The effect of the switching action by the two control grids is shown in Fig. 3A for an input signal at center frequency. Each grid is shown to be in an "on" condition for about half of each cycle, with a pulse of plate current flowing only during about one quarter of a cycle, when overlapping of the "on" periods for both grids occurs. Switching conditions for input (G_1) signals above and below the 4.5-mc. center frequency are shown respectively in Figs. 3B and 3C, where it is seen that the effect of a change in input signal frequency is a change in plate-current pulse duration.

Each pulse of plate current produces a voltage drop across R_L and permits C_1 to discharge through the conducting tube for the period of the pulse. Between pulses, C_1 recharges through R_L .

With an input signal at center frequency, C_1 discharges rapidly for about one quarter of each cycle (Figs. 3A, right, and 4A) and charges at a slower rate during the remaining three-quarters of a cycle, as shown in Fig. 4A. As the signal frequency increases so that the pulse duration increases, discharg-

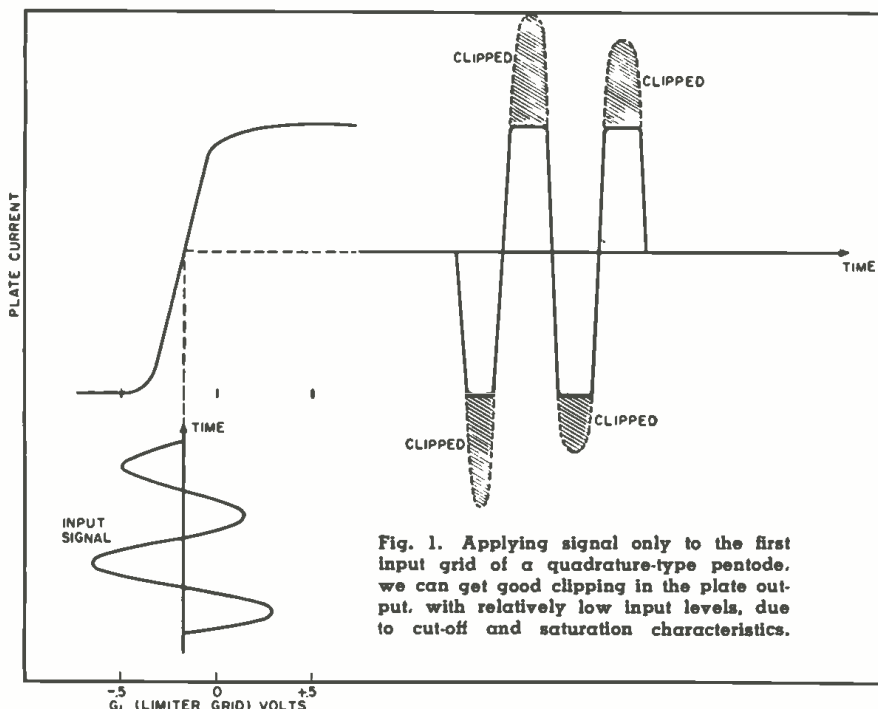

Fig. 1. Applying signal only to the first input grid of a quadrature-type pentode, we can get good clipping in the plate output, with relatively low input levels, due to cut-off and saturation characteristics.

ing time increases and the time available for recharging decreases. Under these conditions (Fig. 4B, right), C_i will be discharged to a lower level, will take a smaller charge than in the previous case, and the average voltage across C_i will assume a steady state which is lower than was the case at center frequency. Similarly a decrease in signal frequency (Fig. 4B, left), will create shorter current pulses and a consequent increase in average voltage across C_i . Fig. 4B illustrates the effect on C_i voltage of a complete frequency swing from minimum frequency, through center frequency, to a maximum. It is seen that the amount of (modulation) frequency change determines the amplitude of the audio signal, while the rate at which these swings occur is, of course, the frequency of the audio signal. This is the essence of FM detection.

Service Hints

Most service problems with this type of circuit stem from misalignment of the tuned circuits. Comparatively few components are involved, voltages and currents are small, and complete breakdown of any component is therefore rare. However, very small changes in component values are sufficient to affect the alignment of the circuit, producing such symptoms as distortion and reduction or loss of output. Cases of slight distortion or reduced output can, therefore, often be corrected merely by slight adjustments.

It is interesting to note that, in a recent series of complaints of inferior sound involving quadrature circuits investigated by the author, six out of eight proved to be the result of front-

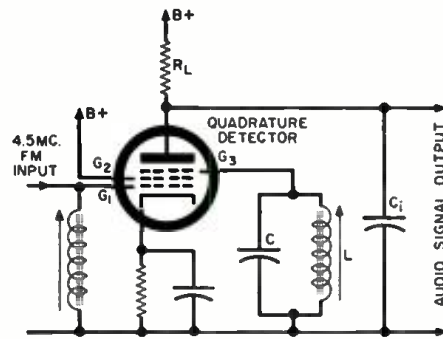

Fig. 2. This circuit is generalized for both types of quadrature tubes.

end (tuner) oscillator mistuning, while a tube failure and a defective multiple-set installation accounted for the other two. Each complaint had been reported by a technician as trouble due to a defective quadrature circuit that he was not able to correct in the home.

Aging of tubes causing slight changes in interelectrode capacitance or changes in the grid characteristics will also throw the circuit out of alignment. This makes it good general policy to install a new tube first and try to align the circuit when trouble is encountered. If good sound is then produced, the old tube may be re-installed and slight changes in alignment made, before deciding whether or not to discard the old tube.

Alignment made on a strong, clear station will not necessarily be good under less favorable conditions. A ghostly, weak, or distorted signal requires very accurate alignment, which is best made on the worst station. Antenna systems, particularly community distribution systems, can create serious trouble if the original relation between

sound and video amplitude is not preserved. It may even be found that a particular station does not maintain customary modulation and amplitude levels, making it essential to align all sets on this transmission.

A change in audio quality and volume is sometimes noticed as the set warms up. Most likely cause again would be the tube, but drift in the quadrature-coil capacitor produces the same effect. Heating the capacitor with a solder gun will reveal any tendency towards drift—but the gun must be removed and the result checked under cooling conditions, if stray detuning effects of the gun tip are to be avoided.

Loss of sound as the contrast level is reduced may be encountered. Most likely causes would be: an open bypass capacitor in the video-output cathode circuit, a defect in the sound take-off circuit, or a video-output tube plate-circuit component, or, once again, alignment.

Another possibility is loss of plate-supply voltage without loss of supply to the screen. The plate supply only, in some models, is taken from the boosted "B+" to prevent operation of the sound circuit before the a.g.c. circuit is operative. This boosted "B+" voltage is dropped and filtered in an RC network handling high peak voltages that may cause trouble.

The trend towards quadrature detectors has now developed to the stage where circuits of this type are used by a majority of manufacturers, but there does seem to be a dislike of the circuit by many service technicians. A better understanding of operation and of what defects may occur may help dispel the attitude.

Fig. 3. Quadrature tube conducts only when both signal grids are "on." Output pulses are shown when the FM signal is on (A), above (B), and below (C) carrier frequency.

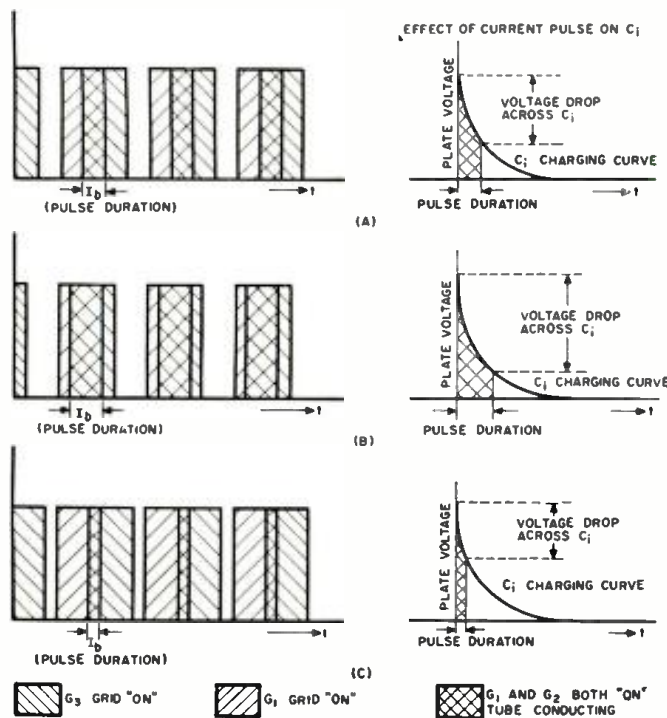
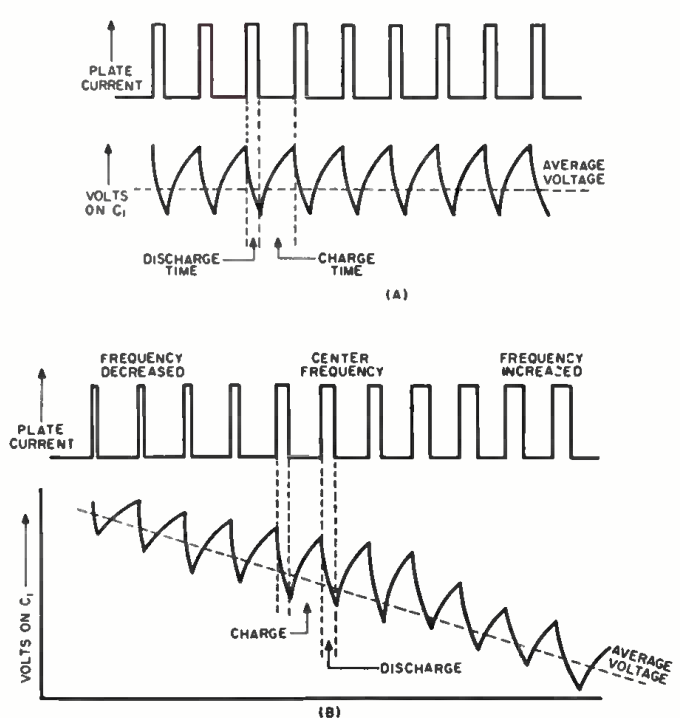

Fig. 4. With input at one frequency (A), average output voltage is steady. As frequency of input signal varies (B), there is a corresponding change in output voltage.



The Spotlight of Leadership is on...

AWARD WINNING

arkay

Kits and Wired

HI-FI STEREO

TODAY'S BEST QUALITY BUY



the Arkay/Harting MS-5
STEREO Record TAPE DECK
Precision Playback

Precision-engineered to the highest professional standards... a new achievement in tape deck design and performance... Mailed by audio engineers and music lovers alike for its surpassing performance, simplicity of design and operation.

FEATURES: Dual-track combination head (mu-metal shielded) for stereo at both 3 3/4 and 7 1/2 IPS • All-metal tape fingers—no cushions to wear out tape • All-metal tape guards for vertical tape control • Double shoe brakes for positive non-slip stops—minimizes tape stretch • Simple, positive-acting 5-button operation, drop-in loading • Large (1/2" diam.) capstan insures constant tape speed—virtually eliminates wow, flutter, distortion • Automatic interlock prevents accidental erasure • Ultra-narrow (3.2-microns wide) gap heads assure maximum fidelity during record and playback.

SPECIFICATIONS: Record and playback frequency response: 7 1/2 IPS, 30-16,000 cycles ± 3 db. Signal-to-noise ratio: better than -55 db. Flutter and wow: at 7 1/2 IPS, 1/4 of 1%; at 3 3/4 IPS, 1/2 of 1%. Rewind time: 110 seconds for 1200 feet. Size: 12-3/16" x 13 1/2" x 6 1/4" deep.

Professional Quality at a Popular Price only \$129.95

NEW! MUSIC MASTERPIECE



ARKAY CS-28
STEREO AMP/PRE-AMP
COMPLETE CONTROL CENTER

Full 28 watts stereo or monaural, 60 watts peak • 14 watts each channel • reverse stereo • balance control • two-channel gain control • full range bass and treble controls • 1M distortion, 4 to 1 • harmonic distortion, 1% 30-20,000 cps • dual pre-amp 2V output jacks • speaker outputs, 4, 8, 16, 32 ohms • response, 20-20,000 cps • push-pull EL84 Williamson circuit • beauty of design that won Fashion Foundation's coveted Gold Medal! Many other incomparable features.

Wired and tested \$99.95 Easy-to-build Kit \$64.95



ARKAY CS-12
STEREO AMP/PRE-AMP

12 watts of clean power with dual inputs and outputs for excellent stereo reproduction • operates from ceramic or crystal cartridge, tape, tuners, auxiliary equipment • push-pull outputs for each channel.

Easy-to-build Kit \$36.95



ARKAY ST-11 AM-FM
STEREO TUNER

Here, for the first time, is an AM-FM STEREO Tuner within the reach of every audiophile. Unmatched by units costing twice the price, the ST-11 is two distinct receivers in one featuring 4 v.v. for 20 db quieting. Variable AFC. Single front panel switch controls AM, FM or STEREO selection.

Wired and tested \$74.50 Easy-to-build Kit \$49.95

SPA-55 STEREO AMP 55 watts stereo-monaural. 27 1/2 watts each channel. Wired \$79.95 Kit \$64.95

See and hear ARKAY Kits at your dealer. FREE! Stereo booklet and catalog. Write Dept. EW

All prices 5% higher west of Mississippi



CERTIFIED
RECORD REVUE

By
BERT WHYTE

I HAD hoped to bring you a report on the New York Hi-Fi Show this month, but circumstances have prevented me from carrying out this plan (see tape column introduction). If all goes well, I'll have my comments for you next month.

Maybe you have noticed in the reviews in many other record or hi-fi journals, an alarming tendency for the reviewer to either deprecate stereo itself in connection with a recording or to reach a conclusion that "there wasn't much difference between the stereo and mono," or "stereo is a waste of time with this piece," etc. Now I am not going to defend stereo on the basis that, if it is stereo, it automatically takes preference over a mono recording. Undoubtedly there is some validity in some of the reviews of this nature but, far too often, the playing down of stereo seems to be little more than an affectation; that is, it is "chi-chi" or the "thing to do in reviews these days." On the other hand, maybe it stems from sheer ignorance of what stereo is all about. I know first-hand that many have poor or inadequate stereo-playback facilities—and I don't mean just in equipment itself but in room acoustics and in the ability to set up and maintain the equipment for optimum results. I hasten to add, before many of my critic friends descend on me in their wrath, that this as a rule does not apply to the top writers in the more responsible journals, but to the "fringe elements" in the profession! In any case, the type of review mentioned can do nothing but trouble and confuse still further the average lay reader regarding stereo.

I've listened to thousands of stereo recordings and will be the first to admit that there are plenty of clunkers on the market that are not only of the worst possible stereo quality, but are to be considered poor recordings under any circumstances. On the other hand, I've seen reviews maligning perfectly good stereo recordings. How anyone can fail to perceive the advantages of stereo over mono, I don't know. Even if there were no such things as directivity and depth, the gain in clarity, the gain in instrumental separation, and the superior acoustic framework would be reason enough for stereo. I've read many reviews quoting such things as "the stereo was quiet and unobtrusive," "directional effects were held to a minimum," etc. It is almost as though they were being apologetic for stereo. No one decries deliberate "ping-pong" directional effects more than I, but by the same token directional effects are part and parcel of the stereo process and they originate in the concert hall under live conditions. The degree of directivity in a given stereo recording, from a responsible company not given to "gimmickry," is solely dependent upon the scoring of the particular work and the acoustic characteristic of the recording

hall which more or less dictates and defines the microphone placement. If in a certain passage there is a lot of antiphonal interplay between, say, the first strings on the left and the cellos on the right, then the directional changes are more obvious. If a particular passage calls for woodwinds alone and they are centrally placed, then this is where you will hear them, and if in a climax the whole orchestra is called upon, the directionality will become more diffuse, although some will still be noted between different instruments due to the varying acoustic energy even when all instruments are played at their most forte level. Above all, no one should accuse a recording of being too right- or left-sided unless he has carefully checked the score to make certain that this "one-sidedness" is not an integral part of the score.

I think a lot of these critics would do well to "put their own house in order" before they pass off stereo either as a passing fancy or as a minor contribution to the more realistic reproduction of music. Stereo is here to stay—it's a big, dynamic, vital, new force in recorded music, which even more than the long-play record is causing a revolution in the listening habits of the public. For all of its early and present shortcomings, it has become a success mainly due to its almost immediate and overwhelming acceptance.

I see another Christmas has come upon us, and I had toyed with the idea of a Christmas stereo buying list but rejected it since I think it is still just a bit too early in the stereo era. This coming year should see not only advances in stereo techniques, but a truly representative stereo catalogue of high quality. So, let's leave it until next year. In the meantime, allow me to extend the warmest Holiday greetings to all of you fine people. I hope the hi-fi Santa is very liberal when he comes to your stocking. Merrie listening!

TCHAIKOVSKY
THE SWAN LAKE BALLET
(Complete)

L'Orchestre de la Suisse Romand conducted by Ernest Ansermet. London Stereo OL2204. Two discs. Price \$11.90.

London continues its stereo survey of the Tchaikovsky ballet under the baton of Ansermet, and so far the results have been very worthy. This is a beautifully modeled performance, paced a bit slower than the Dorati version, and Ansermet seems to emphasize the lyric aspects rather than the rhythmic. The result is a reading which is less brilliant than Dorati's, but which will probably please the dyed-in-the-wool balletomane more. Soundwise this is superb, with lovely strings, mellifluous woodwind, and crisp brass and percussion. All is very wide in frequency and dynamic range and the stereo attributes are much in evidence. Directionality is

positive, as is aural positioning of the various instruments, and the broad acoustics allow a fine sense of depth. Highly recommended.

**RIMSKY-KORSAKOV
SCHEHERAZADE**

New York Philharmonic conducted by Leonard Bernstein. Columbia Mono ML5387. Price \$3.98.

The umpteenth version of the oriental charmer, but this by Bernstein and, whether you like this brilliant young man or not, one thing is sure—you cannot ignore him! As might be expected, Bernstein's "Scheherazade" is a gal with plenty of spirit and a zest for life. His handling of the lyrical sections is expressive, but it is in the fast sections, the "shipwreck," etc., that he really lays the whip to his orchestra and they respond like thoroughbreds with a winning performance. For all the brilliance, however, there is a tinge of brashness some may not care for: they may probably want a little more of the charm and grace with which "Papa" Montoux imbues his lady "Scheherazade." Soundwise this is quite good, with all very clean, good, sharp transients, wide dynamic and frequency range, good directivity and depth perspective.

The recording is fairly close-up and detail is very accurate. For the lovers of the "bing" and the "bang," the "shipwreck" sequence should furnish them with several minutes of delight.

VERDI

OVERTURES TO "LA FORZA DEL DESTINO," "NABUCCO," "LA TRAVIATA" ACTS 1 & 3, "VESPRI DE SICILIANI"

London Symphony conducted by Antal Dorati. Mercury Stereo MG90156. Price \$5.95.

These used to be the special province of Toscanini and truly no one seems quite capable of matching his fiery brilliance. However, Dorati is temperamentally well suited to the task, and his reading is close—very close. He has learned to let the orchestra have its head with these works to whirl along at a dizzy pace, but at the same time always keeping the reins firmly in hand. His readings are splendidly proportioned, with dynamics and phrasing particularly expressive. The London Symphony supports him with some fine, incisive playing. Soundwise this leaves all other versions far behind. All is very big and live, with a notable brilliance in the strings and brass. Articulation, which is so important in these works, is splendidly realized. There is no fusion of orchestral elements which obscure detail, and the transient response throughout is razor-sharp. Dynamic and frequency response is very wide and stereo attributes first class, with good direction and depth, fine center fill, and live, spacious acoustics.

MOZART

VIOLIN CONCERTOS #3 IN G MAJOR AND # 4 IN D MAJOR

Zino Francescatti with Columbia Symphony Orchestra conducted by Bruno Walter. Columbia Mono ML5381. Price \$3.98.

The combination of Francescatti and Mozart raised my eyebrows when I first saw this disc. To my knowledge, Francescatti had never recorded any Mozart previously, nor was he by reputation "sympatico" with Mozart. After hearing his readings, I doff my hat to his versatility, but in spite of the overall general excellence of the performances, I feel that he does not hew closely enough to the pure, classic line of several other more specialized interpreters. He is essentially romantic in his approach and his playing is flawless perfection, but one is always left with the impression that he is slightly un-

EVEREST'S exclusive recording technique brings you THE FINEST SOUND ON RECORDS



DIRECT FROM 35MM MAGNETIC FILM TO DISC

Only on Everest . . . brilliant performances by the world's finest musicians are recorded on 35mm magnetic film . . . then transferred to the discs you hear. The result: great music in the most accurate monaural and stereo high fidelity yet achieved. For you—a revelation in sound.

EVEREST MAGNETIC FILM COMPARED WITH CONVENTIONAL TAPES

Everest's 35mm magnetic film — actual size

1/2" stereo tape — actual size

1/4" tape — actual size

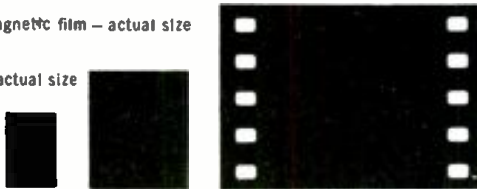

Everest sprocket-driven magnetic film is much wider and five times thicker than conventional tapes. With it, Everest achieves:

- the widest dynamic range ever recorded
- elimination of print-through distortion and tape-stretch
- recording without "wow" or "flutter"
- the lowest possible noise factor

Hear this exciting new sound. Hear it in these and other selections in the growing Everest library. All Everest recordings are high fidelity . . . available in monaural long-play, stereo discs and tape. For a complete Catalogue, in full color, write: Everest Records, Dept E-12, 360 Lexington Avenue, New York 17.

EVEREST RECORDS

Division of Belock Instrument Corp.



Wagner: Parsifal. Good Friday Spell; Synthesis, Act 3. Stokowski, the Houston Symphony Orch. LPBR 6031 SDBR 3031*



Brahms: Symphony No. 3 in F Major, Op. 90. Leopold Stokowski, the Houston Symphony Orch. LPBR 6030 SDBR 3030*



Tchaikovsky: Symphony No. 5 in E minor. Sir Malcolm Sargent, the London Symphony Orch. LPBR 6039 SDBR 3039*



Stravinsky: Petrouchka. Complete. Sir Eugene Goossens, the London Symphony Orchestra. LPBR 6033 SDBR 3033*



Berlioz: Symphonie Fantastique, Op. 14. Sir Eugene Goossens, the London Symphony Orchestra. LPBR 6037 SDBR 3037*

*STEREO NUMBER

RECORDING TAPE
Premium Quality
10-day money back guarantee
1800' Mylar—made by Minn. Mining & Mfg. Co. 3 for \$6.65
2400' Mylar . . . 3 for 9.60
Lots of 10, any assortment, deduct 10%. Add postage 15c per spool.
DON'T BUY HI-FI components, kits, tape recorders, until you get our low, low quotes by return mail. Wholesale Catalog Free.
HI-FIDELITY CENTRE
1799W 1st Ave., New York 28, N. Y.

VOM OWNERS
Get FREE COPY of unusual reference bulletin packed with valuable data:
"ALL ABOUT VOM'S"
Rapid answers to all VOM problems. No strings attached, but quantity is limited. SEND TODAY a post card: paste this ad, or write. GIVE MAKE & MODEL OF YOUR VOM.
NEW WORLD LABORATORIES P. O. BOX 127-W-12 Astoria, L. I. 2, N. Y.

Say you saw it in ELECTRONICS WORLD

CITIZENS BAND TRANSCEIVER KITS !!
\$39.95
COMPLETE
RUSH YOUR ORDER TODAY!
• MAJOR PARTS MOUNTED
• HI-GAIN CERAMIC COILS
• HANDSOME CABINET
• CRYSTAL MICROPHONE
• TUBES—CRYSTAL—ALL PARTS
• FULL 5 WATTS
• MODEL G-110—110 VOLT
• MODEL G-12—12 VOLT
• MODEL G-6—6 VOLT
• INCLUDES FCC FORM 505
• COMPLETE INSTRUCTION MANUAL
GROVE ELECTRONIC SUPPLY CO.
4105 W. BELMONT AVE. CHICAGO 41, ILL.
NO C.O.D.'S—INCLUDE POSTAGE WITH ORDER

TUBE PROBLEM:

The Armed Forces needed a new version of the 6J4 reliable tube type which would provide a tube life of almost 1000 hours. Existing tubes of this type had an average life of only 250 hours. In addition, this new tube had to be produced under ultra-high quality control standards.

SONOTONE SOLVES IT:

By making improvements in the cathode alloy and setting up extremely tight controls in precision, manufacture and checking, Sonotone engineers produced a 6J4WA with a *minimum* life of 1000 hours...most running *much longer*.

RESULTS:

The Sonotone 6J4WA is one of three reliable tubes now being manufactured under U. S. Army Signal Corps RIQAP (Reduced Inspection Quality Assurance Program), monitored by the U. S. Army Signal Supply Agency. And the same rigid quality standards apply to Sonotone's entertainment type tubes as well.

Let Sonotone help solve *your* tube problems, too.

Sonotone.

Electronic Applications Division, Dept. TN-129
ELMSFORD, NEW YORK

Leading makers of fine ceramic cartridges, speakers, micro-phones, tapeheads, electron tubes
In Canada, contact Atlas Radio Corp., Ltd., Toronto

comfortable with the pieces. Bruno Walter helps enormously with his deft, masterful accompaniment, against which no one can cavil, and the disc is made more attractive by the excellent sound. The Francescatti tone is beautifully realized and the violin balanced just a shade more prominently than the orchestra.

Articulation throughout is fine and all other elements are very clean.

FRANCK

SYMPHONY IN D MINOR
New York Philharmonic conducted by Leonard Bernstein. Columbia Mono ML5391. Price \$3.98.

This is the sort of disc that makes me a little sore. I have nothing against old Franck, and Bernstein does a more than creditable job of conducting it, but why oh why are they wasting the talents of Bernstein in this type of repertoire? I know that, in these stereo days, everybody is busy building catalogue, and I know Bernstein is hot box office, but there are so many other works for which he is better suited. Why not give the man a chance to do his own interesting "Jeremiah Symphony," not recorded for many years now, or a remake of his superb "Histoire du Soldat," or—well, one could go on at length.

As to this recording, Bernstein, trying to find something new to say in this redundant work, essays slower tempi than most in an effort, it would seem, to draw out more sonority. A dangerous approach which, wrongly handled, could make for a very dreary reading. Fortunately, Bernstein's innate musicianship comes to the rescue and he does not fall into such a trap. The sound is full and richly resonant, quite clean and wide in range, and an acoustic perspective was wisely chosen on the moderate side as the scoring in this music tends to "muddy-up" and obscure details in an over-reverberant situation.

SUPPE

**OVERTURES "LIGHT CAVALRY,"
"JOLLY ROBBERS," "MORNING,
NOON, AND NIGHT IN VIENNA,"
AND OTHERS**

Halle Orchestra conducted by Sir John Barbirolli. Mercury Stereo SR90160. Price \$5.95.

Here is just the right kind of record for Christmas gifting; especially for those whose tastes are unknown! Almost no one could take exception to these light, gay confections, particularly when they are as sparkingly performed and brilliantly recorded as on this disc. Sir John seems to have a particular affection for these works, as he makes them sound far more substantial than they really are. The tempo here is strictly up-beat and the orchestra responds to Sir John's urgings with gusto. The sound is gorgeous—a big, bright, splashy palette of tonal colors which "zings" and "pings" in every bar. It is utterly clean, remarkable for its sharply graded transients, and with exciting dynamics. The acoustical perspective seems tailor-made for the music and nothing is left wanting in terms of stereo direction and depth. A real hi-fi sizzler for the aficionado!

TCHAIKOVSKY

CONCERTO FOR VIOLIN AND ORCHESTRA

MENDELSSOHN

CONCERTO FOR VIOLIN AND ORCHESTRA

Isaac Stern with the Philadelphia Orchestra conducted by Eugene Ormandy. Columbia Stereo MS6062. Price \$5.95.

Critics may deplore the umpty-umth version of these old potboilers, but it is the kind of record staple that will sell and sell.

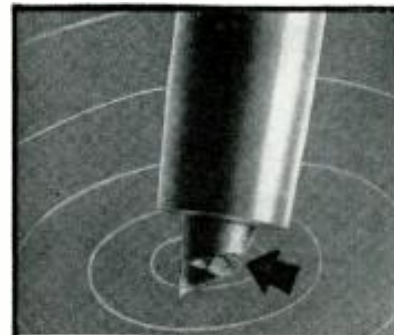

FROM ONE WHO LEARNED

This enlargement shows a diamond-chip needle sent us by a disappointed user, who learned all diamond needles are not O.K. Shows what happens if a heat bubble forms when a chip is welded on. Can't happen with a Duotone Needle that uses only the *whole* diamond set deep in the metal shank.



*Insist on Duotone.
Be sure. Duotone's
whole diamond
can't break off.*

DUOTONE DIAMOND NEEDLE

"that remembers"
Keyport, N. J.

In Canada: Chas. W. Pointon, Ltd., Toronto



**HOW
TO LOOK
AT A
SPEAKER BY
wigo**
PRONOUNCE IT WEEGO

Like this connoisseur, judge a speaker by its sound, not by its looks. With Wigo, you get sound performance...because Wigo puts the quality and value on the inside where you may not see it, but you sure can hear it! For literature, write...

united Audio

PRODUCTS OF DISTINCTION
202-4 East 19th St., N. Y. 3, N. Y.

Stern is tremendous—at the height of his power—and these are readings of great intellect, suavity, and nobility. They do not possess as romantic a flavor as some might wish, but frankly, as far as I am concerned this is a welcome relief. Ormandy and the Philadelphia furnish a sympathetic and knowledgeable accompaniment and my only quibble here is in the sound department. In general, the sound is all right but, although it is obvious that these two concerti back-to-back represent excellent value, getting them on one disc was troublesome. This is mainly true with the Tchaikovsky. There is neither the dynamic compass that is usual in this work, nor sufficient bass response. As I've said before, at the present state of the stereo cutting art you can't have your cake and eat it. If you go beyond the time barrier, you must suffer either loss of level, bass, dynamics, or a combination of all three.

So, while the sound here is clean and well recorded as to violin-orchestral balance, I'm afraid sound purists will not take to it very kindly. Probably this will sound all right on the small, commercial stereo systems, but a good system will highlight the aforementioned deficiencies at once.

MOZART

**SYMPHONY 41 ("JUPITER")
SYMPHONY 39**

London Symphony conducted by Hans Schmidt-Isserstedt. Mercury Stereo SR90184. Price \$5.95.

Schmidt-Isserstedt is one of that breed of conductors who do many things superlatively well but never seem to get the credit they deserve. This Mozart is a case in point. These are fine, idiomatic performances that are hard to fault. The tempi are just, the dynamics and phrasing are carefully handled, but without fussiness, and in the "Jupiter" especially the conductor furnishes some exalted moments. The disc is made still more desirable by the superior sound. Here again is a fine example of what stereo can do in the classic repertoire (where it isn't supposed to shine!) The strings have a lovely, smooth sheen, the woodwinds are almost transparently pure, and while direction and depth may be of little consequence in this score, they nonetheless make their contributions to the general excellence. This is among the purest, cleanest Mozart to be found anywhere today. —50—

OMNIDIRECTIONAL TWEETER

By A. V. J. MARTIN

MOST tweeters have a marked directional effect which is detrimental to good reproduction whenever the listener moves away from the axis of the speaker. To achieve good "presence," several tricks have been tried, a reasonably successful one being the use of a number of loudspeakers distributed over the several faces of the cabinet.

One very good idea involves the use of a tweeter on each of the twelve sides of a dodecahedron, but this is a rather expensive solution. A more economical method has been developed by Grundig. It calls for two speakers, bolted face to face and fed with currents opposite in phase. The whole arrangement then pulsates at the frequency of the current, giving a reasonably good approximation of a pulsating sphere, which is the best omnidirectional speaker.

Of course, this arrangement cannot be used in a cabinet. One version of it employs a metallic mesh around the speakers for decorative effect. The resultant "package" can then be hung from the ceiling, fixed to a wall, or simply stood on the floor. —50—

December, 1959

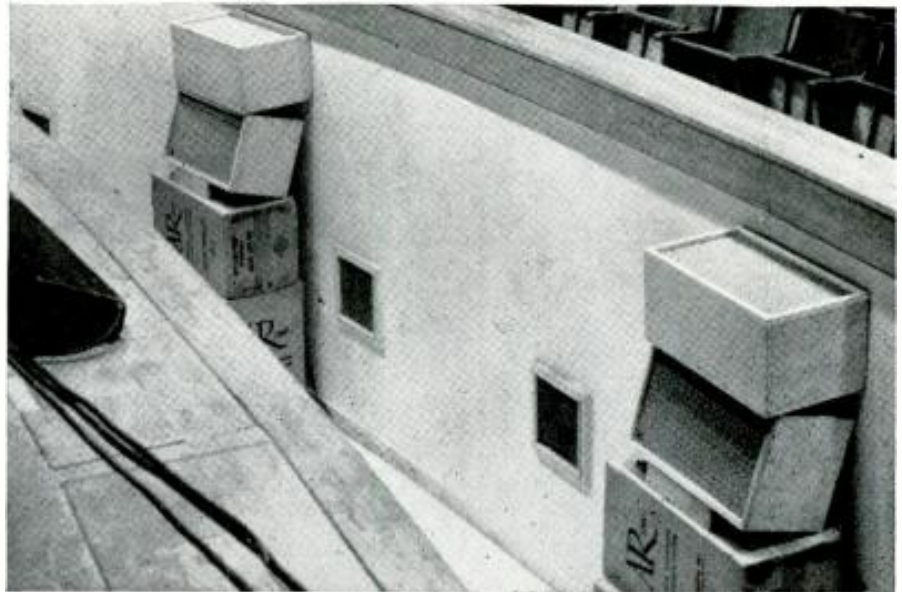

orchestra pit in beersheba

When the Martha Graham dance group toured Israel, six AR-2 loudspeakers, with tape reproducing equipment, were taken along to provide musical accompaniment under circumstances where it was impractical to use live musicians.

Above are four AR-2's mounted in the orchestra pit of Cinema Karen in Beersheba (two more were placed backstage). These speakers were selected for the job because of their musical quality; the natural sound of the live instruments, rather than pseudo-hi-fi exaggerations, was desired.

AR acoustic suspension speaker systems—the AR-1, AR-2, and AR-3—are designed primarily for use in the home, but are also employed extensively by professional laboratories and studios. They are priced from \$89 to \$231.

Literature is available on request.

ACOUSTIC RESEARCH, INC. 24 Thorndike St. Cambridge 41, Mass.

**SAY YOU SAW IT
IN ELECTRONICS WORLD**



Artisan
**ELECTRONIC
ORGAN**

for your **HOME!**

**BUILD-IT-
YOURSELF
SAVE!**

Now you can own a professional electronic organ and save up to 50% on an easy pay-as-you-build plan... The world famous ARTISAN ORGAN—in 14 models from the popular 2-manual Home entertainment style to the majestic 4-manual Theatre and Church style is now available in kit form. Simple step-by-step instructions. pictorial diagrams and schematics make this an ideal spare-time project for anyone.

FREE LITERATURE ON REQUEST

Get the Artisan Story before you purchase any Organ, Kit or commercial model.

ARTISAN
MUSIC HALL



New Home of
ARTISAN ORGANS

ORGAN
KITS
and
COMPONENTS

**ELECTRONIC
ORGAN ARTS, INC.**

4949 YORK BLVD., Dept. EW-12
LOS ANGELES 42, CALIF.

HANDLE JOBS TWICE AS FAST WITH YOUR OSCILLOSCOPE!

*A complete guide to when, where
and exactly how to use the
handiest instrument of all*



Learn to use your 'scope on all types of work—and see how much faster and more accurately you get things done!

This 346-page revised edition of **MODERN OSCILLOSCOPES AND THEIR USES** teaches you all about these versatile instruments. You learn to locate AM, FM or TV troubles quickly. Methods of handling tough realignment jobs are clearly explained. Every detail is outlined—from making connections to adjusting components and setting 'scope controls. And you learn to analyze patterns fast and right! Includes data on quantitative measurements, the slickest way to diagnose many color TV troubles and align circuits. Also covers 'scope uses in lab work, industrial electronics and teaching. 370 illustrations.

PRACTICE 10 DAYS FREE

Dept. RN-125-A, RINEHART & CO., INC.
232 Madison Ave., New York 16, N. Y.

Send **MODERN OSCILLOSCOPES** for 10-day no risk examination. If I like book I will then send you \$6.50 (plus postage) promptly in full payment. If not, I will return book postpaid and owe you nothing. (SAVE! Send \$6.50 with order and Rinehart pays postage. Same 10-day return privilege with money refunded promptly.)

Name
Address
City, Zone, State.....
OUTSIDE U.S.A.—\$7.00 cash only. 10-day money-back guarantee.

RADIO ELECTRONIC SURPLUS

SILICON RECTIFIERS

1N1454	25 amp. 100 volts	\$3.00
1N1455	25 amp. 200 volts	\$3.50
1N1456	25 amp. 300 volts	\$4.00
1N1457	25 amp. 400 volts	\$4.50
1N1451	5 amp. 200 volts	\$1.25
1N1452	5 amp. 300 volts	\$1.50
1N1447	.750 amp. 200 volts	.75
1N1448	.750 amp. 300 volts	.85

BC603 FM RECEIVER

20-.27.9 mc. Equipped with 10 push buttons for selecting channels. Cont. variable tuning over the entire range. Unit complete with tubes, built-in loud speaker, squelch circuit, head phone jacks, schematic diagram on bottom of case. Approx. weight 34 lbs. Used Good. \$9.95 Like New \$12.95



DM-34 Dynamotor 12 or 24-volt D.C. each \$3.95
BC-604 Transmitter, 20-.27.9 mc NEW \$4.95
Crystals (set of 80) for BC604 transmitter, 20 to 27.9 mc Price \$3.00 per set
Manual with schematic for BC603/BC604. Price \$1.00 each

PE120 POWER SUPPLY

6, 12 or 24-volt (specify voltage). Used with BC659 and 620 \$6.95 each

TEST SCOPE—SYNCHROSCOPE—PULSE ANALYZER



ID-59/APA-11. Late production. Modular subassembly construction. Video amplifier is flat to 4 mc. 3BP1 presentation. Test-scope sawtooth 25-20,000 cy. Has all normal test-scope controls. As synchroscope and pulse analyzer, accepts positive or negative pulses.

es. Video delay circuit permits leading edge of pulse to be seen. Calibrated-dial horizontal shift measures pulse durations from 0.5 to 100 microseconds. Sine-wave-oscillator calibrator measures recurrence rates from 200 to 6000 pps accurate within 0.4%. Built-in power supply requires 115V, 400 cy, 196 watts. External 60 cy power supply may be made to furnish plus 350 and -1300 vdc and 6.3 vac. In excellent condition, with all 19 tubes, schematic with parts values, parts-location pictures, operating instructions, theory explanation, and maintenance charts. Shipping weight 60 lbs. Used, good. Price each \$19.50

NO C.O.D.'s. REMIT FULL AMOUNT WITH ORDER. ALL PRICES F.O.B. PASADENA.

C & H SALES CO.

2176 E. Colorado St. - Pasadena 8, Calif.

TV PICTURE TUBES At Lowest Prices

10BP4 \$ 7.95	17BP4 \$ 9.95	21AMP4\$15.75
12LP4 8.50	17CP4 17.00	21ATP4 15.75
14B/CP4 9.95	17GP4 17.60	21AUP4 15.75
16DP4 12.00	17HP4 12.50	21EP4 13.50
16EP4 12.75	17LP4 11.50	21FP4 14.50
16GP4 14.50	17QP4 9.95	21WP4 14.00
16KP4 9.95	17TP4 17.00	21YP4 14.50
16LP4 10.95	19AP4 16.00	21ZP4 13.50
16RP4 9.95	20CP4 13.50	24CP4 23.50
16WP4 12.00	20HP4 14.50	24DP4 24.50
16PT4 9.95	21AP4 22.10	27P4 39.95
17AVP4 12.50	21ALP4 15.75	27RP4 39.95

1 Year Warranty
Aluminized Tubes \$5.00 more than above prices. Prices include the return of an acceptable similar tube under vacuum.
These tubes are manufactured from reprocessed used glass bulbs. All parts and materials including the electron gun are brand new.

ALL PRICES FOB CHICAGO, ILLINOIS. Deposit required, when old tube is not returned, refundable at time of return. 25% deposit required on COD shipments. Old tubes must be returned prepaid. Tubes shipped Rail Express.

WRITE FOR COMPLETE LIST.

PICTURE TUBE OUTLET

3032 MILWAUKEE AVE.
CHICAGO 18, ILLINOIS
Dickens 2-2048

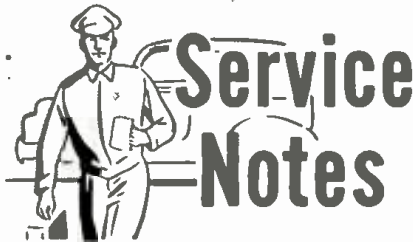

Service Notes

PHILCO: AMPLIFIER HUM

If, in the absence of tube or circuit defects, there is some residual hum in home-radio models G-1906-1907, a satisfactory reduction may be realized by rewiring the ground connections in the front end of the amplifier. This can be done with reference to Fig. 1, showing the amplifier removed and viewed from the bottom. Fig. 1A shows the original wiring, whereas Fig. 1B shows the recommended wiring.

Capacitor C_4 , the .01- μ f. unit directly in back of the loudness control (be-

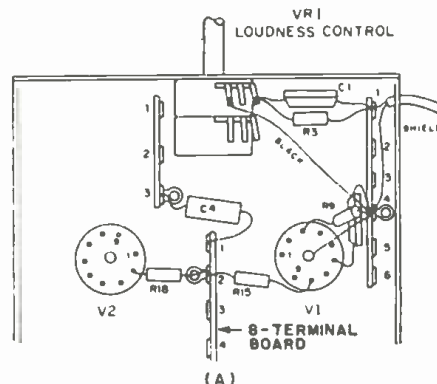
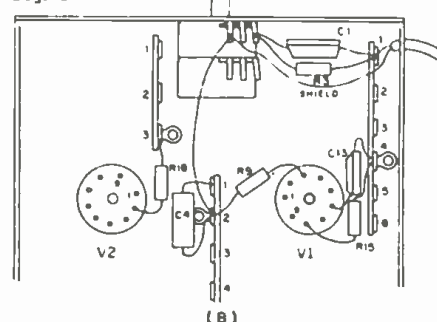

Fig. 1



tween pin 1 of the 8-lug strip and pin 3 of the 3-lug strip) has its ground connection transferred from the 3-lug terminal to pin 2 of the 8-lug terminal. The 470,000-ohm resistor (R_{w2}) going from pin 2 of V_2 to ground on the 2nd lug of the 8-lug terminal board is now grounded to the 3rd lug of the 3-terminal strip. The 2700-ohm cathode resistor (R_{w1}) going from pin 3 of V_1 to ground on lug 4 of the 6-terminal wiring panel is rewired so that it is grounded at the 2nd lug of the 8-lug strip. The outer shield of the input cable from the function switch, originally grounded on pin 4 of the 6-lug panel, is now grounded on the low end of the loudness control. The black wire from the low end of the loudness control, originally grounded to lug 4 of

SURPLUS BUYS

NEW—OIL CONDENSERS—NEW

800VDC	1,000VDC	2,000VDC	4,000VDC
1Mfd \$.40	1Mfd \$.60	1Mfd \$.85	1Mfd \$ 3.50
2 " .50	2 " .80	2 " 1.50	2 " 6.25
4 " .35	4 " .55	4 " 1.00	4 " 4.00
8 " .25	8 " .40	8 " .75	8 " 3.00
10 " .15	10 " .25	10 " .50	10 " 2.00

BC-733—With all Tubes, Dynamotor, and Conversion. Excellent Condition \$7.95

DC POWER SUPPLY—US Navy—PP 236/U. Input 115-VAC 60 Cy. Output 28V .0A Fansteel Rect. Filtered. Housed in Gray Cabinet 7X7X7. Pilot Lite. 3 matching connectors. Under Rated—12 lbs. Brand New \$9.95

DC POWER SUPPLY—Input: 115V-60Cy. Output: 14VDC. 3 amperes Filtered. Relay Control in Metal Case. This is a useful item for dynamotors, relays, battery chargers, model RR, etc. 8" x 12" x 8"—35 lbs. Brand New \$8.95

TUBE CHECKER I-177—Mutual Conductance. Clean operating cond.—With CQ article & Tube Chart \$24.95

COA-6089 VERTICAL GROUND PLANE ANTENNA—72.5 Meters—2x U/w TRY Equip. 1500 Ohmic w/ all hardware. 4 40" Ground Plane Clamps. 2 27" lengths of RG8/U w/Coax Conn. & 1 Feed Thru Coax Conn. 2 4" or 6" Meters—w/Tech Man in kit crate \$35. lbs. \$9.95

PANEL TYPE FREQUENCY METER—Reed type. 115V—58-62 cycl. New \$10.95

POW. FILA. XFORMER—Pri—115V-60 Cy. Sec. 300-0-300V-100 Ma; 12.6 VCT-3A; 12.6V-3A; 5.0V-3A. Open Frame—Compact—Useful as 12 or 24 Volt Transf. for Surplus Gear (U/W RA-20 P.S.) New \$24.49

4 1/2" Sq. METER—Mirror Scale, 1% accur. Basic 0-1 Mil movement. Scale 0-2.5KV with original multiplier. Sig. Corp. New \$7.95

PANEL METERS

Min. Meters—1 1/2" Sq.—DeJur 0-100 u/a.	\$3.95
2" Rd.—Weston—New—0-3A RF.	2.95
2" Rd.—Tripp—500 Mil.	2.95
2" Sq.—100 Ohm. "S" 50ohm over S-D. New.	2.49
2" Square—Tripp—50 Amp AC.	2.49
2" Square—Simpson—50 Micro Amp. Boxed.	4.95

ARC-5 Recvr.—3.6 Mc BC 454. New \$11.95

1625 RCA. W.E., GE. New, Boxed, Dox. \$2.50

MD-7 PLATE MODULATOR for ARC/5 Used, OK \$8.95

BC-456 SCREEN MOD. for ARC/5. Used, OK \$5.95
Sorry, no instructions now. Used, OK \$1.95

3" SCOPE UNIT HOUSING 3FP7. These are the units used as modulation monitors, and TV set testers.

TS-557T IMPEDANCE BRIDGE—(Leeds N. Rheostat, WE 2A Fixed Induct; 1B Imped. Bridge) Wood Crate and Pack (NO TM). New \$10

RGB/U—500' Wood Reels. New \$35

SELENIUM RECTIFIER—FWB—0-30VAC. Input—20 Amps—with matching Xformer 115V—60 Cy—30VAC—12 Amps. Deliver 24VDC—12 Amps—Perfect for Art 13. Etc.—W/Instr. New \$24.95

REX RADIO SUPPLY CO.
84 Cortlandt St.
New York 7, N. Y.
In the Heart of New York's Radio Row

MERRY XMAS SURPLUS!

METERS
G.E.—WESTINGHOUSE—W.E.—WESTON, Etc.

2" R.F. Amp. 0 To 9A	1.95	3" Milliamperes 0 To 1 DC (Calib.)	3.50
2" Milliamperes 0 To 1 DC	2.95	0 To 1 DC (Face)	3.50
0 To 3 DC	2.50	0 To 25 DC	2.95
0 To 10 DC	2.50	0 To 50 DC	2.95
0 To 100 DC	2.50	80-80 DC	2.95
0 To 200 DC	2.50	0 To 100 DC	2.95
0 To 250 DC	2.50	0 To 150 DC	2.95
		0 To 200 DC	2.95
		0 To 250 DC	2.95
		0 To 500 DC	2.95
2" Volt Meters 0 To 15 DC (1MA)	2.95	3" Amp. Meters 0 To 1.5 DC	2.95
0 To 15 AC	1.50	0 To 1.5 DC	3.95
0 To 25 AC	2.50	0 To 15 DC	2.95
0 To 150 AC	2.95	0 To 10 RF	2.95
0 To 300 DC	2.95	0 To 30 RF	2.95
3" Volt Meters 0 To 15 AC	2.50	3" Microamperes 0 To 50 DC	6.95
0 To 150 AC	3.50	0 To 100 DC	6.95
200-0-200 DC	3.50	0 To 200 DC	6.95
0 To 500 DC	3.50		
0 To 750 DC	3.50	2" Decibel Meters	2.50
		3"	3.50

3" DC Kilovolt Meters: All 1 MA Full Scale Movements. Use with external multipliers. 0 To 1.5; 0 To 3; 0 To 4; 0 To 5. Ea. \$2.95

CAPACITOR SPECIAL
10 MFD 600 V. Oil filled Pyranol. Solar, Westinghouse, Etc. Ea. 75c
4 for \$2.50

SYNCHROSCOPE
ID-59/APA-11. Use as test scope. Has sweep of 25 to 20,000 Cy. Use as synchroscope, and pulse analyzer. Complete with all tubes. 115 V. 400 Cy operation. Exc. Condition. \$16.95

LOW VOLTAGE TRANSFORMER
This Transformer produces 6, 7, or 8 Volts. AC 241.8 Amps. Input 115 Volt. 60 cycles. Ea. \$2.95
All New \$10.00
4 for \$10.00

RECORDING BLANKS
New 16" Record Blanks. Make your own recordings. Aluminum base. Lacquered both sides. Professional quality. Late Stock. Ea. \$4.00
Package of 10 \$40.00
Package of 100 \$350.00

See our previous ad for Special Surplus Items. All prices F.O.B. S. F., Calif. Calif. orders add 3% Sales Tax. 20% Dep. on all C.O.D.'s. Purchases under \$5.00 send full amount. Items subject to prior sale.

STANDARD SURPLUS
1230 Market St., San Francisco 3, Calif.
Telephone HEMlock 1-3106

the 6-lug strip, is now grounded to lug 2 of the 8-lug board.

After these changes are made, the hum potentiometer should be adjusted for minimum audible hum. The rewiring described was incorporated in later production.

RCA: RASTER PARASITICS

In the 800 series of portable receivers, parasitic oscillations in the horizontal-output stage may show up in the raster as a jagged or irregular vertical line on the right side of the picture. This is likely to occur when the width control must be set to its maximum position in order to overcome a condition of abnormally low line voltage. This symptom can be eliminated by inserting a 120-ohm suppressor resistor in the screen grid, pin 4, of the horizontal-output tube, a 17DQ6A, as shown in Fig. 2. When these conditions arise, it is also a good idea to check the 15-ohm cathode resistor, R_{106} . Make sure that a good ground connection exists at the bottom end and that the resistor's leads are kept as short as possible.

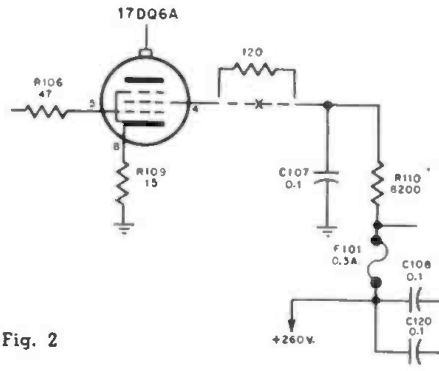

Fig. 2

imum position in order to overcome a condition of abnormally low line voltage. This symptom can be eliminated by inserting a 120-ohm suppressor resistor in the screen grid, pin 4, of the horizontal-output tube, a 17DQ6A, as shown in Fig. 2. When these conditions arise, it is also a good idea to check the 15-ohm cathode resistor, R_{106} . Make sure that a good ground connection exists at the bottom end and that the resistor's leads are kept as short as possible.

ADMIRAL: HORIZONTAL DRIVE

If the correct setting of the horizontal-drive control is near the end of its range, making proper adjustment difficult, a simple change in the horizontal oscillator may center this control properly in models using the 18Z4 and 19Z4 series of chassis. Except for late-production chassis, resistor R_{421} is 120,000 ohms and R_{424} is 3900 ohms. These

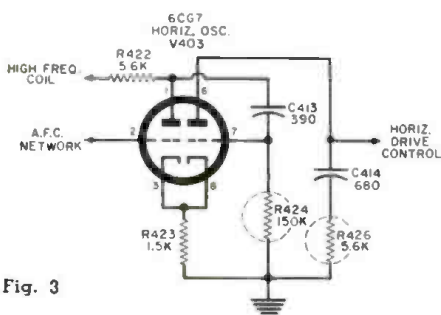

Fig. 3

should be changed respectively to 150,000 ohms and 5600 ohms. In each case, a 1/2-watt unit will suffice. R_{421} is connected between pin 7 (grid) of horizontal-oscillator V_{403} (See Fig. 3), a 6CG7, and ground. R_{426} is connected between ground and C_{414} . The latter is connected to the drive control and pin 6 (plate) of V_{403} .

VIDEO ELECTRIC COMPANY says: DOWN WITH RISING COSTS OF

ELECTRON TUBES
OVER ONE MILLION USED TUBES TO SELECT FROM

Each and every tube is tested by our supplier under actual operating conditions in Radio, FM, Hi-Fi, Industrial Equipment and Television Chassis or Intricate Testing Equipment for Mutual Conductance and Life Test.

Below is a Partial List of Over Three Hundred Popular Types! Write for Free Complete List and Order Blank!

0A2	5AR4CT	6BC5	6L7	717	19
0B2	5A24	6BC7	6M7	7N7	19A5UCT
0B4	5BR7	6BC8	6Q7	7Q7	19D6CCT
1A5CT	5BR8	6BD6	6S4	7X7/KRPM	19F8
1A7CT	5B07	6BE6	6S7	7Y4	2A6
1B3CT	5CC8	6BF5	6S8CT	7Z4	25AV5
1C5CT	5T8	6BF6	6S9Y	12A8	25AV6
1M4C	5U4C	6BG6	6S7	12A8S	25AR4
1M5CT	5U4CA	6BK6	6S7	12AT6	25B06
1L6	5U4GB	6BR5	6S7	12AT7	25DMG
1L8	5UB	6BR7	6S7	12AT7	25L6CT
1M5CT	5V4C	6BL7CT	6S7	12A8	25L6CT
1Q5CT	5V6CT	6BM6	6S7	12A8S	25L6CT
1R7	5Y3CT	6B06CT	6S7	12A8S	25L6CT
1S5	5Y3C	6B07	6S7	12A8S	25L6CT
1T4	5Y4C	6B07	6S7	12A8S	25L6CT
1Y5CT	6A7	6B07	6S7	12A8S	25L6CT
1U4	6A6	6B07	6S7	12A8S	25L6CT
1U5	6A6A	6B07	6S7	12A8S	25L6CT
1V2	6A7	6B07	6S7	12A8S	25L6CT
1X2	6A7A	6C4	6U6CT	12B4	25L6CT
2A3	6AC3	6C5	6U6	12B4	25L6CT
2A7	6AC3	6C5	6U6	12B4	25L6CT
2AF6	6AC3	6C5	6U6	12B4	25L6CT
2AL5	6AC3	6C5	6U6	12B4	25L6CT
2AU6	6AC3	6C5	6U6	12B4	25L6CT
2AV6	6AC3	6C5	6U6	12B4	25L6CT
2BC5	6AC3	6C5	6U6	12B4	25L6CT
2BE6	6AC3	6C5	6U6	12B4	25L6CT
2BM6	6AC3	6C5	6U6	12B4	25L6CT
2BY6	6AC3	6C5	6U6	12B4	25L6CT
2Z6	6AC3	6C5	6U6	12B4	25L6CT
3CB8	6AC3	6C5	6U6	12B4	25L6CT
3C9B	6AC3	6C5	6U6	12B4	25L6CT
3C9S	6AC3	6C5	6U6	12B4	25L6CT
3D7B	6AC3	6C5	6U6	12B4	25L6CT
3L7A	6AC3	6C5	6U6	12B4	25L6CT
3Q4	6AC3	6C5	6U6	12B4	25L6CT
3Q5CT	6AC3	6C5	6U6	12B4	25L6CT
3J4	6AC3	6C5	6U6	12B4	25L6CT
4BC6	6AC3	6C5	6U6	12B4	25L6CT
4B7A	6AC3	6C5	6U6	12B4	25L6CT
4B7	6AC3	6C5	6U6	12B4	25L6CT
5AM6	6AC3	6C5	6U6	12B4	25L6CT
5AN6	6AC3	6C5	6U6	12B4	25L6CT
5AQ5	6AC3	6C5	6U6	12B4	25L6CT
5AS8	6AC3	6C5	6U6	12B4	25L6CT
5AT8	6AC3	6C5	6U6	12B4	25L6CT
5AU8	6AC3	6C5	6U6	12B4	25L6CT
5AV8	6AC3	6C5	6U6	12B4	25L6CT
5AW4	6AC3	6C5	6U6	12B4	25L6CT

GUARANTEE: We guarantee to replace FREE for one (1) year any tube purchased from us which fails to function efficiently under actual operating conditions. Refunds will be made promptly for any defective merchandise.

WE HAVE OVER 1000 USED TV SETS

At All Times In Our Huge Warehouse Buy one or more of these WORKING TVs to sell or use as your own second set! All sets in GOOD WORKING condition!

Your Choice—Console or Table Model

10"	\$23.00	17"	\$46.00
12"	\$28.00	19"	\$58.00
14"	\$33.00	20"	\$64.00
16"	\$40.00	21"	\$72.00
		24"	\$99.00

When ordering TVs, state whether table model or console is desired. All Also, preference on make of set. All TVs sent railway express F.O.B. Newark. On any quantity, WIRE or CALL today!

SEND for our FREE complete TUBE & PARTS LIST and order blank.

FREE Bonus Antenna Given with Any TV Set Order!!

FREE RCA "Cheater" Cord Given with Any Tube Order of \$7.00 or More!!

WIDE

FREE POSTAGE in U.S.A. and Territories on orders over \$5.00. 25¢ handling charge on orders under \$5.00. 25% deposit required on C.O.D.'s. Please send approximate postage or freight on Canadian and foreign orders. Subject to prior sale.

VIDEO ELECTRIC COMPANY
9-15 Sixth St., Harrison, N. J.

RADIO PARTS STORES & HI-FI SALONS!

Hundreds of dealers across the nation profit by selling ELECTRONICS WORLD each month to their customers. Are you one of them? ELECTRONICS WORLD helps build store traffic . . . keeps customers coming back month after month for the merchandise you sell—and, best of all, you earn a neat profit on each copy sold—No RISK INVOLVED.

So get details on selling ELECTRONICS WORLD, the world's largest selling technical electronics magazine. Or, order your copies now. Just use the handy coupon below.

Direct Sales Department
Electronics World
One Park Avenue
New York 16, New York
Att: Jerry Schneider

Send me copies of ELECTRONICS WORLD for resale in my store each month. No risk involved on my part.

Send me details on selling ELECTRONICS WORLD in my store.

STORE NAME _____

ADDRESS _____

CITY _____ ZONE _____ STATE _____

SIGNATURE _____

EW 129

RESIST-O-CADDY



FREE! with any of 4 Handy-Pak Carbon Resistor Assortments
20 Values

\$14⁴⁰ to \$28⁸⁰

Dealer Net

• COMPACT
• HANDY

• Plastic Pouch Fits Tube Caddy or Tool Kit

Order from your IRC Distributor



INTERNATIONAL RESISTANCE COMPANY
DISTRIBUTOR SALES DIVISION
414 N. 13th STREET • PHILADELPHIA 8, PA.

Electronic Countermeasures (Continued from page 49)

are sufficiently stronger than the true one, the actual target may not even be detected.

Another countermeasure which provides false range information is the technique of "range pull-off". Pulses sent out by the ECM transmitter are slowly shifted in timing, relative to the arrival of the enemy's pulses, thus simulating a change in target range.

It is more difficult to obscure the direction of the target than its range. One way of providing false directional information depends upon the presence of side lobes in the pickup pattern of the radar receiving antenna. The ECM transmitter is turned off while the target is in the main beam, but sends out strong spurious pulses when it is in one or more of the side lobes. This creates false targets on the radar scope, with different bearings from the true target position by several degrees.

Another way to confuse the enemy as to target bearing is to rotate a directional reflector on the target thus producing an amplitude modulation of the returned radar echo. This modulated echo is particularly effective in misleading a radar that uses conical beam-scanning to determine the direction of a target.

The launching of decoy missiles is a

useful form of defense against a radar-guided interceptor. The decoy is equipped with a device (corner reflector or Luneberg lens) to make it return a very strong radar echo; this strong echo can fool the attacker into following the decoy instead of the bomber. Similarly, decoys can be used against infrared missiles.

Counter-Countermeasures

Having considered the countermeasures activity being pursued today, it is natural to conclude with a look at counter-countermeasures. Since most countermeasure devices must be tuned to the operating frequency of the radar which they seek to counter, the counter-countermeasure is to design radio or radar systems which can change their operating frequency quickly. The DEW Line, for example, has such provisions.

To counter the spurious-pulse countermeasure systems, the radar may vary pulse length or repetition rate or use a modulation of the pulse to give it an identifiable characteristic.

Future of Countermeasures

Continuing advances in electronic techniques and devices daily increase the potentialities of electronic warfare, but simultaneously provide new scope for ingenuity in ECM. It is clear that the improved communications and detection systems of tomorrow will have their counterparts in improved countermeasures.

-30-

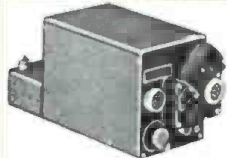

ARR-2 UHF RECEIVER

R-4/ARR-2 Receiver is tunable over the frequency range of 234-258 mc. Uses 11 miniature tubes. In excellent condition complete with TUNING MOTOR and ALL TUBES. \$2.95 ONLY

RM-52 REMOTE CONTROL FOR PHONE PATCHERS

Also can be used with RM-53 as separate phone system: direct control for radio equipment. Provides bias for mic. & Siletone headset. High or low impedance. THIS IS BRAND NEW! \$1.95

EE-8 FIELD PHONES

The standard signal corp. field telephone requires 2 flashlight cells for operation over many miles. Good checked out condition. ONLY \$7.95 Each \$15.00 Per Pair

BC-728 MARINE RECEIVER

2-6 Mc. AM. Self-contained 12 V. or portable power supply AND speaker! May be pre-tuned to any four frequencies thru simple adjustment of 4 push-button assembly. In good, used condition. \$7.95
Top Bargain at

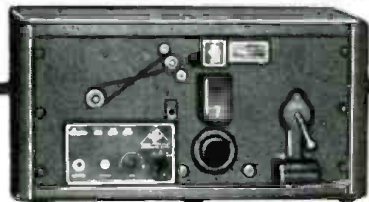

TG-10 CODE PRACTICE SET

Learn to copy code, or improve your speed with this unit. For Individuals and especially fine for schools or groups. Complete automatic unit operating from 110 volt 60 cycle using linked paper tapes to reproduce via an audible means, the Morse code. The keyer may be set from 5 words per minute to 25 words per minute. Use of a key instead of tapes for classroom work especially good due to 10 watt amplifier allowing many sets of carbonates to be connected. These are NEW IN ORIGINAL BOXES for only. \$19.95
TG-10 in used excellent condition only. \$15.95
COMPLETE SET OF 15 Code Tapes in Carrying Case \$15.95

MODEL GR 804 GENERAL RADIO SIG. GENERATOR

Measures and checks receiver alignment and sensitivity. Frequency covered in 5 steps and is read directly from freq. dial. The variable internal modulation is indicated on a percentage modulation meter. Calibrated dial and attenuator indicates output power. CHARACTERISTICS: Freq. range: 7.6-2350 Mc. Output: 1 microvolt to 20 millivolts up to 100 Mc/sec; 1 microvolt to 10 millivolts from 100-350 Mc/sec. Output impedance: 75 Ohms. Accuracy: ±2%. Attenuator: variable capacity voltage divider. T-pad attenuator provides for additional external attenuation. Tubes: one ea. of 9X5, 6X4-G, 6G4-G, 6V6-5. Power input: 115/230 V., 25 W., 40/80 cyc. single phase. Dim: 9 x 19 1/2 x 11 3/8". Wt. 36 lbs. No batteries required. Units checked out and in operating condition. \$89.50

TV-3/U HICKOK DYNAMIC MUTUAL CONDUCTANCE TUBE TESTER

Portable unit designed to measure and test MC values of electron tubes, both receiving and smaller transmitting types. A multi-meter section permits measurement of AC and DC voltages, DC mill resistance and capacity. Entire unit enclosed in aluminum carrying case with built-in compartments for accessories or spares. Units have been completely overhauled and include latest Hickok Electrical tube charts. Power input: 105-125 V; AC 50-1000 cycles, single phase; 50 W min. @ 60 cycles. Current drain: 33 amps. Meter ranges in micro mhos: 0-3000, 0-6000, 0-15,000. AC and DC Volts: 0-20, 0-200, 0-500, 0-1000. DC milliamperes: 0-20, 0-200. Resistance: 0-1 megohm, 0-100 megohms. Capacity: 0-5 and 0-50 microfarads. Accuracy: ±3% of full scale deflection for the DC ranges, ±5% for AC ranges, ±5% at mid-scale values for resistance ranges, and ±10% of all microhm ranges. Ready to go at this bargain price! \$99.50

FILTER CHOKE

9 henries @ 500 MA DC. 87 ohms DC resistance. 12,500 RMS Volt Test. Size: 9 1/2" high x 9 1/2" long x 8 1/2" wide. Mfg. for Collins Radio by Chicago Transformer! Brand new & Individually Boxed! Orig. cost \$59.50. Our special to You Kw boys. \$9.95 ONLY

RGR/U COAX CABLE: NEW! 50 ft. length. \$2.95
Connectors @ each end. Limited quant.
PL-59 60-AX CONNECTORS—Shining new. Ea. 29¢
4 for \$1.00.

WILLARD WET CELL BATTERY

This is the standard Willard 25-2 dry charged. Made to fit many portables using rechargeable wet 20, 15, batteries. 2 Volt 25 Amp. ONLY \$2.95

THE STEAL OF A LIFETIME

BC-442-A or BR-2 ARC-5 Antenna switching units. Contain double pole double throw Antenna change over relay, thermocouple, RF Meter, and 50mmf 5000 volt vacuum capacitor. Complete unit in excellent condition ONLY \$1.50

T-17 CARBON MICROPHONES USED EXC. \$3.95
BRAND NEW, BOXED \$5.50

CODE PRACTICE SET TG-5

Ideal for Novice training. This unit comes complete with carrying case and earphone with built in standard telegraph key. Two or more units may be used together for CW training or for communications purposes over several miles. Brand New, Ea. ONLY \$4.95
Set of 2 \$9.50

COILED MIKE OR TELEPHONE CORD
Off-beat special! Has seven color coded conductors at each end with spade lugs on each. Extends over 5 ft.—yet is no thicker in diam. than standard telephone cord. Neoprene covered. New. Boxed. 95¢
Recent manufacture (1956). Each \$2.50
Save by buying three for only

BC-603 RECEIVER

20-27.9 Mc. FM. Operates from 12 V. dynamotor. Built-in speaker. 10 pre-selected push-button channels. New or Signal Corps overhauled. In orig. Signal Corps carton. Only \$9.50

95¢ BARGAINS BOX!

Control Boxes as follows: all 95¢ each.
C-35/ARR-2 C-116/ARR-2 C-2/ARR-2
C-26/ARC-5 for single receiver.
C125/ARC-5 Later model than C-26.
MT-65/ARC-5 Triple Receiver Racks.
BRAND NEW 95¢ each
MT-71/ARC-5 Dual Transmitter Racks.
BRAND NEW 95¢ each



100 W. COLLINS AUTOTUNE TRANSMITTER
Famous ART-13 AM, CW, MCW, 11 channel Transmitter tunes the band from 2-18.1 mc. Quick automatic tuning to any of 11 preset frequencies or manually tuned. Has extremely accurate VFO. Self contained modulator uses PP 811 to modulate 813 final up to 90% class "B". Will give top performance with either carbon or magnetic microphone. COMPLETE WITH ALL TUBES. \$34.95
Excellent condition. ONLY

SEND FOR NEW FREE BARGAIN-LOADED INTRODUCTORY FLYER!

TERMS: all orders F.O.B. our warehouse Los Angeles. 25% deposit required on all C.O.D. orders. All items subject to prior sale. Minimum order \$3.00. Orders over 20 lbs. shipped via motor truck or rail express whichever may be cheaper.

5645 WEST ADAMS BLVD.
LOS ANGELES 16, CALIF.
PHONE WEBster 3-7538



AERONETICS INTERNATIONAL

Tube Faults & Tests
(Continued from page 56)

In addition, transconductance measurements may not be a true indication of the tube's performance in the circuit. For example, interelectrode capacity is the critical factor in a high-frequency oscillator and electrode interface resistance is critical in many computer and other pulse circuits. Therefore, only the substitution test can give a valid check of tube performance in such cases. Another problem in depending too much on testers is that tubes are not always measured under true operating conditions. A tube tester, for example, may apply approximately 150 volts to the plates and 130 volts to the screen in some cases. Tubes operating at higher voltages are therefore not adequately checked.

The short-circuit and noise test. It is very important to apply the test for short-circuited elements to a tube of doubtful quality before any other tests are made. This procedure protects the meter (or any other indicator) from damage. Also it follows logically that, if a tube under test has elements that are short-circuited, there is no further need to apply additional tests.

Short-circuit tests are usually sensitive enough to indicate leakage resistance less than about 250,000 ohms. The proper heater voltage is applied so that any tube elements which might short as a result of the heating process will be detected.

The noise test may be nothing more than a very sensitive short-circuit test. A normal short-circuit test is made while tapping the tube. If tube elements are loose—perhaps not loose enough to indicate on the neon lamp—loud crashes of noise (or static) will be heard over and above the normal amount of noise that is present. An amplifier-speaker combination (internal or external) is sometimes used for this check.

The gas test. In all vacuum-type electron tubes, the presence of any appreciable amount of gas is undesirable. When present, the electrons emitted by the cathode collide with the molecules of gas. If the amount of the gas in the tube is excessive, the collisions between the numerous gas molecules and the cathode-emitted electrons release many secondarily emitted electrons and positive ions. The result is a tell-tale flow of grid current.

The cathode- or filament-activity test. The filament-activity test is used to determine the approximate remaining life of an electron tube insofar as the longevity of the cathode emitter is concerned. The test is based on the principle that the cathode in almost all electron tubes is so constructed that a decrease of 10 per-cent of the rated heater voltage should cause no appreciable decrease in emission. If a significant decrease does occur, the outlook for continued, useful life is not good.

YOU NEED THIS...

FREE GIANT ALL NEW 1960 B-A CATALOG

A Complete Buying Guide for Everything in

RADIO TV ELECTRONICS

BA

ANNUAL CATALOG 601

SINCE 1927

204 KING-SIZED PAGES

EVERYTHING IN RADIO TV AND ELECTRONICS

100'S OF NEW ITEMS LISTED HERE FOR 1ST TIME

21 PAGES OF BARGAINS NOT IN ANY OTHER CATALOG

RUSH COUPON TODAY!

BURSTEIN-APPLEBEE CO.

BURSTEIN-APPLEBEE CO. Dept. M,
1012-14 McGee St., Kansas City 6, Mo.

Send Free 1960 B-A Catalog No. 601.

NAME _____

ADDRESS _____

CITY _____ STATE _____

LOOK

NO FURTHER... IF YOU'RE UNHAPPY WITH "HI" HI-FI PRICES. WRITE FOR OUR UNUSUAL AUDIO CATALOG.

KEY ELECTRONICS CO.
120-C Liberty St., N. Y. 6.
Phone CLoverdale 8-4288

BEST IN HI-FI VALUES!

NO DELAY SERVICE | All orders rushed to you in factory-sealed cartons.

Write for free catalog.

audion 25-W Oxford Road
Massapequa, New York

GET INTO ELECTRONICS

V.T.I. training leads to success as technicians, field engineers, specialists in communications, guided missiles, computers, radar and automation. Basic and advanced courses in theory and laboratory. Associate degree in electronics in 29 months. B.S. in electronic engineering obtainable. ECPD accredited. G.I. approved. Graduates in all branches of electronics with major companies. Start February, September, Dorms, campus. High school graduate or equivalent. Catalog.

VALPARAISO TECHNICAL INSTITUTE
Dept. RD Valparaiso, Indiana

"GOODHEART'S GOODIES"

\$11.95 BUYS A 2-METER ELECTRONIC-SQUELCH RCVR AND A 2/6/10 METER XMTR

SCR-522-C: Latest production! Receiver BC-624-C clean as new with all 12 tubes has electronic squelch, improved cascade AVC, more output. Transmitter BC-625-AM clean as new, with all 7 tubes, including the 832's. (Those we opened had 832A's, but we cannot select sets.) Both units mounted in rack and case. This Bendix set is 100-155 mc 4-channel xtl-control AM. Price \$11.95 fob Los Angeles for set and \$3.00 for our Cat. 16C3, which is the original schematic with parts list, I.F., xtl formulas, and instructions for an AC power supply, for recess continuous tuning, for xmtr 2-meter use, and for putting xmtr on 6 and 10 meters.

ARB RECEIVER

CRV-46151, RCA AM superhet. Voice, cw, mcw. 195-9,050 kc continuous in 4 bands. 6 tubes include RF & 2 IF. On a.c., needs ext. power supply & control modification described in instruction sheet you get. Also, with added ctrl box, a great favorite for Marine, Sharp & Easy to convert to 12 v. Sheet tells how. Clean 30 lbs fob Los Angeles. Shipped only by Railway Express collect. A rare buy at... **\$17.95**

& instructions. Shpg wt Shipped only by Railway Express collect. A rare buy at...

SPATTER-FREE SPEECH-AMP/MODUL./PWR-SPLY FOR XMTR OR FOR PUBLIC ADDRESS

Audio: 8-tube chassis with Class B p-p 807's delivers 30 W rms at mod. xfrm sec., which you put in series with B+ to your final for standard plate or 2e/ screen modulation. AGC system holds output to $\pm 0.85\%$ over an input range of $\pm 27\%$. It was designed to modulate 95% regardless of the mod. The 2e/ sec. will love you for this! Includes 1 kc tone osc. and cutoff-biased tone ampl., operative when key shorts out the bias. Has sidetone output. Inputs for 60 ohm dyn. mike or 30-50 ohm carbon mike. For PA audio, 6K-ohm-to-voice-coil xfrm can be connected to the modulating output sec. of the mod. xfrm without affecting the AGC system.

Power supply: 115 v. 1 ph 50/60 cy input. Furnishes all voltages for above chassis plus power for your xmtr. A 390-0-390 25 ma xfrm and 3C23 mercury thyratrons connected as diodes in FW bridge circuit furnish 600 volts filtered dc at 445 ma. Two of the tubes are also used with the xfrm for 60 ohm CT ckt to furnish 300 V filtered dc at 175 ma. A separate xfrm heats the 3C23's. A separate fil. xfrm supplies the audio chassis and has plenty of 6.3 v windings for your other xmtr ckts. For bias and any delays you may need, two xfrms, each with aging taps in their sec's, and two FW xfrms at 105/125 v. 12 V DC at 1 A and -115 V DC at 1/2 A. A 115 v. 50/60 cy blower cools the selenium. Pos. and Neg. adjustable bias voltages come from potentiometers in both the HV and the selenium supplies. You get all the above... nothing else to buy... including all tubes (worth \$32.00 at surplus prices)... and with schematic parts values, and AGC adjustment instructions. FOB Milpitas. **\$49.50** Calif. All for only...



\$850 TEST OSCILLOSCOPE FOR ONLY \$69.50

T5-34/AP. The Armed Forces' accepted standard to see a pulse as it really comes. Video response 100 cy to 3 1/2 mc. Use for color TV. Ready to run on 105/125 v. 30/1200 cy. Has all standard facilities, with sweep 10 cy to 50 kc. 1.5 automatic-triggered sweep to show random or recurrent pulses on per sweep. Compact, but the lens gives 5" picture equivalence. Exc. used, checked out OK, in its carrying suitcase, with reprint of the most important 16 pages of the tech manual. **\$69.50** Shpg wt 40 lbs fob Los Angeles. ONLY...

VHF-UHF MICROVOLTAGE SIGNAL GENERATOR

LAF-2. 90-600 MC accurate to 1%; less than .1% drift. Bolometer-Bridge-metered CALIBRATED 50-ohm output CW or mod., 1 uv to .1 v, leaks less than 1 uv. Ext. pulse or sine mod., or int. rect-wave mod. 0-100% 2-30 usec wd. 60-2500 pps. May also use ext. sync. with adj. delay 3-300 usec before sync fires int. wave. May also be used to sync ext. equipment. Works on 105/125 volts, 50/60 cy. Exc. used, checked out, w/calibration charts and reprint of the needed parts of the Tech. manual. FOB Los Angeles. Gross 100 lbs. **\$89.50** Only...

TIME PAY PLAN: Purchases must total \$83.34 or more. Pay 25% down and balance in 12 monthly payments, each 7% of your purchase total. Send deposit and sales tax (if applicable) with your order.

SCHEMATICS/CONVERSIONS, SURPLUS GEAR

List G. NEW! Send large stamped addressed envelope. Includes many Tech Manuals. Add 25c for chart explaining AN Nomenclature. Example of new listings: 20-page book, representing 100 manuals of compilation, on I-177 Tube Tester, MX-949 Socket Adapter, with test data on all tubes to March, 1957, only \$5.00 postpaid.

Calif. buyers please add 4% when remitting.

R. E. GOODHEART CO.

P. O. Box 1220-A Beverly Hills, Calif.

Improving the Mullard 520

(Continued from page 67)

sistors and bypass capacitors in the output stage. A single resistor of about half the value and a capacitor of twice the value were substituted. Slightly higher power and definitely lower distortion were achieved. Here a reduction in the number of components resulted in improved performance. The same held true when the 1000-ohm screen resistors were removed.

The Power Supply

Further experimentation showed that a higher supply voltage and lower value plate resistors for the EF86 voltage amplifier reduced distortion in this stage. That was not all, though, for removal of the two cathode resistors and associated bypass capacitor and substitution of a single cathode resistor, unbypassed and with feedback applied across it, produced even lower distortion. Re-adjustment of the feedback resistor was necessary here because of the change in value of the resistor to which it is connected. Still another change was incorporated at this point. The original sensitivity of the amplifier was .3 volt input for rated output power which proved to be too high for use with modern high-gain preamplifiers. While component values were being changed in the voltage amplifier and phase inverter, a re-adjustment in gain was undertaken to provide a sensitivity of approximately 1 volt, which is far more compatible with modern preamplifiers.

In the power supply, the filament center-tap is returned to ground through a .02 μ f. capacitor. This proved to be a reliable technique; its principal advantage being that the arrangement is far more tolerant of heater-cathode leakage in the tubes involved and thereby assists in keeping the hum level down. In addition, when the power amplifier's power supply is used to furnish power to associated equipment, particularly high-gain preamplifiers, the heaters are not grounded on either side and the best arrangement for minimum hum can be determined at the more crucial point—the preamplifier.

Although a 5U4 rectifier is used in the power supply of this version of the amplifier to keep operating conditions conservative, a 5AR4/GZ34 may be substituted—resulting in higher supply voltages and slightly improved regulation by virtue of its indirectly heated cathode. The use of this rectifier will increase maximum power output and provide improved distortion characteristics. It is imperative that the filter capacitor voltage rating be more than 500 volts for proper safety margin.

Adjustments and Performance

For those constructors who have the necessary test equipment and insist on absolute peak performance, trimming

the pin 1 plate resistor, R_{10} , of the 6CG7 inverter so that it is slightly higher than the pin 6 plate resistor, R_{11} , will provide better inversion balance and lower distortion. It is also possible to reduce distortion slightly by trimming the output cathode resistor downward a trifle. This cannot be carried too far or the output tube dissipation rating will be exceeded. These are only offered as suggestions and were not incorporated in the author's amplifier.

With the experiments, as described, concluded the results proved most gratifying. Improvement in performance, simplicity in construction, and reduction in cost were all products of the effort. Here is how the final amplifier shaped up: Incorporation of the A-420 output transformer proved worthwhile as the power curve of Fig. 2A indicates. One-half db 20 to 30,000 cps at rated power is certainly a more than respectable response! Frequency response from 5 to 50,000 cps at 1 watt is also characteristic of a fine performer. Fig. 3 shows the square-wave response of the amplifier at 10,000, 1000, and 100 cps as taken on a scope. Only a slight wrinkle appears on the 10,000-cps waveform. Stability was considerably improved, for now a wide range of capacitances can be applied to the output with and without resistive load with no detriment to the performance of the amplifier; very little tilt of the 100 cps top indicates negligible phase shift.

Fig. 2B compares the original and new intermodulation distortion curves—indicating a definite reduction in distortion. The original harmonic distortion specification was .05% at 400 cps at the 20-watt level; for this amplifier, harmonic distortion at this point was still in the residual range of the test instrument, or virtually unmeasurable. Hum and noise in the unit remained quiet 90 db down from rated output. Why look further?

The object of all high-fidelity equipment is the best possible reproduced sound which leads to the final and most important test—listening. Due to circumstances beyond our control, the listening tests could not be audibly reproduced in type, therefore an attempt at description is necessary. One of the outstanding differences between power amplifiers is between one that is stable and one which rings, "spills over," or is incapable of good transient response. This difference became a pertinent factor in the listening-test stage of this project. Two terms applicable to this unit describe it best: "clean sound" and "absence of ringing". The rest of the matter can be summed up in three words—"hearing is believing".

REFERENCES

1. Ferguson, W. A.: "Design for a 20 Watt High Quality Amplifier," *Wireless World*, May, June 1955.
2. Mullard: "High Quality Sound Reproduction" (booklet).
3. Porto, E. J.: "High Fidelity Performance with Mullard's 520 Circuit," *RADIO & TV News*, April 1956.
4. Zale, Ben: "Perfectionist's Power Amplifier," *Audiocraft*, January 1958.

Fix Printed-Board Defects (Continued from page 55)

have been a discriminator or ratio-detector can as well, since most of these are fastened to the board with lugs that also serve as the transformer terminals. We went right ahead—heated up the lugs one at a time and, using a pair of pliers and a screwdriver, managed to pry them into an upright position. It only took 45 minutes—plus another three quarters of an hour to clean up the damage that resulted when the screwdriver slipped. There had to be a better way! At that rate, you could only handle about four jobs a day.

On the next transformer replacement, a soldering aid with one notched tip was used, as shown in Fig. 7. The tip not only makes it much easier to manipulate the lugs while disconnecting them, as illustrated by the magnified view, but the better grip it provides appreciably reduces the hazard of an accidental slip. Re-soldering goes much faster and the rest is easy. Slip the defective can out and drop the new one in. Just make sure the lugs are lined up right, then bend them back and re-solder.

You won't believe it, but there are four ways to patch up a break in a printed circuit—and they all work. Of course, some ways may take a lot longer than others. Here they are, in

order of difficulty: First, you can just melt on some solder to bind the break. This works fine—if you don't melt enough to run into a nearby circuit. After a couple of tries we gave this up. Instead you get a printed-circuit repair kit. This works but was given up because it takes quite a bit of time.

The next two methods, however, are practical. If you only have a small break, get a short piece of bare wire and lay it across the break. A small drop of solder on each end and the job is done.

If the break is large or a fairly long section of wiring has raised from the board, cut out the damaged section completely and replace it with regular hook-up wire.

If you haven't done much work on printed-wire circuits or haven't had good results with the work you have done, these experiences may come in handy. Actually there are just a few general points to remember, and most of them apply to any service. There are right and wrong ways of doing things. When you do a job the right way, you save time and money. Nobody has to tell you what can happen if you do things the wrong way. Take your time with repair situations you haven't run into before. Decide what to do before you start, not after you've already begun to do what may be the wrong thing. Use a low-heat iron and a lot of care. After a while, you won't be saying, "Who wants 'em?" because you will.

Now you'll really know how to use OSCILLOSCOPES!

Get this complete guide to using the handiest test instrument of all

Men who know how to use 'scopes don't guess about trouble-shooting and tough realignment problems. They pin-point troubles fast, adjust them quickly and accurately—and this famous 346-page manual teaches you the methods they use.

MODERN OSCILLOSCOPES gets right down to earth in showing you where and how to use these versatile instruments. Particular attention is paid to AM, FM and TV alignment procedures. Every detail is explained from connecting the 'scope and setting its controls to adjusting components in the chassis being tested. Illustrated instructions teach you to analyze patterns. Even includes data on quantitative measurements and use of 'scopes in lab work, industrial electronics, atomic work and teaching. 370 illustrations.

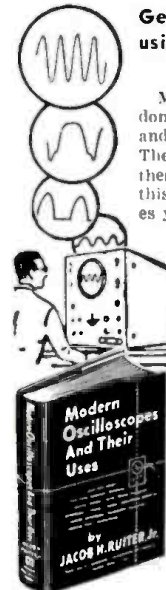

PRACTICE 10 DAYS FREE.

Dept. RN-1298, RINEHART & CO., INC.
232 Madison Ave., New York 16, N. Y.

Send MODERN OSCILLOSCOPES for 10-day no risk examination. If I like book I will then send you \$6.50 (plus postage) promptly in full payment. If not, I will return book postpaid and owe you nothing. (SAVE! Send \$6.50 with order and Rinehart pays postage. Same 10-day return privilege with money refunded promptly.)

Name.....
Address.....
City, Zone, State.....
OUTSIDE U.S.A.—\$7.00 cash only. 10-day money-back Guarantee.

2-WAY CITIZENS RADIO TELEPHONE

(27 MC. CLASS D)



PRICE
\$134.50

*slightly higher
on west coast*

See your dealer, now!

Citi-fone®

by
MULTI-ELMAC

No exam for FCC license ...!

- for
- BOATING
 - MOBILE
 - HOME
 - BUSINESS
 - FARMING
 - SPORTS
 - CAMPING
 - INDUSTRY

5 CRYSTAL CONTROLLED CHANNELS
SQUELCH CIRCUIT • NOISE LIMITER

5 WATTS OF POWER • 7 TUBES IN RECEIVER

MODEL CD-5/6 6 VOLT DC AND 110 VOLT AC
MODEL CD-5/12 12 VOLT DC AND 110 VOLT AC

*Price includes: MICROPHONE, 1 SET OF CRYSTALS,
1 AC CORD, 1 DC CORD WITH CIGAR LIGHTER PLUG

MULTI-PRODUCTS COMPANY
21470 COOLIDGE HWY. OAK PARK, MICHIGAN

What's

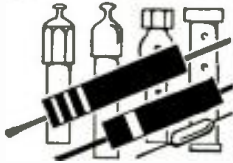

New in Radio

COMMUNICATIONS RECEIVER

A professional-quality superheterodyne communications receiver, the KT-200, has been added to *Lafayette Radio's* line of amateur equipment.

Utilizing 8 miniature tubes plus a tube rectifier and transformer input full-wave rectifier, the receiver provides a sensitivity of 1.25 microvolts for a 10 db signal-to-noise ratio. Selectivity is -60 db at 10 kc. with image rejection -40 db at 3 mc.



All controls, switches, and phono jack, including the built-in "S" meter with adjustment control, are located on the front panel. The b.f.o. and r.f. gain controls are completely variable while a.v.c. and the automatic noise limiter circuits are switchable. The 80-40-20-15 and 10-meter amateur bands are clearly indicated on the illuminated dial face and can be easily tuned with the pre-calibrated bandspread.

Coverage of 455 kc. to 31 mc. is obtained by means of four switchable ranges. The tube complement consists of 1-5Y3, 2-6BF6's, 3-6BD6's, 2-6AV6's, and a 6AR5.

Available in both kit and factory wired forms, the unit is housed in a rugged grey metal cabinet, with hinged top for easy accessibility, which measures 7 $\frac{1}{2}$ " x 15" x 9".

ALL-CHANNEL COLOR ANTENNA

Trio Manufacturing Co. of Griggsville, Ill. has recently introduced a new antenna in its 1960 line, the "All-Channel Color Wing."

The new antenna has three active elements, including an "Extended

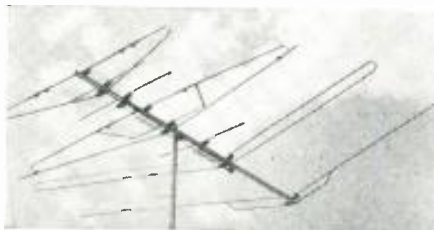

Wing" dipole, a folded dipole, and a ratio-type high-band dipole, accurately phased for maximum efficiency on all

channels. The new unit is gold anodized for attractive appearance and resistance to corrosion.

The company's "No-Strip" lead-in connector, braced reflector elements, "Quick-Lok" clamps, and "Dyna-Coil" phasing features have all been incorporated in this new design. The Model CW-1 comes completely factory assembled.

NEW "HEATHKIT" ITEMS

Heath Company of Benton Harbor, Mich. has added two new items to its line of electronic kits.

The Model XC-2 2-meter converter kit is designed to be used with the "Mohawk" receiver or any other receiver which tunes a 4-mc. segment between 22 and 35 mc., using appropriate crystals. The XC-2 will extend band coverage on such receivers to the 2-meter band with low noise, high sensitivity and gain, and crystal-controlled stability. The new converter is color styled to match the "Mohawk" receiver (RX-1).

The second item is a utility power supply kit, UT-1, which is suitable for



converting the company's "Cheyenne" and "Comanche" mobile gear to fixed-station operation. The UT-1 may be used to provide necessary filament and plate voltage for a wide variety of amateur equipment. The circuit features silicon diode rectifiers, high value filter capacitors for heavy instantaneous current drains, and line filtering for minimum TVI and reduced receiver noise. The unit provides full 150 watts d.c. and filament power for 6.3- or 12.6-volt filament applications; 600 volts @ 250 ma.; 600 volts @ 200 ma.; and 300 volts @ 100 ma. The unit is housed in a green and grey-green cabinet that measures 9" x 4 $\frac{1}{4}$ " x 6".

Write the company for details on either or both of these new items.

PHOTOCONDUCTIVE CELL

The Electron Tube Division of *Radio Corporation of America*, Harrison, N. J. is now marketing a small, cylindrical, side-on type of cadmium-sulfide photo-

conductive cell which has been designed for a variety of industrial light-operated-relay applications.

The 7536 has an illumination sensitivity of 300 μ a per footcandle at 25 degrees C; a maximum current capability of 1000 μ a., and a maximum power-dissipation rating of 50 mw. The photosensitive area is 0.2" x 0.02". The voltage applied between terminals may be as high as 200 volts.

Spectral response of the 7536 covers the approximate range from 3300 to 7400 angstroms. Maximum response occurs at about 5800 angstroms. A technical bulletin providing complete electrical and mechanical specifications is available from the Division on request.

ZENER SUBSTITUTION BOXES

International Rectifier Corporation, 1521 E. Grand Ave., El Segundo, Calif.

has introduced the second in its series of zener diode substitution boxes, the Model B "Zeniack."

The new unit offers a selection of eleven basic 10-watt silicon zener diodes covering the zener voltage range from 3.6 to 30 volts. Housed in a compact, easily portable unit which may be inserted into any breadboard circuit, the decade-type substitution box contains a selector switch enabling interchange of any one of the 11 component diodes, rapidly proving the exact type required in the circuit.

Details on both the Model A (1-watt "Zeniack") and this new Model B are available from the manufacturer.



CONNECTOR FOR MASTER TV

Entron, Inc., P.O. Box 287, Bladensburg, Maryland is now offering a new line of connectors specifically designed for use in master television antenna systems.

The "Tug-Plug" line features new fittings which increase the efficiency of installation and maintenance by permitting plug-in connections which require no special tools for installation.

Fittings for the "Tug Plugs" are available in a variety of models. The EP-600 fits all 300-ohm twin-lead while the EP-700 is available for RG-59/U cable and has an insulated plastic pull-out grip. The EP-700A series is a precision aluminum version of the EP-700. All provide matched impedance.

Additional information on these new plugs and the matching fittings will be supplied by the manufacturer on request.

TRANSISTOR "SERVICE LAB"

Service Instruments Corp. of Addison, Ill. has just introduced a complete transistor radio service "lab" which is said to enable the technician to service any type of transistor radio receiver quickly and profitably.

The "lab" contains the "Sencore" TRC4 transistor tester, the PS103 "Transipak" power supply, and the new HG104 harmonic generator. The transistor tester is designed to test all transistors from the small hearing-aid type to the larger power transistors used in car radio output stages. The power supply is used to power transistor receivers during service and also to monitor the amount of current being drawn by the radio. The harmonic generator is a random generator delivering harmonics from a frequency of approximately 1000 cps up to the r.f. frequencies.

All three units are housed in a color combination display carton and carrying case. The "lab" is currently available at radio and electronic parts distributors.

VR TRANSFORMER

Raytheon Company's Industrial Apparatus Division, Manchester, N. H. has introduced a voltage-regulating transformer that is designed to regulate electronic power supplies compactly and economically.

The new plate-filament transformer performs the same functions as a conventional transformer while maintaining voltage within ± 3 per-cent of rated output with line variations from 100 to 130 volts. Regulating voltage for both plates and filaments, the new transformer prolongs tube life and improves over-all reliability and performance of the equipment in which it is installed.

According to the company the new transformer often eliminates the need for VR tubes or special circuitry and may be used ahead of other regulating circuits so as to provide extremely close regulation.

Three standard models, covering most power supply needs, are available from stock. Non-standard models are available on special order. Write the company for a data pamphlet on these new VRPF voltage-regulating transformers.

TRANSISTORIZED CB RECEIVER

Nunamker, 918 Sixth Street, Portsmouth, Ohio has entered the CB equipment market with the development of a completely transistorized Citizens Band receiver.

The circuit features three r.f. amplifier stages which will produce full audio output when activated by a signal of 1 μ v. or less.

The unit is housed in a metal cabinet that measures 5" x 4" x 5" (from the tip of the antenna connector to the face of the volume control knobs). The circuit is self-contained with the battery power supply housed inside the cabinet. The circuit drives a 2" PM dynamic speaker and full audio output is approximately $\frac{3}{10}$ ths watt. Antenna input impedance is 50 ohms. Although the circuit is designed to be used with a whip antenna cut to the band, the unit will operate effectively from a length of wire, strung vertically, pro-

(Continued on page 132)

YOUR OWN 2-WAY RADIO FOR BUSINESS OR PLEASURE!



VIKING
Messenger

FROM
\$129.75



Anyone can operate — license issued by the FCC on request!

- Complete 23 channel Citizens' Band coverage—choose any 5 channels by the flip of a switch!
- Excellent receiver sensitivity and selectivity—full fidelity voice reproduction!

"More than just 2-way Citizens' Radio equipment"—the Viking "Messenger" offers the finest performance of any equipment available. Meets all FCC requirements. Maximum legal power. Designed for high reliability and easy installation in your home, business location, car, truck, or boat. Built-in Squelch, Automatic Volume Control, and Automatic Noise Limiter. Compact, modern styling—only 5 $\frac{1}{2}$ " high, 7" wide, and 11 $\frac{3}{8}$ " deep. Complete with tubes, push-to-talk microphone, and crystals for one channel.

WRITE TODAY FOR FULLY ILLUSTRATED BROCHURE

E. F. JOHNSON CO
102 Second Ave. S. W. • Waseca, Minnesota

• Please rush me your full color brochure describing the Viking "Messenger" Citizens' Transceiver.

NAME _____
ADDRESS _____
CITY _____ STATE _____

MICRO

ELECTRON TUBE

INTRODUCES FOR THE FIRST TIME
ANYWHERE A SELECT STOCK OF USED
TUBES AT A FABULOUS LOW PRICE

37¢ ea.

FOR any TUBE LISTED

Jan Surplus Tubes!

\$35 PER HUNDRED ASSTD.

ALL TUBES SENT POSTAGE PAID
Please send 25c handling for orders under \$5. Send 25% deposit on C.O.D. orders. Send approximate postage on Canadian and foreign orders.

MICRO

ELECTRON TUBE CO.

- Each and every tube is tested in our own laboratory for mutual conductance and life test.
- We guarantee FREE replacement for one year of any tube purchased from us which fails to function efficiently under any or all operating conditions. Prompt refunds are made on any defective merchandise.
- The advertised tubes are not necessarily new, but may be electrically perfect factory seconds or used tubes—each is clearly so marked.

0A2	5X8	6B86	6SF5	7Z4	198C6G
0Z4	5Y3GT	6B1J6	6SF7	12A8	19J6
1A7GT	5Y4Q	6BK5	6S17	12A05	19T8
1B3GT	6A7	6BK7	6SK7	12AT6	2A4
1H4C	6A8	6BL7GT	6SL7GT	12AT7	25AV5
1H5GT	6AB4	6B86	6SN7GT	12AU6	25B06
1L4	6AC7	6BQ6GT	6SQ7	12AU7	25D06
1L6	6AF4	6BQ7	6SS7	12AV6	25L6GT
1N5GT	6ACS	6BZ6	6T4	12AV7	25W4GT
1Q5GT	6AC7	6BZ7	6T8	12AX7	25Z5
1R5	6AH4GT	6C4	6U8	12AX7	26
1S5	6AH6	6C5	6V6	12A27	2826
1T4	6AK5	6C6	6W4GT	12B27	28
1U4	6AL5	6C6	6W6GT	12B4	35A5
1U8	6AL7	6C86	6X4	12BA6	35B5
1X2	6AM8	6CD6G	6X5	12B7	35C5
2A3	6AN8	6CF6	6X8	12BF6	35L6GT
2AF4	6AQ5	6CG7	6Y6G	12BM7	35W4
3BC5	6AQ6	6CL6	7A4/XXL	12BQ6	35Z5GT
3B86	6A07GT	6CM6	7A5	12BR7	37
3C86	6AR5	6CM7	7A6	12BY7	39/44
3CF6	6AT6	6CN7	7A7	12C5	42
3C56	6AT8	6CS6	7A8	12J5	43
3LF4	6AU4GT	6CS6	7B4	12K7	46
3Q4	6AU5GT	6DE6	7B5	12L6	50A5
3S4	6AU6	6DQ6	7B6	12O7	50B5
3V4	6AU8	6F6	7B7	12Q7	50C5
4B07A	6AV5GT	6H6	7B8	12SA7	50L6GT
4BZ7	6AV6	6J4	7C4	12SG7	50X6
SAS8	6AW8	6J5	7C5	12S7	56
SAT8	6AX4GT	6J7	7C6	12SK7	57
SAV8	6AX5GT	6K6GT	7C7	12SN7GT	58
SAW4	6B8	6K7	7E6	12SQ7	71A
SBK7	6BA6	6K8	7E7	12V6GT	75
SJ8	6BC5	6L7	7F7	12W6GT	76
ST8	6BC8	6N7	7F8	12X4	77
SU4G	6BD6	6O7	7H7	14A7/12B7	78
SU8	6BE6	6P7	7N7	14B6	80
SV4G	6BF5	6S8GT	7Q7	14Q7	84/6Z4
SV6GT	6BF6	6SA7	7X7/XXFM	19	117Z3
	6BG6G	6SC7	7Y4	19AU4GT	117Z6

WRITE DEPT. EW-12 FOR OUR FREE COMPLETE LIST OF TUBES & SPECIAL PURPOSE TUBES

P.O. BOX 55 Park Station, Paterson 3, N. J.

LET THIS 6-VOL. LIBRARY OF CURRENT DATA, FACTS, PRACTICES HELP YOU

"Write Your Own Ticket" in Automation and Computers

Complete background you need to design, analyze, and use all control equipment — ease and speed your work — equip you to take advantage of opportunities in automation boom!

IF YOU ARE NOW a Control Engineer, these six basic handbooks can turn your foothold in automation into a springboard for success. If you want to switch to Control Engineering they will prepare you for a position.

The Control Engineers' Library takes you step-by-step from a "brush-up" in industrial electronic control to an up-to-the-minute knowledge of analog computers. The how-what-why of every subject is thoroughly explained. Clear explanations of control circuits; detailed analyses of automatic feedback control systems; complete mathematical theory of servos; and hundreds of other subjects.

Control Engineers' Library — 2,504 Pages; 1,377 Illustrations



Industrial Electronic Control. Types of electron tubes, circuit components, basic electronic circuits, analysis of complex circuits currently used, and much more. 2nd Ed., photos, diagrams, indexed. 385 pages.

Automatic Feedback Control. Analysis, design, selection, uses of control systems. Illustrated with graphs, curves. Control applications: typical problems in various fields. Methods and procedures supplemented with drawings, diagrams, charts, equations, typical instruments. Indexed. 412 pages.

Servomechanism Analysis. Math theory, math methods of analysis; physical examples, worked-out examples; applying methods to design work, etc. Indexed. 414 pages.

High-Speed Computing Devices. Math methods and physical mechanisms for automatic computation. Character of computers, arithmetic techniques, basic circuits for various functions. Descriptions of several computers to provide examples of integration of techniques and components into complete systems. Indexed. 451 pages.

Electronic Analog Computers. Operating d-c analog computers (including repetitive units) used as differential analyzers and equation solvers. Adapting computers, designing them; circuit information, auxiliary components and computer installation. 2nd Ed., indexed. 452 pages.

Analog Methods in Computers and Simulation. Applying methods to fields of science and engineering. Mechanical, electro-mechanical, electrical, and electronic analog components for performing basic mathematical operations. How such components are combined into mathematical machines for solving equations. Indexed. 390 pages.

Entire 6-Volume Library SHIPPED TO YOU 10 DAYS FREE

Special offer to Readers of this Magazine: Send no money. Certificate below brings you complete Library for 10 days FREE Examination. Then, either return set, or SAVE \$10.00—take 6 MONTHS TO PAY — through this special offer. But hurry; free-examination sets are limited. Mail certificate now.

Free Examination & Discount Certificate

McGraw-Hill Book Co., Dept. ELW-12, 327 W. 41st Street, New York 36, New York

Send me 6-vol. Control Engineers' Library (2,504 pages, 1,377 illus.) for 10 Days FREE Examination. If I decide to keep books, I will remit \$4.50 within 10 days and only \$7.00 monthly until special low price of \$39.50 (reg. price \$49.50) is paid. Otherwise, I will return books within 10 days and owe nothing.

Name..... (please print)
 Address.....
 City..... Zone..... State.....
 Company.....
 Position.....

ELW-12

vided the antenna circuit is retuned slightly.

The detector circuit uses a transistor which is followed by the audio stages, which are low-distortion class "A" types. Power drain is approximately 40 ma. for the receiver.

A companion transistorized transmitter is currently being field tested by the company and will be available shortly. Write the manufacturer direct for complete details and price.

CENTURY'S CRT TESTER

Century Electronics Co., Inc., 111 Roosevelt Ave., Mineola, N. Y. is currently introducing a new instrument which is said to take the guesswork out of picture-tube testing and re-activation.

Known as the Model CRT-2, the unit employs a new circuit designed to test, repair, and re-activate every black-and-white or color picture tube whether in the carton, out of the carton, or in a set. The unit will test for quality, inter-element shorts and leakage, and indicate probable tube life.

Complete control of a unique "Shot" method of re-activation eliminates any



risk which might be involved in the process. A controlled higher voltage pulse method is employed that will restore tubes to new life without danger of stripping the cathode. The "Boost" method of re-activation is said to be effective in improving definition, contrast, and focus.

The circuit is housed in a hand-rubbed oak carrying case with a special compartment for the "Multi-Head" and line cord. The "Multi-Head" is a patented test head with a single cable plug-in which eliminates the need to carry an assortment of cables and adapters.

The manufacturer will supply full details and price on this CRT-2 upon written request.

SOLDER TIP CLEANER

M. N. Leventhal Company, 1806 S. Hobart Blvd., Los Angeles 6, Calif. is now distributing a new soldering tip cleaner which has been especially designed for the servicing field.

The Dickinson #149 soldering tip cleaner is composed of brushes whose bristles have been treated to withstand heat. It is housed in a metal container which stands solidly on the work bench or can be hung or fastened horizontally with screws. The device eliminates fire

KEEP CANDEE HANDEE!

BC-603 FM RECEIVER
 This Special Re-run By Popular Demand! 20-21.9 Mc. 10 push-buttons for channel selection. Continuous tuning. Switch circuit. Complete with tubes, speaker (less dynamotor.) THIS IS BRAND NEW AND ONLY Two for \$18.95
 DM-34 12 V. DYNAMOTOR for above. . . . \$3.95

APR-1 RECEIVER
 Just removed from aircraft, as you know (it's good!) Has self-contained 110 V. 60 cycles power supply. Input 110 V. 60 cye. Excellent. \$22.50
PLUG-IN TUNING UNITS FOR ABOVE:
 TN-1, 38-90 Mc. 15.00
 TN-2, 80-300 Mc. 15.00
 TN-3, 300-1000 Mc. 15.95

APX-6 TRANSPONDER
 A midjet warehouse of parts! Blowers, three Veeder-Root counters, I.F. strips, cavity, over 30 tubes, etc. Includes 3E29 tube. Good cond. A STEAL AT ONLY. . . . \$14.95

BC-733 RECEIVER
 A spunkin' tracker—see C.Q. Magazine Oct/59 for details. VHF. 10 tubes. 6-channel, crystal controlled. Freq. 108.3-110.3 Mc. Dual filter range. Excellent condition. . . . \$6.95

R-4A/ARR-2 RECEIVER
 234-258 Mc. 11 tubes. UHF, tunable receiver. See Aug/59 C.Q. Magazine for conversion. . . . \$2.95
 Excellent cond. Two for \$5.00. Each. . . . \$2.95

2 SPECIALS FOR MARINERS
 R/25 ARC-S MARINE RECEIVER—1.5-3 Mc. Excellent condition. With tubes. . . \$14.95
 T-18 ARC-S MARINE TRANSMITTER—2.1-3 Mc. Excellent condition. With tubes. . . \$9.95

FAMOUS Q 5'er RECEIVER
 190-550 kc. Excellent. With tubes. . . \$12.95
 MD-7 PLATE MODULATOR—Comp. with tubes, Excel. \$6.95

DM-35 DYNAMOTOR
 Input 12.5 VDC, output 625 VDC; input 18.7 A. Output 225 MA. Depot repack. \$9.95
 Like new

MODEL 84 MEASUREMENTS CORP. SIGNAL GENERATOR
 Frequency 300-1000 MC in one band. Individually calibrated direct read dial. Frequency Accuracy ± 0.5%. Output voltage continuously variable from 0.1-100,000 microvolts. Output impedance 50 ohms. Modulation 0-30%. Choice of 400, 1000, 250 cycles. Pulse frequency 60-100 kc. in three ranges: 60-1,000, 600-10,000; and 6 000-100,000 pulses per second. Power supply 117 V. 50/60 cycles. Dim.: 13 x 26 x 12 1/8". Approx. ship. wt. 160 lbs. \$149.95
 Excellent. Checked out. \$100.00
 AS IS. Not checked out. \$100.00

LP-5 SIGNAL GENERATOR
 Freq. 9.5-30,000 Kc. ± 1% in 7 bands. 30-50 Mc. ± 3% (extended range) Output imp. 10 ohms. Amplitude modulated. With power supply. Excel. Checked out. . . \$195.00

NEW TS-13 HANDSET Ea. \$3.95; Two for \$6.95
YOU GOT IT! WE WANT IT! LET'S DEAL!
 We're paying top \$\$\$ for GRC-B; PRC-A, -B, -9, -10; GN-58A; All elect. test equip.

BC-611 HANDIE-TALKIE CHASSIS
 Crystal controlled. 3-6 Mc. Brand new. Boxed. WITH antenna, less tubes, crystal. \$6.95
 colls. Only

APN-1 FM TRANSCEIVER
 420-480 Mc. Complete with tubes. Excel. \$4.95

SCR-522 TRANSCEIVER
 4-channel. Crystal controlled. 10-150 Mc. Ideal for 2 meters. Complete with tubes. Excel. \$14.95

All items FOB Burbank, Calif., subject to prior sale. In Calif. add 4%. Min. order \$3.95.

J. J. CANDEE CO. Dept. R
 509 No. Victory Blvd., Burbank, Calif.
 Phone: Victoria 9-2411

CRYSTAL CONTROLLED CONVERTERS

POLICE • FIRE • COMMERCIAL



For use with 12 V. Transistor type car radios—26-50 MC.

\$24.50

Can be self installed in seconds. Other models for 152-162 MC available. Also complete line of conventional powered converters, tuners and receivers.

A practical converter for emergency use with powered home or auto sets. Tuneable over 12 MC. 26-50 MC or \$13.95
 108-174 MC.



Also available crystal controlled up to 54 MC. \$18.95

ORDER TODAY OR WRITE FOR LITERATURE

KUHN ELECTRONICS
 20 GLENWOOD CINCINNATI 17, OHIO

hazards involved in working with an iron and lasts indefinitely.

The unit is guaranteed not to communicate corrosion to solder joints and



is designed to be used with all types of soldering tips whether guns, standard type irons, or miniatures.

For further details and prices on this new service aid, write the distributor direct.

CHEATER CORD HOLDER

The Wiring Device Department of General Electric Company, Providence 7, R. I. has developed a new "Cord Take-Up Reel" which serves as a convenient holder for cheater cords.

The new reel stores the cord neatly, preventing damage and prolonging its life. The unit eliminates loose, tangled



cords in the tool box and keeps the cord ready for instant use. In use, the cord is simply pulled out of the reel and after use it is quickly rewound by twisting the spindle.

The cord is fully adjustable in length.

Morton Gould (left), noted composer and conductor, is shown receiving the 1959 Institute of High Fidelity Manufacturers Award for "outstanding contributions to music." It is being presented by Joseph N. Benjamin, president of the Institute.



December, 1959



MYSTERY

There's never any mystery about buying from Walter Ashe . . . you're always sure of top quality value . . . and getting exactly the equipment or parts you order!

SUSPENSE

You don't have to hold your breath wondering how long it will take for Walter Ashe to make delivery! Practically every order is shipped the same day direct from Walter Ashe's big, fresh, complete stocks.

SURPRISE

You're in for a big surprise when you get a Walter Ashe's extra big trade-in allowance on your present equipment towards the purchase of any new transmitter or receiver in our 1960 catalog!

The only way we know how to do business with our Amateur friends is to give you the true and complete facts in our catalog . . . price everything we sell as low as we possibly can . . . and give you the best possible service on every order you send us. This has been the Walter Ashe policy for 38

years . . . and it has helped us become one of the Amateur fraternity's biggest and most respected suppliers. We think you'll like our way of doing business . . . and we know you'll like our famous "surprise" Trade-In Allowances! Try us and see for yourself!

NEW 1960 CATALOG NOW READY!

The Only Radio Catalog Compiled and Designed Entirely With The Needs of The Amateur in Mind!

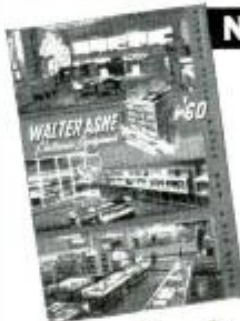

If you're an amateur, experimenter or a newcomer "coming up" . . . you're invited to ask for a copy of our brand new 1960 Walter Ashe catalog . . . just off the press. It's packed from cover to cover with everything that's new and needed . . . in mobile or fixed station equipment, parts and supplies, transmitters, receivers, test equipment and Citizen Band units. Incidentally, Walter Ashe is one of America's leading suppliers of High Fidelity equipment . . . and mail the coupon below . . . we'll rush your copy to you!

You Can Be Sure . . .

that every piece of used equipment Walter Ashe takes in trade . . . and later sells . . . is checked thoroughly and guaranteed to work the same as new. Whether you're trading up to new or in the market for used equipment . . . you'll always be money and satisfaction ahead at Walter Ashe!

Walter Ashe
RADIO CO.

Dept. R-12-59, 1125 Pine Street St. Louis 1, Mo.

IMPORTANT NOTICE TO ALL CITIZEN BANDERS

New FCC rules effective Nov. 15th requires all new C-B transmitters be fitted with tamperproof-sealed oscillator unit. Unless you carry proper operators license you cannot tune, adjust or operate 11 mc CB units built from parts, kits or factory wired that are not equipped with a certified sealed non-tunable oscillator unit. Xtal changing by non-licensed C-Bers is "taboo." Channel changing must be provided for in the factory sealed units.

ESSCO OFFERS for imed. del. FCC certified sealed 3 stage RE assembly. Lineup: 6AK5 buffer & 6BE6 class C amplifier, Pi network antenna tuning. Unit is unique in its high output eff. (75%) and will allow you to use existing C-B gear such as modulator and power supply to make up your own legal setup. THE ESSCO TRI STAGE C-B XMITR any. with 1 1/2 xtal **34.95**

ADDITIONAL CRYSTALS, factory installed only **3.95**

COMPANION MODULATOR UNIT on separate alum chassis III stable quality assured through use of 3 lb output transformer. Provision for stat or carbon mic input. Terminals provided for use with C-B receiver. Factory wired tested unit, complete **19.95**

STABLE regulated & filtered 115 V.A.C. P.S. 14.95
P.S. for 6 or 12 V.D.C. clean 250-300 V. output. 15.95
P.S. KIT for 6 or 12 V.D.C. H.D. type, clean . . . 9.95

The ESSCO DUAL GP antenna, sturdy tempered steel elements. 3db power gain will double your present range **27.95**

"THE C-B NEWS" A monthly info packed bulletin. Will help you obtain the most from C-B operation. Send self addressed #10 envelope for free copy.

ESSCO C-B HQTS 58 WALKER ST. NYC 13, N. Y.

TIME PAYMENT TERMS AVAILABLE ON ALL EQUIPMENT

"SURPRISE TRADE IN" COUPON

Walter Ashe Radio Co. • In Our 38th Year
Your One-Stop Supermarket
Dept. R-12-59, St. Louis 1, Mo.

- Rush New Catalog
- Send lists of guaranteed Used Equipment
- Rush "Surprise Trade-in" offer on My _____

For _____
(Show make and model of equipment desired)

Name _____

Address _____

City _____ Zone _____ State _____

REALIZE YOUR DREAM

Become a graduate Electronics Engineer. Share rewards awaiting college men . . . higher income, rapid advancement. Important firms interview seniors here regularly.

Electrical Engineer in 27 months

B.S. degree in Electrical (Electronics or Power major), Mechanical, Civil, Chemical, Aeronautical Engineering. In 36 Months a B.S. in Business Administration (General Business, Accounting, Motor Transport Management majors). For earnest, capable students. Small classes. More professional class hours. Mature students. Well-equipped labs. Modest costs. Veteran approved. Year-round operation. Enter, January, Mar., June, Sept. Write J. H. McCarthy, Director Admissions, for Catalog and "Your Career in Engineering and Commerce" Book.



16129 College Ave. Angola, Indiana



They'll do a complete job on radio and hi-fi building

FOR STRONG, NOISE-FREE CONNECTIONS...

Dual Heat Soldering Gun Kit

Features the tool that's indispensable in electronic soldering and the favorite of service technicians... the new Weller Dual Heat Gun. Heat and spotlight come on instantly, and 2 trigger positions give 2 soldering temperatures. Switches instantly to low 90-watt or high 125-watt heat as your job requires. High efficiency, long life tip gets into tight spots. Cleaning brush, soldering aid and solder included.



MODEL 8200K
\$795

FOR MAKING CABINETS AND SPEAKER MOUNTS

Sabre Saw

Makes every kind of cut through many materials. Makes its own starting hole for inside cuts. And it's portable, use it anywhere. Exclusive strain-relief design prevents blade breakage. 3 different blades included.

MODEL 800 **\$1995**



Power Sander

Sands wood smooth in a jiffy with big 25 sq. in. sanding area and 14,400 strokes a minute. Assorted sandpaper, polishing cloth included.

MODEL 700 **\$1695**



Available at Electronic Parts Distributors
WELLER ELECTRIC CORP., EASTON, PA.

Resuscitation for Electric Shock

(Continued from page 69)

wide as it must be totally covered by the operator's lips. (On an infant, the operator's mouth should be placed over the child's *mouth and nose*.)

d. The operator then breathes or blows into the victim's mouth, forcefully for adults and gently for children (Figs. 4 and 5).

The victim's chest should be watched and as soon as it rises, the blowing should be stopped and the operator's mouth quickly removed from the mouth of the victim, allowing him to exhale passively.

e. The jaw must be held in an elevated position on both the inspiration and expiration phases.

f. If the chest does not rise, the position of the head (paragraph a) and jaw (paragraph b) should be improved and the blowing done more forcefully. If the victim's lungs are still not ventilated, his airway may be obstructed. He should be placed in a face-down, head-down position, his tongue pulled forward, and patted firmly on the back to dislodge any foreign object.

g. The cycle of inflation and exhalation should be repeated 12 times per minute for adults and 20 times per minute for infants and small children.

h. If the victim's stomach swells during resuscitation, air may be entering it. This may be corrected by the operator gently pressing on the victim's stomach during exhalation.

Back Pressure-Arm Lift Method

a. The victim should be laid on his stomach with his elbows bent and his hands placed (one upon the other) under his head. When the victim is found lying on his back, his arms should be raised above his head and his body rolled over on his stomach by the operator grasping the victim's clothing at the waist and thigh and pulling.

His head may be turned *very slightly* to one side, with the side of his chin resting on the back of one hand. *Do not turn the head too much as this may constrict the windpipe.* Air flow through the windpipe is dependent upon an unobstructed passage, which can be promoted by bending the head backward and pulling the jaw forward. If there is a slope, the body should be placed so that the head is slightly downhill.

The operator kneels at the victim's head on either knee, or on both knees. If on both knees, he places one knee on each side and just above the head of the victim. If on one knee, the knee should be close to the victim's forearm and the foot near the elbow of his other arm (Fig. 6).

The hands should be placed flat on the victim's back so that the heels of the hands lie just below an imaginary line running between the armpits, with the tips of the thumbs just touching and the fingers spread downward and outward (Fig. 7).

b. The operator rocks forward until his arms are almost vertical, allowing the weight of the upper part of his body to exert slow, steady, even pressure downward upon his hands, keeping elbows straight (Fig. 8). About 40 to 50 pounds pressure should be applied to the normal adult. This forces the air out of the lungs.

c. Then the operator rocks back slowly; in releasing the pressure he should avoid a final thrust upon the victim's back. He places his hands under the victim's arms at the elbows (Fig. 9).

d. Keeping the elbows straight, the operator continues rocking backward slowly, drawing the victim's arms toward him and lifting until he feels the resistance of the victim's shoulders (Fig. 10). This armlift expands the chest by pulling on the chest muscles, arching the back, and relieving the weight on the chest. He now lowers the victim's arms gently to the ground.

This completes a full cycle and should be repeated approximately 12 times per minute at a steady uniform rate. The compression and expansion phases should occupy about equal time, the release periods being of minimum duration.

Financing a Business

(Continued from page 65)

schedule for amortizing the cost of modernizing your display room should agree with the percentage you are permitted to write off on your Federal income tax. In order to justify your planned investment in a working stock of hi-fi products you should be able to make a projection of the volume of business you expect to do in this new department. In developing this information, along with the details of how you plan to do it, you will get a clearer picture yourself of what you must do to accomplish your objectives.

These are the facts and figures you must be prepared to supply in applying for a term business loan from your bank. Such records are also essential if you apply for a loan from any of the several new concerns that have been organized under the new Small Business Investment Act. This legislation set up certain provisions for the Small Business Administration to work with small businesses in assisting them to get either operating loans or investment (equity) capital.

In its publication, "Small Marketers Aids #22," the SBA cited the following as the basis on which a credit analysis is usually made when a businessman seeks a term loan:

"Because a term loan covers a period longer than 1 year, your banker is more concerned with long-term financial qualifications than he would be on a loan of a few months' maturity. In this investigation he will examine earning capacity, quality of management, stability of the enterprise, and the extent of the competition facing you.

"Among the factors to be analyzed, the banker will probably include the following:

"(1) Market analysis of the merchandise or services sold by your company.

"(2) Appraisal of the stock, if any, which you carry.

"(3) Investigation of your accounting methods, depreciation schedules, reserve policy, and similar matters.

"(4) Financial analysis of the business covering a period of several years to determine the soundness of the financial position, the trend of earning power, and the projected availability of cash for repayment of the loan.

"(5) Investigation of your personal finances where they might influence the credit standing and earning capacity of your business.

"(6) Estimate of the effect of a recession, war, or other contingency on your business."

The SBA has published a number of special studies, some of which should be of interest to electronic service dealers. A copy of its publications catalogue may be obtained by writing the Small Business Administration, Washington 25, D. C., or from any of the SBA field offices located in principal cities.



PACO is the kit division of **PRECISION** Apparatus Co., Inc., world famous manufacturers of laboratory electronic instruments for over a quarter century.

The new PACO Model SA-40 offers you greater reserve power capacity than any other preamp-amplifier in its category. Its exceptional circuit design assures highly stable performance with extremely low distortion. And...the SA-40 provides maximum flexibility in any stereophonic high fidelity system present or contemplated.

outstanding specifications:

POWER OUTPUT: 20 watts per channel, 40 watts total

RESPONSE: 30 cps to 90 Kc \pm 1 db

DISTORTION:

Harmonic — less than .2% at 20 watts per channel

less than .1% at 10 watts per channel

Intermodulation — less than 1% at full rated output

FRONT PANEL CONTROLS: 14 controls including separate bass and treble controls

POWER SUPPLY: Silicon diode. low impedance for minimum distortion

EXTERNAL DESIGN: gold and satin black hooded case with panel illumination and satin gold panel

At leading parts distributors and sound dealers.

For complete information, write to:

PACO ELECTRONICS COMPANY, INC.

70-31 84th Street, Glendale 27, New York

Export: Morhan Exporting Corp., 458 B'way, N. Y. 13

Can.: Atlas Radio Corp., Ltd., 50 Wingold Ave., Toronto 19

a 40-watt stereo
preamp-amplifier
in kit form
for only
\$79.95 by

PACO

The last
preamp-
amplifier
you'll ever
have
to buy!

also available
factory wired
(SA-40W) ... \$129.95

&

COMING SOON!



Model ST-45
AM/FM Stereo Tuner Kit
matching companion
for the SA-40



Olson



FREE

Fill in coupon for a FREE One Year Subscription to OLSON RADIO'S Fantastic Bargain Packed Catalog — Unheard of LOW, LOW, WHOLESALE PRICES on Brand Name Speakers, Changers, Tubes, Tools, Hi-Fi's, Stereo Amps, Tuners and thousands of other Electronic Bargains.

NAME _____

ADDRESS _____

CITY _____ ZONE _____ STATE _____

If you have a friend interested in electronics send his name and address for a FREE subscription also.

OLSON RADIO CORPORATION

602 S. Forge St. Akron 8, Ohio

**TARZIAN Offers 48-Hour,
Direct Factory Service
on Tuner Repairs**

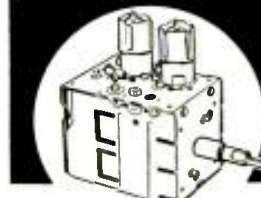

only
\$7.50

That's right. Net, \$7.50 per unit and \$15 for UV combinations, including ALL replacement parts. 90-day warranty against defective workmanship and parts failure. Tuners repaired on approved, open accounts. Replacements offered at these prices* on tuners not repairable:

VHF 12 position tuner . . . \$22.00
VHF 13 or 16 position
tuner 23.00
VHF/UHF combination . . . 25.00
UHF only 15.50

* Subject to change



Tarzian-made tuners are easily identified by this stamping on the unit. When inquiring about replacements for other than Tarzian-made tuners, always give tube complement . . . shaft length . . . filament voltage . . . series or shunt heater . . . IF frequency and chassis identification. Use this address for fast, 48-hour service:

SARKES TARZIAN, Inc.

Att.: Service Mgr., Tuner Division
East Hillside Drive
Bloomington, Indiana

Get

Your First Class Commercial

F.C.C. LICENSE QUICKLY

HOME STUDY OR RESIDENCE CLASSES

Grantham School of Electronics specializes in F.C.C. license preparation. Correspondence training is conducted from Hollywood, Seattle, Kansas City and Washington; also, resident DAY and EVENING classes are held in all four cities. Either way, by correspondence or in resident classes, we train you quickly and well. No previous training is required. A beginner may qualify for his first class F.C.C. license in a minimum of time.

F.C.C. LICENSE—THE KEY TO BETTER JOBS

An F.C.C. commercial (not amateur) license is your ticket to higher pay and more interesting employment. This license is Federal Government evidence of your qualifications in electronics. Employers are eager to hire licensed technicians. We train you quickly—then help you find the job you want.

FOUR COMPLETE SCHOOLS

To better serve our many students throughout the entire country, Grantham School of Electronics maintains four complete Divisions—located in Hollywood, Seattle, Kansas City, and Washington. All Divisions of Grantham School of Electronics offer the same rapid courses in F.C.C. license preparation, either by home study or in resident classes.

MAIL COUPON FOR FREE BOOKLET

Our free booklet, *Careers in Electronics*, gives details of how you can prepare quickly for your F.C.C. license. For your free copy of this booklet, clip the coupon below and mail it to the Grantham School nearest you. Here are the different addresses. Send coupon to any one of these:

GRANTHAM SCHOOL OF ELECTRONICS
1505 N. WESTERN AVE.
HOLLYWOOD 27, CALIFORNIA

GRANTHAM SCHOOL OF ELECTRONICS
408 MARION STREET
SEATTLE 4, WASHINGTON

GRANTHAM SCHOOL OF ELECTRONICS
3123 GILLHAM ROAD
KANSAS CITY 9, MISSOURI

GRANTHAM SCHOOL OF ELECTRONICS
821—19TH STREET, N.W.
WASHINGTON 6, D.C.

To: GRANTHAM SCHOOL OF ELECTRONICS
(Select address from those listed above)

Please send me your FREE booklet explaining how Grantham can prepare me for my F.C.C. license. I understand there is no obligation and no salesman will call.

NAME _____

ADDRESS _____

CITY _____ STATE _____

96-T

In Case of Fire

(Continued from page 53)

ing supplies and materials to the technician who suffers the fire loss. When one owner participating in the agreement suffers extensive fire loss, the others thus help him get back into business immediately even if only on a limited basis.

Beware of bargains. "Bargain" fire insurance can be worse than no insurance at all for it gives one a false sense of security. Every policy you own or plan to take should be checked by your lawyer or some other qualified consultant who knows the actual coverage it provides and the restrictions embodied in the policy. You should have a report in everyday language from him so that you will always know exactly what your insurance dollar is "buying." Cut-rate fire insurance is available because the policy provides inadequate coverage or contains a host of loopholes that may leave the shop owner holding a very large but quite empty sack when settlement time comes.

Deal with a local insurance agent, if possible. Speed is of the essence in avoiding heavy losses in case of fire—speed in settlement of the claim by the company to facilitate your return to active business. The local agent can provide that speed. There may be any number of delays if a distant office must be contacted and a wandering adjuster located. It is also a mighty good idea to find out at the time the policy is under consideration just who the company's claim adjuster is and where he is located so that he can be reached if the local agent is unavailable.

Use fire-prevention and control techniques. Many business men who have had fires have declared, "Despite full payment of my policies, I'd be better off if I had never had a fire." The chances are that extensive fires could have been avoided or damage minimized had the shop personnel known what to do when a small conflagration started. Make certain every person on the shop payroll knows exactly *what* to do in case of fire and that he knows *how* to do it. The best way to insure this is to have a local fire inspector come in and explain the correct procedures at a staff meeting held at least once a year. He will be glad to cooperate as he knows best what should be done and how.

Remember, though, the best prevention program offers no guarantee against a disaster, so you should not feel complacent about taking the measures that will be so vital if and when a fire does occur. If your business is an important factor in your future—and we assume that it is or you would not be in business—don't rely entirely on the cash consolation provided by a wisp of paper—just because that paper happens to be an insurance policy.

ONE CENT SALE

BUY ONE AT OUR REGULAR LOW PRICE AND GET THE SECOND FOR ONLY 1¢ MORE

CITIZENS BAND TRANSMITTER (27 MC) 5 watt chassis, complete with crystal \$14.99 each; two for \$15.00.

CITIZENS BAND RECEIVER chassis tunable through all 22 channels. Complete with audio amplifier. \$9.99 ea. two for \$10.00.

AMATEUR BAND TRANSCEIVER (144-148 MC) chassis with dual VHF triodes for walkie-talkie radiophone. \$9.99 ea. two for \$10.00.

MICROPHONE High output 200 ohm carbon with terminal lugs. \$1.49 ea. two for \$1.50.

COILED CORD 4 conductor 11" telephone cord. Extends to over 4 ft. .99 ea. two for \$1.00.

KIT OF PARTS for AM-FM VHF radio receiver. Tunable from 80-200 mc. which includes U. S. satellite frequencies. \$6.99 ea. two for \$7.00.

TRANSISTOR AUDIO AMPLIFIER gives 50X voltage gain on low level signals. Operates on 1½ volts. \$3.99 each, 2 for \$4.00.

CONVERTER (Crystal controlled) for 27 MC Citizens Band. Adapts any standard broadcast radio to 27 MC band. Tunes all 22 channels. Complete with tubes and crystal. \$14.99 each, 2 for \$15.00.

LIMITED QUANTITY—
NO LITERATURE OR CATALOG

Remit in full. Include sufficient postage.
No C.O.D.'s.

VANGUARD ELECTRONIC LABS

BOX 12-EW12 HOLLIS 23, N. Y.

WHO NEEDS

MILES OF WIRE?

GET
HOME ELECTRICITY
ANYWHERE
WITH A

terado

CONVERTER

Change 6 or 12 volt D.C. to 110 volt, 60 cycle A.C.

No Installation—Just plug into cigarette lighter of car, truck, or boat, and it's ready to go!

Operate lights, electric shavers, dictation machines, record players, small electric tools, portable TV, and testing equipment.

Models from 15 to 200 watts, with prices as low as \$12.95.

"Chief": 75-125 watts, for 6 or 12 volt batteries .. **\$64.95 LIST**



See Your Electronic Parts Dealer or Jobber
terado COMPANY
DESIGNERS & MFRS. OF ELECTRONIC EQUIPMENT SINCE 1927
1058 RAYMOND AVE., ST. PAUL 14, MINNESOTA
IN CANADA: ATLAS RADIO CORPORATION LTD. - ONTARIO

SOUND ON TAPE

By BERT WHYTE

AS YOU know, I promised last month to bring you a report on the latest tape developments from the New York Hi-Fi Show. Unfortunately, I had to leave sooner than I had anticipated on a special recording job in Rome, so the report will have to be delayed. A note in passing on this Rome job in which you may be interested—it involves the use of six channels on 35mm. magnetic film. Not yet used for straight symphonic recording purposes, it is easily applicable and may be a fore-taste of what we can expect in the near future. No, you won't need six separate amplifier-speaker channels! Modern "ghosting" techniques will reduce it to 2-channel stereo (or 4-track as the case may be) although ultimately the ideal medium would be true 3-channel stereo. The six channels afford great flexibility in the control of lateral and depth perspectives and in control of "sound motion" in any recording which is not static, as in operas.

Well, the 4-channel, reel-to-reel stereo seems to be moving along to everyone's satisfaction and I have received several more tapes for review. However, it would appear that some companies are still having problems with their initial production, as selections which have been announced for some time have not yet reached either reviewers' or dealers' hands. Thus, this is in line with the caution I have urged before passing judgment too readily on this new medium. This is a new deal and everybody has a lot to learn before we can begin to enjoy the consistency of quality that was reached with 2-channel stereo. Big strides have already been made and the quality of the tapes reviewed this time reflects a good over-all improvement over the first releases. As far as the cartridges are concerned, there is a lot of momentum here, too. Machines are beginning to appear from first production and other companies are announcing new models. And, some of my worthy contemporaries are reviewing cartridge stereo—albeit they are removing the tape from the cartridge and rewinding it onto a reel, since for the most part they do not have cartridge playback machines. With all due respect, this I will not do—until I have a good, reasonable-quality cartridge playback unit. As far as I am concerned, the cartridge concept must prove itself in its normal operating mode under optimum conditions before I can attempt any evaluation. To me it is pointless to consider the cartridge for any other purpose than for which it was designed. And so, on to this month's tapes.

WHERE
THERE'S
A FINE
TAPE
RECORDER...

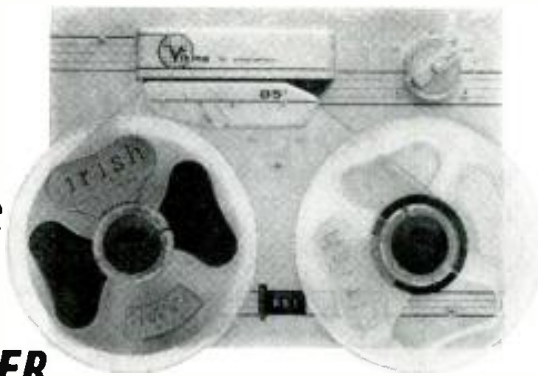

note to **VIKING** owners

To insure optimum recording quality with your machine, the recommended tape is **irish** Long Play #601. Send for technical bulletin.

ORR INDUSTRIES INC.
Opelika, Alabama

Easier-to-build
Grommes
HI-FIDELITY KITS

LAYER BUILT
COLOR GUIDE

"Best buy in its field"
— LIFE MAGAZINE

10 WATT AMPLIFIER—With built-in pre-amp. 20 watts peak. All quality components. Frequency response \pm 1DB. 20-20,000 CPS. 4 inputs. Outputs 4, 8, 16 ohms. Treble, Bass and exclusive Automatic Loudness Control. Punched chassis, color coded, step-by-step instructions. Easily and successfully assembled by anyone with screwdriver, pliers and soldering iron. Model LJ6K...\$24.95



20 WATT STEREO AMPLIFIER with built-in pre-amp and all controls. Model 20LJK...\$59.50

PRE-AMPLIFIER Self powered. 10 controls. .207AK...\$44.50

60 WATT BASIC AMPLIFIER Model 250K...\$79.50

Many other kits available—
At dealers or sent prepaid with check or M.O.

.....**FREE!**

GROMMES Div. of Precision Electronics, Inc. 9101-Q King Ave., Franklin Park, Ill.

Please rush details on Grommes Kit Line.

Name _____
Address _____
City _____ State _____
Your Dealer's Name _____

CROWN
Professional Tape Recorder

STEREO-X

The lightest weight professional stereo recorder made! Excels all other recorders in 4-track recording qualities!

\$695
Less Case

FREQUENCY RESPONSE	IPS FLUTTER	NOISE SPEED & WOW RATIO
\pm 2 db 30-30000 CPS	15	.06% 57 db
\pm 2 db 20-20000 CPS	7½	.09% 54 db
\pm 3 db 20-11000 CPS	3%	.18% 51 db

Write Dept. EW-12 for catalog—also data on professional tape duplicator.

Standard and Stereo models
INTERNATIONAL RADIO & ELECTRONICS CORP.
ELKHART, INDIANA

These men are getting practical training in...

ELECTRICITY ELECTRONICS

ON REAL
Motors • Generators
Switchboards • Controls
Modern Appliances
Automatic Electronic
Control Units

TELEVISION RADIO ELECTRONICS

ON REAL
TV Receivers
Black & White and Color
AM-FM and Auto Radios
Transistors • Printed
Circuits • Test Equipment

Train in NEW Shop-Labs of COYNE

In Chicago—Electrical and Electronic Center of the World. Prepare for a better job and a successful future in a TOP OPPORTUNITY FIELD. Train on real full size equipment at COYNE where thousands of successful men have trained for 60 years—largest, oldest, best equipped school of its kind. Professional and experienced instructors show you how, then do practical jobs yourself on more than a quarter of a million dollars worth of equipment. No previous experience or advanced education needed. Employment Service to Graduates.

Start Now—Pay Later—Liberal Finance and Payment Plans. Pay most of tuition after graduation. Part-time employment help for students. Choose from nine yearly Starting Dates.

Mail Coupon or Write to Address Below for Free Book—"Guide to Careers." Whether you prefer ELECTRICITY, TELEVISION-RADIO or COMBINED ELECTRONICS, which includes both fields, this book describes all training offered.

Information comes by mail. No obligation and NO SALESMAN WILL CALL.

B. W. Cooke, Jr., Pres.

Founded 1899

COYNE ELECTRICAL SCHOOL

Chartered as an Educational Institution Not For Profit
1501 W. Congress Pkwy., Chicago 7, Ill., Dept. 99-6C

MAIL COUPON OR WRITE TO ADDRESS BELOW

COYNE ELECTRICAL SCHOOL
New Coyne Building Dept. 99-6C
1501 W. Congress Pkwy., Chicago 7, Ill.

Send BIG FREE book and details of all the training you offer. I am especially interested in,

Electricity Television Both Fields

Name.....
Address.....
City..... State.....
(I understand no Salesman will call)

GIGI
Original cast (sound track) MGM 4-channel stereo ST3641. Price \$7.95.

This tape is a case in point. One of the most enjoyable movies I have ever seen had an equally enjoyable and charming musical score. "Gigi" is a thoroughly engaging wench and who can resist that gay old Boulevardier, Chevalier? The tunes are catchy, the lyrics clever and the whole a very easy-to-listen-to amalgam.

The sound track did not quite have the brilliance you would expect of a direct studio recording, but was quite acceptable. Transients were clean and solid, dynamics respectably wide.

As to crosstalk, even through the big system, unless a very loud and very soft part were juxtaposed on the opposite tracks, it was quiet and what amount was heard was appreciably lower than on any of the earlier tapes. Rightly recommended as a wonderful item for parties and for entertaining yourself.

TCHAIKOVSKY
NUTCRACKER SUITE
BERLIOZ
ROMAN CARNIVAL OVERTURE
WAGNER
OVERTURE TO MEISTERSINGER
Symphony of the Air (without conductor). Concertapes 4-channel stereo 4T-4002. Price \$7.95.

This recording has certainly done yeoman duty for Concertapes. It first appeared some years back as a 2-track, 7½ ips. stereo tape and was transferred to stereo disc relatively early in the history of that medium. Now we find it on 4-track stereo with, no doubt, stereo tape cartridge in the offing!

The recording is a 2-channel original and is historically interesting in that it was made shortly after Toscanini retired and the NBC Symphony was written out of existence by RCA—or so they thought—for this Symphony of the Air is, of course, the NBC orchestra banded together and giving a concert sans conductor as a mark of respect for Toscanini.

This, then, is essentially Toscanini's orchestra at the height of its power and, as the Symphony of the Air, it survives today. I don't think it unkind to point out, however, that the present orchestra is but a hollow shell, with many of the key personnel dispersed and absorbed by other symphonies across the country. Thus, it does not today have the luster of the virtuoso group that it was under the Maestro. However, more power to them for trying to keep the orchestra an active operating entity—no one wants to see such laudable efforts come to naught.

The performances are not without flaw, of course, but in view of the lack of conductor are remarkably well integrated and are quite a display of orchestral discipline. And, by golly, they even sound like a Toscanini performance, especially the brilliance and blazing inpetus given to the "Roman Carnival Overture." As previously noted, this was a 2-channel stereo original and as such does not have the de-

gree of separation and delineation of instruments as in today's 3-channel masters. While the balance was quite good, the need for the central "ghost" channel is obvious. Other than that, this is a good clean sounding recording, with sharp transients, wide dynamics, and moderately spacious acoustics. In the 4-channel format, there is almost no audible evidence of cross-channel interference and the tape hiss is about on a par with the 2-channel tape. I did hear some occasional print-through, which is probably a consequence of the fact that the tape is getting old and even frequent transfers to low print-through only partially allay this problem. In summation—this is not a tape to be compared with the top efforts today, but it is worth the money for the reasons outlined above.

GERSHWIN
AN AMERICAN IN PARIS
RHAPSODY IN BLUE
Bert Shefter, pianist, Dan Lube, violinist, Ray Heindorf and Orchestra. Warner Bros. 4-channel stereo BST1243. Price \$7.95.

This is one of Warner Bros. first efforts in the classical field and unfortunately leaves quite a bit to be desired. The recording itself is reasonably good—the balance between the piano and orchestra in the "Rhapsody" is excellently maintained with neither one nor the other too prominent. The sound is fairly wide in range and dynamics, recorded moderately close-up but without the crispness of detail and instrumental separation this usually affords when properly applied. The acoustic perspective was not overly broad so this lack of over-all brilliance is a little puzzling. Probably it is a hall characteristic (sound stage?) and this is a tough one to beat. Be that as it may, the sound is good from the stereo aspect and most will find it quite listenable. Musically, Ray Heindorf tries hard but the performances are little more than routine and often quite mannered in terms of tempi, and especially in phrasing and dynamics.

All in all, a bit disappointing but, if we give Warner Bros. a chance, they certainly have the facilities to come up with some first-rate classical material. Let's see!

ONCE UPON A MATTRESS
Original cast. Kapp 4-channel stereo KT41012. Price \$7.95.

This should sell because of the provocative title alone! Actually this play is enjoying a reasonable box office and it would seem from critics' reports that this is a musical better listened to on a recording than seen and heard in the theatre.

It is a mildly farcical and fairly engaging show and the recording itself is bright and clean with excellent transients and spacious acoustics which, however, do not obscure articulation. And, praise be, it is not static and there is plenty of stage motion which the fine stereo directionality shows nicely. Addicts of musicals will probably find this most enjoyable.

coming in January Electronics World:

an up-to-the-minute report on

AIR TRAFFIC CONTROL THROUGH ELECTRONICS!

Giant jet airships thunder across the skies of the world every minute—streaking through a criss-cross maze of airways that allows no margin for error. January **ELECTRONICS WORLD** takes you behind the scenes to see how the Federal Aeronautic Association is using the latest in electronic equipment to tighten its air traffic control—and make air travel as safe as your own armchair!

In addition, you'll enjoy these features in January **ELECTRONICS WORLD**:



- **STEREO ROOM ACOUSTICS (Part One of a Four Part Series):** Learn how to achieve the best possible stereo effect in your home! Part One covers the general/principles of reverberation, room size, and room treatment.
- **A "RUSH SUPPRESSOR" FOR CITIZENS RADIO:** Here's a simple modification, using standard components, that will virtually eliminate noise in any superregen Citizens Band receiver.
- **WHAT DO YOU KNOW ABOUT CAPACITORS?:** Questions and answers on service replacement situations that call for a choice of capacitors. You'll get many helpful tips!

All these features are coming your way in January **ELECTRONICS WORLD**—typical of the coverage you'll enjoy month after month in the world's most authoritative electronics magazine. That's why it's such a good idea to make sure that **ELECTRONICS WORLD** is delivered to your doorstep regularly—by becoming a subscriber. But present subscription rates will be raised in January. Take advantage now of this last-chance opportunity to subscribe at the current low rates!

CURRENT RATES:

one year, \$4

two years, \$7

three years, \$10

ELECTRONICS WORLD, 434 South Wabash Avenue, Chicago 5, Illinois

December, 1959

139

BC-659
\$16.95
RE-NEW

PE-120
\$7.95
RE-NEW

BC-659 FM RECEIVER-TRANS-
MITTER—27 to 39.1 MC FM. 5
Watt. Crystal Control on Two Pre-Set Chan-
nels; with Tubes and Speaker—Re-New... **\$16.95**
PE-120 POWER SUPPLY for BC-659 or BC-620; with
Vibrator for 12 Volt operation—Re-New... \$7.95
BA-41 BIAS BATTERY F/BC-659-620... NEW: \$4.95
AN-29 Telescoping ANTENNA F/BC-659... New: 2.95
FT-250 SHOCK MOUNTING F/BC-659-PE-120—U: 4.95
SCHEMATICS F/BC-659-PE-120 w/voltage &
Resistance: 2.00

BC-603
\$14.95
RE-NEW

BC-683
\$24.95
RE-NEW

BC-603 FM RECEIVER—
20 to 27.9 MC... Re-New: \$14.95
BC-683 FM RECEIVER—27 to
39.1 MC. U: \$19.95—Re-N: \$24.95
BC-604 FM TRNSMTR—20 to
27.9 MC. U: \$4.95—Re-N: \$ 7.95
BC-684 FM TRANSMITTER—
27-39.1 MC... Used: \$ 7.95
FT-237 MOUNTING for Rec. Trans... Re-New: \$ 7.95
FT-346 MOUNTING for Receiver only... Re-New: \$ 4.95
DM-34 DYN. 12V. f/BC-603-683—U: \$2.85—R-N: \$ 4.95
DM-35 DYN. 12V. f/BC-604-684—U: \$6.95—R-N: \$ 9.95
FT-384 TEST ADAPTER For BC-603-683-923—
Used for testing various Voltages and Alignment of
Receivers. Plugs into rear of set; has metering switch &
provision for attaching output meter & V.T.V.M.
Complete with 6 Ft. Battery Leads and Clips. Prices:
USED: \$2.95... RE-NEW: \$4.95

AC POWER SUPPLY
F/BC-603-683—Output: 220
VDC 80MA & 24VAC 2Amps.
Tube Rectification; mounts on
rear Plug of BC-603-683. Can
be adapted to other Receivers.
KIT: \$10.00—WIRED: \$14.95

GROUND PLANE ANTENNA
CITIZEN—COMMERCIAL
Made from sturdy surplus Insulated Base and Screw-in
type Elements. For use in the 25 to 50 MC Bands.
Specially cut to your operating frequency. (Specify
Freq. when ordering.) With Adapter for
1" pipe mounting... **\$14.95**

COLLINS ART-13 TRANS. — \$49.50
2 TO 18.1 MC—100 WATT—PHONE, CW, MCW
The most desired Set on the surplus market—Easily
converted to 10 Meters (See Surplus Conversion Manual
No. 2—\$2.50). Automatic Tuning for selection of 11
Channels in the Freq. Range. Tube Line-Up: 1/8S7,
1/813, 2/1625, 1/12B7, 2/6V6, 2/811, 2/12SL7,
1/12SA7. AC Power Supply requirements: 28 VDC/10
A, 400 VDC/225 MA & 1250 VDC/250 MA. Size:
23 1/2" x 16" x 11 1/2". Wt.: 70 lbs. Price: USED: \$49.50
Price—Same as above—except Less Tubes: 30.00
DY-12/ART-13 24 V. Dyn. w/Filter & Relays—U: 12.95

ALL BAND RECEIVER
NAVY ARB/CRV 46151—190 to
9050 KC—Four Band, 6 Tube
Superhet—Local & remote tuning
and band change; illuminated dial,
sharp & broad tuning; AVC. CW.
provisions for operation of DU-1
Loop. Complete with Tubes:
1/12SA7, 1/12A6, 4/12SF7, & 24
Volt Dynamotor. Size: **\$18.95**
8 x 7 x 10... Used:
ABOVE—Converted to 12 Volt
with Dynamotor (No
band change).....\$24.95
Conversion for 115 V 60 cycle with
Spin Dial, Phone Jack, CW.
Volume Control, On & Off Switch (All on front panel)
—KIT of Parts with Instructions.....\$10.00
Conversion—above—for 12 Volt DC—KIT of
Parts, with Dynamotor..... 10.00
Remote Control Box: \$2.00—Remote Control Shaft: 1.50
Remote Control Head..... 2.00
Tuning Knob for large splined shaft..... 1.00
T-Shaft Adapter for remote and local tuning..... 1.50
PLUGS only—for Receiver or Control Box. Each: 1.00

RECEIVERS:
BC-733 Localizer Rec.—108.3 to 110.3 MC. Used: 4.95
R-23/BC-453 Rec.—190 to 550 KC..... Used: 14.95
R-4/ARR-2 Rec.—540-850 KC: 230-258 MC. R-N: 8.95
BC-1208 Beacon Receiver—200 to 400 KC. R-N: 9.95
BC-652 Receiver—2 to 6 MC—Less Dyn.. Used: 19.95
BC-342 Receiver—1.5 to 18 MC For AC op. Used: 69.50
BC-312 Receiver—1.5 to 18 MC Less Dyn. Used: 59.50
BC-344 Rec.—150 to 1500 KC—For AC op. Used: 49.50

TELEPHONES, HEADSETS, MICS., Etc.:
TS-9 Handset..... Used: \$2.95—New: \$ 3.95
TS-15 Handset, w/PL-55 & PL-68. U: \$2.95—N: 3.95
T-17 Microphone..... Used: \$3.95—New: 6.95
EE-8 Field Telephone..... Used: \$12.95—Recond.: 16.95
BD-71 Switchboard—6 Line..... U: \$14.95—New: 24.95
RM-29 Control Unit..... New: \$6.95—W/Handset 8.95
RM-52 Control Unit (Patch Found.) U: \$1.95—N: 2.95
H-16/U Headset—8000 ohm..... U: \$1.95—New: 2.95
HS-33 Headset—300 ohm..... U: \$4.95—New: 7.95
J-45 Tel. Key—with cord and plug..... New: 1.50

SEND FOR FREE CATALOG!
Address Dept. RM • All Prices F.O.B. Lima, Ohio.
Minimum Order \$5.00, & 25% Deposit on all C.O.D.'s

FAIR RADIO SALES
132 SOUTH MAIN ST. • LIMA, OHIO

1959 INDEX VOLUMES 61-62

As a service to our readers we are again presenting a complete listing of all feature articles which appeared in ELECTRONICS WORLD during 1959. We suggest you keep this for reference.

AMATEUR

ANTENNAS
"Inverted L" Ham Antenna (See, W5LTD)..... 64 Jan.

HAM GEAR
Cover Story..... 39 July
Low-Level Clamp Modulator (Gas-kill, W2BCV)..... 60 May
90-Watt Ham Transmitter Kit (Lab Tested)..... 82 June
1-kw. Final Power Amplifier (Brier, W9EGQ)..... 62 June
Pepping Up 10-Meter Reception (Marler, VE7DS)..... 148 Feb.
Simple "Tune-Operate" Switching for the Ham Transmitter (Pyle, W7OE)..... 114 Mar.
Single-Sideband Transmission (Part 1) (Andrews)..... 68 Sept.
Single-Sideband Transmission (Part 2) (Andrews)..... 76 Oct.
Three-Band Mobile Converter (Reiffin, W5CWP)..... 57 Mar.
Transistorized Double-Sideband Suppressed-Carrier Transmitter (Stoner, W6TNS)..... 48 Apr.
Transistor-Tube "Walkie-Talkie" (Stoner, W6TNS)..... 35 July
Versatile Ham Transmitter Kit (Lab Tested)..... 62 Apr.

MISCELLANEOUS
Air Force Honors Hams..... 82 July
Alphabetical Listing of Countries with Prefixes..... 56 Nov.
Ham Disaster Communications in Los Angeles County (Shepherd)..... 68 Aug.
Let's Legalize Ham Phone Patches (Ehinger, K9IVY)..... 70 Dec.
Long Distance SSB Tropo-scatter Link..... 152 Jan.
Mac's Service Shop (Frye)..... 64 July
Madye Named 1958 "Ham of the Year"..... 108 Apr.
Radio Amateur Great Circle Chart. 54-55 Nov.
Radio Amateur Prefixes..... 53 Nov.
Restoration of Old-Time Wireless Gear (Pyle)..... 62 Nov.
SSB Featured in New U. S. Official Jet..... 87 Aug.

AM-FM

RECEIVERS
Add A.F.C. with a Silicon Diode (Gibson)..... 70 July
All-Transistor Portable Car Radio: 1959 (Sahm)..... 62 Jan.
Don't Junk That Auto Radio (Dulin) 150 Oct.
Dynamic Sideband Regulation Used in New Tuner (Berkovitz)..... 132 Mar.
New FM-AM Tuner Standard (Von Recklinghausen)..... 60 Oct.
Outdoor Amplifier for Transistor Portable (Lawson)..... 100 Mar.

SERVICING
Don't Dodge the One-Tube FM Front End (Philpott)..... 52 Aug.

MOBILE RADIO EQUIPMENT



2 PIECE MODEL FMTR 30-50 MC ED. 7 FM MOBILE TRANS. & REC.—6 VOLTS
Unit complete with Feet Modulation control head, mike, antenna, cables & crystals ground to your specific frequency. Modified for 20F3 emission
Model FMTR—12V. operation..... **\$109.95**
emission..... \$149.95

MODEL 2210 152-162 MC FM MOBILE TRANSMITTER & RECEIVER—6 VOLTS
Trans. modified in accordance with latest FCC Reg. for 20F3 emission. Complete with antenna, cables, control head, mike & crystals ground to your specific frequency. Ready for immediate installation. Specially priced..... **\$139.50**
MODEL 2210—12V. operation..... \$162.50

MODEL 2365 FM MOBILE TRANS. & REC.
As above covering 25-40 or 30-50 MC.
6 V. Modified for 20F3 emission..... **\$119.50**
MODEL 2365—12V. operation..... \$149.50

MOTOROLA TRANSCEIVER
Model FMTRU 80D (A) DSP13
Strip construction, 30 W. power output. Permaky filter, narrow-band, 8 V. Dynamotor power supply. Freq. 152-174 Mc. Complete with Cables. Controls, checked-out, excellent condition..... **\$199.50**
For 12 V. operation..... \$239.50

SPECIAL!
UNIVERSAL 6/12 VOLT VIBRATOR POWER SUPPLY
WIRED, Mfg. by DUMONT. Rating 30V. @ 100 milli. Ideal for all types of mobile applications. Chassis measures 5 1/4" x 3 1/2" x 8" Brand New..... **\$11.95**

Include 25% deposit with order—balance COD. 50c handling charge on all orders under \$5.00. All shipments FOB our warehouse, N.Y.

PLATT ELECTRONICS CORP.
20 MURRAY ST., NEW YORK 7, N. Y.
Telephone: COrtlandt 7-2575

PURCHASING A HI-FI SYSTEM?

Send Us
Your
List of
Components
For A
Package
Quotation

PARTIAL LIST OF BRANDS IN STOCK

- Alec Lansing
- Electrovoice
- Jensen
- Hartley • Stephens
- University
- Austic Research
- Jansco
- Wharfedale
- Karlson
- Viking
- Concertone
- Bell • G.E.
- Weathers
- Harman-Kardon
- Eico • Pilot
- Sherwood
- AcroSound
- Fisher
- Dual Changer
- Bogen • Leak
- Dynakit
- H. H. Scott
- Ferroglyph
- Tanberg
- Pentron
- Ampex • DeWald
- Revere
- Challenger
- Wallensak
- Garrard
- Miracord
- Glaser-Steers
- Rek-O-Kut
- Components
- Norelco
- Fairchild
- Pickering • Gray
- Audio Tape
- Conrac TV
- Full Line of
- Wellcor Cabinets

**WE WON'T BE
UNDERSOLD!**
All merchandise
is brand new, fac-
tory fresh & guar-
anteed.

FREE HI-FI Catalog
Available on Request.

**AIREX
RADIO**
CORPORATION
64-R Cortlandt St., N. Y. 7, CO 7-2137

Drift & A.F.C. in FM (Johnson).....	110 Apr.
Hints on Two-way Radio Service (Darr)	68 Apr.
Improving the A.C.-D.C. Radio Receiver (Fry)	130 May
Mac's Service Shop (Frye).....	56 Jan.
Mac's Service Shop (Frye).....	52 Feb.
Mac's Service Shop (Frye).....	59 June
Mac's Service Shop (Frye).....	74 Nov.
Mobile Receivers: Alignment & Service (Darr)	116 Nov.
Problems in AM Reception (Johnson)	90 Aug.
Save Time on Transistor Radios (Caldwell)	112 May
Tips on FM Alignment (Doyle).....	66 Mar.
Transistor Radio Circuits (Part 1).....	144 Nov.
Transistor Radio Circuits (Part 2).....	94 Dec.
2-Way Mobile Squelch Problems (Eldridge)	72 Feb.

COMPONENTS

"Ins" and "Outs" of Resistor Pads (Eldridge)	112 July
Replacement Problems: Coils & Transformers (Buchbaum).....	48 July
Storing Your Small Components (Frantz, Sr.).....	88 Feb.

BOOK REVIEWS

Additional 1959 Television Servicing Information (Beitman, editor).....	139 Oct.
Algebra of Electronics (Page).....	136 May
Applied Practical Radio-Television (Coyne Staff).....	94 June
Audio Cyclopedia (Tremaine).....	138 Oct.
Audio Measurements (Crowhurst).....	168 Feb.
Basic Audio (Crowhurst).....	116 Dec.
Basic Electricity (Zbar & Schildkraut).....	167 Feb.
Basic Electronics (Zbar & Schildkraut).....	167 Feb.
Basic Electronic Test Procedures (Turner)	138 Nov.
Basic Pulses (Gottlieb).....	136 May
Basics Of Missile Guidance and Space Techniques (Hobbs).....	148 Sept.
Building The Amateur Radio Station (Berens, W2PK).....	126 Aug.
Circuit Analysis Of Transmission Lines (Stewart).....	154 Jan.
Class D Citizen Radio 1959 Call Book (International Crystal Mfg. Co., Inc.).....	138 Nov.
Electronic Avigation Engineering (Sandretto).....	94 June
Electronics For Everyone (Upton).....	148 Sept.
Elements of Radio (Marcus & Marcus).....	118 July
Fundamentals of Nuclear Energy and Power Reactors (Jacobowitz).....	138 Nov.
Fundamentals of Radio and Electronics (Everitt, ed.).....	153 Jan.
Fundamentals of Radio Telemetry (Tepper)	147 Sept.
Fundamentals of Transistors (Krugman).....	110 Mar.
Fundamentals of High Fidelity (Burstein)	118 July
Guide to Mobile Radio (Sands).....	111 Mar.
How to Troubleshoot A TV Receiver (Johnson).....	167 Feb.
International Radio Tube Encyclopaedia (Babani, ed.).....	110 Mar.
Jones North American AM-FM Radio-TV Station Listings (Vane A. Jones Co.).....	153 Jan.
Junction Transistor and Its Applications (Wolffendale, ed.).....	154 Jan.
Junction Transistor Electronics (Hurley)	136 May
Layman's Guide To Hi-Fi (Wels).....	111 Mar.
Loudspeakers (Briggs).....	166 Feb.
Man's World of Sound (Pierce & David, Jr.).....	118 July
Marine Electronics Handbook (Sands).....	148 Sept.
Metallic Rectifiers and Crystal Di-	

LAST CALL at 88¢ ea.

NOW!!! GET A FREE DOUBLE BONUS AS OUR WAY OF THANKING THE 1000's OF LEKTRON CUSTOMERS THE WORLD OVER FOR ANOTHER SUCCESSFUL YR.

FREE! LEKTRON DOUBLE-BONUS

BONUS #1
Deduct \$1 from each \$10 order!



BONUS #2 FREE
\$15.00 WORTH OF RADIO-TV PARTS
OUR OWN ASSORTMENT

= BOTH FREE with every \$10 ORDER



15 "SEALED" CIRCUITS
Built-in resistor coupling networks. Reg. \$10. Wt. 1 lb. **88¢**

30 MOLDED CONDENSERS
0.0001 to .1 to 1000 VDC. Oils, porcelain, black beauties. Reg. \$25. Wt. 3 lbs. **88¢**

60 RESISTOR SPECIAL
W.W. & carbon, precision, power, variable, mini. types too. 1/2W. 50W. Reg. \$15. Wt. 3 lbs. **88¢**

30 POWER RESISTORS
5 to 50 (to 10,000) ohms. Reg. \$10. Wt. 3 lbs. **88¢**

MINI GEIGER COUNTER
TUBE. Dozens of radiation detection uses. Reg. \$12. **88¢**

40 TRANSISTOR
Mini condensers. 0.00025 to 0.1 m.f. In 100's of trms. sets. Reg. \$6. Wt. 1 lb. **88¢**

100 HALF WATERS
Resistors; carbon. 10 ohms to 2 meg. 10% tol. Pop'r makers. Reg. \$10. Wt. 2 lbs. **88¢**

15 "GRAIN-O-WHEAT"
Lamps; by G.E. 1.5 VDC. For mini. work. Worth 25¢ ea. Wt. 1/2 lb. **88¢**

60 MICA CONDENSERS
0.00025 to .01 to 1000 VDC. "Silvers" too. 20 values. Wt. 2 lbs. Reg. \$8. **88¢**

35 TIO WATERS
10 radio & TV values; 100 ohms to 500K. 5% tol. Wt. 1 lb. Reg. \$8. **88¢**

10 ROTARY SWITCHES
1, 2, 3, 4 gang; long shafts. Pop'r types. Wt. 3 lbs. Reg. \$12. **88¢**

10 VOLUME CONTROLS
Long & usable shafts. Up to 1 meg. single; duals, switch types. Reg. \$18. Wt. 3 lbs. **88¢**

"SOLAR" BATTERY
Generates power from Sun & "bulb" light. 100's of projects. Reg. \$2. **88¢**

20 TWIST DRILLS
1/16 thru 1/4" with calibrated case. For electric drills. Wt. 1 lb. **88¢**

20 ARTISTS BRUSHES
pure camel hair 100% bristles. Wt. 1 lb. **88¢**

40 HI Q CONDENSERS
NPO's, standoff types too. 20 values. Finest prec. prec. quality. Wt. 1 lb. Reg. \$8. **88¢**

60 TERMINAL STRIPS
Solder lug type; 0.1 to 10 lugs. Used in every elec. proj. Wt. 1 lb. **88¢**

\$25 SURPRISE PAK
Wide variety of radio'n popular electronic parts. Wt. 3 lbs. **88¢**

60 TUBULAR CONDENSERS
20 values 0.001 to .5 mfd to 1000 VDC. Wt. 2 lbs. Reg. \$8. **88¢**

\$30 RELAY SURPRISE
Never before offered! Wonderful hobby & lab pak. Wt. 4 lbs. **88¢**

40 "SILVER" MICAS
1 & 5%. Asst values. Finest made. Wt. 1 lb. **88¢**

70 INSULATED RESIST'S
Carbon. 1 & 5% tol! 10 ohms to 10 meg. 30 values. 1/2, 1, 2W. Wt. 2 lbs. Reg. \$15. **88¢**

8 RCA PLUG & JACK SETS
Matched pairs. For tuners, amps, recorders. In handy pak-ette. **88¢**

300-FT. HOOK-UP WIRE
16 thru 24. Plastic. Glass insulated. Best colors. Tinned. Wt. 3 lbs. **88¢**

60 RADIO-TV KNOBS
Asst colors, set screw type too! Plastic 1/2" to 4" dia. Some \$1 ea. **88¢**

40 ONE PERCENT-ERS
Precision carbon-film resistors. Nifty lab pak-ette. 15 values. 10C 100 ohms to 1 meg. Reg. \$24 **88¢**

60 CONDENSER SPECIAL
Incl. molded, porcelain, oils, electrolytic, mica, disc. Wt. 2 lbs. Reg. \$25. **88¢**

5 ROLLS MICRO-WIRE
24 & #32. Handy lab pak-ette. Asst colors insulation. Tinned. Reg. \$5. **88¢**

1500 PCS. HARDWARE
Nuts, bolts, screws, brackets, etc. Handy shop pak-ette. Wt. 2 lbs. **88¢**

2 HOBBY TRANSISTORS
For experimental & shop use. Specs unknown. Worth \$3 ea. In handy \$88¢ pak-ette.

30 TUBE SOCKETS
4, 5, 6, 7, 8, 9 pins. Obtain. mini types. Some shield, mica, ceramic. Reg. \$10. **88¢**

20 PILOT LITES
Mini bay & screw types. "Grain, 2" wheat" too. 1.5 to 6V. **88¢**

35 DISC CONDENSERS
Incl. world's thinnest (only 1/4" x 10mm) to 1000VDC. Nifty lab pak. **88¢**

15 "POLY PAKETTES"
Incl. poly boxes, visals, asst sizes. For radio, TV, submini parts. **88¢**

10 ELECTROLYTICS
Pb & tubular paper & can types. Single, duals & triple values. 10 to 500 mf to 450 VDC. Reg. \$18. Wt. 3 lbs. **88¢**

30 MOLDED CONDENS'S
Finest made. Black beauties, porcelain, oils. .001 to .2 to 1000 VDC. Reg. \$15. Wt. 3 lbs. **88¢**

100 CERAMIC CONDENSER SPECIAL
Incl. discs, NPO's, moldeds, tubulars, dogbones. 25 values. In handy **88¢**

70 ONE WATERS
Resistors incl 1 & 5% carbons. 20 pop'r values. Reg. \$15. **88¢**

POSTAGE STAMP MIKE
Crystal. By Bruah. 1" sq. Nifty hide-away unit. 100 to 7000 cps. response. **88¢**

6 SILICON DIODES
Used in gov't & "space" work. IN21, IN22, etc. Worth \$10 ea. In handy **88¢**

60 COILS & CHOKES
HF, ant. use, auto-tuned, & IF styles. 15 types. Reg. \$20. Wt. 3 lbs. **88¢**

12 HOUR CLOCK
Needs only portable battery for power. Light weight. 100's of timing proj. Wt. 2 lbs. Reg. \$8. **88¢**

60 PLUGS & RECT'L'S
Power, battery, audio; 15 types. Wt. 3 lbs. **88¢**

15 POLY VIALS
For stocking submini & transistor parts. E-Z to C. to rest to "stack". Asst sizes. **88¢**

CRYSTAL PHONE
Use as mike too! V cord & plug set. Hearing aid type. 100 to 6000 cps. **88¢**

WORLD'S SMAL'T RADIO
Kit. Germanium powered. Lasts for life. Incl all parts. Instructions. **88¢**

8 GERMANIUM DIODES
For radio & TV de-cod'rs, limiters, rectifiers. Glass sealed, long leads. **88¢**

MINIMETER
0 to 13VAC. Only 1 1/2" dia. Panel mtr. Reg. \$3. **88¢**

125 RESISTORS
Insulated. 31 pop'r values; 1/2, 1, 2W. 5% tol. 10 ohms to 10 meg. Wt. 3 lbs. Reg. \$15. **88¢**

10-IN-1 PAKETTE
electro's, sockets, lites, wire, knobs, v-controls. Handy transistor radio basic **88¢**

GUARANTEE!!
Every Lektron Poly Pak has a money-back guarantee.

FREE! CATALOG
Full year's subscription to "Family Shopper."

FREE DOUBLE BONUS
I am entitled to: BONUS #1 (please check) BONUS #2

HOW TO ORDER: Check items wanted. Return entire client postage; excess returned. C.O.D. orders. 25% down; rated, net 30 days. Print name, address with POSTAL ZONE NO., amount enclosed, in margin. (Canada postage, 48¢, 1st lb., 28¢ ea. add'l lb.)

LEKTRON 133 Everett Ave. Chelsea 50, Mass.

BARGAIN HUNTING? TV SERVICEMEN!
Write for SENSATIONAL CATALOG
HENSHAW RADIO SUPPLY
3619 TROOST KANSAS CITY, MO.

TAPE RECORDERS
HI-FI COMPONENTS SLEEP LEARN KITS
MERITAPE Low cost, high quality recording tape, in boxes of one. UNUSUAL VALUES FREE 1965 Catalog DRESSNER, 69-02 RA, 174 St., Flushing 65, N.Y.

ENGINEERING B.S. DEGREE IN 27 MONTHS
Prepare for unlimited opportunities of the Electronic Age!

Students study engineering under accelerated program leading to B.S. degree in 27 mo.; or standard 4-yr. program leading to B.E. degree in 36 mo. B.S. degree (36 mo.) in Math., Chem., Physics. Year-round classes. Comprehensive training in electronics, television, advanced radio theory and design, math., nuclear physics and elec. engineering. Also prep courses. Low rate. Earn board. G.I. approved. Enter Dec., March, June, Sept. Catalog.

INDIANA TECHNICAL COLLEGE

9129 E. Washington Blvd., Fort Wayne 2, Indiana
Please send me free information on B.S. ENGINEERING DEGREE IN 27 MONTHS as checked.
 Electronics Chemical Aeronautical
 Civil Mechanical Electrical
B.E. DEGREE IN 36 MO. in:
 Aeronautical Mechanical Electrical (Power or Electronics)
 Civil Metallurgical
C.S. DEGREE IN 36 MO. in Math. Chem. Physics
Name
Address

AN/ART-13 100-WATT TRANSMITTER

(Government original cost \$1,000.00)

Designed to provide radio communication by voice, (MCW) or CW telegraphy. Class "B" audio modulator system capable of modulating the carrier at least 90% on voice or MCW. Incorporates automatic tuning mechanism which may be used to select any one of 11 frequencies, range 2000 KC to 18,000 KC. Frequencies 200 KC to 1500 KC range is provided by addition of oscillator 0-16/ART-13-A. Shipping weight 90 pounds.

With Tubes and Meters—
Condition Fair **\$29.50**

Less Meters but with Tubes— " **\$20.00**
Less Meters and Tubes— " **\$10.00**
0-16 Low Frequency Oscillator **\$ 3.95**

AN/ART-13-147 with Tubes and Meters. Condition Good. **\$39.50**
T47A with Tubes and Meters. Condition Excellent. **\$49.50**

TUBES FOR ABOVE—Removed from Units. All guaranteed.

#811	— \$1.95	#6V6GT	— \$.59
#813	— \$4.95	#12S7GT	— \$.59
#837	— \$1.25	#12SA7GT	— \$.59
#1625	— \$.29	#12SL7GT	— \$.59

COMPANION RECEIVER TO ABOVE \$17.95
from 195 KC to 9 MC.

50239 Coax. Chassis Connectors.....ea. \$.29
10 for \$2.00
PL-259A Connectors.....New.....ea. \$.39
10 for \$3.00

BC 603 RECEIVER—20 to 27 MC FM. See Sept. and Oct. 1958 issues of "CQ" for conversion to 20-50 MC and AM

UNUSED each \$12.95
AC POWER SUPPLY for above..... \$ 8.95
12 Volt Dynamotor.....New \$ 4.95
24 Volt Dynamotor.....Used \$ 1.00
BC 604—TRANSMITTER 20-27 MC FM

UNUSED \$ 7.95
Set of 80 crystals for the above.....New \$ 5.95

BC 659 TRANSCEIVER—27 to 38.9 MC FM. Easily converted to new citizens band complete with power supply PE 120 and telescopic antenna. Unused, per set. **\$24.95**
Hand Set for above.....New \$3.95

BC 620 RECEIVER-TRANSMITTER—Same as above except frequency is 20-28 MC with power supply 6-12 or 24 volt PE 120. Hand set, telescopic antenna. Brand New.... **\$24.50**

—For Boats or Planes—

MAGNESYN REMOTE READING COMPASS—Lightweight, operates from 12 or 24 V DC with very low current. Very accurate and simple to use. Includes Transmitter, Indicator and 12 or 24 volt power supply. Complete. Checked out. **\$24.95**

ARR-2 RECEIVER. 234 MC to 258 MC. Easily converted to 220 MC. See August '59 issue "CQ" for conversion instructions. Complete with Tubes.....ea. **\$3.95**

IE19-5 PIECE TEST SET consisting of Signal Generator 100-156 MC, Field Strength Meter, 0-1MA-DC Meter, Battery Box and Chest. Shipping Wt. 100 lbs. **\$19.95**
EXC.....per set

T-17 CARBON HAND MIKE—200 ohm. Press-to-Talk Switch.....BRAND NEW **\$4.95**

ID T69/APN-12. SCOPE INDICATOR. Complete with tubes and conversion instructions for 110 V 60 cycle AC.....BRAND NEW **\$9.95**

HEAD SETS—HS 30—Low Imp.....New \$ 1.09
Excellent \$.69

RS 38 CARBON MIKE..... \$ 3.49

BC 454 RECEIVER—3 to 6 MC..... \$ 9.95

METER—0-20 Micro-Amps.....New \$ 4.95

METER—0-200 Milliamps.....New \$ 2.19

CRYSTALS—100 Assorted FT 241's and others..... \$ 4.95

BC-458 TRANSMITTER—5-3.7 MC.....Used \$ 4.95

BC-459 TRANSMITTER—7 to 9 MC Excel. \$ 9.95

4 TUBE AMPLIFIER consisting of two 7C5's, one 7F7, one 7Y4.....New \$ 1.29
10 for \$10.00

Write for Bargain Flyer

R W ELECTRONICS

2430 S. MICHIGAN AVE., DEPT. N

Phone: Calumet 5-1281 Chicago 16, Illinois

odes (Conti).....167 Feb.
Most-Often-Needed 1959 Television Servicing Information (Beitman, ed.).....110 Mar.
New Sideband Handbook (Stoner). 110 Mar.
101 Ways to Use Your VOM and VTVM (Middleton).....147 Sept.
Oscilloscope Techniques (Haas)....154 Jan.
Pin-Point Record Changer Troubles In 5 Minutes (Coyne Staff).....154 Jan.
Principles of Electronics (Gavin & Houldin).....117 Dec.
Principles of Transistor Circuits (Amos).....138 Oct.
Pulse of Radar (Watson-Watt).....94 June
Radio Amateur Licensing Handbook (Kitchin).....138 Oct.
Radio Amateur's Handbook (ARRL Staff).....118 July
Radio Circuits (Miller).....139 Oct.
Radio Engineering Handbook (Henney).....119 July
Radio Handbook (Orr).....126 Aug.
Radiotelephone License Manual (Editors and Engineers, Ltd.)...139 Nov.
Radio Valve Data (Wireless World Staff).....154 Jan.
Replacement Guide for TV and Auto Controls (Sams Staff).....127 Aug.
Science Study Series.....138 Nov.
Scientific Russian (Condoyannis)....116 Dec.
Servicing Transistor Radios (D'Airo Staff).....166 Feb.
Servicing Transistor Radios (Sams Staff).....148 Sept.
Sound of High Fidelity (Jordan & Cunningham).....138 Oct.
Stereo—How It Works (Burstein)....148 Sept.
Television Receiver Servicing (Kiver).....126 Aug.
Television Servicing (Buchsbaum)....137 May
Television Servicing (Levy & Frankel).....95 June
Transistors (Gillie).....126 Aug.
Transistors in Radio, Television and Electronics (Kiver).....138 Nov.
Transistors, Theory & Practice (Turner).....137 May
Tube & Semiconductor Selection Guide (Th. J. Kroes).....94 June
Vacuum-Tube and Semiconductor Electronics (Millman).....116 Dec.
Video Speed Servicing (Marshall)....116 Dec.
World Radio Handbook (Johansen, ed.).....136 May

BUSINESS MANAGEMENT

Appraising Your Business Position (Leonard).....70 Aug.
Create Your Business Personality (Leonard).....73 Apr.
Dealers Speak on Service Problems (Leonard).....73 Oct.
Electronics in Nigeria (Penn).....41 Apr.
Financing a Service Business (Leonard).....65 Dec.
Get the Most out of Your Service Data (Eldridge).....60 Mar.
In Case of Fire (Fair).....53 Dec.
Is the Name Right? (Leonard)....45 July
Is Your Business Geared for Change? (Leonard).....52 Nov.
Mac's Service Shop (Frye).....64 Aug.
Mac's Service Shop (Frye).....60 Sept.
Outside Call: What to Take Along (Barlowe).....94 July
Profit & Growth (Leonard).....48 May
Promoting a Small Business (Leonard).....48 Mar.
Safeguard Your Shop (Fair).....65 Aug.
Service Business Progress (Leonard).....51 June
Service Keyed to the Community (Wendel).....38 June
Service Plans and the Independent Dealer (Leonard).....61 Sept.
Summer Slump: An Appraisal....55 July
10 Service-Business Problems (Leonard).....50 Jan.
TV Shop Uses Two-Way Radio....45 May

ALL NEW HEADPHONES

HS-30 Low Imp. (feather wt.).....	\$ 1.50
H-16/U High Impedance.....	3.95
TELEX Boom Headset with Cord.....	25.00
AVIOMETER Boom Headset w/Mike. Cord Cushions.....	12.00
H-46/U Boom Headset w/Mike. Chamois Cups, Cords.....	18.00
Earphone Cushions, Chamois. Pr.....	1.50
T-17 Carbon Hand Mike.....	5.25
T-18 Carbon Throat Mike.....	1.79
T-45 Army and Navy 1 1/2" Mike.....	1.75
T-24 Carbon Mike w/Retrax Cord.....	3.95
#3 Handset.....	8.00
RS-38 Navy Type.....	4.95

SYNCHROSCOPES MODEL TS-34/AP.....\$59.50

SOUND-POWERED DYNAMIC PHONES Pr. 4.75

REC. MICROWAVE R-111/APR.5.....49.00

ARB/RCA—SIX TUBE RECEIVER.....17.50

BC-603 AC-SUPPLY

AC Power Supply for HC-603 Receiver and BC-683 no modification needed, plugs directly into Jones Receptacle **\$9.95**

T-47/ART-13 TRANSMITTERS
100 Watt 2-18 MC Autotune, excellent cond., with tubes **\$39.00**

TS-328/U FREQUENCY METER
400 cycle, vibrating reed type, bakelite case with test leads, excellent condition. checked **\$22.50**

MOBILE & FIXED VHF SETS
Complete set for 110-v operation including SCR-522 Transceiver, RA-62 Rectifier, J-type ground antenna, control box, mounts, connectors, tubes (less crystals). Excellent condition CAA **\$124.00**

Same as above for 12 or 24-v operation including PE-98 (12-v) or PE-04 (24-v) dynamotor instead of rectifier. Excellent condition CAA **\$89.00**

Both Mobile and Fixed Sets purchased together, limited time only **\$194.00**

RA-62-C POWER SUPPLY A-C for SCR-522 VHF 110/60 cyc. Like new LTD QTY **\$59.50**

KIT's only for above. Contains special xformer, rectifier, regulator and connectors w/schematic. SPECIAL ONLY **\$17.00**

GROUND-PLANE VHF ANTENNAS \$9.95
GOOD FOR CITIZENS BAND FROM 30-200 MC—NEW

SPERTI VACUUM SWITCH
SP21 or CY824163 or G.E. G1-34, new, factory boxed. Cost—\$9.50 Special **\$1.25** each
\$12.00 dozen—\$85.00 hundred

SEND FOR NEWEST FREE CATALOG

\$5.00 Min. - 25% Dep. C.O.D.'S - F.O.B. Conn.

HI-MU ELECTRONICS

133 HAMILTON ST., NEW HAVEN, CONN.



QUIETROLE

the ANSWER TO NOISY CONTROLS and SWITCHES

over 12 YEARS OF PROVEN SUPERIORITY

Costs Just Pennies more than the poorest substitute . . .

Supplied in Spray can and 2, 4, 8 oz. bottles



GENERAL

CITIZENS BAND

- Build This Citizens Band Transceiver (Stoner)..... 49 Mar.
- Citizens Band Transceiver Kit (Lab Tested)..... 60 Nov.
- Compact Beam for the Citizens Band (Smith)..... 44 Nov.
- FCC Answers Our Questions on Citizens Band..... 41 Sept.
- FCC Information on the Citizens Radio Service..... 130 June
- Hand-Held Citizens Band Transceiver (Price & Overlay)..... 42 Dec.
- License Not Needed for Citizens Radio Adjustments..... 84 Dec.
- New Citizens Band Equipment.... 98 Aug.
- Versatile Citizens Radio Transmitter (Smith)..... 48 Aug.
- Violations of Citizens Radio Regulations 106 Nov.

COMPUTERS & COUNTERS

- How Ring Counters Work (Bukstein) 44 Mar.
- Numbers Systems and Codes (Bukstein) 69 Nov.
- Readouts and Counter Tubes (Bukstein) 57 Oct.

CONSTRUCTION PROJECTS

- Automatic "Talk Squelcher" for Your Radio (Gaskill)..... 60 Apr.
- Compact Electronic Photoflash (Cantor) 40 July
- Experimental Transistor Motor Control (Reed)..... 46 May
- Photoplastic Special Dials (Ives).... 127 Jan.
- Portable Transistor Intercom (Kernin) 54 June
- "Strobolyzer"—A High-intensity Stroboscopic Analyzer (Fender) .. 57 Dec.
- Telephone Intercoms for Home or Shop (Caringella & Clark)..... 50 Sept.
- Transistorized "Fish-Finder" (Cover Story) (Mitchell)..... 42 Aug.
- Transistorized Photoflash (Liljedahl) Tube-Transistor "Carrier Switch" (Stone) 49 Feb.
- Wireless Neighborhood Baby Sitter (Richardson, Jr.)..... 64 Oct.

INDUSTRY

- All-American Service Technician Awards: 1958..... 54 Jan.
- Canadian Market for Low-Power Radiophones (Kitchin)..... 155 Oct.
- Cover Story..... 39 Feb.
- Dielectric Heating (Rothstein & Buchsbaum) 37 Dec.
- EIA Asks Investigation of Transistor Imports 99 Dec.
- Gasoline-Fume Detector Uses Infrared 106 Oct.
- Induction Heating (McCook & Buchsbaum) 35 May
- Infrared—A New Field of Electronics and Optics (Bernard & Buitenkant) 37 Mar.
- Melting Silicon for Semiconductors (Cover Story)..... 39 May
- Phosphors and Their Uses (Fortney) Dec. 50 & 51
- Preserving & Cooking Food With Electronics (Buchsbaum)..... 37 Nov.
- Ultrasonics—and its uses (Rod).... 37 Feb.

MISCELLANEOUS

- Career Opportunities in Electronics (Buchsbaum) 37 Sept.
- Color Codes Chart..... 51-52 July
- Cover Story..... 32 June
- Direction Finders for the Boatsman (Link) 29 June
- Electrical Shock: Fact and Fiction (Peters) 40 May
- Eliminating Shock Hazards (Greenfield) 58 Aug.
- Facts About Lightning Protection (Silver) 59 July

for FUN, BUSINESS, SPORTS, INDUSTRY, BOATING, AUTOMOBILE
the **NEW Citizens Broadcaster**

COMPLETE 11 METER TRANSCEIVER

NO EXAMINATION REQUIRED!

May Be Used by Anyone!

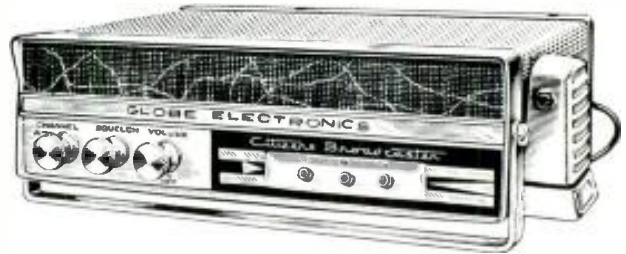

- ★ Universal operation. One unit works on 115V AC or 12V mobile. Operates in Home, Office, Car or Field. No tests or examinations required. Any citizen over 18 years of age may use any of the FCC-assigned 22 channels in the 27mc range (11 meters) for transmitting and receiving.
- ★ EXCLUSIVE! Channel switch allows choice of three channels for operation. Receiver and broadcaster units are tuned to same channel simultaneously.
- ★ Operation extremely easy: only three controls: Channel, Squelch and On/Off/Volume. Squelch control subdues background noise for muted standby operation. Offers push-to-talk operation for instantaneous transmission or reception.
- ★ 10 Tube Receiver/Transmitter is crystal controlled for stable operation. With proper crystals, all channels are covered. Tested pairs available for any channel.
- ★ Power Input: — 5 watts, AM modulated. Compact: — only 3 1/2 x 1 3/8". Light weight, 9 lbs. Meets all FCC requirements.
- ★ Modern "living room" design. Carrying handle also acts as tilt stand for fixed operation or mounting bracket for permanent installation, making the Broadcaster extremely versatile.

COMPLETE WITH CRYSTALS FOR CHANNEL 11 AND PUSH-TO-TALK MICROPHONE

Only \$129⁹⁵

\$130 DOWN \$7⁴⁸ per mo.

PLEASE RUSH NEW BROCHURE ON THE GLOBE CITIZENS BROADCASTER TO

World Radio LABORATORIES
1615 W. BROADWAY COUNCIL BLUFFS, IOWA

NAME: _____

ADDRESS: _____

CITY & STATE: _____

SEND FREE CATALOG. TOO EW-12

OFFERING THE DY-17 ROTOR DYNAMOTORS

Latest type for the T-47/ART-13
New, Export packed
\$5.00 ea.

VETS. DIST. CO., SP 8-8904
3613 N. Western Pky., Louisville, Ky.

MAIL ORDER HI-FI

You can now purchase all your Hi-Fi from one reliable source and be assured of perfect delivery. Carston makes delivery from NY stock on most Hi-Fi, Recorders and Tape within 24 hours. **SEND US A LIST OF YOUR HI-FI REQUIREMENTS FOR OUR WHOLESALE QUOTATION and our FREE wholesale catalogue.**

CARSTON STUDIOS
125-TD East 88 St. New York 28, N.Y.

HI-FI IN A BOTTLE! FLEXICONE

lowers cone resonance . . . extends frequency response and adds "hi-fi" quality to any speaker

Flexicone permanently softens outer edges of any speaker cone. John Dodgson, Audio Consultant of N.R.I. News, reports: "After a Flexicone treatment a 12" speaker which had been resonated at 90 cps dropped to 41 cps. Listening tests clearly show the improvement . . . medium and high frequencies are cleaner and less harsh." Thoroughly tested—takes 15 minutes to apply—provides lasting improvement in your speaker! Each kit treats one 15", two 12", four 8", or six 6" speakers.

- Softens outer edge of speaker cone
- Lowers speaker cone resonance 10 to 40 cps
- Easy 1-2-3 application
- One treatment lasts a speaker lifetime.

SPECIAL INTRODUCTORY OFFER

To acquaint you with FLEXICONE we'll give you absolutely FREE one \$3.25 Tiny Tom 5" x 7" high impact Styrene Speaker Housing with each Flexicone Kit at \$3.00. Available in 6 soft colors: Brown, Grey, Pink, Green, Blue or Yellow.

\$6.25 VALUE for Only \$3.00, postpaid.

PORTER & DIETSCH
2459 University Avenue St. Paul 14, Minn.

ORDER NOW ONLY \$3.00

Complete Kit

RUSH ORDER COUPON

PORTER & DIETSCH, Dept. W
2459 University Avenue, St. Paul 14, Minn.

Gentlemen: Enclosed is my check for \$3.00. Please send me postpaid the \$6.25 value, one \$3.00 FLEXICONE KIT plus one \$3.25 Tiny Tom Speaker Housing (All for \$3.00). State choice of "Tiny Tom" color.....

Name.....

Address.....

City.....

State.....

A... Always
B... Buy
C... Columbia

OUR MERRY XMAS SPECIAL! TECHNICIANS! GENERALS! NOVICES!

SCR-222 Here 'tis! The oldest, most reliable VHF Transmitter-Receiver in ham history, the greatest 2-meter rig ever built — at the most sensational price ever offered! Works on 12 or 24 VDC or 115 V 60 cye. AC. (See below.) Covers 100-156 Mc. — naturally! Crystal controlled. Transmitter has 2-832 tubes, etc., etc. Complete in case, with ALL TUBES. Easily convertible to 6 meters. Excellent condition. **\$12.50**

DOPE FOR CONVERSION TO 6 METERS Good condition. **\$1.00**

REGULATED AC POWER SUPPLY for above. New condition. **29.95**

12 VDC DYNAMOTOR POWER SUPPLY for above. New condition. **8.95**

24 VDC DYNAMOTOR POWER SUPPLY for above. Good condition. **3.95**

BC-1303 LOCAL ADAPTOR CONTROL BOX for above. Like new. **4.95**

TUBES, ANTENNAS, OTHER ACCESSORIES FOR ABOVE. WRITE IN FOR DATA.

BC-659 TRANSMITTER RECEIVER 6 or 12 V, 27-39 Mc. Easily converted to citizens band. (See C.Q. Magazine for conversion.) Used, excellent. WITH POWER SUPPLY. **\$14.95**

Only

BC-620 RECEIVER-TRANSMITTER Same as above except frequency is 20-28 Mc. Brand new. WITH POWER SUPPLY. **\$19.50**

Only

RA-120 AC POWER SUPPLY For either above units. 110V. in 60 cye. New. **\$19.95**

TELEPHONE WANTED Brand new. Special **3.95**

TELESCOPING ANTENNA New. **2.95**

This is a lulu!

Here's A Combination That Can't Be Beat!

FM RECEIVER FRC-6 30-40 Mc. 110 V. 60 cye. input. Mfg. by Motorola for U.S. Army! Commercial rack-panel style. Dual conversion, crystal controlled. Excel. **\$29.95**

FM TRANSMITTER FRC-6 Companion to above. 50 W. output. 110 V. input. 60 cye. Pair of 807's in final. Exc. **\$29.95**

6 FT. RACK PANEL: For above. With speaker and two 0-50 ohm meters and 0-150 VAC meter. Excellent. **\$29.95**

SCR-625 METAL MINE DETECTOR Locate that hidden pipe, search for treasure, use for parts or have a ball! With carrying case. Excel. **\$29.95**

M-M-M! LOOKIT THESE 12 V. DYNAM-M-M-TORS!

DM-35: 625 W. Orig. box. 225 ma. output. Like new. **\$8.95**

WINCO: 50S5 TCS. Output 440 V. @ 200 MA & 225 V. @ 100 MA. New. **4.95**

DM-65: Output 440 V. @ 400 MA. New. **4.95**

ECOR: Type 109 TCS Output 400 V. @ 180 MA. New. **4.95**

DM-40: Output 170 V. @ 135 MA. New. **4.95**

DM-25: Output 250 V. @ 50 MA. New. **2.95**

IMPORTERS & EXPORTERS

WE HAVE THE FOLLOWING ITEMS. GUARANTEED READY FOR IMMEDIATE DELIVERY! CONTACT COLUMBIA TODAY!

RC-26	BC-348	ART-13
RC-27	BC-312	ARC-27
RC-32	RC-375	ARC-28
RC-32	ARC-1	BC-61D
SCR-399	ARC-3	& ALL ACCESSORIES

WANTED! R-540/ARN-14C Receiver and ANY GRC or PRC Equip. Top \$\$\$ paid!

TUBES! TOPS IN TUBE BARGAINS! BRAND NEW! 832 TRANSMITTING TUBES. New. Boxed. Ea. **\$3.95**

4X150A	\$ 7.95	4-65A	THREE for \$10.00
4-125A	17.95	4-400A	\$ 9.95
304TL	25.00	4-250A	24.50

APR-1 TUNING UNITS. EXCEL. COND.!

Can be used on converters with any 30 Mc. Receiver.

TN-1: 40-90 Mc. Only. **\$14.95**

TN-3: 300-1000 Mc. **14.95**

T-14/TRC TRANSMITTER

JUST REDUCED! For action this month! 70-100 Mc. 50 W. input power on phone. Single channel. Built-in 110 V. 60 cps power supply. Table top size. Easily converted to 6 meters. Complete. Fair condition, excellent buy! **\$24.95**

CITIZENS' BAND, ETC.

BC-603 RECEIVER

Covers 20-28 Mc. FM. Terrific for citizens' band. 10 push-buttons. Built-in speaker and squeelch cont. May be operated mobile on 12 V. with dynamotor (see prices below) or 110 VAC with power pack. Converts in 1 minute to **\$9.95**

AM. Info supplied. New condition

12 V. DYNAMOTOR, for above **\$3.95**

115 VAC PACK **\$1.95**

24 V. DYNAMOTOR **2.95**

115 V. KIT **7.95**

CRYSTAL SET FOR ABOVE—Box of 80. New! **\$3.95**

MATCHING TRANSMITTER FOR ABOVE—BC-604: 30 W 10-channel, push-button FM crystal controlled. 20-27 Mc. New condition, complete with tubes, (Lens dyn.). **\$5.95**

COMBO DEAL: Above BC-603 & BC-604. New cond. BOTH for **\$13.00**

WRITE FOR FREE BARGAIN BULLETIN!

All orders FOB Los Angeles. 25% deposit required. All items subject to prior sale. NOTE: MINIMUM ORDER \$3.00. WRITE TO DEPT. R.

Columbia ELECTRONICS
 2251 W. WASHINGTON BLVD.
 LOS ANGELES 18, CALIF.

CODE SENDING SPEED

Be a "key" man. Learn how to send and receive messages in International Morse code. Communicate with operators around the globe. Learn at home quickly through famous Candler System. Used by best operators. Quality for Amateur or Commercial License. Write for FREE BOOK.

CANDLER SYSTEM CO., Dept. 20
 Box 9226, Denver 20, Colo., U.S.A.

Highway Communications System. 90 July

Industrial Telemetry for Technicians (Tepper)..... 46 Sept.

Rechargeable Flashlight Battery... 104 Sept.

Record Number of Sets in Use During '58..... 136 Mar.

Resuscitation for Electric Shock... 68 Dec.

World's Fastest Message Printer... 86 Jan.

MISSILES & OUTER SPACE

"Atlas" Satellite Uses Special Radio System..... 138 Mar.

Cover Story..... 41 Mar.

Electronic Countermeasures—The Art of Jamming (Blatner)... 47 Dec.

Electronics in Outer Space (Part 1) (McQuay)..... 35 Aug.

Electronics in Outer Space (Part 2) (McQuay)..... 72 Sept.

Electronics in Outer Space (Part 3) (McQuay)..... 62 Oct.

IGY—an eighteen-month report... 42 Mar.

Largest Induction Heating Project... 102 Nov.

Lower Cost Scatter Antenna.... 136 Feb.

Meteorological Satellites—Global Weather Observers..... 48 Sept.

Missile Measurement Ship..... 138 May

New Frequency Scanning Radar... 69 Jan.

Our Largest Radar Telescope.... 96 Oct.

Radio Sextant Tracks Moon..... 104 May

Space Platforms for the Future... 140 Nov.

Transportable 10-kw. Radio Communications System..... 45 Aug.

PUZZLES

Crossword Capers (Shippee)..... 125 June

Electronic Terminology (Gill)..... 131 Jan.

Electron Tube Crossword (Comstock)..... 119 May

Technician's Crossword (Crocker)... 161 Apr.

Test Equipment Teaser (Comstock). 137 Mar.

TUBES & TRANSISTORS

Facts About Rebuilt Picture Tubes (Scott)..... 64 Sept.

Foreign Tube Substitution Data... 106 May

Foreign Tube Substitution Data... 104 June

Industrial Tubes & Their Uses (Saslaw)..... 37 Jan.

New Tube Tester Data..... 130 Jan.

New Tube Tester Data..... 102 Feb.

New Tube Tester Data..... 116 Oct.

New Tube Tester Data..... 94 Nov.

Novel Semiconductor Devices (René)..... 50 Oct.

Synthetic Quartz Produced in Pilot Plant..... 120 Mar.

Test New Tubes on Old Checkers (Part 1) (Darr)..... 64 Feb.

Test New Tubes on Old Checkers (Part 2) (Darr)..... 68 Mar.

This Month's Cover..... 39 Jan.

Tiny Vacuum Tube Rivals Transistor..... 100 May

Transistor and Diode Substitutions (Louis)..... 65 Nov.

Transistors Produced by Automatic Line..... 140 Mar.

Transistors—The Inside Story (Bohr) 66 Jan.

Tube Faults & Test Techniques (Hubelbank)..... 56 Dec.

Tube Inventory for Service Shops—1959 (Barlowe)..... 57 Apr.

Tuner for Transistor TV..... 106 Dec.

"Tunnel Diodes"—Experimental Semiconductors..... 41 Oct.

HIGH-FIDELITY AUDIO

AMPLIFIERS

"Carillon" Stereo Amplifier (Lab Tested)..... 52 June

Compact Two-Tube Stereo Amplifier (Augeri & Christiansen).... 44 Sept.

Complete Stereo Amplifier System (Lab Tested)..... 66 Apr.

Direct-Coupled Transistor Amplifier (Burwen)..... 42 Sept.

Improving the Mullard 520 Hi-Fi Amplifier (Laurent)..... 66 Dec.

JAZZ!

a colorful 16-page history for only 15c



Here's an authoritative 16-page history of jazz that appeared recently in HiFi REVIEW, the world's largest selling high fidelity magazine. While they last, you can order this fascinating reprint for just 15c a copy!

Written by John S. Wilson, noted jazz critic, this exciting look at the world of jazz takes you from Storyville in New Orleans to the Royal Garden Cafe in Chicago, from New York's Roseland to the West Coast school of cool music. You'll read how the sound of jazz has evolved and of the influence of a King Oliver or Bix Beiderbecke on today's musicians.



Whether you're a beginner or a jazz buff—or simply interested in a phase of Americana—you'll want a copy of this 16-page reprint on the jazz panorama. And it's yours for just 15c—with the handy coupon below! But the supply is limited, so rush your order today!

Ziff-Davis Publishing Company EW-12
 Box 525
 Church Street Station
 New York 8, New York

Please send me _____ copy(ies) of the 16-page reprint on the history of jazz. I enclose 15c for each copy.

name _____

address _____

city _____ zone _____ state _____



SUITS NEED PRESSING— MERIT DEFLECTION YOKES DO NOT!

Merit deflection yokes are cosine wound TO FORM, not pressed. Pressing can lead to distortion and poor focusing. Pressing after winding frequently causes breakdown.

**MERIT COILS AND TRANSFORMERS
HAVE "BUILT-IN" ADVANTAGES.**



Each Merit yoke is
100% LIVE TESTED

COMPARE IT WITH

MERIT

MERIT COIL AND TRANSFORMER CORP.
MERIT PLAZA • HOLLYWOOD, FLORIDA

add all UHF channels
to your tv set

BLONDER-TONGUE MODEL 99R UHF CONVERTER



Make your present TV set
a modern 82-channel receiver

- sharper, clearer pictures
 - easy, one-knob tuning
 - drift-free performance—no fading
 - approved for color TV
 - UL approved
 - tuned input
- Outperforms all others in its class.
The nation's biggest selling UHF
converter. Only

2295

For fringe areas—the powerful
Blonder-Tongue Ultraverter
Model BTU-2R, 39.95.

Sold by parts distributors. EW-12
BLONDER-TONGUE LABORATORIES, INC.
9 Ailing St., Newark 2, N. J.



Integrated Stereo Amplifier (Lab Tested)	70	Feb.
Low-Cost Stereo System (Meagher)	44	Jan.
Master Stereo Preamp (Lab Tested)	42	Feb.
New Idea in a Stereo Preamp (Lab Tested)	46	Mar.
120 Watts of Hi-Fi Power (Hafner)	118	Feb.
Power Output Ratings for Hi-Fi Amplifiers (Robinson)	44	Oct.
Rebuild the UPX-003 Preamp for Stereo (Jones)	67	Sept.
Ultra-stable OTL Hi-Fi Amplifier (Futterman)	69	May

CIRCUITS

Delayed Audio A. V. C. Output Limiter (Ives)	82	Dec.
Heater-Cathode Leakage Problem (Horowitz)	116	Jan.
Hi-Fi Crossover Network Design Charts	51-52	May
Hi-Fi Crossover Networks—Constructing the Network (Park 2) (Cohen & Cohen)	49	May
Hi-Fi Crossover Networks—General Principles (Part 1) (Cohen & Cohen)	44	Apr.
Hi-Fi with Triodes (Still)	60	July
Simplifying for Low-Level Crossover (Pryor)	41	Feb.
Single Push-Pull Stage for Both Stereo Channels (Crowhurst)	48	Jan.
Stereo Amplifier Controls— and What They Do (Burstein)	55	Aug.
Symmetrical T and H Attenuators (Special Chart)	53	May
RC Coupling Networks (Nomogram) (Bowers)	53	Sept.
Reactance Chart	54	May

MISCELLANEOUS

Decibel Table	56	Feb.
Decorating With Music	41	Dec.
Harmonic Distortion—What It Is and How It's Measured (Snitzer)	72	Nov.
Hi-Fi Fair in England (Mannheim)	132	Feb.
Hi-Fi Institute (Guest Editorial) (Benjamin)	47	Oct.
Industry Launches Stereo Tape Drive	80	Aug.
Measuring Your Audio Power Output (Reed)	92	Nov.
Output Power from Class B Push-Pull Stage (Nomogram) (Briglia, McKibbin & Searing)	56	Sept.
Reminiscing About Stereo (Jensen)	112	Feb.
Shopping for a Hi-Fi Amplifier (Crowhurst)	39	Aug.
Sound (Special Chart on Hi-Fi)	53-54	Feb.
Technique for Tuning Electronic Organs (Meyer, Jr.)	62	Dec.
"Top Choice" Discs in Stereo	56	Oct.

PHONO

Audio Report (Lab Tested)	152	Oct.
Cutting a Stereo Disc (Cover Story)	55	Oct.
Hi-Fi Product Test Report (Lab Tested)	61	Mar.
Hi-Fi Product Test Report (Lab Tested)	47	Apr.
Hi-Fi Product Test Report (Lab Tested)	59	May
London-Scott Stereo Cartridge and Arm (Lab Tested)	120	July
Mac's Service Shop (Frye)	80	Apr.
Mac's Service Shop (Frye)	68	May
New Audio Test Report (Lab Tested)	104	Aug.
New Audio Test Report (Lab Tested)	155	Sept.
1959 Stereophonic Cartridge Directory	74	Oct.
Product Test Report (Lab Tested)	69	Feb.
Stereo Disc Today (Frey)	54	Oct.
Tone-Arm Tracking Error in Stereo (Gicca)	70	Oct.
Transistorized Phono Preamp for Stereo (Gicca)	60	Aug.

POWER SUPPLY—BRAND NEW

PF326-U—Input 110V. AC—Output 24 Volts filtered DC. Rated .9 Amps Capable 1 1/2 Amps. Sel. Rectifier. Size: 6 1/2"x7"x7". Adding a pot. makes ideal transistor supply

NEW VACUUM CAPACITORS

EIMAC VC 12 MMF-32KV ea. \$6.95
EIMAC VC 25 MMF-32KV ea. 7.95
EIMAC VC 50 MMF-32KV ea. 8.95
JENNINGS JMC-15J MMF-50KV ea. 39.95

FREQUENCY METER

Vibrating REO type. Range 57 to 63 cycles. 6 reads. 110 V. Bakelite case

..... ea. \$10.95

BRAND NEW MOBILE DYNAMOTORS

MADE BY EICOR—SMALL SIZE
Input 12 Volts. Output 400V. 180MA
Cont. Duty. 250 Mil. Int. Duty

..... ea. \$4.95

Input 12V. Output 440V. 200MA Cont. Duty. 300 Mil. Int. Duty

..... ea. \$6.95

POWER TRANSFORMER

Pri. 110V. 60 Cy. Sec. 300-0-300 V. 125 Ma. 12 Volt CT @ 3 Amps; 12 Volts @ 3 Amps; 5V @ 2 Amps/Replacement Trans. for BC 342 Rec. (also for 24V. Use)

..... ea. \$2.50

Pri. 115V. Secs. 320-0-320V. @ 150 Ma. 5V. @ 2 Amps 6.3V. @ 3 Amps

..... ea. \$2.95

Write for quantity prices

FILAMENT TRANSFORMERS

Primary 110V. 60 cy. Sec. 5V. @ 10 Amps. Ins. 10,000 V. Small size. 2 for \$7.50

..... ea. \$3.95

Primary 110 volts 60 cycle. Secondary 2 1/2 V. 10 Amps. 10,000 V. Insulation. Suitable for pair of 868 tubes

..... ea. \$3.95

CHOKE—FULLY CASED

5 HENRY @ 200 Ma 1.95
5 HENRY @ 250 Ma 2.25
4 HENRY 400 Mil 2.95
12 HENRY 500 Mil 8.95
4 HENRY 900 Mil 12.95
6 HENRY 800 Mil 8.95

BRAND NEW OIL CONDENSERS

2 MFD 600 VDC .50	4 MFD 2000 VDC 3.50
3 MFD 800 VDC .60	6 MFD 2100 VDC 4.95
4 MFD 1000 VDC .75	8 MFD 2300 VDC 5.95
5 MFD 600 VDC .80	2 MFD 2500 VDC 2.50
6 MFD 800 VDC .85	1 MFD 3000 VDC 1.85
8 MFD 800 VDC .95	1 MFD 3000 VDC 3.50
10 MFD 600 VDC 1.19	4 MFD 3000 VDC 6.95
12 MFD 600 VDC 1.50	1 MFD 4000 VDC 3.25
3x8 (24 MFD) 600 VDC 2.50	2 MFD 4500 VDC 6.25
1 MFD 1000 VDC .60	3 MFD 4000 VDC 8.95
2 MFD 1000 VDC .85	5 MFD 7500 VDC 2.95
4 MFD 1000 VDC 1.35	1 MFD 7500 VDC 6.95
6 MFD 1000 VDC 1.95	2 MFD 7500 " 17.95
10 MFD 1000 VDC 2.50	2 MFD 10,000 " 29.95
12 MFD 1000 VDC 2.95	1 MFD 12,500 " 19.95
15 MFD 1000 VDC 3.50	2 MFD 12,500 " 34.50
1 MFD 1200 VDC .45	1 MFD 15,000 " 34.50
1 MFD 1000 VDC .75	5 MFD 25,000 " 34.95
2 MFD 1500 VDC 1.10	1 MFD 25,000 " 69.95
4 MFD 1500 VDC 1.95	50MFD 125VAC 2.50
8 MFD 1500 VDC 2.95	4 MFD 310 " .85
1 MFD 2000 VDC .85	10 MFD 330 AC. 1.95
2 MFD 2000 VDC 1.50	50 MFD 330 AC. 4.50
	15 MFD 440 AC. 2.50

SOLA CONSTANT VOLTAGE TRANS.

Input 95-125 V.AC 60 Cy. Output Sec. constant 6V. @ 4.16 Amps

..... ea. \$6.95

SIGMA 5F RELAY

16,000 ohm in dual 8,000 ohm coils. SPDT adjustable silver contacts and armature tension. Operates on 500 Microamperes or less

..... ea. \$3.95

Write for quantity prices

RELAYS

24V. AC 3PDT	ea. \$1.65
24V. AC 4PDT	ea. \$1.85
Allied Relay 110 V. AC. DPST	ea. \$1.35
Hermetically Sealed Relay Coil 110V AC 60 cy SPDT Contacts 8 Amps	ea. \$1.50
6 Volt DC DPDT H.S.	ea. 99c
12 Volt DPDT DC Relay	ea. \$1.35
SIGMA type 22RJ 8,000 ohms. SPDT, small sealed relay	ea. \$2.49
Sealed Relay. SPDT. 6,000 ohm coil	ea. \$1.95
G.E. Relay control, contains 8000 ohm relay, sensitivity 2 mils. 10 for 59.25. ea.	ea. \$1.10
LEACH ANT. RELAY 110V. AC DPDT Ceramic Ins.	ea. \$3.45

DUAL GANGED SUPERIOR POWERSTAT

Brand New—0-110 V. AC 60 Cy. Each unit 18 Amps (36 Amps total)

..... ea. \$59.50

PANEL METERS

G.E. WESTINGHOUSE	W.E. SIMPSON, etc.
3" METERS	
1 1/2" METERS	100-0-100 Micro Amps DC 5.95
0-1 Mil 2.95	0-10 Mil DC 3.95
0-100 Micro 3.95	0-100 Mil DC 3.95
2" METERS	
0-50 Micro (0-5 scale) 4.95	0-15 Volts AC 3.95
0-300 Mil DC 2.95	0-800 Volts DC 4.50
0-10 Amps DC 2.95	0-2.5 KV DC 5.50
0-20 Volts DC 2.95	0-4 KV DC 7.50
18-36 Volts DC 1.99	Running Time Meter, 0-9,999.9 hrs. 110V. 60 cy.
0-150 V. AC 3.49 ea. \$9.50
0-3 Amps RF 2.95	
0.4 Amps RF 2.95	

MISCELLANEOUS SPECIALS

36 OHM 50 Watt Globar Non-Ind. Res. 60c ea.
3-12 MMF Erie Ceramic Trimmers. 2 for \$1.00 21c
Murdock Headphones—BRAND NEW 10,000 ohm imped. with std. phone plug. ea. \$2.95
Replacement 6' phone cord for Standard Headsets 35c
CUTLER-HAMMER TOGGLE SWITCH SPDT (ST42D) 4 for \$1.00 ea. 29c
WILLARD STORAGE CELL—2V. 28 Amp hrs Clear Plastic case. 2.50
Shipped dry

Write for quantity prices on all special items

All merchandise sold on a 10 day money back guarantee basis

Min. Order \$3.00—25% with Order—P.O.B. New York

PEAK

ELECTRONICS COMPANY

66 W. Broadway, New York 7, N. Y., WO-2-5439

Advance INVENTORY REDUCTION S-A-L-E! PRICES SLASHED TO CORE! (THIS MONTH ONLY!)

RELAYS!	RELAYS!	RELAYS!
110 V AC DPDT W.L. AC DPDT \$2.35	24 V AC SPDT Sigma 41-F... 1.20	10 V AC... 1.50
Ceramic-Leach. 2.95	16,000 Ohm Plate, Sig- ma 5F SPDT - adj. Will operate on 500 Mma\$3.60	
12 V DC DPDT 1.25		
6 V DC SPDT 1.25		
Sigma 5-000 ohm SPDT 2.05		
LARGE STOCK AC, DC RELAYS		

★★★★★ Solenoids ★★★★★
115V 60 Cyc. cont. duty, 18 Lb. pull... each \$4.75
8 lb. pull... each 2.30
24V & 230V SORENG IN STOCK!

POWER TRANSFORMER	AC INPUT TEST METER
117 V Pri. 600 V Sec., 275 Ma., 6.3 V., 9 Amps; 5 V. & 8 Amps. Flat mounting SPECIAL \$3.10 350 Mills SPECIAL 6.95	4,000 ohms per V. 0-1 to 5 150 VAC... \$9.45

CHOKES FULLY CASED	TUBE CHECKER I-777
6 hy. 100 Ma. \$.95 8 hy. 100 Ma. 1.49 8 hy. 200 Ma. 1.49 10 hy. 150 Ma. 1.79 20 hy. 300 Ma. 7.95 22 hy. 100 Ma. 2.19	115 VAC, mutual con- ductance, exc. cond... \$23.50

★★★★ Transformers ★★★★★
ALL WITH 110 VOLT PRIMARY
6.3 V SEC. 1 Amp \$1.09 12 V SEC. 2 Amp \$1.19
6.3 V SEC. 4 Amp 2.09 24 V SEC. 1 Amp 1.09
Step up down Transformer
110 V-220 V 12 Amp \$9.20
110 V-220 V 10 V-40 V at 4 Amp \$5.20
Primary 115, sec. 6 V-7 V-8 V, 75 VA... 4.05
Plate 3100 V CT 300 MA... 17.75
Sola constant voltage, 95-125 V in 6.3 @ 17.75
10 Amps out... 8.45

CO-AX RELAYS!!
12 or 24 V DC (please specify). NEW. \$8.40 ea.

RG CO-AX CABLE
8 U. 52-ohm impd., 100 ft. length... \$7.75
59 A U (72-ohm) w/ mate and female connectors, 50 ft. coils... 2.45 ea.
58 U. 100 ft. length... 4.25 ea.

OIL CONDENSER BARGAINS

SPECIAL!! 3x8 mfd 500 VDC	\$2.55
2 mfd 600 VDC .40	4 Mfd 1500 VDC 1.60
4 Mfd 600 VDC .69	10 Mfd 1500 VDC 3.40
8 Mfd 600 VDC .83	2 Mfd 2000 VDC 1.39
10 Mfd 600 VDC .99	3 Mfd 2000 VDC 2.45
15 Mfd 600 VDC 1.75	2 Mfd 2500 VDC 2.15
16 Mfd 600 VDC 1.75	1 Mfd 3000 VDC 1.50
40 Mfd 600 VDC 3.95	2 Mfd 4000 VDC 5.30
20 Mfd 650 VDC 2.45	2 Mfd 6000 VDC 14.75
1 Mfd 1000 VDC .55	2 Mfd 10000 VDC 16.95
2 Mfd 1000 VDC .59	1 Mfd 12500 VDC 27.00
8 Mfd 1000 VDC 1.42	

L-O-O-K! PANEL METERS

1" METERS	0-5 Mills	3.25
0-1 Micro-amps \$2.95	0-200 Mills	3.25
0-200 Micro-amps 2.95	0-5 Amp AC (scale marked 0-150)	2.95
2" METERS		
0-1 Ma. RF... 3.25	0-1 Mill (scale 0-50)	4.10
0-3 amps. RF... 2.95	200-2000 V DC	3.25
0-200 Micro-amps 2.95	0-300 Amps DC, w/ shunt	5.45
0-30 Milli-amps 2.95	-10.0 to +60S	5.45
0-250 Milli-amps 2.95		
0-300 V AC		
75-0-75 Micro-amps null indicator... 5.75	RUNNING TIME METERS	
0-7.5 V DC... 2.95	0-9999 QE 110V 7.45	
0-200 V DC... 2.95	0-9999 JBT 230V 9.50	
0-300 V DC... 2.95	Comb w/ freq. meter, JBT, 110 V AC... 17.95	
3" METERS		
0-100 Micro-amps 5.95	Fram freq. meter 110-130 V 58... 62 cyc... 9.95	
0-200 Micro-amps 4.95	400 cyc... 8.95	
0-7.5 V AC... 3.35		
0-150 V AC... 3.35		
0-1 Mill... 4.45		

★★ SELENIUM RECTIFIERS ★★
—FULL WAVE BRIDGE—
130/110 VAC input 30/24 VAC input
150 mills... \$1.25
200 mills... 1.75
300 mills... 2.50
500 mills... 3.50
1 1/2 amps... 5.25
12 amps... 19.75
1/2 amp... 1.15
2 amp... 2.15
5 amp... 4.95
7 amp... 6.25
20 amp... 12.95

SPERTI-VACUUM SWITCH!... \$1.95
same as used in ART-13

4 WIRE TELEPHONE COILED CORDS 76c ea.
7 for \$5.00
STEPPING RELAYS 16 deck, 22 pos. 19.50

WESTERN ELECTRIC VOLUME INDICATOR	POWER SUPPLY KIT!
with Weston -732 db. meter. Var. 2-24... \$14.25	Primary 115V, 60 Cy. Sec., 400- 0-400 V. @ 200 Ma., 6.3 VCT std. mounting plus 8 Hy. 200 Ma. chokes and two 8 mfd. 600 V. oil con- densers... Kit \$6.70

PYROMETER POTENTIOMETER
Single scale, electrically compensated
made by Lewis Eng. in mahog. box... \$49.50

M A R POWER SUPPLY
115 V, 60 Cyc. input 12-14 VDC, 2
Amp output filtered and fully housed... \$8.30

Min. Order \$3.00-25% with order F.O.B. New York
10 DAY GUAR. PRICE OF MOSE. ONLY

Advance Electronics
6 West Broadway • New York 7, N. Y. • Rector 2-0270

SERVICING
Handling Hi-Fi Service Calls (Gor-
don) 68 Oct.
Simplified Speaker Testing (Her-
locker) 41 Nov.
Testing Electrostatic Loudspeakers
(Janszen) 62 Mar.

STEREO
Balancing Your Stereo System (Bur-
stein) 44 Dec.
"Carillon" Stereo Amplifier (Lab
Tested) 52 June
Case for a Third Channel (Feld-
man) 70 Mar.
Compact Two-Tube Stereo Ampli-
fier (Augeri & Christiansen)... 44 Sept.
Compatible Stereo Broadcasts... 125 May
Compatible Stereo for AM Stations
Complete Stereo Amplifier System
(Lab Tested)... 66 Apr.
Experiments in Stereo for P.A. Sys-
tems (Thornton)... 128 May
FM Multiplex—its present and fu-
ture (Part 1) (Hille, Jr.)... 57 Jan.
FM Multiplex—its present and fu-
ture (Part 2) (Hille, Jr.)... 58 Feb.
Integrated Stereo Amplifier (Lab
Tested) 70 Feb.
Low-Cost Stereo System (Meagher)
Making & Using a Stereo Test Rec-
ord (Minter)... 56 May
Master Stereo Preamp (Lab Tested)
New Idea in a Stereo Preamp (Lab
Tested) 46 Mar.
New Stereo System for AM Band... 143 Jan.
New Third Channel Approach
(Kramer) 119 Aug.
Phantom Channel for Stereo (Bur-
stein) 46 June
Rebuild the UPX-003 Preamp for
Stereo (Jones)... 67 Sept.
Stereo Illusion (Harris)... 37 Oct.
"Stereo Master"—a Hi-Fi Control
Center (Lab Tested)... 64 May

SPEAKERS—HOUSINGS
Bass-Reflex Design Charts—Includ-
ing Ducted Port Types... 54-55 Sept.
Ducted-Port Bass-Reflex Enclosure
for 12" Speaker (Lab Tested)... 37 June
Loudspeakers for Stereo (Part 1)
(Crowhurst) 51 Apr.
Loudspeakers for Stereo (Part 2)
(Crowhurst) 42 May
Reflex Enclosures—How They Work
(Augsburger)... 34 June
Subdivided Hi-Fi Speaker Enclosure
(Rehberger) 57 Nov.

TAPE RECORDING
All-Transistor Stereo Tape System
(Jones) 65 July
Slow-Speed Tape Recording (Hog-
an) 56 June
Tape Recorder Conversion Chart... 42 Oct.
Tape Recording Industry (Guest
Editorial) (Brown)... 67 Oct.
20 cps Recorder Switch (Reed)... 102 Apr.

TELEVISION
ANTENNAS
Airborne Relay for Intercontinental
TV (Martin) 46 Jan.
Antenna Installations: Fact & Fic-
tion (Beever) 42 Apr.
Candelabra TV Tower (Johnson)... 112 Oct.
Cover Story... 43 Apr.
Practical Know-How for Multi-Set
TV Installations (Beever)... 51 Jan.
Quarter-Wave Matching Section
(Nomograph) 56 Mar.
Right Way to Stack Antennas
(Buchsbaum) 60 Jan.
TV-FM Signal Distribution for Home
& Shop (Beever)... 62 Feb.
V.H.F. TV Spectrum and Interfer-
ence Chart... 53-54 Mar

STATEMENT REQUIRED BY THE ACT OF AUGUST 23, 1912, AS AMENDED BY THE ACTS OF MARCH 3, 1933, AND JULY 2, 1940 (TITLE 39, United States Code, Section 233) SHOWING THE OWNERSHIP, MANAGEMENT, AND CIRCULATION OF ELECTRONICS WORLD published Monthly at Chicago, Illinois for October 1, 1959.

1. The names and addresses of the publisher, editor, managing editor, and business managers are: Publisher, Ziff-Davis Publishing Company, 434 So. Wabash Ave., Chicago 5, Ill.; Editor, William Stocklin, One Park Ave., New York 16, N. Y.; Business manager, Leonard O'Donnell, One Park Ave., New York 16, N. Y.

2. The owner is: Ziff-Davis Publishing Company, 434 So. Wabash Ave., Chicago 5, Ill.; Estate of William B. Ziff, One Park Ave., New York 16, N. Y.; A. M. Ziff, One Park Avenue, New York 16, N. Y.

3. The known bondholders, mortgagees, and other security holders owning or holding 1 percent or more of total amount of bonds, mortgages, or other securities are: None.

4. Paragraphs 2 and 3 include, in cases where the stockholder or security holder appears upon the books of the company as trustee or in any other fiduciary relation, the name of the person or corporation for whom such trustee is acting; also the statements in the two paragraphs show the affiant's full knowledge and belief as to the circumstances and conditions under which stockholders and security holders who do not appear upon the books of the company as trustees, hold stock and securities in a capacity other than that of a bona fide owner.

5. The average number of copies of each issue of this publication sold or distributed, through the mails or otherwise, to paid subscribers during the 12 months preceding the date shown above was: (This information is required from daily, weekly, semiweekly, and triweekly newspapers only.)
J. L. O'DONNELL, business manager.

Sworn to and subscribed before me this 17th day of September, 1959.

[SEAL] WILLIAM PROEHMER, Notary Public.
(My Commission expires March 30, 1960)

GLOBE ELECTRONICS
A World of Values!

ACTUAL PHOTOGRAPHS OF SQUARE WAVES ON DUMONT #241 5-INCH TEST OSCILLOSCOPE

Ampl. Input Imped. Gain Def. Sens. Response ±3 db
Y 2 M, 40 mmf. 250 .07vrms/in. 20-2,000,000 cy.
X 2 M, 40 mmf. 100 .7vrms/in. 5-100,000 cy.
Z 1 M, 20 mmf. 10 30-2,000,000 cy.
X and Y plates fed push-pull from both amplifiers.
Panel terminals give choice of P-P or unbalanced Direct connections, sensitivity 22vrms for Y, 21 for X. 15-30,000 cy sawtooth rates. Test-voltage post 1.6v peak peak, 60 cy.
Specifications above DO NOT TELL THE STORY. One sq.-wave picture is worth 1000 words of response CLAIMS or specs. #241 is the lab-man's favorite. Big sturdy, always dependable. 65 lbs net of Dumont quality 15"x10 1/2" panel has room for convenient controls and inputs. Sharp appearance you can be proud of. Checked and guaranteed electrically. With reprint of complete instruct. book, large schematic, parts list. Shpg wt 75 lbs., Santa Monica, Calif. \$79.50

GLOBE ELECTRONICS
3103 PICO BLVD. SANTA MONICA, CALIF.
Phone: Exbrook 3-7206

ELECTRONICS

PREPARE FOR A GOOD JOB!
BROADCAST ENGINEER
RADIO SERVICING AUTOMATION

TELEVISION SERVICING
BLACK & WHITE—COLOR

APPROVED FOR VETERANS AND SURVIVORS
OF VETERANS
BUILDING AIR CONDITIONED
SEND FOR FREE LITERATURE

BALTIMORE TECHNICAL INSTITUTE
1425 ETUAW PLACE, BALTIMORE 17, MD.

COLOR

Color TV Service: Fact and Fiction (Mohan) 44 Feb.
 New Color TV Design Makes Its Debut 106 July
 New TV Projector Makes Giant Color Picture..... 65 Mar.

MISCELLANEOUS

Innovation in Plated Circuitry..... 100 Oct.
 New Picture Tube has Built-on Safety Glass..... 117 Apr.
 New TV Designs for 1959 (Buchsbau) 54 Apr.
 Pay-TV Today (Bernsohn)..... 144 Sept.
 RCA Puts Rebuilt Picture Tubes on the Market..... 105 Feb.
 Replacement Parts—Standard or Special? (Buchsbau)..... 72 Mar.
 Super-Sensitive TV Camera Tube.. 94 Aug.
 Transatlantic TV via Phone Cable. 99 Sept.
 Transistorized Midget TV..... 105 Jan.
 TV Service—and the Ladies (Rosen) 44 June
 TV Service is NO Gravy Train (Silver)..... 57 Feb.
 You Can Buy This Transistorized TV 56 July

SERVICE ASSOCIATIONS

Service Association of the Month: Assn. Radio & TV Servicemen of Ill. 100, Jan.; Indiana Electronic Service Assn. 156, Feb.; TEA of San Antonio, Tex. 90, Mar.; ESFETA 102, May; BEST of Ariz. 102, June.

SERVICE NOTES

Another Day in the Shop (Eldridge) 132 May
 Are You "Alignment Happy?" (Bramham) 47 Nov.
 Aspects of Hum (Gary)..... 94 Sept.
 Cover Story..... 51 Nov.
 Defects in the Horizontal Oscillator (Buchsbau)..... 40 Apr.
 Defects in the Sync Section (Buchsbau) 50 Apr.
 Fix Those Printed-Board Defects (Lawrence) 54 Dec.
 "I'm Sure It's Just a Tube" (Hust) 68 Feb.
 Novel TV Circuit Improvements (Martin) 48 June
 Printed Boards: Roadblocks or Road Maps? 50 Nov.
 Problems in Horizontal Blanking (Dines) 70 Jan.
 Problems in TVI Localization..... 55 Mar.
 Problems with Spurious Oscillation (Heller) 57 Sept.
 Quadrature FM Detectors: Function and Failure (Bramham)..... 118 Dec.
 Service Notes 144, Jan.; 154, Feb.; 129, Mar.; 140, Apr.; 142, May; 98, July; 88, Aug.; 132, Oct.; 96, Nov.; 96, Dec. 124
 Servicing with Your Eyes (Bramham) 66 Sept.
 Tame TV "Dogs" with Technique (Smith) 58 July
 Test Bench Puzzler: No. 4 (Lemons) 102 Jan.
 Test Bench Puzzler: No. 5 (Eldridge) 164 Mar.
 Test Bench Puzzler: No. 6 (Margolis) 154 Apr.
 Those Marginal TV Defects (Buchsbau) 42 June
 Troubleshooters' Guide to CRT Defects (Special Chart) (Heller).... 53-54 July
 TV Schematics for 1959 (Motorola TS-552, General Electric U3, RCA KCS124C, D, E, F, H, J, K, & L Chassis) 74-79 Apr.

TEST EQUIPMENT

AMATEUR

Transistorized Frequency Meter (Fox, WIKPN)..... 46 Feb.

AUDIO

Level Indicator for Hi-Fi (Lab

the most important Hi-Fi dollar you'll spend this year will be for the new

HI-FI DIRECTORY

& BUYERS' GUIDE

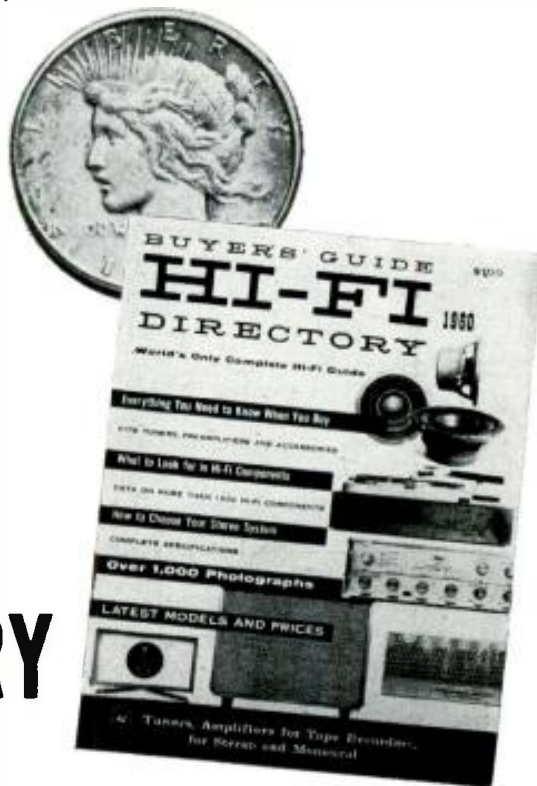

Now on sale or order by coupon today. Only \$1

The hi-fi enthusiast who makes the smartest investment knows long beforehand exactly what equipment, prices, and specifications await him. You too can get the complete story—before you ever actually step into a store by buying the big 1960 edition of the HI-FI DIRECTORY & BUYERS' GUIDE. It's jammed from cover to cover with listings covering virtually every piece of hi-fi equipment manufactured.

Complete with all prices and specifications, it includes illustrations of hundreds of products. The world's most comprehensive hi-fi reference gives you entire sections on:

- TUNERS • RECORD PLAYERS • TAPE RECORDERS
- CARTRIDGES • TONE ARMS • TURNTABLES
- AMPLIFIERS • PREAMPS • LOUDSPEAKER SYSTEMS
- RECORD CHANGERS • ENCLOSURES AND CABINETS

PLUS: Helpful articles and features on what to look for, how to buy, advantages and disadvantages of different models, how to judge quality and recognize a bargain.

BUY YOUR COPY OF THE 1960 HI-FI DIRECTORY & BUYERS' GUIDE AT YOUR NEWSSTAND OR RADIO PARTS STORE, OR ORDER BY MAIL TODAY USING THE HANDY COUPON BELOW. ONLY \$1

Ziff-Davis Publishing Company
 Department EW-129
 434 S. Wabash Avenue
 Chicago 5, Illinois

Please send me a copy of the 1960 HI-FI DIRECTORY & BUYERS' GUIDE. I enclose \$1.00, the cost of the DIRECTORY, plus 10¢ to cover mailing and handling charges. (Canada and Foreign, \$1.25 plus 10¢ postage.)

NAME _____

ADDRESS _____

CITY _____

ZONE _____

STATE _____

Quality Equipment All priced to Sell All Excellent Values!

- New Silicon Rectifiers. Input 130 Volts @ 500 Ma. 75¢ each (10 for \$7.00)
- Audio Devices type 20E5 Silicon Rectifier. 750 Ma. (130 V. RMS) 90¢
- Sonotone Rechargeable Battery Cartridge Model FC-2. \$7.95
- Sola Constant-Voltage Plate & Filament Transformer. Sola Cat. #7105. \$5.95
- Crystal Mike—Also useful as crystal earpiece. Super-compact . . . Only 50¢ ea.
- RCA 5" Scopes WO-58A \$85.00 or WO-60C \$85.00
- 7 Conductor Intercom Cable (color coded)—6¢ per Ft.
- W2EWL SSB Transformers (3 for \$2.50). New
- Model 804 Lab Sig. Gen. (8 to 330 Mcs.) \$100.00
- RCA Model WR-41B UHF Sweep Gen.—Only \$95.00
- Precision Model E8500A. 5" Wide-Band Scope (New) \$125.00
- Precision Model 98 VTVM New. Large 7" Scale. \$90.00
- Weston VTVM Model 375/U \$90.00
- Hickok Model 695 TV/FM Alignment Sig. Gen. New \$150.00
- Measurements Model 84 Sig. Gen. (300-1000 Mcs) \$295.00
- Daven Model 80 (TS497B/URR) Sig. Gen. (2 to 400 Mcs) New \$395.00
- Hewlett-Packard Model 430A Vacuum Tube Voltmeter \$80.00
- Hewlett-Packard Model 320A Distortion Analyzer \$85.00
- Lavoie Model 150S Freq. Meter (90 to 215 Mcs) \$50.00
- W.E. TS-34A/P "X" Band Sig. Gen. Pwr. Meter \$45.00
- CBS Sig. Bar Gen. (60 CPS to 15,750 CPS) Model A. \$50.00
- LM-21 Navy Freq. Meter (125 to 20,000 KCS) \$75.00
- BC-221 Army Freq. Meter (125 to 20,000 KCS) \$85.00
- LM Power Supply 115 VAC 60 CPS \$30.00
- TS-175/U (85 to 1000 MCS) Freq. Meter \$175.00
- Shalcross Model 621-A Per-Cent Limiting Bridge \$90.00
- RCA WR-94B 12 Channel TV Sweep Osc. \$45.00
- Sperry Microline Klystron Sig. Source-Model 444 \$250.00
- GE 3000 VDC Deluxe Bench Lab Power Supply \$150.00
- TN-16 Tuning Unit for APR-4 Receivers, etc. (38 to 95 MCS) \$15.00
- TN-17 Same as above, except 74 to 320 MCS \$15.00
- APR-5A UHF Receiver 1000 to 6100 MCS. Operates from 115 VAC 60 CPS Lab-tested O.K. Special . . . \$45.00
- Century Antenna Line Tester—for Ham & TV Use. Brand new. Jobber boxed (Reg. \$19.95). \$7.95
- Bendix L M-10 (125 to 20,000 KCS) Freq. Meter \$75.00
- G.R. and H.P. Model 75B-A (55 to 400 MCS) Wavemeter. \$9.95
- RCA Type 69C Distortion and Noise Meter \$75.00
- Electro #RHG 110BT Inverter (New). In: 110 V. DC. Out: 110 V. AC. @ 500 Watts Int. (350 W. Cont.) \$35.00
- T.E.C. Camera Chain. \$300 as per visual inspection
- F.T.R. Model 2301 Monoscope Camera. \$250 as per visual inspection
- Raytheon Power Supply. Input: 6 VDC—Output: 117 VAC @ 60 CPS (50 Watts conservative) New. \$16.95
- Jennings "U" Variable Vacuum Capacitor 50 to 250 MMF @ 15 KV new. \$69.00
- Medium Dihedral C.R. Socket 2 1/4" Diam. \$1.00
- In Stock: NC-60, G-50, HQ-100, HQ-160, HQ-145-C, Drake 1-A SSB Rcvr, 32 V2, B & W 5100S. Write
- Elmac Superpower Klystrons type 3K20000LK, 4K50, 000LQ, 4KM50, 000SG. In stock. Write
- HS-30 Headsets with headband and impedance matching Xfmr. Works on hi/lo impedance. \$2.00
- Dehumidifier. Keep Gear Dry—Works on 115 V. AC. New. 75¢ ea. (3 for \$2.00)
- RG-59/U Coax—New—\$4.00/C Ft.
- TS-78/U Tune-Up "Dummy" Load. Excellent for Citizen Band or VHF \$1.00

Write for latest tube list. Largest diversified stock of name brands. 1st Quality TV, Radio, Hi-Fi-Xmtg, industrial tubes and semiconductors in USA, HQTRS. for tubes/tube cartons at sensible prices. Warehouse Factory Distributors for CBS, Westinghouse tubes and semiconductors. Prices FOB, NYC. All mds. guaranteed (cost of mds. only). \$5.00 minimum order. Mds. subject to prior sale.

BARRY ELECTRONICS CORP.

512 Broadway, Dept. EW-12, New York 12, N.Y.
Telephone: WALKER 5-7000

Tested) 124 Jan.
Stereo Sound Balance (Reed). 42 July

AM-FM

Compact, Low-Ripple Radio Battery Eliminator (Loebenstein). 41 Jan.
Dynamic Transistor Checker. 102 Oct.
Expanded-Range A.C. Voltmeter (Lederer) 69 July
Generating Test Signals with Crystals (Herriman). 66 May
Meter Zero Suppression with Zener Diodes (Snedeker). 71 Sept.
New Jobs for Tube Pins (Russell). 53 Oct.
Preamp for Your Meter (Jasper). 132 Sept.
Protection for Your Meter Movement (Pruitt). 116 Aug.

MISCELLANEOUS

Build an Accurate Pulse Timer (Stone) 96 July
Check Inductors with a Test Probe (Winklepleck) 66 Aug.
Evaluating an Oscilloscope (Anderson) 33 June
Mac's Service Shop (Frye). 52 Mar.
Mac's Service Shop (Frye). 66 Oct.
Special Test Instruments. 64 Apr.
"Strobolyzer"—A High-Intensity Stroboscopic Analyzer (Fender). 57 Dec.
Test Equipment for the Basic Shop (Frye) 70 Apr.
Test Equipment for the Complete Shop (Gary). 37 Apr.
Transistorized Tachometer (Small & Brady) 42 Jan.
Transistor-Regulated Power Supply (Vogelgesang) 60 June

TELEVISION

Improving the Rainbow Generator (Libes) 52 Sept.
Transistor Tone Generator (Winklepleck) 108 Feb.
2-Transistor Scope Trace Switch (Curchack) 66 Feb.
"Voltage Minder" (Bryce). 160 Feb.

MARS SCHEDULES FOR DECEMBER

The First Army MARS SSB Technical Net, which operates on 4030 kc. upper sideband, Wednesdays at 9 p.m. (EST), has announced the following speakers for December.

Dec. 2—"Technical Aspects of Satellite Communications" by L. Smilen, Brooklyn Polytechnical Institute.

Dec. 9—"The Trans-Atlantic Submarine Telephone Cable" by H. West, AT&T.

Dec. 16—"Determination of Percent Success Expectable in High Frequency Radio Transmissions" by G. Krause, U. S. Army Signal Radio Propagation Agency, Fort Monmouth.

Dec. 23—"FM Forward Scatter Tropospheric Communications Systems" by J. Lesmez, Radio Engineering Labs., Inc.

Dec. 30—"Coaxial Cable" By M. Ferber, Times Wire & Cable Company.

—30—

PHOTO CREDITS

Pages	Credit
38, 39, 40 (Figs. 1, 8, 10, 11, 12)	The Theratron Company
38 (Fig. 4)	National Cylinder Gas Co.
38, 39 (Figs. 2, 9)	Erdeo Engineering Corp.
39 (Fig. 6)	Allis-Chalmers Mfg. Co.
41, 133	Institute of High-Fidelity Manufacturers
110	Technical Appliance Corp.

PRE-PUBLICATION SPECIAL OFFER!

YOU MAY HAVE EITHER OR BOTH OF THESE BIG, HARD-COVER ELECTRONICS GUIDEBOOKS ON A

7-DAY FREE EXAMINATION



COMPUTERS AND HOW THEY WORK \$4.95

Here is a fact-filled, exciting guidebook to the wonder-world of electronic computers, with more than 120 illustrations and easy-to-follow tables in 10 big chapters. Step by step, you'll see and understand the workings of every type of computer ever used. This important new book illustrates the basic principles of computers with crystal-clear clarity. It's must reading for career-minded students and for electronics professionals who want a more complete knowledge of computers.

THE ELECTRONIC EXPERIMENTER'S MANUAL \$4.95



THE ELECTRONIC EXPERIMENTER'S MANUAL is a big, informative volume, containing hundreds of specially prepared diagrams and construction drawings. There are 10 individual sections, each covering a specific phase of electronic construction. One giant chapter shows projects, test equipment and special tools you can build, plus plans for a complete workshop! With just a few dollars worth of tools, and this book to guide you, you'll have the know-how you need to get started, or advance, in electronic experimentation.

GET ONE OR BOTH FOR 7-DAY FREE EXAMINATION! MAIL THIS COUPON TODAY

ELECTRONICS BOOK SERVICE
A Division of the Ziff-Davis Publ. Co.
One Park Avenue • New York 16, N. Y.

Gentlemen: Send me a copy of:

- COMPUTERS AND HOW THEY WORK
 THE ELECTRONIC EXPERIMENTER'S MANUAL
and bill me at only \$4.95 a copy plus postage. I understand that I may return the book(s) within 7 days and owe nothing.

\$_____enclosed. (SAVE MONEY! Enclose payment now and we'll pay the postage.)

Name _____

Address _____

City _____ Zone _____ State _____

(N.Y.C. orders add 3% sales tax.) EW129

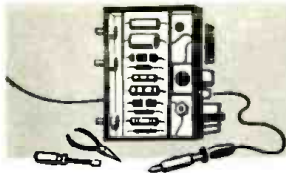

ELECTRONICS MARKET PLACE

RATE: 60c per word. Minimum 10 words. February 1960 issue closes December 10th. Send order and remittance to ELECTRONICS WORLD, One Park Ave., N. Y. C. 16, N. Y.

RADIO ENGINEERING

ELECTRONICS! Associate degree—29 months. Technicians, field engineers, specialists in communications, missiles, computers, radar, automation. Start February, September. Valparaiso Technical Institute, Dept. N, Valparaiso, Indiana.

FOR SALE

CITIZENS' Two-Way radiotelephone for business or pleasure. Conset, Hallicrafters, Johnson, Polycomm. Range 10 to 20 miles. Easily licensed. Free literature. Transmitter and receiver crystals for all 22 Citizens' channels \$2.95 each postpaid. Specify channel number or frequency. Communications Equipment Company, Dept. EW, 518 State Street, La Crosse, Wisconsin.

DIAGRAMS for repairing radios \$1.00. Television \$2.00. Give make, model. Diagram Service, Box 672-RN, Hartford 1, Conn.

RADIO & TV Tubes at manufacturers prices. Guaranteed—Send for free price list. Edison Electronic Tube Co., Menlo Park, N. J.

PROFESSIONAL Electronic Projects—Organs, Timers, Counters, Intercoms, etc.—\$1. each. List Free. Parks, Box 1665, Lake City, Seattle 55, Wash.

TELEVISION Sets \$9.95, plus shipping. Jones TV, Sanatoga, Pa.

GIZMOS & Such of Still River, Mass., offer a limited number of BC779 Hammerlund super pros guaranteed to please at \$74.50 each.

RADIO & TV Tubes at Manufacturers Prices! 100% Guaranteed! Brand New! No re-brands or pulls! United Radio, Box 1000, Newark, N. J.

TUBES—TV, Radio, Transmitting And Industrial Types At Sensibly Low Prices. New. Guaranteed. 1st Quality, Top Name Brands Only. Write For Free Catalog or Call Walker 5-7000, Barry Electronics Corp., 512 Broadway, New York 12N, N. Y.

GOVERNMENT Surplus Snooperscopes, parabolic reflectors, Receivers, Transmitters. Picture list 10c. Meshna, 580 N. Lynn, Malden 48, Mass.

TELEVISION & Radio Tubes, Parts and Supplies Guaranteed. Hi-Quality Tube Co., Inc., 284 Lafayette St., Rahway, New Jersey.

GOVERNMENT SELLS: Surplus Electronics; Test Equipment; Oscilloscopes; Transceivers; Jeeps; Boats; Aircrafts; Misc.—Send for U. S. Depot Directory & Procedure \$1.00—"Government Surplus Sales," Box 425—RT, Nanuet, N. Y.

TV SALES—Service and Parts all Stock & Equipment & Truck. Seven years of good will on main street. \$5,000.00 Cast. Contact Clark TV, 3652 Foothill Blvd., La Crescenta, California. Member SRTT.

AUTO Radio Distributor selling servicing Becker Blaupunkt, FM-AM, other European, American Sets. Save 30% + Square Electronics, 150-60 Northern Blvd., Flushing, N. Y.

TUBES—Television, Radio. Top name brands, Original Manufacturers Boxes, Fully guaranteed, terrific discounts. Write to Teletube Supply Co., 159 Western Promenade, Cranston, Rhode Island.

ORGAN enthusiasts: Build your own electronic organ. We supply special components, diagrams; you furnish the rest. R. E. Pavelka Company, Dept. 2, Box 5985, Cleveland 1, Ohio.

WANTED

CASH Paid! Sell your surplus electronic tubes. Want unused, clean transmitting, special purpose, receiving, TV types, magnetrons, Klystrons, broadcast, etc. Also want military & commercial lab test and communications gear. We swap too, for tubes or choice equipment. Send specific details in first letter. For a fair deal write, wire or telephone. Barry, 512 Broadway, New York 12, N. Y. Walker 5-7000.

WANTED: Tubes—Special purpose and receiving. Top prices for Klystrons, Power Tubes, Thyratrons, I.V. and Receiving Tubes. Tubes must be unused. Also laboratory grade test equipment such as manufactured by HP and GR and AN/UPM prefix. V. & H. Radio & Electronics, 2053 Venice Blvd., Los Angeles 6, California.

CASH For Used Short-Wave Ham Receivers, Transmitters & Accessories. Treger W9IVJ, 2023 N. Harlem Ave., Chicago 35. Tuxedo 9-6429.

MISSING Radio & TV News. July 1951—The Swedish Broadcasting Corp., Techn. Dept., Valhallavagen 117, Stockholm.

CYLINDER and old disc phonographs. Edison, Conqueror, Idelia, and Oratorio models. Berliner Gramophones and Zono-o-phones, Columbia cylinder Graphophones, and coin-operated cylinder phonos. Want old catalogues and literature on early phonos prior to 1919. Will pay cash or trade late hi-fi components. Classified Box 50 % Electronics World, 1 Park Ave., N. Y. C. 16, N. Y.

NOTICE

In replying to box numbers be sure to address letters to

ELECTRONICS WORLD
1 Park Ave., New York 16, N. Y.

Note: This does not apply to box numbers where city and state are shown.

TAPE & RECORDERS

RENT Stereo Tapes—over 800 different—all major labels—free catalog. Stereo-Parti, 1608-L, Centinela Ave., Inglewood 3, California.

TAPE Recorders, Hi-Fi Components. Sleep Learning Kits, Tapes. Unusual Values. Free Catalog. Dressner, 69-02R 174 St., Flushing 65, N. Y.

AMPEX Concertone, Crown, Ferrograph, Presto, Tandberg, Pentron, Bell, Sherwood, Rek-O-Kut, Dynakit, Others. Trades. Boynton Studio, 10RT Pennsylvania, Yonkers, N. Y.

RECORDERS, Stereo Tapes, Hi-Fi Components, Tremendous Values, Catalog, Etsco, 270-H Concord, West Hempstead, N. Y.

NEW Book Mobile Hi-Fi Stereo Taperecorders. F-M Etc. \$5.00 Ekeradio, 650 North Fair Oaks, Pasadena, California.

HIGH-FIDELITY

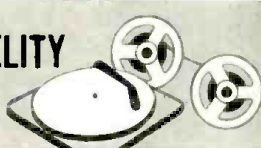

DISGUSTED with "Hi" Hi-Fi Prices? Unusual Discounts On Your High Fidelity Requirements. Write. Key Electronics, 120 Liberty St., New York 6, N. Y. C. Overdale 8-4288.

RECORDERS, Hi-Fi. Free Wholesale Catalogue. Carston 125-R East 88, NYC 28.

REPAIRS and SERVICING

SPEAKERS repaired fast, any type, write for price list. JaMac, 8845 N.E. Sandy Blvd., Portland, Oregon.

ALL Makes High Fidelity Speakers Repaired. Amprite, 70 Vesey St., N.Y. 7, N.Y. BA 7-2580.

METERS and test equipment repaired. Meter sales. Free list. Bigelow Electronics, P.O. Box 1, Bluffton, Ohio.

SPEAKERS—HiFi or Regular rebuilt and repaired. New guarantee. Allied Loudspeaker Company, 819 North Broad, New Orleans, Louisiana.

INSTRUCTION

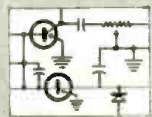

FREE Aptitude Test tells if you can qualify for Radio-Television Servicing. Opportunity for own business if desired. Scientific Aptitude Test will be mailed to you without obligation. Write Sprayberry, Dept. D-25, 1512 Jarvis, Chicago 26, Illinois.

CALCULUS, Powerful Modern Mathematics, Easy Practical Lessons, First Four \$1. Mathco, 4256-3 Minnor, Cincinnati 17, Ohio.

USED Correspondence Courses and Books sold and rented. Money back guarantee. Catalog Free. (Courses Bought). Lee Mountain, Pisgah, Alabama.

EARN college degrees correspondence, all college subjects, \$195, terms, Trinity College, 325 Bankers Trust Building, Indianapolis 4, Indiana.

BUSINESS OPPORTUNITIES

IMPORTANT—Sales and Engineering Positions at Hy-Gain Antenna Products (world's largest manufacturer of communication antennas). Contact Mr. Andros, Phone 2-4320, 1135 North 22nd Street, Lincoln, Nebraska. Applicant must be active licensed amateur radio operator.

RADIO parts stores and Hi-Fi salons! Someone "borrowing" your personal copy of Electronics World each month? You ought to be taking advantage of Electronics World convenient re-sale plan. Sell copies in your store . . . perform a good service for your customers . . . with no risk involved. For details, write: Direct Sales Department, Electronics World, One Park Avenue, New York 16, New York.

MISCELLANEOUS

PHONOGRAPH Records cheap, postpaid. Catalogue. Paramount, Box 2026-N, Pine Castle, Fla.

FREE Flyer Monthly Electronic Surplus. Kurtz, 702C Bay Street, Staten Island 4, N. Y.

SHOPPING GUIDE

Classified

A HANDY GUIDE TO PRODUCTS. NOT NECESSARILY ELECTRONIC, BUT OF WIDE GENERAL INTEREST.

STAMPS & COINS

REVISED Coin Bargain Catalog, 25¢! Dollar Collections: (7 Indian Cents); (6 Liberty Nickels)—both \$1.89! "Prices Paid" listing, \$1.00! Sullivan, 128-FL, East Fourth, St. Paul 1, Minnesota.

THREE Brilliant Uncirculated Mexican Silver Dollars \$1.00. Universal Services, Box 675, San Antonio 6—S12, Texas

PHOTOGRAPHY—FILM, EQUIPMENT, SERVICES

WORLD'S Fair or Miss Universe, Eight Colorslides \$1.00. Eddings, Roberts Avenue, Corning, N. Y.

BUSINESS OPPORTUNITIES

WANT A Good Overseas Or American Job?? High Pay. All Occupations Needed. Transportation Paid. Free Information On Request. Employment Headquarters, 79 Wall Street, Dept. R-2, New York 5.

OVERSEAS Employment. American Firms and United States Government. Comprehensive Job Information \$2.00. Foreign Opportunities, Box 172, Columbus 16, Ohio.

EARN Extra money selling advertising book matches. Free Samples furnished. Matchcorp, Dept. MD-129, Chicago 32, Ill.

MAKE \$25-\$50 Week, clipping newspaper items for publishers. Some clippings worth \$5.00 each. Particulars free. National, 81-DG, Knickerbocker Station, New York.

FOREIGN Employment Information—\$1. Parks, Box 1665A, Lake City, Seattle 55, Wash.

WANT A Good Overseas Or Stateside Job With Higher Pay?? Act Now!! All Occupations Needed. Transportation Paid. Free Information. Employment Headquarters, 79 Wall Street, Dept. R-3, New York 5.

MISCELLANEOUS

FOUR Arrowheads or Hatchhead \$1.00. Birdpoint and Spearhead \$1.00. Iroquois, 435 Washington Road, McKeesport, Pa.

"WINEMAKING; Beer, Ale Brewing." Illustrated. \$2.00. Eaton Books, Box 1242-TC, Santa Rosa, California.

INVENTIONS wanted for immediate promotion. Casco, 703-P, Bernley Building, Philadelphia 7, Penna.

INVENTORS: Protect your invention. Apply for United States Patent. Free "Registration Form." Miss Ardenne, 806 Wm. Penn Annex, Philadelphia 5, Pa.

CLASS "D" CITIZEN BAND CRYSTALS



3rd Overtone: Hermetically Sealed .005% tolerance—Meet FCC requirements, 1/2" pin spacing—.050 pin diameter. (.093 pins available, add 15¢ per crystal.)

\$2.95 EACH
(add 5¢ per crystal for postage and handling)

22 CHANNELS

The following Class "D" Citizen Band frequencies in stock (frequencies listed in megacycles): 26.965, 26.975, 26.985, 27.005, 27.015, 27.025, 27.035, 27.055, 27.065, 27.075, 27.085, 27.105, 27.115, 27.125, 27.135, 27.155, 27.165, 27.175, 27.185, 27.205, 27.215, 27.225.

RADIO CONTROL CRYSTALS in HC6/U HOLDERS—SIX FREQUENCIES

In stock for immediate delivery (frequencies listed in megacycles): tolerance .005% 1/2" pin spacing .050 pin diameter. (.093 pins available, add 15¢ per crystal.) Specify frequency desired.

26.995, 27.045, 27.095, 27.145, **\$2.95 EACH**
27.195, 27.255
(add 5¢ per crystal for postage and handling)

Send for FREE CRYSTAL CATALOG WITH
OSCILLATOR CIRCUITS

ASK YOUR PARTS DEALER FOR TEXAS CRYSTALS
See his next display. If he doesn't stock them,
send us his name and order direct from nearest
factory.

OUR FLORIDA PLANT NOW IN OPERATION
ORDER FROM NEAREST PLANT

TEXAS CRYSTALS

Texas Crystals, Dept. R-129 8538 West Grand Avenue
River Grove, Illinois
Phone: GL 3-3555

Texas Crystals, Dept. R-129 1000 Crystal Drive
Ft. Myers, Florida
Phone: WE 6-2100

ALL ORDERS SHIPPED 1st CLASS MAIL

INDEX OF Advertisers

DECEMBER
1959

ADVERTISER	PAGE NO.	ADVERTISER	PAGE NO.
Acoustic Research, Inc.	123	International Radio & Electronics Corp.	137
Acro Products Company Kit Div.	8	International Resistance Company	126
Advance Electronics	146	Jerrold Electronics Corporation	87
Aeronetics International	126	Johnson Co., E. F.	131
Aerovox Corporation	110	Key Electronics Co.	127
Airex Radio Corporation	140	Kuhn Electronics	132
Allied Radio Corp.	9, 96, 97	Lafayette Radio	103, 104, 105
Amperex Electronic Corp.	Second Cover	Lampkin Laboratories, Inc.	84
Arkay	120	Lektron	141
Ashe Radio Co., Walter	133	McGraw-Hill Book Co.	132
Astatic Corporation, The	29	Mallory & Co., Inc., P. R.	10, 11
Audion	127	Merit Coil and Transformer Corp.	145
B & K Manufacturing Co.	73, 115	Micro Electron Tube Co.	131
Baltimore Technical Institute	146	Milwaukee School of Engineering	116
Barry Electronics Corp.	148	Moss Electronic, Inc.	92, 93
Blonder-Tongue Laboratories, Inc.	145	Multi-Products Company	129
Bogen-Presto	88	National Radio Institute	19, 20
Burroughs Corporation	24	National Schools	23
Burstein-Applebee Co.	127	New World Laboratories	121
CBS Electronics	18	Nipco Mfg. Co., Ltd.	117
C & H Sales Co.	124	Olson Radio Corporation	135
Candee Co., J. J.	132	Orr Industries Inc.	137
Candler System Co.	144	Paco Electronics Company, Inc.	135
Capitol Radio Engineering Institute	25	Peak Electronics Company	145
Carston Studios	143	Picture Tube Outlet	124
Century Electronics Co., Inc.	100, 101	Platt Electronics Corp.	140
Channel Master Corp.	30, 31	Porter & Dietsch	143
Chickasha Electronics, Inc.	94	Quietrol Company, Inc.	142
Cleveland Institute of Electronics	7	RCA Institutes, Inc.	17
Columbia Electronics	144	R W Electronics	142
Coyne Electrical School	84, 108, 138	Rad-Tel Tube Co.	109
DeVry Technical Institute	5	Radio Corporation of America	6
Dressner	141	Radio Shack Corporation	95
Dual	90, 122	Rex Radio Supply Co.	124
Duotone	122	Rider Publisher, Inc., John F.	16
EICO	35, 36, 98	Rinehart & Co., Inc.	22, 123, 129
Electro-Voice, Inc.	Fourth Cover	Sams & Co., Inc., Howard W.	112, 113
Electronic Chemical Corp.	115	Sarkes Tarzian, Inc.	135
Electronic Organ Arts, Inc.	123	Schober Organ Corp., The	91
Electronics Division Book Service	148	Seco Manufacturing Co.	99
Electronics World	139	Sonotone Corp.	122
Electronics World Direct Sales Dept.	125	Sprague Products Company	3
Electronics World Subscriptions	114	Sprayberry Academy of Radio-Television	15
Esco C-B Hqts.	133	Standard Surplus	124
Everest Records	121	Sylvania	83
Fair Radio Sales	140	Terado Company	136
Fisher Radio Corporation	89	Texas Crystals	150
G & G Radio Supply Co.	111	Thorens	Third Cover
General Electric Company	21, 32, 33	Tri-State College	133
Globe Electronics	146	Tru-Vac Electric Company	107
Gonset Division	14	United Audio	90, 122
Goodheart Co., R. E.	128	University Loudspeakers, Inc.	34
Grantham School of Electronics	136	Valparaiso Technical Institute	127
Grommes Div. of Precision Electronics, Inc.	137	Vanguard Electronic Labs	136
Grove Electronic Supply Co.	121	Vets. Dist. Co., The	143
Hallicrafters	84	Video Electric Company	125
Harvey Radio Co., Inc.	102	Weller Electric Corp.	134
Heath Company	74, 75, 76, 77, 78, 79, 80, 81, 82	Wigo	90, 122
Henshaw Radio Supply	141	Winegard Co.	12, 13
Hi-Fi Directory & Buyers' Guide	147	World Radio Laboratories	143
Hi-Fi Review Jazz Reprints	144		
Hi-Fidelity Centre	121		
Hi-Mu Electronics	142		
Hy-gain Antenna Products	106		
Indiana Technical College	141		
International Business Machines Corporation	26, 27		
International Crystal Mfg. Co., Inc.	117		

The transcription turntable that's

HARD TO GET *but* **WORTH WAITING FOR**

It's the Thorens TD-124 . . . hailed by hi-fi fans . . . acclaimed by critics . . . highly recommended by leading technical and consumer publications

Demand for the famous Thorens TD-124 transcription turntable has exceeded expectations. We've had trouble keeping up with orders in some cases. We are pleased at the unexpected demand, but unhappy that we cannot serve all of you immediately.

Looking back now, we can see how irresistible these TD features (most of them lacking in competing turntables) are to the person who wants true stereo fidelity:

- 4 speeds . . . TD-124 gives you all of them: 16 $\frac{2}{3}$, 33 $\frac{1}{3}$, 45, 78.
- 11 $\frac{1}{2}$ pound table for smooth running . . . 12" TD-124 gives you more rotating mass than professional 16-inch turntables.
- Exclusive double-table with clutch for fast starts . . . lets you start record with needle in groove.

- Precision, hairline adjustment for all speeds . . . a simple knob that's easy to turn while record is playing . . . no screwdriver, no special wrench, no mechanic's license needed.

- Built-in illuminated strobe . . . you can see it and use it while record is playing to set electrically exact speed (or you can adjust speed by ear to musically exact pitch to play record along with any musical instrument).

- Easy arm installation or change . . . no metal drilling, no unsightly holes after arm change.

- Built-in precision circular level . . . same kind used on precision instruments . . . plus large knurled leveling screws . . . lets you check and adjust turntable level any time.

These are just a few of the outstanding features of the precision Swiss-crafted Thorens TD-124. See them all and hear this fabulous turntable at your franchised Thorens dealer's today. You'll agree that it's the turntable you've been waiting for.

© 19

Guaranteed for one full year • Sold only through carefully selected franchised dealers



THORENS

SWISS MADE PRODUCTS—MUSIC BOXES • HI-FI COMPONENTS • SPRING-POWERED SHAVERS • LIGHTERS

New Hyde Park,
New York

\$99.75 net



THE ONLY ULTRA-COMPACT
3-WAY WIDE-RANGE
 SPEAKER SYSTEM
 designed for true stereo

Electro-Voice

HIGH FIDELITY

REGAL

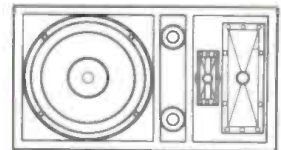

Gives you bass so low you can feel it... bass you would expect from a conventional enclosure three times the size. Gives you balanced, full-range, flat response without attenuation or peaks.

Ideal as an economical "first" system, an "add-on" or in a pair for stereo

You need not be an acoustical engineer to understand why there is so much stereo value in this ultra-compact speaker system. The same *exclusive features* that have always made ELECTRO-VOICE systems best for monaural are an absolute necessity for true stereo... and you get these vital features in the REGAL III.

Acoustically-correct enclosure is matched to specially-designed 12-inch LF driver for *exceptional extension of bass response and unusual dynamic range*... without sacrificing efficiency and without the need for unusually-large amplifier power.

E-V Super Sonax VHF Compression Driver with exclusive Sonophase* throat design assures you of the *smooth, sparkling highs* so necessary for precise musical blend and balance.

E-V Diffraction, in both the Horn-Loaded Mid-Range Driver and the Super-Sonax Tweeter, gives you all-important

FUSION

so essential for *all-position stereo listening*. By wide-angle (180°) diffraction, the higher frequencies are completely dispersed smoothly and evenly throughout the listening area. This insures proper fusing of the significant stereo sounds from two speaker systems in controlled and varying proportions... gives true depth and placement to the musical instruments simultaneously, without spatial distortions... assures easy listening from anywhere in the room. Convenient but concealed "Presence" and "Brilliance" controls permit quick and easy musical balancing to room acoustics.

Luxurious furniture-crafted enclosure is finished on all four sides for placement anywhere on shelf or floor.

REGAL III. Complete 3-way system in enclosure, ready to use. Choice of Walnut, Mahogany or Lined Oak. Size 12½" d, 13½" h, 24" w. Net, \$147.50

ESQUIRE 200. Economical version of the Regal. Complete 3-way system in modern enclosure, with single rear-control. 12-inch bass speaker, special 8-inch cone mid-range driver, and Super-Sonax diffraction-horn compression tweeter. Choice of walnut, mahogany or lined oak. 12½" d, 13½" h, 24" w. Net, \$111.



See it — Hear, it — Enjoy it — on Money-Back Guarantee. At your E-V high-fidelity dealer or write for Catalog No. 134 to Dept. 129-N.

No Finer

Choice than

Electro-Voice®

ELECTRO-VOICE, INC., BUCHANAN, MICHIGAN

*Design Patent No. 182351

