

# ELECTRONICS

MAC 10

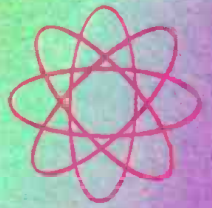

Formerly

**RADIO  
& TV NEWS**

# WORLD

OCTOBER, 1959  
50 CENTS

**SPECIAL  
HI-FI  
STEREO  
ISSUE**

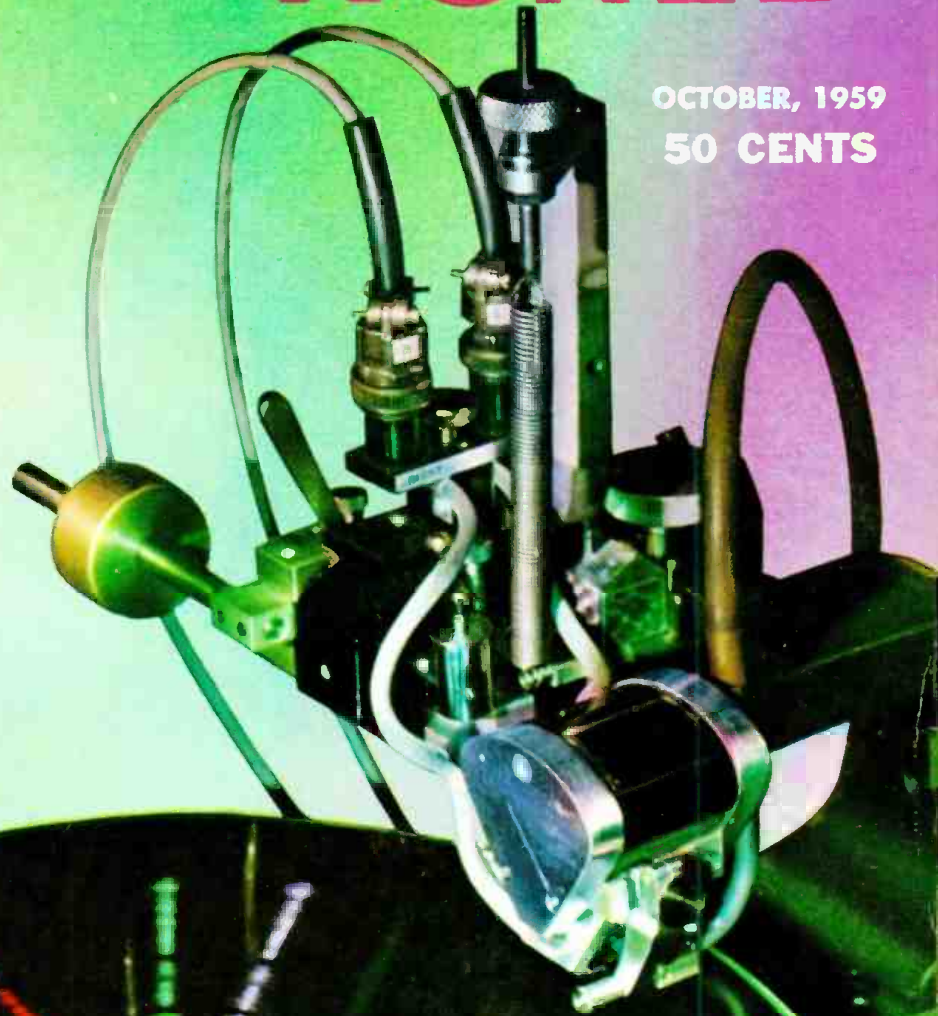

**THE STEREO DISC**  
(See Pages 54 & 55)

**THE  
STEREO ILLUSION**  
A noted psycho-acoustician  
explains the stereo effect.

from the  
audio research center  
of the world



**HI-FI COMPONENTS**  
developed and guild-crafted by  
Philips of the Netherlands

*Norelco*

**FULLY AUTOMATIC  
4-SPEED STEREO  
RECORD CHANGER**

**MODEL AG 1024 — AG1124**

A rugged, versatile, low cost record changer offering years of dependable and trouble-free stereophonic or monophonic reproduction. Both manual and automatic operation. 4 speeds. Automatic 7", 10" and 12" record intermix.



*Norelco*

**"CONTINENTAL"  
TAPE RECORDERS**

Music lover, recordist, high fidelity enthusiast... there's a professional quality "Continental" tape recorder ideally suited to your specific recording requirements.

- ◆ SIMPLE PIANO KEY CONTROLS
- ◆ THREE SPEEDS: 7½, 3¾ AND 1½ I.P.S.
- ◆ FULL FREQUENCY RECORDING... BROADCAST FIDELITY PLAYBACK
- ◆ SPECIAL NARROW-GAP HEADS (0.0002 IN.) FOR EXTENDED FREQUENCY RESPONSE
- ◆ SELF-CONTAINED WITH DYNAMIC MICROPHONE AND WIDE RANGE NORELCO LOUDSPEAKER
- ◆ EASILY PORTABLE... RUGGED... STYLED BY THE CONTINENT'S TOP DESIGNERS
- ◆ CAN ALSO BE PLAYED THROUGH EXTERNAL HI-FI SYSTEM

**STEREO-  
PLAYBACK  
VERSION**

**MODEL EL3516/G53**

Provides every feature of the world-famed original monaural "Continental" Model EL3516—plus stereophonic playback and mixing facilities for monaural recording.

Add the matching Stereo Companion Piece, Model SCP-1 (to your Norelco EL3516/G53) and you have the all important "second voice" for completely self-contained stereophonic playback.



**ORIGINAL  
MONAURAL VERSION**

**MODEL EL3516**

Still the greatest buy in a monaural tape recorder... the favorite of the nation's schools, and voice and music teachers... regarded as the world's most advanced, most versatile, all-in-one, portable tape recorder.

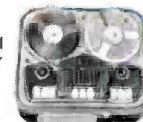

**THE  
CONTINENTAL "400"  
4-TRACK STEREO  
RECORD/PLAYBACK**

**MODEL EL3536**

◆ four-track stereophonic recording and playback ◆ four-track monophonic recording and playback ◆ self-contained including dual hi-fi preamps, recording and playback amplifiers and Norelco wide-range loudspeaker ◆ compatible with conventional pre-recorded tapes ◆ can also be used as a conventional self-contained phono/P.A. amplifier and speaker system.

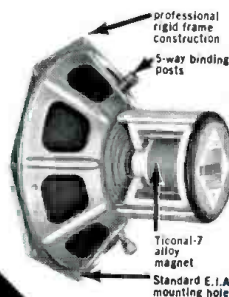

THE  
**T-7**  
LINE

A NEW LINE OF *Norelco*  
5"-12" LOUDSPEAKERS  
FEATURING NEW  
**TICONAL VIII**  
MAGNETS (30%  
more powerful  
than alnico)

*Norelco*

**'EXHIBITION'  
SPEAKER  
ENCLOSURES**

Acoustically designed to achieve moderate size without loss of bass response or wideness of dispersion. Characterized by compact size... outstanding performance... and beautifully styled and handcrafted workmanship. Perfectly matched for the bass response of the new NORELCO T-7 speakers... ideal for most other quality 8" to 12" speakers. Available in 3 sizes in beautiful, hand-rubbed Mahogany, Walnut, Blond or Cherry finishes. "Van Gogh" and "Vermeer" models can be used either vertically or horizontally.



The "HAGUE": Completely integrated quality speaker system. Incorporating two high-efficiency T-7 NORELCO loudspeakers in acoustically matched enclosure. Designed for optimum dispersion... maximum efficiency... extremely wide-range, flat response... and that unexaggerated "European," clean sound. **FOR FURTHER DESCRIPTIVE LITERATURE WRITE TO:** 230 Duffy Avenue, Hicksville, L. I., N. Y.



**NORTH AMERICAN PHILIPS CO., INC.**

High Fidelity Products Division

# NEW DIFILM<sup>®</sup> BLACK BEAUTY<sup>®</sup> MOLDED CAPACITORS

# BEAT THE HEAT AND HUMIDITY!

Now Sprague's new DIFILM BLACK BEAUTY MOLDED CAPACITORS have taken the steam out of heat and humidity problems. These capacitors are so good you can *boil 'em* for 24 hours without affecting their performance.

Unlike straight polyester film tubulars, these capacitors operate in a 105°C environment *without derating*.

And the heart of these new DIFILM capacitors can't be beat. It's a dual dielectric which *combines the best advantages of both Mylar\* polyester film and the highest grade of paper dielectric*. A rock-hard solid impregnant fills every void and pinhole in the film.

Talk about *reliability!* . . . these capacitors have it. DIFILM capacitors are actually low cost versions of the Sprague capacitors now being used in every modern military missile. The basic reliability and outstanding performance of missile-type Sprague capacitors are all yours in this outstanding new development. Why take chances when you can get the best—DIFILM BLACK BEAUTY MOLDED TUBULARS . . . at regular prices.

For the complete DIFILM BLACK BEAUTY story, write for Bulletin M-759 to Sprague Products Company, 51 Marshall St., North Adams, Mass.

\*DuPont trademark

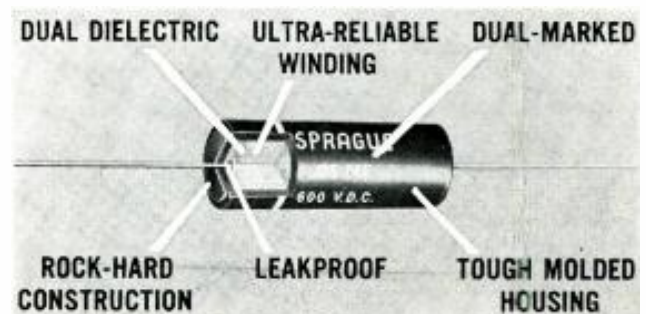

• Capacitance tolerance is held to  $\pm 10\%$  from .001  $\mu\text{F}$  up.



DIFILM BLACK BEAUTY CAPACITORS are now packed in reusable, rigid plastic Klee-Pak<sup>®</sup> boxes at no extra charge.

The major capacitor improvements come from



SPRAGUE RESEARCH IS CONSTANTLY PRODUCING NEW AND BETTER CAPACITORS FOR YOU

ELECTRONICS WORLD is published monthly by Ziff-Davis Publishing Company, William B. Ziff, Chairman of the Board (1946-1953), at 434 S. Wabash Ave., Chicago 5, Ill. Second-class postage at Chicago, Illinois. Authorized by Post Office Department, Ottawa, Canada, as second-class matter. SUBSCRIPTION RATES: one year U. S. and possessions, and Canada \$4.00; Pan American Union countries \$4.50; all other foreign countries \$5.00.



**Publisher**  
**OLIVER READ, D. Sc., WIETI**

**Editor**  
**WM. A. STOCKLIN, B. S.**

**Technical Editor**  
**MILTON S. SNITZER, W2QYI**

**Service Editor**  
**SIDNEY C. SILVER**

**Associate Editor**  
**P. B. HOEFER**

**Assistant Editor**  
**J. JUSTER**

**Industrial Consultant**  
**WALTER H. BUCHSBAUM**

**Art Editor**  
**MILTON BERWIN**

**Art and Drafting Dept.**  
**J. A. GOLANEK**  
**A. J. LICHOTA, JR.**  
**K. W. PAUL, JR.**

**Advertising Director**  
**JOHN A. RONAN, JR.**

**Advertising Manager**  
**GEORGE E. MORRISSEY**

**Midwest Adv. Manager**  
**W. ROBERT WOLFE**

**Western Adv. Manager**  
**DON CENA**



**ZIFF-DAVIS PUBLISHING COMPANY**  
 William Ziff, President; W. Bradford Briggs, Executive Vice-President; Michael Michaelson, Vice-President and Circulation Director; Hershel B. Sarbin, Vice-President; J. L. O'Donnell, Treasurer.

Editorial and Executive Offices  
 One Park Avenue  
 New York 16, N. Y. OR. 9-7200



**BRANCH OFFICES:** Midwestern Office, 434 S. Wabash Ave., Chicago 5, Ill.; Western Office, 215 W. 7th St., Los Angeles 14, Calif.; James R. Pierce, manager.

**FOREIGN ADVERTISING REPRESENTATIVES:** D. A. Goodall Ltd., London; Albert Milhado & Co., Antwerp and Dusseldorf.

*First in radio-television-audio-electronics*

## CONTENTS

### ELECTRONICS—GENERAL

Spot News.....	Washington Correspondent	29
"Tunnel Diodes"—Experimental Semiconductors.....		41
Recent Developments in Electronics.....		48
Novel Semiconductor Devices.....	Harold S. Renné	50
Readouts and Counter Tubes.....	Ed Bukstein	57
Electronics in Outer Space (Part 3).....	Jordan McQuay	62
Our Largest Radar Telescope.....		96
Gasoline-Fume Detector Uses Infrared.....		106
Calendar of Events.....		161

### HIGH FIDELITY AND AUDIO

Standards & The Hi-Fi Industry (Editorial).....	W. A. Stocklin	8
The Stereo Illusion.....	Dr. J. Donald Harris	37
Tape Recorder Conversion Chart.....		42
Power Output Ratings for Hi-Fi Amplifiers.....	Victor Robinson	44
The Hi-Fi Institute (Guest Editorial).....	Joseph N. Benjamin	47
The Stereo Disc Today.....	Sidney Frey	54
Cutting a Stereo Disc (Cover Story).....		55
"Top Choice" Discs in Stereo.....		56
New FM-AM Tuner Standard.....	Daniel R. Von Recklinghausen	60
The Tape Recording Industry (Guest Editorial).....	Herbert L. Brown	67
Handling Hi-Fi Service Calls.....	Dave Gordon	68
Tone-Arm Tracking Error in Stereo.....	Francis A. Gicca	70
1959 Stereophonic Cartridge Directory.....		74
Hi-Fi—Audio Product Review.....		90
Certified Record Revue.....	Bert Whyte	120
Sound on Tape.....	Bert Whyte	125
Audio Report (ELECTRONICS WORLD Lab Tested).....		152

### TELEVISION-RADIO

New Jobs for Tube Pins.....	Robert Russell	53
Mac's Service Shop.....	John T. Frye	66
Dealers Speak on Service Problems.....	William Leonard	73
Innovation in Plated Circuitry.....		100
Candelabra TV Tower.....	M. P. Johnson	112
Service Notes.....		132
Service Industry News.....		142
Don't Junk That Auto Radio.....	Gerald F. Dulin	150

### TEST EQUIPMENT

Dynamic Transistor Checker.....		102
New Tube Tester Data.....		116

### AMATEUR AND COMMUNICATIONS

Single-Sideband Transmission (Part 2).....	Alan Andrews	76
Canadian Market for Low-Power Radiophones.....	J. E. Kitchin	155

### ELECTRONIC CONSTRUCTION

Tube-Transistor "Carrier Switch".....	Dave Stone	64
---------------------------------------	------------	----

### DEPARTMENTS

Letters from Our Readers.....	10	Manufacturers' Literature.....	134
Within the Industry.....	30	Technical Books.....	138
What's New in Radio.....	156		

Net Paid Circulation (Publisher's Estimate, Jan.-June 1959) 242,396

Radio & TV News • Radio News • Television News Trademarks Reg. U. S. Pat. Off.  
 Copyright © 1959 by Ziff-Davis Publishing Company. All rights reserved.

**SUBSCRIPTION SERVICE:** Form 3570 and all subscription correspondence should be addressed to Circulation Department, 434 South Wabash Avenue, Chicago 5, Illinois. Please allow at least four weeks for change of address. Include your old address as well as new—enclosing if possible an address label from a recent issue.

**CONTRIBUTIONS:** Contributors are advised to retain a copy of their manuscripts and illustrations. Contributions should be mailed to the New York Editorial Office and must be accompanied by return postage. Contributions will be handled with reasonable care, but this magazine assumes no responsibility for their safety. Any copy accepted is subject to whatever adaptations and revisions are necessary to meet the requirements of this publication. Payment covers all author's, contributor's, and consultant's rights, title, and interest in and to the material accepted and will be made at our current rates upon acceptance. All photos and drawings will be considered as part of the material purchased.

MEN  
17-55

EMPLOYMENT  
SERVICE

RADIO

RADAR

TELEVISION

NO  
ADVANCED  
EDUCATION  
NEEDED

COMMUNICATIONS

NO PREVIOUS  
TECHNICAL  
EXPERIENCE  
REQUIRED!

MICRO-  
WAVES

COMPUTERS

CHICAGO  
TORONTO  
LABS

GUIDED  
MISSILE  
CONTROL

INDUSTRIAL  
ELECTRONICS

NOTHING  
ELSE LIKE  
IT!

# Follow DeVry Tech's "Road Map" along Opportunity Highway

TO A BETTER JOB IN

## TELEVISION • RADIO ELECTRONICS!

### Prepare in Spare Time at Home Now for that **REAL** Paycheck!



#### Employment Service

Avoid blind alleys! DeVry Tech Training helps you prepare, then its Employment Service is ready to take over. Usually we have more jobs for graduates than we can fill!

#### 2 RESIDENT SCHOOLS

Modern well-equipped, DeVry Training Centers in Chicago and Toronto offer thorough day or evening training.

DeVry's Home Training Program is so effective because it is backed by many years of experience in its Resident Training Centers. There is a difference!



**DEVRY TECHNICAL INSTITUTE**  
4141 Belmont Avenue • Chicago 41, Illinois  
Formerly DeForest's Training, Inc.

There's good money, opportunity for security, a bright future in Electronics. It's a field full of jobs, jobs to suit many tastes and to fit many kinds of ability; jobs from working on space rockets to running a neighborhood service shop. But you don't find jobs like that without some kind of a map, drawn by men who know where the jobs are, what the jobs demand, and how the average man can train to get and hold them. To draw you a map like that takes an organization like DeVry Tech. To provide training like that, again it's DeVry Tech!

DeVry trained men earn good money in many kinds of jobs in almost all branches of Electronics. No advanced education, no special experience is required for our Home Training Program. If you can follow clearly-written directions, understand Training Movies, work basic experiments with commercial-type equipment, and have the will to train for a job with good pay and fine future—then send the coupon today.

Accredited Member of National Home Study Council

#### Let DeVry Plan Your Trip To The Future

DeVry will advise you just what preparation you need for the job you seek. You don't have to go elsewhere—DeVry supplies the training you need.



#### GET THESE TWO FREE BOOKLETS

Where the good jobs are, what training you'll need, how you can get that training: here it all is. Send coupon, get details. It's as simple as that!

"One of North America's  
Foremost Electronic  
Training Centers"

### MAIL COUPON TODAY

DEVRY TECHNICAL INSTITUTE

4141 Belmont Ave., Chicago 41, Ill., Dept. EW-10-P

Please give me your FREE booklets, "Pocket Guide to Real Earnings" and "Electronics in Space Travel," and tell me how to prepare to enter one or more branches of Electronics.

NAME \_\_\_\_\_ AGE \_\_\_\_\_

PLEASE PRINT

STREET \_\_\_\_\_ APT. \_\_\_\_\_

CITY \_\_\_\_\_ ZONE \_\_\_\_\_ STATE \_\_\_\_\_

Check here if subject to military training.

DeVry Tech's Canadian Training Center is located at  
626 Roselawn Avenue, Toronto 12, Ontario.

2059

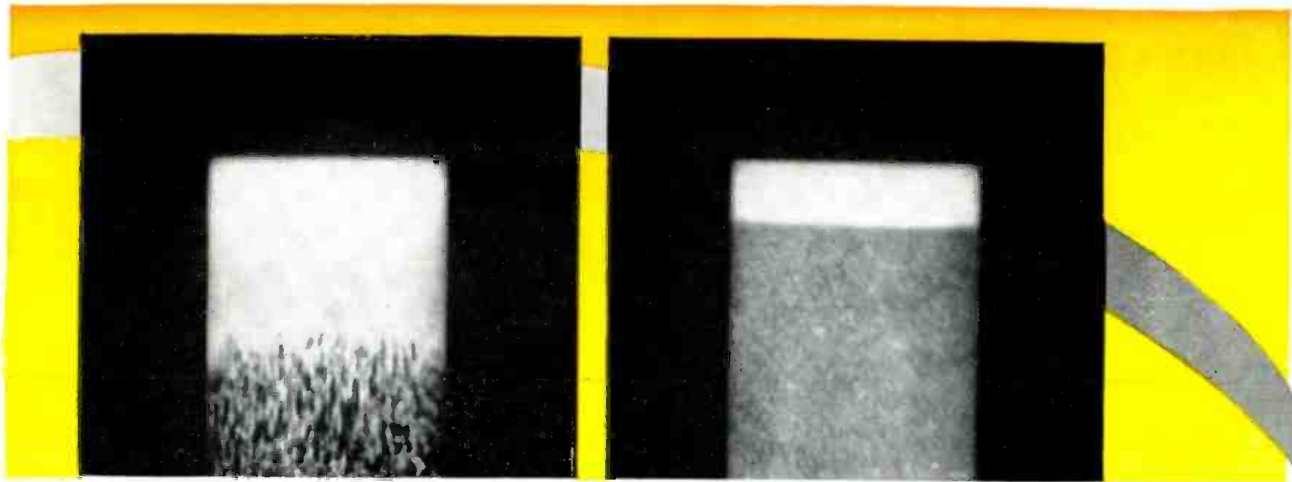

Inherent physical superiority of Sylvania's exclusive Sarong cathode, right, over a conventional cathode, left, is evident in this photomicrograph comparison. The texture,

thickness, sharp coating edges and overall uniformity of Sarong represent major improvements in the heart of the electron tube never before achieved in mass production.

# Only Sylvania has SARONG—

the revolutionary new receiving tube cathode that means better service profits

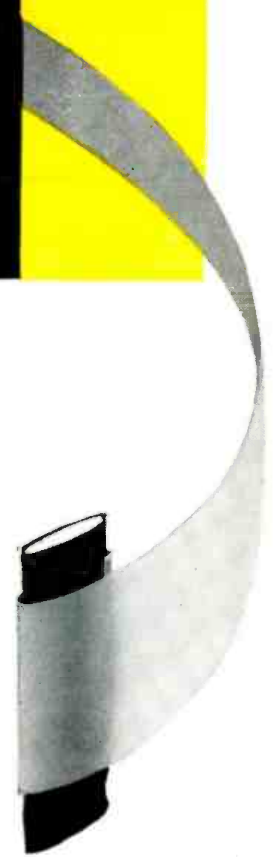

Fewer call-backs due to intermittents and shorts . . . reduced noise and less arcing . . . these are some of the benefits available to you *now* with this "can't be copied" Sylvania development.

The Sarong cathode is a completely new development that transforms conventional sprayed cathode coating into a thin uniform film, precision-wrapped and securely bonded, around each cathode sleeve.

Now in use in nearly 1 million receiving tubes, Sylvania Sarong is a field-proven development setting new standards of efficiency and quality in electron tube performance.

First tubes to incorporate Sarong are tv tuner types 6BZ7, 6BQ7A, 6BC8 and 6BS8. Eventually Sarong

cathodes will be utilized in a full line of Sylvania receiving tubes.

**Here's why it will pay your dealers to replace with Sylvania Sarong cathode tubes:**

- Reduced noise . . . uniformity in spacing has resulted in improved noise level up to 0.6 db for TV frequencies.
- Less heater-cathode leakage . . . Sarong is flake-resistant and smooth textured. No stray coating particles to stick inside cathode.
- Greater tube ruggedness against shock and vibration because of Sarong's superior coating adhesion.
- Reduced cathode-grid shorts, intermittent short circuits, and less arcing due to controlled uniformity of Sarong

thickness. Sarong cathode coating is held to thickness tolerances five times closer than conventional sprayed cathode coating.

Sylvania Sarong will help you make better profits through reductions in call-backs. See your Sylvania representative today for the full story on Sarong—available *only* from Sylvania.

SYLVANIA ELECTRIC PRODUCTS INC.  
1740 Broadway, New York 19, N. Y.  
In Canada: P. O. Box 1190, Station "O,"  
Montreal 9.

Sarong cathodes are now in use in four Sylvania tv tuner types. Eventually all Sylvania receiving tubes will contain Sarong cathodes.

 **SYLVANIA**  
Subsidiary of  
GENERAL TELEPHONE & ELECTRONICS 



# Every Essential Term in Physics and Electronics – 12,000 of Them – now in one giant dictionary!

Send today for a free-examination copy of this 1000-page reference work. Used in homes, offices, schools and laboratories.

THE INTERNATIONAL DICTIONARY OF PHYSICS AND ELECTRONICS is the only book available today that gives you – right at your fingertips – definitions, equations, principles and thorough explanations of every important term in physics and electronics.

More than 12,000 laws, relationships, equations, basic principles, instruments, apparatus and techniques are described in half a million words. You'll find everything from alphanopic, band and cybotaxis to Wronksian, ylem and Zwitterion.

### 16 Reference Books in One

You've never seen so much useful information in one volume. It takes the place of a whole library of reference books on:

- |             |                            |
|-------------|----------------------------|
| Electronics | Units and Dimensions       |
| Meteorology | General Principles         |
| Mechanics   | Heat and Thermodynamics    |
| Gases       | Atomic and Nuclear Physics |
| Liquids     | Mathematical Physics       |
| Solids      | Quantum Mechanics          |
| Acoustics   | Electricity                |
| Optics      | Relativity                 |

No more hunting around from book to book for the information you need. No more wading through long texts to get a simple definition. Everything you need can be found simply and quickly in this one handy volume.

### Answers Your Questions in Seconds

A unique system of cross-referencing helps you locate information instantly. Each article is arranged progressively, beginning with a concise definition and adding additional details in later paragraphs. Boldface "word signals" refer you to other articles relating to the one you are reading. You get the answers you want in a hurry!

### Save Time – Avoid Costly Errors

You'll turn to this giant, 1000-page reference work dozens of times a day – to recheck your work, to clarify technical articles or engineering data, to increase your own understanding of the complex world of physics and electronics. Where you might otherwise trust your memory, you'll now turn to the International Dictionary of Physics and Electronics to get an answer you can be sure of. This helpful volume can pay for itself many times over in just one avoided error!

### Examine it For 10 Days FREE

To fully appreciate the usefulness of this big 2 1/4" thick book, we invite you to use it for ten days. If you do not find it to be one of the most valuable books you have ever owned, you may simply return it and owe nothing. Otherwise, remit payment on the easy terms indicated in coupon. You take no risk. Send coupon today to D. Van Nostrand Company, Inc., Dept. 3710A, 120 Alexander St., Princeton, N. J. (Established 1848).

### Acclaimed by Major Journals in Every Field of Science

"Unique. Useful. Presents a wide variety of terms"  
— SCIENTIFIC AMERICAN

"Remarkably complete. Highly useful. Provides definite and concise answers to a myriad of questions."  
— PHYSICS TODAY

"Will undoubtedly make a

well-deserved place for itself."  
— SCIENCE

"There has been a real need for such a work."  
— ELECTRONICS

"Recommended for all that do any reference work in physics."  
— LIBRARY JOURNAL

"Unique in its field and exceptionally clear in its typography. It should prove a most useful reference."  
— NUCLEONICS

"The best book of definitions available on the market today. Highly recommended."  
— TELE-TECH

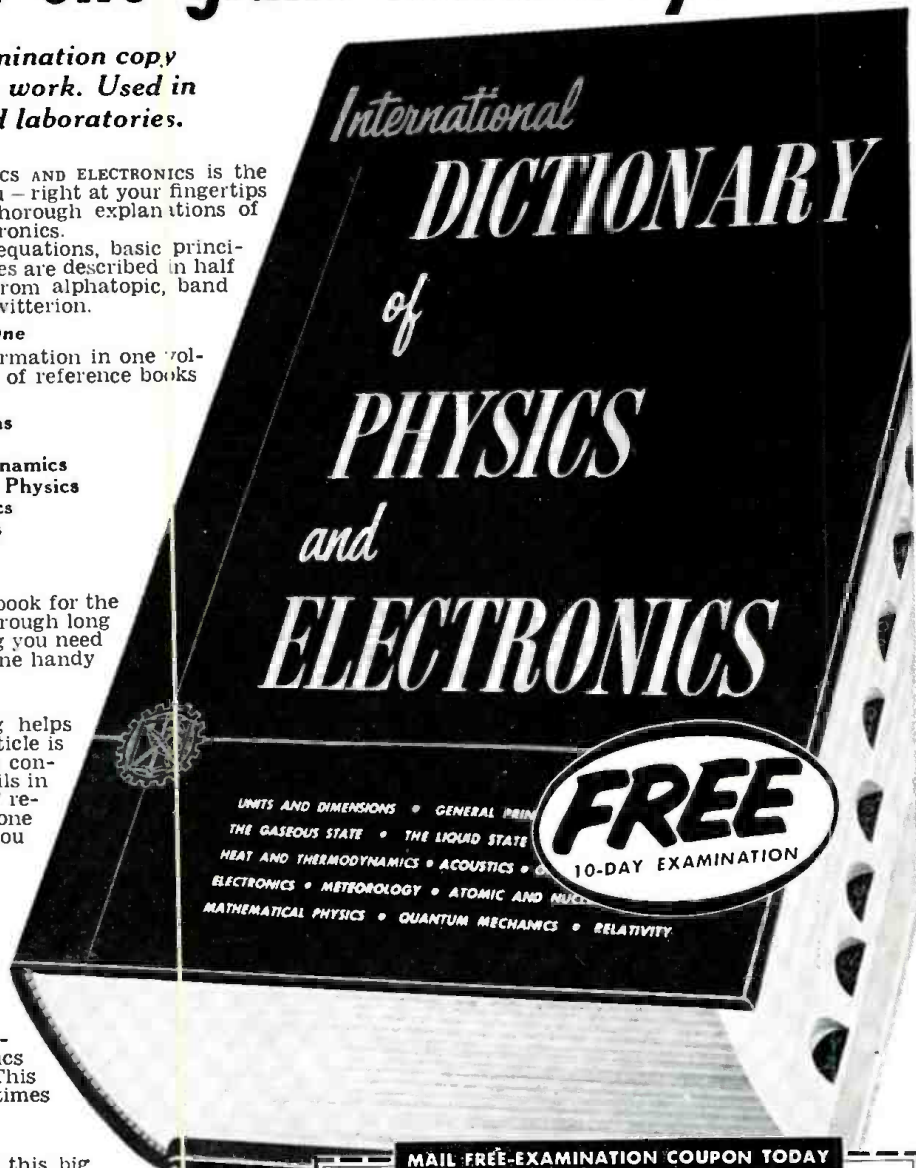

### MAIL FREE-EXAMINATION COUPON TODAY

D. Van Nostrand Company, Inc., Dept. 3710A  
120 Alexander Street, Princeton, N. J.

Please send me – for 10 days' FREE examination – the "International Dictionary of Physics and Electronics" thumb-indexed edition. If not completely satisfied, I may return it and owe nothing. Otherwise I will remit \$7.50 plus small shipping cost, and \$5 a month for 3 months.

Name.....

Address.....

City..... Zone..... State.....

Save! Enclose full payment (\$22.50) and shipping costs will be prepaid. Money back if not delighted.

In Canada: Order from D. Van Nostrand Co., Ltd., 25 Hollinger Road, Toronto 16, Canada (Price slightly higher)

# JansZen



## sound without fury in 3 easy steps

Here's a compact, do-it-yourself speaker system that delivers realistic, transparent reproduction without the fury of bass or treble exaggerations. Perfectly matched Electrostatic mid/high range speakers and a dynamic woofer give measurably flat response over the entire audio spectrum. What's more, you need not be an expert cabinet maker. You create high fidelity at a sensible, do-it-yourself cost.

1



### ELECTROSTATIC MID/HIGH RANGE SPEAKER

Model 65, illustrated, uses two JansZen electrostatic elements with a built-in power supply and high-pass filter. Each element contains 176 perfectly balanced, sheathed conductors to give absolutely clean response from 700 to beyond 30,000 cycles. Furnished complete in cabinet at \$86-\$91.50, depending on finish. Slightly higher in West.

Better yet . . . Model 130—considered as THE mid/high range speaker—contains four elements for a broad, 120° sound source. \$161-\$188, depending on finish. Slightly higher in West.

2



### DYNAMIC WOOFER DRIVER

Specifically designed to complement the delicate clarity of JansZen Electrostatic Mid/High Range Speakers, the Model 350 Dynamic Woofer offers clean, honest bass, devoid of coloration, false resonances, hangover or boom. It is the only separately available woofer to give such clean response in so small an enclosure—only 2.2 cu. ft. Response is uncannily flat from 40 to 2000 cycles with excellent output to 30 cycles. Only \$44.50. Slightly higher in West.

3



### DO-IT-YOURSELF WOOFER ENCLOSURE

Working with the plans we furnish with each woofer, you'll be able to build your own enclosure with basic tools. The enclosure is a sturdy, yet simple, totally enclosed cabinet. There are no tricky baffle arrangements or adjustments. Size without legs: 19" high x 25" wide x 13" deep. Cost of all materials should run about \$12 to \$18.

Discover JansZen clarity for yourself. Write for literature on JansZen's complete speaker systems and the name of your nearest dealer.

\*Including designs by Arthur A. Janszen and made only by NESHAMINY ELECTRONIC CORP, Neshaminy, Pa.

Export Dist.: 25 Warren St., New York 7, N. Y.  
Cable: Simontrice, N. Y.

# ...for the Record

By W. A. STOCKLIN  
Editor



## STANDARDS & THE HI-FI INDUSTRY

HAS the high-fidelity components industry had its heyday? The industry itself has traditionally been composed of relatively small companies. In general, it has not had really lush times, but considering its small beginnings some ten years ago, it has experienced fairly good times over the years. Many individual manufacturers have made names for themselves and have expanded as the industry progressed. These were companies who did most of the major development work in the field of high-quality sound reproduction. They have certainly fought hard to produce nothing but the best and, as a result of their efforts, the end-of-year figures will probably show that 1959 is their peak year as far as gross sales are concerned. It is quite likely that this peak will not be surpassed.

With the advent of the stereo disc and the potential mass demand for equipment on which to play these records, one will now find that the large set manufacturers will go after a share of this market with so-called "packaged" high-fidelity equipment. Needless to say, they will be successful.

This situation was anticipated by the component manufacturers and, as a result, they formed their own organization, the Institute of High Fidelity Manufacturers. It was, and still is, the goal of this organization not only to promote the sale of component hi-fi equipment but to develop standards of audio measurements and do whatever else would help to strengthen this relatively small segment of the industry. The Institute itself has had only minor success along these lines to date. Its greatest achievements have been in the field of planning and operating the various high-fidelity shows throughout the country. Also, the Institute has issued standards for tuner measurements. But from this point on, many of its hopes and plans have failed. We should not criticize because of such failures since it is an almost Herculean task to obtain agreement among so many members. The Institute and its member-manufacturers still have high hopes of future success, but failure is inevitable unless all petty disagreements among companies and personalities are dropped. Only through unity can benefits accrue.

We are certainly proud to be a member of this organization, and it wasn't too long ago that the editors of all

high-fidelity publications gathered together with members of the Institute to help establish future plans. Most of the discussion involved the need for setting up standards on plugs, adapters, color-coded wiring, and phasing of loudspeakers. The willingness to help was certainly there but the points under consideration were of a rather minor nature.

One of the biggest problems facing the component industry is a method, a standard, or what-have-you by which it can prove to the average user of high-fidelity equipment that component quality is far superior to what is being marketed by most of the packaged-goods manufacturers. The only answer is for someone to set minimum requirements for quality reproduction since only by comparison, using facts and figures, can any individual analyze performance. This has been acknowledged by the industry but many sleepless nights have passed without a solution. It seems obvious that the Institute members will not readily reach a unanimous agreement on this point.

It is interesting to note that the *Heath Company*, being aware of the urgent need for such standards, could not wait any longer. On its own, it has inaugurated a set of "minimum standards" so that one can compare quality differences among professional, high-fidelity, and utility performances. Details of these standards were first published on page 72 of our August, 1959 issue.

As all of our readers know, we have been following a set of standards on all of our "ELECTRONICS WORLD Lab Tested" reviews. We are quite proud of the fact that *Heath's* "standards" are not too dissimilar to our own. Most of our work has been done in connection with power amplifiers, preamplifiers, and integrated systems. We have not really gone much beyond this point since setting standards and equipping a lab to exhaustively test components such as cartridges, turntables, tape machines, and speakers is an almost impossible feat. *Heath* alone, or this publication alone, cannot accomplish what is required.

It is our earnest hope that other publications and even other manufacturers who really believe that this is a goal worth achieving will join forces and work as a team to attain it. —30—



**FREE**

# ALLIED'S 1960

## ELECTRONIC SUPPLY CATALOG

*it's value-packed...  
send for it!*

*your complete money-saving  
guide to everything in electronics*

### WORLD'S LARGEST STOCKS

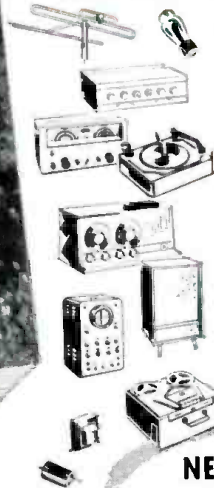
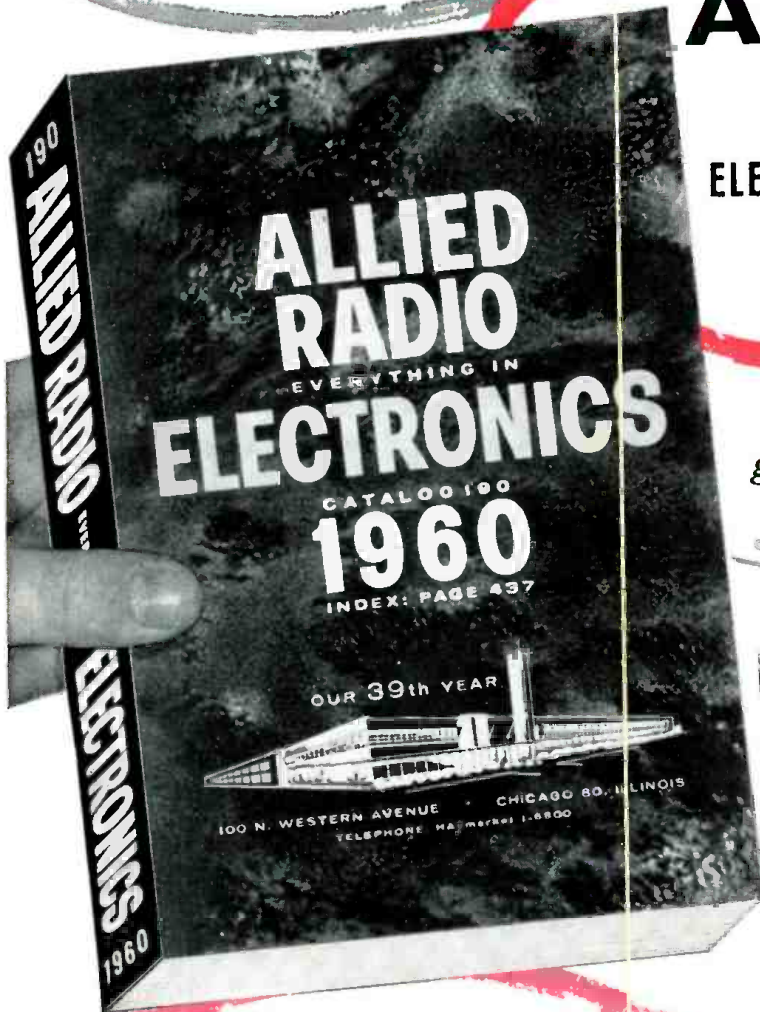

- Latest Stereo Hi-Fi Systems— Everything in Hi-Fi Components
- Money-Saving, Build-Your-Own KNIGHT-KITS for Every Need
- Values in Recorders and Supplies
- Latest Public Address Systems, Paging and Intercom Equipment
- Amateur Receivers, Transmitters and Station Gear
- Test and Laboratory Instruments
- TV Tubes, Antennas, Accessories
- Huge Listings of Parts, Tubes, Transistors, Tools, Books

*featuring  
these ALLIED exclusives:*

**MONEY-SAVING KNIGHT-KITS®**—the very best in build-your-own electronic equipment—designed to save you up to 50%. "Convenience Engineered" for easiest assembly; the only kits covered by Money-Back Guarantee. Complete selection of Stereo hi-fi kits, Hobbyist kits, Test Instrument and Amateur kits. KNIGHT-KITS are an exclusive ALLIED product.

**KNIGHT® STEREO HI-FI**—truly "honored for value"—the best you can buy, yet far lower in cost. Select super-value KNIGHT components or complete systems and save most. Also see the world's largest selection of famous name hi-fi components and money-saving ALLIED-recommended complete systems.

### NEW LOW EASY PAY TERMS

Only \$5 down (or less) on orders up to \$200. Up to 24 months to pay. Fast handling—no red tape.

Get every buying advantage at ALLIED: lowest money-saving prices, fastest shipment, expert personal help, guaranteed satisfaction...

*send for the leading  
electronic supply guide*

**FREE**

## ALLIED RADIO



our 39th year  
World's Largest Electronic Supply House

ALLIED RADIO CORP., Dept. 1-K9  
100 N. Western Ave., Chicago 80, Ill.

Send FREE 1960 ALLIED Catalog.

Name \_\_\_\_\_

Address \_\_\_\_\_

City \_\_\_\_\_ Zone \_\_\_\_\_ State \_\_\_\_\_

# HOW TO MAKE MONEY

## Selling Commercial Sound

Here today and here tomorrow — Commercial Sound is a steady-profit 12-months-a-year business of sales, installation and servicing with lots of customers right in your own neighborhood. Take advantage of the Atlas complete line of speakers — manufactured, advertised and supplied directly by Atlas. Speakers for every application, a mike support for every purpose — plus a wide variety of accessories so necessary for a complete professional installation.



Good markets in stadia, racetracks, athletic fields, etc.



Profitable markets in swimming pools, amusement parks, clubs, schools, etc.



Excellent markets in industry, factories, warehouses, etc.

Write for latest catalog and selling aids to help you get profitable commercial sound business.



**ATLAS  
SOUND CORP.**

RN-10

1449 — 33th St.  
Brooklyn 18, N. Y.

In Canada: Atlas Radio Corp.,  
Toronto, Canada



from our Readers

### SERVICE BUSINESS PROGRESS

To the Editors:

Your magazine *ELECTRONICS WORLD* continues to be a true friend of organized service month after month. As I looked through your June, 1959 edition, I found one page after another devoted to the promotion of the Association idea. I find the usual "Service Industry News" on pages 126 through 129 inclusive. I also find on page 51 an article entitled "Service Business Progress" by William Leonard. This is a terrific article—one that I hope to see followed up by similar reports. It is articles such as this that will help associations promote affiliation among the hold-out individualists. I intend to use articles like this for reference in enticing new membership in New York State. I also intend to give mention to this article in our June edition of the "ESFETAN." It is a gem. You didn't stop here, however, as I see your editorial gave recognition to TEA and TSA affiliation in NATESA, this being given priority over other pending editorial material.

GEORGE CARLSON, Secretary  
Empire State Federation of  
Electronic Technicians Ass'n, Inc.  
Jamestown, New York

*We certainly appreciate Mr. Carlson's comments, and we intend to maintain this type of service coverage.*  
—Editors.

### MORE ON COLOR ORGANS

To the Editors:

The many letters I have received as a result of my article "Photorhythmic" or "Dancing Lights" (August, 1958 issue) have far surpassed in number and reactions those stirred up by any other article this author has ever written. Except for those letters asking for design help in converting the apparatus to a specific application, all letters have been most praising of the results obtained.

I read with particular interest the letter of Mr. Charles E. Singletary published in the July, 1959 issue of this column. He takes severe umbrage with the designation "color organ". First, I have never used that expression to designate my apparatus. Why? Because it is a meaningless combination of words, and it may be the property of some inventor. Many of the letters written to me have referred to my equipment as a "color organ." Why? Probably because it has developed a generic sense.

The important thing Mr. Singletary misses is the concept of light and color combined with sounds. He further misses the fact that simplicity is es-

sential in achieving the "esthetic" objectives so that the apparatus can be duplicated by the many people with limited knowledge and/or restricted budgets. I suggest that Mr. Singletary refer to his own phrase "art of light" and recognize further that "art" takes many forms. Mine took the form that was published as a "Photorhythmic." Call it any name you care to. The important thing is that mine was simple, conventional in circuitry, non-critical of components or wiring, and did not require specially fabricated elements.

LEON A. WORTMAN  
217 South Broadway  
Tarrytown, New York

*We feel that Author Wortman's points are well taken.*—Editors.

### JAPANESE PEN PAL

To the Editors:

I have read your magazine with great interest. I am anxious to start a letter exchange with any of your readers who might be interested. I feel that in this way we can not only learn something about radio, but also get a better understanding between your people and mine.

I am a Japanese boy and am interested in electronics, high-fidelity, classical music, and art.

TADAO ASAHINA  
Onogami, Kitagunma  
Gunma, Japan

### ELECTRICAL SHOCK

To the Editors:

The article on electrical shock by D. P. Peters in your May issue was generally excellent and of great importance to radio experimenters, technicians, and amateurs. Some items therein occur to me as deserving of comment.

First is the difference in effect between a.c. and d.c. It should be noted that d.c. does not cause muscle contraction like a.c. except during actual make or break of contact. Its principal sensory effect during contact is one of heating, and it poses considerably less threat of fibrillation or paralysis than a.c. Consideration must also be given to the relatively greater prevalence of exposure to a.c., both in the home and elsewhere, when analyzing mortality statistics.

The second item is the "left-hand body path" concept. Since most people are right-handed, it is normal for them to use their right hand in adjusting or contacting a possibly hot circuit, and the *unwatched* left hand is the one most likely to come in contact with ground to complete the circuit (which

# What Does F.C.C. Mean To You?

## What is the F.C.C.?

F. C. C. stands for Federal Communications Commission. This is an agency of the Federal Government, created by Congress to regulate all wire and radio communication and radio and television broadcasting in the United States.

## What is an F. C. C. Operator License?

The F. C. C. requires that only qualified persons be allowed to install, maintain, and operate electronic communications equipment, including radio and television broadcast transmitters. To determine who is qualified to take on such responsibility, the F. C. C. gives technical examinations. Operator licenses are awarded to those who pass these examinations. There are different types and classes of operator licenses, based on the type and difficulty of the examination passed.

## What are the Different Types of Operator Licenses?

The F. C. C. grants three different types (or groups) of operator licenses—commercial radiotelePHONE, commercial radioteleGRAPH, and amateur.

**COMMERCIAL RADIOTELEPHONE** operator licenses are those required of technicians and engineers responsible for the proper operation of electronic equipment involved in the transmission of voice, music, or pictures. For example, a person who installs or maintains two-way mobile radio systems or radio and television broadcast equipment must hold a radiotelePHONE license. (A knowledge of Morse code is NOT required to obtain such a license.)

**COMMERCIAL RADIOTELEGRAPH** operator licenses are those required of the operators and maintenance men working with communications equipment which involves the use of Morse code. For example, a radio operator on board a merchant ship must hold a radioteleGRAPH license. (The ability to send and receive Morse is required to obtain such a license.)

**AMATEUR** operator licenses are those required of radio "hams"—people who are radio hobbyists and experimenters. (A knowledge of Morse code is necessary to be a "ham".)

## What are the Different Classes of RadiotelePHONE licenses?

Each type (or group) of license is divided into different classes. There are three classes of radiotelePHONE licenses, as follows:

(1) Third Class RadiotelePHONE License. No previous license or on-the-job experience is required to qualify for the examination for this license. The examination consists of F. C. C. Elements I and II covering radio laws, F. C. C. regulations, and basic operating practices.

(2) Second Class RadiotelePHONE License. No on-the-job experience is required for this examination. However, the applicant must have already passed examination Elements I and II. The second class radiotelePHONE examination consists of F. C. C. Element III. It is mostly technical and covers basic radiotelePHONE theory (including electrical calculations), vacuum tubes, transistors, amplifiers, oscillators, power supplies, amplitude modulation, frequency modulation, measuring instruments, transmitters, receivers, antennas and transmission lines, etc.

(3) First Class RadiotelePHONE License. No on-the-job experience is required to qualify for this examination. However, the applicant must have already passed examination Elements I, II, and III. (If the applicant wishes, he may take all four elements at the same sitting, but this is

not the general practice.) The first class radiotelePHONE examination consists of F. C. C. Element IV. It is mostly technical covering advanced radiotelePHONE theory and basic television theory. This examination covers generally the same subject matter as the second class examination, but the questions are more difficult and involve more mathematics.

## Which License Qualifies for Which Jobs?

The THIRD CLASS radiotelePHONE license is of value primarily in that it qualifies you to take the second class examination. The scope of authority covered by a third class license is extremely limited.

The SECOND CLASS radiotelePHONE license qualifies you to install, maintain, and operate most all radiotelePHONE equipment except commercial broadcast station equipment.

The FIRST CLASS radiotelePHONE license qualifies you to install, maintain, and operate every type of radiotelePHONE equipment (except amateur, of course) including all radio and television stations in the United States, and in its Territories and Possessions. This is the highest class of radiotelePHONE license available.

## How Long Does it Take to Prepare for F. C. C. Exams?

The time required to prepare for FCC examinations naturally varies with the individual, depending on his background and aptitude. Grantham training prepares the student to pass FCC exams in a minimum of time.

In the Grantham correspondence course, the average beginner should prepare for his second class radiotelePHONE license after from 200 to 250 hours of study. This same student should then prepare for his first class license in approximately 75 additional hours of study.

In the Grantham resident course, the time normally required to complete the course and get your license is as follows:

In the DAY course (5 days a week) you should get your second class license at the end of the first 9 weeks of classes, and your first class license at the end of 3 additional weeks of classes. This makes a total of 12 weeks (just a little less than 3 months) required to cover the whole course, from "scratch" through first class.

In the EVENING course (3 nights a week) you should get your second class license at the end of the 15th week of classes and your first class license at the end of 5 additional weeks of classes. This makes a total of less than 5 months required to cover the whole course, from "scratch" through first class, in the evening course.

**HERE'S PROOF** that Grantham Students prepare for F.C.C. examinations in a minimum of time. Here is a list of a few of our recent graduates, the class of license they got, and how long it took them:

	License	Weeks
Ron Taylor, 29 S. Franklin St., Chambersburg, Pa.	1st	12
Beri Moore, P.O. Box 169, Opp, Alabama	1st	15
Donald R. Titus, 270 Park Terrace, Hartford 6, Conn.	1st	12
Robin O. Okinishi, P.O. Box 375, Hanapepe, Kauai, Hawaii	1st	12
Billy R. Kirby, Route #3, Smithfield, N. C.	1st	9
J. H. Reeves, 10621 Ruthelen, Los Angeles 47, Calif.	1st	12
Donald H. Ford, Hyannis Rd. (Cape Cod), Barnstable, Mass.	1st	12
James D. Hough, 400 S. Church St., East Troy, Wis.	1st	12

## FOUR COMPLETE SCHOOLS

To better serve our many students throughout the entire country, Grantham Schools of Electronics maintains four separate Divisions—Hollywood, Calif.; Seattle, Wash.; Kansas City, Mo.; and Washington, D.C.—all offering the same courses in F.C.C. license preparation, either home study or resident classes.

For further details concerning F.C.C. licenses and our training, send for our FREE booklet, "Careers in Electronics". Clip the coupon below and mail it to the School nearest you.

Get your First Class Commercial F. C. C. License Quickly by training at



## GRANTHAM SCHOOL OF ELECTRONICS

1505 N. Western Ave.  
Hollywood 27, Calif.  
(Phone: HO 7-7727)

408 Marion Street  
Seattle 4, Wash.  
(Phone: MA 2-7227)

3123 Gillham Road  
Kansas City 9, Mo.  
(Phone: JE 1-6320)

821 · 19th Street, N.W.  
Washington 6, D.C.  
(Phone: ST 3-3614)

MAIL COUPON NOW—NO SALESMAN WILL CALL →

## MAIL TO SCHOOL NEAREST YOU

To: GRANTHAM SCHOOL OF ELECTRONICS

1505 N. Western • 408 Marion • 3123 Gillham Rd. • 821 · 19th St., N.W.  
HOLLYWOOD SEATTLE KANSAS CITY WASHINGTON

Gentlemen:

Please send me your free booklet telling how I can get my commercial F.C.C. license quickly. I understand there is no obligation and no salesman will call.

Name \_\_\_\_\_ Age \_\_\_\_\_

Address \_\_\_\_\_

City \_\_\_\_\_ State \_\_\_\_\_

Interested in:  Home Study,  Resident Classes 96 R

would account for the number of left-hand burns). I doubt very much if the slight difference in path length between left and right hand to the heart (no difference in path to the brain) through a good conductor such as the blood stream would make any difference in mortality. I would certainly not advise a left-handed person to use his awkward right hand on possibly hot circuits on the basis of this concept. Instead, I prefer to emphasize cautious placement of unwatched body members such as head, elbows, feet, and free hand.

RICHARD A. WALL  
Motorola, Inc.  
Systems Research Lab.  
Riverside, California

*We have been swamped with requests for additional copies of the article on electrical shock. Reprints of the article are available from the Editorial Department of ELECTRONICS WORLD, One Park Avenue, New York 16, New York at a cost of \$.15 each.*

*Many of our readers have supplied us with additional interesting facts on the subject, some of which are included in the letter above.—Editors.*

\* \* \*

#### FINDING A TECHNICIAN

To the Editors:

Your editorial in April made some interesting points about the TV serviceman. You can well imagine the problems when you want hi-fi equipment repaired in a fairly small city.

I would suggest that both TV and high-fidelity service technicians should have adequate training and they should display any diplomas, licenses, or qualifying certificates in much the same way as a doctor or a dentist does.

GEORGE STAMM  
Aurora, Illinois

*We sympathize with your problems in obtaining skilled repairs on your hi-fi and other electronic equipment and in evaluating the qualifications of the technicians who may be doing the work. We do run material from time to time on hi-fi problems and repairs and expect to run more in the future.*

*Concerning your difficulty in evaluating electronic technicians, many responsible members of the service profession are equally concerned. A large number of service associations throughout the country have been sponsoring various types of licensing and certification legislation in their local communities and states. These proposed laws would fix minimum technical qualifications, sometimes by actual tests for electronic service people, and also fix minimum equipment requirements for shops. We understand that such bills are now being considered by the Illinois State Legislature.—Editors.*

\* \* \*

#### SERVICING TRANSMITTERS

To the Editors:

Refer to "Mac's Service Shop" in your July issue. We here at Bainbridge are taught that the only voltage and current checks to be made when serv-

# How to Get

## An FCC License can be

# Get Your FCC License

**We Guarantee**  
to train you until you receive  
**Your FCC License**  
— or your money back

The Master Course in Electronics will provide you with the mental tools of the electronics technician and prepare you for a First Class FCC License (Commercial) with a radar endorsement. When you successfully complete the Master Course, if you fail to pass the FCC examination, you will receive a full refund of all tuition payments.

**Cleveland Institute Training Results in success with commercial FCC examinations . . . easily . . . and quickly.**

# Free!

**FIND OUT HOW:**

- 1. The new electronic devices can be handled by you**
- 2. To solve the problems that will stump your fellow technicians**
- 3. Training is Job Insurance when employment is tough to find . . . and more money for you when times are good**

**Mail Coupon NOW . . .**

(Commercial)  
**an FCC License**

**your Guarantee of Success in Electronics**

**in a Minimum of Time**

*mail  
coupon  
NOW!*

**here's proof of good jobs**

**Irving Laing:**

"Your lessons are helping me a lot in my Navy work. You cover topics that were not presented by the Navy at the E.T. School. . . . Your course has helped greatly to get my 2nd class FCC ticket. I am now a radio and T.V. engineer at WTVS and WDTR in Detroit, Michigan."

*Irving L. Laing,  
15887 Robson,  
Detroit 27, Michigan*

**Get all 3 FREE**

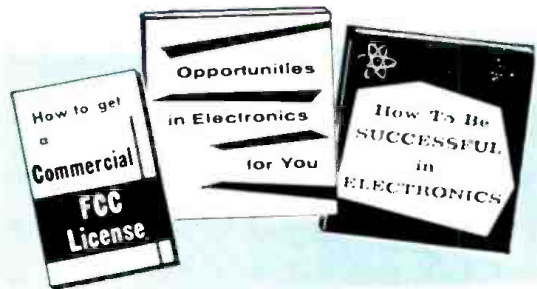

Accredited by The National Home Study Council

**Cleveland Institute of Electronics**

Desk RN-34, 4900 Euclid Ave., Cleveland 3, Ohio



Please send FREE Booklets prepared to help me get ahead in Electronics. I have had training or experience in Electronics as indicated below:

- |   |   |
|---|---|
| <input type="checkbox"/> Military           | <input type="checkbox"/> Broadcasting       |
| <input type="checkbox"/> Radio-TV Servicing | <input type="checkbox"/> Home Experimenting |
| <input type="checkbox"/> Manufacturing      | <input type="checkbox"/> Telephone Company  |
| <input type="checkbox"/> Amateur Radio      | <input type="checkbox"/> Other.....         |

In what kind of work are you now engaged?.....

In what branch of Electronics are you interested?.....

Name..... Age.....

Address.....

City..... Zone..... State.....

Special Tuition Rates to Members of Armed Forces

Desk RN-34

**Receive All These Booklets FREE!**

*Technicians —*  
*look to* **Burroughs**  
*for your successful future*  
*in electronics.*

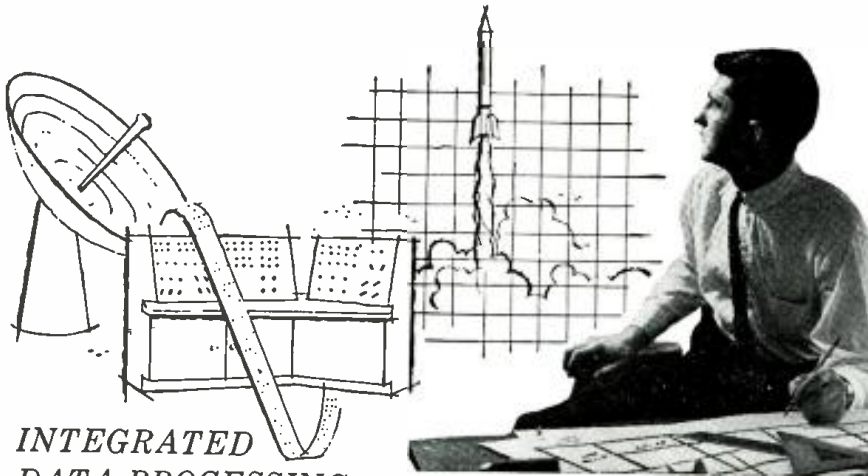

**INTEGRATED  
 DATA PROCESSING  
 FOR MILITARY  
 WEAPONS SYSTEMS**

...at BURROUGHS Military Field Service Division adds up to challenging work on important long range ATLAS and SAGE programs, advancement based on individual performance and a fine career in the field of tomorrow: Digital Computation.

BURROUGHS, consistent with its recognized leadership in equipment, skills and manpower, is providing the answers for complex military weapons systems through automatic suprahuman computation.

Qualified applicants will receive: 1) Formal 16 to 22-week training program in Data Processing Systems. 2) Starting salary commensurate with experience and ability. 3) Full salary while training. 4) Fine fringe benefits including educational assistance in addition to your training program. 5) Current field assignments include Western and Midwestern areas, when your training program is concluded.

If you are a graduate of an accredited Technical School and/or have military training in radar or communications equipment, plus at least 2 years' experience in electronics, you are invited to address your inquiries to Mr. A. J. Bellace, Employment Supervisor, Department 2348, Military Field Service Division, Burroughs Drive, Radnor, Pa. (a suburb of Philadelphia).



**Burroughs Corporation**  
*"NEW DIMENSIONS/in computation for military systems"*

icing a transmitter are from the meters on the front panel. This article seems to be just the opposite to what is taught here.

Is Mr. Frye guessing when he writes these articles or does he have some way of making voltage checks in an operating transmitter that is safe?

W. M. QUINN  
 Room B School USNTC  
 Bainbridge, Maryland

*Mr. Frye does not at any point recommend plunging recklessly into the equipment while it is operating. He simply points out that the service technician unfamiliar with this type of equipment—and thus unaware of the proper technique—tends to be intimidated by the knowledge that high currents and voltages are present. From what we know of his background, it is quite unlikely that the author would be guessing in this case or any other that he writes about.—Editors.*

\* \* \*

**INDUSTRY "BUGABOOS"**

To the Editors:

On page 16 of your February, 1959 issue, you use the term "bugaboos" in talking about *Sylvania's* new tube plant. We assume that the word is a colloquialism, but we would appreciate your defining it for us so that we know your meaning.

KAZIMIERZ ORLOWSKI  
 Przemyslowy Instytut  
 Elektroniki  
 Warsaw, Poland

*According to our dictionary, this term refers to "an imaginary object of fright." Strictly speaking, the term may not have been correctly used in the story since the two problems discussed (intermittent shorts resulting from dust and lint, and unstable emission caused by contamination and humidity variations during tube manufacture) were not imaginary at all, but are very real.—Editors.*

\* \* \*

**PHANTOM-CHANNEL CIRCUIT**

To the Editors:

Thanks for your very thorough and interesting article "Phantom Channel for Stereo" in your June issue. So few writers have been kind enough to extend to Mr. Klipsch recognition for his unearthing the derived third or phantom channel.

We definitely state that the middle channel should be 3 db below the flanking speakers, but many of Mr. Klipsch's articles have had typographical errors in them, and I suspect the material used by Author Burstein may have been incorrect in that the article mentions that the center speaker should be higher in level.

DON DAVIS  
 Vice-President, Sales  
 Klipsch and Associates  
 Hope, Arkansas

*We appreciate Reader Davis' correction as well as a circuit that he sent along showing some interesting methods of deriving the third channel.—Editors.*

—50—

**NOW!**  
at a price  
you can afford!

# MAKE MORE MONEY in TELEVISION RADIO-ELECTRONICS

**BETTER...MORE COMPLETE...LOWER COST...  
WITH NATIONAL SCHOOLS SHOP-METHOD  
HOME TRAINING!**

**BETTER...** Training that is proved and tested in Resident School shops and laboratories, by a School that is the **OLDEST** and **LARGEST** of its kind in the world.

**MORE COMPLETE...** You learn **ALL PHASES** of *Television-Radio-Electronics*.

**LOWER COST...** Other schools make several courses out of the material in our **ONE MASTER COURSE** . . . and you pay more for less training than you get in our course at **ONE LOW TUITION!**

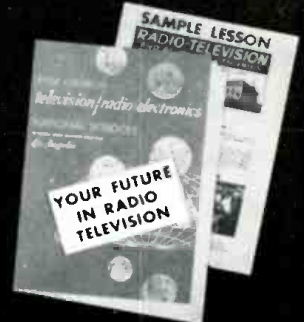

These  
**two FREE books** will  
show you how!

You get all information  
by mail . . . You make  
your own decision . . . at  
home! **NO SALESMAN  
WILL CALL**

## TOP PAY... UNLIMITED OPPORTUNITIES LIFETIME SECURITY CAN BE YOURS!

You are needed in the Television, Radio, and Electronics industry! Trained technicians are in growing demand at excellent pay—in **ALL PHASES**, including Servicing, Manufacturing, Broadcasting and Communications, Automation, Radar, Government Missile Projects.

**NATIONAL SCHOOLS SHOP-METHOD HOME TRAINING**, with newly added lessons and equipment, trains you in your spare time at home, for these unlimited opportunities, including many technical jobs leading to supervisory positions.

**YOU LEARN BY BUILDING EQUIPMENT WITH KITS AND PARTS WE SEND YOU.** Your National Schools course includes thorough *Practical* training—**YOU LEARN BY DOING!** We send you complete standard equipment of professional quality for building various experimental and test units. You advance step by step, perform more than 100 experiments, and you build a complete TV set from the ground up, that is yours to keep! A big, new TV picture tube is included at no extra charge.

**EARN AS YOU LEARN.** We'll show you how to earn extra money right from the start. Many of our students pay for their course—and more—while studying. So can you!

### RESIDENT TRAINING AT LOS ANGELES

If you wish to take your training in our Resident School at Los Angeles, the world's TV capital, start **NOW** in our big, modern Shops, Labs and Radio-TV Studios. Here you work with latest Electronic equipment - - professionally installed - - finest, most complete facilities offered by any school. Expert, friendly instructors. Personal attention. Graduate Employment Service. Help in finding home near school - - and part time job while you learn. Check box in coupon for full information.

**LESSONS AND INSTRUCTION MATERIAL ARE UP-TO-DATE, PRACTICAL, INTERESTING.** Every National Schools Shop-Method lesson is made easy to understand by numerous illustrations and diagrams. All instruction material has been developed and tested in our own Resident School Shops, Laboratories and Studios.

**SEND FOR INFORMATION TODAY . . .** it can mean the difference between **SUCCESS** and failure for you! Send for your **FREE BOOK** "Your Future in Television-Radio-Electronics" and **FREE Sample Lesson.** Do it **TODAY**, while you are thinking about your future. It doesn't cost you anything to investigate!

### GET THE BENEFITS OF OUR OVER 50 YEARS EXPERIENCE

Approved for  
GI Training



**NATIONAL SCHOOLS**  
Los Angeles 37, Calif.

### YOU GET...

- 19 Big Kits—**YOURS TO KEEP!**
- Friendly Instruction and Guidance
- Job Placement Service
- Unlimited Consultation
- Diploma—Recognized by Industry
- **EVERYTHING YOU NEED FOR SUCCESS!**

### SHOP-METHOD HOME TRAINING COVERS ALL PHASES OF INDUSTRY

1. Television, including Color TV
2. Radio AM & FM
3. Electronics for Guided Missiles
4. Sound Recording and Hi-Fidelity
5. FCC License
6. Automation and Computers
7. Radar & Micro-Waves
8. Broadcasting and Communications

## NATIONAL TECHNICAL SCHOOLS

WORLD-WIDE TRAINING SINCE 1905

**MAIL NOW TO**  
**NATIONAL SCHOOLS, Dept RH-109**  
4000 S. FIGUEROA ST. LOS ANGELES 37, CALIF.  
Rush free TV-Radio "Opportunity" Book and sample lesson. No salesman will call.

NAME \_\_\_\_\_ AGE \_\_\_\_\_  
ADDRESS \_\_\_\_\_  
CITY \_\_\_\_\_ ZONE \_\_\_\_\_ STATE \_\_\_\_\_  
 Check if interested **ONLY** in Resident School training at Los Angeles.  
VETERANS: Give date of Discharge \_\_\_\_\_

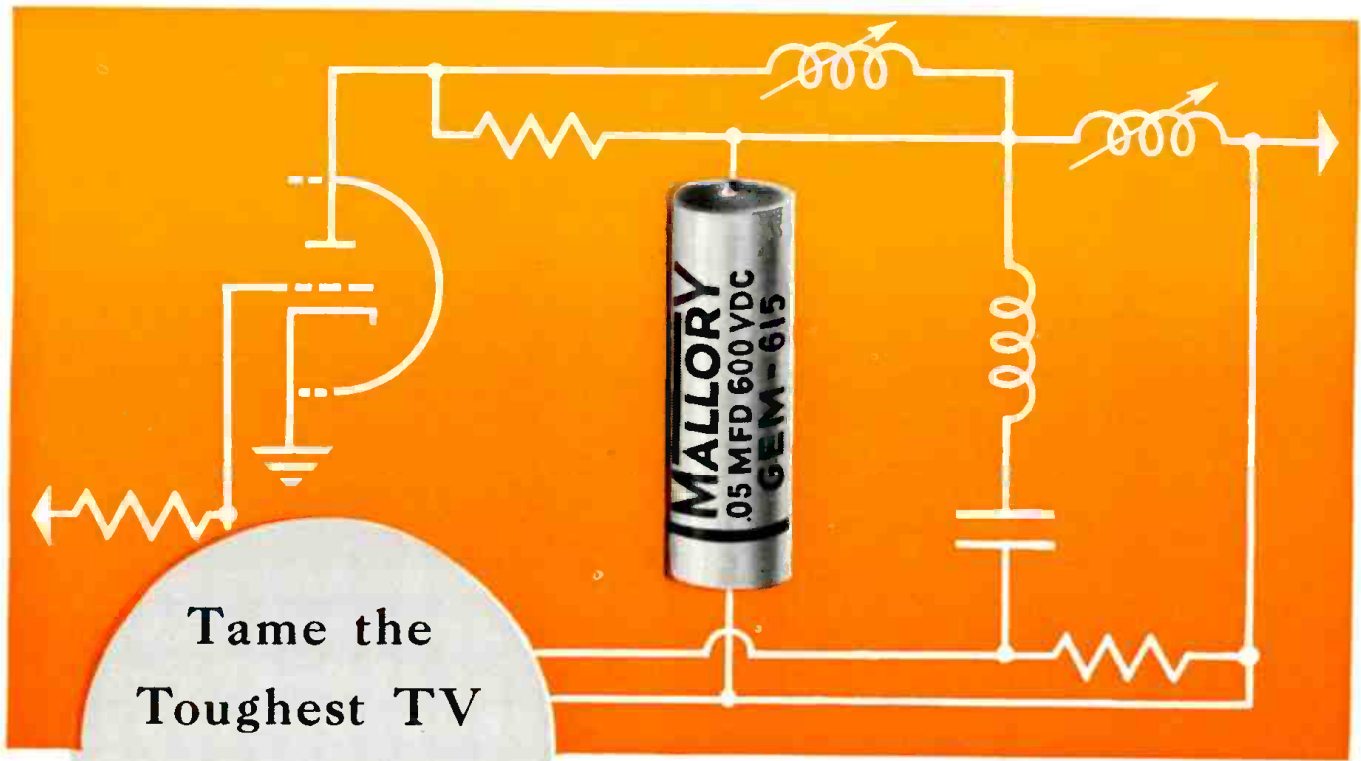

Tame the  
Toughest TV  
Replacement  
Spot with a . . . .

# Mallory Gem Capacitor

This circuit should be familiar—half of a 6SN7 serving as the horizontal oscillator in a typical TV receiver circuit. The marked spot in the diagram is a tough assignment for a capacitor. If it opens, you lose raster. If it changes capacity, or if the replacement is beyond tolerances, the horizontal sweep will not sync in.

When replacing this capacitor, always use a Mallory Gem. It's moisture-proof—won't drift in capacity or internal resistance. Conservative voltage ratings guarantee reliability—in this, or any circuit. Get Gems today from your Mallory Distributor in the handy 5-pack.



**FP Capacitors**—the original 85°C filter

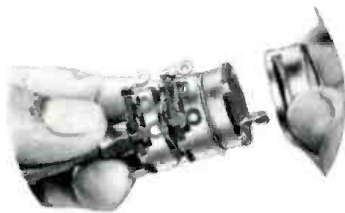

**Sta-Loc Dual Controls**—tailor-made in 30 seconds



**Gold Label Vibrators**—unequaled performance and life

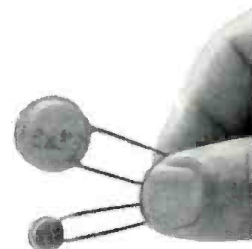

**RMC Discaps**—world's leading ceramic capacitors

**Depend on Mallory components for service**



P. R. MALLORY & CO. Inc., INDIANAPOLIS 6, INDIANA





# LET RCA TRAIN YOU IN ELECTRONICS

*RCA Institutes celebrates Fifty Years of Electronic Training by introducing its newest Home Study Course . . .*

## *ELECTRONICS FOR AUTOMATION*

. . . Now you have *four* comprehensive courses for your electronic training . . . from basic electronic theory to the more advanced principles of color TV and Automation.

**Electronic Fundamentals**



**Electronics for Automation**

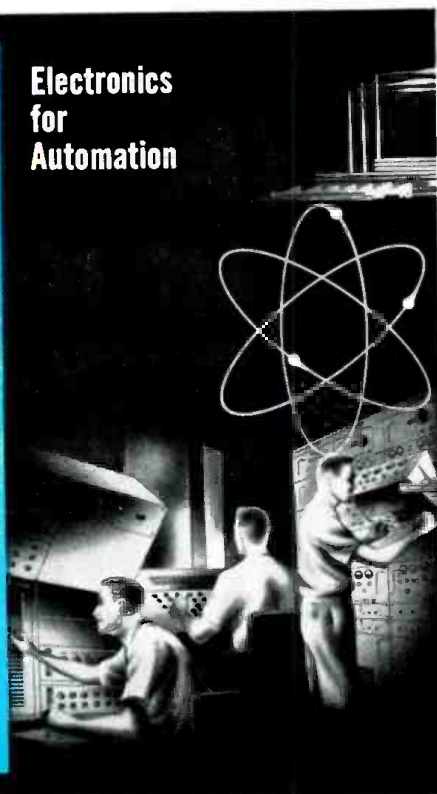

**Television Servicing**

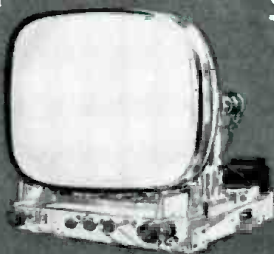

**Color Television**

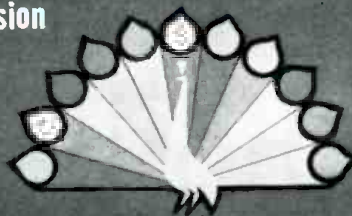

Send for our  
64 page Home  
Study Catalog

**FREE!**

RESIDENT SCHOOL offers Technical Institute and Vocational Courses in Electronics. Day and Evening classes start 4 times each year. Resident School Catalog sent free on request.

ANOTHER WAY RCA SERVES EDUCATION THROUGH ELECTRONICS

October, 1959

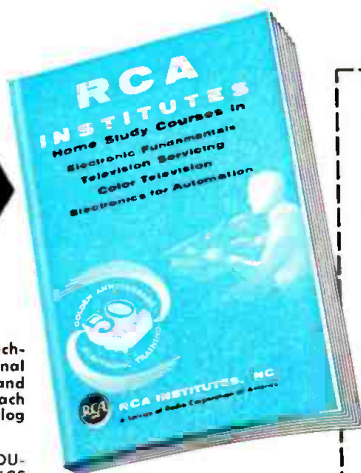

Practical work with the very first lesson. Pay-as-you-learn. You need pay for only one study group at a time.

**RCA INSTITUTES, Inc.** Home Study School, Dept. EW-109

A Service of Radio Corporation of America

350 West Fourth Street, New York 14, N. Y.

Without obligation, send me the FREE catalog of Home Study Courses. No salesman will call.

Name ..... Please print

Address .....

City ..... Zone ..... State .....

Korean Vets! Enter Discharge Date .....

**CANADIANS** — Take advantage of these same RCA courses at no additional cost. No postage, no customs, no delay. Send coupon to: RCA Victor Company, Ltd., 5001 Cote de Liesse Rd., Montreal 9, Quebec

To save time, paste coupon on postcard.

# CBS RADIO SHOWS TOP-RATED BY RATING SERVICES

During the first six months of 1959, an average of 20 of the 25 top-rated popular programs were on CBS Radio . . . over three times as many as on the other three networks combined. A consistent leader is the ARTHUR GODFREY SHOW, a radio favorite for years.

# CBS TUBES TOP-RATED BY LEADING SET MANUFACTURERS



Leading set manufacturers constantly rate and re-rate receiving tubes for quality . . . brand by brand, type by type. We are proud to report that month after month CBS tubes consistently earn top ratings from these manufacturers, and maintain this approval.



**TO YOU,** this is unquestionable proof that when you choose CBS tubes, you choose top-rated quality . . . quality you can depend upon to cut your call-backs to the bone. Always ask for CBS . . . the top-rated name all your customers know and trust.

## CBS ELECTRONICS

Danvers, Massachusetts

A Division of Columbia Broadcasting System, Inc.

ELECTRONICS WORLD

*Receiving, industrial and picture tubes • transistors and diodes • audio components • and phonographs*

# Learn Radio-TV Electronics

*by Practicing  
at Home in  
Spare Time*

**Without Extra  
Charge You Get**

special NRI kits developed to give actual experience with Radio-TV equipment. You build, test, experiment with receiver or broadcasting circuits. All equipment yours to keep.



**Have High Pay, Prestige, Good Future  
as a Skilled Radio-TV Electronic Technician**

People *look up to* and depend on the Technician, more than ever before. Offices, plants, homes everywhere are obliged to buy his knowledge and services. His opportunities are great and are increasing. Become a Radio-TV Electronic Technician. At home, and in your spare time, you can learn to do this interesting, satisfying work—qualify for important pay. To ambitious men everywhere *here* in the fast growing Radio-TV Electronic field is rich promise of fascinating jobs, satisfaction and prestige as well as increasing personal prosperity.

**Increasing Opportunities in Growing Field**

A steady stream of new Electronic products is increasing the job and promotion opportunities for Radio-Television Electronic Technicians. Right now, a solid, proven field of opportunity for good pay is servicing the tens of millions of Television and Radio sets now in use. Color TV, Hi-Fi is growing. The hundreds of Radio and TV Stations on the air offer interesting jobs for Operators and Technicians.

**More Money Soon—Make \$10 to \$15 a  
Week Extra Fixing Sets in Spare Time**

NRI students find it easy and profitable to start fixing sets for friends and neighbors a few months after enrolling. Picking up \$10, \$15 and more a week gives substantial extra spending money. Many who start in spare time soon build full time Radio-Television sales and service businesses—enjoy security.

**Act Now—See What NRI Can Do for You**

NRI has devoted over 40 years to developing simplified practical training methods. You train at home in spare time. Get practical experience, learn-by-doing.

**NATIONAL RADIO INSTITUTE  
Washington 16, D.C.**



**NRI Has Trained Thousands for  
Successful Careers in Radio-TV**



**Studio Engr., Station KATV**  
"I am now Studio Engineer at Television Station KATV. Before enrolling, I was held back by limitation of a sixth grade education." **BILLY SANCHEZ**, Pine Bluff, Ark.

**Has All the Work He Can Do**  
"I have repaired more than 2,000 TV and Radio sets a year. NRI training certainly proved to be a good foundation." **H. R. GORDON**, Milledgeville, Georgia.

**Has Good Part Time Business**  
"Early in my training I started servicing sets. Now have completely equipped shop. NRI is the backbone of my progress." **E. A. BREDÁ**, Tacoma, Washington.

▶▶▶▶▶ **SEE OTHER SIDE** ▶▶▶▶▶

**Cut Out and Mail This Card—No Stamp Needed**

**Sample Lesson and Catalog  
Both Sent FREE**

OLDEST & LARGEST HOME STUDY RADIO-TV SCHOOL  
**National Radio Institute**  
Dept. F, Washington 16, D.C.

Please send me sample lesson of your Radio-Television Training and Catalog FREE. (No salesman will call.)

Name..... Age.....

Address.....

City..... Zone..... State.....

ACCREDITED MEMBER NATIONAL HOME STUDY COUNCIL



**NRI SUPPLIES LEARN-BY-DOING KITS WITHOUT EXTRA CHARGE**  
**Technical Know-How Pays Off in Interesting, Important Work**



**YOU BUILD AC-DC Superhet Receiver**

NRI Servicing Course includes all needed parts. By introducing defects you get actual servicing experience practicing with this modern receiver. Learn-by-doing.



**YOU BUILD This 17 Inch Television Receiver**

As part of your NRI course you can get all components, tubes, including 17" picture tube, to build this latest style Television receiver; get actual practice on TV circuits.

**YOU BUILD Broadcasting Transmitter**

As part of NRI Communications Course you build this low power Transmitter, learn commercial broadcasting operators' methods, procedures. Train for your FCC Commercial Operator's License.



**YOU BUILD Vacuum Tube Voltmeter**

Use it to earn extra cash fixing neighbors' sets; bring to life theory you learn from NRI's easy-to-understand texts.



**For Higher Pay, Better Jobs**  
**Be a Radio-TV Electronic Technician**



**Servicing Needs More Trained Men**

Portable TV, Hi-Fi, Transistor Radios, Color TV are making new demands for trained Technicians. Good opportunities for spare time earnings or a business of your own.



J. E. Smith, Founder

**Train at Home the NRI Way Famous for Over 40 Years**

NRI is America's oldest and largest home study Radio-Television school. The more than 40 years' experience training men for success, the outstanding record and reputation of this school—benefits you in many ways. NRI methods are tested, proven. Successful graduates are everywhere, from coast to coast, in small towns and big cities. You train in your own home, keep your present job while learning. Many successful NRI men did not finish high school. Let us send you an actual lesson, judge for yourself how easy it is to learn.

**Broadcasting Offers Satisfying Careers**

4000 TV and Radio stations offer interesting positions. Govt. Radio, Aviation, Police, Two-Way Communications are growing fields. Trained Radio-TV Operators have a bright future.



**No Experience Necessary—NRI Sends Many Kits for Practical Experience**

You don't have to know anything about electricity or Radio to understand and succeed with NRI Course. Clearly written, well-illustrated NRI lessons teach Radio-TV Electronic principles. You get NRI kits for actual experience. All equipment is yours to keep. You learn-by-doing. Mailing the postage-free card may be one of the most important acts of your life. Do it now. Reasonable tuition. Low monthly payments available. Address: NATIONAL RADIO INSTITUTE, Washington 16, D. C.

**NRI Graduates Do Important Work**



**Now Quality Control Chief**  
 "Had no other training in Radio before enrolling, obtained job working on TV amplifiers before finishing course. Now Quality Control Chief." T. R. FAVAROLO, Norwich, N. Y.

**NRI Course Easy to Understand**  
 "I opened my own shop before receiving my diploma. I have had to hire extra help. I am independent in my own business." D. P. CRESSEY, Stockton, Cal.

**Works on Color-TV**  
 "NRI changed my whole life. If I had not taken the course, probably would still be a fireman, struggling along. Now Control Supervisor at WRCA-TV." J. F. MELINE, New York, N. Y.

FIRST CLASS  
 Permit No. 20-R  
 (Sec. 34.9, P. L. & R.)  
 Washington, D.C.

**BUSINESS REPLY CARD**

No Postage Stamp Necessary if Mailed in the United States

POSTAGE WILL BE PAID BY

**NATIONAL RADIO INSTITUTE**  
 3939 Wisconsin Avenue  
 Washington 16, D.C.

**SAMPLE LESSON**  
**64-page CATALOG**  
**both FREE**

**SEE OTHER SIDE**

# Service Technicians: YOU EARN MORE... you RATE with the public when you own a **PHOTOFACT**<sup>®</sup> service data library!

"I think PHOTOFACTS are the best servicing help ever published."

—Edwin D. Mooers  
Portland, Maine



"I couldn't afford to be without the PHOTOFACT reference library. It saves time in working out wiring circuitry, parts numbers and location. A Sams Folder serves me just right."

—E. D. Muhleman  
Marionville, Missouri

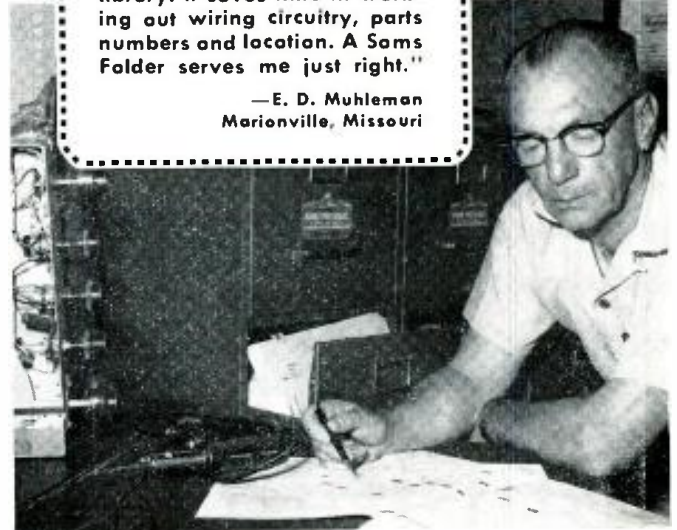

Yes, if you are one of the thousands of owners of a complete PHOTOFACT Service Data Library, you are enjoying maximum earnings. It's inevitable, because no matter how expert you are, you can always *save more time on any job, get more jobs done daily—EARN MORE, DAY IN AND DAY OUT...*

Moreover—as the owner of a complete PHOTOFACT Library, *you know your customers' sets best.* You can actually show each customer you have the PHOTOFACT Folder covering his very own set. Result: *You command public respect and acceptance which paves the way to expanded business for you...*

## HERE'S HOW TO STAY AHEAD...

Today, the truly successful Service Technicians are those who own the complete PHOTOFACT Library, who can meet and solve any repair problem—faster and more profitably. And these men *keep ahead* because they're on a Standing Order Subscription with their Distributors to receive all new PHOTOFACTS as they are released monthly.

For PHOTOFACT Library Easy-Buy Plan details and Standing Order Subscription, see your Sams Distributor today, or write to Howard W. Sams...

## IT'S EASY TO OWN A PHOTOFACT LIBRARY

Howard W. Sams' Easy-Buy Plan is the money-saving way to build your complete profit-making PHOTOFACT Library. NO INTEREST—NO CARRYING CHARGE—AS LITTLE AS \$10 DOWN...



**FREE!** Valuable steel file cabinets given to PHOTOFACT monthly subscribers and Library purchasers

**FREE!** Valuable booklet shows how PHOTOFACT boosts your profit capacity—send for it!



**HOWARD W. SAM'S & CO., INC.**  
2203 E. 46th St., Indianapolis 6, Ind.

Send me Free booklet "Your Guide To Maximum Profits"

I'm a Service Technician:  full-time;  part-time

My Distributor is: \_\_\_\_\_

Shop Name \_\_\_\_\_

Attn: \_\_\_\_\_

Address \_\_\_\_\_

City \_\_\_\_\_ Zone \_\_\_\_\_ State \_\_\_\_\_

**Early American Model,**  
 in fruitwood,  
 80" wide, 24 1/4" high, 13 1/2" deep.  
 \$279.95 user net.



Furniture courtesy of Lopipero Inc.



**TMS-2 ... most sensational advance in stereo reproduction**

When you listen to the TMS-2, you will experience stereophonic reproduction that no conventional system can ever achieve. Its entirely new principle of operation permits every listener *throughout* the room to enjoy fully balanced sound with such extraordinary breadth and three-dimensional depth that it seems to originate beyond the confines of the room itself. Full controls and adjustable doors allow the 'Trimensional' TMS-2 to be placed *anywhere* — along wall or corner — without affecting its performance capabilities. The full TMS-2 story is a fascinating one. Write for it today.



Containing two complete multi-speaker systems in one compact enclosure, the 'Trimensional' TMS-2 projects frequencies of both channels to the rear and side walls of the room. Thus, one large wall area becomes channel A; another channel B... exactly as if you had a series of widely distributed speakers for each channel.

Furniture courtesy of Jens Risom Design Inc.

**Contemporary Model,**  
 80" wide, 25" high, 12 1/2" deep.  
 In mahogany — \$258.00,  
 in blond or walnut — \$263.00 user net.



WRITE DESK S-6, UNIVERSITY LOUDSPEAKERS, INC., WHITE PLAINS, N. Y.



our  
 British  
 cousins  
 at  
 Collaro  
 stress  
 meticulous  
 care and  
 precision  
 engineering  
 in every  
**Collaro**  
 stereo  
 record  
 player!



The Constellation, Model TC-99—\$59.50



The Continental II, Model TSC-840—\$49.50



The Coronation II, Model TSC-740—\$42.50  
 \*The Conquest II, Model TSC-640—\$38.50



Transcription Turntable, Model 4TR-200—\$49.50



Manual Player, Model TP-59—\$29.95



Every Collaro stereo record player is built with typical British attention to every detail. They are precision engineered and rigidly tested to give truly professional performance and the ultimate in operating convenience. Here are some of the important features that make Collaro the logical choice for stereo or monophonic records. • Performance specifications exceed NARTB standards for wow, flutter and rumble —with actual performance test reports accompanying each model TC-99. • Extra-heavy, die-cast, non-magnetic turntables (weighing up to 8½ lbs.). Extra-heavy weight is carefully distributed for flywheel effect and smooth, constant rotation. • Shielded four-pole motors are precision balanced, screened with triple interleaved shields to provide extra 25 db reduction in magnetic hum pick-up. • Detachable five-terminal plug-in head shells (on TC-99, TSC-840, TSC-740, TP-59) provide two completely independent circuits, guaranteeing ultimate in noise reduction circuitry. • Transcription-type stereo tonearms are spring-damped and dynamically counterbalanced to permit the last record on a stack to be played with virtually the same low stylus pressure as the first. • All units are handsomely styled, available with optional walnut, blond and mahogany finished bases or unfinished utility base. There's a 4-speed Collaro stereo record player for every need and budget! Prices slightly higher in the West. For free catalog on the Collaro line, write to: Rockbar Corporation, Dept. EW-10, Mamaroneck, N. Y. (\*Not shown. Similar in appearance to The Coronation.)



STARRING  
**DAVE GARROWAY**  
in NBC-TV's  
"Today" Show

# **CHANNEL MASTER<sup>®</sup>**

Channel Master is telling the T-W story to almost every family in the United States with the **MOST SPECTACULAR ANTENNA PROMOTION OF ALL TIME!**



STARRING  
**JOHN PAINE**  
in ABC-TV's  
"The Restless Gun"



STARRING  
**GALE STORM**  
in ABC-TV's  
"The Gale Storm Show"



STARRING  
**BOB CUMMINGS**  
in ABC-TV's  
"Love That Bob"





# the STARS ★ are out FOR THE



THE BEST OF ANTENNAS DELIVERS  
THIS BEST OF PROMOTIONS!

To help you sell more antenna replacements, Channel Master commercials will be broadcast from coast to coast by 4 of America's most popular TV shows over the entire NBC and ABC networks—210 TV stations.

In addition to this full network coverage, 2 powerful national magazine campaigns will put the T-W story into 17 million homes... many of them right in your community.

These ads are aimed at telling consumers that their antenna installations are becoming old, worn out, obsolete, and that for the best possible TV reception they should replace their antennas with the T-W. This campaign has been designed to create new business for you by making the TV family T-W conscious.

ONLY CHANNEL MASTER GIVES THE DEALER  
THIS KIND OF SUPPORT!

**2** NATIONAL  
TELEVISION  
NETWORKS!



**4** TOP-RATED  
TV SHOWS!



**8** WEEKS OF  
STAR-STUDED  
PROMOTION!

**PLUS**

**2** HARD-HITTING  
NATIONAL  
MAGAZINE  
CAMPAIGNS!



**FARM MAGAZINES**



To reach the rural market  
... where the big fringe in-  
stallations are sold!

**FARM JOURNAL  
SUCCESSFUL FARMING  
PROGRESSIVE FARMER**



**GENERAL  
MAGAZINES**



To reach the vast reader-  
ship of these widely-read  
publications ... in every city  
and hamlet in the country!

**SATURDAY EVENING POST • CORONET**

**Now meet the real star of the show...**

# The **CHANNEL MASTER® T-W**

## ★ **STAR** ★ of Rooftop America!



Three years ago, Channel Master developed the Traveling Wave antenna. This breakthrough in antenna design was so revolutionary...so far ahead of its time...that modern science has not yet been able to produce a comparable antenna.

**Here's why other antennas simply cannot equal the powerful performance of the Traveling Wave.**

The T-W antenna, featuring the Traveling Wave principle, looks and operates differently from other antennas. All but one of its elements are driven. No conventional dipoles are used—only "hairpin" or "fat" dipoles, and a revolutionary new Controlled Impedance Dipole. The 2-stage phasing harness...the critical lengths and angles of the elements...the folded reflector... all combine to deliver these unique Traveling Wave advantages:

- Ideal phase relationships on all channels
- Optimum impedance on all channels
- Equal flow of current in all dipoles on all channels
- Fullest use of transmitted energy on all channels

**As a result, the T-W brings your set miles closer to the TV transmitter, providing the highest gains and highest front-to-back ratios ever achieved in a broad-band antenna.**



**The T-W is the stand-up-and-take-it antenna!**

The T-W is as rugged as it looks. When you install the T-W, you know this hefty performer is up to stay. It

is, without a doubt, the strongest antenna ever built. Here's why:

### "TWIN TRUSS" CONSTRUCTION

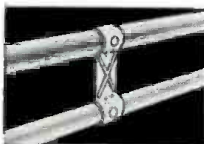

All elements and crossarm are made with "twin truss" design. The truss is a basic construction form used in bridges, airplane wings, and wherever high strength and light weight are required. This "twin truss" design makes each T-W element more than 5 times stronger than an ordinary dipole in its ability to withstand the heaviest wind and ice loads.

### RUGGEDIZED MAST BRACKET



Heavy-duty U-bolt grips the antenna to the mast. Twist-proof construction. 4 rivets secure the bracket to the mast.

### RUGGEDIZED ELEMENTS

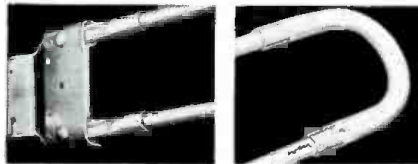

Seamless 1/2" dia. sleeves, seamless 1/2" dia. U-bend... 20% heavier wall thickness than regular antenna construction.

### "LINE-LOK"

Absorbs all transmission line tension. Can't tear at terminals.



### WEATHERPROOF HARNESS



Extra-thick 1/4" virgin polyethylene insulation protects impedance and electrical efficiency against salt air, rain, and ice.

### MASSIVE, HEAVY DUTY INSULATOR MOLDINGS



**The T-W has consumer recognition and acceptance!**

Millions of consumers, including those in your own area, recognize and ask for the Channel Master brand name. Continuous full-scale advertising campaigns, local advertising, newspaper mats, window displays, streamers, and other advertising aids have made the American consumer T-W conscious. The Channel Master T-W out-sells, out-performs, out-lasts every other all-channel antenna. That's why this premium quality product is still the star of rooftop America...and a most profitable experience on the part of the dealer and the consumer alike.

**Call Your Channel Master Distributor Today!**

**CHANNEL MASTER CORP.** ELLENVILLE, N. Y.

© 1964 Channel Master Corp. U.S. Pat. 2,981,000

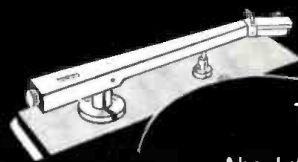

**Stereo  
Transcription arm  
included**

Absolutely non-resonant;  
mounted on friction free  
bearings. Plug-in head accommodates  
all popular stereo and monaural  
cartridges. Stylus pressure easily  
adjusted with micrometer precision.

**Plays all 4 speeds:**

- 16-2/3
- 33-1/3
- 45
- 78

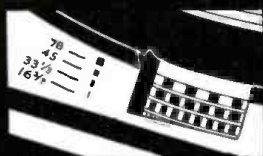
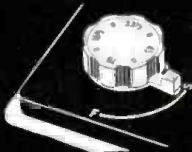

**Built-in, illuminated,  
oversized strobe for all  
speeds. Vernier speed  
control.**

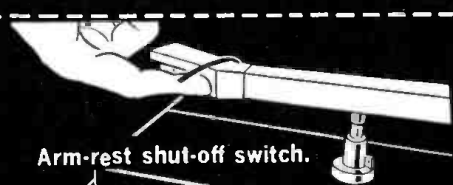

**Arm-rest shut-off switch.**

**Advanced suspension system.**

Operates in electrical  
and mechanical silence.

**Stylus Pressure Gauge  
included**

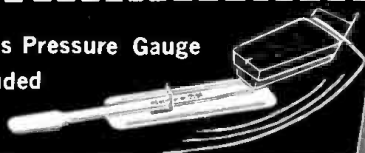

# CHANNEL MASTER

challenges you to  
**Compare this  
new Professional  
Turntable (at \$64<sup>95</sup>)  
with any other  
turntable  
(at any price up to \$119)**



**Model 6652,**  
without base,  
**\$64.95** audiophile net

**Model 6653,**  
with furniture-finished  
mahogany base,  
factory wired plugs  
and jacks,  
**\$79.95** audiophile net

Copyright 1959 Channel Master Corp. Printed in U.S.A. 7949



**Channel Master offers you a full line of  
today's finest matched stereo components.**

- |  |  |
|--|--|
| <p><b>A. Patented Minstrel<br/>Speaker System<br/>Series 6630<br/>\$29.95 audiophile net</b></p> | <p><b>B. Dual 16 Watt<br/>Stereo Amplifier<br/>Model No. 6600<br/>\$99.95 audiophile net</b></p> |
| <p><b>C. 20 Watt<br/>Monaural Amplifier<br/>Model No. 6620<br/>\$79.95 audiophile net</b></p>    | <p><b>D. AM/FM Tuner<br/>Model No. 6610<br/>\$84.95 audiophile net</b></p>                       |



# FUTURA TRIPLETS...

three models... superbly styled... covering a wide range of applications

MODEL 988



## ASTATIC'S FUTURA

### SERIES DYNAMIC MICROPHONES

Most versatile performers in the microphone field are the Astatic Futura Series Dynamic Microphones—Models Metro 788, Tempo 888, and Vogue 988. Beautifully styled, encompassing the newest and most advanced principles in microphone engineering, each model is designed to outperform any other microphone in its price class.

Futura mikes are instantly convertible from hand to stand to lavalier use... offer many special features such as rugged, stable, fatigue-free Mylar diaphragm and, on the 888 and 988, the Cannon XLR-3 connector for instant detachment from cable ("Take the microphone to the cable.")

MODEL 888



MODEL 788



Model No.	Type	Response	Output	Impedance	Finish and Trim	Price
788	Omni-Directional	60-13,000 cps	-55 DB	Hi or 150	Black and Gold	\$ 79.50
888	Omni-Directional	50-15,000 cps	-56 DB	50, 200, Hi	Black and Chrome	110.00
988	Omni-Directional	40-20,000 cps	-58 DB	50, 150, 250	Black and Gold	150.00

**NOTE**— Exclusive Astatic impedance selector permits instant choice of impedance without special tools.

All three microphones come complete with lavalier and belt clip, 360° swivel adaptor for 3/8 #27 thread.

Twenty-foot, two-conductor, shielded cable supplied with each microphone.

THE **Astatic** CORPORATION, CONNEAUT, OHIO

In Canada: Canadian Astatic Limited, Toronto, Ontario  
Export Sales: Roburn Agencies Inc.  
431 Greenwich St., N. Y. 13, N. Y., U.S.A.

FROM WHAT  
YOU HEAR

ASTATIC MICROPHONES ARE A SENSATION ON ANY INSTALLATION



**Latest Information  
on the Electronic Industry**

*Spot News*

By **ELECTRONICS WORLD'S  
WASHINGTON EDITOR**

**STEREO-BROADCASTING-DEVELOPMENT ACTIVITY MOUNTING**—The past weeks have witnessed such surging enthusiasm for stereo among broadcasters—both AM and FM—as well as industry, that the Commission has extended the hearing deadline for stereo multiplexing until December 11th. Latest broadcast entry—ABC—recently premiered a simplified stereo process, which featured a version of the Philco system, before FCC personnel. A number of others say they, too, have effective techniques which meet the requirements set forth by the National Stereophonic Radio Committee. Basically, the NSRC charter calls for a compatible stereo sound method which can be used by AM, FM, and TV stations.

**CITIZENS RADIO AUTHORIZATIONS PASS 50,000 MARK**—The booming interest in Citizens Radio service is breaking all records for operating grants. Over 300 applications are now being processed daily and, at this writing, over 50,000 authorizations have been issued. The development of lightweight portables of the "walkie-talkie" type has opened the door to an endless variety of applications. Washington reports that the private two-way service is now being used to page doctors, nurses, and other professionals; also by department stores, dairies, and laundries to contact delivery trucks. It is an aid to industrial plants, construction projects, farms, and ranches. On-the-air traffic is increasing at such a rate that the FCC may decide to limit duration of any one transmission or exchange of communications between stations—especially those using class D.

**ELECTRONIC BRAIN TO CONTROL TORPEDOES AFTER FIRING**—An electronic brain—the Mark 112 Torpedo Fire-Control System—for the control of torpedoes after they are fired, will be installed on the first Polaris-launching submarine, the "George Washington." Developed and being produced under contracts totaling \$12 million by Sperry, the system—basically a computer—will be installed on nuclear-powered, attack, hunter, killer, and missile-launching submarines. Using one or a combination of several sensing devices, such as radar or sonar, the system can determine an enemy ship's position, direction, and speed. A means of activating torpedoes with acoustic heads is included. When the torpedo has traveled a safe enough distance from the sub, the torpedo is activated so that it will seek out the ship at which it is fired.

**CLOSED-CIRCUIT TV TO HELP SELL SURPLUS DEFENSE PROPERTY**—An experimental large-screen television auction—using closed-circuit lines—will be conducted this Fall when government surplus property located at three widely separated military-supply installations will be offered for sale to over 9000 prospective bidders gathered in six major cities: Boston, New York, Philadelphia, Columbus, Chicago, and St. Louis. Under this new approach, prospective buyers will be able to see and bid simultaneously through a combination of TV and two-way radio circuits.

**\$25-MILLION TRACKING NET DESIGNED FOR MANNED ORBITAL FLIGHT**—A \$25-million contract for a world-wide network of tracking and ground instrumentation stations to be used in "Project Mercury"—the U.S. effort to achieve orbital manned flight—will soon be awarded by the National Aeronautics and Space Administration. The Mercury tracking network—to be completed in 1960—will include both radar tracking and telemetry installations in Africa, South Pacific, Central America, Cape Canaveral, Hawaii, Southern California, on an island in the Atlantic, two on islands in the Pacific, and two on ships.

**COMMISSIONER PROPOSES USE OF CHANNELS 2-13 FOR SAFETY SERVICES**—A bold re-allocation plan involving use of channels 2-13 for Safety and Special Radio Services was offered by FCC Commissioner Robert W. Lee during the recent Senate Interstate and Foreign Commerce Committee hearings. If TV were shifted to u.h.f., he said, the 54- to 216-mc. channels would be ideal for Citizens Radio, model control, broadcast pickup, alarm devices (industrial), etc. The Commissioner presented an allocation chart spelling out channels selected for each service.



for  
the  
**BEST**  
in  
**SERVICE**

**USE  
AEROVOX  
CERAMIC  
CAPACITORS!**



If you're particular about your service . . . be particular about the capacitors you use. Aerovox offers you a complete line of rugged, dependable and versatile ceramic capacitors in every case style for every replacement application.

Choose from a wide selection of disk types in bypass-coupling, general purpose, hi-voltage and temperature compensating. Three tubular types are available from general purpose to temperature compensating to hi-voltage units. For these special applications you have cartwheels, standoffs and feedthrus in all sizes and values.

Your local Aerovox Distributor is your one-stop source of supply. Call on him today for any and all your capacitor needs. Ask him for your personal copy of the latest Aerovox Servicemen's Catalog.

**BUY 'EM BY THE KIT.** . . . two disk ceramic kits (AK-200 and AK-201HS) of popular replacement types in special 3 x 5 metal file drawers now available at your Aerovox Distributor. Pay for only the capacitors and get the file cabinet FREE.



**AEROVOX**  
**CORPORATION**  
DISTRIBUTOR DIVISION  
NEW BEDFORD • MASSACHUSETTS

# Within the Industry

**ALLAN W. GREENE** has been appointed president of the *Heath Company*, Benton Harbor, Michigan. The firm is an operating division of *Daystrom, Inc.* Mr. Greene was formerly general manager of *Moto-Mover, Inc.* of Richmond, Indiana, and a vice-president of *Detroit Harvester Company*. He is a graduate of the University of Wisconsin.



He started his business career as a college trainee with *Sears Roebuck and Company*; later joined the *Packard Motor Car Company*; and then became service manager and manager of sales training of the *Reo Company*.

**AUGUST DIENER**, of *P. R. Mallory & Co.*, has been named chairman of the credit committee, Electronic Industries Association.

Simultaneously named were William F. Trace, *Westinghouse Electric Corp.*, vice-chairman of the committee's western group; and Albert Wilkens, *Clorostat Manufacturing Co., Inc.*, vice-chairman of the eastern group.

The committee was established some years ago to alert credit executives of EIA member-companies to impending financial debacles. It is assisted by the National Credit Office.

**GEORGE A. STRICHMAN** has been named director of manufacturing services for *Raytheon Company*, a newly created post. In his new position, Mr. Strichman will report directly to the office of the president and will guide operating division management in various phases of the manufacturing activity.



He resigned as manufacturing manager of *General Electric Company's* small aircraft engine department to take this appointment. Prior to this, he was factory manager of the *Burr Manufacturing Company*.

Mr. Strichman is a member of the American Management Association and the American Helicopter Society.

**ELECTRONIC INDUSTRIES ASSOCIATION's** newly formed Congressional information committee has named Robert T. Borth of *General Electric Co.* as chairman. The committee will function under the policy supervision of the Association's legislative policy committee which authorized its formation.

The committee's objective will be to acquaint members of Congress more fully with the importance of electronics to the country's defense and economy.

Other members of the committee are: Robert W. Bergen, *Hoffman Electronics Corp.*; Andrew H. Bergeson, *Stromberg-Carlson*; Roland M. Bixler, *J-B-T Instruments, Inc.*; Cecil L. Covington, *Texas Instruments Inc.*; E. Farrell, *Tele-Dynamics Inc.*; Robert E. Kelley, *Sprague Electric Co.*; L. I. Marks, *Adler Electronics, Inc.*; Arthur L. Milk, *Sylvania Electric Products Inc.*; and Lewis D. Spencer, *Motorola Inc.*

**JOSEPH E. KELLEY** has been named manager, merchandising, distributor products department of the *Radio Corporation of America's* electron tube division. In his new assignment, Mr. Kelley will be responsible for developing the marketing strategy for distributor products as well as developing comprehensive merchandising plans and sales promotional programs.



He joined the firm in 1942 as a manufacturing and developmental engineer. Later that year he became a design engineer and in 1950 was assigned to the electron tube division's distributor sales organization as a salesman in the San Francisco territory. Mr. Kelley became manager, northeastern distributor sales district in 1953 and since 1957 has been manager, merchandising, industrial tubes, and semiconductors for the distributor products organization.

**PHINEAS J. ICENBICE, JR.** has been appointed to the post of chief engineer of *Gonset Division, Young Spring & Wire Corp.* In addition, **JOHN HUNT** is now manager, amateur sales . . . **WILLIAM V. LEVINE** has joined *Sylvania Electric Products Inc.* as editor of "Sylvania News" . . . The election of **JOHN E. JOHNSON** as vice-president and marketing manager, electronic data processing division, has been announced by *RCA* . . . **ROD KERSHENSTEIN** has been appointed director of marketing, professional products, for *Telectro Industries Corp.* . . . **JOHN M. LESLIE, JR.** has been elevated to the position of executive vice-president of *Orr Industries, Inc.* . . . **DAVID I. MARGOLIS** is now assistant to the president of *International Telephone and Telegraph Corporation* . . . *Allied Radio Corporation* has announced the appointments of

**WE'RE MAKING IT EASIER THAN EVER TO BECOME A WELL PAID RADIO-TELEVISION SERVICE TECHNICIAN**

**NOW - Just \$6 Starts You Training in**  
**RADIO-TELEVISION**  
 the **SPRAYBERRY** "Learn-by-Doing" Way . . .

**25 BIG, COMPLETE KITS of PARTS & EQUIPMENT**

To help you learn *fast* the practical side of Radio-Television, we send you expertly engineered training kits to test and assemble for interesting, valuable shop-bench practice!

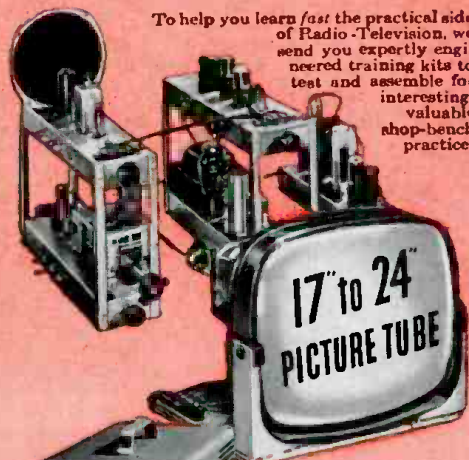

• The new Sprayberry Training Television Receiver, built and tested in 5 sections.

• Now offered . . . this fine modern oscilloscope.

• You build this powerful two-band superheterodyne radio receiver.

**Big New CATALOG AND Sample Lesson FREE!**

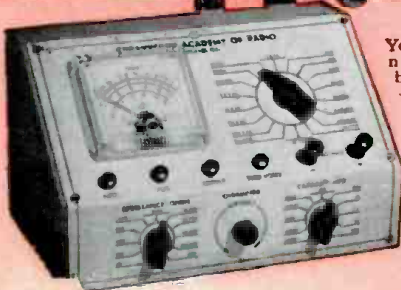
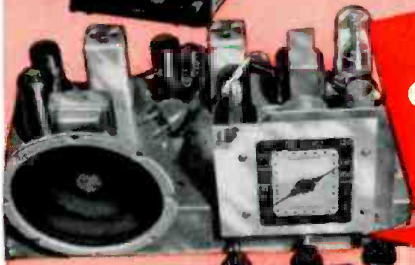

You build the new Sprayberry tester—a complete 18-range Volt-Ohm-Milliammeter test meter.



★ ★ ★ ★ This great industry is begging for trained men . . . to step into good paying jobs or a profitable business of their own! Our new plan opens the doors of Radio-Television wide to every ambitious man who is ready to act at once!

Men by the thousands . . . trained Radio-Television Service Technicians . . . are needed at once! Perhaps you've thought about entering this interesting, top paying field, but lack of ready money held you back. Now—just \$6 enrolls you for America's finest, most up to date home study training in Radio-Television! Unbelievable? No, the explanation is simple! We believe Radio-Television *must* have the additional men it needs as quickly as possible. We are willing to do our part by making Sprayberry Training available for less money down and on easier terms than ever before. This is your big opportunity to get the training you need . . . to step into a fine job or your own Radio-Television Service Business.

**Complete Facts Free—Act Now; Offer Limited**

Only a limited number of students may be accepted on this liberal and unusual basis. We urge you to act at once . . . mail the coupon below and get complete details plus our big new catalog and an actual sample lesson—all free. No obligation . . . no salesman will bother you.

**HOME STUDY TRAINING IN SPARE TIME**

Under world-famous 27-year old Sprayberry Plan, you learn entirely at home in spare time. You keep on with your present job and income. You train as fast or as slowly as you wish. You get valuable kits of parts and equipment for priceless shop-bench practice. And everything you receive, lessons and equipment alike, is all yours to keep.

**LET US PROVE HOW EASILY YOU CAN LEARN!**

Radio-Television needs YOU! And Sprayberry is ready to train you on better, easier terms, that any ambitious man can afford. *Just \$6 starts you!* Mail coupon today . . . let the facts speak for themselves. You have everything to gain. Let us prove the kind of opportunity that's in store for you!

**SPRAYBERRY Academy of Radio-Television**  
 1512 Jarvis Avenue, Dept. 25-C, Chicago 26, Illinois

**Mail This Coupon Now—No Salesman Will Call**

**Sprayberry Academy of Radio-Television**  
 Dept. 25-C, 1512 W. Jarvis Ave., Chicago 26, Ill.

Please rush all information on your ALL-NEW Radio-Television Training Plan. I understand this does not obligate me and that no salesman will call upon me. Include New Catalog and Sample Lesson FREE.

NAME . . . . . Age . . . . .

ADDRESS . . . . .

CITY . . . . . ZONE . . . . . STATE . . . . .

# The DUAL-1006 satisfies every need

...as both a professional  
single play turntable  
and superior  
record changer

Tracks—and operates automatically  
—with stylus pressure as low as 1½  
grams! Minimizes all wear.

## DUAL-1006

Built-in direct reading stylus pres-  
sure gauge. Easy to use, weight ad-  
justment conveniently located.

## DUAL-1006

Big, heavy 10½" turntable is lami-  
nated and concentrically girded.  
Can't warp or become eccentric.

## DUAL-1006

Rumble-free motor is so powerful  
turntable reaches full RPM from  
dead start in less than ¼ turn!

## DUAL-1006

All drive gears disengage automati-  
cally—no "neutral" position to re-  
member, no flat spot thump.

## DUAL-1006

Obsolescence-proof intermix for all  
present or future record sizes. Stack  
in any sequence.

## DUAL-1006

Elevator Action changer-spindle  
prevents damage to record grooves  
and center holes. Truly gentle!

## DUAL-1006

For the full story, write ...

**united audio**  
PRODUCTS OF DISTINCTION  
202-4 East 19th St., N.Y.3, N.Y.

**ROBERT J. COHEN** as promotion assist-  
ant to the sales development manager  
and **SAMUEL S. CRANDELL** as customer  
services manager . . . **J. FRANK PRICE**  
has been elected vice-president, opera-  
tions, and a member of the board of  
directors of *Pleasantville Instrument  
Corp.* . . . **ROBERT BEAGLES** has joined  
*Packard Bell Electronics* as chief en-  
gineer of advanced development, tech-  
nical products division . . . *Granco  
Products, Inc.* has announced the elec-  
tion of **ISIDORE B. SEIDLER** as a director  
of the firm . . . The appointment of  
**BRIG. GEN. EARLE F. COOK** as deputy  
chief signal officer of the U. S. Army  
has been announced by the Department  
of the Army . . . **WILLIAM E. SEAMAN**  
has been named to the post of chief en-  
gineer, *Midwestern Instruments, Inc.*  
. . . **WILLIAM CRAWFORD** has been pro-  
moted to the office of assistant sales  
manager, *Oxford Components, Inc.* . . .  
**ROBERT S. MASON**, *Sylvania Electronic  
Tubes*, equipment sales department,  
has been named manager of entertain-  
ment equipment sales, eastern region.  
**EUGENE M. SORENSEN** is now manager  
of industrial sales for the midwestern  
region.

**MARVIN RUBIN** has joined *Allied Radio  
Corporation* as staff assistant to the  
vice-president and  
general marketing  
manager. In this po-  
sition, Mr. Rubin  
will assist in the co-  
ordination of mar-  
keting division ac-  
tivities and the han-  
dling of special proj-  
ects.



He served earlier as assistant sales  
promotion manager at *Bell and Howell*.  
Mr. Rubin's previous experience in-  
cludes four years as associate editor of  
*POPULAR PHOTOGRAPHY* magazine. He  
has also been associated with *Powell  
Camera Mart*.

**DAYSTROM-WESTON SALES DIVISION**,  
*Daystrom, Inc.*, has opened two new  
branch offices and a new district sales  
office. The branch offices are in Cedar  
Rapids, Iowa and New Orleans, La.  
The district sales office is in Seattle,  
Washington . . . **RAYTHEON COMPANY**  
has announced plans to construct a  
transistor plant in Lewiston, Maine. It  
will be operated by the firm's semicon-  
ductor division . . . **HAZELTINE TECH-  
NICAL DEVELOPMENT CENTER, INC.**, a  
division of *Hazeltine Corp.*, has estab-  
lished a new electronics test and engi-  
neering center at the Weir-Cook Mu-  
nicipal Airport, Indianapolis, Ind. . . .  
**AMPEREX ELECTRONIC CORP.** has an-  
nounced the construction of a new, two-  
story, modern, air-conditioned engineer-  
ing wing. Slated for completion in Oc-  
tober, 1959 the new wing will add 13,000  
square feet of working space to the  
company's building . . . A southern  
California sales office of **ORR INDUS-  
TRIES** has been established at 1715 E.  
Walnut St., Pasadena, Calif. . . . **AP-  
PLIED ELECTRONICS CORPORATION OF  
NEW JERSEY** has moved into its new fa-

cility at 22 Center Street, Metuchen,  
N. J. . . . **TELEMETER MAGNETICS** has  
established a components division as an  
autonomous operation within the com-  
pany. It will be located in the firm's  
plants at Los Angeles and Santa Mon-  
ica, California.

**ROBERT E. BARD**, of the Chicago office  
of *General Radio Company*, has been  
elected chairman of the Chicago sec-  
tion of the Institute of Radio Engi-  
neers. During the past year he has  
served as vice-chairman of the section.  
Currently, he is also a director of the  
National Electronics Conference and  
chairman of its exhibits committee.

**CROSBY ELECTRONICS, INC.**, a subsidi-  
ary of *Crosby-Teletronics Corp.*, has  
acquired the inventory of **MADISON  
FIELDING**. The line of high-fidelity  
equipment is expected to be continued  
and expanded . . . **THE ASTATIC COR-  
PORATION** has established a new divi-  
sion in its engineering department to  
conduct research and development on  
basic materials . . . The announcement  
of **NATIONAL RADIO CO., INC.** as a  
wholly owned subsidiary of **NATIONAL  
COMPANY, INC.** has been made by the  
parent company. The recently acquired  
subsidiary was formerly known as *Mu-  
tual Electronic Industries Corp.* . . .  
**TELEMETER MAGNETICS** has purchased  
80% of the stock of **DIGITAL INSTRU-  
MENT LABORATORIES, INC.** . . . **CBS  
ELECTRONICS** has concluded an agree-  
ment with **RONETTE** (*Ronette Piezo-  
Electrique Industrie N. V.*) of Amster-  
dam, Holland. Under terms of the agree-  
ment, the division of *Columbia Broad-  
casting System, Inc.* will hold distribu-  
tion and license rights in the United  
States and its territories for *Ronette*  
phonograph cartridges, microphones,  
tone arms, and other products . . .  
**AMPEX CORPORATION** has been ap-  
pointed sole authorized distributor in  
the United States of **MARCONI** televi-  
sion cameras, equipment, and broad-  
casting equipment . . . **THOMPSON  
RAMO WOOLDRIDGE, INC.** has pur-  
chased a controlling interest in **MAGNA  
PRODUCTS, INC.** . . . **HAZELTINE COR-  
PORATION** has acquired the outstanding  
stock of **WHEELER LABORATORIES, INC.**  
The firm will become a wholly owned  
subsidiary of the parent organization  
. . . **AMERICAN ELECTRONICS COM-  
PANY** has formed a new division known  
as **MONARCH ELECTRONICS COMPANY**.

**WILLIAM ALONZO PORTER**, student at  
the University of Michigan's Horace  
H. Rackham School of Graduate Stud-  
ies, has been awarded the 1959 Na-  
tional Electronics Conference Fellow-  
ship. Mr. Porter is working toward his  
doctorate in electrical engineering.

The NEC Fellowship is awarded an-  
nually to encourage promising grad-  
uate students working in electronics.  
The Conference is an international  
forum and exhibit attended by ap-  
proximately 10,000 engineering and  
management people. The 15th Annual  
NEC will be held in Chicago's Hotel  
Sherman October 12-14, 1959.



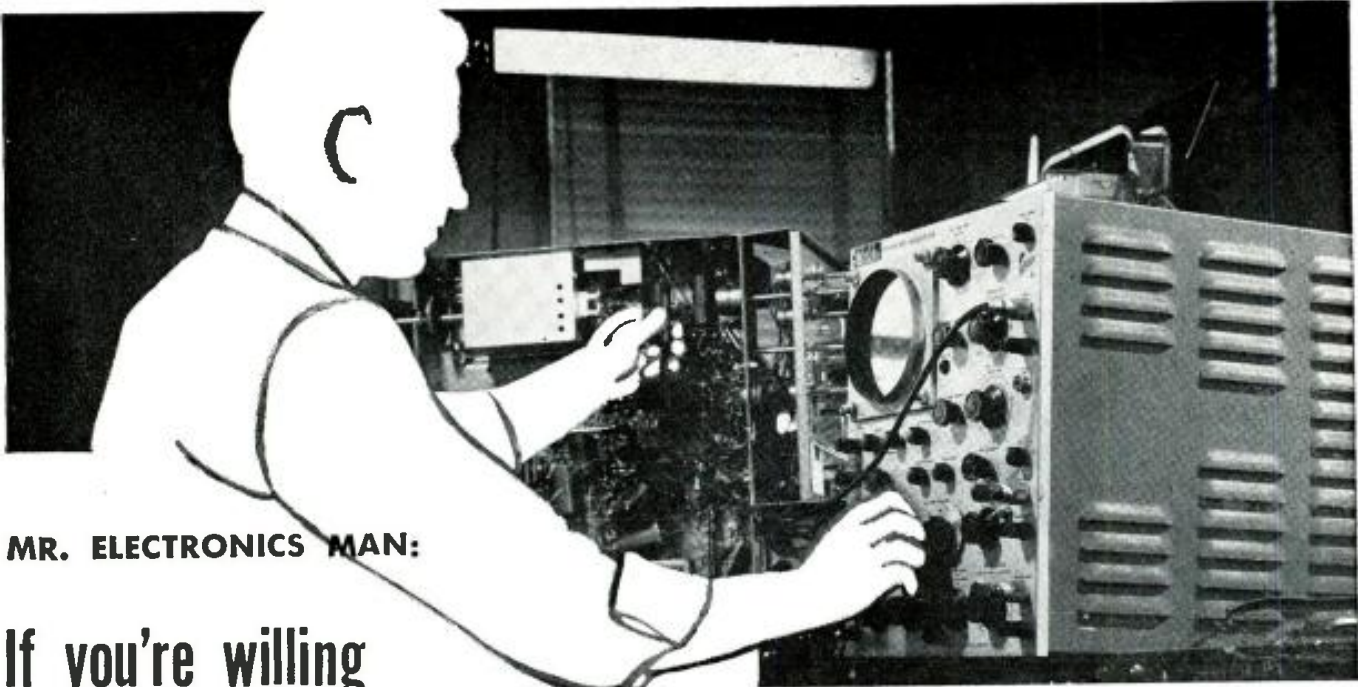

**MR. ELECTRONICS MAN:**

**If you're willing  
to lose your job tomorrow  
to a technically-trained man,  
turn the page, mister**

Many of the men currently on the street are there for a reason. "As many as 8 out of 10 are dead-wood," estimates the chief engineer of a medium-sized Philadelphia firm; the problem is to find the live ones. —from *ELECTRONICS MAGAZINE*

If you're interested in an honest-to-goodness career in the vigorous young electronics industry, here's how you can step ahead of job-competition, move up to a better job, earn more money, AND BE SURE OF HOLDING YOUR TECHNICAL JOB. EVEN WHEN THE "DEADWOOD" IS BEING CLEANED OUT.

The "how" is advanced, professional home study education in Electronic Engineering Technology including AUTOMATION, INSTRUMENTATION, INDUSTRIAL ELECTRONICS, AERONAUTICAL ELECTRONICS, GUIDED MISSILES, SERVOMECHANISMS, COMPUTERS, ASTRONAUTICS, TELEMETERING, COMMUNICATIONS, MANUFACTURING. You don't have to be a college graduate. You *do* have to be willing to study—at home. You can do it while holding down a full-time job. Thousands have. Since 1927 CREI has provided alert young men with the technical knowledge that leads to more responsibility, more job security, more money. And CREI has constantly kept pace with the rapid expansion and progress in electronic achievement.

Remember this: CREI starts with fundamentals and takes you along at your own speed. You are not held back by a class, not pushed to keep up with others. You set your own pace. CREI instructors guide you through the lesson material and *grade* your written work personally. You master the fundamentals, then get into more advanced phases of electronics engineering principles and practice. Finally you may elect education in highly specialized principles of electronic engineering technology as applied to guided missiles, servomechanisms, radar, computers, telemetering, automation, instrumentation and other applications.

Look at this partial listing of organizations that recommend CREI courses for their own personnel: United Air Lines, Canadian Broadcasting Corp., Trans-Canada Airlines, The Martin Co., Columbia Broadcasting System, All-America Cables and Radio, Inc., Gates Radio Co., Canadair Ltd., Federal Electric Corp., and U.S. Information Agency (Voice of America).

What's the next step? *Certainly get more information than we can cram into one page. Fill out and mail the coupon below today, or write Capitol Radio Engineering Institute, Dept. 1110F, 3224 16th St., N.W., Washington 10, D. C.*

CREI ALSO OFFERS RESIDENCE SCHOOL COURSES at the same high technical level in Washington, D. C. Classes start at regular intervals. Qualified residence school graduates earn degree. "Associate in Applied Science" in 27 months. You can qualify for CREI home study advanced technical education if you have had electronic training, or experience in electronics—and realize the need of a high level technical knowledge to make good in the better electronic jobs. (Electronics experience is not required for admission to CREI Residence School.)

**AUTOMATION AND INDUSTRIAL ELECTRONICS  
ENGINEERING TECHNOLOGY**

Complete course; covers all electronic phases of automation. Special emphasis on theory, functioning, and applications of servomechanisms and computers. Also noteworthy: Lessons on machine control, instrumentation, data processing, and telemetry. A "must" for engineers and technicians seeking to enter this fascinating branch of electronic technology.

**MAIL THIS COUPON FOR FREE 54-PAGE BOOK!**

**Capitol Radio Engineering Institute**

ECPD Accredited Technical Institute Curricula • Founded 1927  
Dept. 1110F, 3224 Sixteenth St., N.W., Washington 10, D. C.

Please send me your course outline and FREE illustrated 54-page book "Insurance for Your Future in the New World of Electronics" . . . describing opportunities and CREI home study courses in Practical Electronic Engineering Technology.

- CHECK  Radar, Servo and Computer Engineering Technology **13**  
 FIELD OF  Electronic Engineering Technology  
 GREATEST  Communications Engineering Technology  
 INTEREST  Television Engineering Technology  
 Aeronautical Electronic Engineering Technology  
 Automation and Industrial Electronics Engineering Technology

Name ..... Age.....  
 Street .....  
 City ..... Zone.... State.....  
 Check:  Home Study  Residence School  Korean Veteran

To obtain fast, immediate service and to avoid delay, it is necessary that the following information be filled in:

Employed By.....  
 Type of Present Work.....  
 .....  
 Education:  
 Yrs. High School.....  
 Other .....  
 Electronics Experience.....  
 .....

General Electric's all-new VR-22 Stereo Cartridge

# Outstanding in all four critical areas....

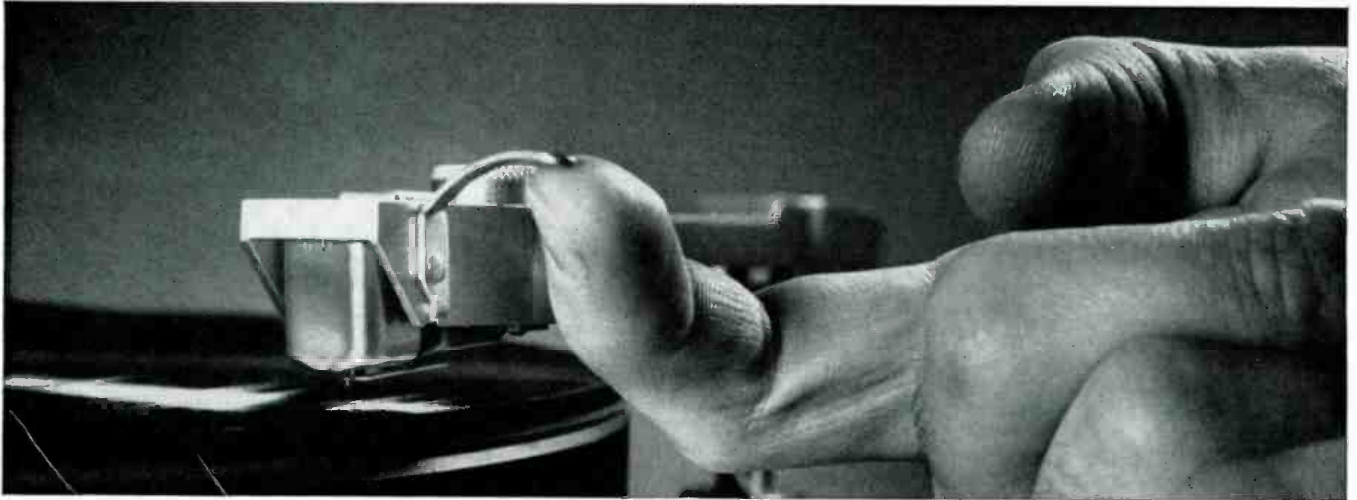

A masterpiece of stereo cartridge design and manufacture, the VR-22 is outstanding in all four critical areas of stereo cartridge performance: *Channel separation*—Up to 28 db for maximum stereo effect. Nothing higher on the market! *Response*—Smooth and flat for superior sound from 20 to 20,000 cycles (VR-225), 20 to 15,000 cycles (VR-227). *Freedom from hum*—triple-shielded against stray currents. *Compliance*—Tracks precisely, not a trace of stiffness. Hear it at your dealer's soon.

VR-225 with .5 mil diamond stylus for professional-type tone arms, **\$27.95\***. VR-227 with .7 mil diamond stylus for record changer or turntable, **\$24.95\***.

TM-2G Tone Arm—a professional-type tone arm designed for use with General Electric stereo cartridges as an integrated pickup system, **\$29.95\***.

\*Manufacturer's suggested resale prices.

Acclaimed  
by the  
experts!



Oliver P. Ferrell  
Editor  
Hi-Fi Review

"... the VR-227 is a top performer. The frequency response... is as flat as any cartridge tested to date. Channel-to-channel separation in the vital area between 700 cycles and 8000 cycles was equal to the very best stereo cartridges now offered the public."



Wm. A. Stocklin  
Editor  
Electronics  
World

"... listening tests did not show up any flaws. Frequency response from 30 to 15,000 cps (limits of our test) was within 2.25 db of flat. Provides about the best channel separation available of any checked with the exception of [cartridge selling for \$65.00] in the frequency range from about 5000 to 9000 cps."



C. G. McProud  
Editor and  
Publisher  
Audio

"... is even better than its predecessor with respect to output, channel separation and extended frequency response and the two channels balance within  $\pm 2$  db to 15,000 cycles. The shielding has been improved and the grounding of the shield and the method of shorting the two 'ground' terminals are well thought out."

For the finest monaural performance, too: the VR-22 or the famous VR-2.

Audio Components Section, Auburn, N. Y.

GENERAL  ELECTRIC

In **STEREO**

and Mono Hi-Fi... the experts say  
your best buy is

**EICO**

"The overall design of the HF-81 is conservative, honest and functional. It is a good value considered purely on its own merits, and a better one when its price is considered as well."

—Hirsch-Houck Labs (HIGH FIDELITY Magazine)

- Advanced engineering • Finest quality components
- "Beginner-Tested," easy step-by-step instructions
- LIFETIME service & calibration guarantee at nominal cost
- IN STOCK — compare, then take home any EICO equipment — right "off the shelf" — from 1500 neighborhood EICO dealers.



Stereo Amplifier-Preamplifier HF81

**HF81 Stereo Amplifier-Preamplifier** selects, amplifies, controls any stereo source & feeds it thru self-contained dual 14W amplifiers to a pair of speakers. Provides 28W monophonically. Ganged level controls, separate balance control, independent bass & treble controls for each channel. Identical Williamson-type, push-pull EL84 power amplifiers. "Excellent" — SATURDAY REVIEW; HI-FI MUSIC AT HOME. "Outstanding quality... extremely versatile." — ELECTRONICS WORLD LAB-TESTED. Kit \$69.95. Wired \$109.95. Includes cover.

**HF85 Stereo Preamplifier** is a complete, master stereo preamplifier-control unit, self-powered for flexibility & to avoid power-supply problems. Distortion borders on unmeasurable even at high output levels. Level, bass, & treble controls independent for each channel or ganged for both channels. Inputs for phono, tape head, mike, AM, FM, & FM-multiplex. One each auxiliary A & B input in each channel. Switched-in loudness compensator. "Extreme flexibility... a bargain." — HI-FI REVIEW. Kit \$39.95. Wired \$64.95. Includes cover.

**New HF87 70-watt Stereo Power Amplifier:** Dual 35W power amplifiers of the highest quality. Uses top-quality output transformers for undistorted response across the entire audio range at full power to provide utmost clarity on full orchestra & organ. IM distortion 1% at 70W, harmonic distortion less than 1% from 20 to 20,000 cps within 1 db of 70W. Ultra-linear connected EL34 output stages & surge-protected silicon diode rectifier power supply. Selector switch chooses mono or stereo service; 4, 8, 16, and 32 ohm speaker taps, input level controls; basic sensitivity 0.38 volts. Without exaggeration, one of the very finest stereo amplifiers available regardless of price. Use with self-powered stereo preamplifier-control unit (HF85 recommended). Kit \$74.95. Wired \$114.95.

**HF86 28W Stereo Power Amplifier Kit \$43.95. Wired \$74.95.**

**FM Tuner HFT90:** Prewired, prealigned, temperature-compensated "front end" is drift-free. Prewired exclusive precision eye-tronic® traveling tuning indicator. Sensitivity: 1.5 uv for 20 db quieting; 2.5 uv for 30 db quieting, full limiting

from 25 uv. IF bandwidth 260 kc at 6 db points. Both cathode follower & FM-multiplex stereo outputs, prevent obsolescence. Very low distortion. "One of the best buys in high fidelity kits." — AUDIOCRAFT. Kit \$39.95. Wired \$65.95. Cover \$3.95. "Less cover, F.E.T. Incl.

**New AM Tuner HFT94.** Matches HFT90. Selects "hi-fi" wide (20c — 9kc @ —3 db) or weak-station narrow (20c — 5kc @ —3 db) bandpass. Tuned RF stage for high selectivity & sensitivity; precision eye-tronic® tuning. Built-in ferrite loop, prealigned RF & IF coils. Sensitivity 3 uv @ 30% mod. for 1.0 V out, 20 db S/N. Very low noise & distortion. High-Q 10 kc whistle filter. Kit \$39.95. Wired \$69.95. Incl. Cover & F.E.T.

**New AF-4 Stereo Amplifier** provides clean 4W per channel or 8W total output. Inputs for ceramic/crystal stereo pick-ups. AM-FM stereo, FM-multi stereo. 6-position stereo/mono selector. Clutch-concentric level & tone controls. Use with a pair of HFS-5 Speaker Systems for good quality, low-cost stereo. Kit \$38.95. Wired \$64.95.

**HF12 Mono Integrated Amplifier** provides complete "front-end" facilities and true high fidelity performance. Inputs for phono, tape head, TV, tuner and crystal/ceramic cartridge. Preferred variable crossover, feedback type tone control circuit. Highly stable Williamson-type power amplifier circuit. Power output: 12W continuous, 25W peak. Kit \$34.95. Wired \$57.95. Includes cover.

**New HFS3 3-Way Speaker System Semi-Kit** complete with factory-built 3/4" veneered plywood (4 sides) cabinet. Bellows-suspension, full-inch excursion 12" woofer (22 cps res.), 8" mid-range speaker with high internal damping cone for smooth response, 3 1/2" cone tweeter. 2 1/4 cu. ft. ducted-port enclosure. System Q of 1/2 for smoothest frequency & best transient response. 32-14,000 cps clean, useful response. 16 ohms impedance. HWD: 26 1/2", 13 3/8", 14 3/8". Unfinished birch \$72.50. Walnut, mahogany or teak \$87.95.

**New HFS5 2-Way Speaker System Semi-Kit** complete with factory-built 3/4" veneered plywood (4 sides) cabinet. Bellows-suspension, 3/8" excursion,



Stereo Preamplifier HF85

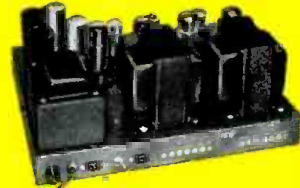

70W Stereo Power Amplifier HF87  
28W Stereo Power Amplifier HF86



FM Tuner HFT90  
AM Tuner HFT94



Stereo Integrated Amplifier AF4



12W Mono Integrated Amplifier HF12  
Other Mono Integrated Amplifiers:  
50, 30, & 20W (use 2 for stereo)



2-Way Bookshelf  
Speaker System HFS1  
3-Way Speaker System HFS3  
2-Way Speaker System HFS5

tion, 8" woofer (45 cps res.), & 3 1/2" cone tweeter. 1 1/4 cu. ft. ducted-port enclosure. System Q of 1/2 for smoothest frequency & best transient response. 45-14,000 cps clean, useful response. HWD: 24", 12 1/2", 10 1/2". Unfinished birch \$47.50. Walnut, mahogany or teak \$59.50.

**HFS1 Bookshelf Speaker System** complete with factory-built cabinet. Jensen 8" woofer, matching Jensen compression-driver exponential horn tweeter. Smooth clean bass, crisp extended highs. 70-12,000 cps range. 8 ohms. HWD: 23" x 11" x 9". Price \$39.95.

**LGS-1 Brass Tip Matching 14" Legs — \$3.95.**  
**HFS2 Omni-Directional Speaker System** (not illus.) HWD: 36", 15 1/4", 11 1/2". "Eminently musical" — HIGH FIDELITY. "Fine for stereo" — MODERN HI-FI. Completely factory-built. Mahogany or walnut \$139.95. Blond \$144.95.

**IMPORTANT NOTE:** All EICO kits built according to our instructions, and all EICO factory-assembled equipment, conform to the high standards and specifications as published in EICO literature and advertisements. All EICO factory-assembled equipment is completely and meticulously hand-wired throughout — no printed circuitry — each factory-assembled unit is 100% final-tested throughout for each feature and function — no "spot" or "partial" checking. In EICO's final-test techniques, nothing is left to chance.

Fill out coupon on other side for FREE CATALOG

Over 1 MILLION EICO instruments in use throughout the world

Copyright 1959 by Electronic Instr. Co., Inc. 33-00 N. Blvd., L. I. C. I., N. Y. Add 5% in the West.

The specs prove it...your best buy is



**B**  
**TV-FM SWEEP GENERATOR  
 AND MARKER #368**  
 KIT \$69.95 WIRED \$119.95

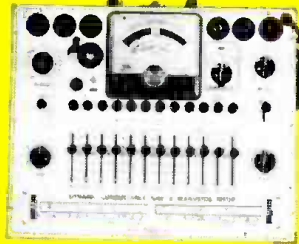

**A**  
**DYNAMIC CONDUCTANCE  
 TUBE & TRANSISTOR  
 TESTER #666**  
 KIT \$69.95 WIRED \$109.95  
 Complete with steel cover & handle

**RF SIGNAL GENERATOR #324**  
 KIT \$26.95 WIRED \$39.95



**E**  
**COLOR & MONOCHROME  
 DC TO 5 MC LAB & TV  
 5" OSCILLOSCOPE #460**  
 KIT \$79.95 WIRED \$129.50  
**5" PUSH-PULL  
 Oscilloscope #425:**  
 Kit \$44.95 Wired \$79.95

**D**  
**PEAK-TO-PEAK  
 VTVM #232 &  
 UNIPROBE (pat. pend)**  
 KIT \$29.95  
 WIRED \$49.95

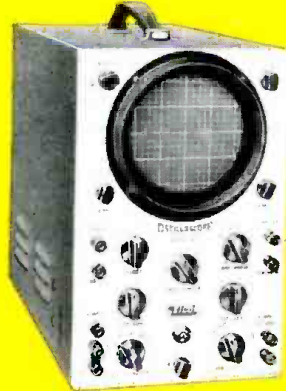

Tests all receiving tubes (picture tubes with adapter), n-p-n and p-n-p transistors. Composite indication of Gm, Gp & peak emission. Simultaneous selection of any one of 4 combinations of 3 plate voltages, 3 screen voltages, 3 ranges of continuously variable grid voltage (with 5% accurate pot.). Sensitive 200 ua meter. 10 six-position lever switches: freepoint connection of each tube pin. 10 pushbuttons: rapid insert of any tube element in leakage test circuit. Direct reading of inter-element leakage in ohms. New gear-driven rollchart. CRA Adapter \$4.50.

Entirely electronic sweep circuit with accurately-biased inductor for excellent linearity. Extremely flat RF output. Exceptional tuning accuracy. Hum and leakage eliminated. 5 fund. sweep ranges: 3-216 mc. Variable marker range: 2-75 mc

in 3 fund. bands, 60-225 mc on harmonic band. 4.5 xtal marker osc., xtal supplied. Ext. marker provision. Attenuators: Marker Size, RF Fine, RF Coarse (4-step decade). Narrow range phasing control for accurate alignment.

150 kc to 435 mc with ONE generator in 6 fund. bands and 1 harmonic band!  $\pm 1.5\%$  freq. accuracy. Colpitts RF osc. directly plate-modulated by K-follower for improved mod. Variable depth of int. mod. 0-50% by 400 cps Colpitts osc. Variable gain ext. mod. amplifier: only 3.0 v needed for 30% mod. Turret-mounted, slug-tuned coils for max. accuracy. Fine and Coarse (3-step) RF attenuators. RF output 100,000 uv, AF output to 10 v.

Uni-Probe — exclusive with EICO — only 1 probe performs all functions: half-turn of probe tip selects DC or AC-Ohms. Calibration without re-

moving from cabinet. Measure directly p-p voltage of complex & sine waves: 0-4, 14, 42, 140, 420, 1400, 4200. DC/RMS sine volts: 0-1.5, 5, 15, 50, 150, 500, 1500 (up to 30,000 v. with HVP probe. & 250 mc with PRF probe). Ohms: 0.2 ohms to 1000 megs.  $4\frac{1}{2}$ " meter, can't-burn-out circuit. 7 non-skip ranges on every function. Zero center.

Features DC amplifiers! Flat from DC to 4.5 mc, usable to 10 mc. Vert. Sens.: 25 mv/in.; input Z 3 megs; direct-coupled & push-pull throughput. 4-step freq.-compensated attenuator up to 1000:1. Sweep: perfectly linear 10 cps — 100 kc (ext. cap. for range to 1 cps). Pre-set TV V & H positions. Auto sync. lim. & amp. Direct or cap. coupling; bal. or unbal. inputs; edge-lit engraved lucite screen with dimmer control; plus many more outstanding features.

FREE CATALOG shows you HOW TO SAVE 50% on 65 models of top quality professional test equipment. MAIL COUPON NOW!



**New Transistor  
 Portable Radio RA-6**  
 Kit \$29.95  
 Wired \$49.95  
 Incl. F.E.T.; less 9V batt.  
 Prealigned RF, IF  
 xfms; push-pull  
 audio; 6" spkr.



**NEW Power & Bias  
 Supply for  
 Transistorized  
 Eqpt. = 1020**  
 Kit \$19.95  
 Wired \$27.95



**NEW Tube &  
 CRT Fil.  
 Tester = 612**  
 Kit \$3.95  
 Wired \$5.95  
 Fast-checks  
 radio/TV tubes,  
 pilot lamps, etc.



**Series/Parallel  
 R-C Combination  
 Box = 1140**  
 Kit \$13.95  
 Wired \$19.95



**Tube Tester = 625**  
 Kit \$34.95  
 Wired \$49.95  
 • tests 600 mil  
 series string type  
 tubes  
 • illuminated  
 roll-chart  
 Pix Tube Test  
 Adapter..... \$4.50



**6V & 12V Battery  
 Eliminator  
 & Charger = 1050**  
 Kit \$29.95  
 Wired \$38.95  
 Extra-filtered for  
 transistor equip.  
 = 1060 Kit \$38.95  
 Wired \$47.95



**20,000 Ohms/Volt  
 V-O-M = 565**  
 Kit \$24.95  
 Wired \$29.95  
**1000 Ohms/Volt  
 V-O-M = 536**  
 Kit \$12.90  
 Wired \$14.90



33-00 Northern Blvd. L.I.C. 1, N.Y.  
 Add 5% in the West. © 1959

TURN PAGE FOR MORE EICO VALUES



**R-C Bridge & R-C-L  
 Comparator = 950B**  
 Kit \$19.95  
 Wired \$29.95  
 Reads 0.5 ohms-  
 500 megs,  
 10 mmfd-5000 mfd,  
 power factor



**VTVM Probes**

	Kit	Wired
Peak-to-Peak	\$4.95	\$6.95
RF	\$3.75	\$4.95
High Voltage Probe-1		\$6.95
High Voltage Probe-2		\$4.95
Scope Probes		
Demodulator	\$3.75	\$5.75
Direct	\$2.75	\$3.95
Low Capacity	\$3.75	\$5.75

EICO  
 33-00 Northern Blvd.  
 L. I. C. 1, N. Y.

R-10

Show me HOW TO SAVE 50% on  Test Instruments  
 Hi-Fi  Ham Gear.  Send free Stereo Hi-Fi  
 Guide. Send me FREE Catalog, name of neighborhood  
 dealer.

Name \_\_\_\_\_  
 Address \_\_\_\_\_  
 City \_\_\_\_\_ Zone \_\_\_\_\_ State \_\_\_\_\_



**O**UR AUDITORY WORLD is an amazingly complex series of concentric spheres. The head occupies the center and seems, for the most part, to be stationary while sound emitters shift and recede and crisscross around us (Fig. 1). The problem of how to locate and track a single moving sound source, or even several simultaneous sound sources, has been met and solved by nature in a variety of ways. The insect, the bat, the porpoise, and man have each worked out special compromises—some more successful than others.

The chief function of the ears of primitive vertebrates was certainly direction-finding. To promote this function the ear's frequency sensitivity had to go far beyond the low-frequency hearing of reptiles, and evolve "directional antennas" and the muscles for directing these "antennas" both together and, to some extent, independently. This improved direction-finding is at the expense of time so that the

eye, at least in the primate, evolved simultaneously into an instrument with an elaborate oculo-motor system for target tracking. We thus have, in the human, the equivalent of an omnidirectional search radar (the ear) and the extremely directional fire-control radar (the eye). See Fig. 2.

Once our ears have put our eyes "on target" they can pretty well be dispensed with and, in fact, the high-frequency-range capabilities and the large mobile outer ear parts of the lower animals are disappearing rather rapidly—as such things go. We no longer boast the exquisite hearing in the higher octaves—enjoyed by the dog and the cat—nor are we independent of our eyes for ordinary locomotion.

Despite these evolutionary changes, a great deal of "liveness" and three-dimensionality exist in our auditory world. Much has been done in recent years to exploit these advantages. Applications have even outstripped theory in this case since the stereophonic en-

#### ABOUT THE AUTHOR

DR. HARRIS received his Ph.D. in physiological psychology from the University of Rochester in 1942. Since 1943 he has headed the Auditory Research Branch of the U. S. Naval Medical Research Laboratory. He is co-founder and director of research of the C. W. Shilling Auditory Research Center, Inc. of Groton, Conn., a private non-profit organization devoted to scholarship and research in the field of hearing. Dr. Harris is the author of the book *Some Relations Between Vision and Audition* as well as of more than 75 articles, chapters, and monographs on all aspects of hearing.

# ILLUSION

By **J. DONALD HARRIS, Ph.D.**  
U. S. Naval Medical Research Laboratory

**A psycho-acoustician examines stereo and explains how the illusion is re-created for the listener.**

gineers have accomplished remarkable things with multiple microphones and speaker arrays. On the other hand, scientists have had to content themselves with a single stationary sound source and have even had to resort to the artificiality of earphone listening. To date no psycho-acoustic laboratory has developed the essential array of moving multiple sound sources in a large anechoic chamber nor devised the required servo systems and X-Y recorders to program and record the stimuli and the subject's response. One can only anticipate such reasearch for the next decade or two.

Nevertheless, a unique and even exciting chapter in psycho-acoustics embraces a number of interesting discoveries regarding the directionality of human hearing, the relative importance of the several possible "cues" for directionality, the conditions under which directionally may be improved, and mathematical-statistical models of binaural hearing.

### Two Ears Better than One?

The first question that must be resolved is whether two ears are really better than one. The answer, for all practical purposes, is *negative* for almost all aspects of hearing except



Fig. 2. Our ears serve as search radar, our eyes as fire-control radar.

directionality. For contact detection or sensory discrimination any improvement of the binaural combination over the monaural involves only a decibel or two—a negligible percentage. For localization of sounds in space, however, the monaural mode has almost nothing to recommend it. Whether one is judging distance to a sound source or angular direction, a second ear is almost indispensable. Probably the best confirmation for this statement involves tests made with bats. While normal bats will be able to avoid wires strung around a room up to 76% of the time, bats with one ear covered, however, have an avoidance record of 38-41%—35%, in this case, being due to chance alone.

One asks, then, how does this come about? Both ears hear the same thing so how can the same information, being 100% redundant, fed into the second ear, add what amounts to *new* information on the basis of which we can make further and remarkably precise judgments?

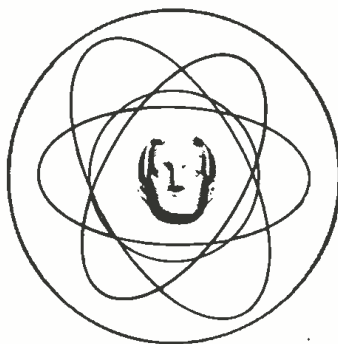

Fig. 1. We all live in an auditory world made up of concentric spheres.

The secret is that when one takes not a first but second look at the information reaching the two eardrums at any moment in time, the acoustic signals can usually be shown to be markedly different in their "hyperfine" details.

The temporal (or time determining) characteristics of the ear, its frequency and intensity handling capacities, and the layout of its nervous system are admirably adapted to make a distinction on the basis of just those hyperfine details by which the two acoustic signals differ. By "make a distinction", we mean that the mechanical construction of the ear itself does not blur any of the features of the acoustic signal but passes them on, transformed, to the auditory nerve where they are again transformed (neural coding), sent upward to the brain, and decoded, with surpassing exactitude, into sensation.

### Temporal Characteristics

Let us first consider the temporal characteristics (time of arrival and phase) of the peripheral organ of hearing. If one presents a series of clicks to the ear, they do not merge into a continuous tone until the repetition rate reaches many hundreds per second. Contrast this phenomenon with the eye, where the critical flicker frequency is something under 50 per second—a relatively slow-acting unit. But the ear is not a biochemical system with slow time-constants like the eye—it is a mechano-hydro-electrical system with almost critical damping. (It is of course true that several distinguishable d.c. and a.c. components within the cochlea—or inner ear—are maintained by bio-chemical-metabolic equations, but the stimulation of the auditory nerve fibers is true electrical stimulation, generated by the hair cells within the inner ear.)

Only by keeping in mind the very fast-acting nature of the peripheral organ of hearing can one believe the almost incredible performance revealed by laboratory tests. If one keeps all other physical parameters constant except the time of arrival at the eardrums of a short burst of noise, the subject can detect a difference in arrival time of as little as *6 millionths of a second*. Evidently the end-organ and its associated nervous system carry and transform time patterns with great fidelity—certainly with sufficient fidelity to provide an accurate sense

of direction on the basis of time of arrival of the stimulus at the two ears.

Let us assume, for easy calculation, that sound travels one foot per millisecond. In .00001 second it will travel .01 foot. In this case a sound source would have to be off the mid line by only a few degrees for one to sense, by the time-of-arrival cue alone, that the sound was not, in fact, in the median plane. (See Fig. 3.) This cue can apply, of course, only to discontinuous sounds.

Note, however, that with a continuous pure tone another correlated cue is present, namely, time of arrival at the eardrums of a particular point in the phase. In this case the ears are sensitive to differences in phase at the eardrums at any moment in time. If one varies the phase (or inserts a time delay, which is the same thing) in one arm of a pure tone which is split and led to the two drums, one has the illusion of the sound moving back and forth between the two ears. Judgments of the (illusory) "sidedness", in degrees off the mid line of the tone, correspond surprisingly well to the actual geometry of a point source and an imaginary line between the ears where the geometry would, under actual acoustic conditions, produce the phase difference generated electronically. A lead or lag by 100 microseconds of a peak at one ear usually permits a clear judgment of "off mid line". (See Fig. 4.)

Phase relations as a localization cue in nature have, of course, a serious limitation where the distance between the two ears equals one wavelength. Here the peak-to-peak times of arrival are identical and non-informative. This is more apt to occur at high frequencies and with small heads. This is why the bat has abandoned continuous tones and emits, instead, a series of heavily frequency-modulated and extremely brief tones, thus utilizing frequency differences and times of arrival rather than phase for localization purposes.

### Intensity Capacities

Let us now consider the intensity handling capacities of the ear and the possible intensity cues to localization.

Of course, if the head is turned away from a sound source there will be a difference in intensity depending on the sound decay over the distance, but the cue is not a simple one even with the immobile pinna (outer ear parts)

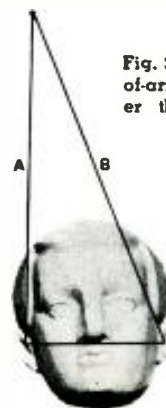
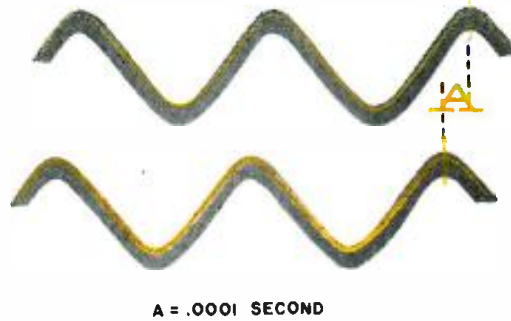

Fig. 3. Our ears can tell time-of-arrival differences briefer than ten microseconds.

B - A = .00001 SECOND

Fig. 4. The human ear is very sensitive to phase differences below about 1500 cps. A lead or lag by 100  $\mu$ sec. of a peak at one ear usually permits a clear judgment of "off mid line" mode.



of the human. The lower frequencies tend to bend around the head so that the sound "shadow" cast by the head introduces a relative bass-boost to the spectrum reaching the farther ear. (See Fig. 5.) Also, there are reinforcements and interferences brought into play by the configuration of the head and pinna. Note that the sensitivity of each ear *by itself* varies with the direction of the sound. The binaural condition must compensate for these differences. In animals with moving pinnae, these variations are probably magnified quite deliberately and used to provide further information.

A quick calculation will show that the intensity differences arising from movements of the head (or, what amounts to the same thing—moving the source off mid line) are much greater through many octaves than the differential loudness discrimination available to the average human ear. An 800-cps tone from one side casts an 8 db "shadow" on the opposite ear, while errors of mid-line localization can be quite negligible on the basis of the 0.5 db discrimination possessed by many individuals.

It is necessary to emphasize what we have stated previously that two distinct mechanisms underlie our sense of directionality—and these in different frequency regions. A graph showing the minimum audible angle, in degrees, to which the average head is sensitive in the median plane reveals a broad minimum at about 1 degree between 250 and 1000 cps and a rapid rise above 1000 cps to a maximum of about 3 degrees at approximately 1500 cps. For these lower frequencies, temporal characteristics (time of arrival, phase) underlie performance. Above 1500 cps, the minimum audible angle in the median plane fluctuates around 2 to 3 degrees up to 10,000 cps. For these higher frequencies the localization cue is provided by intensity differences (the sound "shadow").

When the minimum audible angle is measured for sound arriving at the head at an angle 45 degrees off the mid line, performance is generally similar to the mid-line condition but 1 to 2 degrees worse, up to about 1500 cps. But for higher frequencies, where in-

tensity cues come into play, performance deteriorates so sharply that a very inefficient minimum audible angle of 10 degrees exists at 3000-4000 cps while directionality is, for all practical purposes, completely lost at 7000 cps and above.

Evidently the relations among head size, head shape, and wavelength are not such as to make intensity cues very useful in anything but the symmetrical mid-line condition. This fact must be considered when placing microphones and speakers to create the stereo illusion.

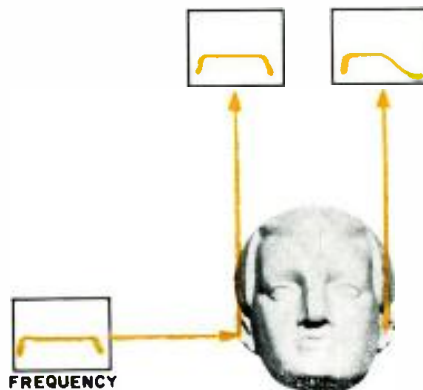
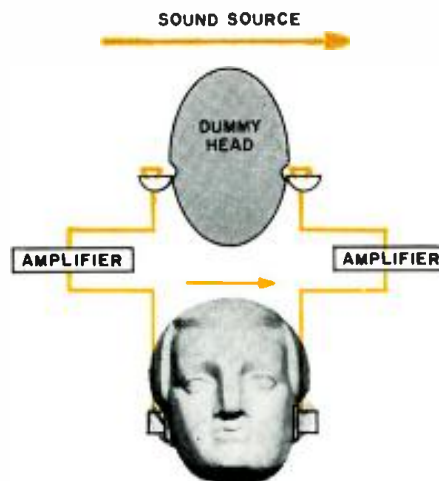

Fig. 5. The head casts a sound shadow that attenuates the higher frequencies.

Fig. 6. The stereo illusion in pure form employs two microphones in a dummy head.



To provide the strongest possible stereo illusion it is only necessary to re-create in a pair of ears, by any convenient means, the time and intensity conditions generated at a point in space by an actual sound source.

#### Re-creating the Illusion

Probably the most compelling illusion of a wide-azimuth sound, or of a moving sound source, is created by placing two omni-directional microphones in the simulated ear canals of a dummy head and recording the output on dual-channel tapes. This program material is then fed to two ear-phones. (See Fig. 6.) Here all cues heard by the ultimate listener are as if his head were in the position occupied by the dummy head and the illusion is complete.

If playback is to be through loudspeakers, other considerations are involved. The original recording studio and the listening room must exhibit certain basic similarities. The speakers must not be too far off mid line in relation to the listener. They must be matched closely in phase and the two channels must be symmetrical to within a few microseconds in time delay.

Fortunately, these rather stringent conditions need not be met 100 per-cent in order to create a satisfactory illusion. A considerable blurring can be tolerated without destroying the illusion and, of course, the two ears will always appreciate the added "liveness" and volume provided by the second channel. But it is very easy to mistake "liveness" and volume for true stereo illusion—which once heard in all its purity is an unforgettable experience.

This blurring can be studied in the anechoic chamber. If one places two microphones four inches apart then records a wide-azimuth sound, when replayed through a two-speaker array there will be a cube (about one foot on a side) where one can "immerse" the head and experience the stereo illusion. If the microphones are placed about a foot apart, the illusion volume will be a cube about a yard on a side. However, the illusion on the fringes of the cube loses some of its force—rather soon one encounters diminishing returns and the reasons are not hard to

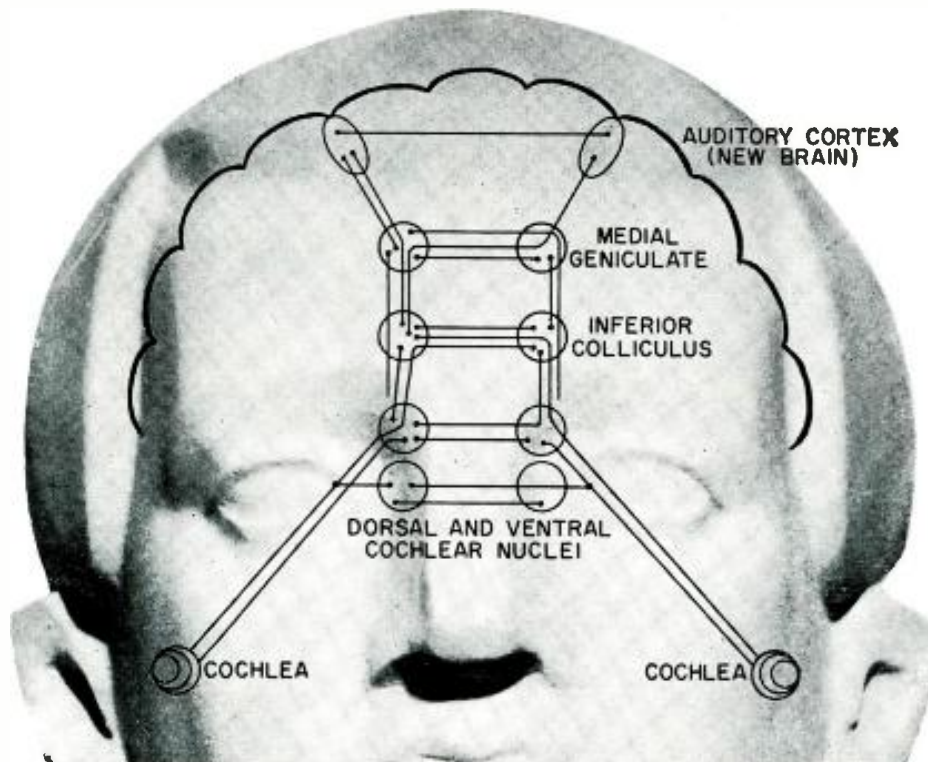

Fig. 7. Some connections in the ascending pathways of the auditory nervous system.

pinpoint. If the phase relations for tones 1500 cps and below, which finally reach the ear by way of the speakers, are not at all those which the ears would hear if immersed in the original sound, there is no reason to expect to re-create the exact illusion. The most one could expect would be a "diffuseness" to the sound so that it might be hard to say, if blindfolded, just where the sound source is in the room. And indeed this is about all that some systems and recordings achieve. It is not necessary, however, to be satisfied with this extension of simple monaural principles.

To the auditory scientist, of course, the compelling question is not how one shall create the stereophonic illusion but how is it possible that the binaural auditory system can be so extremely sensitive to temporal and intensive patterns. After all, the speed of the nervous impulse and delays in neurone-to-neurone connections are on the order of milliseconds—how then can the ears be sensitive to differences on the order of microseconds?

#### Auditory Nervous System

The answer to this question seems to lie in the layout of the auditory nervous system. (See Fig. 7.) The inner ear, though coiled, can be considered unrolled as a piano harp with a regular progression from the high frequencies to the low. The hair cells in this progression attach to and "trigger" the individual auditory nerve fibers. This impulse travels by several "relay stages" to the cortex, or new brain. Unlike a telephone wire through a switchboard, these fibers do not go straight to the cortex. They emerge from the cochlea and go a few millimeters to the brain stem where each

nerve fiber splits and sends one fibril to the dorsal and one to the ventral cochlear nucleus. At this point some of the fibers terminate on another fiber (the juncture, called a "synapse," introduces a time delay) whereupon that fiber goes up the brain stem. On the other hand, some of the fibers from the cochlea continue straight through the dorsal and ventral nuclei with no synaptic delay and proceed up the brain stem.

Note that we are by no means up to the cortex at this point. It is very important to understand that some fibers at the level of the first nucleus cross over to the other side so that even at the first "relay" station we have the possibility of inter-aural effects.

Now the crossed and uncrossed fibers, some synaptically delayed and some not, go up the brain stem to another left-right pair of nuclei called the "colliculi." Here, again, in each colliculus we have three possibilities. A "relay" can cross from the other side, or can go to the other side, and the colliculus can be bypassed by a fiber going straight through to the geniculate body in the mid-brain, just below the cortex.

What we have here is an ideal system for a comparison of stimuli impinging on the two ears. The opportunity for comparing the inputs to the two ears is good—so much so that the neural representation from the left ear is actually greater on the *right* side of the nervous system. There are not just a few fibers which cross. Furthermore the system is not analogous to the visual nervous system where 50 per-cent of the fibers also cross. There, the retina is divided into left and right halves, the fibers from the nasal half

of each eye crossing in the optic chiasma—the fibers from the temporal half going back, uncrossed, to the visual cortex. But this is a simple and uncomplicated layout compared to the "relay" systems, "delay lines," and "switchboard" opportunities in hearing.

For the mathematically minded, the ladder system as we see it here allows for two types of correlation. First a running auto-correlation of one ear on itself. Built-in "delay lines" at the synapses and arising from different fiber lengths make this possible—from a single half-millisecond click we may have nerve impulses reaching a "switchboard" over a period of 5, 10, or 20 milliseconds. Thus a multiple look can be had, within each of several successive "switchboards," at a single monaural input.

How much more, then, is the opportunity laid down for a second type of correlation—a running correlation between the two ears. At every "station" from the brain stem to the cortex a multiplex and indeed superb look can be had of the two inputs simultaneously. It is in the course of these repeated observations that the nervous system shapes and refines the binaural sensation.

Opening a "second ear" to the world results in a dramatic sharpening of auditory experience and in worthwhile improvement in orientation and naturalness. We have seen how this is made possible on the basis of time and intensity cues, with a nervous system designed, as if by a superb architect, for the full utilization of those cues. Future electro-acoustic systems will undoubtedly exploit to the full these capabilities of our binaural sense.



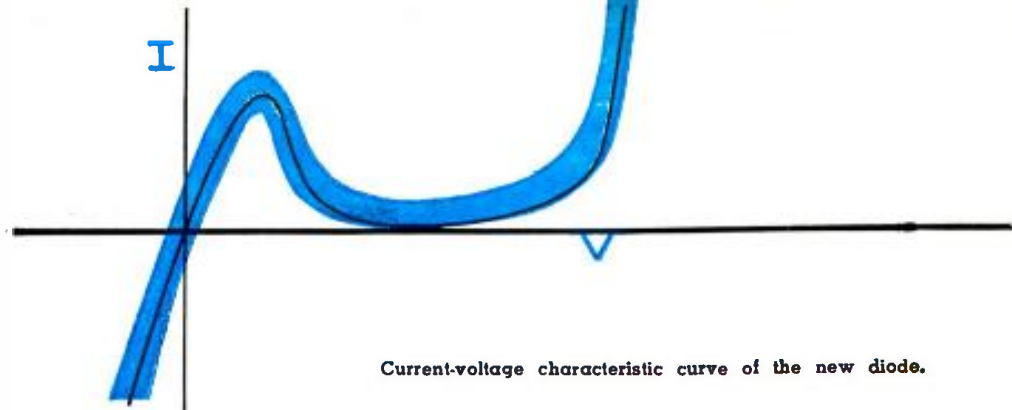

Current-voltage characteristic curve of the new diode.

# “Tunnel Diodes”

## EXPERIMENTAL SEMICONDUCTORS

**Insensitive to temperature changes and 100 times faster than today's transistors, these devices bear watching.**

**T**HE newest “baby” in the fast-growing family of semiconductor devices—the “tunnel diode”—is coming of age. The new device, first reported in 1958 by Japanese scientist Leo Esaki, is closer to commercial application as a result of intensive research programs at G-E and other companies. The special diode is a heavily doped junction semiconductor that has a negative-resistance characteristic over part of its operating range (see the graph above).

The tunnel diode takes its name from the physical phenomenon that makes it possible: “quantum-mechanical tunneling.” The term is used to describe the manner in which the electrical charges move through the device. Such motion takes place with the speed of light, in contrast to the relatively slow motion of electrical charge carriers in transistors. These high speeds make it possible for the device to operate at extremely high frequencies. Oscillation higher than 2000 mc. has already been obtained and frequencies of more than 10,000 mc. are expected in the near future.

This high-speed response also suggests applications in

computers. When used as switches, tunnel diodes have functioned in a fraction of a millimicrosecond—from 10 to 100 times faster than the fastest transistor now available.

The device also resists the damaging effects of nuclear radiation. Because it is less dependent on the structural perfection of its crystal than is the transistor, it is much less affected by the damage that radiation can do to such crystal structures. In this respect it outranks transistors by more than 1000 to 1. Materials used for tunnel diodes include silicon, germanium, gallium arsenide, gallium antimonide, and indium antimonide. Silicon tunnel diodes work at temperatures 250°F higher than temperatures at which conventional silicon diodes and transistors operate.

The negative-resistance characteristic allows the unit to be used as an amplifier, a generator of r.f. power, and a switching device. Its simplicity makes possible the development of integrated circuits. It is superior to vacuum tubes and transistors for applications in low-noise amplifiers and mixers for high frequencies. Many parametric amplifier jobs, for example, could be performed more easily with tunnel diodes.

G-E now has plans to offer limited quantities of experimental samples in the next few months.

—50—



Vest-pocket transmitter, making use of a tunnel diode, and with a range of about one-half mile, is demonstrated by G-E scientists. At left, Dr. Guy Suits, G-E vice-president and director of research, speaks into microphone, while Dr. Jerome Tiemann holds the transmitter. In foreground, ordinary FM receiver picks up signal.

A complete tunnel diode transmitter is compared in size with a 50-cent piece. The transmitter consists of one variable and two fixed ceramic capacitors, a coil that tunes to the operating frequency—which may be higher than 2000 mc.—and the diode itself, located inside the “can” in the center of the device. Battery is not shown.

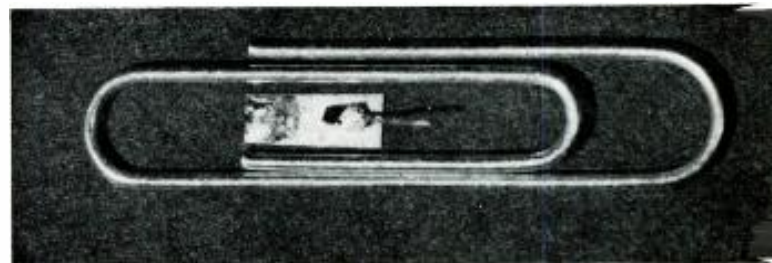

▲Nestled inside a paper clip, a tunnel diode is shown in close-up view. Connecting wire leads to alloy soldered to germanium crystal which is soldered to metal plate.



# Tape Recorder Conversion Chart

With the adoption of 4-track, 7.5 ips pre-recorded tapes, many of our readers are interested in knowing whether or not their present stereo recorders can be converted to accommodate the new heads. In order that our readers could obtain this information regarding their specific units, we queried a large number of makers of tape recorders. Those companies listed below have answered our questionnaire on their tape recorders and indicated their willingness for us to include such information in this tabulation. Many recent models made by the following manufacturers and other manufacturers not listed are already equipped for 4-track tape. These are not included in our list.

COMPANY NAME & ADDRESS	RECORDER TRADENAME	MODEL NUMBER	CONVERSION RECOMMENDED?	COMPANY KIT?	OTHER KIT?
Allied Radio Corp. Chicago 80, Ill.	Knight	176	Yes, when outboard play- back arrange- ment is used	No	Nortronics Model SK-50
		177			
		635			
		675			
		KN-4001			
		KN-4010			
American Concertone Div. Culver City, Calif.	Concertone	20	No	Yes	
		30	No	Yes	
		60	No	No	
		Mark 7	No	No	
		BRX	No	Yes	
Ampex Audio, Inc. Sunnyvale, Calif.	Ampex	A-121	Yes	Yes	Ampex -101- 102
		A-122	Yes	Yes	
Bell Sound Division Columbus, Ohio	Bell	T-201	Yes	Yes	Bell BTK- 200
		T-202	Yes	Yes	
		T-203	Yes	Yes	Bell BTK- 210
		T-211	Yes	Yes	
		T-212	Yes	Yes	
		T-213	Yes	Yes	
Bogen-Presto Co. Paramus, N.J.	Presto	800	No	No	
Broadcast Equipment Specialties Corp. Beacon, N.Y.		Tapak	No	No	
		Pocketape	No	No	
Electronic Applica- tions, Inc. Stamford, Conn.	Revox	B-36-2K2	No		
		C-36-2K2	No		
Ercona Corp. New York 36, N.Y.	Ferrograph	3/Series	No	No	
		88	Yes	Yes	
Heath Company Benton Harbor, Mich.	Heathkit	TR-1C	No	No	{ Available soon MK-5
		TR-1D	Yes		
		TR-1A	Yes		
International Radio & Electronics Corp. Elkhart, Ind.	Crown	See Note 1			
L.E.E. Incorporated Washington, D.C.	Century 21	2100 Series	Yes	Yes	
Magnecord Tulsa, Okla.		Series 100	Some ap- plications	Yes	
North American Philips Co., Inc. Hicksville, N.Y.	Norelco "Continental"	EL3516G	No	No	
		EL3516G/53	No	No	

COMPANY NAME & ADDRESS	RECORDER TRADENAME	MODEL NUMBER	CONVERSION RECOMMENDED?	COMPANY KIT?	OTHER KIT?
Pentron Corp. Chicago 24, Ill.			No (See Note 4)		
Rangertone, Inc. Newark 4, N.J.		Rangerette DC5	No (See Note 5) No (See Note 5)	To order To order	
Roberts Electronics, Inc. Los Angeles 38, Calif.		90-C	Yes	Yes	
Stancil-Hoffman Corp. Hollywood, Calif.		R5	Yes	Yes	
Steelman Phonograph and Radio Co., Inc. Mount Vernon, N.Y.	Transitape	7111	No	No	
Superscope, Inc. Sun Valley, Calif.	Sony Sterecorder	555 555-A	Yes Yes	Yes Yes	
Symphonic Radio & Electronic Corp. New Brunswick, N.J.		BR1200 300	No No	No No	
Tandberg of America Pelham, N.Y.		3B 3BF 3-Stereo	Yes Yes Yes		Yes Model 5 TK 4529 consist- ing of 529 4-track head and stereo preamp
Viking of Minneapolis Minneapolis, Minn.		75 Series	Yes		New head required
V-M Corporation Benton Harbor, Mich.	tape-o-matic	714	Yes	Yes	
Warwick Mfg. Corp. Chicago 48, Ill.		9072 9074 9076	No No No	No No No	
Webcor, Inc. Chicago, Ill.		2821 } 2822 } 2827 } ED 2950 } EP 2820 }	See Note 2		
Wellensak Optical Co. Chicago, Ill.		1500 1515	Yes Yes	No No	Nortronics Nortronics

NOTE 1: The company advises that they do recommend conversion to the four-track mode but only if the conversions are made at the factory. No record heads are sold without the corresponding record/play preamplifier and each head is slightly different in response and in the amount of bias it needs. In order to maintain and guarantee the standard of response, each and every machine is individually inspected and adjusted at all frequencies and at all speeds. Conversions will be performed ONLY at the factory.

NOTE 2: According to the company's Engineering Department, conversion of these three models ("Imperial," "Royal Coronet," and "Royal") is impractical because of the complicated head bridge construction that is employed.

NOTE 3: With these two models conversion is possible when performed by a skilled service technician but is not recommended for the following reasons: New head bridge assembly required, the mounting of which would call for a 5/8" dia. hole to be drilled through the mechanism chassis without injury to the capstan flywheel which is mounted directly

below hole location. Extreme care would be required to avoid having chips fall into mechanism during drilling; the plastic head cover would have to be replaced by one with a hole for knob with appropriate markings; the new 4-track heads employ high-impedance bias whereas the earlier 2-track heads used a separate low-impedance bias winding. This would call for extensive modification of the printed circuitry, while the bias requirement does not affect playback, it is necessary for recording. Accurate setting of the heads both as to height and azimuth alignment, an operation which would require test tapes of both 4-track and 2-track test material, is required.

NOTE 4: According to this manufacturer, their recorders have had compatible two track-four track heads for over a year and they have no conversion kits available for older models. They feel that these would be traded rather than converted by most persons.

NOTE 5: This manufacturer makes tape recorders primarily for motion picture sound and they feel it is not usually wise to consider two-directional recording because of editing.

# POWER

## Power Output Ratings for Hi-Fi Amplifiers

By VICTOR ROBINSON

Chief Eng., PACO Electronics Co., Inc.

The meaning and measurement of steady-state, peak, and music power along with discussion of power-bandwidth.

One of the first steps the prospective purchaser of a hi-fi amplifier undertakes is a comparison of advertised power output ratings. It becomes immediately obvious to him that the higher-priced amplifiers are almost invariably associated with higher output ratings and although there may be a number of apparent irregularities in a "graph" of power output vs selling price, the prospective buyer can be quite sure that more watts in any manufacturer's amplifier line will mean more dollars.

The answer to the question "How much output power do I really need?" is complex and involves many factors such as speaker efficiency, room acoustics and size, and maximum permissible distortion. Before any of these more refined considerations can be tackled, the apparently simple wattage specification must be examined and defined, inasmuch as several types of wattage rating expressions are currently being employed by amplifier manufacturers in their advertised specifications.

Any power-output rating must have an implied or stated relationship to a distortion rating. A 20-watt rating for an amplifier carries within itself a distortion limit even if this limit is not clearly defined in the manufacturer's specifications. If a distortion limit is listed, for example, as "no greater than 1% total harmonic distortion" and power is listed as "20 watts," it can be expected that as a standard test signal at the input of the amplifier is increased, the graphical crossover point between rising power and rising distortion will be reached at 1% distortion and 20 watts of output power.

This point is an important one inasmuch as relatively low-priced amplifiers can show a considerable power advantage if the distortion limit is specified a bit higher than the figure usually expected. This condition exists in this price class of amplifiers wherein little negative feedback may be employed, producing a gently sloping power vs distortion characteristic. Medium- and higher-priced amplifiers, however, usually use appreciable inverse feedback, resulting in a sharp rise in distortion above 1% or 2%. Little advantage is gained here if the maximum distortion limit is specified a bit higher.

When making tests for power output, a non-inductive output load resistance must be substituted for the loudspeaker. This condition for test eliminates the complications which would be introduced by the varied impedance vs frequency characteristics of speakers and the various efficiencies and characteristics of speaker systems.

With these thoughts in mind, we can proceed to discuss the four types of expressions for output power commonly used: 1. steady-state (r.m.s.) power; 2. "peak" power; 3. music power (often referred to as music waveform power output, or "music waveforms," or "program material" power, or "short bursts" power), and 4. power-bandwidth output.

### Steady-State Power Output

This may be defined as "the power output measured across the load resistor at the output of an amplifier with 1000-cps sine-wave signal im-

pressed at the input of the amplifier." This type of test reveals the power capabilities at 1000 cps only; it does not reveal the performance at either the high- or low-frequency ends. It does subject the amplifier to a relatively heavy duty test cycle because of the fact that a sine-wave cycle has a heavier duty characteristic as compared to the more pulse-like character of music or other types of program material. Because of this latter factor and the fact that this type of test can be easily duplicated through use of a sine-wave generator, a.c. voltmeter, distortion analyzer, or scope, the steady-state output specification is used fairly universally and is considered quite revealing.

A typical test setup for measuring steady-state power output is shown in Fig. 1.

If the amplifier includes bass and treble controls, these controls are set to the "flat" positions. The signal is increased to the point just below the level wherein clipping begins to occur. By using  $P = E^2/R$ , the power can be calculated from the voltage reading or by use of the graph shown in Fig. 2. To be as fair as possible to both the amplifier manufacturer and to the amplifier owner, the line voltage should be checked and set, if necessary, to the standard value of 117 volts.

This scope method for checking steady-state power output can be used only to determine *maximum* output values. If power output tests at lower distortion points are desired, a distortion analyzer must be used in place of the scope.

It is important to note that if the

Fig. 1. The test-equipment that may be used to measure the output power of a high-fidelity amplifier.

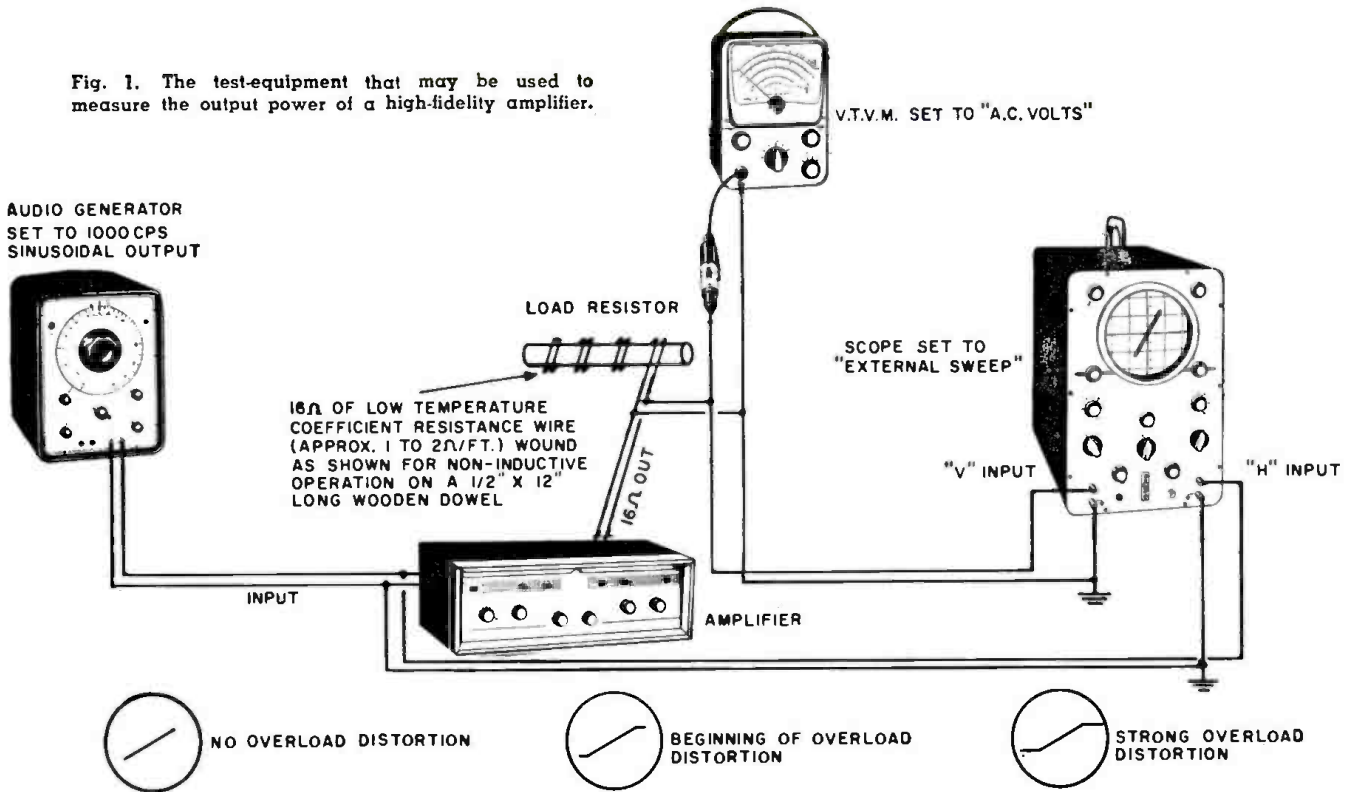

amplifier spec sheet simply lists "power output" as "10 watts" or "20 watts" and does not further describe the "type" of watts, it can be assumed that the manufacturer is talking about "steady-state (based on r.m.s. values of voltage and current) watts."

### Peak-Power Output

This expression in no way relates to the concept of peaks of program material. It is merely a convenient mathematical conversion of r.m.s. power to the a.c. expression for peak of root-mean-square (r.m.s.). This conversion reveals that for a sine-wave signal  $Peak\ Power = 2 \times r.m.s.\ Power$ , derived as follows:

$$P_{rms} = \frac{E_{rms}^2}{R}, \text{ also } 1.414 \times E_{rms} = E_{peak}$$

$$E_{peak} \text{ or } \sqrt{2} \times E_{rms} = E_{peak}$$

$$P_{rms} = \frac{E_{rms} \times E_{rms}}{R}$$

$$P_{peak} = \frac{\sqrt{2} \times E_{rms} \times \sqrt{2} \times E_{rms}}{R}$$

$$P_{peak} = \frac{\sqrt{2} \times \sqrt{2} \times E_{rms}^2}{R}$$

$$P_{peak} = \frac{2E_{rms}^2}{R} = 2 \left( \frac{E_{rms}^2}{R} \right)$$

Therefore:  $P_{peak} = 2 \times P_{rms}$

Steady-state (r.m.s.) power can be conveniently measured and compared. Peak power *could* be measured through use of peak-indicating voltmeters, but it is somewhat easier to obtain peak power simply by multiplying r.m.s. power by 2. For practical purposes, "peak power" is not significant in evaluating amplifier performance. It is unfortunate that the term "peak" in

this commonly used expression infers a "maximum" rating, *apparently* relating to peak *program* conditions, when actually such is not the case.

### Music Power Output

In an attempt to standardize on a power output rating which bears a reasonable relationship to an ampli-

Fig. 2. The graph at the right shows the r.m.s. voltages as read on an output meter or a v.t.v.m. for various power output levels. Values are shown for four commonly used output impedances. As an example of the use of the graph, assume you are measuring the voltage across an 8-ohm load resistor connected to the 8-ohm output terminals. If the r.m.s. voltage reading is 5 volts, the steady-state power output is just a bit over 3 watts as indicated by graph.

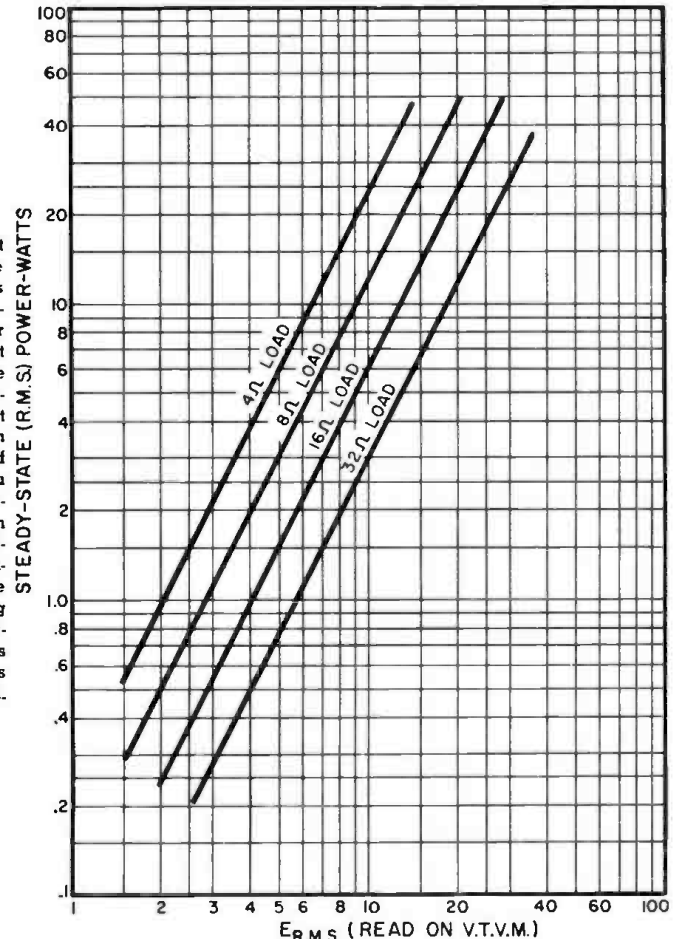

fier's capability for reproducing musical program material at high levels, the term "music power" has been developed. The term has been defined as the maximum amplifier power delivered to a resistive load as a result of applying a short-duration 1000-cps sine-wave input signal. The short-duration signal is specified to establish the requirement that output tube potentials must remain unchanged for "no-signal" conditions to "full-signal" conditions. The maximum power rating (music power) under these conditions is limited by the maximum distortion figure specified for the amplifier. The most significant aspect of these test conditions is the requirement that output tube potentials at maximum-output conditions remain up at the "no-signal" value. This requirement stems from an effort to make this "music power" spec simulate the amplification of typical music.

Because of the basic complex character of music, the *average* dynamic range of musical material is relatively low as compared to *peaks* caused by percussion instruments such as the

practically the same as the "no-signal" supply voltage.

If the program or musical peak is of very short duration, however, the energy storing capabilities of the power supply's filter capacitor maintains the tube potentials at practically "no-signal" value (light load) even in the case of poorly regulated power supplies. On *long*-duration musical peaks, however, the voltage produced by a poorly regulated power supply begins to drop, producing greater distortion at the end of the musical peak.

To make "music power" a practical yardstick, it must be assumed that most musical peaks are of *short* duration. If this assumption is acceptable, then the regulation of the power supply can be assumed to be perfect.

Inasmuch as no power supply has perfect regulation it is necessary to simulate perfect regulation in order to perform a *test* for music power. Theoretically, the test can be performed by starting with no signal and then impressing a 1000-cps signal of such short duration that it will produce no drop in tube potentials. In practice, this

the high- and low-frequency power performance of his amplifier by using the "power bandwidth" expression which is defined as "those frequencies at which the maximum 1000-cps r.m.s. power output drops to one-half its value" (all readings taken at maximum specified distortion level). For example, if the maximum r.m.s. power output (taken with a 1000-cps sine signal input) is 20 watts and drops to 10 watts as the signal frequency is lowered to 40 cps and also drops to 10 watts as the signal is increased to 10,000 cps, then the "power bandwidth" will be "40 to 10,000 cps". See Fig. 3. Although this type of specification reveals two more pertinent performance characteristics of the amplifier, it is not used by all manufacturers probably because of the possibility of misinterpretation on the part of the reader. *Frequency response* of amplifiers is usually in the range of "20 to 20,000 cps" while the *power bandwidth* spec is almost invariably narrower. Thus an advertised power bandwidth of, for example, "40 to 10,000 cps" might be confused with the frequency

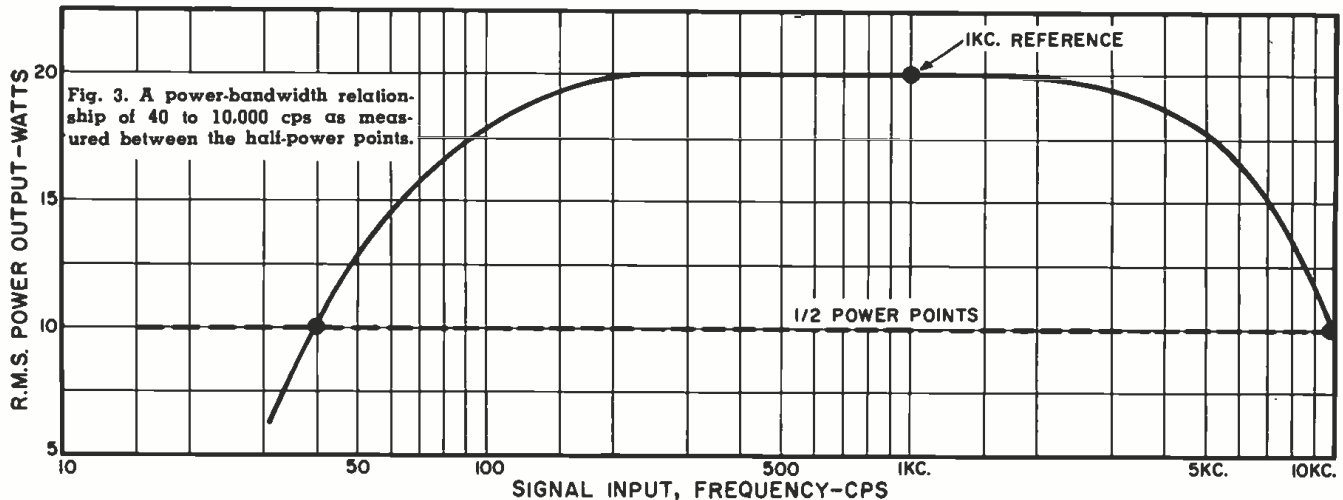

piano, xylophone, etc., for example. The amplifier power required to reproduce the *average* level is correspondingly low; *generous* power, however, is required to reproduce musical *peaks* with low distortion.

With *no* signal applied to the input of the amplifier, the plate and screen voltages of the amplifier are at "no-load" values. As soon as signal is applied, screen and plate currents increase. If the amplifier's power supply has poor regulation, the tube potentials at high signal levels (peak music waveforms) will drop considerably. This voltage drop reduces the low-distortion power capabilities during these peak musical passages and this may produce waveform clipping (distortion) resulting in "muddy" reproduction. The better the regulation of the power supply, the less the difference between "no-signal" and "peak signal" power-supply voltages and the higher the small-distortion power capabilities of the amplifier. The ideal case is achieved with near-perfect regulation, wherein the "peak-signal" power-supply voltage is

type of test is difficult to perform with standard test equipment.

For practical purposes, it is simpler to disconnect the amplifier's own power supply and connect an external power supply with controlled output to plate and screen circuits. As a 1000-cps signal of *any* duration is applied to the amplifier's input, the external power supply can be adjusted so that the tube potentials can be held to the "no-signal" values, thereby simulating perfect regulation. Power output calculations made under these conditions will then agree with the conditions set up in the definition of "music power."

#### Power Bandwidth Output

All of the three preceding power output measurements are made using a standard 1000-cps sine input signal. They obviously do not reveal the power performance at the low and high frequencies. Well engineered amplifiers with generously designed output transformers will usually produce adequate power at the frequency extremes. Occasionally a manufacturer will disclose

response in the mind of the customer.

An understanding of these power output expressions can be a help in analyzing an amplifier on the basis of the manufacturer's specifications as follows: (A) If *both* r.m.s. power *and* music power are listed, the closer the r.m.s. power approaches the music power rating, the better the power supply regulation and the better the maintenance of low distortion on extended power peaks. (B) If the r.m.s. power *only* is listed and it is *sufficiently high* for your purposes, then the value of music power becomes academic inasmuch as the r.m.s. power maximum determines the power capabilities on *extended* power peaks, and (C) if music power is listed and r.m.s. power is *not* listed, then there is a chance that the power-supply regulation may not be as good as in amplifiers which have music power ratings close to the r.m.s. power rating, unless further examination of the amplifier's specifications indicates the incorporation of a low-impedance (well-regulated) power supply.

# THE HI-FI INSTITUTE

## —a Guest Editorial—

By **JOSEPH N. BENJAMIN**

President, Institute of High Fidelity Manufacturers, Inc.

*THE AUTHOR is president of Bogen-Presto Div. of Siegler Corp., a graduate engineer, Senior Member of IRE, and has served on Board of Directors of EIA (1955 and 1958). During World War II, he attained rank of Major in Signal Corps; has been associated with United Transformer and Pilot.*



**A**S president of the Institute of High Fidelity Manufacturers, Inc., I welcome this opportunity to address myself to readers of *ELECTRONICS WORLD*. To me, this audience is important for at least two reasons: you are all knowledgeable about component high fidelity—both monophonic and stereo, and you are “opinion makers” in your community. On both counts you represent a vital force in our industry.

Let me explain first the purposes for which the Institute was formed. About five years ago, when the components industry started to show its phenomenal growth, a group of the leading manufacturers of quality equipment saw the need for some organization to handle the problems of this lusty infant on an industry-wide basis.

At first, the emphasis was primarily on high-fidelity shows designed to attract the greatest possible number of people interested in home music reproduction so that we could demonstrate the quality possible with components. As interest in the shows grew, and as more and more novices were taught that components delivered a vastly superior quality of reproduction, the industry grew in leaps and bounds. For example, in 1954, we sold \$96,000,000 worth of equipment at the retail level. In 1958 the industry volume was \$260,000,000. This represents a growth of almost three times in five years!

It soon became evident that the growth of the industry was generating problems—problems of terminology, problems of standards, the need for general education of dealers as well as the buying public, general promotion of the philosophy of component high fidelity, and investigation into the needs, desires, and habits of the consumer.

In addition to learning about these needs, the Institute was the proper agency to do something positive about informing its members of the problems, suggesting broad and general methods of coping with these problems, keeping the public informed of the positive benefits of component hi-fi, combatting misconceptions, and cooperating with federal agencies, such as the FCC when regulations for FM broadcasting were being drawn up and, most recently, in connection with multiplexing.

The Institute, largely because of its progressive and energetic leadership, has grown until it now includes 90 per-cent of the major component manufacturers among its membership in both general and associate member categories.

There have been many positive contributions, traceable to the Institute, which have contributed directly to the health and growth of the industry. Among the tangible results of the Institute's campaign of education has been public acceptance of the fact that component hi-fi is not complicated—either to hook up or to operate. We have made the public aware of the flex-

ibility of component hi-fi as to decor. (The theme of our shows for 1959-60 is “Decorate Your Home With Music”.) We have taught the lesson that only through purchase of component hi-fi can personal preferences be satisfied. Not the least important lesson learned by the consumer is that component hi-fi is subject to the lowest rate of obsolescence.

We are working with builders and architects who want to incorporate high-fidelity components in their plans for new construction. Education as to quality has been so successful that many package manufacturers are now using the term “components” in their advertising. When the Institute first started its shows, women accounted for only about 3 per-cent of the admissions. In 1958 at the New York Show, this figure had risen to about 40 per-cent. Because of the steadily growing publicity by the Institute, component high-fidelity has become an accepted instrument of culture, it has made its influence felt in the greatly increased sales of musical instruments, records, and, of course, tape.

On the technical side, the Institute has already produced standards for tuners, is about to produce standards for amplifiers, and is working on standards for all other components in the hi-fi chain.

In addition to working with the manufacturers, the Institute early recognized the need for a strong dealer base to handle the mushrooming distribution. One step in the direction of strengthening public recognition of the role of the specialized dealer is the Institute's “registered component dealer” program which recognizes and identifies the properly equipped specialist. To further the development of the dealer we have plans for seminars and other methods of dealer education.

With the advent of stereo there has been an increase in public confusion about high-fidelity. The Institute is about to embark on a campaign of advertising and education, using consumer media, in order to reach the less well-informed public.

Many problems have been solved, but many remain to be tackled. At the Institute we are proud that in our short life we have been able to do so much. We recognize, however, that more remains to be done. Our forecast is for

continued expansion of the component hi-fi industry, for constantly improved equipment, for less confusion and for a greater public acceptance of the self-evident fact that for quality in sound reproduction there is nothing that beats component high-fidelity.

We don't pretend to know all the answers as yet—so if you have any ideas, drop me a note % IHFM at 125 E. 23rd St., New York 10, N. Y. All suggestions will be gratefully received. —30—

### INSTITUTE OF HIGH FIDELITY MANUFACTURERS, INC.

President—Joseph N. Benjamin, Bogen-Presto Div.

Vice-President—Philip L. Gundy, Ampex Audio

Secretary—Saul B. Marantz, The Marantz Company

Treasurer—Milton D. Thalberg, Audiogersh Corp.

Executive Sec'y.—Abraham Schwartzman

### BOARD OF DIRECTORS

George Silber, Chairman—Rok-O-Kut

Joseph N. Benjamin—Bogen-Presto Div.

Milton D. Thalberg—Audiogersh Corp.

William S. Grommes—Grommes Div., Precision Electronics

Bernard Cirlin—Stephens Tru-Sonic, Inc.

Sidney Harman—Harman Kardon

Lawrence J. Epstein—United Audio Products

Walter O. Stanton—Pickering & Co., Inc.

Avery Fisher—Fisher Radio Corp.

# Recent Developments in Electronics



## ▲ Black Light Detects Contaminants

A high-intensity ultraviolet lamp is being used above to check a chassis for contaminants. Such lamps, made by *Black Light Eastern Corp.*, Bayside N. Y., will also show up solder flux residue, hydrocarbons, and lint when present in small traces or thin films.

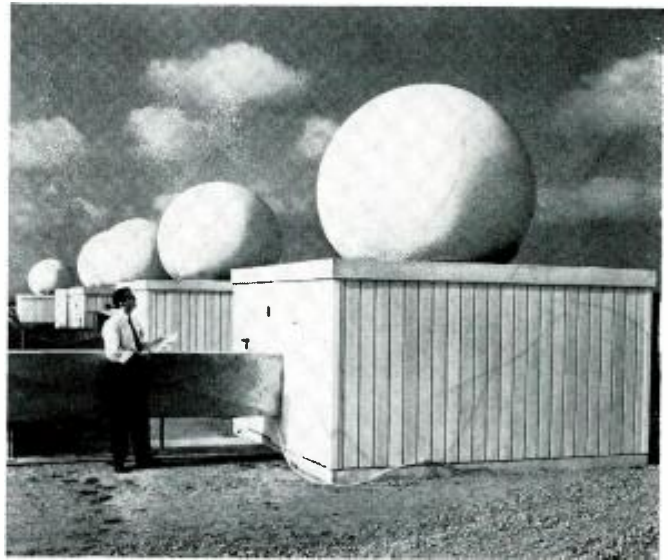

## ▲ New Tracking System for Atlantic Missile Range

The new "Azusa" tracking system for the Atlantic Missile Range, Cape Canaveral, Fla., is undergoing final checkout at the San Diego plant of *Convair* (Astronautics) Div. of *General Dynamics Corp.* When completed, the system will be dismantled and air-shipped to AMR for installation. Plastic radomes are used to protect the tracking system's parabolic antennas. Each antenna installation is pressurized to inflate these radomes and to keep out moisture, dust, and fungus.

## ◀ Tube-less, Transistor-less Radio Transmitter

A tube-less, transistor-less miniature radio communication transmitter tinier than a spool of thread was used as an electronic wand for the first time in a remote-control operation to break ground for a plant expansion of the *G-E* Communication Products Dept. The transmitter measures less than 1 inch in any direction. A spiral antenna protruding from one end and a handle extending from the opposite end gives the unit a wand-like appearance. Heart of the transmitter is one of the new tunnel diodes. (See article "Tunnel Diodes—Experimental Solid-State Devices" in this issue.)

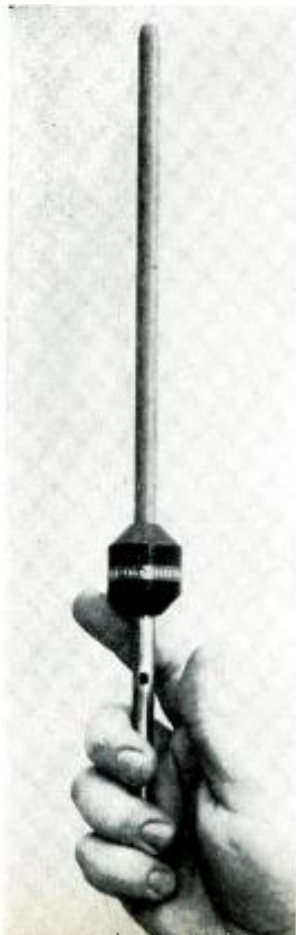



### Music Synthesizer Installed at Columbia ▶

An electronic music synthesizer, capable of generating electronically any imaginable musical tone, has been installed at Columbia University in New York. It will be used in a program of composition and research in electronic music, conducted by Columbia and Princeton Universities under a grant of the Rockefeller Foundation. Developed by an *RCA Laboratories* team under Dr. Harry F. Olson, the synthesizer produces musical sounds in response to coded signals fed into the system on perforated tape prepared by operator at keyboard, as shown here.

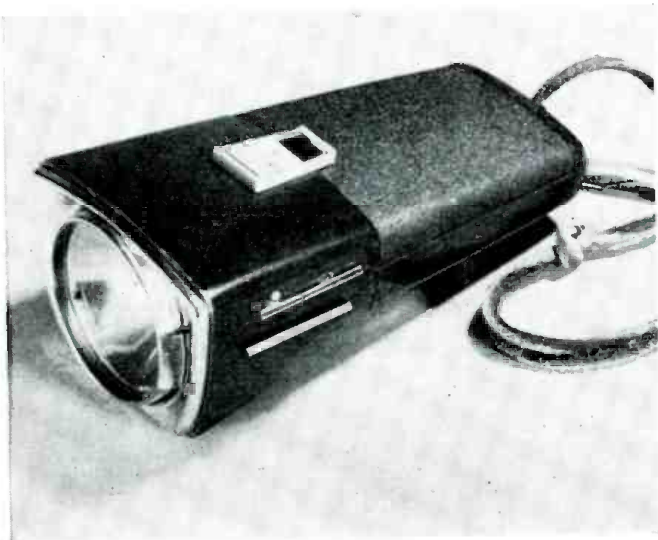

### ◀ Rechargeable 5-Year Flashlight

A rechargeable flashlight, using a nickel-cadmium battery and guaranteed for 5 years, has been introduced by *Gulton Industries, Inc.*, Metuchen, N. J. The flashlight throws an intensive beam for up to two hours of continuous use, and is recharged overnight at a cost of less than one cent. Standard models of the unit will retail for \$9.95.

### Ionic Liquid A.C. Power Switch ▶

Miniaturized prototype models of electro-ionic control units made by *Ovitron Corp.*, Detroit, Mich. are shown. Units contain two tantalum oxide electrodes with a platinum coated control electrode between them, all submerged in a special acidic liquid electrolyte. The application of a small control signal to the control electrode ionizes the electrolyte and permits a.c. current flow between the two main electrodes.

### New Target Display System

Artist's concept of new air traffic tracking system to be installed at North American Air Defense Command and Strategic Air Command headquarters. System, designed by *Temco Aircraft* subsidiary, is called "Iconorama." It uses radar network data and produces color-coded tracks directly. ▼

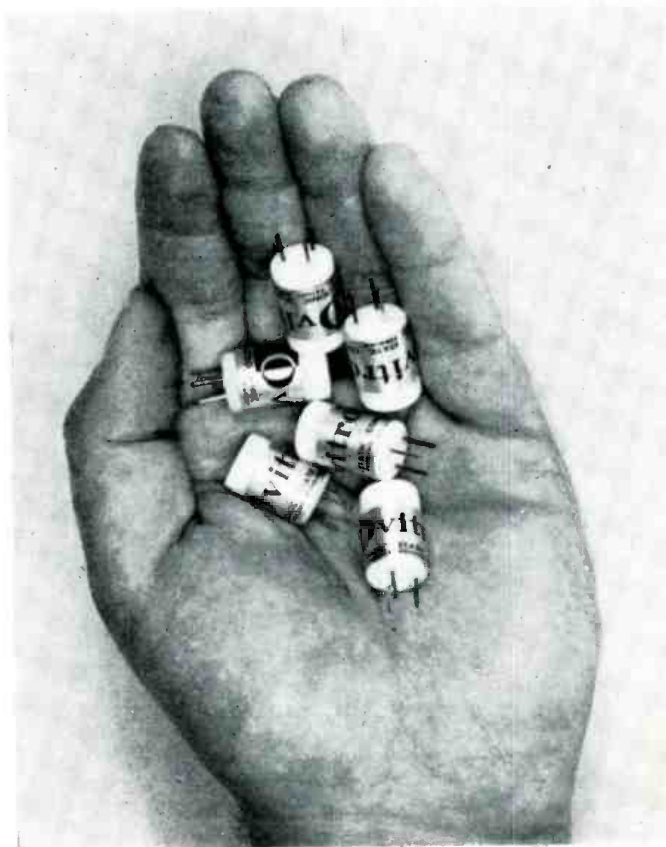
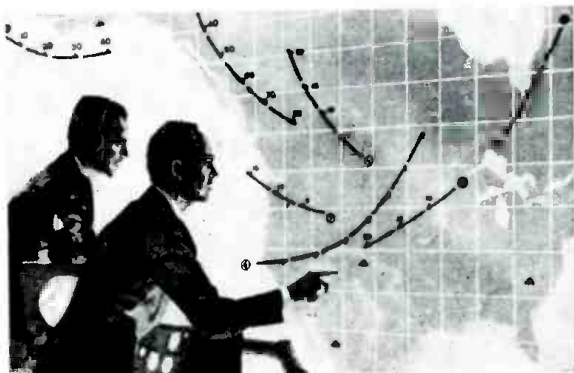



Fig. 1. Germanium resistance thermometer as it appears with the outer case removed.

Some interesting new and unusual semiconductor products along with a few of their applications.



Fig. 2. Pair of probe "Sensistors."

# Novel Semiconductor Devices

THE usefulness of semiconductor materials, such as silicon and germanium, in the field of transistors and diodes is well established. It might be reasoned that materials of such wide usefulness in one area could also find applications in other areas and we find this to be the case. Some of the properties of semiconductor materials, such as extreme stability, temperature sensitivity, and sensitivity to magnetic fields, have been exploited and several devices are now under active development in various laboratories.

## Temperature-Sensitive Resistor

Single-crystal silicon has a very high positive temperature coefficient, that is, its resistance increases very rapidly as its temperature rises. This characteristic has been applied by *Texas Instruments, Inc.* in developing a device which has been tradenamed the "Sensistor." This device has a positive temperature coefficient of resistance of 0.7% per degree C., which means that the resistance increases 0.7% for every degree the temperature rises.

"Sensistors" are available with 1/4-watt and 1/8-watt ratings and a wide variety of resistances. For the sake of comparison and uniformity, the resistance is usually given at 25° C, which is normal room temperature. The actual resistance at any other temperature can then be computed from a chart similar to Fig. 5, which gives the resistance at a given temperature in terms of the value at 25° C multiplied by an appropriate factor.

As an example, suppose we have a nominal 100-ohm "Sensistor" and would like to know its resistance at 50° C. Looking at the 50° point on the chart, we find that the multiplying factor is about 1.18. Therefore, the resistance will be 100 x 1.18 or 118 ohms. Similarly, we can compute the resist-

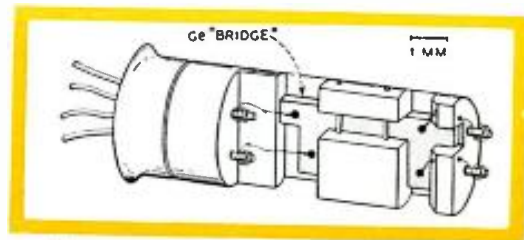

Fig. 3. Cross-section drawing showing construction of germanium resistance unit.



Fig. 4. Germanium resistance thermometer compared in size with common pin.

## Devices / By HAROLD S. RENNÉ

Fig. 5. Ambient temperature correction factor curves for the "Sensistors" shown. The factor from this curve multiplied by the resistance at a temperature of 25° C will give the no-load resistance of the units at the desired ambient temperature.

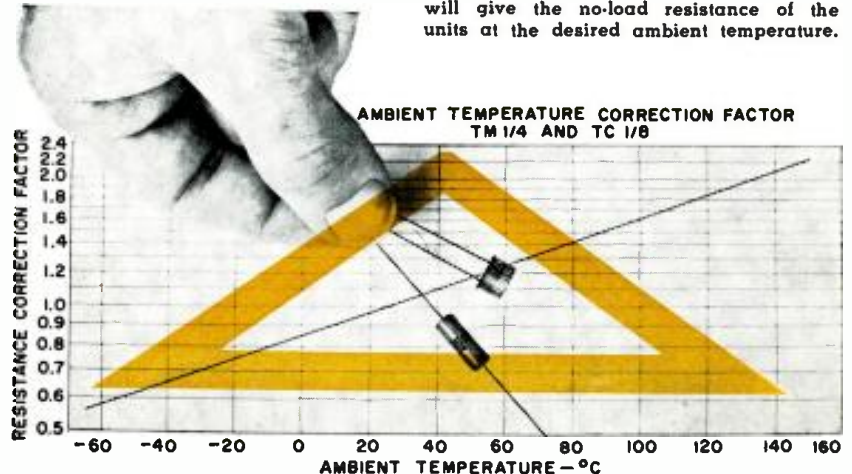

ance value at any other temperature.

We can also compute the resistance by using the temperature coefficient and not referring to Fig. 5 at all. In the example just given, the temperature increase (from 25°C to 50°C) is 25°. Multiplying this by the temperature coefficient, 0.7% (0.007), gives an increase of 0.18 ohm for every ohm of initial resistance. Since the initial resistance was 100 ohms, the new resistance will be (100 x 0.18) or 18 ohms higher than at room temperature.

It can be seen from these properties that the "Sensistor" can be employed as a sensitive thermometer when used with an ohmmeter. A new scale for the ohmmeter can be calculated without the laborious process of calibrating it. Care must be taken in applications of this kind, however, to make certain that the measuring current flowing through the "Sensistor" is not sufficient to alter its temperature due to this  $I^2R$  loss.

For probing into very small spaces where temperature indications are desired, *Texas Instruments* has developed a glass-encased probe "Sensistor." Its temperature-resistance characteristics are very similar to the straight "Sensistor," but its mechanical construction is quite different. It is made in the form of a cylinder about half an inch long and less than one-tenth of an inch in diameter. See Fig. 2.

Many applications for the "Sensistor" are apparent, other than its possible use as a thermometer. For example, it can be used to compensate for temperature changes in devices having a negative temperature coefficient. It can also be employed in telemetering applications where it is desired to transmit information on temperature back to a base location. Other applications include amplifiers, power supplies, servos, and computers.

#### Low-Temperature Thermometer

Along somewhat similar lines, but



Fig. 6. A photograph of the Halltron HS-51 unit. Refer to text for details.

Fig. 7. Semiconductor Hall Effect voltage generation is illustrated here.

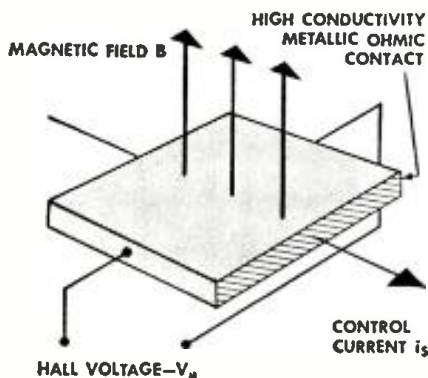

October, 1959

operating in a completely different temperature range, is the germanium low-resistance thermometer (Fig. 1) developed at *Bell Telephone Laboratories*. Although not on the market as yet, this device is undergoing tests and undoubtedly will be made by some interested company in the near future.

Extensive work is now being carried out in the field of cryogenics, that is, low-temperature research. Temperatures involved may be in the neighborhood of the boiling point of helium, 4.2° Kelvin (4.2°C above absolute zero) and may range downward to within a fraction of a degree of absolute zero or upwards to around 50°K or so. Temperature-indicating devices normally employed to cover this range are, in some cases, bulky and in other cases require repeated recalibration, making them highly inconvenient to use.

The new thermometer, which is formed from a single crystal of *n*-type germanium, is extremely stable and, once calibrated, holds its calibration very closely even though repeatedly cycled from room temperature down close to absolute zero.

Fig. 3 shows the general construction of this device and the photograph of Fig. 4 indicates its size in comparison with a common pin. It is very small so as to be useful in places where space is at a premium.

The active element is a bridge cut from a slice of germanium doped with arsenic to make it *n*-type material. It also is a resistance thermometer, meaning that temperature is indicated by measuring the resistance of the germanium slice. This is done by passing a very tiny current through the slice and then measuring the voltage drop across it. The actual resistance can then be computed from Ohm's Law:  $R = E/I$ .

These thermometers have extremely high sensitivity, their resistance changing rapidly with variations in temperature. For example, one unit tested had

a resistance of 0.015 ohm at room temperature, 14 ohms at 10°K, and 216 ohms at 2°K. Both the temperature coefficient and the actual resistance vary widely with minute changes in the amount of doping, making it possible to construct thermometers having any of a wide range of characteristics.

It appears that the germanium resistance thermometer will have wide application—from precise laboratory measurement of low-temperatures for cryogenic and calorimetric work to sensing temperatures in outer space.

#### Strain Gauges

There is another property of semiconductor materials which is in the early stages of exploitation by many laboratories but apparently no commercial devices are yet available. This property is called piezoresistance—extreme sensitivity of the resistance of such materials to tiny stresses and strains. Such a property makes these materials potentially valuable as very sensitive strain gauges.

A strain gauge is normally made of wire. It is cemented to a beam, shaft, or other device and will indicate very small bends or twists by a change of resistance. This resistance change, in general, is quite small, requiring rather sensitive instruments if extremely small motions are to be detected with any reliability.

By using a section from a single crystal of semiconductor material, sensitivities of 10 or even 100 times as great as with conventional wire gauges appear possible. This opens up a whole new field of application for germanium, silicon, and other semiconductor materials.

These materials have other advantages over conventional gauges—they are stable over a wide range of temperatures and respond accurately both to static strains and to varying strains at frequencies up to the resonant frequency of the material employed.

Fig. 8. Hall voltages for typical Hall generator for various values of control current and for various magnetic fields.

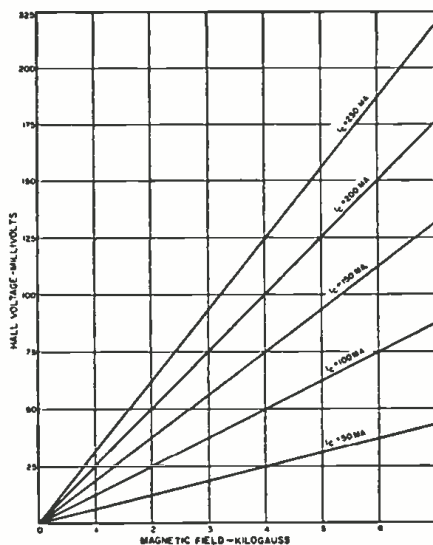
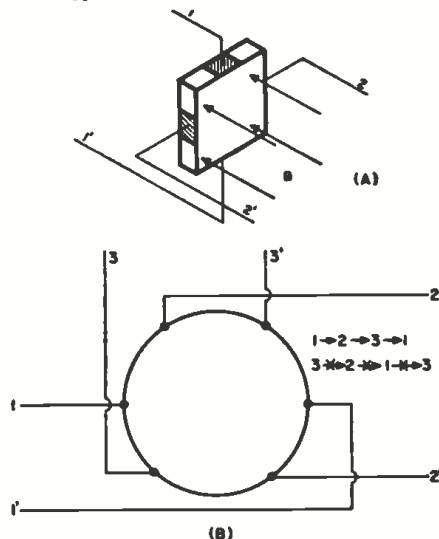

Fig. 9. Basic diagram of (A) Hall Effect gyrator and (B) Hall Effect circulator.



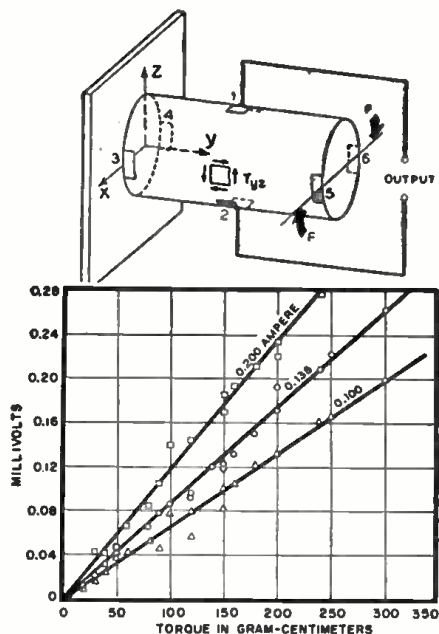

Fig. 10. The torsional transducer. Graph shows calibrations at various bias currents.

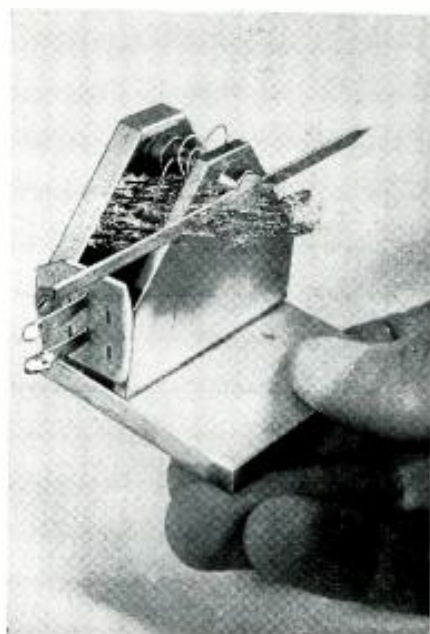

Fig. 12. Shown above is a photograph of the torsional transducer described in text.

Germanium appears to be useful up to 600°K., silicon to 1000°K., and the new intermetallic semiconductor gallium arsenide may extend the temperature range up to around 1400°K.

Semiconductor strain gauges may be designed to measure either displacement, as shown in Fig. 11, or torque, as indicated in Figs. 10 and 12. In the latter case, a cylinder cut from germanium is cemented to the torque member and six leads attached. When provided with appropriate biasing currents, a direct-reading sensitive torque meter results.

Pressure gauges made of semiconductor materials are extremely simple and reliable. The materials are sensitive to pressure, that is, their resistance changes as the pressure changes. Because of their stability and small size, such gauges can be immersed in many different liquids and gases, and pressures measured by bringing two leads out of the container.

Another desirable property is mechanical strength. In general, semiconductor materials are relatively rugged and will withstand fair amounts of bending and twisting without becoming permanently deformed.

### The Hall Effect

From our basic electricity we re-

Fig. 11. Displacement gauge constructed with germanium crystals. Such gauges are up to two orders of magnitude more sensitive than common types that may be used.

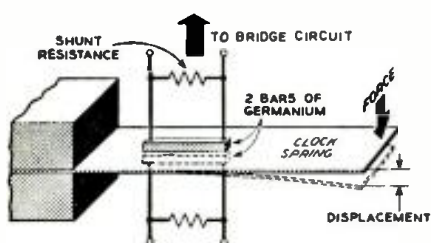

member that if a wire is carrying current while it is in a magnetic field, there will be a force acting on the wire. This is the basic operating principle of electric motors. If we were to explore the situation more fully, we would find that the force actually acts on the free electrons which are carrying the current in the wire and not on the wire itself. The net effect is the same, though, since the electrons are confined in the wire. Any sideways force on the electrons is transferred to the wire.

Because of this force, the electrons in the wire are pushed over to one side, leading to an excess of electrons on that side and on the other side a deficiency. We might then expect that a voltage would exist between the sides of the wire. This is exactly what does happen, except that in good conductors the voltage is very small and hard to detect. This is known as the "Hall Effect" and the voltage is called the "Hall Effect voltage."

The Hall Effect is a very useful tool in studying semiconductors, because in such materials the effect is appreciable and the voltages produced can be measured readily. In a semiconductor, the current may not consist entirely of a flow of electrons but may also include the movement of "holes" or spaces where an electron is absent. As may be expected, the magnitude of the Hall Effect depends on how easily these electrons and "holes," usually called charge carriers, move around in the material. This property has been termed "mobility." Greater mobility produces greater Hall Effect voltage.

Fig. 7 shows the results of the Hall Effect. Here we have a slice of semiconductor material with current flowing through it. A magnetic field is perpendicular to the slice. When these two conditions exist, a voltage will appear across the sides of the slice, its magnitude proportional to the product

of the magnetic field and the current. As a typical example, if the current is ½ ampere and the field strength 10,000 gauss, the voltage may be around ½ volt.

A commercial Hall Effect device is now on the market. It is manufactured by Ohio Semiconductors, Inc. and is known as the "Halltron HS-51," which is shown in the photograph of Fig. 6. The active part of this device is an intermetallic semiconductor known as indium antimonide, a material which has a very high mobility—much higher, in fact, than silicon or germanium.

Many possible applications can be envisioned for the "Halltron HS-51" and similar devices. The most obvious, perhaps, is the measurement of magnetic field strength. For a constant current, the output voltage varies directly with the strength of the magnetic field perpendicular to the slice of semiconductor material. Other possible applications include a clip-on type ammeter, instantaneous power

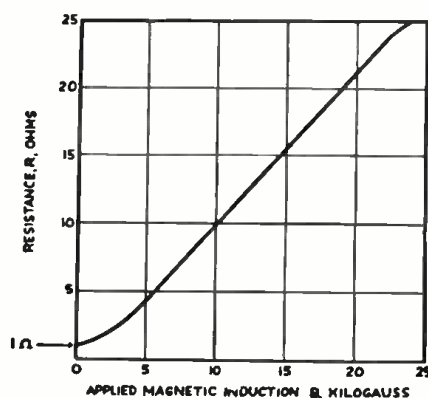

Fig. 13. Resistance of typical MS-41 Magnetoresistor for various magnetic fields.

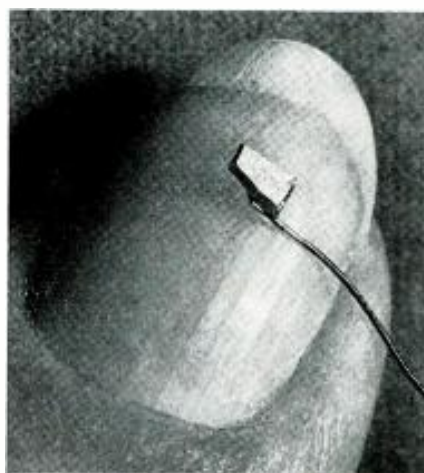

Fig. 14. Neutron detector formed by a thin slice of germanium coated with uranium layer.

meter, d.c.-to-a.c. converter, and perhaps in computers for analogue summation and multiplication.

Westinghouse has also announced the development of Hall generators using both indium antimonide and indium arsenide. Voltages of ½ volt with a magnetic field strength of 5000 (Continued on page 148)

# New Jobs for Tube Pins

By ROBERT RUSSELL

**H**AVE YOU ever considered what a shame it is, when a vacuum tube expires, to discard completely so intricately contrived a component that still incorporates a variety of inherently useful materials? In the case of octal-type tubes, at least, there is some simple salvaging you can do. There are literally dozens of places where the tube pins can be used to make dependable, compact connectors, often providing a more versatile set of terminals than do other connectors. Best of all, once the tubes themselves are useless, the chief raw materials are available free. Principal additional materials needed are the "grippers" or pin inserts found on octal sockets.

For his service bench, the author has used tube pins to simplify such connectors and connections as single-wire leads in several lengths, coaxial cables, special lead-to-lead extender connections, leads that accommodate a choice of plug-in terminals including alligator clips, line cords made to simulate TV cheater cords, and standard plugs with tube-pin input. Several instruments and other equipment have been adapted with tube sockets to which input, output, and power connections have been brought out for simple hook-ups. Many other applications will occur to users who adapt this technique to suit their individual needs.

In addition to the pins and grippers already mentioned (and, of course, the items to which you intend to attach the pins), one other material is needed: a suitable plastic. This too is available in the service shop or easily procured. Polyethylene, which may be taken from ordinary TV twin-lead antenna wire, is highly suitable because it is tough and durable, yet easily molded with the right technique. See Fig. 1 for this plastic and the pins.

To obtain a suitable length for melting and molding, simply strip away the copper conductors from this length. To melt it, a block of wood with a hole about  $\frac{3}{8}$  inch square and about  $\frac{1}{2}$  inch deep is needed. The plastic, which ordinarily sticks to everything including the wood and one's fingernails, is simple to tame. Oiling the hole in the wood and the fingernails will prevent sticking. Use a small soldering iron to melt the plastic gradually into the hole. If the iron becomes too hot, it will begin to break down the plastic, producing smoke, carbon, and possibly gases that should not be inhaled. There are several ways of controlling the iron's heat, if this becomes necessary. One convenient way is to dip the iron occasionally into a glass of water.

October, 1959

Fig. 1. Raw materials: antenna wire and tube pins.

**With small amounts of ingenuity, effort, and expense, you can make up a variety of connectors.**

With the polyethylene prepared, we must ready the other raw materials. To free the pins from the tubes, wrap the latter in paper or cloth individually and smash the glass. The pins can be chipped away from the sockets readily with a chisel. The soldering iron can be used to clean away any connecting leads inside the hollow pins.

Tube sockets will be necessary, to obtain the grippers or pin inserts and also to make up sockets for equipment-panel connectors. For the latter application, plastic tube sockets will generally be used. For salvaging grippers, wafer-type sockets are best. The latter are easily dismembered by cutting or crushing the plastic around the two rivets of each socket. This permits separation of the two plastic wafers making up the socket, between which the pin grippers are sandwiched and held. Dismantling a single wafer socket gives you a fair supply of eight grippers. Each of the latter consists of a strip of metal wrapped around at one end to clasp the tube pin with the other end bent over (see drawing to the left in Fig. 4A) as a single tab with a hole at the end to accommodate connecting leads. In most applications, the gripper will be more useful if pliers are used to squeeze the tab closer to the pin-holding body (to the right in Fig. 4A). In some cases, it will be desirable to solder the tab to the main body.

To make up conventional leads, obtain wire of the desired type and cut to size. Two-conductor, plastic-insulated line cord is quite suitable: it can be split down the middle to provide neat, durable, single-wire leads. For smaller size and greater flexibility, #18 or #20 stranded hook-up wire can be used. Strip about  $\frac{3}{8}$  inch from each end of the wire, twist the exposed conductor, and tin it generously. If the conductor is too thick for insertion in the tube pin, pull back a few strands and wrap them around the remaining ones near the start of the insulation.

Fill the hollow of the tube pin with molten solder and, while the solder is still fluid, insert the tinned end of the wire. If the soldering iron can be rested on a base during this operation to free both hands, a pair of long-nose pliers

(Continued on page 159)

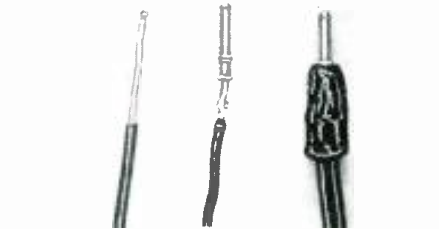

Fig. 2. The three steps in connecting a lead to a pin from a discarded tube.



Fig. 3. How a lead-to-lead connector (center) is used for extension cables.

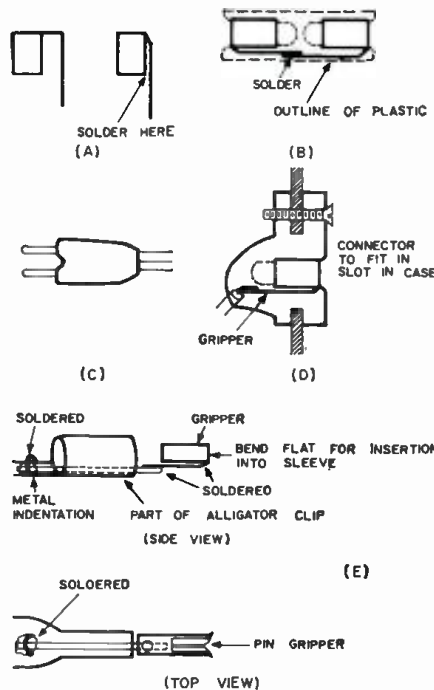

Fig. 4. Construction details for some of the techniques described in the text.

Fig. 5. Two-pin a.c. connector and matching socket for instrument case.



# The Stereo Disc Today



By **SIDNEY FREY**  
President, Audio Fidelity, Inc.



**Summary of present status of stereo discs  
by one of the leading disc manufacturers.**

IT'S difficult to believe that it is hardly a year and a half since the stereo disc made its commercial debut on the American scene. The impact of this innovation in musical reproduction has been nothing short of sensational. Nothing in sound has caught the public's fancy as has stereo sound on records. There are few Americans today who have not heard the exciting sound of stereo—somewhere, at some time—yet “Marching Along with The Dukes of Dixieland”, the first commercial stereo recording, hit the market less than 20 months ago!

## Early History

Stereo has come a long way since the first stereo transmission of music back in 1881 when the then-new telephone was used to transmit programs from the stage of the Paris Opera. The audio engineers of the time used a pair of telephone lines—one for each ear—to create the stereo effect.

Application of the stereo technique to recorded music on discs came in 1931 when A. D. Blumlein, an engineer employed by *Electrical and Musical Industries, Ltd.* (EMI), filed for and received British patents on a system for cutting and reproducing both vertical and lateral tracks on the same disc. In 1936, A. C. Keller and I. S. Rafuse, engineers at *Bell Telephone Labs*, developed a similar technique and were granted U. S. patents. At this point, stereo as we know it today, meant little to anyone except those specializing in the field. There was no excitement, no rush to get on the bandwagon, no scurrying in an industry that was, at that time, in its infancy and struggling to survive.

In 1952, Emory Cook introduced a binaural disc having two independent channels, one track on the outer half of the record and the second track on the inner half. The record was played by means of an odd-shaped pickup arm which had two cartridges mounted side by side.

This system was ingenious in its approach to a solution of the two-channel problem. The resultant sound was good. However, difficulty in adjusting the arm and cartridge for proper tracking and the fact that only half as much program material could be accommodated on the disc precluded wide public acceptance of this so-called binaural system.

The birth of the stereo disc, as we know it today, did not take place until the fall of 1957. At that time British *Decca (London)* introduced a single-groove recording to the United States. Both channels were cut into one groove—one laterally and the other along the bottom. The *London* system was vulnerable since the output of the two channels, each cut differently, were conceivably different in character.

The *Westrex Co.*, manufacturers of recording equipment, operating independently, produced another variation of this two-channel, single-groove cutting technique. This variation consisted of rotating the groove relationship 45° to the record surface, thus overcoming the objection to the *London* system.

*Westrex* designed its cutter with two vertical cutters linked together, their axis forming a 90° angle and coupled to a single stylus in such a way as to make cuts for each channel at 45° to the disc surface. For playback, the

company specified two lateral cartridges coupled together in a similar manner.

It was at this point that we at *Audio Fidelity*, using a master prepared for us by *Westrex*, produced the first commercial stereo disc. The program material was “Marching Along with the Dukes of Dixieland” and “Railroad Sounds”, which we had previously released as a stereo tape. Surprisingly, the quality of this pioneer record was of a high order. All the elements were there: wide channel separation, dynamic range, and good frequency response. The one thing that was lacking was a cartridge with which to play the recording. Up to that point, the only available stereo cartridge was a hand-made unit which *Westrex* was using to demonstrate the output of its cutting equipment.

Actually, it was some time after this first stereo disc was pressed that members of our own organization were able to hear the results. At that time we were able to listen to a stereo playback with one of the first *Fairchild 603* playback cartridges. These units were hand-made and the cartridge and arm assembly sold for \$250.00.

## Improvements & Problems

The rest is history. The original *Westrex 3A* cutter was succeeded by the 3B and then the 3C. Each was a slight improvement over its predecessor. Certain resonant peaks were removed and variable vertical pitch was introduced. The latter was a device which cued the cutting head to cut deeper to prepare for passages with wide dynamic range.

Each development helped to improve

## Cutting a Stereo Disc



the resulting disc by widening the frequency response and increasing the dynamic range. The difficulties involved became apparent when it is remembered that the production of any record is a complicated combination of science and alchemy. In the case of the stereo disc, complications are multiplied. When one considers the simple fact that with a stereo recording, two separate and distinct signals have to be inscribed in a groove less than .003 inch wide, the scope of the problem becomes apparent. Add to this the fact that full dynamic range and wide frequency response for each of these channels has to be crammed into this microscopic space, it is a wonder that such an engineering feat was ever attempted in the first place.

Another problem confronting the record manufacturer is the difficulty involved in plating master recordings for stereo discs. After the record is cut, the master is plated in an electro-galvanic plating bath before it is used to manufacture the stampers which press the actual vinyl record. Because the stereo cartridge is as sensitive to vertical motion as it is to horizontal motion and because the stylus rides so close to the bottom of the groove, material lodging in the bottom of the groove will create ticks, pops, and noise. For this reason the plating of the masters must be very carefully done since the slightest bit of foreign matter in the plating bath can ruin the quality of the record.

Yet another problem, inherent in the records, is that of wear. This problem is aggravated in the stereo disc mainly because of the character of the stereo cartridge. Most stereo tips are .7 mil in radius with one or two as small as .5 mil. For this reason the stylus exerts that much more force per unit area for the same cartridge weight as would a 1 mil monophonic stylus. This is offset, to some extent, by the fact that the pressures used are below those of monophonic pickups.

### Discs and Tapes

From the standpoint of quality, today's stereo discs can be made as good a source of music as any medium on the market. When one considers all the factors: dynamic range, frequency response, signal-to-noise ratio, realism, and ease of handling, no recorded source can surpass discs for stereo. Perhaps this is a rather broad statement but it is my personal conviction that many of the facts will bear me out in this contention. There are others, whose primary interests lie in the tape field, who will claim that the best home method for achieving stereo playback is on 7.5 ips reel-to-reel pre-recorded tape. There are certainly some features of this medium that cannot be denied and do tip the scale as far as quality is concerned. However, when it comes to ease of handling, no one can doubt that the disc is far out in front.

It is not our intention to imply that all stereo discs on the market today are of top quality. As we all know,

OUR cover this month shows a lacquer master of a special stereo disc being cut at Olmstead Sound Studios in New York City, as arranged by Audio Fidelity. The cutting head being used is a Westrex 3C that costs over \$4000. It is carefully mounted in a counter-balanced and spring-loaded carriage on the cutting lathe. Note the two sets of leads that connect the right- and left-channel audio signals to the cutting head. These leads come from recording amplifiers rated at 150 watts per channel. The rubber suction hose (at the extreme right) draws off the "chip" formed as the disc is cut.

The disc itself is mounted on the heavy, weighted turntable of a Neumann fully automatic cutting lathe. Strobe markings are machined into the table's periphery. The turntable is partly hollow and has a number of small holes drilled into its top face on which the disc rests. The spindle at the center of the table is also hollow. When a master is being cut, a suction line is slipped over the spindle and the resulting vacuum holds the disc firmly and prevents slipping or warping. The entire cutting lathe costs around \$12,000.

In taking the photograph, a number of colored lights were arranged around the disc in such a way as to show the light patterns formed by the signals in the grooves. These patterns are used by the recording engineer to measure the recorded velocity of the signal that has been cut.

The outer band on the disc, with only one of the two channels being cut, is a frequency-response run. The standard RIAA equalization was used. First, a 1-kc. reference tone was cut and this was followed by narrow bands of tones beginning at 15 kc. and going all the way down in step to 30 cps. The latest stereo cutters are able to cut this frequency range within 2 db without any difficulty. Some cutters may even go down to 20 cps within 2 db. This is not to say that it is impossible to cut even lower frequencies or frequencies as high as 20 kc. or perhaps 25 kc. on the disc, but such signals will be substantially reduced in

level, if they appear at all, and not within the 2 db. limit.

The second band consists of some stereo program material. Both channels were in operation for this part of the disc. Separation between the two channels on the order of 18 to 22 db is common, although figures as high as 35 db have been measured under the very best of conditions with some cutters.

The inner band on the disc illustrates the dynamic range possible. Here again, in order to show a more easily photographed light pattern, only one of the stereo channels was in use. A constant tone of 1000 cps was recorded here, first at the maximum usual level. Then the level was gradually reduced until the signal disappeared into the noise on the disc. The dynamic range obtainable is on the order of 50 db in the case of most stereo discs. Of course, it is possible to get even greater dynamic range of perhaps 60 or even 65 db if more distortion is allowable or if a restricted frequency range is used. Further, remember that the usual stereo disc master is made from a master stereo tape recording, and the limitations of the tape system must be taken into account. If a live performance were to be cut directly on the disc, the limitation of the tape recording system, minor as it is with professional equipment, would not be a factor.

It appears then that the gap between the quality of the very finest monophonic disc and the very finest stereophonic disc available today, once quite wide, has become increasingly narrowed.

(Photo by Bob Loeb)

most recordings are made so that the poorest as well as the best cartridges and arms can track them. Compromises must, of necessity, be made and since record companies look to the mass market for their outlets most records today are not intended to combine, in a single pressing, the maximum possible degree of quality obtainable.

There are, of course, exceptions to this and some recording companies do produce pressings that are specifically designed to be used solely with the best hi-fi sound reproduction systems. In some cases manufacturers indicate on the album that only top-quality arms and cartridges should be used in playing the record. Obviously a greater degree of skill in recording and in cutting the master is employed along with the most advanced design of the associated electronic equipment.

### Microphone Technique

One of the technical factors which

contributed to our success in the stereo disc field was the adoption of the mid side (or MS) microphone technique. This technique employs a *Telefunken* stereo microphone which consists of a self-contained two-microphone unit with crossed cardioid and figure-8 patterns on one axis. This stereo microphone can be placed in a central position rather than is the case with the more generally used technique involving two widely separated microphones.

One of the phenomena created by the MS technique is the feeling of depth experienced by the listener. This is in addition to the breadth and directionality illusions which are the basis of all stereo sound. This recording technique results in music that gives the listener the sensation that by approaching his speakers he can walk into the center of the orchestra. In addition, stereo produced by the MS method doesn't confine the listener to

(Continued on page 145)

# "TOP CHOICE" DISCS IN STEREO

The list below has been prepared by a recognized hi-fi authority who must, we are sorry to say, remain anonymous. Evaluation is based on quality of reproduction and not necessarily on musical values.

## DEMONSTRATION DISCS

- CAPITOL SN-1  
"What's New on Stereo" (Highlights from recent releases)
- CAPITOL SPRO-846  
(A potpourri from the company's best pop release)
- CAPITOL SWAL-9032  
"The Stereo Disc" (Introduction to stereo with special "balancing band")
- CONCERT-DISC CSD-2  
(A potpourri of classical, organ, heavy, light, and jazz music. Last three bands of Side 2 are especially recommended)
- LONDON FFSS PS-100  
"A Journey Into Stereo" (Variety of dramatic stereo sounds, railroads, racing cars, music, etc.)
- WESTMINSTER WSS-1  
(All-purpose demo record with railroad effects, rain, traffic noises, and potpourri of classical and light repertoire)

## STANDARD CLASSICS

- ANGEL S35407  
MOZART "SYMPHONY #25" and "SYMPHONY #40"  
Otto Klemperer and Philharmonic Orchestra
- ANGEL S35505  
RIMSKY-KORSAKOV "SCHEHERAZADE"  
Sir Thomas Beecham and Royal Philharmonic Orchestra
- ANGEL S-35529  
PROKOFIEV "CINDERELLA" (excerpts)  
Robert Irving and Royal Philharmonic Orchestra
- ANGEL S35620  
BEETHOVEN "SYMPHONY #7"  
Guido Cantelli and Philharmonic Orchestra
- CAPITOL SP-8373  
BRITTEN "YOUNG PERSON'S GUIDE TO THE ORCHESTRA"  
Felix Slatkin and Concert Arts Orchestra
- CAPITOL SP-8450  
MUSSORGSKY "NIGHT ON BALD MOUNTAIN"; TSCHAIKOVSKY  
"MARCHE SLAV"; BORODIN "POLOVTSIAN DANCES"; GLINKA  
"KAMARINSKAYA"  
William Steinberg and Pittsburgh Symphony Orchestra
- COLUMBIA K25-602  
HANDEL "CONCERTI FOR ORGAN"  
E. Power Biggs with London Philharmonic conducted by Sir Adrian Boult
- COLUMBIA KS-6005  
BACH "BACH AT ZWOLLE"  
E. Power Biggs, organist
- EPIC BC-1003  
BRAHMS "CONCERTO #1 FOR PIANO AND ORCHESTRA"  
Leon Fleisher with Cleveland Orchestra conducted by George Szell
- EPIC BC-1001  
BEETHOVEN "SYMPHONY #3"  
George Szell and the Cleveland Orchestra
- LONDON CS-6019  
BEETHOVEN "EMPEROR CONCERTO"  
Clifford Curzon with Vienna Philharmonic conducted by Hans Knappertsbusch
- LONDON CS-6025  
BERLIOZ "SYMPHONIE FANTASTIQUE"  
Ataulfo Argenta and Paris Conservatory Orchestra
- LONDON CS-6031  
STRAVINSKY "LA SACRE DU PRINTEMPS"  
Ernest Ansermet and Orchestre de la Suisse Romande
- LONDON CS-6066  
MOZART "EINE KLEINE NACHTMUSIK"; TSCHAIKOVSKY "SERENADE FOR STRINGS"  
George Solti and Israel Symphony Orchestra
- LONDON CS-6024  
DEBUSSY "LA MER" and "L'APRES-MIDI D'UN FAUNE"; RAVEL "RHAPSODIE ESPAGNOLE"  
Ernest Ansermet and Orchestre de la Suisse Romande
- LONDON CS-6058  
MASSENET "LE CID" (ballet suite); MEYERBEER "LES PATINEIRS" (ballet)  
Jean Martinon and Israel Philharmonic
- LONDON CS-6062  
BIZET "CARMEN SUITE" AND "L'ARLESIENNE SUITES"  
Ernest Ansermet and Orchestre de la Suisse Romande
- LONDON CS-6049  
GRIEG "PEER GYNT" (incidental music)  
Oivon Fjelstad and London Symphony
- MERCURY 90129  
HAYDN "SYMPHONY #96" and "SYMPHONY #35"  
Paul Paray and Detroit Symphony Orchestra
- MERCURY 90002  
GERSHWIN "RHAPSODY IN BLUE" and "CONCERTO IN F"  
Eugene List with Eastman-Rochester Symphony Orchestra conducted by Howard Hanson
- RCA LSC-1817  
OFFENBACH "GAITE PARISIENNE"  
Arthur Fiedler and the Boston Pops
- RCA LSC-2201  
MUSSORGSKY "PICTURES AT AN EXHIBITION"  
Fritz Reiner and the Chicago Symphony Orchestra

- RCA LSC-2209  
BRAHMS "SYMPHONY #3"  
Fritz Reiner and the Chicago Symphony Orchestra
- VANGUARD SRV-10DSD  
HAYDN "SYMPHONY #100" and "SYMPHONY #101"  
Hermann Scherchen and the Vienna State Opera Orchestra
- WESTMINSTER 14043  
BACH "TOCCATA AND FUGUE IN d FOR ORGAN"  
Carl Weinrich, organist

## OPERA

- LONDON OS-25044  
WAGNER "ARIAS"  
George London, bass
- LONDON OS-25045  
MOZART "MARRIAGE OF FIGARO" (excerpts)  
Siepi, Gueden, Danco, Poell, Corena with Vienna Philharmonic conducted by Eric Kleiber

## LIGHT MUSIC

- CAMDEN CAS-428  
WILLSON "MUSIC MAN"  
Hill Bowen and his band (special at \$2.98)
- CAPITOL SWAO-595  
RODGERS "OKLAHOMA"  
Jay Blackton with orchestra and soloists from film version soundtrack
- CAPITOL ST-1110  
SOUSA "MARCHING BAND"  
Meredith Willson and a military band (watch for bagpipes on Side 2)
- CAPITOL SW-740  
RODGERS "KING AND I"  
Orchestra, soloists, and chorus from film version soundtrack
- CAPITOL SP-8427  
"LA BELLE FRANCE"  
Carmen Dragon and Capitol Symphony Orchestra
- CAPITOL ST-868  
"PORTS OF PLEASURE"  
Les Baxter and his Orchestra
- CAPITOL ST-915  
"SEA OF DREAMS"  
Nelson Riddle Orchestra
- LONDON PS-118  
STRAUSS "WALTZES"  
Mantovani and his Orchestra
- LONDON OSA-1201  
GILBERT & SULLIVAN "MIKADO"  
D'Oyly Carte Opera Company (especially Sides 1 & 4)
- LONDON PS-153  
LECUONA "MUSIC OF LECUONA"  
Stanley Black and his Orchestra

## JAZZ AND POPS

- AUDIO FIDELITY 5849  
"LIONEL HAMPTON AND HIS VIBES"  
Lionel Hampton and his Orchestra (only for fans who can "take it." Buy only if willing to forget "ping-pong" effect)
- CAPITOL ST-1082  
"LATIN LACE"  
George Shearing and his Quintet
- CAPITOL ST-1180  
"JACKIE DAVIES MEETS THE TROMBONES"  
Jackie Davies, organist, with his band
- CAPITOL SW-993  
"ST. LOUIS BLUES"  
Nat "King" Cole and his band
- CAPITOL SPAO-8421  
STRAUSS "WALTZES"  
Felix Slatkin and Hollywood Bowl Symphony
- HI-FI SR607  
"LEIS OF JAZZ"  
Arthur Lyman and his Jazz Ensemble (advanced jazz)
- HI-FI SR-806  
"TABOO"  
Arthur Lyman and his Jazz Ensemble (exotic tunes)
- HI-FI SR-813  
"LEGEND OF PELE"  
Arthur Lyman and Troical Ensemble (jungle stuff)
- LONDON PS-152  
"CHA-CHA-CHA"  
Edmundo Ross and his Latin Ensemble
  - LONDON PS-114  
"RHYTHMS OF THE SOUTH"  
Edmundo Ross and his Rhythmic Ensemble
  - LONDON PS-117  
"ALL TIME TOP TWELVE"  
Ted Heath and his band

## CHRISTMAS

- CAPITOL SP-8393  
"MUSIC OF XMAS"  
Hollywood Bowl Symphony Orchestra
- RCA LSC-2139  
"CHRISTMAS HYMNS AND CAROLS"  
Robert Shaw Chorale with Orchestra

• TOP rated



# Readouts and Counter Tubes

By ED BUKSTEIN

Northwestern Television and Electronics Institute

Important adjuncts for all electronic counting circuits: indicators that give visual tallies.

**EDITOR'S NOTE:** In earlier articles, the author has explored the various types of electronic counting circuits and the ways in which they work rather extensively. Now he turns to the matter of usefully extracting information they develop. Obviously indicators that make this information readily available are needed. There are many such, as the author shows

IT IS CHARACTERISTIC of binary and decade counting circuits that some of the tubes in them are below cut-off while others are at saturation. Which of the tubes are in each of these conditions at any given instant is determined by the number of pulses that have been applied to the input of the counter. Conversely, conditions of the tubes in the counter may be used to determine the number of pulses applied.

Earlier articles have shown how neon lamps may be wired into counting circuits to provide external indication of internal conditions. In fact, neon lamps are frequently used as front-panel indicators on counters.

Some typical arrangements of such readout lamps are shown in Fig. 1. For a pure binary counter, lamps are numbered, from input stage, 1, 2, 4, 8, 16, and so on up, with the total pulse count being obtained by adding the numbers of the lamps that are on. In the pure binary counter of Fig. 1A, 174 pulses have been applied to the input ( $128+32+8+4+2$ ).

When a number of 4-lamp decade counters is connected in cascade, the neon lamps are arranged as shown in Fig. 1B, with each vertical column of lamps representing another decade. Here, each of the five decades is assumed to be of the type consisting of four binary stages, with feedback networks being used to re-set each decade on every tenth pulse.

The lamps lit in each decade add up to the digit for that vertical column. The right-hand column or decade represents ones or units ( $8+1=9$ , in this

case), the next decade represents tens ( $4+2+1=7$  tens, or 70), the next hundreds, and so on. Thus the lights in Fig. 1B indicate 26,179.

In Fig. 1C, five 10-lamp decades have been connected in cascade. Again the

pulse count is determined by reading the "on" lights, but the task is made easy because only one light at a time must be read in any vertical decade. Nevertheless, there is still a reading problem: except when the digits in all decades happen to be the same, the numbered lights do not appear in a single, horizontal line.

For easier readability, several types of in-line readout devices have been developed. The front panel of an instrument using such a device is shown in Fig. 3. It is a digital voltmeter made by *Electro Instruments, Inc.* In-line readout devices fall into three general categories:

1. The projection type, in which a light source is used to project an image of the desired numeral onto a ground-glass screen. In a variation of this type, lighted-line segments, instead of complete numerals, are selected and projected in such a pattern that they form the desired numeral.

2. The edge-lighted type, in which the numerals are engraved on individual sheets of lucite. The lucite sheets for a set of numerals are then stacked one in front of the other. A numeral is then selected for displaying by edge-lighting the sheet on which it is engraved.

3. Multi-element electron tubes with built-in numerals that are made to light up selectively by tube action. These include *Burroughs Nixie®* and *Pixie* indicators.

The general techniques for activating projection and edge-lit readout devices are not too different from those used with neon indicators. Tubes, however, are another matter.

## Pixie & Nixie Indicators

The Pixie readout indicator is a gas-filled tube containing ten cold cathodes located beneath a single disc-shaped anode. As shown in Fig. 2, the anode disc has ten perforations shaped like

Fig. 1. Neon readout lamps for (A) pure binary counter, (B) for five 4-lamp decades, and (C) for five 10-lamp decades.

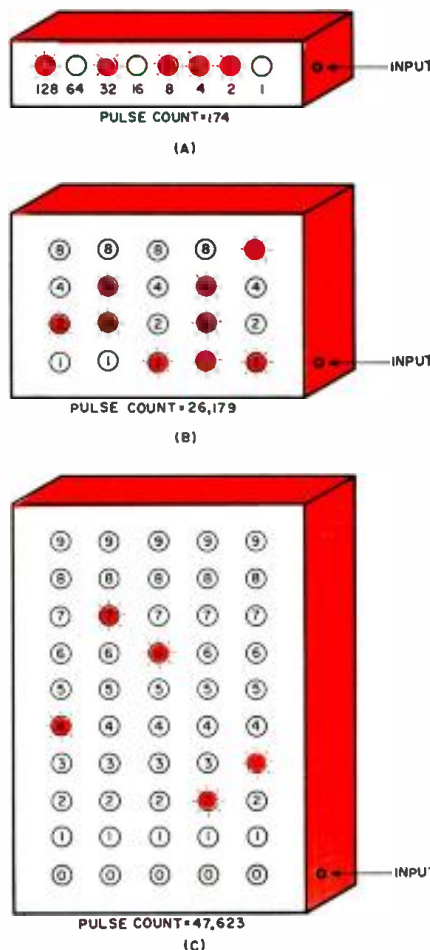

the numerals from 0 to 9. The cathodes are arranged so that one falls under each perforation. When sufficient voltage to ionize the gas is applied between the disc anode and one of the cathodes, the resulting ionization glow is visible through the corresponding numerical perforation. In Fig. 2, the cathode under number 5 is activated. Numerals can be illuminated in succession as the voltage applied is shifted from cathode to cathode.

The Nixie is also a gas-filled tube containing ten cold cathodes and a common anode. In this case, however, the cathodes themselves are shaped like the numerals from 0 to 9. When sufficient voltage is applied between the anode and one of the cathodes, the ionization glow surrounding the selected, numeral-shaped cathode provides visual readout. To accommodate different applications, Nixie indicators are available in a variety of sizes ranging from the miniature to jumbos that provide readable indications 150 feet away. Three sizes are shown in Fig. 4. The numeral 5 above each indicates the relative size of indications, which are viewed looking down at the tubes when they are in the positions shown.

Fig. 5 shows two complete, compact, decade counters. The one on the left includes an integral Nixie indicator, with the latter horizontally mounted to provide easy, head-on reading. A number of these compact decades can be connected in cascade and mounted so that their Nixies provide in-line readout. The counter at the right is a similar unit that is used to control a remotely located Nixie.

### The Glow-Transfer Tube

One type of multi-electrode tube has been designed so that it can be operated as a complete, self-indicating decade counter, with no external readout device required. Like other indicator tubes, it is gas-filled, has ten cold cathodes, and a single anode. However

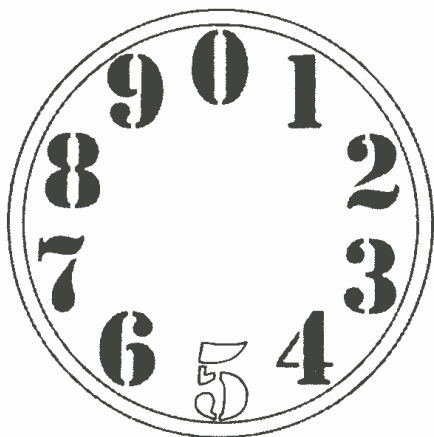

Fig. 2. One of 10 cathodes in Pixie glows through perforation in the anode.

it also has other elements to make the counting function possible, which will be discussed shortly, and the cathodes are pin-like structures arranged in a circle around the disc-shaped anode. When ionization occurs between the anode and one of the cathodes, the glow appears as a bright, visible spot at the tip of the cathode pin. As input pulses are applied to the tube, ionization transfers around the circle from cathode to cathode, with the position of the glow thus providing an indication of the pulse count.

A counter, made by Westport Electric, using glow-transfer tubes is shown in Fig. 7. The ten cathode positions for each tube have been numbered externally, so that the position of the glow can be read as a decimal digit on each tube. After ten input pulses have been applied to a glow-transfer tube, the glow returns to the initial cathode and the tube produces an output pulse, as do other decade counters. This output may then be used to trigger another tube of the same type to indicate the next decimal position. The counter of Fig. 7 uses five glow-transfer tubes in cascade. It therefore has

a total counting capacity of  $10^5$ , or 100,000.

Concerning the tube itself, for each cathode there are two additional electrodes, called guide pins (see Fig. 8). The cathodes are labeled  $K_n$  through  $K_{10}$ . Between any two adjacent cathodes, there is a pair of guide pins ( $G_1$  and  $G_2$  for each pair). The latter serve to transfer the glow from one cathode to the next. All of the guide pins identified as  $G_1$  are tied together internally and brought out to a single pin on the base of the tube. All  $G_2$  guide pins are similarly tied together internally and brought out to a single connection on the tube base.

When voltage is applied to the glow-transfer tube, ionization occurs between the anode and one of the cathodes. There is an external anode resistor, shown in Fig. 6, across which a voltage drop occurs when the tube has started to conduct between any one cathode and the common anode. This drop immediately lowers voltage across the tube so that it falls below the firing point. Thus a glow cannot form at any cathode except the one that has already been ionized, and only one cathode at a time can be activated.

In order to transfer the ionization glow from one cathode to the next adjacent one, we must apply two negative pulses to the tube, one to the  $G_1$  pins and the other to the  $G_2$  pins. Furthermore, as shown in Fig. 6, these pulses must overlap in time, so that all  $G_1$  pins become negative before the  $G_2$  pins do, but that the  $G_2$  pins remain negative for a short time after the  $G_1$  pulse is completed. These requirements would seem to complicate practical application of the glow-transfer tube, but the matter can be resolved simply: a single pulse source may be used, with a delay network feeding to the  $G_2$  circuit.

When any particular cathode in this tube is glowing, this is because it is the most negative electrode in its group



Fig. 3. (Upper left) An application of in-line readout: a digital voltmeter that provides quick, direct readings.

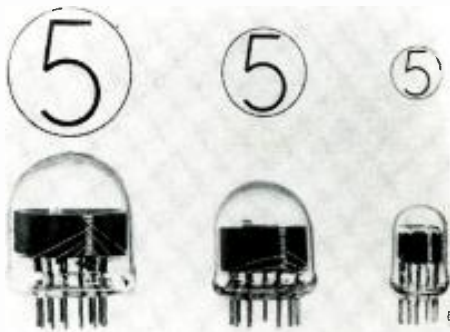

Fig. 4. (Above) These 3 Nixie sizes, from left to right are super, standard, and miniature. Digits at top show relative size of indications, seen looking down at tubes.

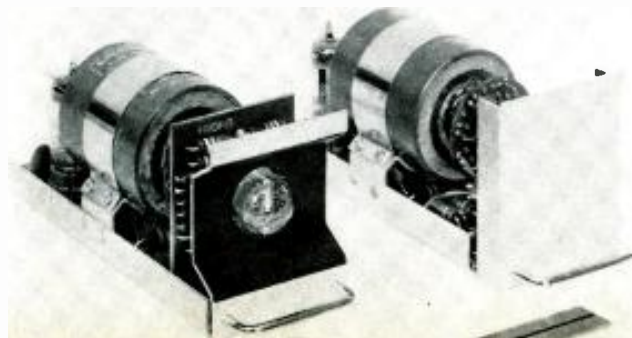
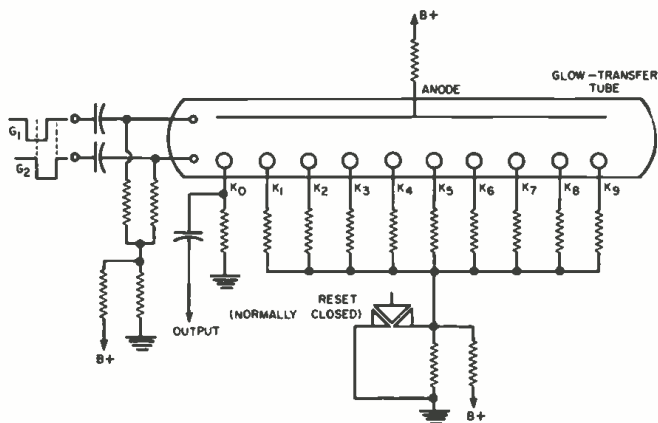

Fig. 5. (Lower left) Burroughs decade counters including Nixies, like one at left, mount side-by-side for in-line readout. Decade at right controls remotely located Nixie.



◀ Fig. 6. This decade counter is built around a single glow-transfer tube. Reset switch forces  $K_1$  to  $K_9$  positive, returning the glow only to cathode  $K_0$ .



▶ Fig. 7. Device with 5 glow-transfer tubes can count to 100,000. Position of glow in each tube can be read by external digits marked on the panel.

of elements. Let us assume that this is cathode  $K_n$  in Fig. 8. When the first pulse is applied, the  $G_1$  pins become more negative than the cathodes. Thus the glow at  $K_n$  transfers to the nearest  $G_1$  guide pin, which happens to be the one to the right of it, going clockwise. When the  $G_1$  pulse ends, the  $G_2$  guide pins are the most negative electrodes in the tube, so the glow darts clockwise again to the nearest  $G_2$  pin. However, the  $G_2$  pulse passes quickly and the cathodes, which are maintained at the lowest fixed potential applied to the tube, become the most negative electrodes. Thus ionization glow transfers to the closest cathode, which is  $K_1$  in this example.

The fixed potential at the cathode, in the absence of input pulses, is kept more negative than that on other electrodes by the application of a small positive bias to all guide pins from the "B+" line, as shown in Fig. 6. Although each cathode has its own resistor in Fig. 6, a common resistor may be used for all cathodes except  $K_0$  in certain applications. Individual resistors, however, permit greater flexibility in using the tube as a ring counter, for an output pulse may be taken from any one of the stages (cathodes) within the tube for external use. When the tube is used only to count by tens, the common resistor is sufficient. In fact, some glow-transfer tubes are designed so that all cathodes except  $K_0$  are tied together internally and brought out to a single base pin. This simplifies circuit wiring.

A glance at Fig. 6 shows that, when the normally closed re-set switch is opened momentarily, a positive potential is applied to cathodes  $K_1$  through  $K_9$  inclusive. At this moment, the  $K_0$  cathode is the most negative electrode in the tube, and the glow will occur only at that point. The same end can be achieved by using a negative re-set pulse or voltage and applying it to the independent  $K_0$  cathode. Whichever method is used, a definite starting position is provided from which the counting can begin. Once counting has begun, the application of every tenth pulse will return the glow, in its clockwise progression, to the  $K_0$  position. The drop that then occurs across the separate resistor of this cathode may then be used as an external output

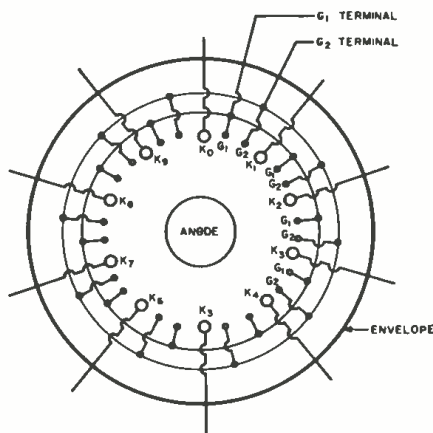

Fig. 8. The anode of a glow-transfer tube is ringed by ten cold cathodes.

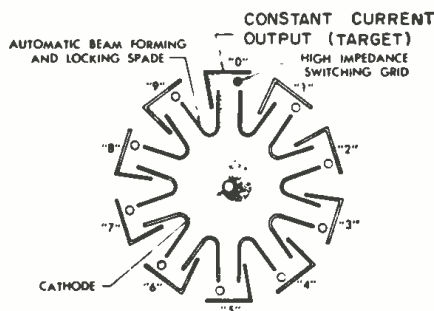

Fig. 9. MBS counter tube has 1 cathode.

Fig. 10. Outer magnet rings MBS tube.



pulse, for application to the next decade in cascade or for other use.

In some counting applications where the ratio is less than 10 it is nevertheless desirable to use glow-transfer tubes. The tube is made to produce a lower counting ratio by the method known as *forced re-setting*. Actually, this technique is related to the use of feedback, described in earlier articles, for reducing the ratio of other counting circuits. For such applications, of course, there must be separate external connections for the cathodes; a tube with nine of its ten cathodes tied together internally is limited to decade counting only.

### The Beam-Switching Tube

The last device to be considered here is one that functions like the glow-transfer tube in many ways, from the practical viewpoint, but is quite unlike it in important respects. The magnetron beam-switching (or MBS) tube has a single, centrally located cathode that is surrounded by ten anodes also known as targets; it thus reverses a relationship already discussed in the glow-transfer tube. Another important difference arises from the fact that the MBS tube is a vacuum type. This permits higher switching rates than can be achieved with gas-filled devices, with some MBS versions capable of switching at rates in excess of five megacycles.

Important to the operation of this tube is a cylindrical magnet attached to the glass envelope. The magnetic field produced by this structure interacts with the fields existing between electrodes inside the tube in such a way that it can influence the direction of electron flow. This beaming or deflection technique will be familiar to anyone who knows that magnetic fields, such as those produced by external yokes and focus coils, control the deflection of the electron beam in a TV picture tube.

In general terms, operation of the MBS tube may be described as follows: As a result of interaction of the various fields involved, electrons flow from the common cathode to one of the anodes. Each time an input pulse is applied, this flow from the cathode is transferred to the next target. The

(Continued on page 136)

# new tuner standard

fm  
am

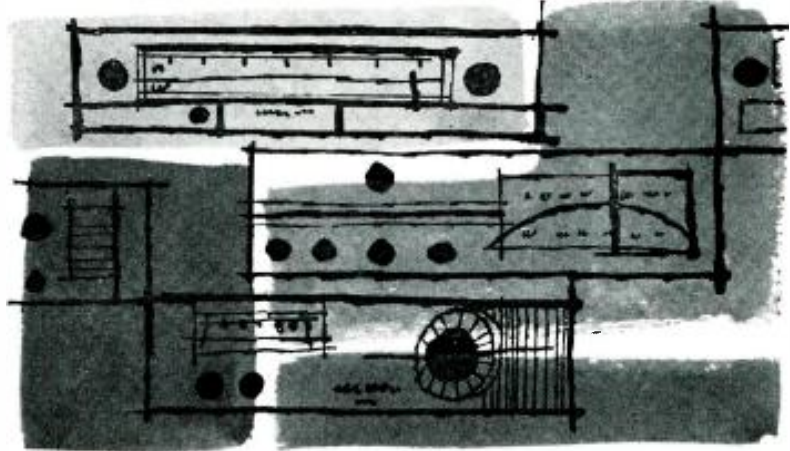

By DANIEL R. VON RECKLINGHAUSEN

Chairman, IHFM Sub-Committee on Tuners  
Chief Research Engineer, H. H. Scott, Inc.

**Salient features of the Hi-Fi Institute's recently adopted standards for measuring AM/FM tuners.**

**T**HE Institute of High Fidelity Manufacturers has recently released its first standard, IHFM-T-100, entitled "Methods of Measurement for Tuners."

This standard represents a step forward in the techniques of tuner measurement. Previously, the only standards covering this field were those released by the Institute of Radio Engineers in 1947-48. These IRE standards were the best that could be devised at the time but later experience showed that certain necessary characteristics of tuner performance had not been included while other characteristics were measured in such a way that "good" test results did not necessarily mean "good" listening performance.

According to this new standard, a number of characteristics of either or both AM and FM tuners are to be measured: tuning range and frequency calibration, usable sensitivity, volume sensitivity, capture ratio, selectivity, amplitude modulation suppression, frequency response, distortion, spurious response, hum and noise, frequency drift, radiation, automatic frequency control, squelch control, loop antenna, and crosstalk.

#### Standard Conditions

All of these listed characteristics are to be measured under "standard" conditions. These conditions are:

Carrier frequencies: For FM tests, 90, 98, and 106 mc. and for AM tests 600, 1000, and 1400 kc. are standard test frequencies. Some tests are to be made using only one carrier frequency in which case it will be 98 mc. for FM

and 1000 kilocycles for an AM tuner.

Since the settings of the various tuner controls will affect test results, certain standardized control positions have been specified. For example, the a.f.c. control, if present, is set for minimum control; the squelch control for maximum sensitivity; any tone controls for flattest response as indicated by panel markings; and volume control for maximum. Only in the case of tuners which incorporate extra stages of amplification, such as units equipped with phono-preamplifier or power-output stages, should the volume control be set for 20 db attenuation. This is to prevent clipping of the audio signal due to excessive amplification.

Input voltages, their measurement, and dummy antennas to be used for both AM and FM testing have been specified. These standards are diagrammed in Figs. 1 through 4.

The standard test modulation has also been specified. For most tests, the modulation frequency, except for some distortion and frequency response tests, is 400 cps. The standard modulation for FM is 100% or 75 kc. deviation while for AM this figure is 30%, except for distortion tests, where 90% is to be used.

#### Usable Sensitivity

If one wished to specify the most important characteristic of an FM tuner, a measurement of "usable sensitivity" would have to be made. The definition and measurement of usable sensitivity constitute the most important contribution made in the new standard. This term will be used gen-

erally within a few months to describe the sensitivity of tuners rather than the "quieting" figure as defined in the IRE standards and used up to now. The best definition and test method covering usable sensitivity of FM tuners is found in Section 6.03.02 of the new standard. Here is this section in its entirety:

*"This test is performed at each of the standard test frequencies with the signal generator connected to the tuner under test through the standard 300-ohm dummy antenna. The signal generator should be frequency modulated with standard test modulation. The controls of the tuner shall be set to the normal control settings. The signal intensity should then be reduced to the least value which will produce a 30 decibel rise in indicated output with standard test modulation as compared with the indicated output with standard test modulation measured through a 400-cps null filter. This test serves to indicate the relative freedom of the tuner from objectionable internal receiver noise during pauses in modulation and receiver noise is least likely to be masked by modulation. This test also serves to indicate the relative freedom of the tuner from objectionable distortion during periods of maximum modulation.*

*"The results are expressed in microvolts."*

What is new and different about this definition and how does it help the user to decide about the performance of a tuner?

First, this and all other measurements in the new standard are to be

made with a 300-ohm antenna since most antennas have this impedance. This insures that the same yardstick is used on all tuners. It may not be generally realized but measurements performed at 75 ohms will give results, in microvolts, which are half those obtained with 300-ohms impedance although performance of the tuner is not one hair better. The reason is that the same power is required by the tuner for a given performance and this power is simply the square of the voltage at the antenna terminals divided by the antenna impedance.

Second, a 300-ohm dummy antenna will have to be used and the input voltage to the tuner measured by replacing the tuner with a voltmeter having an input impedance of 300 ohms. This input voltage is the same as the "soft microvolts" used before except that here the 300-ohm impedance is specified. This will insure that tuners are designed for best possible performance with a standard 300-ohm antenna rather than for the lowest microvolt figure, irrespective of impedance.

Third, if a tuner should have more than 3% distortion it would be impossible to obtain a usable sensitivity figure no matter how high the input to the tuner might be. In this way, the customer is assured of getting a tuner with no more than 3% distortion at any input voltage equal to, or higher than, the usable sensitivity test input. Generally, this distortion figure will run considerably lower. Distortion is measured at 75 kc. deviation at a 400-cps rate which is standard test modulation in the IHFM Standard as well as 100% modulation for an FM broadcast station. In this type of measurement care must be taken to insure that the null filter has a high-impedance input to avoid attenuating the frequencies far removed from 400 cps. A low-impedance filter may cause distortion in the audio circuits of the tuner and a filter which attenuates the second and higher harmonics of 400 cps will give a distortion figure which is much lower than the actual distortion.

### Volume Sensitivity

Closely linked to the measurement of usable sensitivity is the measurement of "volume sensitivity," as covered in Section 6.03.03. This covers the r.f. input required to produce an audio output 20 db lower than that produced by a 100,000  $\mu$ v. signal. High-quality, high-gain tuners will measure zero microvolts in this test while tuners with insufficient amplification or limiting may show a microvolt figure which is greater than that obtained in the usable sensitivity test. For this purpose, Section 6.03.03 states:

*"The rated sensitivity of a tuner shall be equal to the highest number of microvolts obtained in all tests of Sections 6.03.02 and 6.03.03. . ."* and these tests to be made at 90, 98, and 108 mc. All this should insure that tuners with rated sensitivities in low microvolt figures should have good sensitivity, low distortion, and adequate

audio output irrespective of signal strength.

As users and designers of FM tuners know, sensitivity is not the only important tuner characteristic although it is often given as the major specification. Equally important is the tuner's ability to reject interference.

### Capture Ratio Test

The capture ratio test is a measure of the tuner's ability to reject unwanted signals occurring at the same frequency to which the unit is tuned. This test shows the inherent effectiveness of the detector, limiter, and automatic volume control circuits. For this test, two signal generators are required, one of which is modulated 100% and the other unmodulated. A dummy antenna, which permits two signal generators to be connected to a single tuner, is used in this test.

To measure the rated capture ratio of the tuner the modulated generator is set to produce a 1000  $\mu$ v. input to the tuner while the output of the unmodulated generator is advanced until the audio output of the tuner falls 1 decibel. The output of the generator is then recorded. Next the output control of the unmodulated signal generator is advanced until the audio output of the tuner falls a total of 30 decibels. This figure is again recorded.

The ratio of the two values thus recorded is converted to decibels and this figure is divided by 2. This result is defined as the "db capture ratio" for 100% modulation. This is the ratio of desired or undesired signal required for 30 db suppression of the undesired signal. This test is extremely important since there are a number of stations in the northeastern section of the United States which are assigned the same

frequency but are physically separated by less than 100 miles. If a tuner has a low capture ratio, then one or the other of these stations can be received in some areas without noticeable interference by simply rotating the antenna to pick up the signal from the desired station.

### Selectivity Test

Equally important is the tuner's ability to reject interference and signals which differ in frequency from that of the desired signal. Part of this measurement is performed in the selectivity test.

Test conditions are the same as those described in the capture ratio test except that the interfering signal generator is separated in frequency from the desired signal by two standard channels (400 kc.). The signal generator delivering the desired signal is set to produce an input of 100  $\mu$ v. to the tuner and the audio output voltage with 100% modulation is recorded. Then the modulation of the signal generator is switched off. The interfering signal produced by the other signal generator is 400 kc. removed from that of the desired signal. This interfering signal is modulated with 400 cps, 75 kc. deviation and the output of this signal generator is advanced until the audio output of the tuner has risen to a value 30 db below the previously determined audio output. The two signal generator output voltages are recorded and converted to a ratio which is then converted to decibels. This decibel figure gives the selectivity of the tuner.

The same procedure is followed in the case of AM tuners except that 30% amplitude modulation is used.

It should be noted that all of these  
(Continued on page 117)

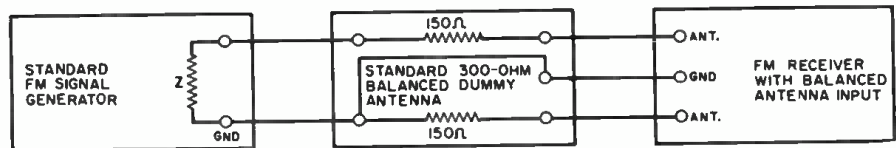

Fig. 1. Standard 300-ohm balanced dummy antenna and the method of connection.

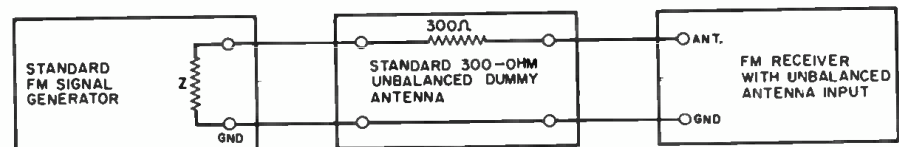

Fig. 2. Standard 300-ohm unbalanced dummy antenna and the method of connection.



Fig. 3. Method of measurement of input signal intensities and connection method.

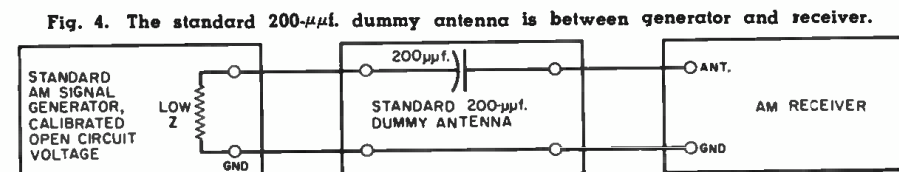

Fig. 4. The standard 200- $\mu$ f. dummy antenna is between generator and receiver.

# ELECTRONICS IN OUTER SPACE

PART

3

By JORDAN McQUAY

**Some interesting applications of artificial earth satellites as space communications relay stations as well as for television transmissions.**

**T**HE previous parts of this series have covered some of the specific electronic equipment used in outer space. This, the concluding article, will cover the application of satellites as communications relays and as part of a television transmission system.

### Communications Relays

Although satellites and space probes provide a wealth of scientific and environmental data, specially equipped electronics payloads can provide a number of *direct* communication services. Chief among these is the use of satellites as space relay stations.

First use of a satellite as a radio relay station occurred accidentally during the one-day flight of "Pioneer I" in October 1958. The electronics payload included a command receiver, which was supposed to trigger a reverse rocket and thus propel the vehicle further into space. Although the rocket

failed to function on command, the command signals were instantaneously rebroadcast by the data transmitter aboard the "Pioneer I." These command signals were heard half-way around the world!

Not so accidental was the "talking" satellite known as "Project Score"—for Signal Communications by Orbital Relay Equipment. Carried aboard an "Atlas" missile and operated successfully during December 1958, this electronics payload had been specifically designed as a radio relay station for operation in the upper atmosphere. This was also the first step toward future "courier" satellites for military types of communication requiring extreme security of operation.

The payload consisted essentially of an FM messenger receiver (150 mc.), a control switching circuit, a commercial-type magnetic tape recorder, an FM message transmitter (132 mc.),

and a battery power supply. The payload also included a beacon or tracking transmitter (108 mc.). See Fig. 15.

The FM message receiver operated continuously. Other components of the payload were not in operation *except* when activated by the control circuit. When the appropriate command signal was received from a ground station, the control circuit triggered any one of three operating conditions: (1) turned on the tape recorder to *receive* messages from ground stations; (2) turned on the tape recorder to *play back*, and turned on the FM message transmitter to broadcast the recorded tape; or (3) connected the output of the message receiver directly to the FM message transmitter.

With conditions 1 and 2, the electronics payload functioned as a delayed repeater, with no limitation on the time between receipt and rebroadcast of a message. With condition 3, the payload functioned as an instantaneous radio relay.

The payload accepted and relayed voice messages and as many as seven teletypewriter channels. It was loaded, switched, and triggered successfully throughout the 12-day period of its existence—proving the feasibility of space relay stations.

Other, more sophisticated, payloads are being developed for use during the next two years. These will feature refined circuitry and expanded operating bandwidths up to about 100 kc. By 1965, bandwidths of from 4 to 5 mc. will be achieved, making possible the long-distance relay of television signals by space relay stations aboard orbiting satellites.

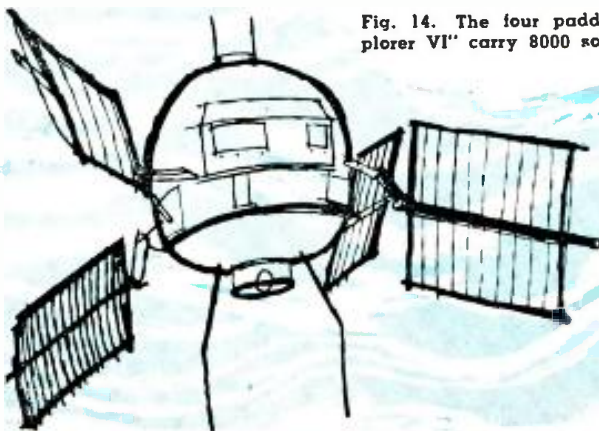

Fig. 14. The four paddle wheels on "Explorer VI" carry 8000 solar cells for power.

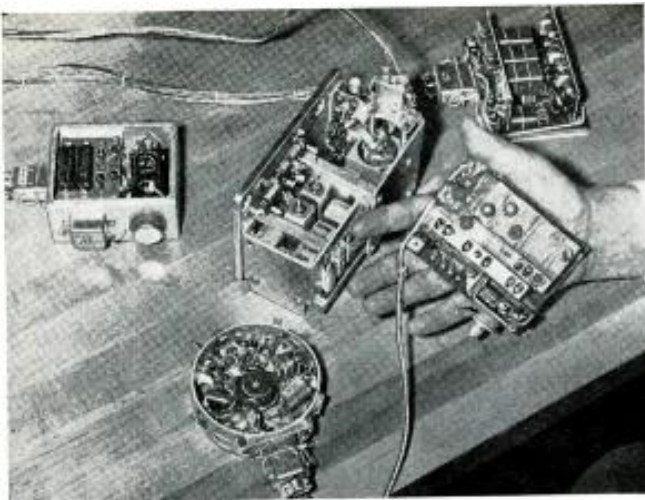

Fig. 15. The elements that form the electronics payload employed for the Project "Score." Being held at the right is the 10-ounce command receiver. Behind it is the electronics control unit. The large unit in the center is the FM message transmitter, with its power converter at the left. Foreground unit is  $\frac{3}{4}$ -lb. beacon or tracking transmitter.

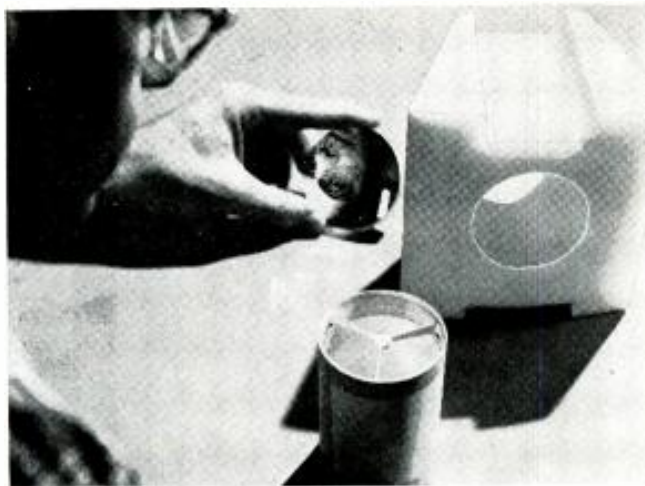

Fig. 16. Being held in the photograph above is the scanning device for photoelectric cell sensory unit in the "Pioneer I."

### Photoelectric Systems

Special types of *optical* sensory units have been developed primarily for mapping and crude surveillance of large areas. These units employ photocells with appropriate scanning devices and switches. Characteristically, they can distinguish only between light and dark areas; but they can map effectively in terms of black-and-white contrast—such as between sea and land regions. They can be used similarly to record the distribution of clouds over the surface of the earth or other planets, again in terms of black-and-white contrast. But in any application, photoelectric sensory units provide poor definition.

First of these optical sensory units was part of the electronics payload aboard the "Pioneer I," but was not operative because the space probe failed to reach the vicinity of the moon. The sensory unit will be used on later space probes for the identical purpose of mapping areas of the moon and other planets.

Such a sensory unit consists essentially of a scanning device (Fig. 16) and two photocells and other elements sensitive to infrared illumination. The entire unit is contained in a barrel which turns as the space vehicle rotates in flight. There are two small circular apertures on each side of the barrel. Each aperture is equipped with a small mirror-type telescope and is armed with a hydraulic timer.

At an altitude above 100,000 miles, the earth offers too small an image to activate the photocells but when the space vehicle is pointed properly on a pass near the moon or any other planet, the reflected sunlight from the planet is sufficient to enter both apertures and trigger the photocells simultaneously. These signal impulses are broadcast by the data transmitter.

By this method, a "strip" of the region is scanned, with the photocells registering impulses for all sunlight reflections. Enough of these "strips," placed alongside each other, provide a crude electronic "picture" of the distant surface—devoid of much defini-

tion, but with enough black-and-white contrast to differentiate between water and land masses.

Another type of optical sensory unit was used in "Vanguard II" satellite to determine the distribution of clouds around the earth. Essential elements of the unit are two photocells mounted behind circular, gridded windows projecting from opposite sides of the satellite. The photocells project opposite each other at an angle of 45 degrees from the spin axis of the satellite, so that one always sweeps the surface of the earth. After amplification, signal impulses from the photocells are fed directly to a magnetic tape recorder containing a 75-foot erasable tape. The recorder operates only when the photocells are scanning the sunlit part of the earth—about 50 minutes out of every hour. The recorder is turned off during darkness by an automatic switch activated by solar cells.

When interrogated by a ground station, the command receiver in the electronics payload triggers the recorder and the data transmitter and an entire 50 minutes of taped data is broadcast in a single 60-second "burst"

Fig. 17. Series bank of mercury batteries used as power supply in "Pioneer III."



of data transmission. Then the payload is reset to record again as the satellite continues its orbit around the world.

### Television Systems

Refined types of optical-viewing satellites for the future will utilize small TV cameras as the sensory units of their electronics payload. In a very real sense, these are the sophisticated successors of the photocell devices described previously. A TV system is far more desirable because of its higher definition characteristics.

Initial satellite to be launched will be in the shape of a shallow cylinder, resembling a "flying saucer" and spinning about ten times per minute at an altitude of from 200 to 500 miles above the earth. Three TV cameras, of the RCA "Vidicon" type, are installed around the periphery of the cylinder.

One camera has a field of view of about 1000 miles with a resolution of about 2.5 square miles. The second camera, with a smaller field of view, resolves a square of about 0.5 mile. The third camera, with the smallest field of view, resolves a square of about 0.1 mile or slightly more than 500 feet.

The TV camera with the widest field of view is aimed perpendicular to the spin axis of the satellite and the other two are aimed in the same direction but along the spin axis.

Each camera produces signal impulses in accordance with the amount of sunlight reflected by the surface of the earth. Cloud areas reflect about 80 per-cent of the sunlight; land about 15 to 20 per-cent; water surfaces about 5 per-cent.

Each camera scans for a fraction of a second and stores the data on a magnetic tape during about two seconds. This results in three channels of data, one from each camera. Subsequently, on command from a ground station, the data is broadcast by a 3-channel multiplex data transmitter.

The TV sensory units are controlled by an automatic switch activated by solar cells so that the cameras operate only during daylight hours. An elec-

(Continued on page 114)

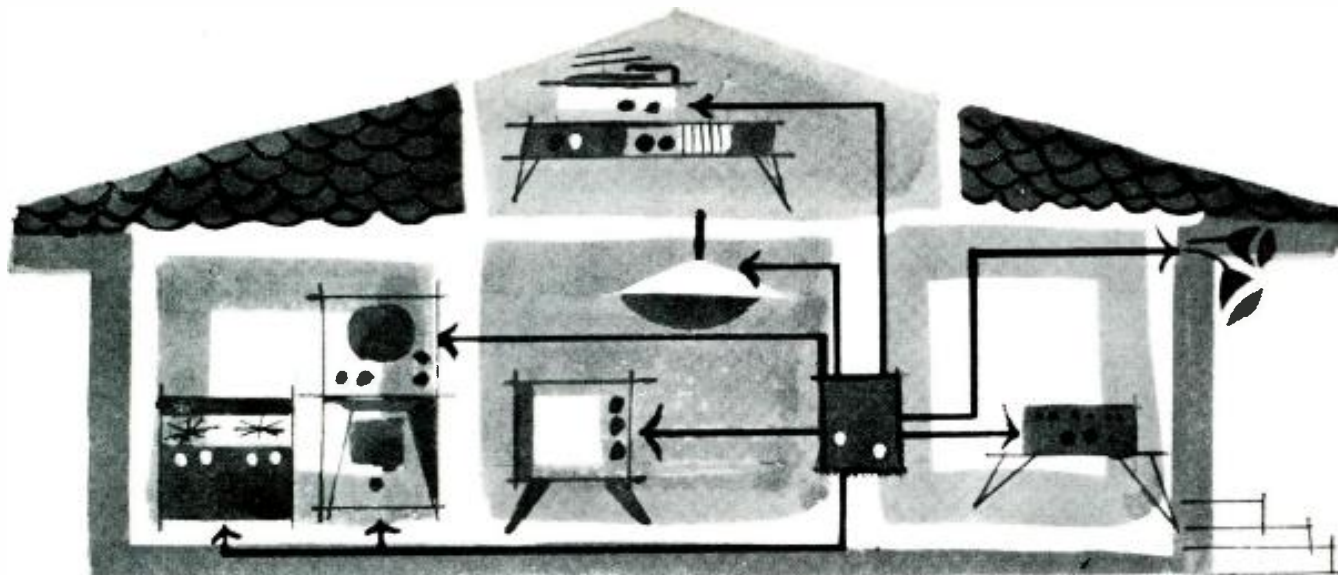

# Tube-Transistor "Carrier Switch"

By DAVE STONE

Use power line for remote control with this easy-to-build and easy-to-align carrier-current transmitter and receiver.

CARRIER receiver and transmitter systems are "old hat" in the field of electronic remote-control devices. They are a time-tested means of using the power lines to carry a transmitted low-power, low-frequency radio signal to operate a remotely located receiver relay unit. The receiver relay set can operate other electronic equipment, turn on motors, lights, open garage doors and, in general, control many other types of appliances which need to be turned on or off.

Today's miniature components lend themselves readily to the construction of compact transmitters and sensitive receivers for carrier-control work. This transmitter-receiver combination is uncomplicated, easy to construct and align, and is very reliable for operation over moderate distances. It uses standard components and best of all, it calls for easily obtained TV replacement width coils for the tuned circuits so coil winding is unnecessary. The frequency can be varied from approxi-

mately 60 to 80 kc. and the low power output of the transmitter precludes interfering radiation from the power line.

## Circuit

The transmitter uses a 6AQ5 in an electron-coupled oscillator circuit, as shown in Fig. 2. This circuit arrangement is very stable and tends to keep power-line variations from loading and affecting the oscillator frequency.  $L_1$  with  $C_1$  forms the tuned tank circuit for the oscillator section, with feedback obtained from the cathode winding into the grid circuit. The plate tank circuit,  $L_2-C_2$ , tunes to the same frequency established by the grid tank and couples the signal out to the power line via  $L_2$ 's secondary.  $C_3$  blocks the a.c. line from being short-circuited through the secondary winding and  $RFC_1$  keeps the r.f. output from being shunted by the power transformer's primary winding. This insures that all the output is sent into the line.

The transmitter power supply is

compact, consisting of a small power transformer, selenium rectifier, and miniature electrolytics. The transmitted signal is simply turned on and off with the "Carrier On-Off" switch  $S_2$  which applies "B+" to the 6AQ5's screen grid and plate.  $R_1$  is the filter resistance and  $R_2$  provides bleeder action by serving as a constant load to the power supply when the "B+" is disconnected in the "Carrier Off" position.

The transmitted signal enters the receiver (Fig. 1) through the tuned circuit  $L_3-C_{10}$  and is detected by the 1N34A germanium diode. The amount of rectified signal applied to the base of the 2N35 *n-p-n* transistor is controlled by the "Sensitivity" potentiometer. The two transistors are connected as a d.c. amplifier circuit and the resulting amplified current in the collector of the 2N43 *p-n-p* transistor operates the 8000-ohm sensitive relay. The 1N69 germanium diode in the emitter of the second transistor pro-

Fig. 1. Circuit of the transistorized carrier-current receiver.

Front views of the complete carrier-current unit with the transmitter at left and the receiver at the right in this photograph.

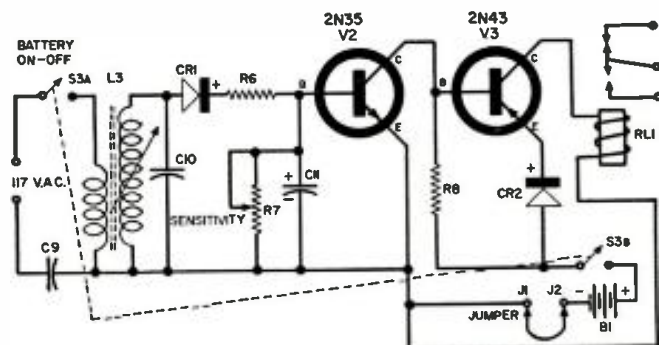
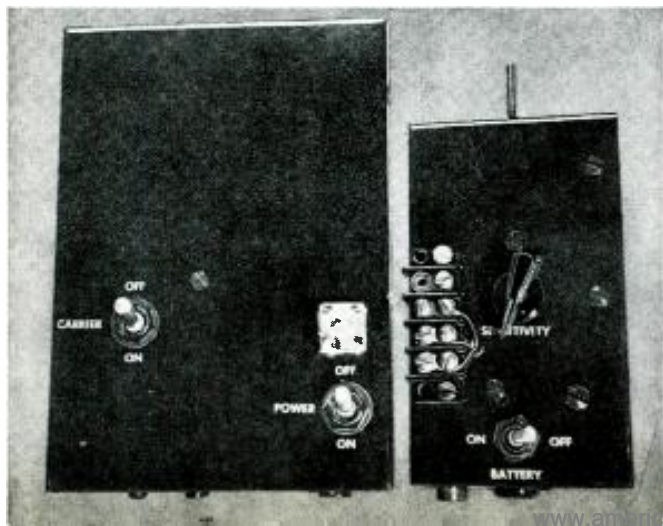

- $R_6$ —1000 ohm,  $\frac{1}{2}$  w. res.
- $R_7$ —10,000 ohm linear taper carbon pot
- $R_8$ —4700 ohm,  $\frac{1}{2}$  w. res.
- $C_9$ —.01  $\mu$ f., 600 v. disc capacitor
- $C_{10}$ —500  $\mu$ f., 600 v. disc capacitor
- $C_{11}$ —5  $\mu$ f., 15 v. miniature elec. capacitor
- $CR_1$ —1N34A germanium diode
- $CR_2$ —1N69 germanium diode

- $RL_1$ —S.p.d.t. 8000-ohm sensitive relay (Sigma 8000 CDS or equivalent)
- $J_1, J_2$ —Pin jack
- $B_1$ —9-12 v. battery
- $S_2$ —D.p.d.t. toggle switch
- $V_2$ —"n-p-n" transistor (2N35)
- $V_3$ —"p-n-p" transistor (2N43)



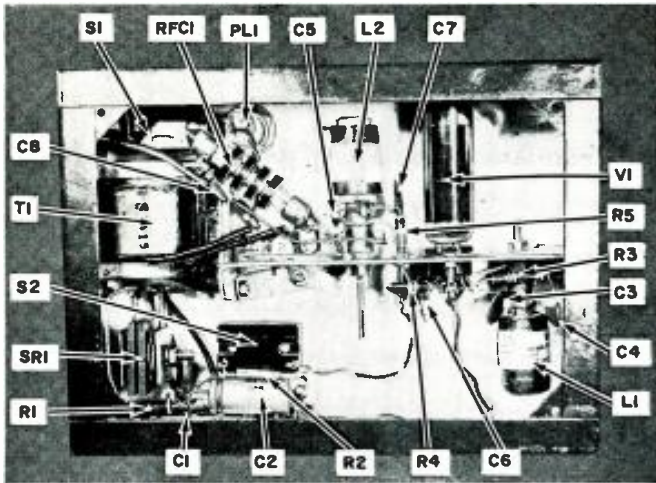

Under-chassis view of the one-tube carrier-current transmitter.

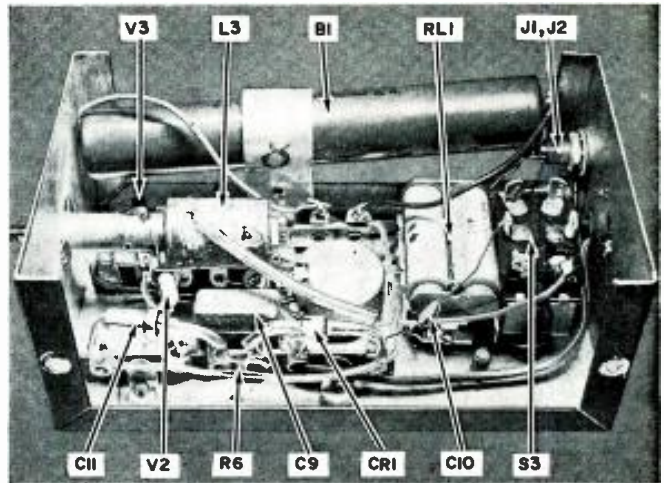

Under-chassis view of the companion two-transistor receiver.

vides cut-off bias when no signal is being received and reduces the current drain during these standby periods. Collector current changes, due to an increase in temperature, tend to be minimized by the diode so it prevents relay operation until a very definite signal is received.

A set of test jacks is wired in series with the negative supply voltage to the 2N43's collector to measure the current flow for alignment purposes and the relative strength of the received signal. During normal use a short jumper wire is connected to the test jacks to complete the circuit. The power requirement for the receiver is nominally 9 to 12 volts. If a 12-volt battery is used, the battery can age and still provide maximum reliability. The current drain during standby periods when no signal is being received is approximately 100 microamperes. When the receiver is installed the current drain is set with the "Sensitivity" control for approximately 2 milliamperes upon receipt of the signal.

### Construction

The transmitter is compactly installed in a 7"x5"x2" chassis. A shelf was constructed to run about two-thirds the length of the chassis and the tube socket, coils, and the rest of the r.f. circuitry is installed on the shelf. The power supply components are mounted in the remaining space. The transformer can be seen to the left in the photo, with the rectifier, filter circuit, and  $S_2$  mounted directly below.

$L_1$  is mounted directly below the shelf and  $L_2$  is mounted above, next to the r.f. choke and power-line connections. This effectively shields the oscillator and output circuits from each other and results in very short connections from the output coil secondary to the power-line cord. The r.f. wiring is kept as short as possible by mounting  $C_1$ ,  $C_5$ , and  $C_7$  on their respective coils and one single ground tie-point is used for each coil circuit. The rest of the wiring is straightforward.

The receiver is housed in a small 5"x3"x2" "Minibox". All transistor circuitry was pre-assembled on terminal

strips and interconnected with the other components when the strips were mounted. The transistors were wired into place, although transistor sockets can be used if desired. Remember to keep a long-nose pliers between the transistor and soldering iron if they are to be wired in. Any layout and straightforward wiring can be used as long as the input coil connections to the power-line cord are short.

### Alignment

The transmitter and receiver are aligned and checked after construction with a standard 20,000 ohms-per-volt v.o.m. Plug the transmitter into the line, apply power, and let it warm up for a few minutes. Throw  $S_2$  to "Carrier Off" and insert v.o.m. between the power supply connection on  $S_2$  and chassis. The meter should indicate about 130 volts d.c., and the reading will drop to 90 volts when  $S_2$  is thrown to the "on" side.

Place the voltmeter between grid 1

and ground to check for oscillation. If all is well the meter will indicate a negative 7 to 10 volts. If no reading, or a very low reading, is obtained reverse either the primary or secondary connections of  $L_1$ . If the rest of the wiring is correct the oscillator will operate immediately when  $S_2$  is closed. Run the slug of  $L_1$  about half-way into the coil.

Connect the v.o.m. probes directly across the plate resistance,  $R_p$ , negative probe to the coil end and positive to the power supply side. Switch the meter-range to read about 10 volts and the meter will indicate the voltage drop across  $R_p$  produced by the plate current flow. Adjust the slug of  $L_2$  for a minimum voltage reading on the meter. This action will tune  $L_2$  to the same frequency as  $L_1$  and will run about 4 to 5 volts when  $L_2$  is fully tuned.

The transmitter's frequency can be roughly determined with a broadcast  
(Continued on page 146)

Fig. 2. Complete schematic diagram of the carrier-current transmitter. Entire circuit, including the power supply components, can be housed in a compact 7" x 5" x 2" metal chassis with a special shelf added.

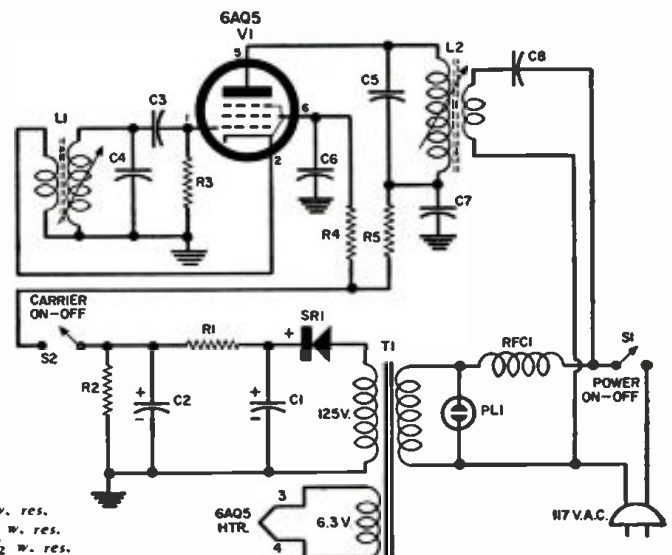

- $R_1$ —3000 ohm, 1 w. res.
- $R_2$ —50,000 ohm, 1 w. res.
- $R_3$ —22,000 ohm, 1/2 w. res.
- $R_4$ —3300 ohm, 1/2 w. res.
- $R_5$ —1000 ohm, 1/2 w. res.
- $C_1$ —4  $\mu$ f., 300 v. elec. capacitor
- $C_2$ —10  $\mu$ f., 150 v. elec. capacitor
- $C_3$ —120  $\mu$ f., 600 v. disc capacitor
- $C_4$ ,  $C_5$ —500  $\mu$ f., 600 v. disc capacitor
- $C_6$ ,  $C_7$ —0.01  $\mu$ f., 600 v. disc capacitor
- $C_8$ —0.015  $\mu$ f., 1000 v. disc capacitor
- $RFC_1$ —2.5 mhy., r.f. choke

- $PL_1$ —117 v. pilot lamp
- $S_1$ ,  $S_2$ —S.p.s.t. toggle switch
- $L_1$ ,  $L_2$ —4-28 mhy. TV width coil (Stancor WC-10 or equiv.)
- $T_1$ —Power trans. 125 v. @ 15 ma.; 6.3 v. @ .6 amp. (Stancor PS8415 or equiv.)
- $SR_1$ —50 ma. selenium rectifier
- $V_1$ —6A05 tube

By JOHN T. FRYE

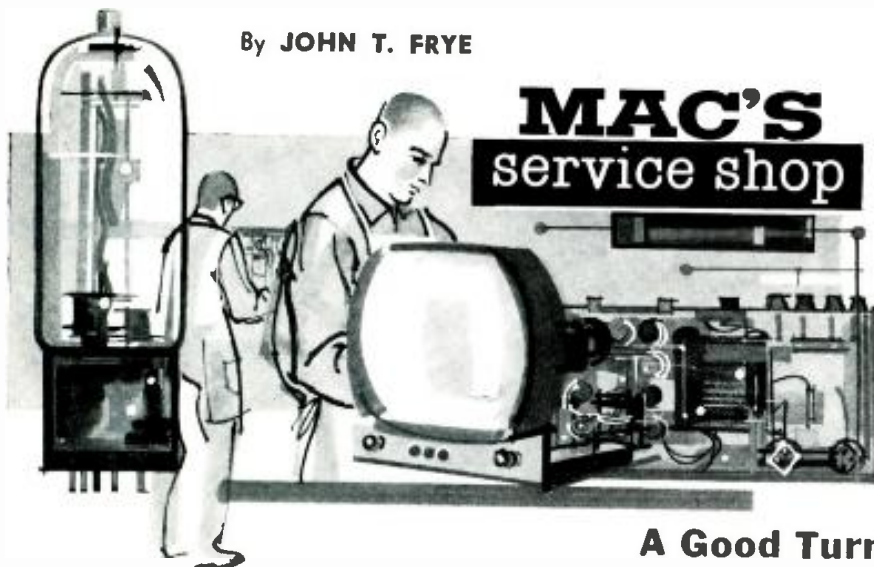

## A Good Turn

**B**ARNEY always moaned and groaned a good bit about having to "slave away" in Mac's Service Shop; but after having been on vacation two weeks, he found himself strangely eager to get back into his shop-coat. Naturally, he would never admit this. Instead, he came bounding into the service department this Monday morning literally bursting with wild tales of how reluctantly he tore himself away from the arms of the gorgeous, amorous females surrounding his uncle's Colorado ranch.

"Howdy, pardner—," he started to greet his employer and then broke off short as he spied an affair of gleaming aluminum standing in the middle of the floor. "Oh, oh!," he said accusingly; "you went and got something new while I was gone. You do it every time. What on earth is it?"

"What does it look like?" Mac asked quizzically.

"Well," Barney reflected, "at the bottom it looks like an office chair; in the middle, like a metal lathe; and at the top, like a praying mantis—king-size, that is."

"Very good!" Mac said with a chuckle. "Actually it's a 'Tel-a-Turn,' manufactured by the *Rogers Manufacturing Company* of Lindsey, Ohio. You might describe it as a rolling service-bench-and-chassis-cradle for holding and turning through 360 degrees on a horizontal axis any radio, TV, hi-fi, transmitter, turntable, or other chassis ranging from 9" to 25" in width and weighing up to 200 pounds. That four-legged cast-iron floor stand *does* look like the bottom part of an office chair; the flat bench with the two upright stands at the ends and the chassis-rotating wheel on the gear stand reminds a person of a lathe; and a 'Luxo' lamp, such as the one mounted on top of the speaker stand, always reminds me of a praying mantis."

"Why do you call this one a 'speaker stand'?"

"Because a little PM speaker is mounted here in the base behind this slotted cover. These two leads from it are clipped to the speaker terminals

of a radio or TV chassis held in the cradle. Here above the speaker are a couple of outlets for plugging in a solder gun, v.t.v.m., etc. This switch above the sockets breaks both sides of this cheater cord that connects to a TV set in the cradle. That is good for working on 'hot-chassis' sets. When the cheater cord is energized, this red pilot lamp at the top of the speaker stand lights up and warns you."

"I guess the chassis is clamped in these two arms sticking out from the tops of the two stands."

"You guess right. A versatile and clever clamp arrangement permits you to fasten any type of chassis, flanged or unflanged, between those two arms. Then turning this wheel on the gear stand revolves its arm, and the chassis with it, through 360 degrees. The arm sticking out from the speaker stand is simply a 'follower' that supports that side of the chassis. The revolving chassis can be stopped and held firmly at any point for most convenient service. The gear stand can be set to any one of three positions on the aluminum bench to accommodate chassis of different width, and the ability of the follower shaft to slide back and forth through its bearing provides an additional 'fine' width adjustment."

While Mac had been talking, Barney, who learned most easily by doing, had been busy clamping a TV set in the "Tel-a-Turn." An appreciative grin spread over his freckled face as he turned the little wheel on the gear stand and the chassis turned over on its back and presented its rat's nest of sub-chassis wiring to the sharp light of the "Luxo" lamp. Barney clipped the "Tel-a-Turn's" speaker leads to the chassis and inserted the cheater cord in the chassis receptacle. An antenna was clipped to the set and the switch on the speaker stand flipped on. As the set began to play, Barney turned the wheel so that the picture tube turned back to its normal position.

"Hey, a TV for wheeling out on your patio!" Barney exclaimed as he pushed the "Tel-a-Turn" easily about the floor

with one finger. "No house should be without one!"

"Well, now, I wouldn't go that far," Mac demurred; "but I think we're going to find a lot of use for it here in the shop. You know how hard it is lots of times to prop up a TV chassis so that you can see and work where you've got to. You usually end up working in an awkward, strained position, holding your breath all the while for fear the thing will topple over and smash tubes or damage other parts. Putting such a set in this cradle should end all that. You can work comfortably and safely and see exactly what you're doing. Tools and small test instruments can be placed on the aluminum bench, or the whole set can be pushed over to the scope, sweep generator, and other bench instruments."

"Yeah, and after the work is done but we want the set to 'cook' a while to make sure nothing else is going to show up, we can just push it to one side and let it run while we go ahead with work on the bench," Barney suggested. "If anything does show up, we can pounce on it at once. Every part, top or bottom, is immediately accessible. The thing is a 'natural' for working on intermittents."

"You're reading my mind," Mac accused; "and don't forget how handy it will be for working on record players."

"Where did you run across the thing?" Barney asked curiously.

"You remember Red Baker, the service technician at Hinesdale," Mac answered. "You know he has a left arm badly crippled by polio. He does all right with small radio sets, but manhandling heavy TV chassis was practically impossible for him. Well, I dropped in there a couple of weeks ago, and he had one of these. Thanks to it, he's in the radio and TV business. After his son helps him mount a TV chassis in the cradle, he can handle it as well as anyone. He leaves the chassis right in the cradle until it is ready to go back in the truck. The 'Tel-a-Turn' is more than just a handy gadget to handicapped people, people who can't do heavy lifting, or those with very limited bench area. Being made almost entirely of aluminum, it weighs only 37 pounds and can easily be taken right into the customer's home for performing a fairly extensive home-repair job. Using it will certainly be a lot more convenient than working on your knees on the floor; but far more important, I'm sure, is the impression it will make on our customer. Since this impressive affair of gleaming cast aluminum is something he can understand, seeing it in action will do far more to convince him that we are 'really equipped' to do service work than would our using a seven- or eight-hundred dollar oscilloscope. People are funny."

"Here in the shop we won't put every chassis in the thing, will we?"

"Of course not. That would be foolish and time-wasting. It will be re-

(Continued on page 108)

# The Recording Industry



*Author is vice president & manager of Ampex Audio Inc., a division of Ampex Corp. He joined firm in 1955 and has been with Raytheon and Jeffried Trans-former in addition to some non-electronic firms. He is a graduate of Mackay College; took advanced work at the University of Calif.*

a Guest Editorial

# Handling Hi-Fi

## Service Calls

By **DAVE GORDON**  
Audio Workshop, Inc.

hi-fi work, the  
here and

[www.americanradiohistory.com](http://www.americanradiohistory.com)



# The Tape Recording Industry



*Author is vice-president & manager of Ampex Audio, Inc., a division of Ampex Corp. He joined firm in 1955 and has been with Raytheon and Jefferied Trans-former in addition to some non-electronic firms. He is a graduate of MacKay College; took advanced work at the University of Calif.*

## a Guest Editorial

By **HERBERT L. BROWN**

President, Magnetic Recording Industry Association

**T**HE magnetic recording industry is playing a vital role in the communications network that implements and binds together many aspects of modern life—ranging from the arts and entertainment to education, manufacturing, and research. It has experienced fantastic growth in the past few years, undergoing the "growing pains" and facing the problems that are encountered by any new industry in this jet and space age.

The Magnetic Recording Industry Association is the alert and vital organization which represents this young and energetic industry. It has proved to be the right vehicle for bringing together varied interests and helping to weld into a unified approach, the problems and opportunities of the medium.

In its self-imposed role, MRIA is taking the initiative for speaking for the industry before government bodies, allied associations and organizations, as well as to the various American businesses with which we work.

All segments of the industry are represented on MRIA's roster of forty-four members—manufacturers of recorders, raw tape, recorded tape, accessories, heads, reels and cartridges, educational recorders, as well as language laboratories and tape duplicators.

At the annual meeting of the MRIA membership, held in Chicago last May, the association adopted a new and expanded program that cleared the way for legal representation and the establishment of a permanent address at 110 N. Wacker Drive, Chicago. The members also approved a long-range public information program which is now being implemented. Another important phase of the plan is being carried out by the Standards Committee which is currently conducting a survey among MRIA members to determine which aspects of standardization deserve priority.

Recently someone made the statement that the stereo disc was the best thing that ever happened to magnetic tape. In many ways this is true. A year ago stereo tape's potential audience was perhaps 5,000,000. Today 95,000,000 Americans, or 54.4% of our population, are aware of stereo. These are people who presently have phonographs and record playing equipment in their homes and have been "exposed" to the current trend toward stereo reproduction. Thus, instead of being an esoteric subject for the sophisticated music lover alone, stereo has become a household world in millions of families—virtually overnight.

As more and more music lovers become conscious of the benefits of stereo reproduction, or are "stereo oriented," an increasing number will, inevitably, adopt stereo tape as the

finest medium for recorded music and entertainment. For this reason, the tape industry's potential has increased fantastically. We welcome this new challenge and are prepared to meet it with the same enthusiasm and know-how which has characterized our progress in the past.

It was only 12 years ago that the first single-track tapes made their appearance. The signal was recorded across the full width of the tape while the tape ran at 30 ips. Speed was gradually reduced to 15 and then to 7.5 ips, without impairing the frequency response seriously.

It is interesting to note that no change in speed or number of tracks was ever made until the industry was certain it could be done with no loss of the quality which characterized tape from the very beginning.

The single track was divided in 1949 with one half used for monophonic recording in one direction. The reel was then flopped and the second half of the tape was used for recording in the other direction. When stereo came into the picture in 1951, tape was ready for it.

The first multi-track machines were used professionally and it wasn't until 1955 that the first home stereophonic tape phonographs were introduced. It was a two-channel system which has remained virtually unchanged until the four-track stereo tape was launched in May of this year.

Machines to play the new four-track, 7.5-ips reel-to-reel stereo tapes are coming off the assembly lines in ever increasing numbers. Three-quarters of a million four-track recorders will have been produced by the end of this year. More than a half-million machines now in use can be converted and, for these, the industry is already bringing out conversion kits. The tape cartridge has been revived and will be available in increasing numbers this Fall.

Most significant of all from the standpoint of the music lover is the fact that literally hundreds of new stereo tape titles from recognized tape libraries, as well as the music catalogues heretofore available only on discs, will be offered in the new four-track, 7.5-ips stereo format.

This trend will insure the availability of the great music libraries which have been put on master tapes over the past decade by all of the recording companies. The music lover can now have this new and exciting repertoire at a considerably lower cost without sacrificing any of the fidelity that tape alone can insure.

The members of MRIA look to a bright future with the quiet confidence of those who know their job and are prepared to offer the music-loving public the best in sound reproduction.

—30—

# Handling Hi-Fi Service Calls

By **DAVE GORDON**  
Audio Workshop, Inc.

**With no experience in hi-fi work, the technician's chief problem is where and how to start checking. This technique is for house calls, where service begins.**

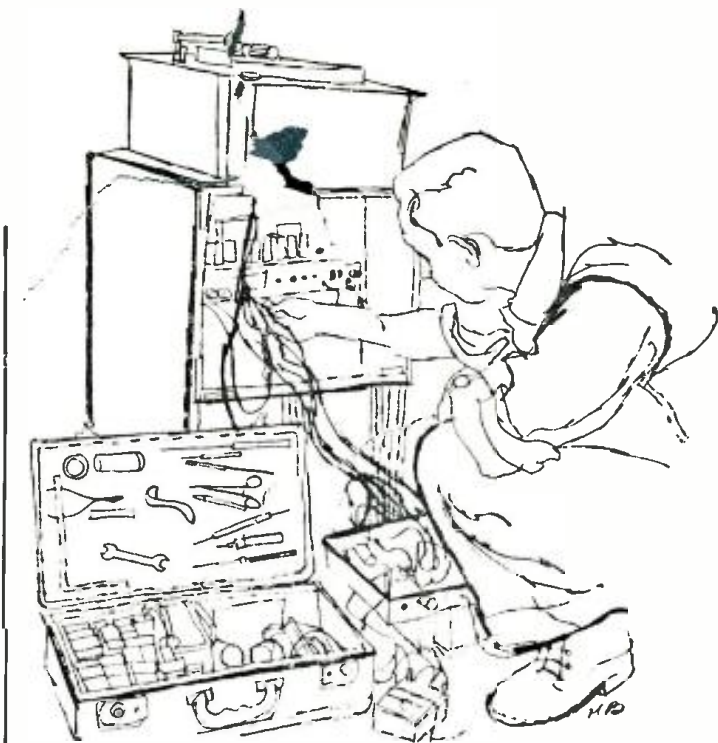

**A**S THE high-fidelity market continues to expand, the electronic service technician continues to hear, again and again, that worthwhile opportunities for him in installation and repair are also increasing. Yet his own reaction, more often than not, continues to be one of mistrust. He knows or soon learns that hi-fi repair is *not* the same as TV repair. He may also feel that a sizable investment in specialized equipment is required for him to do a thorough job.

As to the difference between hi-fi service and other types, a background in any area of electronic service is extremely helpful—so much so that filling in the additional requirements is not an impossible task at all. In the matter of special equipment, a check of many hi-fi service shops in metropolitan areas reveals an interesting point: it rarely becomes necessary to use the special instruments even when they are on hand. The experience at the *Audio Workshop* in metropolitan New York is probably typical. Although it is equipped with more than adequate testing facilities including distortion analyzers, wide-band oscilloscopes, and other instruments, this establishment does 90 per-cent of in-shop troubleshooting and check-out testing with a technique that involves a generator, a wattmeter, and an oscilloscope in a special setup.

The technique involved is being withheld for a later article. Although it is important, something else comes first, in point of time. That something else is the home service call, whether any of the customer's gear eventually winds up in the shop or not. In fact, the home call is even more important to hi-fi work than it is in, say, TV service. For many good reasons, more work will be completed in the home than is the case with TV. The bulk of a high-fidelity system as compared to a relatively transportable TV chassis, the importance of the specific acoustic

environment of the room in which the hi-fi rig is used, and the fact that many problems grow out of the relationship of the various components to each other rather than out of something that can be isolated to a separate component on the bench, are just some of the reasons for stress on work in the home.

The house call for hi-fi service bears many similarities to the call for TV service. There are also important differences. The customer himself is likely to be different, since he tends to be a music lover on the highbrow side. This need not be a difficulty if the technician has the right attitude. An attempt to approach the customer on the latter's terms will be appreciated by him, and pay off in a good customer relationship.

The hi-fi service technician *must* learn to know what he hears. He must know what real high-fidelity sounds like. His primary diagnostic tools are his own two ears and he must be able

to judge whether the system under inspection is operating well, within its own particular limitations, by the use of these same ears. However, training the ear to establish consistent subjective standards for good and bad sound is far less difficult than many people assume. Prolonged listening to good systems is important. It will teach one, for example, to differentiate between "juke-box bass" that emphasizes the range between 70 and 100 cycles and the real item at 40 cycles or even below. At the other end, good tweeters or amplifiers that can handle highs honestly should sound clean with no tendency toward a harsh or piercing quality.

A typical service call starts with the customer's telephoned request for help. At this point it is necessary to get as much information as possible about the components in the customer's system. There are several reasons for this. Having a complete set of model numbers of the tuner, amplifier (and separate preamp, if present), record player, cartridge and speaker will enable you to "research" these units in advance in your specialized hi-fi manuals or file of manufacturers' data. You will be able to get a good idea of the age of the components and the tube line-ups. You may also anticipate a few likely candidates for replacement if you are sufficiently familiar with the units involved.

When you ask Mrs. Jones what equipment she owns, she may indignantly reply, "Why hi-fi of course!" but a little judicious digging and information as to where the model numbers are likely to be found on the chassis will help.

Once you've arrived at the customer's home, get a "case history" of the components involved. Is the problem intermittent? Is it experienced on the tuner or phonograph only, or on both? If it appears on the phonograph only, is it noticed at both the inner and outer

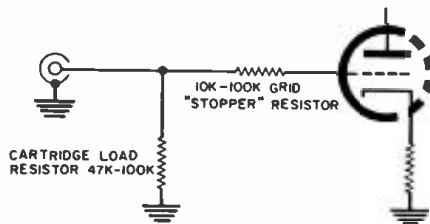
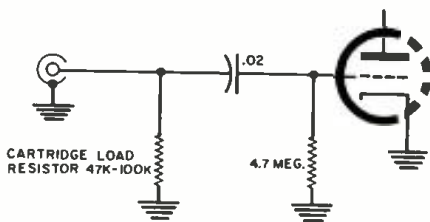

Fig. 1. A "stopper" resistor suppresses unwanted grid pickup at low-level stage.

Fig. 2. RC-coupled preamp input is especially sensitive to unwanted noise.



grooves of the record? Has the problem appeared suddenly or has it been building up and growing worse over a long period? Has the set had any rough treatment lately either through spring cleaning or handling by outsiders? These questions themselves suggest the reasons for asking them.

Having heard the customer's story, turn on the set, gather your own impressions, and hope they correspond with the customer's. Whatever your conclusions, your next step will probably be to reach for your tool kit. The contents of this kit is important. In addition to the usual hand tools, accessories, and other materials used for other types of electronic service, it should carry the items listed in Table 2. The exact nature and purpose of some of these will come up for discussion.

If the phonograph appears to be involved, for example, you should have with you at least one known recording of good quality for comparison purposes, in addition to a conventional test record, as you can't rely on the customer to own a disc with which you are familiar.

A good routine for turntable, tone-arm, and cartridge checking should include inspection of the turntable drive mechanism for dried-up rubber components; also a cleaning of the inner drive surface of the turntable platter and the rubber driving wheels with alcohol. Check the stylus for alignment (both horizontal and vertical) and the condition of the damping blocks (if present). A small mirror placed face-up on the turntable, with the tone arm resting on it, should suffice for the alignment check. The older *G-E* cartridges may suffer from hardening of the blocks or actually have the blocks torn away from the stylus bar. The barest touch of Duco cement will usually serve to fix the blocks securely in place.

Check for a hard dust accumulation around the stylus tip. Cartridges that use an internal viscous damping fluid are particularly prone to accumulate "gook" which is not easily removed by flicking the stylus with the finger. A dab of alcohol on a pipe cleaner will dissolve the accumulation.

A spot of oil on the turntable bearings and petroleum jelly (Vaseline) thinly applied to the friction surfaces on gears and levers will frequently do wonders in bringing a slow turntable up to speed. There are cases, however, when a replacement motor or more stringent overhaul methods are necessary: it then frequently becomes a toss-up as to whether the mechanism is worth repairing.

Turntables using rubber-belt drives (such as the frequently encountered *Garrard RC-80*) may slow down in the change cycle or not operate at all on one or more of the three speeds. Dried-out drive belts are the culprits and replacement is in order. These belts should be a standard item in the well-stocked repair kit. Another frequent cause of turntable slippage and slow-

5U4	6SN7
5Y3	6V6
6AN8	6X4
6AQ5	12AT7
6BQ5/EL84*	12AU7/ECC82*
6C4	12AX7/ECC83*
6CA7/EL34	5879
6L6/5881/EL37*	GZ34
6SC7	KT66
6SL7	KT88
	Z729/EF86

**Table 1. Common amplifier-preamp tubes.**  
See text for listings with asterisks.

down is glazing of drive wheels, that is, their friction surfaces become too smooth. An emery board such as is used for trimming milady's finger nails can rough up a drive wheel nicely without removing too much rubber. Use a gentle hand in this operation.

The strobe disc and tone-arm stylus-pressure gauge are another pair of service kit "musts" for turntable inspection. A small pocket microscope or powerful magnifying glass, while not entirely adequate for checking a stylus for wear, serves nicely in providing a close-up look in checking for stylus alignment.

A light source satisfactory for observing the pattern on a stroboscopic disc is also essential. A fluorescent lamp or neon bulb with sufficient light output will do. The NE-57 neon bulb listed in Table 2, which has a built-in limiting resistor, will do nicely. Its screw-in candelabra base fits the socket of many pencil-type soldering-iron handles that accommodate screw-in element-and-tip combinations. If this type of iron, which is a handy one for the outside call in any case, is not used, a separate socket with a.c. cord can easily be arranged.

A replacement cartridge or stylus of the same model as the customer's is another valuable service kit accessory. Direct A-B listening comparison between the old cartridge or worn stylus and the new one you have temporarily installed will convince the most recalcitrant penny pincher that replacement is in order. Make your A-B comparison on a good, new recording, preferably featuring a solo female voice or solo violin. Either one will sound "raspy around the edges" or seem to crack or break up if every-

**Table 2. Add these special items to the regular tool kit for hi-fi work.**

Alcohol (in dropper container)
Cement (Duco or similar)
Pipe cleaners
Light oil
Petroleum jelly
Drive belts (record changer)
Emery board
Small mirror
Pocket microscope
Stroboscopic disc
Stylus-pressure gauge
Cartridges
Styli
Test records
NE-57 neon lamp
Phono plugs and jacks
Thin phono cable, insulated & shielded. 25 ft.

thing isn't right with the stylus assembly. There aren't that many popular types of cartridge around that you can't afford to stock a spare selection. A couple of good magnetics and a couple of good ceramics will certainly facilitate testing even when they are not identical replacements.

From the turntable we come to the phono preamp section of the amplifier. The big problems here are microphonics, hum and noise; and the culprit is usually the first, low-level stage, frequently a 12AX7/ECC83. While the quality of these tubes has improved steadily over the years, hard service and old age show up as a gradual increase in the noise level and a tendency toward microphonics.

It's a good idea to pre-test your service kit tubes in your own bench amplifier for their hum and noise properties. It's embarrassing to replace one bad tube with an equally noisy one while the customer looks on. Some of the other preamp tubes, such as the Z729/EF86 or 5879, require the same pre-testing technique. The 5879, in particular, which is found in a number of tape-recorder preamps, oftentimes may require extensive pre-testing before a quiet one is found.

All the hum and noise problems in a preamp, of course, are not due to faulty tubes or components. Frequently buzzes and hum will appear coincident with the opening up of a new TV channel in the vicinity or some renovation or change in house wiring. Bad grounds on the a.c. line are a frequent but little suspected cause of "incurable" hum conditions.

A good test for the ground condition of an a.c. line is to measure between the ground side of the line and an external cold water pipe or other available element at earth ground with a v.o.m. A five- to ten-volt reading can cause a lot of noise in a sensitive phono circuit, especially in stereo.

A problem which seems allied with the bad ground condition is TV sync buzz pickup. An examination of the phono-input position of the new stereo preamps will reveal a number of "purposeless" resistors spotted about the stage. The theoretical explanation for these resistors functioning the way they do is rather complicated but, practically, they serve to eliminate TV sync buzz and sometimes TV and FM sound from the phono channel. You will find values from 10,000 to 100,000 ohms at the input triode installed directly on the tube socket between the grid-return resistor and the tube pin. See Fig. 1. Older preamps, whose input circuit configuration involves the magnetic cartridge load resistor across the input jack coupled to the high-value grid-return resistor by a capacitor (Fig. 2), are particularly prone to sync pickup and benefit by the installation of a "stopper" resistor as described.

Most stereo preamps have all the circuit precautions possible already installed. There is little that you can do with these in stubborn hum pickup  
(Continued on page 128)

# Tone-Arm Tracking Error in Stereo

By FRANCIS A. GICCA  
Raytheon Co.

**A serious loss of the stereo effect occurs with tracking error. Here is how this may be minimized by proper mounting of straight or offset tone arms.**

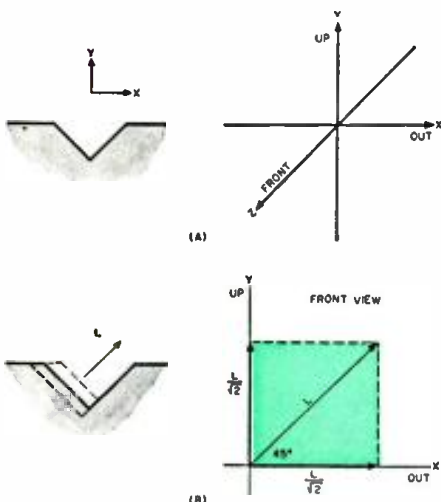

Fig. 1. (A) Groove coordinates. (B) Vector representation of left-channel output.

EDITOR'S NOTE: This article deals with the horizontally measured tracking error. Equally important is the effect produced by vertical misalignment of the stylus. For information on this topic we refer our readers to the article "Pickup Cartridges for Stereo" by Norman Crowhurst in our October, 1958 issue.

IT IS generally well known that unless a phonograph cartridge is at all times tangent to the groove of a monophonic recording, distortion is produced. With any pivoted pickup arm it is obvious that the angle between the axis of the cartridge and the tangent to the groove must change as the cartridge moves across the record. This angular error between the axis

of the cartridge and the tangent to the groove is called "tracking error" and should always be minimized in order to reduce distortion. (For a discussion of tracking distortion see B. B. Bauer's article, "Tracking Angle in Phonograph Pickups," *Electronics*, March, 1955.)

However, it is not as generally known that tracking error also produces a serious loss of stereophonic effect when reproducing stereo discs. For example, if a 9-inch-long straight pickup arm is oriented so that the cartridge's stylus passes over the center of the disc, a loss in stereophonic effect of 31 db will occur in the outer grooves.

In order to investigate the cause of this degradation, and how it may be minimized, it is first necessary to establish a set of three-dimensional reference axes centered about the bottom of a stereophonic groove. Fig. 1A shows the coordinate system chosen. The X axis runs from the inside to the

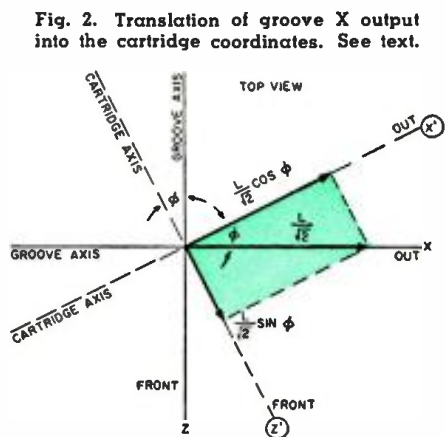

Fig. 2. Translation of groove X output into the cartridge coordinates. See text.

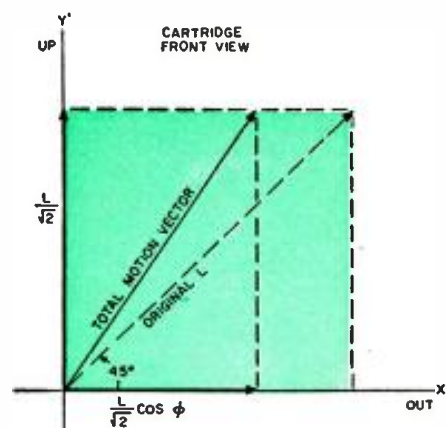

Fig. 3. Comparison between the total motion vector and the original L vector.

outside of the groove, the Y axis runs up and down the groove, and the Z axis runs front to back. These axes are mutually perpendicular.

Assume that the disc is modulated with "left" output only, that is, the inner wall of the groove moves back and forth at a 45-degree angle to the horizontal as shown in Fig. 1B. This motion of the inner wall may be represented by a motion vector at a 45-degree angle in the in-out, up-down (X-Y) plane. Such a vector of length L has been drawn in the X-Y plane of Fig. 1B.

Since the groove wall is moving at a 45-degree angle, this is equivalent to equal lateral (in-out) and vertical (up-down) motions of the reproducing stylus. In other words, the L vector may be represented by two other vectors of equal length, one up-and-down and the other in-and-out. By trigonometry it is apparent that each of



these vectors must have a length of  $L \sin 45^\circ$ , or  $L/\sqrt{2}$ . These two vectors are shown in Fig. 1B.

If we look down upon the groove from above, we see the lateral in-and-out motion which the left modulation produces, but we will not notice the vertical up-and-down motion. In Fig. 2 we are looking down upon the groove (the X-Z plane) where we see the lateral  $L/\sqrt{2}$  vector just found. If the cartridge's longitudinal axis is tangent to the groove, no tracking error exists and the cartridge's X-Z axes are the same as the groove's X-Z axes. In this case, the groove's lateral motion produces an equal lateral motion in the cartridge.

However, if a tracking error does exist, then the cartridge's X-Z axes will be rotated with respect to the groove's X-Z axes by a tracking error angle  $\phi$ . The X'-Z' axes shown in Fig. 2 represent the axes of the cartridge rotated from the groove's X-Z axes, by the angle  $\phi$ .

In order to determine the electrical output which the left groove motion will produce in a cartridge, it is necessary to determine the motion which the groove produces along the cartridge's output-sensitive axes. If there is no tracking error, then the left-lateral modulation produces only left-lateral motion in the cartridge. When tracking error is present, however, lateral modulation produces a front-to-back motion of the cartridge's stylus as well as lateral motion. The effect of this front-to-back motion is to reduce the effective lateral motion of the stylus. This reduction in lateral motion is a function of tracking error and can be found by projecting the lateral  $L/\sqrt{2}$  modulation onto the cartridge's in-out (X') and front-back (Z') axes.

Fig. 2 shows this projection. By trigonometry it can be shown that the

MANUFACTURER	OFFSET ANGLE ( $\beta$ , degrees)	ARM LENGTH (L, inches)	OVER-SHOOT (- $\alpha$ , inches)*	MAX. TRACKING ERROR ( $\phi$ , degrees)	MIN. CROSSTALK RATIO (db)
Audax KT-16	19.50	12.19	.56	1.94	71.6
Electro-Sonic S1000	23.00	8.75	.60	2.27	68.2
Fairchild 282	23.00	8.94	.50	3.43	61.0
General Electric TM-2G	21.75	9.10	.54	2.27	68.2
Gray 212-SP	23.80	9.05	.68	1.75	72.6
Pickering 196 Unipoise	21.00	8.63	.50	3.65	58.8
Rek-O-Kut S-120 (12")	21.00	8.78	.53	3.63	60.0
Rek-O-Kut S-160 (16")	22.00	11.75	.75	2.02	70.2

\* Note: The overshoot distance (- $\alpha$ ) must be adjusted as accurately as possible in order to obtain these results.

Table 1. Tracking error, crosstalk for various stereo arms with typical cartridge.

front-to-back (Z') motion is  $L/\sqrt{2} \sin \phi$  and the in-and-out (X') lateral motion is  $L/\sqrt{2} \cos \phi$ . Since front-to-back motion of the stylus ideally produces no output, it may be neglected.

If we now look at a front view of the cartridge, we see the lateral  $L/\sqrt{2} \cos \phi$  motion caused by the tracking error angle  $\phi$  and the vertical  $L/\sqrt{2}$  motion found previously in Fig. 1B. These two vectors are shown again in Fig. 3. If these two vectors are recombined into a single vector, it is seen that this total motion vector is no longer the same as the original L vector which produced it. This new vector is shorter than the original L and is no longer at a 45-degree angle.

Since the stylus motion is no longer at a 45-degree angle, the electrical output can no longer be exclusively left channel, but a crosstalk output is produced in the right channel as well. The result is a degradation in stereophonic effect since left output now appears in the right channel.

Mathematically, the left output is  $L/2 (1 + \cos \phi)$ , and the right output is  $L/2 (1 - \cos \phi)$ . If the tracking error is zero, that is  $\phi = 0$ , then  $\cos \phi = 1$  and the left output becomes L and the right output is zero. If the tracking error is as severe as 60 degrees, then

$\cos \phi = 1/2$ , which means the left output is  $3L/4$ , and the right output is  $L/4$ . This 3 to 1 ratio represents a separation between channels of only about 10 decibels. Of course, tracking errors of 60 degrees are generally not encountered, but it is possible to get tracking errors as high as 30 degrees with some currently advertised straight pickup arms mounted so that the stylus passes over the center of the disc. Because of the symmetry of the stereophonic groove, the situation is exactly the same for right-channel modulations.

A good figure of merit for the stereophonic leakage caused by tracking error is a "crosstalk ratio" of left output to right output, expressed in decibels, when only left modulation is present on the disc. Ideally, this ratio should be infinite which means that no right-channel output is produced by a left-channel signal. An infinite crosstalk ratio is achieved only when there is no tracking error. Since it is impossible to achieve zero tracking error across a stereophonic disc with a pivoted pickup arm, the arm should be mounted so that the crosstalk ratio is as high as possible across the entire disc. Fig. 4 illustrates how the crosstalk ratio varies as a function of track-

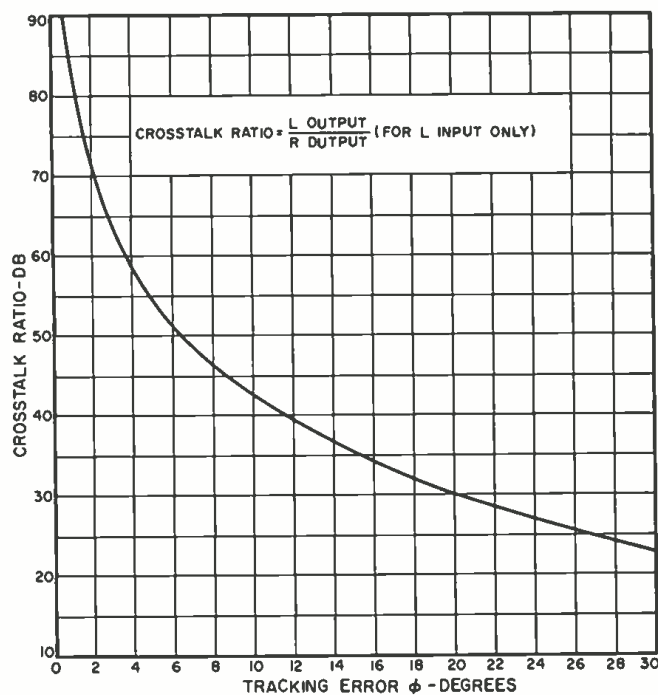

Fig. 4. Crosstalk ratio versus tracking error in degrees. Note that the crosstalk ratio is the relationship between the two output signals with an input to one channel only.

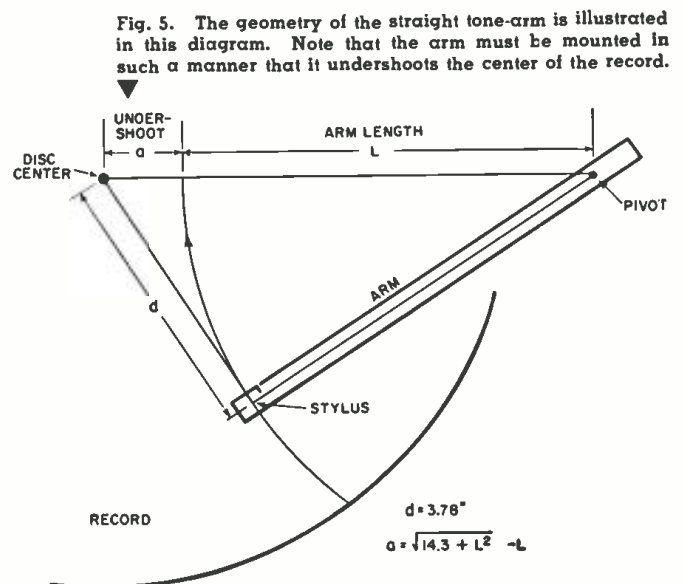

Fig. 5. The geometry of the straight tone-arm is illustrated in this diagram. Note that the arm must be mounted in such a manner that it undershoots the center of the record.

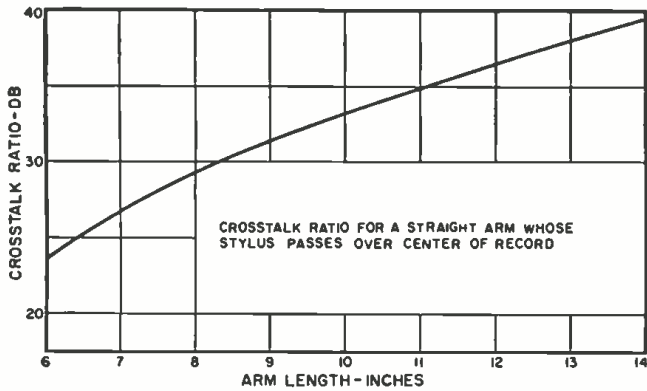

Fig. 6. Straight-arm crosstalk ratio versus length of arm.

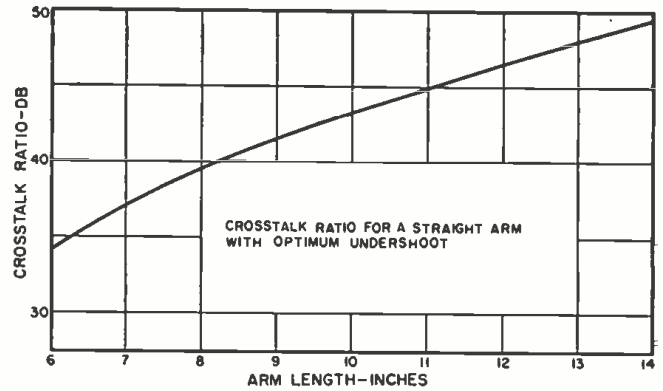

Fig. 7. Straight-arm crosstalk with optimum undershoot.

ing error from 0 to 30 degrees. Note that a tracking error of 30 degrees produces a crosstalk ratio of only 23 db, scarcely enough to maintain the stereophonic effect when the additional crosstalk already present in the disc, cartridge, and amplifier is considered.

In summary, tracking error causes a decrease in the lateral component in a stereo cartridge which, in turn, produces crosstalk between channels. The remainder of this article will analyze how tracking error may be minimized with straight and offset pickup arms so that the crosstalk ratio is maximized.

#### Straight Pickup Arms

Fig. 5 shows the general geometry for a straight pickup arm of length  $L$ . At some distance  $d$  from the center of the disc, the cartridge is tangent to the grooves. At this point the tracking error is zero, therefore the crosstalk ratio is infinite. As the arm moves away from this point, the tracking error increases and the crosstalk ratio decreases. In order to minimize tracking errors across the disc, the perpendicular distance  $d$  should be located somewhere in the middle of the disc so that the tracking errors are equal at the outside and inside of the disc. It is apparent that if  $d$  is located at the inside of the disc, the tracking error will increase tremendously at the outside. The same holds true for the inside if  $d$  is set at the outside. Minimum over-all error must occur if  $d$  is located somewhere between these two extremes, and it can be proven that minimum error occurs when the inner and outer tracking errors are made equal. Intuition also suggests this to be true.

Several 12" recordings were measured in order to determine at what maximum outer radius modulations started and at what minimum inner radius modulations ended. For a completely full, 12-inch disc, recording was started at a radius of 5.75 inches and ended at an inner radius of 2.50 inches. Setting the tracking errors equal at these two radii, yields  $d = 3.78$  inches. Note that this value is the geometric mean of the two radii. This result means that all straight pickup arms, irrespective of length, should be tangent to the grooves at a distance of 3.78 inches from the center of the disc. Since it is difficult to determine tan-

gency accurately, a more useful quantity is the undershoot  $a$  shown in Fig. 5, which specifies by how far the stylus should undershoot the center of the disc. The final result, see Fig. 5, is that  $a$  should equal  $\sqrt{14.3 + L^2} - L$ .

It is important to note that the stylus should *always* undershoot the center of the record for straight arms if optimum performance is to be achieved. Fig. 6 shows how the cross-

talk ratio varies at the outer diameter of a stereo disc when a straight pickup arm is used whose stylus has been set to pass over the center of the disc, as a function of arm length. In contrast, Fig. 7 shows the crosstalk ratio that is achieved at the outer diameter if the correct undershoot is used. In both cases, the crosstalk ratio at the outer diameter is the worst condition. Note that optimum overshoot achieves a crosstalk ratio that is 11 db higher than the incorrectly positioned pickup.

#### Offset Pickup Arms

It is always possible to reduce the tracking error even further if an arm is used whose cartridge is offset from the arm axis by a small angle. Fig. 8 shows the general geometry for an offset pickup arm. As before, the length of the arm  $L$  is measured from the needle to the pivot point of the arm, which places  $L$  off the arm in the offset case. The offset angle  $\beta$  is measured as the angle which the lateral axis of the cartridge makes with  $L$ .

Using the same general analysis as for the straight pickup arm, a tangent distance  $d$  can be found for the offset arm which makes the tracking errors equal at inner and outer disc diameters, and this distance related to an optimum overshoot  $a$ . The result of this analysis for the offset case, however, is quite interesting and unique. It is found that the offset arm is tangent to the grooves at *two* points as the arm moves across the disc, rather than at just one point. It is also found that the tracking errors are equal at *three* points if the errors are set to be equal at the inner and outer disc radii as previously done. This third point turns out to be the *geometric mean* of the extreme radii, or 3.78 inches, as determined for the straight arm.

In other words, an optimum offset arm should be oriented so that it produces equal tracking errors at radii of 2.50, 3.78, and 5.75 inches. If we bear in mind the results of the straight arm analysis, it is clear that the offset arm should be designed and oriented so that it is tangent to the grooves at points which are the geometric means of the radii where equal tracking errors are desired. For equal errors at 2.50 and 3.78 inches, the arm should be tangent

(Continued on page 94)

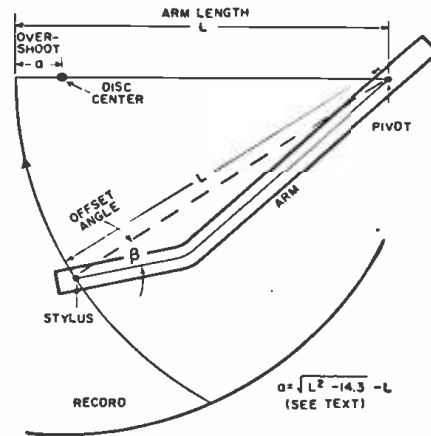
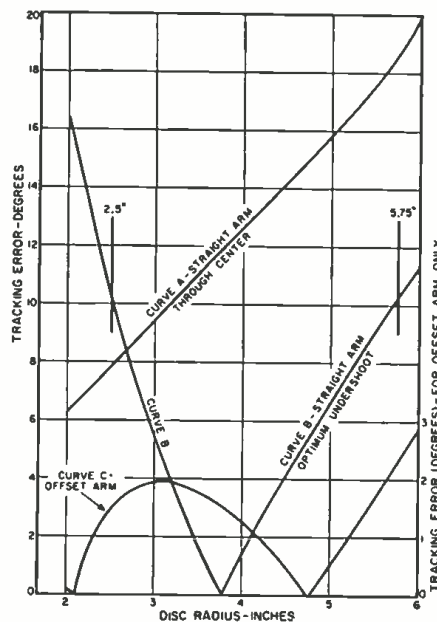

Fig. 8. Geometry of the offset tone-arm is illustrated in this diagram.

Fig. 9. Tracking error for two 9" arms.



# Dealers Speak on Service Problems

By WILLIAM LEONARD

Comparing notes from various parts of the country on a constantly changing industry proves fruitful.



THE DIRECTION of the conversation at a recent session of service dealers, gathered together from widely separated parts of the country, led into the subject of the changes that are rapidly taking place in the consumer TV service business.

"Dealers who are specializing in one or two products and are almost entirely dependent on their income from service," said one northern service dealer, "are heading into real trouble."

"In our area," he continued, "tube testers in non-service locations are now getting about fifty per-cent of the replacement tube business. How do we know it? We have two yardsticks to measure it. The first of these is the number of sets we have to pull in for service that do not need tubes. It is clearly apparent that the people who own these sets first tried to repair them by checking the tubes on do-it-yourself testers and buying new ones for those that tested bad. They called us when the new tubes failed to solve the problem. The replacement-parts income we get from these service jobs is restricted to the defective components we have to replace."

"Another thing about these jobs," he added, "is that they are giving us a customer-relations problem we never had to contend with before. When a customer has checked all of his tubes and bought new ones for those that tested bad, and we find that one of these new tubes will not function in the circuit and must be replaced, we have a serious problem. The customer feels that we have done something to the tube or to the set to make him buy a new tube. I am certain that every customer who has this experience with us or with other dealers pays the bill with the conviction that he fell into the hands of pirates."

"The second gauge we have to measure the percentage of tubes that are

being sold through self-service testers is our current volume of tube sales as compared to what it was a couple of years ago. A few years ago we were buying tubes at an average rate of five-hundred per week. Now we have to scratch to dig up a weekly order for seventy-five tubes. Yet we are handling about the same volume of service calls.

"This loss of income from tube sales would be really serious for us if we had not taken certain protective measures. Our charges for time and labor have always been based upon our costs of operating. We have not depended on the income from tube and parts sales to subsidize our service time. The other thing that has cushioned our loss of tube income is our expansion into sales of sound and hi-fi equipment. Otherwise we would have been in serious financial trouble."

"Evidently tube checkers in the hands of non-electronic businesses have not, as yet, penetrated our market as deeply as they have yours," said a dealer from the deep south. "And I do not think we have been affected as much by factory and distributor service as you dealers in densely populated northern cities."

"This does not mean," he continued, "that we will enjoy this preferred position for an indefinite period. I believe that what is happening in these metropolitan centers will soon hit ours and other areas. When they do it will happen fast: the invasion of our businesses will be better organized because of the experience gained by these competitors in your cities."

The talk then turned to the protective measures a dealer must or should take to preserve his business against loss of revenue from replacement tube sales. The dealers were in accord that the do-it-yourself trend in owner replacement of defective TV

tubes is a normal economic development. They generally agreed that the fifty to sixty per-cent margin they have enjoyed on tube sales was a retail sales bonus that helped the self-service tube testers to get a strong foothold in the industry.

It was pointed out that the latest *Dun & Bradstreet* report on business failures indicated that 56.2% of the failures of service-type businesses was due to inadequate sales. It was also pointed out that this survey indicated that 19.1% of the service-type business failures was due to competitive weaknesses. The dealers' interpretation of these facts in relation to a TV service business was that any dealer who is unwilling to adjust his business to suit the demands of changing economic conditions will eventually find himself

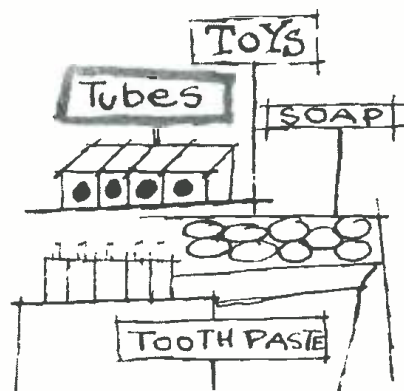

listed as a statistic in one of these categories of failures.

Referring to an article written by a service dealer who bitterly criticized the suggestions that the service industry should reduce the price of tubes and sell them at a narrower, more realistic mark-up, one of the group said:

"This is one of the most serious problems of our business as an industry. Far too many service dealers depend on their income from the sale of tubes to subsidize their service charges. The man who is charging three dollars for a service call, when his actual cost is five dollars, must make up the difference in the profit he gets from the sale of tubes and parts. This might have been the easy, comfortable way to run a service business back in the days when eight out of ten service calls could be completed in the home by replacing two or three tubes. But it will not work today."

"Those service dealers who are not up-grading their charges for time and

(Continued on page 88)

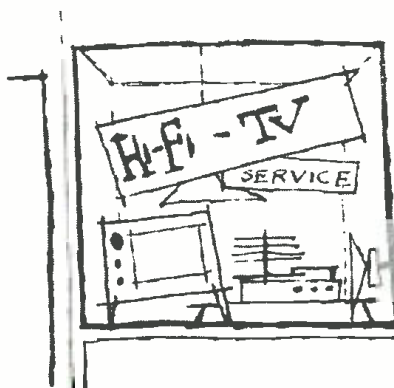

# 1959 Stereophonic

MAKER	MODEL NO.	TYPE *	STYLUS			TRACKING FORCE (grams)	LOAD FLAT RESP. (ohms)	NO. OUTPUT LEADS	NET PRICE
			TYPE**	RADIUS (in mils)	NO.				
ASTATIC	70TS	Cer.	Sa.-Sa.	.7 & 3	2	10	2 meg. or more 2 meg. or more	4	\$ 7.95 \$13.95
	74TS	Cer.	Sa.-Sa.	.7 & 3	2	10		4	
	76TS-TB	Cer.	Sa.-Sa.	.7 & 3	2	10		4	
	11T7B	Cer.	Sa.-Sa.	.7 & .7	2	5-7		4	
	13TBX	Cer.	D.-Sa.	.7 & 3	2	5-7		4	
AUDIO EMPIRE	88	Mag.	D or Sa.	.7	1	2-5	47,000	4	\$24.50
AUDIOGERSH	Stereotwin 210/D	Mag.	D	.7	1	3-6	33,000	4	\$34.50
CBS ELECTRONICS	SC-1D	Cer.	D	.7	1	5-7	1.2 meg.	3	\$24.25
	SC-2D <sup>1</sup>	Cer.	D	.7	1	5-7	1.2 meg.	3	\$24.25
	SC-1S	Cer.	S	.7	1	5-7	1.2 meg.	3	\$17.00
	SC-2S <sup>1</sup>	Cer.	S	.7	1	5-7	1.2 meg.	3	\$17.00
	Pro. 55	Cer.	D	.5	1	1.5-4	1.2 meg.	3	\$28.95 <sup>2</sup>
CBS RONETTE	BF-40	Cry.	S	.75	1	4-6	500,000	4	Price not avail- able as yet
	105	Cry.	Sa.-Sa.	.75 & 2.5	2	4-6	500,000	4	
	105-1	Cry.	Sa.-Sa.	.75 & 2.5	2	4-6	500,000	4	
	106	Cry.	Sa.-Sa.	.75 & 2.5	2	4-6	500,000	4	
	106-1	Cry.	Sa.-Sa.	.75 & 2.5	2	4-6	500,000	4	
	OV	Cry.	Sa.-Sa.	.75 & 2.5	2	4-6	500,000	4	
	OV-1	Cry.	Sa.-Sa.	.75 & 2.5	2	4-6	500,000	4	
DUOTONE	GP73S	Cry.	Sa.-Sa.	.7 & 3	2	2-4	1-2 meg.	4	\$14.50
	GP73SD	Cry.	D.-Sa.	.7 & 3	2	2-4	1-2 meg.	4	\$24.50
DYNACO-B&O	Stereodyne II	Mag.	D	.7	1	2-4	47,000 or more	4	\$29.95
	TA-12	Mag.	D	.7	1	2-4	47,000 or more	5	\$49.95 <sup>3</sup>
ELECTRO-SONIC	ESL-C100	Mag.	D	.7	1	2-4	Not critical	3	\$69.95
	ESL-P100	Mag.	D	.7	1	2-4	Not critical	3	\$79.95
ELECTRO-VOICE	21D	Cer.	D	.7	1	3-6	3 meg. or more	3	\$12.00
	21S	Cer.	Sa.	.7	1	3-6	3 meg. or more	3	\$ 7.60
	26DST	Cer.	D.-Sa.	.7 & 3	2	3-6	3 meg. or more	3	\$13.20
	26ST	Cer.	Sa.-Sa.	.7 & 3	2	3-6	3 meg. or more	3	\$ 8.40
	21MD	Cer.	D	.7	1	5-7	22,000	3	\$14.40
	21MS	Cer.	Sa.	.7	1	5-7	22,000	3	\$10.00
	21MDST	Cer.	D.-Sa.	.7 & 3	2	5-7	22,000	3	\$15.60
	21MST	Cer.	Sa.-Sa.	.7 & 3	2	5-7	22,000	3	\$10.80
	Magneramic 31MD-5	Cer.	D	.5	1	2-4	Mag. inputs (trans arm)	4	\$24.00
	Magneramic 31MD-7	Cer.	D	.7	1	4-6	Mag. inputs (changer)	4	\$24.00
Magneramic 31D-5	Cer.	D	.5	1	2-4	Cer. inputs (trans. arm)	4	\$22.50	
Magneramic 31D-7	Cer.	D	.7	1	4-6	Cer. inputs (changer)	4	\$22.50	
ERIE RESISTOR	StERIEo 1303	Cer.	Sa.-Sa.	.7 & 3	2	5-6	3 meg.	3	\$ 8.95
	StERIEo 1304	Cer.	D.-Sa.	.7 & 3	2	5-6	3 meg.	3	\$16.50
	StERIEo 1301-01	Cer.	Sa.-Sa.	.7 & 3	2	5-6	3 meg.	3	\$ 6.95 <sup>4</sup>
	StERIEo 1302-01	Cer.	D.-Sa.	.7 & 3	2	5-6	3 meg.	3	\$14.50 <sup>1</sup>
FAIRCHILD	232	Mag.	D	.6	1	2-4	5K or more	3	\$34.95
	SM-1	Mag.	D	.6	1	2-4	47,000	4	
GENERAL ELECTRIC	VR-225	Mag.	D	.5	1	2-4	47,000	4	\$27.95
	VR-227	Mag.	D	.7	1	5-7	47,000	4	\$24.95
	GC-5	Mag.	D	.5	1	2-4	100,000	4	\$26.95
	GC-7	Mag.	D	.7	1	3.5-7	100,000	4	\$23.95
	CL-7	Mag.	Sa.	.7	1	3.5-7	100,000	4	\$16.95
GRADO	Custom	Mag.	D	.7	1	3	5000 or over	4	\$32.50
	Master	Mag.	D	.7	1	3	5000 or over	4	\$49.50
NEUMANN	DST	Mag.	D	.6	1	6.5		5	\$69.00

# Cartridge Directory

MAKER	MODEL NO.	TYPE	STYLUS			TRACKING FORCE (grams)	LOAD FLAT RESP. (ohms)	NO. OUTPUT LEADS	NET PRICE
			TYPE	RADIUS (in mils)	NO.				
PICKERING	371AMk II	Mag.	D-Sa.	.7 & 2.7	2	2-5	27K-47K	4	\$26.40
	371CMk II	Mag.	D-Sa.	.7 & 2.7	2	3-7	27K-47K	4	\$24.00
	380A	Mag.	D-Sa.	.7 & 2.7	2	2-5	47K-100K	4	\$34.50
	380C	Mag.	D-Sa.	.7 & 2.7	2	3-7	47K-100K	4	\$29.85
	196	Mag.	D-Sa.	.7 & 2.7	2	2-5	27K-47K	3	\$49.50
SCOTT, H. H. & LONDON RECORDS	1000	Mag.	D	.5	1	3.5	50K	4	\$89.95 <sup>5</sup>
SHURE	M7D	Mag.	D	.7	1	4.7	47K	4	\$24.00
	M3D	Mag.	D	.7	1	3-6	50K	4	\$45.00
SONOTONE	8TA4-S	Cer.	Sa.-Sa.	.7 & 3	2	4-6	1-5 meg.	4	\$14.50
	8TS4-SD	Cer.	D-Sa.	.7 & 3	2	4-6	1-5 meg.	4	\$19.50
	8TA4-D	Cer.	D-D	.7 & 3	2	4-6	1-5 meg.	4	\$29.50
	8TA4S77	Cer.	Sa.-Sa.	.7 & .7	2	4-6	1-5 meg.	4	\$14.50
	10T2-S	Cer.	Sa.-Sa.	.7 & 3	2	5-7	1-5 meg.	4	\$ 6.45
	10T2-SD	Cer.	D-Sa.	.7 & 3	2	5-7	1-5 meg.	4	\$16.50
	10T2-S77	Cer.	Sa.-Sa.	.7 & .7	2	5-7	1-5 meg.	4	\$ 6.45
	10T2-SD77	Cer.	D-Sa.	.7 & .7	2	5-7	1-5 meg.	4	\$16.50
TANNOY	Vari-Twin	Mag.	D	.7	1	3-4	50K	4	\$43.50
WEATHERS	C501D	Cer. <sup>6</sup>	D	.7	1	1-2	47K	5	\$17.50
	D501S	Cer. <sup>6</sup>	Sa.	.7	1	3-5	47K	5	\$ 9.75
WEBSTER ELECTRIC	MC1	Cer.	Sa.	.3	1	7	1-3 meg.	3	\$ 6.50
	MC2	Cer.	Sa.	.3	1	7	1-3 meg.	4	\$ 6.50
	SC1D	Cer.	D	.7	1	7	1-3 meg.	3	\$19.50
	SC2	Cer.	Sa.	.7	1	7	1-3 meg.	3 or 4	\$ 9.50
	SC2D	Cer.	D	.7	1	7	1-3 meg.	3 or 4	\$17.50
	SC3	Cer.	Sa.	.7 & 3	2	7	1-3 meg.	3 or 4	\$11.50
	SC3D	Cer.	D-Sa.	.7 & 3	2	7	1-3 meg.	3 or 4	\$20.00

The directory on these pages lists the stereo cartridges that are available as we go to press along with some of their important specifications. Other characteristics, often given by some cartridge manufacturers, were not included because of the lack of standardized testing procedures that would permit an accurate comparison to be made. For example, the amount of output voltage from a cartridge depends on the particular test record used, the recorded velocity employed, and the load on the cartridge. In general, crystal and ceramic cartridges have high outputs on the order of .25 to 1 volt per channel. Magnetic cartridges, on the other hand, have outputs ranging from 1 to 25 millivolts, with the moving-coil types at the low end of this range. Frequency response of all types is given as a nominal

figure ranging from 10 to 30 cps at the low end through 12,000 to 30,000 cps at the high end. Channel-to-channel separation of most of the units shown is said to be about 20 db at the mid-frequencies, with a few claiming as much as 25 or more db separation. Lateral compliance varies from approximately  $1 \times 10^{-6}$  cm./dyne to as high as  $6$  or  $8 \times 10^{-6}$  cm./dyne, with most of the cartridges claiming compliances of about  $2$  to  $5 \times 10^{-6}$  cm./dyne. Vertical compliance of most units is given by the manufacturers as the same as the lateral figures, although in one or two cases, a slightly lower vertical compliance is specified. If and when industry-wide standards are set up for determining some of these figures, a more intelligent comparison will be able to be made among the various units that are available.

NOTES: \* Mag. = magnetic; Cer. = ceramic; Cry. = crystal \*\* D = diamond; Sa. = sapphire

1. Out-of phase outputs for CBS-Simplex Amplifiers; 2. Supplied with plug-in equalizing networks; 3. Arm-cartridge combination; 4. Element only; 5. Includes special arm; 6. For operation into magnetic phono preamp.

Coming in November **ELECTRONICS WORLD:**

**A must for every Radio Amateur . . .**

**GIANT FOLD-OUT GREAT CIRCLE WALL CHART!**

# Single-Sideband

# Transmission

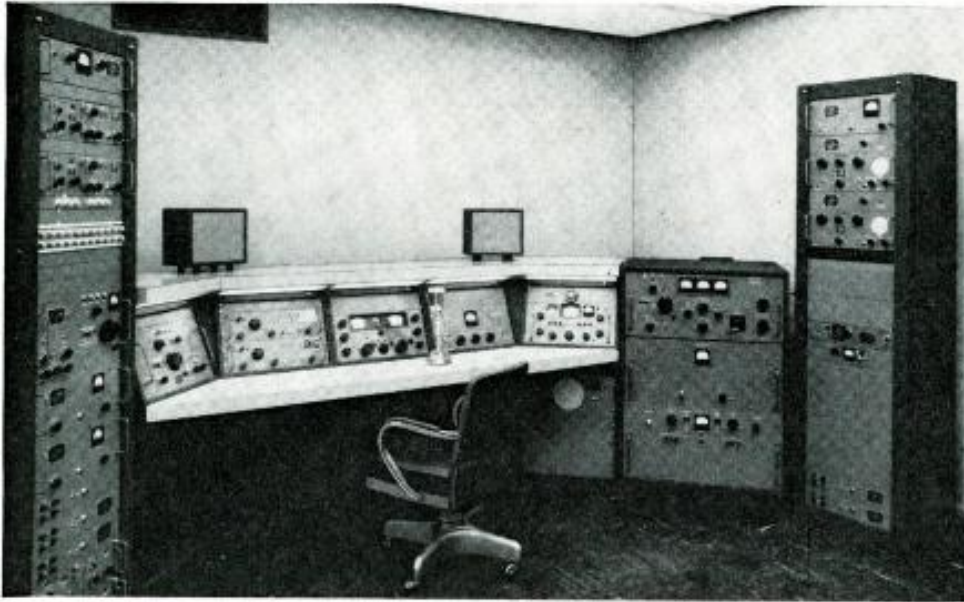

A complete SSB station installation using Technical Materiel equipment.

## PART 2 Linear Amplifiers and Receivers

By ALAN ANDREWS / Methods used to suppress one sideband, along with a discussion of linear amplifiers and receivers for SSB.

IN PART 1 of this series the advantages of single-sideband transmission were discussed. Also included were descriptions of the basic single-sideband system, as well as methods of suppressing the carrier signal. In this article we will cover the methods used for suppressing the unwanted sideband and provide information about transmitter amplifiers and single-sideband receivers.

### Suppressing a Sideband

Two basic methods of sideband suppression are in current use. The first employs a balanced modulator, the output of which consists of the two sidebands. One of these sidebands is then removed by a very selective filter. In the other method, two balanced modulators are used. To one of them are fed both the audio and the r.f. signals. The input of the other includes the same audio and r.f., except that both are shifted 90° in phase. This process eliminates the carrier and one sideband

without the use of a separate filter.

A block diagram of the filter method is shown in Fig. 6. The balanced modulator functions the same as described in Part 1, and the output of the modulator consists of the two sidebands produced as a result of modulation, the carrier having been suppressed. The filter eliminates either sideband, so that only the other sideband appears in the filter output.

This filter must be extremely selective and it is difficult to obtain the required selectivity except at low frequencies. So most often, when using this arrangement, the r.f. oscillator is operated at a much lower frequency than the carrier. The remaining sideband is then also much lower than that required for transmission. A SSB signal cannot be multiplied in frequency by the usual methods, without creating extreme distortion, so some other method must be used.

As shown in Fig. 6 another oscillator is used, this one producing the actual

carrier frequency although it is not used for transmission. The single-sideband heterodynes with the carrier in the mixer stage to produce two additional frequencies. One of these is equal to the carrier plus the sideband,



Drake Model 1-A sideband receiver.

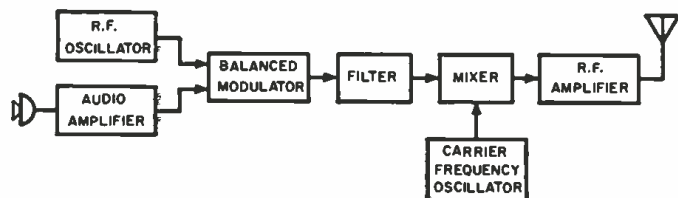

Fig. 6. Block diagram of the filter method used to suppress one of the two sidebands.

the other the carrier minus the sideband. There is a large frequency difference existing between these two signals, so the mixer stage output can be tuned to either of these newly created sidebands. Now we can proceed to the following step.

The sideband which remains is then amplified by one or more stages of linear amplification to increase the power level to that required for radiation. When the transmitted frequency is much higher than that produced in the initial stages of the transmitter, several successive stages of r.f. generation and mixing can be used to step up the frequency.

The second method used for sideband suppression, illustrated in Fig. 7, eliminates the need for mixing stages as used in Fig. 6. It is known as the "phasing method" and suppresses both the carrier and one sideband simultaneously.

With this arrangement the audio signal is fed to an "audio phase shifter" which gives two outputs, which are 90° out-of-phase with each other. The same process is performed on the r.f. signal with the phase shift being in the same direction as the audio. If the audio shift were 90° leading, the r.f. phase shift must be the same.

Into balanced modulator No. 1 are fed both the audio and the r.f. in their original phases. Balanced modulator No. 2 is supplied the phase-shifted audio and r.f. signals. By the process already described, each balanced modulator removes the r.f. carrier and produces two sideband frequencies in its output. These signals can be analyzed by using  $F_c$  for the carrier frequency and  $F_a$  for the audio, as shown in Fig. 7. The phase-shifted components are labeled  $F_c + 90^\circ$  and  $F_a + 90^\circ$ .

In the output of circuit No. 1 the two sidebands are  $F_c + F_a$  and  $F_c - F_a$ . From No. 2 one sideband is  $F_c + 90^\circ + F_a + 90^\circ$ , which is equal to  $F_c + F_a + 180^\circ$ . The other output is  $F_c + 90^\circ - F_a - 90^\circ$ , or  $F_c - F_a$ . These four outputs are labeled in Fig. 7 in the order listed here. Outputs (1) and (3) are identical except that they are 180° out-of-phase, therefore they cancel. Outputs (2) and (4) are identical, and thus reinforce each other. This is the  $F_c - F_a$  signal and it is then amplified before being transmitted.

In the process the carrier and the upper sideband were eliminated, leaving only the lower sideband to be radiated. By reversing either the audio or the r.f. the lower sidebands can be cancelled, leaving only the upper. One way of doing this is to change the phases of the audio and r.f. in different directions, for example if the r.f. were shifted to lead by 90° and the audio to lag by 90°.

The major problem encountered in this method is that of maintaining the phase shift at exactly 90° for all audio modulating frequencies. Phase shifting can be performed with RC networks but the values must be exact and all the components needed are not standard commercial values. However, some manufacturers are now providing these networks in packaged units. One type which is available has all its components mounted in a metal tube envelope which plugs into a standard octal socket. This unit maintains the phase shift to within less than two

degrees for a range of about 300 to 3000 cps.

The availability of these units has eliminated the primary disadvantages of the phasing system—difficult design and alignment. With these disadvantages removed, the phasing method can be considered better than the filter method because of its lower initial and operating costs.

An example of an audio phase-shift network is shown in Fig. 8. The audio signal  $F_a$  is applied to the grid of  $V_1$ ,  $F_a + 90^\circ$  is applied to  $V_2$ . Notice especially the non-standard values of components needed for proper phase shift over a wide enough band of frequencies.

The r.f. phase shifting is not as critical, nor as difficult to obtain. There are two reasons for this, the r.f. is a much higher frequency, also, the r.f. is always the same frequency and does not vary over a band as does the audio.

Two r.f. phase-shifting networks are shown in Figs. 9A and 9B. Operation

is similar, the only difference is that in Fig. 9B an output resistor replaces the coil used in Fig. 9A. In each circuit the No. 1 output leads the No. 2 output by 90°.

### Linear Amplifiers

Single-sideband and suppressed-carrier transmitters require the use of linear amplifiers after the modulation stages. Schematically, linear amplifiers are not very different from any other type used in transmitters, but in performance they should have two primary characteristics. These are low distortion and maximum power gain, which are mutually exclusive factors in most amplifiers.

Linear amplifiers are those in which the output signal voltage is proportional to the input signal voltage. Audio amplifiers can be classed as linear, so can the r.f. and i.f. amplifier stages used in radio receivers.

In order to utilize its full effectiveness, carrier and sideband suppression

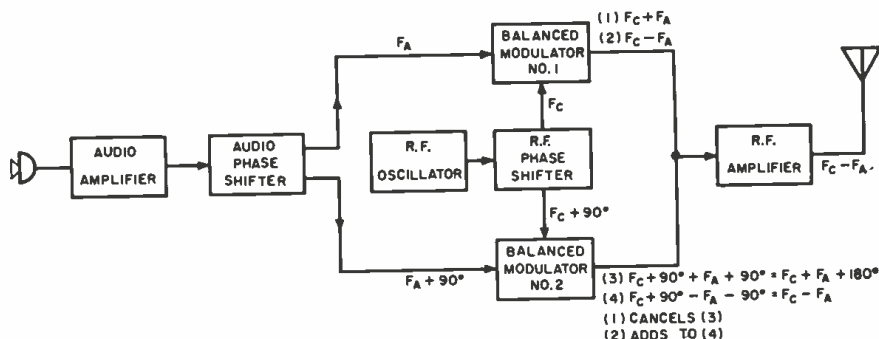

Fig. 7. Block diagram of sideband suppression by means of the phasing method.



Heathkit "Mohawk" amateur-band receiver.

The RME—Electro-Voice sideband selector.



should take place at very low signal level, otherwise no appreciable savings in power would result. It would be senseless to waste power in generating a high-level carrier and then immediately suppress it. This means that single-sideband systems must amplify the signal many times before it reaches the full power required for radiation.

In any amplitude-modulation system, class C amplification cannot be used for any stage after the one in which modulation occurs. This limits the usage to either class A or B, or in some cases AB, if serious distortion is to be avoided.

Class A amplifiers can be used in the transmitter, and they are quite linear, but efficiency is low (usually less than 30%). This may not be too much of a disadvantage at low power, but decidedly increases costs for a higher powered transmitter. Class B push-pull gives much better efficiency (about 60 to 70%) and, if designed properly, can give the desired linearity.

To design a stage to amplify in a very linear manner often results in low gain, which means that more stages are required to give a certain amount of gain. As class C cannot be used, the maximum possible efficiency cannot be obtained, all the more reason why few stages are desirable. In many cases negative feedback is used to im-

prove the linearity of these stages. By thus improving the linearity, the tubes can be driven harder to obtain even more signal output. One popular method of feedback is to feed r.f. from the plate of the final stage to the cathode of the driver, thus improving the linearity of both stages.

An additional advantage of linear amplification is the reduction of harmonic radiation. And for best results, distortion of these stages should be kept below 0.1%. At least one manufacturer of SSB equipment uses servo tuning to make sure the amplifiers remain at the point of maximum-signal tuning.

Single-sideband equipment is rated as to peak-envelope-power, abbreviated "p.e.p." This is the r.m.s. power developed at the peak of the modulation cycle. In SSB, the instantaneous power undergoes a much larger variation than in conventional AM transmission, so the peak rating gives a better idea of power than would the average.

The power rating can be measured in a dummy load with an oscilloscope. Peak voltage can be determined, then multiplied by .707 to obtain the r.m.s. value. The "p.e.p." then equals the square of the r.m.s. voltage divided by the resistance of the dummy load. Peak-envelope-power can also be defined in terms of input, and is then equal to the peak swing of plate current of the final amplifier multiplied by the d.c. plate voltage.

### Receivers

Receivers for SSB reception must be comparable in quality to the transmitter with regards to stability, bandwidth, and linearity. Double, and even triple, i.f. conversions are used in some designs to obtain the selectivity characteristics needed. Receiver tuning is probably the biggest disadvantage encountered in SSB because of the required accuracy. However, most of the newer equipment overcomes this disadvantage admirably.

So that demodulation can take place, the carrier must be generated locally in each receiver. This means that an oscillator operating at the carrier frequency must be in the receiver and its output added to the sideband being received, otherwise there would be no signal to heterodyne with the sideband in the second detector stage.

Bear in mind that the sideband which

Hammarlund HQ-170 amateur-band receiver.

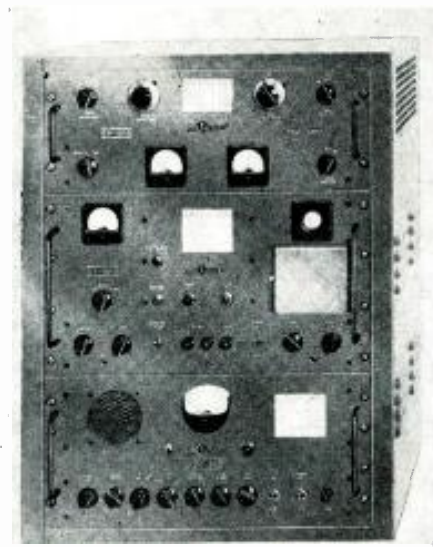

A complete Eldico SSB installation.

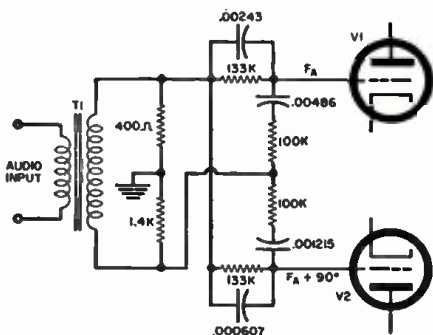

Fig. 8. An audio phase-shift network.

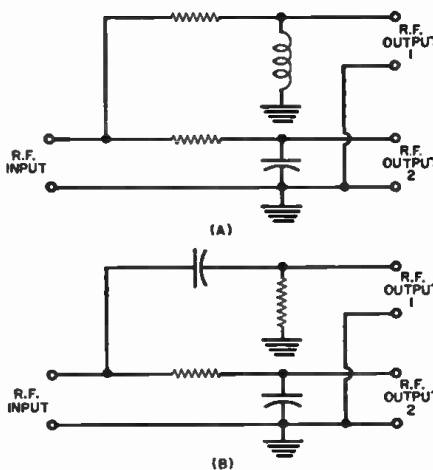

Fig. 9. Two r.f. phase-shift networks.

A "Knight-Kit" communications receiver.



was transmitted is equal in frequency to the carrier plus or minus the audio. But in itself it is only a single frequency and if applied to the second detector by itself would produce no usable output. After the carrier is added, the two signals can beat together to form the audio difference frequency, a replica of the original modulating signal.

Using a superhet receiver we can inject the carrier at an intermediate frequency into one of the i.f. stages. Or, a frequency equal to that of the original carrier can be generated and introduced at the receiver antenna input terminals. Actually it could be re-inserted at any point between the antenna and the second detector, but the two points listed are those which are most often used.

Receivers containing a beat-frequency oscillator (b.f.o.) can use this stage to generate the required carrier, eliminating the need for an extra stage. The b.f.o. signal should be at least twice the amplitude of the SSB signal, at the insertion point, to prevent overmodulation and distortion.

Front-end insertion is considered to be superior to i.f. insertion because it facilitates tuning, is more easily controlled, and does not require as good receiver stability. In a double-conversion receiver, carrier insertion at the high intermediate frequency is better than at the low i.f. for somewhat the same reasons.

To tune in a lower sideband, the inserted carrier frequency must be above the incoming sideband, for tuning in an upper sideband the carrier must be lower. Amplitude of the re-inserted carrier can be varied by changing receiver coupling or by varying oscillator amplitude. When interference is heavy, increasing the amplitude of the re-inserted carrier usually gives better results.

Filters, some of them adjustable, are often used in the i.f. stages to improve selectivity where needed. Even more selectivity occurs as a result of using a slicer after the last i.f. stage. This is a phasing-type unit, similar to that used in the transmitter (except in reverse) which also demodulates the SSB signal while eliminating undesired signals.

No matter how it is generated, the re-inserted carrier still requires extreme stability. If different from the

(Continued on page 130)

National Radio NC303 amateur receiver.

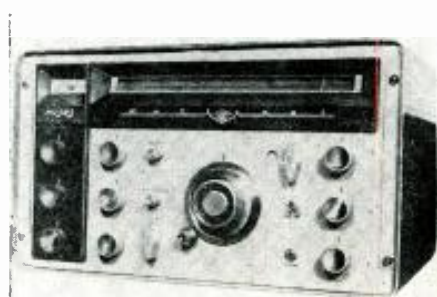



# GET *more!* DO *more!* MAKE *more!*

PROFIT PROFESSIONALLY ON EVERY CALL WITH

## NEW **B&K** LOW-COST PROFESSIONAL Model 550 DYNA-QUIK

DYNAMIC MUTUAL CONDUCTANCE TUBE TESTER

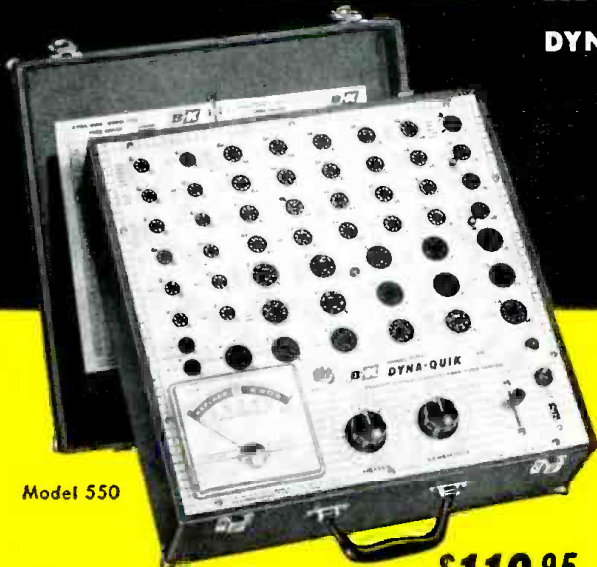

Model 550

NET \$119.95

### MODEL 550 DYNA-QUIK TUBE TESTER

*Tests Each Section of Dual-Section Tubes Separately*

Great new value in professional quick-check at small cost. Provides more tube sockets to test more tubes faster. Accurately checks most of the TV and radio tubes usually encountered in everyday service work. Tests each section of dual-section tubes separately. Measures true dynamic mutual conductance. Checks tubes for shorts, grid emission, gas content, and leakage. Completely tests each tube in seconds, checks average TV set in a few minutes, in home or shop. One switch tests everything. Fast, convenient reference listings on socket panel. Patented circuit provides automatic line voltage compensation. 7-pin and 9-pin straighteners on panel. Handsome, luggage-type carrying case. Net, \$119.95

### MODEL 650 DELUXE DYNA-QUIK

*Today's Finest Portable Tube and Transistor Tester*

Accurately checks over 99% of the tubes most widely used in television receivers, plus popular home and portable radio tubes. Tests over 600 tube types. Lists over 125 most popular tube types, with settings, on socket panels for maximum operating speed. Complete listing in fast, index-type selector. Measures true dynamic mutual conductance. Tests each section of multiple tubes separately for GM, Shorts, Grid Emission, Gas Content and Life. Includes 16 spare sockets and ample filament voltages for future new tube types. Transistor Section checks transistors, diodes, and selenium rectifiers. Luggage-type carrying case. Net, \$169.95

Every service-technician now can easily check tubes the B&K professional way! Only with a *genuine dynamic mutual conductance tube tester* can you make a complete and accurate test under the actual dynamic operating conditions of the TV set. The compact new "550" is not just an emission checker. *It completely checks more tubes faster*—with laboratory accuracy. And the cost is so amazingly low, it pays its way over and over again! Take a tip from thousands of professional servicemen—*use B&K Dyna-Quik*. There is nothing like it.



*Get More for Your Money*

—IN SPEED, ACCURACY, AND VALUE



*Save Customers*

—SAVE CALL-BACKS, SAVE COST



*Sell More Tubes*

—MAKE MORE MONEY PER CALL



Model 650



**B & K MANUFACTURING CO.**

3726 N. Southport Ave. • Chicago 13, Illinois

Canada: Atlas Radio Corp., 50 Wingold, Toronto 10, Ont.  
Export: Empire Exporters, 277 Broadway, New York 7, U.S.A.

See Your Distributor or Send Now for Bulletin ST24-N

# ANOTHER FIRST FOR HEATHKIT®

## ... amplifier power rating standards

Heathkit is accustomed to pioneering . . . to leading the way. We led the way into the kit field of electronic equipment. Now, we are leading the way to audio amplifier power rating standards . . . standards clearly defined to assure you of Heathkit quality . . . to enable you to compare before you buy.

The Heathkit amplifier standards have been established upon these following beliefs after reviewing over one hundred published treatises on the subject:

WE BELIEVE any amplifier should be rated for its intended use . . .

**PROFESSIONAL** amplifiers must be so nearly perfect that no audible change occurs in the program material.

**HIGH FIDELITY** amplifiers must be almost as perfect, almost as efficient.

**UTILITY** amplifiers can be less perfect and still fulfill their practical job.

WE BELIEVE the rated power of an amplifier in any of the above "use" categories should be that power which satisfies all requirements in that category.

Each of the three "use" categories we have chosen has requirements which can be translated into performance specifications with rather definite limits . . . limits established by recognized authorities. The Heath requirements and their limits for each of the categories are as follows:

### PROFESSIONAL RATING

The professional power rating shall be that power which satisfies the following five tests:

1. Maximum power at which total harmonic distortion (THD) does not exceed 0.3% at 1000 CPS.
2. Maximum power at which total harmonic distortion (THD) does not exceed 2.0% at 20 CPS.
3. Maximum power at which total harmonic distortion (THD) does not exceed 2.0% at 20,000 CPS.
4. Maximum power at which response does not deviate by more than  $\pm 1$  db between 20 and 20,000 CPS.
5. Maximum equivalent single-frequency power at which intermodulation distortion does not exceed 1.0% (60 and 6000 CPS, 4:1).

### HIGH FIDELITY RATING

The high fidelity power rating shall be that power which satisfies the following five tests:

1. Maximum power at which total harmonic distortion (THD) does not exceed 0.7% at 1000 CPS.
2. Maximum power at which total harmonic distortion (THD) does not exceed 2.0% at 30 CPS.
3. Maximum power at which total harmonic distortion (THD) does not exceed 2.0% at 15,000 CPS.
4. Maximum power at which response does not deviate by more than  $\pm 1$  db between 30 and 15,000 CPS.
5. Maximum equivalent single-frequency power at which intermodulation distortion does not exceed 2.0% (60 and 6000 CPS, 4:1).

### UTILITY RATING

The utility power rating shall be that power which satisfies the following five tests:



1. Maximum power at which total harmonic distortion (THD) does not exceed 1.0% at 1000 CPS.
2. Maximum power at which total harmonic distortion (THD) does not exceed 3.0% at 60 CPS.
3. Maximum power at which total harmonic distortion (THD) does not exceed 3.0% at 7000 CPS.
4. Maximum power at which response does not deviate by more than  $\pm 1$  db between 60 and 7000 CPS.
5. Maximum equivalent single-frequency power at which intermodulation distortion does not exceed 3.0% (60 and 6000 CPS, 4:1).

We at the Heath Company are now rating all our amplifiers to these standards. To show you just how this rating system works, let's look at the Heathkit EA-3 amplifier:

As a professional amplifier—

1. Maximum Power at which T.H.D. does not exceed 0.3% at 1000 CPS: 15.1 watts
2. Maximum Power at which T.H.D. does not exceed 2.0% at 20 CPS: 13.9 watts
3. Maximum Power at which T.H.D. does not exceed 2.0% at 20,000 CPS: 15.3 watts
4. Maximum power at which response does not deviate more than  $\pm 1$  db between 20 and 20,000 CPS: 17.6 watts.
5. Maximum equivalent single-frequency power at which intermodulation distortion (60 and 6000 CPS, 4:1) does not exceed 1%: 18.0 watts.

Taking that power which satisfies all five tests, we could rate the EA-3 for professional use, at 13.9 watts. Its advertised professional rating is a conservative 12 watts.

A review of the chart below shows why the EA-3 is rated at 14 watts for high fidelity applications, and 16 watts as a utility amplifier.

Notice that our specifications are set at rated power for one or more classifications (when our customers need an amplifier for a particular use, we believe they want it to deliver its rated power under those particular conditions). Observe that our distortion figures are specified at the limits of the amplifier frequency range as well as at the traditional 1000 CPS (the common practice of rating distortion only at 1000 CPS does not tell you what happens throughout the full range of the amplifier).

As an example of how these standards work on several competitive amplifiers, we have prepared the following chart. Notice that if the amplifiers did not meet standards at rated output power, we have determined the power output where they do meet the standards set up under the three categories.

AMPLIFIER COMPARISON CHART

Amplifier Description and Price	Heath Standard Rating		Maximum Power Output Satisfying:				
	Classification	Power (watts)	Power Rating at Test 1 Stds.	Power Rating at Test 2 Stds.	Power Rating at Test 3 Stds.	Power Rating at Test 4 Stds.	Power Rating at Test 5 Stds.
Kit "A" "12 w. HI FI" \$23.90	Professional High Fidelity Utility	Disqualified Disqualified 8.6 watts	8.4 watts 9.1 9.8	0.02 watts 1.3 8.9	0.65 watts 1.67 8.6	Disqualified Disqualified 12.3 watts	3.9 watts 5.9 11.6
Assembled Amp. "B" "14 w. HI FI" \$39.50	Professional High Fidelity Utility	0.3 1.1 7.8	4.7 12.1 13.2	0.3 1.1 7.8	4.8 5.7 12.9	1.2 5.3 15.8	4.0 8.2 13.9
Kit "C" "12 w. HI FI" \$34.95	Professional High Fidelity Utility	3.6 8.0 11.9	11.0 11.8 12.0	3.6 8.0 12.0	7.5 11.2 11.9	7.5 13.4 15.0	6.5 14.3 14.9
Assembled Amp. "D" "15 w. HI FI" \$64.50	Professional High Fidelity Utility	3.8 10.6 14.7	13.2 14.3 14.7	3.8 10.6 14.7	14.5 14.5 15.0	12.0 18.3 23.7	14.6 16.3 17.0
Heathkit EA-3 "14 w. HI FI" \$29.95	Professional High Fidelity Utility	13.9 15.5 16.4	15.1 16.2 16.5	13.9 15.8 16.6	15.3 15.5 16.4	17.6 18.3 19.0	18.0 18.9 19.5

The Heathkit amplifier power rating standards have been established as further assurance to you of the high quality of our products. We will live by these standards until industry-wide standards are established.



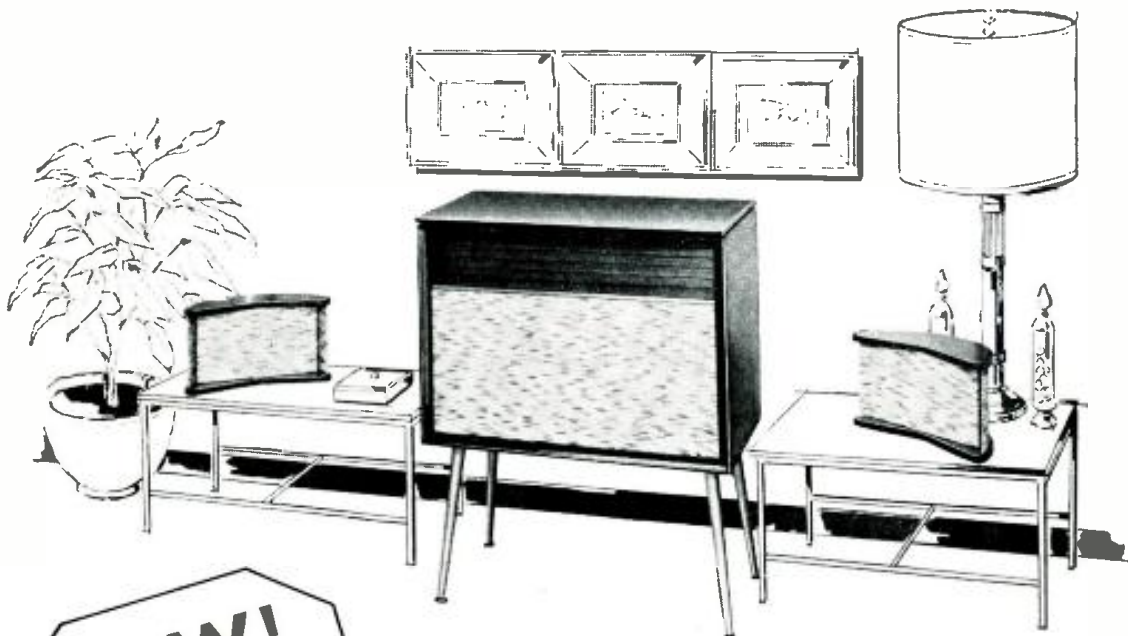

**NEW!**  
from the  
HEATHKIT  
AUDIO LABS

**BRAND NEW!**  
a complete Heathkit Stereo "Package"

**THRILL TO A NEW DIMENSION  
IN STEREO SOUND**

HEATHKIT SD-1 B (birch  
or SD-1 M (mahogany))

**\$179<sup>95</sup>**

(cabinet legs included;  
end tables not included)

### HI-FI STEREO SYSTEM KIT

For the first time anywhere . . . a stereo-kit package, ready-to-play after only a few hours assembly time and complete with cabinet, stereo amplifier, stereo record changer, bass woofer and stereo speaker wings. And the unbelievably low price sets an unprecedented record for stereophonic systems of this quality anywhere on the market. One of the factors behind this phenomenal achievement is the introduction of the revolutionary stereophonic "sum and difference" amplifier used in this kit—licensed in kit form exclusively by Heath Company from CBS Laboratories. This unique development in audio science employs a new principle of stereophonic reproduction. The single chassis amplifier separates the individual stereo channels by utilizing the sum and difference of the total signal and directing the sound to the appropriate right and left channels, reproduced by the stereo wing speakers. The centrally located woofer reproduces the non-directional bass frequencies. The result of this modern stereo reproduction is a breathtaking experience of sound coming to you with depth and direction seldom achieved by conventional stereophonic methods. The beautifully styled console cabinet houses the stereo amplifier, stereo record changer and low-frequency woofer. Controls on the handsome black and gold amplifier panel consist of: on-off switch, bass and treble tone controls, input selector switch and level balancing control. The new CBS sum-and-difference or matrix-type circuit employs only four tubes and is extremely easy to assemble. The woofer, mounted behind the attractive grille cloth, is a high compliance 8" speaker capable of 30 cycle response when housed in the acoustically designed ducted-port enclosure. The specially designed crossover employs a dual bass-mixing 250 cycle network. The twin stereo speakers are 6" x 9" extended range dual cone oval speakers. The completely automatic, four speed record changer employs a ceramic stereo cartridge with micro-groove diamond stylus capable of obtaining the best from the latest stereo or LP monophonic recordings. A 45 RPM spindle is also included for 45 RPM monophonic or stereo records. Separate inputs are provided for AM/FM tuners or multiplex. Both in styling and performance, the all-new SD-1 Stereo offers you the greatest Heathkit value in years. Shpg. Wt. 88 lbs.

October, 1959

- 9 Watt High Fidelity Rating (monophonic)
- Complete—No "Extras" to Buy
- Revolutionary Stereo Amplifier
- Assemble in Just a Few Hours From Easy Step-By-Step Instructions
- Beautifully Styled Cabinetry
- Stereo Sound With Such Impact You'll Find It Hard to Believe!

**SPECIFICATIONS**—Overall System Frequency Response:  $\pm 5$  db. 30-16,000 cps. Amplifier: (push-pull conditions except where specified). Power versus Distortion: 10 watts, less than 3% THD from 30-16,000 cps; 9 watts, less than 2% THD from 30-16,000 cps; 1 watt, less than 0.7% from 30-16,000 cps. Peak Power: 20 watts; Mid-range individual channel power, 5 watts. Frequency Response: Tuner input, tone controls in mid-position, 1 watt level,  $\pm 1$  db. 30-16,000 cps. Ceramic cartridge input—equalized for RIAA characteristics, input sensitivity: 0.1 volt at 1000 cps to each tuner input for 10 watt output. Hum and Noise: 70 db below 10 watt level with inputs shorted. Channel Separation at Significant Frequencies: (2 watt level on operating side) 250 cps—29.0 db, 1 kc—34.0 db, 2 kc—35.0 db, 5 kc—36.0 db, 8 kc—37.0 db, 12 kc—35.0 db, 16 kc—29.0 db. Overall Channel Separation: using RCA test record #1427-1, cartridge supplied, 1000 cps, 20 db. Bass Tone Control 50 cps: accumulation 3 db, Attenuation 9 db. Treble Tone Control 10 kc: accumulation 9 db, Attenuation 7 db. Power Requirements: 117 volts, AC, 60 cycles, 75 watts. Crossover Network: crossover frequency—250 cps. Attenuation rate 12 db per octave. Power rating—5 watts per channel. Changer: speeds—16, 33 $\frac{1}{2}$ , 45, 78 rpm. Cartridge: ceramic stereo, out-of-phase connected (.0008" diamond stylus). Cabinets: dimensions—main cabinet, 30" wide x 34 $\frac{1}{2}$ " high x 15" deep. Satellite speaker, 14 $\frac{1}{2}$ " wide x 8" high x 6 $\frac{1}{2}$ " deep.



### EASY TIME PAYMENTS

The thrills of stereo sound from this New Heathkit Stereo System can be yours NOW . . . while you pay in easy installments.

a complete line of stereophonic and monophonic

**NEW!**  
from the  
**HEATHKIT**  
AUDIO LABS



# Tape Recorders

Field Tested for One Year



**SPECIFICATIONS**—Tape Speed: 7.5 and 3.75" per second. Maximum reel size: 7". Frequency response: (record-playback):  $\pm 2.5$  db, 30-12,000 cps at 7.5 IPS,  $\pm 2.5$  db, 30-6,500 cps at 3.75 IPS. Harmonic distortion: 1% or less at normal recording level; 3% or less at peak recording level. Signal-to-noise ratio: 50 db or better, referred to normal recording level. Flutter and wow: 0.3% RMS at 7.5 IPS, 0.35% RMS at 3.75 IPS. Heads (3): erase, record, and in-line stereo playback. Playback equalization: NARTB Curve, within  $\pm 2$  db. Inputs (2): microphone and line. Input impedance: 1 megohm. Outputs (2): A and B stereo channels. Output levels: approximately 2 volts maximum. Output impedance: Approximately 600 ohms (cathode followers). Recording level indicator: Professional type db meter. Bias-erase frequency: 60 kc. Timing accuracy:  $\pm 2\%$ . Power requirements: 105-125 volts AC, 60 cycles, 32 watts. Dimensions: 15 $\frac{1}{2}$ " W. x 13 $\frac{1}{2}$ " D. total height 10 $\frac{1}{2}$ ". Mounting: requires minimum of 8 $\frac{1}{2}$ " below and 1 $\frac{1}{2}$ " above mounting surface. May be operated in either horizontal or vertical position.

## NEW PROFESSIONAL-TYPE TAPE RECORDER KITS

Designed to take their place in the finest of hi-fi systems, the new models TR-1C and TR-1D Tape Recorders will provide superb performance for years to come. These completely field tested, precision engineered instruments provide monophonic record and playback in the TR-1C or monophonic record and playback plus stereo playback in the TR-1D.

The mechanical assembly, with fast forward and rewind, is completely finished and adjusted—you build only the tape amplifier. Easy to assemble, the amplifier features two circuit boards which virtually eliminate wiring errors and assure the high stability necessary for consistently good results.

Low noise EF-86 tubes in input stage and push-pull bias erase oscillator assure maximum freedom from hum and noise in recording and playback.

Two inputs are provided (mike and high level line) for recording from microphone, preamplifier, tuner, phono, or TV. In the TR-1D, a separate playback channel with cathode follower output is provided for each stereo track—one of the stereo channels is used for monophonic playback.

Separate record and playback heads and amplifiers allow monitoring from tape while recording. Built-in sound level meter indicates proper recording level and bias for top quality recordings. A pause control allows instant starting and stopping of tape for accurate cueing and tape editing. Kit includes counter for cueing and editing ease.

The precision tape mechanism features heavy duty fan cooled motor, balanced flywheel, long-life bearings, and positive acting braking system. Push button provides instant selection of 3 $\frac{3}{4}$  or 7 $\frac{1}{2}$  IPS tape speed. Safety interlock on record switch minimizes the possibility of accidental erasing. The handsome styling includes plastic escutcheon in soft gold mounted on semi-gloss black panel with black knobs with gold inserts. Complete instructions provided for assembly and operation. This outstanding kit offers a combination of features found only in higher priced professional tape decks selling for \$350 to \$400.

**MODEL TR-1C** Monaural Tape Deck: Has all features of model TR-1D with the exception of stereo playback. Shpg. Wt. 30 lbs. **\$159<sup>95</sup>**

**MODEL TR-1D** Stereo Tape Deck: Provides monaural record and playback and stereophonic playback of the pre-recorded tapes (stacked). Shpg. Wt. 30 lbs. **\$169<sup>95</sup>**

**MODEL C-TR-1C** Conversion Kit: Converts model TR-1C to include stereo function of model TR-1D. **\$19<sup>95</sup>**

## NOW! TWO NEW STEREO-MONO TAPE RECORDERS IN THE TR-1A SERIES

Our most versatile tape recorder kit, the model TR-1A now can be purchased in any one of three versions. You can buy the new half-track (TR-1AH) or quarter-track (TR-1AQ) versions which record and play back stereo and monophonic programming, or you can buy the original monaural version (TR-1A) and add either half-track or quarter-track stereo provisions later using the MK-4 or MK-5 Conversion kits. The tape deck is extremely simple to assemble and uses precision bearings throughout the rugged mechanism assuring long and faithful service. One control lever selects all tape handling functions on the deck, greatly simplifying operation. Speeds of 7.5 or 3.75 IPS are available. Flutter and wow are held to less than 0.35%. Each tape preamplifier features NARTB playback equalization, separate record and playback gain control, cathode follower output and provision for mike or line input. Record level is indicated on "magic eye" tube. A safety interlock is provided to minimize accidental erasure of tape. Filament balance control allows adjustment for minimum hum level. Cathode follower output from playback channel is approximately 600 ohms impedance. Two circuit boards are used for easy assembly. Supplied with attractive vinyl-clad steel cover in black leather texture, with inlaid gold design. Templates and instructions provided for panel mounting or equipment enclosure installation.

### NOW AVAILABLE IN THREE MODELS!

**MODEL TR-1A:** Monaural record/playback with fast forward and rewind functions. Shpg. Wt. 24 lbs. **\$99<sup>95</sup>**

**TR-1A SPECIFICATIONS**—Frequency Response: 7.5 IPS  $\pm 3$  db 50-12,000 cps, 3.75 IPS  $\pm 3$  db 50-7,000 cps. Signal to Noise Ratio: Better than 45 db below full output of 1.25 volts/channel. Harmonic Distortion: Less than 2% at full output. Bias Erase Frequency: 60 kc (push-pull oscillator).

**MODEL TR-1AH:** Monaural and half-track stereo record/playback with fast forward and rewind functions. Shpg. Wt. 35 lbs. **\$149<sup>95</sup>**

**TR-1AH SPECIFICATIONS**—Frequency Response: 7.5 IPS  $\pm 3$  db 40-15,000 cps, 3.75 IPS  $\pm 3$  db 40-10,000 cps. Signal to Noise Ratio: 45 db below full output of 1 volt/channel. Harmonic Distortion: Less than 2% at full output. Bias Erase Frequency: 55 kc (push-pull oscillator).

**MODEL TR-1AQ:** Monaural and quarter track stereo with record/playback fast forward and rewind functions. Shpg. Wt. 35 lbs. **\$149<sup>95</sup>**

**TR-1AQ SPECIFICATIONS**—Frequency Response: 7.5 IPS  $\pm 3$  db 40-15,000 cps, 3.75 IPS  $\pm 3$  db 40-10,000 cps. Signal to Noise Ratio: 40 db below full output, .75 volts/channel. Harmonic Distortion: Less than 2% at full output. Bias Erase: 55 kc (push-pull oscillator).



### NOW! FULL STEREO CONVERSION FOR TR-1A OWNERS

**MK-4 Half-Track Stereo Conversion Kit:** Modifies TR-1A monaural tape recorder to include function of record and playback of half-track stereo program material. Consists of a TE-1 tape preamplifier, a stereo head array plus components and instructions to convert TR-1A to TR-1AH. **\$62.95**

**MK-5 Quarter-Track Stereo Conversion Kit:** Modifies TR-1A monaural tape recorder to include function of record and playback of quarter-track stereo. Allows playing stereo both ways on standard tape for twice the playing time or four times playing time with monophonic recordings. Consists of a TE-1 tape preamplifier, a stereo head array plus components and instructions to convert TR-1A to TR-1AQ. **\$62.95**



monophonic or stereo Hi-Fi

# Program Sources



**MODEL FM-4**  
**\$34<sup>95</sup>**

88-108 mc. Quieting 3.5 uv for 30 db of quieting. Frequency: 10.7 mc. Image 75 kc per volt. AM Suppression 2 db 20-20,000 cps. Harmonic 400 cycles 100% modulation. In 1% 60 cycle and 6 kc mixed (enna: 300 ohms unbalanced, mode follower). Output Voltage: 20 uv signal. Power 60 cycle AC at 25 watts. Overall x 5 1/2" D.



**MODEL PT-1**  
**\$89<sup>95</sup>**



**MODEL BC-1A**  
**\$26<sup>95</sup>**

## HIGH FIDELITY AM TUNER KIT (BC-1A)

Delivers AM broadcast reception comparable to FM quality. Features a special detector using crystal diodes and broad-band IF circuits for low signal distortion. Precaligned RF and IF coils eliminate the need for special alignment equipment. Sensitivity better than 3 microvolts for one volt output. Two output levels provided. Built-in power supply. Special antenna supplied, also provision for outside antenna. Shpg. Wt. 9 lbs.



**MODEL FM-3A**  
**\$26<sup>95</sup>**

## HIGH FIDELITY FM TUNER KIT (FM-3A)

Featuring broad-banded circuits for full fidelity and better than 10 microvolt sensitivity for 20 db of quieting, the FM-3A pulls in stations with clarity and full volume. Incorporates stabilized temperature compensated oscillator, built-in power supply, pre-aligned IF transformers and ratio detector. The pre-assembled tuning unit is pre-aligned. Two output levels provided. Shpg. Wt. 8 lbs.

## NEW HIGH FIDELITY FM TUNER KIT (FM-4)

This superbly designed unit incorporates advancements in circuit design with features asked for by hi-fi fans everywhere. Better than 2.5 microvolt sensitivity, automatic frequency control (AFC) with defeat switch, flywheel tuning and prewired, pre-aligned and pretested tuning unit... bring you the finest in FM listening entertainment. The exceptionally clean chassis layout, pre-aligned IF transformers and the prewired, pre-aligned tuning unit insure ease of construction with no further need of alignment after the unit is completed. The five tube circuit features a generous power supply utilizing a silicon diode rectifier for cool running operation and low power consumption. The attractive styling of the FM-4 features a vinyl-clad steel cover with leather-like texture, soft black front panel, set off with brushed-gold trim and new soft evenly-lit dial scale. A multiplex adapter output is provided. Feature for feature the FM-4 offers the most outstanding dollar value in FM entertainment available today. Shpg. Wt. 8 lbs.

## MONOPHONIC-STEREO AM-FM TUNER KIT (PT-1)

Outstanding features in both styling and circuitry are combined in this 16-tube deluxe stereo AM-FM combination tuner to bring you the very finest of program sources for your listening enjoyment. Features include three printed circuit boards for easy construction and high stability—wired, pre-aligned 3-tube FM tuning unit—built-in AM rod antenna—tuning meter—automatic frequency control (AFC) with on-off switch—and flywheel tuning. Other features include variable AM bandwidth, 10 kc whistle filter, tuned-cascade FM front end, FM AGC and amplified AVC for AM. AM and FM circuits are separate and individually tuned so they can be used simultaneously for stereo applications. Cathode follower outputs with individual level controls are provided for both AM and FM, with a multiplex adapter output provided. A tuning meter and flywheel tuning combined with two edge-lit slide rule scales provide effortless tuning. Styling features vinyl-clad steel cover in black with inlaid gold design and soft black, rigid die-cast panel set off by brushed gold trim, black knobs with gold inserts. Shpg. Wt. 24 lbs.

## AUTOMATIC HI-FI RECORD CHANGER KIT (RP-3)

Combining automatic convenience with turntable quality through unique and simple design the Heathkit RP-3 handles your records with the finest of care for full fidelity reproduction. The unique "turntable pause" feature during change cycle and smooth friction clutch start prevents record damage. Proper weight distribution and low pivot point friction of the tone arm minimize arm resonance, tracking error, and record wear. All record changer kits come equipped with changer base, stylus pressure gauge, 45 RPM spindle, and necessary wire.



**STEREO MODEL RP-3S:** Equipped with Shure diamond stylus magnetic cartridge providing frequency response of  $\pm 4$  db from 30 to 14,000 CPS. Shpg. Wt. 19 lbs. **\$74.95**

**MONAURAL MODEL RP-3-LP:** (monaural microgroove recordings only): Equipped with Fairchild Magnetic diamond stylus cartridge. Shpg. Wt. 19 lbs. **\$74.95**

**MONAURAL MODEL RP-3:** Features a GE VRH magnetic cartridge with diamond LP and sapphire 78 stylus. Shpg. Wt. 19 lbs. **\$64.95**

**SPECIFICATIONS**—Operates from: 105-130 volts 60 cycles. Wow and Flutter: Less than 0.18% peak at 33-1/3 RPM. Turntable Speed: Accurate within  $\pm 2\%$ . Change Cycle: Completed in 9 seconds. Dimensions: 13 1/2" wide x 12" deep, 5" above and 3" below mounting board. Motor Type: 4 Pole hum shielded. Type of Drive: Friction. Record Speeds: 4 speeds. Automatic and manual 33 1/3, 45, 78 RPM. Manual only—16 RPM. Variations in Tracking Force: Less than 0.9 gram from first record to tenth record. Controls: "ON-OFF" switch, Manual Rept., "Speedminder" (automatic speed selection and indexing). Manual speed selector (4 speed). Finish: Midnight Gray. Base: Maple (unfinished). Mounting Board: Birch (unfinished).

**NEW**  
from the  
**HEATHKIT**  
AUDIO LABS

a complete line of monophonic



**Hi-Fi Amp**



MODEL SA-3

**NEW**

**\$29.95**



MODEL EA-1

**NEW**

**\$15.95**



MODEL EA-3

**NEW**

**\$29.95**

**PREAMPLIFIERS**



- Model WA-P2 "Master Control" hi-fi pre-amplifier kit, 7 lbs. .... **\$19.75**
- Model SP-2 Mono-Stereo (2 channel mixer) Pre-amplifier kit, 15 lbs. .... **\$56.95**
- Model SP-1 Single Channel version of SP-2, 13 lbs. .... **\$37.95**
- Model C-SP-1 Converts SP-1 to SP-2, 5 lbs. .... **\$21.95**

**NEW "ECONOMY" STEREO AMPLIFIER KIT (SA-3)**

The all-new Heathkit SA-3 Stereo Amplifier has all the convenience of dual channel control at a fraction of the cost of comparable equipment. The preamplifier section of the SA-3 provides complete control for both channels. Tone controls provide "boost" and "cut" for base and treble. Dual concentric volume controls make possible precise channel balancing. A channel reversing and a speaker phasing switch allows optimum performance. Two separate inputs are provided for each channel to accommodate ceramic cartridge phono, AM-FM tuners, or tape recorder. Program source may be reproduced in monophonic or stereo form. A really big package of stereo performance for small investment! Shpg. Wt. 13 lbs.

**SPECIFICATIONS:** Power Output: 3 watts per channel. Utility Rating. Power Response:  $\pm$  1 db 20 cps to 20 kc at 3 watts output. Total Harmonic Distortion: less than 3% at 3 watts output using 60 cps and 6 kc signal mixed 4:1. Intermodulation Distortion: less than 3% at 3 watts output using 60 cps and 6 kc signal mixed 4:1. Hum and Noise: 65 db below full output. Controls: dual clutch-dial volume, independent bass and treble, and 7 position selector speaker phasing switch "on-off" switch. Inputs: (each channel) tuner, crystal or ceramic phono. Outputs: (each channel) 4, 8, and 16 ohms. Finish: black with gold trim. Dimensions: 12" x 6 1/2" D. x 3 1/2" H.

**NEW "ECONOMY" 3 WATT AMPLIFIER KIT (EA-1)**

More than enough for room filling volume... ideal for getting started on a low cost individual component system. Designed for use with ceramic cartridge record players, tuners, tape recorders, etc. Built-in preamplifier provides you with all the necessary tone and volume controls for adjusting the sound reproduction to your personal taste. Smart appearance, quality components, assemble it in a few hours for years of trouble-free enjoyment. Shpg. Wt. 7 lbs.

**SPECIFICATIONS:** Power Output: 3 watts. Utility Rating. Power Response:  $\pm$  1 db 60 cps to 20 kc at 3 watts output. Total Harmonic Distortion: less than 3% at 3 watts output using 60 cps and 6 kc signal mixed 4:1. Intermodulation Distortion: less than 3% at 3 watts output using 60 cps and 6 kc signal mixed 4:1. Hum and Noise: 70 db below full output. Power Supply: transformer operated full wave rectifier. Inputs: (2) crystal or ceramic phono cartridge, tuner. Input Sensitivity: 100 mv for 3 watts output. Output Impedance: 4, 8, and 16 ohm. Dimensions: 3 1/2" H. x 9 1/2" W. x 6" D.

**NEW 14-WATT HI-FI AMPLIFIER (EA-3)**

From HEATHKIT audio labs comes an exciting new kit... New Styling, New Features, Brilliant Performance! Designed to function as the "heart" of your hi-fi system, the EA-3 combines the pre-amplifier and amplifier into one compact package. Providing a full 14 watts of high fidelity power, more than adequate for operating the average system, the EA-3 provides all the controls necessary for precise blending of musical reproduction to your individual taste. Clearly marked controls give you finger-tip command of bass and treble "boost" and "cut" action, switch selection of three separate inputs, "on-off" and volume control. A hum balance control is also provided.

**NOTE THESE OUTSTANDING SPECIFICATIONS:** Power Output: 14 watts. Hi-Fi: 12 watts. Professional: 16 watts. Utility. Power Response:  $\pm$  1 db from 20 cps to 20 kc at 14 watts output. Total Harmonic Distortion: less than 2%, 20 cps to 5 kc at 14 watt output. Intermodulation Distortion: less than 1% at 16 watt output using 60 cps and 6 kc signal mixed 4:1. Hum and Noise: mag. phono input, 47 db below 14 watts; tuner and crystal phono, 63 db below 14 watts.

**POWER AMPLIFIERS**



- Model UA-1 "Universal" hi-fi 12-watt amplifier kit, 13 lbs. .... **\$21.95**
- Model W-4AM Single Chassis 20-watt hi-fi amplifier kit, 28 lbs. .... **\$39.75**
- Model W-3AM Dual Chassis hi-fi 20-watt amplifier kit, 29 lbs. .... **\$49.75**
- Model W-7M "Extra Performance" hi-fi 55-watt amplifier kit, 28 lbs. .... **\$54.95**
- Model W-5M high fidelity 25-watt amplifier kit, 31 lbs. .... **\$59.75**
- Model W-6M high fidelity 70-watt amplifier kit, 52 lbs. .... **\$109.95**

**SPEAKER SYSTEMS**

- Model SS-3 "Basic" fir hi-fi speaker system kit, 26 lbs. .... **\$34.95**
- Model SS-2 "Basic Range" hi-fi speaker system kit, 26 lbs. .... **\$39.95**
- Model SS-1B "Range Extending" hi-fi speaker system kit, 80 lbs. .... **\$99.95**

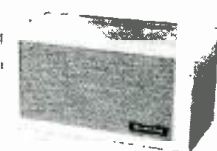

Model HH-1 "Legato" hi-fi speaker system kit, 195 lbs. .... **\$299.95**

HEATH COMPANY, Benton Harbor, Michigan

a subsidiary of Daystrom, Inc.

**HEATHKIT**

NEW: Heath Now Puts 2-Way Radiotelephone Communications in Reach of Everyone

# Citizen's Band Transceiver Kit

NEW: No Radio Operators License Necessary!



- Designed to meet all FCC requirements for new 11-meter "Citizens Band" class D operation.
- Any U.S. citizen 18 or older eligible for license.
- No theory to study—no tests to take.
- Hundreds of uses in business or pleasure.
- Top quality components—proven performance—easy to build.



MODEL CB-1  
Includes transceiver, microphone, and special power cords.

**\$42<sup>95</sup>**

**SPECIFY FREQUENCY CHOICE**

**CLASS D CITIZEN'S BAND FREQUENCIES**

26.965 mc	27.035 mc	27.115 mc	27.185 mc
26.975 mc	27.055 mc	27.125 mc	27.205 mc
26.985 mc	27.065 mc	27.135 mc	27.215 mc
27.035 mc	27.075 mc	27.155 mc	27.225 mc
27.015 mc	27.085 mc	27.165 mc	*27.255 mc
27.025 mc	27.105 mc	27.175 mc	

\*This channel shared with Class C Radio Control.

First and only kit of its kind . . . designed to meet all FCC requirements for two-way radio telephone communication on new class D 11-meter "citizens band" . . . any U.S. citizen eighteen or older eligible for license . . . no code test, no radio theory exams, no knowledge of specialized operating procedures required . . . just fill out simple form included with kit and mail to FCC for registration. The Heathkit CB-1 Transceiver is light, compact, simple to assemble, easy to use. Buy two or more units, have your own communications system . . . talk with family, friends, associates from your car, home, boat or office . . . cover distances from one to ten miles depending on location and type of installation (extensively field tested). A flick of a switch selects "transmit" or "receive" while single receiver tuning control selects any of 23 assigned channels . . . third knob controls volume and turns set on and off. With separate vibrator power supply available from Heath, along with two special power cords included with kit, you can convert transceiver from fixed location at home or office to mobile operation in cars, boats, etc., in minutes, after initial installation, with no tools or adjustments. There's a Heathkit accessory antenna for any application, mobile or fixed. Kit comes complete with microphone, station identification card which fits in plastic window at end of cabinet, all pertinent FCC regulations and application forms, a sheet of adhesive-back letters and numbers to affix call letters in space provided on front panel, and crystal for one channel. Specify your frequency choice or we will supply crystal of appropriate frequency. The famous Heathkit quality coupled with the market-shattering low price of this kit make it truly a value of a lifetime. Shpg. Wt. 10 lbs.

**SPECIFICATIONS**—Receiver Type: Superregenerative detector w/rf stage. Power Input: 5 watts to plate of final RF amplifier (FCC maximum). Transmitter Frequency Control: Third overtone type quartz crystal operating within 0.005% of marked channel frequency between 32 F and 140 F. Modulation: AM plate modulation automatically limited to less than 100% (FCC requirements). Power Supply: 117 V 50/60 cycle, AC, 6 V battery using Model VP-1-6 Vibrator Power Supply or 12 V battery using Heathkit VP-1-12. Power Requirements: 117 volts 50/60 cycle AC 35 watts; 6 V battery w/VP-1-6, 6.5 amps., 12 V battery w/VP-1-12, 4.0 amps. Total B + requirements, 260 volts at 60 ma; total heater requirements, 6.3 volts at 1.8 amps. or 12.6 volts at 0.9 amps. Power Rectifier: 2 silicon diodes in full wave voltage doubler circuit. Microphone: Combination hand-held and desk type, ceramic element, plastic case, with cord and connector. RF Output Impedance: 50 ohms. Speaker Size: 4 inch (round). Undistorted Audio Power Output: Approximately 1 watt. Line Cords: Two supplied, one for AC operation, one for battery operation. Power circuits automatically switched when appropriate line cord is plugged in. Cabinet Dimensions: 8" H. x 6" D. x 9 3/4" W.

## ANTENNAS

### MODEL CBU-1 "UTILITY" ANTENNA

Low cost, portable antenna for CB-1 Transceiver for temporary installations, mobile or fixed, where maximum coverage is not required. Rugged clip for mounting on eaves-trough of house or rain gutters of cars, trucks, etc. Bracket supplied for mounting on transceiver or any flat surface. 45 1/2" base-loaded, antenna with 12' connecting cable comes complete, ready to use. Shpg. Wt. 3 lbs. **\$9.95**

### MODEL CBM-1 "MOBILE" ANTENNA

For CB-1 Transceiver permanent mobile installations where greatest coverage is desired. Easy to install double chain-type bumper mount spring base—no cutting or drilling. Easily adapted to boats, etc. 1/4 wave whip antenna approximately 9' from mounting surface to tip—supplied with clip for securing in semi-horizontal position to clear obstructions. Kit is complete with 102" whip in 2 sections, 15' connecting cable and all necessary hardware. Shpg. Wt. 7 lbs. **\$19.95**

### MODEL CBF-1 "FIXED LOCATION" ANTENNA

A 1/4 wave "ground plane" type antenna for CB-1 Transceiver using 4 radial elements as the "ground plane" and 1 vertical element as the radiator. Excellent coverage, essentially non-directional, making it ideal for communications between fixed and mobile units. Antenna measures 9' 4" from bottom of mounting bracket to top of vertical radiator. Radial length 9'. Kit is complete with 50' connecting cable and easy to install mounting clamp. Shpg. Wt. 7 lbs. **\$19.95**

### POWER SUPPLIES FOR MOBILE USE OF CB-1:

- MODEL VP-1-6 Vibrator Power Supply kit for 6 volt batteries. Shpg. Wt. 4 lbs. **\$7.95**
- Model VP-1-12 Vibrator Power Supply kit for 12 volt batteries. Shpg. Wt. 4 lbs. **\$7.95**

**NEW**

MODEL CO-1  
**\$7<sup>95</sup>**

(batteries included)

### NEW TRANSISTOR CODE PRACTICE OSCILLATOR KIT (CO-1)

Your best buy in a high quality code oscillator, the CO-1 is ideal for Boy Scouts or beginning radio hams. Practice code by authentic CW tone or blinker light. Switch selects built-in speaker or light. Contactor provided for practice keying or any standard key can be connected. Completely transistorized for long battery life. Powered by two standard flashlight batteries. Batteries included. Shpg. Wt. 3 lbs.



## TRANSISTOR PORTABLES

. . . and other Do-it-Yourself Hobby Kits

- Model XR-1P Transistor Portable Radio kit . . . 6 lbs. . . . . **\$29.95**
- Model CR-1 Crystal Radio kit . . . 3 lbs. . . . . **\$7.95**
- Model BT-1 Battery Tester kit . . . 2 lbs. . . . . **\$8.50**
- Model ET-1 Enlarger Timer kit . . . 3 lbs. . . . . **\$11.50**
- Model BR-2 Broadcast-Band Receiver kit . . . 10 lbs. . . (less cab.) . . . **\$18.95**
- Model RC-1 Professional Radiation Counter kit . . . 8 lbs. . . . . **\$79.95**

## MARINE KITS . . .

For Fun and Safety Afloat

- Model DF-2 Two Band Transistor Radio Direction Finder kit 9 lbs. . . . . **\$69.95**
- Model FD-1-6 Fuel Vapor Detector kit (6 v.) . . . 4 lbs. . . . . **\$35.95**
- Model FD-1-12 Fuel Vapor Detector kit (12 v.) . . . 4 lbs. . . . . **\$35.95**
- Model MC-1 Marine Battery Charge kit . . . 16 lbs. . . . . **\$39.95**
- Model PC-1 Power Converter kit . . . 8 lbs. . . . . **\$24.95**



MODEL XR-1P



MODEL DF-2

**NEW**  
from Heath Test  
Equipment Labs

MODEL IA-1A  
**\$59.95**

## New—Electronic Ignition Analyzer Kit—IA-1A



- A Fraction of the Cost of Comparable Instruments
- Shows "Picture" of Entire Ignition System Performance on Cathode Ray Screen
- Shows Primary or Secondary Circuit Patterns
- "Trouble-Shoot" Complicated Ignition Faults in Minutes

A revolutionary development in the automotive tune-up field. Heathkit offers the small garage owner, service station operator or hobbyist an ignition analyzer with qualities and features of scopes costing several times as much (comparable to instruments costing as much as \$750.00). The savings you realize through do-it-yourself kit assembly are only part of the story. Heath engineering know-how and tremendous buying power play an important role in keeping prices at rock bottom. Yet, this scope, as with all Heathkits, is designed to be "beginner built". A few hours of your spare time . . . and you're in business. The IA-1A lets you check the complete ignition system of an automobile in operation by merely connecting two leads to observe the tell-tale spark pattern of the cylinders. Can be used with the car under load and in motion by adding a vibrator power supply. Shows condition of coil, condenser, points, plugs and ignition wiring. A switch selects either primary or secondary circuit patterns; or alternately

provides choice of parade or superimposed secondary patterns. It will also indicate coil reserve, a poor spark plug, defective wiring and will even identify the offending plug or wire. Also detects breaker point bounce, a defective condenser, or will allow setting of the dwell-time of the points. The IA-1A is simple to use, with a minimum of controls, yet is completely flexible for all types of internal combustion engines with coil ignition and accessible breaker points. Shows complete engine cycle or just one cylinder at a time. Test leads and comprehensive instruction manuals are supplied with kit. Shpg. Wt. 20 lbs.

### NEW MODIFICATION KIT FOR OWNERS OF MODEL IA-1 IGNITION ANALYZERS:

Gives you switch selection of either primary or secondary circuit patterns; or alternately provides choice of parade or superimposed secondary patterns. Kit includes test lead modification parts and comprehensive instructions for modification and use. Shpg. Wt. 2 lbs. Heathkit MK-6. **\$4.95.**

## A COMPLETE LINE OF INSTRUMENT KITS

### OSCILLOSCOPES

Model OM-3 "General Purpose" 5" oscilloscope kit . . . 22 lbs. . . . .	<b>\$39.95</b>
Model O-12 "Extra Duty" 5" oscilloscope kit . . . 22 lbs. . . . .	<b>\$65.95</b>
Model OP-1 "Professional" 5" DC oscilloscope kit . . . 34 lbs. . . . .	<b>\$179.95</b>

### METERS

Model V-7A Etched Circuit VTVM kit . . . 7 lbs. . . . .	<b>\$25.95</b>
Model AV-3 Audio VTVM kit . . . 6 lbs. . . . .	<b>\$29.95</b>
Model MM-1 20,000 ohms/volt VOM kit . . . 6 lbs. . . . .	<b>\$29.95</b>
Model AW-1 Audio Wattmeter kit . . . 7 lbs. . . . .	<b>\$29.50</b>
Model M-1 Handitester kit . . . 3 lbs. . . . .	<b>\$17.95</b>

### GENERATORS

Model TS-4A TV Alignment Generator kit . . . 16 lbs. . . . .	<b>\$49.50</b>
Model CD-1 Color Bar and Dot Generator kit . . . 13 lbs. . . . .	<b>\$59.95</b>
Model SG-8 RF Signal Generator kit . . . 8 lbs. . . . .	<b>\$19.50</b>
Model TO-1 RF Test Oscillator kit . . . 4 lbs. . . . .	<b>\$16.95</b>
Model LG-1 Laboratory RF Generator kit . . . 16 lbs. . . . .	<b>\$48.95</b>
Model AG-9A Audio Generator kit . . . 10 lbs. . . . .	<b>\$34.50</b>
Model AG-10 Sine-Square Generator kit . . . 12 lbs. . . . .	<b>\$49.95</b>
Model AA-1 Audio Analyzer kit . . . 13 lbs. . . . .	<b>\$49.95</b>

### TEST INSTRUMENTS

Model TC-3 Tube Checker kit . . . 12 lbs. . . . .	<b>\$39.95</b>
Model CC-1 Cathode Ray Tube Checker kit . . . 10 lbs. . . . .	<b>\$24.95</b>
Model T-4 Visual-Aural Signal Tracer kit . . . 5 lbs. . . . .	<b>\$19.95</b>
Model C-3 Condenser Checker kit . . . 7 lbs. . . . .	<b>\$19.50</b>
Model CM-1 Direct Reading Capacity Meter kit . . . 7 lbs. . . . .	<b>\$29.50</b>
Model CT-1 In-Circuit Capacitance Tester kit . . . 5 lbs. . . . .	<b>\$7.95</b>

Plus many more quality instruments for every need!

## A COMPLETE LINE OF HAM GEAR

### FIXED STATION

Model DX-20 CW Transmitter kit . . . 19 lbs. . . . .	<b>\$35.95</b>
Model DX-40 Phone and CW Transmitter kit . . . 25 lbs. . . . .	<b>\$64.95</b>
Model DX-100-B Phone and CW Transmitter kit . . . 107 lbs. . . . .	<b>\$189.50</b>
Model VHF-1 "Seneca" VHF Ham Transmitter kit . . . 56 lbs. . . . .	<b>\$159.95</b>
Model TX-1 "Apache" Ham Transmitter kit . . . 110 lbs. . . . .	<b>\$234.95</b>
Model RX-1 "Mohawk" Ham Receiver kit . . . 66 lbs. . . . .	<b>\$274.95</b>

### MOBILE

Model MT-1 "Cheyenne" Mobile Ham Transmitter kit . . . 19 lbs. . . . .	<b>\$99.95</b>
Model MR-1 "Comanche" Mobile Ham Receiver kit . . . 19 lbs. . . . .	<b>\$119.95</b>
Model MP-1 Mobile Power Supply kit . . . 8 lbs. . . . .	<b>\$44.95</b>
Model PM-2 Power Meter kit . . . 2 lbs. . . . .	<b>\$12.95</b>
Model AK-7 Mobile Speaker kit . . . 4 lbs. . . . .	<b>\$5.95</b>



**NEW EDUCATIONAL ELECTRONIC ANALOG COMPUTER KIT (EC-1)**

- 9 DC operational amplifiers—3 initial condition power supplies
- 5 coefficient potentiometers—repetitive solution oscillator
- Electronically regulated power supply

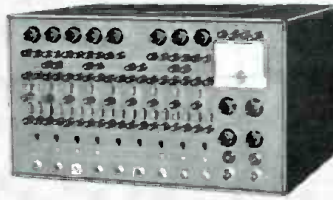

HEATHKIT EC-1  
**\$199<sup>95</sup>**

Filling a multitude of needs in the fields of education and electronics, the model EC-1 puts advanced engineering techniques within easy reach of the average individual or institution. An assortment of precision components and patch cords are provided for setting up many complex problems. Solutions are read directly on the panel mounted meter or on an external read-out device such as the Heathkit OR-1 DC Oscilloscope. An informative manual is provided, illustrating operating procedures and basic computer information as well as showing how to set up and solve typical problems. Shpg. Wt. 43 lbs.



**NEW 5" DC OSCILLOSCOPE KIT (OR-1)**

- Identical DC coupled vertical and horizontal amplifiers
- 5ADP2 flat-face CRT—edge-lit graticule
- Transformer operated silicon diode power supply



HEATHKIT OR-1  
**\$119<sup>95</sup>**

Offering all the features of a high quality DC oscilloscope, the model OR-1 is ideal as a read-out indicator in computer applications as well as many types of testing and development work. Features DC to 200 kc (1 db point) bandwidth, 0.1 V (peak-to-peak) per CM sensitivity (uncalibrated). Normal frequency coverage is from 5 to 50 kc in four overlapping ranges. Critical voltages are regulated with gas-filled VR tubes. Coupling may be either AC or DC as selected by the input attenuator switch. Many uses in industrial, educational and medical fields. Shpg. Wt. 21 lbs.



**Free Catalog**

Over 100 easy-to-build kits are illustrated and described in the latest Heathkit catalog. If you are among the thousands interested in saving one-half or more on hi-fi, test, marine, or ham radio instruments, send for your free copy today.

**COMING SOON! ELECTRONIC ORGAN KIT...**

... an instrument that will excite the entire musical world. Engineered to familiar Heathkit perfection, and styled for the most discriminating taste... yet simple to assemble and priced for the average home. Interested? Send your name and address, we'll rush information as soon as available. No obligation.

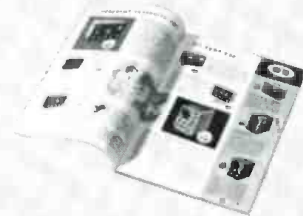

**ORDER BLANK**

NOTE: all prices and specifications subject to change without notice.

Enclosed find ( ) check ( ) money order. Please ship C.O.D. ( )

On Express orders do not include transportation charges—they will be collected by the express agency at time of delivery.

On Parcel Post Orders include postage for weight shown. All prices are NET F.O.B. Benton Harbor, Michigan, and apply to Continental U.S. and Possessions only. 20% Deposit required on all C.O.D. orders.

**HEATH COMPANY BENTON HARBOR 15, MICH.**

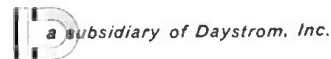

Name \_\_\_\_\_  
 Address \_\_\_\_\_  
 City & Zone \_\_\_\_\_ State \_\_\_\_\_  
 (PLEASE PRINT)

SHIP VIA  
 Parcel Post  
 Express  
 Freight  
 Best Way

QUANTITY	ITEM	MODEL NO.	PRICE
<input type="checkbox"/> SEND FREE HEATHKIT CATALOG			POSTAGE
			TOTAL

**HEATHKITS are also available at your Dealer** see listing on next page



**Authorized****Dealers**

Convenient "over-the-counter" delivery is now available through any of the Authorized Heathkit Dealers listed below. Although you will find the price of Heathkits slightly higher when buying locally, we're sure you'll agree that this increase is justified. Your dealer absorbs all transportation charges, carries a complete stock of kits for immediate de-

livery, provides demonstration facilities, offers you a reliable source for parts and fast service . . . and stands ready to counsel or advise you on any problem that might arise.

This new service does not affect your continued privilege to buy directly from Heath Company if you prefer.

**NOW READY TO SERVE YOU...****CALIFORNIA**

- BAKERSFIELD**  
Kiesub Corporation  
2615 "F" Street
- BERKELEY**  
zacKIT Corporation  
2002 University Avenue
- CHICO**  
Dunlap Radio & TV  
928 Main Street
- EL CAJON**  
Telrad Electronics  
182 East Main Street
- FRESNO**  
Dunlap Radio & TV  
2617 Tulare Street
- LONG BEACH**  
Kierulff & Company  
1501 Magnolia
- LOS ANGELES**  
Bushnell Sound Corp.  
12024 Wilshire Boulevard  
Kierulff Sound Corp.  
820 West Olympic Boulevard  
Kierulff & Company  
6303 E. Corsair
- MARYSVILLE**  
Dunlap Radio & TV  
5th & "J" Street
- MERCED**  
Dunlap Radio & TV  
234 West 17th Street
- MODESTO**  
Dunlap Radio & TV  
419 10th Street
- NATIONAL CITY**  
Telrad Electronics  
639 National
- ONTARIO**  
Kiesub Corporation  
124 N. Benson
- OXNARD**  
Kierulff & Company  
508 E. Date Street
- PALO ALTO**  
Zack Electronics  
654 High Street
- SACRAMENTO**  
Dunlap Radio & TV  
1800 22nd Street
- SAN BERNARDINO**  
Kierulff & Company  
390 South Mt. Vernon
- SAN DIEGO**  
Telrad Electronics  
3453 University Avenue
- SAN FRANCISCO**  
Zack Electronics  
1422 Market Street
- SANTA BARBARA**  
zacKIT Corporation  
513 State Street
- STOCKTON**  
Dunlap Radio & TV  
27 North Grant Street
- TARZANA**  
Valley Sound Corp.  
18841 Ventura Boulevard
- VAN NUYS**  
Kierulff & Company  
14511 Deiano
- VISALIA**  
Dunlap Radio & TV  
1725 Mooney Avenue
- DELAWARE**
- WILMINGTON**  
Radio Electric Service Co.  
Third & Tatnail Streets
- FLORIDA**
- COCOA**  
Thurou Distributors, Inc.  
540 St. Johns Street
- MIAMI**  
Thurou Distributors, Inc.  
1800 Northwest 23rd Street
- LOUISIANA**
- LAFAYETTE**  
Sterling Radio Products, Inc.  
1005 Cameron Street
- MARYLAND**
- SALISBURY**  
Radio Electric Service Co.  
736 South Salisbury Boulevard

**MASSACHUSETTS**

- BOSTON**  
Audiionics, Incorporated  
1348 Boylston Street
- MICHIGAN**
- ALLEN PARK**  
Volta Electronics  
6716 Park Avenue
- DETROIT**  
High Fidelity Workshop  
16400 West Seven Mile Road
- MINNESOTA**
- MINNEAPOLIS**  
Audio King Company  
913 West Lake Street
- NEW JERSEY**
- ATLANTIC CITY**  
Radio Electric Service Co.  
452 North Albany Avenue
- CAMDEN**  
Radio Electric Service Co.  
513 Cooper Street
- MOUNTAINSIDE**  
Federated Purchaser, Inc.  
1021 U. S. Route #22
- NEWARK**  
Federated Purchaser, Inc.  
114 Hudson Street
- NEW YORK**
- BELLEROSE**  
Cross Island Electronics, Inc.  
247-40 Jericho Turnpike
- BROOKLYN**  
Acme Electronics, Incorporated  
59 Willoughby Street
- FARMINGDALE**  
Gem Elec. Distributors, Inc.  
34 Hempstead Turnpike
- FOREST HILLS**  
Beam Electronics, Incorporated  
101-10 Queens Boulevard
- HICKSVILLE**  
Gem Elec. Distributors, Inc.  
236 Broadway
- MINELA**  
Arrow Electronics, Incorporated  
525 Jericho Turnpike
- MT. VERNON**  
Davis Radio Distributing Co., Inc.  
70 East Third Street
- NEW YORK**  
Arrow Electronics, Incorporated  
65 Cortlandt Street  
Harvey Radio Company  
103 West 43rd Street
- NO. CAROLINA**
- CHARLOTTE**  
Southeastern Radio Supply Co.  
1200 W. Morehead Street
- GREENSBORO**  
Southeastern Radio Supply Co.  
404 N. Eugene Street
- FAYETTEVILLE**  
Southeastern Radio Supply Co.  
525 Gillespie Street
- KINSTON**  
Southeastern Radio Supply Co.  
408 N. Heritage Street
- RALEIGH**  
Southeastern Radio Supply Co.  
414 Hillsboro Street
- OHIO**
- CHILLICOTHE**  
Buckeye Electronics Dist., Inc.  
565 North High St.
- COLUMBUS**  
Buckeye Electronics Dist., Inc.  
236-245 East Long Street
- DAYTON**  
Ham 'N Hi-Fi, Inc.  
826 North Main Street  
Srecco, Inc.  
314 Leo Street
- HAMILTON**  
Srecco, Inc.  
145 Highland Avenue

**OHIO**

- MIDDLETOWN**  
Srecco, Inc.  
2104 Brenwood Avenue
- NEWARK**  
Buckeye Electronics Dist., Inc.  
114 Union Street
- PIQUA**  
Srecco, Inc.  
R.R. #1, Box 308
- SPRINGFIELD**  
Standard Radio-Springfield, Inc.  
1300 S. Paris Road
- ZANESVILLE**  
Buckeye Electronics Dist., Inc.  
120 South Eighth Street
- OREGON**
- PORTLAND**  
Eccles Electric Company  
237 Northeast Broadway
- SALEM**  
Cecil Farnes Company  
440 Church Street, Northeast
- PENNSYLVANIA**
- ALLENTOWN**  
Federated Purchaser, Inc.  
1115 Hamilton Street
- EASTON**  
Federated Purchaser, Inc.  
925 Northampton Street
- PHILADELPHIA**  
Austin Electronics, Inc.  
1421 Walnut Street  
Radio Electric Service Co.  
701 Arch Street  
Radio Electric Service Co.  
3412 Germantown Avenue  
Radio Electric Service Co.  
5930 Market Street
- WILLOW GROVE**  
Radio Electric Service Co.  
29 York Road
- YORK**  
Radio Electric Service Co.  
1114 Roosevelt Extension
- RHODE ISLAND**
- PROVIDENCE**  
Audiionics, Incorporated  
790 North Main Street
- TEXAS**
- BEAUMONT**  
Sterling Radio Products, Inc.  
1160 Laurel Street
- BRYAN**  
Sterling Radio Products, Inc.  
2615 Texas Avenue
- DALLAS**  
Hillicrest Records, Inc.  
6309 Hillicrest Avenue
- HOUSTON**  
Sound Equipment, Incorporated  
2506 Crawford Street
- HOUSTON**  
Sterling Radio Products, Inc.  
1618 McKinney Avenue
- LUFKIN**  
Sterling Radio Products, Inc.  
428 Atkinson Street
- VIRGINIA**
- ARLINGTON**  
Key Electronics, Inc.  
126 South Wayne Street
- WASHINGTON**
- SEATTLE**  
Seattle Radio Supply, Inc.  
2117 Second Avenue
- WISCONSIN**
- MADISON**  
Hi-Fi Corner  
401 State Street  
Satterfield Electronics, Inc.  
1900 South Park
- MILWAUKEE**  
Hi-Fi Center  
4236 West Capitol Drive  
Netzow's  
2630 North Downer Avenue

**Dealers Speak on Problems***(Continued from page 73)*

labor to bring them in line with their actual costs of doing business will find the going pretty rough as more and more set owners buy replacement tubes at the corner drug stores."

Reflecting the opinion widely held among independent service dealers, the majority of those involved in this discussion expressed the feeling that the independent service industry is at a critical crossroads of its existence. In addition to the internal strife that has kept the field in an uproar for a number of years, the feeling is growing that wishful thinking has blocked the industry from accepting the competitive challenge posed by all of the forces that are out to snag a share of the public's TV service dollars.

As one dealer expressed it, "Most of us have felt, at one time or another, that we have some sort of dower rights in the business of servicing TV sets. Because of that, we are inclined to look on all types of competition as predatory forces, poaching in a market that is exclusively ours. This sort of thinking blinds a dealer to the realities of operating a business in a free, competitive market. It has blocked the TV service industry from making an objective appraisal of its position. This has prevented the collective action that could have slowed down or completely stopped some of our present competition before it got firmly entrenched."

Accepting the fact that the self-service tube testers are here to stay, dealers feel they will lap up a growing percentage of the replacement tube market until independent service dealers as a whole start to use the economic tools at their command to compete with them. It was stressed that, at the present suggested list prices for tubes, vending-machine operators are able to pay location owners a handsome profit for the space taken up by the tube testers. In drug stores, for instance, the thirty per-cent profit given on tube sales is higher than the average mark-up on merchandise that the druggist must buy outright and gamble on selling.

Some dealers feel that a sliding-scale discount on tubes would be an effective competitive weapon. Under this plan, the amount of discount allowed the set owner would be determined by the number of tubes required to put the set back in good operating condition. The theory back of this plan is that it would provide an added inducement to customers to replace tubes that are on the fringe of failure when a set is serviced. Irrespective of the plan selected, however, all of these dealers were in accord that the service industry must meet the tube challenge head-on with a new service-industry schedule of suggested list prices for tubes, based upon more realistic retail mark-ups.

-30-

**HEATH COMPANY**

Benton Harbor, Mich.

A Subsidiary of Daystrom, Inc.



How to keep your profits from going to the "dogs"!

Another way  
RCA helps you  
improve your  
business.

# STOP PROFIT LEAKS!



## Review these important facts about heater-cathode leakage

Did that TV set come back? Same symptoms—60-cycle hum bars? You diagnosed the trouble correctly—a leaky tube.

Here's why a leaky tube can cause you a lot of trouble.

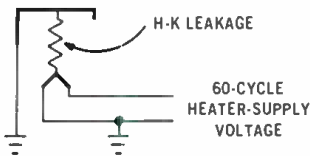

H-K leakage provides a path for 60-cycle current to flow from the heater to the cathode. If there is no resistance or impedance in the cathode circuit, this leakage current usually causes no difficulty.

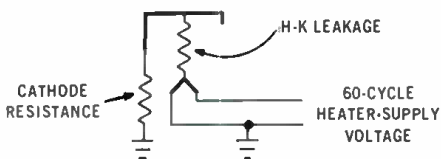

When there is resistance in the cathode circuit, the H-K leakage current develops a 60-cycle voltage across the cathode resistor. This voltage may produce visible and/or audible 60-cycle "hum".



H-K leakage in the RF, IF, or video stages of a TV receiver can produce 60-cycle horizontal pulling and "hum" bars.



H-K leakage in the sync-separator tube or in the horizontal AFC, oscillator, or output tubes can produce 60-cycle horizontal pulling without "hum" bars.

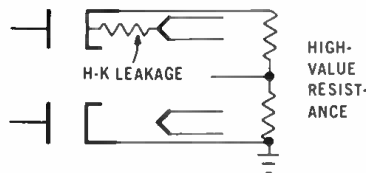

In detector, discriminator, and AFC stages, which usually have relatively high values of resistance in the cathode circuit, even a slight amount of H-K leakage current can easily cause visible and/or audible 60-cycle "hum" symptoms.

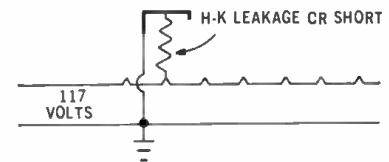

An H-K short circuit, or low-resistance leakage, in a series-string tube, short-circuits part of the heater circuit. The resulting higher voltage across the remaining heaters may cause heater burnout.

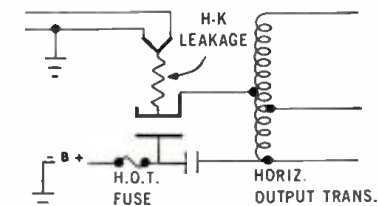

H-K leakage in a damper tube which has its heater grounded may cause the H.O.T. fuse to blow.

RCA tubes help you beat these problems—drastically reduce heater-cathode leakage and shorts through such improvements as precise control of heater coatings to eliminate "thin spats"...better heater stem lead arrangements...new cathode materials and structures. Avoid callbacks caused by tubes that develop H-K leakage problems and keep your profits from "leaking" too. Remember to always ask your distributor for **RCA TUBES!**



**RADIO CORPORATION OF AMERICA**

Electron Tube Division

Harrison, N. J.



why your next speaker system should be

# THE NEW AUDAX PARAFLEX

- Only Audax incorporates the Patented Paraflex Foam Suspension to give longer travel to the cone, resulting in honest bass without boom or hangover. You get bass with real bottom!

- New Styrofoam Radial Strut-Bracing reinforces cone, assures rigid piston action, preventing cone break-up. Eliminates distortion, provides clean reproduction up to the full-rated power output. Needs as little as 10 watts output. You get greater amplifier economy in stereo installations.

- New Oriented Grain-Processed Magnet gives 20% more efficiency than standard Alnico V.

- New Ducted-Slot Enclosure specifically designed to enhance the depth and striking realism of the Paraflex high-compliance speaker units. Speakers are located symmetrically on each side of the ducted slot, resulting in clean bass without trace of boom or unnatural heaviness.

- New, dramatic enclosure styling by George Nelson—featuring... new, three-dimensional Dynel "AcousticScreen" grille, removable for cleaning!

- Audax Paraflex Speakers are lab-tested and a performance seal on each unit indicates its resonant frequency  $\pm 1$  cycle.

Model CA-80 12" x 12" x 24" with two full range speakers—\$99.95

Model CA-100 15" x 12" x 25" with two 10" full range speakers and 2 matching cone tweeters—\$139.95



Write for free catalog and specifications, to:  
AUDAX Division of the Rek-O-Kut Co., Inc.  
Dept. EW-10, 19 108th St., Corona 68, N. Y.

Name \_\_\_\_\_  
Address \_\_\_\_\_  
City \_\_\_\_\_ State \_\_\_\_\_

Export: Morhan Exporting Corp., 458 Broadway, New York 13  
Canada: Atlas Radio Corp., 50 Wingold Ave., Toronto 19, Ont.



## STEREO P.A. AMPLIFIER

Radio Shack Corporation, 730 Commonwealth Ave., Boston 17, Mass. has recently introduced a stereo-adapted public-address amplifier as its Model PA 30/60.

This new unit in the company's "Realistic" line features two microphone and one phonograph channels



and is rated at 30 watts. Separate volume, bass, and treble controls permit input blending and continuous tone variations over a wide range. Four impedances are available, including one constant-voltage tap for speaker matching. This 117-volt a.c. amplifier has an auxiliary power receptacle plus an additional plug and receptacle for operation by an external 6- or 12-volt d.c. power supply.

The company will supply complete specifications and price on this new amplifier upon request.

## "SPHERICON" SUPER TWEETER

Lafayette Radio, 165-08 Liberty Ave., Jamaica 33, N. Y. has announced the availability of a new "super tweeter" which is being marketed as the "Sphericon" SK-131.

The unit is equipped with a built-in 3000 cps crossover network and is said to provide smooth linear response from

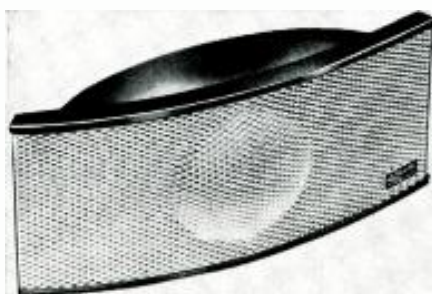

3000 to beyond 40,000 cps  $\pm 1$  db from 3000 cps to supersonic frequencies.

An advanced-design phenolic domed diaphragm radiates a sound pattern of 120 degrees in all directions, vertically as well as horizontally. Power capacity is 30 watts. The unit is designed to be used with any 4-16 ohm speaker without need of an L-pad. Housed in a

sturdy satin-black plastic case with an acoustically designed gold anodized aluminum grille, the unit comes completely assembled and ready to hook up.

## NEW G-E STEREO CARTRIDGES

General Electric Company, West Genesee St., Auburn, N. Y. has just introduced a newly designed series of stereo-magnetic cartridges which has been designated the VR-22 Series.

Major improvements in the essential areas of stereo performance—response, separation, compliance, and freedom from hum—have been achieved with this new series, according to the company.

The VR-225 has a frequency response of 20 to 20,000 cps  $\pm 3$  db; up to 30 db channel separation; lateral compliance of 4 x 10<sup>-4</sup> cm/dyne and vertical compliance of 2.5 x 10<sup>-4</sup> cm/dyne. Recommended tracking force is 2 to 4 grams.



It uses a .5 mil diamond stylus and is intended for use with professional turntable systems.

The VR-227, for record changer and turntable application, uses a .7 mil diamond stylus. Frequency response is 20 to 17,000 cps  $\pm 3$  db; up to 30 db channel separation; 3 x 10<sup>-4</sup> cm/dyne lateral compliance and 2 x 10<sup>-4</sup> cm/dyne vertical compliance. Recommended tracking force is 5 to 7 grams.

Replacement styli will be available for both models but are not interchangeable with previous stereo cartridges made by the company.

## RCA TAPE CARTRIDGES

Radio Corporation of America, Camden, N. J. has unveiled its stereophonic tape cartridge player and announced the availability of approximately 150 tape cartridges to be used with the instrument.

The cartridges will carry up to an hour of stereophonic music, both popular and classical. An assortment of 16 cartridges are in the hands of dealers now and an additional 50 titles will be available by Christmas. The cartridge, a plastic magazine 5"x7"x1/2", is in-

served in the machine where it plays and rewinds automatically.

The companion tape unit operates at 3.75 ips and has four-track, two-channel heads. The player-recorder is 18" wide, 15" deep, and 12" high in a portable carrying case. Auxiliary speakers for stereo applications are available at

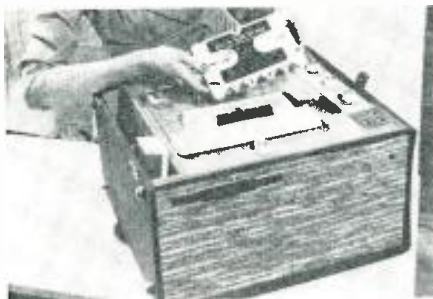

additional cost. Either stereo or monophonic home recordings can be made on the machine and direct recordings (either stereo or mono) made from phonograph, radio, or TV. Live voice or music recordings in either mode can be made by using accessory microphones.

#### SMALL BOZAK SPEAKER

The R. T. Bozak Sales Company, Darien, Conn. is now offering a new, small-size speaker system which is being marketed as the "Spinnet."

Designed especially for those with extremely limited space, the new system measures 14½" x 23¼" x 11½". The "Spinnet" is available in two models—one with the two-way B-500 system and the other with the three-way B-502 speaker system. Each model utilizes the same integrated components found in the manufacturer's larger units.

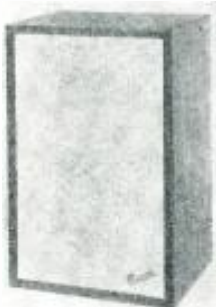

The modern cabinet may be used vertically or horizontally. The enclosures come in mahogany, walnut, blonde, or ebony finishes or unfinished for those who wish to match the cabinet to existing decor. Further information and complete specifications on those two models are available from the manufacturer.

#### FISHER "DUPLEX" AMPLIFIER

Fisher Radio Corporation, 21-21 44th Drive, Long Island City 1, N. Y. has recently introduced a new master audio control/duplex amplifier unit which has been designated as the Model X-101A.

Mounted on a single, compact chassis, this unit combines a two-channel preamplifier-equalizer, complete audio controls, and a 40-watt two-channel power amplifier with a reserve peak-power rating of 75 watts. The unit will operate equally well in both stereo and mono modes. Twelve inputs permit any program source, stereo or mono, to be used with maximum effectiveness, and any existing phono cartridge—ceramic,

October, 1959



INTEGRITY IN MUSIC...

## NEW SINGLE-SPEED MANUAL TURNTABLE BY STROMBERG-CARLSON

From the same engineers who created the widely acclaimed "Perfectempo" Turntable comes a revolutionary new concept in turntable design: a dual-drive system consisting of two hysteresis-synchronous motors, operating in tandem through one belt drive.

The motors are spaced exactly 180° apart. Any variations in the 33⅓ RPM speed are automatically compensated for by the interaction of the motors and impregnated belt. Rumble and noise are virtually eliminated by the belt drive and a unique suspension system.

Tone arm, pin plugs, A.C. cords, wired for stereo, ready to use for \$69.95 (Audiophile Net, Zone 1).

Your dealer is listed in the Yellow Pages—or write for complete details to Stromberg-Carlson, Special Products Division, 1477 N. Goodman Street, Rochester 3, N. Y.

*"There is nothing finer than a Stromberg-Carlson"*

**STROMBERG-CARLSON**  
A DIVISION OF **GENERAL DYNAMICS**

# PICK THE BEST FOR YOUR STEREO PICKUP SYSTEM by WEATHERS

These are the same components which play an important role in producing Weathers TrioPhonic Stereo—the sound that outmodes conventional stereo.



## StereoRamic Cartridge C-501

The first ceramic cartridge to outperform the finest magnetic pickups.

### SPECIFICATIONS

Frequency Response..... 15-30,000 cps  
Compliance.....  $6 \times 10^{-6}$  cm/dyne  
Dynamic Moving Mass..... 1.0 milligrams  
Recommended Tracking Force  
Professional Arms..... 1-2 grams  
Changers and other type arms..... 2-6 grams  
Stylus..... 0.7 mil diamond or sapphire  
Separation..... 25 db  
Signal-to-noise Ratio..... -60 db  
Output per channel..... 0.25 Volts 7 cm/sec  
Audiophile Net

C-501-D—Diamond.... \$17.50  
C-501-S—Sapphire.... \$9.75



## StereoRamic Pickup System

MC-1. Features the StereoRamic cartridge and the Micro-Touch Tonearm. Leads plug directly into the phono magnetic input of all preamplifiers.

### SPECIFICATIONS

Arm Bearing System..... Viscous Damping  
Tracking Force..... Easily adjusted 1 to 8 grams  
Finish..... Ebony with gold trim  
Overall Length..... 13 inches  
Pivot to Stylus Tip Length.....  $9\frac{3}{4}$  inches  
Recommended Overhang.....  $\frac{1}{2}$  inch  
Audiophile Net

MC-1-D—(Diamond).... \$55.95  
MC-1-S—(Sapphire).... \$48.25

For more information about Weathers components, write for "The Audiophile's Album"

## WEATHERS INDUSTRIES

Division of Advance Industries, Inc.

66 E. Gloucester Pike, Barrington, N.J.  
Export: Jos. Plasencia, Inc., 401 Broadway, N. Y.

crystal, or magnetic—can be employed.

Stereo or mono tape recordings can be made using the monitor facilities provided. There is no interference with normal listening while making recordings. There are eight input selector positions and mono or stereo tape heads can be connected directly to the unit for maximum amplification without distortion. Four input level controls allow initial signal balancing on both channels.

Frequency response is 20-20,000 cps. Dimensions, including knobs, are  $15\frac{1}{8}$ " x  $4\frac{1}{16}$ " x 13". Hand-rubbed custom cabinets are available at extra cost. They are offered in mahogany, walnut, and blonde finishes.

### HEAD DEMAGNETIZER

Argonne Electronics Mfg. Corp., 165-11 South Road, Jamaica 33, N. Y. is now offering a new tape head demag-



netizer, Model AR-294, which is designed to be used with any tape recorder.

Three complete sets of interchangeable pole pieces are supplied (straight, 45 degrees, and 90 degrees) providing quick and easy access to any tape head. Complete head demagnetization is accomplished without removing the head from the recorder.

The demagnetizer operates from 117-volt, 60-cycle a.c. power sources.

### PACO STEREO KIT

PACO Electronics Company, Inc., 70-31 84th St., Glendale 27, L. I., New York has entered the audio field with its Model SA-40 stereo amplifier-pre-amp in kit form.

Consisting of two 20-watt amplifiers, each with its own preamp control system, the Model SA-40 has 40 watts peak power output per channel or a total of 80 watts. Frequency response is  $\pm 1$  db from 30 to 90,000 cps meas-



ured at 1 watt steady-state output. Harmonic distortion is less than .2% at 20 watts per channel output and less than .1% at 10 watts per channel output. IM distortion is less than 1% at full rated output.

Controls include a two-position phono and tape equalization switch, a mode selector switch, rumble filter, contour switch (for Fletcher-Munson compen-

# PURCHASING A HI-FI SYSTEM?

Send Us Your List Of Components For A Package Quotation

WE WON'T BE UNDERSOLD!

All merchandise is brand new, factory fresh & guaranteed.

## AIREX RADIO

CORPORATION  
64-R Cortlandt St., N. Y. 7, CO 7-2137

### PARTIAL LIST OF BRANDS IN STOCK

Altec Lansing  
Electrovoice  
Jensen  
Hartley  
University  
Acoustic Research  
Janszen  
Wharfedale  
Karlson  
Viking  
Concertone  
Bell • G.E.  
Weathers  
Harman-Kardon  
Eico • Pilot  
Sherwood  
Acrosound  
Fisher  
Bogen • Leak  
Dynakit  
H. H. Scott  
Ferrograph  
Tanberg  
Pentron  
Ampro • VM  
Revere  
Challenger  
Wallensak  
Garrard  
Miracord  
Glaser-Steers  
Rek-O-Kut  
Components  
Norelco  
Fairchild  
Pickering • Gray  
Audio Tape  
Conrac TV  
Full Line of  
Wellcar Cabinets



**CROWN**  
Professional Tape Recorder

## STEREO-X

The lightest weight professional stereo recorder model Excels all other recorders in 4-track recording qualities!

FREQUENCY RESPONSE	IPS FLUTTER NOISE SPEED & WOW RATIO	
$\pm 2$ db 30-30000 CPS	15 .06%	57 db
$\pm 2$ db 20-20000 CPS	7 1/2 .09%	54 db
$\pm 3$ db 20-11000 CPS	3 3/4 .18%	51 db

**\$695**  
Less Case

Write Dept. EW-10 for catalog—also data on professional tape duplicator.

Standard and Stereo models  
INTERNATIONAL RADIO & ELECTRONICS CORP.  
ELKHART, INDIANA

ELECTRONICS WORLD

sation), two speaker-system selector switches, input selector switch, balance control, loudness control, bass and treble controls, and monophonic operation switch. There is a total of 14 inputs and five outputs (dual tape, separate preamp, and standard dual speaker outputs). Speaker connections for 4, 18, 16, and 32 ohm voice coils are provided.

The kit comes complete with a gold and satin black hooded case, panel illumination, and satin gold panel plus illustrated and step-by-step assembly and operation manual. Write the manufacturer for price and additional details. A factory wired version is available as the Model SA-40W.

#### ATLAS "DECOR PROJECTOR"

Atlas Sound Corporation, 1449 39th Street, Brooklyn 18, N. Y. is now offering a high efficiency, driver-type projector which features the high styling contours of a modern lighting fixture.

The DU-12 "Decor Projector" is designed to harmonize with the most ultra-modern decor. Response is 400 to 9000 cps for the crisp reproduction of speech without reverberation. The unit is equipped with a ratchet-type, positive-lock bracket that permits the speaker to be quickly and easily directed at any angle on either a vertical or horizontal plane. All wiring is concealed with a line-matching transformer under the mounting canopy.

For further information and complete specifications, write to the manufacturer.

#### AUDIO CATALOGUES

##### E-V HI-FI CATALOGUE

Electro-Voice Incorporated, Buchanan, Mich. has just released a colorful 28-page catalogue covering its line of speakers and systems for high-fidelity applications.

In addition to complete specifications on the components, the catalogue carries an introduction to stereophonic sound and illustrates the proper placement of speaker systems for most effective sound reproduction.

The company's distributors will supply copies of the new catalogue or readers may write direct to the manufacturer. Please specify Catalogue 134.

##### HI-FI TUBES/TRANSISTORS

CBS Electronics, Danvers, Mass. has issued a four-page bulletin which discusses the use of vacuum tubes and transistors in high-fidelity applications.

Written by Robert Tomer, the new publication traces the history of high-fidelity tubes and discusses problems related to the use of variable-reluctance phonograph cartridges and magnetic tape playback heads.

The bulletin also discusses some of the new hi-fi tubes and outlines the properties of transistors which make them ideally suited for high-quality audio equipment.

For a copy of Bulletin PA-218, entitled "Tubes and Transistors in Hi-Fi," write the firm's Advertising Service, Parker St., Newburyport, Mass. —30—

To  
Make  
Your  
Components  
Sound  
**NEW**  
Again!



Available  
Singly and in  
Matched Pairs

## THE FISHER Laboratory Matched Tubes

Every new FISHER product has attained leadership for one essential reason: it filled a need which, until its introduction, no other comparable product could fully satisfy. FISHER Laboratory Matched TUBES have the same objective. If your high fidelity components sound "wrong" because of tube difficulties, FISHER TUBES can restore them to top performance again.

FISHER TUBES are individually selected to fulfill the maximum requirements of your components, exactly as specified by the manufacturer (no "variables," nothing less than the best in every box.)

FISHER TUBES are chosen for stability, maximum gain, low noise, exact tolerances, long life and for absolutely identical performance characteristics, as revealed by rigid comparison tests!

The next time you need any tubes, insist on FISHER.

Audio-Fans, Servicemen, Dealers—  
WRITE TODAY FOR COMPLETE INFORMATION



FISHER RADIO CORPORATION, 21-38 44th Drive, L. I. C. 1, N. Y.

I want to know more about FISHER Laboratory Matched TUBES!

NAME \_\_\_\_\_

STORE NAME \_\_\_\_\_  
(If a serviceman or dealer)

ADDRESS \_\_\_\_\_ CITY \_\_\_\_\_ STATE \_\_\_\_\_

**TUBE PROBLEM:**

An amplifier manufacturer was plagued by noise, microphonics and hum that developed in the high gain stages of his amplifiers. Sonotone engineers were consulted on the problem.

**SONOTONE SOLVES IT:**

Sonotone engineers discovered that they could correct *all three* complaints by redesigning just *one* tube.

**RESULTS:**

The heater element was changed to a coil heater, eliminating the hum. And rigid controls on the mount structure and processing reduced microphonics and noise. This resulted in the Sonotone reliable type 7025. It's now available for initial equipment and replacement purposes.

Let Sonotone help solve *your* tube problem, too.

**Sonotone** EST. 1900

Electronic Applications Division, Dept. TN-109  
**ELMSFORD, NEW YORK**  
 Leading makers of fine ceramic cartridges, speakers, microphones, tape heads, electron tubes.  
 In Canada, contact Atlas Radio Corp., Ltd., Toronto

**Tracking Error in Stereo**  
*(Continued from page 72)*

at 3.07 inches (the geometric mean). For equal errors at 3.78 and 5.75 inches, the arm should be tangent at 4.66 inches (again, the geometric mean). This analysis establishes the two tangency points for an offset arm to be at 3.07 and 4.66 inches. As before, an undershoot distance *a* can be found which will satisfy all of these conditions. The result is that *a* should equal  $\sqrt{L^2 - 14.3 - L}$ .

There are two important things to note about this result. First, *a* will always be *negative* for an offset arm since the square-root term will always be smaller than  $-L$ . A negative value of *a* means that an offset arm always requires an *overshoot* rather than an undershoot. This is in contrast to the straight arm case which always requires an *undershoot*.

The second thing to note is that *a* does not depend upon the offset angle  $\beta$ . This is so because each length of offset arm automatically requires a specific offset angle which satisfies all conditions for minimum over-all tracking error. In other words, once an arm length is chosen by the manufacturer there is one, and *only* one, offset angle that will properly set the tracking errors equal at radii of 2.50, 3.78, and 5.75 inches. Any other choice of offset angle will set the tracking errors equal at completely different radii than those chosen in this article.

Unfortunately, there does not exist a general agreement among arm manufacturers as to what radii should be used in setting the tracking errors equal. The outer radius generally varies from 5.75 to 6.00 inches and the inner radius anywhere from 1.80 to 3.00 inches. These wide variations make it impossible to specify a simple formula which will allow the user to properly position any manufacturer's arm for minimum over-all tracking error. Therefore, each arm must be oriented so that it satisfies the tangency criteria which the manufacturer originally chose in the design of his arm. We can only question whether or not the manufacturer's choice is a realistic one.

Luckily, the offset arm is so superior to the straight arm that variations in design cause only minor variations in tracking error. To illustrate the superiority of the offset arm, Fig. 9 shows a comparative plot of the tracking error as two nine-inch arms proceed across a disc. Curve A shows the variation in tracking error for a nine-inch straight arm improperly oriented to pass over the center of the disc. Curve B is for the same straight arm re-oriented for an optimum undershoot of 0.77 inch. Curve C is for a nine-inch offset stereo arm (in this case, the *General Electric* TM-2G arm) mounted according to the manufacturer's instructions. Note the tremendous superiority of the offset arm. Perhaps the only criticism that can be made of

**RCA Sound Tape**



**for superb recording and playback!**

RCA Sound Tape is famous for incomparable high-fidelity reproduction. Available in the popular and economical 5" and 7" reel sizes, on splice-free Mylar\* and acetate bases. Ask for RCA Sound Tape wherever superior quality magnetic recording products are sold!

\*DuPont Reg. TM



**RADIO CORPORATION OF AMERICA**

Electron Tube Division

Harrison, N. J.

**Special Offer 25¢**

Hear these authentic recordings of dramatic events from



**"The Amazing World of Short Wave Listening"**  
 narrated by Alex Dreier, Radio-TV "Man on the Go"

- President's voice from outer space!
- Actual capture of a desperate criminal!
- Radio amateur at Little America!
- Ships at sea . . . aircraft in action!

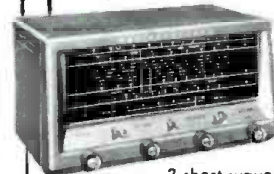

**S-38E**  
 receiver  
**\$59.95**

3 short wave bands plus standard broadcast. Built-in speaker, head-set output.

MAIL COUPON TODAY!



**hallicrafters**  
 DEPT. 20, CHICAGO 11, ILL.

Gentlemen: Please rush by return mail my recording. "The Amazing World of Short Wave Listening." I enclose 25¢.

NAME \_\_\_\_\_  
 ADDRESS \_\_\_\_\_  
 CITY \_\_\_\_\_ STATE \_\_\_\_\_

**ELECTRONICS WORLD**



this arm is that the tracking error is much larger at the outer radius than it actually need be. With a slight re-design, the outer tracking error could be reduced at a cost of inner tracking error. However, this would make the *over-all* tracking error much lower, which is to be desired.

In terms of crosstalk ratio, the incorrectly located straight arm has a crosstalk ratio of 31.6 db at an outer radius of 5.75 inches. When properly oriented, the crosstalk ratio increases to 42.1 db at this same radius, an improvement of 10.5 db. In sharp contrast, the offset arm has a crosstalk ratio of 68.2 db, a further increase of over 26 db!

#### Summary

The equation for optimum undershoot for straight pickup arms (Fig. 5) suggests that a straight stereo arm should be as long as practical in order to minimize tracking error and maximize stereophonic crosstalk ratio. However, a long arm must, of necessity, have a large dynamic mass which is undesirable for stereophonic reproduction since it causes excessive groove sidewall pressure. As a result, an offset arm is always preferable since this type allows tracking error to be minimized with a relatively short arm by proper design and selection of offset angle. In this case, then, it is desirable to have as *short* an arm as possible in order to lower the dynamic mass.

Fig. 8 includes the formula for optimum overshoot with an offset arm when the conditions of equal tracking errors at 2.50, 3.78, and 5.75 inch radii are present. Since most manufacturers do *not* use these conditions in the design of their arms, this equation is *not* universally useful but only helps indicate the general procedure used.

Table 1 gives the length, offset angle, and recommended overshoot for many commercially available stereo arms. The overshoot distance listed should be used for properly orienting the pickup arm. Using this optimum orientation, the resulting *maximum* tracking error has been calculated and tabulated along with the minimum crosstalk ratio at this point.

*Note that in all cases the minimum crosstalk ratio is sufficiently high to guarantee a minimum of degradation of the stereophonic effect due to tracking error.* This is the result of proper arm design and optimum orientation. Unless the arm is properly located for optimum overshoot, unnecessary degradation of the stereophonic effect will occur, and it must be remembered that this degradation is in addition to the crosstalk already present in the disc, cartridge, and amplifiers.

For arms not listed in Table 1, it is advisable to follow the manufacturer's recommendations carefully with regard to optimum overshoot or undershoot. It is wise to mount the pickup arm so that it may be moved readily when in place and the undershoot or overshoot distance accurately adjusted.

-30-

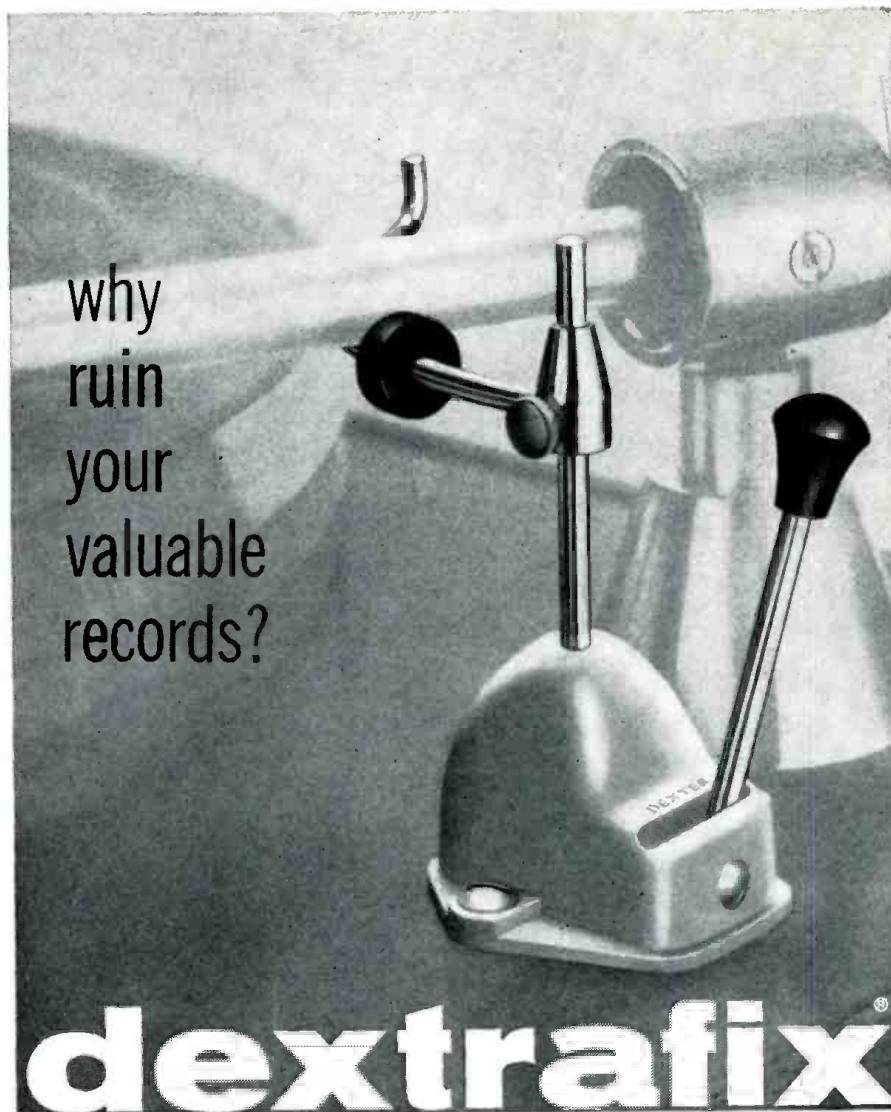

why  
ruin  
your  
valuable  
records?

# dextrafix<sup>®</sup>

## TONARM CONTROL

lowers the  
tonearm  
into the  
lead-in  
groove...  
lifts it  
after play!

If the tonearm slips out of your fingers and bounces over the record—the record is ruined! If you're unlucky, you will also need a new stylus and possibly a new cartridge.

Why take a chance? DEXTRAFIX<sup>®</sup> TONEARM CONTROL prevents such accidents! It places the stylus in the lead-in groove—gently and accurately. Then, at the end of play or at any point on the record, it lifts the stylus from the record. And the stylus cannot touch the record until the lift bar is again lowered for the next play. The DEXTRAFIX<sup>®</sup> TONEARM CONTROL also facilitates "cueing" at any point on the record.

A must for turntables—and record changers with manual operation!

**\$4.95**

Another quality product  
by the manufacturers of

**LEKTROSTAT<sup>®</sup>**  
Record Cleaning Kit



**dexter** chemical corp. • consumer products div. • 845 Edgewater Rd., N. Y. 59

# BARGAINS—OUTSTANDING SURPLUS ELECTRONICS

## CONVERT TO CITIZEN'S BAND POGO STICK WALKY-TALKY

For conversion to the new Class D Citizen's Band, the Pogo Stick Walky-Talky (IC-745, part IC-745-1), we believe, is one of the surplus Transmitter-Receiver units that is most suitable and will give best results. Because this unit is a low-powered amplitude modulated Transmitter, with really selective super-heterodyne Receiver, both crystal controlled, it requires a minimum of circuit or part changes. Also, because of its compact novel design, with built-in telescopic antenna, installation is much simpler and versatile since it can be installed against the side of the car near the driver, who can reach out the window to operate the "Push-to-Transmit" switch. The Pogo Stick Walky-Talky (IC-745) in unmodified form covers the 3-6 MC range, but when converted to the Citizen's Band and used with the 12.5 Power Supply, with self-contained 2 V. Storage Battery and loudspeaker will have a power output of just under 3 watts, and an RF output of almost 3 watts, and an HF power also be used with Chest Unit T-39 and dry batteries 12-1.5 V. 1.5 amp. Batteries permitting the operation. Schematic diagrams and modification data supplied with each purchase only.

### PRICE—EACH BC-745 POGO STICK TRANS-RECEIVER

with tubes, less crystals. 1—IC-746 Tuning Unit modified for Class D Citizen's Band operation, and modification data for Trans-Receiver conversion. NEW UNITS. \$49.95

USED—EXCELLENT units. Shpg. Wt. 20 lbs. \$49.95

CHEST UNIT T-39, for above. Houses dry batteries explained above, for field operation and self-contained Microphone-speaker Unit, less batteries. Shpg. Wt. 14 lbs. EACH. \$15.45

POWER SUPPLY PE-157. Vibrator-type Power Supply for above, with built-in loudspeaker and self-contained dry-charged rechargeable batteries. Shpg. Wt. 22 lbs. EACH. \$29.95

## HI-PRECISION FM SIGNAL Generator—Mobile Band

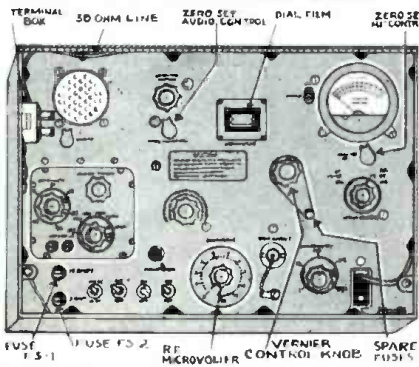

Model I-208, is a precision instrument worthy of the finest lab, mobile service, and installation shop, for production testing of mobile FM equipment. Previously, it was a scarce and expensive instrument, until we made a fortunate buy in a limited quantity. Price range in 2 bands, 1.8 to 4.5 mc (for RF alignment and tests) and 19 to 45 mc. Freq. of output of signal is maintained within .02% of dial calibration over a temperature range from 0 to 65 degrees. Other outstanding features are: Variable Frequency Deviation, 0-5 KC on 1.8 to 4.5 mc band, 0-50 KC each side of testing frequency on 19 to 45 mc band. Calibrated Microvoltage Attenuator, adjustable up to 100,000 microvolts, developed at the termination of a 30-ohm line. 0 to 84 volt available at high output terminals. RF Vacuum Tube Voltmeter incorporated. 5 modulation frequencies provided by internal audio oscillator, 20, 40, 100, 200, and 500 cps. External modulation also provided. Operates from either 110 volts, 60 cycles AC, or 12 volts DC which is ideal for in the field work. Crystal Calibrator, whose output is 1 mc and harmonics for checking and maintaining accuracy of signal generator. Each I-208 is supplied complete with tubes, calibrator crystal, 12V DC dynamometer and 110V AC power supply are self-contained. Instruction Sheets and Schematic Diagram. Shpg. wt. is 14.5 lbs. In wooden case. Available in NEW-UNUSED (tested) or Used-Excellent (not tested) condition. Act fast, our limited supply won't last long!

USED EXCELLENT. EACH \$69.95  
NEW, UNUSED. EACH \$110.00

## MISCELLANEOUS BARGAINS

### BC-329L—SMALL AIRPORT TOWER CONTROL TRANSMITTER

Crystal-controlled, modernized BC-329L Tower Control Transmitters just received. Frequency Range 200 to 410 KC; minimum power output on A1, A2, and A3. Uses 830B in RF Final, 1-807A in Amp., and 1-6V6 Crystal Osc. Speech Modulation section used 2-8U7A as Modulators. Driver, and 4-643 as Speech Amp. Rectifier section for 110 V AC operation employs 2-800A's, 3-2Z3, and 1-5Y3 Low-Voltage rectifier. Completely metered including RF output meter, and beautifully constructed by Technical Devices Corp. Dim. 20 1/2" H. x 24" W. x 20 1/2" Deep. Like-New condition units. Shpg. Wt. 375 lbs. \$160.00 EACH

6 or 12V. DC VIBRATOR POWER SUPPLY. Type PE-104, operates from either voltage and supplies completely filtered voltages as follows: 1.5-15 (thru), and 90 volts DC. Uses swing vibrator tubes. Ideal for mobile banks, transmitters, etc. Dim. 3" x 4 1/2" x 6 1/2". NEW UNITS. Shpg. wt. 12 lbs. EACH. \$9.95

12V. DC, 1, 12 HP DC MOTOR. Make electric car or tractor for kidnap. Rated at 17.2 HP at 1725 rpm, but with built on reducing gear assembly which delivers more power at final speed of 43 rpm. 7 heavy brass worm gear, available separately for 2 1/2 rpm. N.W. material. MOTOR EACH \$12.95  
WORM GEAR, 7" for 2 1/2 rpm. \$2.75

## LIMITED QUANTITY BARGAINS

TC-34 CODE PRACTICE SETS. Learn to copy code, or improve your speed with the aid of this instrument. schools, etc. Complete, portable automatic unit for reproducing readily built-in Loudspeaker code signals recorded in pre-recorded tapes. Pre-recorded tapes, lessons 1 to 15 (on 15 reels), available from many other surplus houses. Also usable for practicing "sending" by means of internal oscillator keyed by external hand key. Operates from 90 to 120 V, or 100 to 240 Volts, 60 Cycles. AC SPECIAL! Used—Very Good \$18.75  
AS ABOVE, NEW—UNUSED. \$22.50

BC-312 RECEIVER. Well known Signal Corps Communications Receiver, 1500 KC to 18.0 MC. For 12 V DC operation. Used—Excellent condition. \$60.00  
Tested. Shpg. wt. 75 lbs. EACH

RA-20 POWER SUPPLY. To convert above Receiver to 110 V AC operation. USED—GOOD \$14.95 ea. NEW UNITS. \$17.95 ea.

BC-342 RECEIVER. Same as BC-312 except includes Crystal Filter and Phasing Control and for \$84.50  
110 V AC operation. Used—Tested. EACH

BC-312, 342, 344 INSTRUCTION BOOK, postpaid. \$2.50

BC-344 LOW FREQ. R/C'V'R. Same appearance & construction as BC-342. Sensitive Superhet covering 150 to 1500 KC in 4 bands. Incorporates BFO for CW reception. For 110 V AC operation. NEW units. Tested. \$84.50  
Shpg. wt. 80 lbs. EACH

BC-221 FREQUENCY METER. The best instrument possible for determining frequency of transmitter or receiver, alignment, testing, etc. Frequency Range 125 KC to 20,000 KC. Complete with Calibrating Crystal tubes, including Calibration Book. Tested. Used—Excellent. EACH \$79.95  
Shpg. wt. 35 lbs.

BC-1306—TRANSMITTER-RECEIVER for MARS application. 100 to 180 KC to 18.0 MC. Includes: Crystal Calibration and Net Controls. NEW UNITS, with all tubes except Final RF 2E22 tube. \$22.50  
Shpg. wt. 50 lbs. EACH

PE-237 POWER SUPPLY. For Above IC-1306. Supplies all necessary voltages and current for both transmitter and receiver sections. Operates from 6, 12, or 24 Volts DC. NEW—UNUSED units. \$14.95  
Shpg. wt. 125 lbs. EACH

BC-659 FM TRANSCEIVER. 2-Channel, 27.0 to 38.9 MC. 2 Watts Output. Can be modified for use on new Class D Citizen's Band in 26.96 to 27.23 MC range. See June '50 CQ magazine. Used—Excellent units, complete with tubes and built-in loudspeaker. Shpg. wt. 45 lbs. PRICE, EACH \$11.95

PE-117 or PE-120 POWER SUPPLY, FOR ABOVE. PE-117 operates from 6 to 12 V. PE-120 operates from 6, 12 or 24 Volts input. NEW—UNUSED units with all tubes. Shpg. wt. 40 lbs. \$14.50  
EACH

BC-1335 FM TRANSCEIVER. 2-Channel, 27.0 to 38.9 MC, with built-in 6 or 12 V DC Power Supply. Small, convenient, receiver measuring 10 1/2" x 8 1/2" x 13 9/16" using miniature tubes, yet has power output of 2 Watts. See July '50 CQ magazine for complete modification data for converting to Citizen's Band. Almost-New condition units, with all tubes, and schematic. Shpg. wt. 35 lbs. \$29.95  
EACH

BC-603 FM RECEIVER. 20 to 28 MC Red-Hot receiver that can be easily modified for 6 meter band or 40-50 MC monitoring. See Sept. and Oct. '50 issues of CQ. Used—Clean units, with all tubes, built-in loudspeaker and 12 V DC dynamotor. Shpg. wt. 45 lbs. \$17.95  
EACH  
REC. NEW UNITS. EACH \$22.95

BC-604 FM TRANSMITTER. 10-Channel Companion to Above. Each channel crystal controlled; power output with IM-35 dynamotor 25 to 30 Watts. NEW UNITS, complete with tubes (less DM-35 Dynamotor). \$9.95  
Shpg. wt. 65 lbs. EACH

DM-35 DYNAMOTOR FOR ABOVE. For 12 V DC operation. Output 825 V. 10" at 225 rpm. NEW. \$9.95

30-40 MC DELUXE FM TRANSCEIVER. Model IC-237. VU-2 Single-Channel, Double-Conversion Superhet, with features such as double limiter, stretch circuit, crystal control of both 1st and 2nd Converter oscillators, built-in 6 V DC Power Supply, etc. Dimensions 11 1/2" x 10" x 1 1/2". Used—Excellent condition units, with tubes, less crystals or control unit or loudspeaker. Schematic diagrams. Shpg. wt. 65 lbs. \$29.95  
EACH

TRANSMITTER COMPANION TO ABOVE. Model T-102. VU-2. Power Output 25 Watts. Crystal-controlled single-channel unit with built-in 6 V DC Power Supply. Can be used for NIT FM amateur transmissions, or may be applicable to Fire, Police, or other applications. Used—Excellent condition units. With schematic. \$19.95  
Shpg. wt. 65 lbs. EACH

BC-611 WALKY-TALKY CHASSIS. Replacement chassis for famous Walky-Talky. Crystal-control AM Transmitter, 3.0 to 6.0 mc chassis only, less tubock coils. See previous ads for details. NEW units, with schematic. Shpg. wt. 8 lbs. EACH \$6.95  
RF & ANT. COILS FOR ABOVE—PAIR \$1.25

250W BEACHMASTER AUDIO AMPLIFIER. SUPER-POWER complete amplifier. Designed by Bell Tel. Labs. All self-contained in waterproof wood case, with blower system for ventilation, weatherproof receptacles, etc. Ideal for field and indoor use. Also available in package, or easy to convert to modulator for 500 Watt transmitter. Operates from 110 V, 50/60 cycles AC. Uses total of 14 tubes, including 1-6X4 triodes in push-pull power stage and 1-6X4 angle-eye tube to indicate gain. Like new condition equipment. Dim. 26 1/2" x 16 1/2" x 10". Shipping weight, complete with tubes, 100 lbs. Supplied with schematic diagrams. \$169.50  
PRICE EACH. SLASHED TO

All Above Material Subject to Prior Sale. REMIT IN FULL ON ALL ORDERS UNDER \$20.00, 50% DEPOSIT ABOVE THIS AM'T, BAL. C.O.D. Min. Order — \$5.00. All Prices F.O.B. Our Address.

## TELEMARINE

COMMUNICATIONS CO., INC.  
140 WEST B'WAY, NEW YORK 13, N. Y.

COlandt 7-5444

Cable Address: Telemarine N. Y.

# Our Largest Radar Telescope

Will include most powerful  
20 to 60 mc. transmitter  
with megawatt power supply.

A DISH antenna as tall as a 15-story building will soon appear on the Stanford University campus. It will be a "radar telescope" with a parabolic reflector 142 feet in diameter. When completed in about a year, the big dish will be America's largest and the world's second largest.

A 20-60 mc. radio transmitter—the most powerful ever built in this frequency range and requiring a million-watt supply—will be installed near the dish, making the combined installation a new and sensitive tool for space research.

The project will be a joint undertaking by Stanford Research Institute's Communication and Propagation Laboratory and the University's Radio Propagation Laboratory, with support from the Air Force Cambridge Research Center.

Usually radio telescopes are equipped to receive only naturally occurring electromagnetic radiation from the cosmos. But with the high-powered transmitter, it will be possible to bounce signals against heavenly bodies, as was recently done with the planet Venus.

This technique is becoming increasingly important in studies of the solar system, and the Stanford group will attempt to obtain radar echoes from Mars and from the sun itself. The radar-echo method is called "radar astronomy" to distinguish it from "radio astronomy," which does not involve reflection of man-made signals but only reception of natural radiation.

Some of the research findings the group foresees are: (1) more accurate measurements of cosmic distances; (2) surface explorations of the moon and planets by radar; (3) the rotation speed of Venus, whose surface is hidden by perpetual fog; (4) the ionization density and distribution in the sun's outer corona, and around various planets; (5) data on the amounts and movements of ionized gases and space debris between the earth and the moon, and in interplanetary space.

The cost of the 142-foot dish is estimated at about \$250,000. Special use of welded structural members and aluminum fabrication methods will cut some costs 90 per-cent in comparison with other big dishes. The antenna is designed for use at frequencies between 20 and 2000 mc. The transmitter is valued at more than a million dollars. The total investment will be around \$1,500,000, it is estimated.

The largest U. S. radio telescope, now under construction, is a 140-foot dish at the National Radio Astronomy Observatory in Green Banks, West Virginia.

# FREE

## 350 BIG PAGES OF BARGAINS LIKE THIS



WRITE TODAY FOR **FREE**

12 MONTHS SUBSCRIPTION TO BARGAIN BULLETINS

Page-after-page, month-after-month. Exclusive bargains in HI-FI and LP RECORDS plus 1001 other items. To be "in-the-know" you must be on Radio Shack's mailing list. Just check the coupon below and mail it today!



**SEND 35c FOR A COMPLETE GUIDE TO ELECTRIC PARTS BUYING**

300 pages, 8½ x 11, illustrated handbook. Articles, engineering data plus buying guide. Over 40,000 items.

# NEW REALISTIC 40-W STEREO

## OUTPERFORMS \$140 AMPLIFIERS

\$8 DOWN **\$79<sup>50</sup>** INCLUDING CABINET  
\$7 MONTHLY

\$50 TO \$90 LESS THAN COMPARABLE QUALITY UNITS

**REALISTIC STEREOLYNE-40 AMPLIFIER** Only REALISTIC could bring you this sensational value! Our buyers shopped the entire market. Our engineers made comparison test after test. All agree the REALISTIC-40 delivers more watts per dollar than any other stereo amplifier on the market today! Note that it's not a kit . . . the REALISTIC-40 is completely wired, and this amazing low price includes the cabinet . . . there's nothing else to buy! Read the specs. You'll agree it's one more reason why REALISTIC is America's best buy in HI-FI!

**SPECIFICATIONS and FEATURES:** Two 20-watt stereo channels or 40-watts monaural; 80-watts total peak audio output. Frequency Response: 20-20,000 cps ±1 db. Feedback: 20 db. Less than 1% total R.M.S. harmonic distortion at 400 cps; hum level: -59 db on phono and tape head inputs; -79 db on tuner input at 20 watts output. Controls: individual bass and treble controls for each channel; balance control and phasing switch; single volume control adjusts both channels simultaneously; separate loudness switch; AC accessory outlet. Inputs: Tuner, Stereo Phono, Stereo Tape Head. Outputs: 4/8/16 ohms and Tape Recorder. 117 VAC, 50/60 cycles. Size: 12" W x 4 1/8" H x 9 1/16" D. Custom-styled gold, maroon and white metal cabinet.

----- FILL IN -- CLIP -- MAIL TODAY -----

**RADIO SHACK CORPORATION, Dept. 10F**  
730 COMMONWEALTH AVENUE, BOSTON 17, MASS.

Please send me

- Bargain Bulletins for 1 year FREE!       1960 Guide to Electronic Buying at 35c
- REALISTIC 40-W AMPLIFIER Order #90LX023 at \$79.50\*       FREE Brochure on REALISTIC Line
- Check     Money Order     C.O.D.    \*Shipped by express only

NAME \_\_\_\_\_

ADDRESS \_\_\_\_\_

CITY \_\_\_\_\_ ZONE \_\_\_\_\_ STATE \_\_\_\_\_

**RADIO SHACK CORPORATION**

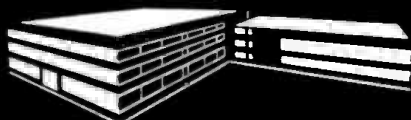

167 WASHINGTON STREET, BOSTON 8, MASS.  
730 COMMONWEALTH AVENUE, BOSTON 17, MASS.  
230-234 CROWN STREET, NEW HAVEN 10, CONN.

REALISTIC... *America's BEST BUY in HI-FI!*



AMPLIFIERS



TUNERS



TURNABLES AND TONE ARMS

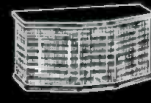

ELECTROSTAT-3 TWEETER

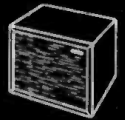

SPEAKERS AND SPEAKER SYSTEMS

send for a FREE Brochure on the complete REALISTIC Line



# SUPERIOR'S NEW MODEL TW-11 STANDARD PROFESSIONAL TUBE TESTER

- ★ Tests all tubes, including 4, 5, 6, 7, Octal, Lock-in, Hearing Aid, Thyratron, Miniatures, Sub-miniatures, Novals, Sub-minars, Proximity fuse types, etc.
- ★ Uses the new self-cleaning Lever Action Switches for individual element testing. Because all elements are numbered according to pin-number in the RMA base numbering system, the user can instantly identify which element is under test. Tubes having tapped filaments and tubes with filaments terminating in more than one pin are truly tested with the Model TW-11 as any of the pins may be placed in the neutral position when necessary.
- ★ The Model TW-11 does not use any combination type sockets. Instead individual sockets are used for each type of tube. Thus it is impossible to damage a tube by inserting it in the wrong socket.
- ★ Free-moving built-in roll chart provides complete data for all tubes. All tube listings printed in large easy-to-read type.
- ★ NOISE TEST: Phono-jack on front panel for plugging in either phones or external amplifier will detect microphonic tubes or noise due to faulty elements and loose internal connections.

**Model TW-11—TUBE TESTER** . . . Total Price \$47.50—Terms: \$11.50 after 10 day trial, then \$6.00 per month for 6 months if satisfactory. Otherwise return, no explanation necessary!

**EXTRAORDINARY FEATURE—SEPARATE SCALE FOR LOW-CURRENT TUBES.** Previously, on emission-type tube testers, it has been standard practice to use one scale for all tubes. As a result, the calibration for low-current types has been restricted to a small portion of the scale. The extra scale used here greatly simplifies testing of low-current types.

The Model TW-11 operates on 105-130 Volt 60 Cycles A.C. Comes housed in a beautiful hand-rubbed oak cabinet complete with portable cover.

**\$47<sup>50</sup>**  
NET



**Model 83—C.R.T. Tube Tester**  
Total Price . . . . . \$38.50  
Terms: \$8.50 after 10 day trial, then \$6.00 monthly for 6 months if satisfactory. Otherwise return, no explanation necessary.

## SUPERIOR'S NEW MODEL 83

# C.R.T. TESTER

TESTS and REJUVENATES ALL PICTURE TUBES  
**ALL BLACK AND WHITE TUBES**      **ALL COLOR TUBES**

From 50 degree to 110 degree types—from 8" to 30" types.

- Model 83 is not simply a rehashed black and white C.R.T. Tester with a color adapter added. Model 83 employs a new improved circuit designed specifically to test the older type black and white tubes, the newer type black and white tubes and all color picture tubes.
- Model 83 provides separate filament operating voltages for the older 6.3 types and the newer 8.4 types.
- Model 83 employs a 4" air-damped meter with quality and calibrated scales.
- Model 83 properly tests the red, green, and blue sections of color tubes individually—for each section of a color tube contains its own filament, plate, grid and cathode.

- Model 83 will detect tubes which are apparently good but require rejuvenation. Such tubes will provide a picture seemingly good but lacking in proper definition, contrast and focus. To test for such malfunction, you simply press the rej. switch of Model 83. If the tube is weakening, the meter reading will indicate the condition.
- Rejuvenation of picture tubes is not simply a matter of applying a high voltage to the filament. Such voltages improperly applied can strip the cathode of the oxide coating essential for proper emission. The Model 83 applies a selective low voltage uniformly to assure in-cathode damage.

Model 83 comes housed in handsome portable Saddle Stitched Texon case—complete with sockets for all black and white tubes and all color tubes.

**\$38<sup>50</sup>**  
NET



**Model TV-50A—Genometer**  
Total Price . . . . . \$47.50  
Terms: \$11.50 after 10 day trial, then \$6.00 monthly for 6 months if satisfactory. Otherwise return, no explanation necessary.

# GENOMETER

## 7 Signal Generators in One!

- ✓ R.F. Signal Generator for A.M.
- ✓ R.F. Signal Generator for F.M.
- ✓ Audio Frequency Generator
- ✓ Bar Generator
- ✓ Marker Generator
- ✓ Cross Hatch Generator
- ✓ Color Dot Pattern Generator

A versatile all-inclusive GENERATOR which provides ALL the outputs for servicing:

**A.M. Radio • F.M. Radio • Amplifiers • Black and White TV • Color TV**

**R. F. SIGNAL GENERATOR:** The Model TV-50A Genometer provides complete coverage for A.M. and F.M. alignment. Generates Radio Frequencies from 100 Kilocycles to 60 Megacycles on fundamentals and from 60 Megacycles to 180 Megacycles on powerful harmonics.

**VARIABLE AUDIO FREQUENCY GENERATOR:** In addition to a fixed 400 cycle sine-wave audio, the Model TV-50A Genometer provides a variable 100 cycle to 20,000 cycle peaked wave audio signal.

**BAR GENERATOR:** The Model TV-50A projects an actual Bar Pattern on any TV Receiver Screen. Pattern will consist of 4 to 16 horizontal bars or 7 to 20 vertical bars.

**THE MODEL TV-50A** comes absolutely complete with shielded leads and operating instructions.

**CROSS HATCH GENERATOR:** The Model TV-50A Genometer will project a cross-hatch pattern on any TV picture tube. The pattern will consist of non-shifting, horizontal and vertical lines interlaced to provide a stable cross-hatch effect.

**DOT PATTERN GENERATOR (FOR COLOR TV):** Although you will be able to use most of your regular standard equipment for servicing Color TV, the one addition which is a "must" is a Dot Pattern Generator. The Dot Pattern projected on any color TV Receiver tube by the Model TV-50A will enable you to adjust for proper color convergence.

**MARKER GENERATOR:** The Model TV-50A includes all the most frequently needed marker points. The following markers are provided: 189 Kc., 282.5 Kc., 456 Kc., 600 Kc., 1000 Kc., 1400 Kc., 1600 Kc., 2000 Kc., 2500 Kc., 3579 Kc., 4.5 Mc., 5 Mc., 10.7 Mc., (3579 Kc. is the color burst frequency)

**\$47<sup>50</sup>**  
NET

**EXAMINE BEFORE YOU BUY!**  
**USE APPROVAL FORM ON NEXT PAGE**

Superior's New **MODEL 77**

# VACUUM TUBE VOLTMETER

## WITH NEW 6" FULL-VIEW METER



Compare it to any peak-to-peak V. T. V. M. made by any other manufacturer at any price!

- ✓ Model 77 completely wired and calibrated with *all* accessories (including even portable carrying case) sells for only \$42.50.
- ✓ Model 77 employs a sensitive six inch meter. Extra large meter scale enables us to print all calibrations in large easy-to-read type.
- ✓ Model 77 uses new improved SICO printed circuitry.
- ✓ Model 77 employs a 12AU7 as D.C. amplifier and two 9006's as peak-to-peak voltage rectifiers to assure maximum stability.
- ✓ Model 77 uses a selenium-rectified power supply resulting in less heat and thus reducing possibility of damage or value changes of delicate components.
- ✓ Model 77 meter is virtually burn-out proof. The sensitive 400 microampere meter is isolated from the measuring circuit by a balanced push-pull amplifier.
- ✓ Model 77 uses selected 1% zero temperature coefficient resistors as multipliers. This assures unchanging accurate readings on all ranges.
- ✓ AS A DC VOLTMETER: The Model 77 will measure any voltage up to 1500 volts with negligible loading. It is indispensable in receiver and Hi-Fi Amplifier servicing and a must for Black and White and Color TV Receiver servicing where circuit loading cannot be tolerated. A special feature permits accurate zero center measurements necessary for the true alignment of Foster-Seely (Armstrong) FM detectors, Ratio Detectors and the newer Gated Beam Detectors.
- ✓ AS AN AC VOLTMETER: The old-fashioned laboratory AC V.T.V.M. was cumbersome, erratic and required several dial manipulations to arrive at a reading. The Model 77 when connected to a circuit will quickly and simply measure its RMS value if sine wave, and its peak-to-peak value if complex wave. Pedestal voltages that determine the "black" level in TV receivers, sync. pulses and saw tooth voltages are easily read with the Model 77.
- ✓ AS AN ELECTRONIC OHMMETER: Because of its wide range of measurement in the resistance range (from .2 ohms to 1,000 megohms) the Model 77 will be your most frequently used resistance meter. Leaky capacitors which may not show up on other resistance meters, show up glaringly when tested with the new model 77. Because of its sensitivity and low loading, intermittents are more easily found, isolated and repaired.

**Model 77—Vacuum Tube Voltmeter**  
Total Price ..... **\$42.50**

Terms: \$12.50 after 10 day trial, then \$6.00 monthly for 5 months if satisfactory. Otherwise return, no explanation necessary.

Traditionally, the V. T. V. M. has been the one instrument used for voltage measurements where low-drain or wide frequency response is essential. And now, the Model 77 V. T. V. M. by taking advantage of new developments including modern balanced push-pull circuit design, etched circuitry, an extra large meter circuit and other improvements provides such measurements and other improvements provides such measurements and with quicker, with a higher degree of accuracy and with better readability.

The Model 77 will measure DC with negligible loading AC of ANY FORM WAVE; whether sine wave, pulse wave, square wave, or other complex wave forms. It will measure all AC from 30 cycles to over 5 megacycles and will do so without additional accessories or cables.

**SPECIFICATIONS**

- DC VOLTS—0 to 3/15/75/150/300/750/1500 volts at 11 megohms input resistance.
- AC VOLTS (RMS)—0 to 3/15/75/150/300/750/1500 volts.
- AC VOLTS (Peak to Peak)—0 to 8/40/200/400/800/2000 volts.
- ELECTRONIC OHMMETER—0 to 1000 ohms/10,000 ohms/100,000 ohms/1 megohm/10 megohms/100 megohms/1,000 megohms.
- DECIBELS —10 db to +18 db, +10 db to +38 db, +30 db to +58 db. All based on 0 db = .006 watts (6mw) into a 500 ohm line (1.73v).
- ZERO CENTER METER—For discriminator alignment with full scale range of 0 to 1.5/7.5/37.5/75/150/375/750 volts at 11 megohms input resistance.

Model 77 comes complete with operating instructions, probe and test leads. Use it on the bench—use it on calls. A streamlined carrying case, included at no extra charge, accommodates the tester, instruction book, probe and leads. Operates on 110-120 volt 60 cycle. Only

**\$42<sup>50</sup>**  
**NET**

# SHIPPED ON APPROVAL

## NO MONEY WITH ORDER — NO C. O. D.

Try any of the instruments on this or the facing page for 10 days before you buy. If completely satisfied then send down payment and pay balance as indicated on coupon. **No interest or Finance Charges Added!** If not completely satisfied return unit to us, no explanation necessary.

**MOSS ELECTRONIC, INC.**

Dept. D-572, 3849 Tenth Ave., New York 34, N. Y.

Please send me the units checked on approval. If completely satisfied I will pay on the terms specified with no interest or finance charges added. Otherwise, I will return after a 10 day trial positively cancelling all further obligations.

- Model 77..... Total Price \$42.50 \$12.50 within 10 days. Balance \$6.00 monthly for 5 months.
- Model TV-50A... Total Price \$47.50 \$11.50 within 10 days. Balance \$6.00 monthly for 6 months.

- Model TW-11.... Total Price \$47.50 \$11.50 within 10 days. Balance \$6.00 monthly for 6 months.
- Model 83..... Total Price \$38.50 \$8.50 within 10 days. Balance \$6.00 monthly for 5 months.

Name .....

Address .....

City ..... Zone... State.....

All prices net. F.O.B., N.Y.C.

# Introducing **ATR** CUSTOMIZED Karadio

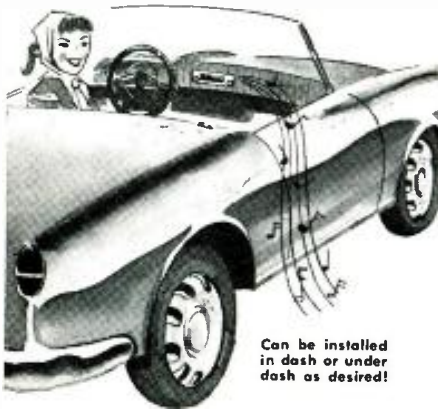

Can be installed in dash or under dash as desired!

for  
small import cars  
and  
compact U.S. cars



There is a trim plate kit for YOUR CAR!

## **ATR** CUSTOMIZED Karadio

### • VIBRATOR-OPERATED with Tone Control

The ATR Customized Karadio is a compact, new, self-contained airplane-styled radio for small import and compact American cars. This economical unit is perfect for all small cars because it can be easily and inexpensively installed in-dash or under-dash on most any make or model automobile—and its powerful 8-tube performance provides remarkable freedom from engine, static, and road noises. ATR Karadios are built to look and fit like original equipment with sleek, modern styling and solid, single-unit construction. They offer many customized features and provide highest quality fidelity—yet cost far less than comparably designed units. The ATR Customized Karadio comes complete with speaker and ready to install... and is the ideal way to add fun and value to your small import or American automobile!



ATR KARADIO... is ideal for small import cars or compact American cars! Unit is

completely self-contained—extremely compact! Can be mounted in-dash or under-dash—wherever space permits! For 6 volt or 12 volt!

SEE YOUR JOBBER OR WRITE FACTORY

• "A" Battery Eliminators • DC-AC Inverters • Auto Radio Vibrators



AMERICAN TELEVISION & RADIO CO.  
Quality Products Since 1931  
SAINT PAUL 1, MINNESOTA, U. S. A.

# Innovation in Plated Circuitry

Motorola plug-in board with "road map" features reliability, may be serviced in or out of the set.

WITH ONE NEW model being introduced this fall using a plated-circuit board, *Motorola* abandons its position of relying exclusively on conventional chassis wiring in its TV receivers. According to Karl Horn, chief TV development engineer, the manufacturer feels the new board not only overcomes objections generally raised

ing materials are also being employed.

Sets using the design survived severe salt-spray, temperature-extreme, flexing, and overvoltage-life tests simulating between 10 and 15 years normal use. Temperature testing consisted of 20 cycles of immersion in a cold chamber (-40°C) for four hours, immediately followed by insertion in a humidity chamber (85°C, 95 per-cent relative humidity) for 16 hours. After each cycle, the sets were run at room temperature for four hours.

As to serviceability, wiring is plated on both sides but all components, including about 80 to 85 per-cent of the receiver circuit, are mounted on one side of the board. The latter is held horizontally at the bottom of the cabinet (Fig. 1), with good access. For convenience, color coding based on the standard EIA code is used to identify all connections on either side of the board, so that tracing may be performed on only one side. Tube type numbers are also engraved. Only the three circuit sections shown in Fig. 1, which are also accessible, are mounted off the board.

By removing a few screws, the entire board may be lifted out of the cabinet (Fig. 2) for external service. Doing this, however, breaks connections to the remainder of the set normally made through 30-odd contacts along one edge. However, the multiple connector strip that mates with the edge of the board may also be removed by loosening two screws. Leads to it are sufficiently long to allow connection outside the cabinet for operational tests. The design also uses two modules. Service "road maps" are pasted inside the cabinet.

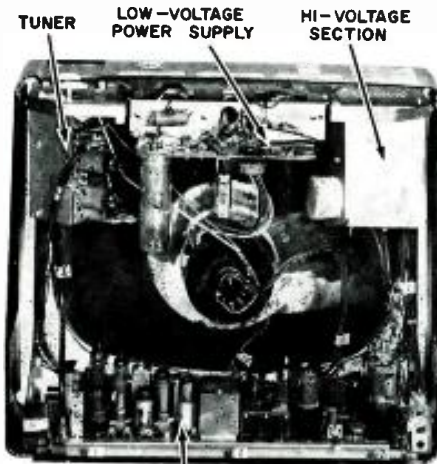

CHASSIS BOARD IN PLACE

Fig. 1. Rear of set using the new board, which carries 80 to 85% of the circuitry.

against printed boards but provides advantages over conventional wiring.

Used only in one 17-inch receiver at the outset, the board was designed with two factors chiefly in mind: reliability and serviceability. As to reliability; the chassis board has extra thickness, uses a new material, and is re-inforced with Fiberglas. New plat-

Fig. 2. The board taken out of set. Removal is said to require 33 seconds.

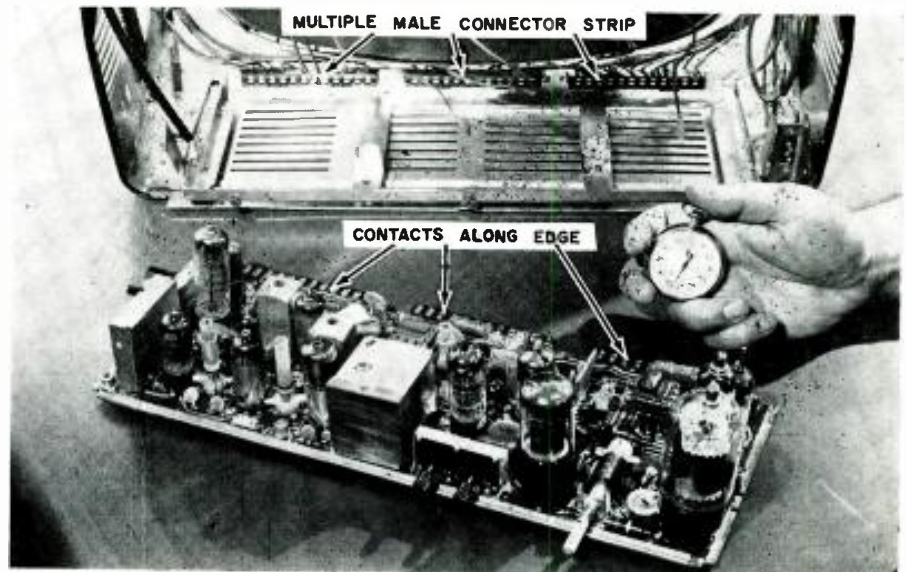

MULTIPLE MALE CONNECTOR STRIP

CONTACTS ALONG EDGE

**Viking** builds the **PERFECT MEMORY**

*for your music system*

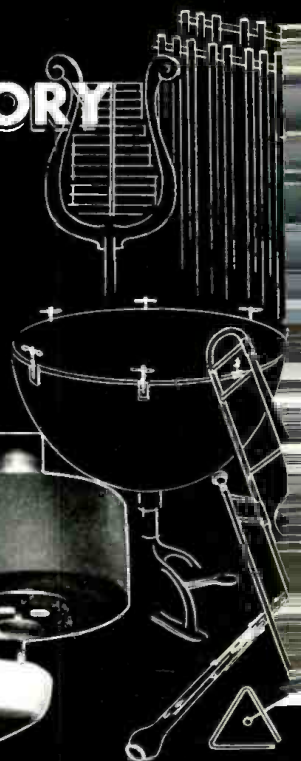

85ESQ HEAD ASSEMBLY, WITH QUARTER-TRACK SHIFT.  
(Tapelifter and pads not shown.)

The Viking 85 Series deck and Viking recording amplifiers provide the perfect memory for your high fidelity music system. Record monaural or stereo programs at the flick of a switch. Record with the full performance provided by laminated heads. Record quarter track if you prefer, but better still, use the brilliant, ultra short-gap quarter-track head for simultaneous monitoring from the recorded track.

All Viking 85 Series decks now feature laminated (not single laminar) half-track and quarter-track record and playback heads; the same heads used on the professional 95 Series. A laminated head permits a substantially higher recording level without saturation, requires less equalization for brilliant high-end performance and provides much longer head life.

All Viking "Q" model decks may be used equally well for playing the new 7½ i.p.s. four-track tapes and the 3¾ i.p.s. tapes featured in cartridges. Cartridge tapes may be removed from the cartridge and played reel-to-reel on the Viking 85.

*Viking tape components are sold through high fidelity dealers, exclusively. Further technical information may be obtained by writing directly to Viking's Customer Service Department.*



**Viking** OF MINNEAPOLIS, INC.

9600 Aldrich Avenue South, Minneapolis 20, Minnesota

EXPORT DIVISION: 23 Warren Street, New York City 7, New York  
Cable: SIMONTRICE, NEW YORK (All Codes)

### BC-603 FM RECEIVER

20 TO 27.9 MC. GOV'T. RECOND. . . **\$14.95**

BC-683—FM RECEIVER—27 to 39.1 MC. Used: \$24.95  
 BC-684—TRANSMITTER—27 to 39.1 MC. Used: \$7.95  
 BC-604 TRANSMITTER—20 to 27.9 MC. Used: \$4.95—Ne-New: \$7.95  
 FT-237 Mounting for Trans. & Receiver—Re-New: \$4.95  
 FT-346—Mounting F/Receiver Only. Re-new: 4.95  
 DM-34 12 V Dyn F/MC-683-603. U: \$2.95—R-N: 4.95  
 DM-35 Dyn. F/BC-684-604. U: \$7.95—R-N: 9.95

### AC POWER SUPPLY PS-603

Output: 220 VDC 80 MA & 24 AC 2 Amps. Tube Rectification. mounts on rear Plug of BC-603-683. Can be adapted to other Receivers—KIT: \$10.00—Wired: \$14.95

### RECEIVERS:

BC-733 Localizer Rec.—108.3 to 110.3 MC. Used: \$ 7.95  
 ARB-Receiver—190 to 9050 KC. Used: 18.95  
 R-23/BC-453 Rec.—190 to 550 KC. Used: 14.95  
 R-27/BC-455 Rec.—6 to 9 MC. Used: 8.95  
 R-4/ARR-2 Rec.—540-890 KC; 230-258 MC. R-N: 8.95  
 BC-1206 Beacon Receiver—200 to 400 KC. Re-N: 9.95  
 BC-652 Receiver—2 to 6 MC. Less Dyn. Used: 19.95  
 BC-342 Receiver—1.5 to 18 MC For AC op. Used: 59.50  
 BC-312 Receiver—1.5 to 18 MC Less Dyn. Used: 59.50  
 BC-344 Rec.—150 to 1500 KC—For AC op. Used: 49.50

### ALL BAND RECEIVER

NAVY ARB/CRV 46151—190 to 9050 KC—Four Band. 6 Tube Superhet—Local & remote tuning and band change; illuminated dial, sharp & broad tuning; AVC, CW, provisions for operation of DU-1 Loop. Complete with Tubes: 1/12SA7, 1/12A6, 4/12SF7, & 24 Volt Dynamotor. Size: **\$14.95**  
 ABOVE—Converted to 12 Volt, with Dynamotor (No electric band change) \$24.95  
 Conversion for 115 V 60 cycle with Spin Dial, Phone Jack, CW, —KIT of Parts with Instructions: \$10.00  
 Conversion—as Above—for 12 Volt DC—KIT of Parts, with Dynamotor: 10.00  
 Remote Control Box: \$2.00—Remote Control Shaft: 1.50  
 Remote Control Head: 2.00  
 Tuning Knob for large spined shaft: 1.00  
 T-Shaft Adapter for remote and local tuning: 1.50  
 PLUGS only—for Receiver or Control Box. Each: 1.00

### KEYERS, TELEPHONES, HEADSETS, MICS.

TS-9 Handset. . . . . Used: \$2.95—New: \$ 3.95  
 TS-13 Handset. w/PL-55 & PL-68. U: \$2.95—N: 3.95  
 T-17 Microphone. . . . . Used: \$3.95—New: 6.95  
 CM-1-SC Hand Carbon Mic.—Mobile type. New: 6.95  
 EE-8 Field Telephones. Used: \$12.95—Recond.: 16.95  
 BD-71 Switchboard—6 Line. . . . . U: \$14.95—New: 24.95  
 BD-72 Switchboard—12 Line. . . . . U: \$21.95—New: 31.95  
 RM-29 Control Unit. . . . . New: \$6.95—W/Handset: 8.95  
 RM-52 Control Unit (Patch Found.) U: \$1.95—N.: 2.95  
 H-16/JU Headset—8000 ohm. . . . . U: \$1.95—New: 2.95  
 HS-35 Headset—300 ohm. . . . . U: \$4.95—New: 7.95  
 TG-34 Keyer F/Code Practice. . . . . Re-New: 22.95  
 Code Practice Tapes, Inked Paper—15 to Set. N.: 16.95  
 J-45 Tel. Key with cord and Plug. . . . . New: 1.50

### COLLINS ART-13 TRANS.—\$49.50



### 2 TO 18.1 MC—100 WATT—PHONE, CW, MCW

The most desired Set on the surplus market—Easily converted to 10 Meters (See Surplus Conversion Manual No. 2—\$2.50). Automatic Tuning for selection of 11 Channels in the Freq. Range. Tube Line-Up: 1/8B7, 1/8I3, 2/1625, 1/12SJ7, 2/6V6, 2/8I1, 2/12SL7, 1/12SA7. AC Power Supply requirements: 28 VDC/10 A, 400 VDC/225 MA & 1250 VDC/250 MA. Size: 23 1/2 x 16 x 11 1/2. Wt.: 70 lbs. Price. USED: \$49.50  
 Price—Same as above—except, Less Tubes. . . . . 30.00  
 DY-12/ART-13 24 V. Dyn. w/Filter & Relays—U: 12.95

### PULSE ANALYZER AND OSCILLOSCOPE

1P-148/APA-11A RADAR PULSE ANALYZER with remote Freq. of 200 to 6000 CPS with either a negative or positive pulsed signal. Has calibrated dials for pulse width & rate. Used with APR-1, APR-4, and other receivers. Also can be used as an oscilloscope. Complete with 1/31P2 Cathode Ray Tube, 6/12AT7, 2/6AG7, 2/6AG5, 2/2X2, & 1/5R4 Tubes. Voltage required: 115 V 400 cycle & 24 Volts. USED: \$19.95

### LARGEST VARIETY OF SURPLUS EVER OFFERED! See CATALOG F-59!

Address Dept. RM • All Prices F.O.B., Lima, Ohio. Minimum Order \$5.00, & 25% Deposit on all C.D.D.'s

**FAIR RADIO SALES**  
 132 SOUTH MAIN ST. • LIMA, OHIO

# Dynamic Transistor Checker

New Seco Model 100 is a self-contained, self-powered unit which tests a wide range of transistor types.

THE Seco Model 100 Transistor Checker is a low-cost dynamic checker for transistors. The unit is a completely self-contained, self-powered tester which checks a wide range of transistor types either in or out of the circuit. Transistors under test may simply be plugged into the unit or may be easily clipped into the circuit with alligator clips affixed to the external leads.

The unit is designed with a new but proven concept of dynamic checking under current-amplifier conditions. Fast and easy to operate, the checker provides a visual means of observing signal output by means of the glow in a neon lamp. The indicator lamp simultaneously checks for (1) opens, (2) shorts, and (3) gain. The unit permits matching of similar type transistors in an actual operating oscillator circuit. It also provides for a rapid "go-no-go" test at practical collector currents.

The over-all dimensions of the Model 100 are 2 1/4 x 3 1/4 x 6 1/4 inches. Shipping weight is only 1 1/2 pounds. Price of the unit is \$19.95.

### Principle of Operation

The tester incorporates a specially designed pulse signal generator. The a.c. signal developed in the primary winding of the transformer (see diagram below), when an operating transistor is connected to the checker, is stepped up to a voltage sufficient to fire a neon glow lamp (NE-51). An oscilloscope or a.c. v.t.v.m. may also be used to check the output of the transistor in the circuit of the tester.

When using the lamp as an indicator, the brightness is in direct proportion to the signal output. When using an a.c. v.t.v.m. or the oscilloscope to note output, the lamp switch is opened to pre-

vent any clipping that would be caused by the neon lamp itself.

The design of the transformer and the selection of RC components is such that a large range of transistors can be accommodated, from small-signal types to power types. The switch on the control knob which allows the user to select the "Power Types" position changes the amount of feedback by unshorting the 680-ohm resistor. Power transistors are checked at 50 ma. or more, depending on the transistor type. For "quick-check" operation, the base current control knob is set fully to the left at "0". Then the control knob is advanced to reduce the base current and to establish lower collector current. The higher the dial reading at which a given transistor cuts out of operation, the higher the gain. For "in-circuit" testing, the impedance of the circuit is such that signal genera-



Front-panel view of the transistor tester.

Complete schematic diagram of transistor checker. The transformer used is a special unit with a 16 to 1 step-up ratio.

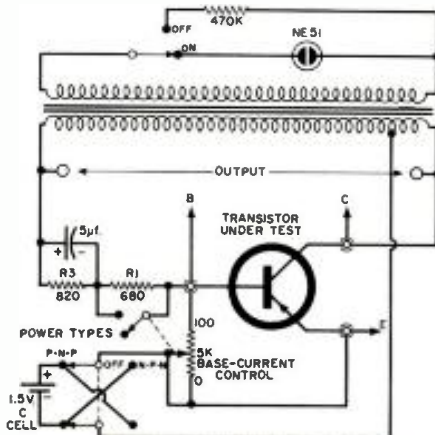

tion is possible with the 1.5-volt battery in the checker.

In using the tester to match transistors, a comparison is made of the dial reading at which oscillation "drop-out" occurs. Two perfectly matched units will stop oscillating at exactly the same position of the control.

To increase the usefulness of the tester, extra batteries may be attached in series with the collector leads. For more current loading on power transistors, a 500-ohm pot may be connected across the output jacks. —30—



**NOT USED, NOT PULLED OUT OF OLD SETS**

# Brand New TUBES

**BETTER  
THAN  
70%  
OFF!**

**BETTER  
THAN  
70%  
OFF!**

**and RAD-TEL'S FIRST QUALITY!  
REMEMBER ... ALL RAD-TEL TUBES  
GUARANTEED ONE FULL YEAR**

Send for New Free Brochure of Tubes & Parts—And Radio & TV Trouble Shooter Guide Free!

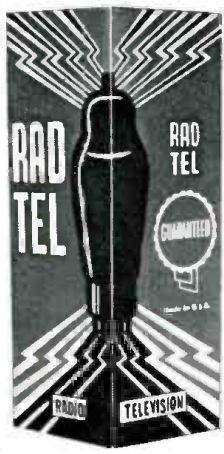

**RAD-TEL TUBES**

Individually Boxed!  
NOT USED, NOT PULLED  
OUT OF OLD SETS  
Every Rad-Tel Tube Is  
**BRAND NEW**  
Guaranteed 1 Full Year!

Type	Price	Type	Price	Type	Price	Type	Price	Type	Price	Type	Price
1AX2	.62	5BQ7	.97	6BC5	.54	6CU6	1.08	12AF6	.49	12V6GT	.53
1B3GT	.79	5CG8	.76	6BD6	.51	6CY7	.71	12AQ5	.52	12W6	.69
1S5	.51	5CL8	.76	6BE6	.55	6DE6	.58	12AT6	.43	17AX4	.67
1U4	.57	5J6	.68	6BF6	.44	6DG6GT	.59	12AT7	.76	17BQ6	1.09
1U5	.50	5T8	.81	6BG6G	1.66	6DQ6	1.10	12AU6	.50	19AU4	.83
1X2B	.82	5U4GB	.60	6BH8	.87	6DT6	.53	12AU7	.60	19BG6	1.39
2AF4	.96	5U8	.81	6BK7	.85	6J5GT	.51	12AV6	.41	19T8	.80
2BN4	.60	5V6	.56	6BN4	.57	6J6	.67	12AV7	.75	25BQ6GT	1.11
3AL5	.42	5X8	.78	6BN6	.74	6K6GT	.58	12AX7	.63	25C5	.53
3AU6	.51	5Y3GT	.46	6BQ/		6L6	.84	12AZ7	.86	25CD6	1.44
3AV6	.41	6AB4	.46	CU6	1.25	6S4	.48	12B4	.63	25CU6	1.11
3BZ6	.55	6AC7M	.96	6BQ5	.65	6SK7GT	.74	12BD6	.50	25L6	.57
3BY6	.55	6AF4	.97	6BQ5GT	1.05	6SN7GT	.65	12BE6	.53	35C5	.51
3CB6	.54	6AG5	.65	6BQ7	.95	6T4	.99	12BH7	.73	35Z5GT	.60
3CF6	.60	6AH6	.99	6BR8	.78	6T8	.80	12BQ6GT		50B5	.60
3DT6	.50	6AK5	.95	6BY6	.54	6U8	.78		1.06	50C5	.53
3V4	.58	6AL5	.47	6BZ6	.54	6V6GT	.54	12BY7	.74	50L6GT	.61
4BN6	.75	6AM8	.78	6BZ7	.97	6W4GT	.57	12C5	.56		
4BQ7	.96	6AN8	.85	6C4	.43	6W6GT	.69	12CU5	.58	All Tube Prices Subject To Change Without Notice!	
4DT6	.55	6AQ5	.50	6CB6	.54	6X4	.39	12CU6	1.06	..... Ask for Types Not Listed!	
4BZ7	.96	6AT6	.43	6CD6	1.42	6X8	.77	12DQ6	1.04	..... Use This Ad As Your Order Blank	
4CB6	.59	6AT8	.79	6CF6	.64	6Y6G	.65	12F8	.66		
5AM8	.79	6AU4GT	.82	6CG7	.60	8AU8	.83	12K5	.65		
5AN8	.86	6AU6	.50	6CG8	.77	8AW8	.93	12L6	.58		
5AQ5	.52	6AU8	.87	6CM7	.66	11CY7	.75	12SA7M	.86		
5AT8	.80	6AV6	.40	6CN7	.65	12A4	.60	12SK7GT	.74		
5BK7A	.82	6BA6	.49	6CS6	.57	12AD6	.57	12SN7GT	.64		

**RAD-TEL TUBE CO.** Est. 1945 **55 Chambers Street  
Newark 5, N. J.  
Mitchell 2-3147**

NOT AFFILIATED WITH ANY OTHER MAIL ORDER TUBE CO. October, 1959

TERMS: A 25% deposit must accompany all orders—balance C.O.D. Please send approximate postage. All shipments F.O.B. Newark warehouse. Orders under \$5—50c Handling Charge. Subject to prior sale. No C.O.D.'s outside continental U.S.A.

...Build the Best  
Portable... **EICO**



### 6-TRANSISTOR RADIO RA-6

Kit \$29.95      Wired \$49.95

INCLUDES F.E.T.'s, LEAD 9V BATTERY

Easy creative fun to build... a lifetime of big-set entertainment wherever you go... designed so that even the novice can build it & obtain a handsome professional assembly & outstanding performance. American-made modern super-heterodyne all-transistor circuitry, plus finest quality parts throughout, assure you of highest durability & stability.

- high sensitivity & selectivity
- big-set volume & tone quality with 4" x 6" PM speaker & 250 mw push-pull audio output stage
- built-in Ferrite rod antenna for good reception in any location
- pre-aligned RF & IF transformers
- planetary vernier tuning (7:1 reduction) for easy station selection & tuning
- high-impedance earphone jack for private listening; eliminates drain of output stage when using earphone
- attractive tan leatherette case, retractable handle
- compact: 8 1/2" w, 4 1/2" h, 2 1/2" d. Only 3 lbs.

Build the BEST BUYS in  
"HAM" gear... **EICO**



### 90-WATT CW TRANSMITTER #720

Kit \$79.95      Wired \$119.95

"Ideal for veteran or novice" - ELECTRONIC KITS GUIDE. "Top quality" - POPULAR ELECTRONICS. "Well designed" - ELECTRONICS WORLD. 80 thru 10 meters with one-knob band-switching. Full "clean" 90W input, 65W external plate mod. Matches loads 50 to 1000 ohms. May be used as basic exciter unit. TVI shielded. Tubes: 6146, 6CL6, 2-6AQ5, GZ34. Attractive "living room" low-silhouette design. 15" w, 5" h, 9" d.

### UNIVERSAL MODULATOR-DRIVER #730

Kit \$49.95  
Wired \$79.95

Cover E-5 \$4.50

Delivers 50W undistorted audio. Modulates transmitters having r.f. inputs up to 100W. Unique over-modulation indicator. Output transformer matches 500-10,000 ohms. Low-level speech clipping & filtering. Inputs for xtal or dynamic mikes, phone patch, etc. 7 tubes. 6" h, 14" w, 8" d.

### GRID DIP METER

Kit \$29.95  
Wired \$49.95 #710

Includes complete set of coils for full band coverage. 400 kc-230 mc in 8 overlapping ranges. 500 ua meter. Plug-in coils are pre-wound, pre-calibrated to 0.5% accuracy. Transformer-operated power supply. 2 1/4" h, 2 3/4" w, 6 7/8" l.

Compare-judge for yourself-at your neighborhood EICO distributor. For free catalog on 65 models of EICO test instruments, hi-fi & "ham" gear, fill out coupon on Page 36

**EICO** ELECTRONIC INSTRUMENT CO., Inc.  
33-00 N. Blvd., L. I. C. I., N. Y.

© 1959

# Gasoline-Fume Detector Uses Infrared

New Raytheon automatic gas-fume detector for motor boats and yachts employs unique operating principle.



The gas detector consists of a detector unit, at left, and an indicator unit. The detector, which is installed in the bilges or engine compartment, actuates a flashing red light on the indicator installed on the instrument panel. The unit can be tested electrically by simply turning the "On-Off" knob to the "Test" position. The price of the unit is \$99.50.

A NEW CONCEPT in gasoline-fume detection to guard motorboats and yachts against explosions of deadly gasoline fumes has been announced by Raytheon Co. While conventional detectors operate on the principle of measuring resistance changes in a platinum filament when exposed to fumes, this new detector measures the changes in light intensity, much of which is in the infrared range, of the filament. These light changes are detected by a silicon photocell, similar to the solar cell. The output of the photocell is amplified by a transistor amplifier, which, in turn, actuates an alarm light.

The instrument consists of a detector, containing the platinum filament, and the amplifier-alarm, containing the transistor circuitry and indicator lamps. The detector is installed in the bilges or engine com-

partment, and the amplifier-alarm is installed at the instrument panel. When the switch on the unit is turned on, the system is activated and the white stand-by jewel glows. Limited current flows through the filament in the detector head and the filament glows faintly. Under normal (safe) atmospheric conditions this glow remains constant. When gasoline fumes are present in the surrounding atmosphere, the filament glow increases in brilliance and activates the adjacent photocell. This, in turn, generates sufficient current to flash the alarm.

The sensing element in the gas detector has a protective gauze screen around it which acts like the one in the Davy safety lamp used by miners. Although the small sample of flammable gas that passes through the screen to the filament burns and raises the temperature of the filament, the flame cannot flash back through the screen to ignite the gas outside.

With this new instrument it is not necessary to make repeated zeroing adjustments of indicating meters and it is unnecessary to remove the sensing unit into free air to check proper functioning and calibration. The new device is said to be more stable and less easily upset by impact or fluctuations in temperature or voltage.

To test the system, the boat owner simply turns a knob on the indicator unit. This momentarily places a higher-than-usual voltage across the sensing filament, artificially duplicating the presence of gasoline fumes. This triggers the alarm proving that the gas detector is on the job and working properly. With older units it was necessary to expose them to fumes from gasoline-soaked rags in order to check their operation.

-30-

The automatic gas alarm employs a solar cell to pick up infrared energy given off by a platinum wire when gas fumes are present. The solar cell's signal goes to a transistor amplifier. This closes the alarm circuit (dashed line) and flashes the red alarm light on the instrument panel. In the standby condition the current flows through the solid-line circuit. During test, additional power is applied to the platinum wire causing it to emit infrared energy and trigger the alarm circuit. Conventional gas alarms are based on the Wheatstone-bridge principle. Here a carefully balanced circuit produces no current flow in the normal condition. When gas fumes reach the exposed platinum filament, it overheats and expands changing its electrical resistance and upsetting the balance of the bridge. The unbalance causes current to flow from the bridge to operate a meter or light.

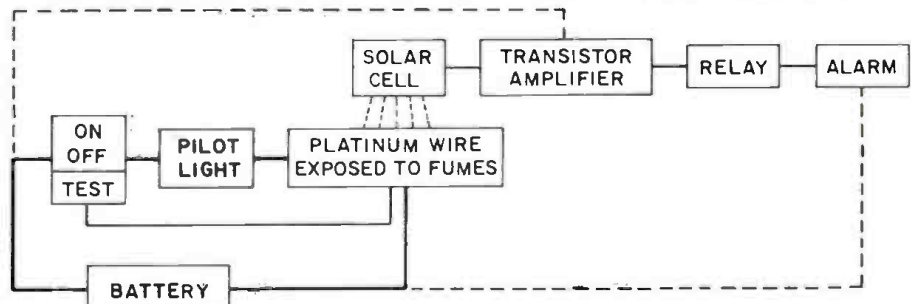

announcing

# TRU-VAC®



REMARKABLE TUBE VALUES AT 1950 PRICES

ALL TUBES INDIVIDUALLY BOXED, CODE DATED  
AND BRANDED "TRU-VAC®"

Typical TRU-VAC® Bargains!

THIS IS A PARTIAL LIST  
Thousands More Always In Stock

6SN7GT	ALWAYS	30c							
6W4GT	ALWAYS	30c							
OYA	3AU6	6A6	6B8	6CH8	6S7	7B4	12A16	12SA7	36
OZ4	3BC5	6AB4	6BA6	6CL6	6S8GT	7B5	12A17	12S17	38
1A7GT	3BN6	6AC7	6BC5	6CM6	6SA7	7B6	12AU6	12SK7	39/44
1B3GT	3BZ6	6AF4	6BCB	6CM7	6SD7GT	7B7	12AU7	12SN7GT	41
1C6	3CB6	6AG5	6BD6	6CN7	6SF5	7B8	12AV6	12SQ7	42
1C7	3Q4	6AM4GT	6BE6	6CQ8	6SF7	7C4	12AV7	12V6GT	43
1F4	3S4	6AH6	6BF5	6CR6	6SG7	7C5	12AX4GT	12W6GT	45
1F5	3V4	6AK5	6BG6G	6CS6	6SH7	7C6	12AX7	12X4	50A5
1G4	4BQ7A	6AL5	6BH6	6CUS	6S17	7C7	12A27	14A7/12B7	50B5
1H5GT	4B5B	6AM8	6BJ6	6CU6	6SK7	7E5	12B4	14B6	50C5
1I4	4BZ7	6AN8	6BK5	6D6	6SL7	7E6	12BA6	14Q7	50L6
1I6	4CB6	6AQ5	6BK7	6DE6	6SQ7	7E7	12BA7	19	56
1N5GT	5AMB	6AQ6	6BL7GT	6DG6GT	6SR7	7F7	12BD6	19AU4GT	57
1R5	5AN8	6AQ7	6BN6	6DQ6	6T4	7F8	12BE6	19B6G6	58
1S5	5AT8	6AR5	6BQ6GT	6F5	6U8	7G7	12BF6	19J6	71A
1T4	5AVB	6AS5	6BQ7	6F6	6V6GT	7H7	12BH7	19T8	75
1U4	5AZ4	6AT6	6BR8	6H6	6W6GT	7N7	12BQ6	24A	76
1U5	5BR8	6AU4GT	6BS8	6J4	6X4	7Q7	12BR7	25Z6GT	77
1V2	5J6	6AUSGT	6BY5G	6J5	6X5GT	7S7	12BY7	26	78
1X2	5R4	6AU6	6BZ6	6J6	6X8	7X6	12CA5	27	80
2AF4	5U4	6AU8	6BZ7	6J7	6Y6G	7X7	12CN5	35	84/624
2BN4	5U8	6AV5GT	6C4	6K6GT	7A4/XXL	7Y4	12D4	35A5	11723
2CY5	5V4G	6AV6	6CB6	6K7	7A5	7Z4	12F5	35B5	
3A4	5V6GT	6AW8	6CD6G	6N7	7A6	12AB	12K7	35C5	
3A5	5X8	6AX4GT	6CF6	6Q7	7A7	12AB5	12L6	35W4	
3AL5	5Y3	6AX5GT	6CG7	6S4	7A8	12AQ5	12Q7	35Z5	

# 35¢

# \$33 PER HUNDRED

For any used or factory second tube!

### 1 YEAR GUARANTEED PICTURE TUBES

Brand New\* Allied A-1 Tubes Brand New  
Below listed prices do not include dud. Add Additional \$5.00 Deposit on tube sizes to 20"; on 21" and 24" tubes - \$7.50. Deposit refunded immediately when dud is returned prepaid. Aluminized tubes - \$4.00 extra.

Picture tubes shipped only to continental USA and Canada — All tubes F.O.B. Harrison, N. J.

10BP4	7.99	16MP4	12.19	17CP4	16.99	19AP4	18.39	21ATP4	18.79	21FP4	18.39	21YP4	18.39
12LP4	10.49	16KP4	11.99	17GP4	17.89	20CP4	15.89	21AMP4	17.99	21MP4	18.39	21ZP4	17.49
14B/CP4	11.99	16IP4	12.19	17HP4	16.99	20DP4	15.89	21AU4	18.79	21MP4	22.39	24AP4	39.49
16AD4	16.09	16RP4	11.99	17IP4	14.99	20HP4	17.89	21AVP4	18.79	21YP4	18.39	24CP4	27.79
16DP4	12.19	17AVP4	15.49	17OP4	13.89	21AP4	21.49	21AWP4	17.49	21WP4	17.49	24DP4	29.79
16CP4	16.09	17BP4	13.49	17IP4	16.99	21AIP4	18.79	21EP4	17.29	21XP4	17.49		

**SENSATIONAL \$100,000 GIVE-AWAY**  
We want 100,000 new customers by Nov. 1st. For every new order of \$25 or more received by that date, we will send you a crisp, new dollar bill.

**FREE FUSE CLIP!**  
Sent With Any Order Of \$5 Or More

**GUARANTEE**  
Only TRU-VAC guarantees to replace free any tube which becomes defective in use within one year of date of purchase.

**USED TV CONSOLES GUARANTEED To Work When You Receive Them**

10" & 12"	\$29
14" & 16"	\$37
17"	\$45
19"	\$59
20" & 21"	\$70

All sets shipped in two cartons to avoid breakage. Sets shipped express to continental U.S.A. and Canada only. F.O.E. Harrison, New Jersey.

**FREE BONUS—RABBIT EARS**  
\$7.95 Value  
FREE with each set purchased

**ATTENTION QUANTITY USERS!**  
Big Discounts Are Yours . . . Call or Write For Our 1000 Tube "Private Label" Special! Attention Branding Dept. MGR.

**MONEY CHEERFULLY REFUNDED WITHIN FIVE (5) DAYS, IF NOT COMPLETELY SATISFIED!**

**TRU-VAC® PAYS YOUR POSTAGE**  
On orders of \$5 or more in U.S.A. and Territories. Send approximate postage on Canadian and foreign orders. Any order less than \$5 requires 25c handling charge. Send 25% on C.O.D.'s. All orders subject to prior sale.

Complying with Federal regulations, the following statement appears in all Tru-Vac advertising: Tubes appearing in this ad may be FACTORY SECONDS or USED tubes and are clearly marked.

# TRU-VAC®

Harrison Avenue Box 107 Harrison, New Jersey  
HUMboldt 4-9770

Write Dept. I For FREE LIST Of Other Tube Types and Products Sold By TRU-VAC®  
**Electric Company**

Visit Our Huge Testing Dept. In The Heart Of Harrison, N. J.'s Electronics Industry

## NEW FROM SECO DYNAMIC TRANSISTOR CHECKER



MODEL  
100

### DYNAMICALLY CHECKS WIDE RANGE OF TRANSISTOR TYPES EITHER "IN OR OUT" OF CIRCUIT!

This new low-cost checker uses an entirely new approach but a proven DYNAMIC principle for checking transistors. safely tests PNP and NPN transistors either "in or out" of the circuit. Covers wide range of types: small signal including "drift" types, medium power; and power types. Provides positive check for "opens," shorts, and gain—condition indicated by means of a visual indicator plus jacks for meter or scope. Also provides GO-NO-GO test at practical currents—and permits matching of similar transistor types. No set-up required—no further leakage tests necessary. Model 100 is compact, lightweight, complete, and ready-to-use . . . helps you cash-in on the big profits in the fast growing transistorized equipment servicing field!

MODEL 100—Wired and factory tested . . . \$19.95 NET

## NEW FROM SECO LOW COST, COMPLETE TUBE TESTER



MODEL 78

### GRID CIRCUIT and TUBE MERIT TESTER

Complete test coverage of all modern TV tube types as well as all heater type radio tubes including hybrid types, using only 5 sockets. Incorporates patented Seco GRID CIRCUIT TEST plus a reliable CATHODE EMISSION test using new low impedance low test voltage circuit—also checks filament continuity and provides open element test. One easy-to-read meter indicates results for both Grid Circuit and Tube Merit Tests. Two-stage DC amplifier isolates meter from tube under test to protect meter—and makes it possible to achieve a wide range of load currents and test conditions. Complete with portable carrying case, pin straighteners, and flip-chart for quick set-up data.

MODEL 78—Wired and factory tested . . . \$69.50 NET



### outstanding reliability, accuracy

Provides 3 important tests: amplifier types tested for gain by Dynamic Mutual Conductance method—power types tested for cathode current by Cathode Emission method—all types tested for shorts and grid error by Grid Circuit Test developed and patented by Seco. Dynamic Mutual Conductance Test pre-wired to eliminate elaborate set-up. Cathode Emission Test done by free point pin-selector method—will not be obsolete. Completely self-contained in portable carrying case.

MODEL 107—Wired and factory tested \$139.50 NET



### positive, on-the-spot check of horizontal output current!

This new, low-cost current checker provides simple means for making a positive on-the-spot check of TV horizontal circuits. Can be placed into the circuit in seconds—no unsoldering of circuit wiring—immediately indicates whether horizontal tube cathode current is within manufacturer's recommended limits. Valuable as a fast, accurate indicating device when adjusting horizontal drive and linearity. Eliminates one of the most common causes of callbacks. Compact, inexpensive, easy to use.

MODEL HC-3—Wired and factory tested \$12.95 NET

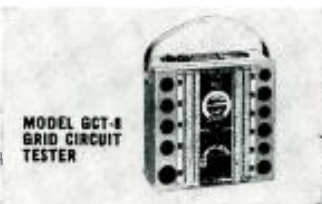

### fast check of critical "control grid" conditions

Model GCT-8 checks "control grid" condition of vacuum tubes faster, more accurately than any other tester! As many as eleven simultaneous checks—automatically! Quickly spots grid errors and leakage—stops guessing, substitution checking, and costly rechecks. Electron-Eye tube indicates faults at a glance. Truly portable. The perfect companion to any tester that employs only conventional gas and shorts test. Carry it on all calls.

MODEL GCT-8 Complete kit . . . \$19.95 NET

MODEL GCT-8 Wired and tested . . . \$29.95 NET

## Mac's Service Shop

(Continued from page 66)

served for heavy sets, sets that cannot be safely turned on side or back for service, intermittent sets, turntables . . .

"Hold it!" Barney interrupted. "If you keep going, you're not going to leave us anything for bench work."

"OK," Mac obeyed, "but I have a hunch this chassis-flipper won't be empty much of the time."

"What else is new?" Barney asked as he shrugged his shoulders into his shop-coat.

"Well, for one thing, we're going to Center City tonight to a service meeting on new color TV circuits. What's more, we're going to make every one of these educational service meeting shindigs we can from here on in."

"That's OK with me, but isn't it somewhat a new policy? I thought you took the stand a technician could learn more about new circuitry, etc., by reading books, studying service literature, and keeping up with the magazines than he could by listening to lectures."

"Yeah, I know," Mac said with a sigh; "and that's just another fine example of how stupid I can be when I work at it. It's true some fellows *can* learn more by reading than they can by listening; but many other fellows are just the opposite. What they hear sticks with them lots better than what they read. Anyway, few of these service meetings consist of straight lectures. The guy giving the talk almost always accompanies it with slides, motion pictures, or actual demonstration of equipment."

"However, the technical information you pick up at one of these meetings is only part of the benefit. More important, it seems to me, is the contact it affords the technician with other technicians, with distributors, and with manufacturers."

"I'll buy that," Barney agreed. "I get a big boot out of talking to other technicians. It's amazing how often I pick up a tip that actually helps me in my work; but even when I don't manage to pick the other guy's brain, I still enjoy it. Letting our hair down and lambasting our cranky customers is fun. Just knowing the other technician is suffering from the same frustrating exasperations I am makes these a lot more bearable."

"Know what you mean," Mac nodded with an understanding grin. "I also like chatting with my distributor in a relaxed and social atmosphere. Really I think we owe it to him to try to attend a meeting he sets up. He goes to a lot of trouble and expense arranging the meeting, publicizing it, etc. Then, if only a few of his customers show up, that makes him look bad. It's a poor return for all the favors he does us."

"Finally, these meetings provide service technicians with an excellent

SEND FOR COMPLETE SECO STORY ON . . .

- Three Tube Testers
- VTVM
- Dynamic Transistor Checker
- In-Circuit Current Checker
- 100% Accurate Flyback Checker
- Battery Eliminator

Sold Only Thru Electronics Parts Distributors

OUTSTANDING RELIABILITY—TOP DOLLAR VALUE!



SECO MANUFACTURING CO.  
5015 Penn Ave. So., Minneapolis, Minn.

NAME \_\_\_\_\_

ADDRESS \_\_\_\_\_

CITY \_\_\_\_\_ ZONE \_\_\_\_\_ STATE \_\_\_\_\_

opportunity to impress the manufacturer through his representative. Believe me, he relays what he picks up at these meetings. If there is something wrong with the product he is selling or if the technicians have any ideas for improving it or making it easier to service, he provides a pipeline right to the manufacturer. And let's not forget this: Those of us who are deeply opposed to factory service have an excellent opportunity in these service meetings to show the manufacturer we are intelligent, progressive, eager to learn, and completely capable of servicing his product. We can demonstrate there is no need for factory service.

"You might say," Mac concluded, "that these service meetings tend to pull all segments of the radio and TV industry together and promote better understanding among them. Anything that does that helps all of us. It would be interesting to know how many service organizations have really been started in a coffee-and-doughnuts session following one of these meetings."

"I'll bet a lot of them," Barney said. "But, hey! I haven't told you about my vacation yet. I darned near didn't get back. Those Colorado lovelies weren't going to let me come. Man, do I go big west of the Mississippi! There was this one cute little filly—"

And so on, far into the morning.

-30-

### "SNAKE BATTERIES" FOR SUBMARINE CABLES

"SNAKE batteries" which are strung on submarine communications cables to power repeaters have been developed for the U. S. Army Signal Corps, according to a recent announcement issued by the Department of the Army.

The flexible zinc-silver chloride batteries, also called "electric eels," were developed by the Chemical Division of Aerojet-General Corporation, Azusa, California in cooperation with the U. S. Army Signal Research and Development Laboratory, located at Fort Monmouth, New Jersey.

The batteries, which are activated when immersed in water, can be easily wound on drums with the military communications cable for which they are primarily designed.

In use, a battery is placed next to each repeater. These are spliced into the cable every mile to boost voice or teletypewriter signals. The repeaters, which are transistorized, are also flexible and easily roll off the cable drum on which they are wound.

The batteries obtain their flexibility through segmented construction. Spool-shaped links of silver chloride are separated by rubber rings from zinc segments. A wire which spirals the length of the battery is employed to interconnect the sections.

The basic battery size is  $\frac{3}{4}$  of an inch in diameter and 30 inches long. These deliver a required five milliamperes continuously at one volt for a year. Life can be extended by using two or more of the 30-inch batteries or by making them larger. They can be built to any size, with a delivery rate of more than 40 watt-hours per pound.

-30-

THE BIG NEWS FOR 1960

# SYLVANIA 23-INCH TV



\*Viewing area 275 square inches. 23-inch picture tube measured diagonally.

Big 23-inch\* picture is the sensation of 1960 that *changes the face of television . . .* and Sylvania scoops the industry with the first complete line.

- Square corners of the 23-inch\* bonded shield picture tube pioneered by Sylvania presents more of the TV picture as the camera sees it. New squared shape is closer to the 3 x 4 ratio of the true TV camera raster.
- The 23-inch\* tube flattens the TV screen. "Bonded shield" face-panel eliminates the dust trap, cuts reflections in half, and improves brightness and contrast.
- ◆ New Super HaloLight® is bigger and better than ever. It's a Sylvania exclusive that adds eye comfort to eye appeal.

SYLVANIA 23\*\* TV OFFERS THE NEWEST AND  
FINEST FEATURES YOU CAN RECOMMEND

 **SYLVANIA**  
Subsidiary of  
GENERAL TELEPHONE & ELECTRONICS 

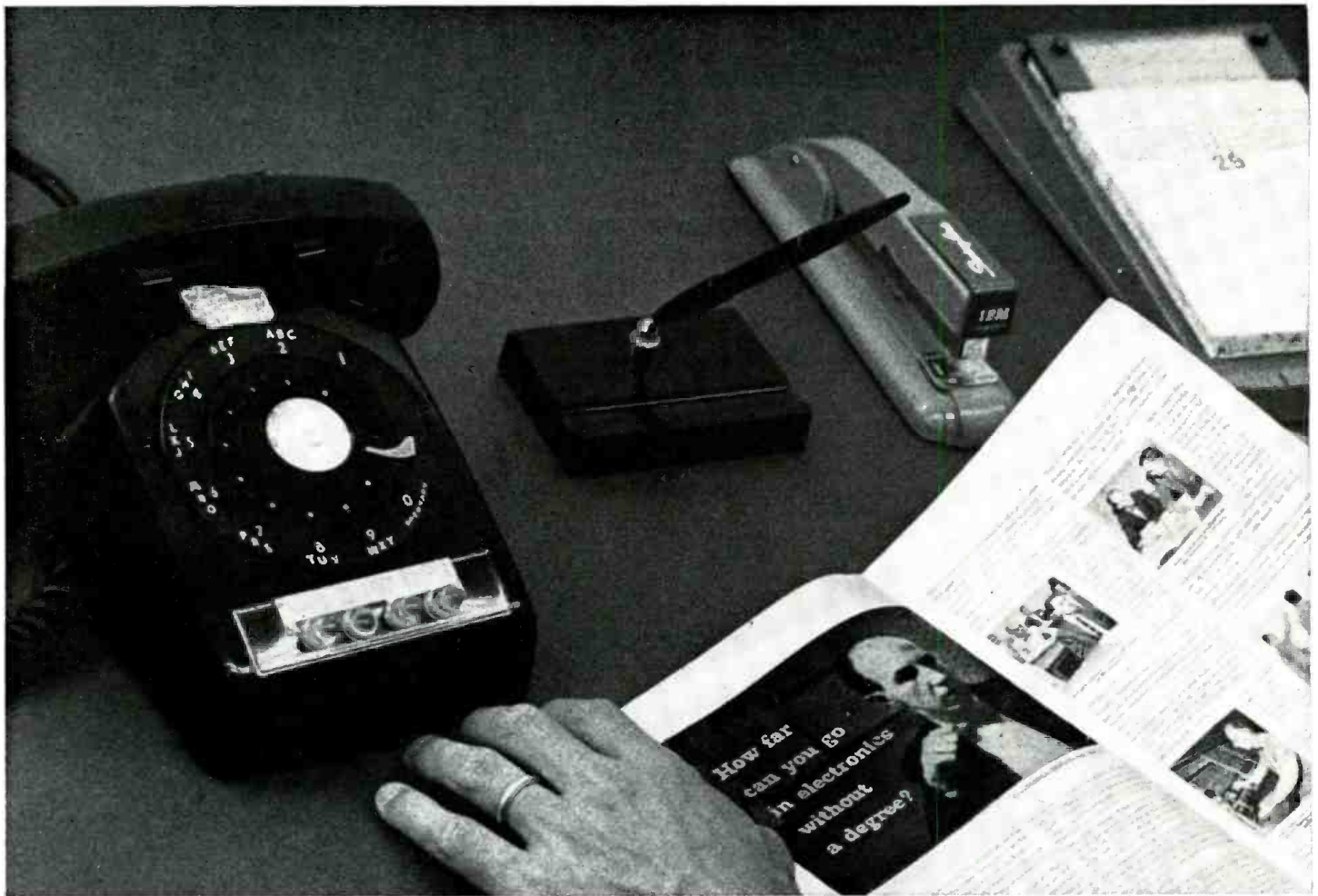

## How far can you go in electronics . . .

**Two years ago, Field Engineer William G. Miles was asked to outline his thinking on how far he could go in electronics at IBM . . . without a degree. Now, he reviews the progress he's since made. His present position: Group Manager, responsible for keeping one of America's largest electronic computers in top operating condition. Here's his story.**

**HURDLING THE DEGREE BARRIER.** "A few years ago," recalls Bill Miles, "I felt that I'd gone about as far as a technician could without a degree. I just couldn't hurdle that education barrier. Now, thanks to IBM, I have a solid electronics education. I'm a Group Manager on the SAGE project, responsible for 20 field engineers. My future looks brighter than it ever did. I don't know of another company where a technician can go farther or receive more recognition, without a degree, than at IBM."

**UTILIZING HIS NAVAL TRAINING.** Bill Miles spent three years as a Naval Aviation Radar Technician. After discharge from service, he worked as a TV serviceman, at the same time pursuing an engineering education at night. "I knew there were good career opportunities around somewhere, but I couldn't find them," Bill Miles says. "I investigated several big companies. They were impressed with my ability, but my lack of a degree kept me from the kind of a career I wanted. Then I answered an ad similar to this."

**EXTENSIVE ELECTRONICS SCHOOLING.** In May, 1955, he joined IBM and began an extended training course. "The teaching was as technically advanced as I could ask for. Each day, I gained

a deeper knowledge of electronics and added to my professional stature. IBM shows real interest in you as an individual: what your goals are, what plans you've made to reach your goals, how the company can help speed you toward them or even higher goals."

**ASSIGNED TO SAGE SITE.** After his training, Bill Miles was assigned to a SAGE site. SAGE is an important link in America's air defense, and the heart of SAGE is a real-time computer made by IBM. The SAGE computer analyzes radar data with uncanny accuracy, checks it against available air traffic information, and presents visual displays to assist the Air Force in identifying flying objects as friend or foe.

**UPGRADING TECHNICIANS.** "The job of IBM field engineers is to keep SAGE computers running," he explains. "This involves maintaining, testing, and checking computer units. It means anticipating trouble before it occurs. The work turned out to be exactly what I was looking for. I had a chance to do work ordinarily done by graduate engineers . . . work usually denied to men without a degree. Of all the companies I know, IBM appears to be one of the few which upgrades technicians to levels of engineering responsibility . . . levels dictated not by your formal education but by your native talents."

**MANY EDUCATIONAL OPPORTUNITIES.** "SAGE field engineers have many opportunities for education beyond the 'basic' training, which lasts 20 weeks," says Bill Miles. "After a year or two in the field, they may be selected for further training to learn how the complete SAGE electronic computer system works. To

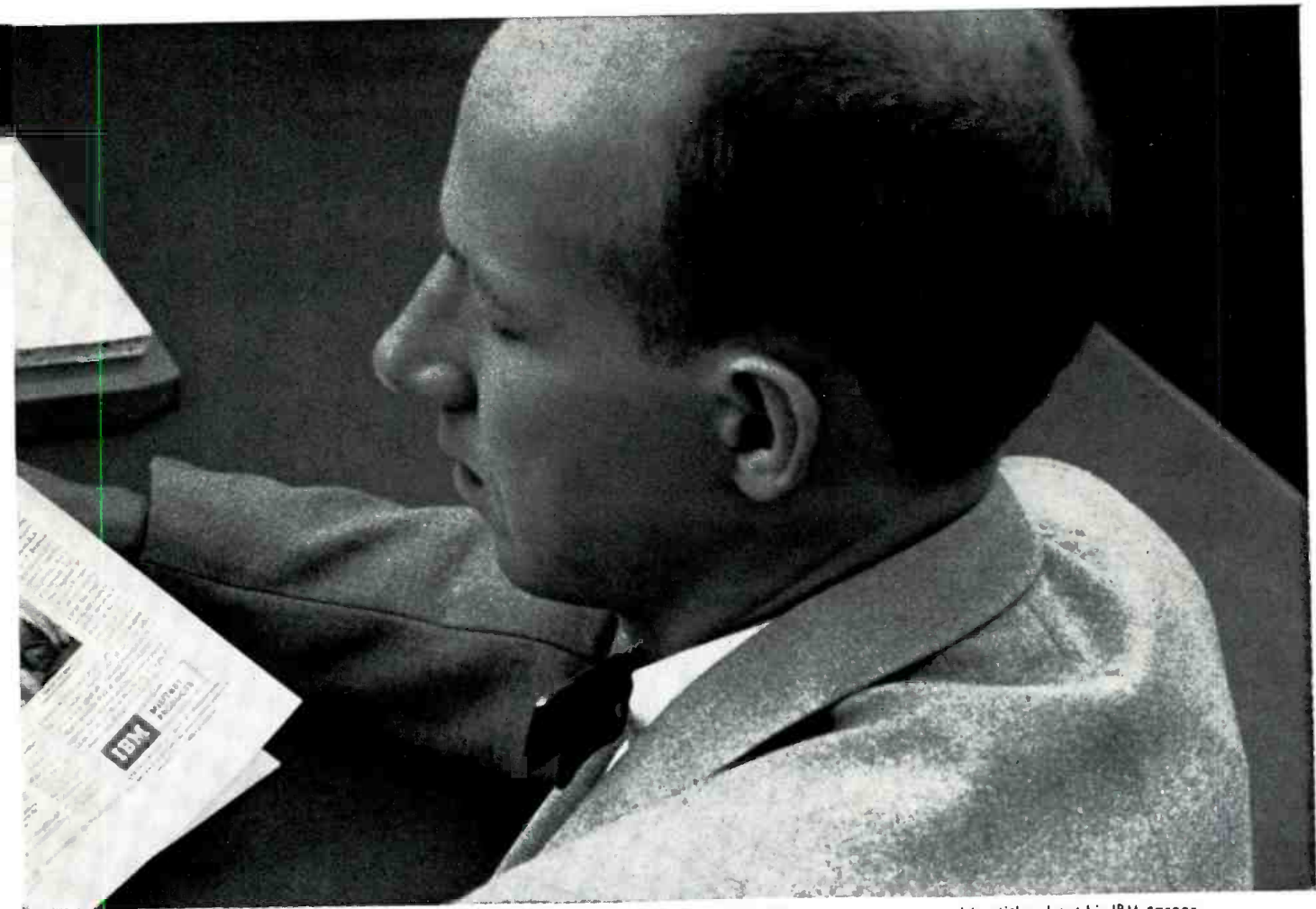

Bill Miles reviews two-year-old article about his IBM career.

## without a degree?

keep up with the most advanced electronic developments, they may also attend classes during working hours."

**RAPID ADVANCE TO GROUP MANAGER.** In his four years with IBM, Bill Miles has received several promotions. He is now Group Manager at a SAGE site. "My advancement is an example of IBM's policy of promoting from within," he says. "The company is quick to recognize a man's contributions and quick to reward him. This means lots of opportunities for new men who show potential for advancement along clearly defined routes—both in the technical and managerial areas. There are no limits set on your future. Everything IBM has ever promised about advancement in field engineering, I've seen happen—either to me or to someone I know."

\* \* \*

If you have a minimum of 3 years' technical schooling after high school—or equivalent experience—you may be eligible for 20 weeks' training as a Computer Units Field Engineer. While training, you receive full salary plus living allowance and overtime pay.

IBM is the leader in a field that offers you unlimited horizons. And, as you may already know, at IBM you receive company-paid benefits that set standards for industry today.

**WRITE TODAY TO:** Mr. N. H. Heyer  
Dept. 650J  
Federal Systems Division  
IBM Corp., Kingston, N. Y.

You'll receive a prompt reply. Personal interviews arranged in all areas of the United States.

October, 1959



Discussing counseling methods with personnel management.

Demonstrating how SAGE operating console works.

# IBM®

INTERNATIONAL BUSINESS MACHINES CORPORATION

111

for FUN, BUSINESS, SPORTS, INDUSTRY, BOATING, AUTOMOBILE  
the **NEW Citizens Broadcaster**

COMPLETE 11 METER  
TRANSCIVER

**NO EXAMINATION  
REQUIRED!**

May Be Used  
by Anyone!

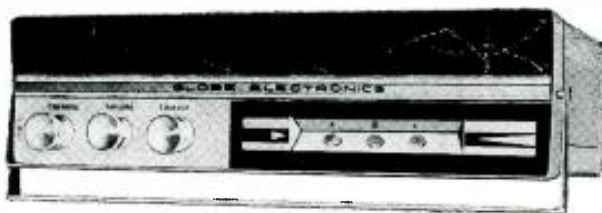

★ Universal operation. One unit works on 115V AC or 12V mobile. Operates in Home, Office, Car or Field. No tests or examinations required. Any citizen over 18 years of age may use any of the FCC-assigned 22 channels in the 27mc range (11 meters) for transmitting and receiving.

★ **EXCLUSIVE!** Channel switch allows choice of three channels for operation. Receiver and broadcaster units are tuned to same channel simultaneously.

★ Operation extremely easy; only three controls: Channel, Squelch and On/Off/Volume. Squelch control subdues background noise for muted standby operation. Offers push-to-talk operation for instantaneous transmission or reception.

★ 10 Tube Receiver/Transmitter is crystal controlled for stable operation. With proper crystals, all channels are covered. Tested pairs available for any channel.

★ Power Input: — 5 watts, AM modulated. Compact: — only 3½x12x10¼". Light weight, 9 lbs. Meets all FCC requirements.

★ Modern "living room" design. Carrying handle also acts as tilt stand for fixed operation or mounting bracket for permanent installation, making the Broadcaster extremely versatile.

COMPLETE WITH CRYSTALS  
FOR CHANNEL 11 AND  
PUSH-TO-TALK MICROPHONE

Only **\$129.95**

\$13.00 DOWN \$7.00 per mo.

**Candelabra TV Tower**

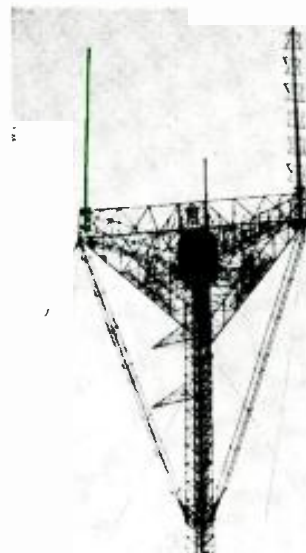

By M. P. JOHNSON

Transmitting antennas of 3  
stations on unique TV tower.

**A**N unusual new television tower is rapidly nearing completion in Baltimore, Maryland. The transmitting antennas of the three Baltimore stations are supported at identical heights by means of a unique candelabra structure. The top of each antenna soars 730 feet above the ground, or 1049 feet above sea level. This is a considerable increase over the previous individual towers of the TV stations involved.

The tower has been several years in planning, designing, and engineering phases, while construction actually began in September, 1958. It is located on a site overlooking Druid Hill Park in northwest Baltimore on ground adjacent to the present WJZ-TV facilities. Some of the technical specifications jointly released by WBAL-TV, WMAR-TV, and WJZ-TV, the three participating stations, give an idea of the immensity of the project.

Although presently reaching 730 feet, the tower was designed for possible future extension to 1000 feet, if such a move should ever prove feasible. The three-sided candelabra supports an antenna at each corner of the triangle. Each antenna is over 100-feet long. The channel-2 radiator is a six-bay turnstile, while channels 11 and 13 utilize travelling-wave designs. Each station currently is broadcasting at maximum allowable power.

Truss members tie each corner of the candelabra to a lower support point on the tower. Designed to withstand winds to 165 mph, the tower is considered one of the safest and most advanced designs of its type. The tower is guyed at four points in its height, with cables terminating at three anchors.

PLEASE RUSH NEW BROCHURE ON THE GLOBE CITIZENS BROADCASTER TO

WORLD'S MOST PERSONALIZED ELECTRONIC SUPPLY HOUSE

**World Radio LABORATORIES** PH. 2-0377

NAME: \_\_\_\_\_

ADDRESS: \_\_\_\_\_

CITY & STATE: \_\_\_\_\_

SEND FREE CATALOG, TOO

EW-10

3415 W. BROADWAY, COUNCIL BLUFFS, IOWA

IF YOU PRIZE IT...KRYLON-IZE IT!  
Seal electronic parts completely  
...instantly...the "push button" way



**KRYLON**  
CRYSTAL-CLEAR  
ACRYLIC SPRAY

A "must" in every repairman's kit!

Radio, TV and hi-fi equipment need Krylon Crystal-Clear, the protective coating with high dielectric strength and weatherproof qualities that seal the surface indefinitely.

- Prevents corona in high voltage section
- Keeps lead-in connections tight
- Prevents rusting and pitting of antenna
- Goes on in seconds—**DRIES IN MINUTES**

Use Krylon Spray Paints (22 colors) for quick, easy, professional touch-up jobs

IF YOU PRIZE IT...KRYLON-IZE IT!

**CITIZENS LOW COST 2 WAY RADIO!**

**NOW! TWO WAY RADIO FOR EVERYONE!**  
No license or permit needed on new Low Power 100 Mw. 27 mc. Citizens Band. No age limit—no restrictions of any kind. Talk and listen to ANYONE—ANY TIME. Complete ready to operate—weighs only 4 lbs. Size 6 1/2 W x 4 1/2 H x 6 1/2 deep. Includes microphone and speaker. Talk-listen switch. 5 ft. top of cabinet antenna carries handle. steel cabinet. Range depends on location but can be from 10 to 5 miles. Operation everywhere. 110 volt plug. Absolutely nothing else to buy—Just touch switch to talk or listen—meets all Gov't FCC requirements. Two or more units can be used together, as desired.

**SEND ONLY \$5.00** (1.11 ck. mo) delivery for each. Postage and COD charges or send \$29.95 plus \$2.00 (postage and insurance) for each radio wanted. Guaranteed to work or money back. Order now for early delivery before price goes up. Available only from

**WESTERN RADIO Dept. MTN-10 KEARNEY, NEBR.**

It's all there on

**SOUNDCRAFT TAPE**

because Soundcraft is the world's best recording tape!

Buy it today!

Reeves Soundcraft Corp., 6t. Pasture Rd., Danbury, Conn.



Dealer's Choice . . .

# JERROLD'S TV/FM HOME SYSTEM

now available in  
any combination



Amplifier  
Model HSA-46

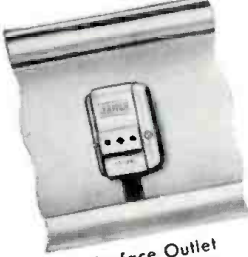

Surface Outlet  
Model HS-135



Flush Outlet  
Model HS-140



Twin Lead Clamp  
Model HS-36



Weatherproof Plate  
Model HS-37

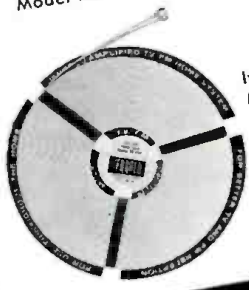

Ivory Twin Lead  
Model IV-300



Plastic Outlet Box  
Model HS-50

**TV/FM Home Amplifier**  
Greatly improves TV and FM reception. Only 2 tubes:  
**\$49.95 list**

**Plug InTenna Outlets**  
For use with one or more TV and/or FM sets. Combines "tap off" with "plug-in receptacle" in a single unit. No interference between sets. No soldering or wire stripping:  
Model HS-140: **\$2.75 list**  
Model HS-135: **\$1.95 list**

**Plastic Outlet Boxes**  
For mounting flush outlets:  
**\$.45 list**

**Weatherproof Cover Plate**  
**\$1.70 list**

**Ivory Twin-Lead**  
100-foot reel, 300 ohm:  
**\$3.50 list**

**Twin Lead Insulators**  
Molded polyethylene.  
Bag of 24: **\$1.80 list**

working display

or complete kit



**Model HSK-300**  
Includes amplifier, twin lead, five outlets for either flush or baseboard mounting and accessories: **\$67.75 list**

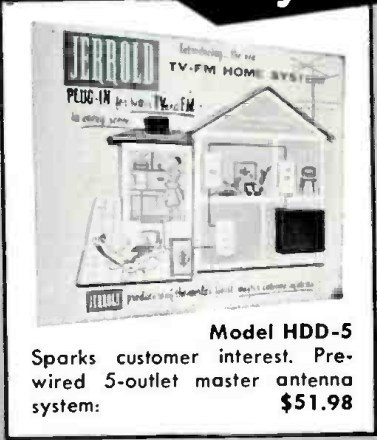

**Model HDD-5**  
Sparks customer interest. Pre-wired 5-outlet master antenna system: **\$51.98**



**ELECTRONICS CORPORATION** *Distributor Sales Division*

Dept. PD 186 • The Jerrold Building • Philadelphia 32, Pa.

Jerrold Electronics (Canada), Ltd., Toronto, Ontario • Export Representative, CBS International, N.Y. 22, N.Y.

LOOK TO JERROLD FOR AIDS TO BETTER TELEVIEWING

# FIX ANY TV OR RADIO ever made!

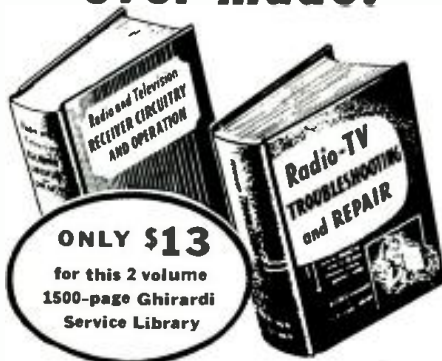

## COMPLETE TRAINING FOR BETTER RADIO-TV SERVICE JOBS

These two giant Ghirardi home training manuals make it easy for you to be an expert on ALL types of TV-AM-FM service... at only a fraction of the price you might expect to pay for such complete training. Almost 1500 pages, over 800 clear illustrations and dozens of procedure charts explain each detail of every service job as clearly as A-B-C. Each book contains up to the minute data. Each is based on approved professional methods. You learn time-saving shortcuts. You learn to work better, more profitably. Ideal as complete training for beginners or as a handy reference library for experienced servicemen who want to look up puzzling jobs or develop new and faster methods.

### A complete guide to TROUBLESHOOTING & REPAIR

① This 820-page **RADIO & TV TROUBLESHOOTING AND REPAIR MANUAL** guides you through each service procedure... from locating troubles to making repairs fast and right. Step-by-step charts cover practically every type of troubleshooting from Television problems to AM and FM realignment to IF and Detector Sections, car radios, record players, communications receivers, etc. 417 illustrations. Price \$7.50 separately. (Outside U.S.A. \$8.00.)

### The complete "know how" of SET CIRCUITS & OPERATION

② Learn all about circuits and their peculiarities and watch your service "headaches" disappear! This 669-page **RADIO & TV RECEIVER CIRCUITRY AND OPERATION** manual covers all basic circuits and circuit variations used in modern home equipment... explains their likely trouble spots; teaches you to go right to the seat of trouble without useless testing; helps you develop fast, truly professional service techniques. Price \$6.75 separately. (Outside U.S.A. \$7.25.)

### SAVE \$1.25—Pay As You Learn!

If sold as a course and sent to you in lesson form, you'd regard these two famous manuals as a bargain at \$75.00 or more. Instead, you buy them complete in handy book form for only \$13.00 for the two (regular price \$14.25). You save \$1.25... and you have 3 months to pay if desired. No lessons to wait for! Everything is at your finger tips. You learn fast... and you learn right! OUR MONEY-BACK GUARANTEE PROTECTS YOU FULLY!

### STUDY 10 DAYS FREE!

Dept. RN-109, RINEHART & CO., Inc.  
232 Madison Ave., New York 16, N. Y.

#### MONEY-SAVING OFFER ON BOTH BOOKS!

Send Radio & TV TROUBLESHOOTING AND REPAIR and Radio & TV CIRCUITRY & OPERATION home training manuals for 10-day free examination. If I decide to keep books, I agree to pay \$13.00 (plus postage) for the two a saving of \$1.25 over the regular price of \$14.25. I will pay \$4 (plus postage) after 10 days and \$3.00 a month thereafter until \$13.00 has been paid. Otherwise I will return books and owe you nothing. (SAVE! \$13 with order and we pay postage. 10-day money-back guarantee if you're not more than satisfied.)

Name .....  
Address .....  
City, Zone, State .....

(Outside U.S.A.—\$14.00 for both books. Cash with order only, but same return privilege with money refunded.)

## Electronics in Outer Space (Continued from page 63)

tronic cut-off device prevents the cameras from operating when a large percentage of the useful viewing area is outside their field of vision.

Although initial uses of TV cameras aboard earth satellites are primarily for meteorological purposes, such space vehicles have tremendous military potential for the direct surveillance of various areas around the world.

Ultimate development of larger satellites will make possible larger and more sophisticated electronics payloads, permitting the use of more definitive TV cameras and related equipment for a wide variety of surveillance purposes.

Toward this end, at least nine such satellites will be launched during the fall and early winter of 1959, each equipped with a TV-type sensory unit as the principal payload—and each payload weighing about a ton. These satellites are part of the extensive "Project Sentry."

### Power Supplies

The majority of U. S. and Russian satellites and space probes have utilized mercury or chemical batteries as the principal source of power. Where space and weight are not critical, this is an obvious choice. As future space vehicles accept larger payloads with higher power requirements, mercury or chemical batteries will be utilized more widely.

In the early days of space exploration, however, weight and volume were factors of significance. For these reasons, clusters of solar cells were employed to power the data transmitter aboard the "Vanguard I" launched in March 1958.

Light energy from the sun incident on each of six clusters of solar cells, connected in parallel, produced about 50 milliwatts—enough to operate the data transmitter. So successful was this conversion process, that today this satellite—still circling the earth—continues to transmit temperature data and will continue to do so for hundreds of years.

A further development of the solar-cell power supply was used for "Explorer VI," launched in August, 1959 (Fig. 14). Here, four paddle wheels, each 20" x 20" with 1000 solar cells on each side, generate electricity to recharge internal chemical batteries.

With the decided trend to larger space vehicles, however, weight and volume are no longer critical considerations—and chemical or mercury batteries will find continued and expanded use.

Operating power for the "Pioneer III" was supplied by a ring of 18 mercury batteries, built into a periphery around the electronics payload (Fig. 17).

In "Project Score," a battery of zinc-silver oxide cells provided operating

The Top Technical Reference  
To High Fidelity  
Is Yours For Only \$1.00!

## 1960 HI-FI ANNUAL & AUDIO HANDBOOK

On sale at Newsstands and electronic parts stores Oct. 6 or order by coupon today!

If you're a man with a background in electronics theory and you know your way around hi-fi—here's a perfect workshop companion! It's the all new 1960 Edition of the HI-FI ANNUAL & AUDIO HANDBOOK that will provide you with the latest available technical information. And its cost—just \$1.00.

You'll find over 30 big, definitive articles—prepared under the supervision of the Editors of ELECTRONICS WORLD. Gives you five big sections covering:

**STEREO**—Authoritative articles on low cost systems...adding a third channel...phantom channels.

**AMPLIFIERS AND PREAMPLIFIERS**—Features on the push-pull single stage for both stereo channels...single stereo amplifiers.

**LOUDSPEAKERS AND ENCLOSURES**—All that's new on loudspeakers for stereo... reflex enclosures and how they work... testing electrostatic loudspeakers...simplexing for low-level crossover...hi-fi crossover networks.

**FM, TAPE RECORDERS AND RECORD CHANGERS**—How to improve your FM tuner...tips on FM alignment...drift and A.F.C. in FM...FM Multiplex...20 CPS tape recorder switch...measuring flutter...slow speed tape recording...reducing recorder noise and hum...electronic level indicators.

**PLUS—GIANT COLOR FOLD-OUT SECTION on "Sound":** authoritative charts on audio frequency ranges...sound levels...equal loudness curves.

All the skill and know-how of the nation's top hi-fi authorities are yours for only \$1.00 in the 1960 HI-FI ANNUAL & AUDIO HANDBOOK. Use handy coupon below to order by mail today!

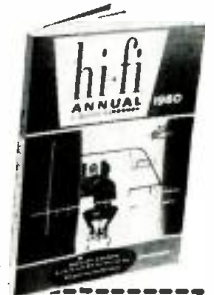

Ziff-Davis Publishing Company  
Department EW109  
434 S. Wabash Avenue  
Chicago 5, Illinois

Please send me a copy of the 1960 Hi-Fi ANNUAL & AUDIO HANDBOOK. I enclose \$1.00 plus 10¢ to cover mailing and handling charges. (Canada and Foreign \$1.25 plus 10¢ postage.)

NAME \_\_\_\_\_

ADDRESS \_\_\_\_\_

CITY \_\_\_\_\_ ZONE \_\_\_\_\_ STATE \_\_\_\_\_

voltages ranging from -6 to -18 volts d.c.—coupled with a d.c.-d.c. converter for obtaining higher voltages. While these cells had a capacity limited to about 1000 watt/hours, they were intentionally selected because of the anticipated short life of the satellite.

All of these power sources are severely contrasted with a radically new type: the nuclear battery. Several kinds are under development, of which two—the tritium cell, and the strontium 90 cell—will be used in satellites and space probes during 1960 and 1961. While these tiny batteries yield only a few microwatts of power, they will last an incredibly long period of time—about 20 years.

Although it is certainly difficult to predict exactly what will happen to electronics in that period of time, one thing is certain—electronics is going into outer space! —30—

### PATCH-CORD HOLDER

By CHARLES E. DIEHL

**M**INIMUM space and the neat storage of patch cords is a major problem in the ham shack or shop. We call the holder shown in the photograph the "bear's claw" and it does a neat job of storing as many as 27 cords in a mere 7½ inches. Cords can be removed easily as the spacing is such that fingers can grasp a cord without disturbing those on either side. The cords are arranged in order of increasing length from left to right with one length per slot. Each slot normally holds three banana plug cords but four can be accommodated in a pinch.

The holder was constructed of ¼" Lucite. Slots are ⅛" wide and 1" deep. Spacing is ¾" center-to-center. The slots are made by sawing two cuts with a hacksaw and breaking out the center. The cuts are then smoothed with a file. Total size of the plastic sheet is 7½" x 4" for top of the cabinet mounting and 3" wide with a 1" flange turned up for wall or pegboard mounting. Claws are turned up by putting the front or claw edge of the plastic on a flat hot plate and bending the front down ¾" with a wood block while the plate is warming up.

When the plastic softens, turn the back edge up at about a 45-degree angle. Move the plastic to a smooth cold surface and hold the bend with the block until it cools and re-sets. If this is not done the bend will straighten out as the sheet cools. The back may be treated the same way. Dimensions, slot depth, and width or length may be varied as desired. Thicker plastic can be used but is not as easy to work.

A piece of black paper was slotted and placed in back of the holder for photographic purposes, the actual rack in our shop is clear. —30—

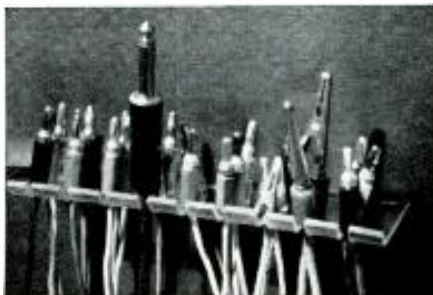

FIRST TIME ... a versatile

# DUAL HEAT SOLDERING GUN

FOR ONLY  
**\$7.95**  
LIST  
Model E200K



...and best of all,  
it's a new

**Weller**®

Here from Weller, long time leader in the soldering field, is the newest and finest soldering gun value on the market.

**WELLER DUAL HEAT FEATURE** saves time, gives greater convenience and greatly increases tip life. A touch of your finger on the Triggermatic control switches heat to high (125 watts) or low (90 watts) as your job requires. It adapts instantly to varying needs, and you use high heat only when necessary.

**HIGH EFFICIENCY WELLERTIP** utilizes copper for superior heat transfer and soldering efficiency, plus iron plating for durability. Flat cross-section design gives added strength and rigidity.

**NEWEST DESIGN** with sturdy plastic housing that resists hard knocks. Compact "feel" and comfortable balance aid precision soldering. Like all other Weller guns, this new model features instant heat, and a spotlight illuminates your work.



### KIT INCLUDED

In addition to the Dual Heat Soldering Gun you get:

- Wire Bristle Cleaning Brush
- Soldering Aid for opening old joints, twisting wires
- All-purpose Solder

On sale now at your  
Electronic Parts Distributor

WELLER ELECTRIC CORP. • 601 Stone's Crossing Rd., Easton, Pa.

prepare for your career in

# ELECTRICAL ENGINEERING ELECTRONICS COMPUTERS RADIO-TV

At MSOE, you can equip yourself for a career in many exciting, growing fields: **MISSILES**

**RADAR • AUTOMATION  
RESEARCH • DEVELOPMENT  
ELECTRICAL POWER  
AVIONICS • ROCKETRY**

When you graduate from the Milwaukee School of Engineering, you are prepared for a dynamic career as an Electrical Engineer or Engineering Technician. Under a faculty of specialists, you gain a sound technical education in modern, completely equipped laboratories and classrooms. As a result, MSOE graduates are in great demand and highly accepted by industries nationally.

At MSOE you will meet men from all walks of life and all parts of the country — some fresh out of high school or prep school, others in their twenties — veterans and non-veterans.

You can start school in any one of four quarters and begin specializing immediately. Engineering technicians graduate in 2 years with an Associate in Applied Science degree. For a Bachelor of Science degree in Engineering, you attend 4 years. A 3-month preparatory course also is available.



### FREE CAREER BOOKLET!

If you're interested in any phase of electronics, radio or television, be sure to look into the programs of study offered by the Milwaukee School of Engineering. Just mail the coupon.

## MILWAUKEE SCHOOL OF ENGINEERING

Dept. EW-1059, 1025 N. Milwaukee St.  
Milwaukee, Wisconsin

Please send FREE Career Booklet. I'm interested in  Electrical Engineering:  
 Electronics  Computers  
 Electrical Power  Radio-TV  
 Mechanical Engineering.

PLEASE PRINT

Name..... Age.....

Address.....

City..... Zone..... State.....

I'm eligible for veterans education benefits.  
MS.123



# New Tube Tester Data

Recent listings with which owners of Triplet tube checkers can keep roll charts up to date.

## TRIPLETT MODEL 3414

FIL.	TYPE	1	2	3	4	5	6	7	8	9	0	CKT.	LOAD
Off	OA2	—	D†	—	D†	—	—	D†	—	—	—	7	28
1 & 5 show short													
C	1A14	D*	—	—	—	D*	D	U*	—	—	—	6	69
C	1H2	D*	U*	—	D*	U*	D*	—	U*	D*	—	6	49
E	2CY5	D*	D†	U*	D*	—	—	D†	—	—	—	6	13
E	2EA5	D	D†	U*	D*	—	—	D†	—	—	—	6	23
E	2EN5	—	D	U*	D*	D	—	—	—	—	—	3	19
E	2EN5 Test 2	—	—	U*	D*	D	—	D	—	—	—	3	19
H	4BZ6	—	D	U*	D*	—	—	D	—	—	—	4	21
H	4CS6	—	D	U*	D*	D	—	D	—	—	—	4	22
H	4CS6 Test 2	D	D	U*	D*	—	D	—	—	—	—	7	100
Good = 30													
H	4DE6	D	D	U*	D*	—	—	D	—	—	—	4	86
H	4DT6	—	D	U*	D*	—	—	D	—	—	—	2	60
H	5BW8	—	—	—	U*	D*	D	D†	—	—	—	6	17
H	5BW8 Test 2	D	D	—	U*	D*	—	—	—	—	—	3	19
H	5BW8 Test 3	—	D	D	U*	D*	—	—	—	—	—	3	19
H	5EH8	D†	D	D	U*	D*	D†	D	—	—	—	6	17
H	5EH8 Test 2	D†	—	—	U*	D*	D†	D	D	D	—	4	21
H	5EU8	—	—	—	U*	D*	—	D	D	—	—	6	16
H	5EU8 Test 2	—	D	—	U*	D*	D	—	—	—	—	6	18
J	6AF3	—	—	—	U*	D*	—	—	—	—	D	3	18
2 & 9 show short													
J	6CH6/EL821	—	D	D	U*	D*	—	—	—	D	—	3	65
J	6CS7	—	—	—	U*	D*	—	D	D	—	—	6	26
J	6CS7 Test 2	—	—	D	U*	D*	—	—	—	D	—	3	48
J	6CY7	—	—	—	U*	D*	—	D	D	—	—	7	49
J	6CY7 Test 2	—	D†	D†	U*	D*	—	—	—	D	—	5	49
J	6DE7	—	—	—	U*	D*	—	D	D	—	—	6	26
J	6DE7 Test 2	—	D†	D†	U*	D*	—	D	—	D	—	4	42
J	6EH8	D†	—	—	U*	D*	D†	D	—	—	—	4	20
J	6EH8 Test 2	D	D	—	U*	D*	D†	—	—	—	—	4	21
J	6EM5	—	—	D†	U*	D*	D†	D	—	—	—	4	66
J	6EW6	D	D	U*	D*	—	—	D	—	—	—	4	80
K	8CX8	—	—	—	U*	D*	D	D	—	—	—	3	83
K	8CX8 Test 2	D	D	—	U*	D*	—	—	—	—	—	6	33
K	8EB8	—	—	—	U*	D*	D	D	—	—	—	3	37
K	8EB8 Test 2	D	D	—	U*	D*	—	—	—	—	—	7	36
L	8EM5	—	—	D†	U*	D*	D†	D	—	—	—	4	56
M	10DE7	—	—	—	U*	D*	—	D	D	—	—	6	23
M	10DE7 Test 2	—	D†	D†	U*	D*	—	—	—	D	—	5	51
N	12DW8	—	—	—	U*	D*	—	D	D	D	—	1	34
N	12DW8 Test 2	—	D	D	U*	D*	—	—	—	—	—	1	16
N	12DW8 Test 3	—	—	—	U*	D*	D	—	D	—	—	1	8
N	12EN6	—	U*	—	—	D	—	D*	D	—	—	5	60
N	12FM6	D	D	U*	D*	D	D	—	—	—	—	1	100
N	12FM6 Test 2	D	D	U*	D*	—	D	D	—	—	—	1	64
N	12FM6 Test 3	D	D	U*	D*	D	—	D	—	—	—	1	64
N	13DR7	—	—	—	U*	D*	—	D	D	—	—	7	38
N	13DR7 Test 2	—	D†	D†	U*	D*	—	—	—	D	—	5	56
P	17D4	—	—	D	—	—	—	U*	D*	—	—	5	18
R	25EH5	D	D†	U*	D*	D†	—	—	—	—	—	5	78
J	KT66	—	U*	—	—	—	—	D*	D	—	—	4	63

\*Denotes square around U or D

†Denotes circle around U or D

## NOTICE TO OWNERS OF SECO TESTERS

The manufacturer has new 1959 panels for grid-circuit testers GCT-5 and GCT-8. These list latest tube types plus many popular industrial and other types not listed before. Panels for the GCT-5 (Part No. 595) and the GCT-8 (Part No. 598) may be ordered directly from the manufacturer at \$1.00 each. Address Seco Manufacturing Co., 5015 Penn Ave. So., Minneapolis, Minn.

**New Tuner Standard**  
(Continued from page 61)

tests of selectivity and capture ratio have to be performed at the three standard carrier frequencies and the poorest figure obtained becomes the "rated performance" of the tuner.

**Spurious Response**

The third type of measurement which indicates the capability of a tuner in rejecting interference is the spurious response test. Here the tuner is set to each of the standard carrier frequencies and a signal generator with sufficient output voltage tuned over a wide frequency range. At each frequency where the tuner shows an audio output the signal generator output voltage is adjusted so that the measurement procedure of the usable sensitivity test is followed. This voltage with the usable sensitivity test input voltage is converted to a ratio and then expressed in decibels. The number of decibels gives the amount of spurious response rejection by the tuner. A number of these spurious response frequencies may be found, possibly due to forms of r.f. distortion within the tuner. Two particular ones will have to be recorded separately: image response and i.f. response. These frequencies may turn out to be 10.7 mc. for i.f. response and equal to the tuned frequency plus 21.4 mc. for the image response frequency of the tuner.

**Other Tests**

The other tests normally performed on tuners are self-explanatory and it is merely a case of following the conditions specified in the standard. Some of these tests were made in the past so it is only necessary to adopt the proper reference levels in order to meet the new IHFM standard. The tests which have been described are basically new tests and their general acceptance will be a matter of gradual education.

A copy of the new standard, giving complete details, may be obtained from the Institute of High Fidelity Manufacturers, Inc., 125 East 23rd Street, New York 10, N. Y. The price of IHFM-T-100 is \$1.00.

The author wishes to thank the members of the IHFM Standards Committee, Sub-Committee on Tuners: Lawrence B. Arguimbau, *McIntosh Laboratories*; Joseph N. Benjamin, *Bogen-Presto Division of the Siegler Corporation* (president of IHFM); Leonard Feldman, *Madison Fielding Corporation*; Robert F. Furst, *Hurman-Kardon, Inc.*; A. A. Hart, *Precision Electronics*; Allen Holstrom, *Stromberg-Carlson*; Joseph Levitsky, *Bogen-Presto Division of the Siegler Corporation*; F. L. Mergner, *Fisher Radio Corporation*; Edward Miller, *Sherwood Electronic Laboratories*; and Richard Shottenfeld, *Pilot Radio Corporation* for their cooperation and assistance in establishing these new standards. —50—

**START YOUR OWN TUBE BUSINESS with Sensational ZALYTRON "Deal"!**

**YOU GET THIS**

**DELUXE Shell 102 TEST-O-MATIC**

**SELF-SERVICE TUBE TESTER**

**PLUS ZALYTRON "PACKAGE DEAL" OF 150 RADIO & TV RECEIVING TUBES**

**COMPLETE FOR ONLY \$245.00**  
F.O.B. N.Y.C.,

- If You Want to Start a New Tube Route
- If You Want to Add to Your Present Route
- If You Want to Increase Your Store Traffic

**Here's a Deal that starts you RIGHT: with a PROFIT as soon as you unpack it!**

This superb Shell Tube Tester is nationally advertised by the factory, for dealers, at a net cost of \$199.95. When you buy it in our "Package Deal" you are, in effect, getting with it a Complete Stock of Tubes, worth \$450 retail, FOR ONLY \$45.00 — which is actually 90% discount! And when you have sold only half of the tubes, you have recovered your entire original investment, and have begun a PROFITABLE Self-Service Tube Tester Business!

**WE MAKE THIS SENSATIONAL OFFER TO INTRODUCE TO A WIDER MARKET OUR ZALYTRON BRAND QUALITY TUBES—ALREADY WELL-KNOWN AND RESPECTED AMONG THOUSANDS OF DEALERS AND SERVICEMEN.**

102 SOCKETS  
"ONE-KNOB" CONTROL

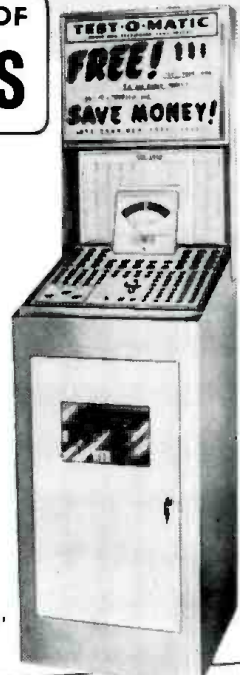

**NATIONALLY SOLD ZALYTRON TV & RADIO TUBES**

are BRAND NEW Quality Tubes — guaranteed to perform as well and as long as tubes much higher priced. Why Pay More? Each tube is individually boxed in bright and cheerful carton, and Guaranteed Unconditionally for ONE FULL YEAR.

**THESE 150 ZALYTRON TUBES INCLUDED WITH SELF-SERVICE TESTER IN "PACKAGE DEAL"**

Quan.	Type	Quan.	Type	Quan.	Type	Quan.	Type		
1	02A	1	6AH6	1	6BG6	1	6S4	1	12AX7
3	1B3	1	6AK5	1	6BH6	1	6SA7	1	12B4
1	1R5	5	6AL5	1	6BJ6	1	6SK7	3	12BA6
1	1S5	1	6AM8	1	6BK7A	5	6SN7	1	12BE6
1	1T4	1	6AN8	1	6BN6	1	6SQ7	2	12BH7
1	1U4	5	6AQ5	2	6BQ6	1	6T8	1	12BQ6
1	1U5	1	6AS5	2	6BQ7A	5	6U8	1	12BY7
3	1X2A/B	1	6AT6	1	6BZ6	2	6V6	1	12CU6
1	13CB6	1	6AT8	2	6BZ7	2	6W4	1	12SA7
1	13V4	5	6AU6	1	6C4	1	6W6	1	12SK7
1	15AM8	1	6AU8	5	6CB6	1	6X4	1	12SN7
1	15AQ5	1	6AV6	1	6CD6	1	6X5	1	12SQ7
1	15J6	1	6AW8	1	6CG7	2	6X8	1	12BQ6
3	5U4G	2	6AX4	1	6CM7	1	7AU7	1	125CU6
1	5UB	3	6BA6	2	6CU6	2	12AT6	1	125L6
2	5Y3	1	6BC5	1	6DQ6	2	12AT7	2	125W4
1	6AC7M	1	6BC8	5	6J6	5	12AU7A	1	135Z5
3	6AG5	2	6BE6	1	6K6	1	12AV6	2	50C5
								2	50L6

**LIMITED OFFER!**

ORDER NOW, include remittance in full, or 25% Cash with Order balance C.O.D. Allow one week for delivery, F.O.B. NYC. This great Offer is for a limited Time only — act TODAY, get started RIGHT with ZALYTRON — a respected name in the Tube Industry!

**FREE!** New Giant Wholesale Catalog of Radio & TV Receiving Tubes, Electronic Components. Free on Request.

**ZALYTRON TUBE CORPORATION**  
220 West 42nd Street New York 36, N. Y.  
Telephone: BRyant 9-2542

# SHIPPED ON APPROVAL

**NEW**

## CRT TESTER-REACTIVATOR Model CRT-2

**NOW . . .** a TESTER-REACTIVATOR really designed to test, repair and reactivate EVERY PICTURE TUBE MADE — whether black and white or color . . . with exclusive features never before found in picture tube testers.



Housed in hand-rubbed oak carrying case — complete with MULTI-HEAD\*

Model CRT-2  
**\$57<sup>50</sup>**  
Net

TERMS: \$13.50 within 10 days. Balance \$11 monthly for 4 months.

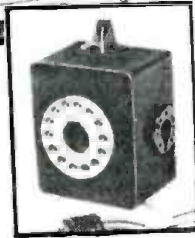

The CRT-2 steps in and solves the limitations and shortcomings of present day CRT Testers. Unlike ordinary CRT testers that keep entering the field with a limited range of operation, the CRT-2 employs a new brilliantly engineered circuit designed to test, repair and reactivate every black and white or color picture tube made. The CRT-2 eliminates the guesswork and risk that until now, has always been present when a picture tube is reactivated. It accomplishes this by providing perfect control of either the 'Boost' or 'Shot' method of reactivation.

**THE CRT-2 DOES ALL THIS RIGHT IN THE CARTON, OUT OF THE CARTON OR IN THE SET**

### TEST

- ✓ for quality of every black and white and color picture tube
- ✓ for all inter-element shorts and leakage up to one megohm
- ✓ for life expectancy

### REPAIR

- ✓ Will clear inter-element shorts and leakage
- ✓ Will weld opens between any two elements in the tube gun

### REACTIVATE

- ✓ The unique controlled 'SHOT' (high voltage pulse) method of reactivation provided by the CRT-2 will restore picture tubes to new life in instances where it was not possible before. Furthermore the high voltage is applied without danger of stripping the cathode as you always have perfect control of the high voltage pulse.
- ✓ The 'BOOST' method of reactivation also provided by the CRT-2 is used effectively on tubes with a superficially good picture but with poor emission and short life expectancy. It will improve definition, contrast and focus greatly and add longer life to the picture tube.

1. **THE MULTI-HEAD** (patent pending) . . . A SINGLE PLUG IN CABLE AND UNIQUE TEST HEAD — A tremendous advance over the maize of cable and adapters generally found with other testers. Enables you to test, repair and reactivate every type of picture tube with greater convenience than ever before . . . 50 degree to 110 degree types from 6" to 30", whether 12 pin base, 8 pin base, 14 pin base . . . even the very latest 7 pin base. A special color switch on the MULTI-HEAD enables you to test, repair and reactivate each of the red, green and blue color guns separately.
2. **WATCH IT REACTIVATE THE PICTURE TUBE** — You actually see and control the reactivation directly on the meter as it takes place, allowing you for the first time to properly control the reactivation voltage. This eliminates the danger of stripping the cathode of the oxide coating. It enables you to see the speed of reactivation and whether the build-up is lasting. You will see if the cathode contamination is too great and if the picture tube is too far gone to be reactivated.
3. **CONTROLLED "SHOT" WITH HIGHER VOLTAGE FOR BETTER REACTIVATION** — Stronger than any found in other testers . . . high enough to really do the job — yet controlled to avoid damage to the picture tube.
4. **UNIQUE HIGH VOLTAGE PULSE CIRCUIT** — Will burn out inter-element shorts and weld open circuits with complete safety to the picture tube.
5. **VISUAL LIFE TEST** — Enables both you and your customer to see the life-expectancy of any picture tube right on the meter. The fact that your customer can see the results of your tests as you make them virtually eliminates resistance to picture tube replacement when necessary.
6. **TESTS, REPAIRS AND REACTIVATES SPECIAL LOW SCREEN VOLTAGE TUBES** — Many new type picture tubes use special low voltage of approximately 50 volts. The CRT-2 will test, repair and reactivate these types with the same thoroughness as the regular types with complete safety.
7. **SEPARATE FILAMENT VOLTAGES** — Including the very latest 2.35 volt and 8.4 volt types as well as the older 6.3 volt types.
8. **TESTS, REPAIRS AND REACTIVATES 'SF' PICTURE TUBES** — found in the newest Sylvania and Philco TV sets. These picture tubes have different base pin connections than standard picture tubes and there is always an element of risk that the tube may be burned out when tested with ordinary picture tube testers. The CRT-2 is designed to accommodate this new base pin arrangement and will test the tube with no danger of damage.

### ADDITIONAL FEATURES

- Employs the time proven dynamic cathode emission test principle
- Large 4½" meter with heavily damped movement for smooth action, accuracy and long life
- Filament shorts test for each element in the picture tube
- Provides separate glow indicator
- An easy to read instruction manual contains all the latest testing information on old and new type picture tubes
- Housed in handsome hand-rubbed oak carrying case with special compartment for MULTI-HEAD and line cord.

\* patent pending

## IN-CIRCUIT CONDENSER TESTER Model CT-1

Here is an IN-CIRCUIT CONDENSER that DOES THE WHOLE JOB! The CT-1 actually steps in and takes over where all other in-circuit condenser fail. The ingenious application of a dual bridge principle gives the CT-1 a tremendous range of operation . . . and makes it an absolute 'must' for every serviceman.

### in-circuit checks:

- ✓ Quality of over 80% of all condensers even with circuit shunt resistance . . . (This includes leakage, shorts, opens, intermittents)
- ✓ Value of all condensers from 200 mmfd. to .5 mfd.
- ✓ Quality of all electrolytic condensers (the ability to hold a charge)
- ✓ Transformer, socket and wiring leakage capacity

### out-of-circuit checks:

- ✓ Quality of 100% of all condensers . . . (This includes leakage, shorts, opens and intermittents)
- ✓ Value of all condensers from 50 mmfd. to .5 mfd.
- ✓ Quality of all electrolytic condensers (the ability to hold a charge)
- ✓ High resistance leakage up to 300 megohms
- ✓ New or unknown condensers . . . transformer, socket, component and wiring leakage capacity

### OUTSTANDING FEATURES

- Ultra-sensitive 2 tube drift-free circuitry
- Multi-color direct scale readings for both quality and value . . . in-circuit or out-of-circuit
- Simultaneous readings of circuit capacity and circuit resistance
- Built-in hi-leakage indicator sensitive to over 300 megohms
- Cannot damage circuit components
- Electronic eye balance indicator for every greater accuracy
- Isolated power line
- Housed in sturdy hammertone finish steel case . . . comes complete with test leads

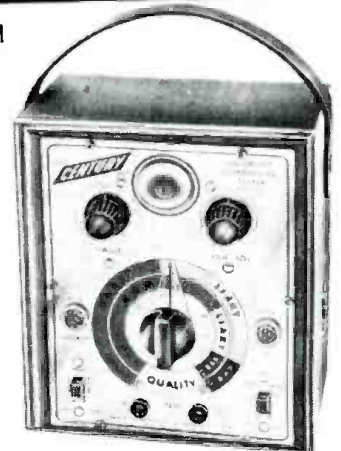

Model CT-1  
**\$34<sup>50</sup>**  
Net

TERMS: \$9.50 within 10 days. Balance \$5 monthly for 5 months.

**EASY TO BUY IF SATISFIED — see order form on facing page**

# FOR 10 DAY FREE TRIAL

Convince yourself at no risk that CENTURY instruments are indispensable in your every day work. Send for instruments of your choice without obligation... try them for 10 days before your buy... only then, when satisfied, pay in easy-to-buy monthly installments — without any financing or carrying charges added.

## NEW Battery Operated Peak-to-Peak VACUUM TUBE VOLT METER Model VT-1

WITH LARGE EASY-TO-READ 6" METER —

featuring the sensational new MULTI-PROBE Patent Pending

No extra probes to buy! The versatile MULTI-PROBE does the work of 4 probes

- ① DC Probe ② AC-Ohms Probe ③ Lo-Cap Probe ④ RF Probe

The VT-1 is a tremendous achievement in test equipment. With its unique MULTI-PROBE it will do all the jobs a V.T.V.M. should do without the expense of buying additional probes. No longer do you have to cart around a maize of entangled cables, lose time alternating cables or hunting for a misplaced probe. With just a twist of the MULTI-PROBE tip you can set it to do any one of many time-saving jobs. A special holder on side of case keeps MULTI-PROBE firmly in place ready for use.

### FUNCTIONS

**DC VOLTMETER** ... Will measure D.C. down to 1.5 volts full scale with minimum circuit loading, and give accurate readings of scale divisions as low as .025 volts ... Will measure low AGC and oscillator bias voltages from 1 volt or less up to 1500 volts with consistent laboratory accuracy on all ranges ... Zero center provided for all balancing measurements such as discriminator, ratio detector alignment and hi-fi amplifier balancing.

**AC VOLTMETER** ... True Peak-to-Peak measurements as low as 3 volts of any wave form including TV sync, deflection voltages, video pulses, distortion in hi-fi amplifiers, AGC and color TV gating pulses ... Scale divisions are easily read down to .1 volts ... Measures RMS at 1/20th the circuit loading of a V.O.M. ... Unlike most other V.T.V.M.'s there is no loss in accuracy on the lowest AC range.

**ELECTRONIC OHMMETER** ... Measures from 0 to 1000 megohms ... Scale divisions are easily read down to .2 ohms ... Will measure resistance values from .2 ohms to one billion ohms ... Will detect high resistance leakage in electrolytic and by-pass condensers.

**RF and LO-CAP MEASUREMENTS** ... With these extra VT-1 functions you can measure voltages in extremely high-impedance circuits such as sync and AGC pulses, driving saw tooth voltages, color TV gating pulses, mixer output levels, I.F. stage-by-stage gain and detector inputs.

### OUTSTANDING FEATURES

- Completely portable — self powered with long life batteries — permits use everywhere
- New advanced pentode amplifier circuit assures amazingly low battery drain
- Large 6" 100-microampere meter, many times more sensitive than meters used in most V.T.V.M.'s
- Laboratory accuracy performance — 2% of full scale on DC, 5% of full scale on AC
- Simplified multi-color easy-to-read 4-scale meter
- No heat operation assures rigid stability and accuracy
- Immune to power line fluctuations
- Amplifier rectifier circuit with frequency compensated attenuator — a feature found only in costly laboratory instruments
- Meter completely isolated — practically burn-out proof
- Hand-crafted circuitry eliminates the service headaches of printed circuitry
- 1% resistors used for permanent accuracy
- Separate RF ground return for low-loss RF measurement
- Micro-phon type co-axial connector
- Matching cover protects instrument face — snaps on and off instantly.

### SPECIFICATIONS

- DC Volts — 0 to 1.5/6/30/150/300/600/1500 volts
- AC Volts (RMS and Peak-to-Peak) — 0 to 3/12/60/300/1200 volts
- Ohms — 0 to a billion ohms, 10 ohms center scale — Rx1/10/100/1K/10K/100K/1M
- RF — Peak reading demodulator supplied for use on all DC ranges
- Zero Center — available on all DC volt ranges with zero at mid-scale
- Decibels — from -10 Db to +10/22/36/50/62 based on the Dbm unit: 0db-1mW in 600 ohms
- Impedance — 11 megohms DC, 1 megohm AC, 10 megohms Lo-Cap
- Input Capacity — 130 mmfd. RMS, 250 mmfd. Peak-to-Peak, 25 mmfd. Lo-Cap



Housed in hammertone steel-case — complete with MULTI-PROBE

Model VT-1  
**\$58.50** Net  
TERMS: \$14.50 within 10 days. Balance \$11 monthly for 4 months.

## FAST-CHECK TUBE TESTER Model FC-2

Simply set two controls ... insert tube ... and press quality button to test any of over 700 tube types completely, accurately ... IN JUST SECONDS!

Over 20,000 servicemen are now using the FAST-CHECK in their every day work and are cutting servicing time way down, eliminating unprofitable call-backs and increasing their dollar earnings chose the FAST-CHECK above all other tube testers.

### PICTURE TUBE TEST ADAPTER INCLUDED WITH FAST-CHECK

Enables you to check all picture tubes (including the new short-neck 110 degree type) for cathode emission, shorts and life expectancy ... also to rejuvenate weak picture tubes.

### RANGE OF OPERATION

- ✓ Checks quality of over 700 tubes types, employing the time proven dynamic cathode emission test. This covers more than 99% of all tubes in use today, including the newest series-string TV tubes, auto 12" plate-volt tubes, 0Z4s, magic eye tubes, gas regulators, special purpose hi-fi tubes and even foreign tubes.
- ✓ Checks for inter-element shorts and leakage.
- ✓ Checks for gas content.
- ✓ Checks for life-expectancy.

### SPECIFICATIONS

- No time consuming multiple switching ... only two settings are required instead of banks of switches on conventional testers
  - No annoying roll chart checking ... tube chart listing over 700 tube types is located inside cover. New listings are added without costly roll chart replacement
  - Checks each section of multi-section tubes and if only one section is defective the tube will read "Bad" on the meter scale
  - 41 phosphor bronze beryllium tube sockets never need replacement
  - 7-pin and 9-pin straighteners protected against accidental burn-out
  - Special scale on meter for most sensitive available, yet rugged — fully line voltage variation
  - 12 filament positions
  - Separate gas and short jewel indicators
  - Compensation for no shock hazards
  - Long lasting etched aluminum panel.
- NOTE:** The Fast-Check positively cannot become obsolete ... circuitry is engineered to accommodate all future tube types as they come out. New tube listings are furnished periodically at no cost.



Housed in hand-rubbed oak carrying case complete with CRT adapter

Model FC-2  
**\$69.50** Net  
TERMS: \$14.50 within 10 days. Balance \$11 monthly for 5 months.

## CONVENIENT TIME PAYMENT PLAN — NO FINANCING CHARGES

# CENTURY ELECTRONICS CO., INC.

ALL CENTURY INSTRUMENTS ARE GUARANTEED FOR ONE FULL YEAR

The extremely low prices are made possible because you are buying direct from the manufacturer.

### CHECK INSTRUMENTS DESIRED

- Model CRT-2 CRT TESTER REACTIVATOR ..... \$57.50  
\$13.50 within 10 days. Balance \$11 monthly for 4 months.
- Model CT-1 In-Circuit Condenser Tester ..... \$34.50  
\$9.50 within 10 days. Balance \$5 monthly for 5 months.
- Model VT-1 Battery Vacuum Tube Volt Meter ..... \$58.50  
\$14.50 within 10 days. Balance \$11 monthly for 4 months.
- Model FC-2 Fast-Check Tube Tester ..... \$69.50  
\$14.50 within 10 days. Balance \$11 monthly for 5 months.

Prices Net F.O.B. Mineola, N. Y.

111 Roosevelt Avenue, Dept. 210, Mineola, New York

Please rush the instruments checked for a 10 day free trial. If satisfied I agree to pay the down payment within 10 days and the monthly installments as shown. If not completely satisfied I will return the instruments within 10 days and there is no further obligation. It is understood there will be NO INTEREST or FINANCING charges added.

Name ..... Please print clearly

Address .....

City ..... State .....



... the progress which started when Fairchild turned out its first piece of professional recording equipment. Never a company to be satisfied with the status quo, Fairchild's engineering staff developed one major improvement after another, keeping giant-steps ahead of the industry. The transition and expansion to professional-quality equipment for the serious home music enthusiast was a logical one. Today, with an established record of achievement, Fairchild presents its *pièce de résistance* in stereophonic transducers...

**The SM-1 Rotating Magnet Compatible Stereo/Monophonic Cartridge.** Its high output (16.2 mv at 7 cm/sec) permits quiet operation of the most economical of kit amplifiers, while the wide response (better than  $\pm 2$  db from 20-15000 cycles) will test the finest stereo amplifier-preamplifier units on the market. These features coupled with high vertical and lateral compliance make the SM-1 a stand-out choice for your music system. And Fairchild's rugged design will stand the abuse of any record changer. Yet it will enhance the performance of the finest professional arms and turntables.

See and hear the Fairchild SM-1 at your sound dealer now. Price, including installation hardware, gram gauge and screwdriver... \$34.95.



**FAIRCHILD RECORDING EQUIPMENT CORP.**  
10-40 45th Ave., Long Island City 1, N. Y.



## CERTIFIED RECORD REVUE

By  
**BERT WHYTE**

IN A recent issue of one of the pocket-sized "digest" magazines, is an article on the "new miracle of stereophonic sound." This article, written by a purported "expert" in the field, is designed to educate the public on the "why's, how's, and wherefore's" of stereo. After I had somewhat incredulously read and re-read this gem, the most charitable opinion I could muster of the article was that it boosted stereo in general in a widely read mass circulation magazine.

As far as any true picture of stereo is concerned or what is necessary to achieve optimum quality in this medium, it was grossly lacking. In fact it presented the "package-console" concept of stereo in the most glowing terms and, at the same time, took a number of derogatory swipes at component stereo. It would require far too much space to document the inaccuracies and misleading statements that abound in this article, but I have a suggestion to make... as in the case of radio and TV political broadcasts where opponents can demand "equal time"... so should some one of our more erudite components spokesmen write an article showing their products' advantages, as well as point out the true facts of stereo and who pioneered in bringing it to the public.

If the component manufacturer is to remain in business and maintain the integrity of his products, it would behoove him to take a page out of his opponents' book and utilize every aspect of publicity and public relations that can show his products in a favorable light.

With the Fall approaching, the tempo of hi-fi and record life quickens and already the record releases are beginning to swell in number. A note in passing... I can't review what is not sent to me and some of the record companies are far more conscientious in their dealings with reviewers than others. Of course I am as selective in what I review as any other critic but, as in this issue, when there seems to be a preponderance of *London* and *Mercury* records, it is usually due to regularity and number of releases sent to me, when the records arrived in relation to my deadline, etc. It does not mean I own stock in either of these companies nor that I have a certain predilection for their products. It is true that both of these companies are noted for the excellent sound qualities of their records... but there are many other companies who make records and if they send them in and they pass muster as to quality, I am only too happy to review them.

It is patently impossible to review all the records a reviewer gets, which is why this column was named "Certified." I freely admit that many records never get past the first 6 or 7 minutes on my turntable, their sonic qualities obviously not permitting consideration as a "Certified" product.

On the other side of the coin, I am sure I don't have to point out that just because a certain record which has been highly praised in other journals, doesn't appear in this column, is no reason to suppose that the record is not up to snuff... it is simply that it was never sent to me for review.

Just thought I would remind you of my policies before we swing into another audio season!

### **TCHAIKOVSKY**

**THE NUTCRACKER (Complete Ballet)**

**L'Orchestre de la Suisse Romande conducted by Ernest Ansermet. London Stereo CSA2203. Price \$11.90. Two discs.**

Ansermet employs a somewhat slower pace throughout this work than does Dorati and Rodzinski in their versions, but what he lacks in spirit he makes up for in cohesive balance and lyric beauty. Above all, he gets from the *London* engineers a marvelously realistic job of recording. Each section of the work is treated separately as to sonic weight and thus the "Sugar Plum" sequence is airily spacious and gossamer in texture... and on the other hand the "Battle of the Mouse King" episode is darkly sonorous and weighty in brass and percussion.

Stereo effects are discreet as to directionality, better in matters of depth. Strings are outstanding here for their rounded smoothness and lack of "edginess." The frequency and dynamic range was impressively wide and, all in all, the album should delight both music lover and audiophile. Oh, I almost forgot, the famous pistol shot in the "Mouse Battle"! It is on the record all right, but I'm afraid the *London*-ers used a dainty .22 instead of the big .45 blaster that was made famous in the old *Mercury* mono recording!!

### **HANSON**

**SYMPHONY #2 ("ROMANTIC")  
LAMENT FOR BEOWOLF**

**Eastman Rochester Symphony Orchestra and Chorus conducted by Howard Hanson. Mercury Mono MG50192. Price \$3.98.**

This is a tremendous recording, both from the sonic aspects which are dazzling and from the repertoire. I feel Hanson's "Romantic" symphony is one of the finest American works ever written... a genuine masterpiece. It is an extremely colorful score abounding in spirited rhythmic devices and on the over-all basis compounded of lyric elements of compelling beauty. It is an easily accessible work and if you've always shied away from American symphonies, you will find this exceptionally palatable.

The "Lament for Beowolf" is also of interest. It is a highly dramatic, supercharged work for chorus and orchestra that makes



# 3 NEW TUNERS FROM



# H. H. SCOTT

for thrilling listening. *Mercury* has gone all out in the recording here and this is superlatively clean, well balanced sound, of exceptional frequency range and extreme dynamic compass. If you are the owner of a big system, the opening passages of the "Lament," with an enormous bass drum, will make your hair stand up! I can't recommend this one too highly. Just wish I had been sent the stereo version, which must be shattering!

## PUCCHINI

**TURANDOT (Complete Opera)**  
Renata Tebaldi, Inge Borkh, Mario del Monaco, other soloists and Chorus and Orchestra of *Academia di Santa Cecilia*, Rome, conducted by *Alberto Erede*. London Stereo CSA1308. Price \$17.85.

*London* is justly famous for its opera recordings and this one of Puccini's exotic "Turandot" is quite magnificent. The cast, and most especially the principals, are of unquestioned authority. Tebaldi as Liu is most effective, Del Monaco as the impassioned Calaf is in very good voice and only occasionally does he let his power run away and start to bellow. Borkh is tremendous as Turandot and affords an exquisite portrayal. She skips up and down the octaves in her difficult role without the least sign of strain.

Again the *London* engineers have given us a sound equal in stature to the cast and have used stereo to its fullest. No static deployment of forces here! The singers move about the stage in their accustomed ways and thus you hear them disposed both left and right and stage center and in depth as well. The balance achieved between vocal and orchestral sections is superb. Except for a very few times when the chorus appears slightly too distant, everything is heard with precise articulation.

The score abounds in tricky quasi-oriental effects and *London* has given us a recording of exceptional frequency and dynamic range with which to enjoy these exotic sounds. An outstanding achievement in opera recording and convincing evidence that stereo is the only truly realistic format for this medium.

## WAGNER

**GREAT CHORUSES FROM "FLYING DUTCHMAN," "TANNHAUSER," "LOHENGRIN," "DIE MEISTERSINGER," "GOTTERDAMERUNG," "PARSIFAL"**

Bayreuth Festival Chorus and Orchestra conducted by *Wilhelm Fitt*. Decca DGX Stereo 712000. Price \$5.95.

Here is a record obviously produced for the avid Wagnerite, but which should also find favor with those who like the sound of a superbly trained choir. The word for this sound is *BIG*. It is hugely proportioned and richly resonant, perhaps for some tastes a mite too much so . . . The miking used was of the rather distant type preferred by *Deutsche Grammophon*, so that a very rounded literal representation of the hall acoustics is afforded. This does add a fine sense of stereo depth but somewhat at the expense of articulation in the chorus. No matter . . . the music is glorious . . . thrilling, and gives one at least a small savoring of what it must be like to hear Wagner at Bayreuth!

## LEHAR. STRAUSS

**MERRY WIDOW WALTZ, KLIPP KLAPP GALOP, FURIOSO GALOP, ETC.**

Vienna State Opera Orchestra conducted by *Anton Paulik*. Vanguard Stereo Demonstration SRV-3SD. Price \$2.98.

Here is another of *Vanguard's* fine stereo demo records, an especially good deal at the low price. Nothing much need be said for the music as it is among the most universally

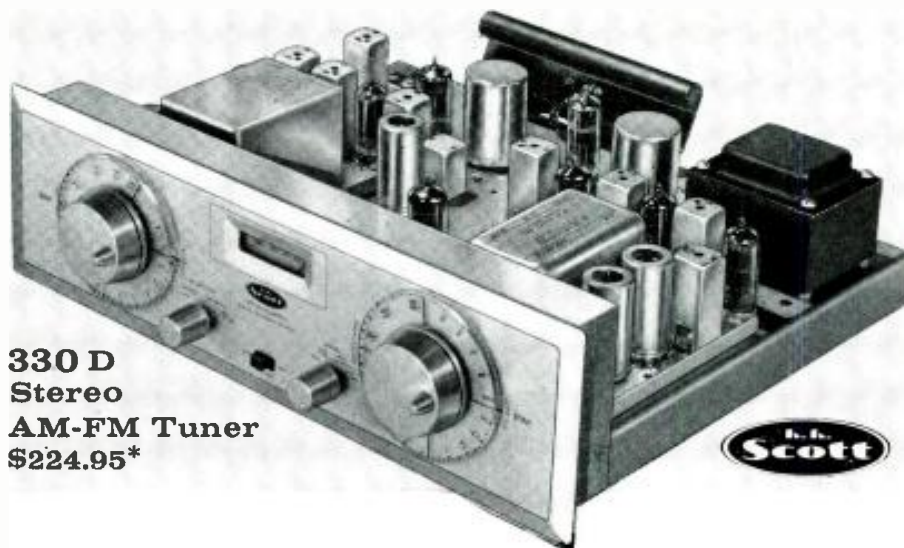

**330 D  
Stereo  
AM-FM Tuner  
\$224.95\***

## Wide-Band FM...Wide-Range AM Make These World's Most Sensitive, Most Selective Tuners!

The completely separate FM section of the radically new H. H. Scott 330D stereo tuner utilizes H. H. Scott's exclusive Wide-Band FM circuitry to assure absolutely drift-free and interference-free reception in even the weakest signal areas. Wide-Band design also lets you separate stations so close together on the dial that ordinary tuners would pass them by. The separate AM section utilizes H. H. Scott's unique Wide-Range detector so that, for the first time, you can receive full range AM broadcasts with fidelity and frequency response comparable to FM. Special multiplex adaptor facilities let you convert to multiplex at any time.

### 320 AM-FM TUNER

The many fine features built into this superlative tuner, including Wide-Range AM and Wide-Band FM, have never been available before for less than \$200. This tuner is ideal where AM-FM stereo reception is not available. \$139.95\*



### 310C FM TUNER

This professional tuner is the most sensitive and selective available. Its outstanding performance and sensitivity have made it the choice of universities and laboratories throughout the world. Sensitivity 1.5  $\mu\text{V}$  for 20 db of quieting. (IHFM rating 2  $\mu\text{V}$ ) \$174.95\*



\*Slightly higher West of Rockies. Accessory case extra.

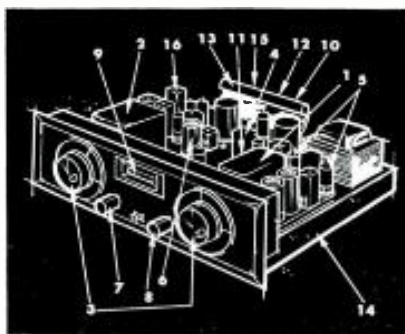

1. Separate FM front-end, silver plated for maximum sensitivity.
2. Separate AM front-end.
3. Separate AM and FM professional tuning controls.
4. Wide-Band FM detector for distortion-free reception on all signals.
5. Highly selective FM IF stages permit separation of stations close together on dial.
6. Wide-range AM detector.
7. Selector switch.
8. Band switch with these positions: FM, AM Wide, AM Normal, AM Distant.
9. Illuminated tuning meter.
10. Stereo output jacks.
11. Jack for instant connection of multiplex adaptor.
12. Stereo tape recorder output jacks.
13. AM Ferrite Loop Antenna.
14. Chassis constructed of heavy copper bonded to aluminum to insure reliability.
15. 10 KC whistle filter. Specifications: FM sensitivity 2 microvolts for 20db of quieting; (IHFM rating 2.5  $\mu\text{V}$ ); FM detector bandwidth 2 megacycles.

••••• **H. H. SCOTT** •••••

H.H. Scott, Inc. 111 Powdermill Road, Dept. EW-10, Maynard, Mass.  
Rush me new catalog and complete technical specifications on all new H. H. Scott components.  
Name.....  
Address.....  
City..... State.....  
Export: Telesco International, 36 W. 40th St., N.Y.C.

HEAR THE FABULOUS LONDON-SCOTT INTEGRATED STEREO ARM AND CARTRIDGE



**SUITS NEED PRESSING—  
MERIT DEFLECTION YOKES  
DO NOT!**

Merit deflection yokes are cosine wound TO FORM, not pressed. Pressing can lead to distortion and poor focusing. Pressing after winding frequently causes breakdown.

**MERIT COILS AND TRANSFORMERS  
HAVE "BUILT-IN" ADVANTAGES.**



Each Merit yoke is  
100% LIVE TESTED

COMPARE IT WITH  
**MERIT**  
MERIT COIL AND TRANSFORMER CORP.  
MERIT PLAZA • HOLLYWOOD, FLORIDA

**TARZIAN Offers 48-Hour,  
Direct Factory Service  
on Tuner Repairs**

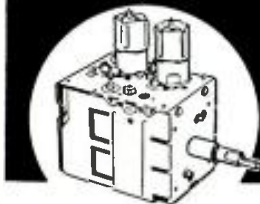

only  
**\$7.50**

That's right. Net, \$7.50 per unit and \$15 for UV combinations, including ALL replacement parts. 90-day warranty against defective workmanship and parts failure. Tuners repaired on approved, open accounts. Replacements offered at these prices\* on tuners not repairable:

- VHF 12 position tuner . . . \$22.00
- VHF 13 or 16 position tuner . . . . . 23.00
- VHF/UHF combination . . . . . 25.00
- UHF only . . . . . 15.50

\*Subject to change



Tarzian-made tuners are easily identified by this stamping on the unit. When inquiring about replacements for other than Tarzian-made tuners, always give tube complement . . . shaft length . . . filament voltage . . . series or shunt heater . . . IF frequency and chassis identification. Use this address for fast, 48-hour service:

**SARKES TARZIAN, Inc.**  
Att.: Service Mgr., Tuner Division  
East Hillside Drive  
Bloomington, Indiana

popular ever written and maestro Paulik is an acknowledged exemplar in the field. The Vienna Philharmonic in its recording guise as the Staatsoper Orkester plays the music lovingly and with great elan.

The record is supposed to demonstrate Vanguard's prowess in stereo recording and this it does most effectively. This company essays a fine "blended" type of stereo, in other words, they have enough directivity, but not exaggerated "ping-pong" effects and they concentrate on the realism besetting properties of cleverly handled acoustics and judicious placement of instruments. Add the good wide frequency and dynamic range they achieve and the over-all sound is most natural and easy to listen to for extended periods.

**BELOVED CHORUSES**

**Mormon Tabernacle Choir with Philadelphia Orchestra conducted by Eugene Ormandy. Columbia Mono ML5364. Price \$4.98.**

I feel cheated on this disc because this magnificent choir should certainly be heard in stereo! I must admit, however, that even on this mono disc, their artistry is a thrilling experience. The program is very well chosen, with tried and true Bach like . . . "Sheep May Safely Graze," "Jesu, Joy of Man's Desiring," "A Mighty Fortress," and for good measure items like the "Hallelujah Chorus," and Haydn's "The Heavens Are Telling."

Throughout the disc choral articulation is good with a very minimal amount of "blur and fusion" to mar things. The accompaniment of the Philadelphians is great and adds an extra fillip of interest. The sound is wide range and clean with nice dynamics, but as with any choral work the need for stereo is obvious. (This disc is available in the stereo format . . . I just happen to have been sent the mono.)

**MOZART**

**SYMPHONY IN C MAJOR ("LINZ")  
EINE KLEINE NACHTMUSIK**

**London Symphony Orchestra conducted by Antal Dorati. Mercury Stereo SR-90121. Price \$5.95.**

Dorati may not have sufficient "gemutlichkeit" in his "Eine Kleine" to suit some tastes, but neither does he over-sentimentalize as do so many conductors. His is a good, straightforward reading mainly notable for the fine playing of the Londoners, who play much more Mozart than many people think. Much the same can be said for the "Linz" symphony and both works have the benefit of first rate stereo recording. The engineers are to be commended for using an acoustic perspective suited to the "chamber-scale" of these works.

**RACHMANINOFF**

**CONCERTO #2 FOR PIANO AND ORCHESTRA**

**BALAKIREV**

**ISLAMEY (Solo Piano)**

**Julius Katchen, pianist, with London Symphony Orchestra conducted by George Solti. London Stereo CS6064. Price \$5.95.**

Katchen has always had a particular affinity for this concerto and his old recording in mono (now available on London's inexpensive subsidiary Richmond label) was highly regarded. His approach to the work is an interesting combination of faster pace than most, solidly founded rhythmic security, and an appreciation of the lyric qualities without over-romanticizing them. He is aided by the perceptive and sympathetic accompaniment of Solti, who also deserves a kudo for the fine playing he elicits from the London Symphony.

Some may prefer the manner and authority of Rubenstein's version, but this reading can

**PRE-PUBLICATION  
SPECIAL OFFER!**

YOU MAY HAVE EITHER OR BOTH  
OF THESE BIG, HARD-COVER  
ELECTRONICS GUIDEBOOKS ON A

**7-DAY  
FREE  
EXAMINATION**



**COMPUTERS  
AND  
HOW THEY WORK  
\$4.95**

Here is a fact-filled, exciting guidebook to the wonder-world of electronic computers, with more than 120 illustrations and easy-to-follow tables in 10 big chapters. Step by step, you'll see and understand the workings of every type of computer ever used. This important new book illustrates the basic principles of computers with crystal-clear clarity. It's must reading for career-minded students and for electronics professionals who want a more complete knowledge of computers.

**THE  
ELECTRONIC  
EXPERIMENTER'S  
MANUAL \$4.95**



THE ELECTRONIC EXPERIMENTER'S MANUAL is a big, informative volume, containing hundreds of specially prepared diagrams and construction drawings. There are 10 individual sections, each covering a specific phase of electronic construction. One giant chapter shows projects, test equipment and special tools you can build, plus plans for a complete workshop! With just a few dollars worth of tools, and this book to guide you, you'll have the know-how you need to get started, or advance, in electronic experimentation.

**GET ONE OR BOTH  
FOR 7-DAY FREE EXAMINATION!  
MAIL THIS COUPON TODAY**

**ELECTRONICS BOOK SERVICE**

A Division of the Ziff-Davis Publ. Co.  
One Park Avenue • New York 16, N. Y.

Gentlemen: Send me a copy of:

- COMPUTERS AND HOW THEY WORK
  - THE ELECTRONIC EXPERIMENTER'S MANUAL
- and bill me at only \$4.95 a copy plus postage. I understand that I may return the book(s) within 7 days and owe nothing.

\$\_\_\_\_\_enclosed. (SAVE MONEY! Enclose payment now and we'll pay the postage.)

Name \_\_\_\_\_

Address \_\_\_\_\_

City \_\_\_\_\_ Zone \_\_\_\_\_ State \_\_\_\_\_

(N.Y.C. orders add 3% sales tax.)

stand on its own merits and has the advantage of *London's* fine stereo sound. The piano is big and bright and in splendid balance with the orchestra. Directional qualities and aural positioning are well delineated.

**RIMSKY-KORSAKOV**  
**LE COQ D'OR (Suite)**  
**BORODIN**

**POLOVTSIAN DANCES**  
London Symphony Orchestra conducted by Antal Dorati. Mercury Stereo SR-90122. Price \$5.95.

Here is the stereo version of these works, which gained a wide reputation for sonic excellence in their monophonic format. The advantages of stereo are very apparent on comparison with the mono original. The choral articulation is much improved and everything seems bigger and more open. Perhaps I should temper that just a bit . . . there was a special monstrous bass drum used in "Le Coq d'or," which was quite famous in the mono version for testing the low-frequency response of the bigger loudspeakers. Here, the frequency does not seem to extend quite so low nor does the sound have the tremendous impact . . . the *whoomp*, as in the original.

The recording has fine stereo directivity with *Mercury's* three-channel "ghost middle" technique, aptly handling the middle "fill" problem and the dynamic range is as wide as the mono.

**SIBELIUS**  
**CONCERTO FOR VIOLIN AND ORCHESTRA**

**TCHAIKOVSKY**  
**SERENADE MELANCHOLIQUE**  
**SOUVENIR D'UN LIEU CHER**  
Ruggiero Ricci, violinist, with London Symphony Orchestra conducted by Oivin Fjelstad. London Stereo CS6067. Price \$5.95.

Sibelius' lovely violin concerto in a reading which leaves little to be desired. Ricci has a happy facility for this work and except for a little hardness of tone now and then, he must be regarded as the peer of Heifetz, (whose old mono recording has been withdrawn from the Schwann). Fjelstad provides a knowledgeable accompaniment and the recording is notable for the clean rounded spaciousness of its stereo. The smoothness of Ricci's instrument for the most part and the London Symphony strings is exceptional. Fine aural positioning with Ricci in dead center and there is no "wandering." The Tchaikovsky bits are rarely heard but interesting trivia, well played by Ricci.

**HAYDN**  
**SYMPHONY #96 IN D**  
**MOZART**  
**SYMPHONY #35 ("HAFFNER")**  
Detroit Symphony Orchestra conducted by Paul Paray. Mercury Stereo SR90129. Price \$5.95.

Knowing and sympathetic performances of these two works are aided by stereo sound of unusual transparency and cleanness. The "Haffner" is notable for the superb woodwind playing and the fine hearty brass.

**VIRTUOSO SHOWPIECES**  
Ruggiero Ricci, violinist, and Ernest Lush, pianist. London Stereo CS6039. Price \$5.95.

The attention of those who question the value of stereo in recording of single or small groups of instruments is directed to this disc. With intelligent microphoning and an appreciation of the dynamic scale and acoustic power of the music involved, the improvement over mono is most marked, not so much

October, 1959



# WHAT MAKES THE TD's TOPS?

...finer for stereo...finer for mono

If you move in circles where component hi-fi is a by-word, you've no doubt heard about the Thorens TD-124 transcription turntable and its fabulous performance. But for late-comers we'd like to point up just a few of the really big features (non-technical readers may skip remarks in parentheses): • Extra heavy table for constant speed (10 lb rim-concentrated table insures low wow and flutter; higher moment of inertia than any similar table). • Exact speed ( $\pm 3\%$  adjustment on all speeds—16 $\frac{2}{3}$ , 33 $\frac{1}{3}$ , 45, 78—with built-in illuminated strobe for setting after stylus is on record). • Easy on records (unique two-table design permits starts

after you've placed stylus, permits  $\frac{2}{3}$  rev. starts, makes cueing easy). • Extremely low rumble (mirror-finish main-bearing, nylon-seated ball-thrust-bearing reduce both vertical and horizontal rumble to a new low, so important for stereo). • 2-way motor rumble reduction (both an extra-large idler and an ultra-compliant belt-drive keep motor vibration and speed variations from table). Driving parts electronically balanced. No costly base necessary (only \$9.00). 50/60 cycles, 100/250 volt operation.

These are just a few of the TD-124's features. Ask your dealer to tell you the whole story on the fabulous TD-124.

**Now two budget-priced TD turntables**



These 4-speed turntables have same basic adjustable-speed precision-drive as famous TD-124 but you save two ways: (1) they come already equipped with stereo-wired professional arm without overhang making them ideal changer replacements. (2) Some TD features have been eliminated to save you money. But they still top the performance of every similar turntable and player on the market. TD-184 has semi-automatic operation. TD-134 is manually operated. Precision metal stroboscope (50/60 cycles) furnished with each unit. 100/250 volt operation. Wooden base only \$6.00.



Write Dept. R-10 for catalog on complete Thorens Hi-Fi Line

# THORENS

**SWISS MADE PRODUCTS**  
HI-FI COMPONENTS • LIGHTERS  
SPRING-POWERED SHAVERS  
MUSIC BOXES  
NEW HYDE PARK, NEW YORK

**BOGEN**  
the sound way  
to better stereo

## NEW STEREO RECEIVER

NO ONE BUT BOGEN, builder of over one million high-fidelity and sound-distribution components, could have engineered the new SRB 20 stereo receiver. A superb all-in-one instrument, it's a highly sensitive FM-AM stereo tuner, a versatile audio control center, a magnificent 20 watt (10 per channel) stereo amplifier, and it's *only* \$199.50—a price you'd expect to pay for a comparable tuner alone!

YEARS AHEAD. Bogen's engineering staff (largest of any sound-equipment maker) has designed the SRB 20 to be years ahead in performance as well as price. Here is all the flexibility...all the distortion-free tone quality...all the power you need for perfect stereo pleasure. Reflecting over 25 years of experience gained in building specialized sound systems for schools, theatres, industrial plants and offices, in addition to high fidelity components, the SRB 20 provides the faithful sound reproduction listeners have learned to expect from Bogen. Enjoy the beautifully styled SRB 20 yourself or install it for your customers—either way you get the best buy in hi-fi today!



### BOGEN SRB 20 STEREO RECEIVER

**CONTROLS:** Selector. FM Tuning. AM Tuning. Separate Bass and Treble for each channel (lock for simultaneous control of both). Volume for each channel (correct imbalance, then lock for simultaneous control). On-Off Power. FM On-Off and AFC out. AM On-Off and Multiplex.

#### MAIL COUPON NOW!



BOGEN-PRESTO CO., PARAMUS, N. J.  
A Division of the Siegler Corporation  
Please send me illustrated booklet,  
"Understanding High Fidelity." 64-  
page explanation of hi-fi and stereo.  
Enclosed is 25c.

Name and title \_\_\_\_\_

Address \_\_\_\_\_

City \_\_\_\_\_ Zone \_\_\_\_\_ State \_\_\_\_\_

in terms of frequency response or range but in aesthetic terms, wherein the suave, rounded fullness of tone of the piano and violin and the singular lack of distortion makes listening a delight.

The program Ricci has chosen is well balanced and, of course, shows off his flashing virtuosity. Included are such as Sarasate's "Jota Aragonesa," Wieniawski's "Scherzo Tarantelle," Suk's "Burlaska," Kroll's clever and delightful "Banjo and Fiddle," and others.

### Richmond Releases

On this new subsidiary label of *London Records* are to be found some superlative performances coupled with sound that, although dating from 1952, is in many cases equal to many of today's mono records. At the \$1.98 price these are the best library builders I know.

This month you can enjoy a good rousing performance of Borodin's "Polovtsian Dances" performed by the late Eduard Van Beinum and the London Philharmonic, coupled with Falla's "El Amor Brujo" conducted by Anthony Collins and the London Philharmonic on *Richmond* B19032. On B10036 you can marvel at the writing in Sibelius' seldom heard "5th Symphony" as conducted by the late Eric Tuxen and the Danish State Radio Symphony Orchestra. A superb reading is set off by a recording of fine balance and low distortion. The other filler on this disc is rarely heard... the "Karelia" suite of Sibelius, this being performed by the same orchestra under the baton of Thomas Jensen.

### FIESTA IN HI-FI

**Eastman Rochester Symphony Orchestra conducted by Howard Hanson. Mercury Stereo SR90134. Price \$5.95.**

This record is certainly aptly named, for a fiesta in hi-fi it is! It contains such spectacular showpieces as McBride's "Mexican Rhapsody," Nelson's "Savannah River Holiday," Mitchell's "Kentucky Mountain Portraits," and Vardell's "Joe Clark Steps Out." This is one of the very best stereo records I have heard to date. It has everything... gay clever scores, extremely tuneful and rhythmic playing of very high order, and sound which is staggering! There is brass and percussion galore here, all heard in the cleanest, wide-range stereo imaginable. The dynamic range in the "Mexican Rhapsody" is almost unbelievable and throughout are sonic surprises to stimulate the most jaded of hi-fi appetites. If you are a hi-fi or stereo enthusiast, this is definitely on the "must" list!

### DELIBES

**COPPELIA (Complete Ballet)**  
**Minneapolis Symphony Orchestra conducted by Antal Dorati. Mercury Stereo SR2-9005. Price \$11.90. Two discs.**

To complement its recent issue of the complete ballet "Sylvia," here is Delibes' other masterpiece in its complete format, "Coppelia." As is to be expected by now, ballet performances under the baton of Dorati are near definitive. He has that uncanny sense of rhythmic exactitude which makes his performances flow along so beautifully and, at the same time, he is ever aware of the lyric aspects of the score.

This is wonderfully balanced throughout and *Mercury* has furthered the project by giving the disc some outstanding stereo. This is especially notable for the ease in aural positioning of instruments, the solid sonic wall presented by the 3-channel technique and the over-all lack of distortion and wide frequency and dynamics. Add a final fillip in the form of spacious acoustics and the disc is a winner



## SPEAKERS for SOUND INSTALLATION

Regardless of your application... P.A., Inter-com, outdoor, extended range... OXFORD is the SPEAKER for you. Our very complete line includes speakers that will meet your every need... quality... delivery. Write for our new catalog today.

Leading distributors carry OXFORD.

COMPONENTS, INC.

556 West Monroe Street

Chicago 6, Illinois

Export: Roburn Agencies, New York

In Canada: Atlas Radio, Toronto

## OXFORD

OXFORD BRANDS: Supreme Transmitters,  
Hudson Lamps, Tempe Hi-Fi,

Oxford Speakers & Rear Deck Kits.

## add all UHF channels to your tv set BLONDER-TONGUE MODEL 99R UHF CONVERTER



Make your present TV set  
a modern 82-channel receiver

- sharper, clearer pictures
- easy, one-knob tuning
- drift-free performance—no fading
- approved for color TV
- UL approved
- tuned input

Outperforms all others in its class.  
The nation's biggest selling UHF  
converter. Only

**2295**

For fringe areas—the powerful  
Blonder-Tongue Ultraverter  
Model BTU-2R, \$9.95.  
Sold by parts distributors. EW-10  
BLONDER-TONGUE LABORATORIES, INC.  
9 Ailing St., Newark 2, N. J.



# SOUND ON TAPE

By BERT WHYTE

**M**ATTERS in the tape world are relatively quiet after the big noise at the NAMM show. I suspect that all the various forces, opposing and otherwise, are gathering their strength, girding their loins, and preparing for the big attack next month. I have not been fortunate enough to acquire one of the new cartridge machines as yet . . . let alone any cartridges . . . so my report on these must wait until I can flangle the necessary stuff. In the meanwhile, you will no doubt recall that my initial report on the 4-channel reel-to-reel tapes was somewhat less than enthusiastic.

Frankly, I was disappointed and, in fact, in thinking over the deal, came to the conclusion that the results I had obtained could only have been that the tapes were hurriedly made and not truly representative of the potential of this tape format. Going a step farther, I reasoned that perhaps I was expecting too much of the tapes, especially under the test conditions to which I had subjected them. Sooooo . . . I tried listening to the tape again, through the same set-up I had used originally. The results were the same. In other words through an *Ampex* 4-channel machine and my 60-watt *McIntoshes* and monster *Bozak* and *Wharfedale* set-up, the tapes just didn't measure up to the old 2-channel variety.

I then obtained some smaller speakers of the currently popular "book-case" variety and several integrated stereo amplifiers of far less wattage and hooked them all up to the *Ampex*. Voila! This was a horse of a different color! Now the tapes sounded perfectly respectable. Gone was most of the crosstalk between the opposing channels, the noise level was reasonably low and other spurious noises I had noticed had vanished. As to the reproduction . . . it was pleasing in quality, about on a par or a little better than could be obtained with a stereo disc operating through the same system.

The obvious lesson of this is that for the real finicky hi-fi boys with the big systems, there will have to be considerable improvement in 4-channel tapes before they find them acceptable or desirable. For average good systems the tapes would appear to be OK and, of course, for many of the really inexpensive "package" units that the public will be using, there is no question that they will prove satisfactory. However, down at this level, comes the bug-a-boo of tape handling and here is where the cartridge ma-

# Build This Superb *Schober* Organ From Simple Kits and SAVE OVER 50%!



LET US SEND YOU FREE DETAILS HOW TO ASSEMBLE A *Schober* ELECTRONIC ORGAN IN SPARE TIME!

The Beautiful *Schober* CONSOLETTA  
 - the only small organ with two full 61-note keyboards and 22 stops. Requires only 2' x 3'2" floor space! Commercial value approximately \$1600 or more - yet you save over 50% when you build this thrilling instrument!

Give Your Family A Lifetime of Musical Joy With A Magnificent Schober ELECTRONIC Organ!

Now you can build the brilliant, full-range Schober CONSOLETTA or the larger CONCERT MODEL with simple hand tools. No skills are necessary to construct an instrument with one of the finest reputations among electronic organs. No woodworking necessary - consoles come completely assembled and finished. All you do is assemble clearly marked electronic parts guided by clear illustrations and detailed step-by-step instructions. Even teen-agers can assemble the Schober! You build from kits, as fast or as slowly as you please . . . at home, in spare time - with a small table serving as your entire work shop!

Send For Complete Details On Schober Organs and For Hi-Fi Demonstration Record  
 The coupon will bring you a handsome 16-page booklet in full color describing Schober organs in detail, plus articles on how easy and rewarding it is to build your own organ and how pleasant and quick it is to learn to play the organ. In addition, we have prepared an exciting 10" hi-fi LP record demonstrating the full range of tones and voices available on the Schober, which you may have for only \$2.00 (refunded when you order a kit). Literature on the Schober is FREE! There is no obligation; no salesman will call.

THE GREAT CONCERT MODEL meets specifications of American Guild of Organists

Pay As You Build Your Organ; Start With As Little As \$18.94!

You may start building your Schober at once with an investment of as little as \$18.94. The musical instrument you assemble is as fine, and technically perfect, as a commercial organ built in a factory - yet you save over 50% on top-quality electronic parts, on high-priced labor, on usual retail store markup! In your own home, with your own hands you build an organ with *genuine pipe organ tones* in an infinite variety of tone colors to bring into your home the full grandeur of the Emperor of Instruments. You may build the CONSOLETTA for your home, or you may want to build the great CONCERT MODEL for home, church, school or theatre. You save 50% and more in either case.



Mail This Coupon For FREE Literature and Hi-Fi Record Today!

The Schober Organ Corp., Dept. RN-1  
 2248 Broadway, New York 24, N. Y.  
 Please send me FREE full-color booklet and other literature on the Schober organs.  
 Please send me the 10" hi-fi Schober demonstration record. I enclose \$2.00 (refundable on receipt of my first kit order).  
 Name.....  
 Address.....  
 City..... Zone... State.....

**WHERE  
THERE'S  
A FINE  
TAPE  
RECORDER... there's**



*note to **BELL** owners*

To insure optimum recording quality with your excellent machine, the recommended tape is **irish** #211... and for uninterrupted recording, **irish** #724 with its 6 lb. tensile strength gives you one full hour at 7½ i.p.s.

Send for technical bulletin.

**ORR INDUSTRIES INC.**  
Opelika, Alabama

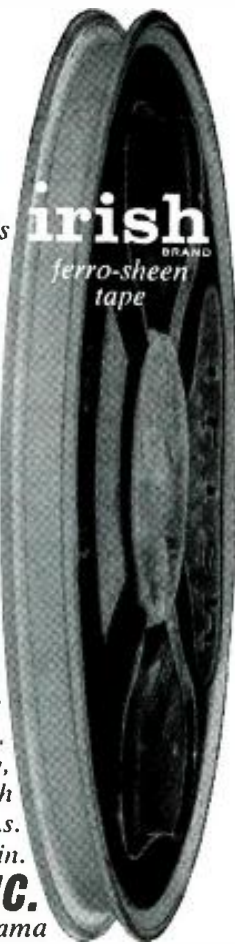

chines will probably take precedence. Hereafter, in reviewing 4-channel tapes, I will indicate whether they were reviewed on the big top system or on lesser equipment or both.

A note in passing about magnetic tape head gaps. Some people are evidently getting a little confused on some aspects of this matter. Now, as *Ampe*x and some others have shown in their latest designs, the closer together you can bring the walls of the gap in the head without actually touching each other, the more parallel to each other these walls can be, and the smoother the edges of the gap walls can be . . . the more extended will be your frequency response . . . naturally coupled with the appropriate circuitry. *BUT* . . . even if you gain with this ultra-tiny gap, if then you reduce the over-all area of the gap by going, for example, from a full-track tape to a half-track tape (or I should say tape heads) you will impair the signal-to-noise ratio. So with 4-channel tape, even though the gap itself be small, by cutting the area down again (by, in essence, cutting a half-track head in half again) you run into this same signal-to-noise problem. *Ampe*x and others have done much work in reducing these deleterious effects, but there remains some residual problems to be licked. Actually we should wait another six months before we evaluate anything as new as these heads and the 4-channel tape. By that time production problems will have been overcome and we can assume that the product we will be receiving represents the best the industry can do at this time and at the present state of the art.

**TABOO  
LEGEND OF PELE**

Arthur Lyman and Orchestra. Hi-Fi tapes R806 and R813 combined on 4-track stereo.

This is a collection described as "exotic sounds." Actually these are rather florid imitations of South Sea and Hawaiian songs and chants. There has been extensive use of many unusual percussion instruments and, in my humble opinion, the whole thing is an amalgam of flapdoodle. However there are undoubtedly many who like this sort of thing (the albums have been best sellers) and from a strictly sound viewpoint they may find many devotees.

On the big system, cross-channel modulation is less evident here than in most of the other 4-channel tapes I've tried, most probably because the music was recorded at a very high level. Ordinarily this, in itself, might give rise to cross-channel noise, but it was necessary to reduce the over-all gain of the system therefore bringing down this noise considerably. The sound was reasonably clean, but I found the very boomy bass objectionable, which is a personal reaction—I admit.

On the small system, the tape behaved nicely and the bass response probably made up for some speaker deficiency in this respect (which is



**NO  
GIMMICKS  
WITH  
wigo  
SPEAKERS**

Just solid, sensible acoustic engineering. Nothing fancy but the performance. That's the Wigo story, short but sweet. For literature, write . . .

**united  Audio**  
PRODUCTS OF DISTINCTION  
202-4 East 19th St., N. Y. 3, N. Y.

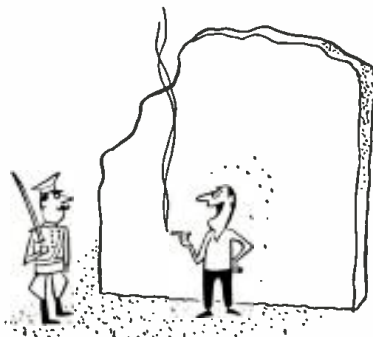

"My last wish? Shoot me with JENSEN NEEDLES."

why I suspect the bass was deliberately boosted on the tape).

**ELLA FITZGERALD SINGS THE RODGERS AND HART SONGBOOK VOLS. 3 & 4**

Ella Fitzgerald, Verve 4-channel stereo tape combining Nos. VST1003 & 10004.

Here is a horse of another color. You can't get gal entertainers much better than Queen Ella and on these tapes is a very generous sampling of her art. In her inimitable fashion she gives us "I Didn't Know What Time It Was", "Where or When", "Blue Moon", "My Heart Stood Still", "Lover", and many others.

On the big system were the usual faults of crosstalk, etc. On the small setup, this was not noticeable and the tape was a reasonable stereo representation of Ella. The noise level was a little high though, even on the small unit and I felt that the frequency range was somewhat restricted. I must confess that although I like the material on this tape, I have a feeling that if I were to compare it with a stereo disc of the same on a good system, the disc would probably win. As I said earlier, give 'em time! These are first trys and things are sure to improve.

-30-

**HAM CONVENTION**

**T**HE Cleveland Area Council of Amateur Radio Clubs is sponsoring the Second Cleveland Amaterradio Convention on October 16 and 17. It will be held at the Manger Hotel, East 13th Street and Chester Avenue, Cleveland, Ohio.

Registration is \$2.00 per person and banquet tickets are \$4.00. Hotel reservations may be obtained by writing to the hotel. For convention registration and banquet tickets, write to The Cleveland Amateuradio Convention, P. O. Box 5167, Cleveland I, Ohio. Pre-registrants will qualify for special prizes.

-30-

**NEW SYLVANIA PLANT**

**S**YLVANIA Electric Products Inc. has purchased a 29,000-square-foot plant at Manchester, N. H. for the manufacture of transistors. The firm is a wholly owned subsidiary of General Telephone & Electronics Corporation.

Within the next few months new production machinery and testing equipment will be moved into the facility. Manufacturing operations are scheduled to begin early in 1960.

The new plant, situated on a 10-acre site, will employ between 800 and 1000 persons. It is a one-story building, and will be completely air conditioned.

Mr. Robert Wood will be manager of this new facility. He is currently the manager of the manufacturing plant at the Semiconductor Division headquarters in Woburn, Mass.

The new plant will manufacture transistors and should attain full employment of approximately 1000 people within two years.

The company's Semiconductor Division produces transistors, crystal diodes, microwave diodes, and other semiconductor devices.

-30-

October, 1959

**Mullard TUBES CIRCUITS**

*engineered for high fidelity*

*stereo  
am / fm  
television*

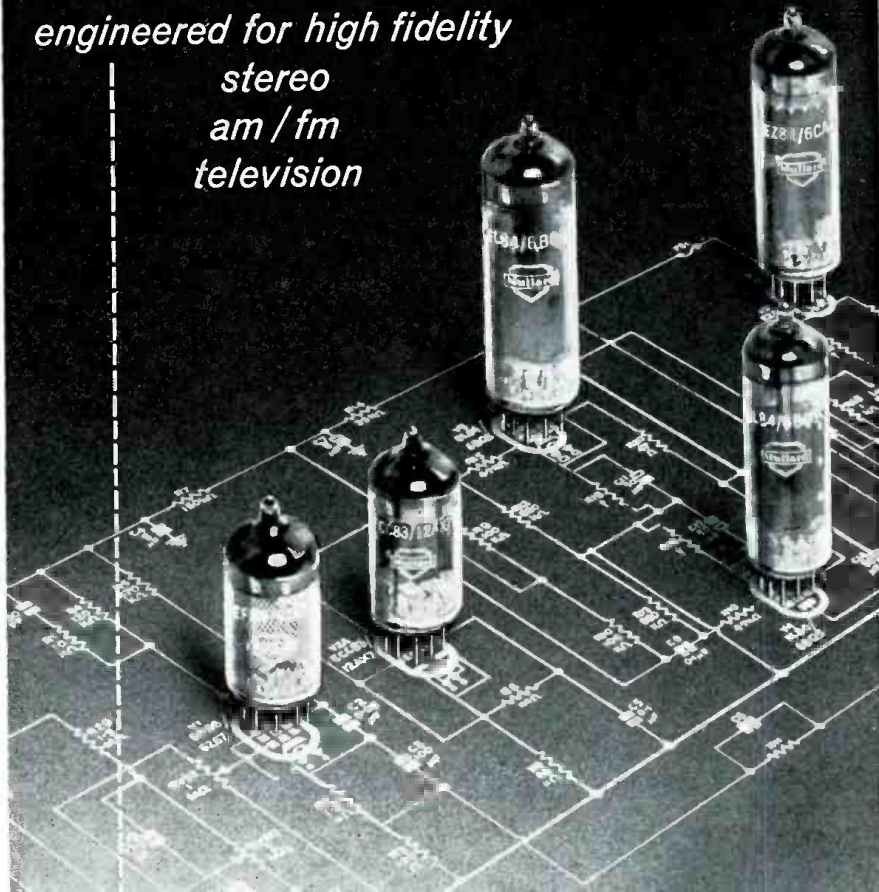

MULLARD electron tubes, universally recognized for their advanced designs and reliability, offer a selected range\* of tubes for High Fidelity, AM/FM, Television, and Industrial Applications.

This selected range\*, which uses frame grids, special glass, coiled heaters, bifilar windings, special mica construction, low hum and microphony, rugged construction, longer life are features found in more expensive premium tubes.

At MULLARD these extras are standard in the regular commercial production — AT NO EXTRA COST.

Discover the advantages of MULLARD tubes in your equipment — now!

Detailed data and application engineering assistance available upon request.



Trade Mark Mullard Ltd.



"Circuits for Audio Amplifiers" is a new MULLARD publication in which the wide range of MULLARD high quality audio circuits is presented conveniently in one book. Four introductory chapters are devoted to theoretical and practical considerations of high quality sound reproduction with monophonic equipment or with stereophonic systems. The rest of the book comprises circuit descriptions, constructional details, and some performance figures of 12 MULLARD circuits. These circuits include well-known MULLARD designs, some modifications and improvements to these circuits, and a number of completely new ones. Only \$2.50 from your dealer or by mail from our Technical Services Division.

**INTERNATIONAL ELECTRONICS CORP.**  
81 SPRING ST., NEW YORK 12, N. Y.

# Genalex KT66



## THE TUBE CHOSEN FOR THE FAMOUS HEATHKIT W5-M AMPLIFIER

The Heathkit reputation for quality allows no deviation from the highest possible standards of performance. Heathkit assures greatest customer satisfaction by utilizing stability and full power at a harmonic distortion rate of less than 1%. Result? An outstanding amplifier, the W5-M.

*KT66 Tubes are available at all leading hi-fi dealers.*



For literature, write Dept. XR-49  
**BRITISH INDUSTRIES CORP., PORT WASHINGTON, N. Y.**



## Handling Hi-Fi Service (Continued from page 69)

cases except to try, as a last resort, physically relocating the ground points of the input stages.

There are few problems peculiar to the remainder of the amplifier circuitry that are not encountered in p.a. or radio repair work. If the customer complains that he seems to run through output tubes on a fifty- or sixty-watt amplifier (these higher-power units almost always use fixed bias) every four or five months, it is a good idea to check the bias setting in his home and under both day and evening a.c. line conditions. In residential districts near factories, you may find the line varies as much as 20 volts between the daylight and evening hours. Output tubes which have had their bias accurately set during the day may react poorly to this treatment when line voltage rises. Under these circumstances, there is no harm in setting the bias voltage a little higher (more negative) than normal.

Popular tube types used in preamplifiers and amplifiers, which should be taken along on calls, are listed in Table 1. Where more than one type number appears on a line followed by an asterisk, the last one will safely replace the others, but reverse interchangeability is not always advisable. For example, the ECC83 is claimed to be less susceptible to hum, noise, and microphonics than the otherwise identical 12AX7. Replacing the former with the latter might create a problem instead of clearing one up. FM tuner tubes have not been listed. These, which exist in great variety, are generally the same r.f. and i.f. types used in TV receivers.

A problem that has become increasingly severe now that high-fidelity is reaching the mass market is customer misuse of the various tone and loudness controls. When dealing with an experienced audiophile it is generally safe to suggest the controls be set to what his ear likes best. With the newcomer to hi-fi, brought up on the sound of the corner juke box, a little more instruction is usually necessary. Many a service call for the complaint "severe distortion" ends up as a lecture on proper control setting. Customers must be educated to the fact that adding 15 db of treble and bass boost does not make the "fi" higher, but will usually result in unnatural reproduction and excessive listening fatigue. Inform the customer that there is nothing wrong in judicious use of tone controls, but excessive use will be paid for in the coin of increased distortion.

You will seldom encounter occasions where the speaker is mechanically at fault. Infrequently a section of the crossover network will open up and cause a loss at a certain portion of the audio band. Occasionally, if there is a three- or four-way crossover where the bottom crossover frequency is 250 cy-

# HEAR the difference

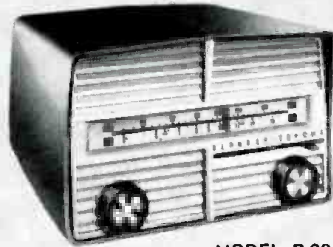

MODEL R-98

## BLONDER-TONGUE FM-AM RADIO

**DRIFT-FREE**  
 Drift compensated circuit

**STATIC-FREE FM**  
 In even the most difficult areas

**SUPER SENSITIVE**  
 Brings in all stations, AM or FM

**CIRCULAR SOUND**  
 Rear-mounted speaker for 360° sound dispersion

Hear the R-98 today at your dealer 47.50 list



**BLONDER-TONGUE LABS**  
 9 Alling Street, Newark 2, N. J.

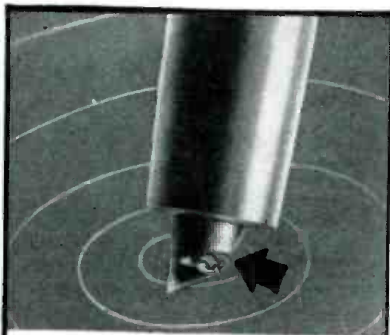

### FROM ONE WHO LEARNED

This enlargement shows a diamond-chip needle sent us by a disappointed user, who learned all diamond needles are not O.K. Shows what happens if a heat bubble forms when a chip is welded on. Can't happen with a Duotone Needle that uses only the whole diamond set deep in the metal shank.

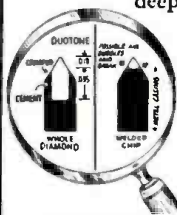

*Insist on Duotone. Be sure. Duotone's whole diamond can't break off.*

### DUOTONE DIAMOND NEEDLE

*"that remembers"*  
 Keyport, N. J.

In Canada: Chas. W. Pointon, Ltd., Toronto



cles or below, the loss of bass will not be immediately evident to the casual listener. Connection of your v.o.m., set to a low a.c. range, across each pair of the crossover output terminals while listening to program material, will check out the network quickly.

The major speaker problems usually resolve themselves into questions of placement in the listening room. At times you will get mechanical feedback from the speaker to the turntable tone arm over a distance of fifteen or more feet, if the turntable happens to be located in an area where the room's standing waves happen to peak. A slight redirection of the speaker cabinet or relocation of the turntable or both will solve this problem.

Where the complaint of unsatisfactory bass reproduction is made against a speaker system that you know, from experience, can do much better, relocation of the system may be the answer. Some systems are more sensitive to placement than others, and sometimes a slight shift will do the trick. Sometimes it is the chair generally used by the listener that is in a bad spot with respect to room reflections.

If a coaxially mounted tweeter happens to be overly piercing at the normal listening position, a small pad of coarse material glued to the cabinet grille cloth immediately in front of the tweeter will work wonders. This may often be required in addition to a tweeter level control to smooth down an overly directional tweeter.

Just as the speaker manufacturers have different ideas as to what constitutes good design, so their products differ in the specific quality of the sound produced. There are "dead" speakers and there are "live" ones. There are low-efficiency speakers with a tight, "clinical" sound and corner horns with a live "barrel house" sound. All types have their partisans. Particularly with regard to speakers, the service technician must divorce himself from his own personal prejudices in judging the condition of the customer's system. It may have always sounded "that way" and nonetheless provided enormous pleasure. You can be sure that, if a customer has lived happily with a specific type of speaker sound for some time, it is his standard for "good" sound, and any departure from it may be considered "inferior" sound.

The intent of this article was to cover some of the "rules and regulations" of in-the-home hi-fi service, as well as some of the more likely difficulties that will be encountered to help you get off on the right foot. With experience you will be able to amplify on this starting information with techniques and approaches of your own. Competent hi-fi service requires a combination of know-how, talent, and special self-training. It comes closer to being an art than most other areas of electronic service. However, unlike many another art, it is not one in which you need starve. There's gold in them thar hi-fi hills.

AWARD WINNING  
**arkay**  
STEREO, HI-FI KITS

Presents with Pride

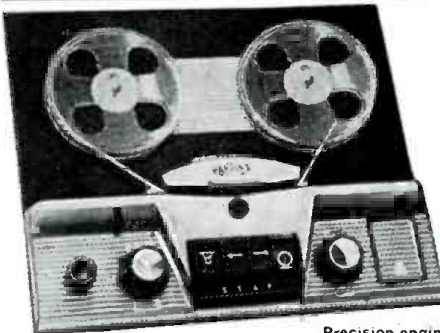

The ARKAY-HARTING MS-5  
**STEREO RECORD  
PLAYBACK  
TAPE DECK**

LONG AWAITED... NOW HERE AT LAST!  
A professional quality, popular-priced  
stereo tape deck... **\$129.95**  
only

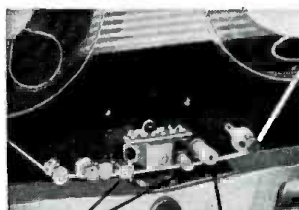

Metal guards control vertical tape alignment large capstan insures constant tape speed.

Precision-engineered to the highest professional standards... the ARKAY/HARTING captures and records your favorite music with all the faithful clarity and smoothness of tape recorders costing many times more. Hailed by audio engineers and music lovers alike for its surpassing performance, simplicity of design and operation, the ARKAY/HARTING is the finest instrument of its kind. No other tape deck—regardless of price—offers so many important professional features. Here are just a few:

- Dual-track combination head (mu-metal shielded) for stereo at both 3 3/4 and 7 1/2 IPS
- All-metal tape fingers—no cushions to wear out tape
- All-metal tape guards for vertical tape control
- Double shoe brakes for positive non-slip stops—minimizes tape stretch
- Simple, positive-acting 5-button operation, drop-in loading
- Large (1/2" diam.) capstan insures constant tape speed—virtually eliminates wow, flutter, distortion
- Automatic interlock prevents accidental erasure
- Ultra-narrow (1.2-microns wide) gap heads assure maximum fidelity during record and playback

... AND THESE SIGNIFICANT PERFORMANCE SPECIFICATIONS:

- Record and playback frequency response: 7 1/2 IPS, 30-16,000 cycles  $\pm 2$  db.
- Signal-to-noise ratio: better than -55 db.
- Flutter and wow: at 7 1/2 IPS, 1/4 of 1%; at 3 3/4 IPS, 1/3 of 1%
- Rewind time: 110 seconds for 1200 feet
- Size: 12 1/4" x 14 1/2" x 6 1/4" deep

Available soon new ARKAY stereo record and playback PRE-AMPLIFIER, in kit or Pre-wired form, specifically designed for the ARKAY/HARTING.

Write today for illustrated literature and complete specifications

**FM TUNER OF TOMORROW!**



**ARKAY FM-8**

Designed in the Arkay tradition of highest professional quality at lowest cost. No other kit or wired component

OFFERS ALL THESE ADVANTAGES:

Variable AFC — no drift • tuning meter • silent tuning mute control • "standby" off-on switch • low frequency filter • level control • 3 tuned RF stages • dual limiters • Armstrong FM — Foster Seeley discriminator • hi-level, cathode follower and stereo multiplex output jacks • sensitivity, 1.9  $\mu$ V for 20 db quieting • response, 20-20,000 cps  $\pm 1/2$  db • 8 tubes, selenium rectifier.  
Cover \$4.95

Wired and tested \$59.95, Easy-to-build Kit **\$39.95**

**NEW! MUSIC MASTERPIECE**



**ARKAY CS-28  
STEREO  
AMP/PRE-AMP  
COMPLETE  
CONTROL CENTER**

Full 28 watts stereo or monaural, 60 watts peak • 14 watts each channel • reverse stereo • balance control • two-channel gain control • full range bass and treble controls • IM distortion, 4 to 1 • harmonic distortion, 1% 30-20,000 cps • dual pre-amp 2V output jacks • speaker outputs, 4, 8, 16, 32 ohms • response, 20-20,000 cps • push-pull EL84 Williamson circuit • beauty of design that won Fashion Foundation's coveted Gold Medal!  
Wired and tested \$99.95 Easy-to-build Kit **\$64.95**



**ARKAY ST-11 AM-FM  
STEREO TUNER**

Here, for the first time, is an AM-FM STEREO Tuner within the reach of every audiophile. Unmatched by units costing twice the price, the ST-11 is two distinct receivers in one featuring 4  $\mu$ V for 20 db quieting. Variable AFC. Single front panel switch controls AM, FM or STEREO selection.  
Wired and tested \$74.50 Easy-to-build Kit **\$49.95**



**ARKAY CS-12  
STEREO AMP/PRE-AMP**

12 watts of clean power with dual inputs and outputs for excellent stereo reproduction • operates from ceramic or crystal cartridge, tape, tuners, auxiliary equipment • push-pull outputs for each channel.  
Easy-to-build Kit **\$36.95**



**NEW! ARKAY VT-10 6-INCH  
MULTI-PURPOSE  
VACUUM TUBE VOLTMETER**

Advanced design and precision features make the Arkay VT-10 a truly sensational buy, unmatched at this price. You get exclusive larger 6-INCH 400  $\mu$ a meter movement, within 2% accuracy, and edge-lighted for easier reading. 1% precision multiplier resistors are used throughout the range switch. There are 7 AC (RMS) and DC ranges, 7 AC (peak-to-peak) ranges. Resistance, db and other essential ranges. Durable plastic case.  
Wired and tested \$47.95 Easy-to-build Kit **\$25.95**

**ARKAY AV-20 6-INCH  
AUDIO VTVM  
PRE-AMPLIFIER**

Easy-to-build Kit **\$29.95**  
Wired and tested \$49.95

**ARKAY AW-30 6-INCH  
DIRECT READING  
AUDIO WATTMETER**

Easy-to-build Kit **\$29.95**  
Wired and tested \$49.95

**ARKAY CAP-40 6-INCH  
DIRECT READING  
CAPACITY METER**

Easy-to-build Kit **\$29.95**  
Wired and tested \$49.95

**ARKAY MT-50 6-INCH  
20,000 OHMS  
PER VOLT METER**

Easy-to-build Kit **\$29.50**  
Wired and tested \$42.95

See and hear completely wired ARKAY Kits at your dealer. All prices 5% higher west of Mississippi.

FREE! "Let's Talk Stereo"—informative booklet on how and why of Stereo—plus new 16 page ARKAY catalog.

Write Dept. EW

**arkay** HIGH FIDELITY MANUFACTURING  
88-06 Van Wyck Expressway Richmond Hill 18, N. Y.

# MONEY-MAKING METERS

That's what hundreds of Mobile-Radio Engineers call their Lampkin Test Equipment!



**LAMPKIN 105-B MICROMETER FREQUENCY Meter.** Range 0.1 to 175 mc. (to 3,000 mc. by checking multipliers). No additional crystals or coils needed. Price \$220.00 net.



**LAMPKIN 205-A FM MODULATION METER.** Measures peak FM swing  $\pm 12.5$  kc. or  $\pm 25$  kc. on transmitters from 25 to 500 mc. in one band. Price \$240.00 net.

Wouldn't you like a *guaranteed* income in this competition-free field? To learn more, ask for free booklet, "How To Make Money in Mobile-Radio Maintenance."



MAIL COUPON TODAY!

LAMPKIN LABORATORIES, INC.  
MFM Division, Bradenton, Florida  
At no obligation to me, please send  
 Free booklet     Data on Lampkin meters

Name \_\_\_\_\_  
Address \_\_\_\_\_  
City \_\_\_\_\_ State \_\_\_\_\_

LAMPKIN LABORATORIES, INC.  
MFM Division  
BRADENTON, FLORIDA

## Single-Sideband Transmission (Continued from page 78)

original carrier by too many cycles, the reproduced audio sounds unnatural and, in extreme cases, can become unintelligible. Pitch of the reproduced audio varies directly with the frequency difference between the sideband and the re-inserted carrier. As this frequency difference increases, pitch of the audio is also increased. This difference should be kept to less than about 50 cycles-per-second for best results. If we divide the transmitter and receiver drift equally it means that each can have a maximum frequency deviation of  $\pm 25$  cps. At communications frequencies this is extremely close tolerance.

If broadcast, a small degree of carrier amplitude can help greatly in tuning the receiver more accurately. In some services, especially in the v.h.f. band and higher, it is essential that some carrier be transmitted. Current practice, at least in some cases, is to transmit only about 10% of full carrier power. This still represents considerable savings and eliminates one of the primary disadvantages of single-sideband transmission, that of critical tuning. Some equipment uses automatic-frequency-control in a further effort toward stabilization.

For a group of SSB stations operating as a network, the transceiver-type system is advantageous. Transmission and reception are both on the same carrier frequency, giving duplex advantages with a simplex arrangement. This minimizes tuning problems because if an operator hears a message, he knows automatically that he is on the correct frequency for transmission.

SSB equipment is available from a large number of manufacturers for almost any frequency range in which it can be used. For lower power systems the initial equipment is more costly than for conventional AM systems, primarily because of the added stages which are necessary. However, as the power rating of the transmitter is increased, SSB equipment becomes proportionally cheaper than other AM gear. The saving in cost for the larger equipment is due primarily to the reduction of power requirements for the modulator, driver, and final stage of the transmitter.

For use with existing AM transmitters, SSB generators are available and at least one manufacturer has a model available in kit form. These separate generators create SSB output from conventional AM signal input. Receiver costs do not differ greatly when compared to other AM receivers.

The two disadvantages of SSB, stability requirements and critical tuning, are more than offset by the advantages already listed. Improved components, both in transmitter and receiver, have made SSB a definite possibility and a definite probability for extensive use in all communications services. —30—

ANOTHER HUNTER FIRST!



3 NUT DRIVERS in 1  
IN 3 POPULAR SIZES

1/4" · 5/16" · 3/8"

FREE!  
32 PAGE TOOL CATALOG

SLUG RETRIEVERS

Magic-Tip  
SCREW HOLDING  
SCREWDRIVERS

NOW IN 14 PROVEN SIZES!

9851 ALBURTIS AVE.  
SANTA FE SPRINGS, CALIFORNIA



## CITIZENS BAND TRANSCEIVER 27 MC TWO-WAY TOP PERFORMANCE AT POPULAR PRICES



**NEW CUSTOM DISPATCHER**  
Crystal controlled receiver and transmitter, complete with mike, power supply—squelch ..... **\$129<sup>95</sup>**

**KIT FORM—MODEL 1000 DK**  
C.E.I.'s now popular kit, complete with all parts and easy-to-follow instructions, F.C.C. form 505. A superheterodyne receiver with RF stage amplifier. At the price others charge for super regenerative set..... **\$59<sup>95</sup>**  
The 1000 DK can be tuned to all 22 channels, plus 10 meter band.

All units come complete with mike, squelch and noise limiter, and will operate on 6V DC, 12V DC or 117V AC merely by connecting proper wires in the power plug. Prices F.O.B. Chickasha. 15% deposit on C.O.D. orders.

**CHICKASHA ELECTRONICS, Inc.**

P. O. Box 702 Chickasha, Oklahoma

# Very Few Left!

While the supply lasts...  
get this brand new

## STEREO-MONOPHONIC TEST RECORD

produced by the editors of  
**ELECTRONICS WORLD**  
...and enjoy top performance  
from your hi-fi system!



Special to  
our readers  
for only...

Now we know what the Gold Rush must have been like! The past month has brought an unprecedented landslide of orders for this new, trouble-shooting test record from readers of **ELECTRONICS WORLD**. We're still counting and filling them by the thousands! But the supply is practically depleted. So unless your order is already in the mail, we urge you to fill in and return the coupon below—*right now!*

Here are some of the questions this record will answer for you!

- ✓ How good is my stylus? Is it worn?
- ✓ Will it damage my records?
- ✓ What about my stereo cartridge?
- ✓ Does it have enough vertical compliance so that it won't ruin my expensive stereo records?
- ✓ Is my turntable running at the right speed? Is it free of rumble, wow, and flutter?
- ✓ What sort of standing waves do I get in my listening room?
- ✓ Are my speakers hooked up correctly? Are they phased properly, and is the correct speaker connected to the right stereo channel?
- ✓ How perfectly is my system equalized?
- ✓ What about separation? Is it adequate?

You'll get on-the-spot-answers to these and many other questions when you use this Stereo-Monophonic Test Record. It's the *most complete test record* of its kind—contains the widest range of essential check-points ever incorporated into one test disc! And, best of all, you need no expensive test equipment when you use this record! Just listen and get the thorough results you want—all checks can be made by ear!

As a man who is seriously interested in hi-fi, you can immediately see the ex-

traordinary 2-way value you get from this special test record. First, it guides you in evaluating the quality of reproduction your equipment now produces. Second, it specifies the adjustments necessary to get the best recorded sound you have ever heard! Add up the advantages! Check the special low price! This is easily the best value of the year for everyone who owns a hi-fi system—either monophonic or stereo!

**Don't miss out—Order your Test Record for just \$1 now!**

This Stereo-Monophonic Test Record has been produced as a service for readers of *Electronics World*. You can be sure that it comes as close to perfection as is humanly possible, because the editors have poured their accumulated know-how into this project for a period of many, many months. You

may obtain a copy at the special reader-price of just \$1.

But the supply is running out... and orders will be filled on a *first-come, first-served* basis. So avoid disappointment—fill in and mail the coupon, together with your check (\$1 per record) *today!*

### Special Features of ELECTRONICS WORLD 7" Stereo-Monophonic Test Record

- Four bands for stereo checks only—plus three bands for checking stereo or monophonic equipment!
- Made of top-quality virgin vinyl for long wear!
- Specially-reinforced center resists wear!
- Delivered in special polyethylene envelope—dust and dirt are sealed out!
- Fully guaranteed!

**FILL IN  
AND  
MAIL  
TODAY!**

**ELECTRONICS WORLD • P.O. Box 523, New York 8, N.Y.**

Please send me \_\_\_\_\_ test records at \$1 each. My money order or check for \$\_\_\_\_\_ is enclosed. I understand that you will pay the postage and that each record is fully guaranteed.

Name \_\_\_\_\_ Please Print

Address \_\_\_\_\_

City \_\_\_\_\_ Zone \_\_\_\_\_ State \_\_\_\_\_

SORRY—no charges or C.O.D. orders!

W-10

**IF YOU MUST SPEND YOUR MONEY**  
 Why not get something for it?  
 get **QUIETROLE**



**QUIETROLE**  
 MADE IN U.S.A.  
 Costs little more than the poorest substitutes. Why take less than the BEST...  
 No Product can match its merit...  
 None can equal its quality...  
 It's the answer to noisy controls and switches  
 QUIETROLE is the original product of its kind  
 BY **QUIETROLE** Company  
 SPARTANBURG, South Carolina  
 IN CANADA: ACTIVE RADIO and TV DISTRIBUTORS  
 58 Spadina Ave., Toronto 28, Ontario

It's all there on **SOUNDCRAFT TAPE**  
 because Soundcraft is the world's best recording tape!  
 Buy it today!

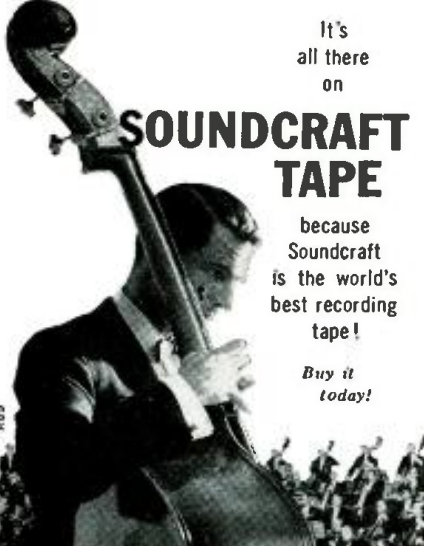

Reeves Soundcraft Corp., Gt. Pasture Rd., Danbury, Conn.

**ELECTRONICS**  
 PREPARE FOR A GOOD JOB!  
 BROADCAST ENGINEER  
 RADIO SERVICING AUTOMATION  
 TELEVISION SERVICING  
 BLACK & WHITE—COLOR  
 APPROVED FOR VETERANS AND SURVIVORS OF VETERANS  
 BUILDING AIR CONDITIONED  
 SEND FOR FREE LITERATURE  
**BALTIMORE TECHNICAL INSTITUTE**  
 1425 EUTAW PLACE, BALTIMORE 17, MD.

# Service Notes



## MOTOROLA: NO H.V.

When no high voltage can be found at the second-anode connector of TV receivers using the RTS-544 chassis, a good possibility is that  $R_{515}$ , the 27,000-ohm high-voltage decoupling resistor, has become open. The obvious remedy is replacement of this unit with another 27,000-ohm unit, rated at 1 watt. However, when this occurs, another precautionary check is called for to prevent repeat failure. If the 3A3 high-voltage rectifier has become gassy,  $R_{515}$  will tend to overheat, paving the way to breakdown. The 3A3 should accordingly be checked for possible gassiness whenever the resistor has failed.

## PHILCO: LINE RADIATION

When other receivers are operated from the same a.c. source to which a TV set using the 9L35 chassis is connected, it is possible that signals from the 9L35, while it is operating, may feed back into the power line, causing interference to other units. If this condition is discovered, eliminating the symptom at the source is easily accomplished by adding a bypass capacitor to the Philco TV receiver. A convenient way of doing this is to wire a .047- $\mu$ f., 400-volt capacitor from lug 8 of socket 1 on the main chassis to nearby lug 7 of terminal board 2. Later versions of this receiver, beginning with run 4, have such a capacitor added.

## SYLVANIA: 10DE7 FAILURE

When the vertical-oscillator and output tube ( $V_9$ , 10DE7) in receivers using the 1-537-5, -6, or 1-539-3, -4 chassis fails, correction of the fault should not stop with the replacement of the tube itself. With the circuit used in the original version of these chassis, life ex-

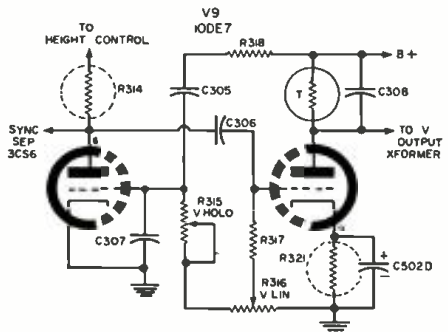

Fig. 1  
 pectancy of the tube is somewhat reduced. However, a simple change involving two resistors, made in later production (CO3 revisions, beginning with chassis serial numbers 537503 and

**RADIO ELECTRONIC SURPLUS**

**BC603 FM RECEIVER**  
 20.-27.9 mc. Equipped with 10 push buttons for selecting channels. Cont. variable tuning over the entire range. Unit complete with tubes, built-in loud speaker, squelch circuit, head phone jacks, schematic diagram on bottom of case. Approx. weight 34 lbs.  
 Used Good.....\$9.95  
 Like New.....\$12.95

DM-34 Dynamotor 12 or 24-volt D.C....each \$3.95  
 BC-604 Transmitter; 20.-27.9 mc  
 NEW.....\$4.95  
 Crystals (set of 80) for BC604 transmitter, 20 to 27.9 mc  
 Price.....\$5.00 per set  
 Manual with schematic for BC603/BC604.  
 Price.....\$1.00 each

DM35 DYNAMOTOR: 12 Volt input, output 625V., 225A  
 Used with BC-604.....\$9.95  
 12V Eitor Dynamotor: Output 440V, 200A. NEW \$7.95

**PE120 POWER SUPPLY**  
 6, 12 or 24-volt (specify voltage).  
 Used with BC659 and 620.....\$6.95 each

**TEST SCOPE—SYNCHROSCOPE—PULSE ANALYZER**  
 ID-59/APA-11. Late production. Modular subassembly construction. Video amplifier is flat to 4 mc. 3BP1 presentation. Test-scope sawtooth 25-20,000 cy. Has all normal test-scope controls. As synchroscope and pulse analyzer, accepts positive or negative pulses. Video delay circuit permits leading edge of pulse to be seen. Calibrated-dial horizontal shift measures pulse durations from 0.5 to 100 microseconds. Sine-wave-oscillator calibrator measures recurrence rates from 200 to 6000 pps accurate within 0.4%. Built-in power supply requires 115v, 400 cy, 196 watts. External 60 cy power supply may be made to furnish plus 350 and -1300 vdc and 6.3 vac. In excellent condition, with all 19 tubes, schematic with parts values, parts-location pictures, operating instructions, theory explanation, and maintenance charts. Shipping weight 60 lbs. Used, good. Price each \$19.30

NO C.O.D.'s. REMIT FULL AMOUNT WITH ORDER. ALL PRICES F.O.B. PASADENA.

**C & H SALES CO.**  
 2176 E. Colorado St. - Pasadena 8, Calif.

Locate Hard to Get Tubes at Big Savings!  
**DIRECTORY and BUYERS GUIDE for Electron Tubes**  
**GET YOUR COPY ABSOLUTELY FREE!**  
 This brand new "Directory" covers almost every tube made by American manufacturers. Top name brands as well as specialized brands are included. Receiving, Television and Special Purpose tubes are listed by type numbers and low, low prices.  
 Send for your copy now, it's FREE and will Save You Money On Tubes  
**METROPOLITAN SUPPLY CO. • Dept. E-10**  
 1133 Broadway • New York 10, N. Y.

**GET INTO ELECTRONICS**



V.T.I. training leads to success as technicians, field engineers, specialists in communications, guided missiles, computers, radar and automation. Basic and advanced courses in theory and laboratory. Associate degree in electronics in 29 months. B.S. in electronic engineering obtainable. ECPD accredited. G.I. approved. Graduates in all branches of electronics with major companies. Start February, September, January campus. High school graduate or equivalent. Catalog.

**VALPARAISO TECHNICAL INSTITUTE**  
 Dept. RD Valparaiso, Indiana

537603 in each of the two chassis versions), will prolong tube life. Check the value of the plate-load resistor in the first triode (connected to pin 6). The original component,  $R_{214}$ , was a 1.2-megohm unit. See Fig. 1. This should be changed to  $R_{214-1}$ , 820,000 ohms,  $\frac{1}{2}$  watt. The resistor may be found by guiding on coordinates E-7 on the location chart in the service data. The cathode resistor for the second triode of  $V_2$ , connected to pin 9, should also be checked. The original part,  $R_{221}$ , was 150 ohms. See Fig. 1. It should be changed to  $R_{221-1}$ , 270 ohms, 2 watt. It may be found on coordinates F-8 on the location chart for identifying components in the manufacturer's service literature.

### OLYMPIC: AUDIO HUM

On some radio-phono combinations using audio amplifier chassis SA 812 and SA 813, there may be a tendency for buzz or hum to develop. This symp-

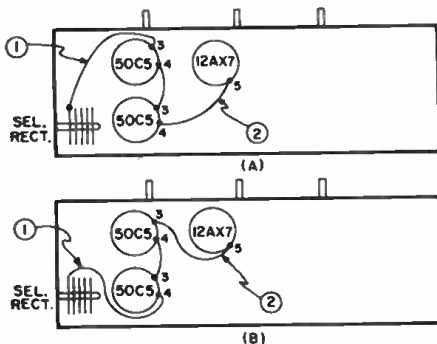

Fig. 2

tom can generally be remedied by altering the series-filament wiring of the audio-amplifier tubes. As shown in Fig. 2 (old wiring in part A, new wiring in part B), only three tubes are involved in the change. Furthermore, only two connections need be opened and interchanged. The wire from the selenium rectifier to pin 3 of one 50C5 (lead 1) is disconnected at the tube pin. The wire from pin 5 of the 12AX7 (lead 2) to pin 4 of the other 50C5 is also disconnected at the latter point. These two are then reconnected, each going to the tube pin formerly occupied by the other.

### TRAV-LER: DEAD RECEIVER

When there is no sound or raster on TV receivers whose model numbers begin with 721, or which are in the 1700 series, an open tube filament is not the only possibility. Checks should be made of the Surlgistor and plug-in type fuse resistors used in these sets. If the receiver is dead and no tubes are lit, Surlgistor  $F_6$  should be checked in addition to tubes for a possible open condition. If there is no sound and no raster but the small tubes are glowing, plug-in type resistor fuses  $F_{6-1}$ ,  $F_n$ , or  $F_{10}$ , depending on the chassis used, should be investigated. This condition may also be due to a defective low-voltage rectifier, 5U4GB.

**BASIC AUDIO** by Norman H. Crowhurst. The Rider "picture-book" approach has made many technical subjects understandable to many hundreds of thousands of people. Now, everything about sound and audio reproduction is made crystal-clear. If hi-fi is your interest—or if you work with tape recorders—or the broad subject of sound reproduction, interests you,—or if you assemble your hi-fi equipment or buy a complete "package"—you must read **BASIC AUDIO**.

If you already own sound reproducing equipment—this "picture-book" course will give you an all-around background on all the important details of sound reproduction. It will enable you to get most from your equipment.

You can learn easily, rapidly at very low cost. You build your knowledge step-by-step. There's one idea and one specially prepared illustration per page. More than 400 illustrations for maximum understanding.

Beyond a knowledge of electricity at the basic level, no previous electronic experience is needed to get the maximum from this course. Whatever electronics circuit theory is required is provided.

This Rider "picture-book" audio course is completely different from anything that has even been presented. We guarantee your satisfaction.

#201, 3 vols., soft covers, \$8.70 per set.

**LOW-FREQUENCY AMPLIFIER SYSTEMS** (Volume 31 in the Electronic Technology Series) edited by Alex. Schure, Ph.D. A companion volume to **LOW-FREQUENCY AMPLIFIERS**, this text extends the study into the field of low-frequency amplifier systems including the d-c amplifier. #166-31, \$1.80.

**SHORTWAVE PROPAGATION** by Stanley Leinwoll (Radio Frequency and Propagation Mgr.—Radio Free Europe). Of special interest to those concerned with radio communications, this text provides a modern, up-to-the-minute analysis of shortwave propagation. Ionosphere characteristics are discussed together with the nature of radio waves. The book then carries the reader into the sky wave, measuring the ionosphere, ionospheric variations, the sunspot cycle, and abnormal phenomenon. Sky wave propagations are covered and the preparation of MUF curves are discussed. There is considerable material of interest to the amateur radio operator. #231, \$3.90.

### BASICS OF MISSILE GUIDANCE & SPACE TECHNIQUES

by Marvin Hobbs. You can learn and easily understand the fundamentals of the important electronic areas that will contribute to the conquest of space with this two-volume "picture-book" course. Volume 1 covers elements of control and guidance—radio and radar command links; guide beams, doppler and homing methods; fundamentals of gyroscopes; inertial and celestial navigation; computer applications; actuators and their related components. Volume 2 covers radio telemetry and space techniques; testing and telemetering; space exploration by optics and electronics; satellite theory and practice; monitoring, tracking; earth satellite applications; space navigation. #229, 2 vols., soft covers, \$7.80; #229-H, 2 vols., in one cloth binding, \$9.00.

**PRINCIPLES OF TRANSISTOR CIRCUITS** by S. W. Amos, B.Sc. A remarkably lucid presentation of the principles underlying the application of transistors. The book deals with the fundamental theory of the transistor, but emphasis is on design of a wide variety of circuits. #241, \$3.90

learn code faster, easier than ever before—

## RIDER SOUND-N-SIGHT CODE COURSE

by Lewis Robins & Reed Harris

- applies REINFORCED LEARNING—a psychological principle proved successful by the Armed Forces.
- uses LP records to teach you to hear signal pattern correctly and identify it—how to transmit.
- uses identification cards to teach you the correct letter associated with each signal pattern.
- uses instruction book to speed your progress. . . plus an imaginary instructor (in complete and novice courses) provides correct answers to speed code learning. Many people have learned to receive 5 words per minute within 9½ hours. Eliminates code plateau barrier!

**Scores Nation-wide Successes**—Frank Alessi, Jr., 9-year-old achieves general class license using Sound-N-Sight Code Course.

**From the Monmouth Message, April 30, 1959.** "Fort Monmouth—Student officers of the Radio Officer MOC Course, Section 3210, have made exceptional progress . . . mastering Morse Code instructions utilizing the Rider 'Sound-N-Sight' method . . . students have progressed much faster than all previous classes."

\* Prices subject to change without notice. or order direct.

### R-L-C COMPONENTS HANDBOOK

by David Mark. An extremely comprehensive coverage of the fundamental components used in radio and electronic equipment is provided for the beginner as well as the technician. The text leaves nothing to the imagination. It starts and finishes with the practical approach to the functioning and utility of electronic components without which no electronic device could function. Most component failures can be avoided by properly utilizing basic principles. Resistors, capacitors, inductors, and transformers—are covered. Voltage, temperature, resistance, current, and numerous other electrical characteristics and ratings are explained as well as coding techniques and physical details. #227, \$3.50.

**R-F AMPLIFIERS** (Volume 27 in the Electronic Technology Series) edited by Alex. Schure, Ph.D. An excellent discussion of the operation of amplifiers in the r-f portion of the radio frequency spectrum. The design and theory of operation of a wide range of r-f voltage and power amplifiers are covered. #166-27, \$2.40.

### EFFECTS OF NUCLEAR RADIATION ON MEN AND MATERIALS

by T. C. Helvey (Director of Biophysics and Astrobiology Branch, Radiation, Inc.) Nuclear power for propulsion of military and civilian vehicles has become a reality. However, the application of nuclear energy in mobile units has presented a great many unexpected and unheard-of technological and biological problems. This book discusses the basic nature of nuclear radiation—alpha, beta and gamma rays—and their physiochemical and biochemical effects. Radiation effects on man, deals with details of ionizing radiation, dose tolerance, genetic effects of radiation, and air ionization and its biological effects.

In covering radiation effects on materials, the author discusses the effects of nuclear particles on materials such as textiles, adhesives, plastics, fuels, and inorganic materials such as metals, ceramics and glass.

A feature of this book is a chapter on shield configuration covering transparent shielding materials, partial body shielding, and special shields for gamma and neutron bombardment. #243, \$1.80.

# NEW RIDER BOOKS TO SPARK YOUR PROGRESS IN ELECTRONICS

THE EASIEST, MOST ECONOMICAL WAY

### 4 FABULOUS 'PICTURE BOOK' COURSES

You can learn any electronic subject easily, rapidly at low cost with these "picture-book" courses. Important areas of electronics are presented in simple down-to-earth language. There's a specially prepared and selected illustration on each page—to support each idea.

**BASIC ELECTRICITY** by Van Valkenburgh, Nooger & Neville, Inc., #169, soft cover, 5 vols., \$10.00; #169H, all 5 vols. in single cloth binding, \$11.50.

**BASIC ELECTRONICS** by Van Valkenburgh, Nooger & Neville, Inc., #170, soft cover, 5 vols., \$10.00; #170H, all 5 vols. in single cloth binding, \$11.50.

**BASIC TELEVISION** by Alexander Schure, Ph.D., #198, 5 vols., soft cover, \$10.00; #198H, all 5 vols. in single cloth binding, \$11.50.

**BASICS OF DIGITAL COMPUTERS** by John S. Murphy, #196, 3 vols., soft cover, \$7.50; #196H, all 3 vols. in single cloth binding, \$8.50.

### 3 INDIVIDUAL COURSES—THERE'S ONE FOR YOU

**COMPLETE COURSE** (0-20 words per minute)—Six 10" LP records (192 minutes of recording, 46 recordings), 47 cards, book, #REC-020, \$15.95.

**NOVICE COURSE** (0-8 words per minute)—Three 10" LP records (96 minutes of recording, 28 recordings), 47 cards, book, #REC-08, \$9.50.

**ADVANCED COURSE** (9-20 words per minute)—Three 10" LP records (96 minutes of recording, 28 recordings), book, #REC-920, \$8.95.

Records prepared in collaboration with the N Y Institute of Technology and mfd. by Decca Records.

Other Rider books that add to amateur radio enjoyment are: Getting Started In Amateur Radio; Building The Amateur Radio Station; Radio Operator's License Q & A Manual (6th edition) How To Read EW-10 Schematics.

At your jobber or book store, or order direct.



JOHN F. RIDER PUBLISHER, INC., 116 West 14th Street, New York 11, N. Y.  
Canada: Chas. W. Pointon, Ltd., 66 Racine Rd., Rexdale, Ont.  
Europe & British Isles: Chapman & Hall Ltd., 37 Essex St., London. India: Asia Publishing House, Bombay and other cities.

# NOW Service Any TV Set Like a "PRO"!



Brand-New Edition of Famous Shop Manual Will Lick "Tough Dogs," Save You Time, Increase Your Income 25% to 65%!



MAN, if you've ever cursed over a tough repair . . . if you've ever wanted more money . . . if you've ever wanted your business and reputation to grow . . . here's a powerful shove in those directions—the new *Television Receiver Servicing!* Everything . . . and that means every new idea, every technique, every profitable practice . . . collected from little repair shops, part-time servicemen, big research centers . . . all

the "red meat" of TV maintenance, repair and service has been collected into this big 300-page guide and manual.

### Huge . . . Yet So Easy to Use!

You want quick facts on how to deal with tough antenna installations and ghost problems? Turn to Chapter 1 and get many field tested suggestions. What frequency an antenna should be cut to? Turn to page 6 and get 4 columns of clear explanation, with examples. What does an ideal video amplifier response curve look like? Page 127 illustrates it for you. What should you know about servicing color television receivers? Read the simple text from page 281 to page 300. Antennas (30 pages) . . . installing TV receivers (12 pages) . . . test equipment (27 pages) . . . RF, IF and video detector stages (45 pages) . . . video amplifiers (12 pages) . . . AGC systems (10 pages) . . . picture tubes, test patterns, deflection systems (23 pages) . . . receiver alignment (20 pages) . . . UHF . . . Color (32 pages) . . . there's even an easy-reference trouble-shooter's chart, and end-of-chapter questions, plus a complete, subject-by-subject index to put everything at your fingertips fast! With all this material, 421 pictures, 15 chapters, explained in A-B-C fashion, it's no wonder that TV Receiver Servicing is the "Bible" of the industry!

### 10-Day FREE Examination for Readers of This Magazine

Use this for ten full days at our expense. Put its good sense to work on your toughest problems. If you're not 100% sure it's the biggest profit-making and time-saving friend you ever had, return it. You owe nothing. But mail coupon now. Once the printing is gone, it will take months to rush out another.

D. VAN NOSTRAND COMPANY, INC.  
Dept. 3710, 120 Alexander St., Princeton, N. J.

### Mail This for Free-Use Copy

D. VAN NOSTRAND COMPANY, INC.  
Dept. 3710, 120 Alexander St., Princeton, N. J.

Please send me—for 10 days' FREE USE—a copy of the new 4th Edition of *Television Receiver Servicing*. If I'm not completely sure it will increase my income by at least 25%, I'll return it within 10 days and owe nothing. Otherwise I'll pay \$2.50 down, plus small delivery charge, then \$2.00 a month for two months as full payment.

Name

Street

City  State  Zone

SAVE POSTAGE by enclosing \$6.50 with this coupon. Same return privilege, money back if not completely satisfied.  
(In Canada: 25 Hollinger Rd., Toronto 16)

# Manufacturers' Literature

### "CALL-BACK" INSURANCE

CBS Electronics, Parker Street, Newburyport, Mass., has released a new bulletin entitled "Call-Back Insurance." This bulletin, PA-222, can be obtained by writing to the firm's Advertising Service.

Two of the more common causes of premature failure of replacement tubes in the customer's set are heater current surges and internal arcing. In this new four-page bulletin, author Bud Tomer describes simple circuit modifications and adjustments the service dealer can make himself to help eliminate these two important causes of "call-backs."

### CAPACITOR CATALOGUE

Illinois Condenser Company, 1616 North Throop Street, Chicago 22, Illinois, has released a new six-page, two-color catalogue on subminiature electrolytic capacitors.

The booklet includes pictures, diagrams, technical information, and general information as well as charts for the guidance of anyone interested in the company's line.

For a copy of the catalogue and additional information, contact the firm at the above-mentioned address.

### MODULAR BENCH SYSTEM

Products For Industry, Inc., 1530 Summer Street, Stamford, Conn., has a new illustrated six-page bulletin describing modular assembly benches which are not limited to fixed dimensions and which are made from standard catalogue parts.

The bulletin illustrates various configurations in which benches can be arranged showing modular and other accessories, used only where needed. Four different installations are featured, each meeting different needs. Also described is a layout planning package which can make at least 34 different layouts.

### LAFAYETTE'S 1960 CATALOGUE

Lafayette Radio's new catalogue, No. 600, is now available free upon request. Write to the firm at 165-08 Liberty Avenue, Jamaica 33, N. Y.

The 1960 general catalogue contains over 300 pages of the latest electronic parts and equipment, including a complete line of stereo hi-fi components.

A full presentation of radio and television parts, transistor kits and miniaturized components, antennas and installation accessories, amateur gear, tools, technical books, telescopes, microscopes, and cameras are shown, as well as an extensive section on public address equipment.

The section on industrial equipment contains receiving and special purpose tubes, rectifiers, switches, relays, transformers, converters, and specialized components.

A new line of precision scientific instruments is offered, including refractometers, spectrometers, and an engineer's transit.

### 1959 NEDA BATTERY INDEX

National Electronic Distributors Association, 343 S. Dearborn St., Chicago 4, Illinois, is now distributing the 1959 NEDA Battery Index.

This seventh edition is available to all electronic distributors, whether members of the Association or not.

The format of the 1959 Index has been changed to make it usable both as a wall chart and in counter catalogue racks. It is a cross-reference and interchangeable numbers compilation prepared by representatives of manufacturers of batteries and the NEDA battery index committee.

### REPLACEMENT GUIDE

Triud Transformer Corporation, 4055 Redwood Avenue, Venice, California, has released its new replacement guide and catalogue TV-60. Copies may be obtained through the firm's distributors or by writing the company direct.

In addition to the guaranteed recommendations for the majority of replacement problems, the booklet contains a catalogue of transformers manufactured by the company for television and audio applications.

### CONVERSION CHART

Precision Equipment Co. has published a reference table for engineers in wall-chart form. For a free copy, write to the firm, 4411E Ravenswood Ave., Chicago 40, Illinois.

Included in the chart are common conversions such as inches to centimeters or watts to horsepower, as well as many conversions that are sometimes difficult to locate in reference manuals.

### POWER AND GAS TUBES

RCA's Electron Tube Division has published a revised and enlarged edition of its popular 24-page booklet on the firm's power and gas tubes.

This new 32-page edition contains data on 19 new tube types. It provides concise technical information on power tubes, rectifier tubes, thyratrons, and ignitrons. Each tube type is covered by a thumb-nail text description; charted dimensions, ratings, and operating values; and a base or terminal-connection diagram. Photographs of represen-

tative tube types in each tube family are shown throughout the publication.

The booklet, PG-101D, may be obtained from the company's electron tube distributors or by sending 30 cents direct to Commercial Engineering, RCA Electron Tube Division, Harrison, N. J.

### NEW CENTRALAB CATALOGUE

Centralab, a division of Globe-Union, Inc., 900 E. Keefe Avenue, Milwaukee 1, Wis., has just published a new 24-page catalogue. It may be obtained through any of the firm's distributors or by writing direct to the company.

The new brochure lists over 1700 composition and wirewound controls, ceramic capacitors, switches, and packaged circuits. It contains 128 new replacement auto radio controls, exact replacement stereo controls, a full line of miniature 5-watt wirewound controls with ratings to 100,000 ohms, 10-volt ultraminature capacitors for transistor circuits, and many other items.

### FILTERS AND TRANSFORMERS

United Transformer Corporation, 150 Varick Street, New York, N. Y. has issued two new catalogues.

Now available is a general catalogue which covers the full range of over 800 stock items, complete with specifications, applications, and all pertinent information. Also, a new separate catalogue, covering filters and inductors, has been issued. Attractively covered and lending convenience for filing and reference, it contains specifications and all pertinent information on stock items in this category.

### OHMITE BULLETINS

Ohmite Manufacturing Co., 3634 Howard Street, Skokie, Illinois, has available its Bulletin 152D, obtainable at no cost direct from the firm.

The bulletin gives complete details on the firm's series TF tantalum foil electrolytic capacitors.

Made-to-order and stock capacitor values are listed along with equivalent MIL type designations.

-30-

## NEW CITIZENS' TRANSCEIVER!

Your own personal 2-way radio for business or pleasure!



Anyone can operate—license issued by FCC on request!

- Maximum legal power • Push-to-talk microphone • Meets all FCC requirements • Complete Class "D" (27 Megacycles) Citizens' Band coverage — your choice of 5 channels at the flip of a switch!

"More than just 2-way radio" — the Viking "Messenger" is the very finest personal communications equipment available in the field! Designed for reliability and easy installation in your home, business location, car, truck, or boat. Excellent receiver sensitivity and selectivity. Built-in Squelch, Automatic Volume Control, and Automatic Noise Limiter. Compact, modern styling — only 5 3/8" high, 7" wide, and 11 3/8" deep. Complete with tubes, microphone, and crystals for one channel. 3 models available: 115 Volts AC; 6 Volts DC and 115 Volts AC; or 12 Volts DC and 115 Volts AC.

Manufacturers of the world's most widely used personal communications transmitters



### E. F. JOHNSON CO.

101 Second Ave. S. W. • Waseca, Minnesota

- Please rush me your full color brochure describing the Viking "Messenger" Citizens' Transceiver.

NAME \_\_\_\_\_

ADDRESS \_\_\_\_\_

CITY \_\_\_\_\_

STATE \_\_\_\_\_

**FREE BROCHURE**

SEND COUPON TODAY!

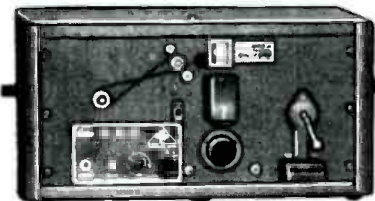

### TG-10 CODE PRACTICE SET

Learn to copy code, or improve your speed with this unit. For individuals and especially one for schools or groups. Complete automatic unit operating from 110 volt 60 cycle using lined paper tapes in Reader Drive via an audible means the Morse code. The keyer may be set from 5 words per minute to 25 words per minute. Use of a key instead of tapes for classroom work especially good due to 10 watt amplifier allowing many sets of earphones to be connected. These are NEW IN ORIGINAL BOXES for only **\$19.95**

TG-10 in used excellent condition only... **\$14.95**

COMPLETE SET OF 15 Code Tapes in Carrying Case... **\$15.95**

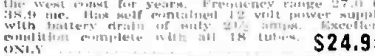

### BC-1335 10 METER TRANSCEIVER

Late model miniature FM unit has been the rave on the west coast for years. Frequency range 27.0 to 28.0 mc. Has self contained 12 volt power supply with battery drain of only 2.5 amps. Excellent condition complete with all 18 tubes... **\$24.95**



### EE-8 FIELD PHONES

The standard signal corp. field telephone requires 2 flashlight cells for operation over many miles. Good checked out condition. ONLY **\$7.95** Each... **\$15.00** Per Pair



### FM TRANSMITTER-RECEIVER

APN-1 Transceiver ideal for conversion to citizens band. Has a frequency range of 420-440 mc. Complete with 14 tubes in excellent condition. ONLY **\$3.95**



### ARR-2 UHF RECEIVER

R-1 ARR-2 Receiver is tunable over the frequency range of 234-278 mc. Uses 11 miniature tubes. In excellent condition complete with TUNING MOTOR and ALL TUBES. ONLY **\$2.95**



### RADAR DIRECTION FINDING OSCILLOSCOPE

DR-80 APA-17: Amplifies and gives visual indication of the relative bearing of radar or radio signals in the frequency range of 250-1000 mc when used in conjunction with a receiver covering the same range. Ideal for conversion to high quality oscilloscope. Has 8 tubes plus three inch scope tube. Tubes, Scales, controls, and other components alone are worth **\$9.95**

T-17 CARBON MICROPHONES... USED EXC. **\$3.95**

BRAND NEW, BOXED... **\$5.50**

### POWER SUPPLY SPECIALS BOTH MOBILE AND FIXED

DM-35-11 Miley Mite dynamotor. 12VDC input will give you 625 VDC @ 225 ma in an extremely small package. Will fit the glove compartment of almost any auto. BRAND NEW... ONLY **\$7.95**



### PE-100

Originally built for 10" panel mounting. Unit has joined **20** 1/2 volt dynamotor on chassis. Dynamotor outputs are 225 VDC @ 60 ma. Continuous or better Intermittent. Complete filtered and fused with pilot light indicator on panel. BRAND NEW... ONLY **\$2.95**



### CIA-20330

This is the steel of the century. This power supply is voltage regulated, completely enclosed with its own crackle finish cover, and fused. Input voltage is 115 volts 60 cycle. The Three outputs deliver 100 VDC, 100 VAC and 1/2 VAC for filament. Only a few at this remarkable price... ONLY **\$4.95**

### PRECISION VACUUM TUBE VOLT METER

As illustrated this unit covers the following measurement ranges. Resistance in 8K steps from one ohm to 1000 megohms. DC VOLTS in 8K steps and two scales from 1-1000 VDC. AC VOLTS in 8K steps and two scales from 1 volt to 1000 VAC. DC VOLTS read both negative and positive. These VTVMs apparently in excellent condition with built in DC probe... ONLY **\$19.95**



### 100 W. COLLINS AUTOTUNE TRANSMITTER

Famous APT-13 AM, CW, MCW, 11 channel Transmitter tunes the band from 2-18.1 mc. Quick automatic tuning to any of 11 preset frequencies or manually through the extremely accurate VFO. Self contained modulator uses PP 811 to modulate 813 dual up to 60% class "B". Will give top performance with either carbon or magnetic microphone. COMPLETE WITH ALL TUBES... **\$34.95**

Excellent condition... ONLY **\$34.95**

### 95¢ BARGAINS BOX!

Control Boxes as follows: all 95¢ each. C-15 ARR-2... C-16 ARR-2... C-2 ARR-2... C-25 ARR-5 for single receiver... C-26... MT-55 ARR-5 Triple Receiver Racks... BRAND NEW... 95¢ each

MT-75 ARR-5 Dual Transmitter Racks... BRAND NEW... 95¢ each

### HIGH POWERED OIL CAPACITORS

3 Mfd. @ 4000 VDC... Limited Quantity... **\$5.95**

5 Mfd. @ 9000 VDC... **\$2.95**

### WILLARD WET CELL BATTERY

This is the standard Willard 25-2 dry charged. Made to fit many portables using rechargeable wet batteries. 2 Volt 25 Amp... ONLY **\$2.95**

### THE STEAL OF A LIFETIME

IC-112-A or IC-2 ARR-5 Antenna switching units. Contain double pole double throw Antenna change over relay, thermocouple, RF Meter, and 500ma 500 volt vacuum capacitor. Complete unit in excellent condition... ONLY **\$15.00**

### CODE PRACTICE SET Tg-5

Ideal for novice training. This unit comes complete with carrying case and carbine with built in standard telegraph key. Two or more units may be used together for CW training or for communications purposes over several miles. Brand New, Ea... ONLY **\$9.50**

Set of 2... ONLY **\$9.50**

### SEND FOR NEW FREE BARGAIN-LOADED INTRODUCTORY FLYER!

TERMS: all orders P.O.B. our warehouse Los Angeles. 25% deposit required on all C.O.D. orders. All items subject to prior sale. Minimum order \$3.00. Orders over 20 lbs. shipped via motor truck or rail express whichever may be cheaper.

# AERONETICS INTERNATIONAL

5645 WEST ADAMS BLVD.  
LOS ANGELES 16, CALIF.  
PHONE Webster 3-7538

HERE'S THE LIBRARY YOU NEED!

# "101 WAYS" BOOK SERIES

by Bob Middleton

BEST-SELLING  
**SAMS BOOKS**



NEWEST VOLUME

## "101 Ways to Use Your Audio Test Equipment"



A practical, invaluable "how-to-do-it" book for audio test work. Describes uses of special instruments, such as harmonic-distortion meters, intermodulation-distortion analyzers, audio wattmeters, audio VTVM's and tone-burst generators; covers

general uses of regular VOM's, VTVM's, scopes and square-wave generators in audio work. Each application is cross-indexed for quick location. 100% practical information for the professional audio technician and engineer; an important book for audio enthusiasts, too. Illustrated; 128 pages; \$200 5 1/2 x 8 1/2". Only . . . . .



## "101 Ways to Use Your Sweep Generator"

Covers full data on connections required for each application, proper test procedure, evaluation of results. Includes use of generator for checking and calibrating test instruments, antenna measurements, RF and IF alignment, special uses in color receiver tests, etc. Illustrated; 148 p.; 5 1/2 x 8 1/2". \$200 Only . . . . .

## "101 Ways to Use Your Oscilloscope"

Fully covers standard and unusual uses; shows connections and equipment needed, proper procedures and how to evaluate results. Over 400 illustrations of wave-forms and test setups are shown. A "must" book for all scope users. 180 pages; 5 1/2 x 8 1/2". \$250 Only . . . . .

## "101 Ways to Use Your VOM and VTVM"

Describes equipment checks; DC voltage tests; ohmmeter tests; signal-tracing tests; AC voltage tests; DC current tests; alignment applications; color TV tests. Covers all connections and equipment required for each test and how to perform it. Illustrated; 116 pages; 5 1/2 x 8 1/2". Only . . . . . \$200

## "101 Ways to Use Your Signal Generator"

Complete data on fullest use of this important instrument. Each application is fully and clearly described and illustrated. Includes proper procedures for antenna tests; AM-FM receiver tests; TV set tests; component tests. Illustrated; 128 pages; \$200 5 1/2 x 8 1/2". Only . . . . .

ORDER THE COMPLETE LIBRARY

### HOWARD W. SAMS & CO., INC.

Order from your Sams Distributor today, or mail to Howard W. Sams & Co., Inc., Dept. K-19, 2201 East 46th St., Indianapolis 6, Ind.

Send me the following books:

- "101 Ways to Use Your Audio Test Equip." (TEM-5)
- "101 Ways to Use Your Sweep Generator" (TEM-1)
- "101 Ways to Use Your Oscilloscope" (TEM-2)
- "101 Ways to Use Your VOM and VTVM" (TEM-3)
- "101 Ways to Use Your Signal Generator" (TEM-4)

Name \_\_\_\_\_

Address \_\_\_\_\_

City \_\_\_\_\_ Zone \_\_\_\_\_ State \_\_\_\_\_

(outside U.S.A. priced slightly higher)

## Readouts and Counters

(Continued from page 59)

electron stream thus revolves like the spoke of a wheel, remaining in each of the ten positions used until the next input pulse is applied. After ten input pulses, the electron stream is back to the initial anode target, and an output pulse, as is usual for such decade counters, is produced at that point.

A more complete understanding of this action is possible with the help of Fig. 9. This shows that two other electrodes are associated with each target. The one identified as the spade is used to "lock" the electron stream in its path to one anode until the next input pulse is applied. The other electrode, known as the switching grid, is used to transfer the electron stream to the next target. The not unexpected sequence from 0 to 9 identifies the individual targets in the sequence.

Although it is not shown in Fig. 9, all even-numbered switching grids are tied together internally, reducing the number of base pins required and simplifying circuit wiring. For the same reasons, the odd-numbered switching grids are also connected internally. Alternate triggering of the odd and even grids will deflect the electron stream so that it transfers from target to target in sequence.

A circuit designed around the MBS tube is shown in Fig. 11. The tube itself appears in Fig. 10. In the circuit shown, a binary stage is used to trigger the switching grids. The back-and-forth action of two triodes in the binary provides the alternate switching required. Cathode-follower coupling is used to reduce the loading effect on the binary circuit.

As ever, there must be some way of clearing the tube and re-setting to the 0 target. In the technique used, a positive pulse applied to the common cath-

ode cuts off the electron stream altogether, thus providing clearing. The pulse is applied at the point marked "pin D, clear" in Fig. 11. A negative pulse is simultaneously applied to the circuit, feeding to spade 9 at the point marked "pin H, re-set." This causes the beam to form in the 9 position, where it is ready to be transferred to the initial or 0 position.

A check of the circuit will show that the negative re-set pulse is also applied to the binary stage used for switching. Action of the binary then advances the beam to position 0, the desired starting point.

The MBS tube is identified as a type BD300 or BD301. A 5963 is used as the binary. The two sections of the 12AU7 act as the cathode followers, one for each side of the binary. For simplicity, only some of the targets with their associated electrodes appear in Fig. 11. Target 1 shows the types of circuit connections for all odd-numbered anodes; target 8 shows as much for even-numbered anodes; while targets 0 and 9 show the special connections required for clearing and re-setting the circuit to zero.

Another, important item in the schematic has not been mentioned. This tube, the 6844A, is a Nixie indicator. Obviously then, the MBS and the glow-transfer tubes differ in another important respect: the former is not self-indicating. However, where the greater counting speed it makes possible is desired, one factor balances out another.

It would obviously be impossible to cover every circuit and every type of indication used in electronic counting. However, the reader of this and preceding articles in this series has had the opportunity to become familiar with circuits and special components that cover the vast majority of actual applications. A forthcoming article will cover counting and coding systems actually used. —50—

Fig. 11. Burroughs DC-106A. Labels for odd and even grids should be reversed.

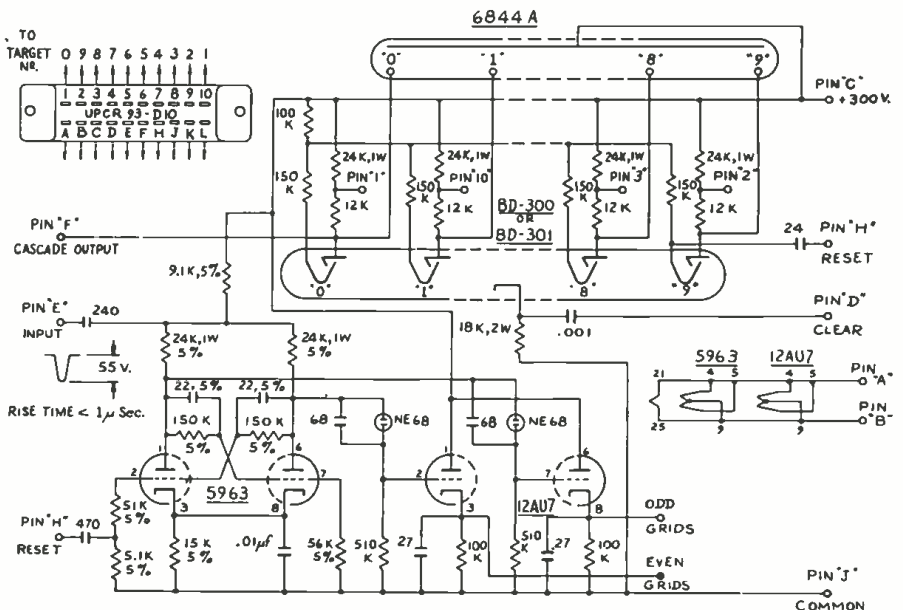



### FM TRANSMITTER-RECEIVER



APN-1. 420 to 460 Mc Aircraft Radio altimeter equipment. Tubes: 1—95J, 3—12SJ, 1—12SH17, 2—12H6, 1—VR150. Complete with all tubes and mount. For 27 V DC. **\$8.95**  
**BRAND NEW**  
 Original operating manual for above \$1.00

### TS-100AP OSCILLOSCOPE

(worth \$750) **OUR LOW PRICE \$3333**

Can be used with linear sweep or general purpose test scope. Cables included. Also used with circular sweep as precision range calibrator. Self-contained in metal case 8" x 12 1/2" x 10" deep. For 110 V 50 to 1200 cycles AC. Excellent used, like new, with all tubes including crystals and C. R. Tube.

### BC-929 3-INCH SCOPE



Low cost station monitor and/or bench scope. Has Horiz. focus, sweep, intensity controls. Tubes: 2—6SN7, 2—6H6, 1—6X5, 1—6G6, 1—2X2, 3BP1 CR Tube. Voltage range 115V 400 cy. and 24VDC. Complete with tubes, exc. **\$9.95**  
 USED \$12.95  
**BRAND NEW** ..... \$19.95  
 Conversion instructions for 110V 60 cyc AC **65c**

### BC-733 VHF 10-TUBE AIRCRAFT RECEIVER

6-channel xtal control. Freq. 108.3 to 110.3 Mc. Dual filter range. Easily converted for tracking Sputnik! **\$7.95**  
 Exc. used. Complete with tubes. .... **\$8.95**  
**BRAND NEW** complete with tubes. .... **\$5.95**  
 Dynamotor for above 12 or 24 V.—New **\$5.95**

### AN/ARN-5A AIRCRAFT RECEIVER

11 tube superhet, 3-crystal control UHF for static-free reception. Exc. used with tubes. .... **\$9.95**

### ASB-5 'SCOPE INDICATOR



**BRAND NEW**, including all tubes, together with 5 B P 1 'Scope Tube. Originally used in Navy Aircraft RADAR equipment. Easily converted for AC operation. **VALUE \$250.00**  
**OUR LOW PRICE \$15.95**

### SCR-522 2-METER RIG!

Terrific buy! VHF Transmitter-receiver, 100-150 Mc. 4 channels. Xtal-controlled. Amplitude modulated voice. They're going fast! Excellent condition. **SCR-522 Transmitter-Receiver**, complete with all 18 tubes, top rack and metal case. Special **\$32.32**  
**COMBINATION** ..... **\$32.32**  
 Receiver only, with all tubes. .... \$19.50  
 Transmitter Only, with all tubes. .... \$22.25  
 Accessories for above available.

### LORAN APN-4 FINE QUALITY NAVIGATIONAL EQUIPMENT



Determine exact geographic position of your boat or plane. Indicator and receiver complete with all tubes and crystal. **INDICATOR ID-68/APN-4, and RECEIVER R-9B/APN-4**, complete with tubes. Exc. used **\$42.50**  
**Receiver-Indicator as above. BRAND NEW \$59.50**  
 Complete Kit of Accessories for Above: PE-208 Indicator, Set of PLUGS, Vialer for Indicator, Operation Manual. ALL BRAND NEW. .... **\$49.50**

### LORAN APN/4 OSCILLOSCOPE



Easily converted for use on radio-TV service bench. **Completely Assembled**  
 LIKE NEW! Supplied with 5" Scope, type SCPI only. .... **\$14.95**  
**Brand New** ..... **\$19.50**

### BC1206-C BEACON RECEIVER

195 to 420 Mc. made by Satchel-Carlson. Works on 24-28 volts DC. 135 Kc. IF. Complete with 5 tubes. Size 4" x 4" x 6". Wt. 4 lbs. **\$8.88**  
**BRAND NEW** ..... **\$2.95**  
 USED, less tubes. .... **\$2.95**

### LORAN R-65/APN-9 RECEIVER & INDICATOR



Used in ships and aircraft. Determines position by radio signals from known transmitters. Accurate to within 1% of distance. Complete with tubes and crystal. Exc. used. **Value \$1200.00.**  
**Our Price..... \$79.50**

SCHEMATIC DIAGRAMS For any equipment on this page, each.. **65c**

SEND FOR FREE CATALOG, many more Wonderful Surplus Buys!

October, 1959

### ARC-5/R28 RECEIVER



2-meter Superhet. 100 to 150 Mc in 4 crystal channels. Complete with 10 Tubes. **BRAND NEW \$24.45**  
 110V AC Power Sup. Kit for above **\$9.75**

### ARC-5/T-23 TRANSMITTER

100-150 Mc Includes 2—832A, 2—1625 Tubes. **BRAND NEW \$21.50**  
**SPECIAL** Limited quantity ARC-5/T23 xmitters. OFFER! Excellent Used, less tubes. .... **\$5.95**  
**MD-7 MODULATOR** for T-23, complete with 4 tubes. LIKE NEW. .... **\$9.95**

### ARC-5 MARINE RECEIVER-TRANSMITTER

Navy Type Comm. Receiver 1.5 to 3 Mc **BRAND NEW** with 6 tubes. .... **\$16.95**  
 Navy Type Comm. Transmitter 2.1-3 Mc **BRAND NEW** with 4 tubes and Xtal **\$12.45**  
**MODULATOR** for above, new with tubes. .... **\$5.95**

### BC-906 FREQ. METER—SPECIAL



Cavity type. 145 to 285 Mc. **BRAND NEW**, complete with antenna. Manual included. **OUR LOW PRICE \$9.88**

#### STANDARD TUBES

REMOVED FROM BRAND NEW GOV'T EQUIPMENT	RECEIVING	6J4	59	813	6.95
155	35	6X5	55	814	2.25
164	35	6AR5	55	815	2.15
6AG5	35	6J6	32	827	8.85
12AT 7	45	6BA6	35	1625	2.99
12X4	35	6AS6	55	1629	2.99
6AK5	35	SPECIAL PURP.	2013	2013	3.99
6CA	25	12A5	4.25	4X-150	5.95
6X4	35	807	95	3BP1	1.49

### BC-659 TRANSMITTER & RECEIVER

27 to 38.0 Mc F.M. Two preselected channels crystal controlled. 5 to 10 watts. Complete with speaker, tubes. Exc. Used **\$11.95**  
**POWER SUPPLY** for BC-620, 659, available for 6, 12 or 24 Volts DC. Specify. .... **\$8.95**

### SCR-625 MINE DETECTOR

Complete portable outfit in original packing, with all accessories. **Brand New \$22.50**

### TG-34A CODE KEYS



Self-contained automatic unit. Reproduces code practice signals recorded on paper tape. By use of built-in speaker, provides code-practice signals to one or more persons at speeds from 5 to 25 WPM. **\$16.88**

### DYNAMIC BOOM MIKE M-35/AIC

Low impedance. With mounting bracket for attachment to headsets. A REAL VALUE at **\$3.95**

### DYNAMIC HANDMIKE

with "Press-to-talk" switch on handle, cord and plug—**BRAND NEW**, only. .... **\$2.95**

### DYNAMIC HANDMIKE, aircraft

made by Telephonics Corp. Press-to-talk switch on mike. **BRAND NEW**. .... **\$4.85**

### HI-FI DYNAMIC HEADSET with Cushions

Freq. Range: 40-14000 CPS. No Distortion. **\$7.85**  
**BRAND NEW**

#### MICROPHONES

Model	Description	Excellent Used	BRAND NEW
T-17	Carbon Hand Mike	.....	<b>\$5.45</b>
T-30	Carbon Throat Mike	.....	<b>74c</b>
T-45	Army and Navy Lip Mike	.....	<b>1.25</b>
T-24	Carbon Mike	.....	<b>5.95</b>
TS-9	Handset	.....	<b>3.88</b>
RS-38	Navy Type	.....	<b>4.75</b>

#### HEADPHONES

Model	Description	Excellent Used	BRAND NEW
HS-23	High Impedance	.....	<b>\$2.19</b>
HS-33	Low Impedance	.....	<b>4.65</b>
HS-30	Low Imp. (featherwt.)	.....	<b>1.15</b>
H-16/JU	High Imp. (2 units)	.....	<b>3.75</b>

TELEPHONICS—500 ohm Low Impedance HEADSETS. **BRAND NEW, PER PAIR \$3.25**  
 CD-307A Cords, with PL55 plug and JK26 Jack ..... **.99**  
 Earphone Cushions for above—pair. .... **.50**

### MOBILE-MARINE DYNAMOTOR



Input 12V DC. Output: 625 V DC @ 225 Ma. for press-to-talk intermittent operation. Shpg. wt. 14 lbs. **OUR LOW PRICE... \$6.45**

#### OTHER DYNAMOTOR VALUES: Excellent BRAND

Type	Input	Output	Used	BRAND NEW
DA-19-A	28V 11A	400V .400A	.....	<b>\$4.95</b>
DM-28	28V	224V .07A	2.75	4.75
DM-32A	28V 1.1A	260V .05A	2.45	4.45
DM-33A	28V 5A	575V .16A	.....	<b>3.75</b>
	28V 7A	540V .25A	1.95	3.75
DM-34D	12V 2A	220V .080A	4.15	5.25
DM-35A	28V 1.4A	220V .080A	3.75	5.45
DM-64A	12V 5.1A	275V .150A	.....	<b>7.95</b>
PE-73C	28V 20A	1000V .350A	7.95	10.50
PE-86	28V 1.25A	230V .050A	2.75	4.95

Please include 25% deposit with order—Balance C.O.D. or Remittance in Full. 50c Handling Charges on all orders under \$5.00. All shipments F.O.B. Our Warehouse, N.Y.C. All Merchandise subject to Prior Sale and Price Change.

### G & G Radio Supply Co.

Telephone: CO 7-4605  
 51 Vesey St., New York 7, N. Y.

### AN/ART-13 100-WATT XMTR



11 CHANNELS 200-1500 Kc **\$4850** Complete with Tubes  
 2 to 18.1 Mc

Famous Collins Autotune Aircraft Transmitter. AM, CW, MCW. Quick change to any of ten pre-set channels or manual tuning. Speech amplifier/clipper uses carbon or magnetic mike. Highly stable, highly accurate VFO. Built in Xtal controlled calibrator. PP811a modulate 813 in final up to 90%, class "B." A Real "HOT" Ham buy at our low price! **Orig. cost \$1800.** **\$48.50**  
 Exc. Used. .... **7.95**  
 0-16 Low Freq. Osc. Coil for ART-13. .... **11.95**  
 24V Dynamotor for ART-13. .... **11.95**

### NAVY AIRCRAFT RADIO RECEIVER

CRV-48151(ARB). Communications receiver made by RCA. Complete coverage 195 to 9050 Kc in 4 bands continuous tuning. Complete with tubes and dynamotor. Used **\$17.95**  
 Like NEW ..... **\$26.50**

### POWER SUPPLY

for above, 110V AC, complete ready to plug in, wired. .... **\$9.75**

### 234-258 MC RECEIVER



AN/ARR-2  
**BRAND NEW** 11-tube UHF Tunable Receiver with schematic. Only a few at this low price!  
 Complete with tubes **\$8.88**

### SCR-274 COMMAND EQUIPMENT

ALL COMPLETE WITH TUBES

Type	Description	Used	Like New
BC-453	Receiver 100-550 KC	\$14.50	\$15.50
BC-454	Receiver 3-6 Mc	9.45	12.45
BC-455	Receiver 6-9 Mc	10.45	12.45
BC-450	3-Receiver Control Box	1.29	1.75

### 110 Volt AC Power Supply Kit

for all 274-N and ARC-5 Receivers. Complete with metal case, instructions. **\$7.95**  
 Factory wired, tested, ready to operate. **\$11.50**  
**SPARE TUNING KNOBS** for 274-N and ARC-5 RECEIVERS. Fits BC-453, BC-454 and others. Only **49c**

### BC-457 TRANSMITTER—4-5.3 Mc.

complete with all tubes and crystal. **BRAND NEW \$7.85**  
 BC-458 TRANSMITTER—3 to 7 Mc. Complete with all tubes and crystal. **BRAND NEW \$9.75**  
 BC-459 TRANSMITTER—7-9.1 Mc. Complete with all tubes and crystal. **BRAND NEW \$12.75**  
**ARC-5/T-19 TRANSMITTER—3 to 4 Mc.** (BRAND NEW complete with all tubes & crystal) **\$8.85**  
 BC-456 Modulator. USED 3.45 NEW 5.95  
 BC-451 Transmitter Control Box. 1.25 NEW 1.49  
 ALL ACCESSORIES AVAILABLE FOR COMMAND EQUIPMENT.

### BC-603 FM RECEIVER



20 TO 27.9 MC. **\$1495**  
**BRAND NEW** ..... **\$12.95**  
 Like New ..... **\$12.95**

10-Channel, pushbutton tuning or continuous tuning. Complete with speaker, tubes, switch.

12 or 24V Dynamotor for Above. **Brand New \$5.50**  
 Exc. Used \$4.25. .... **\$23.50**  
 BC-683 same as above except 27 to 38.0 Mc. LIKE NEW. .... **\$23.50**

### AC POWER SUPPLY FOR BC603, 683

Interchangeable, replaces dynamotor. Has On-Off Switch. NO REPAIR, CHANGE NEEDED, provides 220 VAC @ 80 Ma. 24VAC @ 2 Amps. Complete kit, with easy instructions. .... **\$8.45**  
 Wired. .... **\$10.49**  
 Complete 240-page Technical Manual for BC-603, 683. .... **\$2.95**

### REMOTE CONTROL RM-52



Direct remote control for radio equipment. Uses 4 flashlight batteries. Provides bias for Microphone and sidetone to headset. HI or LO Imp. Mike and Phone Jacks. Makes good phone match unit. **BRAND NEW \$2.49**

### MIDGET FAN MOTOR



1 3/4" square x 2" long. 1/8" shaft extends 1/2". 10,000 RPM. 24V DC. **\$2.19**  
 Input. Complete with fan. .... **\$1.19**

### WILLARD 6-VOLT MIDGET STORAGE BATTERY



3 Amp. Hour. **BRAND NEW**. 3 1/2" x 1-13/16" x 2 3/4". Uses Standard Electrolyte. .... **\$2.69**

### 2 VOLT BATTERY "PACKAGE"



1—2V. 20 Amp. Hr. Willard Storage Battery. .... **\$2.79**  
 1—2V. 7 prong Synchronous Plug-in Vibrator. .... **1.49**  
 1—Quart Bottle Electrolyte for 2 cells. .... **1.45**  
**ALL BRAND NEW!**  
 Combination Price **\$5.45**

# SURPLUS? COME and GET IT!

**DIAL TELEPHONES**  
French type phone made by Kellogg. Can be used for standard extension phone.  
Used With Dial Ea. **\$4.95**

**TELEPHONE DIALS**  
Standard Dials. Ideal for Multi Channel Selection or Remote Control Work. Exc. Cond. Ea. **\$1.50**

**TELEPHONE STEP RELAY**  
3 Pole 10 Position "Mirror" Switch. Ideal for use with Telephone Dials for remote switching. 3 Levels—Each 1 pole 1st position operates from 24 DC using 1 coil to step and 1 coil to reset. W.P.T. Approx. 2 Lbs. Ea. **\$4.95**  
Exc. Cond. Used

**DC TO AC CONVERTER**  
Kite-Lite Converter. DC Input 11.5 V. AC 60 Cycle. Output Approx. 450 Watts. For use Boats, Ships, Etc. to power Radio Transmitter TV or any appliances. All New. Ea. **\$49.95**

**CODE PRACTICE OSCILLATOR**  
Type TG-5 Code Oscillator provides 1000 Cycle tone for practice. The two units for transmission over wire between 2 points. Uses 1-22 1/2 Volt Battery actuated. Unit will follow a bug. All New. Complete and 2 Flashlight Batteries. Tone Oscillator is relay with single Earphone. Less batteries. **\$1.50**  
Set of batteries for above **\$2.00**

**TANK PERISCOPES**  
U. S. Army Tank Telescope Periscope Type M-14. This is a Prism Type assembly measuring 8" x 11". Has 45° Prism Head Assembly and can be viewed either through 1 to 1 lens or through 6 Power Telescope Lens. Unit contains many lenses and Prisms. All New. Ea. **\$8.95**

Type M 4 Periscope—Tank type using 2-45° Prisms for sighting. Dimensions 8" x 12" x 2". New. **\$1.95**  
Type M4A1. Same as above only with 2 Power Telescope mounted inside. New. Ea. **\$4.95**

**TELESCOPIC ANTENNA**  
Type AN-20C 12 Ft. Telescoping Section Antenna. 12 Brass Sections which fold down to 18" Ideal for mobile or portable use. All New. Ea. **\$2.50**

**WHIP ANTENNA**  
3 Section Whip, each section 6 Ft. long, total 18 Ft. Whip tapers from 3/4" diam. to 1/4" diam. Ideal for Mobile or Boat use. All New. Ea. **\$3.95**

See our previous ad for Special Surplus Items. All prices F.O.B. S. F. Calif. Calif. orders add 3% Sales Tax. 20% Dep. on all C.O.D.'s. Purchases under \$5.00. Send full amount. Items subject to prior sale. Canadian Orders add Postage. No stamps.

## STANDARD SURPLUS

1230 Market St., San Francisco 3, Calif.  
Telephone HEmlock 1-3106

## SCHEMATIC BOOK

Over 25 Schematics, popular surplus gear—24 pages, large 11 x 7 foldovers, printed one side, fiber cover, less than 15¢ ea., includes: See ELECTRONICS WORLD, August, September

postpaid COMPLETE BOOK **\$3**

**BC-603 AC-SUPPLY**  
AC Power Supply for IC-601 Receiver and BC-603 No modification needed, plugs directly into Jones Receptacle **\$9.95**

**T-47/ART-13 TRANSMITTERS**  
100 Watt 2-18 MC Autotune, excellent cond., with tubes. **\$49.00**

**BENCH POWER SUPPLY** variable from 0 to 30 volts @ 50 amps contin. metered. Variac con. trol. Altered. Send for special sheet. ONLY **\$295.00**

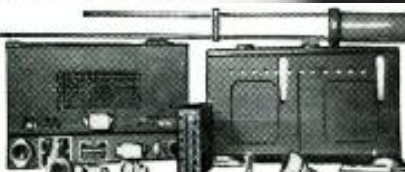

**MOBILE & FIXED VHF SETS**  
Complete set for 110-v operation including SCR-522 Transceiver, RA-62 Rectifier, J-type ground antenna, control box, motor, connectors, tubes (less crystals). Excellent condition CAA **\$124.00**

Same as above for 12 or 24-v operation including PE-08 (12-v) or PE-04 (24-v) dynamotor instead of rectifier. Excellent condition CAA **\$89.00**

Both Mobile and Fixed sets purchased together, limited time only. **\$194.00**

**RA-62-C POWER SUPPLY** A-C for SCR-522 VHF 110/60 cyc. Like new LTD QTY. **\$59.50**

RITS only for above. Contains special transformer, rectifier, regulator and connectors w/schematic. SPECIAL. ONLY **\$17.00**

**REC. MICROWAVE R-11/APR-5**  
Frequency range 1000-6200 mc, fully metered power 110v/60/1 ph. self contained, one unit used exec. **\$49.00**

**GROUND PLANE VHF ANTENNAS \$9.95**  
GOOD FOR CITIZEN BANDS FROM 30-200 MC-NEW

**MOTOR J-RPM**, wear-resistant for any outdoor application (beam rotator etc.) 24-vdc, operates on a-c, reversible, splined shaft, 5" x 3/4" x 4" od, mounting base with 4 tapped holes. High torque motor will carry good load. **\$4.50 ea.**

BRAND NEW ..... ONLY **\$4.50 ea.**

SEND FOR NEWEST FREE CATALOG  
**\$5.00 Min. - 25% Dep. C.O.D.'S - F.O.B. Conn.**

**HI-MU ELECTRONICS**

133 HAMILTON ST., NEW HAVEN, CONN.



# Technical Books

"THE AUDIO CYCLOPEDIA" by Howard W. Tremaine. Published by Howard W. Sams & Co., Inc., Indianapolis. 1269 pages. Price \$19.95.

Within this large volume, the author has gathered together an enormous amount of data that will be of help and interest to any serious student of audio, the audio technician, or the audio engineer. In an effort to make the coverage just as broad as possible, much basic material is included. But the real value of the "cyclopedia" lies in its wealth of practical applications, particularly in the fields of disc, magnetic, and optical recording. Information on sound motion picture projection equipment, audio test equipment and techniques, and a large number of general informational charts and tables on audio subjects are included.

Most of the information in the volume is presented in a question-and-answer format with over 3400 separate questions on audio thoroughly covered. A 54-page index permits any subject to be located readily by means of a unique chapter and paragraph numbering system.

This source book should meet the needs of those who design, install, and repair audio equipment or are interested in this new and important science.

"THE SOUND OF HIGH FIDELITY" by R. O. Jordan & J. Cunningham. Published by Windsor Press, Chicago. 208 pages. Price \$3.95.

While this is far from being a "definitive" text on high fidelity it will meet the needs of a goodly number of audio enthusiasts. The authors have tackled the job of covering 80 years of sound recording plus an evaluation of the current state of the art and equipment in slightly over 200 pages hence the treatment is, of necessity, somewhat superficial.

The authors have attempted a rather ambitious testing program on various items of commercial equipment but the results are far from inclusive since the products of only some twenty or so manufacturers are covered out of the entire high-fidelity and audio industry.

The book itself is beautifully presented with many two-color diagrams and charts. Illustrative material was supplied by staff photographers who show kits in the process of being assembled and equipment in use. The text material is divided into nine chapters covering sound, hearing, sound in history, amplification, loudspeakers, disc recordings, tuners, tape recording, and microphones. Tables of ab-

brevisions and schematic symbols complete the book.

It is a little hard to evaluate the technical level of this text as it varies from chapter to chapter. On the whole, however, the non-technical audiophile shouldn't find himself too far "at sea" with this book.

"RADIO AMATEUR LICENSING HANDBOOK" by J. E. Kitchin. Published by Radiotelephone Directories of Canada Ltd., 119 W. Pender St., Vancouver 3, B.C. 105 pages. Price \$2.00 Soft cover.

This compact volume, written by the Regional Supervising Radio Inspector of the Canadian Department of Transport (Canadian equivalent of our FCC), will be of interest not only to hams of our neighbor to the north but also U. S. hams who are interested in how Canadian amateur regulations differ from ours.

The text is divided into six sections covering examinations, station licensing, station operation, operating and traffic handling, useful information, and appendices containing International Morse; International "Q" signals; ARRL "Q" signals; ARRL phonetic alphabet; miscellaneous abbreviations; QRO, QRK, QSA, RST scales; standard color code; common radio symbols; and a whimsical "memo" to wives and mothers of those bitten by the "ham bug."

Hams who have heavy contact schedules to and from Canada will find this an excellent source book for getting "on the beam"—Canadian style.

"PRINCIPLES OF TRANSISTOR CIRCUITS" by S. W. Amos. Published by John F. Rider Publisher, Inc., New York. 166 pages. Price \$3.90. Soft cover.

This volume, a joint venture of Rider and the British publisher Iliffe & Sons Ltd., was written by a member of the Engineering Training Department of the BBC and is at the junior engineer or electronic lab technician level.

The text is divided into ten sections covering semiconductor and junction diodes, basic principles of point-contact and junction transistors, common-base amplifiers, common-emitter amplifiers, common-collector amplifiers, bias stabilization, small-signal amplifiers, large-signal amplifiers, transistor superhets, and other applications of transistors as well as other types of transistors.

Although the author has based his exposition on British-made transistors, specific type numbers are not mentioned and all the types discussed have U. S. counterparts. The treatment is

mathematical to some extent but in most instances the formulas have been worked out for the student.

While those with some early courses at an engineering level will profit most from this presentation, the serious experimenter who has worked with transistors will have no difficulty in deriving considerable benefit from this exposition.

\* \* \*

"ADDITIONAL 1959 TELEVISION SERVICING INFORMATION" compiled by M. N. Beitman. Published by *Supreme Publications*, Highland Park, Ill. 192 pages. Price \$3.00. Soft cover. Vol. TV-16.

This latest service handbook in this publisher's series follows the same format as its predecessor volumes. Diagrams are printed across two pages with information on alignment, waveforms, voltage values, parts descriptions, printed board views, and circuit revisions included.

This volume covers television receivers from fifteen manufacturers and a variety of chassis and model numbers, which are indexed separately in the back of the book. Those who have found these manuals helpful in the past in speeding service jobs will welcome this new volume which covers additional receivers in the set makers' 1959 lines.

\* \* \*

"RADIO CIRCUITS" by W. E. Miller, revised by E.A.W. Spreadbury. Published by *Iiffe & Sons Ltd.*, Lon-

don. 170 pages. Price by mail 15s./10 d.

This is the fourth edition of a popular radio treatise which has earned a wide and enthusiastic following in England. It covers, in simple language and progressive style, all of the various circuits to be encountered in radio receivers.

The author discusses each stage of the receiver, piece by piece, and explains it without the complication of associated circuitry. In the eight years since the third edition made its appearance there have been enough new techniques and components developed to warrant this revised and up-to-date version.

The text is divided into 38 chapters which cover superhet principles, antenna input circuits, tuned input stage, bandpass coupling, r.f. amplifier stage, frequency converters, oscillators, i.f. amplifiers, a.g.c. principles, delayed a.g.c. a.f. amplification, push-pull circuits, loudspeaker arrangements, a.c. power supplies, a.c.-d.c. supplies, a.c. battery portables, tone control circuits, negative feedback, phono reproduction, transistor receivers, auto radios, FM receivers and circuitry, AM/FM receivers, etc.

We do not believe that the English terminology will prove confusing to U. S. readers since the exposition is clear and detailed throughout. The material itself is so well presented that this text might serve as a basic source book for "beginning radiomen" as well as students.

## PUT YOUR OSCILLOSCOPE TO WORK!

Learn to use the handiest service instrument of all!



Dust off that oscilloscope of yours! Put it to work fully on the dozens of jobs it can do better than any other service instrument.

Handle jobs twice as fast—and lots more profitably!

This big book, **MODERN OSCILLOSCOPES AND THEIR USES** shows you how . . . in a way you can really understand. Clearly and simply, it explains exactly where and how to use your 'scope on all types of AM, FM and TV service . . . from troubleshooting to set realigning and everything in between. No fancy theory. You quickly learn

how to make connections; how to adjust circuit components; how to set the controls; and how to analyze patterns fast and right!

New section even covers quantitative measurements—the slickest method of locating many color TV troubles and aligning sets properly. Book has 326 pages and 370 clear pictures including many pattern photos.

### PRACTICE 10 DAYS FREE!

Dept. RN-109 RINEHART & CO., Inc.  
232 Madison Ave., New York 16, N. Y.

Send MODERN OSCILLOSCOPES AND THEIR USES for 10-day FREE EXAMINATION. If I decide to keep book, I will then send you \$6.50 plus postage in full payment. If not, I will return book postpaid and owe you nothing. (SAVE! Send \$6.50 with order and we pay postage. Same return privilege.)

Name \_\_\_\_\_

Address \_\_\_\_\_

City, Zone, State \_\_\_\_\_

OUTSIDE U. S. A.—Cash with order. Price \$7.00. Money Back if book is returned in 10 days.

New  
4th edition  
now available!

The book that keeps growing in usefulness and popularity

It's here! The brand-new 4th Edition of General Electric's famous Transistor Manual . . . 227 pages jam-packed with vital information you need to keep abreast of this fast-moving and fabulous field.

You'll find 74% more information . . . new material on small and large signal characteristics, transistor radio servicing techniques and basic computer circuits . . . all the latest G-E transistor specs and a complete, up-to-date list of registered JEDEC types.

This is the one book in the transistor field you can't afford to do without! Get your copy from your General Electric Tube Distributor, or by mailing the coupon at right.



### Partial List of Contents:

- Basic Semiconductor Theory
- Transistor Construction
  - Techniques
- Small Signal Characteristics
- Large Signal Characteristics
- Biasing
- Audio Amplifiers
- "Hi-Fi" Circuits
- Radio Receiver Circuits
- Transistor Radio Servicing
  - Techniques
- Switching Characteristics
- Basic Computer Circuits
- Logic
- Unijunction Transistor Circuits
- Silicon Controlled Rectifier
- Tetrode Transistors
- Power Supplies
- Transistor Specifications
- Rectifier Specifications

General Electric Company  
Semiconductor Products Dept., Section S58109,  
Electronics Park, Syracuse, N. Y.

Rush me the new enlarged 4th Edition of the General Electric Transistor Manual. I enclose \$1.00. (No stamps, please.)

Name \_\_\_\_\_

Address \_\_\_\_\_

City \_\_\_\_\_ Zone \_\_\_\_\_ State \_\_\_\_\_

GENERAL  ELECTRIC

# Lafayette Superior Quality Hi-Fi Kits

## 50 WATT INTEGRATED STEREO AMPLIFIER



**KT-250**  
IN KIT FORM  
**64.50**

---

**LA-250**  
COMPLETELY WIRED  
**89.50**

- 50 WATTS MONAURALLY—25 WATTS EACH STEREO CHANNEL
- RESPONSE 17-21,000 CPS  $\pm$  1 DB (at normal listening level)
- UNIQUE "BLEND" CONTROL
- PREMIUM EL86 OUTPUT TUBES
- SEPARATE BASS AND TREBLE CONTROLS
- CLUTCH-OPERATED VOLUME CONTROL
- 3RD CHANNEL OUTPUT

A completely new stereo high fidelity amplifier with a high quality of reproduction, versatility of operation, and distinctive styling. A full range of controls enable you to enjoy the utmost in listening pleasure in any situation. Deluxe features include: unique "Blend" control for continuously variable channel separation—from full monaural to full stereo, 4-position Selector, Mode, Loudness and Phase switches. Also provided are outputs for 4, 8 and 16 ohm speakers. Hum-free operation is insured by the use of DC on all pre-amp and tone control tubes. Harmonic distortion, less than 0.25%, 1M distortion, less than 1%. Hum and noise, 74 db below full output. Designed with the kit builder in mind, assembly is simple—no special skills or tools required. Complete with deluxe cabinet and legs, all parts, tubes and detailed instruction manual. Shpg. wt., 26 lbs.

KT-250 Stereo Amplifier Kit.....6.45 Down.....Net 64.50  
LA-250 Stereo Amplifier, wired.....8.95 Down.....Net 89.50

## LAFAYETTE PROFESSIONAL STEREO MASTER AUDIO CONTROL CENTER

Solves Every Stereo/Monaural Control Problem!



**KT-600**  
IN KIT FORM  
**79.50**

---

**LA-600**  
COMPLETELY WIRED  
**134.50**

- UNIQUE STEREO & MONAURAL CONTROL FEATURES
- AMAZING NEW BRIDGE CIRCUITRY FOR VARIABLE 3d CHANNEL OUTPUT & COSS-CHANNEL FEED
- PRECISE "NULL" BALANCING SYSTEM
- RESPONSE 5-40,000 CPS  $\pm$  1 DB
- 6 CONCENTRIC FRONT PANEL CONTROLS

A REVOLUTIONARY DEVELOPMENT IN STEREO HIGH FIDELITY.

Provides such unusual features as a Bridge Control, for variable cross-channel signal feed for elimination of "ping-pong" (exaggerated separation) effects. Also has full input mixing of monaural program sources, special "null" stereo balancing and calibrating system. 24 equalization positions, all-concentric controls, rumble and scratch filters, loudness switch. Clutch type volume controls for balancing or as 1 Master Volume Control. Has channel reverse, electronic phasing, input level controls. Sensitivity 2.2 millivolts for 1 volt out. Dual low-impedance outputs (plate followers), 1500 ohms. Response 5-40,000 cps  $\pm$  1 db. Less than .03% 1M distortion. Uses 7 new 7025 low-noise dual triodes. Size 14" x 4 1/2" x 10 1/2". Shpg. wt., 16 lbs. Complete with printed circuit board, cage, profusely illustrated instructions, all necessary parts. LAFAYETTE KT-600—Stereo Pre-amplifier kit .....7.95 Down.....Net 79.50 LAFAYETTE LA-600—Stereo Pre-amplifier, Wired.....13.45 Down.....Net 134.50

## Outstanding Design — Incomparable Performance

### LAFAYETTE STEREO/MONAURAL BASIC POWER AMPLIFIER KIT



**KT-310**  
IN KIT FORM  
**47.50**

---

**LA-310**  
COMPLETELY WIRED  
**72.50**

- 36-WATT STEREO AMPLIFIER—18-WATTS EACH CHANNEL
- 2 PRINTED CIRCUIT BOARDS FOR NEAT, SIMPLIFIED WIRING
- EMPLOYS 4 NEW PREMIUM-TYPE 7189 OUTPUT TUBES
- RESPONSE BETTER THAN 35-30,000 CPS  $\pm$  1/2 DB AT 18 WATTS
- LESS THAN 1% HARMONIC OR INTERMODULATION DISTORTION

A superbly-performing basic stereo amplifier, in easy-to-build kit form. Dual inputs are provided, each with individual volume control, and the unit may be used with a stereo pre-amplifier, for 2-18 watt stereo channels, or, at the flick of a switch, as a fine 36-watt monaural amplifier—or, if desired, it may be used as 2 separate monaural 18-watt amplifiers! CONTROLS include 2 input volume controls, channel Reverse switch (AB-BA), Monaural-Stereo switch, DUAL OUTPUT IMPEDANCES are: 4, 8, 16 and 32 ohms permitting parallel (monaural) operation of 2 speaker systems of up to 16 ohms. INPUT SENSITIVITY is 0.45 volts per channel for full output. TUBES are 2-6AN8, 4-7189; GZ-34 rectifier. SIZE 9-3/16" d (10-9/16" with controls) x 5 1/2" h x 13 1/4" w. Supplied complete with perforated metal cage, all necessary parts and detailed instructions. Shpg. wt., 22 lbs.

KT-310 Stereo Power Amplifier Kit.....4.75 Down.....Net 47.50  
LA-310 Stereo Power Amplifier, Wired.....6.95 Down.....Net 72.50

### LAFAYETTE STEREO TUNER KIT The Most Flexible Tuner Ever Designed

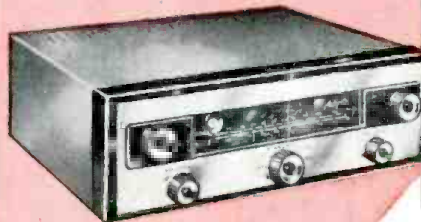

**KT-500**  
IN KIT FORM  
**74.50**

---

**LT-50**  
COMPLETELY WIRED  
**124.50**

- Multiplex Output for New Stereo FM
- 11 Tubes (including 4 dual-purpose) + Tuning Eye + Selenium rectifier Provide 17 Tube Performance
- Pre-aligned IF's
- Tuned Cascode FM
- Dual Cathode Follower Output

More than a year of research, planning and engineering went into the making of the Lafayette Stereo Tuner. FM specifications include grounded-grid triode low noise front end with triode mixer, double-tuned dual limiters with Foster-Seeley discriminator, less than 1% harmonic distortion, frequency response 20-20,000 cps  $\pm$  1/2 db, full 200 kc bandwidth and sensitivity of 2 microvolts for 30 db quieting with full limiting of one microvolt.

The AM and FM sections are separately tuned, each with a separate 3-gang tuning condenser, separate flywheel tuning and separate volume control for proper balancing when used for stereo programs. Simplified tuning is provided by magic eye. Automatic frequency control "locks in" FM signal permanently. Two separate printed circuit boards make construction and wiring simple, even for such a complex unit. Complete kit includes all parts and metal cover, a step-by-step instruction manual, schematic and pictorial diagrams. Size is 13 1/4" W x 10 1/4" D x 4 1/2" H. Shpg. wt., 22 lbs.

KT-500 ..... 7.45 Down ..... Net 74.50  
LT-50 Same as above, completely factory wired and tested. ....Net 124.50  
12.45 Down

## LAFAYETTE RADIO

NEW YORK, N. Y.  
100 6th Ave.  
Worth 6-5300

BOSTON, MASS.  
110 Federal St.  
HUBbard 2-7850

BRONX, N. Y.  
542 E. Fordham Rd.  
Fordham 7-8813

NEWARK, N. J.  
24 Central Ave.  
MARKet 2-1661

PLAINFIELD, N. J.  
139 W. 2nd St.  
PLAINfield 6-4718

165-08 LIBERTY AVE., JAMAICA 33, N. Y.  
AXtell 1-7000

**FREE**

# LAFAYETTE'S 1960 CATALOG 308 GIANT SIZED PAGES

*Our 39th Year*

The Complete Catalog Featuring  
"The Best Buys In The Business"

- FOR THE NEWEST AND FINEST IN  
STEREOPHONIC HI-FI EQUIPMENT AND SYSTEMS
- TAPE RECORDERS ● PUBLIC ADDRESS SYSTEMS
  - AMATEUR EQUIPMENT ● INDUSTRIAL SUPPLIES
  - MINIATURE COMPONENTS ● RADIO & TV TUBES AND PARTS
  - EXCLUSIVE LAFAYETTE TRANSISTOR & HI-FI KITS

Send for Lafayette's FREE Catalog—the most complete, up-to-the-minute electronic supply catalog crammed full of everything in electronics at our customary down-to-earth money-saving prices.

CONTAINS HUNDREDS OF EXCLUSIVE LAFAYETTE ITEMS NOT AVAILABLE IN ANY OTHER CATALOG OR FROM ANY OTHER SOURCE — SEND FOR YOUR COPY NOW!

A "must" for the economy-minded hi-fi enthusiast, experimenter, hobbyist, engineer, technician, student, serviceman and dealer.

*Leaders in Hi-Fi*

The most complete selection and largest stocks of hi-fi components and systems—available for immediate delivery at the lowest possible prices. Save even more on Lafayette endorsed "best-buy" complete systems.

**EASY PAY TERMS** Available on orders over \$20  
Only 10% down—Up to 18 months to pay



**TM-66 STEREO  
AUDIO ANALYST**  
11.95

**KT-135  
4-BAND  
RECEIVER  
KIT  
(Less  
Cabinet)**  
18.50

**PK-330  
4 SPEED CHANGER  
WITH BRAND NEW  
GE VR-22 (.7 MIL) DIAMOND  
STEREO CARTRIDGE**  
42.50

**PA-56 TRANSISTORIZED  
POWER MEGAPHONE**  
29.50

**PROFESSIONAL  
COMMUNICATIONS  
RECEIVER**  
KT-200 KIT 64.50  
HE-10 WIRED 79.95

**PK-331 33 1/3 RPM  
HYSTERESIS TURNTABLE**  
47.50

**RW-60  
20,000  
OHM  
PER VOLT  
MULTIMETER**  
13.50

**SK-128 ULTRA-LINEAR  
8" DUAXIAL SPEAKER**  
19.50

*Lafayette  
Radio*  
"Everything in  
Electronics"

**FREE** LAFAYETTE RADIO, Dept. RJ-9  
P.O. Box 222, Jamaica 31, N. Y.  
SEND FOR THE WORLD'S LEADING ELECTRONICS,  
RADIO, T.V., INDUSTRIAL, AND HI-FI GUIDE

Send FREE LAFAYETTE Catalog 600

Name .....

Address .....

City..... Zone..... State.....

**KEEP CANDEE HANDEE!**

**NEW TS-13 HANDSET**

Latest version! Same as H-94U Handset. Push-to-talk button. Butterfly Switch. **\$6.95**  
 TWO (2) for ..... **\$13.95**  
 Each Only

**BC-603 FM RECEIVER**

This Special Re-run By Popular Demand! 20-27.9 MC. 10 push-buttons for channel selection. Continuous tuning. Squelch circuit. Complete with tubes, speaker (less dynamotor.) THIS IS BRAND NEW AND ONLY **\$12.95**  
 DM-34 12 V. DYNAMOTOR for above. \$ 3.95  
 110 VAC POWER SUPPLY for above. Just plug it in. NO conversion needed. Only 11.95

**AN/APA 38 PANADAPTOR**

115 VAC. Single phase. 400-2700 cycles. 30 Mc. adaptor. Approx. 10 Mc. band width. For conversion dope, see July/59 C.Q. Mag. \$14.95  
 azine. Excellent cond. .... **\$14.95**

**3 MUSTS FOR LABORATORIES!**

**DUMONT 256-B OSCILLOSCOPE**

Full 5" scope! Freq. response of vertical amplifier within 30% @ 10 Mc. 110 VAC. 60 cycles. Delay may be read from calibrated dial with accuracy of 1/10% (full scale). Crystal calibrated. Tuning markers of either polarity available. Trigger generator provides variable repetition rate. Movable marker output included. Wt. approx. 150 lbs. This top quality test equip. is worth many times the price! Original cost \$1,700.00. Excel. **\$69.50**

**LP-5 SIGNAL GENERATOR**

Freq. 9.5-30,000 Kc. ± 1% in 7 bands. 30-50 Mc. ± 3% (extended range) Output Imp. 10 ohms. Amplitude modulated. With 100-0-100 power supply. Excel. Checked out. **\$195.00**

**TS-13 TEST SET**

For bench and field testing of X-band radar. Measures: power output, smir. freq., signal-to-noise ratio, I.F. band pass, etc. Tests signal generators, etc. 150 W., 105-120 V., 60-800 cycles. Single phase. AC. Freq. 9.305-9.455 Mc. ± 2 Mc. Excellent condition. **\$39.50**  
 Terrible buy!

**YOU GOT IT! WE WANT IT! LET'S DEAL!**

We're buying top \$\$\$ for: GIC, PRG-4, -8, -9, -10; GN-58A; All elect. test equip.

**APR-1 RECEIVER**

Just removed from aircraft so you know it's good! Has self-contained 110 V. 60 cycles power supply. Input 110 V. 60 cyc. Excellent. **\$22.50**

**PLUG-IN TUNING UNITS FOR ABOVE**

TN-1, 38-90 Mc. .... **15.00**  
 TN-2, 80-300 Mc. .... **15.00**  
 TN-3, 300-1500 Mc. .... **19.95**

**SCR-522 TRANSCIEVER**

4-channel. Crystal controlled. 100-150 Mc. Ideal for 2 meters. Complete with tubes. Excel. **\$14.95**

All items FOB Burbank, Calif., subject to prior sale. In Calif. add 4%. Min. order \$3.95.

**J. J. CANDEE CO.** Dept. R  
 509 No. Victory Blvd., Burbank, Calif.  
 Phone: Victoria 9-2411

**Solder Chief**  
**ELECTRIC SOLDERING IRONS**

Unconditionally Guaranteed **Ideal for Electronics, TV, Radio, Hi-Fi, Printed Circuitry**



- 30 Watt Model Retail Price **\$1.58**
- 60 Watt Model Retail Price **\$2.18**
- 80 Watt Model Retail Price **\$2.58**

FACTORY PRE-TINNED

- Newly Designed Cool Handle
- Fast Heating
- Perfectly Balanced
- New Design Barrel Concentrates Full Heat At Tip
- Replaceable Tip
- Quality Construction and Performance—Economy Price

See Your Local Dealer or Write Us for Free Literature and Name of Nearest Dealer

Some Areas Still Open for Manufacturers Reps

**L. I. ELECTRO-LABS, INC.**  
 1186 BROADWAY, Dept. 88E  
 HEWLETT, N. Y.



**ASSOCIATION** leaders in general are seriously concerned by the lackadaisical attitude of so many service dealers toward the causes for the steady deterioration of the consumer-TV service business. One association official summarized the situation caustically:

"Now that they are picking up a few extra crumbs tossed from the table of the present boom, service dealers have gotten more independent than ever. They have gotten so independent that they won't lift a finger to protect their interests and investment in the service business. They refuse to see the tremendous gains that manufacturers, distributors, jobbers, and retailers have made because they created powerful, effective associations. They shut their eyes to the fact that this is an age of collective security in which group action is the only way a man can protect his business future."

**ITVSDA of Los Angeles**

The subject of dealer indolence toward cooperative effort prompted the following editorial by H. W. Wilkins, president of the Independent TV Service Dealers Association, 213 South Coronado Street, Los Angeles:

"Why do we organize? Is it because we are chronic joiners? Is it because we are idealists? . . . because we are 'do-gooders'? . . . because we like social contacts with others in our profession?"

"Nonsense! We organize because we are smart enough to realize that the independent television servicing industry, as we know it, is on the way out unless we alter the trends. And we can alter the trends by getting together . . . by organizing!"

"The stench created by the thieving practices of a minority in this field is going to drive our customers right into the arms of any new system of servicing which can capture greater public confidence.

"'Not my customers,' I can hear many of you saying. 'My customers know they are being treated right. They'll never leave me for some new gimmick.'

"Better come down to good old solid earth. This optimism may be justified by existing conditions. But what if conditions change? What if new people with new capital develop a new maintenance plan in which there is no room for the crooked operator because there is too much money at stake to risk losing public confidence? In other words, what if the stormy, uncertain seas on which the public has been bounced around suddenly become calm

and your friends no longer need your reliable haven? Especially, what if a new system—by its very efficiency—offers the same high-quality, reliable service at lower prices? YOU, Mr. Unorganized Service Shop Owner, will be left crying in your beer over how fickle your dear, loyal customers can be when something better is offered them.

"Together we can map out—and carry out—our own servicing system, one which will win public support because it serves the public best. Together we can plug up the many holes that make for inefficiency and high overhead. Together we can solve problems of financing, personnel turnover, bad credit risks.

"You, Mr. Independent Shop Owner, need not put on the uniform of an employee in a new maintenance plan. No, indeed. You can still be Mr. Independent Shop Owner, with all your individuality and with a thousand times more opportunity to put into practice the many fine ideas that come to your mind—and wander right out again—while you struggle alone to keep your head above water under the present dog-eat-dog conditions."

**Oregon State Association**

Plans for the formation of a state-wide service association for the Beaver State were crystalized recently at a meeting held in Salem, Oregon. The association leaders who met to exchange views on the new organization included Paul Brandon of Salem; Bill Elkins of Eugene; Colin Gregory, Bud Parrott, and Cliff Kadell of the Yamhill County Association; Les Armstrong, Roscoe Watts, and Jim Murphy of the Portland Television Appliance Association; and H. W. McClure of Toledo, Oregon.

Les Armstrong was appointed chairman *pro tem* of the organizational committee. He appointed Cliff Kadell to serve as secretary and Bud Parrott to handle the post of membership chairman. Oregon TV Service Association was the official name selected for the state-wide organization. Plans called for a state convention to be held at the Eugene Hotel, Eugene, Oregon, in September. Information about the plans and purposes of this new association may be obtained from Les Armstrong, Portland Television Appliance Association, 424 Failing Building, Portland, Oregon.

**TVB of Elkhart, Indiana**

The Television Bureau of Elkhart, Indiana, 1823 North Michigan Street, Elkhart, has been conducting an inten-

sive campaign to extend its own membership and also to interest service dealers in other northern Indiana cities in forming associations. Dean R. Mock of the Elkhart association, who is vice-chairman of the Indiana Electronic Service Association, recently offered to meet with any group of dealers in northern Indiana cities to discuss licensing or any other subject of interest to the TV service industry.

Associations or dealers who are interested in contacting Mr. Mock can reach him at the following address: Dean R. Mock, *Mock's TV & Appliances*, 1823 North Michigan St., Elkhart, Indiana.

### TESA-Ohio Grows

Now numbering fifteen member associations, the Buckeye State organization is well on the road to setting a new association record for speedy growth. Associations now affiliated in the TESA-Ohio association include:

TESA of Bellefontaine, 503 Eastern Ave., Bellefontaine; TESA of Chillicothe, 87 South Brownell, Chillicothe; TESA of Cincinnati, 1901 Vine St., Cincinnati; TESA of Cleveland, 5827 Turney Rd., Cleveland; ARTSD of Columbus, 2552 North High St., Columbus; TESA of Dayton, 2020 West Third St., Dayton; TESA of Lorain County, 92 E. Broad St., Elyria; SORTTA of Hillsboro, 634 North West St., Hillsboro; TESA of Middleton, 1426 Central Ave., Middleton; TESA of Sandusky, 245 East Market St., Sandusky; TESA of Springfield, P. O. Box 851, Spring-

field; ETAT of Toledo, P. O. Box 6658, Toledo; WREA of Warren, P. O. Box 966, Warren; TESA of Wilmington, 94 South Walnut, Wilmington; MVTVDA of Youngstown, 1742 Market St., Youngstown.

John P. Graham, 2552 North High St., Columbus, is secretary of TESA of Ohio.

### Appliance Service Problems

It is said there are more than 375,000,000 appliances currently in use in homes and that there could be a critical shortage of maintenance men to handle appliance servicing by 1960. The electric power companies, who have their fingers on the pulse of consumer needs for electrical repair services, are seriously concerned over the growing public irritation with the quality and character of the service they sometimes get on appliance repairs.

At a sales conference attended by more than one-thousand appliance sales executives, four factors were cited as bottlenecks in providing the public with competent appliance service. There were: faulty design, lack of parts interchangeability, lack of proper training of service personnel, and inadequate customer instructions.

Many electronic service dealers have found that certain types of appliance servicing are both simple and profitable. Electronic components are used in the automatic-control mechanisms of many appliances. Dealers who solicit

(Continued on page 144)

"Have used my Tel-A-Turn several months now and can truly say it's like having a couple extra hands. Wonderful, too, for trouble-shooting a set from top to bottom! Saves a lot of wear on nerves as well as TV parts! No more broken parts caused by chassis slipping. In other words—it's TOPS!" Mr. F. C., Michigan  
 "Tel-A-Turn holds sets 9" to 25" wide and up to 200 lbs. Ideal, too, for servicing amplifiers, record changers, and other electronic equipment."

### Direct Factory-to-you Price

Mail coupon TODAY for descriptive, illustrated folder, telling how you can make more profit with a Tel-A-Turn service cradle in your shop.

ROGERS MFG. CO., Dept. EW-109, Lindsey, Ohio  
 Please send me free folder about Tel-A-Turn.

Name \_\_\_\_\_  
 Address \_\_\_\_\_  
 City \_\_\_\_\_ State \_\_\_\_\_

Just Out

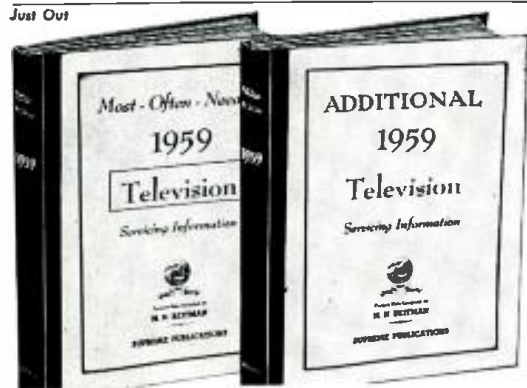

These two 1959 TV volumes cover practically all sets of all makes. The new ADDITIONAL 1959 TV manual includes material almost to the minute. Each flant manual has 192 pages of service data and repair hints, factory changes, double-size circuits. Special price, each only...

\$3

## New ADDITIONAL 1959 TV Volume

### LARGE MANUAL COVERS NEWEST 1959 TV SETS EARLIER TV VOLUMES STILL SOLD AT ONLY \$3

### AMAZING BARGAINS

Supreme twin 1959 TV manuals are the scoop of the year. Cover all sets of all important makes. New ADDITIONAL 1959 TV volume gives you the very latest material. Your price for this mammoth manual is only \$3. Supreme super values defy competition. Each prior-year manual (at only \$3) has a whole year of service material. Each volume covers different material, from 1948 to latest 1959 sets. Include circuits, wave-forms, alignment, voltage charts, service hints, changes, and double-spread diagrams. Practically tell you how to make every repair. More pages, more diagrams, more service data per dollar of cost. To get the best for less, get Supreme manuals.

Supreme TV manuals supply all needed service material on every TV set of every important manufacturer. Here is helpful, practical, factory-prepared data. It will really make TV servicing and adjustment easy for you. Join 167,000 servicemen who use, benefit, and save with SUPREME service manuals. In these volumes you get correct factory-checked circuits, alignment procedure, printed boards views, service hints, recommended changes, wave-forms, voltages, easy-to-use giant-size diagrams.

### BEST AT LOWEST COST

Here is your TV service material to help you do expert work double-quick; and priced at only \$3 per annual volume. Be ready to repair any model by carrying in your car all 14 TV volumes listed in coupon below. Or try one of the new 1959 TV manuals to see what an amazing bargain you get for only \$3. See no-risk coupon.

**TELEVISION SERVICING COURSE**  
 Let this new course help you in TV servicing. Covers everything from the most recent 1959 radios to pre-war old-timers; home radios, auto sets, combinations, changers, stereo, FM, and portables. Sensational values. Only \$2 for many volumes. Every manual has extra large schematics, all needed alignment facts, printed boards, voltage values, trimmers, dial stringing, and helpful hints. Volumes are large in size 8 1/2 x 11 inches, about 180 pages. See coupon at right for a complete list of these radio manuals. →

\$3

### NO-RISK TRIAL ORDER COUPON

### SUPREME PUBLICATIONS, 1760 Balsam Rd., Highland Park, Ill.

Rush today TV manuals checked  below and Radio manuals at left. Satisfaction guaranteed.

- New Additional 1959 Television Manual, only \$3.
- Early 1959 Television Manual, \$3.  1958 TV, \$3.
- Early 1957 TV, \$3.  Additional 1957 TV, \$3.
- 1956 TV Manual, \$3.  Additional 1955 TV, \$3.
- Early 1955, \$3.  1954 TV, \$3.  1953 TV, \$3.
- 1952 TV, \$3.  1951 TV, \$3.  1949 TV, \$3.
- 1948 TV, \$3.  1957-58 RCA TV Manual, \$1.50
- New Television Servicing Course, complete... \$3.

I am enclosing \$... Send postpaid.  
 Send C.O.D. I am enclosing \$... deposit.

Name: \_\_\_\_\_

Address: \_\_\_\_\_

**RADIO DIAGRAMS**  
 Supreme is your best source for all needed RADIO diagrams and service data. Covers everything from the most recent 1959 radios to pre-war old-timers; home radios, auto sets, combinations, changers, stereo, FM, and portables. Sensational values. Only \$2 for many volumes. Every manual has extra large schematics, all needed alignment facts, printed boards, voltage values, trimmers, dial stringing, and helpful hints. Volumes are large in size 8 1/2 x 11 inches, about 180 pages. See coupon at right for a complete list of these radio manuals. →

- 1959 } Popular RADIO
- 1958 } Diagram Manuals
- 1957 } at only \$2.50
- 1956 } each....
- 1955 Radio Manual, only \$2
- 1954
- 1953 } These annual
- 1952 } RADIO volumes
- 1951 } specially priced
- 1950 } at only \$2.50
- 1949 } each....

**THIS GROUP ONLY**

- 1948
- 1947
- 1946
- 1942
- 1941
- 1940
- 1926-1938 Manual, \$2.50
- Radio and TV Master Index, 25¢

**Supreme Publications**  
 Sold by All Leading Parts Jobbers

October, 1959

**VIDEO ELECTRIC COMPANY says: DOWN WITH RISING COSTS OF**

Each and every tube is tested by our supplier under actual operating conditions in Radio, FM, Hi-Fi, Industrial Equipment and Television Chassis or Intricate Testing Equipment for Mutual Conductance and Life Test.

Below is a Partial List of Over Three Hundred Popular Types! Write for Free Complete List and Order Blank!

6B2	3AX4GT	6BC5	6L7	T77	1J
6B2	3AX7	6BC7	6M7	T81	19AUC4T
6B2	3B7	6BC8	6N7	T82	19BCC
6B2	3B7	6BC9	6P7	T83	19B
6B2	3B7	6BD5	6Q7	T84	19B
6B2	3B7	6BE5	6R7	T85	19B
6B2	3B7	6BF5	6S7	T86	19B
6B2	3B7	6BG5	6T7	T87	19B
6B2	3B7	6BH5	6U7	T88	19B
6B2	3B7	6BJ5	6V7	T89	19B
6B2	3B7	6BK5	6W7	T90	19B
6B2	3B7	6BL5	6X7	T91	19B
6B2	3B7	6BM5	6Y7	T92	19B
6B2	3B7	6BN5	6Z7	T93	19B
6B2	3B7	6BO5	7A7	T94	19B
6B2	3B7	6BP5	7B7	T95	19B
6B2	3B7	6BQ5	7C7	T96	19B
6B2	3B7	6BR5	7D7	T97	19B
6B2	3B7	6BS5	7E7	T98	19B
6B2	3B7	6BT5	7F7	T99	19B
6B2	3B7	6BU5	7G7	T100	19B
6B2	3B7	6BV5	7H7	T101	19B
6B2	3B7	6BW5	7J7	T102	19B
6B2	3B7	6BX5	7K7	T103	19B
6B2	3B7	6BY5	7L7	T104	19B
6B2	3B7	6BZ5	7M7	T105	19B
6B2	3B7	6C1	7N7	T106	19B
6B2	3B7	6C2	7O7	T107	19B
6B2	3B7	6C3	7P7	T108	19B
6B2	3B7	6C4	7Q7	T109	19B
6B2	3B7	6C5	7R7	T110	19B
6B2	3B7	6C6	7S7	T111	19B
6B2	3B7	6C7	7T7	T112	19B
6B2	3B7	6C8	7U7	T113	19B
6B2	3B7	6C9	7V7	T114	19B
6B2	3B7	6CA	7W7	T115	19B
6B2	3B7	6CB	7X7	T116	19B
6B2	3B7	6CC	7Y7	T117	19B
6B2	3B7	6CD	7Z7	T118	19B
6B2	3B7	6CE	8A7	T119	19B
6B2	3B7	6CF	8B7	T120	19B
6B2	3B7	6CG	8C7	T121	19B
6B2	3B7	6CH	8D7	T122	19B
6B2	3B7	6CI	8E7	T123	19B
6B2	3B7	6CJ	8F7	T124	19B
6B2	3B7	6CK	8G7	T125	19B
6B2	3B7	6CL	8H7	T126	19B
6B2	3B7	6CM	8I7	T127	19B
6B2	3B7	6CN	8J7	T128	19B
6B2	3B7	6CO	8K7	T129	19B
6B2	3B7	6CP	8L7	T130	19B
6B2	3B7	6CQ	8M7	T131	19B
6B2	3B7	6CR	8N7	T132	19B
6B2	3B7	6CS	8O7	T133	19B
6B2	3B7	6CT	8P7	T134	19B
6B2	3B7	6CU	8Q7	T135	19B
6B2	3B7	6CV	8R7	T136	19B
6B2	3B7	6CW	8S7	T137	19B
6B2	3B7	6CX	8T7	T138	19B
6B2	3B7	6CY	8U7	T139	19B
6B2	3B7	6CZ	8V7	T140	19B
6B2	3B7	6D1	8W7	T141	19B
6B2	3B7	6D2	8X7	T142	19B
6B2	3B7	6D3	8Y7	T143	19B
6B2	3B7	6D4	8Z7	T144	19B
6B2	3B7	6D5	9A7	T145	19B
6B2	3B7	6D6	9B7	T146	19B
6B2	3B7	6D7	9C7	T147	19B
6B2	3B7	6D8	9D7	T148	19B
6B2	3B7	6D9	9E7	T149	19B
6B2	3B7	6DA	9F7	T150	19B

**ELECTRON TUBES  
OVER ONE  
MILLION USED  
TUBES TO  
SELECT FROM**



each FOR ANY  
**TUBE**  
**\$37.00**  
PER HUNDRED

**GUARANTEE:** We guarantee to replace FREE for one (1) year any tube purchased from us which fails to function efficiently under actual operating conditions. Refunds will be made promptly for any defective merchandise.

**WE HAVE OVER  
1000 USED TV SETS**  
At All Times In Our Huge Warehouse  
Buy one or more of these WORKING TVs  
to sell or use as your own second set.  
All sets in GOOD WORKING condition!  
Your Choice—Console or Table Model

10"	\$23.00	17"	\$46.00
12"	\$25.00	19"	\$58.00
14"	\$33.00	20"	\$64.00
16"	\$40.00	21"	\$72.00
24"	\$99.00		

When ordering TVs, state whether table model or console is desired. All sets, preference on make of set. Also, preference on express F.O.B. Newark. On any quantity, WIRE or CALL today!

SEND for our FREE complete TUBE & PARTS LIST and order blank.

**FREE**  
Bonus Antenna  
Given with  
Any TV Set  
Order!!

**FREE**  
RCA "Cheater"  
Cord Given with  
Any Tube Order  
of \$7.00 or  
More!!

Phone HUMBOLDT 4-9848



**FREE POSTAGE**  
In U.S.A. and Territories on orders over \$5.00. 25¢ handling charge on orders under \$5.00. 25% deposit required on C.O.D.'s. Please send approximate postage or freight on Canadian and foreign orders. Subject to prior sale.

**ELECTRIC COMPANY**  
9-15 Sixth St., Harrison, N. J.

this type of business claim that customers pay normal charges for home service on appliances with better grace than they do for TV service.  
Some service associations have taken cognizance of the possible opportunities in this field by placing the subject of appliance servicing on their schedules for fall and winter meetings.

**California Event**

In connection with its Fourth Annual Installation Dinner-Dance, members of the Radio TV Association of Santa Clara Valley, Calif., have persuaded county supervisors to proclaim Radio and TV Week, from October 18 to 24. Members will concentrate their advertising during this period on salutes to the association. Local newspapers, radio stations, and TV broadcasters have pledged cooperation and publicity.

**Licensing Pro and Con**

In the minority group of service associations that oppose licensing, TEAM of Missouri highlights the question in a recent issue of "TEAM News." A favorable report on licensing is reprinted from another, pro-licensing association publication, followed by an unfavorable one in a letter to TEAM. The featured editorial presents this group's reasons for its dim view toward regulation by government. The editorial argues that licensing will not and, where tried, has not done anything to eliminate part-timers, improve the financial plight of service businesses, increase wages, inhibit dishonest operators, or ameliorate public relations.

TEAM feels that remedies can be applied only by the industry itself acting in an organized way. ("A license law won't clean a dirty store front. It won't make a service dealer dress, talk, think, or act any different, and these are the basic elements of our problems.") However, this Missouri group sees merit in a voluntary system of Certified Electronic Technicians to give qualified people prestige in the way the CPA enjoys special status among accountants.

**National Unity**

The matter of the application by TSA of Detroit for NATESA membership may not yet be dead. Several member groups within NATESA are talking about re-opening the question at the national convention. The newly joined Indianapolis group feels that a revision of the NATESA constitution and bylaws that will permit acceptance of more than one member group from a given area is in order to permit entry of TSA.

Available from NATESA is a reprint of a letter signed by John H. Stefanski, president of TESA of Michigan, giving background material, as he sees it, on differences between TSA and the rival Detroit and Michigan groups who succeeded in gaining admission to NATESA.

**BC 603—20 to 27 MC FM RECEIVER**  
See Sept. and Oct. 1958 issues of "CQ" for conversion to 20-50 MC and AM.  
UNUSED.....ea. **\$12.95**

**RADAR SYNCHRONIZER UNIT** with 7 ea. 717 A's only, 12-SO239 Coax. Chassis, Connectors, Relays, Switches, etc.....ea. \$2.49  
4 for \$8.00

**DU MONT OSCILLOSCOPE** Model 256. Govt. Acq. Cost \$1700.00. Condition Good...\$69.50

WRITE FOR BARGAIN FLYER  
**R W ELECTRONICS**  
2430 S. Michigan Ave., Dept. N  
Phone: CALumet 5-1281 Chicago 16, Ill.

**LOOK**  
NO FURTHER... IF YOU'RE UNHAPPY WITH "HI" HI-FI PRICES. WRITE FOR OUR UNUSUAL AUDIO CATALOG.  
KEY ELECTRONICS CO.  
120-C Liberty St., N.Y. 6.  
Phone EV 4-6071

**TAPE RECORDERS**  
Recording Tape  
Bell Tape Decks  
Hi-Fi Equipment  
Norelco Speakers

**WE WILL NOT BE UNDERSOLD!**  
Send for our discount catalog and see why!  
**COMMISSIONED ELECTRONICS CO.**  
1776 Columbia Road Washington, D. C.



## The Stereo Disc Today

(Continued from page 55)

a "stereo seat." Sitting to the right or the left of center is no different than the listener sitting to the right or left of the orchestra in the concert hall.

The industry as a whole is, of course, never satisfied with its present achievements. We are always looking for ways to improve the quality of the records we turn out. There are, of course, many minor problems—as there are in any industry. One of these involves the development of a "quieter" plastic material for blanks. Record wear is still more of a problem than with mono-

phonic discs but here the user can do much to alleviate this particular problem.

In the final analysis, the quality of reproduction that the music lover obtains is actually up to the listener himself. This is particularly true in the case of stereo records since the smaller stylus rides much closer to the bottom of the groove and any dust or dirt that is allowed to gather in the grooves will be ground in, creating ticks, pops, and noises for the life of the record. As a manufacturer, we go to considerable time, trouble, and expense to produce the highest quality record possible. The rest is up to the audiophile. The worst thing that the user can do is to leave the record ex-

posed on the turntable after he has finished playing it. As soon as you are through playing your records take them off the turntable, put them in their protective poly bags, and store them in their jackets. Your records represent a considerable investment—often a greater investment than the equipment on which they are played. They will give many hours of satisfactory service and maximum listening pleasure if you will just take care of them properly.

With all this in mind, one can be assured that *right now* anyone buying a quality stereo recording will obtain sound reproduction much richer, fuller, and better than anything heretofore obtainable on mono discs. -30-

### ACTUAL PHOTOGRAPHS OF SQUARE WAVES ON DUMONT #241 5-INCH TEST OSCILLOSCOPE



AT 50 CYCLES



AT 100 KC

Ampl.	Input Imped.	Gain	Defl. Sens.	Response
Y	2 M, 40 mmf.	250	.07vrms/in.	20-2,000,000 cy.
X	2 M, 40 mmf.	100	.7vrms/in.	5-100,000 cy.
Z	1 M, 20 mmf.	10		30-2,000,000 cy.

X and Y plates fed push-pull from both amplifiers. Panel terminals give choice of P-P or unbalanced Direct connections. sensitivity 22vrms for Y, 21 for X, 15-30,000 cy sawtooth rates. Test-voltage post 1.6v peak/peak, 60 cy. Specifications above **DO NOT TELL THE STORY.** One square wave picture is worth 1000 words of response CLAIMS or specs. #241 is the lab-man's favorite. Big, sturdy, always dependable, 65 lbs net of Dumont quality. 15" x 10 1/2" panel has room for convenient controls and in-guaranteed electrically. With reprint of complete instruction book, large schematic, parts list. Ship w/ \$129.50. 75 lbs fob Los Ang. Cash price only.

Time Pay Plan: \$32.00 cash and 12 mos at \$9.10/mo.

### MINIATURE 30,000 VOLT DC POWER SUPPLY

Cond. Prod. Co. P530-1M60. Oil-sealed. Only 7" x 7" x 8" h. plus terminals and anti-corona balls. 1 ma with 5% max. ripple. Input 120 v, 60 cy. If Variac used at input, output may be varied. \$69.50. 0-32,000 v. FOB Los Angeles.

### MEASUREMENTS CORP. MODEL 84 SIG. GEN.

300-1000 mc accurate to 1/2% and mod. by internal sine or pulse. MICROVOLTAGE CALIBRATED output 1 uV to 1 v. Exc. condition, checked PERFECT by Standards Lab. 160 lbs gross fob \$179.50. Los Angeles. Time Pay Plan: \$45.25 cash and 12 mos at \$12.53/mo.

### TERRIFIC BARGAINS in

CONSTANT-VOLTAGE TRANSFORMERS

End fluctuating line voltage!  
Sola, Raytheon, G.E.



Sola 30768 (pictured above) 2 KVA: 95-125 or 190-250 v, 60 or 50 c, 1 ph, to 115 v ±1%, 0-17.4 a. Shpg wt 260 lbs fob Los Angeles, Calif. \$147.50

Sola 30710: Same as above except capac. box mtd. above instead of alongside; less floor space. Shpg wt 260 lbs fob Harrisburg, Pa. \$147.50

Raytheon 3 KVA: 230-440 v 1 ph 60 cy, steps down to 117 v ±1% 0-25.6 a, for inputs 180-270 or 360-540 v. Shpg 374 lbs fob Ogden, Utah. \$147.50

G.E. 2.3 KVA: 57-63 cy 1 ph, 100-135 v, in. to link-switch selected 113/115/117 v ±2%, 220 lbs fob constant freq. Shpg 594 lbs fob Seattle, Wn. \$179.50

Sola 301110 1 1/2 KVA: 58-62 cy 1 ph, 95-125 v, in. Newark, New Jersey. \$99.50

### SCHEMATICS—CONVERSIONS FOR SURPLUS GEAR

Send stamped addressed envelope for NEW List E; has many new items. Includes many Tech Manuals. Add 25¢ for chart explaining AN Nomenclature. **DO IT TODAY!**

\*Minimum monthly payment is \$6.00. Combine with other material from this advertisement to exceed \$5.99/mo.

### COMMUNICATIONS RECEIVER BARGAIN

DAQ Navy's Long-Range DF. 14 tubes. 1.5-30 mc in 4 bands with 10-turn band-spread logging dial to cover each calibrated band. Has built-in ac power supply for 120 v 60 cy. NEW, with schematic. \$99.50. FOB Norfolk, Va. Only \$17.50/mo. Time Pay Plan: \$9.95 cash and 12 mos. at \$8.36/mo.

### HV POWER SUPPLY FOR ANY 5" OSC

DAQ's CRT-20169 supplies 1800 vdc 2 ma. filtered; also has 6AC7 defl. coil ampl. and VR supply for it. Input 120 v 60 cy. New. W/schematic. \$17.50. FOB Norfolk, Va. Only \$1.75/mo. Time Pay Plan: \$1.75 cash and 12 mos. at \$1.47/mo.



### \$850 TEST OSCILLOSCOPE FOR ONLY \$69.50

TS-34 AP. The Armed Forces' accepted standard to see a pulse as it really is. Video response 11 cy to 50/120 cy. Has all standard facilities, with sweeps 10 cy to 50 kc, PLUS automatic-triggered sweeps to show random or recurrent pulse on sweep. Compact, but the lens gives 5" picture equivalence. Exc. used, checked out OK, in its carry-in suitcase, with reprint of the most important 16 pages of the tech manual. \$69.50. Shpg wt 40 lbs fob Los Angeles. ONLY. \$69.50. Time Pay Plan: \$18.50 cash and 12 mos at \$4.76/mo.

### VHF-UHF MICROVOLTER SIGNAL GENERATOR

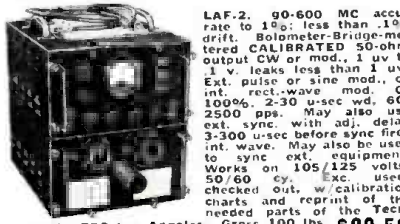

LAF-2. 90-600 MC accurate to 1%; less than 1% drift. Bolometer-Bridge-meter CALIBRATED 50-ohm output CW or mod., 1 uV to 1 v, leaks less than 1 uV. Ext. pulse or sine mod., or int. rect-wave mod. 0-100%. 2-30 u-sec wd. 60-2500 pps. May also use ext. sync. with adj. delay 3-300 u-sec before sync fires int. wave. May also be used to sync ext. equipment. Works on 105/125 volts, 50/60 cy. Exc. used, checked out, w/calibration charts and reprint of the needed parts of the Tech. manual. FOB Los Angeles. Gross 100 lbs. \$89.50. Only \$25.00/mo. Time Pay Plan: \$25.00 cash and 12 mos at \$6.02/mo.

### GROUND-TO-AIR . . . OR 220 MC AMATEUR BAND

MAR. 225-390 mc, tunes down to 220 mc. Receiver-Transmitter, AM voice and mcw, 10 W to antenna. 10 crystals plug into front panel. Each controls one channel for both rcvr & xmtr. One knob on front panel selects xtl and Autotone mechanism. Works on any of the following: 12, 24, 110, 230 v dc and 115 or 230 v, 60 cy. Use it in a truck, boat, home, or airport. All you need are xtl, mike, phones, plugs, antenna. Metered tune-up. 52 ohm antenna 50 plug, 1 W, 600 ohm phone jack, 4 IF stages. Adjustable squelch. Complete with all 24 tubes. 2C39 final. Pair 6L6G mod. to 100%. Very late design. In 3 waterproof aluminum cases, each 2 1/4" wd, 18 1/2" dp; total stacked height 30". With schematics, operating, and tune-up instructions. Shpg wt 250 lbs fob Hartford, Conn. Used, but in exc. condition. Acq. \$69.50. Cost \$7000.00. You pay only \$25.00/mo. Time Pay Plan: \$18.50 cash and 12 mos at \$4.76/mo.

### RT-18/ARC-1

10-channel xtl-controlled Autotune xmtr-rcvr 100-155 mc. Favorite for flight, now available to amateur. Export packed by NavAr in absolutely like-new condition. With schematic. Shpg 85 lbs fob Corpus Christi, Texas. \$49.50. Time Pay Plan: \$12.75 cash, 12 mos at \$3.43/mo.



### RECEIVER/RF PRESELECTION/RF AMPLIFIER TUNES 550-32,000 KC

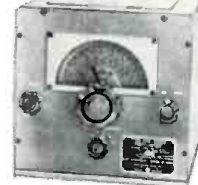

CME-50063 RF Preselector, New, clean, in factory pack with tech. manual, TRF tuner/amplifier to improve any receiver. Add xtl tube in series with headset across output and it is a complete receiver for BC, SW, Citizens. With 25 mmf instead of headset, it is a Hi-Fi tuner. As a preselector, it is a powerful signal booster, adds 20-25 db sensitivity, improves selectivity and signal/noise ratio, and cuts image to 1/50,000. Complete and self-contained. 9 1/4" h, 10 1/2" w, 13" d. OA. Net 19 lbs. Input 120 v, 60 cy. Includes rect. 2-6K7, 3 sets of 6 RF xfrms (ant., 2 RF, 6-sect. tuning gang, band sw, gain control, and In-Out sw. 40:1 ratio vernier tuning. Large illuminated dial accurately calibrated in 6 overlapping bands, plus a 6 1/2" db lead ground; output 100-300 ohms. Shpg \$29.95. Net 35 lbs fob Stockton or Seattle. ONLY. \$29.95. Time Pay Plan: \$4.45 cash and 12 mos at \$2.38/mo.

### DYNAM. MUTUAL-CONDUCTANCE TUBE TESTER

I-177-B: Recognizing that a tube tester is only as good as the data and sockets available, we went to great expense to reproduce the latest data book (March 1957) and to print diagram of simple socket adapter kit, plus the most important parts of the tech manual. With the adapter, you will test 9-pin 6E7, 12AK7, etc., plus xmtg tubes such as 832A, 829B, etc. Every shipment will include the literature, 25 lbs fob Los Angeles. \$29.50. Good used condition. \$17.50. Time Pay Plan: \$7.75 cash and 12 payments of \$2.03 per month. Brand New, in original packing, only \$37.50. Time Pay Plan: \$3.75 cash and 12 mos at \$3.15/mo.



### TUNING-FORK STANDARD FREQUENCIES FROM AMERICAN TIME PROD. UNUSED MODULARS

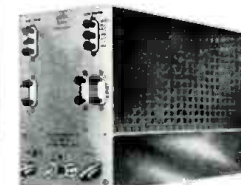

Combination BENCH POWER SUPPLY & 400 CY Standard Model 100-0.001% & 2 6AU6 supplied by VR150 & 5U4. Signal thru amplitude control to 6V6G & xfrms to Hi-Imped., i.e. 8 & 4 ohm binding posts. Other binding posts give: Filtered dc 300 v (no load) reducible by 1500 ohm rheostat in series with fixed 500 ohms effective internal resistance; take out up to 120 ma. Also 6.3 v ac, 4 A, & 2 isolated 7 1/2 v ac. All components on front panel. 6" wd, 9" h, 14" dp. Input 50/60 cy at 95/117/130/190/210/234/250 v. NEW. Tested and guaranteed. With schematic. 40 lbs. Raitex fob Los Angeles. \$97.50. ONLY. Time Pay Plan: \$24.75 cash and 12 mos at \$6.79/mo.

1000, 500, 250, 125, & 62 1/2 Cy ±.02% 7" x 4" 1/2" ac plug-in fork #2003, 7 12AT7's, and 4 Walkit plug-in binary flip-flop count-downs, each usable from 25 kc to 0. NEW. Tested and guaranteed, ready to use. Requires an external 250-300 v d.c., 35 ma., & 6.3 v a.c. 2.5 a, both had at front panel of the #400A described above. With schematic and circuit information. Shpg wt 4 lbs fob Los Angeles. \$79.50. Time Pay Plan: \$20.25 cash and 12 mos at \$5.53/mo.



### THUMBNAILED DESCRIPTIONS OF GIANT VALUES

Ballantine 220-A Decade Amplifier, steps up 10-150,000 cy by 10 or 100 ±2%. New \$49.50  
LP-3. Gen. Radio sec. std., CAA-approved accuracy, stability. 10 kc-50 mc u-volter. \$199.50  
LX-2. Metal-cased u-volter 712-330 mc. \$179.50  
Photof. F2 2-pen Recorder. \$279.50  
Hewlett-Packard 205AG Audio u-volter. \$249.50  
Brush 6-pen Recorders. . . . . Brush 2-chan. DC Ampl.  
G.R. Capac. Bridge. . . . . 455 kc Panadapters. . . . . R00  
38-1000 mc Rcvs. . . . . TTY #15 Keyboards. . . . . DRE  
Loran. . . . . WRITE FOR NEEDS!  
etc. etc. etc.

Buy anything mentioned in this ad on TIME PAY PLAN. Write for details on items of interest to you.

California Buyers add 4% Sales Tax  
**R. E. GOODHEART CO.**  
P. O. Box 1220A  
BEVERLY HILLS CALIFORNIA

# SURPLUS BUYS

**TUBE CHECKER** 1-177-115V-60 Cy. Mutual conductance tester. Almost new condition. The work horse of the Signal Corps. Information for new tube type testing will be made available shortly. A \$300 unit for only... **\$24.95**

**BC733 AIRCRAFT RECEIVER**—10 Tubes, w/lyna., 20 lbs., 100-110 Mc Converter for this unit will appear in CQ Magazine for 2 or 3 meters. Price on this unit sure to go up. With all tubes, like new cond. While our stock lasts... **\$59.95**

**SUITS CASE TRANSCIEVER AN PROC-5-117 x 12" x 4 1/2"**, used by O.S.S., 4 to 18 Mc—2 Band—Xmtl Ntal controlled—Receiver Tunable, 115-230 VAC—60 cy. Input, Xmtl. Bld. (12 watt) Output, Selenium Etc. Cond.,... **\$69.95**

**DC POWER SUPPLY**—Input: 115V-60Cy. Output: 14VDC, 3 amperes Filtered, Relay Control in Metal Chest. This is a useful item for dynamometers, relays, battery chargers, model RR, etc. 8" x 12" x 8"—15 lbs., Brand New... **\$8.95**

**WILLARD PLASTIC WET CELL**—2V—20 Amp Hrs., Incl. Carton, Brand New... **\$2.79 ea.**—12 for \$30.00

**Panel Type Frequency Meter**—Heed type, 115V—50-102 cycle... **New \$10.95**

**POW. FLA. XFORMER**—115V-60 Cy. Sec. 700, 0-300V—100 Ma; 12.6 VCT—3A; 12.0V—3A; 5.0V—3A. Open Frame—Compact—Useful as 12 or 24 Volt Transf. for Surplus Gear (U/V RV-20 P.S.) New... **\$2.49**

## PANEL METERS

Min. Meters—1 1/2" Sq.—(60 or 90) 100 u.a. ... **\$3.95**  
 Min. Meters—1 1/2" Sq.—(60 or 90) 100 u.a. ... **\$2.95**  
 2" Rd.—Weston—New—0-5A RF... **3.49**  
 3" Rd.—Hercftz.—"N" 50db over Sd. Now... **3.49**  
 2" Square—Tripp—20 Amp AC... **2.49**  
 2" Square—Simpson—50 Micro Amp. Boxed... **4.95**  
 2" Rd.—Tripp—500 Mill... **2.95**

## NEW—OIL CONDENSERS—NEW

600VDC	1,000VDC	2,000VDC	4,000VDC
1Mid \$ .40	1Mid \$ .60	1Mid \$ .88	1Mid \$ 3.50
2 " .75	2 " 1.35	2 " 3.50	2 " 13.95
4 " 1.15	4 " 2.50	4 " 6.00	4 " Quant. Avail.
10 " 1.95	10 " 3.90		All Sizes

TS345A/ART-22—Nolke & Gate Generator, 115V—60 cy. Brand New... **\$49.95**

ARC-5 Rechr.—3-6 Mc BC 451... **New \$11.95**

1625 RCA. W.L. GE... **11.95**

## RELAYS

**DPST—12VDC**—Str. **\$5.00**

**DPDT—115VAC**—Ceram. Leach... **\$2.95**

**SPDT—5MV**—Small \$69.3 **\$2.00**

**DPST—110VAC**—Alled \$1.35, 4 **\$5.00**

**POWER STAT**—Superior—120V AC—50/40 cps—Two 18 Amp windings in tandem can be separated. Cat. No. S406P... **Brand New \$59.95**

**Selenium Rectifier**—FWB—0-10VAC. Input—20 Amps—with matching Mformer 115V—60 Cy—50V AC—12 Amps. Delivered 24VDC. Auto—Perfect for Art. 15, Etc.—W/Instr... **New \$24.95**

**Portable Receiver RB2-2-6 MC** (Marine Bands). Light-weight, compact. Complete w/47 1/2 V. Batt. and 2 Flashlite cells—Operating 6 lbs. ... **New \$22.95**

**REX RADIO SUPPLY CO.**  
 84 Cortlandt St.  
 New York 7, N. Y.  
*In the Heart of New York's Radio Row*

# GLOBE ELECTRONICS

*A World of Values!*

The Transceiver Buy of a Lifetime!  
**1215 MC TRANSMITTER & RECEIVER**

Consists of superheterodyne receiver and pulse transmitter for operation on 950-1350 Mc. band.

**TRANSMITTER:** 212 W. output, CW. Freq: 1215-1255 Mc.

**RECEIVER:** 100 DBM, 925-1350 Mc. 30 DBM, 2300-2465 Mc. Superheterodyne.

**CAVITY:** Contains local osc., xmtl., pulse osc., crystal mixer, 1-2C12, 1-2C16 tubes, Veeder-Root counters. Complete by wired.

60 MC. IF STRIP: Contains 8 - 6AK5, 1 - 6AL5, 1 u.b.c. Completely wired. RI-1037 and RI-1039

Relays included. Receiver practically ready to go as is. Transmitter easily converted from pulse to CW. Easy-to-follow, complete conversion instructions written by Don Goslay, W6MMU, 1215 Mc. World Record holder—sample free of charge! Wt. approx. 20 lbs.

**COMPLETE, AS ABOVE, ONLY... \$34.95**

**CAVITY, AS ABOVE, complete, sold separate... \$4.95**

**IF STRIP, AS ABOVE, complete with tubes... 24.95**

**RELAYS, RI-1037, RI-1039, Each... 1.99**

Write For New Free Flyer! Visit Our New Sales Center

**GLOBE ELECTRONICS**  
 3103 PICO BLVD. SANTA MONICA, CALIF.  
 Phone: EXbrook 3-7206

**BEST IN HI-FI VALUES!**

**NO DELAY SERVICE** | All orders rushed to you in factory-sealed cartons. Write for free catalog.

**audion** 25-W Oxford Road, Massapequa, New York

## "Carrier Switch"

(Continued from page 65)

receiver if the transmitter is brought very close to the antenna coil or loop. A power-supply hum will be heard at a number of places on the receiver's dial and the kilocycle separation between these settings is approximately the frequency of the transmitter. If a good communications receiver is used the frequency may be determined more accurately, but this is not too important as long as  $L_2$  in the transmitter and  $L_3$  in the receiver are both tuned to the same frequency as determined by  $L_1$ .

Turn the transmitter off to check the receiver. Remove the jumper from the test jacks and insert the v.o.m.'s probes, with the v.o.m. scale set to a low current range. Apply the battery power and check for approximately 100-microampere current flow. If this is not present, or the current drain is appreciably higher, check the transistors, the wiring, and the battery polarity and voltage for correct values. Increase the v.o.m. scale to the 5 milliampere range, plug the receiver's cord into the socket nearest the transmitter's plug, and turn the transmitter back on. Run the slug of  $L_3$  in or out of the coil to obtain an increase in the meter reading. Tune the slug of  $L_3$  for maximum meter reading but, at the same time, keep this reading below the 2 milliamperes level at all times. When the maximum is obtained,  $L_3$  is tuned to the transmitter's frequency. Leave the meter connected to the test jacks and return to  $L_2$  in the transmitter. Retune  $L_2$ 's slug slightly to see if a higher reading can be obtained. This touch up adjustment will complete the alignment and if  $L_1$ 's slug is ever re-adjusted to shift the frequency of the transmitter, this same alignment procedure must be followed. The "Carrier-Switch" can now be put to use.

The range of the "Carrier Switch" depends upon the number of appliances, lamps, or other shunting equipment placed across the same line used to carry the signal. Also, if a distribution transformer is in the path of the carrier signal it may not be possible to pass enough useful signal across its windings to activate the receiver. Generally, the combination will work well in a small building or apartment house, or from house to house in a rural area where the power lines are overhead and the houses are served from a common distribution transformer.

Plug the transmitter and receiver into the line at their respective locations and energize the transmitter. Place the v.o.m. at the receiver's test jacks and determine whether the signal is being received by noting an increase in the standby current reading, with the "Sensitivity" control set about half-way. Reverse the power plugs of the transmitter and receiver to obtain the highest possible reading

## CAMERA FANS:

# KNOW BEFORE YOU BUY!

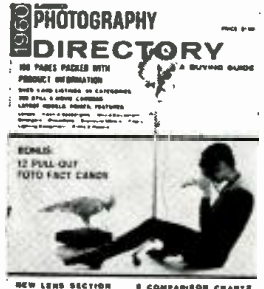

NEW LEAD SECTION • COMPARISON CHARTS  
 12 PULL-OUT PHOTO FACT CARDS

You'll find the most complete catalogue of photographic equipment ever published in the brand new 1960 PHOTOGRAPHY DIRECTORY AND BUYING GUIDE!

Now on sale at your newsstand—  
 or order today using handy coupon below!  
**Only \$1.00**

Here's a rundown of over 5,000 of the latest photo products—complete with data, prices, comparisons, illustrations! Get all the facts on everything from cameras to lenses to films and filters... from black and white or color to movie or still photography. Make intelligent comparisons before you shop—and save time, money and effort.

You'll also enjoy these other extra features:

- **CAMERA COMPARISON CHARTS**  
 Compare prices, shutter ranges, lens speeds, special features on over 300 cameras of all types.
- **PORTRAIT LIGHTING SETUPS**  
 How to light a model, complete with diagrams.
- **MODEL RELEASE FORMS**  
 May save you from costly legal tangles.
- **ROUNDUP OF LATEST PHOTO BOOKS**  
 Your guide to the latest in good photo reading.

### PLUS—NEW SPECIAL FEATURE:

**FOTO FACTS FILE CARDS**—Handy data section bound right into the 1960 PHOTOGRAPHY DIRECTORY—figures on films, lenses, filters, exposure and conversion scales right at your finger tips. Will be supplemented every year—so start your file now!

Compiled by the Editors of POPULAR PHOTOGRAPHY—World's largest selling photographic magazine—the 1960 PHOTOGRAPHY DIRECTORY AND BUYING GUIDE will save you far more than the dollar it costs.

Buy your copy today at your favorite newsstand—or better still, send for a copy by using the handy coupon below!

Ziff-Davis Publishing Company  
 Department EW109  
 434 South Wabash Avenue  
 Chicago 5, Illinois

Please send me a copy of the 1960 PHOTOGRAPHY DIRECTORY AND BUYING GUIDE. I enclose \$1.00, the cost of the DIRECTORY, plus 10¢ to cover mailing and handling charges. (Canada and Foreign \$1.25 plus 10¢ postage.)

(name) \_\_\_\_\_  
 (address) \_\_\_\_\_  
 (city) \_\_\_\_\_ (zone) \_\_\_\_\_ (state) \_\_\_\_\_

and see whether it is possible to obtain at least a 2-milliampere current reading with further adjustment of the "Sensitivity" control. If this can be obtained, turn on all the appliances, lights, or other equipment which may be connected to the power line carrying the transmitted signal and note if the reading drops below 1 milliampere.

For maximum reliability, it will be necessary to have at least one milliamp of signal current under the worst line-loading conditions. If this can be met, turn off all the appliances and leave the "Sensitivity" control set for a maximum reading of 2 milliamperes for best operation without overloading the transistors.

The relay contacts can be connected to either turn on or turn off the controlled device upon receipt of the signal. The contacts will safely handle a 250-watt load, but if much heavier equipment is to be controlled the relay contacts can operate a heavier relay to control the gear.

Use the "Carrier Switch" to cut off the TV or radio speaker when you want some quiet around the house, turn on your TV from the armchair, or start a pump out in the barn when it's too cold to go outside. —30—

## ELECTRONIC TV TAPE EDITING

**A** NEW method of producing TV programs on tape, permitting for the first time the electronic editing or mixing of taped scenes and sounds, was described by engineers of the Reeves Sound Studios, Inc. and RCA. The new concept will permit mixing information on TV tape with much the same flexibility as on motion picture film.

The method of assembling a TV production on tape involves the use of pre-recorded tapes bearing picture information from any number of cameras, along with the sound tracks. By employing several tape recording and playback machines with matching monitors, the system will enable the producer and director to see different views simultaneously and choose the most desirable scenes. Then he can schedule the complete program and electronically edit, or "splice," by means of fast switching circuits, the desired sequences into a master monitor and recorder.

Main elements of the system are eight RCA TV tape recorders, two equipped for color, two monochrome and one color live camera, one monochrome and one color film chain with 16-mm and 35-mm projectors, three editing rooms, and a master control room. —30—

## ANNUAL VHF ROUNDUP

**T**HE Syracuse VHF Club is holding its Fifth Annual VHF Roundup on October 10th at 3 Rivers Inn, 10 miles north of Syracuse, N. Y. on Route 57 and Thruway Exit No. 28.

Reservations will be by pre-registration only. Proceedings are set to start at 10 a.m. for early birds and at noon for those needing an extra forty winks.

Registration fee includes dinner, professional entertainment, prizes, and a full program of events for hams and XYL's. Contact K2PKL, Robert C. Stewart, 114 E. Newell St., Syracuse, N. Y. for details. —30—

October, 1959



**The last  
preamp-  
amplifier  
you'll ever  
have  
to buy!**

*A new  
40-watt  
stereo  
preamp-amplifier  
in kit form  
for only  
\$79.95  
by*

**P A C O**

*also  
available  
factory wired  
for \$129.95*

*Ask your own  
Audio-Radio-TV  
Serviceman about  
PACO and PRECISION  
products. He'll tell you that  
they always live up to their  
specs. That's why we can  
say that the PACO SA-40  
is the last preamp-amplifier  
you'll ever have to buy*

*Available at leading electronic  
parts distributors and  
wherever good sound is sold.*

*For complete information  
write to:*

**P A C O**

*Electronics Co., Inc.  
70-31 84th Street  
Glendale 27, L. I., N. Y.*

*A Division of  
PRECISION  
Apparatus Company, Inc.*

*Export:  
Morhan Exporting Corp.  
458 Broadway  
N. Y. 13, N. Y., U.S.A.*

*Canada:  
Atlas Radio Corp., Ltd.  
50 Wingold Ave.  
Toronto 19, Ontario*

PACO is the kit division of **PRECISION** Apparatus Co., Inc., world famous manufacturers of laboratory electronic instruments for over a quarter century. The new Model SA-40 is the first of a series of component high fidelity kits from PACO...engineered for utmost performance and lasting value—designed for maximum eye-appeal.

Whether you're an experienced audiophile or a newcomer to the thrill of high fidelity, the factors you must consider in choosing the amplifier you need are: **POWER, DISTORTION, FLEXIBILITY and VALUE.**

The PACO SA-40 offers you greater reserve power capacity than any other preamp-amplifier in its category. Its exceptional circuit design assures highly stable performance with extremely low distortion. Step-by-step assembly instructions and giant-size wiring diagrams are so clearly detailed and simple that the technical difference between expert and novice disappears. And...the SA-40 provides maximum flexibility in any stereophonic high fidelity system... present or contemplated.

For those interested in engineering details, some of the more important technical specifications are listed below:

### POWER OUTPUT:

Steady State Power Output: 20 watts per channel, 40 watts total.

Music Waveform Power Output: 25 watts per channel, 50 watts total.

Peak Power Output: 40 watts per channel, 80 watts total.

RESPONSE: 30 cps to 90 Kc.  $\pm$  1.0 db.

### DISTORTION:

Harmonic: Less than .2% at 20 watts per channel output. Less than .1% at 10 watts per channel output.

Intermodulation: Less than 1% at full rated output.

**FRONT PANEL CONTROLS AND SWITCHES:** 14 controls including separate bass and treble controls for complete flexibility with any monophonic or stereo program source.

**INPUTS:** 14 total; 3 dual high-level and 4 dual low-level.

**OUTPUTS:** Dual tape outputs, separate preamp output as well as standard dual speaker outputs.

### HUM AND NOISE LEVEL:

High Level Input: 80 db below rated output.

Low Level Input: 70 db below rated output.

Tape Input: 65 db below rated output.

**SPEAKER CONNECTIONS:** 4, 8, 16, 32 ohms.

### SENSITIVITY FOR RATED OUTPUT:

Aux Input: .75 V Phono 1: (Magnetic) 5 Mv.

Tuner: .75 V Phono 2: (Magnetic) 5 Mv. or Ceramic. 3V

**INVERSE FEEDBACK:** 25 db

**DAMPING FACTOR:** 22

**BASS TONE CONTROL RANGE:**  $\pm$  15 db at 50 cps.

**TREBLE TONE CONTROL RANGE:**  $\pm$  15 db at 10 Kc.

**RUMBLE FILTER:** 6 db per octave below 50 cps.

**EQUALIZATION:** Phono: "RIAA"; "EUR";

Tape: 3% and 7 1/2 ips, NARTB

**TAPE OUTPUT LEVEL:** 2 volts per channel.

**POWER SUPPLY:** Silicon diode, low impedance for minimum distortion on extended high level passages.

**EXTERNAL DESIGN:** Gold and satin black hooded case, with panel illumination and satin gold panel.

**DIMENSIONS:** 15 1/2" wide x 11 1/4" deep x 5 1/2" high

Model SA-40: Complete with case and step-by-step assembly-operating manual ..... Kit Net Price \$ 79.95

Model SA-40W: Factory Wired ..... Net Price \$129.95

### COMING SOON — MODEL ST-45

AM/FM STEREO TUNER KIT

matching companion  
for the SA-40



**A**.... Always  
**B**.... Buy  
**C**.... Columbia

**CITIZENS' BAND, ETC.**

**BC-603 RECEIVER**

Covers 20-28 Mc. FM. Terrific for citizens' band. 10 push-buttons. Built-in speaker and squelch cont. May be operated mobile on 12 V. with dynamotor (see prices below) or 110 VAC with power pack. Converts in 1 minute to \$9.95 AM. Info supplied. New condition. \$9.95  
 12 V. DYNAMOTOR, for above \$3.95  
 115 VAC PACK \$1.95  
 24 V. DYNAMOTOR \$2.95  
 115 V. KIT \$7.95

**MATCHING TRANSMITTER FOR ABOVE—BC-604:**  
 30 W. 10-channel, push-button FM crystal controlled. 20-27 Mc. New condition. \$5.95  
 complete with tubes, (Leas dyn.) \$10.00  
**COMBO DEAL:** Above BC-603 & BC-604. New cond. BOTH for \$13.00

**BC-683 RECEIVER**

Same as above BC-603 except frequency is 27-30 Mc. Excellent cond. \$14.95

**BC-659 TRANSMITTER-RECEIVER**

0 or 12 V. 27-30 Mc. Easily converted to citizens' band. (See C.Q. Magazine for conversion). Used, excellent. WITH POWER \$14.95  
 SUPPLY Only

**BC-620 RECEIVER-TRANSMITTER**

Same as above BC-659 except frequency is 20-28 Mc. BRAND NEW. With power \$19.50  
 supply. A Columbia leader \$3.95  
 TELEPHONE HANDSET. New \$3.95

**TUBES! TOPS IN TUBE BARGAINS! BRAND NEW!**

832 TRANSMITTING TUBES. New. Boxed. Ea. \$3.95  
 TUBE \$10.00  
 4X150A \$ 7.95 4-65A \$ 9.95  
 4-125A \$ 17.95 4-400A \$ 29.95  
 304TL \$ 25.00 4-250A \$ 24.50

**APR-1 TUNING UNITS, EXCEL. COND.!**

Can be used on converters with any 30 Mc. Receiver.  
 TN-1: 40-80 Mc. Only \$14.95  
 TN-2: 80-300 Mc. \$19.95  
 TN-3: 300-1,000 Mc. \$14.95

**TG-5 TELEGRAPH SET**

Uses flashlight batteries. With key and bell. Wire two of 'em together for code intercom! If you and a buddy practice in CW, you can't beat this set-up for efficiency! Brand new with canvas carrying case & headset. EACH ONLY \$5.50  
 BETTER GET TWO OF THEM FOR ONLY \$9.95

**T-14/TRC TRANSMITTER**

70-100 Mc. 50 W. Input power on phone. Single channel. Built-in 110 V. 60 cps power supply. Table top size. Easily converted to 0 meters. Complete. Fair condition, excellent \$39.95  
 buy!

**BC-348 COMMUNICATIONS RECEIVER**

Freq.: 200-500 kc. and 1.5-18 Mc. in 6 bands. Built-in crystal filter. This is the U. S. Air Force rig so you know it's tops! 8 tubes (including 2 stages RF). Operates on 110 VAC with addition of power supply. Like new. ONLY \$79.50

**PE-103 DYNAMOTOR!**

Columbia rolls back prices to 1946! 6 or 12 V. Input; output 500 VDC @ 160 ma. will handle 200 ma. Complete with filter, condensers, mounting base, circuit breakers, and two 8 ft. heavy duty battery cables. Excel. \$9.95  
 ship. wt. approx. 100 lbs.

WRITE FOR FREE BARGAIN BULLETIN!  
 All orders FOB Los Angeles. 25% deposit required. All items subject to prior sale. NOTE: MINIMUM ORDER \$3.00. WRITE TO DEPT. R.

**ELECTRONICS**  
 2251 W. WASHINGTON BLVD.  
 LOS ANGELES 18, CALIF.

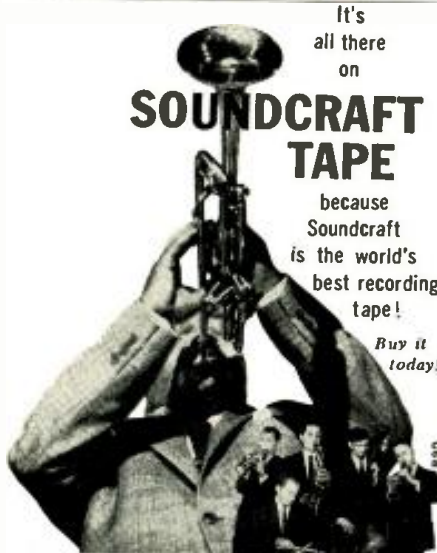

It's all there on  
**SOUNDCRAFT TAPE**  
 because Soundcraft is the world's best recording tape!  
 Buy it today!

Reeves Soundcraft Corp., Gt. Pasture Rd., Danbury, Conn.

**Novel Semiconductor Devices**

(Continued from page 52)

gauss and a control current of 1/2 ampere are obtainable with these devices. Fig. 8 shows the characteristics of a typical device. Output impedances can be adjusted from 0.01 to 20 ohms and their maximum frequency response ranges from 10 to 100 megacycles.

A study was made recently at Bell Telephone Laboratories of the many possible applications of the Hall Effect. This study revealed that of the many possible uses two of the most interesting are the gyrator and the circulator. These devices are sketched in Figs. 9A and 9B.

The gyrator has probably received more attention than any other Hall Effect device. By employing the gyrator in suitable circuitry, an isolator can be constructed in which signals can be transmitted in one direction but not in the other. A germanium isolator has been built with a forward loss of 14 db and a reverse loss of 75 db. Thus, the gyrator could be used to isolate an antenna from a load, for example.

Fig. 9B shows what is known as a three-port circulator. In this device, signals can pass from terminals 1-1' to 2-2', 2-2' to 3-3', and 3-3' to 1-1', but not in the other direction, such as 2-2' to 1-1'. The circulator can be constructed from a slab of semiconductor material with six equally-spaced edge contacts. Forward loss in a device of this kind is about 17 db, and reverse loss in a typical n-type germanium slab may be as high as 64 db. A relatively high magnetic field is required with germanium, but a device of this kind made of indium antimonide could operate satisfactorily with a relatively low field of about 1000 gauss.

Because of the relatively high forward loss, Hall Effect devices of this kind must normally employ a negative resistance amplifier for maximum usefulness. However, they have the big advantage of theoretically being able to transmit d.c. signals as well as a.c. signals at frequencies approaching the dielectric relaxation frequency of the semiconductor material.

Other Hall Effect devices which have been explored, either experimentally or theoretically, include a negative resistance amplifier, mechanical transducer, electrical compass, modulator, and demodulator. These devices do not involve p-n junctions and so the surfaces do not need elaborate protection.

**Magnetoresistance**

As mentioned before, when a slice of current-carrying semiconductor material is placed in a magnetic field, the charge carriers are pushed over to the sides of the slice in a direction perpendicular to the current flow. This has the effect of increasing the resistance of the slice. Here, then, we have a device whose resistance can be altered by changing the strength of the magnetic field in which it is placed.

**HI-FI, STEREO SALE**

MAKE & MODEL	DESCRIPTION	AUDIO NET SALE PRICE
Net'l "Copley"	cabinet/speakers	\$ 99.95 \$ 59.95
Net'l "Wellesley"	cabinet/speakers	\$169.95 \$ 99.95
El-V'ce "Sky-ik"	cabinet/speakers	\$ 95.00 \$ 69.95
El-V'ce "Aristo"	cabinet/speakers	\$246.90 \$159.95
El-V'ce "Regency"	cabinet/speakers	\$393.00 \$199.95
El-V'ce "Cent. IV"	cabinet/speakers	\$ 99.50 \$ 69.95
P-Flux CH-16B	cabinet/speakers	\$184.00 \$ 99.95
Cabinart KR-3M	corner cabinet	\$108.00 \$ 69.95
Cabinart KR-3 uni	corner cabinet	\$ 84.00 \$ 49.95
Cabinart 27 blonde	cabinet	\$ 69.00 \$ 44.95
Cabinart 28 borina	equipment cabinet	\$117.00 \$ 69.95
Cabinart 21 korina	equipment cabinet	\$ 19.95 \$ 12.95
Cabinart 61 kit	corner horn	\$ 18.00 \$ 11.95
Markell RC116	wall buffet	\$ 79.50 \$ 39.95
El-V'ce A15/PC-2	amp. & pre-amp.	\$136.50 \$ 89.95
El-V'ce A20/PC-1	amp. & pre-amp.	\$184.50 \$129.95
El-V'ce A15CL	amp., inc. pre-amp.	\$ 99.50 \$ 59.95
Pilot AA-505 30W	amp., inc. pre-amp.	\$29.50 \$ 19.95
Pilot AA-520 20W	amp., inc. pre-amp.	\$ 99.50 \$ 59.95
Calbest 7615 15W	amp., inc. pre-amp.	\$ 79.95 \$ 44.95
Calbest 7935 35W	amp., inc. pre-amp.	\$119.95 \$ 79.95
B'vard 117-24S	dual 12 watt stereo	\$ 79.95 \$ 49.95
Precise	pre-amp. only	\$ 29.95 \$ 17.95
Pilot WF-42 20W	amp. & AM-FM tuner	\$209.50 \$129.95
Calbest 7110	AM-FM tuner only	\$114.95 \$ 69.95
Calbest 7160 15W	amp. & AM-FM tuner	\$189.95 \$119.95
Quincy	AM-FM tuner	\$109.95 \$ 69.95
Presto 1-2	turntable	\$ 59.95 \$ 39.95
Presto 1-18A	turntable	\$ 75.00 \$ 49.95
Pentron Aristocrat	tape recorder	\$199.95 \$129.95
Pentron PS-10	table amp. speaker	\$ 69.95 \$ 39.95
Pentron CS-20	cons. amp. speaker	\$ 79.95 \$ 49.95

**TV PICTURE TUBES**

At Lowest Prices

10BP4 \$ 7.95	17BP4 \$ 9.95	21AMP4 \$15.75
12LP4 8.50	17CP4 17.00	21ATP4 15.75
14B/CP4 9.95	17FP4 17.60	21AUP4 15.75
16DP4 12.00	17HP4 12.50	21EP4 13.50
16EP4 12.75	17LP4 11.50	21FP4 14.50
16GP4 14.50	17QP4 9.95	21WP4 14.00
16KP4 9.95	17TP4 17.00	21YP4 14.50
16LP4 10.95	19AP4 16.00	21ZP4 13.50
16RP4 9.95	20CP4 13.50	24CP4 23.50
16WP4 12.00	20HP4 14.50	24DP4 24.50
16PT4 9.95	21AP4 22.10	27P4 39.95
17AVP4 12.50	21ALP4 15.75	27RP4 39.95

1 Year Warranty  
 Aluminized Tubes \$5.00 more than above prices.  
 Prices include the return of an acceptable similar tube under vacuum.  
 These tubes are manufactured from reprocessed used glass bulbs. All parts and materials including the electron gun are brand new.  
 ALL PRICES FOR CHICAGO, ILLINOIS. Deposit required, when old tube is not returned, refundable at time of return. 25% deposit required on COB shipments. Old tubes must be returned prepaid. Tubes shipped Rail Express.

WRITE FOR COMPLETE LIST.  
**PICTURE TUBE OUTLET**  
 3032 MILWAUKEE AVE.  
 CHICAGO 18, ILLINOIS  
 Dickens 2-2048

**Electronics Engineering Degree in 27 Months**

Realize your dream. Become a graduate engineer. Share rewards awaiting college men... higher income, rapid advancement. Important firms visit Tri-State to interview seniors. Approved for veterans.

**Electronics or Power Major**  
 Bachelor of Science Degree in 27 months in Electrical, Mechanical, Civil, Chemical, Aeronautical Engineering. In 36 Months a B.S. in Business Administration (General Business, Accounting, Motor Transport Management majors). For earnest, capable students. Small classes. Enrollment limited. More professional class hours. Mature students. Well-equipped labs. Modest costs. Beautiful campus. Year-round operation.  
 Enter Jan., Mar., June, Sept. Write J. H. McCarthy, Director Admissions, for Catalog and "Your Career" Book.



**TRI-STATE COLLEGE**  
 16109 College Ave. Angola, Indiana

**SENDING CODE RECEIVING SPEED**  
 Be a "key" man. Learn how to send and receive messages in International Morse code. Communicate with operators around the globe. Learn at home quickly through famous Candler System. Taught by best operators. Quality for Amateur or Commercial License. Write for FREE BOOK.  
**CANDLER SYSTEM CO.**, Dept. 2-L,  
 Box 9228, Denver 20, Colo., U.S.A.

This effect is known as "magnetoresistance."

Ohio Semiconductors, Inc. has developed a device utilizing this effect and has tradenamed it the "Magnetoresistor." The type MS-41 utilizes a thin slice of indium antimonide, again because of the high mobility of the charge carriers in this material. A resistance change of as much as 1 to 10 can be obtained with a change in field strength from zero to 10,000 gauss. The change in resistance is proportional to the square of the magnetic field up to about 7000 gauss and is then directly proportional to field strength to over 20,000 gauss. A typical characteristic curve is shown in Fig. 13.

This device has many possible applications, including a contactless potentiometer, modulator chopper, amplifier, and regulator. The MS-41 has a zero-field resistance of one ohm, but units having values ranging from 0.01 to 50 ohms are being developed.

#### Neutron Detection

One of the most unusual applications of semiconductor materials was recently announced by Westinghouse Electric Corp. Scientists at Westinghouse have developed a neutron detector made of a tiny slice of germanium or silicon no larger than the head of a pin. The slice is treated to form a *p-n* junction and a very thin layer of uranium is spread on the top surface.

Slow-speed neutrons strike this uranium layer and cause U-235 atoms to split apart just as they do in a nuclear reactor. The high energy products of this fission produce an electrical pulse at the *p-n* junction, and so can be counted. Fast neutrons do not produce fission and so are not counted, nor are *gamma* rays.

If desired, this neutron detector can be converted to count fast neutrons by replacing the uranium layer with a material rich in hydrogen, such as paraffin.

Accurate mapping of both slow- and high-speed neutrons is a necessity in a nuclear reactor. Because of its very small size, this detector can plot neutron flux variations down to dimensional changes as small as one twenty-fifth of an inch. Thus, this neutron detector can be a highly useful device wherever accurate neutron mapping is necessary. The size of the detector is indicated in Fig. 14, where it is shown resting on a man's thumbnail.

#### Conclusion

We have discussed here a few of the many possible applications of semiconductor materials, based on phenomena which have been explored intensively. Which of these will find wide usage is very hard to say at this time, but it is obvious that they are all of great interest. They are all products of the intensive research into the properties of semiconductor materials which was sparked by the invention of the transistor at Bell Telephone Laboratories in 1948.

—50—

October, 1959



**PERFORMANCEWISE,  
QUALITYWISE,  
and PRICEWISE,**

## You can't beat the TARZIAN "HOT ROD" TUNER

Hailed as an engineering triumph, the "HOT ROD" is backed up by 15 years of Tarzian experience in the design . . . development . . . and manufacture of television tuners. This Tarzian "know-how"—coupled with new, automated production methods—brings you the

### "HOT ROD" TUNER

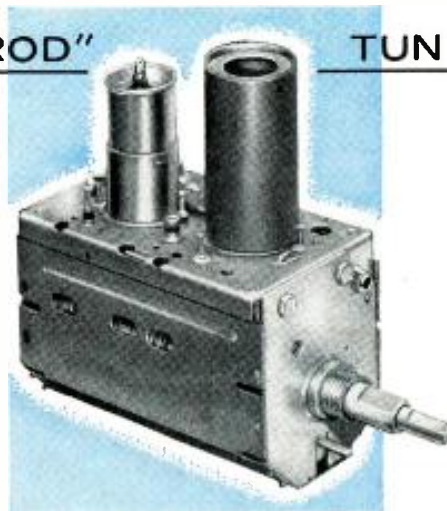

Engineers like its performance and purchasing agents like the LOW COST. Look at these features:

*Tetrode R.F. stage . . . high gain . . . low noise . . . 13 permanent positions . . . easily converted to UHF . . . very low oscillator drift . . . individual oscillator front adjustment . . . small in size . . . good resetability . . . I.F. output tunable from the front . . . and it's adaptable for remote control operation.*



Call or write for information

**SARKES TARZIAN, INC.**

Sales Department, Tuner Division  
East Hillside Drive • Bloomington, Indiana

## MOBILE RADIO EQUIPMENT

Recond.—Mfd. by LINK

We specialize in and have available all replacement parts for present and past LINK Mobile & Base Equipment. Let us know your requirements.

**2 PIECE MODEL FMTR 30-50 MC ED. 7 FM MOBILE TRANS. & REC.—6 VOLTS**



Unit complete with Peak Abatement control head, mike, antenna, cables & crystals ground to your specific frequency. Modified for 20F3 emission.  
**MODEL FMTR—12V. operation.....\$109.95**  
**MODEL FMTR—12V. operation.....\$149.95**

**MODEL 2210 152-162 MC FM MOBILE TRANSMITTER & RECEIVER—6 VOLTS**

Trans. modified in accordance with latest FCC Reg. for 20F3 emission. Complete with antenna, cables, control head, mike & crystals ground to your specific frequency. Ready for immediate installation. Specially priced.....  
**MODEL 2210—12V. operation.....\$162.50**

**MODEL 2365 FM MOBILE TRANS. & REC.**

As above covering 25-41 or 30-50 MC. 6 V. Modified for 20F3 emission.....  
**MODEL 2365—12V. operation.....\$149.50**

### MOTOROLA TRANSCIEVER

Model FMTRU 80D (A) DSP13

Strip construction, 30 W. power output, Permalloy filter, narrow-band, 6 V. Dynamotor power supply, Freq. 152-174 Mc. Complete with Cables, Controls, checkbook, excellent condition.....  
**For 12 V. operation.....\$239.50**

**UNIVERSAL 6/12 V. VIBRATOR POWER SUPPLY**

Wired. Mfg. by RUMMONT. Rating 500 V. or 100 mA. Ideal for all types of mobile applications. Chassis measures 5 1/4" x 5 1/4" x 8".  
**SPECIAL—Brand New.....\$11.95**

Include 25% deposit with order—balance C.O.D. 50c handling charge on all orders under \$5.00. All shipments FOB our warehouse, NYC.

## PLATT ELECTRONICS CORP.

20 MURRAY ST., NEW YORK 7, N. Y.  
 Telephone: COrtlandt 7-2575



**FREE**

Fill in coupon for a FREE One Year Subscription to OLSON RADIO'S Fantastic Bargain Packed Catalog—Unheard of LOW LOW WHOLESALE PRICES on Brand Name Speakers, Changers, Tubes, Tools, Hi-Fi's, Stereo Amps, Tuners and thousands of other Electronic Bargains.

NAME \_\_\_\_\_

ADDRESS \_\_\_\_\_

CITY \_\_\_\_\_ ZONE \_\_\_\_\_ STATE \_\_\_\_\_

If you have a friend interested in electronics send his name and address for a FREE subscription also.

**OLSON RADIO CORPORATION**

600 S. Forge St. Akron 8, Ohio

# Don't Junk That Auto Radio!

By GERALD F. DULIN

Engr., Electroacoustics Laboratory  
 Stromberg-Carlson Company

*Many high-quality auto receivers can be salvaged and converted to a.c. operation for use at home.*

**H**UNDREDS of high-quality radio receivers are being junked daily. For a small cost you can convert them to a.c. operation for home use. In these days of transistor and hybrid transistor auto radios we are inclined to forget the vacuum-tube models of the late '40's. Prior to the widespread adoption of transistors, auto radios had attained a plateau of high quality with more or less standardized circuitry.

Among the quality features of these receivers are: high sensitivity—because of the short antennas used, these sets required high r.f. gain; a.g.c.—large signal fluctuations require very healthy automatic gain control features (not only do hills and other natural obstacles decrease the signal strength but power lines along the highway maintain standing waves of the r.f. signals being received); high power output—a sizable power output is required (6-8 watts) because ambient noise in an auto is considerable, at times reaching levels of more than 70 db; rugged—these radios must have considerable resistance to vibration. Shielding electric interference in an automobile is a critical problem in radio design. The car's electrical system and the static electricity discharge give off a high intensity noise field so strong that the components of the radio must be completely shielded.

Although better than the average table model radio, most auto receivers have rather limited high-frequency response. The loudspeaker is probably

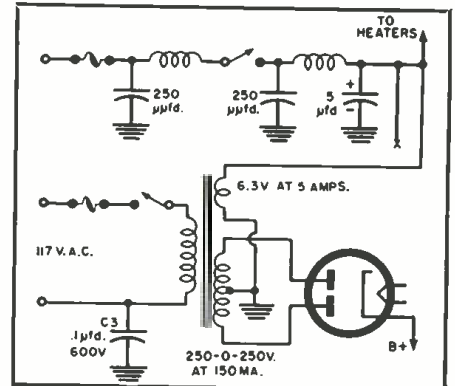

Fig. 2. Receiver conversion by the second method described by author in the text.

the limiting feature. However, since high-intensity, high-frequency sound is annoying to many people, auto radios are built to restrict the output from the high end of the audio spectrum. Revisions in the tone control circuit can usually remedy this.

### Getting a Set

How can you get one of these receivers? Many cars are ready for the junk yard after 10 years of use. The receivers in these automobiles have also lost their dollar value. If inoperable, these sets can sometimes be purchased for about a dollar. The inoperable part is usually the vibrator, which will be discarded in the conversion we have in mind.

Once the receiver has been procured, conversion is an easy job. You

Fig. 1. (A) A standard auto radio circuit. (B) Conversion by Method #1. See text.

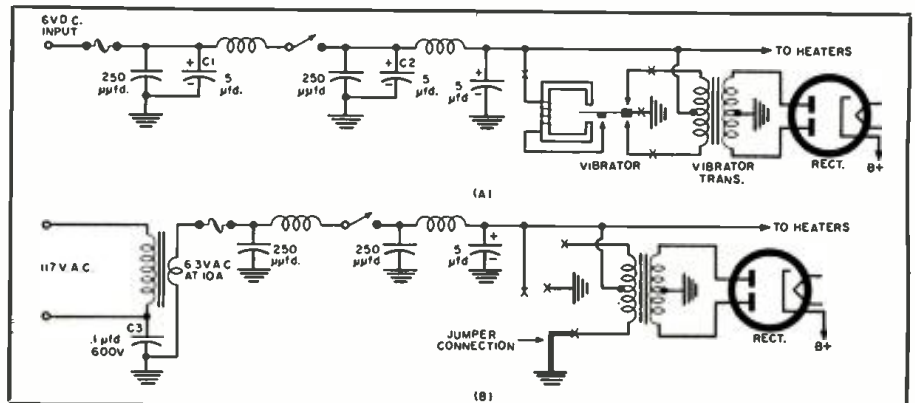

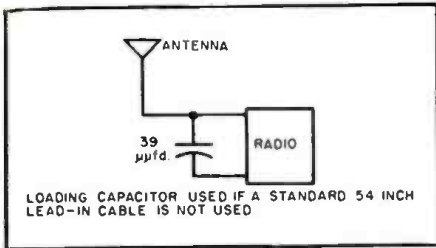

Fig. 3. How a loading capacitor is added if standard 54-inch lead-in cable is not used.

may use either of two methods, both being entirely satisfactory.

**Method One:** First apply 6.3 volts a.c. to the normal 6 volt d.c. input lead (Fig. 1A); remove the vibrator and bridge the connection as shown in Fig. 1B. The 6.3-volt a.c. transformer should be capable of supplying at least 10 amperes.

**Method Two:** Remove the vibrator and vibrator transformer. Next, install a standard power transformer, using the 6.3-volt winding for the heaters and the high-voltage winding for "B+," as indicated in Fig. 2. Don't forget that if the radio uses an OZ4, the voltage each side of the center tap must be at least 215 volts r.m.s.

#### Operation

In order to get the best performance, a tuned antenna should be used. This is easily accomplished by using a standard auto antenna or by loading a short whip antenna with a shunt capacitor, as shown in Fig. 3. Normally, short lead-in cables have a capacitance of approximately 40  $\mu\text{fd}$ .

Capacitors  $C_1$  and  $C_2$  may be removed for a.c. operation. If hum is a problem, capacitor  $C_3$  may be added, as shown in Figs. 1B and 2.

Once an idea of how easy it is to adapt these car radios sifts through, there should be a rush to pick up "junked" auto sets. In almost all instances, the small amount of time and trouble spent in making such a conversion will be adequately repaid by the enjoyment which can be derived from having an extra receiver around the house—one for whose tone and performance there will be no need to apologize.

-30-

#### TRANSISTOR AMP HINT

By CHARLES ERWIN COHN

IT IS considered good practice not to operate a transistor audio power amplifier with its speaker disconnected. The reason for this is that, with the speaker disconnected, signals can build up considerable voltage across the unloaded output transformer. Such peaks might exceed the collector voltage rating and burn up the transistor.

Therefore, when external speakers are used with such amplifiers, as in car radios for example, it is a good idea to make the speaker connection through a phone plug and shorting jack for very good reason.

This will short the secondary of the output transformer when the speaker is removed and thus prevent a build-up of dangerous voltages.

-30-

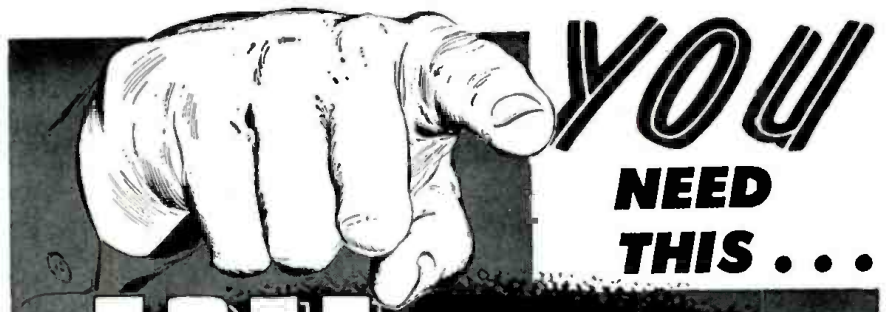

# FREE GIANT ALL NEW 1960 BA CATALOG

*A Complete Buying Guide for Everything in*

## RADIO 1960 TV ELECTRONICS

ANNUAL CATALOG 601

**BA**

SINCE 1927

**Guarantee**

We guarantee every item in our catalog to be the highest quality product available. If you are not completely satisfied, we will refund your money or replace the item at our expense.

**204 KING-SIZED PAGES**

**EVERYTHING IN RADIO TV AND ELECTRONICS**

**100'S OF NEW ITEMS LISTED HERE FOR 1ST TIME**

**21 PAGES OF BARGAINS NOT IN ANY OTHER CATALOG**

**RUSH COUPON TODAY!**

BURSTEIN-APPLEBEE CO. Dept. M,  
1012-14 McGee St., Kansas City 6, Mo.

Send Free 1960 B-A Catalog No. 601.

NAME \_\_\_\_\_

ADDRESS \_\_\_\_\_

CITY \_\_\_\_\_ STATE \_\_\_\_\_

**INSIST ON PROVED BRAND NAMES**

insist on the GENUINE "NO NOISE" big 3 Beware Of Cheap Substitutes!

**NO-NOISE VOLUME CONTROL and CONTACT RESTORER**

- Cleans
- Protects
- Lubricates

NOT A CARBON TET SOLUTION  
2 Oz. Bottle \$1.00 6 Oz. Spray Can \$2.25  
NET TO Servicemen

**NO-NOISE TUNER-TONIC**

With PERMA-FILM  
6 Oz. Aerosol Can \$3.25  
NET TO Servicemen

- Economical—a little does a lot.
- Cleans, lubricates, restores all tuners, including water type.
- Non-toxic, non-inflammable.
- Use for TV, radio and FM.

**NOW AVAILABLE FREE AT YOUR JOBBERS**

**5" PLASTIC EXTENDER**

With Push Button Assembly... For PIN-POINT APPLICATIONS!

**NO-NOISE RUBBER COAT SPRAY**

- Insulates
- Waterproofs
- Protects

6 Oz. Spray Can \$3.25  
NET TO Servicemen

**ELECTRONIC CHEMICAL CORP.** 873 Communipaw Avenue Jersey City 4, N. J.

# HIT THE TOP IN TV Engineering

**BIG OPPORTUNITIES** are waiting for the man who masters television theory, design, transmission. Now, this complete 2,300 page library tells you everything you must know to succeed in this profitable, fast-growing field.

## THE MCGRAW-HILL Practical Television ENGINEERING LIBRARY



Four Giant Volumes, With  
More Than 1,600 Illustrations.



**FREE**  
\$9.50 book  
Wentworth's  
COLOR TV  
ENGINEERING  
Valuable handbook will be sent at no extra cost. Covers color from A to Z!

**10 DAYS  
FREE  
TRIAL**

This complete technical library can help you become an expert in servicing, engineering research, circuit design, or TV transmission. Leading engineers explain—simply and clearly—everything from basic theory to advanced circuit design. 2,300 pages and 1,600 illustrations show you the answers to your questions, give you the practical working knowledge you need to get ahead in TV. The coupon below will bring you all four volumes for free ten day trial. Mail it today!

- Television Fundamentals. By K. Fowler and H. Lippert of General Electric.
- Television Engineering. By D. Fink, Philco Corp.
- Theory and Design of Television Receivers. By S. Deutsch, Polytechnical Research and Devel. Co.
- Color Television Standards. By D. Fink, Philco Corp.

McGraw-Hill Book Co.  
Dept. ELW-10

327 West 41st St., New York 36, N. Y.

Send the 4-volume Practical Television Engineering Library plus Color Television Engineering for FREE EXAMINATION. I will send \$10 within 10 days and only \$6 monthly until low price of \$35 is paid. Otherwise I will return all 5 books postpaid and owe nothing.

Name .....  
Address .....  
City ..... Zone ..... State .....  
Employed by ..... ELW-10

## CLASS "D" CITIZEN BAND CRYSTALS



3rd Overtone; Hermetically Sealed  
.005% tolerance—Meet P.C.C. requirements. 1/2" pin spacing—.050 pin diameters. (.093 pins available, add 15c per crystal.)

**\$2.95**  
EACH

22 CHANNELS

(add 5c per crystal for postage and handling)

The following Class "D" Citizen Band frequencies in stock (frequencies listed in megacycles): 26.965, 26.975, 26.985, 27.005, 27.015, 27.025, 27.035, 27.055, 27.065, 27.075, 27.085, 27.105, 27.115, 27.125, 27.135, 27.155, 27.165, 27.175, 27.185, 27.205, 27.215, 27.225.

## RADIO CONTROL CRYSTALS in HC6/U HOLDERS—SIX FREQUENCIES

In stock for immediate delivery (frequencies listed in megacycles); tolerance .005%, 1/2" pin spacing—.050 pin diameter. (.093 pins available, add 15c per crystal.) Specify frequency desired.

26.995, 27.045, 27.095, 27.145, **\$2.95**  
27.195, 27.255 ..... EACH

(add 5c per crystal for postage and handling)  
Send for FREE CRYSTAL CATALOG  
WITH OSCILLATOR CIRCUITS

ASK YOUR PARTS DEALER FOR TEXAS CRYSTALS  
See big red display . . . if he doesn't stock them,  
send us his name and order direct from nearest  
factory.

OUR FLORIDA PLANT NOW IN OPERATION  
ORDER FROM NEAREST PLANT

## TEXAS CRYSTALS

Texas Crystals, Dept. R-109 Texas Crystals, Dept. R-109  
853 West Grand Avenue OR 1000 Crystal Drive  
River Grove, Illinois Ft. Myers, Florida  
Phone: GL 3-3555 Phone: WE 6-2100

ALL ORDERS SHIPPED 1st CLASS MAIL

# AUDIO REPORT

ELECTRONICS WORLD

LAB TESTED

## "Empire 88" Stereo Cartridge

It is quite obvious within the trade that the industry is going through its second round as far as stereo cartridges are concerned. Many companies are coming out with new designs or revised versions, resulting in much better performance than obtained in the early stages of stereo disc reproduction.



A company that is new in the field of high-fidelity, *Audio Empire*, a division of *Dyna-Empire Inc.*, has just announced its entry into the stereo-cartridge field. Other high-fidelity products are in the design stage but any further comment on this will have to await another day.

Its new cartridge, known as the "Empire 88", is of the moving-magnet type and is designed to be used with either record players or turntables. Plans are to market this unit in various stylus radii with either diamond or sapphire tip. The one we checked was the Model S88-7RD which has a .7 mil diamond stylus.

The frequency response and channel separation for the left channel are shown in the curves. It is quite obvious that the results are most gratifying in that frequency response was within  $\pm 2.6$  db from 30 to 15,000 cps without abnormal peaks or dips. The channel separation warrants special comment, being 19.8 db at 1000 cps and maintaining good separation to 10,000 cps. This performance is exceptionally good when compared with many other car-

tridges on the market today. Many early cartridges had a channel separation starting between 15 and 20 db at 1000 cps and then gradually diminishing until, in many cases, no separation would be obtained in the neighborhood of 12,000 cps. Channel separation is an important factor in obtaining good audio separation in the final output and, although there are no specific standards within the industry, we would like to see at least 15 db maintained as far out in frequency as possible. The stereo illusion is obtained mainly from signals in the mid- and high-frequency end of the audio range. It is well known that the very low frequencies contribute little to this illusion.

The compliance of the cartridge is rated by the manufacturer as  $5 \times 10^{-9}$  cm./dyne both vertically and laterally. The dynamic mass is rated as .7 milligrams at 1000 cps. According to the manufacturer, this gradually decreases as frequency increases, being practically zero at 15,000 cps. With this type of characteristic there should be little record wear at the extreme high end.

Frequency response and channel separation characteristics with left channel input. Channel separation below 1000 cps is not shown as it is not measurable when using the Westrex 1-A test record. Channel separation below 1000 cps presents no problems since high separation at the very low frequencies is not required as these frequencies do not contribute much to the stereo illusion. The right channel performance for both frequency response and channel separation was quite similar to that of the left channel and therefore was omitted from the graph. The left channel had an output of 5.6 mv. while the right channel had 6.0 mv. output on a 1000-cps signal at a recorded velocity of 5 cm./sec. All tests were made using 3.5 grams pressure, which we found provided the best performance for our particular equipment. According to the manufacturer, this pressure could be increased to 8 grams, which may be required for some of the older types of record changers. We found no hum problems. The results of our tests regarding hum are about the same as other cartridges we have checked.

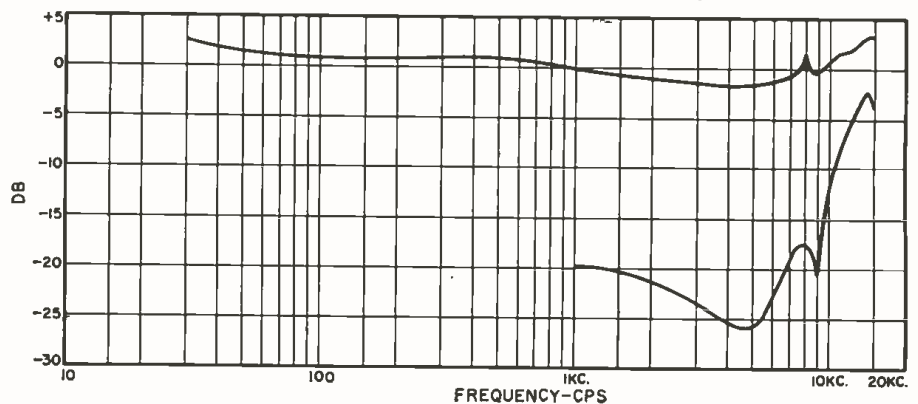



**WALTER ASHE**  
has  
**hallicrafters NOW!**

# AMATEURS—WHY WAIT for “PROMISED” DELIVERY on your new Single-Sideband Equipment?

Guaranteed same day shipment of any SSB equipment on this page!

Why wait for promised delivery on equipment that may take months to hit the market . . . when Walter Ashe can make actual delivery on all Hallicrafters Single Sideband equipment. We can make shipment the same day your order reaches us!

**TIME PAYMENT TERMS AVAILABLE ON ALL EQUIPMENT!**

**YOUR PRESENT  
XMITTER  
or RECEIVER  
IS WORTH  
BIG MONEY**

## Get Our “Surprise” Allowance

Tell us what you have to trade . . . any name brand equipment made since 1946 . . . and we'll rush our biggest-ever “Surprise” allowance that is sure to make you wonder how Walter Ashe can do it. Incidentally, all used equipment we sell is checked thoroughly and guaranteed to work the same as new. Whether you're trading up to new or purchasing used equipment . . . you're always money and satisfaction ahead at Walter Ashe!

**Why Wait? Get on SSB With This Powerhouse Combination . . . NOW!**



HALLICRAFTERS  
HT 32 A  
CW-AM-SSB  
Transmitter  
Amateur Net  
**\$695**

Shipping Weight 85 Lbs.



HALLICRAFTERS  
HT 33 A  
LINEAR KW  
Amateur Net  
**\$795**

Shipping Weight 130 Lbs.



HALLICRAFTERS S-107  
All Band RECEIVER  
Amateur Net  
**\$89<sup>95</sup>**

Shipping Weight 19 Lbs.

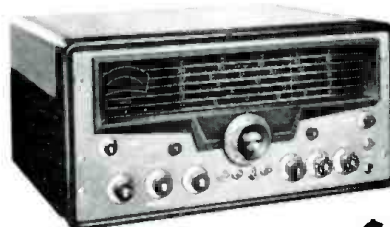

HALLICRAFTERS  
famous  
SX 101A  
AMATEUR BAND  
RECEIVER

Amateur Net

**\$395<sup>50</sup>**

Shipping Weight 80 Lbs.

HALLICRAFTERS  
precision-built  
SX-110 RECEIVER  
Amateur Net

**\$159<sup>95</sup>**



Shipping Weight 36 Lbs.

### NEW 1960 CATALOG READY!

Here's the "ham's own" catalog . . . compiled and designed entirely with the amateur in mind. Exclusively new mobile and fixed station equipment . . . parts and supplies . . . of interest to the amateur. Rush coupon for your copy.



**Walter Ashe RADIO CO.**  
Dept. R-10-59, 1125 PINE STREET  
ST. LOUIS 1, MISSOURI

### “SURPRISE TRADE-IN” COUPON

WALTER ASHE RADIO CO.  
YOUR ONE-STOP SUPERMARKET  
Dept. R-10-59 • St. Louis 1, Mo. In Our 37th Year

- Rush New Catalog
- Send latest lists of guaranteed Used Equipment
- Rush “Surprise Trade-in” offer on my \_\_\_\_\_

For \_\_\_\_\_  
(Show make and model of equipment desired)

Name \_\_\_\_\_

Address \_\_\_\_\_

City \_\_\_\_\_ Zone \_\_\_\_\_ State \_\_\_\_\_

# WHO NEEDS MILES OF WIRE?

GET  
HOME ELECTRICITY  
ANYWHERE  
WITH A

## terado CONVERTER

Change 6 or 12 volt D.C. to 100 volt, 60 cycle A.C.

No Installation—Just plug into cigarette lighter of car, truck, or boat, and it's ready to go!

Operate lights, electric shavers, dictation machines, record players, small electric tools, portable TV, and testing equipment.

Models from 15 to 200 watts, with prices as low as \$12.95.

"Chief": 75-125 watts, for 6 or 12 volt batteries .. **\$64.95 LIST**



See Your Electronic Parts Dealer or Jobber

### terado COMPANY

DESIGNERS & MFRS. OF ELECTRONIC EQUIPMENT SINCE 1927  
1058 RAYMOND AVE., ST. PAUL 14, MINNESOTA  
IN CANADA: ATLAS RADIO CORPORATION LTD.-ONTARIO

### 2 WAY PORTABLE RADIO SET

Sends—Receives up to 10 miles as shown  
or hundreds of miles with outside antenna! 80 and 40 meter amateur radio bands (not included) also Aircraft and Overseas broadcasts (3 to 8 mc.) POWERED WITH SELF-CONTAINED PORTABLE RADIO BATTERIES. NO AC PLUG-INS NEEDED! Take it with you everywhere you go—Keep in contact with home, friends, Has 5 watt crystal controlled transmitter—Sensitive Regenerative Receiver. Send receive switch. Wt. only 3 lbs. Rise, only 6 1/2" x 4" x 4" TESTED—PROVED—SIMPLIFIED—PRACTICAL. Full information given on quick easy to get literature.

**SEND ONLY \$3.00** (bill, ex. mo) when \$16.95 (COD postage and pay post) and \$10.95 for postpaid delivery. This kit includes all parts, time, collated cabinet, easy instructions. (Set of batteries—\$3.99; crystal \$1.99) (C.O.M. COMPLETELY WIRED AND TESTED POSTPAID \$24.95. A regular \$50.95 value—Order now before price goes up. GUARANTEED AVAILABLE ONLY FROM!

WESTERN RADIO Dept. BNT-10 KEARNEY, NEBR.

### CODE PRACTICE or COMMUNICATION SET

U. S. Signal Corps TG-5-B Telegraph Set. . . Brand new complete with heavy canvas & leather carrying case, earphones, and instructions. . . bell ringer type has a clear 1,000 cycle tone. . . Can be used singly for code practice or in units up to six or more for communication up to 25 miles. . . Uses regular Eveready batteries. . . Shipping Wt. 8 lbs. Guaranteed and Brand New. Only \$9.95 plus postage.

DeRosier & Pugh-Electronics Dade City, Florida

### BARGAIN HUNTING? TV SERVICEMEN!

Write for SENSATIONAL CATALOG  
HENSHAW RADIO SUPPLY  
3619 TROOST KANSAS CITY, MO.

### TAPE

1800 ft. genuine Dupont Mylar. Fully guaranteed, Manufactured and Nationally advertised by 1 of the top 4 U.S. companies.

1ST QUALITY NO SPLICES BRAND NEW  
Unheard Prices  
**\$1.89 ea., 10 for \$18.00, 100 for \$170.00**  
25% deposit on C.O.D. orders—include postage.

**THE SOUND ROOM**  
7959 Melrose Dept. S.F. Los Angeles 46, Calif.

We found that this cartridge worked extremely well on either stereo or mono records, both in the quality of sound reproduction and in matters of tracking where no difficulty was encountered even on loud passages.

An important feature is that the stylus is easily replaceable. Quoted prices for this particular cartridge with its diamond stylus is \$24.50. A diamond replacement stylus is priced at \$12.50.

## EICO's New Transistor Portable

ONE of the recent portable radio kits to make its appearance on the market is EICO's Model RA-6. It is a 6-transistor, AM superhet receiver. In view of its size (8 1/2" long, 4 1/2" high, and 2 1/2" deep) it can hardly be considered a "vest-pocket" type. However, because of its larger size, it does include a 4" x 6" oval speaker. About 250 mw. of audio power is available from its transistorized push-pull output stage. Among other features is a vernier tuning dial, providing a reduction of 1:6; a high-impedance earphone jack; and a built-in rod-type antenna.

This new portable, which is housed in a simulated tan leather carrying case, is among the finest we have seen to date. It has unusually high sensitivity and good selectivity with a relatively high sound output, considering portable application.

The kit is relatively simple to assemble and no trouble should be encountered, even by the uninitiated, provided construction details are followed closely. Pre-aligned r.f. and i.f. transformers are used and we found that with slight touch-up alignment, using any ordinary AM radio station broad-



cast, good performance was obtained.

Almost anyone using this type of alignment procedure will find the performance satisfactory. However, being perfectionists at heart, we rechecked using a conventional signal generator. We found that some improvement was possible. For those who want maximum performance and do not have the proper test equipment, simply have a local service technician do the final alignment. The cost is small.

This portable is available as a kit for \$29.95 or completely wired at \$49.95.

Complete wiring diagram of the 6-transistor EICO Model RA-6 portable receiver.

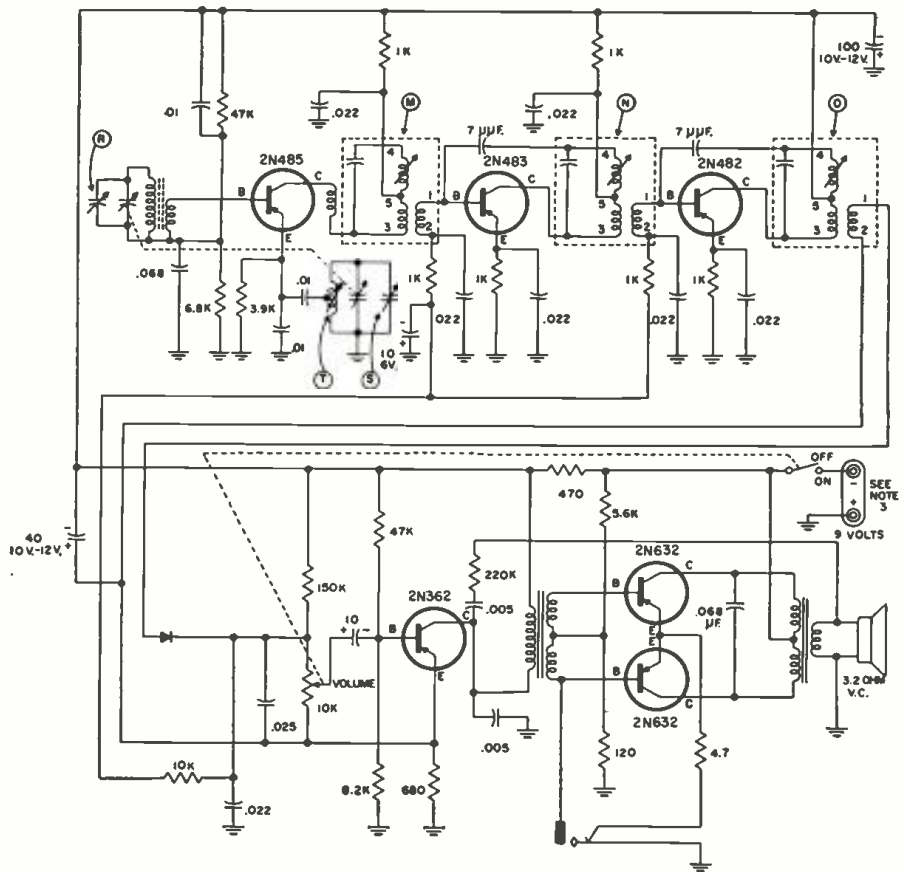

# CANADIAN MARKET for Low-Power Radiophones

By J. E. KITCHIN

Inspector, Canadian Department of Transport

NEW specifications are now being drafted by the Canadian government covering radiotelephone equipment with a maximum power under 15 watts, intended for use on small boats where lack of space or primary power sources precludes higher powered sets. Until now the requirement has been for a minimum power of 15 watts r.f. output and the lowering of this limit will enable a number of smaller boats to be equipped for safety purposes.

It is expected that specifications will become effective November 1, 1960. Present drafts of specifications call for compulsory installation of 2182 kc. (International distress and calling frequency) and one inter-ship communication channel. At the present time there are approximately 2000 radio-equipped vessels on the East Coast and about 4000 on the West Coast of Canada. It is anticipated that powers under 15 watts will result in a greatly increased market in the form of small, battery-operated phones.

Batteries may, or may not, be self-contained. Construction must follow

good engineering practice and flame-resistant wire used throughout. Frequencies must be crystal-controlled and all crystals and tubes must have clamps to prevent mechanical movement. Change-over from one frequency to another must not be over five seconds and a time limit of two seconds applies on the change from sending to receiving and *vice versa*. Canadian intership frequency assignments are:

East Coast 2134, 2638, and 2738 kc.; Great Lakes 2003 kc.; Lake Winnipeg area 2318 and 4645 kc.; West Coast 2318 for fishing vessels; 2366 for other than fishing vessels, and 2638 and 2738 kc. for all vessels.

Equipment for sale in the Canadian market must meet the requirements of the specifications which outline the various engineering tests which must be performed to obtain government approval. Drafts of "Radio Standards Specifications" (#134 for transmitters and #135 for receivers) are obtainable free of charge from the Department of Transport, Telecommunications Branch, Ottawa, Canada. -30-

most needed  
most wanted



...the  
**FUSEMASTER!**  
dealer-serviceman's fuse rack  
...for wall mounting

...dealer-serviceman's fuse  
requirements at a glance

For further information,  
contact your nearest Littelfuse Distributor.

**LITTELFUSE**  
DES PLAINES, ILLINOIS

# IT'S THE NEW MARK II FROM WESTON:



**WESTON**

*Instruments*

WORLD LEADER IN MEASUREMENT AND CONTROL

October, 1959

an advanced new design for the  
WORLD'S FINEST PORTABLE ANALYZER

Here's an all-new version of the famous WESTON MODEL 980 Volt-Ohm-Milliammeter . . . engineered to offer you

- **INCREASED RANGE.** High-voltage range has been extended to 4000 volts.
- **INCREASED SENSITIVITY.** D-C sensitivity of 20,000 ohms/volt; accuracy within 2% of full scale.
- **IMPROVED SHIELDING.** Cormag® mechanism assures positive magnetic shielding; housing shields against electrostatic interference.
- **GREATER RUGGEDNESS.** Spring-backed jewel movement resists shock, vibration; case is impact-resistant. Ohm-ranges are fuse-protected.
- **SIMPLIFIED CONTROL.** Single dial control for range and function switching.
- **NEW COMPACTNESS.** Size and weight are reduced for maximum convenience and portability.

Order from your local Weston distributor. For information, write to Daystrom-Weston, Sales Division, Newark 12, N. J. In Canada: Daystrom, Ltd., 840 Caledonia Rd., Toronto 19, Ont. Export: Daystrom Int'l., 100 Empire St., Newark 12, N. J.

## FREQUENCY METER

Vibrating REED type. Range 57 to 63 cycles.  
6 reeds, 110 V. Bakelite case ..... ea. **\$10.95**

## BRAND NEW MOBILE DYNAMOTORS

MADE BY EICOR—SMALL SIZE  
Input 12 Volts. Output 400V. 180MA  
Cont. Duty. 250 Mil. Int. Duty. **\$4.95**  
Input 12V. Output 440V. 200MA Cont. Duty. 300 Mil. Int. Duty. **\$6.95**

## POWER TRANSFORMER

Pri. 110V. 60 Cy. Sec. 300-0-300 V. 125 Ma.  
12 Volt CT @ 2 Amps; 12 Volts @ 2 Amps;  
5V @ 2 Amps/Replacement Transf. for  
BC 342 Rec. (also for 24V. Use) ..... ea. **\$2.50**  
Pri. 115V. Secs. 320-0-320V. @ 150  
Ma. 5V. @ 2 Amps 6.3V. @ 3 Amps ..... **\$2.95**  
Write for quantity prices

## FILAMENT TRANSFORMERS

Prim. 115V. 60 cy. Sec. 6.3V. @ 20  
Amps. H-4 1/2" x W-4" x D-3 1/2" ..... ea. **\$3.50**  
@ 10 Amps. Ins. 10,000 V. Small size.  
2 for \$7.50 ..... ea. **\$3.95**  
Primary 110 volts 60 cycle. Secondary  
2 1/2 V. 10 Amps. 10,000 V. Insulation.  
Suitable for pair of 858 tubes ..... **\$3.95**

## WESTON 506 SQ. VU METER

Calib. Minus 20 to plus 3 VU.  
Square case ..... **\$6.95**

## CHOKE—FULLY CASED

5 HENRY @ 200 Ma ..... 1.95  
5 HENRY @ 250 Ma ..... 2.25  
12 HENRY 500 Mil ..... 12.95  
4 HENRY 900 Mil ..... 12.95  
6 HENRY 600 Mil ..... 8.95

## BRAND NEW OIL CONDENSERS

2 MFD 600 VDC .50	2 MFD 2000 VDC 1.50
3 MFD 600 VDC .60	4 MFD 2000 VDC 3.50
4 MFD 600 VDC .75	6 MFD 2000 VDC 4.95
5 MFD 600 VDC .80	8 MFD 2000 VDC 5.95
6 MFD 600 VDC .85	2 MFD 2500 VDC 2.50
8 MFD 600 VDC 1.15	4 MFD 3000 VDC 1.85
10 MFD 600 VDC 1.25	6 MFD 3000 VDC 2.95
12 MFD 600 VDC 1.30	4 MFD 3000 VDC 6.95
388 (24 MFD)	2 MFD 4000 VDC 3.25
800 VDC ..... 2.50	8 MFD 15,000 " 74.50
1 MFD 1000 VDC .60	3 MFD 4000 VDC 8.95
2 MFD 1000 VDC .85	1 MFD 7500 VDC 6.95
3 MFD 1000 VDC 1.35	5 MFD 7500 VDC 1.85
5 MFD 1000 VDC 1.95	1 MFD 12,500 " 19.95
10 MFD 1000 VDC 2.50	2 MFD 12,500 " 32.50
12 MFD 1000 VDC 2.95	1 MFD 15,000 " 49.50
15 MFD 1000 VDC 3.15	.02 MFD 15,000 " 3.50
1 MFD 1200 VDC .45	1 MFD 25,000 " 49.50
1 MFD 1000 VDC .75	50MFD 125VAC 2.50
2 MFD 1500 VDC 1.10	1 MFD 4500 AC .85
4 MFD 1500 VDC 1.95	10 MFD 350 AC 1.95
8 MFD 1500 VDC 2.95	50 MFD 350 AC 4.50
1 MFD 2000 VDC .85	15 MFD 440 AC 2.50

## REDMOND BLOWER

110V. 60 cyc. .3 Amp. 1800 Rpm. 3 1/2"  
Blower wheel—Outlet 2" Diameter. ea. **\$1.95**  
2 for **\$15.00**

## SIGMA 5F RELAY

16,000 ohm in dual 8,000 ohm coils. SPDT  
adjustable silver contacts and armature tension.  
Operates on 500 Microamperes or  
less ..... Ea. **\$3.95**  
Write for quantity prices

## RELAYS

Allied Relay 110 V. AC. DPST ..... ea. **\$1.35**  
Allied 110V. AC 4PDT 10 amp ..... **\$2.50**  
contacts ..... ea.  
Hermatically Sealed relay Coil 110V AC  
60 cy SPDT Contacts 5 Amps. .... ea. **\$1.50**  
5 Volt DC DPDT H.S. .... ea. **99c**  
12 Volt DPST DC  
Relay ..... ea. **\$1.10**  
12 Volt DPDT DC Relay ..... ea. **\$1.35**  
SIGMA type 22RJ 8,000 ohm ..... ea. **\$2.49**  
SPDT, small sealed relay ..... **\$1.95**  
Sealed Relay. SPDT, 6,000 ohm  
coil ..... **\$1.10**  
G.E. Relay control, contains 8,000 ohm  
relay, sensitivity 2 mills 10 for 49.25. ea. **\$1.10**  
LEACH ANT. RELAY 110V. AC  
DPDT Ceramic Ins. .... ea. **\$3.45**

**DUAL GANGED SUPERIOR POWERSTAT**  
Brand New—0-110 V. AC 60 Cy. Each  
unit 18 Amps. .... ea. **\$59.50**

## PANEL METERS

G.E. WESTINGHOUSE. W.E. SIMPSON, etc.  
**1 1/2" METERS** **3" METERS**  
0-1 Mil ..... 2.95  
0-100 Micro ..... 3.95  
0-10 Mil DC ..... 3.95  
0-50 Mil DC ..... 3.95  
0-100 Mil DC ..... 3.95  
0-150 Mil DC ..... 3.95  
0-12 Volts AC ..... 3.95  
0-15 Volts AC ..... 3.95  
0-800 Volts DC ..... 4.50  
0-2.5 KV DC ..... 5.50  
0-4 KV DC ..... 7.50  
5" Meter Calib. to  
50db ..... 3.95  
Running Time Meter,  
18-36 Volts DC ..... 9.95  
0-150 V. AC ..... 3.49  
0-3 Amps RF ..... 2.95  
60 cy ..... 9.90

## MISCELLANEOUS SPECIALS

SPERTI VACUUM SWITCH. CYS24163 Replacement  
in Antenna Unit ART13. .... ea. **\$1.95**  
NEW, BOXED ..... ea.  
36 Ohm 50 Watt Globar Non-Ind. Res. .... 60c ea.  
3-12 MMF Erie Ceramic Trimmers. 2 for **\$1.00**  
Murdock Headphones—BRAND NEW 10,000 ohm  
imped. with std. phone plug ..... ea. **\$2.95**  
Replacement 6' phone cord for Standard  
Headsets ..... 35c  
UTC OUNCER TRANS. Pri. 100 ohm.  
Sec. 125,000 ohm. Ideal for mike  
or phone patch—2 for **\$1.00**. .... ea. **59c**  
CUTLER-HAMMER TOGGLE SWITCH  
SPDT (ST42D) 4 for **\$1.00**. .... ea. **29c**  
WILLARD STORAGE CELL—2V. 28 Amp hrs.  
Clear plastic case. .... ea. **2.50**  
Shipped dry ..... ea.

Write for quantity prices on all special items

All merchandise sold on a 10 day money back guarantee basis

Min. Order \$3.00—25% with Order—F.O.B. New York  
**PEAK**  
ELECTRONICS COMPANY  
66 W. Broadway, New York 7, N. Y., WO-2-5439

# What's

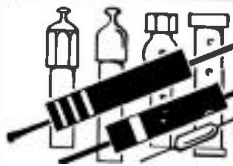

# New in Radio

## "CITI-FONE"

Multi-Products Co., 21470 Coolidge  
Highway, Oak Park 37, Michigan

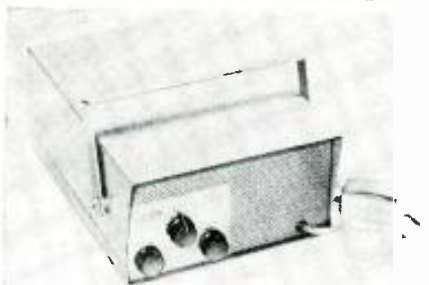

now offering a compact Citizens Band  
transmitter-receiver unit under the  
tradename "Citi-fone."

Available in either 6-volt d.c. and  
110-volt a.c. (CD-5/6) or 12-volt d.c.  
and 110-volt a.c. (CD-5/12) models, the  
circuit employs nine tubes. Both trans-  
mitter and receiver frequencies are  
crystal controlled. Five channels can  
be selected by means of a front-panel  
control. Power input is rated at 5  
watts.

The unit comes with a ceramic mi-  
crophone, a crystal for one channel  
(others are available as required), and  
all necessary power cords. The entire  
transmitter-receiver is housed in a  
compact blue and grey case measuring  
4 1/4" high, 11" deep, and 8" wide.

A data sheet giving complete speci-  
fications, price, and details on avail-  
able accessories will be forwarded by  
the manufacturer on request.

## B&K TUBE TESTER

B&K Manufacturing Co., 3726 N.  
Southport Ave., Chicago 13, Ill. is cur-  
rently marketing a low-cost profession-  
al dynamic mutual conductance tube  
tester as its Model 550.

This compact new instrument pro-  
vides over fifty tube sockets enabling



the user to test a maximum number of  
tubes in minimum time. It quick-  
checks most of the TV and radio tubes  
ordinarily encountered in service work.  
It tests each section of dual-section  
tubes separately and measures true dy-

amic mutual conductance under the  
actual operating conditions of the set.  
The unit will also test tubes for shorts,  
grid emission, gas content, and leak-  
age.

Most commonly used tube types,  
with settings, are listed directly on the  
socket panel for fastest operation. A  
convenient and complete reference  
chart is also provided on the cover of  
the case. New reference charts will be  
made available by the factory at regu-  
lar intervals. Pin straighteners for 7-  
and 9-pin tubes are included.

A 4 1/2-inch plastic meter measures  
tubes on a "Good-Bad" scale. The en-  
tire tester measures 15 1/2" x 15" x 6 1/4"  
and weighs 16 pounds. It will operate  
on 105-125 volts. 50-60 cycle a.c. Bulle-  
tin ST24 on this instrument is available  
from the manufacturer on request.

## HARMONIC GENERATOR

Scencore of Addison, Illinois has just  
released a transistorized harmonic gen-  
erator, the Model HG-104.

Designed for service technicians, la-  
boratories, and industry, the new unit



has been designed to simplify and speed  
servicing of transistor radios and other  
types of transistor circuits. The unit  
may also be used for troubleshooting  
tube radios, TV receivers, hi-fi compo-  
nents, and other audio circuits.

The new unit provides audio, r.f., and  
i.f. signals simultaneously. This is said  
to eliminate time-consuming setup and  
frequency selection procedures. Ac-  
cording to the company, the technician  
can signal-trace a complete receiver in  
one minute. For price and additional  
specifications, write the manufacturer  
direct.

## HEAVY-DUTY OUTLET BOXES

Wuber Electronics, 105 Heatherwood  
Road, Haverton, Pa. has added a heavy-  
duty multiple outlet box to its exten-  
sive line of such components.

The new unit, useful in laboratories,  
retail stores, home workshops, etc., pro-  
vides facilities for a third ground wire.  
The receptacles are made for ground  
insertion and the line cord has a  
molded, three-prong plug. Included

with the unit is an adapter plug for wall outlets not having the three-element receptacle.

The unit consists of an "on-off" switch, a neon indicator, and six receptacles. The panel-mounted fuse is conveniently placed. The device is housed in a hammertone grey case of drawn steel. Mounting ears are provided for fixed installation applications.

The Model 24 is rated at 15 amperes, 117 volts.

### 9-BAND TRANSISTOR PORTABLE

Admiral Corporation, 3800 Cortland St., Chicago 47, Ill. has announced its entry into the transistor short-wave field with a new 9-band "All World" receiver.



The new receiver uses nine transistors and three diodes. It provides coverage of the 31, 25, 19, 16, and 13 meter bands in addition to the standard broadcast, short-wave, long-wave, marine, and weather bands. A dial light simplifies night tuning. Four built-in antennas include a ferroscope antenna for broadcast band frequencies, an antenna for the low-frequency range (both built into the carrying handle), a telescopic antenna that extends to 6 feet, and a remote unit with extension cable for attaching to windows of cars, trains, ships, planes, etc.

The receiver weighs 13 pounds, including the eight flashlight cells which power the set. The chassis is specially treated to resist humidity.

### ANTENNA ANALYZER

The Electronic Division of *Haydu Industries, Inc.*, 1426 W. Front St., Plainfield, N. J. is now marketing a simple and inexpensive antenna analyzer which is intended to insure perfect matching of antennas and feeder lines.

Especially designed to help maintain maximum operating range in mobile radio networks such as those used by

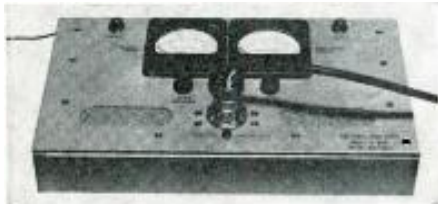

police, fire, marine, taxis, and oil companies, the Model B-3-58 antenna analyzer can be operated by personnel without special training in electronics. It instantly spots any mismatch between transmitter and feeder line or between feeder line and antenna.

The new analyzer operates from 3 to 260 mc. with powers up to 1 kw. Packaged in a ruggedized carrying case, the instrument consists of two units—a directional coupler measuring 8" x 2½" x 2" and a double d.c. amplifier measuring 12" x 7" x 2" con-

## Now for the first time! SOLDER ALUMINUM EASILY, INEXPENSIVELY with Reynolds new soldering brush kit

At last, you can do a first-class soldering job on aluminum, right in your own workshop—produce strong, clean, corrosion-resistant joints with Reynolds new soldering brush kit. The secret lies in the stiff fibre glass brush which abrades the aluminum oxide on the metal surface so solder can be readily bonded to the bare aluminum. Soldering is fast, easy, economical . . . no flux required. See your local dealer or send check or money order for \$1.98 to: Mailing Services, Dept. EW, P. O. Box 5027, Richmond 20, Va. Be sure to print name and address plainly. Do it today!

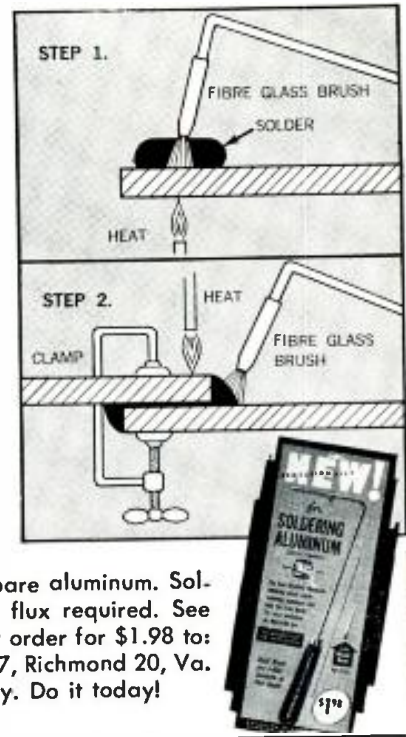

## WANTED!

### Equipment, Components or Parts!

If you have something to sell, let **ELECTRONICS WORLD** readers know about it in our classified section. It costs very little: just 50¢ a word including name and address. Minimum message: 10 words. For further information, write:

**Martin Lincoln**  
**ELECTRONICS WORLD**  
One Park Ave.  
New York 16, N. Y.

### CRYSTAL CONTROLLED CONVERTERS

POLICE • FIRE • COMMERCIAL



For use with  
12 V. Transistor type  
car radios—  
26-50 MC.

**\$24.50**

Can be self installed in seconds. Other models for 152-162 MC available. Also complete line of conventional powered converters, tuners and receivers.

A practical converter for emergency use with powered home or auto sets. Tuneable over 12 MC. 26-50 MC or **\$13.95**  
108-174 MC. . . .

Also available crystal controlled up to 54 MC. . \$18.95



ORDER TODAY OR WRITE FOR LITERATURE

**KUHN ELECTRONICS**  
20 GLENWOOD CINCINNATI 17, OHIO



SEND  
**ELECTRONICS  
WORLD  
EVERY  
MONTH**

Check one:  3 years for \$10  
 2 years for \$7  
 1 year for \$4

In the U. S., its possessions, and Canada.

Foreign rates: Pan American Union countries, add .50 per year; all other foreign countries, add \$1.00 per year.

name \_\_\_\_\_  
address \_\_\_\_\_  
city \_\_\_\_\_ zone \_\_\_\_\_ state \_\_\_\_\_

Mail to: **ELECTRONICS WORLD**  
Dept. EW109  
434 S. Wabash Ave., Chicago 5, Ill.

# Advance

## POWER SUPPLY KIT BARGAIN!

Primary 115V, 60 Cy. Sec., 400-0-400 V., @ 200 Ma., 6.3 VCT @ 4 Amp. 5 VCT @ 2 Amp. std. mounting plus 8 Hy 200 Ma chokes and two 8 Mfd. 600 V oil condensers Kit \$7.50  
DC Power Supply Kit 24 VDC—2 amp output...\$3.95

RELAYS!	RELAYS!	RELAYS!
110 V AC DPDT \$2.95	Sigma 41-F... 1.35	
110 V AC DPDT	w/1stmr for	
Ceramic-Leach. 3.45	16,000 Ohm Plate, Sig-	1.65
12 V DC DPDT 1.35	ma SP SPDT—adj.	
6 V DC SPDT 1.35	Will operate on 500	
24 V AC SPDT	Mma	\$3.95

LARGE STOCK AC, DC RELAYS

\*\*\*\*\*Solenoids\*\*\*\*\*  
115V 60 Cyc cont. duty, 18 Lb. pull... each \$5.50  
8 lb. pull each 2.75 (2 for \$5) (2 for \$10.00)  
24V & 230V SOLENOIDS IN STOCK!

**POWER TRANSFORMER**  
117 V Pri., 800 V C.T., 275 Ma.  
6.3 V., 9 Amps; 5 V., 6 Amps.  
Flat mounting... SPECIAL 5.95  
350 Mills... SPECIAL 7.95

**McELROY TAPE PULLER**  
115V AC-DC... \$8.95

CHOKES FULLY CASED	Signal Corps Earphones
6 hy, 100 Ma. \$1.09	Hi-Impedance Dual
8 hy, 100 Ma. 1.49	Headset, complete w/
10 hy, 200 Ma. 1.89	headband & Cord. Used
10 hy, 350 Ma. 2.19	—terrace Value \$3.00
20 hy, 300 Ma. 8.95	Per Set... \$1.79
22 hy, 100 Ma. 2.59	2 for \$3.25

\*\*\*\*\* Transformers \*\*\*\*\*  
ALL WITH 110 VOLT PRIMARY  
6.3 V. 12 V SEC. 2 Amp. 1.19  
1 Amp. \$1.25 24 V SEC. 1 Amp. 1.25  
3 Amp. 1.85 24 V SEC. 3 Amp. 2.95  
4 Amp. 2.45  
15 Amp.C.T. 3.95  
Step up/down Transformer  
110 V-220 V 12 Amp. \$9.95  
110 V-220 V 110 V-440 V at 5 Amp. \$9.95  
Primary 115, sec. 6 V-7 V-8 V. 75 VA. \$4.95  
Plate 3100 V CT 300 MA. \$18.95  
Sola constant voltage 95-125 V in 6.3 @  
10 Amps out. \$9.50

**CO-AX RELAYS!**  
12 or 24 V DC (Please specify). NEW \$10.75 ea.

**RG-58U**  
100 ft. \$4.75

## OIL CONDENSER BARGAINS

SPECIAL! 3x8 mfd 500 VDC	
2 Mfd 600 VDC .75	4 Mfd 1500 VDC 1.75
4 Mfd 600 VDC .75	16 Mfd 1500 VDC 2.95
8 Mfd 600 VDC .90	2 Mfd 2000 VDC 1.50
10 Mfd 600 VDC 1.10	3 Mfd 2000 VDC 2.75
12 Mfd 600 VDC 1.35	1 Mfd 3000 VDC 1.85
15 Mfd 600 VDC 1.90	2 Mfd 4000 VDC 5.75
50 Mfd 600 VDC 4.25	4 Mfd 4000 VDC 14.50
20 Mfd 650 VDC 2.75	2 Mfd 5000 VDC 8.75
1 Mfd 1000 VDC .60	1 Mfd 7500 VDC 6.95
2 Mfd 1000 VDC .75	2 Mfd 10000 VDC 10.50
8 Mfd 1000 VDC 1.60	1 Mfd 12500 VDC 24.50
12 Mfd 1000 VDC 2.75	2 Mfd 12500 VDC 32.50

## L-O-O-K! PANEL METERS

1" METERS	0.150 V AC
0-1 Ma. \$3.50	0-1 Milli 4.45
0-200 Micro-amps 3.50	0-5 Milli 3.45
0-500 Micro-amps 3.50	0-100 Milli 3.45
0-1 Ma. 3.25	0-5 Amp AC (Scale marked 0-150) 2.95
0-3 amps RF 2.95	0-200 Milli V DC 3.45
0-200 Micro-amps 2.95	200-0-200 V DC 3.45
0-30 Milli-amps 2.95	0-300 Amps DC 5.45
0-250 Milli-amps 2.95	w/shunt 5.45
0-300 V AC 3.25	-10.0 to +60.0
-10.0 to +60.0 3.95	RUNNING TIME METERS
75 Micro-amps null indicator 5.75	0-9999 OE 110V 7.45
0-7.5 V DC 2.95	0-9999 JBT 230V 9.50
0-150 V DC 2.95	Comb w/freq. meter, JBT, 110 V AC 17.95
0-200 VDC 2.95	Cramer freq. meter 110-130 V 58-82 cyc 9.95
3" METERS	
0-200 Micro-amps 4.95	
0-8 V AC 3.45	

## ★ SELENIUM RECTIFIERS ★

—FULL WAVE BRIDGE—

130/110 VAC input	12 amps	19.75
150 milli	30 24 VAC input	3.75
200 milli	2 amp	1.15
300 milli	1/2 amp	2.15
500 milli	7 amp	5.25
1 1/2 amps	20 amp	12.95

## SPERTI-VACUUM SWITCH! ...2.95

same as used in ART-13  
**TELEPHONE STUFF!**  
4 WIRE TELEPHONE COILED CORDS... 89c ea.  
TELEPHONE DIAL Automatic Elec. 6 for \$5.00  
TELEPHONE HAND SET W.E. TYPE G1... 6.39  
STEPPING RELAYS  
2 deck, 44 pos. 6.95  
16 deck, 22 pos. 22.50

## POWER SUPPLY Special!!

BC-1086 ALL WIRED—READY TO USE  
PRI-115V AC SEC. 300V 20 MA  
105V SEC. Reg. supply @ 20 Ma.  
1 Meter 0-15 Ma; 5 Tubes (6SK7, VR105) \$19.75  
6HG, sup. 6SN7 ONLY  
**PYROMETER POTENTIOMETER**  
Single scale, electrically compensated, made by Lewis Eng. in manon. box \$56.50  
**POWERSTAT**  
0-135 V AC dual—36 Amp. \$64.95

## M A R POWER SUPPLY

115 V. 60 Cyc. input 12-14 VDC, 2 amp output filtered and fully housed... \$8.95  
Min. Order \$3.00—25% with order F.O.B. New York 10 DAY GUAR. PRICE OF MODEL ONLY

**Advance Electronics**  
6 West Broadway • New York 7, N. Y. • Rector 2-0270

taining meters that display incident and reflected power directly. The unit comes complete with metering cables, coaxial adapters, spare fuses, and spare tubes.

Further information will be provided by the manufacturer on request.

## "THE FUSEMASTER"

Littelfuse, Inc. of Des Plaines, Ill. is now merchandising a new wall-mounting fuse rack containing 60 different types of the most commonly needed and wanted fuses.

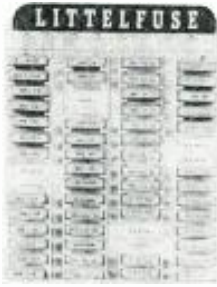

The clear plastic rack has a backing that tells the dealer or the technician when a particular fuse type is out of stock. Blank white pressure-sensitive labels are furnished with the rack. These labels can be used to alter the inventory listing on the back board to suit individual requirements.

The "Fusemaster" back is pre-drilled to facilitate easy wall mounting with the two screws furnished. A total of 300 fuses is included in this handy assortment.

## "HEAT SINK" PLIER

Handicraft Tools, Inc., a division of X-Acto, Inc., 48-41 Van Dam St., Long Island City 1, N. Y. has recently introduced a new "Lock-Gripplier" which is especially designed for electronic, TV, radio, and hi-fi technicians.

The new unit is designed to be used as a heat sink in soldering jobs, drawing off enough heat to prevent injury



to the part. A special locking device on top of the 5 1/8" tool holds the jaws closed, freeing the other hand for the soldering operation. The case-hardened steel jaws are cam-actuated. Pistol grip construction and levered trigger permit application of strong pressure with minimum physical effort.

Full details on this new tool will be supplied by the manufacturer on request.

## "COMCO" BASE STATIONS

Communications Company, Inc., 300 Greco Ave., Coral Gables, Fla. is now offering two new model base stations designed to operate with its "Fleetcom" two-way mobile gear.

The Model 580 is a 25-54 mc. base station console with transistorized reluctance microphone. It requires desk mounting space of only 15.25" x 11.5" x 10". The complete unit weighs only 30 pounds. The console is finished in grey hammertone. Base station trans-

coming soon...

## The Big, Exciting RIGO

### HIGH FIDELITY MUSIC SHOWS

featuring hundreds of exhibits and displays of the very latest in hi-fi and stereo equipment!

All shows open to the public Fri., Sat., Sun., 1 to 10 P.M.  
Admission 75c, children free.

ROCHESTER, N. Y.—Sept. 25, 26, 27  
Sheraton Hotel

BUFFALO—Oct. 30, 31, Nov. 1. Statler Hotel

SEATTLE—Nov. 6, 7, 8. New Washington Hotel

PORTLAND, ORE.—Nov. 13, 14, 15  
New Heathman Hotel

PHILADELPHIA—Nov. 20, 21, 22  
Benjamin Franklin Hotel

## RIGO Enterprises, Inc.

500 N. Dearborn St. • Chicago 10, Ill.

## ● THIRD ANNUAL DETROIT HIGH FIDELITY SHOW

Oct. 16, 17, 18. Statler Hotel

## The Battery That's Used in Guided Missiles Now Released as Government Surplus

For Photography, Aircraft, Models, Searchlights, Radios, etc. \$1.95 ea. Postpaid



Sintered-plate Nickel-Cadmium alkaline storage batteries designed for "NIKE" missile and now surplus due to design change. A lifetime battery with no known limit of service (over 5000 recharges on test without loss of capacity). Other features: Virtually indestructible, compact & lightweight, withstands heavy shock and vibration. Flat voltage curve during discharge retains charge year or more, high discharge rate up to 50 amps. for this cell, no corrosive fumes to harm clothing or equipment, spill-proof construction, discharge in any position, indefinite storage without deterioration, operates in temperatures -20° F. to +200° F. Each cell is approx. 10 ampere hour capacity. Nominal voltage per cell is 1.2 volt. (A 6 V. battery requires 5 cells.) Cell size 6" N. x 2" W. x 1 1/2" T. Wt. 6 oz. ea. Uses Potassium-Hydroxide (30%) electrolyte. Negligible loss during life-time service. Add only distilled water once a year. A fraction of Government cost.

Used Test Cells... \$1.95 ea. Postpaid  
Brand New Cells... 2.95 ea. Postpaid

All cells guaranteed to your satisfaction or money refunded (less postage).

**ESSE RADIO COMPANY** Dept. 5J  
42 W. South Street Indianapolis 25, Indiana

## MAIL ORDER HI-FI

You can now purchase all your Hi-Fi from one reliable source and be assured of perfect delivery. Carston makes delivery from NY stock on most Hi-Fi, Recorders and Tape within 24 hours. SEND US A LIST OF YOUR HI-FI REQUIREMENTS FOR OUR WHOLESALE QUOTATION and our FREE wholesale catalogue.

**CARSTON STUDIOS**  
125-TD East 88 St. New York 28, N. Y.

\*\*\* ATTENTION \*\* CITIZEN BANDERS \*\*\*  
**DON'T OVERLOOK THIS LITTLE ITEM...**  
ESSCO'S C-B EQUIPMENT operation proven/gives MORE RELIABILITY—BETTER PERFORMANCE—BEST BUY!  
Example (1) The Essco Dual Ground Plane Antenna doubles transmitter output through 3db gain... Sturdy, long lasting, easy install. complete with 25' coax cable & connectors. \$27.95  
Example (2) THE C-B NEWS: A monthly info packed bulletin. Will help you get the most out of C-B operation. 10c  
**ESSCO C-B HQTS.** 58 Walker St. NYC 13, N. Y.

mitter output is approximately 60 watts. The Model 582 "Basecom" offers



identical features but is intended for operation in the 144-174 mc. band. Its output is approximately 30 watts.

Complete spec sheets are available from the manufacturer upon written request.

### CITIZENS BAND CHASSIS

Premier Metal Products Co., 337 Manida St., New York, N. Y. is now offering a pre-punched chassis which has been expressly designed for the construction of the new 11-meter Citizens Band transceiver.

Catalogued as No. CBT-792, the new chassis is made of etched finish aluminum and measures 7" deep, 9" wide, and 2" high. It is available at local parts distributors.

### New Jobs for Tube Pins

(Continued from page 53)

can be used to hold the tube pin. Oil your fingers, as already noted, and use the iron to pull some of the molten plastic in the wood block around the base of the tube pin where it meets the wire. The desired amount of plastic can be rolled on by twisting the wire. About 3/16 inch is a suitable diameter for the rolled-on plastic. If it is too thick, it may interfere with such applications as where several tube pins are going to be inserted into a single socket. The stages in this procedure are shown in Fig. 2.

If you wish a neat-appearing finished product, the soldering iron may be used to smooth over the plastic. Then, before the polyethylene is cool, this insulation can be rolled over a sheet of smooth, oiled metal.

To make up lead-to-lead connectors, for use where long leads are needed, solder a couple of flattened pin grippers together back-to-back, in the manner shown in Fig. 4B. Make sure they are spaced sufficiently apart so that each of two tube pins can be inserted fully, as shown by the finer broken line in Fig. 4B. To insure this spacing, a couple of pins should be inserted temporarily, as they must be in place for the next step anyhow: they will prevent plastic from clogging up the gripper openings. Now cover the grippers with a jacket of insulating polyethylene in the manner already described, as shown in Fig. 4B. A razor

# EXTRA!... the 1st time anywhere!

## LEKTRON'S \$1.00 POLY PAKS®

PICK ANY **6 PAKs** for **\$4.99**

PICK ANY **12 PAKs\*** for **\$9.77**

**\*FREE! "Pik-a-Pak free" with any 12-Pak order!**

POLY PAKS for a very LIMITED TIME at ...

**88¢ EA.**

- 6 SILICON DIODES: 591v. 1N22, 1N23. Reg. \$30. **88c**
- S7 POSTAGE STAMP MIKE: 100-700 cps. **88c**
- 70 ONE WATTERS: asstd. carbons. 5% imp. **88c**
- 2 TRANSISTOR IFS: double-tuned. 456 kc. **88c**
- 4 OUTPUT XFMRs: 500.0, etc. Reg. \$8.00. **88c**
- 55 HEARING AID PHONE: complete & plus **88c**
- 30 ASSTD. MOLDED CONDENSERS: finest. **88c**
- 10 ELECTROLYTICS: 10-500mf. 10-50VDC. **88c**
- 6 ROLLS TAPE: plastic-frie.-rubber-cellulose. **88c**
- 8 SUB-MINI SOCKETS: mica filled. **88c**
- 10 POLY BOXES: clear plastic, snap locks. **88c**
- 8 GERMANIUM DIODES: glass-sealed. **88c**
- 35 DISC CONDENSERS: to 3000VDC. \$5 reg. **88c**
- 20 PILOT LIGHTS: base, screw types. 2-0V. **88c**
- JEWELERS SCREWDRIVERS: 3 sizes. **88c**
- 35 TUBE SOCKETS: 4-9 pin. \$10-reg. **88c**
- WIRE STRIPPER: cuts 1/16 thru 22 hookup. **88c**
- 2 NPN TRANSISTORS: worth \$15. **88c**
- S6 1500 HARDWARE: nuts-screws-etc. \$6-val. **88c**
- 2 SELENIUM RECTIFIERS: 200-60, 65 amp. **88c**
- 110VAC circuits. Mfg. by Federal. (1 lb.) **88c**
- 5 ROLLS MICRO-WIRE: 24 thru 32; for transistor, sub-mini circuits. (1 lb.) **88c**
- 60 CONDENSER SPECIAL: molded, paper, ceramic, oil, mica, disc, variable. (2 lbs.) **88c**
- 40 PRECISION RESISTORS: asst. carbon. W.W. 1/2, 1W. Reg. \$10. (1 lb.) **88c**
- 60 RADIO-TV KNOBS: asstd. colors. Insulation. Reg. \$17. some \$1 ea. (2 lbs.) **88c**
- 4 POWER WOOD BITS: H-Q steel. 3/8, 1/2, 3/4, 1", 5" long. For electric drills. Reg. \$3. **88c**
- 300-FT. HOOKUP WIRE: tinned, asstd. sizes, colors. Reg. \$5. (2 lbs.) **88c**
- 8 RCA PLUG-N-JACK: sets matched. For most popular amps, tuners, phono's. **88c**
- 70 HI-Q RESISTORS: Insulated, carbon; 1/2 watt, 1/2 & 1W, 10 ohms to 10 mega. Reg. \$13. (2 lbs.) **88c**
- 2 WUERTH SURGISTORS: protects tube life in TV's. Simple to use. w/built-in 10-sec. time delay. Reg. \$3. **88c**
- 2 "FLEA" POWER MOTORS: 1 1/2 to 6VDC; powered by penlite cells. Perm. magn. Size: 1 1/2 sq. 1" shaft. **88c**
- 40 "SILVER" MICAS: finest made condensers; 1 to 500 asstd values, axial leads. Reg. \$25. some \$1. **88c**
- S15 SEALED RELAY: used in jets, glass-sealed. 3PST cont. 0VDC coil. For precision circuits. (1 lb.) **88c**
- 2 VARI-LOOPSTICKS: 540-1500 kc. **88c**
- 70 TUBULARS: paper, milled; .5 mf to 1000V. **88c**
- S25 SURPRISE PAK: large, radio-TV parts. **88c**
- 60 TERMINAL STRIPS: solder-lug, binding. **88c**
- 40 HI-Q CONDENSERS: NPO's too. Reg. \$15. **88c**
- 20 ARTISTS BRUSHES: 100% bristle. \$2.50. **88c**
- S8 12-HR. "SPACE" CLOCK: penlite cell pow. **88c**
- 7 SCREWDRIVER SET: wall rack. \$3 val. **88c**
- 16-END WRENCH SET: 15/64 to 7/16" **88c**
- MOLDED TIP JACKS: red; for multimeters. **88c**
- 50 PLUGS/RECEPT'L: audio, battery. \$7 Reg. **88c**
- 15-PC. DRILL SET: 1/16 thru 1/4" x 6/16ths. **88c**
- S2.50 SUN BATTERY: similar to famed B2M. **88c**
- HOBBY BENCH VISE: steel; clamp type table. **88c**
- S9 10 VOL. CONTROLS: some w/switches. Reg. \$9. **88c**
- ROTARY SWITCHES: asstd. ranges. Reg. \$12. **88c**
- S12 35 TWO WATTERS: carbons; incl. 1% **88c**
- S4 4 OSCILLATOR COILS: mini; 650-1600 kc. **88c**
- 60 MICA CONDENSERS: .00025 to .01 to 1200V. Silver top, 25 values. Reg. \$28. **88c**
- 40 SUBMINI RESISTORS: 1/4" long. Asstd. values 1.5W to 10 mfgs. Reg. \$6. **88c**
- 3 TRANSISTOR XFMRs: submini size, 100's of uses, multiple etc. Reg. \$10. **88c**
- 100 HALF-WATTERS: asstd. value carbon resistors. Incl. 5% Reg. \$12. **88c**
- 5-IN-1 DRILL BIT: reams, saws, cones, shades, drills; use with hand or power drills. **88c**
- MINI-RADIO KIT: 100's of parts, diode and instructions. Reg. \$3. (1 lb.) **88c**
- 2 TRANSISTOR VARIABLES: 1 1/2" sq. 2" shaft. Incl. 363 mfm. Reg. \$3. (1 lb.) **88c**
- 40 SUBMINI CONDENSERS: for transistor, printed circuit work. Reg. \$7. (1 lb.) **88c**
- MINI GEIGER COUNTER TUBE: dozens of radiation detectors; asstd. sizes. 1/2" dia. **88c**
- 30 POWER RESISTORS: W.W. 5 to 50W to 600V. Reg. \$15.00. (3 lbs.) **88c**
- 75 RESISTOR SPECIAL: W.W., precision, carbon, variable, miniature types. Worth \$15. **88c**
- 20 HI-Q MOLDED COILS: condensers used in finest commercial gov't eqmt; 1 mf to 1 mf to 600V. Reg. \$40. **88c**
- 15 "SEALED" CIRCUITS: built-in resistor, condenser coupling circuits for sub-mini work. Reg. \$9. (1 lb.) **88c**

Surprise gift Free with every order!

**FREE! Write for giant bargain catalog—yrs. subscription**

MINIMUM ORDER  
2 paks per order

ORDER BY BLACK-TYPE HEADLINES, i.e. 70 HI-Q RESISTORS. 88c. State price with each item. Send check or M.O. including sufficient postage.

postage, excess returned. C.O.D. orders, 25% down, rated net 30 days. INCLUDE POSTAL ZONE in address. (Canada postage, 48c 1st lb.; 28c ea. add'l lb.)

**LEKTRON**

133 Everett Ave.  
Chelsea 50, Mass.

## TAPE RECORDERS



HI-FI COMPONENTS  
SLEEP LEARN KITS

MERITAPE Low cost, high quality recording tape, in boxes of cans. DRESSNER, 69-02 RA 174 St., Flushing 65, N.Y.

UNUSUAL VALUES

FREE

1959 Catalog

**Now! HEAR RECORDS AT THEIR BEST!**

Time Tested STAT-SIL Static Silencer inhibits dust and static noise

Get rid of "pops" and "crackles" that interfere with ideal sound reproduction—enjoy your listening pleasure. Use STAT-SIL to inhibit airborne dust attracted to the record by electro-static charges—keeps records cleaner, longer. Easy to apply. Money-back guarantee. Complete STAT-SIL \$1.50 kit only. Postpaid.

GENEX CORP., Dept. E, G. P. O., Box 1124, N.Y. 1, N.Y.

## ENGINEERING

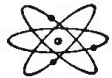

**B.S. DEGREE IN 27 MONTHS**

Prepare for unlimited opportunities of the Electronic Age!

Students study engineering under accelerated program leading to B.S. degree in 27 mo.; or standard 4-yr. program leading to B.E. degree in 36 mo. B.S. degree (36 mo.) in Math., Chem., Physics. Year-round classes. Comprehensive training in electronics, television, advanced radio theory and design, math., nuclear physics and elec. engineering. Also prep courses. Low rate. Earn board, G.I. approved. Enter Dec., March, June, Sept. Catalog.

### INDIANA TECHNICAL COLLEGE

9109 E. Washington Blvd., Fort Wayne 2, Indiana

Please send me free information on B.S. ENGINEERING DEGREE IN 27 MONTHS as checked.

- Electronics
- Chemical
- Aeronautical
- Civil
- Mechanical
- Electrical

B.S. DEGREE IN 36 MO. in:  
 Aeronautical     Mechanical  
 Civil             Electrical (Power or Electronics)  
 Chemical        Metallurgical     Chem.     Physics

Name \_\_\_\_\_  
Address \_\_\_\_\_

• Highest Quality • Top Brand Names Only  
Boxed • Lowest Sensible Prices • Guaranteed

SEND FOR FALL, '59 TUBE PRICE LISTS.  
JUST COMPILED! 2,000 TYPES IN STOCK.

### OCTOBER, SUPER-VALUES!

- **7.5 KVA Isolation Transformer**  
Pri: 115/230/115/60 CPS with 10% taps.  
Sec: 115/115/60 CPS @ 7.5 KVA. Unused. (\$500 value—500 lbs.) \$150.00.
- **Auto-Transformer**  
Pri: 115/115/60 CPS—30 Amps.  
Sec: 115 thru 135 Volts in two Volt steps @ 25 Amps. (3.37 KVA) \$100 value. Unused, orig. pack. Only \$15.00.
- **High-Voltage Transformer**  
Pri: 115 VAC @ 60 CPS.  
Sec: 20,000 Volts @ .75 KVA (approx. 30 Ma.).  
Special \$15.00. Weight: 67 lbs. New, orig. box.
- **Scintillation Counter**  
Brand new. Orig. cartons. Ready to operate with fresh set batteries. Reg. \$245.00. Special \$49.95. 10 times more sensitive than usual Geiger Counter.
- **Evans Gasoline or Kerosene Heaters**  
Orig. Gvt. pack. Special \$5.00.
- **Dual Emergency Lamp**  
Use as portable lamp or attach to 110 VAC or DC line. When power fails, lamp lights. 7 1/2" Dia. 7 1/2" High. \$3.95 (less battery).
- **Coax Relay**  
Made for Navy. Deluxe. Will handle over 2 KW. RF. 3 reg. coax connections. 24 VDC Coil. \$4.95. 115 VAC 60 cycle Coil \$7.95.
- **Telephone Wire**  
3,000 Ft. Reel. \$12.00.  
\$22.50 for two reels.
- **Electro-Voice Xtal Mike.**  
Model 915. Brand new/orig. mfr's cartons. \$4.95.
- **Acorn Socket—15c each.**
- **Five Way Binding Posts—Red or Black—22c ea.**
- **Adjustable Glass Capacitor**  
.5 to 5 Mmfd. 1" H.—1/2" Dia. 10 for \$1.00.
- **Cardwell 150 Mmfd. Fixed Padding-Capacitor.** Jobber boxed \$1.00.
- **Brand New Vector Sockets**  
7 or 9 pin miniature (specify). 50c each.
- **3 Digit Veeder-Root Counter—\$1.00.**
- **SPST Knife Switch jobber boxed \$1.00 (10 for \$8.00).**
- **Intercom Cable—7 Conductor Color-Coded 3/4" Dia.** \$7.50 per 100 ft. \$60.00 per 1,000 ft. reel.
- **Dummy Load Type TS-78U.** Standard Coax input. Excellent for VHF. 10-pwr use with three pilot bulbs. Compact. Excellent value. \$1.00 ea. 3/\$2.50.
- **Micamold 40 Mfd. @ 300 VDC. Capacitor—40c ea. (10/\$3.)**
- **GE High-Voltage Power Supply**  
115 Volt @ 60 CPS input. Output approx. 6500 VDC. Low current. Relay-rack mounted. Unused. \$15.00. (Super value.)
- **.2 Mfd @ 10 KVDC GE Pyranol Capacitors.** \$4.95.
- **RCA Xfmr. (Jobber-Boxed)**  
Pri: 117 Volt—60 CPS  
Sec: 38 Volt @ 150 Ma. \$1.25.
- **Tube Filterette Heavy-Duty Line Filter**  
(250 VAC @ 10 amps.) \$2.50.
- **Step-Down Transformer**  
Pri: 220/240 CPS  
Sec: 115 V. @ 5.2 Amps. \$5.95.
- **Ohmite 50 Watt Rheostat**  
3 Lugs. Special. 75c ea.
- **Ceramic Rotary Switch 3 PDT 35c**
- **Electric Shoe Dryer.** 115 VAC. UL approved. Reg. \$29.95—Deluxe item makes excellent gift for golfers, etc. Close out \$9.95 in orig. cartons—new.
- **4X150A Tubes—Special—\$7.00**
- **826 Tubes—Special—60c**

Separate Export Dept. promptly expedites your orders and inquiries. Write.

All prices F.O.B. N.Y.C. Specify method of shipment. All merchandise insured and guaranteed for cost of mdse. only. Receiving tubes guaranteed 90 days—Special purpose & Xmtg. tubes guaranteed 30 days. Phone: WAlker 5-7000.

SEND FOR GREEN SHEET CATALOG

**BARRY** ELECTRONICS  
CORP.

512 Broadway, Dept. EW-10, New York 12, N. Y.

blade can be used to clean away plastic scrap. The temporary tube pins can now be removed easily—especially if they have been oiled in advance. The finished product is used in the manner shown in Fig. 3.

Instead of using a permanent line cord for a.c. on some instruments, especially where a few home-built items are employed, it is often convenient to use a single line cord that can be plugged into whichever instrument is in use at the time. Suitable connectors can be made up easily. Cut the line cord, if one already exists, at the point where it enters the equipment and attach two tube pins to this end of the cord. To support the pins in the properly spaced position, insert them in the twin-hole socket that will be used as a connector at the other end. Fabrication of such a double female connector will soon be described. Polyethylene molded around the two prongs, once the plastic has hardened, will hold them firmly in the right position. See Fig. 4C.

A mating female connector can be a ready-made socket, such as those designed for mounting crystals, or it can be a couple of pin grippers molded into a plastic base. A cut-away view of the latter, showing one gripper in profile, appears in Fig. 4D as it would be mounted to an instrument case. The matching combination appears in Fig. 5. Connectors of this type also come in handy for the output cables on many instruments.

Where semi-permanent circuit connections are desired for leads that terminate in tube pins or other tips of like configuration, alligator clips may be equipped with pin grippers so that they can be slipped onto the leads

temporarily. To adapt the alligator clips, cut a straight length of bare wire (about 1 1/4 inches is generally satisfactory) and tin it at both ends. Next force one end of this wire into the punched-out metal loop usually located about 1/2 inch from the back end of the alligator clip, as shown in Fig. 4E, and solder it in place. It may be necessary to enlarge this loop with a pick to accommodate the wire's thickness. If you should happen to break open the loop, no harm will be done.

Now bring a flattened pin gripper up to the other end of the bare wire and tack-solder it into place. Flattening the gripper is particularly important if the alligator clip is of the kind that has a plastic sleeve at the back end. This sleeve is, of course, removed before the short wire is soldered to the clip, but you will want to keep the point of connection as narrow as possible so that the sleeve can be slipped back on the finished product without excessive forcing. If no sleeve is involved, the usual polyethylene insulation can be molded on, using a temporary tube pin to prevent filling of the gripper.

If there is a plastic sleeve, make sure that the gripper is so spaced that it will come to the end of the sleeve after the latter is put back. To get the sleeve back into position, you may have to enlarge the hole in it, or flatten the metal on the gripper as much as possible, or both.

Once you start using the techniques described here, many different applications will occur to you. The writer has "standardized" his work bench with such connections, even to using them on test speakers, output transformers, and other test components used for temporary connections.

Four well-known electronics executives were among the eleven persons receiving the "American Success Story Awards" presented by the Free Enterprise Awards Association, Inc. From left to right are: Harry R. Ashley, president, Electronic Instrument Co., Inc. (EICO); Eugene T. Turney, Jr., president, North Shore Nameplate, Inc.; Frank P. Scully, Sr., president, Scully Signal Co.; and Joe Friedman, president, Trav-Ler Radio Corp. Talbot T. Speer (far right), Maryland newspaper publisher, made the presentations. The citations were given those whose "up-from-the-ranks careers symbolize the rewards of success possible under the U. S. competitive free enterprise system." The citations further noted that the recipients had "won an enduring place in the history of American endeavor by achieving success, despite adversity, through industry, sacrifice, and ethics symbolizing the success possible under our free enterprise system." The awards were presented at ceremonies held at the Waldorf Hotel in New York. The winners later visited the Russian Trade Fair at the Coliseum. Other winners included: Floyd B. Odum, chairman of the board, Atlas Corp.; George Spatta, president, Clark Equipment Co.; Clarence J. Reese, president, Continental Motors Corp.; Victor W. Farris, president and founder, Farris Engineering Corp. & Affiliates; Vic Tanny, president and founder, Vic Tanny Enterprises; Dr. Alfred J. Marrow, president, Harwood Mfg. Co.; and Herbert J. Taylor, chairman of the Board, Club Aluminum Products Co., who were present but are not pictured below.









A complete, authoritative Great Circle chart of the world—a must for every ham shack—is coming your way in next month's *ELECTRONICS WORLD*.

This giant, two-color fold-out special chart gives you mileage direct from Mead's Ranch, Kansas, to any point in the world—plus direction, in degrees North—important when orienting your antenna.

You'll also find use for the complete chart of amateur call-letter prefixes for all countries—prepared from the official ARRL list. They're indexed both by call-letter and by location—giving you quick, easy reference whenever you need it. This big map and accompanying charts will be perfect for framing on the wall of your ham shack—and it's yours with the November issue of *ELECTRONICS WORLD*.

**YOU'LL ALSO ENJOY THESE AUTHORITATIVE NOVEMBER *ELECTRONICS WORLD* FEATURES:**



- **COOKING AND PRESERVING FOODS WITH ELECTRONICS** — The day is not too far off when fresh and unspoiled food will be available without any special storage or preserving problems. Find out how electronics will make this possible—in this broad survey of extensive research and survey work now going on.
- **SIMPLIFIED SPEAKER TESTING** — Here's a technique that every audiophile can apply in his own home—using just an oscilloscope and audio oscillator to measure loudspeaker impedance, phase angle, and distortion.
- **NEW LOOK IN PRINTED BOARDS** — Complete rundown of recent changes in printed wiring boards—including use of new materials to improve reliability—"one side only" wiring, road-map techniques—and much more!

These November *ELECTRONICS WORLD* features are typical of the coverage you'll enjoy month after month in the world's most authoritative electronics magazine. Be sure of getting your copy every month by subscribing now.

The newsstand price of *ELECTRONICS WORLD* is now 50c... subscription rates will be increased soon. So act now to take advantage of the present low rates. Subscribe today!

**SUBSCRIPTION RATES**

**one year \$4**

**two years \$7**

**three years \$10**

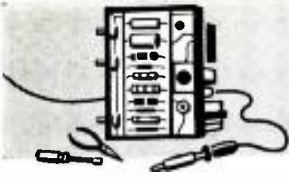

# ELECTRONICS MARKET PLACE

RATE: 50¢ per word. Minimum 10 words. December 1959 Issue closes October 12th. Send order and remittance to ELECTRONICS WORLD, One Park Ave., N. Y. C. 16, N. Y.

## RADIO ENGINEERING

**ELECTRONICS!** Associate degree—29 months. Technicians, field engineers, specialists in communications, missiles, computers, radar, automation. Start September, February, Valparaiso Technical Institute. Dept. N, Valparaiso, Indiana.

**BACHELOR** of Science in Electronic Engineering. Degree in 4 years of Home Study. No Resident attendance necessary. Pacific International College of Arts and Sciences, primarily a correspondence school. Resident classes also carried. 5719-U Santa Monica Boulevard, Los Angeles 38, Calif.

## FOR SALE

**ELECTRONIC Surplus**—Whole and retail monthly. 12 issues, \$1. Box 784, Wash. 4, D. C.

**PREMIUM Type Tubes** \$.75 each, 5751, 5814, 6005, 5726, 6073, 5727, 6106, 6096. Also 5692, 6044, C6L at \$2.50. Limited Quantities. These Tubes removed from USAF Computers. Guaranteed perfect. No COD's. Center TV, 7 Center St., Garwood, N. J.

**MAGNETIC Tape** at Bargain Basement Prices. Acetate Base: 600'—5" Reel—3 for \$2.85; 900'—5" Reel—3 for \$3.40; 1200'—7" Reel—3 for \$3.95; 1800'—7" Reel—3 for \$5.25. Mylar Base: 900'—5" Reel—3 for \$4.20; 1800'—7" Reel—3 for \$6.85; 2400'—7" Reel—3 for \$10.60. Guaranteed top quality—30—15000 CPS satisfaction or money refunded. Add 15 cents per reel P. P. handling. Florman & Babb, Inc., 68E West 45th Street, New York 36, New York.

**DIAGRAMS** for repairing radios \$1.00. Television \$2.00. Give make, model. Diagram Service, Box 672-RN, Hartford 1, Conn.

**TELEVISION Sets** \$9.95 Plus shipping. Jones TV, Sanatoga, Pa.

**RADIO & TV Tubes** at manufacturers prices. Guaranteed—Send for free price list. Edison Electronic Tube Co., Menlo Park, N. J.

**FM TUNERS**, 88-108 megacycles, 4 tubes complete \$14.95. Grulmans, 1 E. 167 St., N. Y. C. 52, N. Y.

**GOVERNMENT Surplus** Snooperscopes, parabolic reflectors, Receivers, Transmitters. Picture list 10¢. Meshna, 580 N. Lynn, Malden 48, Mass.

**TUBES**—TV, Radio, Transmitting And Industrial Types At Sensibly Low Prices. New, Guaranteed. 1st Quality. Top Name Brands Only. Write For Free Catalog or Call Walker 5-7000, Barry Electronics Corp., 512 Broadway, New York 12N, N. Y.

**GIZMOS & Such** of Still River, Mass., offer a limited number of BC779 Hammerlund super pros guaranteed to please at \$74.50 each.

**FOREIGN Auto Radio** Distributor, FM-AM and AM, trade discount. Square Electronics, 150-60 Northern Blvd., Flushing, N. Y.

**TELEVISION & Radio Tubes, Parts and Supplies** Guaranteed. Hi-Quality Tube Co., Inc., 284 Lafayette St., Rahway, New Jersey.

**TUBES**—Radio—Television, Guaranteed big discount. Atom Tube Co., Inc., 1709 Lawrence Street, Rahway, New Jersey. Distributorship openings at present.

**FREE Fluorescent Bargain Catalog**—Fixture kits, Fixtures, Circuits, Parts. Shoplite, 650 N. Franklin, Nutley 10, New Jersey.

**PROFESSIONAL Electronics Projects**—Organs, Timers, Counters, Intercoms, etc.—\$1 each. List Free. Parks, Box 1665, Lake City, Seattle 55, Wash.

**ALIGN Your BC-603, BC-683, BC-923 Adapter FT-384** plugs in rear of receiver. Provides all necessary internal and power connections. Brand New with Tech. Manual. \$3.95 Postpaid U.S.A.; Pam Electronics, Dept. E, 2129-A E. Holt Ave., Milwaukee 7, Wisconsin.

**PRINTED Circuit boards** for project or product; one or many. Free brochure. Electronic Aids, Box 137, Stamford, Conn.

**CITIZENS' Two-Way radiotelephone** for business or pleasure. Gonset, Hallicrafters, Johnson. Range 10 to 20 miles. Easily licensed. Free literature. Communication Equipments Company, Dept. EW, 518 State Street, La Crosse, Wisconsin.

**PHONOGRAPH Records** cheap, postpaid. Catalogue. Paramount, Box 2026-N, Pine Castle, Florida.

**SIX transistor radio**, complete with leather case, 2 1/4" speaker, earphone, battery. Size 2 1/2x4 1/4x1 1/4. Fully guaranteed. \$27.50 Gold's, 345 Grubbel Road, Wyncote, Pa.

## WANTED

**SURPLUS Measurement Model 78 or 80 Signal Generators.** Also Federal 804. State Quantity. Price and Condition. Communications Service, Inc., 3209 Canton Street, Dallas, Texas.

**CYLINDER** and old disc phonographs. Edison, Conqueror, Idelia, and Oratorio models. Berliner Gramophones and Zono-ophones. Columbia cylinder Graphophones, and coin-operated cylinder phonos. Want old catalogues and literature on early phonos prior to 1919. Will pay cash or trade late hi-fi components. Classified Box 50 C, Electronics World, 1 Park Ave., N. Y. C. 16, N. Y.

**CASH Paid!** Sell your surplus electronic tubes. Want unused, clean transmitting, special purpose, receiving, TV types, magnetrons, Klystrons, broadcast, etc. Also want military & commercial lab test and communications gear. We swap too, for tubes or choice equipment. Send specific details in first letter. For a fair deal write, wire or telephone. Barry, 512 Broadway, New York 12, N. Y. Walker 5-7000.

**LABORATORY Quality Equipment** and Military Surplus Electronics bought, sold. Engineering Associates, 432 Patterson Road, Dayton 9, Ohio.

**CASH for used Short-wave Ham Receivers, Transmitters and Accessories.** Treger, W91VJ, 2023 N. Harlem Ave., Chicago 35, Tuxedo 9-6429.

## TAPE & RECORDERS

**SCOTCH recording tape** at 'Profit Sharing' prices—send for catalog—you'll be glad you did!—Tapeco, Dept. L, P. O. Box 4353, Inglewood 3, California.

**RENT Stereo Tapes**—over 800 different—all major labels—free catalog. Stereo-Parti, 1608-L Centinela Ave., Inglewood 3, California.

**TAPE Recorders, Hi-Fi Components, Sleep Learning Kits, Tapes, Unusual Values.** Free Catalog. Dressner, 69-02R 174 St., Flushing 65, N. Y.

**AMPEX, Concertone, Crown, Ferrograph, Presto, Tandberg, Pentron, Bell, Sherwood, Rek-D-Kut, Dynakit, Others, Trades.** Boynton Studio, 10RT Pennsylvania, Yonkers, N. Y.

**RECORDERS, Tapes, HiFi Components, Four Track Stereo Replacement Heads, Catalogue, Efsco, 270-E Concord, West Hempstead, N. Y.**

## HIGH-FIDELITY



**RECORDERS, Hi-Fi. Free Wholesale Catalogue.** Carston, 125-R E. 88, N. Y. C. 28.

**PRICES? The Best! Factory-sealed Hi-Fi Components?** Yes! Send for free catalog. Audion, 25T Oxford Road, Massapequa, N. Y.

**DISGUSTED with "Hi" Hi-Fi Prices? Unusual Discounts** On Your High Fidelity Requirements. Write. Key Electronics, 120 Liberty St., New York 6, N. Y. EVergreen 4-6071.

**INDUCTORS for Crossover Networks.** 118 types in stock. Send for brochure. C & M Coils, 3016 Holmes Avenue N. W., Huntsville, Ala.

## INSTRUCTION

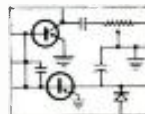

**LEARN transistor and Electronic Tube Fundamentals** from Practical Army Manuals. Over 450 pages. \$2.50. James Mullin, 25-34 88 St., Jackson Hghts. 69, N. Y.

**ELECTRONIC and Aeronautical Engineering Technology.** Two Year Courses. Bachelor of Science Degree in three years. Northrop Institute in Southern California prepares you for highly paid positions in Aviation and Electronic industries. Employment assistance during school and after graduation. Approved for Veterans. Write for free catalog. Northrop Institute of Technology, 1183 Arbor Vitae, Inglewood 1, California.

**CALCULUS, Powerful Modern Mathematics, Easy Practical Lessons, First Four \$1.** Mathco, 4256-3 Minnor, Cincinnati 17, Ohio.

**USED Correspondence Courses and Books** sold and rented. Money back guarantee. Catalog Free. (Courses Bought.) Lee Mountain, Pisgah, Alabama.

**ENGINEERING and Art Degrees** earned through home study. Electronics, Electrical, Mechanical, Civil, Physics, Business Administration, Liberal Arts. When writing, specify course desired. Pacific International College of Arts & Sciences, primarily a correspondence school. Resident classes also carried. 5719-C Santa Monica Boulevard, Hollywood 38, California.

**SPECIAL offer, complete correspondence course** in Electronics, Television and Radio only \$49.50. All new modern material. Formerly sold for \$400.00. 43 texts, over 2000 pages. Limited number available. Write dept. EW, Electronics Training, P. O. Box 764, Pittsburgh 30, Pa.

**CALCULUS or Algebra, Powerful modern mathematics.** Easy. Practical lessons. First four \$1, Mathco, 4256-3 Minnor, Cincinnati 17, Ohio.

## HELP WANTED

**OVERSEAS American Jobs. High Pay. Men. Women.** Transportation Paid. Free Information. Employment Headquarters, 79 Wall Street, Dept. R-1, New York 5.

## BUSINESS OPPORTUNITIES

**RADIO parts stores and Hi-Fi salons!** Someone "borrowing" your personal copy of Electronics World each month? You ought to be taking advantage of Electronics World convenient re-sale plan. Sell copies in your store . . . perform a good service for your customers . . . with no risk involved. For details, write: Direct Sales Department, Electronics World, One Park Avenue, New York 16, New York.

**MAKE \$25-\$50 Week, clipping newspaper items** for publishers. Some clippings worth \$400.00 each. Particulars free. National, 81-DC, Knickerbocker Station, New York.

**FOREIGN Employment Information**—\$1. Parks, Box 1665A, Lake City, Seattle 55, Wash.

**AMERICAN Overseas Jobs. High Pay. Men. Women.** Transportation Paid. Free Information. Write: Transworld, Dept. UW, 200 West 34th St., New York 1.

**TV Picture Tube rebuilding plant and training program** still available for many territories. Investment \$8,000-\$11,000. Annual volume \$25,000 to \$100,000. Windsor Co., 999 N. Main St., Glen Ellyn, Ill.

**JOBS Overseas!** Write Jancek Development Co., 109 Hub Station, New York 55, N. Y.

**EARN Extra money** selling advertising book matches. Free Samples furnished. Matchcorp, Dept. MD-109, Chicago 32, Ill.

## REPAIRS and SERVICING

**METERS and test equipment** repaired. Meter sales. Free list. Bigelow Electronics, P. O. Box 1, Bluffton, Ohio.

**ALL Makes High Fidelity Speakers** Repaired. Amprite, 70 Vesey St., N. Y. 7, N. Y. BA 7-2580.

**ELECTRICAL Instrument Repairing**—V.O.M.—V.T.V.M.—Scopes—Tubetesters—11 years in business, presently representing Simpson—Precision Apparatus—Weston—as a warranty repair station. Send instruments prepaid to Industrial Instrument Works, 3328 Magazine St., New Orleans, La.

# SHOPPING GUIDE

## Classified

A HANDY GUIDE TO PRODUCTS. NOT NECESSARILY ELECTRONIC, BUT OF WIDE GENERAL INTEREST.

### PHOTOGRAPHY—FILM, EQUIPMENT, SERVICES

OPTICAL Bargains—Request Free Giant Catalog "CJ." 96 pages—Astronomical Telescopes, Microscopes, Lenses, Binoculars, Kits, Parts. Amazing war surplus bargains. Edmund Scientific Co., Barrington, N. J.

### STAMPS & COINS

REVISED Coin Bargain Catalog, 25¢! Dollar Collections: (7 Indian Cents); (6 Liberty Nickels)—both \$1.89! "Prices Paid" listing, \$1.00! Sullivan, 128-F, East Fourth, St. Paul 1, Minnesota.

### MISCELLANEOUS

DECALS—Trademarks, Service, Sales, etc. Write Allied Decals, Inc., 8378 Hough, Cleveland, Ohio.

"WINEMAKING; Beer, Ale Brewing." Illustrated. \$2.00. Eaton Books, Box 1242-TC, Santa Rosa, California.

"HOME Brewed Wines, Beers." Complete Book \$1.00. ABC Publications, Box 849, San Francisco 1-00, California.

Do You  
Know These  
Trademarks?



You should! The winged horse symbolizes the world's leading publisher of special-interest magazines... and the hexagon stands for the organization that proves this leadership beyond a shadow of a doubt.

The publisher, of course, is Ziff-Davis—who brings you ELECTRONICS WORLD each month. Along with Ziff-Davis' six other leading special-interest monthlies, ELECTRONICS WORLD is the established circulation leader in its field.

But how do we know for sure? And how can our advertisers be positive? That's the job of the ABC. The Audit Bureau of Circulations is the governing body among publishers that sets circulation standards and audits the official figures on magazine sales.

We are proud to display the ABC symbol alongside of our own. It means trust in our circulation—and for both you, our readers, and our advertisers.

# INDEX OF Advertisers

OCTOBER  
1959

ADVERTISER	PAGE NO.	ADVERTISER	PAGE NO.
Advance Electronics	158	Key Electronics Co.	144
Aeronetics International	135	Krylon	112
Aerovox Corporation	30	Kuhn Electronics	157
Airex Radio Corporation	92	L. I. Electro-Labs., Inc.	142
Allied Radio Corp.	9, 104, 105	Lafayette Radio	140, 141
Arkey	129	Lampkin Laboratories, Inc.	130
American Television & Radio Co.	100	Lektron	159
Ashe Radio Co., Walter	153	Littlefuse	155
Astatic Corporation, The	28	McGraw-Hill Book Co.	152
Atlas Sound Corp.	10	Mallory & Co., Inc., P. R.	16
Audio	146	Merit Coil and Transformer Corp.	122
Audit Bureau of Circulation	164	Metropolitan Supply Co.	132
B & K Manufacturing Co.	79	Micro Electron Tube Co.	161
Baltimore Technical Institute	132	Milwaukee School of Engineering	116
Barry Electronics Corp.	160	Moss Electronics, Inc.	98, 99
Blonder-Tongue Labs.	124, 128	National Radio Institute	19, 20
Bogen-Presto Co.	124	National Schools	15
British Industries Corp.	128	Neshaminy Electronic Corp.	8
Burroughs Corporation	14	North American Philips Co., Inc.	Second Cover
Burstein-Applebee Co.	151	Olson Radio Corporation	150
CBS Electronics	18	Orr Industries, Inc.	126
C & H Sales Co.	132	Oxford Components, Inc.	124
Candee Co., J. J.	142	Paco Electronics Co., Inc.	147
Candler System Co.	148	Peak Electronics Company	156
Capitol Radio Engineering Institute	33	Photography Directory	146
Carston Studios	158	Picture Tube Outlet	148
Century Electronics Co., Inc.	118, 119	Platt Electronics Corp.	150
Channel Master Corp.	24, 25, 26, 27	Quietrol Company	132
Chickasha Electronics, Inc.	130	RCA Institutes, Inc.	17
Cleveland Institute of Electronics	12, 13	R W Electronics	144
Columbia Electronics	148	Rad-Tel Tube Co.	103
Commissioned Electronics Co.	144	Radio Corporation of America	89, 94
Coyne Electrical School	161	Radio Shack Corporation	97
DeRosier & Pugh-Electronics	154	Reeves Soundcraft Corp.	112, 132, 148
DeVry Technical Institute	5	Rek-O-Kut Co., Inc.	90
Dexter Chemical Corp.	95	Rex Radio Supply Co.	146
Dressner	159	Reynolds Metal Company	157
Dual	32, 126	Rider Publisher, Inc., John F.	133
Duotone	128	Rigo Enterprises, Inc.	158
EICO	35, 36, 106	Rinehart & Co., Inc.	114, 139
Electro-Voice, Inc.	Fourth Cover	Rockbar Corporation	23
Electronic Chemical Corp.	151	Rogers Mfg. Co.	143
Electronics Division Book Service	122	Sams & Co., Inc., Howard W.	21, 136
Electronics World	162	Sarkes Tarzian, Inc.	122, 149
Electronics World Classified Information	151	Schober Organ Corp., The	125
Electronics World Stereo Discs	131	Scott, Inc., H. H.	121
Electronics World Subscriptions	157	Seco Manufacturing Co.	108
Esco C-B Hqts.	158	Sonotone Corp.	94
Esse Radio Company	158	Sound Room, The	154
Fair Radio Sales	102	Sprague Products Company	3
Fairchild Recording Equipment Co.	120	Sprayberry Academy of Radio-Television	31
Fisher Radio Corporation	93	Standard Surplus	138
G & G Radio Supply Co.	137	Stromberg-Carlson	91
General Electric Company	34, 139	Supreme Publications	143
Genex Co.	159	Sylvania Electric Products Inc.	6, 109
Globe Electronics	146	Telemarine Communications Co., Inc.	96
Goodheart Co., R. E.	145	Terado Company	154
Grantham School of Electronics	11	Texas Crystals	152
H & H Electronic Supply, Inc.	148	Thorens	123
Hallcrafters	94	Tri-State College	148
Heath Company	80, 81, 82, 83, 84, 85, 86, 87, 88	Tru-Vac Electric Company	107
Henshaw Radio Supply	154	United Audio	32, 126
Hi-Fi Annual & Audio Handbook	114	University Loudspeakers, Inc.	22
Hi-Mu Electronics	138	Valparaiso Technical Institute	132
Hunter Tools	130	Van Nostrand Company, Inc., D.	7, 134
Indiana Technical College	159	Video Electric Company	144
International Business Machines Corporation	110, 111	Viking of Minneapolis, Inc.	101
International Electronics Corp.	127	Weathers Industries	92
International Radio & Electronics Corp.	92	Weller Electric Corp.	115
JansZen Loudspeakers	8	Western Radio	112, 154
Jensen Industries	126	Weston Instruments	155
Jensen Manufacturing Company	Third Cover	Wigo	32, 126
Jerrold Electronics Corporation	113	World Radio Laboratories	112
Johnson Co., E. F.	135	Zalytron Tube Corporation	117

*You should know there is something better...*

New HI-FI STEREO

# GALAXY\* II

SATELLITE SPEAKER SYSTEM

by Jensen

The ultimate space-solving  
speaker system for panoramic  
stereo sound in the home

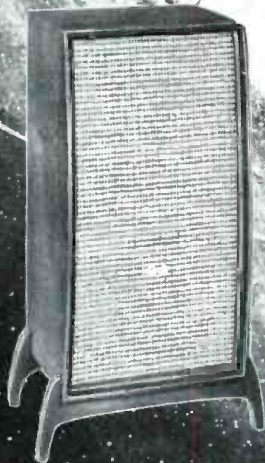
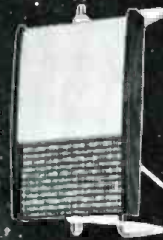

Shown against a background  
of the Andromeda Galaxy

You've never seen a stereo speaker system like this . . . an inspired merging of function with decor . . . that takes less than a square foot of floor space (or can be off-the-floor\* entirely) . . . yet gives you big speaker dual 3-way system performance with wide panoramic stereo sound for an entirely new listening thrill! For living room, or any room in your home . . . Jensen Galaxy is the most liveable stereo speaker system ever. You'll want to find out about Galaxy. Brochure GY is free on request.

Only  
**\$169.50**  
Complete



Jensen

Division of The Muter Company

MANUFACTURING COMPANY  
6601 South Laramie Avenue, Chicago 38, Illinois  
In Canada: J.R. Longstaffe Co., Ltd., Toronto  
In Mexico: Radios Y Television, S.A., Mexico, D. F.

\*T.M.

Design by Palma-Knapp

# HEAR PAGING Clearer... Easier

**SAVE MONEY, TOO!**



advanced engineering assures

**CLEARER COVERAGE with FEWER SPEAKERS**  
...improves efficiency ...reduces listener fatigue

Every installation further proves the efficiency, utility, and economy of E-v sound projectors. Messages become easier to understand without listener fatigue. At the same time, you save cost by using fewer speakers for proper coverage of the listening area. Wherever paging is required, get the benefit of natural voice reproduction.

**Choose the Type Designed to Meet Your Paging Needs**

**WIDEST DISPERSION.** Exclusive CDP dual-diffraction design\* gives uniform, wide angle coverage at all frequencies . . . no dead spots, no hot spots. Exclusive E-v compound horn reduces compression distortion to as low as 2% at full power—thus assuring minimum listener fatigue at any sound level. High efficiency performance cuts the need for costly high power amplifiers.

**CONCENTRATED COVERAGE.** E-v newly designed reentrant projector provides highest intelligibility at lowest cost where sound must be concentrated. Handles twice the power of conventional speakers, for greater penetration.

**Model 847** 25-watt CDP. Has two coaxially-mounted horns working from opposite sides of a single diaphragm. Special edgewise-wound voice coil provides 18% greater efficiency. Wide-range response: 250-10,000 cps. Sound pressure level: 114 db. Dispersion: 60° x 120°. Imp.: 16 ohms. Indestructible fiberglass horn. Size: 11 1/4" x 7 3/4" x 10 1/4" deep. Net wt. 6 1/2 lbs.

List Price, \$46.33

**Model 847-45** CDP with 45-ohm voice coil for intercom applications.  
List Price, \$47.83

**Model 844** 30-watt Reentrant. Diecast aluminum horn, with removable driver, and universal mounting bracket. Designed for easy servicing with field-replaceable voice coil. Wide-range response: 250-10,000 cps. Dispersion: 90°. Sound pressure level: 120 db. Imp.: 8 ohms. Size: 9 1/4" diam. x 8 1/4" deep. Net wt. 5 lbs. 10 oz.

List Price, \$34.50

**Model 844-45** Reentrant with 45-ohm voice coil for intercom use.  
List Price, \$36.00

(Sound pressure level measured at 4 ft. on axis from 500 to 1500 cps with full rated input.)

E-v sound projectors are extra-rugged for long-life service indoors or outdoors. They are weatherproof, blastproof, splashproof. Actual comparison on the job proves their superiority.

\*Design Patent 169,904

Write for Bulletin 258A to Dept. 109-N

No Finer  
Choice than

## Electro-Voice®

**Other Popular Models in the Complete E-V Line**

For large area sound reinforcement: Model 848 30-watt CDP or Model 848LT 30-watt Long-Throw CDP, at \$75.00 list. For high-fidelity voice and music: the E-V Musicaster at \$80.00 list. Remember too, you get even better sound when you choose an E-v high-fidelity professional microphone from today's most complete line.

**ELECTRO-VOICE, INC. • BUCHANAN, MICHIGAN**



Model 847

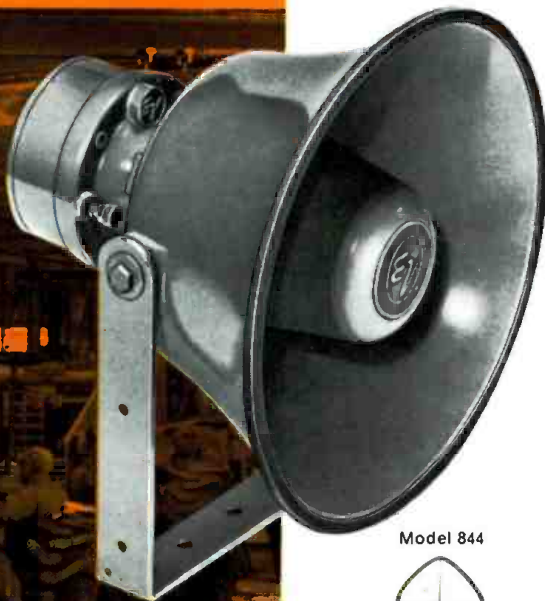

Model 844



848 CDP



848LT CDP



Musicaster

