

How To Get Surplus Electronics Bargains From Uncle Sam!

ELECTRONICS ILLUSTRATED

By the Publishers of **MECHANIX ILLUSTRATED**

APRIL • 354

TEACHING MACHINES

- **What They Mean To You**
- **Machine-Taught Electronics**



COMPLETE PLANS FOR THESE TRANSISTORIZED PROJECTS:

- RF Signal Generator** →
- All-Purpose Metal Detector**
- Marine Band Converter**



al Training Kits tra Charge

is practical—based on
SOUND methods. Be-
treated lessons designed
for men without pre-
vious experience—you get special
instructions that give actual practice,
the things you study.
To keep without extra
charge, you get all parts,
picture tube, to build
a vacuum tube volt-
meter. Read course de-
scribing 4-PAGE CATALOG.
Order today.

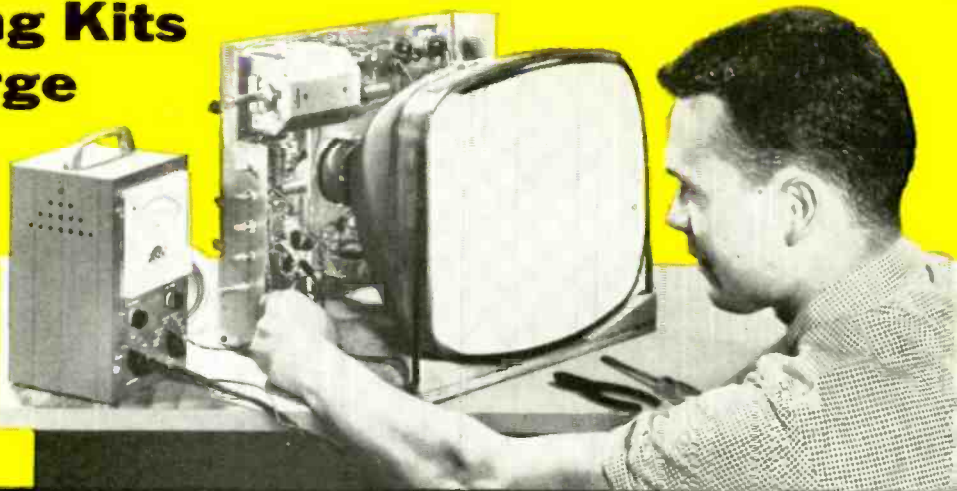

START AND A BRIGHT FUTURE Electronics Radio Television in SPARE TIME

Fast Growing Field of Electronics Needs More Trained Technicians

New developments are creating more and more job opportunities for men with Electronics training, and these are better than average jobs. Take NRI training at home in your spare time. Hold your present job while training. Prepare now for a brighter future.

Added Income in Spare Time Starting Soon

Soon after enrolling we show you how to earn extra money in spare time, repairing sets. Many use this extra money to pay for their NRI course, or buy things they normally couldn't afford. Some have found better paying jobs within a year. Others have started their own businesses.

Train With the Leader—Get Started Fast

NRI is the oldest and largest school of its kind. For 45 years, NRI has featured the best training for beginners—for men without previous experience. Mail postage-free card for 64-page Catalog. Read success stories. See equipment you get. Find out about 60-day trial enrollment offer.

Convenient monthly terms. ACT NOW.



NRI Graduates help build, install, operate and service electronic equipment for the "Space Age" we live in—equipment used in offices, factories, the military. Others are inspectors, laboratory technicians, etc., or work with the Government and Armed Forces.



From Radio-TV Servicing and Broadcasting to missiles NRI graduates share in the gigantic Electronics industry. Interesting jobs await you in studios, on ships and planes in your own Radio-TV business. Mail coupon today.

**MAIL
CARD
NOW**

OLDEST & LARGEST HOME STUDY RADIO-TV SCHOOL
National Radio Institute
WASHINGTON 16, D.C. ESTABLISHED 1914

NRI PREPARES YOU FOR JOBS LIKE THESE

Electronic Technician • Service Technician • Assistant Engineer
Cameraman • Civil Service Specialist • Computer Technician
Computer Programmer • Designer • Field Technician • Field Maintenance Man • Plant Parts Inspector • Instrument Technician • Laboratory Technician • Radio Operator • Transmitter Engineer • Airlines Technician

“Zero-five-seven...you are fifty feet above glide path... increase your rate of descent... you are now on course, on glide path...over touchdown point...take over visually for landing and contact tower.”

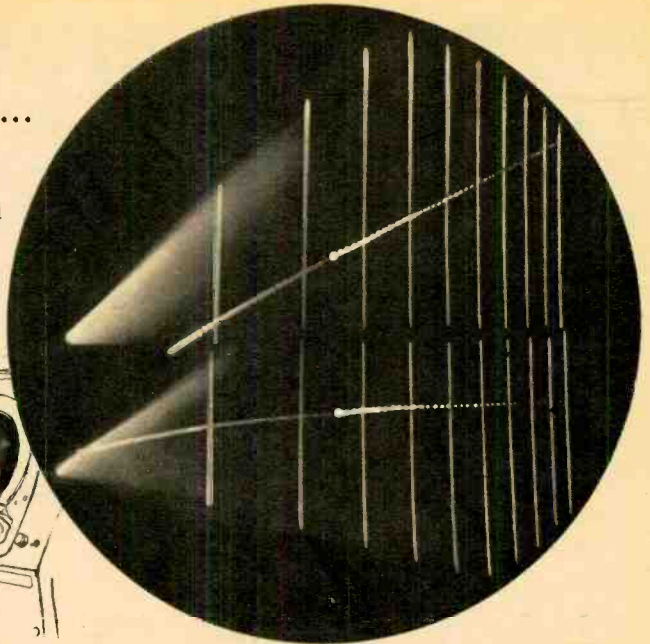

YOU MAY HANDLE A SITUATION LIKE THIS...

If you measure up to the Aerospace Team

The man in command of this situation is an Air Force Ground Control Approach Radar Technician. And those “blips” on the glide paths of his radar screen represent an aircraft coming down blind through bad weather. This is the kind of man whose dependable skill and calm judgement make him a key member of the Aerospace Team...he is the kind of man who can meet the qualifications of the U. S. Air Force.

Are you that man? As a trained and ex-

perienced Air Force technician, you will have an opportunity to build a career for yourself in the Aerospace Age—the age of air and space travel. Such a career offers you valuable training and education, steady advancement and an assured future.

If you are the kind of young man who could learn to handle situations of increasing responsibilities, we of the Air Force would like to talk to you. If you are interested, just clip and mail this coupon.

U.S. AIR FORCE

There's a place for tomorrow's leaders on the Aerospace Team

PASTE COUPON ON POSTCARD AND MAIL TO:

Airman Information, Dept. ME14, Box 7608, Washington 4, D. C.

Please send me more information on my opportunities in the U.S. Air Force. I am between the ages of 17-34 and reside in U.S.A. or possessions.

Name _____

Address _____

City _____ Zone _____ County _____ State _____

ELECTRONICS ILLUSTRATED

April, 1961

Vol. 4, No. 4

A Fawcett Publication

ROBERT G. BEASON Editor
Larry Klein Technical Editor
Joe Dubovy (W2TCC) Feature Editor
Robert D. Freed Associate Editor
Murray Cooper Art Editor
Lou Rubsamen Art Associate
Elaine E. Sapoff, Editorial Assistant

In This Issue:

Special Features

There's a Teaching Machine in Your Future	29
Machine-Taught Electronics	33
Black Light Communications	50
Speed Mail is Here!	68
The MHD Revolution	75
Your Career as a Tech Writer	86
Bargain Buys from Uncle Sam	94

Short Features

TV Keeps an Eye on Ice	42
Ruggedize Your Rig	44
Army Brain Takes to the Field	56
DXing In Between	82

EI Projects

Marine Band Converter	36
Bandswitching Wavemeter	39
RF Signal Generator	45
CB Receiver	62
Flea Power Oscillator	66
Radio Gizmo	78

Theory & Practice

How to Repair Radios III	52
All About Electroplating II	60

EI Reports

EMC Tube Tester	57
PACO AM-FM Tuner	71

Departments

Electronics in the News	10
EI Marketplace	16
Electronic Brain	49
Ham Shack	59
Good Reading	61
Construction Kinks	74
Hi-Fi Doctor and Clinic	84

Ralph Daigh Editorial Director
James Boynton Advertising Director
Al Allard Art Director
Ralph Mattison Associate Art Director
George H. Carl Production Director

Larry Eisinger Editor-in-Chief
Phyllis Bendremer Production Editor
Benita Mills Assistant Production Editor
John F. Webster Advertising Manager

ELECTRONICS ILLUSTRATED is published monthly by Fawcett Publications, Inc., Fawcett Place, Greenwich, Conn. W. H. Fawcett, Jr., President; Gordon Fawcett, Secretary and Treasurer; Roger Fawcett, General Manager; Roscoe K. Fawcett, Circulation Director; Donald P. Hanson, Assistant General Manager.

EDITORIAL AND ADVERTISING OFFICES: 67 West 44th Street, New York 36, N. Y.
ADDRESS ALL MAIL: Subscriptions, change of address, Form 3579 to Subscription Dept., Fawcett Bldg., Greenwich, Conn.; and all editorial and advertising to Fawcett Publications, Inc., 67 W. 44th St., New York 36, N. Y.

Second-class postage paid at Greenwich, Conn., and at additional mailing offices.
Subscription price \$4.00 per year in the U. S. and possessions and Canada. All other countries \$6.00 per year. Foreign subscriptions and sales should be remitted by International Money Order in U. S. funds payable at Greenwich, Conn.

Printed in U.S.A. Copyright 1961 by Fawcett Publications, Inc.
Permission hereby granted to quote from this issue of this magazine on radio or television provided a total of not more than 1,000 words is quoted and credit is given to the title of the magazine and issue, as well as the statement, copyright 1961, by Fawcett Publications, Inc.

Member of: Audit Bureau of Circulations



Magazine Publishers Association, Inc.



JOIN THE MEN LIKE YOURSELF WHO ARE NOW ABLE TO SAY—

"Imagine Me Making \$3 to \$5 an Hour in My Spare Time... Fixing Electric Appliances!"

Do you realize that **FOUR HUNDRED MILLION** appliances are in use right now in American homes — and that these are increasing by the millions every year? No wonder that men who know how to service them properly are making \$3 to \$5 an hour — in spare time or full time! **FREE BOOK** tells how you can quickly and easily get into this profitable field.

STOP AND THINK for a minute about your present job and future. Are you making enough money? Are you happy in your work? Can you bank on a steady income — in good times or bad?

Now you can have the answer to these money and job worries, once and for all. Get in "on the ground floor" of a booming industry — servicing electrical appliances. The coming of the auto created a multi-million dollar service industry, the auto repair business. Now it's happening in the electrical appliance field. But with this important difference: anybody with a few simple tools can get started in it!

Why the Boom in Appliances Means Money in Your Pocket

In addition to the 400 MILLION appliances already in use, this year alone will see sales of 76 million new appliances! For example, 4,750,000 coffee makers, 2,000,000 room air conditioners, 1,425,000 clothes dryers. A nice income awaits the man who can service

such appliances. That man can be you! Even if you don't know a volt from an ampere now, you can soon be making \$3 to \$5 an hour in your spare time.

The NRI training in Servicing Electrical Appliances tells you everything you need to know, right from the basic fundamentals about electricity. And your training will cost less than 20¢ a day.

Your Skill Always in Demand — "Set Up Shop" Anywhere

People need their appliances fixed in good times or bad. Once word gets around that you are trained to service them properly, you'll have plenty of work.

You need only the few basic tools that you may already have — and an Appliance Tester which we provide at no extra charge. You can work in a corner of your basement or garage. If you like, you can open up your own shop. And you can save money by fixing your own appliances. Mail coupon for Free Book telling how you can "cash in" on the big opportunities open.



EARN WHILE YOU LEARN with this

APPLIANCE TESTER

YOURS—AT NO EXTRA CHARGE

Your NRI Course comes *complete* with all the parts to assemble a sturdy, portable Appliance Tester that helps you earn while you learn. Easy-to-follow manual tells how to assemble and use the Tester right away. Locate faulty cords, short circuits, poor connections, etc. in a jiffy; find defects in house wiring; measure electricity used by appliance; many other uses.

With this Tester you save time and make money by doing jobs quicker, making sure appliances operate correctly after repairs.

FREE BOOK and SAMPLE LESSON

Our 24-page Free Book tells about America's "Electrical Appliance Boom" — how we train you to "cash in" on it. Free Sample Lesson shows how simple our instruction is — how it can quickly prepare you for a profitable future. Mail coupon to: *National Radio Institute, Dept. KD1, Washington 9, D. C.* (No obligation — and no salesman will call on you.)



Earns \$510 in One Month's Spare Time

"In one month I took in approximately \$548 of which \$510 was clear. I work only part time. I do a lot of service calls on ranges, dryers, and other major appliances. The NRI course has been priceless to me." — Earl Reid, RFD 1, Thompson, Ohio



His Business a Success

"Since taking your course I have opened up a small repair shop. At present I am operating the shop on a spare time basis — but the way business is growing it will be a very short time before I will devote my full time to the shop." — J. G. Stinson, 1598 Pansettia St., Long Beach, Cal.



More Than Doubled Cost of Course

"Had practically no knowledge of repair work. Now am busy almost all my spare time and day off, with more and more work coming in. Have my shop in basement. I have more than doubled amount training cost me." — John D. Pettis, 172 N. Fulton, Bradley, Ill.

NATIONAL RADIO INSTITUTE
Dept. KD1, Washington 9, D.C.

Tell me how I can "cash in" on the "Electrical Appliance Boom." Send me your illustrated **FREE BOOK** that outlines the whole NRI Course, tells what opportunities are open to me, answers my questions, describes success of other students, and much more. Also send me the **FREE SAMPLE LESSON**, so I can see how clear and easy your instructions are. I am particularly interested in:

Spare Time Earnings Business of My Own Better Job

I understand there is no obligation on my part; and no salesman will call on me.

Name.....
(PLEASE PRINT PLAINLY)

Address.....

City..... Zone..... State.....
Accredited Member National Home Study Council

FEEDBACK From Our Readers

● PS To The FCC

I can't help but smile at Mr. Hertzberg's comments in your December issue (An Open Letter to the FCC). If the Citizens Band is such a mess, as he puts it, why does he bother to acknowledge the fact that he also is a CBer? He forgets it was created for John Q. Public as well as business. I, too, monitored CB channels on vacation and found most people afraid to acknowledge any transmissions. Is this fair? Give us a fair shake, Mr. Hertzberg, and don't knock it unless you've tried it.

L. G. McFadden, 15W0308
Denver, Colo.

He has.



I disagree with you on one point. The FCC made a big mistake allowing the CB band to be used for things such as taxis, auxiliary police, fire and civil defense. These people can buy and get licenses for commercial equipment and don't have to put up with all the chattering. I feel the amateurs are hurt because they lost the 11-meter band. We limit our talks to five minutes and try to obey the rules. We do talk about our rigs but only when the air is clear. CB should be for the *people*.

John DeFazio
Danbury, Conn.

Cheers for Robert Hertzberg. His letter delighted me no end. A lot of confusion exists among prospective hams, who say, "What's this CB, anyway. I hear ya don't have to take a test or nothing." True, true. How sad that some people decide to escape taking The Test and use CB, saying it's for a necessary purpose, as a ham band. I do not favor liquidation of the 11-meter band but I do want these jerks off.

Fred Henrikson, KN1PVR
Glastonbury, Conn.



We made tapes of the "hams" on CB and sent them to the district office of the FCC. We learned that the FCC can do nothing unless one of their engineers hears the violations and he himself makes the tape.

The engineer in charge of the Savannah sub-office of the FCC then came to Charleston and listened for himself. As a result, he issued citations to five stations and I am glad to say we now have a little peace and quiet.

C. L. Riecke, 6W0652
Charleston, S. C.

● Those CB Transmitters

Your article on a pocket-size CB receiver (November '60 EI) aroused my interest in whether a companion transmitter or transceiver could be made in

Train in New Coyne Shop-Labs for Today's Top OPPORTUNITY FIELDS!



Instructor helping students check the wiring and trace the circuits of television receivers.

This modern fire-proof building which is occupied entirely by Coyne, houses the NEW COYNE SHOP-LABS.

Instructor explaining operation and testing of a large Motor Generator.

TELEVISION-RADIO ELECTRONICS

Here at COYNE you're trained for Testing, Trouble-Shooting and Servicing on AM and FM Radio, Auto Radio, Television, Color TV, etc. Thousands of COYNE trained men in good jobs or own well paying TV-Radio businesses.

ELECTRICITY ELECTRONICS

Big opportunities everywhere—city, town and country, in Power Plant Work, Motors, Industrial Electronics, Armature Winding, Home and Factory Wiring, Appliances, Refrigeration, Maintenance, Illumination, etc.

OLDEST AND BEST EQUIPPED SCHOOL OF ITS KIND IN THE U. S.

Send Coupon or Write for

FREE BOOK

"GUIDE to CAREERS"
Whether you prefer Electricity—Television—Radio or Combined Electronics Training this book describes all training offered.

Information comes by mail and no salesman will call.



WE TRAIN YOU IN CHICAGO

Our famous Practical-Technical method gives you practical experience on a massive outlay of equipment—over a quarter of a million dollars worth—plus necessary technical training right here in the NEW COYNE Shop-Labs.

Training in Refrigeration and Electric Appliances can be included.

Training offered to VETERANS and NON-VETS alike

START NOW—PAY LATER

Enroll now, pay most of tuition after Graduation. Part time employment help for students. Lifetime employment service to Graduates. Starting dates, every six weeks.

B. W. COOKE, JR., President **COYNE ELECTRICAL SCHOOL** FOUNDED 1899
 CHARTERED AS AN EDUCATIONAL INSTITUTION NOT FOR PROFIT
 1501 W. Congress Parkway, CHICAGO, Dept. 41-8C
 ELECTRICITY • RADIO • TELEVISION • REFRIGERATION • ELECTRONICS

COYNE ELECTRICAL SCHOOL, Dept. 41-8C
 1501 W. Congress Pkwy., Chicago 7, Ill.

At no obligation to me send FREE book "Guide to Careers" and details of all the training you offer. However, I am especially interested in:

- ELECTRICITY TELEVISION BOTH FIELDS

Name _____

Address _____

City _____ State _____

(I understand no Salesman will call.)

April, 1961

fastest, easiest way
to learn math
BASIC MATHEMATICS

(A PICTURED-TEXT COURSE)
by Norman H. Crowhurst

New approach and pictorial technique makes it easier than ever before possible to learn all the math you need to get ahead.

This remarkable 4-volume course takes you in easy stages from counting through algebra, geometry, trigonometry to calculus so that you will understand easily, quickly, all the math you will need to get ahead—regardless of your previous education! It employs an exciting new technique wherein basic mathematics is presented as one continuous development of mathematics. The individual branches of mathematics are not divided into separate and unrelated subjects. Algebra, geometry, trigonometry, calculus are interwoven at progressively rising levels in the different volumes. Each volume reinforces your understanding as you penetrate more deeply into the subjects. Selected illustrations create clear images of mathematical ideas formerly difficult to understand or imagine through words alone.

NOW AVAILABLE VOLUME I—FIRST STEP TOWARD MASTERY OF MATHEMATICS—In Volume I you gain the self-confidence you need to master mathematics! You build a solid foundation in mathematics without realizing that you are being introduced to subjects usually considered dry and difficult-to-master. You learn addition, subtraction, multiplication, division, taking of roots, decimals, areas, angles, distance/time, rate of growth, ratios, percentages, etc. All subjects follow one another so easily that learning is 'painless'.

Imagine a dedicated teacher sitting next to you and very patiently and painstakingly explaining step by step the processes of mathematics in each subject area... This is Basic Mathematics.

WHY A KNOWLEDGE OF MATH SPEEDS YOUR PROGRESS IN ELECTRONICS—No matter what your plans are in electronics—mathematics plays a vital role. The more math you know, the easier it is to learn electronics. And, if you've set your sights on being an advanced technician or an engineer, you must have a firm foundation in mathematics to achieve your goal. This course will speed you towards your goal.

4 VOLUMES TAKE YOU FROM COUNTING TO CALCULUS—VOL. I—Arithmetic as An Outgrowth of Learning to Count—(now available) #268-1, \$3.90.

VOL. II—Introducing Algebra, Geometry, Trigonometry, Calculus as Ways of Thinking in Mathematics. (available May). VOL. III—Developing Algebra, Geometry, Trigonometry, Calculus as Working Methods in Mathematics. (available in late 1961). VOL. IV—Developing Algebra, Geometry, Trigonometry, Calculus as Analytical Methods in Mathematics. (available in late 1961).

At book stores, parts distributors, or direct. Dept. EI-4

No matter where you buy these books, we guarantee satisfaction or your money back within 30 days.

JOHN F. RIDER PUBLISHER INC.

116 West 14th Street, New York 11, N. Y.

Canada: Chas. W. Pointon, Ltd., 66 Racine Rd., Rexdale, Ont.

Export: Acme Code Company, Inc., 630 9th Ave., N. Y.

FEEDBACK

about the same size.

I am particularly interested because I am a surveyor and my crews could find good use for these little sets.

Robert Elliott
Cincinnati, Ohio

Pocket-size transceivers are available commercially, Bob, but Uncle Sam does not allow the hobbyist to build any CB transmitter.

● How Many?



Since the number of transistors in radios is on the increase, what is the largest number a manufacturer can put in a radio and still call it a radio?

William H. Anthony
Washington, D. C.

Well, W.H., it's like this . . .

● Electronic Ignition

Last year you had an article about a transistorized car ignition and said you would publish instructions telling how the do-it-yourselfer could make the conversion. You haven't. What gives?

Jerry Boles
Baywood Park, Calif.

Transistorized ignition gives us trouble, that's what gives, Jerry. There are still design and circuit problems to be solved. However, our engineers are going to tackle them again, as soon as they get out of the rest home. Just have patience!

● That's Good!

I wish to congratulate you on your plans for worthwhile projects. I built the two-tube AM-FM receiver (July '60 EI) and it works extremely well.

Carson Wiedeman
Dayton, Ohio
[Continued on page 8]

PICK YOUR OWN SUCCESS STORY FROM THIS PAGE



Wins \$3000 contest—"After my I. C. S. courses I secured a new position," says Mr. Cecil Rhodes. "My income has more than doubled and I recently won a \$3000 sales contest."



From clerk to Assistant Estimator, thanks to I.C.S. "Any way you look at it," writes Mrs. Edna James, "the time and money one spends for I. C. S. Courses will be repaid a thousandfold."

These are the true stories of people who seemed trapped in routine, low-pay shaky jobs. Handicapped by lack of proper training, they couldn't get the things they wanted out of life—more money, a job they liked, security and happiness.

They are a small sample of the thousands of men and women—young and old—who turn to I. C. S. for help. Their will-to-learn plus I. C. S. training have changed the course of their lives.

Are you discouraged with your job and pay and feel you can't improve yourself because of lack of specialized education? Well, these men and women were in the same boat. With I. C. S. training, one of these success stories could be about you.

I. C. S. is the oldest and largest correspondence school. 277 courses. Business, industrial, engineering, academic, high school. One for you. Direct, job-related. Bedrock facts and theory plus practical application. Complete lesson and answer service. No skimping. Diploma to graduates.



"As a college graduate, I found I.C.S. very valuable." Robert Lee took the I. C. S. Course in Advertising, is now Promotion Manager for a large corporation. "I. C. S. got me started on the way up," he says.



From \$152 to \$395 a month—"I.C.S. made my engineering work more interesting," Frank Bachtik tells us, "I was a Jr. Draftsman making \$152 a month. My present income is \$395.25 a month."

3 FREE BOOKS—a 36-page pocket-size guide to advancement, a gold mine of tips on "How to Succeed." Also a big catalog outlining opportunities in your field of interest and a sample I.C.S. lesson (Math.).

For Real Job Security—Get an I. C. S. Diploma! I. C. S., Scranton 15, Penna. Accredited Member, National Home Study Council

INTERNATIONAL CORRESPONDENCE SCHOOLS

BOX 92057C, SCRANTON 15, PENNA. (In Hawaii, reply P.O. Box 418, Honolulu) (Partial list of courses)

Without cost or obligation, send me "HOW TO SUCCEED" and the opportunity booklet about the field BEFORE which I have marked X (plus sample lesson):

<p>ARCHITECTURE and BUILDING CONSTRUCTION</p> <input type="checkbox"/> Air Conditioning <input type="checkbox"/> Architecture <input type="checkbox"/> Arch. Drawing and Designing <input type="checkbox"/> Building Contractor <input type="checkbox"/> Building Estimator <input type="checkbox"/> Carpenter Builder <input type="checkbox"/> Carpentry and Millwork <input type="checkbox"/> Heating <input type="checkbox"/> Painting Contractor <input type="checkbox"/> Plumbing <input type="checkbox"/> Reading Arch. Blueprints <p>ART</p> <input type="checkbox"/> Commercial Art <input type="checkbox"/> Magazine Illus. <input type="checkbox"/> Sign Painting and Design'g <input type="checkbox"/> Sketching and Painting <p>AUTOMOTIVE</p> <input type="checkbox"/> Automobile <input type="checkbox"/> Auto Body Rebuilding and Refinishing <input type="checkbox"/> Auto Engine Tuneup <input type="checkbox"/> Auto Electrical Technician <input type="checkbox"/> Diesel Engines	<p>AVIATION</p> <input type="checkbox"/> Aero-Engineering Technology <input type="checkbox"/> Aviation Engine Mech. <input type="checkbox"/> Reading Aircraft Blueprints <p>BUSINESS</p> <input type="checkbox"/> Accounting <input type="checkbox"/> Advertising <input type="checkbox"/> Bookkeeping and Cost Accounting <input type="checkbox"/> Business Administration <input type="checkbox"/> Business Management <input type="checkbox"/> Clerk Typist <input type="checkbox"/> Creative Salesmanship <input type="checkbox"/> Managing a Small Business <input type="checkbox"/> Professional Secretary <input type="checkbox"/> Public Accounting <input type="checkbox"/> Purchasing Agent <input type="checkbox"/> Real Estate Salesmanship <input type="checkbox"/> Salesmanship <input type="checkbox"/> Salesmanship and Management <input type="checkbox"/> Traffic Management <p>CHEMICAL</p> <input type="checkbox"/> Analytical Chemistry <input type="checkbox"/> Chemical Engineering <input type="checkbox"/> Chem. Lab. Technician <input type="checkbox"/> General Chemistry	<p><input type="checkbox"/> Oil Field Technology <input type="checkbox"/> Pulp and Paper Making</p> <p>CIVIL ENGINEERING</p> <input type="checkbox"/> Civil Engineering <input type="checkbox"/> Construction Engineering <input type="checkbox"/> Highway Engineering <input type="checkbox"/> Professional Engineer (Civil) <input type="checkbox"/> Reading Struc. Blueprints <input type="checkbox"/> Sanitary Engineer <input type="checkbox"/> Sewage Plant Operator <input type="checkbox"/> Structural Engineering <input type="checkbox"/> Surveying and Mapping <input type="checkbox"/> Water Works Operator <p>DRAFTING</p> <input type="checkbox"/> Aircraft Drafting <input type="checkbox"/> Architectural Drafting <input type="checkbox"/> Drafting & Machine Design <input type="checkbox"/> Electrical Drafting <input type="checkbox"/> Electrical Engineer Drafting <input type="checkbox"/> Industrial Piping Drafting <input type="checkbox"/> Mechanical Drafting <input type="checkbox"/> Sheet Metal Drafting <p>ELECTRICAL</p> <input type="checkbox"/> Electrical Appliance Servicing <input type="checkbox"/> Electrical Engineering
<p><input type="checkbox"/> Electric Motor Repairman <input type="checkbox"/> Elec. Engr. Technician <input type="checkbox"/> Elec. Light and Power <input type="checkbox"/> Practical Electrician <input type="checkbox"/> Practical Lineman <input type="checkbox"/> Professional Engineer</p> <p>HIGH SCHOOL</p> <input type="checkbox"/> Good English <input type="checkbox"/> High School Diploma <input type="checkbox"/> High School General <input type="checkbox"/> H. S. College Prep. (Eng'g & Science) <input type="checkbox"/> High School Math <input type="checkbox"/> High School Science <input type="checkbox"/> Short Story Writing <p>LEADERSHIP</p> <input type="checkbox"/> Industrial Foremanship <input type="checkbox"/> Industrial Supervision <input type="checkbox"/> Personnel-Labor Relations <input type="checkbox"/> Supervision <p>MECHANICAL and SHOP</p> <input type="checkbox"/> Diesel Engines <input type="checkbox"/> Gas-Elec. Welding <input type="checkbox"/> Heating and Air Conditioning <input type="checkbox"/> Industrial Engineering <input type="checkbox"/> Industrial Instrumentation	<p><input type="checkbox"/> Industrial Safety <input type="checkbox"/> Machine Shop Practice <input type="checkbox"/> Mechanical Engineering <input type="checkbox"/> Plumbing and Heating <input type="checkbox"/> Professional Engineer <input type="checkbox"/> Quality Control <input type="checkbox"/> Reading Shop Blueprints <input type="checkbox"/> Refrigeration and Air Conditioning <input type="checkbox"/> Tool Design <input type="checkbox"/> Tool Making</p> <p>RADIO, TELEVISION</p> <input type="checkbox"/> General Electronics Tech. <input type="checkbox"/> Industrial Electronics <input type="checkbox"/> Practical Radio-TV Eng'r'g <input type="checkbox"/> Radio-TV Servicing <input type="checkbox"/> TV Technician <p>RAILROAD</p> <input type="checkbox"/> General Railroad <p>STEAM and DIESEL POWER</p> <input type="checkbox"/> Combustion Engineering <input type="checkbox"/> Power Plant Engineer <input type="checkbox"/> Stationary Diesel Engr. <input type="checkbox"/> Stationary Steam Engines <p>TEXTILE</p> <input type="checkbox"/> General	

Name _____ Age _____ Home Address _____

City _____ Zone _____ State _____ Working Hours _____ A.M. to P.M. _____

Occupation _____

Canadian residents send coupon to International Correspondence Schools, Canadian, Ltd., Montreal, Canada. . . . Special low monthly tuition rates to members of the U. S. Armed Forces.

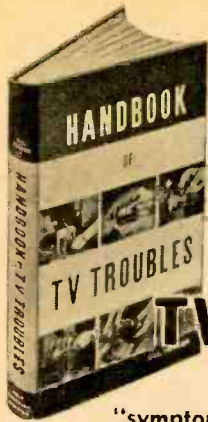

new Master Guide to TIME- SAVING TV SERVICE

A modern manual for fast,
"symptomatic trouble analysis" and
servicing of TV receivers



**TAKES THE
GUESSWORK
OUT OF TV
REPAIRS!**

Covers all causes
of practically
every trouble you
are likely to be
called on to fix
including:

- BRIGHTNESS
TROUBLES—
- CONTRAST
TROUBLES—
- PICTURE
DISTORTION—
- UNSATISFACTORY
PICTURE DETAIL—
- LINE OR BARS IN
PICTURE—
- SYNCHRONIZATION
TROUBLES—
- MISSING PICTURE—
- SIZE AND CENTERING
TROUBLES—
- SOUND TROUBLES—
- TELEVISION
INTERFERENCE, ETC.

This isn't a "study" book! From beginning to end, this big manual is designed for daily use at the bench as a complete, easily understood guide to practically any job on any TV receiver.

Just turn to the Index. Look up the trouble symptoms exhibited by the TV you're working on. The HANDBOOK OF TV TROUBLES then tells you exactly what and where to check. Outlines time-saving short cuts. Explains puzzling details. Eliminates guesswork and useless testing. More than 150 test pattern, wave form and circuit illustrations help explain things so clearly you can hardly fail to understand.

LOOK! LISTEN!
Then Follow This Easy Guide!

Almost regardless of set make or model, this remarkable new 302-page Handbook helps you track down TV troubles from the symptoms they produce in the set itself—screen intermittently dark; "blooming"; abnormal contrast in spots; "snow"; poor detail; sync troubles; sound troubles—and all the many others. Then it explains how to make needed adjustments or replacements.

**Designed for Use Right
at the Bench!**

Printed in large type. Has sturdy, varnished covers for "on the job" use. The TV TROUBLE INDEX helps you find what you want in a jiffy. Throughout, it's the ideal guide for beginners and experienced servicemen alike! Try it for 10 days AT OUR RISK. You be the judge!

TRY IT 10 DAYS—See for yourself!

Dept. PR-41, HOLT, RINEHART and WINSTON, Inc.
Technical Div., 383 Madison Ave.,
New York-17, N. Y.

Send new 302-page HANDBOOK OF TV TROUBLES for 10-day FREE trial. If I decide to keep book, I will then send you \$7.50 in full payment. If not, I will return book postpaid and owe you nothing. SAVE: Send \$7.50 with order and we pay postage. Same 10-day return privilege with money promptly refunded.

Name _____

Address _____

City, Zone, State _____

OUTSIDE U.S.A.—Price \$8.00 cash only. 10-day return privilege.

FEEDBACK

● He's Got Problems

In your January issue you have a one-transistor FM radio, which I built. The radio works, except I only receive TV channels 2, 4 and 5. Can you tell me how I might correct this? If not, will you publish the video circuit for a portable TV? This sound without pictures is crazy.

Paul T. Shomer
Brooklyn, N. Y.

The answer on the FM radio is easy, Paul. Just spread the windings on L1. And thanks for the TV suggestion.

● Where Is It?

The construction article on the Therman in your January issue revived interest in this wonderful instrument. I would like to build it but can't find the electrolytic can capacitor C26. Where can I get one?

Incidentally, as an ex-high school physics teacher, I would like to congratulate you on the excellent quality of your articles explaining various facets of electronics and electricity.

William H. Lyman
Norwood, N. Y.

Thanks for the compliment. Almost any can-type electrolytic will do for C26. Voltage rating can be from 350 to 450; capacity of 20-50 mf per section is suitable.

● Obsolete Antenna

Your article GETTING ON THE AIR (January '61 EI) was a job well done. As usual, your magazine presented a difficult topic and made it look easy.

We were surprised to see an obsolete Kurman series 25 antenna pictured on page 55. But we are pleased to announce that a redesigned version is now on the market. Thought you would like to know about this.

Wallace Green
Kurman Electric Co.
Brooklyn, N. Y.

Sorry about the booboo and thanks for letting us know.

BREAK THROUGH TO HIGHER PAY

in

ELECTRONICS

TV-RADIO

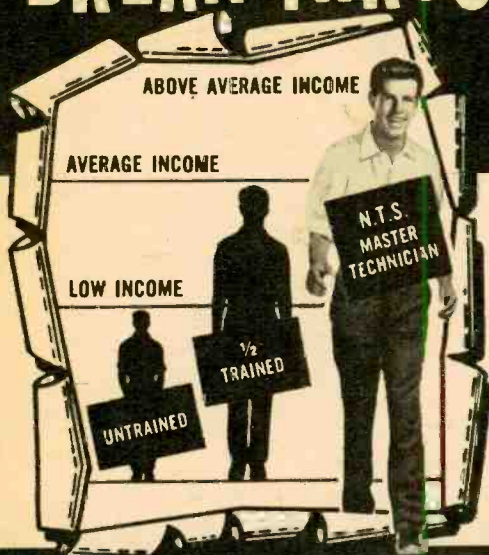

START NOW! Break through the Earning Barrier that stops half-trained men. N.T.S. "All-Phase" training prepares you — at home in spare time — for a high-paying CAREER in Electronics — TV — Radio as a MASTER TECHNICIAN. One Master Course at One Low Tuition trains you for unlimited opportunities in All Phases: Servicing, Communications, Preparation F.C.C. License, Broadcasting, Manufacturing, Automation, Radar and Micro-Waves, Missile and Rocket Projects.

A more rewarding job... a secure future... a richer, fuller life can be yours! As an **N.T.S. MASTER TECHNICIAN** you can go straight to the top in industry... or in your own profitable business.

You work on actual job projects

SUCCEED IN MANY HIGH-PAYING JOBS LIKE THESE...

- TV-Radio Sales, Service and Repair
- Profitable Business of Your Own
- Communications Technician — F.C.C. License
- Hi-Fi, Stereo & Sound Recording Specialist
- TV-Radio Broadcasting Operator
- Technician in Computers & Missiles
- Electronics Field Engineer
- Specialist in Microwaves & Servomechanisms
- Expert Trouble Shooter
- All-Phase Master Technician

19 BIG KITS YOURS TO KEEP

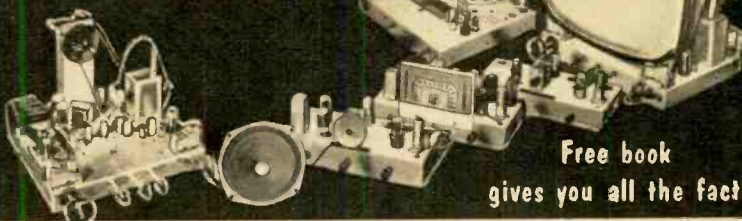

Free book gives you all the facts

NATIONAL TECHNICAL SCHOOLS

WORLD-WIDE TRAINING SINCE 1905
4000 S. FIGUEROA ST., LOS ANGELES 37, CALIF., U.S.A.

Write Dept. R4Y-31



RESIDENT TRAINING AT LOS ANGELES

If you wish to take your training in our Resident School at Los Angeles, the world's TV capital, start NOW in our big, modern Shops, Labs, and Radio-TV Studios. Here you work with latest Electronic equipment — professionally installed — finest, most complete facilities offered by any school. Expert friendly instructors. Personal attention. Graduate Employment Service, help in finding home near school — and part time job while you learn.

WRITE FOR SPECIAL RESIDENT SCHOOL CATALOG AND INFORMATION



ACCREDITED MEMBER
the only nationally recognized accrediting agency for private home study schools

N.T.S. Shop-Tested HOME TRAINING is Better, More Complete, Lower Cost... and it is your key to the most fascinating, opportunity-filled industry today!

YOU LEARN QUICKLY AND EASILY THE N.T.S. SHOP-TESTED WAY

You get lessons, manuals, job projects, unlimited consultation, graduate advisory service.

You build a Short Wave-Long Wave Superhet Receiver, plus a large-screen TV set from the ground up, with parts we send you at no addi-

tional cost. You also get a Professional Multimeter for your practical job projects.

EARN AS YOU LEARN... WE SHOW YOU HOW!

Many students pay for entire tuition — and earn much more — with spare time work they perform while training. You can do the same... we show you how.

SEND FOR INFORMATION NOW... TODAY! IT COSTS YOU NOTHING TO INVESTIGATE.

N.T.S. HOME TRAINING is

- Classroom Developed
- Lab-Studio Planned
- Shop Tested
- Industry-Approved
- Specially Designed for Home Study



MAIL COUPON NOW for FREE BOOK and ACTUAL LESSON

NATIONAL TECHNICAL SCHOOLS

WORLD-WIDE TRAINING SINCE 1905

Mail Now To
National Technical Schools, Dept. R4Y-31
4000 S. Figueroa St., Los Angeles 37 Calif.

Please rush FREE Electronics-TV-Radio "Opportunity" Book and Actual Lesson. No Salesman will call.

Name _____ Age _____
Address _____
City _____ Zone _____ State _____

Check here if interested ONLY in Resident Training at Los Angeles.
VETERANS: Give date of discharge.

NO OBLIGATION!
NO SALESMAN WILL CALL

...electronics in the news



Wanta go sliding? . . . Looks inviting but we wouldn't advise it. Actually, what appears to be an outdoor movie screen is the equivalent of nearly 9,000 tiny radar antennas that have the ability to explore a wide expanse of space without turning physically. Hundreds of targets can be tracked simultaneously. Called ESAR for Electronically Steerable Array Radar, it was built by the Radio Division of Bendix Corporation for the Air Force and is in operation at Towson, Md.

Because of its design, Bendix engineers feel this antenna may eventually be used for direct communication with spaceships millions of miles from earth . . . just as easy as picking up the receiver and dialing Aunt Minnie down the street.

—o—

To tell the truth . . . With the protection of the consumer always in mind, the Federal Trade Commission has moved to force manufacturers to identify their TV cabinet materials. The cabinets of many sets are made of metal or plastic but finished to look like wood. Now the maker must reveal this fact by means of a tag or label attached to it.

There's more to this matter than meets the eye. Not many years ago a child was electrocuted when he touched the metal cabinet of a television set. The set was a hot-chassis AC-DC type and the usual insulation between chassis and cabinet had broken down. That tragic accident created a general impression that TV receivers with metal cabinets were dangerous. Actually, of course, metal cabinets are dangerous only if they enclose an AC-DC set having the chassis connected to one side of the power line (they can become shorted). With this new FTC rule enforced, the consumer will at least have no doubt about the composition of his TV cabinet.

—o—

All for 4¢ . . . The advent of satellite communications may well introduce a new dimension into the international hobby of philately . . . stamp collecting, that is!

Shortly before Christmas a letter containing the traditional message, Shop and Mail Early, was converted to microwaves by a facsimile process, beamed to the Echo satellite and bounced back to a Bell Labs receiver at Holmdel, N. J. It was then returned to its original printed form, opening a new era in stamp collecting.



MAKE MORE MONEY

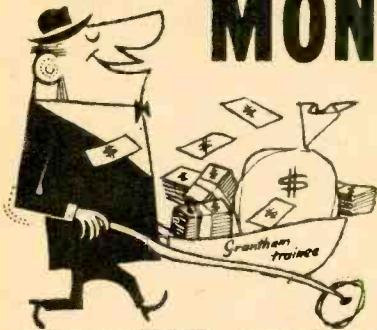

TRAIN FOR ELECTRONICS . . .

In RESIDENT CLASSES

Grantham *resident* schools are located in four major cities—Hollywood, Seattle, Kansas City, and Washington, D. C. Regularly scheduled classes in F. C. C. license preparation are offered at all locations. New *day* classes begin every three months, and new *evening* classes begin four times a year. The day classes meet 5 days a week and prepare you for a first class F. C. C. license in 12 weeks. The evening classes meet 3 nights a week and prepare you for a first class license in 20 weeks. For more information about the Grantham resident schools, indicate in the coupon the city of your choice and then mail the coupon to the School's home office in Hollywood, Calif. Free details will be mailed to you promptly.

Get your First Class Commercial F. C. C. License by training at

GRANTHAM SCHOOL OF ELECTRONICS

HOLLYWOOD

SEATTLE

KANSAS CITY

WASHINGTON

This booklet **FREE!**

This free booklet gives details of our training and explains what an F. C. C. license can do for your future. Send for your copy today.

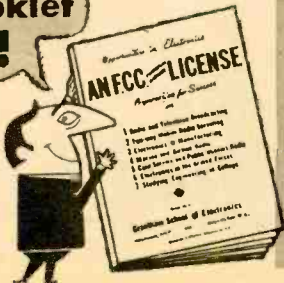

for **FREE** Booklet **CLIP COUPON** and mail in envelope or paste on postal card.

Through HOME STUDY

Grantham training is the easy way to learn more quickly—to prepare more thoroughly—for F. C. C. examinations. And your first class license is the quick, easy way to prove to your employer that you are worth more money.

This correspondence course is directed toward two major objectives—(1) to *teach* you a great deal about electronics, and (2) to prepare you to *pass* all of the F. C. C. examinations required for a first class commercial operator's license. We teach you step by step and have you practice with FCC-type tests which you send to the school for grading and comment. You prepare for your F. C. C. examinations under the watchful direction of an instructor who is especially qualified in this field.

GET your first class commercial F. C. C. LICENSE

To get ahead in electronics—first, you need the proper training; then, you need "proof" of your knowledge. Your first class commercial F. C. C. license is a "diploma" in communications electronics, awarded by the U. S. Government when you pass certain examinations. This diploma is recognized by employers. Grantham School of Electronics specializes in preparing you to earn this diploma.

Grantham training is offered in resident classes or by correspondence. Our free booklet gives complete details. If you are interested in preparing for your F. C. C. license, mail the coupon below to the School's home office at 1505 N. Western Ave., Hollywood 27, California—the address given in the coupon—and our free booklet will be mailed to you promptly. No charge—no obligation.

for **FREE** Booklet **CLIP COUPON** and mail in envelope or paste on postal card.



To: **GRANTHAM SCHOOL OF ELECTRONICS**
1505 N. Western Ave., Hollywood 27, Calif.

Please send me your free booklet telling how I can get my commercial F. C. C. license quickly. I understand there is no obligation and no salesman will call.

Name _____ Age _____

Address _____

City _____ State _____

I am interested in: Home Study, Kansas City classes, 18-D
 Hollywood classes, Seattle classes, Washington classes



83 YX 929. Stereo Tape Record-Play Preamp Kit. \$79.95 (less case)

One of the many great Knight-Kit stereo component kits. Professional quality; superb performance with virtually any 3-head tape transport; separate dual-channel recording and playback preamps; permits tape monitoring, sound-on-sound and echo effects. Packed with quality features for every possible stereo and monophonic function...

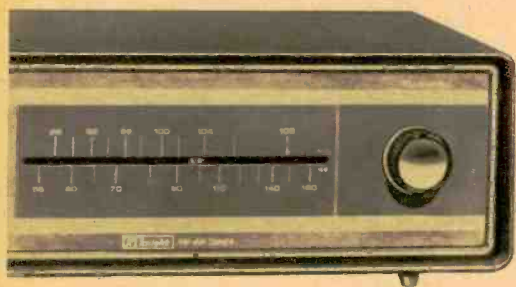

83 YX 928. FM-AM Hi-Fi Tuner Kit. \$49.95

Typical Knight-Kit hi-fi value—incomparable at the price. With AFC, tuned RF stage on FM, multiplex jack. Straight FM tuner kit also available at \$38.95. For deluxe Stereo FM-AM and FM tuner kits, see the Allied catalog...



83 YX 927. 20-Watt Stereo Hi-Fi Amplifier Kit. \$39.95

Biggest bargain in quality Stereo hi-fi. Has special clutch-type dual-concentric level control; simplified control facilities; DC preamp filaments. Similarly styled 32-Watt Stereo Amplifier Kit with full frequency center channel available at a low, low \$59.95...

83 YU 934. Deluxe 70-Watt Stereo Hi-Fi Amplifier Kit. \$119.95

Super-power to drive any of today's speakers, a do-it-yourself stereo masterpiece, featuring: special "blend" control; full-range center channel; tape-source monitor; dual phasing switches; Stereo paralleling switch. For deluxe 40-watt Stereo amplifier at only \$76.95, and 60-watt Stereo amplifier, see the Allied catalog...

Simply

these and 59

knight
A PRODUCT

a pleasure to build...

The most satisfying do-it-yourself experience awaits you when you build a Knight-Kit! You'll marvel at the sheer ease of assembly, absolutely assured by exclusive "show-how" manuals, wall-sized picture diagrams, step-by-step do-and-check instructions, pre-cut wire, "visi-packed" parts and an engineering perfection that eliminates guesswork. You'll get perfect results. You'll enjoy with pride a true custom-built electronic product, professionally engineered and styled—the best you can own. And to top off your pleasure, you'll save substantially at the unbeatable Knight-Kit price...



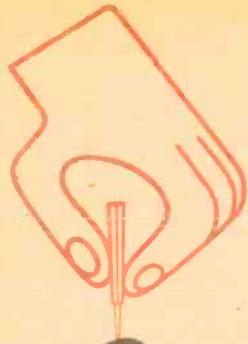

83 YX 712-2. Superhet Citizen's Band Transceiver Kit. \$79.95

Dual-conversion for highest sensitivity and selectivity; crystal-controlled operation on any 2 channels, plus manual tuning. Another Knight-Kit Citizen's Band Transceiver is available at an amazing low \$39.95—see the Allied catalog for full details...

Great!

other money-saving

-kits[®]

OF ALLIED RADIO

and you own the best

money back guarantee

Every Knight-Kit is unconditionally guaranteed to meet our published specifications for performance or your purchase price is refunded in full.

only \$2 down

It's easy to buy any Knight-Kit: only \$2 down on orders up to \$50; \$5 down up to \$200; \$10 down over \$200—up to 24 months to pay.

Featured

IN THIS VALUE-PACKED 1961
444-PAGE ALLIED CATALOG

Send coupon today for the 1961 Allied electronics catalog (the world's biggest), featuring the complete Knight-Kit line. See the best in electronic kits—save on everything in Electronics. Send for your FREE copy now!

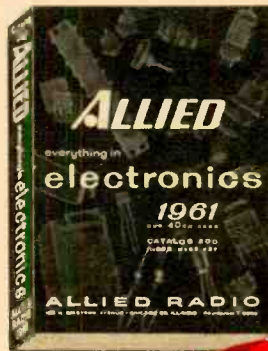

also available in Canada

sold exclusively by

ALLIED RADIO

pioneer in electronic kit development

our 40th year



83 YX 258. 4-Band "Span Master"® Receiver Kit. \$25.95

Fabulous performer for world-wide reception; thrilling shortwave adventures, plus fine Broadcast; band-switching, 540 KC to 30 MC; with cabinet. For additional receiver kits, radio-intercom, clock-radio, transistor radios, intercom systems, electronic labs and other great hobbyist Knight-Kits, see the Allied catalog...

83 Y 125. Electronic VTVM Kit. \$25.75

High sensitivity general-purpose VTVM; 11 meg input resistance; balanced-bridge circuit; 4 1/2" meter. One of many fine instrument kits including 5" scopes, AC VTVM, tube checkers, signal tracer, audio generator, sweep generator, and others, described in detail in the Allied catalog...



send coupon today!

ALLIED RADIO, Dept. 203-D1
100 N. Western Ave., Chicago 80, Ill.

Send Free 1961 Allied Catalog No. 200

Name _____
PLEASE PRINT

Address _____

City _____ Zone _____ State _____



... News

Targets: Mars and Venus . . . An infrared guidance system to control final approach of space probes during their flights to Venus and Mars is being developed by Barnes Engineering Company of Stamford, Conn.

It is expected the infrared-bearing probes, named Mariner, will be launched to the vicinity of Mars and Venus during 1962. When a probe is within 100,000 miles of the target, the system will take over to assure that the vehicle is on the right bearing for the planet. The infrared guidance sensor detects objects by means of the infrared radiation that is emitted by all materials at temperatures above absolute zero. It can thus distinguish these objects by their radiation from the much colder space background. The radiation from the atmosphere of both Venus and Mars is much warmer than the -459.7° F of absolute zero. A favorable date for the flight to Venus will be August 16, 1962, and to Mars, November 16, 1962.

Higher and higher . . . Only a decade ago, the newly-established Citizens Radio Service never got off the ground because no manufacturer could produce commercially satisfactory equipment for the then-assigned frequency in the 460-mc range. Today, a routine press release from Motorola announces the marketing of a new transceiver operating on 12,000 megacycles.

—o—

The moon is so romantic . . . but not to the Navy. For the sailors (at least it's claimed) the moon is a space body of tremendous importance in radio communications. Recently a solar flare disrupted global communication networks. The Navy quickly pressed into service its experimental Moon Relay System which uses the satellite as a passive reflector. It took signals $2\frac{1}{2}$ seconds to cover the 480,000 miles between the Pentagon and Hawaii.

Study Programs in . . .

APPLIED SCIENCE AND ENGINEERING

Associate in Applied Science degrees — 2 years

Electronics Communications Technology
Electrical Power Technology
Computer Technology
Air Conditioning Technology
Industrial Technology
Metallurgical Technology

Bachelor of Science degrees — 4 years

Electrical Engineering
— Communications option
— Electrical power option
Mechanical Engineering

At MSOE, new classes begin quarterly. Pre-technology program, scholarships, financial aid, and placement service available.



New! FREE "Your Career" booklet. Send coupon today.

MILWAUKEE SCHOOL OF ENGINEERING
1025 N. MILWAUKEE STREET • MILWAUKEE 1, WIS.



MILWAUKEE SCHOOL OF ENGINEERING
Dept. EI-461, 1025 N. Milwaukee St., Milwaukee 1, Wis.

Name..... Age.....

Address.....

City..... State.....

Course Interest.....

(Please Print)

BUILD 20 RADIO

CIRCUITS AT HOME

with the New
PROGRESSIVE RADIO "EDU-KIT" [®]

only
\$26⁹⁵

Reg. U.S.
Pat. Off.



A Practical Home Radio Course

Now Includes

- ★ 12 RECEIVERS
- ★ 3 TRANSMITTERS
- ★ SQ. WAVE GENERATOR
- ★ SIGNAL TRACER
- ★ AMPLIFIER
- ★ SIGNAL INJECTOR
- ★ CODE OSCILLATOR

- ★ No Knowledge of Radio Necessary
- ★ No Additional Parts or Tools Needed
- ★ EXCELLENT BACKGROUND FOR TV
- ★ School Inquiries Invited
- ★ Sold in 79 Countries

YOU DON'T HAVE TO SPEND HUNDREDS OF DOLLARS FOR A RADIO COURSE

The "Edu-Kit" offers you an outstanding PRACTICAL HOME RADIO COURSE at a rock-bottom price. Our Kit is designed to train Radio & Electronics Technicians, making use of the most modern methods of home training. You will learn radio theory, construction practice and servicing. THIS IS A COMPLETE RADIO COURSE IN EVERY DETAIL.

You will learn how to build radios, using regular schematics; how to wire and solder in a professional manner; how to service radios. You will work with the standard type of punched metal chassis as well as the latest development of Printed Circuit chassis.

You will learn the basic principles of radio. You will construct, study and work with RF and AF amplifiers and oscillators, detectors, rectifiers, test equipment. You will learn and practice code, using the Progressive Code Oscillator. You will learn and practice trouble-shooting, using the Progressive Signal Tracer, Progressive Signal Injector, Progressive Dynamic Radio & Electronics Tester, Square Wave Generator and the accompanying instructional material.

You will receive training for the Novice, Technician and General Classes of F.C.C. Radio Amateur Licenses. You will build 20 Receiver, Transmitter, Square Wave Generator, Code Oscillator, Signal Tracer and Signal Injector circuits, and learn how to operate them. You will receive an excellent background for television, Hi-Fi and Electronics.

Absolutely no previous knowledge of radio or science is required. The "Edu-Kit" is the product of many years of teaching and engineering experience. The "Edu-Kit" will provide you with a basic education in Electronics and Radio, worth many times the complete price of \$26.95. The Signal Tracer alone is worth more than the price of the entire Kit.

THE KIT FOR EVERYONE

You do not need the slightest background in radio or science. Whether you are interested in Radio & Electronics because you want an interesting hobby; a well paying business or a job with a future, you will find the "Edu-Kit" a worth-while investment. Many thousands of individuals of all

ages and backgrounds have successfully used the "Edu-Kit" in more than 79 countries of the world. The "Edu-Kit" has been carefully designed, step by step, so that you cannot make a mistake. The "Edu-Kit" allows you to teach yourself at your own rate. No instructor is necessary.

PROGRESSIVE TEACHING METHOD

The Progressive Radio "Edu-Kit" is the foremost educational radio kit in the world, and is universal accepted as the standard in the field of electronics training. The "Edu-Kit" uses the modern educational principle of "Learn by Doing." Therefore you construct, learn schematics, study theory, practice trouble-shooting—all in a closely integrated program designed to give you the thorough and interesting background in radio.

You begin by examining the various radio parts of the "Edu-Kit." You then learn the function, theory and wiring of these parts. Then you build a simple radio. With this first set you will begin learning to regular broadcast stations, learn theory, practice testing and trouble-shooting. Then you build a more advanced radio, learn more advanced theory and techniques. Gradually, in a progressive manner, and at your own rate, you will find yourself constructing more advanced multi-tube radio circuits, and doing work like a Professional Radio Technician.

Included in the "Edu-Kit" course are twenty Receiver, Transmitter, Code Oscillator, Signal Tracer, Square Wave Generator and Signal Injector circuits. These are not unprofessional "breadboard" experiments, but genuine radio circuits, constructed by means of professional wiring and soldering on metal chassis, plus the new method of radio construction known as "Printed Circuitry." These circuits operate on your regular AC or DC house current.

THE "EDU-KIT" IS COMPLETE

You will receive all parts and instructions necessary to build 20 different radio and electronics circuits, each guaranteed to operate. Our Kits contain tubes, tube sockets, variable, electrolytic, mica, ceramic and paper dielectric condensers, resistors, tie strips, coils, hardware, tubing, punched metal chassis, Instruction Manuals, hook-up wire, solder, selenium rectifiers, volume controls and switches, etc.

In addition, you receive Printed Circuit materials, including Printed Circuit chassis, special tube sockets, hardware and instructions. You also receive a useful set of tools, a professional electric soldering iron, and a self-powered Dynamic Radio and Electronics Tester. The "Edu-Kit" also includes Code Instructions and the Progressive Code Oscillator, in addition to F.C.C.-type Questions and Answers for Radio Amateur License training. You will also receive lessons for servicing with the Progressive Signal Tracer and the Progressive Signal Injector, a High Fidelity Guide and a Quiz Book. You receive Membership in Radio-TV Club, Free Consultation Service, Certificate of Merit and Discount Privileges. You receive all parts, tools, instructions, etc. Everything is yours to keep.

PRINTED CIRCUITRY

At no increase in price, the "Edu-Kit" now includes Printed Circuitry. You build a Printed Circuit Signal Injector, a unique servicing instrument that can detect many Radio and TV troubles. This revolutionary new technique of radio construction is now becoming popular in commercial radio and TV sets.

A Printed Circuit is a special insulated chassis on which has been deposited a conducting material which takes the place of wiring. The various parts are merely plugged in and soldered to terminals.

Printed Circuitry is the basis of modern Automation Electronics. A knowledge of this subject is a necessity today for anyone interested in Electronics.

UNCONDITIONAL MONEY-BACK GUARANTEE

ORDER DIRECT FROM AD—RECEIVE FREE BONUS RESISTOR AND CONDENSER KITS WORTH \$7

- Send "Edu-Kit" postpaid. I enclose full payment of \$26.95
- Send "Edu-Kit" C.O.D. I will pay \$26.95 plus postage.
- Rush me FREE descriptive literature concerning "Edu-Kit."

Name

Address

PROGRESSIVE "EDU-KITS" INC.

1186 Broadway, Dept. 535AE, Hewlett, N. Y.

FREE EXTRAS

• SET OF TOOLS

- SOLDERING IRON
- ELECTRONICS TESTER
- PLIERS-CUTTERS
- ALIGNMENT TOOL
- WRENCH SET
- VALUABLE DISCOUNT CARD
- CERTIFICATE OF MERIT
- TESTER INSTRUCTION MANUAL
- HIGH FIDELITY GUIDE & QUIZZES
- TELEVISION BOOK & RADIO TROUBLE-SHOOTING BOOK
- MEMBERSHIP IN RADIO-TV CLUB: CONSULTATION SERVICE & FCC AMATEUR LICENSE TRAINING
- PRINTED CIRCUITRY

SERVICING LESSONS

You will learn trouble-shooting and servicing in a progressive manner. You will practice repairs on the sets that you construct. You will learn symptoms and causes of trouble in home, portable and car radios. You will learn how to use the professional Signal Tracer, the unique Signal Injector and the dynamic Radio & Electronics Tester. While you are learning in this practical way, you will be able to do many a repair job for your friends and neighbors, and charge fees which will far exceed the price of the "Edu-Kit." Our Consultation Service will help you with any technical problems you may have.

J. Stataitis, of 25 Poplar Pl., Waterbury, Conn., writes: "I have repaired several sets for my friends, and made money. The "Edu-Kit" paid for itself, I was ready to spend \$240 for a Course, but I found your ad and sent for your Kit."

FROM OUR MAIL BAG

Ben Valerio, P. O. Box 21, Magna, Utah: "The Edu-Kits are wonderful. Were I am sending you the questions and also the answers for them. I have been in Radio for the last seven years, but like to work with Radio Kits, and like to build Radio Testing Equipment. I enjoyed every minute worked with the different Kits; the Signal Tracer works fine. Also like to let you know that I feel proud of becoming a member of your Radio-TV Club."

Robert L. Shuff, 1534 Monroe Ave., Huntington, W. Va.: "Thought I would drop you a few lines to say that I received my Edu-Kit, and was really amazed that such a bargain can be had at such a low price. I have already started repairing radios and phonographs. My friends were really surprised to see me get into the swing of it so quickly. The trouble-shooting tester that comes with the Kit is really swell, and finds the trouble, if there is any to be found."

RESIDENT SCHOOL COURSES IN
LOS ANGELES AND NEW YORK CITY

START YOUR CAREER IN ELECTRONICS NOW AT RCA INSTITUTES... Choose from this list

	Course	Qualifications	Length of Course
A	Advanced Electronic Technology (T-3)	High School grad, with Algebra, Physics or Science	Day 2 1/4 yrs. Eve. 6 3/4 yrs.
B	TV and General Electronics (V-7)	2 yrs. High School, with Algebra, Physics or Science	Day 1 1/2 yrs. Eve. 4 1/2 yrs.
C	Radio & TV Servicing (V-3)	2 yrs. High School, with Algebra, Physics or Science	Day 9 mos. Eve. 2 1/4 yrs.
D	Transistors	V-3 or equivalent	Eve. 3 mos.
E	Electronic Drafting (V-11 V-12)	2 yrs. High School, with Algebra, Physics or Science	Eve. Basic: 1 yr. Advanced: 2 yrs.
F	Color TV	V-3 or equivalent	Day 3 mos. Eve. 3 mos.
G	Audio-Hi Fidelity	V-3 or equivalent	Eve. 3 mos.
H	Video Tape	V-3 or equivalent	Eve. 3 mos.
I	Technical Writing (V-10)	V-3 or equivalent	Eve. 3-18 mos.
J	Computer Programming	High School grad	Day 6 weeks Eve. 24 weeks Sat. 30 weeks
K	Radio Code (V-4)	8th Grade	Eve. as desired
L	Preparatory Math & Physics (P-O)	1 yr. High School	Day 3 mos.
M	Preparatory Mathematics (P-OA)	1 yr. High School	Eve. 3 mos.

RCA Institutes is one of the largest technical institutes in the United States devoted exclusively to electronics. Coeducational Day and Evening classes. Free placement service. Applications now being accepted.



The Most Trusted Name
in Electronics
RADIO CORPORATION OF AMERICA



Send to the school nearest you!

RCA Institutes, Inc. Dept. EIR-41
350 West Fourth Street Pacific Electric Building
New York 14, N. Y. 610 S. Main St., L.A. 14, Calif.

Please send me your FREE catalog. I am interested in the courses circled below.

A B C D E F G H I J K L M

Name _____ (please print)

Address _____

City _____ Zone _____ State _____

For Home Study Courses See Ad On Opposite Page



Electronic Marketplace

Pocket/Table Radio . . . The Mini-Convertible is a compact combination of a pocket-size, eight-transistor radio and a larger table-type cabinet with its own loudspeaker. The portable functions as a self-contained unit. For home use, it is



inserted into the cabinet. This connects in the larger speaker and disconnects the portable's speaker. It is priced at \$69.95. Majestic, 743 N. LaSalle, Chicago, Ill.

New tube for transmitters . . . A quick-heating beam power tube for use in mobile transmitters has been introduced by RCA's Electron Tube Division, Harrison, N. J. It was developed especially for push-to-talk service in which stand-by power is at a premium.

The 4604 can deliver 30 watts of power at 175 mc and more at lower frequencies. It incorporates the basic construction of the 6146, long a favorite in amateur and commercial mobile equipment.

RCA training at home can be the smartest investment you ever made

Look what you get in the Course in Radio and Electronic Fundamentals

40 Fascinating THEORY LESSONS



Containing all the basic principles of radio and electronics in easy-to-understand form.

40 EXPERIMENT LESSONS



Each containing absorbing, practical experiments bound together in 20 books.

40 SERVICE PRACTICES



Full of practical, time-saving and money-saving servicing tips, bound into 20 books.

PLUS ALL THIS AT NO EXTRA COST...

15 KITS

to build a Multimeter, AM Receiver and Signal Generator. Kits contain new parts for experiments, integrated so as to demonstrate what you learn in the lessons and to help you develop technical skills. Each kit is fun to put together!

MULTIMETER



A sensitive precision measuring instrument you *build* and use on the job. Big 4½" meter with 50 micro-amp meter movement, 20,000 ohms-per-volt sensitivity d-c, 6,667 a-c.

AM RECEIVER



Have the satisfaction of building your own radio receiver with this high-quality 6-tube superheterodyne set. Big 5" speaker, fine tone!



SIGNAL GENERATOR

A "must" for aligning and trouble-shooting receivers. Build it for your own use. 170 KC to 50 MC fundamental frequencies for all radio and TV work.

Also, comprehensive, fully-integrated home study courses in • *Television Servicing* • *Color Television* • *Electronics For Automation* • *Transistors*. Stake out your future in electronics with any one of this wide variety of courses.

Practical work with the very first lesson! Pay-only-as-you-learn! No long-term contracts to sign! No monthly installments required. Pay only for one study group at a time, if and when you order it!

SEND FOR FREE HOME STUDY CATALOG TODAY!

RESIDENT SCHOOL COURSES in Los Angeles and New York City offer comprehensive training in Television and Electronics. Day and Evening classes. Free Placement Service. Catalog free on request.

RCA INSTITUTES, INC.
A Service of Radio Corporation of America • 350 W. 4th St., New York 14, N. Y. • 610 S. Main St., Los Angeles 14, Calif.



The Most Trusted Name in Electronics



RCA INSTITUTES, INC. Home Study School, Dept. EI-41
A Service of Radio Corporation of America
350 West Fourth Street, New York 14, N. Y.

Without obligation, rush me the FREE 64-page illustrated booklet "Your Career in Electronics" describing your electronic home study training program. No salesman will call.

Name.....

Address.....

City..... Zone..... State.....

Veterans: Enter discharge date.....

CANADIANS—Take advantage of these same RCA courses at no additional cost. No postage, no customs, no delay. Send coupon to: RCA Victor Company, Ltd., 5581 Royalmount Ave., Montreal 9, Quebec.



**Greatest Savings
and Precision Features
all inclusive in this
"QUALITY LINE"!**



EMC TEST EQUIPMENT

Compare all our features and you'll
AGREE the name to buy is EMC



Model 102 Volometer

Features a 3½", 2% accurate—800 micro-ampere D'Arsonval-type plastic front meter with 3 AC current ranges; and the same zero adjustment for both resistance ranges. Specifications . . . AC Voltage—5 Ranges: 0 to 12-120-600-1200-3000 volts. DC Voltage—5 Ranges: 0 to 6-60-300-600-3000 volts. AC Current—3 Ranges: 0 to 30-150-600ma. DC Current—4 Ranges: 0 to 6-30-130ma: 0 to 1.2 amps. Two Resistance Ranges: 0 to 1000 ohms, 0 to 1 megohms. Model 102, Wt. 1 lb. 5 oz. Size: 3¾" x 6¼" x 2". \$14.90; Kit, \$12.50.

Model 205 Tube Tester

Uses standard emission test. Tests all tubes including Noval and subminiatures. Completely flexible switching arrangement. Checks for shorts, leakages and opens.

Model 205P, Hand rubbed oak carrying case, \$47.50 (Illustrated); Kit, \$36.20. Model CRA, Cathode ray tube adaptor, \$4.50.



Model 700 RF-AF-Crystal Marker TV Bar-Generator

Complete coverage from 18 cycles to 108 megacycles on fundamentals. Bar generator for TV adjustment with a variable number of bars available for horizontal or vertical alignment. Square wave generator to 20 kilocycles. Wien Bridge AF oscillator with sine wave output from 18 cycles to 300 kilocycles. Crystal marker and amplitude control. Individually tuned coils. Constant RF output Impedance. Stepped RF attenuator. Variable percentage of modulation.

Model 700 \$55.90



Yes, tell me more, send me FREE—a detailed catalog of the complete EMC line. EL-4

NAME _____

ADDRESS _____

CITY _____

STATE _____

EMC Electronic Measurements Corp.
625 B'way, New York 12, N. Y.

Ex. Dept., Pan-Mar Corp., 1270 B'way., New York 1, N. Y.

Marketplace

Earphones for stereo listening . . .

Want to enjoy the full flavor of stereo music without disturbing other members of the family? Simply use a pair of split earphones to put the full stereo effect directly into your ears. Do the job with the new Knight Model KN-840



headset which consists of two light-weight units that are actually small dynamic speakers delivering a frequency response of from 20 to 16,000 cycles. Priced at \$23 from Allied Radio.

Megaphone is two-way . . . The conventional electronic megaphone, which consists of a microphone, amplifier and loudspeaker is a one-way affair. The Hail-O-Matic however, works as both a transmitter and receiver to permit



**AT
LAST!**

RADIO-TV and ELECTRONICS TRAINING

**... AT A PRICE
YOU CAN AFFORD!**

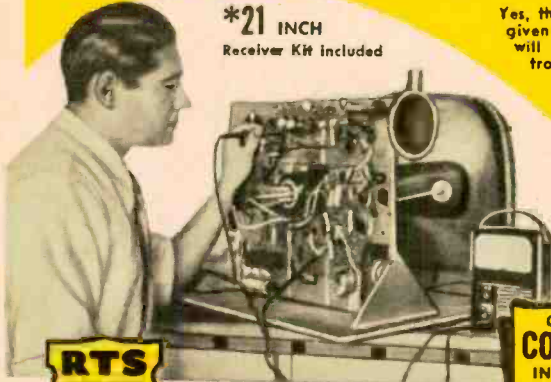

***21 INCH**
Receiver Kit included

Yes, this great course costs far less than any training of its kind given by other major schools! Radio-Television Training School will train you for a good job in Television or Industrial Electronics — **AT HOME IN YOUR SPARE TIME.**

Think of it—a complete training program including over 120 lessons, Fourteen Big Radio-Television Kits, Complete Color-TV Instruction, Unlimited Consultation Service... **ALL at a really big saving to you.** How can we do this? Write to us today... and find out!

And what's more — you can (if you wish)

OPEN YOUR OWN RTS-APPROVED AND FINANCED RADIO-TV SERVICE SHOP
We Want Many More Shops This Year

This 39 year old training organization — called RTS, that's Radio-Television Training School — wants to establish a string of Radio-TV Repair Shops in principal cities throughout the U. S. So far, a great many such shops are **NOW IN BUSINESS AND PROSPERING.** We are helping and training ambitious men to become future owners and operators of these shops in all areas.

FOR UNSKILLED INEXPERIENCED MEN ONLY — WE TRAIN YOU OUR WAY!

We must insist that the men we sign up be trained in Radio-TV Repair, Merchandising and Sales by our training methods—because **WE KNOW** the requirements of the industry. Therefore, we will **TRAIN YOU**... we will show you how to earn **EXTRA CASH**, during the first month or two of your training period. **YOU KEEP YOUR PRESENT JOB. TRAINING TAKES PLACE IN YOUR OWN HOME, IN YOUR SPARE TIME!**

RTS
APPROVED
SERVICE
SHOP

**COMPLETE
COLOR TV
INSTRUCTION
INCLUDED**

you build these
and other units



MULTIMETER
KIT INCLUDED!

*tubes
excluded

RADIO-TELEVISION TRAINING SCHOOL

815 EAST ROSECRANS AVENUE
LOS ANGELES 59, CALIFORNIA

Est. 1922



Get your free book on the
FAMOUS RTS BUSINESS PLAN
find out how you can open
A REPAIR SHOP OF YOUR OWN

We supply and finance your equipment

When you are ready and qualified to operate one of our RTS-Approved TV Repair Shops **WE WILL SUPPLY AND FINANCE EVERY BIT OF EQUIPMENT YOU NEED TO GET STARTED** plus an inventory of parts and supplies. In other words we will stake you... **AN OFFER NEVER MADE BEFORE BY ANY TRAINING ORGANIZATION.** Under the RTS Business Plan you receive:

1. An electric sign for the shop front.
2. Complete laboratory of test equipment.
3. Letterheads, calling cards, repair tickets, etc.
4. Basic inventory of tubes, parts, supplies.
5. Complete advertising and promotional material.
6. Plans for shop arrangement.
7. Instructions on how to go into business.
8. Continuous consultation and help.
9. The right to use RTS Seal of Approval, and the RTS Credo.
10. The right to use the Famous Trade Mark.

**ACT
NOW!**

CUT OUT AND MAIL — TODAY!

RADIO-TELEVISION TRAINING SCHOOL
815 EAST ROSECRANS AVE Dept. E1-41
LOS ANGELES 59, CALIFORNIA

SEND ME FREE — all of these big opportunity books — "Good Jobs in TV-Electronics," "A Repair Shop of Your Own" and "Sample Lesson." I am interested in:

- Radio-Television Industrial Electronics (Automation)

Name _____ Age _____

Address _____

City & State _____

301

Mail This Coupon Now — No Salesman Will Call



RTS' Membership in The Association of Home Study Schools is your assurance of Reliability, Integrity, and Quality of Training.

**ALL
THESE
FREE!**



New "Mechanical Educator" to IMPROVE MEMORY

Inability to recall names, places, facts quickly is a common, often costly, shortcoming that can now be easily overcome with the aid of a new device for mental training. This versatile new educational tool can also be used effectively in language learning, speech correction and improvement, in mastering tables, formulae—anything to be memorized—faster than ever while you sleep.

DORMIPHONE Memory Trainer

Works for you—YOU LEARN WHILE YOU SLEEP

- Speeds up learning processes
- Aids concentration
- Provides entertainment

Using a new recording principle, the Memory Trainer records, instantly plays back, and automatically repeats speech, music, or any spoken or broadcast material by clock control. No reels of tape to snarl or rewind. Completely portable. Ideal aid for home, school, industrial safety training use. So simple to use, children benefit—so helpful and practical, it is used by educators, psychologists, people of all ages and professions.

SELF-CONTAINED RECORDING CARTRIDGES

from 30 seconds to 55 minutes. Easily removed. Can be stored or "erased" instantly and re-used repeatedly. Just record, flip a switch for play-back and listen!

Write TODAY for FREE folder with complete information. Modernophone, Inc. 367-041 Radio City, New York 20, N.Y.



MODERNOPHONE, INC.

Circle 7-0830

367-041 Radio City, New York 20, N. Y.

Gentlemen: Please send me your FREE Booklet. I am interested in finding out all about Scientific Sleep Learning and what the Dormiphone Memory Trainer can do for me. No obligation—no salesman will call.

Name _____
 Address _____
 City _____ Zone _____ State _____
 My main interest in the Memory Trainer is for:
 Language Learning Speech Improvement
 Memorization School or College Work
 Sleep Learning Bridge Rules



studying antenna system in Tri-State's electronics lab

twenty to one return from degree

You can receive a twenty to one dividend from your college education in engineering or business. Invest in yourself. Important firms regularly interview seniors. They like Tri-State graduates. **BACHELOR OF SCIENCE DEGREE IN 27 MONTHS** in Electrical (Electronics or Power major), Mechanical, Chemical, Aeronautical, Civil Engineering. **IN 36 MONTHS** in Business Administration (General Business, Acctg., Motor Transport Mgt. majors). For earnest, capable, mature students. Small classes. More professional class hours. Campus. Well-equipped labs, modernized buildings, new dorms. Modest costs. Enter June, Sept., Jan., Mar. Write J. A. McCarthy, Admissions, for Catalog and "Your Career" Book.



TRI-STATE COLLEGE

4841 College Avenue, Angola, Indiana

Marketplace

two-way communication. It is fully transistorized and works on flashlight batteries. The megaphone can be used as a mobile instrument or mounted on a pedestal. Priced at \$149 it is available from Allen-Bradford, Inc., 3181 N. Elston Avenue, Chicago, Ill.

Organ in kit form . . . A project to challenge the skill of musically-inclined kit builders is this impressive looking electronic organ. Appropriately called the Regal, it is marketed by Electronic Organ Arts, Inc., 4949 York Blvd., Los Angeles, Calif. It contains 64 stops, three 61-note manuals and a 32-note



pedal board. The organ is a series of component kits which the builder assembles progressively as his time and finances permit. Full information available from the manufacturer on request.

Radio sunglasses? . . . Yes, that's what they are! This interesting novelty from Japan has a three-transistor broadcast receiver built into the frame. Tuning knob is on the left earpiece,



tells how

FREE

Completion of the Master Course (both Sections) will prepare you for a First Class Commercial Radio Telephone License with a Radar Endorsement. Should you fail to pass the FCC examination for this license after successfully completing the Master Course, you will receive a full refund of all tuition payments. This guarantee is valid for the entire period of your enrollment agreement.

Your FCC Commercial License -or your money back

**"License and \$25 raise due to
Cleveland Institute training"**

"I sat for and passed the FCC exam for my second class license. This meant a promotion to Senior Radio Technician with the Wyoming Highway Department, a \$25 a month raise and a District of my own for all maintenance on the State's two-way communication system. I wish to sincerely thank you and the school for the wonderful radio knowledge you have passed on to me. I highly recommend the school to all acquaintances who might possibly be interested in radio. I am truly convinced I could never have passed the FCC exam without your wonderful help and consideration for anyone wishing to help themselves."

CHARLES C. ROBERSON, Cheyenne, Wyoming

**CIE HELPS
TRAINEES GET BETTER JOBS**



**Investigate Our NEW
Training Program
in Computer, Servo-Mechanisms,
Magnetic Amplifier and Others.**

**GET THIS HANDY POCKET
ELECTRONICS DATA GUIDE**

Free...

Puts all the commonly used conversion factors, formulas, tables, and color codes at your fingertips. Yours absolutely free if you mail the coupon today. No further obligation!

TO GET THIS FREE GIFT, MAIL COUPON TODAY!

Cleveland Institute of Electronics

1776 E. 17 Street Desk E1 31 Cleveland 14, Ohio

Cleveland Institute of Electronics
1776 E. 17th Street, Desk E1 31, Cleveland 14, Ohio
Accredited by National Home Study Council.
Please send free career information material to help me get ahead in Electronics. I have had training or experience in Electronics as indicated below.

<input type="checkbox"/> Military	<input type="checkbox"/> Broadcasting
<input type="checkbox"/> Radio-TV Servicing	<input type="checkbox"/> Home Experimenting
<input type="checkbox"/> Manufacturing	<input type="checkbox"/> Telephone Company
<input type="checkbox"/> Amateur Radio	<input type="checkbox"/> Other

In what kind of work are you now engaged?

.....

In what branch of Electronics are you interested?

.....

Name Age

Address

City Zone State

E1 31



PUZZLED?

KIT didn't work?

Probably cold solder joints!

World's Finest

ERSIN *Multicores*
FIVE CORE SOLDER



Sold only by Radio Parts Distributors.

MULTICORE SALES DIVISION BRITISH INDUSTRIES CORP., Post Washington, N. Y.

QUICKLY CUT HOLES

in metal, plastics,
hard rubber...



ROUND



SQUARE



KEY



"O"



GREENLEE CHASSIS PUNCHES

Make smooth, accurate openings in 1½ minutes or less... for sockets, plugs, controls, meters, panel lights, etc.

Easy to use... simply turn with wrench. Many sizes and models. Write for literature.



Marketplace

volume control on the right. The earphone is a tiny plug that fits directly into



the right ear. About \$30 from Custom Displays, 1 Riverdale Avenue, New York 63, N. Y.

A versatile VTVM kit... just introduced by Lafayette Radio. Called the KT-174, it offers an easy-to-read two-color scale, accessible calibration controls and scope terminals. Special low AC ranges, down to 1 millivolt for audio



applications, and conventional facilities for resistance and AC and DC voltage measurements are included. Designed along horizontal rather than vertical lines, the instrument has an adjustable mounting handle. \$40.

Stylus magnifier... It isn't necessary to remove a stylus from its cartridge to examine it for wear if the new Syl-A-

GREENLEE TOOL CO. 1915 Columbia Ave., Rockford, Illinois

Marketplace

Scope is used. This instrument fits directly on the turntable and provides a magnified image of the needle on an

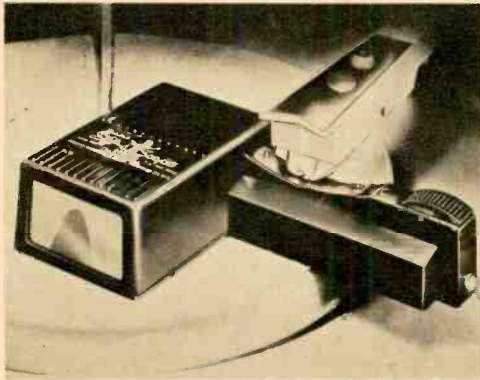

illuminated ground-glass screen. Any irregularities show up unmistakably. Two models are available: the SG-33 with penlight battery supply at \$6.75, and the SG-66 for AC supply at \$20. Robins Industries Corporation, Flushing 54, N. Y.



Educational kit . . . Youngsters and grown-ups alike can learn radio theory

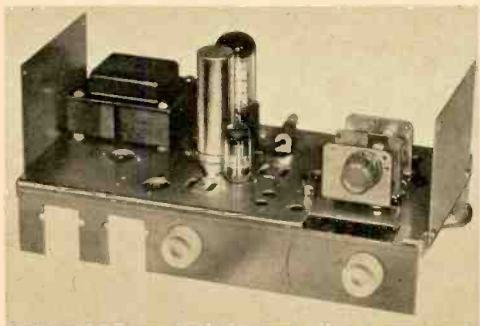

and practical circuitry with the aid of the new Heathkit Model EK-2A Educational Kit. The student starts with a basic crystal receiver and progresses to a transformer-operated AC regenerative set. The kit is priced at \$20 from the Heath Company, Benton Harbor, Mich.

COYNE'S New Complete *Pin-Point* **TROUBLE SHOOTING** *Series*

See All 4
Books On 7-Day
FREE TRIAL!

**Takes Headaches Out Of
All Servicing Problems!**

Pin-Point

Transistor Troubles in 12 Minutes!

Trouble-shoot every type of circuit in ALL transistorized equipment! 325 pages; hundreds of Illustrations; 120 check charts! \$5.95

Pin-Point

Record Changer Troubles in 5 Minutes!

Locate mechanical and electronics troubles fast. Covers all makes. 320 pages; 450 photos; 58 check charts! \$3.95

Pin-Point

TV Troubles in 10 Minutes!

Find the exact sound or picture trouble in any TV set from 700 possibilities! 300 pages; 300 diagrams, check charts! \$4.95

Pin-Point

Color TV Troubles in 15 Minutes!

Covers every type color TV and picture tube! 550 pages; 362 check charts, diagrams, picture patterns! \$5.95



Simple Check Chart System Saves Time

These amazing practical handbooks with an ENTIRELY NEW METHOD, show you how to find the trouble in ANY tv, record changer or transistor circuit FAST! Index tells you where to look; famous Check-Charts help you pin-point the exact trouble in minutes! These on-the-job books quickly pay for themselves in profitable new business and valuable time saved!

SEND NO MONEY

Just mail coupon for 7 DAY FREE TRIAL. If you keep all 4 books, pay only \$3.00 per month until \$21.35 plus postage is paid. Cash price for Set only \$18.95. On return books and pay nothing. Either way, FREE BOOK IS YOURS.

**VALUABLE
FREE GIFT!**
Send for FREE TRIAL
OFFER of all 4 Pin-
Point books and get
FREE book, 'Bigger
Profits in TV' whe-
ther you keep series
or not!

FREE TRIAL OFFER...Mail Coupon Now!

Educational Book Publishing Div.
COYNE ELECTRICAL SCHOOL, Dept. 41-EI
1455 W. Congress Pkwy., Chicago 7, Ill.

Rush 4-book PIN-POINT Series for 7-day FREE TRIAL per offer
For individual books, check below.

RECORD CHANGER (\$3.95 plus postage)

TRANSISTORS (\$5.95 plus postage)

TV (\$4.95 plus postage)

COLOR TV (\$5.95 plus postage)

Name _____ Agg. _____

Address _____

City _____ Zone _____ State _____

\$18.95 Cash Price enclosed for 4 books.

Send 4 books C.O.D. for \$18.95 plus M.O. fee. COYNE PAYS POSTAGE ON ALL CASH & C.O.D. ORDERS. 7-Day money-back guarantee on Cash or C.O.D. orders.

FABULOUS FREE OFFER!

ALCO 20,000 ohms per volt

MULTITESTER With Leather Case!

Only

20,000 ohms per volt tester for \$16.95
20,000 opv tester with case for \$16.95

\$16.95
ONLY Postpaid

4" Meter Scales!



Tube Caddy Meter!

- High sensitivity — 20,000Ω/V
- New design; wide scale arc
- Compares with 4½" meters
- Measures 3¼" W x 4½" x 1¼"
- Compact black bakelite case

DC V. ranges: 5-25-250-500-2500 @ 20,000Ω per V.
AC V. ranges: 10-50-100-500-1000 @ 10,000Ω per V.
DC current: 50 μa, 2.5 ma.
Resistance: 0-60,000 ohms, 0-6 meg.

FREE LEATHER CASE

SEND FOR FREE CATALOG

Send TS-60H Multi-tester — \$16.95 enclosed

Name _____
Address _____
City _____ Zone _____ State _____

Order direct or thru local distributor



ALCO

ELECTRONIC PRODUCTS, INC.
3 Walcott Ave., Lawrence 26, Mass.



LOOK FOR



A BRAND NAME IS A MAKER'S REPUTATION

Brand Names Foundation, Inc.

Short-wave converter for car . . .

A new broadcast-to-shortwave converter for standard automobile radios is announced by International Crystal Mfg. Co., Inc., 18 North Lee, Oklahoma



City, Oklahoma. Using three transistors and crystal-controlled, "Mobilette 61" features include a signal peaking control for greater gain, separate inputs for short-wave and broadcast antennas, new RF amplifier, and internal jumper wires which allow operation of the unit in automobiles with either negative or positive ground systems with minimum alteration.

The unit measures 4¾"x2¾"x1⅞". It is designed for easy installation under the dashboard with no sacrifice of valuable leg room. A single switch places the unit in or out of operation. When not in use, it allows the automobile radio to remain in its standard broadcast range. The new converter uses the 600 kc to 1600 kc intermediate frequency range to provide reception in specific portions of six amateur bands, the 27-mc class D Citizens Band, 10 or 15 mc WWV time broadcasts and low-band Civil Air Patrol. Price, about \$23.00.

CUT OUT AND MAIL TODAY



8 FREE
BIG ISSUES

OLSON CATALOGS

TYPICAL VALUE

DIAL TELEPHONE

\$7.93

No. PH-31

Standard phone company model.



We will send you a new issue every 6 weeks for a full year — NO CHARGE! Compare our World Famous Values.

SEND FREE CATALOGS

Send Dial Telephone @ \$7.93, plus postage

MAIL TO: **OLSON ELECTRONICS**
(Formerly Olson Radio)
418 S. Forge St., Akron 8, Ohio

NAME _____

ADDRESS _____

CITY _____ ZONE _____ STATE _____

**COMPLETELY NEW
DIFFERENT!
EXCITING!**

**Men-Women
17-55**

**NO ADVANCED
EDUCATION NEEDED!**

To help you **EARN GOOD MONEY** later in industry, DeVry's modern training provides a thorough grounding in basics . . . then develops your skill. Thus, there is no need for advanced education or previous technical experience at the start. Whether you train in your spare time at home or in our well-equipped Chicago or Toronto Laboratories, DeVry helps you become a well-trained technician, ready for a real career in Electronics.

NEW! ALL NEW!

Shown below is the valuable new combination oscilloscope and voltmeter which DeVry Tech men build during the new "space" training program. But that's not all! New movies, new subjects, new texts, new experimental projects — all prepare you thoroughly in this latest and greatest DeVry Tech training program.

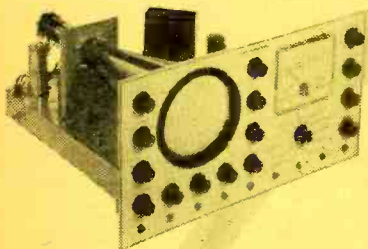

**EFFECTIVE
EMPLOYMENT SERVICE**

When your training is completed our Employment Service helps you get started in Electronics. Yes, you get the same effective nationwide employment aid that has helped so many men in the past toward good jobs or a business of their own.

DRAFT AGE?

If you are subject to military service, mark the coupon. We have valuable information for you.

MAIL TODAY!

**2 FREE
BOOKLETS**

**GIVE YOU FACTS ON
HOW YOU MAY GET STARTED!**

Prepare Now for a **REAL** Job in

**SPACE and
MISSILE**

Electronics
from RADIO to ROCKETRY

**NO PREVIOUS
ELECTRONICS
EXPERIENCE
NEEDED!**

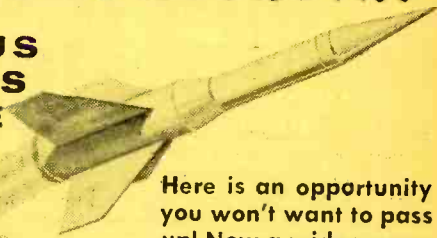

Here is an opportunity you won't want to pass up! Now a wider range

of Electronic opportunities lies ahead for the trained technician—from starting your own Radio-TV service shop to working with rockets and missiles . . . from industrial electronics to space electronics. And make no mistake about it, this is one of the largest and finest opportunity fields of our time. Here, trained technicians are in demand, to build, install, service and maintain all sorts of equipment used in Communications, Radar, Broadcasting, Automation, Industrial Electronics . . . and the exciting developments in Space and Missile Electronics. Now DeVry makes it possible for you to prepare for just such opportunities. Check the fields that interest you on the coupon below, and mail **TODAY**. You'll get honest-to-goodness **FACTS** about your chances of preparing for a better career in Electronics.

**FOR
MORE
FACTS!**

DeVry Technical Institute

4141 Belmont Ave., Chicago 41, Ill., Dept. EI-4-R



Please give me your two free booklets, "Pocket Guide to Real Earnings" and "Electronics in Space Travel!"; also include details on how to prepare for a career in Electronics. I am interested in the following opportunities (check one or more):

- Space & Missile Electronics Television and Radio Microwaves
 Radar Automation Electronics Communications
 Computers Broadcasting Industrial Electronics
 Special "Short Courses"

Name _____ Age _____

Please Print

Address _____ Apt. _____

City _____ Zone _____ State _____

Check here if you face military service. Canadian residents: Write DeVry Tech of Canada, Ltd., 970 Lawrence Avenue West, Toronto 19, Ontario.



**DeVRY
OFFERS**

Electronics Training

FROM BASICS TO OUTER SPACE ROCKETRY!

Not only the basic applications of electronics like Radio and TV, but also the satellites, space ships, guided missiles, all depend on Electronics Technicians who install, adjust, maintain and repair the equipment needed. What other job can be so exciting, profitable and promising? Yet many men, 17-55, can now train in the DeVry way at home for such jobs—without previous technical experience or advanced education.

DeVRY TECH PRESIDENT VISITS MISSILE FACILITIES!

Mr. T. J. Lafeber, DeVry's President, is shown here at missile test stand. During an inspection tour, he was deeply impressed with the role that is being played in national defense by electronic technicians.



THE COUNT DOWN! Here is a control panel for missile tests. Missile check-out and adjustment are largely the work of the Electronics Technician.

WHAT SOME DeVRY TECH GRADUATES ARE DOING!

Edward Hahn, Illinois, was a laborer. Now he is an Electronic Project Engineer with the Martin Company, a large producer of missiles.

Charles Morishita, Oregon, worked as a farmer before taking DeVry's training. Now he builds and tests equipment at Lockheed's Space and Missile Division.

Dale L. Gawthorpe, Illinois, left a clerk's job to take the DeVry program. He is now enjoying his work with automatic pilot equipment at Sperry Phoenix Company.

George D. Crouch, California, was a retail store clerk. He took the DeVry training program and today he is doing very well with his own business in the servicing field.

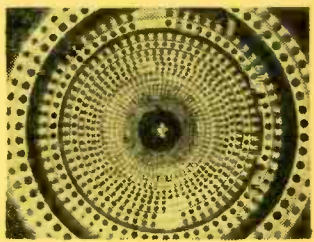

A RARE VIEW! This inside view of a ballistic missile is seldom seen by a civilian. It's a sight that greatly impressed Mr. Lafeber.

SEND FOR 2 FREE BOOKLETS!

Postage
Will be Paid
by
Addressee

No
Postage Stamp
Necessary
If Mailed in the
United States

BUSINESS REPLY MAIL
First Class Permit No. 4148, Chicago, Ill.

DeVry Tech
4141 Belmont Avenue
Chicago 41, Illinois

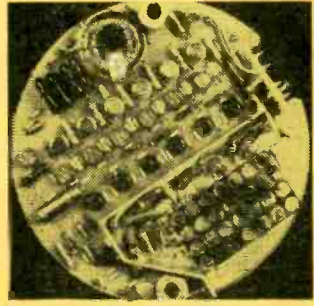

THE HEART OF THE MISSILE! Missile wiring soon becomes clear to a DeVry Tech man because he learns basic circuits by use of the "Electro-Lab," a training device that helps speed up learning.

**DON'T DELAY
MAIL TODAY!**

Marketplace

TV stand doubles as antenna . . . In a new line of mobile television receiver stands designed primarily for school use, the metal legs themselves

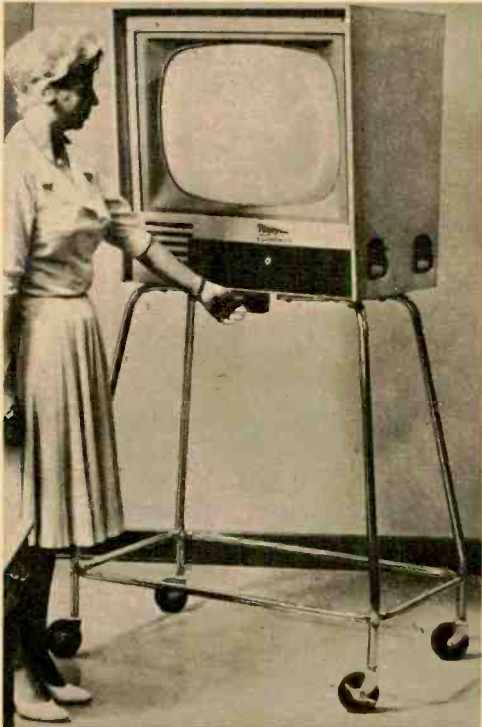

act as antenna elements. They can be switched into various combinations of connections for directional effects. Two heights, 40 and 48 inches, are available.

The top is made of insulating material and can accommodate all of the standard TV sets now on the market, including both small-screen jobs and the new super-size ones. The legs are castored to permit easy movement around a room. The standard is manufactured by Transvision Electronics, Inc., 460 North Avenue, New Rochelle, N. Y.

Back-date issues of **ELECTRONICS ILLUSTRATED** may be obtained from the Circulation Department, Fawcett Publications, Fawcett Place, Greenwich, Conn.

free

ALLIED

MONEY-SAVING 1961 ELECTRONICS CATALOG

444 PAGES

COMPLETE UP-TO-DATE

only \$2 down
on orders up to \$50;
only \$5 down up to \$200; \$10 down over \$200

SAVE MOST ON EVERYTHING IN ELECTRONICS

Send for this leading, value-packed catalog featuring everything in Electronics, including products available only from ALLIED. Whether you're a kit builder, experimenter, hi-fi fan, Amateur, serviceman or engineer, you'll save most on:

- **KNIGHT-KITS®**—Best in Build-Your-Own
- Everything in Stereo High-Fidelity
- **KNIGHT®** Super-Value Stereo Hi-Fi
- Tape Recorders & Phono Equipment
- TV Tubes, Antennas, Accessories
- Parts, Tubes, Transistors
- Everything in Tools & Technical Books
- Amateur Station Equipment
- Citizen's Band 2-Way Radio
- Public Address & Paging Systems
- Latest Test & Lab Instruments



SAVE on everything in Electronics at ALLIED—get fastest shipment, expert personal help, easiest-pay terms, satisfaction guaranteed or your money back. Send coupon for FREE 1961 ALLIED Catalog.

SEND FOR FREE CATALOG

YOU CAN DEPEND ON THE WORLD'S LARGEST ELECTRONIC SUPPLY HOUSE our 40th year

ALLIED RADIO

ALLIED RADIO, Dept. 86-D1
100 N. Western Ave., Chicago 80, Ill.

Rush FREE 1961 Allied Catalog No. 200

Name _____
PLEASE PRINT

Address _____

City _____ Zone _____ State _____



BEST BUYS IN STEREO AND MONO HI-FI

New Stereo/Mono 4-Track Tape Deck RP100 Semikit (electronics in kit form) \$289.95 Wired \$395.00



New FM-AM Stereo Tuner ST96 Kit \$89.95 Wired \$129.95 Incl. FET



New 70-Watt Integrated Stereo Amplifier ST70 Kit \$94.95 Wired \$144.95

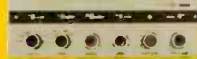

New 40-Watt Integrated Stereo Amplifier ST40 Kit \$79.95 Wired \$124.95

FM Tuner HFT90 Kit \$39.95 Wired \$65.95 Incl. FET Metal Cover \$3.95



Stereo Preamplifier HF85 Kit \$39.95 Wired \$64.95

28W Integrated Stereo Amplifier HF81 Kit \$69.95 Wired \$109.95



AM Tuner HFT94 Incl. FET Kit \$39.95 Wired \$65.95

Stereo Power Amplifiers



100W HF89: \$99.50 Kit \$139.50
70W HF87: \$74.95 Kit \$114.95
28W HF86: \$43.95 Kit \$74.95



Stereo/Mono Changer/Player 1007 with stereo cartridge and dual sapphire styli \$49.75



Bookshelf Speaker System HFS1 Kit \$39.95 Wired \$47.95

BEST BUYS IN CITIZENS TRANSCEIVERS, HAM GEAR, RADIOS

Citizens Band Transceivers from Kit \$59.95 Wired \$89.95



New 60W CW Transmitter =723 Kit \$49.95 Wired \$79.95



Transistor Portable Radio RA6 Kit \$29.95 Wired \$49.95 Incl. FET

BEST BUYS IN TEST EQUIPMENT

New Metered Variable AC Bench Supplies Model 1073 (3 amps) Kit \$35.95 Wired \$47.95 Model 1078 (7 1/2 amps) Kit \$42.95 Wired \$54.95



Peak-To-Peak VTVM =232 & Uni-Probe® Pat. =2,790,051 Kit \$29.95 Wired \$49.95 VTVM =221 Kit \$25.95 Wired \$39.95



DC-5 MC 5" Scope =460 Kit \$79.95 Wired \$129.50 5" Push-Pull Scope =425 Kit \$44.95 Wired \$79.95



Tube Tester =625 Kit \$34.95 Wired \$49.95



RF Signal Generator =324 Kit \$26.95 Wired \$39.95



1000 Ohms, Volt V-O-M =536 Kit \$12.90 Wired \$14.90



6- & 12V Battery Eliminator & Charger =1050 Kit \$29.95 Wired \$38.95 Extra-filtered for transistor eqpt. =1060 Kit \$38.95 Wired \$47.95



R-C Bridge & R-C-L Comparator =950B Kit \$19.95 Wired \$29.95



Multi-Signal Tracer =145A Kit \$19.95 Wired \$28.95



EICO

EXCELLENCE IN CREATIVE ELECTRONICS

Over 2 MILLION EICO instruments in use throughout the world. Compare, take them home — right "off the shelf" — from 1500 neighborhood dealers, most of whom offer budget terms.



EICO, 3300 N. Blvd., L.I.C. 1, N.Y. E-14
 Send free Catalog describing over 80 top-quality products, free Stereo Hi-Fi Guide, free Short Course for Novice License, name of nearest EICO dealer. Send new 36-page GUIDEBOOK TO HI-FI for which I enclose 25¢ for postage & handling.

Name _____
 Address _____
 City _____ Zone _____ State _____
 Add 5% in the West

there's a TEACHING MACHINE in your future!

By Ed Nanas, WA2HFF

Automation helps you learn almost anything faster and better.

IF YOU have a desire or need to learn about any new subject—and most of us do—your introduction to education's latest handmaiden, the teaching machine, probably is not far away. Whether you are a young homeowner with a wife and two kids and a mortgage, a high school student just getting interested in science or a grandfather who has decided that when he retires he's finally going to learn all about something that he never quite got around to studying before—no matter which person you are, a teaching machine can be a helpful ally of yours. Just how helpful depends on what you want to learn and what kind of a machine you choose.

There are many types of teaching machines. The term itself is a loose one which describes various types of automated instruction, programmed learning, automatic tutoring and scrambled-text material.

Industries, the military services, home-study institutions and public and private schools are starting to adapt automated [Please turn page]



Low-cost teaching device, Dyna-Slide Verti-mask sells for \$7.50; another version costs just \$1. They are used to mask scrambled books.

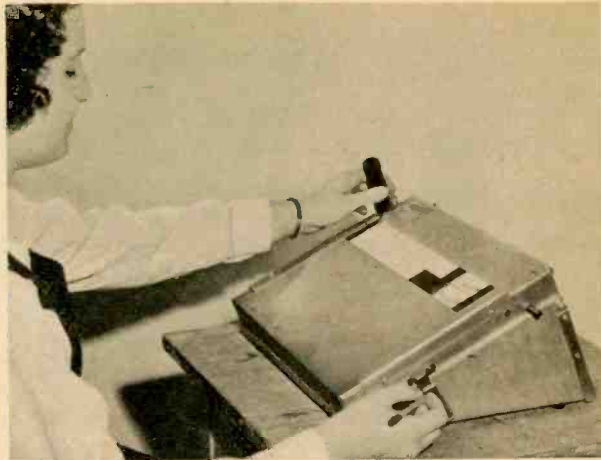

Mechanical apparatus by Foringer costs \$80, has material on paper roll. Student jots answer at right; correct one shows in window.

methods that employ mechanical, electromechanical and electronic devices. The reason is simple. With the aid of a teaching machine, almost anyone can learn certain types of subjects easier, faster and more enjoyably. And they remember it longer, too.

Not all teaching machines are true machines but all have certain common principles, whether they are immense computer-controlled installations using electronic random-access slide projectors, simple mechanical devices costing under \$20, small masking arrangements priced at \$1 or books containing scrambled texts.

The first thing they all have in common is that they are not manipulated by teachers, but by students. Another point in common is that they present subjects piecemeal, ask questions and don't let you go on until you have become thoroughly familiar with what they're trying to teach you.

Just about any subject which can be learned in an orderly progression—electronics, algebra, physics, contract bridge—can be split into tiny capsules that are easily digested one at a time by willing students. There are areas of learning that don't fit the teaching-machine picture, however. Those that are based on rote memorizing, such as spelling, and subjects involving aes-

thetic judgment or taste, such as art appreciation, are not readily adapted to machine methods.

After a subject is split into capsules, usually called frames, psychologists and educators arrange the bits in such a way that each one helps the student understand the next frame. This is programming.

Simple? Yes, but it takes hundreds of hours to arrange the most effective sequence of information and questions for even a low-level subject.

In a typical teaching-machine application, the student sits before a device (or book) containing a program designed to teach a series of skills, facts or ideas. The first frame comes up, presenting a bit of basic information in paragraph or picture form. After this information comes a question which may appear in a slot, on a tape recording, at the bottom of the page or on a screen, depending on the device used. The student selects his answer by pressing a button or writing in an indicated blank. Then the machine tells him whether he is correct by flashing a light, ringing a bell or just saying, "You're right," and continuing with another frame or another question.

The business of telling the student he is right and inviting him to go on is called a reward by psychologists, who say it tends to strengthen learning. The



Questions on Astra electro-mechanical Auto-score are answered by putting probe in holes and lights respond; it tallies errors and time.

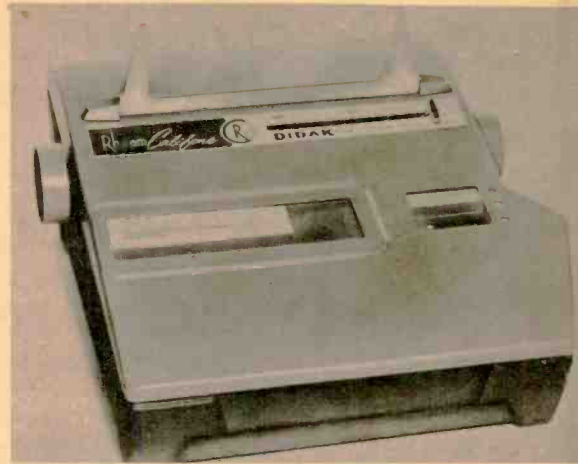

Student sees question on Rheem-Califone Didak (\$157.50), writes in small window, sees answer. Smudges on tape record responses.

student gets the satisfying feeling that he is beating the machine.

However, if the answer selected is incorrect, nothing happens because psychologists have found punishment does not encourage learning. The student usually just gets a bit more learning and then is asked basically the same question again.

In the case of a scrambled program devised by psychologist Norman Crowder of Western Design Division, U. S. Industries, an incorrect answer brings a mild reprimand, a paragraph or two of additional information and a suggestion that the student go back and pick out the right answer. Until the student does know which answer is right he cannot go on to more difficult material.

The teaching machine without doubt is the most potent new force in American education today and nowhere does its promise appear to be greater than in the home-study area. By all signs, the whole home-study concept is about to undergo a revolution. The use of teaching-machine methods would make it easier for students to learn many subjects and, because progress through a course of instruction truly depends on the learning of each step, it would be impossible to get to the end without picking up a good grasp of the subject studied. Teaching machines at their best



AutoTutor Mark II (\$900) was developed by Norman Crowder (left). Material is on film and appears automatically, inside view below.

do not demand merely correct answers; they also require understanding.

Whatever the cost of a teaching machine, it would have to be added to the price of a home-study course. This is seen as an immediate stumbling block. However, there are answers. If the quality of learning were better, or the course easier, most home-study students would be willing to pay more. Even if expensive machines were used, they could be owned by the school and leased for a fee to students in the same way that people rent typewriters, motor cars and sanding machines. Using the lower-price machines might be another answer, but at this time the method that seems to offer most is the scrambled text. All home-study courses require books of some sort. If the books were in the form of programmed texts, the student would have his teaching machine at no extra cost. And the programmed text is highly flexible. It can be mailed anywhere and used anywhere.

A teaching machine of some type can help make the home-study student's lonely night-time vigil almost exciting. Rather than studying alone, he can have the feeling that a tutor is looking over his shoulder, telling him immediately whether he is right or wrong, in some cases showing him where he went astray. And waiting for the mail to learn

how he did in the last lesson would be a thing of the past.

Dr. B. F. Skinner, professor of psychology at Harvard University and one of the acknowledged leaders in programmed learning techniques, is on record as saying that any subject which can be explained by words can be taught through programs.

"I am sure," Dr. Skinner says, "that material as programmed for self-instruction would be particularly suited for home study, and machines are simple and cheap enough to be economically feasible."

P. Kenneth Komoski, head of the Collegiate School's automated teaching project in New York, has found no significant difference in the rate of learning or amount learned, whether the program is presented via machines or in book form. The first consideration in automated education is choosing the best way to program the desired material, and then if a mechanical or electro-mechanical or electronic device can materially help the student, it should be used with the program.

Dr. Robert Allen, executive director of the National Home Study Council, says his office is encouraging research among its member schools in reorganized correspondence courses which take advantage of [Continued on page 101]

Experimental System Development machine uses a Bendix computer as control. Questions shown on screen are answered on typewriter.



Robodyne Digiflexes are used by post office to retrain displaced personnel. They require an instructor to operate and cost \$115,000 each.



Machine-Taught Electronics

Experiments show that electronics is subject well suited to new automated methods of instruction.

CAN teaching machines teach electronics? They not only *can*, but they *have* done exactly that. Programs have been developed and tested which reach well beyond the fundamentals of electronics and into the elusive art of troubleshooting.

As observed in the preceding article, all teaching machines are not machines. A programmed textbook also is a teaching machine and the latest one on the market is titled, *Introduction to Electronics*. In it, the basics of electronics are presented in the scrambled fashion developed by Norman Crowder of the Western Design Division, U. S. Industries. The 400-page book is published by Doubleday & Co.

As the title implies, the book is a fundamental one, beginning with the life and times of the electron, atomic theory and Ohm's Law and progressing step by step to diodes, triodes, grid-leak resistors, transformers and transistors. All along the way the

Airmen at Keesler AFB study electronics on AutoTutor Mark I machines costing \$5,000. Lessons appear on screen; students answer by pressing buttons.



Student on teaching machine reads information and question, selects answer, presses button. He is told immediately whether he was correct.

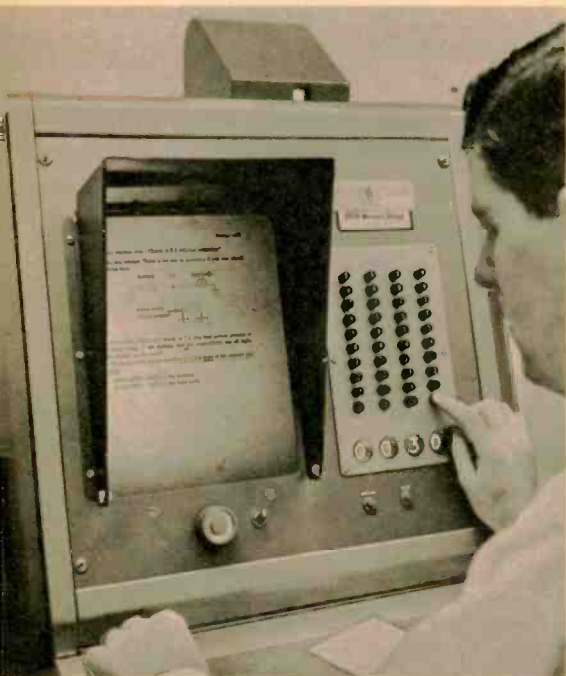

Base, Biloxi, Miss. The difference is that each airman sits before a \$5,000 machine called an AutoTutor Mark I. This device can handle as much as 10,000 frames (pages) of information, diagrams and quiz material on film.

With the textbook the student must turn the page to see whether he selected the correct answer but the airman merely punches a four-digit code corresponding to his answer and the answer frame automatically appears before him.

The program at Keesler is still experimental but results so far have been encouraging, according to Crowder. The first phase, just being completed at this writing, consists of bringing the airmen from scratch to radar circuitry in 19 weeks.

The second phase is to teach the operation and setup of specific pieces of equipment, such as communications receivers and transmitters. Following this, the airmen will be taught troubleshooting.

Until the 1950s, no attempt was made

beginner is quizzed and requizzed.

On page 131, for example, the student is told that he was correct when he said, "The wave length of a 10-kilocycle radio wave is 18.6 miles." This was the answer to a question on page 120. Now that he thinks he understands frequency and wave length, he is given a couple of additional paragraphs of information on the inverse relationship between frequency and wave length and is asked: "Now, which has the greater wave length, 10 kilocycles or 10 megacycles?"

If his answer is 10 mc he is told to turn to page 138, where he finds out he was wrong. He is given additional basic information, asked to remember that when you squeeze more cycles into a unit of time you shorten the wave length, and told to turn back to page 131. After re-reading page 131 and picking 10 kc as his answer, he will be led to bigger and better things on page 121.

The material presented in the Tutor-Text on electronics is almost identical to that given airmen at Keesler Air Force

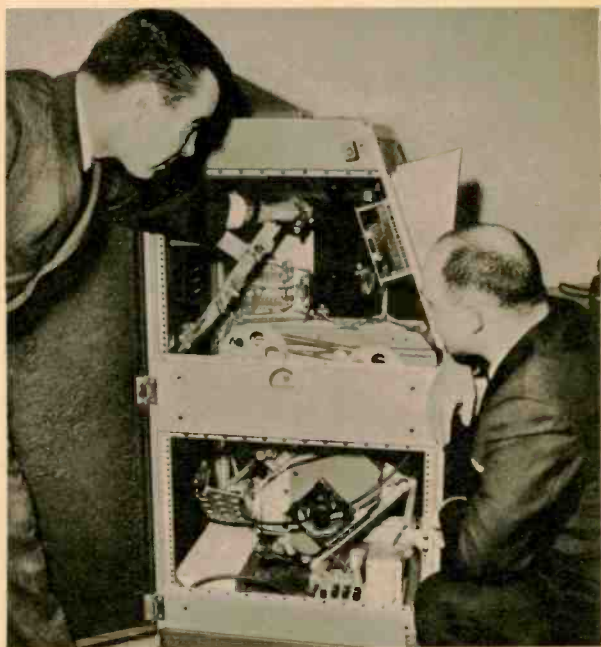

Inner workings, of AutoTutor Mark I programmed with basic electronics course. Reels in the center hold 10,000 information frames.

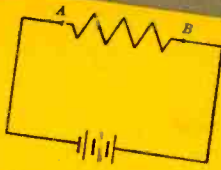

In the above circuit, current is:

The same at Point A and Point B. page 67

Different at Point A and Point B. page 70

67

(from page 74)

YOUR ANSWER: The current is the same all around the circuit.

Correct. Kirchhoff's Law for current says that the total current flowing from any point is equal to the current entering the point. In this series circuit, there is only one path current can take. The number of electrons departing from the negative pole of the battery every

70

(from page 74)

YOUR ANSWER: The current is different at Point A and Point B.

Well, your answer is wrong. But this question was tough and a little tricky.

Remember what current is. It's in amperes, so many electrons per second.

Now try this problem:
A 150-watt bulb in a 100-volt circuit draws a current of:

1500 watts. page 42

2/3 amps. page 45

1.5 amps. page 48

I'm not sure about how to use the formula in this case. page 51

42

(from page 38)

YOUR ANSWER: A 150-watt bulb in a 100-volt circuit draws a current of 1500 watts.

You selected the wrong answer. Sorry, but you evidently do not know how to use the formula, $P = EI$, to solve for I . Try playing with high voltages!

48

(from page 38)

YOUR ANSWER: 1.5 amps.

Correct. We can transpose the formula $P = E \times I$, into $I = P/E$. Then current = power/voltage = $150/100 = 1.5$ amps. (If this and you're not sure of how this transposition works, try it now.)

45

(from page 38)

YOUR ANSWER: A 150-watt bulb in a 100-volt circuit draws a current of 2/3 amp.

Good try. But not correct. You evidently don't know how to use the formula in this case.

51

(from page 38)

YOUR ANSWER: You're not sure about how to use the formula in this case.

Good! Now's the time to learn, because there's a manipulation involved which you'll need again and again in electronics. You know that $P = EI$. But in this case you are

Typical questions, with possible answers beneath, from scrambled textbook on basic electronics.

to use automated methods to teach skills requiring the student to use his hands—such as troubleshooting an inoperative piece of electronic gear. But now electronic equipment is becoming increasingly complex and technicians, the ham, even the professional electronics engineer is faced with circuitry that he could not have imagined ten years ago. No longer can the troubleshooter Easter-egg, looking randomly for trouble spots. He needs to know.

That is where a machine can step in and actually teach the art of troubleshooting. Assuming that you have a basic knowledge of electronics and know the operation of a piece of gear and the use of test equipment, the next step is to learn how to approach a trouble spot in the most efficient manner. Machines can teach this.

In a California test, groups of Navy electronics school students were given instruction on [Continued on page 108]

This book is a teaching machine, too, because it has a programmed text. It contains about same material as used in machine at the left.



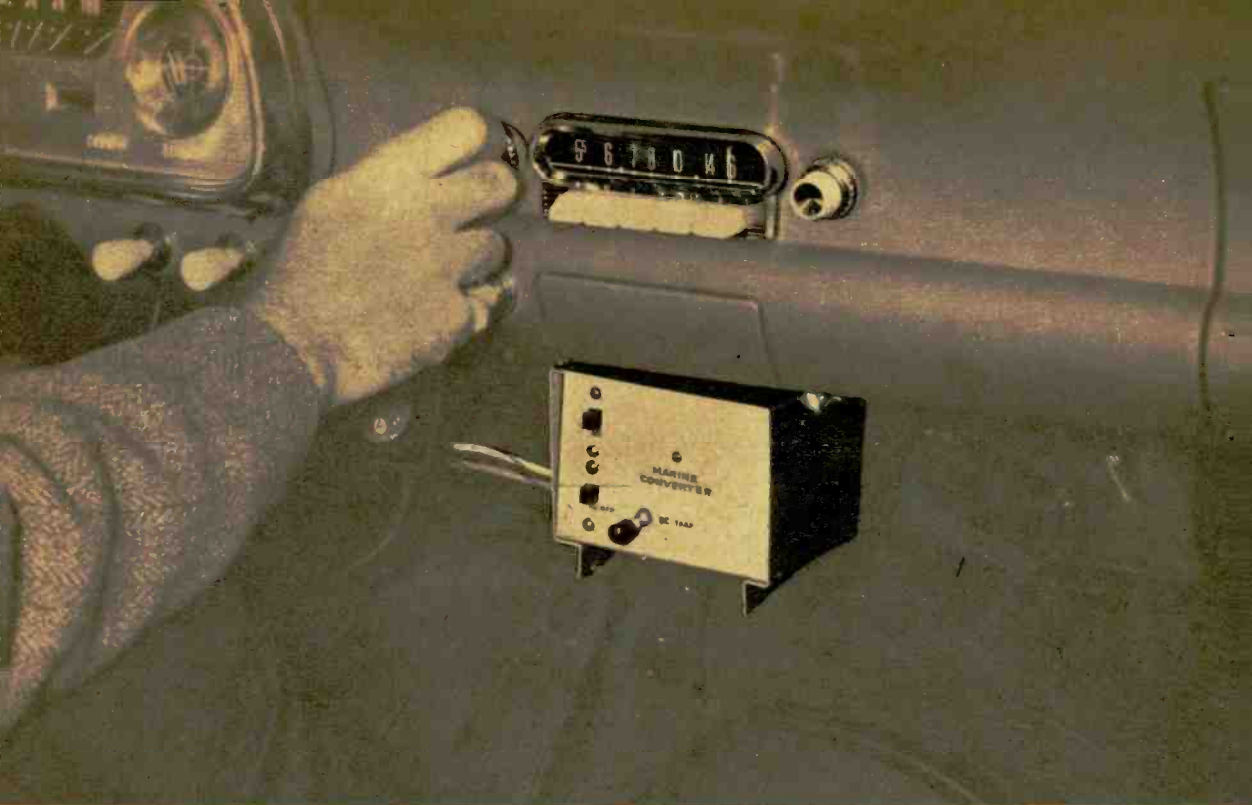

build a **Marine Band Converter**

Install this self-powered converter in your car and it will make up its ten-dollar cost in fresh fish.

By Len Buckwalter

ONE of the more valuable uses for a marine converter is tuning in on the professional anglers. They're the radio-equipped captains, of both commercial and private boats, who keep up a constant jabber; where the fish are biting, how many caught and where they're heading next. And you can sit in your car and take notes.

Installation is a snap. Simply plug the car antenna into the Converter and the Converter's output plug into the radio's antenna jack.

The marine band (between 2 and 3 mc) will appear on the broadcast dial so you use the car radio's tuning and volume controls. The converter has its own battery—which should last several hundred hours since negligible current

is consumed by the single transistor.

Construction

First fasten all the parts on the front and rear panels of the converter's case. A few drops of Duco cement on the battery will glue it in place. Position the battery so it will not disturb other parts and can be pried out when it's exhausted.

The phenolic board is next and there's no need to mount the resistors and capacitors on it before installation. Position it atop the battery and secure one end to the front panel with a small L-bracket. The bracket serves as one ground point, so place a solder lug under the screw which holds it to the perforated board. The other circuit ground is

the shell of antenna jack J1. Wire the components as shown, using "flea clips" where convenient, and for mounting the transistor. Grasp the transistor leads with long-nose pliers to dissipate the soldering heat.

Coil L2A requires an additional 5-turn winding L2B. If No. 20 enamel wire is not handy, hookup wire will do. Coils L3 and L4 require removal of an extra winding. Look for a wrapping of enamel wire which has a free end (the other end is soldered to one coil lug) and twist it off and discard. Use the pictorials to identify the coil-lug numbers since the coils are intended for other applications and the information sheets supplied with them may be misleading.

Tune-Up

Oscillator coil L2 must be set so the transistor oscillates at *exactly* 3500 kc. Tune a short-wave receiver to 3500 kc

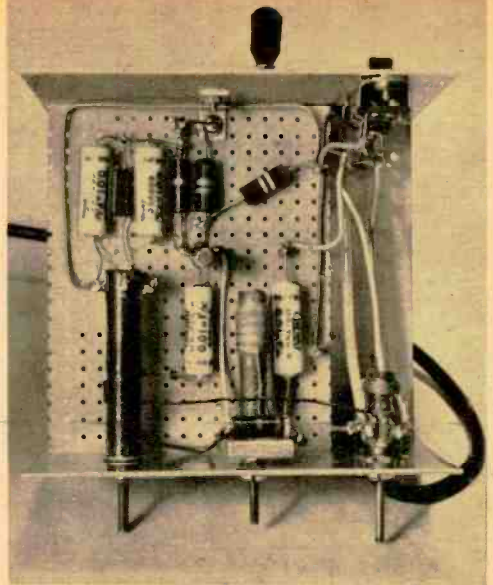

Top adjustment is BC trap. Bottom from left to right are oscillator, output, and antenna.

See perforated parts board in place so bolt through GND lug goes through bracket on rear panel.

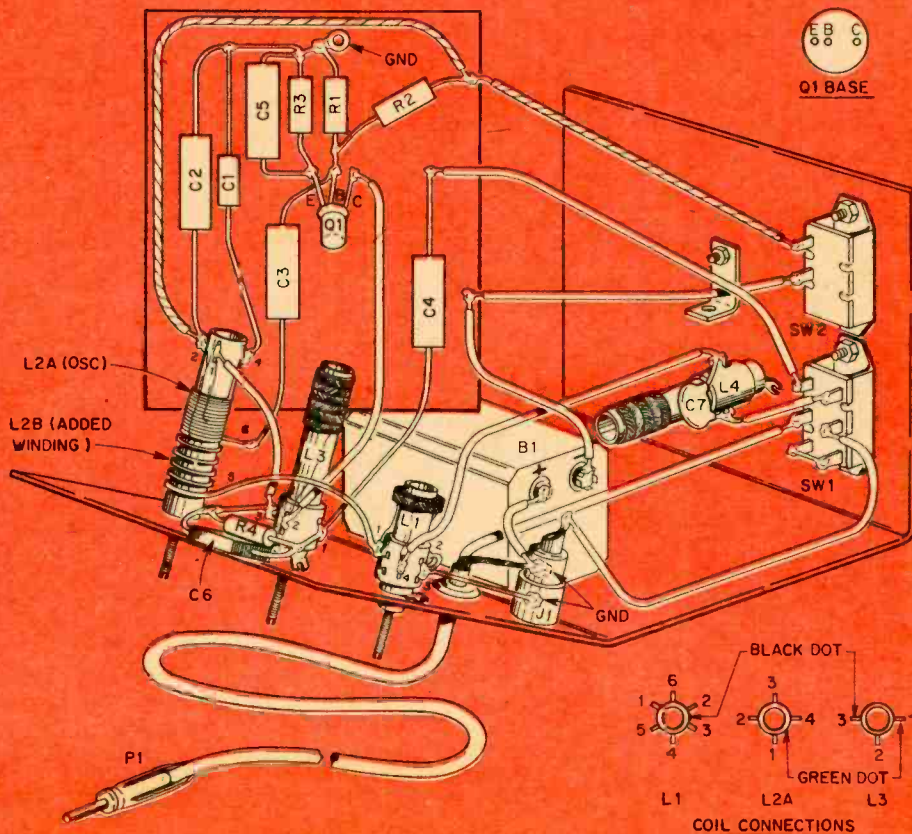

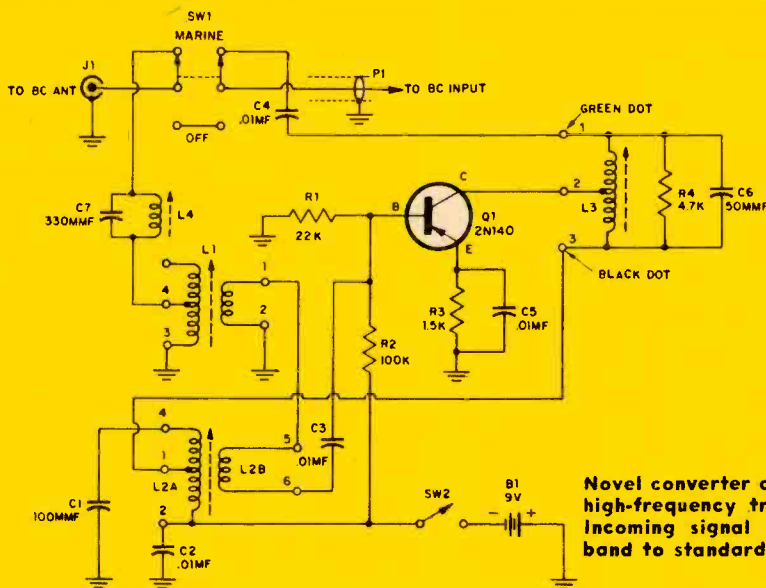

Novel converter circuit requires only one high-frequency transistor for operation. Incoming signal is shifted from marine band to standard broadcast frequencies.

and vary the slug of L2 until a strong signal is heard. The signal may be identified by tapping L2 and noting a disturbance in the speaker. If the receiver has a BFO, turn it on and tune the slug for a zero beat at 3500 kc. Coils L1 and L3 are broadly tuned. When the converter is connected to the auto radio, and receiving a marine station near the center of the band, peak L1 and L3 for maximum signal strength.

Installation and Operation

The converter may be fastened to the lower lip of the auto dashboard close to

Typical marine frequencies and their location on the broadcast band dial.

Marine (kc)		Broadcast (kc)
2182	Calling and Distress	1318
2638	Ship to Ship in all areas	862
2738	Ship to Ship in all areas except Great Lakes and Gulf of Mexico.	762
2830	Ship to ship in Gulf of Mexico area	670

To determine other marine frequencies, subtract the BC dial frequency from 3500. Note that the highest marine frequencies appear at the low end of the dial. The above marine frequencies are the most commonly used; others are assigned on a local basis.

PARTS LIST

- Resistors**—1/2 watt, 10%
 R1—22,000 ohms
 R2—100,000 ohms
 R3—1500 ohms
 R4—4700 ohms
Capacitors—all 25 volts or higher
 C1—100 mmf mica
 C2, C3, C4, C5—.01 mf tubular
 C6—50 mmf mica
 C7—330 mmf ceramic
 Q1—2N140 transistor
 SW1—DPDT slide switch
 SW2—SPST slide switch
 B1—9-volt battery (Eveready 246 or equiv.)
 P1—auto-type antenna plug
 J1—auto-type antenna jack
 L1—Antenna coil (Lafayette MS-165)
 L2A—Oscillator coil (Miller B 5495-C)
 L2B—5 turns #20 enamel wire wound on L2A
 L3—output coil (Lafayette MS-229)
 L4—Trap coil (Lafayette MS-11)
 Misc.—2 1/2' of coaxial cable (RG58U); aluminum case 3 1/4" x 4" x 4 1/2"; perforated phenolic board 3/4" wide, cut length to fit case

the radio. Two nuts and bolts through its top cover will hold it securely. After installation, remove the antenna lead going to the broadcast set and plug it into J1 at the rear of the converter. Plug the converter lead into the car radio's antenna jack.

When the two slide switches on the front panel are down, normal broadcast reception is heard. Flip them up and the converter is activated for marine band reception. The switching applies battery power to the converter and makes the necessary [Continued on page 108]

for ham bands

A Bandswitching Wavemeter

By Howard S. Pyle, W7OE

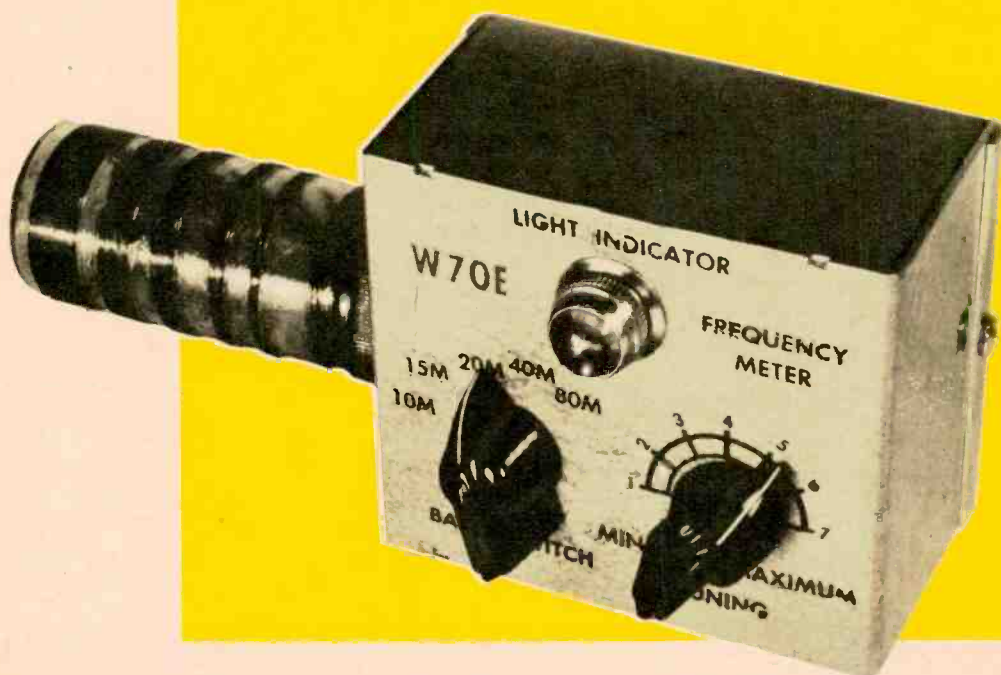

ONE of the most useful radio frequency measuring devices around the ham shack is the absorption frequency meter or "wavemeter" as it is often known. Simple to build and requiring no power supply, the device will supply a positive indication of the output frequency of any stage in the transmitter. While its accuracy is not as great as more elaborate frequency measuring equipment, it is sufficiently reliable for all practical work. When doubling or tripling in multi-band transmitters you can feel safe that you have not accidentally multiplied into an illegal area as an absorption-type meter will respond *only* the one frequency to which it is tuned. This project shows the novice what happens to the transmitter output under varied conditions.

Construction

The majority of absorption meters calls for a series of separate plug-in coils for coverage of the popular amateur bands. To eliminate the nuisance of changing coils and storing those not in use, all coils are wound (spaced $\frac{3}{8}$ " apart) on one form and band switching is provided.

The coil form is a plastic pill bottle available at the local drug store for five cents. The bottle cap was mounted on the cabinet with two $\frac{4}{40}$ machine screws, coils were wound on the bottle and the final assembly plugged together with a bit of glue inside the bottle cap to insure rigidity.

Rather than a continuous tapped coil, separate windings were used for each of

the five bands as it is simpler to prune and adjust the coil band-by-band. Use two or three more turns than shown, since it is easier to prune than add to your coil wire.

Once you've found the proper number of turns for the lowest frequency coil by the cut and try method (using your transmitter and a dummy antenna to excite the wavemeter) treat the other four coils the same way. Try to make the middle of each band fall in the approximate mid-scale position on wavemeter tuning capacitor C1.

It is possible to get by with three coils and a three position switch if you prefer. The 10, 15 and 20 meter bands can be covered by one coil by proper choice of turns and selection of the proper tap point in about the middle of the coil for 15 meters. You'll find 20 meters at the maximum setting of C1, and 10 meters somewhere near the minimum. The choice is yours.

Calibration

Wrap your receiver antenna lead around the wavemeter coil, and, as you

One end of each winding is brought out to a common junction. Note the unused lug on S1.

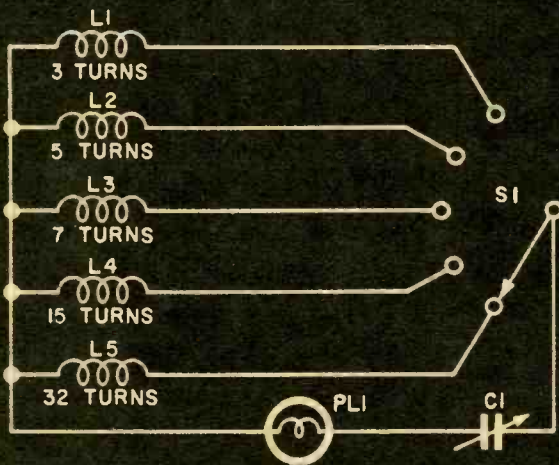
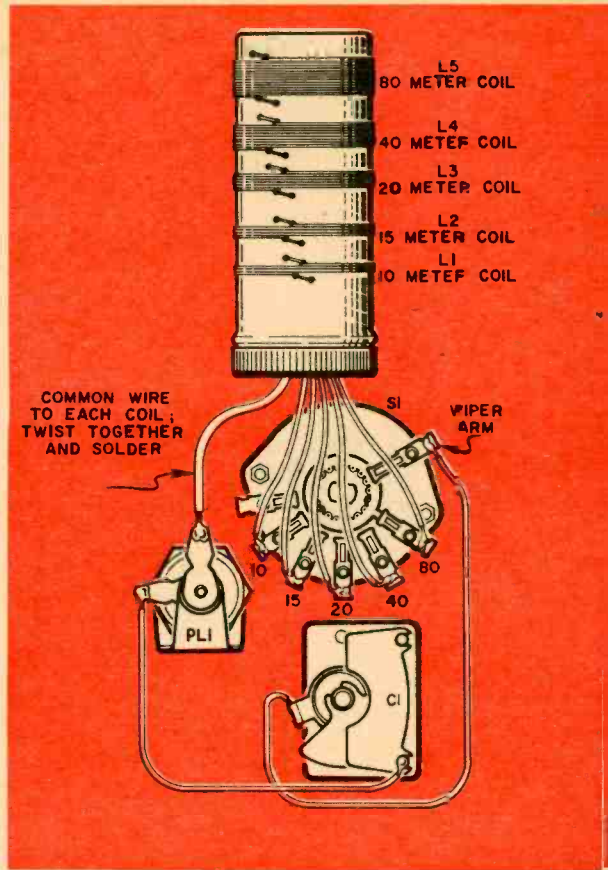

PARTS LIST

- C1—50 mmf variable capacitor (Hammarlund HFA-50-B or equivalent)
- PL1—No. 47 pilot lamp and socket assembly
- S1—Single-pole 5-position rotary switch (Centralab 1409 or equivalent)
- Cabinet—Aluminum Minibox 3 3/4" x 3" x 2"
- Misc.—Plastic pill container 1 1/4" dia. x 3" long, 4-40 screws and nuts, No. 24 solid enamel wire

tune across a band, retune the wavemeter until the background noise, or a signal, suddenly drops out. The wavemeter is then tuned to the frequency indicated on your receiver dial. This completes the calibration.

An absorption wavemeter does what its name implies: it absorbs power from a circuit tuned to its frequency and uses this power to light an indicator lamp. This wavemeter is not a very sensitive device, so it must be closely coupled to the circuit under test. Just hold the wavemeter's coil near the coil being checked. Where there is more than a whiff of power available, *link coupling* will do nicely. This requires a temporary coil of one, two, or three turns around the coil of the circuit being checked, connected by a short two-wire line (twisted pair, a length of coax cable, even a foot or so of lamp cord!) to a similar coil wrapped around (or near the end of) the wavemeter coil.

With the capacitor tuning units set at the approximate frequency, the transmitter circuit can be tuned for maxi-

mum bulb brightness. For an unknown frequency, the wavemeter is tuned until the bulb lights, and the frequency read from the wavemeter dial or your calibration chart.

It can be used as a harmonic "sniffer" for your transmitter (tune it through successively higher bands than the one you are operating on), or as a resonance-tuning indicator (maximum bulb brightness means most accurate tuning of the rig), etc. You'll think of other uses around the shack yourself. Don't leave it coupled to a circuit when you are through checking, since the power radiated by your transmitter will only light the bulb and won't be radiated by your antenna.

The panel is marked with ordinary electronic decals. If you want to plot a curve on graph paper for more accurate tuning, choose a dial or scale with fine markings.

The total cost of the wavemeter is about four dollars with new parts. You can do it for substantially less if your junk box is well stocked. 

It may be necessary to remove a few turns from each coil depending on wire size, insulation thickness, coil spacing, and lead routing. Make a test coil on a 1 1/4" dia. cardboard mailing tube.

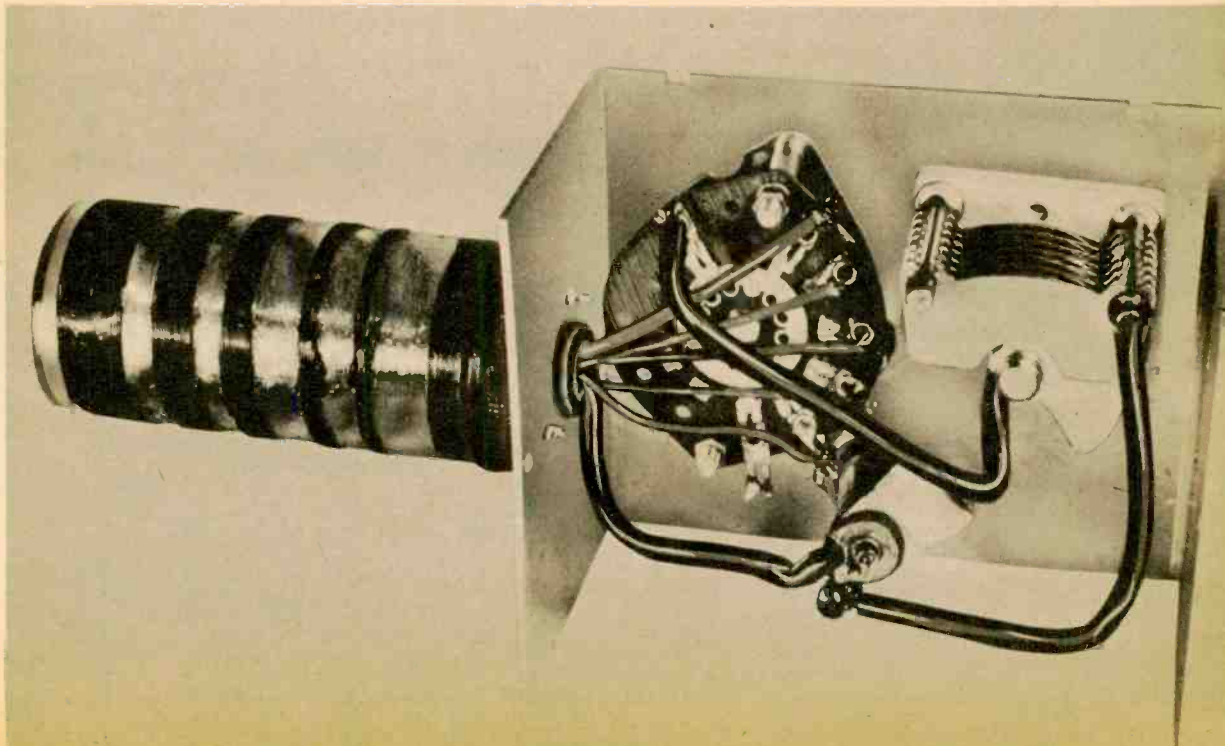

TV Keeps An Eye On



Flying-eye helicopter which is keeping track of leads in ice appears off bow of the USS Glacier, which it is guiding near Greenland.

In closeup of reconnaissance helicopter the TV camera can be seen protruding from door. Transmitting antenna sticks down from belly.

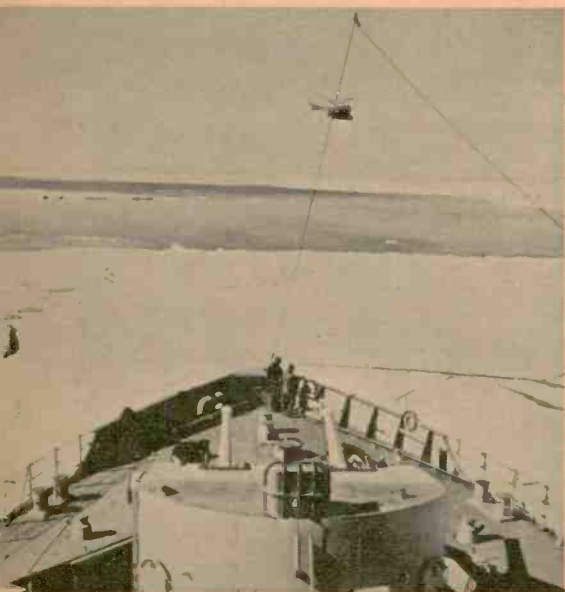



TELEVISION and helicopters, the two great forces of our time that have done so much to give man a lift outside the house and to put him flat on the couch inside, are working as a team in one remote area of our lives. This is in the far North, where the whisper of icebergs or pack ice strikes terror in the heart of the bravest ship captain. Ice activity there usually hits its stride in April and May and it is a hazard to anything afloat. Standing on his bridge, a captain can steer around icebergs and through big holes in ice fields. But when he is looking for narrow leads in pack ice, or simply for not-so-thick ice in the case of icebreakers, the captain could pick out his best route easiest if he were a couple of hundred feet high and a few hundred yards ahead of his ship. The Navy is now carrying out experiments to give the captain just that view. A television camera, mounted in a helicopter, flies out ahead and sends back live pictures of the ice. Its lens points through a door on the side of the chopper. The captain looks at a monitor screen and picks out his best route. Sometimes he sees the bow of his ship in the picture; at other times the helicopter is as much as 35 miles ahead of him. The photographs here were made when the USS Glacier, an icebreaker, tried out the flying-eye idea on a trip to Greenland. The TV transmitter and receiver are made by Philco. Operating frequencies range from 780 to 900 mc. Special 17-inch picture tubes are employed. They are capable of holding an image longer than the regular commercial tubes. The transmitter puts out 35 watts of RF power. Contrary to commercial practice, transmissions are via FM rather than AM. In the future the Navy plans to put such flying watchdogs in pilotless, remote-controlled helicopters, thus removing the chopper pilot from danger

Cameraman inside helicopter swivels camera to cover desired area and watches monitor screen. Signal goes to transmitter, left.

Screen in USS Glacier, an icebreaker, shows picture of ship itself in ice nearing Thule. Helicopter, out ahead, swung camera on ship.

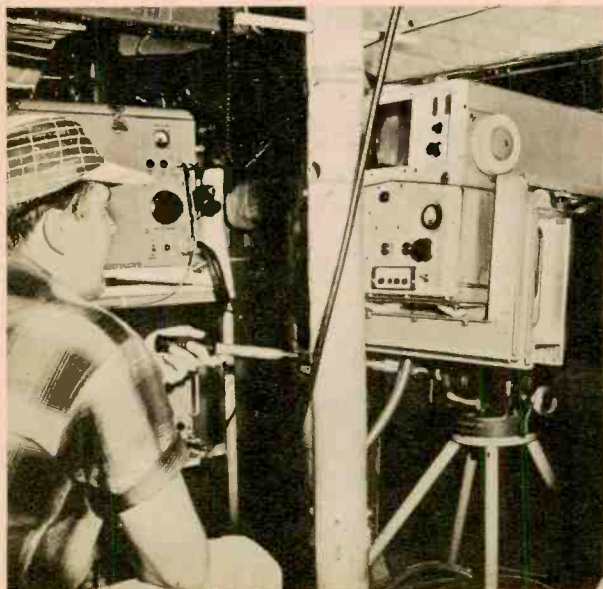

Ruggedize Your Rig

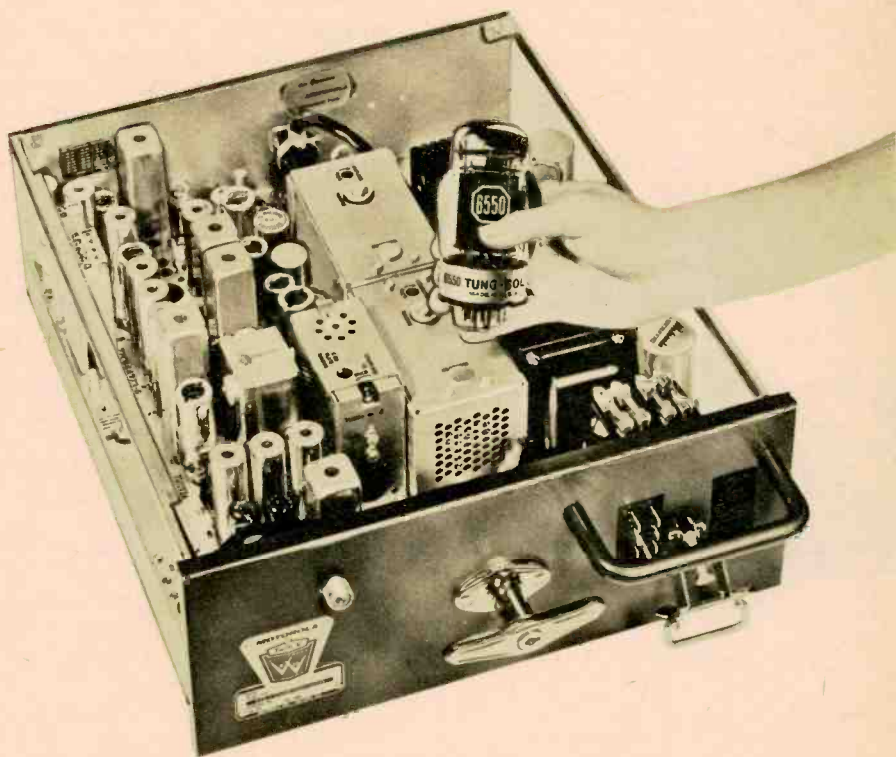

IF YOU are a ham or Citizens Band licensee or if you monitor those bands frequently you no doubt have heard some important, or even emergency, two-way conversation brought to a sudden halt when one transmitter or receiver conked out.

The odds are prohibitively high that the bug was a tube. Any two-way contact lasts only as long as the weakest tube in the four pieces of equipment involved (two receivers and two transmitters).

One way of minimizing tube failure is to substitute heavy duty or ruggedized tubes for those now in your set. Ruggedized tubes, developed for critical military applications, have a low rate of failure, high stability and resist shock and vibration. They are well suited to mobile operation and their long life increases the dependability of any piece of electronic gear. [Continued on page 113]

STANDARD TUBE RUGGEDIZED REPLACEMENTS

0A2	0A2WA, 6073, 6626
0B2	0B2WA, 6074, 6627
5U4G	5931
5Y3GTA	5Y3WGTA, 6106
6AL5	6AL5W, 5726, 6058, 6097, 6663
6AQ5	6AQ5W, 6005
6AU6	6485
6AV6	6066
6BA6	6485*, 68A6W, 5749, 6660, 6661
6BE6	6BE6W, 5750, 6660
6BJ6	6662
6BZ6	7732*
6C4	6C4W, 6100
6CB6	7732
6DE6	7732*
6DJ8	E88CC, 6922
6DK6	7732*
6SA7	6SA7WGT
6SG7	6AC7WA*, 6134*
6SK7	6AC7WA*, 6134*, 65K7W, 65K7WA, 6137
6SS7	6AC7WA*, 6134*
6U8A	7731
6X4	6X4W, 6063
12AT7	7728, 12AT7WA, 6060, 6201, 6679
12AU7	12AU7WA, 6067, 6189, 6680
12AX7	7729, 5751WA, 6057, 6681
12BY7A	7733

*Not usual replacement but will improve performance; if used as 1F amplifier realignment may be necessary because of increased output.

transistorized

RF Signal Generator

Two-transistor signal generator for bench or field troubleshooting and alignment.

By Ronald Benrey

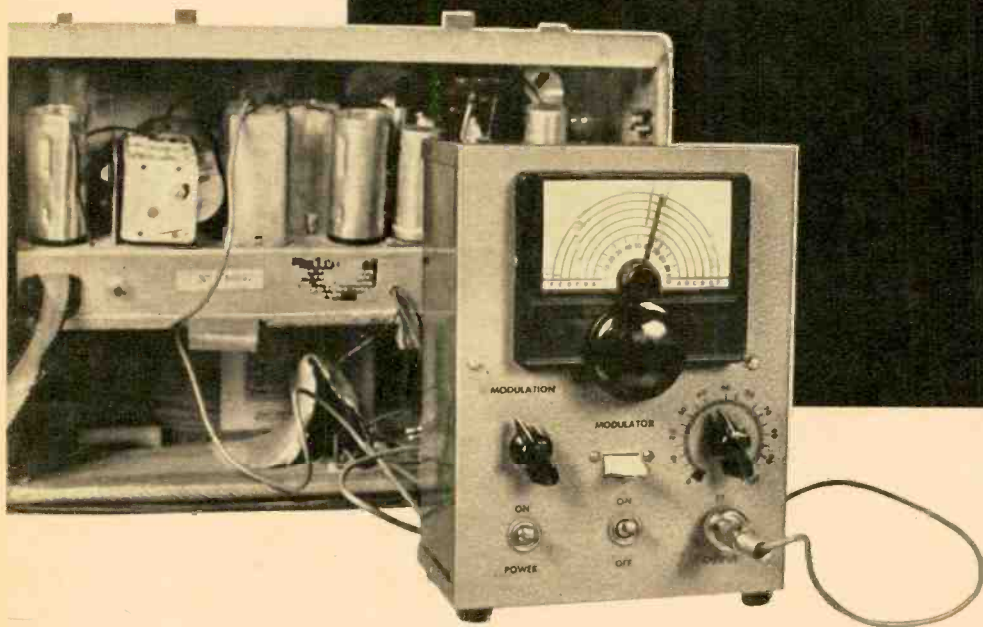

A MULTI-RANGE, RF-signal generator is a basic tool on every radio repairman's test bench for a good reason. The device is a *must* for correctly aligning superhet radio receivers and in addition it is a valuable troubleshooting tool.

Although the average home experimenter doesn't require an elaborate instrument, there are many occasions when a stable modulated or unmodulated RF signal in the broadcast band comes in handy. You can build this signal generator for about \$2.50 worth of transistors and a handful of other standard parts. This generator will supply modulated and unmodulated RF from about 450 kc-1600 kc, and produces

usable 1 mc marker signals, for dial calibration, up past 25 mc. And because it is battery powered, you won't get spurious radiation through the AC line.

When used with a broadcast receiver, the device can serve as a code practice oscillator since it closely duplicates the sound of a CW transmitter on the air. Because it is battery powered it is portable and useful for service calls in the home.

Construction

The author's model was not miniaturized, but a scaled-down chassis and miniature parts can be used if a pocket-sized generator is desired. Since the signal generator is an RF instrument,

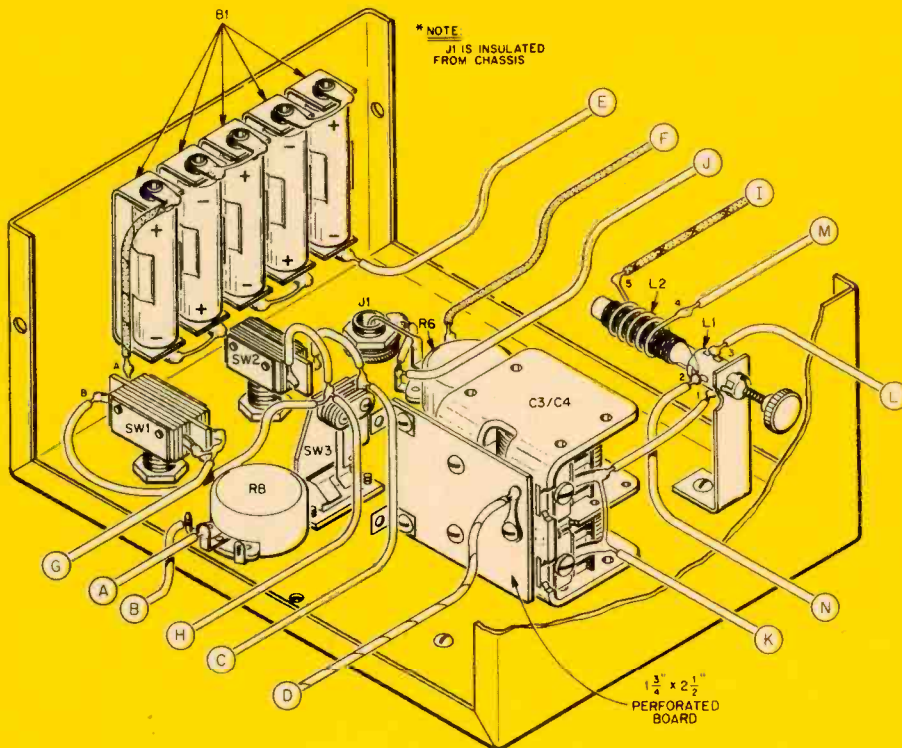

View of front panel wiring without subchassis which is shown on opposite page. Letters on lead ends indicate connections between subchassis and front panel. Center L2 between ends of L1.

keep all wiring as short as possible and follow the recommended parts layout.

Most components are mounted on a perforated fiber subchassis. Flea clips are used as wiring terminal points, and the transistors are mounted in sockets. A pair of needlenose pliers should be used as a heat sink when soldering the leads of T1 and CD1. Antenna coil L1 is mounted on a small bracket supplied with the coil, and is bolted to the panel using one of the vernier dial mounting screws. Position L1 out of the way of other components, especially the tuning capacitor. The five turn secondary (L2) is wound centered on L1 and it is held in place by a drop of cement.

Unscrew the ferrite core of L1 half-way from its "full in" position to allow proper frequency range for the instrument. After some use, the dial may have to be recalibrated. Readjustment of the ferrite core is all that is necessary.

PARTS LIST

Resistors— $\frac{1}{2}$ watt, 10% unless otherwise indicated

R1, R2—2,200 ohms	R3—300 ohms
R4—1,200 ohms	R5—12,000 ohms
R6, R8—2,500 carbon potentiometer	
R7—2,700 ohms	R9—1,500 ohms
R10—27,000 ohms	

Capacitors—All capacitors 50V miniature tubular or disc types unless otherwise specified. Higher voltage units may be used.

C1—.002 mf	C2, C5—.1 mf
C3, C4—dual 365 mmf tuning capacitor (Lafayette MS-142 or equivalent)	
C6—.001 mf	C7—.005 mf
C8—.25 mf	

L1—Tapped ferrite antenna coil (Lafayette MS-299 or equivalent)

L2—5 turns #18 enameled wire close wound over middle of L1 (see text)

RFC1—10 millihenry RF Choke

CD1—1N34A diode

Q1—2N94 transistor

Q2—2N35 transistor

T1—Subminiature audio transformer, Pri., 100,000 ohms, Sec., 1000 ohms. (Lafayette TR-97 or equivalent)

J1—Microphone jack (Amphenol 75-PC1M) and matching plug

SW1—DPST toggle switch

SW2—SPST toggle switch

SW3—Lever type SPST switch (Lafayette SW-69)

I—Midget panel dial (Millen 10039)

Misc.—Aluminum Minibox 8"x6"x3 $\frac{1}{2}$ ", perforated board, 2-transistor sockets, hardware, shielded cable (2')

The 1N34A mixing diode (CD1) receives bias from the common battery and the R3-R4 resistor dividing network. Trimmers of tuning capacitor C3-C4 should be used for corrections during calibration rechecks. Space is available for single 7.5-volt battery instead of the five series-connected penlight cells. Leads from components installed on front panel of the case are connected to flea clips on bottom of subchassis.

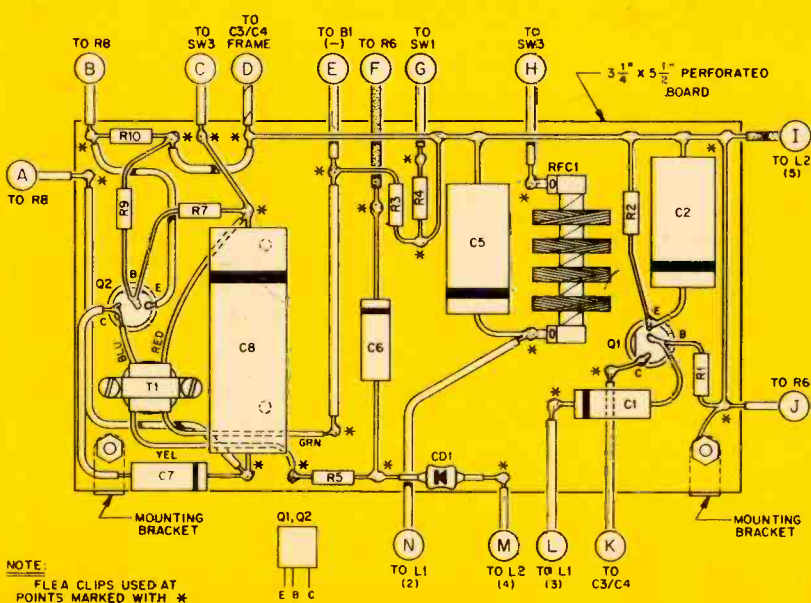
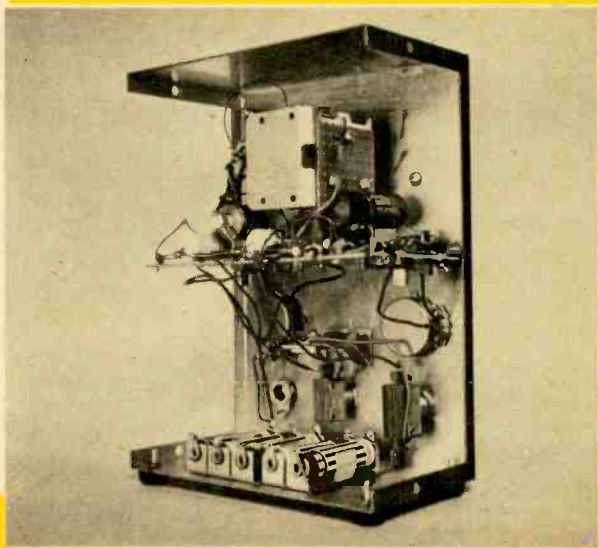
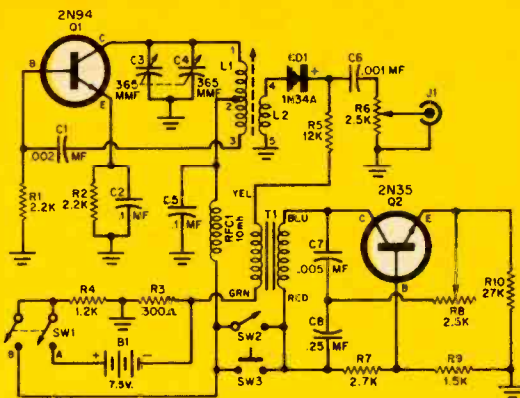

How to Align Superhet Receivers

Connect the "hot" (ungrounded) lead of the signal generator to the signal grid of the converter tube (12SA7, 12BE6, etc.) in tube radios, or the base of the mixer-oscillator transistor in transistor sets. Connect the ground lead of the generator to the receiver chassis and use a jumper lead to ground the oscillator section of the tuning capacitor.

Turn on MODULATOR switch SW2, set the generator to 455 kc and set the RF output control (R6) to as low a level as possible that will still permit a signal to be heard in the set's speaker. Turn off SW2, and use MODULATOR key SW3 to determine if the signal is actually coming from the generator. Turn on SW2 again and with an insulated alignment tool adjust the screws or slugs of the second (or output) IF transformer (farthest from oscillator-

mixer) for maximum volume level.

Adjust the first IF transformer (closest to the oscillator-mixer tube) for maximum output. Repeat this procedure at least twice.

This aligns the IFs. The oscillator and RF section are aligned with a small capacitor (500 mmf or lower) in series with the "hot" lead of the generator. Connect the capacitor to the antenna terminal or to the ungrounded terminal of the antenna coil or loop. Remove the ground from the oscillator section of the tuning capacitor and set both the receiver dial and generator to 1500 kc. Adjust the oscillator trimmer capacitor, located on the smaller section of tuning capacitor, for maximum output. Adjust the RF trimmer capacitor (on the larger section of the tuning capacitor) for maximum output. This completes alignment of the receiver.

The two sections of variable capacitor (C3,C4) are wired in parallel to provide a total capacitance of about 730 mmf. A 1 $\frac{3}{4}$ "x2 $\frac{1}{4}$ " section of perforated board supports the capacitor above the subchassis. C3, C4 should be mounted on the subchassis board after wiring is completed to allow sufficient space for soldering the other components into place.

The completed subchassis board is mounted on the rear of the front panel with small angle brackets. Carefully position the subchassis so that the shaft of C3, C4 fits into the vernier mechanism properly. Poor alignment will make tuning difficult, and may damage the vernier. A single 7.5 volt battery may be used instead of the penlight cells shown, but it is much larger, and more expensive. Long battery life can be expected.

Calibration

Before applying power recheck the socket connections of Q1, Q2, and be sure that connections to CD1 and L1 are correct.

The device can be calibrated easily with an accurately aligned broadcast re-

ceiver. Check your receiver dial markings against the frequencies of local radio stations before calibrating the signal generator.

The first calibration to be made is the IF frequency. Connect the generator leads to the receiver's antenna and ground terminals or across the loop antenna terminals. (You may have to hook a small capacitor (any value 70-50 mmf) between the "hot" lead of the generator and the antenna input on the receiver.) Connect a jumper lead from the oscillator section of the receiver's tuning capacitor to ground. Turn the receiver and generator on and turn on the MODULATOR switch (SW2). Set the RF control (R8) to a low level and turn the C3, C4 vernier so the pointer is about $\frac{1}{4}$ " above the extreme left position. Adjust the ferrite core of L1 until you hear a signal in the receiver. Assuming the receiver has a 455 kc IF frequency the point at which the signal is loudest is 455 kc. Mark this on the generator dial.

Disconnect the jumper from the receiver's oscillator section and switch off the modulation. Tune the receiver to a station of [Continued on page 113]

Electronic Brain

Have you any question on electronics? Send it in and the Electronic Brain will provide the answer.*

Wire Locations

In running the wires to my communications receiver, I found it convenient to have the AC power, the antenna lead-in, and the ground wires close to each other. Will I get hum pickup?

Paul S. Cherry
Philadelphia, Penna.

The power line cannot induce hum in your receiver since receiver input impedance at 60-cps is low.

However, it is not a good idea to have your antenna lead-in near the ground wire or the AC line since there may be enough capacitance between them to effectively ground the RF energy picked up by your antenna. This will reduce the signal strength at your receiver.

In addition, interference in the AC lines from motors, sparks, etc., are apt to be heard in your receiver.

TV Sync Adjustment

The picture on my TV set will not lock in unless I turn the horizontal hold control all the way to the left. Can I make an internal adjustment so the picture will lock in with the control set midway?

Donn Ryder
Hartford, Conn.

All television receivers have a horizontal sync adjustment on the chassis which may be called *Synchroguide*, *Phase Detector*, or *Synchrolock*. To make the adjustment set the horizontal hold control midway and adjust the horizontal sync control to get the picture to lock in. If the problem develops again there may be a defective component in the horizontal sweep circuit.

Blown Fuse Indicator

I have a number of fuses protecting the 117 volt AC lines to my transmitting

and receiving equipment. Is there some simple device I can use to tell me which fuse is blown?

Arthur Hammer
Callista, Mo.

The accompanying circuit will give a visual indication of a blown fuse. As

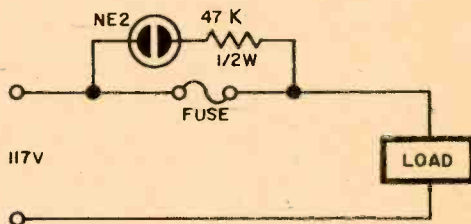

long as the fuse is okay, the neon lamp will be out. When the fuse blows, the full line voltage will appear across the fuse and the neon lamp will light.

Train Transformer Power

I have a model train transformer with a 12-volt secondary. If connected to a rectifier, could this be used to power a car radio?

Claire H. Smith
Sarasota, Florida

The older 12-volt auto radios required about 6 amperes at 12.6 volts. Radios made after 1956 may not require this much power and if the train transformer can deliver the required current, it may be used in a DC power supply.

A full-wave rectifier should be followed by a suitable filter network to minimize hum. A complete description of a home-built auto radio supply appeared in the bonus section of the February, 1960 issue of *EI*.

*Write to Electronic Brain, Electronics Illustrated, 67 West 44th Street, New York 36, New York. Enclose a stamped, self-addressed envelope for a prompt reply.

Black Light Communications

By Sanford Maizel

UP, UP, UP have gone communications frequencies over the past 40 years. In the Twenties frequencies now used for everyday international short wave were considered the upper limit. But not long afterward pioneer work by hams and private research brought us VHF, UHF and finally microwave communications. Still, the search goes on in a world feverishly looking for any new means of getting a message from here to there.

The successful propagation of microwaves ran the usable spectrum clear to the top of the radio wave range at about 1,000,000 mc. Electron tube oscillators coupled with harmonic generators produce these frequencies. At this point the light spectrum begins,

IT&T engineers below demonstrate experimental portable rigs which transmit full-range speech on ultraviolet light beam. Receiver with its parabolic antenna is in the background. Engineer at right holds microphone hooked to transmitter. Insert shows transmitter's UV lamp and its reflector.

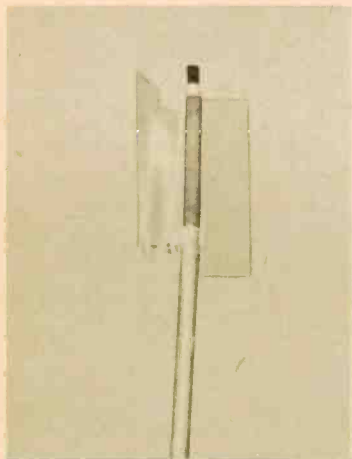



Experimental Westinghouse apparatus transmits video (picture) information on narrow beam of modulated ultraviolet light. Left foreground is camera, right background is transmitter. Photomultiplier, which feeds signal to TV set, is in right background. The broken white line represents invisible UV beam.

giving us infrared first, then visible light and finally ultraviolet before the X-ray spectrum appears. (The term *light* applies to infrared and ultraviolet, which cannot be detected by the human retina, as well as to visible or optical light.) Researchers, fresh out of radio waves, naturally started delving into the next-higher area as a communications medium. Next-higher was light. The idea was not really new since experiments with modulated beams in the middle of the visible spectrum had been carried out back in the 1930s. At any rate, research resumed and crept along until a big breakthrough came just recently. This was the invention of the optical maser, capable of amplifying and transmitting a beam of light (subtending less than a tenth of a degree) that is a million times brighter than the sun and can be modulated relatively easily. Bell Laboratories has been able to transmit a beam of coherent red (visible) light 25 miles, picking it up with a photomultiplier tube.

The maser development was the first of several little fireworks displays in the

light spectrum, most of them not actually related to the maser at all. A few weeks ago a two-way communications system using infrared was put on the market. A California firm now is designing a solar-energy wireless rig for outer space which would use wide-spectrum sunlight as a medium.

Things are now beginning to happen farther up the light scale, in the ultraviolet (black light) area. Several companies are known to be delving into UV research. Westinghouse is designing an outer-space apparatus that is to carry information up to 20,000,000 miles (the vacuum of space is an excellent propagation medium for UV waves). Bell Labs is experimenting with ultraviolet, it is known, and International Telephone and Telegraph recently showed off experimental UV transmitters and receivers in portable form. They are designed for point-to-point communications over narrow bandwidths. They promise static-free, wireless transmissions that are difficult to detect because to do so an ultraviolet-sensitive receiving device [Continued on page 110]

How to Repair Radios

Part III in our troubleshooting technique series.

By George Gordon



IN the first two parts of this series we reviewed basic superheterodyne theory and introduced some troubleshooting techniques. Here we continue our discussion of symptoms and how to pinpoint their cause.

No Reception (tubes light, speaker hums)

We know from the symptoms that the power supply is providing B-plus since speaker hum is audible. Since the power supply is eliminated as a source of trouble we must look for the difficulty elsewhere.

You can check out the entire audio section by fully advancing the volume control (R-4) and then touching its top terminal with the end of a screwdriver. Now touch the metal shaft of the screwdriver with your finger. (*Caution:* when you make the screwdriver test at other places in the circuit, keep your other hand clear since you will be touching

the plates of the audio stages which carry slightly over 100 volts DC.) If the audio stages are operating properly, you will hear a hum or buzz in the speaker. If there is no response then somewhere between the top terminal of the volume control and the power amplifier stage the audio signal has been lost. Use this same "signal input" technique to check out the rest of the audio circuit. Simply touch the screwdriver to each significant point in the circuit after the volume control—the grid of the audio amplifier section (V-3 pin 1) the plate of V-3 (pin 7), and the grid of V-4 (pins 2 and 5). As you work your way toward the speaker, you will eventually touch a point that will cause buzzing. This means that a component somewhere *before* this point is defective. Note that since there are more amplification stages between the test signal and the speaker as you go toward the set's antenna the signal will get louder as you

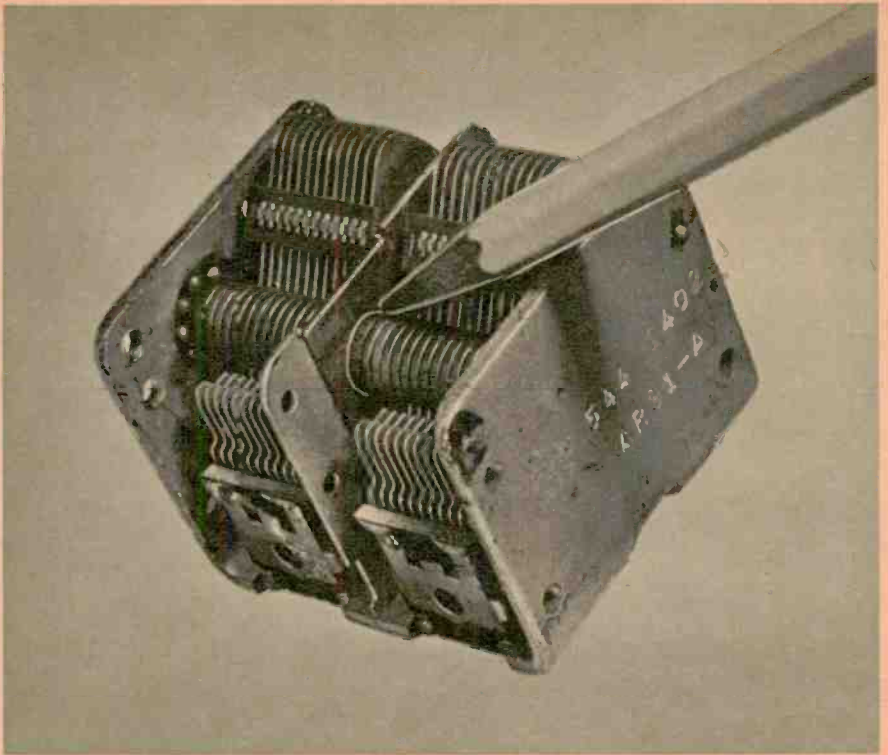

A common source of noise when tuning is poor contact between the capacitor's rotor shaft and the brass wiper. Scrape away dirt and douse with contact cleaner.

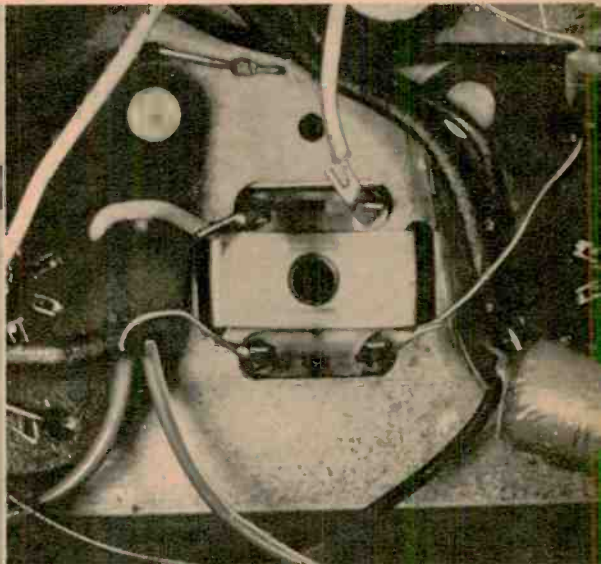
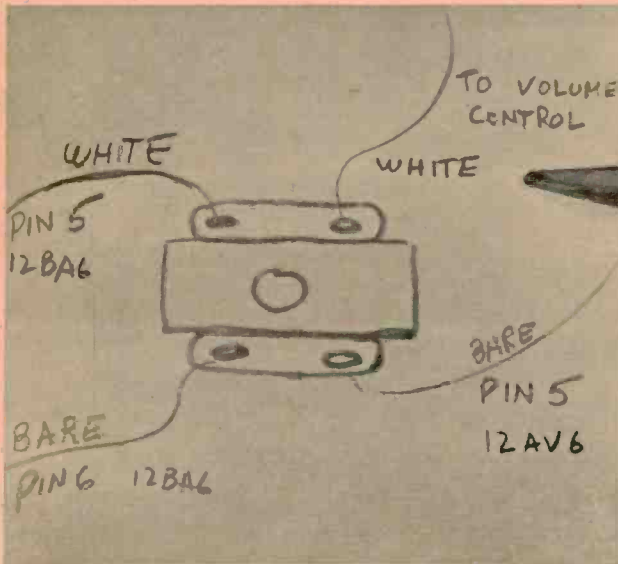

To avoid errors when replacing an IF, make a sketch showing the connections. To remove the IF's mounting clip, push the clip toward the chassis and pull it from the slot in the side of the can.

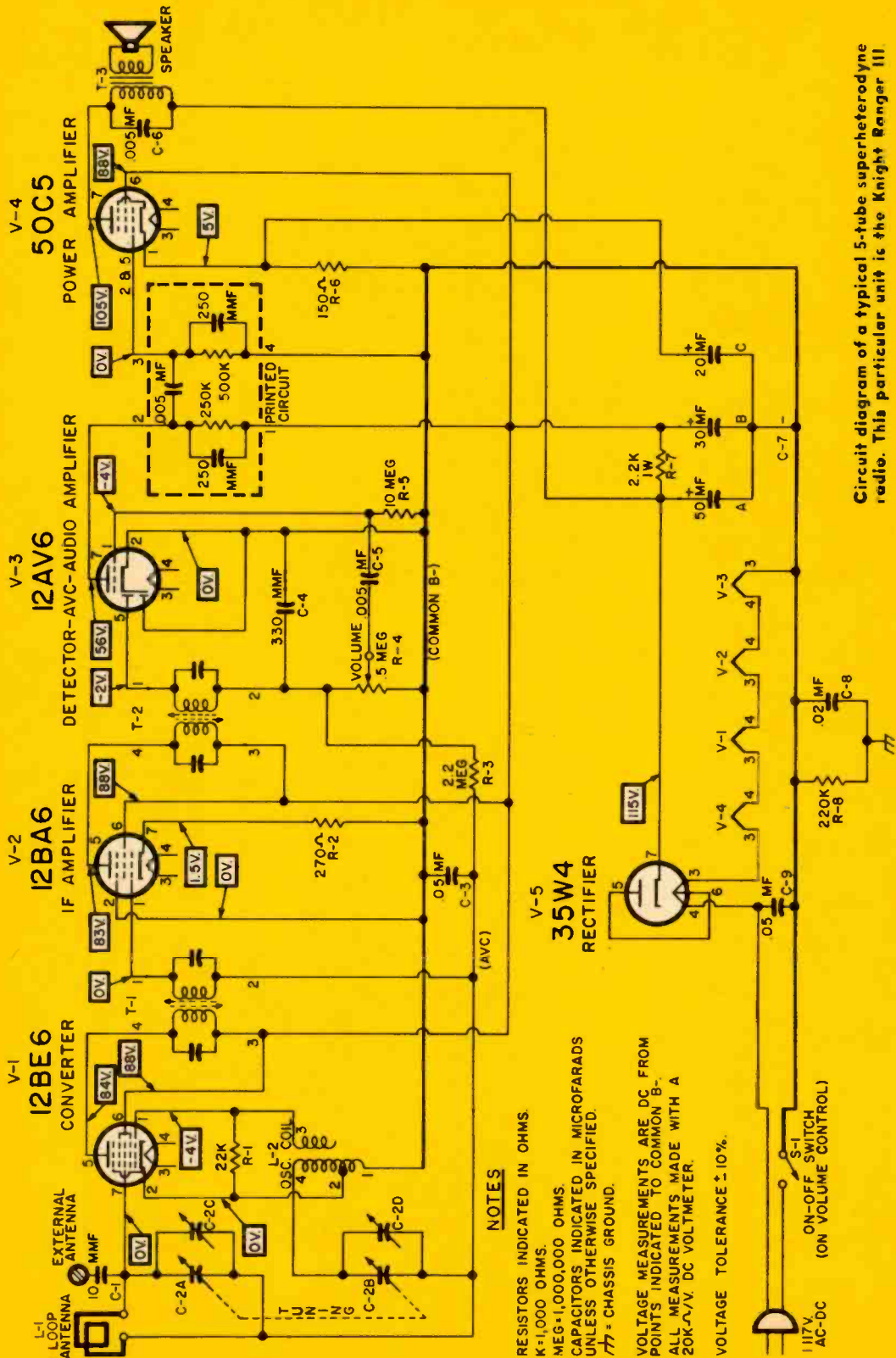

Circuit diagram of a typical 5-tube superheterodyne radio. This particular unit is the Knight Ranger III

go away from the output stage. When you have reached the point in the circuit where the defect exists use the same type of voltage and resistance checks described in the second article of this series to isolate the faulty component.

If the audio section is found to be functioning properly but there is still no reception, we must assume that the trouble lies somewhere between the detector diodes of V-3 and the loop antenna. Let's work backwards again from V-3. Here are several hints and clues to look for.

If there's a short between the windings of T-2, B-plus voltage will appear at pin 5. If AVC resistor R-3 is open, there is no grid return for converter V-1 and IF amplifier V-2 and hence no reception. Measure the plate and cathode voltage of V-2. If correct, then the trouble may be in IF transformer T-1. What else could cause this kind of signal loss? If C-4 was shorted, the audio signal would be grounded. However C-4 is directly across the volume control R-4 and if this capacitor (or the secondary of T-2) was shorted, we would not have heard a buzz by touching the top of R-4. If the meter reading from V-3 pin is infinity (instead of 500,000 ohms), then the detector circuit is open. This would indicate either an open secondary winding or an open volume control (R-4).

To repair an open or shorted IF remove the can from the chassis and the transformer from the can. This is a delicate operation and should be done with

great care so as not to damage any of the surrounding components or the transformer windings.

Mark each lead or make a sketch of the connections before removing the IF can. When the transformer is out of the can, use the ohmmeter to check for shorted capacitors or an open winding. Also examine the transformer for obvious defects such as nicks or exposed wire. Unless the trouble can be spotted and corrected, it's best to replace the IF. IF cans have been standardized and you should have no difficulty finding a replacement at a parts distributor.

When an IF can is replaced, the chances are the set will operate properly as the transformer is pre-tuned at the factory. If you feel that the sound is not quite up to snuff, tune the set to a weak station and give the iron-core slugs (or trimmer capacitors in older sets) a quarter turn in each direction with a fibre or plastic screwdriver and note if the sound improves. If it does, continue to adjust for maximum volume.

If the IF can is not at fault proceed to IF amplifier tube V-2. We have already checked the plate, screen, and cathode voltages on V-2 so let's examine the grid (pin 1) voltage. Notice that the grid is connected to the secondary of IF transformer T-1. The normal voltage reading at this grid is 0 volts, so if you measure any voltage at all there's something wrong. Check for an open winding (T-2 secondary) or suspect a short in any [Continued on page 99]

Older replacement IF at left usually has connections indicated. Copy these as code is standard. New midget IF has an identification mark near one lug. Plastic base requires care in soldering.

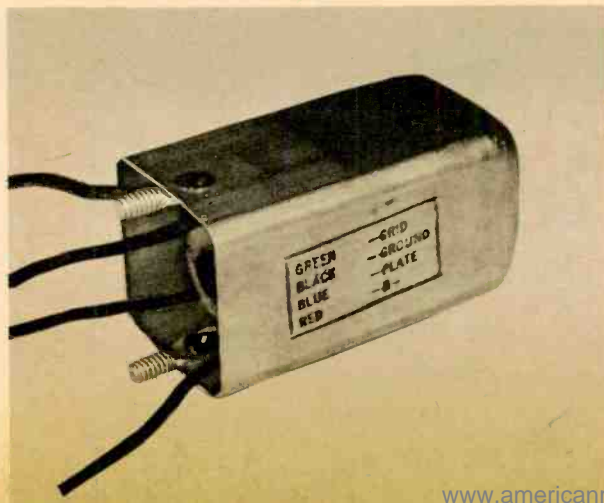



MOBIDIC's public showing in Central Park, New York, was during a heavy snowstorm.

Army Brain Takes To The Field

THE Army took great pride recently in showing off its new computer, housed in a 30-ft. van which can travel by ground or air. The scene was Central Park at mid-winter and the brain, MOBIDIC (Mobile Digital Computer), got an acid test right off because the

snow was knee-deep at the time. Well, sir, old Moby did the Army proud and just ignored the precipitation. The brain, built by Sylvania, is for all kinds of field computations, from artillery ranges to the beans needed for a regiment for three days. —

Field communications lines hook into side of big van carrying Army's mobile computer.

Information is fed to computer by operator sitting at control panel; note tape reels.



El builds a Miniature Tube Tester

TODAY the big trend is toward compactness. Cars, apartments, transistor radios, TVs, and now test equipment have been scaled down to midget proportions. One of the first low-cost tube testers to reach the market that is truly miniature is the EMC model 211. The Bakelite case of this compact emission tester measures 6 $\frac{3}{4}$ " x 5 $\frac{1}{4}$ " x 2 $\frac{1}{4}$ "; just about the same size as an average VOM. Despite its dimensions it includes sockets for 7 and 9 pin miniatures, octal, and loctal tubes.

After completion, we almost had difficulty finding the tester on our cluttered bench after returning from a hunt for some tubes to check it with.

A separate operating manual lists the

settings for over 950 tubes including ballasts, voltage regulators, "eye" indicators, and some of the latest types including the KT66, GZ34 (5AR4), EF89, 7189, 12SD7, 12DZ6, etc. The tester checks for interelectrode shorts, leakage between any two elements, opens, intermittents, and cathode emission. The cathode emission test circuit for a 6AQ5 is shown.

Construction

Construction was easy and ran to about four hours. Seven large, clear pictorials were easy to follow. However, since the step-by-step instructions do not refer to switch lug numbers or state when a connection is to be soldered you

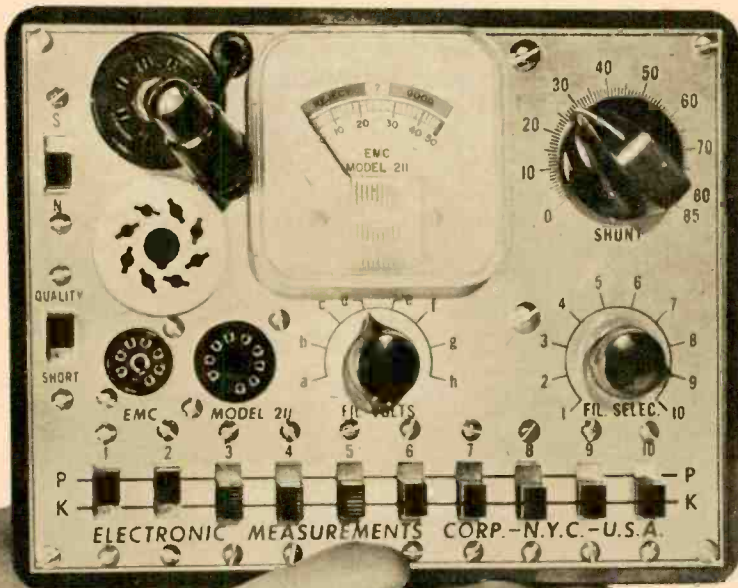

You can slip this tester in your service kit without displacing other tools or equipment.

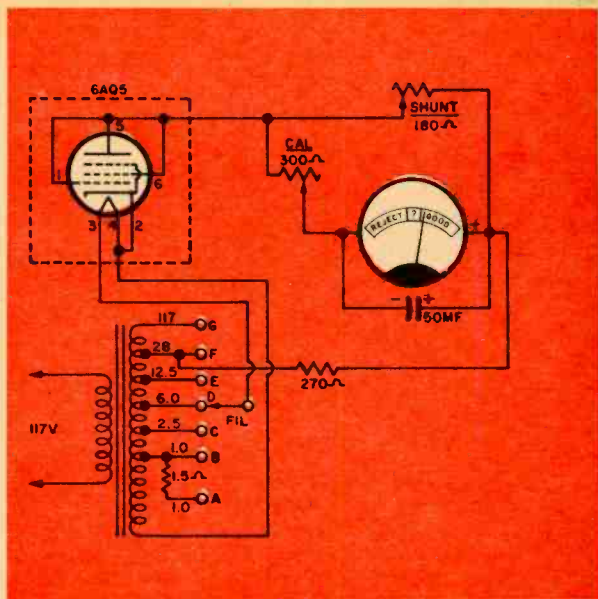

Screwdriver indicates calibration pot. Extreme care was necessary in soldering sockets. Schematic shows circuit for emission test made at low voltage with grids and plate tied together.

must refer ahead to all the pictorials to see if any further connections will be made to a particular point.

An iron with a small soldering tip is a *must* for this kit as the area between the 7-pin, 9-pin, and octal sockets is extremely congested. Be careful when mounting the transformer. You may have to add two flat washers between the stand-off sleeve spacers and the transformer mounting tabs to keep the sleeves from slipping through the tab holes. There is just enough room for the transformer and not a bit to spare so you'll probably have to loosen and reposition the meter slightly while mounting the transformer. The author placed a small piece of insulating tape between the transformer mounting tab and the Filament Selector switch contacts to prevent an accidental short.

Calibration is simple. You insert a good tube and adjust a calibration pot behind the panel for a reading of 36 on the meter. We checked a number of tubes and found the set-up operation simple and the results reliable.

Curious as to how the small filament transformer in the kit could provide heavy filament current demanded by

some tubes, we set up the 5U4 test and measured the filament supply. We found that the actual filament voltage applied was 1.8 volts, however, the tube checked out properly. In some cases a lower than normal filament voltage may even prove an advantage for it will quickly indicate those tubes which check okay with normal filament voltage, but whose cathode emission days are about over.

There are three panel controls and twelve slide switches. One control selects the filament voltage and the other selects the tube pins to which it will be applied. The third control, a potentiometer, sets the maximum tube and meter current. Ten slide switches permit flexibility in selecting the tube elements for each test circuit configuration. One other slide switch is used for the short test and the twelfth slide switch is normally left in the N position.

For \$14.90 (kit price; factory-wired is about \$20) you sure do get a "handful" of tube tester. The functional equal of many others two or three times its size, the EMC 211 is one of the first to really break the space barrier.

—Robert D. Freed, Associate Editor

The Ham Shack



By Robert Hertzberg, W2DJJ

NO AGE LIMIT . . . Would-be hams who drop into radio stores just to look at the displays always ask, "How old do I have to be to apply for a license?" Invariably, they are surprised to learn from the salesmen (who probably are hams themselves) that there is no age limit. Teen-agers by the thousands obtain tickets without difficulty, and so do men and women in their sixties, seventies and even eighties.

Coached by parents who are hams, many boys and a few girls under 10 have passed the novice exam. Remember that when you're boning up on the code!

One important legal requirement that is often overlooked, however, is that applicants for amateur licenses must be citizens of the United States.

Another detail to keep in mind is the temporary nature of the novice license. It's good for one year and cannot be renewed. However, the technician and general tickets run for five years and

can be renewed indefinitely. You can be a veteran ham but not a novice.

Phony Phonetics . . . When listening on the phone bands I sometimes feel that I am hearing a tape recording being run at the wrong speed. In their efforts to clarify call letters, names and addresses, some hams are going overboard on home-brew phonetics. Instead of helping, this just adds to the confusion. I find particularly objectionable the habit of applying place names to individual letters. In the midst of a lot of noise and interference sometimes I hear a voice saying, ". . . this is . . . Henry . . . Zanzibar . . ." I perk up, hoping that the station is in Zanzibar. It isn't. Turns out to be a lad with H and Z in his call.

I can't understand why the FCC doesn't promulgate an official phonetic alphabet and require everybody to use it. The commission has long specified the only allow- [Continued on page 100]



ROBERT HERTZBERG, who with this issue begins a monthly amateur radio column, was licensed in 1919 and has been writing and talking about ham radio ever since, in the process helping make the avocation popular and himself famous as an amateur. In his life on the air, he is known to thousands as W2DJJ. At left he is shown in his shack with his current equipment (on table: National NC-183D receiver, Mallicrofters SX-101A receiver, Mallicrofters HT-32 transmitter; on shelf: Heath Mohican receiver, loudspeakers, Precision E-200C frequency standard). He is now a full-time writer, author of 16 books and a prolific contributor to *EI* and other magazines. He invites hams and would-be hams to write to him at *EI* on matters of general interest to the amateur radio fraternity.

All About Electroplating

Part 2

By James E. Pugh, Jr.

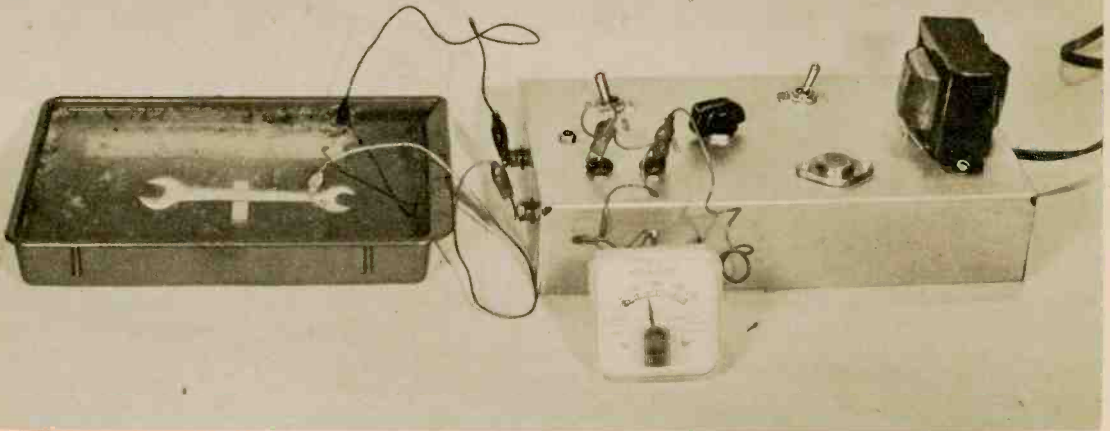

The wrench is being tin plated in a plastic tray. For a better finish keep the current low and allow some extra time. Watch out for electrode shorts.

PART one of this article discussed the construction of the electroplater and the electrochemical process. This second and last part covers the use of the electroplater.

How To Use It

Electroplating is more an art than a science. As a beginner you should work with the simpler processes first then after becoming familiar with handling safe solutions, try the more effective, but more dangerous solutions. In any case *use extreme care when handling all solutions containing strong acids and alkalines. Keep all solutions and chemicals where children cannot get to them.*

A copper plating bath of about 7 ounces of copper sulfate dissolved in a quart of warm water is ideal as a start. The anode should be soft copper in the form of a bar, rod, or length of bare wire wound in a coil and should have at least as much surface area as the object to be plated. Use an open glass or plastic container to hold [Continued on page 107]

The Galvanic Series

Base end (corrosive)

Magnesium

Zinc

Aluminum

Cadmium

Steel

Iron

Lead-tin solder

Lead

Tin

Brass

Copper

Bronze

Nickel

Stainless Steel

Noble end (least corrosive)

Metals close to the base end corrode easily in many solutions and are difficult to plate. Metals close to the noble end will not corrode easily and are easy to plate.

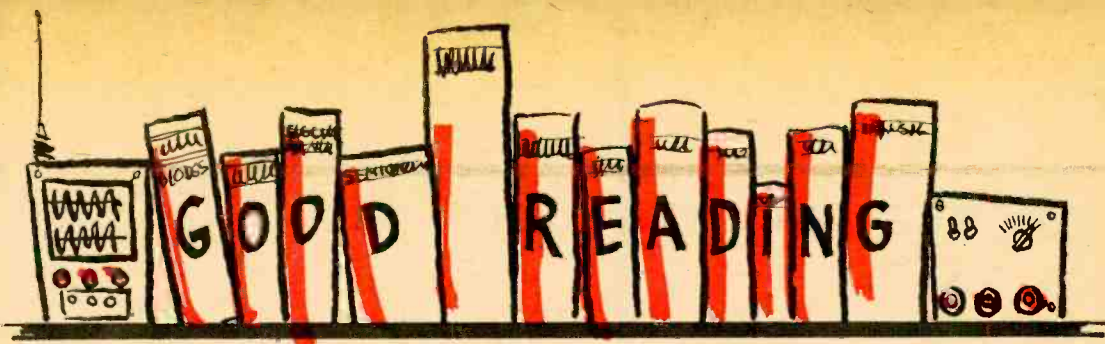

THE SCIENTIFIC AMERICAN BOOK OF PROJECTS FOR THE AMATEUR SCIENTIST. By C. L. Stong. Simon & Schuster, New York. 584 pages. \$5.95.

If you like to tackle an occasional project in *EI*, you're certainly enough of an amateur scientist to get full enjoyment from this book. Written with maximum clarity and minimum fussiness, it outlines "experiments and constructions, challenges and diversions" in every branch of science from archaeology to nuclear physics. Some projects are exceptionally practical, such as building a good and inexpensive telescope. Others, like construction of an electronic mouse, are just fun. But all are interesting and they all succeed in making worthwhile points as enjoyable as possible. Each project, by the way, uses junkbox parts when possible to keep costs down. If you like to tinker, or if you're just plain curious, this book is for you.

STEREO HANDBOOK. By G. A. Briggs. British Industries Corp., Port Washington, N. Y. 146 pages. \$2.50.

This is the sixth book on hi-fi topics by G. A. Briggs, British audio engineer and designer of Wharfedale speakers, and just a few minutes of browsing will tell you why his books are popular with audiophiles the world over. Briggs has the credentials to do plenty of fancy theorizing but he concentrates here on down-to-earth advice for achieving good stereo. If you want to know where to place your stereo speakers or how to keep your stereo discs from wearing unduly, you'll find plenty of concrete information in this slim volume. There are also special sections contributed by other audio authorities, and if you're not thrown by an occasional bit of

British humor, you'll probably find this the best guide to stereo enjoyment to date.

HANDBOOK OF ELECTRONIC TABLES AND FORMULAS. Compiled by Donald Herrington and Stanley Meacham. Howard W. Sams & Co. Indianapolis, and The Bobbs-Merrill Co., New York. 128 pages. \$2.95.

Here in one volume is a compilation of just about all the electronic data you're ever likely to need. Separate sections cover laws and formulas of electronics, standards, symbols and codes, service and installation data, and mathematical tables and formulas. If you want to find the electrical resistance of a metal or alloy, the information is right at your fingertips. And so is something as down-to-earth as a chart of American equivalents for European tubes. For a compact, all-purpose reference book on electronics, you'll find this hard to beat.

RADIO AMATEUR LICENSING HANDBOOK. By J. E. Kitchin. Radio Telephone Directories of Canada, Ltd., 119 West Pender St., Vancouver, B. C. 106 pages. \$2.

Here is a convenient and well-written summary of all rules governing Canadian amateur radio. It has sections on examination requirements, station licensing, station operation and general procedures for operating and handling traffic. Canadian regulations differ widely in many ways from American requirements, and if you intend to visit fellow hams across the border, you'll find some of the differences important to know. It also is just plain interesting to American hams to find out what our companions to the north are required to know in order to obtain an amateur ticket.

two-transistor CB Receiver

Superregen circuit in pocket-sized unit features high sensitivity with automatic noise limiting.

By Harry Kolbe

HERE is an inexpensive Citizens Band receiver which incorporates high sensitivity and low battery drain in a small package. The entire receiver (except for the antenna) is contained in a metal candy box, which measures only $3\frac{7}{8}'' \times 2\frac{3}{8}'' \times 1\frac{3}{16}''$. A metal case is desirable for a number of reasons: detuning of the receiver due to hand capacitance is eliminated; the shielding provided by the metal case reduces undesirable receiver radiation; and, good mechanical rigidity is ensured.

Most of the sensitivity and simplicity of this receiver is due to the super-regenerative detector (possibly the most sensitive detector circuit ever developed) which uses an excellent high-gain RF transistor, the inexpensive Amperex OC170. The antenna is a high-efficiency center-loaded 48'' whip with a center loading coil that electrically lengthens it to $\frac{1}{4}$ -wave length and provides a better impedance match to the receiver input.

If the pictorial and photographs are

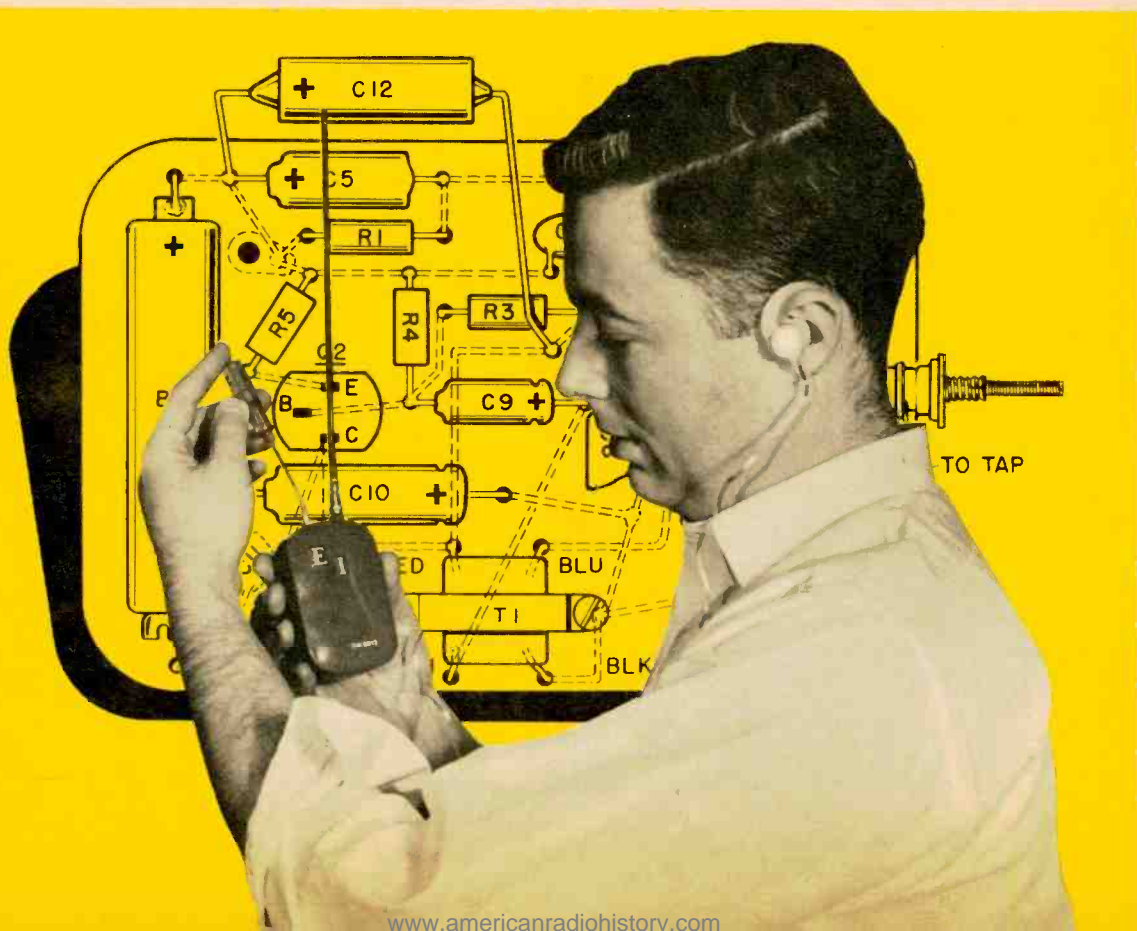

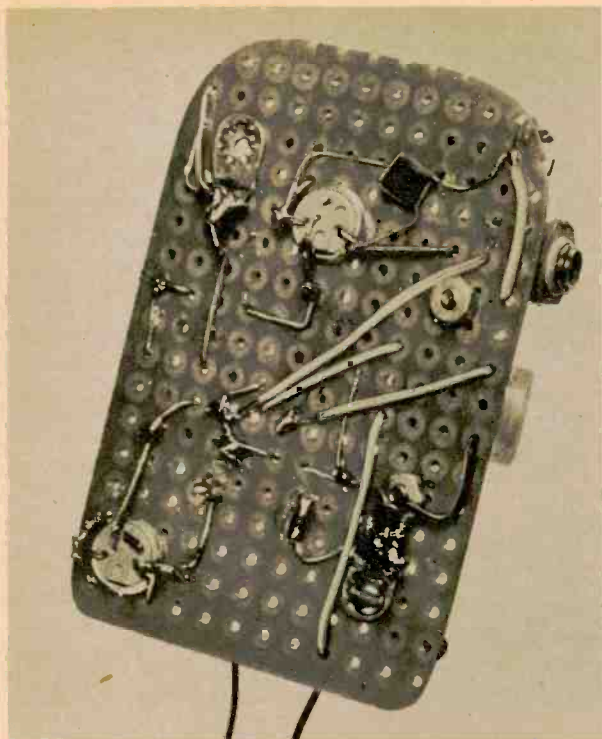

Exposed wiring requires use of spacers between underside of board and metal case.

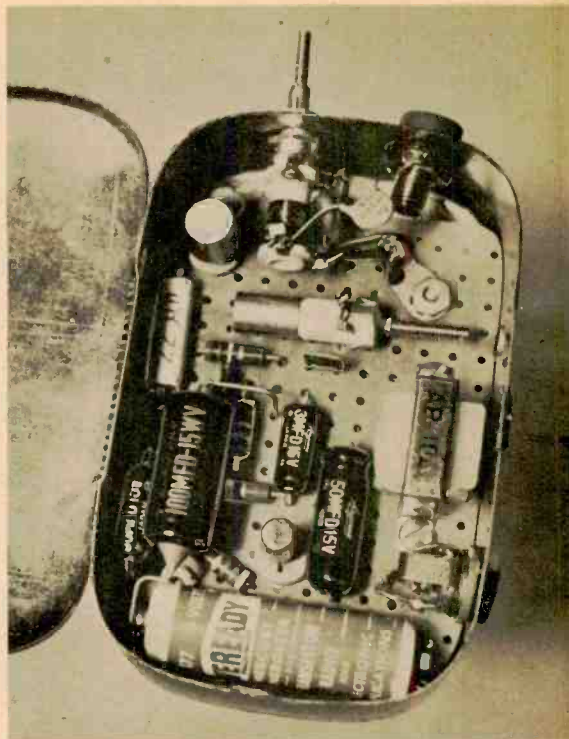

Bolt through case, spacer, and chassis board holds ground lug. Insulate jacks from case.

followed carefully, you should have no trouble getting the receiver to function properly. Preserve the layout, keep component leads very short, and use a heat sink on all component leads when soldering. Construction should be broken down into five separate steps: the case; the chassis; the tuning coil; final assembly and wiring; and lastly, the antenna.

In one end of the metal case drill two holes for mounting tuning coil L1 and antenna jack J1. The hole for J1 must be large enough to accommodate a fiber insulating washer. Two more holes are drilled in the bottom of the case for the chassis mounting screws and another is drilled in the side of the case for a phone jack and its fiber insulating washers.

The chassis is a piece of perforated phenolic board trimmed to fit in the case. Four holes are made in the board: two mounting holes and two for the transistor sockets. Cut two slots for mounting tubular trimmer C4. A thin, narrow file

or a nail file can be used to cut the slots.

All of the components are now mounted on the chassis with the exception of the L1, C1, C2, and J1. Note that C2 is mounted beneath the board. Wiring will be greatly facilitated if the three ground lugs are temporarily bolted in position. J1 can now be connected to the chassis if enough lead is provided to permit mounting in the case. Bring the blue lead of T1 up through the chassis board and leave it disconnected. Connect a two-inch wire to the collector pin of the Q1's socket, bring it up through the chassis, and leave it disconnected. These wires will be trimmed later and connected to tuning coil L1.

L1 is a 16-turn coil wound on a miniature slug-tuned coil form. Start at the bottom of the form and wind $1\frac{1}{4}$ turns then insert a small piece of thin cardboard to raise one turn of wire for the tap. Continue winding the coil. When you finish, carefully scrape the insulation from the raised turn and solder a

Inserting phone plug provides collector load for audio transistor Q2 and energizes circuit.

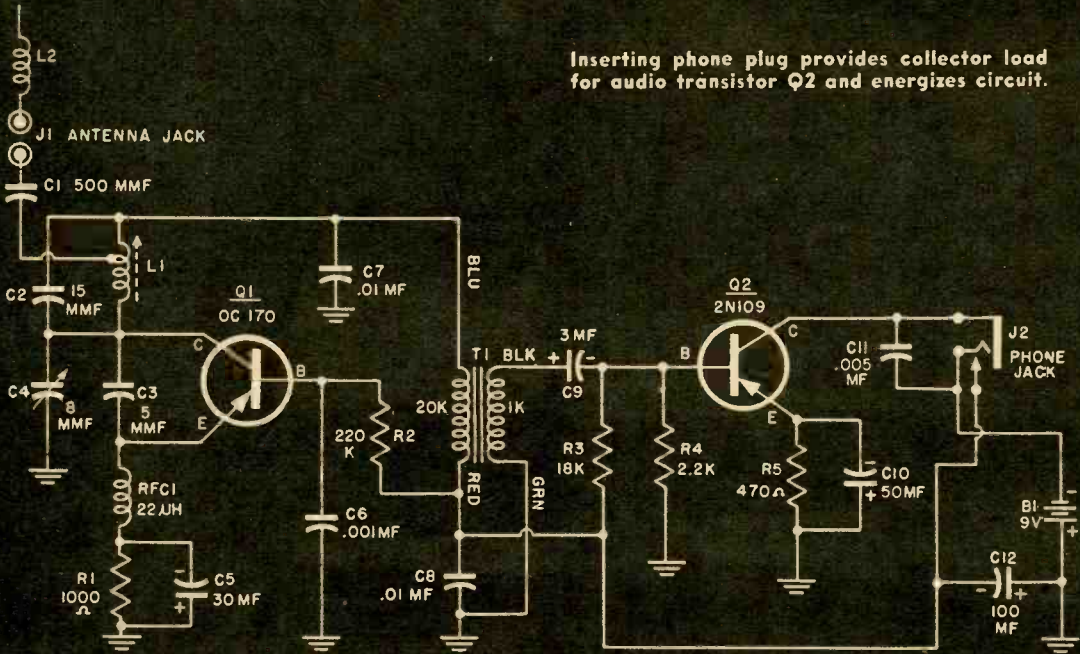

short length of wire between this point and the second bottom terminal. Apply a liberal coat of coil dope to the winding then solder C2 between the top and bottom coil terminals.

Mount the chassis board in the case using two 1/2" screws, two 1/4" dia. metal spacers, two lock washers, and two nuts. Place the lock washers between the case and the spacers. Install the tuning coil, jack, and phone jack. Connect C1 between the coil tap and J1.

The antenna is built from a 48" collapsible antenna modified in the following manner: Cut the antenna in half and solder a banana plug to each cut end. (The ends of the banana plug may have to be reamed to fit the antenna rod.) The bottom end of the antenna has a threaded base onto which a third banana plug should be screwed. This completes the top and bottom sections of the antenna. The middle section is a loading coil (L2). Drill 3/8" deep holes in the ends of a 2 1/2" length of 1/16" dia. polystyrene rod. Cement a banana jack into the holes in each end of the rod. Carefully center the rod within a 34 turn B & W

PARTS LIST

Resistors:

- R1—1000 ohms, 1/2-watt, 10%
- R2—220,000 ohms, 1/2-watt, 10%
- R3—18,000 ohms, 1/2-watt, 10%
- R4—2,200 ohms, 1/2-watt, 10%
- R5—470 ohms, 1/2-watt, 10%

Capacitors:

- C1—500 mmf disc ceramic
- C2—15 mmf disc ceramic
- C3—5 mmf disc ceramic
- C4—1-8 mmf tubular trimmer (Erie 532-B)
- C5—30 mf 15-volt electrolytic capacitor
- C9—3 mf 15-volt electrolytic capacitor
- C10—50 mf 15-volt electrolytic capacitor
- C12—100 mf 15-volt electrolytic capacitor
- C6—.001 mf 75-volt ceramic capacitor
- C7, C8—.01 mf 75-volt ceramic capacitor
- C11—.005 mf 75-volt ceramic capacitor
- Q1—OC170 transistor (available from your local dealer or Amperex Electronic Corp., 230 Duffy Avenue, Hicksville, N. Y.)
- Q2—2N109 transistor
- L1—16-turns No. 22 enamel wire on North Hills coil form No. F-1000. (Form available at Radio Shack Corp. and elsewhere)
- L2—34-turn B & W Miniductor (No. 3011)
- RF C1—22-microhenry RF choke (National B15978 or equiv.)
- B1—9-volt mercury battery
- T1—Transformer, 20,000 ohms primary; 1,000 ohms secondary (Lafayette TR-110 or equiv.)
- J1—Insulated banana jack
- J2—Closed-circuit miniature phone jack (Modified—see text)
- I—2 7/16"x3 3/8" piece of perforated phenolic board
- E—7000-ohm earphone (Lafayette MS-260 or equiv.)
- A—48"-collapsible antenna (Lafayette F-440 or equiv.) plus 3 - banana plugs and 2 matching jacks
- Misc.—hardware, transistor sockets, wire, etc.

Banana plugs soldered to cut ends of antenna fit in jacks in the loading coil support rod.

Miniductor No. 3011 and support the coil by soldering its ends to the banana jack terminal lugs.

To turn on the receiver plug in the earphone. A loud rushing sound, or hiss, should be heard. A 27-mc signal from either a grid-dip meter, or other signal source, should be coupled to the antenna. With C4 set for maximum capacitance, adjust L1's slug until the signal is heard. Capacitor C4 should tune the entire Citizens Band. It is difficult to tune with L1 because of its broad tuning characteristics. The receiver has a sensitivity of 4 microvolts, and the super-regen detector acts as an automatic noise limiter.

Dotted lines show wiring under board. J2 is modified so the phone plug will close contacts.

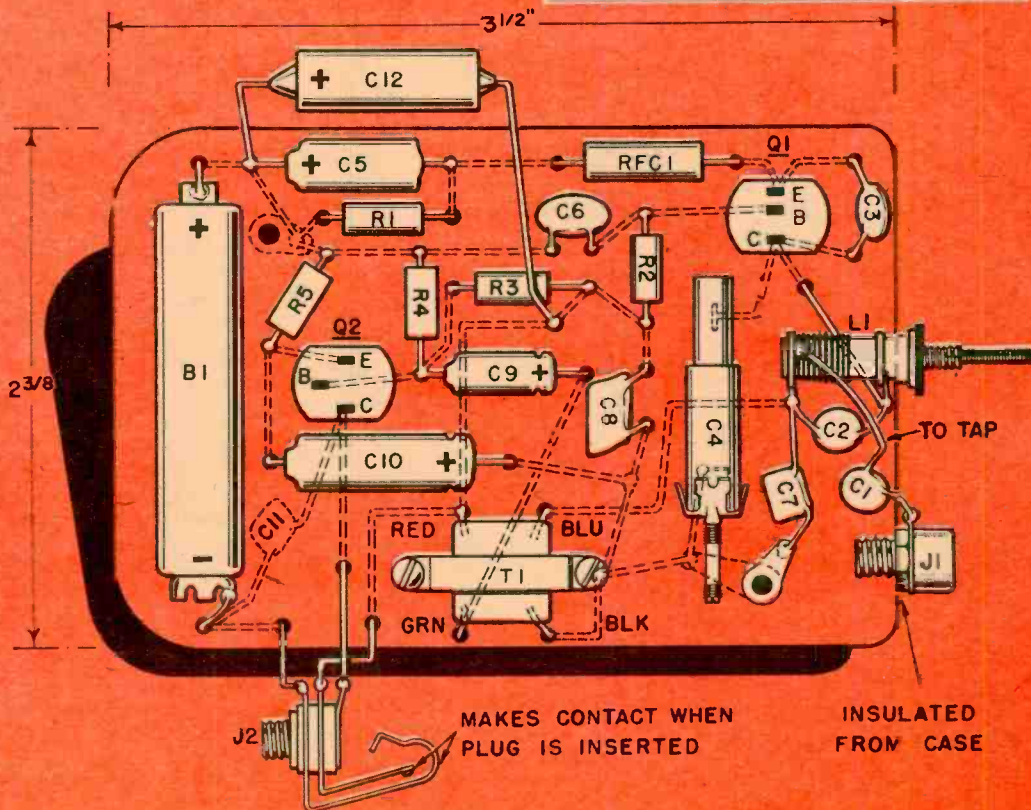
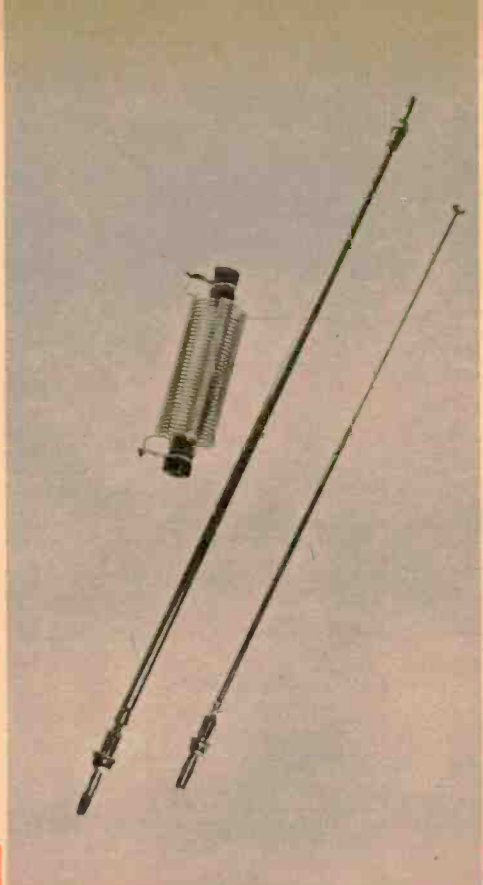

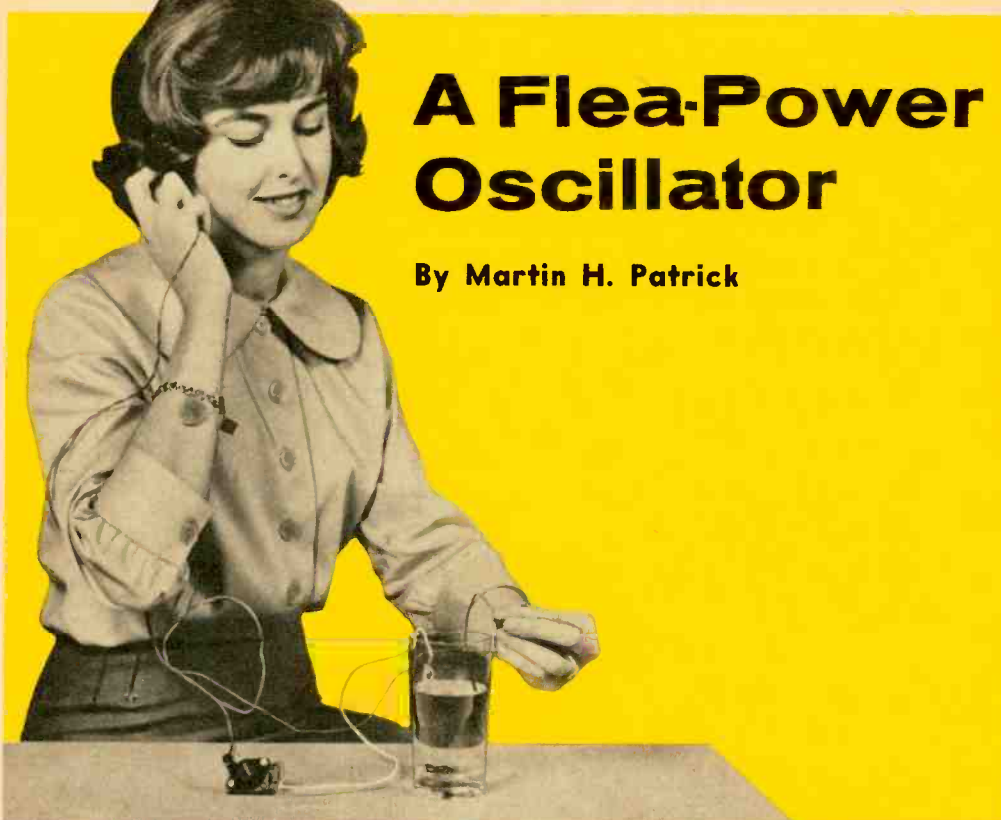

A Flea-Power Oscillator

By Martin H. Patrick

Science Fair Project

THIS little "no-current" oscillator will go into action as soon as the two electrodes are immersed in a glass of ordinary tap water provided the water contains sufficient mineral salts to render it a weak electrolyte. Put the electrodes in your mouth and it will again take off with a nice crisp tone. Or, if you were to plunge the electrodes into a lemon or orange it would again perk up. Or, you may make a simple voltaic cell by sandwiching a piece of paper, moistened with saliva, between a penny and a quarter and again it will respond. And of course, even the simplest solar cell will set it squealing.

This is possible because the circuit requires but a few microamperes of current to run it. Using a fixed resistance in series with a mercury cell you can make a continuously operating frequency standard that should last the shelf life of the cell. The current will partially determine the frequency of the tone.

The circuit uses a low-wattage power transistor (Q2) direct-coupled to a 2N233 (Q1). The configuration is somewhat similar to a relaxation oscillator but differs in that NPN transistor Q2 is connected in reverse. That is, the collector is negative with respect to the emitter. Capacitor C1 feeds back enough energy to sustain oscillation. It may be necessary to try several Q2 transistors to arrive at a minimum current requirement.

The electrodes completely immersed in a drinking glass filled with tap water should provide enough power to run the oscillator for hours.

Drop about twenty grains of salt into the water and you have a power plant that will drive the oscillator for days. Because of the chemical action that takes place in the solution, it may be necessary to remove polarized film that forms on the electrodes with fine sandpaper or steel wool.

Audio Standard

To use the oscillator as an audio frequency standard, connect a fresh mercury cell in series with a fixed resistor, determined by test, for the frequency desired. The tone should remain fixed for almost the shelf life of the cell. It is a good idea to let the oscillator run for a long period before making the final adjustment so that the transistors working together establish a norm. The frequency can be raised or lowered by varying C1. The lower the capacity, the higher the frequency.

Feedback is provided by C1 in a configuration similar to a relaxation oscillator. Be sure to scrape paint from Q2 (X844) flanges so hex-head screws make good electrical contact.

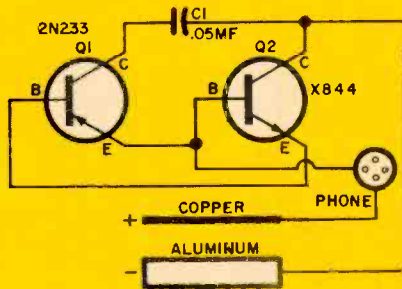

PARTS LIST

- C1—.05 mf. 50 volts miniature tubular
- Q1—X-844 power transistor (Olson Radio)
- Q2—2N233 transistor (Sylvania)
- Misc.—Lucite, strips of aluminum and copper, machine screws, nuts, self-tapping screws, spring-loaded binding post, low-impedance headphone

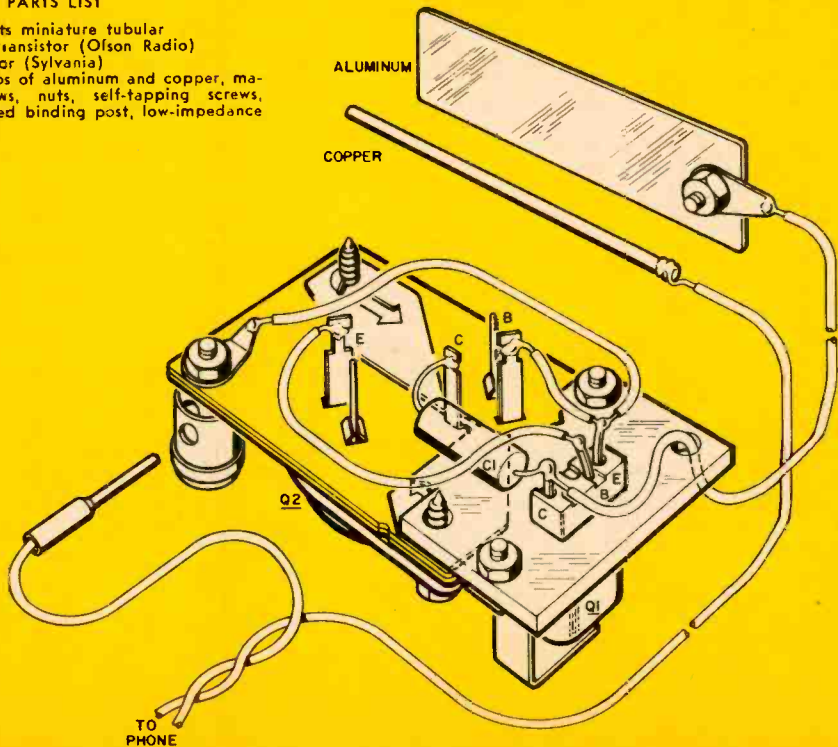



Electronics makes it possible to deliver a letter anywhere in the country on same day it is mailed.

By Paul Daniels

In beginning of Speed Mail cycle a letter is typed on special form designed by Post Office Department. Forms are like V-Mail letters.

After being opened secretly, Speed Mail letter is scanned by this machine and signal is transmitted. Scan resolution is 120 lines per inch.

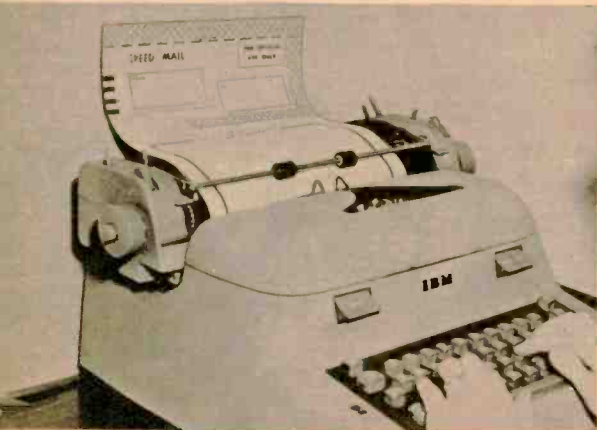

A CHANGE that could make possible the delivery of a letter anywhere in the country on the same day it is mailed would have to be called revolutionary. And so there is a post office revolution brewing right now, because that is exactly what is planned. There hardly could be better news for those of us who have suffered three-day waits while a check from Uncle Ned or a Very Important Letter from that gal meandered up from the next town, all of ten miles away.

The postal people have their ideas pretty well worked out on how they're going to bring about this miracle of the first magnitude, the most sweeping change in the letter-delivery system since Ben Franklin's original post. The heart of the matter is microwaves, which will carry a letter from one city to another, or clear across the country, at the speed of light. At the destination there will be automatic machinery to process the data and convert it again to the printed word.

Two concepts are guiding the Post Office Department in its research and development: 1) *Mail in Motion*, a complex of automatic machinery and conveyers to keep each letter on the move from the minute it comes into a post office until it leaves in the delivering letter-carrier's bag; and 2) *Speed Mail*, the facsimile transmission of a letter by

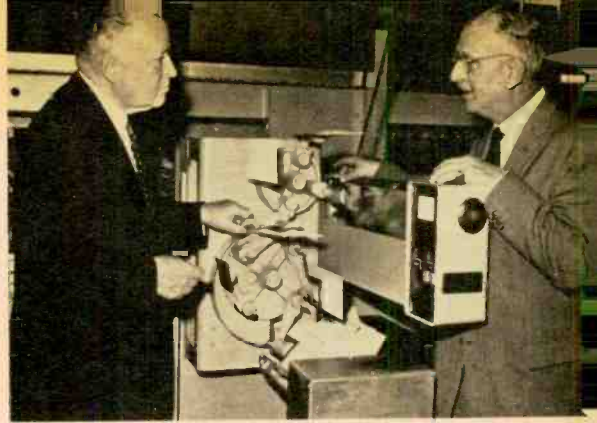

Post office's newest time-saver is this automatic address reader now being tested. Note how vacuum fingers in center pick up letters.

microwave from one post office to another.

Electronics will play a major part in making the dream possible and, although much of the equipment has been doing other jobs for some time, many of the modifications made for mail-handling are ingenious.

The facsimile system goes by the name of *Speed Mail*. It is different in two ways from the facsimile used by the wire-photo and telegraph services. It is faster and all electronic, not a mixture of mechanical scanners, printers and photo cells. And it is also elaborately designed to keep each letter secret so no one but the addressee can read its contents.

Signal is received in distant city, put through scanner-in-reverse and winds up in xerographic printer (below), comes out as letter.

At end of automated cycle roll of letters is fed to machine which cuts them apart and seals them. Postman on foot then delivers them.

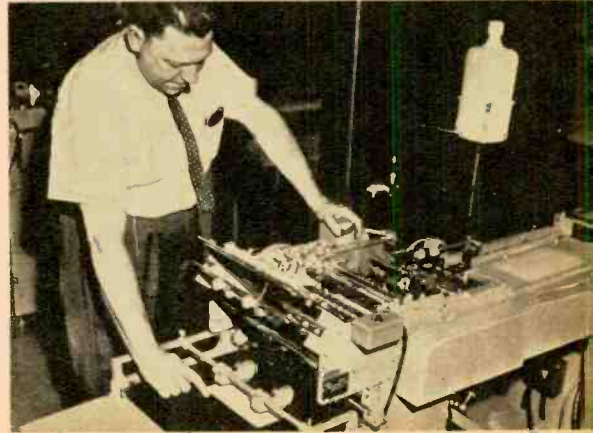
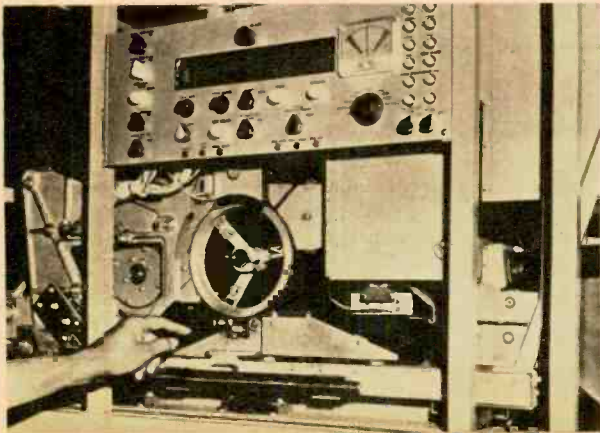

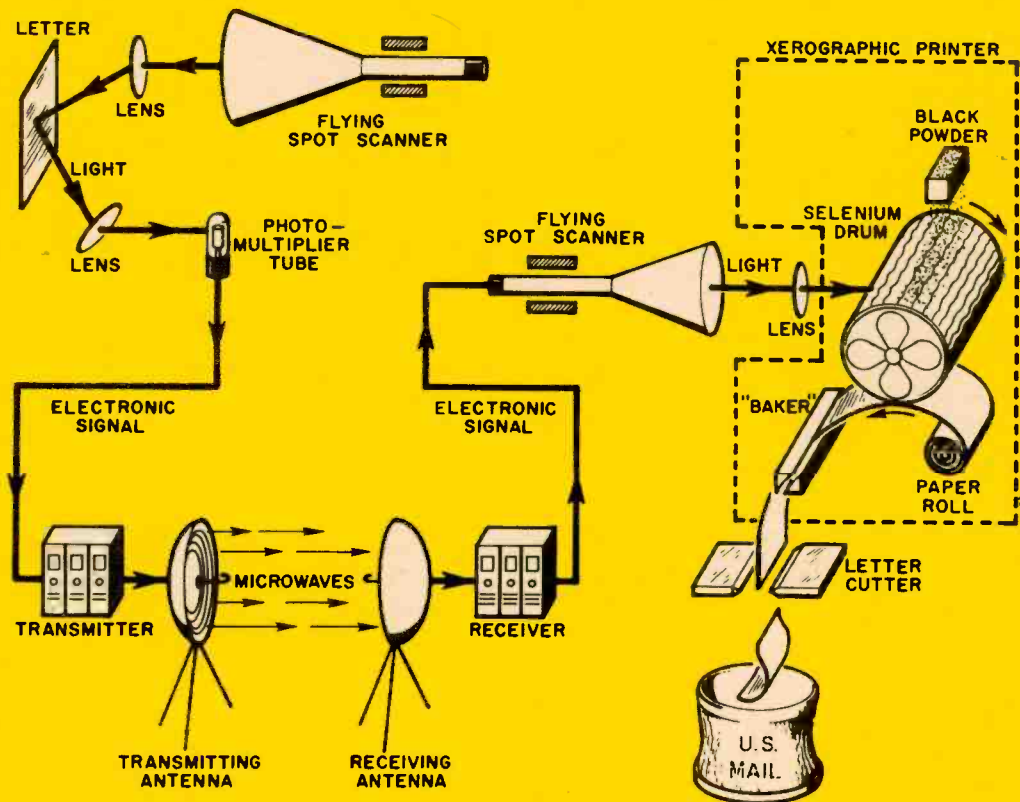

Simplified diagram shows how Speed Mail system is operated between major population centers, making same-day delivery possible anywhere in country.

The major components in Speed Mail are the flying spot scanner and the xerographic printer. The scanner has been used in TV for converting the image on films into a signal for transmission, among many other jobs. Xerography is an electronics printing method used for duplicating business papers, photos and diagrams. Xerography and flying spot scanners together mean speed and more speed. This is how they work as a team:

After a letter is written on a special form designed by the post office, it is sealed by the writer and sent to the central post office the usual way. It is then placed in a cartridge with many others and the cartridge is locked into a transmitter. This machine opens the letter, scans it via a flying spot of light from a cathode ray tube, transmits the signal

and returns the letter to a sealed cartridge, which is eventually destroyed.

At the destination post office the signal is received via microwave, fed to demodulating circuits and another flying spot scanner. This unit reproduces the original letter electrostatically with a spot of light on a selenium coated drum. The drum then revolves past a reservoir of electrostatically positive black powder, which is attracted to charged areas and clings to them (and not to non-charged areas). As the drum continues to revolve it rolls against paper, to which the powder adheres, much as in conventional printing. The paper comes from a long roll, teletype fashion. After baking to harden the powder and prevent smudges, the letters are cut apart, folded, ad- [Continued on page 98]

El builds an AM-FM Stereo Tuner

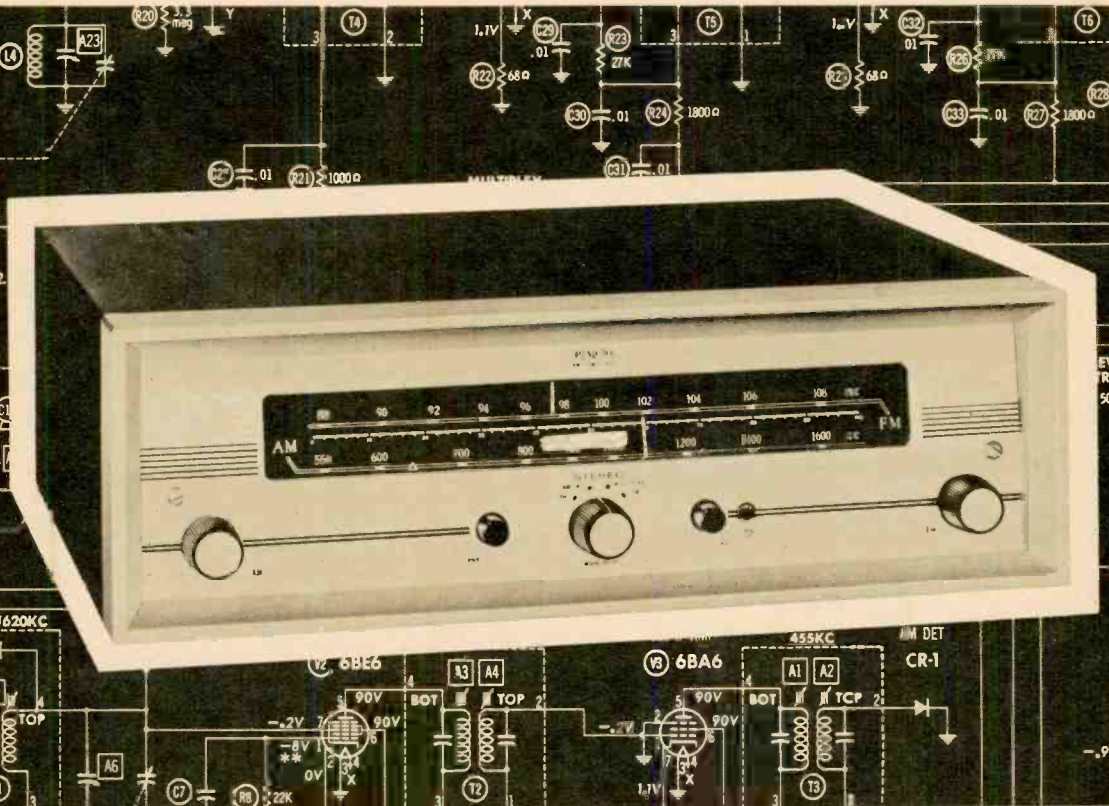

WITH the increasing popularity of hi-fi kits, there have emerged two approaches to kit design. The first is the "traditional" kit in which the builder receives a chassis, a box of components, and an instruction manual. A more recent development is the kit that is supplied partially wired and assembled by the manufacturer. The builder need only mount a few parts, solder a few connections, and his unit is ready to go. PACO, with the introduction of stereo tuner kits models ST-45 and ST-45PA, has resolved both these seemingly divergent views. The heart of the kit is on two printed circuit boards. One includes almost the entire AM section and the other the FM section. In the ST-45 ver-

sion, these boards must be wired and mounted by the builder. In the ST-45PA, however, the boards are pre-wired, installed, and aligned. The unit built for review was the ST-45PA and as was expected, the little that remained to be done was mainly mechanical assembly. Mounting holes lined up easily, and the chassis assembly and component mounting went smoothly. A roomy and well laid out chassis left ample space to mount and wire the remaining components.

The instruction book was responsible for the ease with which this kit went together. Large fold-out pictorials, many insert drawings showing minute details, and a logical mounting and

wiring sequence all went to make this one of the best instruction books we have seen. The book is common to both kits and includes many pages devoted to wiring, mounting, and soldering techniques. Nothing is left to chance and as a testament to the clear instructions, even the dial cord stringing was accomplished on the first try.

Circuit Description

Note that this unit is a true stereo tuner, in that, unlike the older AM-FM models, the AM and FM channels of the PACO are entirely independent of each other. The AM section consists of

a tuned RF stage, a converter, an IF amplifier, and a diode detector. There is a 10 kc whistle filter to prevent heterodyning caused by strong adjacent stations. As opposed to the mere three tubes plus diode detector and cathode follower required by the AM section, the FM part of the tuner has a grand total of nine tube sections (we say sections, because many of the tubes are dual function) in operation.

The FM section includes a tuned RF stage, two IF stages, two limiter stages and a discriminator detector. AFC is incorporated and can be switched out of the circuit for tuning in weak stations.

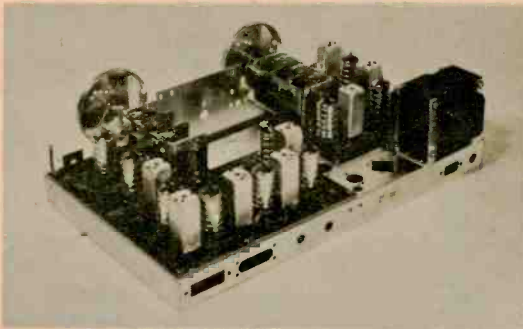

Partially assembled tuner (left) as supplied by manufacturer. Completed unit has space and socket in center for a multiplex adapter and clearly identified parts on the circuit boards of the AM and FM sections.

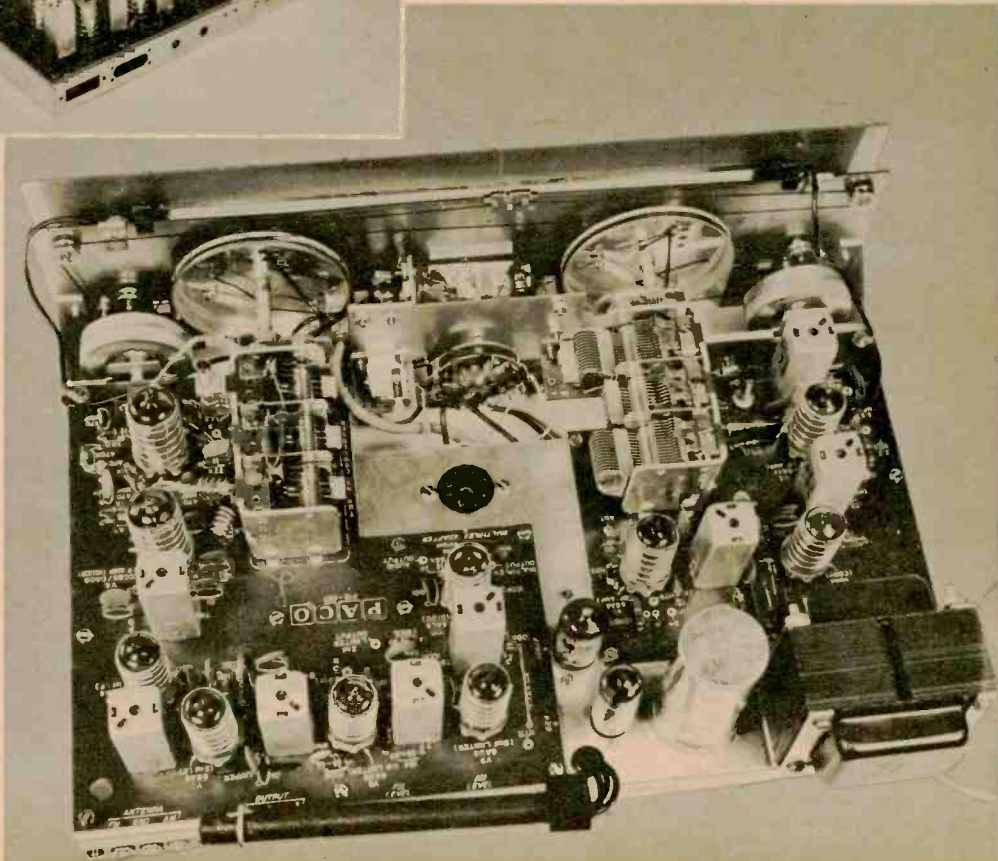

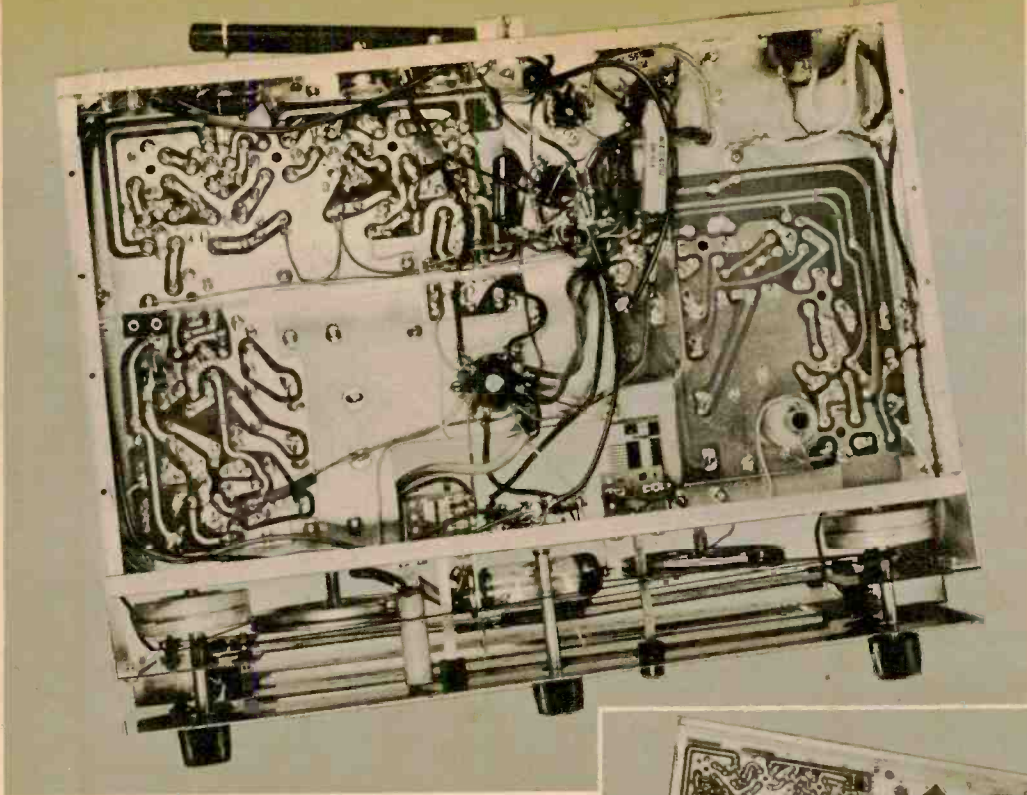

Before and after views of underside of the chassis shows small amount of wiring and mechanical assembly that is necessary to complete the PW version of the tuner kit.

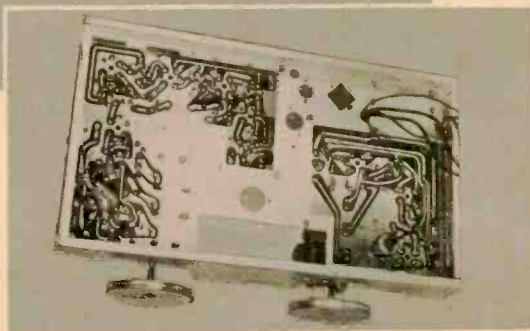

Both the AM and FM audio sections have cathode follower outputs and are controlled by level pots at the rear of the chassis. In addition there is a multiplex output. An octal socket mounted on the chassis provides power for a multiplex adapter. When a system of multiplex transmission is finally approved by the FCC, PACO will make available a multiplex adapter for use with this unit that can be plugged in without additional wiring or circuit changes. External adapters require a socket jumper.

Fly-wheel tuning, a large slide-rule dial, and an EM84 tuning indicator make tuning a cinch. When the tuner is set for AM-FM stereo the indicator serves the FM section only. On/off push-buttons are used for AFC and power switching. A pilot lamp lights when the AFC is on.

Upon completion, the tuner was switched on and the factory prealignment of the printed circuits certainly paid off. Tuning was right on the nose and drift and distortion were conspicuous by their absence. The PACO manual states that the tuner's FM section has a sensitivity of 2 microvolts for 30 db quieting. An A-B comparison with other highly rated tuners on weak stations seems to support their claim.

When completed (the construction time was about six hours), the tuner worked perfectly. The excellent instruction manual, uncomplicated construction, and wired and aligned AM and FM sections make this kit a good buy at \$99.95. The more ambitious can save \$15.00 by buying the Model ST-45 and wiring the circuit boards themselves.

—Dave Muirhead



Construction Kinks

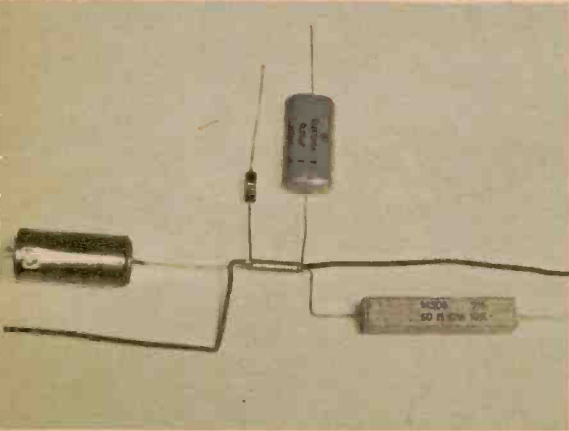

When you can't mount a tie point in a chassis, a neat self-supporting solder joint can be made using #20 bare wire. Insert component leads and flow solder into the coil.

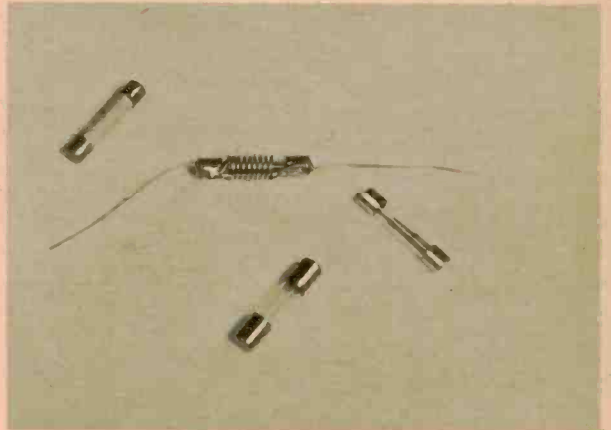

Blown glass fuses make excellent forms for small RF coils and chokes. Solder pigtail leads to the ends then they can be mounted in the same manner as a resistor or a capacitor.

It is often necessary to drill another hole in a completed chassis. To avoid damaging mounted parts, slip a metal tube or block over the drill to limit travel at punch through.



Give projects a neat look by squaring off all wiring and cementing parallel wires together. Dabbing the wires with some rubber or standard cement is faster than string cabling.

The MHD Revolution

Cheaper electric power produced by new method is promise of concept called magnetohydrodynamics.

By John Dowell

TO MAKE electricity commercially, you've got to think big—about immense and complex equipment, millions of dollars and billions of kilowatt hours. The installations are awesome, and so is the planning that goes into building a generating station.

Just at the horizon of our power-devouring world is a new generating system that may change our whole electric power industry. The magic it possesses is simplification, because the new concept promises to do away with almost all the moving parts in the electric power generator. The jaw-breaking name given the idea is magnetohydrodynamics, a term which also describes a new branch of physics dealing with the motion and behavior of electrically conducting fluids or gases in the presence of magnetic fields (this relationship, we might add, is the heart of the new

In MHD cycle gas is ionized by heat, flows through magnetic field and picks up electrical charge which is tapped off by the two electrodes as DC current.

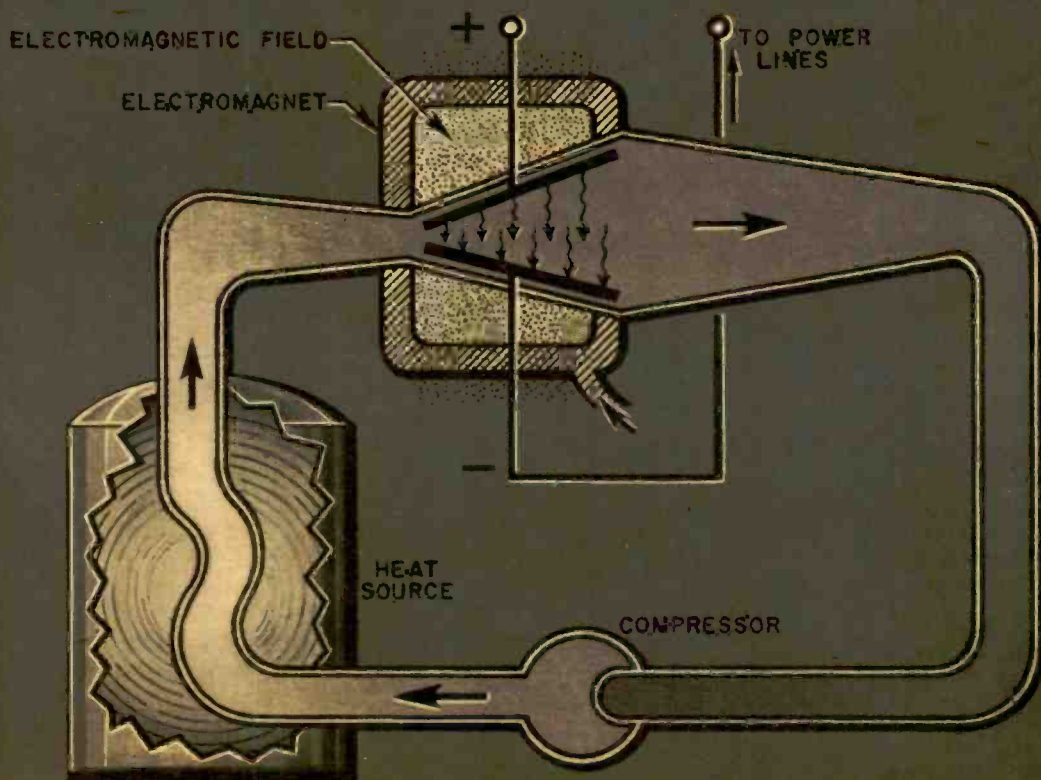

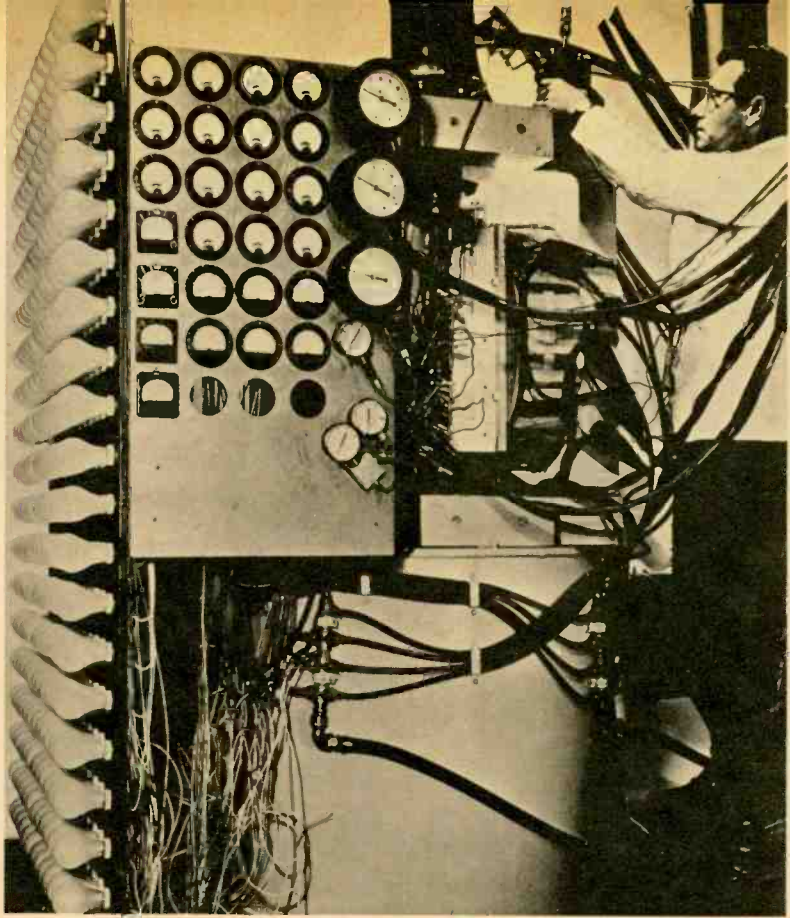

Pilot MHD generator built in Massachusetts produces more than 10,000 watts. The experiment shown here lighted 228 incandescent bulbs at once.

generating concept). Luckily for all of us, magnetohydrodynamics has been shortened to MHD for easier usage. MHD actually represents the joining of two fields which have been pondered a long time independently—gas dynamics and electro-magnetism (these two terms explain the origin of the first and last parts of the word magnetohydrodynamics; engineers refer to compressible gases as fluids, which explains the middle section, *hydro*).

Most of us have, at one time or another, performed the simple experiment of creating electric current by moving a piece of metal between the legs of a magnet, and perhaps we've even wondered a little about the minor marvel we witness every time we turn our lights on. But with all the forces of science and engineering brought to bear, our crude experiment is still a perfect picture of the way the lights and refrig-

erator and TV are powered at home.

In commercial electric power production, of course the moving metal (armature) has grown to gargantuan proportions and the plant and personnel needed to make power available to even a small city represent an investment that may run into the millions.

MHD, according to its developer, Dr. Richard Rosa, would cut that needed investment substantially. Dr. Rosa has supervised the construction of pilot MHD plants at the Avco Research Laboratories in Everett, Mass. The pilot plants are expected to prove many of Dr. Rosa's contentions.

To explain how MHD works we might start with the observation that when gases are heated to elevated temperatures some of the electrons start racing around so fast that they fly off their individual atoms, leaving each atom with an over-abundance of protons. Protons

are positive. The atom thereupon ceases to be neutral and takes on a positive charge. It is now called an ion and it is electrically conductive. Ions, of course, can be positive or negative.

When anything conductive—gas in this case—moves through a magnetic field it takes on an electric charge. All we need to do to tap this electric power is place a pair of electrodes on either side of the chamber through which it passes, much as a pair of lightning rods introduced into a charged cloud would tap the electricity there. In an MHD generator ionized gas passes through a magnetic field and picks up an electrical charge, which is immediately siphoned off by negative and positive electrodes.

The gas flows constantly in one direction. Therefore, the current as it comes from the generator is DC. No armatures, no bearings, no moving parts—just a new concept of efficiency that may reduce the cost of electricity by as much as 25%!

There are two general types of MHD generators—an open-cycle coal-burning plant and closed-cycle nuclear system. The open-cycle plant is similar in concept to a conventional gas-turbine, steam-turbine combination. The MHD generator merely replaces the gas turbine. To operate, coal is burned to obtain extremely high (about 4000°F) temperatures. The furnace gases produced (which are seeded with .1% potassium to increase conductivity) then pass through the MHD generator where about 75% of the heat energy is converted directly to electric power. But not even the remaining 25% is wasted. It is used to produce electricity in a conventional steam-cycle system.

The generator is a simple construction problem and is built to relatively low tolerances. It contains no moving parts. MHD systems using coal have an indicated heat-rate of 6,200 BTU per kilowatt-hour thermal efficiency.

The closed- [Continued on page 102]

Avco Corp., MHD developer, is headed by Victor Emanuel (left), shown with generator specialist.

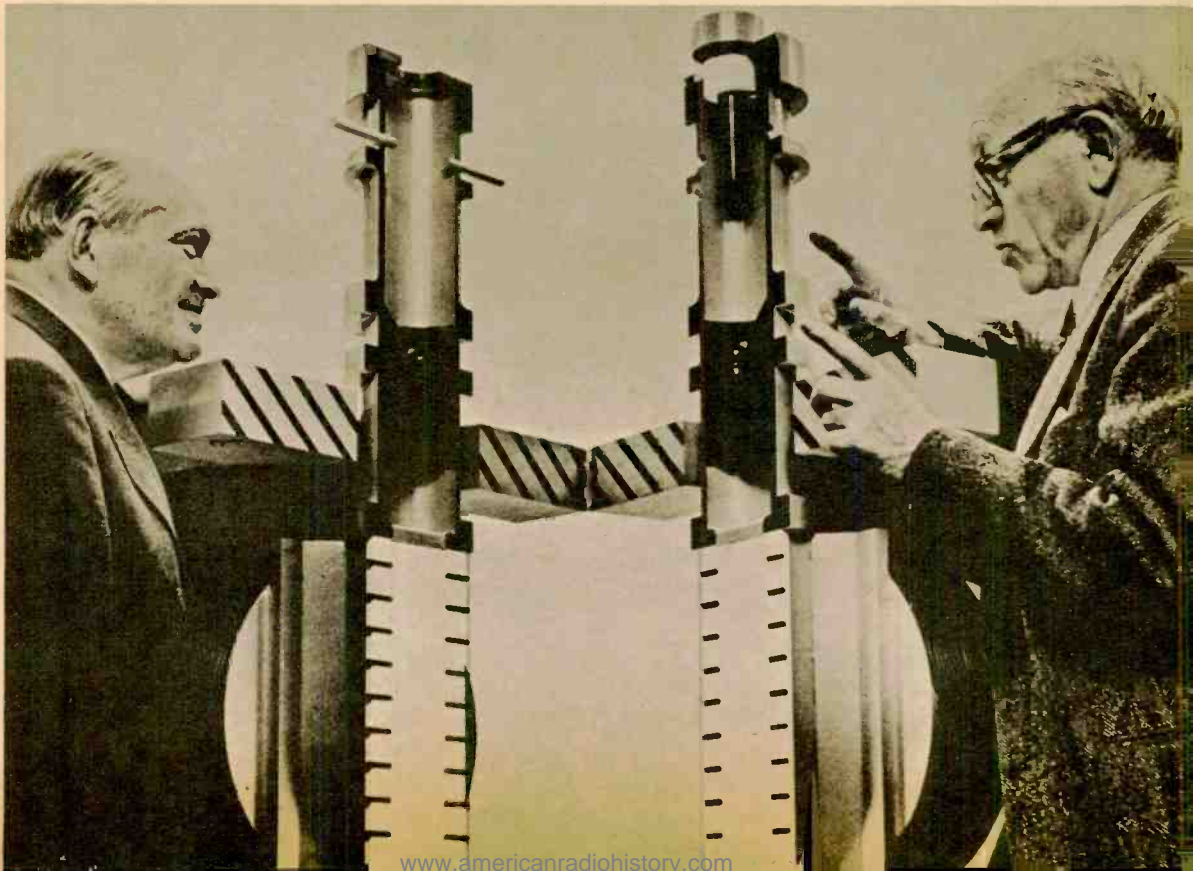

The Radiogizmo

Multi-purpose gadget operates as a metal locator, wireless metronome, etc., all on one transistor.

By Fred Maynard

Motorola Semiconductor Products

THIS electronic "Gizmo" used in conjunction with a transistor radio can provide a lot of fun as well as a number of useful functions. The Gizmo is in reality a very short range radio transmitter. Its relaxation circuit provides a timed series of very short RF pulses covering the standard broadcast band. By tuning the receiver to a dead spot between stations, maximum sensitivity to the Radiogizmo can be obtained at full receiver volume.

The maximum range between receiver and transmitter is about 30 feet of straightline distance with the transmitter and receiver loopsticks *in parallel orientation*. At any shorter distance, a zero or weak signal will be received if the receiver and transmitter are oriented with the loopsticks in "null," that is at right angles to each other.

The radio voice of the Gizmo is a steady click in the receiver's loudspeaker. When the values shown in the schematic are used,

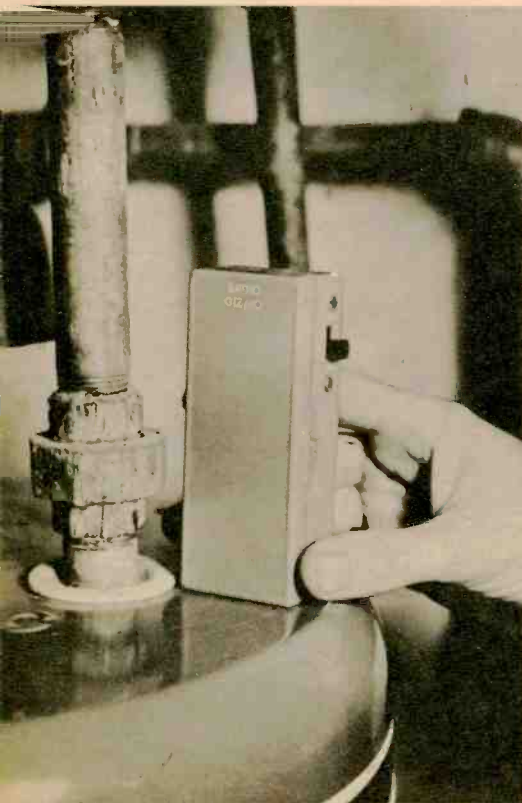

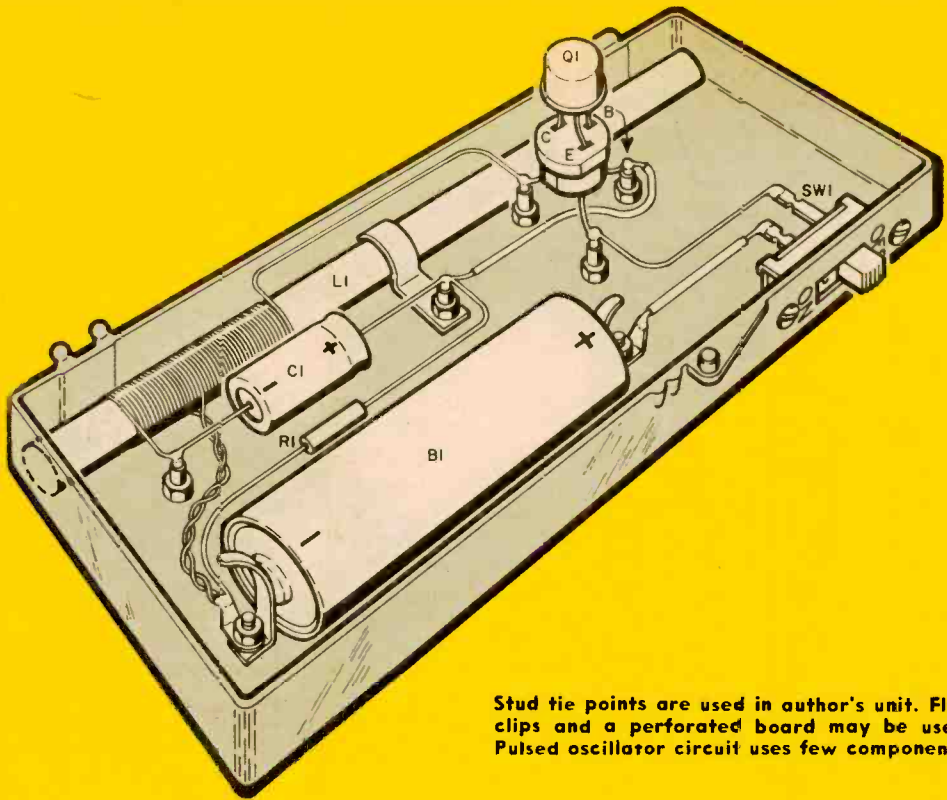

Stud tie points are used in author's unit. Flea clips and a perforated board may be used. Pulsed oscillator circuit uses few components.

the clicks are generated at the rate of 2 or 3 per second. If variable resistance is substituted for R1, the click rate may be varied over a wide range. This is useful in one of the applications to be described, the radio metronome.

Any ferrite antenna rod may be used for L1. These come in various lengths and cross sections, the most common being $\frac{1}{4}$ " to $\frac{5}{16}$ " diameter rods, 3"-6" long. These may be purchased as separate antenna cores or salvaged from an old radio. Provide a single layer winding of No. 26 insulated magnet wire of approximately 40 turns, tapped at 20 turns. There is nothing critical about either the number of turns or the wire size.

Operation

The remainder of the circuit consists of the transistor Q1, the timing resistor R1, the base blocking capacitor C1, an on-off switch SW1, and a 4-volt battery B1. Capacitor C1 has a large value (25 mf @ 10 volts) since this provides the essential function of blocking the base of Q1, and a long time constant. This blocking effect is derived from the feed-

back voltage developed in L1 which biases the transistor base strongly positive, thus cutting it off. The stored charge in C1 takes time to leak off through R1. When the charge reduces sufficiently for Q1 to conduct again, a new cycle is generated, which provides blocking once more.

Thus the operation of the circuit is a high-amplitude pulse of a few milliseconds and a long quiet period between these bursts. The length of the quiet period is controlled by R1.

A higher battery voltage gives some-

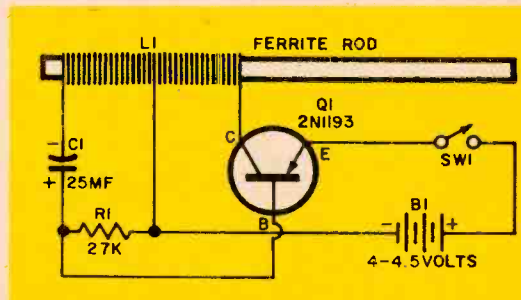

what greater range, but at risk of transistor failure due to L1's higher kick-back voltage across Q1. The 4.5-volt source may be conveniently obtained from 3 penlight batteries in series or a 4-volt mercury cell.

The final adjustment of the transmitter is made by monitoring with a radio receiver a few feet away, and in proper antenna orientation. It may be desirable to use a miniature 100,000 ohm potentiometer for R1 to provide a continuously variable click rate.

The components of this transmitter can easily be fitted into a small plastic box the size of a king-size cigarette pack. Here are some of the practical things which you can do with the Gizmo.

● *Buried Metal and Pipe Locators*

This area presents a serious and useful application of the Radiogizmo and transistor-receiver combination. This combination can be used in various ways for such important functions as (1) locating the position of buried septic tanks, fuel storage tanks, and the like; (2) tracing buried pipes or conduit from the surface of the ground and finding the location of pipes, conduit or electrical wiring in the walls of a building.

The locator utilizes the principle of

radio field distortion by large metallic objects within the field. To build a locator, we start with a board about 6' long and 2" wide. A piece of flooring board is ideal. Nail some cleats on one end to snugly hold the transmitter in a fixed position. On the other end, pivot a wooden piece, also equipped with cleats to hold the receiver. A suggested construction for this assembly is shown. The pivoted piece should rotate when forced, but stay put in any position.

With both the transmitter and receiver on at *maximum* volume, rotate the receiver for *minimum* or *no signal*. This is called the *radio null* orientation. The axes of the transmitter and receiver loopsticks will be very nearly at right angles in the null position. This adjustment should be made away from the area where you suspect your object is buried.

When the null is obtained, move with the carrier stick over the suspected area, holding the stick parallel to the ground. When you begin to come in over the object, the clicks should grow louder, becoming maximum when you are directly above it. By exploring at various angles, you will be able to predict the center of the object and indicate where to dig.

Interior view of Radiogizmo. Pocket radio alongside makes a suitable receiver for pulsed signal.

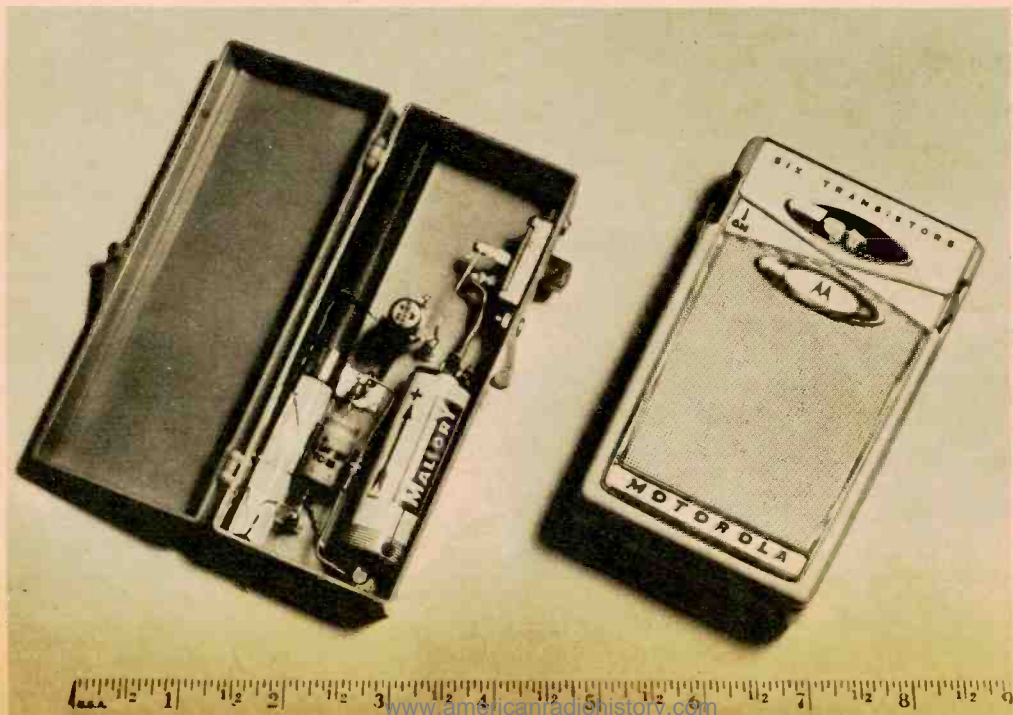

Simple hand-held metal locator that can be assembled from scrap wood. The Gizmo and a transistor standard broadcast-band radio serve as the signal source and receiver. After the receiver has been rotated for null, any metal in the Gizmo's radiation field will cause an increase in the receiver's output.



RADIOGIZMO TRANSMITTER



FLOORING BOARD 5' TO 6' LONG

PLATFORM CAN BE PIVOTED

TRISTOR RECEIVER



This method of detection is good for metallic objects which are buried to a depth *not* exceeding their longest dimension. For very large objects which may be buried quite deeply, more sensitivity may be obtained by extending the length of the exploring stick, say to 10 feet.

Better audio contact with the receiver can be obtained by using earphones than by depending on the audio from the speaker, especially in a windy or other noisy condition. Most small transistor radios are equipped with earphone jacks.

● *Following Underground Pipes, Conduit or Wires, and Locating Pipes or Wires in the Walls of a Building*

If possible, place the transmitter on some exposed part of the pipe or conduit, such as a hydrant or junction box. The orientation of the transmitter loopstick is not too important, but better coupling is generally obtained if the axis of L1 is approximately parallel to the pipe axis. Under these conditions, the radio waves actually wrap around and follow a conductor for long distances.

A radio is then used to explore the

surface of the ground in the direction it is suspected the pipe will run. Its loopstick orientation should be changed with respect to the run line of the pipe, since an unsuspected elbow or turn in the pipe may alter the polarization plane. In any event, the clicking should be heard when the radio is over the pipe even at distances several hundred feet from the transmitter.

● *The Radio Metronome*

If the transmitter is built with a potentiometer for R1, the click rate can be changed at will to provide a steady drum-like beat. A radio serves as the metronome which may be driven to any steady rhythm by the transmitter even from a remote point.

PARTS LIST

- R1—27,000 ohm, 1/2 watt resistor
- C1—25 mf @ 25-volt electrolytic capacitor
- L1—40 turns No. 26 wire, single layer wound directly on rod and tapped at 20 turns
- Q1—2N1193 transistor
- SW1—SPST slide switch
- B1—penlight cells (3) or 4-volt mercury battery (Mallory TR-133R)
- Misc.—Plastic box, tie points, hardware

DXing In Between

Eavesdropping in the 30 to 50 mc band brings you mobile telephone, foreign TV, police, fire stations.

By Tom Kneitel

NESTLED inconspicuously between the high-frequency end of the 10-meter amateur band (29.7 mc) and the low-frequency end of the 6-meter amateur band (50 mc) is a rip snortin' utility band with the DX properties of the 10- and 6-meter amateur bands.

Thousands of stations can be heard here. The old standbys, police stations, are the most interesting and exciting to monitor. Most state and county police (sheriffs) use this band because it allows better coverage than 150 mc. Police networks, for example, have 1,200 mobile units operating on 42.30 mc and 44 base stations on 42.14 mc (the mobile units are also licensed for

United Air Lines employee at lower left uses walkie-talkie to coordinate intra-airport operations. At right, bus driver in Rochester using 44.52 mc hits a traffic jam and reports in to KED927, or the Rochester Transit Corp.





Telephone answering service uses radio paging system on four frequencies. A radio paging system in Hawaii is often received in the continental U.S.

operation on 42.14 mc). It's interesting to park your rig on one frequency and see how many stations from one network you can log (and verify). By the way, TV western fans can scoop the broadcasting networks by listening directly to the stations of The (real) Sheriff of Cochise who, with his 20 mobile units, operates on 39.18 mc under the calls KOA812 and KOK556. Fire stations offer a fare similar to that of the police stations.

The real utility stations on this band are the power, petroleum and gas pipelines and the special industrial and emergency boys who are on the air around the clock, patching, fixing and installing everything from Coke machines to burglar alarms. Many of the stations in the petroleum service are located on oil drilling rigs in the Gulf of Mexico. When one of those tropical storms goes barreling through the gulf, their frequencies buzz with instructions from land-side offices. Special emergency stations are operated by doctors,

ambulance services, hospitals, disaster patrols and veterinarians.

Mobile stations abound on these frequencies and hundreds of fixed telephone company stations can be heard working mobile telephones installed in cars. The fixed stations operate on different frequencies from those of the cars, but the fixed station usually rebroadcasts the car station's signal so you are able to hear both sides of a conversation. There are also telephone company maintenance trucks to be heard and inter-city trucks, buses, tow trucks, wreckers and repair trucks communicating with their garages.

One of the more recent additions to the band is the one-way signaling or radio paging service. These stations run a voice tape of code numbers for the benefit of their subscribers, usually doctors, who listen periodically on pocket-size receivers. When they hear their number transmitted they telephone the answering service for the message which [Continued on page 111]

EI'S Hi-Fi Doctor

Second Thoughts on Stereo—Part One

SINCE this year marks the third anniversary of the modern stereo disc, it's really high time for a fresh look at stereo and its role in hi-fi. There's no disputing the fact that stereo now completely dominates the audio scene, but there's no point in pretending that it has come through on all of its early promises. There have been so many confusing and even contradictory guideposts on the road to stereo enjoyment that even the most experienced audiophiles have wandered. And most audio newcomers are still stuck at the first turn in the road. What I'd like to try to do in my next few columns is provide some common-sense tactics—rather than ivory-tower strategy—for achieving good stereo. I'm not going to try to sell you any new equipment; I'm going to show you how to get the most out of what you now own.

Hi-Fi vs Stereo

It *should* go without saying (but unfortunately it can't) that you can't get good stereo by short-circuiting traditional hi-fi standards. Audio stores seem to be swarming with people who once thought that stereo was a completely new breed of cat, separate from and unrelated to hi-fi, and who had to learn the hard and expensive way that a poorly designed portable phonograph still sounds cruddy, even though it's *stereo*. Although stereo's second channel, and particularly a second speaker system, *can* make for easier listening with even a midget portable, realistic stereo still requires all the old mono hi-fi virtues in audio equipment.

While the audio veteran may not need reminding that hi-fi yardsticks apply to stereo, he sometimes tends to overlook the fact that stereo requires another old-time virtue: the willingness to experiment. If anything, stereo is far less exact a "science" than good old

single-channel fidelity. If stereo discs and tapes were recorded *binaural*, that is, over a pair of mikes as far apart as the average pair of human ears, and played back only via earphones, stereo results might be uniform. As things stand, though, no two companies seem to agree even on how to set up their recording mikes for stereo. Some engineers emphasize directionality, for that drums-on-the-left and trumpets-on-the-right effect valued by some audiophiles. Others sneer at ultra-directional recording, dubbing it "ping-pong stereo," and try instead to come up with a sound that emphasizes spaciousness and depth. (The latter seems to me a more realistic approach, since I'm fairly unaware of directionality in most "live" listening situations.) And there are plenty of other areas for disagreement, such as the merits of close-up miking (for those who like first-row seats at concerts) vs. the appeal of a distant pick-up (for balcony tenants).

Experimentation Needed

What all this means is that the audiophile had better be ready for some experimenting at home on matters like stereo speaker placement. Certainly we're a long way from being able to put speakers in permanent locations—such as walls and closet doors—with any confidence in the results. And there are no set rules even for maximum and minimum distances between speakers, with factors like the size of the listening room and the separation between speakers and listeners preventing arbitrary standards. We'll look at these and other factors in a future column, but, in the meantime, anyone who ever spent long hours adjusting the port on a bass-reflex cabinet to just the right size should be getting ready to give stereo problems the time and effort they deserve.

and Clinic

Hi-fi questions are all answered by mail. If of general interest they will appear in this column.

Bass Control Trouble

When the bass control on my hi-fi amplifier is turned to the 3 or 4 o'clock position the volume falls sharply. I've tried replacing the control but this doesn't work. What do you suggest?

Stephen A. Memanolo
Quincy, Mass.

Look for a shorted capacitor connected from the center arm to either of the two outside terminals of your bass control.

Stereo Add-On Speaker

I would like to build the Stereo Add-on Speaker System featured in the October '60 issue. I have had difficulty locating the specified tweeters and would like to use the tweeters I already have. However, they are of a different impedance than those specified. Can I use them or will it upset the circuit?

W. Springfield
N. Hollywood, Calif.

Speakers of impedance other than those specified in the article may be used. The tweeters would simply be connected across the transformer taps that match their impedance; a 4-ohm tweeter should be connected across the two 4-ohm taps, an 8-ohm tweeter across the two 8-ohm taps, etc. The midrange speaker should be connected to the transformer tap that is half the speaker impedance. For example, a 16-ohm midrange speaker would be connected across the two 8-ohm taps.

Electrolytic Failure

About 10 seconds after I turn on my amplifier I hear a snapping in the power amplifier. All the tubes checked okay. What components are bad?

R. M. Tucker
Elmhurst, New York

The electrolytic capacitors in the power supply section of the amplifier are what you hear. Here's what's happening. If the rectifier tube is a 5U4, it heats up fast and delivers full DC

voltage before the other tubes have started drawing current. At that time the B-plus voltage may be well above the peak voltage rating of the capacitors and cause a breakdown of their dielectric. What you hear is internal arcing in the capacitor.

We suggest you replace both electrolytics and to avoid future trouble replace the 5U4 with a GZ34/5AR4. This tube heats as slowly as the output tubes.

Recorder Distortion

I use my tape recorder to tape programs off the air. However, when I play back the programs I get bad distortion at full bass boost. I also get a sort of fluttering sound and changes in pitch in the music. Any suggestions?

C. Brewley
Passaic, N. J.

You are probably overloading your amplifier and possibly your speaker by using excessive bass boost. The cure is not to do it. Wow and flutter are caused by mechanical problems in the tape transport mechanism. Try a good cleaning and check the drive elements.

Tuner Frequency Change

While rummaging through the attic the other day I found an old FM tuner that covers the 42 to 50 mc band. Is it possible to modify it to operate on the 88-108 mc band?

Martin Heller
Concord, N. H.

This would be a very involved job since almost all the major tuning components have to be changed. The IF transformers, antenna and oscillator coils, and the variable capacitor would have to go. (The old IF frequency was 4.3 mc. The new IF is 10.7 mc.) In terms of time and money it just wouldn't pay. We suggest a new FM tuner. 

Address inquiries to Hi-Fi Clinic, c/o Electronics Illustrated, 67 West 44th St., New York 36, N. Y. Enclose a stamped self-addressed envelope for a prompt reply.

Help Wanted—Male

TECHNICAL WRITERS

Needed for long-range missile program. Experience in electrical, hydro, mechanical areas desired. Should be familiar with MIL-SPC. M-2064, B-2005, H-25393, WDT-54-5C.

TECHNICAL EDITOR

Needed for long range program. Experience in classification, editorial layout, insurance, editorial qualifications. Should be with MIL-SPC: M-45005, H-25393, H-44005474C and WDT-54.

AMV offers its employee optional benefit program lightened management.

Please send resume or 1

TECHNICAL WRITERS

Engineering Writer

We need

Technical Writers

Beland & Boyce is currently supplying hundreds of temporary technical personnel to many companies of all sizes including GE. Write or

Tech Writers (19)

VOLT continues to expand!

WE NEED THE FOLLOWING

Electronic Tech Writers

In any of the following categories

- A... Minimum 3 yrs exp; heavy analog computer or GEC exp. Out-of-town with Per Diem
- B... Minimum 3 yrs exp; heavy digital or radar exp. Out-of-town with Per Diem
- C... Minimum 3 yrs exp; thorough knowledge of MIL-STD-883C. Out-of-town with Per Diem
- D... Minimum 1 yrs experience Madison, New Jersey office

PARTS LISTERS

EXPERIENCED MIL-B-2005A & FIELD ASSIGNMENTS

Electronics Personnel

Min 4 yrs electronics exp in profitable field of Tech

DESIGN SERVICE CO. INC.
76-9th Ave 115 St, NY. OR 3-6400

TECH WRITER!

Expd in Radar, Microwave or TV
OOT assignments with Per Diem
APPLY NOW

FOR POST HOLIDAY ASSIGNMENTS

TECH WRITERS

EXPERIENCED ELECTRONICS
CUSHING & NOVELL
191 Park Ave (40th), OR 9-2110. Est. 1954

your career as a Tech Writer

Industry pays high for the man who can interpret the engineer's language for the layman customer.

By Jim Kyle, K5JKX/6

ALMOST every job in electronics is different in some way from every other one. The branch of the industry known as technical writing, however, is more than just a little different. The toilers in this vineyard keep only one foot in the world of electronics. The other is planted firmly in the universe of verbs and adjectives and adverbs, blue pencils and proofs, printers ink and halftones.

The main concern of the technical writer is, of course, writing. But he also must have a general understanding of electronics and an ability to become highly conversant, at least for a time, on various specialized areas in the field. The technical writer can come from a great variety of backgrounds. Education and experience are not as important as the ability to communicate ideas. Salaries are like most other facets of the trade: they vary greatly.

Technical writing at its most mundane furnishes a comfortable living. At the other end of the scale, it is by no means unusual for a tech writer's salary to exceed that of a graduate engineer, and the chances of moving from behind the typewriter to a mahogany desk on the executive floor are better than average. Although the material turned out by the tech writer can hardly be compared to prose by Hemingway, Faulkner or even Spillane, he can at least comfort himself by saying that all three of them put to-

gether couldn't write a piece on tunnel diodes. And besides that, he doesn't have to grow a beard or wear a ragged T-shirt.

Thousands of technical writers are needed today by America's electronics industry and some companies are offering \$15,000 a year for experienced men.

To explain the reason for this demand, let's go back fifty years when life was uncomplicated, nobody knew about electronics and few had even heard of a mysterious new thing called wireless, except for some experimenters who either knew what they were doing or were trying to learn.

But with the extension of technology equipment grew more complicated and so did the job of operating and repairing it. The man who built the first radio knew how to operate and repair it. But someone had to train the man who bought the second set.

From that hazy beginning has grown

the industry known today as technical writing. Every item of complex equipment, whether civilian or military, electronic or mechanical, must be accompanied by operating instructions and maintenance information, most of it produced by technical writers. In a real sense, the technical writer is the interpreter between the engineer who designed the equipment and the layman who will use it. He thus must be able to speak and write the language of both groups.

As the 1960s open, industry is feeling a real pinch for tech writers. Experts in military technical writing, for instance, say there are not enough qualified men in this country to produce the handbooks and manuals needed for just one major weapon system—and our arsenal is by no means limited to a single system. The result is a wide-open door of opportunity for anyone who wants to be a technical writer.

Technical writing team confers with engineer (second from left) about a new plant development.





Douglas Aircraft tech writers once worked under desert sun at White Sands (and secretly enjoyed it) while office was being finished.



Two men in foreground are a writer and a field service representative, going over details of service manual to be prepared by large firm.

In addition to defense needs, the civilian market must have instruction books and service manuals on nearly every item of equipment manufactured. Who will produce them? Technical writers.

To be a top technical writer in the electronics field you need some general knowledge of electronics and printing in addition to skill with words. Intuition and fast reactions won't hurt, either. We remarked earlier that there are many doors to the tech writer's office and several ways to open each one. In general, suitable training and a year or two of practical experience usually qualify you as a junior writer. The average salary in the West Coast defense industry at this level is \$100 a week and in other areas varies according to local conditions. After this start, the rest is up to you.

There are different educational approaches to technical writing but most experts in the field agree, strangely, that special courses in technical writing are not one of the best. A liberal education without specialization is recommended, and especially valuable are courses in mathematics, physics, chemistry and basic electronics. English and journalism courses also are desirable.

A would-be tech writer should begin taking such courses in high school and



Tape recorder is used by a Boeing technical writer to collect information at the source for series of step-by-step maintenance books.



Library research is one of the less exciting parts of a tech writer's job, but an important one.

follow through in technical school, home-study courses or resident college training. Any one of these types of schools is capable of turning out top-notch candidates for technical writing.

If you plan to go to a vocational or trade school, take the electronics technology or engineering aide courses rather than the technical writing curriculum. The training you receive will be adaptable to more positions.

Another excellent background is amateur radio. Many companies consider several years of active ham experience equal to a considerable amount of formal training. At least one company (General Electric) has actively recruited technical writers from the ham ranks.

Once you become a junior writer, what can you expect?

Since nearly 90 per cent of technical writing today is for the military, we'll concentrate on that part of the field. There, each writer is assigned one book to prepare. If the book is a large or a complicated one, he may have assistants. They usually are junior writers.

On the job, the writer is frequently

responsible for the book from start to finish. He must outline the manual, gather all information to be included, verify the information for technical accuracy, write it in a manner understandable to the average service technician and, finally, see that it is set into type and printed properly. Along the way, he also originates all illustrations and checks them, although artists do the actual work.

His assistants may write individual sections of the book, may act as leg men hunting information, may run all sorts of miscellaneous errands connected with the publishing process and almost undoubtedly will do the proofreading.

After a year or so as an assistant, a junior writer can expect promotion to the level of technical writer. At this point, he's doing just about the same things as before. The difference is that now the responsibility is all his, and his paycheck is fatter. Later, he will have assistants.

A good electronics writer with five to ten years experience can make \$10,000 a year on the West Coast, slightly less in the East. Ad- [Continued on page 110]

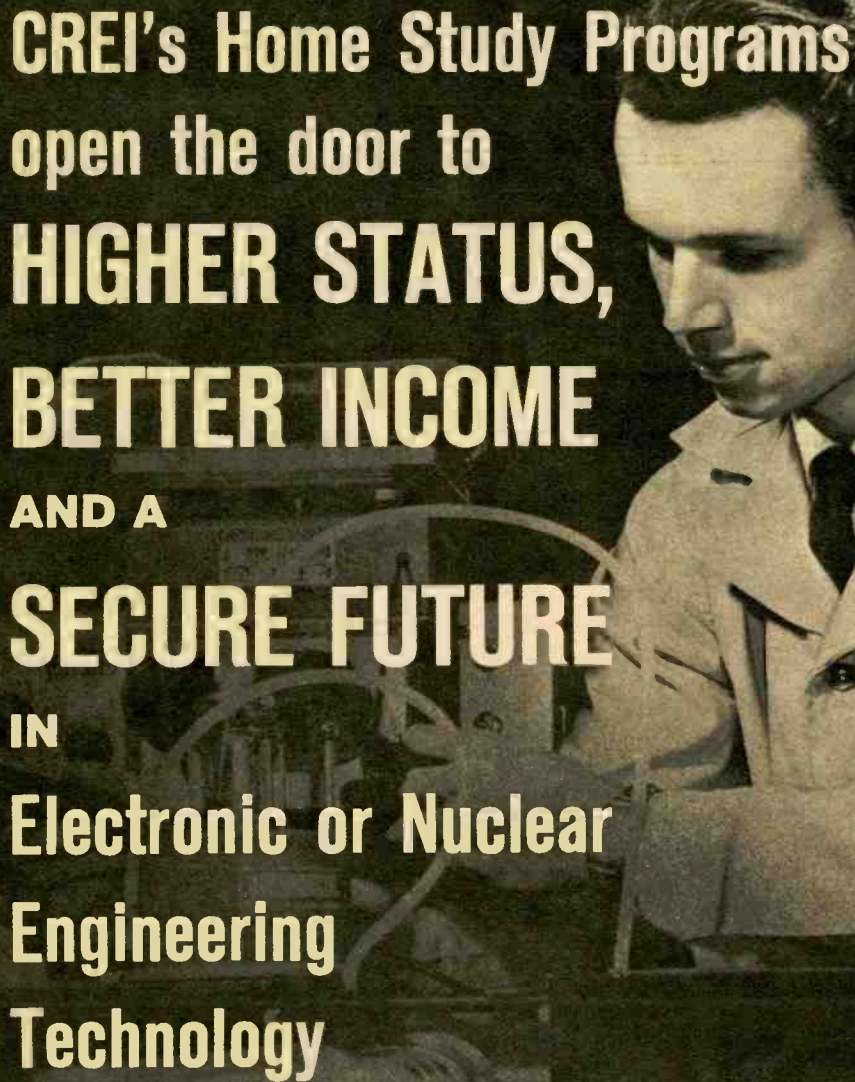

**CREI's Home Study Programs
open the door to
HIGHER STATUS,
BETTER INCOME
AND A
SECURE FUTURE
IN
Electronic or Nuclear
Engineering
Technology**

The world of science is the world of the future. Deep space probes and orbital satellites . . . air-transportable nuclear power plants for use anywhere on the globe . . . electronics and radioisotopes for use in medicine, agriculture and industry . . . missile systems for the armed forces . . . computers and data processing for finance, industry and government . . . developing these and hundreds of similar concepts will make our world a better place for all. You can have a career . . . or speed your present career . . . if you qualify for a CREI home study program in electronic or nuclear engineering technology . . . a program recognized everywhere as excellent insurance for a secure future, high professional stature, and better income.

CREI now offers you college-level programs combining the technological content of advanced residence courses with the convenience and economy of home study.

The proven fact that the demand for CREI graduates in recent years far exceeds the supply speaks for the recognized quality of a CREI education. Many leading electronic firms and government agencies visit CREI's Placement Bureau every year to hire graduates and students for their technical staffs.

There are now more than 20,000 CREI students in all the 50 states and most countries of the free world. You, too, can benefit from a CREI program while you stay in your present job. You study at home, when and as you choose . . . and you avoid the time and expense of commuting to a residence school. Within 2 to 4 years, depending upon the program you select and the time you have to apply, you can complete a CREI program in engineering technology. The home study courses are written in an easy-to-understand format, and your personal progress is carefully guided by experienced instructors.

CREI programs are designed to meet your present and future employment needs

CREI students frequently gain promotions and raises long before they complete their program. As a graduate you will find that you gain stature and respect among your professional colleagues and supervisors, and that you enjoy the personal satisfaction of work on interesting and important projects. Your employer will

recognize and reward your ambition . . . and your increased technical capabilities.

CREI is recognized and accredited by industry and government

Founded in 1927, CREI is one of the oldest technical institutes in the country. CREI co-founded the National Council of Technical Schools, and was one of the first three institutes whose curricula was accredited by the Engineers' Council for Professional Development. The U. S. office of Education lists CREI as "an institution of higher learning."

Over 50 electronic organizations actually pay *all or a substantial portion of the tuition* for employees taking a CREI Home Study program. Right now, there are 5,240 U. S. Navy personnel enrolled in the CREI extension program.

CREI conducts a residence school in Washington, D. C. for those who wish to attend classes. The regular program of 27 months leads to an AAS degree. No previous training or experience is necessary for the residence school.

Qualifications for enrollment in the home study program

If you have a high school diploma or the equivalent, and if you have some basic training or experience, you can qualify for a CREI program. Tuition is reasonable, and veterans can take advantage of the G. I. Bill.

SEND Attached Post Card for new 56-Page Catalog Without Obligation

Learn all about the promising future of electronics and nucleonics just published to include new courses being offered by CREI. This informative catalog discusses the electronic and nuclear industries, and answers searching questions about future manpower requirements and career opportunities. The catalog describes all the courses, the alternate programs . . . it introduces the faculty who will be guiding your progress . . . and it points out how the courses are designed for home study.

This catalog is free, and is of vital importance to every man wishing to progress in the field of science and technology. You owe it to your future to investigate this college-level, home study program as soon as possible.

CREI The Capitol Radio Engineering Institute

<i>Home Office:</i>	<i>England:</i>
3224 16th Street, N.W.	CREI London, Granville House
Washington 10, D. C.	132-135 Sloane Street, London, S.W. 1, England

Bargain Buys From Uncle Sam

New policy makes it easy for you to get surplus electronics gear for as little as 1% of the cost.

By James Joseph

THE BIG news in surplus electronics is Uncle Sam's new policy of consolidated sales, which makes it easier for you as an electronics hobbyist to obtain equipment no longer of use to the government. Surplus electronics gear has always been available theoretically to individuals (see December '59 *EI*) but disposal sales were so varied, scattered and unpredictable that it used to be easier to buy from a dealer rather than directly from the government. This, of course, made the equipment cost more because the dealer had to mark up the price to come out in the black.

As of late last year, however, the Department of Defense began a complete revamp of its huge surplus sales operation to make it easier for individuals and direct users to get in on the bargains. It all amounts to a gold-plated invitation to electronics hobbyists to buy government surplus at a small fraction of original cost.

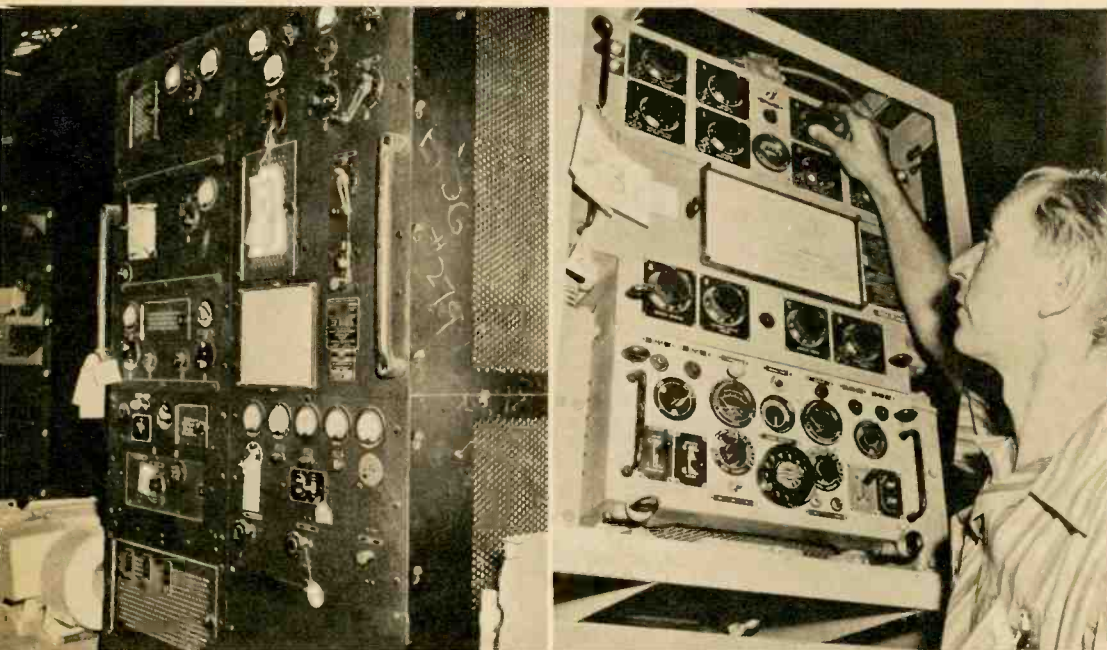

Surplus TBA-6 transmitter waits to be sold to high bidder. Similar TBL-6, originally costing \$8,560, recently went for \$27 bid.

This transmitter, listed in poor condition, would look good to the lucky bidder who can very likely haul it home for less than \$25.

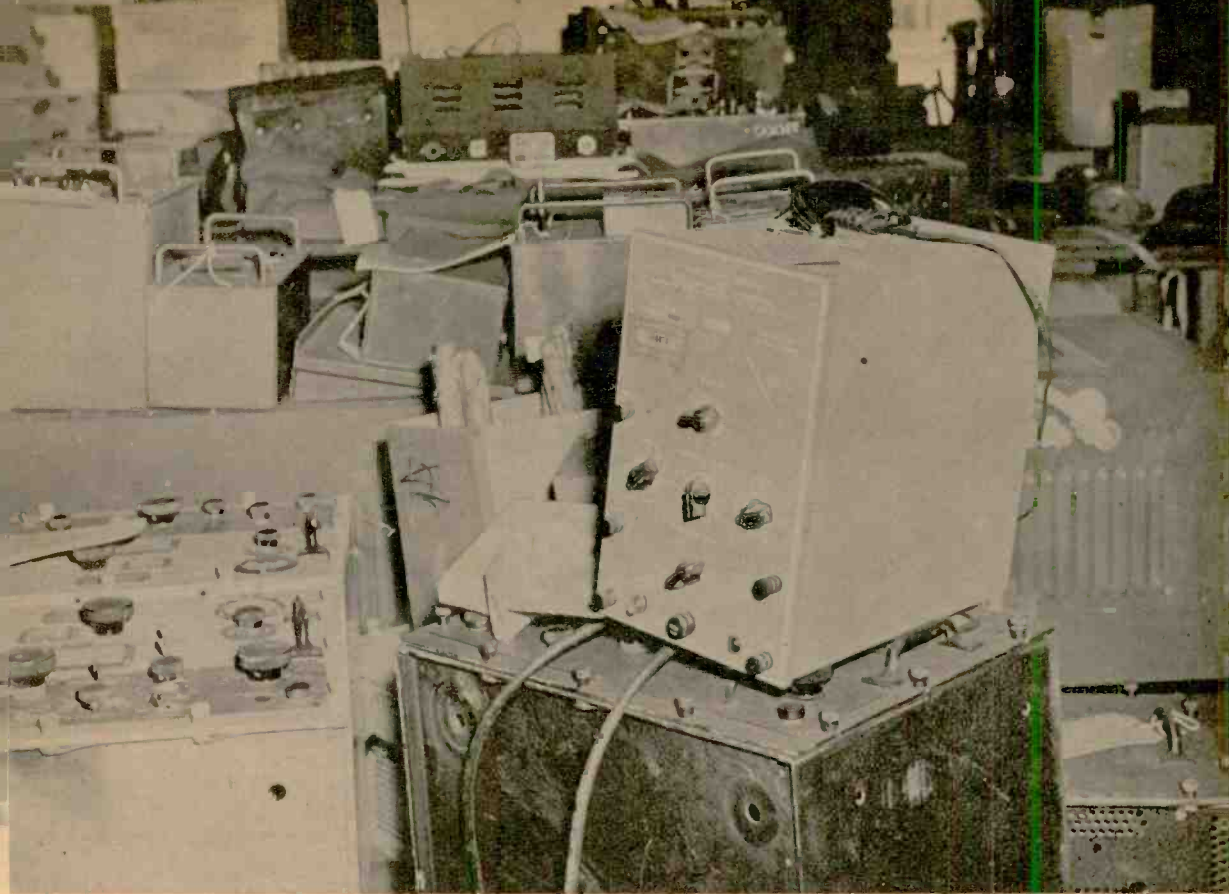

Electronics gear fills a warehouse at a newly organized Consolidated Surplus Office. In foreground is electronic switch, square-wave generator.

Invitation to Bid on surplus looks like this. Buyer writes in his offer, which should be the equipment's value to him, not based on original cost.

STANDARD FORM 1140 (11-60) 1140-856 (09-57) (2-60)
 AUGUST 1960
 Prescribed by General Services Admin.
 Federal Property Management
 Regulation No. 1

SALE OF GOVERNMENT PROPERTY
 INVITATION, BID, AND ACCEPTANCE
 (Continuation sheet)

ITEM	DESCRIPTION AND LOCATION OF PROPERTY	QUANTITY (Number or Units)	UNIT OF MEASURE	TO BE SUPPLIED BY BIDDER	
				PRICE BID PER UNIT	Other Price Bid Quantity Units
27	TRANSMITTER, Radio, Hand (TW-6) operating frequency, two-band, 175 to 500 KC/S and 2,000 to 18,100 KC/S. 250 watt power output, power required max. 415 V. DC. Mfg. Westinghouse Electric Co. Used, fair condition Acquisition Cost \$8,560.00	1	Each		27.00
28	TRANSMITTER, Radio, portable, field use. Frequency range 350 to 1,000 KC/S, 3,000 to 18,900 KC/S. On silver A1, A2, A3. Manual power output. Without motor generator set or gasoline engine generator for power. Used, poor condition Acquisition Cost \$3,200.00	1	Each		20.80
29	TRANSMITTER, Radio, floor mounted. Frequency 225 to 400 KC/S, 10 preset channels. Modulation A2, A3. Power output 30 watts non. Frequency crystal. Keying - relay keying max. speed 40 WPM. Modulation - 25% Power required 110/120/240 V. 50/60 cycles. 1-ph. ss. 0.87/0.955/0.99 4VA. Used, fair condition Acquisition Cost \$7,730.00	1	Each		12.50
	1430 SET, Mobile, fixed. Frequency 225 to 750 KC/S. Modulation A2, A3. ta. Pres-	1	Each		7.00



Elaborate portable tube checker is complete with cover at the left and a carrying strap. Other surplus checkers appear in foreground.

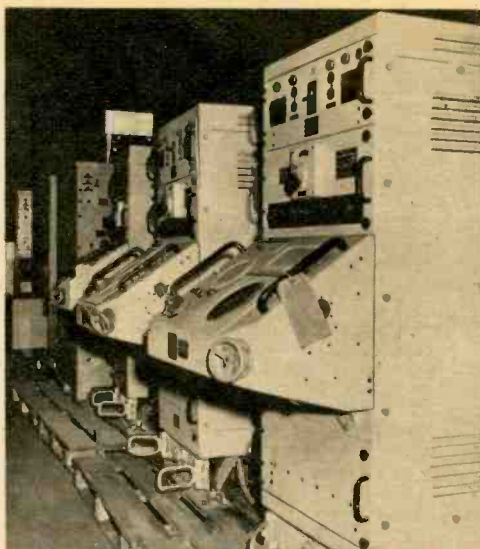

Sonar consoles are obsolete for the military but hobbyists may cannibalize them and use some of the components for their own projects.

Take a look at these bargains:

- Transmitter, radio. Frequency, 300 kc to 18.1 mc. Power output: CW, 125 watts; MCW, 35 watts; voice, 30 watts. Power: 230 volts DC. Used, good condition. Acquisition cost: \$2,860. *An electronics enthusiast bid \$17 . . . and came away with a bargain.*

- Receiver, radio. Frequency range 1.5 to 30 mc. Used, needs repair. Acquisition cost: \$6,300. *A ham in Oregon picked this one up for an unbelievable \$32.*

- Transceiver, mobile or stationary. Frequency, 1500 kc to 12 mc in three bands. Power output: 20 watts voice, 40 watts CW. Designed to work into 500-ohm load. Used, good condition. Acquisition cost (without power supply): \$2,000. *A teen-ager from Memphis handed in a \$32.32 sealed bid . . . and hit the electronic jackpot.*

Consolidation is the key word in Uncle Sam's big switch in handling surplus sales. The government is gathering the myriad Navy-Army-Air Force-Marine disposal depots under 35 Consolidated Surplus Sales Offices in 25 continental sales areas. Each CSSO has jurisdiction over all surplus electronics

in its area—regardless of what service or military base the items come from.

For instance, if you live in Minnesota, Wisconsin, eastern Iowa or northern Illinois and want to reach into Uncle Sam's electronics grab bag, you need contact only one CSSO sales point: Rock Island Arsenal, Rock Island, Ill. Previously, you were plain out of luck unless you had the time to contact a dozen different military bases.

Things are even easier for the fellow who lives in Oregon or Washington. The new CSSO at the Auburn General Army Depot, Wash., handles everything in the Pacific Northwest. And a single Naval Supply Depot in Newport, R. I., keeps track of all electronic surpluses in New England.

One top Defense Department executive has predicted a super-super CSSO facility, tentatively scheduled for Kelly Air Force Base, Texas, would reconsolidate all the consolidated offices and permit you to obtain from one office a list of every piece of electronic gear offered anywhere in the U. S. It might even happen!

A Naval disposal officer explains why the CSSO [*Continued on page 102*]

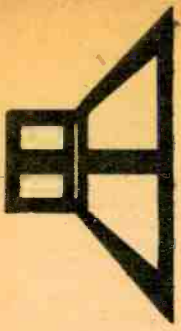

Speaker Leads

Identifying Speaker Types

To determine if a speaker is a PM (permanent magnet) or electro-dynamic (field coil) type, hold a compass in front of the speaker and turn on the radio. If the needle doesn't move, the speaker is a PM type. However, if the compass needle moves while the radio is warming up, and when switched off, the speaker is an electro-dynamic type.

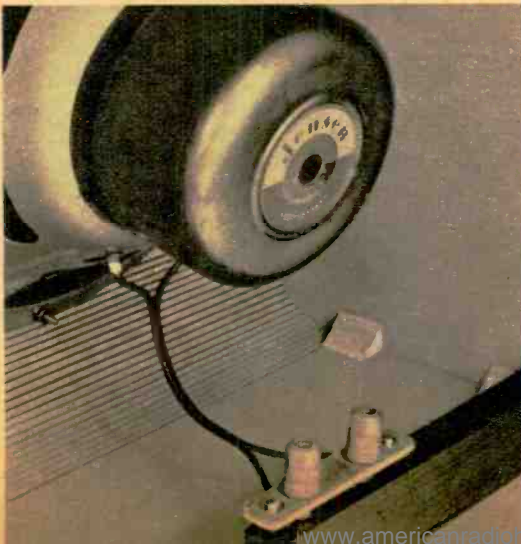
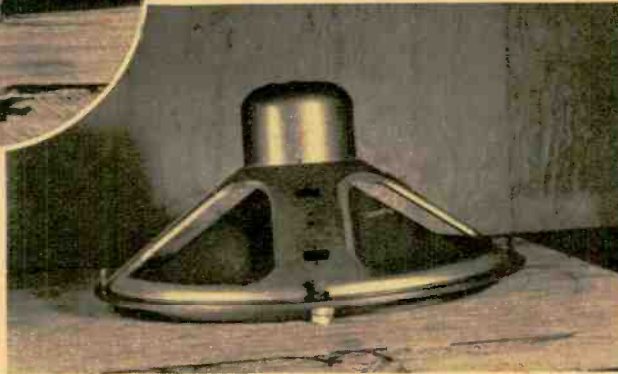
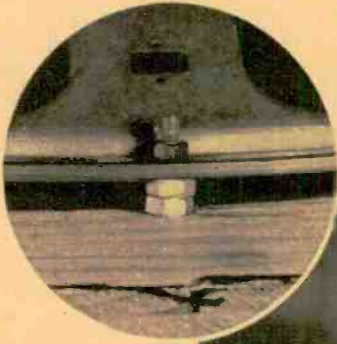

Speaker Mounting

If your speaker sounds excessively boomy after it's been mounted in its cabinet and you can't change the port size, try the trick shown above. Use some heavy washers or nuts to space the speaker about $\frac{1}{2}$ " back from the front panel. The boom will be gone and in all other respects the speaker's response will be unchanged.

Handy Connectors

For a time and trouble saver, install 5-way binding posts on a strip of composition board at the rear of a wall baffle. A pair of $\frac{3}{8}$ "-long standoffs serve to hold the strip off the surface of the cabinet. Ordinary lamp cord can be used to wire the posts to the speaker voice coil lugs.

Speed Mail Is Here!

Continued from page 70

dressed and delivered to a container. At this point humans come back into the picture to pick up the container and deliver the letters.

All the equipment just described was used by the Post Office Department in a test transmission between Washington, Chicago and Battle Creek, Mich. Each machine proved capable of handling one letter every four seconds, operating about 400 times faster than the facsimile units now used by wire-photo services.

Plans call for the use of Speed Mail as a preferred category (like special delivery) for an extra fee. If Congress approves, it could go into service by 1962 or thereabouts. About 71 big post offices at strategic locations would serve the major population centers. Businesses are expected to be prime users because the most complicated drawings, blueprints and charts may be transmitted via Speed Mail without error.

Although Speed Mail is predicated on the use of microwave transmitters or cable facilities, the possibility of using satellite bounce is not ruled out. This would be of greatest value for mail between California and New York or overseas. In a test, the Echo satellite was used to bounce a letter from Washington to Newark. The signal's path was from Washington to the radio astronomy telescope of the Naval Research Labs at Stum Neck, Md. From there it was beamed to 1,000-mile-high Echo and reflected to the Bell Labs receiving antenna at Holmdel, N. J. Cable took it to Newark's post office. This experiment was called Space Mail.

By adapting data machinery and modern conveyers to mail-handling, the post office hopes to make the inside work match the speed of Speed Mail. Without better handling inside Speed Mail would be like taking a one-hour jet flight between cities and then driving an hour and a half to get from the airport to the center of town (which is not exactly uncommon, as far as that goes).

There are five things that have to be done to mail after it is picked up from the box into which it has been deposited: 1) It is brought to the post office; 2) sorted into types (packages or letters); 3) the stamps are cancelled; 4) it is sorted as to destination; and 5) it is sent on its way to destination.

Each step takes a lot of time when done

by human hands. But in a new post office in Providence, R. I., all steps are automated, at least partially. The Providence office, newest in the country, is a kind of testing center where speedy handling methods are tried out. Similar post offices are to be built in other large population centers.

From the outside, the Providence building looks more like a hangar than a post office. A visitor takes one look inside and is struck by the absence of postal workers swarming over a processing floor. He sees only machines. Gone are the letter and package handlers (stompers, we used to call them), the sorters, stampers, cart-pushers and the others. In their places are conveyer belts and trays with built-in memories which stop at the right place, tables which vibrate letters and packages into separate channels and machines which face letters the right way for stamp cancellation. All this equipment is directed by some key supervisors sitting high up in a conning tower in the middle of the work floor.

Electronics enters this picture right at the beginning. When the mail is taken out of the sack it is fed to vibrating tables which separate the letters from the packages and send the letters into a culling and facing machine. Here, the letters are straightened and faced for cancellation. Photoelectric tubes scan the letter and note the position of the stamp. (If a letter has no stamp it goes to a reject line.) The photocells determine such things as whether the piece of mail is a letter or postcard and whether the stamp is in the upper right or lower left corner (if the letter is upside down). The photocells send letters with the stamp in the upper right to one cancelling line, the other letters to another.

After cancellation the letters are whisked into trays to which an electronic sensing element is attached. The trays move down the line until sensing tabs trip the matching electronic switch. At this point each tray is bumped off the conveyer and fed to the next stage, sorting.

The semi-automatic sorter is a data-processing step. As letters swish past an operator at 50 a minute she taps out on a memory core a three-letter code for each one according to destination. The memory system then takes over the movement of the letter and deposits it at the correct out box for bundling and distribution.

But electronics naturally is eager to hog the whole show. Now there's a new machine undergoing tests that may replace the semi-automatic sorter. This is an address reader which determines the destination of

the letter and sends it to the memory-conveyer. At present, this machine only reads capital and lower-case addresses (such as Chicago, Ill.), but under development is a system to read all-capital addresses, such as are found on magazines and business mail. This machine can sort more than 9,000 envelopes an hour for 40 destinations. It is transistorized.

To read the address of an envelope moving past its two slit windows, the machine uses small movable mirrors, a scanning wheel, more slits and photomultiplier tubes. As the envelope passes the first slit a light flashes onto the address, is reflected into the slit, hits mirrors and finally goes to a sensitive photomultiplier. The first slit is a position indicator which locates the bottom line of the address (the line that gives city and state) so it can be read by the mirrors and light beam of the second slit. The second slit's equipment moves into the right position to do its reading job according to the data from the first slit.

As the light reflected by the address line comes through the second slit it is bounced off mirrors and through a scanning disc. Here, the light representing the address is cut up into segments and ends up in photomultiplier tubes. What happens is that the machine cuts the city and state into several segments. For Arizona, the photo tubes may read A iz a, leaving out the r and on. This simplifies the amount of memorizing that the machine must do. The segments that do get through to the photo tubes are recognized by the machine's memory and the letter is routed accordingly.

Those addresses which, for one reason or another, cannot be properly read by the machine are rejected and handled by semi-automatic means.

There are many research projects in laboratories all over the country directed toward making our mail system as up-to-date as other communications. Better, faster mail service seems assured.

How To Repair Radios

Continued from page 55

of the sections of tuning capacitor C-2. The short will return to ground (common B-) through oscillator coil L-2.

We now arrive at the converter-mixer tube V-1. Although this is more complex than the three other stages, it is simple when broken down to its three basic functions. Briefly, V-1 generates an oscillator signal at pin 1 and mixes it with the RF carrier entering at pin 7. The resulting IF

signal appears at the plate (pin 5) and is sent through T-1.

To check out this stage first measure the plate, screen and cathode voltages (see voltage notations on schematic). If these appear to be normal, measure the voltage at pin 1, which is part of the oscillator circuit with L-2. A reading of -4 volts indicates that the oscillator section is working. If there is no voltage, then the oscillator circuit is at fault. However, remember that unless a 20,000 ohms/volt meter is used, you may not be able to measure the -4 volts. A meter with a lower input resistance may load down the oscillator circuit and prevent its operation. So, if all voltages on V-1 are normal and you suspect oscillator coil L-2, turn off the set and make resistance measurements of L-2. A simple way to determine if the oscillator is functioning (if you have a VTVM) is to measure the negative voltage on pin 5 of V-3 as you rotate the tuning capacitor. The meter needle will rise and fall as you tune through each station. If voltage and resistance checks reveal nothing, replace the 12BE6 (V-1) and check for operation.

Incidentally, the tuning capacitor itself can cause a good deal of mischief. You'll notice that as you turn the tuning knob, the movable plates in each section mesh with a set of fixed plates. These plates may be nicked or bent and will then touch each other and ground the oscillator or RF signal. As you turn, carefully observe the plates under a strong light to see if they are touching. If you discover the short, use the blade of a knife or a thin screwdriver tip to pry the plates apart or to remove nicks. Use extreme care in bending the plates for it is possible to cause further shorts in bending. Metal filings or other dirt between the plates may also cause a short. Use a small brush, blower, or a thin knife blade to remove this dirt. *Note:* An accurate check for short-circuits in the RF and oscillator section can be made with the ohmmeter. Disconnect one end of the loop antenna and connect your meter probes to the fixed and movable capacitor plates (at the trimmer lug) and rotate the tuning knob. As the plates mesh, the needle should read infinity. Any short will make the meter read zero ohms.

Loop antenna L-1 is another possible source of trouble. Since this is the point at which all signals enter, an open or short will stop reception. If, after changing V-1 there still is no reception, examine the loop antenna and make a continuity check with the ohmmeter.

We'll wind up our troubleshooting in the fourth and last article next month.

Ham Shack

Continued from page 59

able dot-and-dash code for radiotelegraph purposes, so why not phonetics? With as many hams now using voice as CW (Continuous Waves, keyed by hand to make dots and dashes), the need for a sensible list is urgent.

The alphabet heard most widely is the military one adopted in 1942. A new international list devised by the airlines recently is catching on slowly. It contains a minor weakness in Quebec for the letter Q. American and British operators pronounce this word kweebeck and to use the kwee sound means Q. However, by some European and all Frenchmen, Quebec is pronounced kay-beck. To American ears, this should be phonetic for the letter K, but isn't. It's K as in Kilo.

There is also a list drawn up by the American Radio Relay league, national ham organization.

For your guidance, here are all three lists. Tape this to the front panel of your receiver for quick reference.

Letter	Military	International	ARRL
A	Able	Alpha	Adam
B	Baker	Bravo	Baker
C	Charlie	Cocoa	Charlie
D	Dog	Delta	David
E	Easy	Echo	Edward
F	Fox	Foxtrot	Frank
G	George	Golf	George
H	How	Hotel	Henry
I	Item	India	Ida
J	Jig	Juliet	John
K	King	Kilo	King
L	Love	Lima	Lewis
M	Mike	Metro	Mary
N	Nan	Nectar	Nancy
O	Oboe	Oscar	Otto
P	Peter	Papa	Peter
Q	Queen	Quebec	Queen
R	Roger	Romeo	Robert
S	Sugar	Sierra	Susan
T	Tare	Tango	Thomas
U	Uncle	Union	Union
V	Victor	Victor	Victor
W	William	Whiskey	William
X	X Ray	Extra	X Ray
Y	Yoke	Yankee	Young
Z	Zebra	Zulu	Zebra

The Neighbor . . . Ham I know spent a pleasant Sunday putting up a new TV an-

tenna, tightening the connections on his small 10-meter beam and cleaning leaves out of the gutters. He'd washed up and was changing clothes when the phone rang. "Mr. Jones, your broadcasting is interfering with my television. Please stop," said the voice of the gal across the street.

Understandably flabbergasted, since he hadn't been on the air and his transmitter had never caused trouble before, he held his anger and asked the caller how she knew the trouble was his fault.

"You're the only amateur on the block, and I just saw you on your roof," was her reply.

"Is the interference still there?" Told it was, friend ham went right over. The screen was cut up with irregular white lines. Mr. Jones also noticed that from the garden came the high-pitched whine of a motor.

"That's Henry trying out his new electric hedge trimmer," the woman said.

"Oh, it is, it is?" muttered Jonesy. "Suppose we ask him to come in a minute?"

The trimmer stopped and the screen cleared up instantly. The woman looked at Jones, at the TV set, at her husband and retreated in confusion.

Moral: Don't take unjustified TVI (television interference) complaints sitting down.

Hams and Cbers . . . Unlike amateur licensees, Citizens Band applicants are not required to familiarize themselves with regulations of the Federal Communications Commission. This has led to much confusion on the air, partly because of a failure to understand correct procedure. The FCC is now working to correct the oversight by circularizing applicants and licensees and warning them to obey the law. Here are some extracts from a recent FCC form letter:

"The Commission's monitoring stations are continuing to detect violations of the Citizens Radio Service rules and are issuing large numbers of citations to licensees. The violations fall mainly into two large groups—off-frequency operation and the use of Citizens Radio Service stations for communications which are not permissible under the rules. Most citations for improper use result from the mistaken belief that the Citizens Radio Service is similar to the amateur Radio Service with respect to permissible communications and that amateur-type communications (such as calling CQ, working distant stations for the fun of talking to someone far away,

communications for personal pleasure, etc.) are permitted. Nothing is further from the truth. Class A, Class B and Class D stations are authorized primarily to communicate with other units of the same station, and secondarily with units of other stations in the Citizens Radio Service only when required for the exchange of necessary messages related to the business or personal activities of the individuals concerned.

"Don't put your Citizens Radio transmitter on the air unless you have a message which you need to send."

Some hams who are also CB licensees would do well to heed the foregoing. When they switch from amateur to CB bands they tend to carry over their operating habits. The two services just aren't the same.



Dits and Dahs . . . Everyone thinks of dits and dahs as the Morse Code but, strictly speaking, this should be identified as the *International Morse Code*. When operators use the word Morse alone, they intend to refer to the American Morse Code, which was used for almost a century on land-line telegraph circuits. Today it is a virtually dead language, manual telegraphy having been replaced almost entirely by the teletypewriter.

International Morse is often also called Continental because it was used originally on the telegraph circuits of Europe. The major difference between the older Morse and the newer International is that in the former some of the characters had spaces (that is, silent periods) between assortments of dits. For instance, both C and R are represented by three dits, but C is ditdit dit, while R is dit ditdit. Confusing? Sure is. International Morse is easier to learn. All its letters are straight combinations of dits and dahs. 📡

Teaching Machine

Continued from page 32

various types of programmed techniques that have been developed or would be worked out by the schools themselves.

E. C. Estabrooke, educational director of American School, a home-study institution in Chicago with over 140,000 students, is conducting a parallel-group experiment to determine the effectiveness of a programmed teaching machine course in algebra as compared with the school's standard course.

International Correspondence Schools is

cooperating with Dyna-Slide Co., Chicago, makers of Vertimask, in programming a portion of an ICS course in Modern Supervision. The Vertimask device is used in a loose-leaf binder or a bound textbook containing program material and questions. All types and all sizes of questions are used: sentence-completion, multiple choice, true or false, etc. Line drawings or pictures also are employed.

After choosing an answer, the student unmask the program's answer and determines immediately whether he was right or wrong.

Fast strides are being made in the scrambled-text area. Doubleday & Co. has brought out four scrambled TutorTexts at \$3.95 each. They are an Introduction to Electronics, Arithmetic of Computers, Adventures in Algebra and The Elements of Bridge.

Crowder told *EI* that by the end of 1961 a complete first-year college course is expected to be available in TutorTexts dealing with algebra, chemistry, physics, differential equations and calculus.

Teaching Machines, Inc., Albuquerque, makers of the Wyckoff Film-Tutor (\$445), the Min/Max mechanical teaching machine (\$19.84) and a series of programmed textbooks (\$5 to \$15), offers programmed instruction in the fundamentals of music, algebra, descriptive statistics and modern Hebrew.

The programmed-learning surface has merely been scratched in the classroom. With teaching machines, students progress at their own rate and fast learners go deeper into a subject while slower students do the normal work.

The military services are helping advance automated teaching. Keesler Air Force Base at Biloxi, Miss., is using 14 of Western Design's AutoTutor Mark I machines to teach fundamental electronics and the Navy uses teaching machines to improve the proficiency of its electronics troubleshooters. (The Crowder-designed Mark II AutoTutor, a lower-priced version of the Mark I, is pictured on this month's *EI* cover.)

Industry is beginning to view teaching machines as the answer to in-plant training and industry-sponsored adult education. American Standard, plumbing fixture manufacturer, plans a Crowder-type course in fundamentals of plumbing; Polaroid will have programmed courses in languages and recreational photography for its employees. Eastman Kodak is programming courses for employees in use of the slide rule, economics, photography and other subjects and Bell Laboratories is set-

ting up an experimental program in basic electricity for its non-technical personnel.

The teaching machine, though a new concept, has gained wide acceptance in a short time and has aroused surprisingly little opposition. It is here to stay, and to help.

The MHD Revolution

Continued from page 77

cycle nuclear model uses an inert working medium, helium or argon, with 1% cesium seeding. This insures better conductivity, reduces the working temperatures required and helps control the chemical reaction with the structural materials, a problem which may be posed in the coal-fired system.

An output of 5,800 BTU/kw-hr. becomes possible—better than any conventional nuclear systems now operating.

Note that comparisons are given in number of British Thermal Units required to produce a kilowatt-hour of electricity. Therefore, the lower the BTU, the higher the efficiency.

MHD promises to have many other applications besides commercial power production. For example, some information being gathered on the generation of electric power is applicable to space propulsion, missile and satellite re-entry and controlled nuclear fission power.

The pilot planning has been done around the 450,000-kilowatt size generator and the same size has been used to figure all comparisons.

The present system of electric power production converts heat to steam, steam to electrical energy. Much of the original energy (heat) is wasted through radiation and other leaks. Therefore, our most efficient thermal electric power plants have an efficiency rating of only 37.5%. Improving technology may raise it to about 40%. By comparison, MHD delivers a thermal efficiency of 60% to 65% right at the start!

The cost of building MHD generator systems is estimated to be about the same as that for conventional generators at present but they will produce about 25% more electricity. One big hope is that research and development will take the relatively crude working model that has been built and in time achieve a highly refined piece of equipment which will cost less than conventional generators.

The result will be a growing efficiency in power production and, more important for you, a reduction in electric bills.

Bargain Buys From Uncle Sam

Continued from page 96

concept is so important to people like you and me. "Until now," he says, "the only people with time and know-how to visit the hundreds of surplus sites were dealers. With this new deal, however, one CSSO sales point in your area handles—and catalogs—everything regionally available.

"And now you can even get electronics bargains mail order!"

You can, too, under the sealed-bid system.

Disposal officers advise prospective buyers to inspect surplus before bidding, but you can in fact bid by mail sight-unseen. Better bet: if you can't get there, engage an appraiser to inspect the equipment, report its condition and advise you what to bid.

Electronic bargains seem to run the gamut from marine radar and aircraft receivers to such workbench essentials as voltmeters, tube testers and power supplies. You name it and Uncle Sam likely has it for sale.

The quality of surplus electronics gear varies greatly.

"Some items are like new and, in fact, have never been used," says a disposal officer in California. "Some others need extensive repair."

What does Uncle Sam expect to get for his surplus? Well, a few items return up to 40% of acquisition costs and the government would like at least a 10% return, but the fact is that surplus seldom brings more than 1% of original cost.

Consider a sound recorder which cost the government \$3,000 and was offered recently for sale. Somebody bid \$6.20 . . . and carted home a once-in-a-lifetime bargain. Or a \$500 voltage regulator. A high bid of \$15 got it. What of an unused control unit with an original cost of \$200? It went for \$5.50!

Sometimes highly specialized items go for truly astounding prices. A cathode ray tube indicator for sonar which had cost \$3,000 fetched but \$21.62 at San Diego. That was less than 1% of cost. But its new owner hadn't plunked down \$21.62 for sonar. As an electronics cannibal, he merely wanted the console's heavy-duty power supply, which now reposes on his basement workbench.

Is the government giving away electronics gear, squandering tax dollars? Actually, it may be saving money, by disposing of equipment whose repair costs

aren't, by government standards, economically justified.

Explains a disposal officer: "Generally, when repairs are estimated to exceed 65% of original cost the equipment is tagged for high-bid disposal."

Does this mean that electronic bargains consigned to a regional CSSO are junk? Not at all. Experts admit—and most government estimators concur—that Uncle Sam's cost of repair far exceeds the fix-it-yourselfer's.

"What a basement fixiteer can put back into working shape for \$100, we'd have to contract out for maybe \$300," explains a disposal officer.

Of course, plenty of Uncle's electronics bargains are that only to the fellow who can find use for odd-ball gear, or who's canny enough to convert military electronics to civilian use.

Recently, one amateur boatman picked up a \$2,500 radar indicating console for a mere \$7.10 and for not much more got a surplus Navy radar transmitter antenna. In all, he outfitted his new cabin cruiser with about \$5,000 worth of radar for less than \$200.

The popular ARC-5 and BC series of transmitters and receivers have been used on the ham band by many industrious amateurs. In most cases, only a proper power supply must be added to the surplus sets.

Some of the surplus VHF equipment can make good Citizens Band rigs and also can be used on the 10-through-1¼-meter ham bands.

Cannibalizing, or buying the equipment for its parts, is a popular sport.

But how do you get in on these bargains . . . from Uncle Sam? Begin by writing one or more of the regional CSSO offices (listed at the end of this article). A postcard will do. Tell them you're interested in disposable electronics equipment. By return mail you'll receive a Disposal Bidders List. On it are listed 20 categories of surplus gear.

Example: Communication equipment . . . and components.

Example: Electronic and electrical equipment . . . testing devices, parts, tubes.

Example: Repair Shop . . . and maintenance equipment.

You simply check one or more of the disposal categories, and thus put your name on the surplus-available list. Next time a sealed-bid sale is scheduled, you'll receive a comprehensive listing of every item—an Invitation to Bid.

The invitation, which may run to 50 or more pages and lists hundreds of electronics items, is really a bid contract. You'll

have anywhere from three weeks to several months to pick your items, personally inspect them if convenient and submit your bid (along with payment covering upwards of 20% of your bid).

In submitting a bid you enter into a contract and if you're high bidder you can't back out. Furthermore, you have agreed to pay the remainder of the price within ten days, accept the equipment as-is and where-is and provide for its transport to your home. Usually a high-bidder has from 14 to 30 days to pick up his equipment. Most CSSOs will load your gear on a rail car or truck at no charge. Some, for a crating fee, will box it and send it right to your home.

Ernest W. Jack, in charge of the new CSSO office in Southern California, advises: "Make a bid based not on what you think the other fellow may bid but on what the item is worth to you."

Typically, says he, a transmitter may have cost the government \$3,500, may have a market value of \$1,500 but may be worth \$2,000 to you. So bid \$2,000. Maybe its value to you is only \$50. Bid it. You may be surprised to find yourself the owner, and a lucky guy.

To get in on Uncle Sam's surplus bargains in electronics, write to the CSSO nearest you. Here are CSSO locations:

1. Washington-Oregon: Auburn Genl Depot, Wash.
2. N. California-Nevada: Oakland Naval Supply Cntr, Oakland, Calif.; McClellan AFB, Calif.; Sharpe Genl Depot, Lathrop, Calif.
3. S. California: Naval Supply Center, San Diego; Norton AFB, Calif.; Barstow Marine Corps Supply Center, Barstow, Calif.
4. Arizona: Davis-Monthan AFB.
5. Utah-Idaho-Montana-Wyoming: Clearfield Naval Supply Depot, Ogden, Utah.
6. Colorado-North Dakota-South Dakota-W. Nebraska-E. Wyoming: Pueblo Ordnance Depot, Colo.
7. New Mexico-W. Texas: Ft. Bliss, Tex.
8. SE. Texas: Kelly AFB.
9. NE. Texas: Ft. Worth Genl Depot.
10. Oklahoma: Tinker AFB.
11. Kansas-E. Nebraska-Missouri-W. Iowa: Ft. Leavenworth, Kans.
12. Minnesota-Wisconsin-E. Iowa-N. Illinois: Rock Island Arsenal, Ill.
13. E. Missouri-S. Illinois: Granite City Engineer Depot, Ill.
14. Arkansas-W. Tennessee-N. Mississippi: Memphis Genl Depot.
15. S. Mississippi-S. Alabama-Louisiana-W. Florida: Brookley AFB, Mobile, Ala.
16. E. Florida: Jacksonville NAS.
17. S. Georgia-S. South Carolina: Marine Corps Supply Cntr, Albany, Ga.
18. N. Alabama-E. Tennessee-N. Georgia-N. South Carolina: Atlanta Genl Depot.
19. North Carolina-S. Virginia: Norfolk Naval Supply Cntr.
20. Kentucky-West Virginia: Lexington Signal Depot.
21. Maryland-D. C.-N. Virginia: Ft. Holabird, Baltimore.
22. Ohio-Indiana-Michigan: Gentile AF Depot, Dayton; Columbus Genl Depot.
23. Pennsylvania-New Jersey-S. New York: Philadelphia Naval Shipyard; Ft. Dix, N. J.; Letterkenny Ordnance Depot, Chambersburg, Pa.
24. N. New York: Schenectady Genl Depot.
25. Maine-New Hampshire-Vermont-Massachusetts-Connecticut-Rhode Island: Newport Naval Depot.



50-WATT STEREO AMPLIFIER

Get the most from your stereo tapes, records, tuners, etc., with this top-of-the-line stereo amplifier and control center! Power-packed 50 watts (25 watts per channel); complete tone, balance and stereo/mono function controls; five stereo inputs plus separate monophonic magnetic phono; mixed-channel center speaker output for stereo "fill-in" or wiring sound to patio or other rooms. Superbly styled with luggage-tan vinyl clad steel cover. 31 lbs.

Kit Model AA-100.....\$84.95
 Assembled Model AAW-100.....\$144.95



STEREO-PHONO CONSOLE, ASSEMBLED OR KIT

Here's big stereo sound in a little package at low, low cost. Six speakers fill your room with rich stereo... two 12" woofers, two 8" speakers and two 5" tweeters. "Anti-skate" 4-speed automatic stereo/mono changer has diamond and sapphire styli. Complete controls, concentric volume and separate, dual bass and treble tone. Factory assembled and finished cabinet has genuine walnut frame, walnut veneer front and "wood-grained" sliding top; measures 31 3/4" L x 17 5/8" D x 26 3/4" H. 70 lbs.

Model GD-31
 (kit—includes completed cabinet).....\$129.95
 Model GDW-31 (assembled, ready to play) 149.95

NOW ONLY
HEATH
 BRINGS YOU
ALL 3!

1. HEATHKIT for do-it-yourself hobbyists.
2. HEATHKIT factory-built, ready to use.
3. HEATHKIT learn-by-doing Science Series for youngsters.



look forward to the



"WALKIE-TALKIE" CITIZEN'S BAND TRANSCEIVER

Ideal companion for the outdoorsman... for hunting trips, boating, sport car rallies, sporting events of all kinds! Talk to friends up to a mile away. No license required... anyone can use it... also complies with FCC regulations for licensed use in communicating with Class C Citizen's Band Stations. Features 4-transistor circuit, superregenerative receiver, crystal controlled transmitter. Powered by single long-life battery. Simulated black leather case with carrying case included. 3 lbs. (less battery).

Kit Model GW-30 each.....\$32.95
 Assembled Model GWW-30 each.....50.95



DELUXE CITIZEN'S BAND TRANSCEIVER

For boat, car, home or office! Features superheterodyne receiver with switch selection of crystal control of any one channel or continuous tuning of all 23 channels; automatic "series gate" noise limiter; adjustable squelch control; press-to-talk mike; 3-channel crystal-controlled transmitter; built-in power supply. AC and 6 or 12 vdc models available. 11 lbs.

- Kit Model GW-10 **\$62.95**
- Assembled Model GWW-10 **99.95**



6-TRANSISTOR PORTABLE RADIO KITS

Your all-summer entertainment companions! Both models feature vernier tuning; 6-transistor circuit; 4" x 6" speaker; prealigned transformers. 6 flashlight cells furnish power.

- Model XR-2P (plastic) . . . 6 lbs. **\$29.95**
- Model XR-2L (sim. leather & plastic) **34.95**



3-BAND MARINE RADIO DIRECTION FINDER

The DF-3 operates on marine beacon, standard broadcast and ship-to-shore bands to offer you both portable radio entertainment and reliable direction finding and weather forecasting facilities aboard your boat. Features: 9-transistor circuit; 6 flashlight battery power supply; preassembled, prealigned tuning section; new sense antenna for non-ambiguous bearings; lighted dial and tuning meter. 13 lbs.

- Kit Model DF-3 **\$99.95**
- Assembled Model DFW-3 **169.95**



TRANSISTOR DEPTH SOUNDER

For safer summer boating fun! Shows depth to 100'! Rotating neon light gives clear indications on hooded dial face. Powered by flashlight batteries. 10 lbs.

- Kit Model MI-10 **\$69.95**
- Assembled Model MIW-10 . **107.95**

happy months ahead of outdoor living with heath equipment



ORDERING INSTRUCTIONS: Include charges for parcel post according to weights shown. Express orders shipped delivery charges collect. All prices F.O.B. Benton Harbor, Mich. A 20% deposit is required on all C.O.D. orders. Prices subject to change without notice. Dealer and export prices slightly higher.

Please send the following items:

ITEM	MODEL NO.	PRICE

HEATH COMPANY

Benton Harbor 39, Michigan

Please send me the Free Heathkit Catalog

NAME _____

ADDRESS _____

CITY _____ ZONE _____ STATE _____

Order Direct by Mail or See Your Heathkit Dealer

Try These

Earphone Cushions

Those plastic and vinyl foam door-knob covers, sold in dime and variety stores make ideal cushions for standard magnetic earphones. These cushions also provide a better phone-to-ear seal which helps keep out extraneous noises. The door knob covers come in various colors, the writer used black ones to match the headbands.

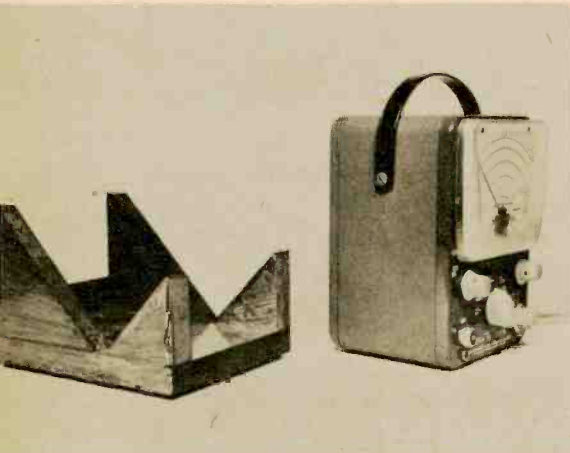

Easier-to-Read Meter

If placed in its normal upright position on a test bench, a VTVM can literally be a pain in the neck to the user, because he has to bend down uncomfortably to see the scales. The meter is easier to read if it is mounted in a simple cradle made of scrap pieces of wood, cut to 45 degrees and nailed to flat base. Furthermore, it is much less likely to be pulled over by its own leads.

Fast Breadboard

Simple transistor circuits can be assembled in a jiffy with a wire "breadboard." Connect parts to a frame of #16 fanned wire, which serves as the common or ground lead. The entire assembly can be mounted later on a more conventional chassis or board.

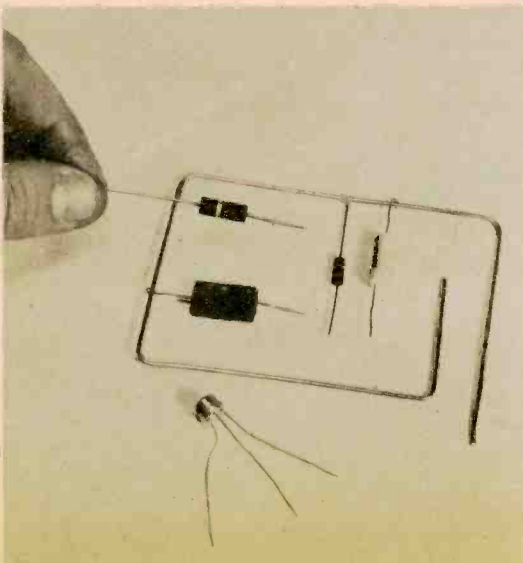

Electronics Illustrated

All About Electroplating

Continued from page 60

the plating solution. Eight or ten ounce plastic tumblers are suitable for very small work. Suspend the electrodes from opposite sides of the container.

For good results the object to be plated must be close in the galvanic series (Table 1) to the plate being deposited. Those metals farther separated in the galvanic series should have a base coat or strike plating applied to assure good results.

Grind, buff, and polish the part to be plated to obtain a smooth surface. Remove all grease or oil and wash thoroughly with a detergent. Avoid getting finger prints on the metal to be plated. Rinse the object to be plated thoroughly and insert in the plating solution while still wet.

As a first step in cleaning the material, connect the negative output terminal (J1) to the anode and the positive terminal (J2) to the cathode then set the OUTPUT ADJUST CONTROL (R1) for a current of about 2 amps per square inch of the cathode. The fine bubbles that come off the cathode aid in cleaning it. After a minute reduce the current to zero and reverse the connection to the electrodes. Turn control R1 until the plating current is about 125 ma per square inch of cathode area. Two to four hours will be required to obtain a suitable plating.

The plating will adhere better if a low current is used. If the current is too high the deposit will become grainy and will scale off. As you gain experience other chemicals can be added to the bath to obtain fine-grain deposits at higher currents, and to make a harder, brighter, and evenly colored plating. References such as *Handbook of Practical Electroplating* by Thomas G. Rodgers (Macmillan Company) and *Modern Electroplating* by Allen G. Gray (John Wiley and Sons, Inc.) include complete details on other plating solutions and how to use them.

Metals can be cleaned and etched by reversing the electrodes (anode negative and cathode positive) and old, worn plating can also be stripped from metal very easily by this method.

Small pieces of copper foil can be made by plating a smooth section of stainless steel. After the deposit is made, peel it off with a sharp knife.

After plating, the object should be washed thoroughly to remove all trace of the plating solution.

COMPLETE SERVICE TRAINING

... written so you can understand it!



Fix any TV or Radio Ever Made

EASIER - BETTER - FASTER!

No complicated theory or mathematics! These famous Ghirardi books get right down to brass tacks in showing you how to handle all types of AM, FM, and TV service work by approved professional methods. Almost 1500 pages and over 800 clear illustrations show how to handle every phase of troubleshooting and servicing. Each book is co-authored by A. A. Ghirardi whose manuals have helped train more servicemen than any other books or courses of their kind!

1—Radio and Television Receiver TROUBLESHOOTING AND REPAIR

A complete guide to profitable professional methods. For the beginner, it is a comprehensive training course. For the experienced serviceman, it is a quick way to "brush up" on specific jobs, to develop improved techniques or to find fast answers to puzzling service problems. Includes invaluable "step-by-step" troubleshooting charts that show what to look for and where. 820 pages, 417 illustrations, price \$10.00 separately.

2—Radio and Television Receiver CIRCUITRY AND OPERATION

This 669-page volume is the ideal guide for servicemen who realize it pays to know what really makes modern radio-TV receivers "tick" and why. Gives a complete understanding of basic circuits and circuit variations; how to recognize them at a glance; how to eliminate guesswork and useless testing in servicing them. 417 illus. Price separately \$9.00.

Special low price . . . you save \$2.00

If broken into lessons and sent to you as a "course," you'd regard these two great books as a bargain at \$100 or more! Under this new offer, you buy both books for only \$17.00 you save \$2.00. No lessons to wait for. You learn fast—and right!

STUDY 10 DAYS FREE!

Dept. PR-41, HOLT, RINEHART & WINSTON, INC.,
Technical Div., 383 Madison Ave.,
New York 17, N. Y.

Send books below for 10-day FREE EXAMINATION. In 10 days I will either remit price indicated (plus postage) or return books postpaid and owe you nothing.

Radio & TV Receiver TROUBLESHOOTING & REPAIR (Price \$10.00 separately)

Radio & TV CIRCUITRY & OPERATION (Price \$9.00)

Check here for MONEY-SAVING COMBINATION OFFER . . . Save \$2.00. Send both of above big books at special price of only \$17.00 for the two. (Regular price \$19.00 . . . You save \$2.00.)

SAVE! Send cash with order and we pay postage. Same return privilege with money promptly refunded.

Name _____

Address _____

City, Zone, State _____

Outside U.S.A.—\$10.50 for TROUBLESHOOTING & REPAIR; \$9.50 for CIRCUITRY & OPERATION; \$18.00 for both. Cash only, but money refunded if you return books in 10 days.

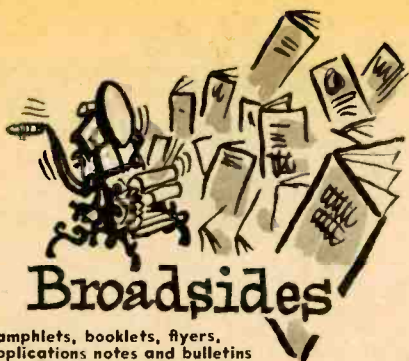

Pamphlets, booklets, flyers,
applications notes and bulletins
available free or at low cost.

THE 2N741 Mesa Transistor As a Power Oscillator and Class C Amplifier, a 4-page application note by Motorola which describes circuits using the low-cost mesa transistor. Available free from Technical Information Center, Motorola Semiconductor Products, Inc., 5005 East McDowell Road, Phoenix, Ariz.

An 8-page booklet describing the theory and design of the solid-state optical maser (light amplifier) is available free from H. W. Mattson, Bell Telephone Laboratories, Murray Hill, N. J.

A 144-page catalog listing science, mathematical and optical equipment, such as magnifiers, projection sets, microscopes, telescopes, spectrometers, etc. Available free from Edmund Scientific Company, Barrington, N. J.

Stereo Guide for 1961, a 160-page catalog giving product information and prices on stereo hi-fi and other audio equipment, is available free from Leonard Radio, Inc., 69 Cortlandt Street, New York 7, N. Y.

Tape Recording Head Reference Guide, containing information for repair, upgrading or conversion to stereo, is a 16-page booklet available free from Robins Industries Corp., 36-27 Prince Street, Flushing 54, N. Y.

Hoffman Semiconductor Product Application News contains illustrated articles on voltage regular diode surge ratings, the silicon uni-tunnel diode and solar cells used for voice transmission. Available free from R. S. Saichek, Advertising Manager, Semiconductor Division, Hoffman Electronics Corp., 3761 South Hill Street, Los Angeles, Calif.

An 8-page booklet by CBS Electronics describes characteristics and uses for CBS instrument (long-life) tubes which are specifically for instrument manufacturers. Identified as bulletin PA-391, it can be obtained by writing on company letterhead to CBS Electronics, Technical Information Services, 100 Endicott Street, Danvers, Mass.

Marine Band Converter

Continued from page 38

antenna change over. While the unit is receiving the marine band it is possible for some broadcast stations to cause interference. This is especially true of the high-power stations in the larger cities. Turning the "BC Trap" control will tune them out without affecting marine band reception.

The converter exhibits good sensitivity but it must be remembered that the power of most marine stations is below one hundred watts. This means that their range is somewhat limited. For its intended use (a fisherman's accessory), the converter will bring in valuable information from nearby fishing areas.

Machine-Taught Electronics

Continued from page 35

loran equipment. Then each was brought face-to-face with a piece of inoperative gear. Each test point had a tab stuck to it and the tab was marked with a three-digit code. When he decided to make a check, the technician set the code number of the test point into a small timing and sequencing device. If his choice duplicated the move programmed by an expert, a green light flashed on. If his selection was wrong no light came on and the technician would have to refer back to the problem materials and choose another check point. When the green light flashed, the technician turned to a special booklet that told him the results of the check he had just made in terms of voltage reading, waveform, etc.

Dr. Robert F. Mager, formerly with the Army's Human Research Unit at Ft. Bliss, Tex., set up an experiment in which programs were devised to teach the calibration of a strange (to the student) piece of military electronics gear. Dr. Mager believes that bare printed materials presented by programming methods can be used to teach even advanced lessons about equipment never seen by the students.

Some 70 per cent of the Army men in his experiment were able to set up and calibrate the gear perfectly the first time they saw it.

Electronics as an industry and as a hobby is just beginning to explore the possibilities of teaching-machine methods. As experiments are completed and additional programs developed, more people will be able to learn quickly and pleasantly.

FREE!

LAFAYETTE'S 1961 CATALOG 324 GIANT SIZED PAGES

The Complete Catalog Featuring
"The Best Buys In The Business"

- Stereophonic Hi-Fi Equipment
- Public Address Systems
- Tape Recorders
- Radio and TV Tubes and Parts
- Citizen Band Equipment
- Amateur Equipment
- Industrial Supplies







Send for Lafayette's FREE Catalog—the most complete, up-to-the-minute electronic supply catalog crammed full of everything in electronics at our customary down-to-earth money-saving prices.

CONTAINS HUNDREDS OF EXCLUSIVE LAFAYETTE ITEMS NOT AVAILABLE IN ANY OTHER CATALOG OR FROM ANY OTHER SOURCE — SEND FOR YOUR COPY NOW!

A "must" for the economy-minded hi-fi enthusiast, experimenter, hobbyist, engineer, technician, student, serviceman and dealer.



Our 40th Year

<p>NEW!</p> <p>29.95</p>  <p>RK-125 Transistorized Portable Tape Recorder with 80 Ohm Speaker</p>	<p>19.95</p>  <p>TE-15 Tube Checker</p>	<p>39.50</p>  <p>HE-20 Deluxe 6 Trans Band Transceiver</p>
<p>13.50</p>  <p>RW-60 20,000 Ohms Per Volt Multimeter</p>	<p>64.50</p> <p>KY-200, Kit</p>  <p>64.50</p> <p>5.00 Down</p> <p>Communications Receiver</p>	<p>79.95</p> <p>HE-10, Wired</p>  <p>79.95</p> <p>3.00 Down</p> <p>NEW!</p> <p>49.95</p> <p>2.00 Down</p> <p>HE-29</p> <p>9-Transistor Portable Citizen Band</p> <p>Two for 96.50</p> <p>3.00 Down</p>

EASY PAY PLAN—the simplest, and quickest way to get what you want when you want it. As little as \$2 down ... up to 24 months to pay.

LAFAYETTE RADIO

Mail the coupon today for your FREE copy of Lafayette Radio's 1961 catalog.

FREE!

Lafayette Radio Electronics Corp.
Dept. E10-1, P.O. Box 196
Jamaica 31, N. Y.

Send me the FREE Lafayette 324 page 1961 catalog 610

Name _____

Address _____

City _____ Zone _____ State _____

Black Light Communications

Continued from page 51

must be placed directly in the modulated beam, which is invisible to the human eye.

IT&T claims high reliability for its little portable UV sets. The beam the equipment transmits could carry up to 100 conversations at a time, although experiments thus far have been concentrated on mere two-way communications.

Earlier communications via light beams used low frequency or base band modulation and were limited to a single channel. IT&T's ultraviolet apparatus uses the high-frequency carrier modulation technique and is open to multiple-channel transmission.

The best wavelengths to be used for ultraviolet transmissions have not yet been defined because research is still pretty basic in the field. It might be noted that above microwave range, frequencies become so high and the numbers so large that they are not generally used. The measurement used is the other half of the equation, wavelength, and the unit of measurement is the angstrom, which is one hundred-millionth of a centimeter. The ultraviolet spectrum runs from about 4,000 angstroms to 100 angstroms. The usable section is thought to lie in the 4,000-1,800 angstrom range. Shorter wavelengths are extremely difficult to propagate.

In the IT&T application the transmitted message travels along the invisible ultraviolet ray to a photomultiplier and amplifier in the receiver. The light energy is converted to electrical energy to reproduce the transmitted message.

The UV system is so versatile that it can be adapted to handle messages from any kind of signal source. So far, IT&T has concentrated on voice transmission but teleprinters, computers and even telemetry systems are applicable.

Now let's look at some of the potentials. First, remember that ultraviolet is unseen by the naked eye, so it works (as does radio) with no visible evidence of its activity. Second, it is unaffected by most types of local interference which beset present-day short-range radio.

With these basic characteristics noted, it is easy to see an exciting future for this idea. For example, various phases of short-range military communications require secrecy and the system used must be jamproof. Then think of air-to-air, air-to-ground, ship-to-ship and ship-to-shore applications. In all these there are many times when radio silence is called for but

reliable communications are more important than ever.

Possible civilian uses are many. For instance, on construction jobs, a supervisor on the ground often finds it necessary to talk to a worker high on a building or across an excavation. Now they rely on blaring paging systems and a rat's-nest of telephone wires. An ultraviolet setup could solve the problem easily and neatly.

Simplicity and efficiency mark the design of the IT&T equipment. The transmitter weighs only a pound and the transistorized receiver two. The light source is a four-watt General Electric mercury vapor lamp with a transistorized driver operating on four 8-volt DC batteries, which work at full efficiency for about an hour and a half before they need recharging.

The receiver uses a nine-stage RCA photomultiplier (1P28) as a primary detection device. The rest of the receiver, even the high-voltage power pack for the multiplier, is fully transistorized.

Tests conducted with these units in the presence of high ambient fluorescent lighting (inside a building) indicate that a 4,000-cycle voice channel can easily be accommodated over path lengths of 500 feet. Additional voice channels can be added by means of subcarrier modulations. In bright daylight the 4,000-cycle voice channel can be handled up to 250 feet. Tests are under way to extend these ranges.

When it reaches a refined form, ultraviolet light transmission will offer a static-free, wireless communication system in a remarkably versatile, compact package. ●

Your Career as a Tech Writer

Continued from page 89

vancement opportunities include managing writing departments (\$10,000 to \$12,000 yearly), editing (about the same range), coordinating production (\$10,000 to \$15,000, depending on company and location) and general management (no limit if you're good enough).

In addition, some firms have a writing level known as the engineering writer. This man is usually a graduate engineer who can also write well, but the degree isn't always necessary. His job is to write engineering reports so that they will be understandable to management as well as to other engineers. His position is not clearly defined by a salary bracket, but he usually makes about the same income as the regular technical writer.

All these positions and salaries are

based on the assumption that you plan to work for an established firm in one of the firm's own facilities. In technical writing, a strange phenomenon known as the vendor shop exists. This is an establishment which specializes in writing alone, working on subcontract from equipment manufacturers. Salaries in vendor shops are usually several notches higher than in established firms but the job can end on an hour's notice.

In addition, some technical writing is done in the field, which may mean at a military base or a remote Arctic installation accessible only half the year. These jobs carry a bonus of about \$10 to \$15 a day.

Those are the facts on technical writing in electronics. Opportunities are many and varied and as our technology continues to grow, so will the need for skilled communicators.

DXing In Between

Continued from page 83

has been left. Business radio, a newcomer, is full of everything from dry cleaners to private detectives.

The most novel of the stations to be DXed are those belonging to the motion picture companies who need two-way radio while on location.

Other inhabitants of this little-known band are forestry conservation, highway maintenance, local government, federal government and forest products stations. Some European stations can be heard at times. These include aeronautical beacons between 33 and 38.6 mc, the TV audio for Caen, France, on 41.25, London's TV audio on 41.50 and various English TV audio transmissions on 48.25 mc.

One of the frequencies used by Sputnik I was 40.001 mc (many DXers picked up Sputnik's beeps). The band from 39.986 mc to 40.002 mc has been allocated for space and earth-space research. The frequencies 38 mc and 40.68 mc are being used by radio astronomy stations.

It's interesting to get verifications from stations in the 30-50 mc band and it can be done. Don't let anyone tell you it can't! First you must be able to identify the station you are hearing. This can be done by utilizing the registries published by the Communication Engineering Book Company, Monterey, Mass. These call books are published in four volumes. They list the

MICRO

ELECTRON TUBE

INTRODUCES FOR THE FIRST TIME
ANYWHERE A SELECT STOCK OF USED
TUBES AT A FABULOUS LOW PRICE

37¢
ea.

\$35 PER
HUNDRED
ASSTD.

Jen Surplus Tubest!

FOR any TUBE LISTED

ALL TUBES SENT POSTAGE PAID
Please send 25¢ handling for orders under \$5. Send 25% deposit on C.O.D. orders. Send approximate postage on Canadian and foreign orders.

MICRO

ELECTRON TUBE CO.

Dept. EI-4, P. O. Box 55 Park Sta., Paterson 3, N. J.

- Each and every tube is tested in our own laboratory for mutual conductance and life test.
- We guarantee FREE replacement for one year of any tube purchased from us which fails to function efficiently under any or all operating conditions. Prompt refunds are made on any defective merchandise.
- The advertised tubes are not necessarily new, but may be electrically perfect factory seconds or used tubes—each is clearly so marked.

0A2	6X8	6BH6	6SF5	7Z4	198CGG
0Z4	6Y2GT	6BJ6	6SF7	12A8	19J6
1A7GT	6Y4G	6BK6	6SK7	12AQ5	19T6
1B2GT	6A7	6BK7	6SR7	12AT6	19T8
1H4G	6A8	6BL7GT	6SL7CT	12AT7	24A
1H9GT	6AB4	6B8	6SR7GT	12AU6	25AVS
1L4	6AC7	6B0GT	6S7	12AU7	25BQ8
1L6	6AF6	6B2G	6S7	12AV6	25DN6
1L6	6AG7	6B2G	6T4	12AV7	25L6GT
1N5GT	6A05	6B2G	6T8	12AX4GT	25W4GT
1Q5GT	6A07	6B2G	6U8	12AX7	25Z5
1R5	6AH4GT	6B2T	6V6	12AX7	25Z6
1S8	6AH6	6C4	6W4CT	12BA7	26
1T4	6AH8	6C4	6W6CT	12BA8	35A5
1U4	6AL5	6C8	6X8	12BA7	35B5
1U8	6AL7	6C8	6Y8	12BE6	35C5
1V2	6AM8	6C8	6Y8	12BF6	35L6GT
1X2	6AM8	6C8	6Y8	12BH7	35W4
2A3	6AN8	6C8	7A4/XXL	12BQ6	35Y4
2A7	6AQ8	6C8	7A8	12BR7	35Z6GT
3BC5	6AQ8	6C8	7A8	12BY7	37
3BN6	6AQGT	6C8	7B4	12CA5	39/44
3C7C	6AS5	6C8	7B6	12J5	42
3C8G	6AS7	6C8	7B6	12K7	43
3CF6	6AT8	6C8	7B7	12L8	45
3C9	6AU4CT	6C8	7B7	12M7	50A5
3L4	6AU5GT	6D6E	7C4	12S6GT	50B5
3Q4	6AU8	6D8	7C5	12S7	50CGT
3S4	6AV8	6E8	7C6	12S8	50K6
3V4	6AV8	6E8	7C7	12SN7GT	56
4BQ7A	6AV8	6E8	7C7	12S7	57
514	6B5	6E8	7E7	12V6GT	58
5A5	6B5	6E8	7E7	12W6GT	71A
5A5B	6B5	6E8	7E7	12X4	73
5A7	6B5	6E8	7E7	12X3	78
5A7B	6B5	6E8	7E7	14A7/12B7	77
5AV8	6B5	6E8	7E7	14B7	78
5AW4	6B5	6E8	7E7	14C7	80
5BK7	6B5	6E8	7E7	18A4CT	84/8Z4
5B7	6B5	6E8	7E7	18A4CT	117Z3
5B7C	6B5	6E8	7E7	117Z6	117Z6
5B7D	6B5	6E8	7E7		
5B7E	6B5	6E8	7E7		
5B7F	6B5	6E8	7E7		
5B7G	6B5	6E8	7E7		
5B7H	6B5	6E8	7E7		
5B7I	6B5	6E8	7E7		
5B7J	6B5	6E8	7E7		
5B7K	6B5	6E8	7E7		
5B7L	6B5	6E8	7E7		
5B7M	6B5	6E8	7E7		
5B7N	6B5	6E8	7E7		
5B7O	6B5	6E8	7E7		
5B7P	6B5	6E8	7E7		
5B7Q	6B5	6E8	7E7		
5B7R	6B5	6E8	7E7		
5B7S	6B5	6E8	7E7		
5B7T	6B5	6E8	7E7		
5B7U	6B5	6E8	7E7		
5B7V	6B5	6E8	7E7		
5B7W	6B5	6E8	7E7		
5B7X	6B5	6E8	7E7		
5B7Y	6B5	6E8	7E7		
5B7Z	6B5	6E8	7E7		

FREE **GIANT 1961
204 PAGE
CATALOG**

B-A 1961
ANNUAL CATALOG #11

Guarantee

SINCE 1927

A Complete Buying Guide for Everything in
**RADIO TV
ELECTRONICS**

BURSTEIN-APPLEBEE CO.

Dept. E1, 1012 McGee St., Kansas City 6, Mo.
 Send Free 1961 B-A Catalog No. 611

Name

Address

City State

SEND FOR IT TODAY

SAVE UP TO 50% ON B-A SELECTED KITS

HI-FI AND STEREO SYSTEMS & COMPONENTS

TOP VALUES IN POWER AND HAND TOOLS

30 PAGES OF BARGAINS NOT IN ANY OTHER CATALOG

here's help...



Ably assisted by Joseph Marshall and Norman Crowhurst, Author Don Hoefler shows you how to select your original hi-fi system, improve it, or convert to stereo most economically.

AT YOUR FAVORITE NEWSSTAND

To order direct, send 75 cents plus 10 cents per copy for mailing to FAWCETT BOOKS, Dept. E1-4, Greenwich, Connecticut. No Canadian orders.

names and addresses of station licensees, plus operating frequency and type of equipment. One volume covers industrial stations (utilities, forest products, VHF maritime, etc.), another covers public safety stations (police and other local governmental stations), another covers transportation systems (taxicabs, trucks, etc.) and still another lists common carrier and miscellaneous systems (telephone companies, studio-transmitter links for TV, business stations, etc.).

Once you have identified the station you have heard you are ready to write up a detailed reception report which should include the date, time (give both the local time at your station and the time at the station being reported to), the call letters of the station worked by the station you heard, the quality of the reception and the type of receiving equipment (including antenna) at your station. Never give details of what was actually said over the air during any of the contacts made by the station. If you do you'll not only be breaking the law, you'll kill your chances for a verification. Always include a prepaid, self-addressed reply card for the station to fill in and return to you. Send your report to the communications supervisor.

This band can be received in whole or part by many of the better communications receivers (S-40, SX-62A, NC-109, NC-188, HRO-60, etc.) and several reasonably priced 30-to-50-mc-only sets (Monitoradio M-40, MR-33, DR-200, PR-31, PR-35 models, Hallicrafters S-82, S-94, others). Check your local police regulations before you attempt to use one of these receivers in your car. Some communities don't allow it. In some states it is a misdemeanor to have in your car equipment capable of tuning in police broadcasts. In others this is permitted if the equipment has this capability only incidentally as part of a mobile amateur station, CAP station, or other legal and licensed use. The reason for this is obvious. The laws do not prohibit your having any kind of receiver in your home.

Although communications are carried on utilizing FM, the author has DXed across the country on this band while using an AM receiver. All you have to do is tune the receiver slightly to one side for IF slope detection.

Although transmissions here are almost all from vertically polarized antennas and better results can be obtained from similarly polarized receiving antennas, a long horizontal wire will do a satisfactory job. Happy listening!

RF Signal Generator

Continued from page 48

known frequency at the high end of the dial. Turn the generator vernier until you hear a heterodyne whistle, which should lower in frequency, disappear, then rise in frequency. Mark the frequency of the broadcast station on the vernier dial at the point where the heterodyne whistle becomes a growl and disappears. Repeat this process at the low end of the dial and at one or two other places in between.

Operation

RF transistor Q1, operates in a simple feedback oscillator circuit whose frequency is controlled by the parallel L/C tuned circuit made up of L1 and variable capacitor C3, C4. The output of Q2 (in a common-base Colpitts audio oscillator configuration) is coupled through T1 to mixer diode CD1 where it modulates the RF output of Q1. Potentiometer R6 is the output attenuator. Modulation control R8 adjusted for a clean audio tone.

Ruggedize Your Rig

Continued from page 44

During manufacture, ruggedized tubes are subject to rigid quality controls. Their heaters are extra-heavy, their micas have additional contact points to decrease vibration and shock and their plates have extra-large wings for heat dissipation. Factory testing is rigid and complete.

With some exceptions, ruggedized tubes cost about the same as their standard equivalents. Some few are even cheaper. One supply-house catalogue lists the 6BJ6 at \$1.37 and its ruggedized version at \$1.26.

Manufacturers don't supply these tubes with their equipment because they are not generally available at radio-TV shops and could cause customer inconvenience when replacement becomes necessary. They are, however, available through major electronics supply companies and bear the labels of Sylvania, RCA, CBS Electronics, General Electric, Tungsol and Raytheon.

In the chart we have listed the ruggedized versions of some of the more common standard tubes. Most of these are directly interchangeable, with no rewiring or realigning necessary. There are exceptions, however, and these have been noted. Next time a tube goes out in your ham, CB or SWL gear, try a ruggedized replacement.

—Tom Kneitel

You can ...

PICK UP A HUMAN HAIR

with these
precision-machined points



Specially
Designed

CHANNEL LOCK[®]

No. 738 Long-reach

Round-Nose Plier

A precision gripping tool for precision work ... the CHANNELLOCK No. 738 Round-Nose Plier. Gives you a long slim, firm grip in tight places you can't reach with other pliers. Hundreds of uses on electrical, radio, TV, Hi-Fi and all other types of electronic work. Comfortable, blue-plastic grips. Top quality, polished forged steel. Ask your tool supplier for a CHANNELLOCK No. 738 Round-Nose Plier. If he's out of them, ask him to order one for you.



Write for Catalog of
Complete Line of Pliers

CHAMPION DEPARTMENT TOOL COMPANY
Meadville, Pennsylvania

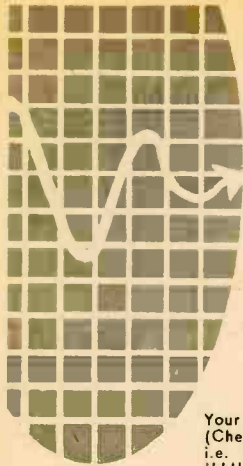

ELECTRONICS ILLUSTRATED

Classified Ads

Your advertisement can reach this mail-buying audience for only 40¢ per word . . . payable in advance (Check or M.O. please). . . minimum 10 words. Closing dates are the 20th of 3rd preceding month i.e. copy for the July issue must be in our office by April 20th. Mail to ELECTRONICS ILLUSTRATED, 67 West 44th St., New York 36, N. Y. Word count: Zone number free. Figure one word: Name of state (New Jersey), name of city (New York); sets of characters as in key (14-D); also abbreviations as 35MM, 8x10, D.C., A.C.

SAVE MONEY • ORDER BY MAIL

• • • FOR SALE

INFRA-RED SNOOPERSCOPIES!! Optics, Lamps, Parts. World's largest stock Infra-red components. Write for FREE Infra-red Catalog. McNeal Electric & Equipment, Dept. EI-4, 4736 Olive, St. Louis 8, Mo.

EXCELLENT BUYS on Tubes and equipment all listed in the "Green Sheet." Send .25¢ for your copy today. Cash paid for unused tubes. Write. Barry Electronics Corp., 512 Broadway, Dept. EI, NYC 12, NY.

BUY GOVERNMENT Surplus: Electronics; Test Equipment; Oscilloscopes; Transceivers; Radiotelephones; Jeeps; Boats; Aircrafts; Misc.—Individuals can now buy direct from Govt.—Send for: "U. S. Depot Directory & Procedure" \$1.25. To: Brody Surplus, Box 425-EL, Nanuet, New York.

"MAGIC" MULTIPLYING "Machine," with understandable instructions, \$1.00. "Slipstycck," 1725 Farmers, Tempe, Arizona.

BOOKS—ALL 10¢, 2000 titles, all subjects, catalogs free. Cosmay, Clayton, Ga.

• • • PRINTING, MULTIGRAPHING, MIMEOGRAPHING

RUBBER STAMPS. You name it; we'll stamp it. 11¢ word, 88¢ minimum. Cox, 463 B St., Ashland, Oregon.

• • • BUSINESS OPPORTUNITIES

GROW MUSHROOMS. Cellar, shed and outdoors. Spare, full time, year round. We pay \$4.50 lb. dried. We have 29,000 customers. Free Book. Mushrooms, Dept. 315, 2954 Admiral Way, Seattle, Wash.

VENDING MACHINES—No selling. Operate a route of coin machines and earn high profits. 32-page catalog free! Parkway Machine Corp., Dept. 33, 715 Ensor St., Baltimore 2, Md.

• • • HI-FI

COMPONENTS, RECORDERS. Free Wholesale Catalogue. Carston, 125-G East 88, NYC 28.

HI-FI AND stereo diamond needles. American, famous brand. Any style. Guaranteed, only \$2.55 postpaid. Dealer inquiries invited. Damco, Box 178, Route 6, Mansfield, Ohio.

• • • EMPLOYMENT OPPORTUNITIES

PRINTING - ADVERTISING SALESMEN. Excellent moneymaking sideline selling Decalcomania Name Plates. Advertising Specialties. Sign letters, Automobile initials. Free Samples. "Ralco"—EI, Box L, Boston 19, Mass.

• • • TAPE RECORDERS

LEARN WHILE Asleep with your recorder, phonograph or amazing new "Electronic Educator" endless tape recorder. Details free. Sleep-Learning Research Association, Box 24-EI, Olympia, Washington.

TAPE RECORDERS Hi-Fi Components. Sleep Learning Equipment, tapes. Unusual values. Free Catalog. Dressner, 1523Z Jericho Tpke., New Hyde Park, N. Y.

NEW CONCEPT of self-hypnosis teaches you quickly, easily. New tape! New record! Free literature. McKinley-Smith Co., Dept. T-3, Box 3038, San Bernardino, Calif.

RENT STEREO Tapes—over 1500 different—all major labels—free catalog. Stereo-Parti, 811-AY Centinela Ave., Inglewood 3, California.

• • • RADIO & TV

FREE! GIANT wholesale catalog on electronics, Hi-Fi, transistor, scientific, hobby, optics, photographic, housewares, jewelry, tools, novelties, toys. Write: Lektron, 241B Everett Ave., Chelsea 50, Mass.

HIGHLY EFFECTIVE Home-Study Review For FCC Commercial Phone Exams. Free Literature. Wallace Cook (EI-4), Box 10634, Jackson 9, Miss.

16 TESTED TRANSISTOR Plans, Flyer, Catalog—all 25¢. Laboratories, 1131-K Valota, Redwood City, California.

SAVE ON Citizens Radio, Dealer Discounts—Write Promotion Engineering, Box 84, Waseca, Minnesota.

TV SCHEMATICS & Service Guide. Each Schematic measures 11" by 24" covering 20 Manufacturers' lines—over 200 Chassis and 700 models. Indexed and easy to read. A "Must" for all Television Servicemen and Do-It-Yourselfers. Send \$1.00 to Dept. R9A. National Business Journals, 280 Madison Avenue, New York, N. Y.

FREE! 1961 CATALOGS for newest, best electronic bargains available. Stereo, hi-fi, ham radio, 1000 other items. Alco Electronics, Lawrence 4, Mass.

DIAGRAMS FOR Repairing Radios, Television \$2.00. Give make, model. Diagram Service, Box 672EI, Hartford 1, Conn.

• • • EDUCATION & INSTRUCTION

ENGINEERING EDUCATION for the Space Age. Northrop Institute of Technology is a privately endowed, nonprofit college of engineering offering a complete Bachelor of Science Degree Program and Two-Year accredited technical institute curricula. Students from 50 states, many foreign countries. Outstandingly successful graduates employed in aeronautics, electronics, and space technology. Write today for catalog—no obligation. Northrop Institute of Technology, 1116 West Arbor Vitae Street, Inglewood 1, California.

• • • INVENTIONS & INVENTORS

INVENTORS! YOU can market and protect your invention without the costly time and expense involved in patent procedures. For information, write to Prometheus, Box 1341, Akron 8, Ohio.

• • • PERSONAL

NEED WORLDS Of Help? Borrow up to \$600 for any purpose entirely by mail. Repay in 24 monthly payments. Write for free loan application: World Finance Co., 620 Symes Bldg., Dept. 31-AS, Denver 2, Colo.

• • • DETECTIVES

DETECTIVES—WORK Home—Travel. Experience unnecessary. Detective Particulars free. Write, Wagner, 8-125 West 86th, New York 24.

THE SIGN OF RAD-TEL'S QUALITY PERFORMANCE

BUY DIRECT FROM
RAD-TEL!!
ORDER RAD-TEL'S
FIRST QUALITY TUBES TODAY!
NOT USED!! NOT PULLED OUT OF SETS!!

SERVICEMEN: HUGE SAVINGS!! COMPARE!!
FAST ONE DAY SERVICE.



GUARANTEED ONE FULL YEAR UP TO 75% OFF ON BRAND NEW TUBES

SEND FOR FREE TROUBLE SHOOTER
GUIDE AND NEW TUBE & PARTS CATALOG

TRANSISTORS — AT FABULOUS DISCOUNTS					
PRICE	TYPE	RETRNG	ELECTRICAL CHARACTERISTICS	hfc	
<input type="checkbox"/> RF 49¢ ea.	GE PNP ALLOY JUNCTION GENERAL PURPOSE RF/AF	200 MW	1CBO max. 20 ma VCB = -2V	1EBO max. 20 ma VEB = -3V	VCE = -1.5 lb = 5 ma 20 min
<input type="checkbox"/> AF 39¢ ea.	Power AF Mgd. Freq. to 5		20 ma VCB = -2V	20 ma VEB = -16V	VCE = -1.5 lb = 1 ma 40 min
<input type="checkbox"/> 80¢ ea.	Hi Power 15 AMP to 36	MIN. POWER OUTPUT 2.26 W	40 ma VCB = -100	40 ma VEB = -100	VCE = -1.5 lb = 1 ma 30 min

SILICON RECTIFIER

35 AMP
50 PIV
(max. 20 ma)
\$2.50 ea.

Lots of 40
\$2.25 ea.
(No Hardware)

NOT AFFILIATED WITH ANY OTHER MAIL ORDER TUBE COMPANY

RAD-TEL TUBE CO.

55 CHAMBERS STREET, NEWARK 5, N. J. DEPT. EI-461

TERMS: 25% deposit must accompany all orders, balance COD. Orders under \$5: add \$1 handling charge plus postage. Orders over \$5: plus postage. Approx. 8 tubes per 1 lb. Subject to prior sale. No COD's outside continental USA.

EACH TUBE INDIVIDUALLY & ATTRACTIVELY BOXED

Qty.	Type	Price	Qty.	Type	Price	Qty.	Type	Price
—	024M	.79	—	6AW8	.89	—	12AF6	.49
—	1AX2	.62	—	6AX4	.65	—	12A16	.46
—	1B3GT	.79	—	6AX7	.64	—	12A15	.45
—	1DN5	.55	—	6BA6	.49	—	12A18	.95
—	1G3	.73	—	6BC5	.54	—	12AQ5	.52
—	1J3	.73	—	6BC7	.84	—	12A16	.43
—	1K3	.73	—	6BC8	.97	—	12A17	.76
—	1L6	1.05	—	6BD6	.51	—	12AU6	.50
—	1LM5	.59	—	6BE5	.55	—	12AU7	.60
—	1R5	.62	—	6BF6	.44	—	12AV5	.97
—	1S5	.51	—	6BG6	.66	—	12AV6	.41
—	1T4	.58	—	6BH6	1.65	—	12AV7	.75
—	1U4	.57	—	6BH8	.87	—	12AX4	.67
—	1U5	.50	—	6BJ6	.62	—	12AX7	.63
—	1X2B	.82	—	6BK7	.85	—	12AX7	.86
—	2AF4	.96	—	6BL7	1.00	—	12B4	.63
—	3AL5	.42	—	6BN4	.57	—	12B6	.50
—	3AU6	.51	—	6BN6	.74	—	12B06	.50
—	3AV6	.41	—	6BQ5	.65	—	12BE6	.53
—	38A6	.51	—	6BQ6GT	1.05	—	12BF6	.44
—	38C5	.54	—	6BQ7	.95	—	12BH7	.73
—	38F6	.52	—	6BR8	.78	—	12BL6	.56
—	38N6	.76	—	6BU8	.70	—	12B06	1.06
—	38U8	.78	—	6BV6	.54	—	12BY7	.74
—	38Y6	.55	—	6BZ6	.54	—	12BZ7	.75
—	3BZ6	.55	—	6BZ7	.97	—	12C5	.56
—	3CB6	.64	—	6C4	.43	—	12CA5	.59
—	3CF6	.50	—	6CB6	.54	—	12CN5	.56
—	3C56	.52	—	6C06	1.42	—	12CR6	.54
—	3CY5	.71	—	6CF6	.64	—	12CU5	.58
—	3DK6	.60	—	6CG7	.60	—	12CUE	1.06
—	3DT6	.50	—	6CG8	.77	—	12CX6	.54
—	3Q5	.80	—	6CM7	.66	—	12DB5	.69
—	3S4	.61	—	6CN7	.65	—	12DB8	.75
—	3V4	.58	—	6CR6	.51	—	12DL8	.85
—	4BC5	.56	—	6CS6	.57	—	12DM7	.67
—	4BC8	.96	—	6CU5	.58	—	12D06	1.04
—	4BN6	.75	—	6CUE	1.08	—	12DS7	.79
—	4BQ7	.96	—	6CY5	.70	—	12DZ6	.56
—	4BS8	.98	—	6D4	.71	—	12EL6	.50
—	4BU8	.71	—	6DA4	.68	—	12ED6	.54
—	4BZ6	.58	—	6DB5	.69	—	12EZ6	.53
—	4BZ7	.96	—	6DE6	.58	—	12F5	.66
—	4CS6	.61	—	6DG6	.59	—	12F8	.66
—	4DE6	.62	—	6DQ6	1.10	—	12FM6	.45
—	4DK6	.60	—	6DT5	.76	—	12K5	.65
—	4DT6	.55	—	6DT6	.53	—	12SA7M	.86
—	5AM8	.79	—	6EUB	.79	—	12SK7GT	.74
—	5AN8	.86	—	6EAB	.79	—	12SN7	.67
—	5AQ5	.52	—	6HG6T	.58	—	12SQ7M	.73
—	5AT8	.80	—	6J5GT	.51	—	12U7	.62
—	5BK7A	.82	—	6J6	.67	—	12VG6T	.53
—	5BQ7	.97	—	6K6	.63	—	12W6	.69
—	5BR8	.79	—	6S4	.48	—	12X4	.38
—	5CG8	.76	—	6SA7GT	.76	—	17AX4	.67
—	5CL8	.76	—	6SK7	.74	—	17B06	1.09
—	5EA8	.80	—	6SL7	.80	—	17C5	.58
—	5EU8	.80	—	6SN7	.65	—	17CA5	.62
—	5I6	.68	—	6SQ7	.73	—	17D4	.69
—	5T8	.81	—	6T4	.99	—	17D06	1.06
—	5U4	.60	—	6U8	.78	—	17L6	.58
—	5UB	.81	—	6V6GT	.54	—	17W6	.70
—	5V6	.56	—	6W4	.54	—	19AU4	.83
—	5X8	.78	—	6W6	.69	—	19B6G	1.39
—	5Y3	.46	—	6X4	.39	—	19T8	.80
—	6AB4	.46	—	6X5GT	.53	—	21EX6	1.49
—	6AC7	.96	—	6X8	.77	—	25B06	1.11
—	6AF3	.73	—	7AU7	.61	—	25C5	.53
—	6AF4	.97	—	7A8	.68	—	25CA5	.59
—	6AC5	.65	—	7B6	.69	—	25C06	1.44
—	6AH6	.99	—	7Y4	.69	—	25CUE	1.11
—	6AK5	.95	—	8AU8	.83	—	25DN6	1.42
—	6AL5	.47	—	8AW8	.93	—	25EH5	.55
—	6AM8	.78	—	8BQ5	.60	—	25L6	.57
—	6AN4	.95	—	8CG7	.62	—	25W4	.68
—	6AN8	.85	—	8CM7	.68	—	25Z6	.66
—	6AQ5	.50	—	8CN7	.97	—	35C5	.51
—	6AR5	.55	—	8CX8	.93	—	35L6	.57
—	6AS5	.60	—	8EB8	.94	—	35W4	.52
—	6AT6	.43	—	11CY7	.75	—	35Z5CT	.60
—	6AT8	.79	—	12A4	.60	—	50B5	.60
—	6AU4	.82	—	12AB5	.55	—	50C5	.53
—	6AU6	.50	—	12AC6	.49	—	50DC4	.37
—	6AU7	.61	—	12AD6	.57	—	50EH5	.55
—	6AU8	.87	—	12AE6	.43	—	50L6	.61
—	6AV6	.40	—	12AF3	.73	—	11Z73	.61

AMERICAN BASIC SCIENCE CLUB



A REAL SCIENCE COURSE

Developed with World Famous
SOUTHWEST RESEARCH INSTITUTE

The 8 manuals are expertly written, clearly illustrated, excitingly different.

NO EXPERIENCE NECESSARY

You can complete every project and **GAIN A VALUABLE SCIENCE BACKGROUND** that will **ENRICH YOUR LIFE** and could **SHAPE YOUR FUTURE!**



Analyzing Glowing Gases with the **SPECTROSCOPE**

Trouble Shooting with the **SIGNAL TRACER**

PHOTOMICROGRAPH of a Fly's Wing made with Microscope and Photo Lab (Actual Size 5" diameter)

A VALUABLE SCIENCE LAB

Containing Parts by **RCA, MALLORY, PYRAMID, STACKPOLE, TRIM** and other reliable manufacturers. Retail Value of Parts Alone is over **FIFTY DOLLARS**

MEMBERS ARE ENTHUSIASTIC!

I wish I could provide each of my Physics students with all of your enjoyable kits. You are doing a wonderful job.

Your course is very enjoyable and educational for all ages. I would not sell mine for twice the price.

Francis Pitcher
13 Friendship Dr.
Tivoli, New York

Allen T. Ayers, Physics Dept.
Jamestown High School
Jamestown, New York

FREE! These 6 Auxiliary Textbooks

FOR SAFETY!

Circuits use low voltage supplied by isolation transformer that comes with kit.



Sensational LOW COST SCIENCE LAB

NOW over 110 fascinating projects with

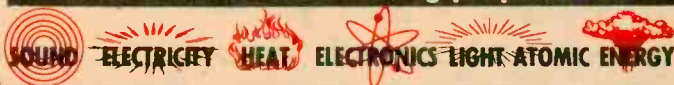

COMPLETE LABORATORY COMES IN 8 KITS, ONE A MONTH... SUPPLIES ALL THE EQUIPMENT FOR ALL THE FOLLOWING:

ELECTRICAL EXPERIMENTS

Educational fun with Electro-Magnets, Transformers, Galvanometer, Rheostat, Relay, Voltmeter, Wheatstone Bridge, and other electric equipment.

PHOTOELECTRIC EYE

Photoelectric Cell, Exciter lamp — and Electronic Relay. Everything you need to control motors, bells, alarms, and do other light beam experiments.

CODE PRACTICE SET

Signal Oscillator, Key and Flasher ...the complete outfit to learn to receive and transmit the Morse Code ...the first step to a Ham License.

RADIO SERVICE EQUIPMENT

All the parts to build your own Radio Signal Tracer and a Probe Light Continuity Tester. Both pieces are invaluable in radio servicing.

PHOTOGRAPHY LAB

Complete dark room equipment: Printer — Enlarger — Electronic Timer — Safe Light — Developing Trays and supply of paper and chemicals.

SPECTROSCOPE

Fascinating optical instrument used to identify and analyze substances by observing the spectrum of their flame. Spectrum charts are included.

ULTRAVIOLET LAMP

Produce dazzling color effects with invisible "black light". Used extensively for crime detection, mineralogy and science. Fluorescent ink, Crayon and Tracer Powder are included.

RADIO RECEIVER

Three Tube Short Wave (80 Meter) and Standard Broadcast Receiver. Sensitive Regenerative Circuit uses regular 115 volt AC. Complete with Head Set.

MICROPHONE

A sensitive carbon-button microphone that greatly amplifies unsuspected noise. Also adaptable for use with your radio transmitter.

STROBE LIGHT

A variable pulse neon lamp. "Freezes" motion of rapidly vibrating or rotating objects for close study and checking frequencies. RPM.

SOUND EXPERIMENTS

Laboratory demonstration of sound waves, resonance and pitch. Includes: Variable Frequency Oscillator, Sonometer and Rippla Tank.

SLIDE PROJECTOR

Takes 16mm and 35mm slides, sharp focusing, convection cooled. G.E. Projection Lamp included. Also adaptable as a Projection Microscope.

ATOMIC RADIATION EXPM.

A variety of projects using Spin-Fluoroscope and sensitive Electroscope. Sample sources of radioactive Uranium Ore and Radium are included.

HEAT EXPERIMENTS

Study the Molecular Theory of heat using 2 Thermometers, Thermostat, 3 foot Gas Thermometer and special Microscope arrangement that shows the effect of Molecular Movement.

DC POWER SUPPLY

Power Transformer, Vacuum Tube Rectifier and 20-20 mfd. Capacitor Filter Circuit. Converts home AC to the DC required for Electronic Circuits.

ELECTRONIC EXPERIMENTS

Explore functions of vacuum tubes and other electronic components. Build an Electronic Switch-Amplifier, and other experimental circuits.

BROADCAST TRANSMITTER

Sends clear transmissions of both code and voice to nearby radios. Can be used with your microphone, record player, or code oscillator.

TELESCOPE

A mounted astronomical Telescope. High quality ground lenses enable you to examine details of the moon's surface and distant objects.

MICROSCOPE

High and low power, precise ground lenses. Substage Light and Polarizer. Adaptable for photomicrography in connection with Photo Lab.

ATOMIC CHAMBER

See illuminated tracks of speeding nuclear particles emanating from radioactive Alpha source and mysterious cosmic rays from outer space.

WEATHER STATION

Aneroid Barometer, Cup Anemometer that electronically measures wind speed, Sling Psychrometer, Humidity Gauge, Cloud Speed Indicator, Cloud Chart and Weather Map.

ALL THE EQUIPMENT FOR ALL THE ABOVE—only \$29.60

SEND **\$2.00** WITH **Coupon ONLY** PAY **\$3.45** ONLY FOR EACH KIT YOU RECEIVE (ONE A MONTH FOR 8 MONTHS) **FREE** SOLDERING IRON with second Kit

Your Satisfaction or Your Money Back...AND you may cancel at any time without obligation.

These "no risk" assurances because we know you will be...

SURPRISED! AMAZED! DELIGHTED!

AMERICAN BASIC SCIENCE CLUB
501 E. Crockett, San Antonio 6, Texas

Start sending me A.B.S.C.'s "Science Lab" in eight kits, one each month. If not satisfied on inspection of first kit I may return it for immediate refund. (I choose the plan checked.)
 I enclose \$2.00 and will pay \$3.45 plus COD postage on arrival of each kit. I may cancel unshipped kits at any time.
 I enclose \$29.60, full payment, Postage Paid, for all 8 kits. I may cancel any time and get full refund on unshipped kits.

NAME _____
 STREET _____
 CITY _____ STATE _____ EL-4
 MAIL COUPON TODAY

AMERICAN BASIC SCIENCE CLUB, Inc. San Antonio, Texas

SHIPPED ON APPROVAL NO MONEY WITH ORDER — NO C. O. D.

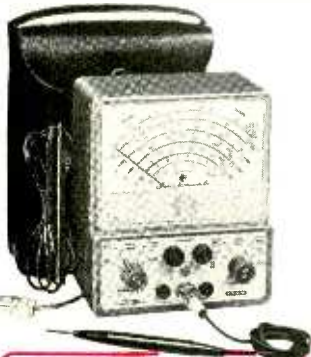

Model 77—VACUUM TUBE VOLT-METER. Total Price . . . \$42.50
Terms: \$12.50 after 10 day trial, then \$6.00 monthly for 5 months if satis- factory. Otherwise return, no explana- tion necessary

Superior's
New
Model 77

VACUUM TUBE VOLTMETER WITH NEW 6" FULL-VIEW METER

Compare it to any peak-to-peak V. T. V. M. made by any other manufacturer at any price!

- Extra large meter scale enables us to print all calibrations in large easy-to-read type.
- Employs a 12AU7 as D. C. amplifier and two 9006's as peak-to-peak voltage rectifiers to assure maximum stability. • Meter is virtually burn-out proof. The sensitive 400

micro-ampere meter is isolated from the measuring circuit by a balanced push-pull amplifier. • Uses selected 1% zero tempera- ture coefficient resistors as multipliers. This assures unchanging accurate readings on all ranges.

SPECIFICATIONS

- DC VOLTS—0 to 3/15/75/150/300/750/1,500 volts at 11 megohms input resistance.
- AC VOLTS (RMS)—0 to 3/15/75/150/300/750/1,500 volts. • AC VOLTS (Peak to Peak)—0 to 8/40/200/400/800/2,000 volts.
- ELECTRONIC OHMMETER—0 to 1,000 ohms/10,000 ohms/100,000 ohms/1 meg- ohm/10 megohms/100 megohms/1,000 meg- ohms. • DECIBELS: -10 db to + 18 db, + 10 db to + 38 db, + 30 db to + 58 db. All based on 0 db = .006 watts (6 mw) into a 500 ohm line (1.73v).
- ZERO CENTER METER—For discriminator alignment with full scale range of 0 to 1.5/1.5/3/7.5/75/150/375/750 volts at 11 megohms input resistance.

AS A DC VOLTMETER: The Model 77 is indis- pensable in Hi-Fi Amplifier servicing and a must for Black and White and color TV Receiver servicing where circuit loading cannot be tolerated.

AS AN ELECTRONIC OHMMETER: Because of its wide range of measurement leaky ca- pacitors show up glaringly. Because of its sensitivity and low loading, Intermittents are easily found, isolated and repaired.

AS AN AC VOLTMETER: Measures RMS values if sine wave, and peak-to-peak value if complex wave. Pedestal voltages that determine the "black" level in TV receivers are easily read.

Comes complete with operating instructions, probe, leads, and stream- lined carrying case. Operates on 110-120 volt 60 cycle. Only

\$42.50

Superior's New Model 70 UTILITY TESTER®

FOR REPAIRING ALL ELECTRICAL APPLIANCES and AUTOMOBILE CIRCUITS



Model 70—UTILITY TESTER
Total Price . . . \$15.85—
Terms: \$3.85 after 10 day trial, then \$4.00 monthly for 3 months, if satisfactory. Otherwise return, no explanation necessary.

As an electrical trouble shooter the Model 70:

- Will test Toasters, Irons, Broilers, Heating Pads, Clocks, Fans, Vacuum Cleaners, Refrigerators, Lamps, Fluorescents Switches, Thermostats, etc.
- Measures A.C. and D.C. Voltages, A.C. and D.C. Current, Resistances, Leakages, etc.
- Will measure current consumption while the appliance under test is in operation.
- Incorporates a sensitive direct-reading resistance range which will measure all resistances com- monly used in electrical appliances, motors, etc.
- Leakage detecting circuit will indicate continuity from zero ohms to 5 megohms (5,000,000 ohms).

As an Automotive Tester the Model 70 will test:

- Both 6 Volt and 12 Volt Storage Batteries • Generators • Starters • Distributors • Ignition Coils • Regulators • Relays • Circuit Breakers • Cigarette Lighters • Stop Lights • Condensers • Directional Signal Systems • All Lamps and Bulbs • Fuses • Heating Systems • Horns • Also will locate poor grounds, breaks in wiring, poor connections, etc.



INCLUDED FREE This 64-page book—practically a condensed course in electricity. Learn by doing.

Just read the following partial list of contents: What is electricity? • Simplified version of Ohms Law • What is wattage? • Simplified wattage charts • How to measure voltage, current, resistance and leakage • How to test all electrical appliances and motors using a simplified trouble-shooting technique. • How to trace trouble in the electrical circuits and parts in automobiles and trucks.

Model 70 comes com- plete with 64 page book and test leads

\$15.85
Only

We invite you to try before you buy any of the models described on this page and the follow- ing page.

If after a 10 day trial you are completely satisfied and decide to keep the Tester, you need send us only the down payment and agree to pay the balance due at the monthly indicated rate.

NO INTEREST OR FINANCE CHARGES ADDED!

If not completely satisfied, you are privileged to return the Tester to us, cancelling any further obligation.

SEE OTHER SIDE

CUT OUT AND MAIL TODAY! ▶

MOSS ELECTRONIC, INC.

Dept. D-866 3849 Tenth Ave., New York 34, N. Y.

Please send me the units checked on approval. If completely satisfied I will pay on the terms specified with no interest or finance charges added. Otherwise, I will return after a 10 day trial positively cancelling all further obligation.

Model TV-50A . . . Total Price \$47.50
\$1.50 within 10 days. Balance
\$6.00 monthly for 6 months.

Model 77 . . . Total Price \$42.50
\$12.50 within 10 days. Balance
\$6.00 monthly for 5 months.

Model 85 Total Price \$52.50
\$2.50 within 10 days. Balance
\$8.00 monthly for 5 months.

Model 70 . . . Total Price \$15.85
\$3.85 within 10 days. Balance
\$4.00 monthly for 3 months.

Name

Address

City Zone State

All prices net. F.O.B., N. Y. C.

SHIPPED ON APPROVAL NO MONEY WITH ORDER — NO C. O. D.

Superior's New Model 85—a DYNAMIC type **TRANS-CONDUCTANCE**

TUBE TESTER



Model 85—Trans-Conductance Tube Tester. Total Price—\$52.50.

Terms: \$12.50 after 10 day trial, then \$8.00 monthly for 5 months if satisfactory. Otherwise return, no explanation necessary.

• Employs latest improved TRANS-CONDUCTANCE circuit. Tests tubes under "dynamic" (simulated) operating conditions. An in-phase signal is impressed on the input section of a tube and the resultant plate current change is measured as a function of tube quality. This provides the most suitable method of simulating the manner in which tubes actually operate in radio, TV receivers, amplifiers and other circuits. Amplification factor, plate resistance and cathode emission are all correlated in one meter reading.

• **SYMBOL REFERENCES:** For the first time ever in a trans-conductance tube tester Model 85 employs time-saving symbols (X, +, ●, ▲, ■) in place of difficult-to-remember letters previously used. Repeated time studies proved to us that use of these scientifically selected symbols speeded up the element switching step. As the tube manufacturers increase the release of new tube types, this time-saving feature becomes more necessary and advantageous.

• **THE "FREE-POINT" LEVER TYPE ELEMENT SWITCH ASSEMBLY** marked according to RETMA basing, permits application of test voltages to any of the elements of a tube. The addition of an extra switch position permits the application of the necessary grid voltage needed for dynamic testing and insures against possible obsolescence due to changes in basing design.

• **NEW IMPROVED TYPE METER** with sealed air-damping chamber provides accurate, vibrationless readings.

• **FREE FIVE (5) YEAR CHART DATA SERVICE.** The chart provided with Model 85 includes easy-to-read listings for over 1,000 modern tube types. Revised up-to-date subsequent charts will be mailed to all Model 85 purchasers at no charge for a period of five years after date of purchase.

• **SPRING RETURN SAFETY SWITCH** guards Model 85 against burn-out if tube under test is "shorted."

• **7 AND 9 PIN TUBE STRAIGHTENERS** have been included on the front panel to eliminate possibility of damaging tubes with bent or out-of-line pins.

• **AN ULTRA-SENSITIVE CIRCUIT** is used to test for shorts and leakages up to 5 megohms between all tube elements.

Model 85 comes complete, housed in a handsome portable cabinet with slip-on cover. Only.....

\$52.50

Superior's New Model TV-50A **GENOMETER**

7 Signal Generators in One!

- ✓ R.F. Signal Generator for A.M.
- ✓ R.F. Signal Generator for F.M.
- ✓ Audio Frequency Generator
- ✓ Marker Generator

- ✓ Bar Generator
- ✓ Color Dot Pattern Generator
- ✓ Cross Hatch Generator

This Versatile All-Inclusive GENERATOR Provides ALL the Outputs for Servicing:

• A.M. RADIO • F.M. RADIO • AMPLIFIERS • BLACK AND WHITE TV • COLOR TV

R. F. SIGNAL GENERATOR: 100 Kilocycles to 60 Megacycles on fundamentals and from 60 Megacycles to 180 Megacycles on powerful harmonics.

VARIABLE AUDIO FREQUENCY GENERATOR: Provides a variable 300 cycle to 20,000 cycle peaked wave audio signal.

MARKER GENERATOR: The following markers are provided: 189 Kc., 262.5 Kc., 456 Kc., 600 Kc., 1000 Kc., 1400 Kc., 1600 Kc., 2000 Kc., 2500 Kc., 3579 Kc., 4.5 Mc., 5 Mc., 10.7 Mc., (3579 Kc. is the color burst frequency)

BAR GENERATOR: Pattern consists of 4 to 16 horizontal bars or 7 to 20 vertical bars.

DOT PATTERN GENERATOR (FOR COLOR TV): The Dot Pattern projected on any color TV Receiver tube by the Model TV-50A will enable you to adjust for proper color convergence.

CROSS HATCH GENERATOR: The pattern consists of non-shifting horizontal and vertical lines interlaced to provide a stable cross-hatch effect.

Complete with shielded leads

\$47.50 Net



Model TV50-A—Genometer

Total Price \$47.50

Terms: \$11.50 after 10 day trial, then \$6.00 monthly for 6 months if satisfactory. Otherwise return, no explanation necessary.

TRY FOR 10 DAYS BEFORE you buy THEN if satisfact

pay in easy, interest free, monthly payments. See coupon inside.

We invite you to try before you buy any of the models described on this and the preceding page. If after a 10 day trial you are completely satisfied and decide to keep the Tester, you need send us only the down payment and agree to pay the balance due at the monthly indicated rate. (See other side for time payment schedule details.)

NO INTEREST OR FINANCE CHARGES ADDED!

If not completely satisfied, you are privileged to return the Tester to us, cancelling any further obligation.

SEE OTHER SIDE

CUT OUT AND MAIL TODAY!

FIRST CLASS

Permit No. 61430

New York, N. Y.

BUSINESS REPLY CARD

No Postage Stamp Necessary if Mailed in the U. S.

POSTAGE WILL BE PAID BY —

MOSS ELECTRONIC, INC.

3849 TENTH AVENUE

NEW YORK 34, N. Y.

VIA AIR MAIL

