

# HOW TO BUILD A LIE DETECTOR

AUGUST • 35 CENTS

# ELECTRONICS ILLUSTRATED

By the Publishers of MECHANIX ILLUSTRATED

16 Page Bonus  
**BOAT  
ELECTRONICS**



Fish & Depth Finders  
Direction Finders  
2-way Radios





# Radio Television Electronics

me

NRI training is for beginners. No previous experience or advance education needed.



## Why This Fast Growing Field Offers You High Pay, Success, Bright Future



E. SMITH  
founder

This is the age of Electronics. Job counselors are recommending careers in Electronics because they know the pay is high, jobs interesting, advancement opportunities great. If you are dissatisfied with your present job and pay, you will want to investigate the big, exciting, fast growing Electronic Industry. It offers good income, prestige and a bright future in Industrial or Military Electronics, Radio Television Communications, Radio Television Servicing.

Act now to assure a better future. Remember the difference between those who *want* to succeed and those who *do* succeed is that one group *does something about it*. Take the first step toward a better future now. Mail the postage-free card. Find out how you can train at home for a career in Electronics.

## Start Soon Earning Extra Money in Spare Time

You don't have to go away to school and you don't need a high school diploma. You keep your present job until you are ready for a better one. You can coast to coast NRI graduates now fill good positions, earn high pay, starting soon after you enroll. NRI provides instructions you need to add your income doing servicing work in spare time. You start quickly to radio or television sets or other electronic equipment for friends, neighbors, small businesses in your neighborhood. Mail postage-free card now.

## You Get Special Training Kits No Extra Charge Makes Learning Easier, Faster

NRI is America's oldest, largest home study Radio Television Electronics School. The special equipment NRI training includes makes learning at home easier and faster. You bring to life principles you read about in illustrated lesson texts. You recognize electronic circuits, capacitors, diodes, other components. You make experiments and tests that make learning a pleasure. Act now to be a part of the age of Electronics. New 64-page catalog tells the fascinating story of electronics. It tells what NRI graduates are doing. It gives facts about NRI training in Industrial and Military Electronics, Radio Television Servicing and Radio Television Communications. Monthly payments available. Cut out and mail the postage-free card today.



## Need for Men Who Know Electronics Increasing



## NRI Trained These Men

"I am Senior Electronics Instructor for Sikorsky Aircraft, teaching Auto-pilot systems. The Basic Electronics I learned thru NRI helped me qualify." J. SENIA, Stratford, Conn.



"Thanks to NRI, I am in a top position with FAA. We install 12S. Vor Tacan, Vortac and other major Navalid Electronics." J. K. DUCKWORTH, Ft. Worth, Texas.

"Now with GE Advanced Electronics Center, Cornell University. Thanks to NRI I now have a job which I enjoy and which also pays well." T. BILAK, Cayuga, N. Y.





# YOU be the judge of *knight-kit* value

A PRODUCT OF ALLIED RADIO



## FREE examination privilege

More and more people are finding out how easy it is to build exciting Knight-Kits, how satisfying they are to own, and how much they save.

If you haven't yet enjoyed the experience and fun of building and owning a Knight-Kit, we invite you to take advantage of our free examination offer. Order any Knight-Kit. Examine it on arrival. Inspect the

quality of the components, the circuitry, the easy-assembly manual. We're so confident you'll want the kit, we can make this offer: If you're not COMPLETELY SATISFIED, just return the kit for full refund.

Order a Knight-Kit now. Know the thrill of the most satisfying build-your-own experience in electronics.



**Y-731 Deluxe FM-AM Stereo Hi-Fi Tuner (Multiplex add-in) \$87.50**  
only \$5 down



**Y-774 Deluxe 40-Watt Stereo Amplifier (with Center Channel) \$79.50**  
only \$5 down



**Y-773 Super-Value 20-Watt Stereo Hi-Fi Amplifier... \$44.95**  
only \$2 down



**Y-787 FM-AM Hi-Fi Tuner (with Multiplex Jack) \$49.95**  
only \$2 down



**Y-713 Best-selling Citizens Band Transceiver. Tunable 22-channel super-regen receiver... \$39.95**

only \$2 down



**Y-258 4-Band "Span Master" Receiver (with cabinet) \$25.95**

only \$2 down

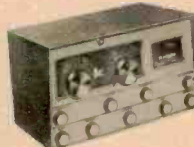

**R-100 Amateur Communications Receiver (HI-gain, with built-in Q-Multiplier) \$104.50**

only \$5 down



**Y-708 1000 Ohm/Volt Pocket Volt-Ohm-Milliammeter \$9.95**



**Y-737 "Ranger" Clock-Radio with "sleep" switch... \$24.95**

only \$2 down



**Y-771 5-Transistor Superhet Portable Radio (less battery) \$25.95**

only \$2 down



**Y-125 General-purpose VTVM (11 meg. input res.) \$25.75**

only \$2 down



**Y-143 Model "600" Tube Checker (checks over 700 types) \$32.95**

only \$2 down

easiest to build...  
satisfying to own  
... money-saving

**ONLY \$2 DOWN**  
on orders up to \$50;  
\$5 down on orders  
up to \$200...

see scores of  
other *knight-kits*

### HI-FI KITS

Stereo Preamplifier  
60-W Stereo Amplifier  
Monaural Amplifiers  
Hi-Fi Tuners  
Speaker Systems  
and others

### HOBBYIST KITS

"Space-Scanner" Radio  
"Ranger" Radios  
Transistor Radios  
2-Way Intercom  
Electronic Lab Kits  
and many others

### INSTRUMENT KITS

Lab AC VTVM  
VOM's  
5" Scopes  
Tube Checkers  
Signal Tracer  
Audio Generator  
Sweep Generator  
plus many others

### AMATEUR KITS

50-Watt Transmitter  
Self-Powered VFO  
100 kc Crystal Callibrator  
Code Practice Oscillator  
Grid Dip Oscillator

there's a money-saving *knight-kit*  
for every need... see them all in the

### ALLIED CATALOG

Describes the complete KNIGHT-KIT line in detail. Order the kit of your choice—judge quality and value for yourself under our Free examination privilege!

**FREE**

send  
for it!



## ALLIED RADIO

ALLIED RADIO, Dept. 26-H  
100 N. Western Ave., Chicago 80, Ill.

Send FREE Catalog featuring Knight-Kits.

Name \_\_\_\_\_

Address \_\_\_\_\_

City \_\_\_\_\_ Zone \_\_\_\_\_ State \_\_\_\_\_

# ELECTRONICS ILLUSTRATED

August, 1960

Vol. 3, No. 8

A Fawcett Publication

CHARLES TEPFER . . . . . Editor  
Larry Klein . . . . . Technical Editor  
Nicholas Rosa . . . . . Feature Editor  
Murray Cooper . . . . . Art Editor  
David Kipnes . . . . . Assistant Editor  
Lou Rubsamen . . . . . Art Associate  
Elaine Sapoff . . . . . Editorial Assistant

## CONTENTS

### 16 PAGE FEATURE

Small Boat Electronics . . . . .	65
Directory . . . . .	80

### FEATURES

1960 Political Conventions . . . . .	25
Voice Communications Underwater . . . . .	29
2 New Battery Operated TV Sets . . . . .	30
Skyways of the Future . . . . .	40
Weather at Sea . . . . .	50
Surgery of the Future — Today . . . . .	51
New Style in Sound . . . . .	58
All About Strain Gages . . . . .	60
Pioneers on Postage . . . . .	89
Milt Kiver on Transistor Testing — 3 . . . . .	90
There's Booodle in Boats . . . . .	96

### BUILD-IT ARTICLES

A Lie Detector . . . . .	32
Loudhailer-Intercom for the Boatman . . . . .	36
Transistorized Theremin . . . . .	44
CB Alignment Generator . . . . .	47
El Echo Chamber . . . . .	54
Try These . . . . .	64
Electrolytic Capacitor Checker . . . . .	81
Small Speaker Repairs . . . . .	84
Pogo Stick Ham Antenna . . . . .	86
Wire Connections Made Easy . . . . .	92
Hi-Fi Clinic . . . . .	85
Electronic Brain . . . . .	93

Cover illustration by Aubrey Kochman.

On the cover: ERA Dynamics, Heathkit and Sonar depth finders.

Ralph Daigh . . . . . Editorial Director  
James Boynton . . . . . Advertising Director  
Al Allard . . . . . Art Director  
Ralph Mattison . . . . . Associate Art Director  
George H. Carl . . . . . Production Director

Larry Eisinger . . . . . Editor-in-Chief  
Phyllis Bendremer . . . . . Production Editor  
Benita Mills . . . . . Assistant Production Editor  
John F. Webster . . . . . Advertising Manager



ELECTRONICS ILLUSTRATED is published monthly by Fawcett Publications, Inc., Fawcett Place, Greenwich, Conn. W. H. Fawcett, Jr., President; Gordon Fawcett, Secretary and Treasurer; Roger Fawcett, General Manager; Roscoe K. Fawcett, Circulation Director; Donald P. Hanson, Assistant General Manager.

EDITORIAL AND ADVERTISING OFFICES: 67 West 44th Street, New York 36, N. Y.  
ADDRESS ALL MAIL: Subscriptions, change of address, Form 3579 to Subscription Dept., Fawcett Bldg., Greenwich, Conn.; and all editorial and advertising to Fawcett Publications, Inc., 67 W. 44th St., New York 36, N. Y.

Second-class postage paid at Greenwich, Conn., and at additional mailing offices.  
Subscription Price \$4.00 per year in the U. S. and possessions and Canada. All other countries \$6.00 per year. Foreign subscriptions and sales should be remitted by International Money Order in U. S. funds payable at Greenwich, Conn.

Printed in U.S.A. Copyright 1960 by Fawcett Publications, Inc.

Permission hereby granted to quote from this issue of this magazine on radio or television provided a total of not more than 1,000 words is quoted and credit is given to the title of the magazine and issue, as well as the statement, copyright 1960, by Fawcett Publications, Inc.

Member of: Audit Bureau of Circulations  Magazine Publishers Association, Inc. 





**A HIGHLY  
RESPECTED TRADE—  
START SOON TO  
EARN EXTRA MONEY  
IN SPARE TIME**

# Learn at Home IN YOUR SPARE TIME to Fix Electrical Appliances

To build a better future, get into a field where there's much important work and the security that comes from knowing a good trade. Servicing electrical appliances offers that OPPORTUNITY. Every wired home has many electrical appliances and millions and millions of new appliances are sold every year. Owners pay well to keep them in repair. That's making a fast-growing need for trained men.

job. You can train at home in your spare time for only \$3.00 down and \$6.00 a month. A small price to pay for increased earnings, a more secure future. Paste coupon below on a postal or mail in envelope for free book and sample lesson. Address **National Radio Institute, Dept. KHO, Washington 16, D. C.**

## Add To Your Income Starting Soon Need For Service Technicians Increasing

Make extra money in your spare time. Start soon to fix electric toasters, fans, clocks, vacuum cleaners, and other electric appliances for your neighbors and friends. Work in your basement, garage or spare room. It's easy to increase your earning power—to pay for your training many times over—to have extra money to buy things you need.

**MAILING THIS  
COUPON MAY START  
YOU TO SUCCESS  
LESSON AND BOOK  
FREE**



## Learn and Earn with Multi-Use Tester Built with Parts We Send

This course includes the parts to build a portable, sturdy Appliance Tester that helps you locate electrical defects quickly and easily. You use it to learn and do actual electrical appliance repair jobs. If you want better pay learn this good trade. No need to give up your present

**NATIONAL RADIO INSTITUTE, Dept. KHO, Washington 16, D. C.**

Please send me Electric Appliance Training lesson and book free. (No salesman will call.)

Name ..... Age .....

Address .....

City ..... Zone ..... State .....

ACCREDITED MEMBER NATIONAL HOME STUDY COUNCIL

# A Message From the Editor



Complete Novice amateur radio station for under \$40

I recently read something interesting relative to our space satellite program. It seems that some scientists believe we are wasting money and scientific effort on our plan to put someone into space. These scientists claim that the volume an astronaut would have to occupy in a space vehicle could more profitably be used for electronic instruments which can tell us more about space than a man could. We in electronics would be the last ones to underestimate the efficiency and data gathering ability of electronic gear but, what computer, what oscilloscope, what detector is as imaginative and ingenious as a highly trained, alert astronaut? And, isn't it impossible to accurately predict all the results of an exploration— isn't the chance discovery often of greatest importance? Yes, by all means, let's send a man into space after we're sure we can get him back safely.

And now to get down to earth, have you seen the special 16-page section in this issue devoted to electronics for the small boat? This is not intended to be a buyers' guide, but an explanation of how to use the new electronic depth finders, direction finders and 2-way radios. Also, you will find many practical installation hints and data to guide you when installing this gear on your boat.

Our 16-page section for the September issue is devoted to Novice amateur radio. The Novice license is a special amateur radio class set up by the FCC to encourage an increase in the ranks of amateur radio. All you need to know to get a Novice amateur radio license will be included in our special 16-page section as well as plans for a complete Novice station: transmitter and receiver. This complete station can be built for less than \$40.



These men are getting practical training in...

# ELECTRICITY ELECTRONICS



*On Real:*

**A. C. and D. C. Motors  
Generators  
Switchboards  
Controllers  
Modern Appliances  
Automatic Electronic  
Control Units**

*(Shown at left—Instructor explaining operation and testing of a large Motor Generator in our A.C. Department.)*

# TELEVISION RADIO ELECTRONICS

*On Real:*

**Television Receivers  
Black & White and Color  
AM-FM and Auto Radios  
Transistors—Printed  
Circuits—Test Equipment**

*(Right — Instructor helping students check the wiring and trace circuits of television receivers.)*

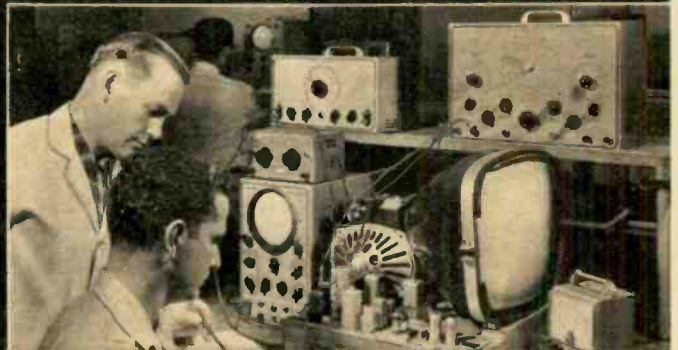

## Train in the NEW SHOP-LABS of COYNE

*Largest, Oldest, Best Equipped School of Its Kind in the U.S.*

Prepare for your future now in today's top opportunity field. Don't be satisfied with a "No Future" job. Train the Coyne way for a better job in a field that offers a world of opportunities in the years ahead.

**You train in Chicago**—the Electrical and Electronic Center of the World—on real equipment. Professional and experienced instructors show you how, then you do practical jobs yourself. No previous experience or advanced education is needed.

**FINANCE PLAN:** Enroll now, pay most of tuition after graduation. Part-time employment help for students.

**Mail coupon or write** to address below for free book—"Guide to Careers". Whether you prefer Electricity, Television-Radio or Combined Electronics Training, which includes both fields, this book describes all training and gives facts to Vets and Non-Vets.



### Mail Coupon or Write for FREE Book

Book comes by mail. No obligation and no salesman will call.

Mail coupon below in an Envelope or paste on a Postal Card or write Address given and Free book, "Guide to Careers", with information will be sent to you by return mail.

**COYNE ELECTRICAL SCHOOL**  
Dept. CO-8C, New Coyne Building  
1501 W. Congress Pkwy., Chicago 7, Illinois

Send BIG FREE book and details of all the training you offer. However, I am especially interested in:

Electricity     Television     Both Fields

Name \_\_\_\_\_

Address \_\_\_\_\_

City \_\_\_\_\_ State \_\_\_\_\_

*(I understand no Salesman will call)*

B. W. Cook, Jr., Pres. **COYNE** Founded 1899  
**ELECTRICAL SCHOOL**

CHARTERED AS AN EDUCATIONAL INSTITUTION NOT FOR PROFIT  
1501 W. CONGRESS PARKWAY, CHICAGO 7 Dept. CO-8C  
ELECTRICITY ★ RADIO ★ TELEVISION ★ REFRIGERATION ★ ELECTRONICS

August, 1960



Nicholas Rosa, W1NOA, new *EI* Feature Editor

We have pre-tested this thoroughly and assure you that you will find it highly satisfactory. We hope, however, that you will go on to a General class ticket at which time you may modify the *EI* Novice ham rig for more advanced use.

We have a letter here from one of our Canadian readers who would like to petition the Canadian Government to set up a Class "D" type Citizens Band service. Those of you in Canada who are interested should write to Henry Ruhl at Box 25 in McCord, Saskatchewan if you live in the West; Eastern Canadians should write to Larry D. Whiting at L. W. Electronics in Strathroy, Ontario. Incidentally, there are many Citizens Band Clubs now in existence in the United States. We have the names of several and plan to make up a complete list. If you belong to such a group or know of one, write to us.

The feature articles in this issue are the last ones that Ed Nanas, our Feature Editor, prepared for us. Ed left us to join the staff of an engineering newspaper. The new *EI* Feature Editor is Nicholas Rosa whose radio amateur call is W1NOA. He comes to us after almost four years with the Woods Hole Oceanographic Institution on Cape Cod, an important part of the team that

found out so much about our oceans during the International Geophysical Year. A radio amateur since 1941, Nick was an electronics tinkerer before that and is an old hand at hi-fi, having built his first amplifier in 1942.

We are very gratified at your response to the *EI* Hi-Fi Test Record in our June issue. As a matter of fact, I am looking over some of the many letters that we have received, here is part of one: "I would like to congratulate you on the test record that was included in your June issue. Not only did I find it to be of the same quality as many of the commercial test records, but I found it to be just as useful." Another reads: "Just received my copy of *EI* and got the hi-fi test record out first thing. The results were great. Keep up the good work!" Another says: "Your record is really something, especially the way it comes unscathed through the magazine fabrication and delivery process." Thank you again for your response and remember, you saw it first in *EI*.

In our next issue we have an exclusive article on electronic frauds and how to protect yourself from them. "Electronics" is a glamorous word right now, people think it can do anything and there are some vendors who are trying to cash in on this feeling. You, as someone in the know electronically, can help yourself and your neighbors by being alert to electronic frauds.

As a result of many requests from our readers, in our next issue we are reprinting a build-it-yourself project from an early *EI*. This is the automatic lawn sprinkler which will water your lawn without your individual attention, based upon the moisture of the earth itself. As usual, the September *EI* will also have the Electronic Brain and Hi-Fi Clinic columns and many more build-it-yourself items. Be sure to be with us.

Charles Zeffu



In Spare Time at Home—Prepare for a Better Job—or  
Your Own Business in One of the Many Branches of

# ELECTRONICS



You build and keep this valuable Vacuum Tube VOLT METER

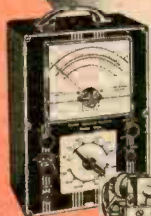

You build and keep this 5-inch COLOR OSCILLOSCOPE—almost a "must" for TV servicing.



**HOME MOVIES . . .**  
... make important points crystal clear. Speeds your learning. It's almost like having an instructor at your side!

## COLOR TV

DeVry Tech's program also includes training in Color Television

**MILITARY SERVICE**  
If you are subject to military service, the information we have should prove very helpful. Mail coupon today.

## RADIO - TELEVISION - RADAR

If you are seeking a better job or a business of your own, the appealing field of Television-Radio-Electronics offers **REAL PROMISE!**

In this fast-growing field, trained Electronic technicians find many good-paying, interesting jobs in manufacturing, installing, operating, servicing. Equally important is the fact that these are **GOOD JOBS**—offering the kind of a future that an untrained man often dreams about.

No previous technical experience or advanced education needed. Prepare for this profitable field in your spare time at home, or in our modern Chicago or Toronto Laboratories. Nothing else like it! Send for **FREE** details.

### EARN WHILE YOU LEARN

After you get part of DeVry Tech's training with equipment at home, you may then in your spare time, begin to earn real money servicing Radio and Television sets.



**21 INCH**

Build and keep this BIG DeVry Engineered TV set—easily converted to U.H.F. (DeVry offers another home training, but without the TV set.)

## Your GUIDE

### to Profitable Job Opportunities

TV-Radio Broadcast Technician  
Color Television Specialist  
Radar Operator • Laboratory Technician  
Airline Radio Man • Computer Specialist  
Quality Control Manager  
Your Own Sales & Service Shop  
**PLUS MANY OTHERS**

### YOU GET THE SAME EMPLOYMENT SERVICE

that has helped thousands of our graduates toward fine careers in Electronics.



Send for **FREE BOOKLET TODAY!**

Accredited Member of National Home Study Council  
"One of North America's Foremost Electronics Training Centers"



# DeVRY TECHNICAL INSTITUTE

CHICAGO 41, ILLINOIS



You work over **300** Learn-By-Doing projects

Build over 300 practical projects from many shipments of Radio-Electronic parts. You build and operate TV-Radio circuits... wireless microphone... and many other major projects—all designed to provide outstanding practical experience at home.

**ACT NOW!** Get information-packed publication **FREE!** Mail coupon today.

**DeVRY TECHNICAL INSTITUTE**  
4141 Belmont Ave., Chicago 41, Ill., Dept. E1-8-Q  
Please give me your **FREE** booklet, "Electronics in Space Travel," and tell me how I may prepare to enter one or more branches of Electronics.

Name \_\_\_\_\_ Age \_\_\_\_\_

PLEASE PRINT

Street \_\_\_\_\_ Apt. \_\_\_\_\_

City \_\_\_\_\_ Zone \_\_\_\_\_ State \_\_\_\_\_

2044 Canadian residents address DeVry Tech of Canada, Ltd.  
970 Lawrence Ave. West, Toronto, Ont.

## electronics in the news

LONG DISTANCE DIALING TV? Yup! Telectro Industries has come up with a transmitting system to allow any closed circuit TV user to hook up with any other closed circuit TV user merely by dialing-in. The system (Telectrovision) sends live or graphic pictures over ordinary telephone lines; no costly coaxial cables.

.....

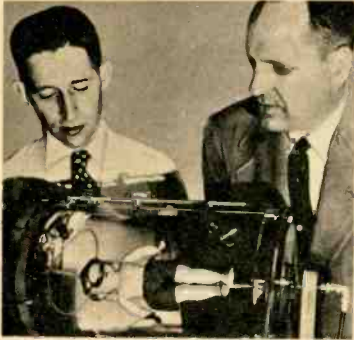

THIS IS NOT A VOODOO RITE, BUT RATHER AN experiment at Marietta, Ga., to learn how man reacts to weightlessness in outer space over long periods of time. Lockheed Aircraft, conducting "human factors in space travel" tests, calls this device a "null-gravity simulator." Doll symbolizes man who soon will be placed in huge revolving tank of water. Immersion will give him a weightless environment and his reactions will be monitored by electronic transducers on body.

.....

SCHOOL SCIENCE PROGRAMS ARE SOON DUE FOR A BOOST. A series of electronic kits for students from age 10 through college are being developed by Arkay International. One kit, already tested in New York City, can perform at least ten rocket and missile functions with the addition or deletion of certain parts from the basic kit. It sells to schools for less than \$10. Similar electronics kits are available commercially at a slightly higher price. A complete catalog of educational kits can be obtained from Arkay at 88-06 Van Wyck Expressway, Jamaica, N. Y..... Hertz Engineering Scholarship Foundation has expanded its student assistance programs to include all fields of engineering. Write to the Foundation, 1314 Westwood Blvd., Los Angeles 24, Calif.

.....

NO, IT ISN'T A RECORDING SESSION, AND THAT MAN IN THE WHITE JACKET isn't holding a microphone. He is Dr. Wallace Gardner, a Cambridge, Mass., dentist, who has discovered that sound can be used to block the reception of pain in the brain. Madeline Coubre still has a happy (rather than pained) expression on her attractive face after having a molar extracted. The trick of the pulling was in the headset and control box held in Madeline's hands. Instead of hearing ineffective assurances by the dentist, she heard the sound of music and the soothing rush of a waterfall.





Cast your ballot for a successful future!

# 249 I.C.S. COURSES



I.C.S. is the oldest and largest correspondence school. 249 courses. Business, industrial, engineering, academic, high school. One for you. Direct, job-related. Bedrock facts and theory plus practical

application. Complete lesson and answer service. No skimming. Diploma to graduates.

Send for the 3 free booklets offered below and find out how I.C.S. can be your road to success.

## ACCOUNTING

Accounting  
Auditing  
Cost Accounting  
General Accounting  
Junior Accounting  
Practical Accounting  
Public Accounting

## ADVERTISING

Advertising  
Magazine & Newspaper  
Advertising

## ARCHITECTURE AND BUILDING

Architectural Drawing & Designing  
Architectural Interiors  
Architecture  
Building Contractor  
Building Contractor with Drawing  
Building Estimator  
Building Maintenance  
Carpenter-Builder  
Carpentry & Millwork  
House Planning  
Lumber Dealer  
Mason  
Painting Contractor  
Reading Arch. Blueprints  
Reading Struct. Blueprints

## ART

Advertising Layout & Illustration  
Amateur Artist  
Commercial Art  
Commercial Cartooning  
Fashion Illustrating  
Figure Drawing & Painting  
Magazine Illustrating  
Show Card & Sign Prod'n  
Show Card Writing  
Sign Painting & Designing  
Sketching & Painting

## AUTOMOTIVE

Auto Engine Tune-up  
Automobile  
Automobile Body Rebuilding and Refinishing  
Automobile Electrical Technician  
Automobile Technician  
Diesel Engines

Diesel-Gas Motor Vehicle Engines  
Gas Engines  
Internal Combustion Engines

## AVIATION

Aero-Engineering Technology  
Aircraft & Engine Mechanic  
Aircraft Mechanic  
Aviation Engine Mechanic

## BUSINESS

Business Administration  
Business Correspondence  
Business Law  
Business Management  
Business Management & Marketing  
Business Management & Production  
Business Psychology  
Canadian Business Management  
Clerk-Typist  
Commercial  
Condensed Business Practice  
Federal Tax Course  
Managing a Small Business  
Marketing  
Office Administrative Engineering  
Office Management  
Professional Secretary  
Programming for Digital Computers  
Purchasing Agent  
Retail Business Management  
Shorthand  
Stenographic  
Typewriting

## CHEMICAL

Analytical Chemistry  
Chemical Engineering  
Chemical Engineering Unit Operation  
Chemical Laboratory Technician  
Elements of Nuclear Energy  
General Chemistry  
Industrial Analytical Chemistry  
Industrial Chemistry  
Professional Engineer—Chemical

## PULP AND PAPER

Pulp Making  
Paper & Paper Engineering

## Pulp & Paper Making

Pulp Making  
**CIVIL ENGINEERING**  
Bridge & Building Foreman  
Civil Engineering  
Construction Engineering  
Highway Engineering  
Mine Surveying & Mapping  
Principles of Mapping  
Principles of Surveying  
Professional Engineer—Civil  
Railroad Engineering  
Roadmaster  
Sanitary Engineering  
Section Foreman  
Sewage Plant Operator  
Structural Engineering  
Surveying and Mapping  
Water Works Operator

## DRAFTING

Aircraft Drafting  
Architectural Drafting  
Drafting & Machine Design  
Electrical Drafting  
Electrical Engineer Drafting  
Electronic Drafting  
Industrial Piping Drafting  
Junior Mechanical Drafting  
Mechanical Drafting  
Sheet Metal Drafting  
Structural Drafting

## ELECTRICAL

Elec. Appliance Servicing  
Electrical Contractor  
Electrical Eng'g (Power Plant option—Electronic option)  
Electrical Engineering Tech.  
Electric Motor Repairman  
Illumination Eng'g Tech.  
Industrial Electrical Techn.  
Power-House Engineering  
Power Line Design and Construction  
Practical Electrician  
Practical Lineman  
Professional Engineer—Electrical  
Reading Electrical Blueprints

## HIGH SCHOOL

Good English  
High School Business  
High School College Prep (Arts)

High School College Prep (Engineering & Science)  
High School General  
High School Mathematics  
High School Secretarial  
Modern Letter Writing  
Short Story Writing

## LEADERSHIP

Industrial Foremanship  
Industrial Supervision  
Personnel-Labor Relations  
Supervision

## MATHEMATICS

Mathematics and Mechanics for Engineers  
Mathematics and Physics for Engineers  
Mathematics and Physics for Technicians

## MECHANICAL

Industrial Engineering  
Industrial Instrumentation  
Junior Mechanical Engineering  
Mechanical Engineering  
Professional Engineer—Mechanical  
Quality Control  
Introductory Technical Writing

## PETROLEUM

Natural Gas Production & Transmission  
Oil Field Technology  
Petroleum Production  
Petroleum Prod'n Eng'g  
Petroleum Refinery Operator  
Petroleum Refining  
Petroleum Technology

## PLASTICS

Plastics Technician

## PLUMBING, HEATING, AIR CONDITIONING

Air Conditioning  
Air Conditioning with Draw'g  
Air Conditioning Maintenance  
Domestic Heating with Oil & Gas  
Domestic Refrigeration  
Heating  
Heating & Air Conditioning with Drawing

Heating, Drawing & Estimat'g  
Plumbing  
Plumbing, Drawing & Estimating  
Plumbing & Heating  
Plumbing & Steamfitting  
Practical Plumbing  
Refrigeration  
Refrigeration & Air Conditioning  
Steamfitting

## RAILROAD

Air Brake Equipment  
Car Inspector & Air Brake Diesel Electrician  
Diesel Engineer & Fireman  
Diesel Locomotive  
Diesel Machinist  
Railroad Administration  
Railroad Car Repairer

## SALESMANSHIP

Creative Salesmanship  
Real Estate Salesmanship  
Retail Merchandising  
Retail Selling  
Sales Management  
Salesmanship & Sales Management

## SHOP PRACTICE

Boilermaking  
Electric Welding  
Foundry Practice  
Gas and Electric Welding  
Gas Welding  
Heat Treatment of Metals  
Industrial Metallurgy  
Machine Shop Inspection  
Machine Shop Practice  
Machine Shop Practice & Toolmaking  
Metallurgical Engineering Technology  
Physical Quality Control of Metals  
Practical Millwrighting  
Reading Shop Blueprints  
Resistance Welding Technology  
Rigging  
Safely Engin'g Technology  
Sheet Metal Worker  
Tool Design  
Tool Engineering Technology

Toolmaking  
Welding Engineering Technology

## STEAM AND DIESEL POWER

Combustion Engineering  
Power Plant Engineering  
Stationary Building Eng'g  
Stationary Diesel Eng'g  
Stationary Diesel-Electric Engineering  
Stationary Fireman  
Stationary Steam Eng'g  
Steam Engine Operation

## TEXTILES

Carding and Spinning  
Carding  
Cotton Manufacturing  
Cotton Warping & Weaving  
Dyeing & Finishing  
Hosiery and Circular Knitting  
Loom Fixing  
Spinning  
Synthetic Fabric Manufacturing  
Synthetic Throwing, Warping & Weaving  
Textile Designing  
Textile Engineering  
Textile Mill Supervisor  
Woolen Manufacturing  
Worsted Manufacturing

## TRAFFIC

Motor Traffic Management  
Railroad Rate Clerk  
Traffic Management

## TV-RADIO-ELECTRONICS

Gen'l Electronics Technician  
Industrial Electronics  
Practical Radio-TV Eng'g  
Radio Operating  
Radio Servicing  
Radio Servicing with Practical Training  
Radio & TV Servicing  
Radio & TV Servicing with Practical Training  
Servicing Electr'n'c Devices  
Servicing Sound Equip't  
Practical Telephony  
Telephone and Radio Communications  
TV Receiver Servicing  
TV Technician

For Real Job Security—Get an I. C. S. Diploma! I. C. S., Scranton 15, Penna.

Accredited Member, National Home Study Council

## INTERNATIONAL CORRESPONDENCE SCHOOLS

BOX 84574G, SCRANTON 15, PENNA.

In Hawaii reply P.O. Box 418, Honolulu

Without cost or obligation, send me "HOW TO SUCCEED," the opportunity booklet about the field I have indicated below, and a sample lesson (Math.)

Name of the course in which you are interested \_\_\_\_\_

Your Name \_\_\_\_\_ Age \_\_\_\_\_ Home Address \_\_\_\_\_

City \_\_\_\_\_ Zone \_\_\_\_\_ State \_\_\_\_\_ Working Hours \_\_\_\_\_ A.M. to \_\_\_\_\_ P.M.

Occupation \_\_\_\_\_ Canadian residents send coupon to International Correspondence Schools, Canadian, Ltd., Montreal, Canada. . . . Special low monthly tuition rates to members of the U. S. Armed Forces.



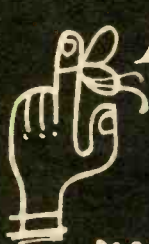

# Remember!...

**EMC GUARANTEE**  
is that each  
instrument is by far  
the **BEST VALUE**  
obtainable in  
wired or kit form!



**EMC Model — 211 Tube Tester** — The smallest, lowest priced, domestic made tube tester on the market. It is completely flexible and obsolescent proof. It checks each section of multi-purpose tubes separately, checks all octal, loctal, 9 prong and miniature tubes for shorts, leakages, opens, intermittents as well as for quality. Quality is indicated directly on a two color meter dial using the standard emission test. Comes complete with instructions and tube charts in ring bound manual. Size 6 3/4" x 5 1/4" x 2 1/4" deep. Shipping weight: 3 lbs.  
Wired ..... \$22.90    KIT ..... \$14.90  
CRT Picture Tube Adapter ..... \$ 4.50



**EMC Model 109 — Voltmeter** — Features 20,000 OHMS volts DC sensitivity and 10,000 OHMS per volt AC sensitivity. Uses a 4 1/2, 40 microampere meter, with 3 AC current ranges, and 3 resistance ranges to 20 megohms. 5 DC and AC voltage ranges to 3000 volts and 3 DC current ranges; also 5 DB range.  
**Model 109** — With carrying strap, Weight 2 lbs.  
5 ozs.: Size: 5 1/4" x 6 3/4" x 2 7/8" .... \$26.95  
**Model 109K** — Kit Form ..... 19.25  
**Model HVT** — 30,000 Volt Probe for .....  
**Model 109** ..... 7.95

Yes, tell me more, send me **FREE** a detailed catalog of the Complete EMC Line. **EL-8**

NAME .....  
STREET .....  
CITY ..... STATE.....

**EMC** Electronic Measurements Corp.  
625 B'way, New York 12, N. Y.  
Ex. Dept., Pan-Mar Corp., 1270 B'way, New York 1, N. Y.



DATA from a number of new ionospheric and solar observation stations set up during the International Geophysical Year have improved the accuracy of National Bureau of Standards' predictions of maximum usable frequency for radio communications between any two points in the world. The NBS, with their new facilities for observing the everchanging ionosphere, can now make predictions three months in advance.

**HUGHES AIRCRAFT ENGINEERS** predict space savings of over 40 percent in car radios through the use of sub-miniature semiconductors in automotive design. To illustrate their point, they built and displayed a complete auto radio tuner no larger than a pack of cigarettes—and located the unit in a standard automobile steering wheel assembly. The radio, with manual dialing and pushbutton control, is not planned for company production, but rather to demonstrate a possible consumer use of their silicon capacitors, each no larger than a grain of rice, which do the job of conventional mechanical tuners.

**BIGGER AND BETTER STEAKS**—that's the object of research at Penn State University in which custom-built X-ray gear is used to detect any compression in the last five thoracic vertebrae at the base of the spine of calves under 10 days old. Object: to eliminate dwarf strains from breeding stock.



**NOW!**  
at a price  
you can afford!

# MAKE MORE MONEY in TELEVISION RADIO-ELECTRONICS

**BETTER...MORE COMPLETE...LOWER COST...  
WITH NATIONAL SCHOOLS SHOP-METHOD  
HOME TRAINING!**

**BETTER...** Training that is proved and tested in Resident School shops and laboratories, by a School that is the **OLDEST** and **LARGEST** of its kind in the world.

**MORE COMPLETE...** You learn **ALL PHASES** of *Television-Radio-Electronics*.

**LOWER COST...** Other schools make several courses out of the material in our **ONE MASTER COURSE**... and you pay more for less training than you get in our course at **ONE LOW TUITION!**



These two **FREE** books will show you how!

You get all information by mail... You make your own decision... at home! **NO SALESMAN WILL CALL**

## TOP PAY... UNLIMITED OPPORTUNITIES LIFETIME SECURITY CAN BE YOURS!

You are needed in the Television, Radio, and Electronics industry! Trained technicians are in growing demand at excellent pay—in **ALL PHASES**, including Servicing, Manufacturing, Broadcasting and Communications, Automation, Radar, Government Missile Projects.

**NATIONAL SCHOOLS SHOP-METHOD HOME TRAINING**, with newly added lessons and equipment, trains you in your spare time at home, for these unlimited opportunities, including many technical jobs leading to supervisory positions.

**YOU LEARN BY BUILDING EQUIPMENT WITH KITS AND PARTS WE SEND YOU.** Your National Schools course includes thorough *Practical* training—**YOU LEARN BY DOING!** We send you complete standard equipment of professional quality for building various experimental and test units. You advance step by step, perform more than 100 experiments, and you build a complete TV set from the ground up, that is yours to keep! A big, new TV picture tube is included at no extra charge.

**EARN AS YOU LEARN.** We'll show you how to earn extra money right from the start. Many of our students pay for their course—and more—while studying. So can you!

### RESIDENT TRAINING AT LOS ANGELES

If you wish to take your training in our Resident School at Los Angeles, the world's TV capital, start **NOW** in our big, modern Shops, Labs and Radio-TV Studios. Here you work with latest electronic equipment... professionally installed... finest, most complete facilities offered by any school. Expert, friendly instructors. Personal attention. Graduate Employment Service. Help in finding home near school... and part time job while you learn. Check box in coupon for full information.

**LESSONS AND INSTRUCTION MATERIAL ARE UP-TO-DATE, PRACTICAL, INTERESTING.** Every National Schools Shop-Method lesson is made easy to understand by numerous illustrations and diagrams. All instruction material has been developed and tested in our own Resident School Shops, Laboratories and Studios.

**SEND FOR INFORMATION TODAY...** it can mean the difference between **SUCCESS** and failure for you! Send for your **FREE BOOK** "Your Future in Television-Radio-Electronics" and **FREE Sample Lesson.** Do it **TODAY**, while you are thinking about your future. It doesn't cost you anything to investigate!

### GET THE BENEFITS OF OUR OVER 50 YEARS EXPERIENCE

Approved for  
GI Training



**NATIONAL TECHNICAL SCHOOLS**  
Los Angeles 37, Calif.

## YOU GET...

- 19 Big Kits—**YOURS TO KEEP!**
- Friendly Instruction and Guidance
- Job Placement Service
- Unlimited Consultation
- Diploma—Recognized by Industry
- **EVERYTHING YOU NEED FOR SUCCESS!**

### SHOP-METHOD HOME TRAINING COVERS ALL PHASES OF INDUSTRY

1. Television, including Color TV
2. Radio AM & FM
3. Electronics for Guided Missiles
4. Sound Recording and Hi-Fidelity
5. FCC License
6. Automation and Computers
7. Radar & Micro-Waves
8. Broadcasting and Communications

## NATIONAL TECHNICAL SCHOOLS

WORLD-WIDE TRAINING SINCE 1905

### MAIL NOW TO

**NATIONAL TECHNICAL SCHOOLS, Dept. R4Y-70**  
4000 S. FIGUEROA ST. LOS ANGELES 37, CALIF.

Rush free TV-Radio "Opportunity" Book and sample lesson. No salesman will call.

NAME \_\_\_\_\_ AGE \_\_\_\_\_  
ADDRESS \_\_\_\_\_  
CITY \_\_\_\_\_ ZONE \_\_\_\_\_ STATE \_\_\_\_\_

Check if interested **ONLY** in Resident School training at Los Angeles  
**VETERANS:** Give date of Discharge \_\_\_\_\_

# COMPLETE SERVICE TRAINING ... written so you can understand it!



Only \$13  
for the complete  
2-volume course

3 MONTHS TO PAY

## Fix any TV or Radio Ever Made

### EASIER - BETTER - FASTER!

No complicated theory or mathematics! These famous Ghirardi books get right down to brass tacks in showing you how to handle all types of AM, FM, and TV service work by approved professional methods. Almost 1500 pages and over 800 clear illustrations show how to handle every phase of troubleshooting and servicing. Each book is co-authored by A. A. Ghirardi whose manuals have helped train more servicemen than any other books or courses of their kind!

#### 1—Radio and Television Receiver TROUBLESHOOTING AND REPAIR

A complete guide to profitable professional methods. For the beginner, it is a comprehensive training course. For the experienced serviceman, it is a quick way to "brush up" on specific jobs, to develop improved techniques or to find fast answers to puzzling service problems. Includes invaluable "step-by-step" troubleshooting charts that show what to look for and where. 820 pages, 417 illustrations, price \$7.50 separately.

#### 2—Radio and Television Receiver CIRCUITRY AND OPERATION

This 669-page volume is the ideal guide for servicemen who realize it pays to know what really makes modern radio-TV receivers "tick" and why. Gives a complete understanding of basic circuits and circuit variations; how to recognize them at a glance; how to eliminate guesswork and useless testing in servicing them. 417 illus. Price separately \$6.75.

### Special low price . . . you save \$1.25

If broken into lessons and sent to you as a "course," you'd regard these two great books as a bargain at \$75 or more! Under this new offer, you buy both books for only \$13.00 . . . you save \$1.25—and have the privilege of paying in easy installments while you use them! No lessons to wait for. You learn fast—and right!

### STUDY 10 DAYS FREE!

Dept. PR-80, RINEHART & CO., Inc.  
232 Madison Ave., New York 16, N. Y.

Send books below for 10-day FREE EXAMINATION. In 10 days I will either remit price indicated (plus postage) or return books postpaid and owe you nothing.

Radio & TV Receiver TROUBLESHOOTING & REPAIR (Price \$7.50 separately)

Radio & TV CIRCUITRY & OPERATION (Price \$6.75)

Check here for MONEY-SAVING COMBINATION OFFER  
Save \$1.25. Send both of above big books at special price of only \$13.00 for the two. (Regular price \$14.25 . . . you save \$1.25.) Payable at rate of \$4 plus postage after 10 days if you decide to keep books and \$3 a month for 3 months until the total of \$13.00 has been paid.

SAVE! Send cash and we pay postage. Same 10-day return privilege with money promptly refunded.

Name \_\_\_\_\_

Address \_\_\_\_\_

City, Zone, State \_\_\_\_\_

Outside U.S.A.—\$8.00 for TROUBLESHOOTING & REPAIR; \$7.25 for CIRCUITRY & OPERATION; \$14.00 for both. Cash only, but money refunded if you return books in 10 days.

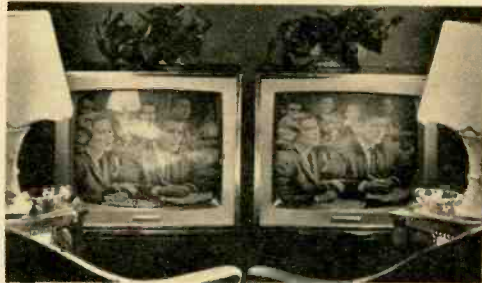

These TV sets are identical in all but one respect: The one at the right is sporting a new reflection-free picture tube cap introduced by Corning Glass that diffuses 75 percent of reflected light. Set at left, with conventional tube cap, reflects lamp and chairs.

INSTANTANEOUS EDITING OF VIDEO TAPE is said to be possible with the electronic TVola, developed by Paramount Television Productions. This gadget will enable the editing of tape with accuracy and speed down to a single TV frame—1/30 of a second. Any given frame can be isolated within one minute as compared with 15-40 minutes required under existing videotape editing techniques. TVola is built around a 200-transistor timing circuit coupled to four Hughes memory tubes, which can freeze a TV frame for a period up to 20 minutes.

BY RELIEVING PRISONER TENSIONS, TV is proving beneficial to some 2000 men locked up at Cook County Jail in Chicago, as well as to the security guards who are charged with keeping order. Some 37 sets, operated by the guards, keep the men's minds occupied, relieve their tensions, and disciplinary problems have been cut to a minimum, says Warden Jack Johnson. In TV, the criminal always gets caught, a gentle reminder that crime doesn't pay.

TEN YEARS FROM NOW, says Clair Lasher, general manager of the General Electric Computer Dept., more than 80 percent of electronic computers will be used in applications unheard of today.



# BUILD YOUR OWN RADIO

## CIRCUITS AT HOME with the New PROGRESSIVE RADIO "EDU-KIT"®

only  
**\$26.95**

Reg. U.S.  
Pat. Off.



### A Practical Home Radio Course

#### Now Includes

- ★ 12 RECEIVERS
- ★ 3 TRANSMITTERS
- ★ 50. WAVE GENERATOR
- ★ SIGNAL TRACER
- ★ AMPLIFIER
- ★ SIGNAL INJECTOR
- ★ CODE OSCILLATOR

- ★ No Knowledge of Radio Necessary
- ★ No Additional Parts or Tools Needed
- ★ EXCELLENT BACKGROUND FOR TV
- ★ School Inquiries Invited
- ★ Sold in 79 Countries

### YOU DON'T HAVE TO SPEND HUNDREDS OF DOLLARS FOR A RADIO COURSE

The "Edu-Kit" offers you an outstanding PRACTICAL HOME RADIO COURSE at a rock-bottom price. Our specially designed train Radio & Electronics Technicians, making use of the most modern methods of home training. You will learn radio theory, construction practice and servicing. THIS IS A COMPLETE RADIO COURSE IN EVERY DETAIL. You will learn how to build radios, using regular schematics; how to wire and solder in a professional manner; how to service radios. You will work with the standard type of Punched metal chassis as well as the latest development of Printed Circuit chassis.

You will learn the basic principles of radio. You will construct, study and work with RF and AF amplifiers and oscillators, detectors, rectifiers, test equipment. You will learn and practice code, using the Progressive Code Oscillator. You will learn and practice trouble-shooting, using the Progressive Signal Tracer, Progressive Signal Injector, Progressive Dynamic Wave Generator and Electronics Tester, Square Wave Generator and the accompanying instructional material.

You will receive training for the Novice, Technician and General Classes of F.C.C. Radio Amateur License. You will build 20 Receiver, Transmitter, Square Wave Generator, Code Oscillator, Signal Tracer and Signal Injector circuits, and learn how to operate them. You will receive an excellent background for television, Hi-Fi and Electronics.

Absolutely no previous knowledge of radio science is required. The "Edu-Kit" is the product of many years of teaching and engineering experience. The "Edu-Kit" will provide you with a basic education in Electronics and Radio, worth many times the complete price of \$26.95. The Signal Tracer alone is worth more than the price of the entire Kit.

### THE KIT FOR EVERYONE

You do not need the slightest background in radio or science. Whether you are interested in Radio & Electronics because you want an interesting hobby, a well paying business or a job with a future, you will find the "Edu-Kit" a worth-while investment. Many thousands of individuals of all

ages and backgrounds have successfully used the "Edu-Kit" in more than 79 countries of the world. The "Edu-Kit" has been carefully designed, step by step, so that you cannot make a mistake. The "Edu-Kit" allows you to teach yourself at your own rate. No instructor is necessary.

### PROGRESSIVE TEACHING METHOD

The Progressive Radio "Edu-Kit" is the foremost educational radio kit in the world, and is universally accepted as the standard in the field of electronics training. The "Edu-Kit" uses the modern educational principle of "Learn by Doing." Therefore you construct, learn schematics, study theory, practice trouble-shooting—all in a closely integrated program designed to provide an easily-learned, thorough and interesting background in radio.

You begin by examining the various radio parts of the "Edu-Kit." You then learn the function, theory and wiring of these parts. Then you build a simple radio. With this first set you will enjoy listening to regular broadcast stations, learn theory, practice testing and trouble-shooting. Then you build a more advanced radio, learn more advanced theory and techniques. Gradually, in a progressive manner, and at your own rate, you will find yourself constructing more advanced multi-tube radio circuits, and doing work like a professional Radio Technician.

Included in the "Edu-Kit" course are twenty Receiver, Transmitter, Code Oscillator, Signal Tracer, Square Wave Generator and Signal Injector circuits. These are not unprofessional "breadboard" experiments, but genuine radio circuits, constructed by means of professional wiring and soldering on metal chassis, plus the new method of radio construction known as "Printed Circuitry." These circuits operate on your regular AC or DC house current.

### THE "EDU-KIT" IS COMPLETE

You will receive all parts and instructions necessary to build 20 different radio and electronics circuits, each guaranteed to operate. Our Kits contain tubes, tube sockets, variable, electrolytic, mica, ceramic and paper dielectric condensers, resistors, tie strips, coils, hardware, tubing, punched metal chassis, Instruction Manuals, hook-up wire, solder, selenium rectifiers, volume controls and switches, etc.

In addition, you receive Printed Circuit materials, including Printed Circuit chassis, special tube sockets, hardware and instructions. You also receive a useful set of tools, a professional electric soldering iron, and a self-powered Dynamic Radio and Electronics Tester. The "Edu-Kit" also includes Code Instructions and the Progressive Code Oscillator, in addition to F.C.C.-type Questions and Answers for Radio Amateur License training. You will also receive lessons for servicing with the Progressive Signal Tracer and the Progressive Signal Injector, a High Fidelity Guide and a Quiz Book. You receive Membership in Radio-TV Club, Free Consultation Service, Certificate of Merit and Discount Privileges. You receive all parts, tools, instructions, etc. Everything is yours to keep.

### PRINTED CIRCUITRY

At no increase in price, the "Edu-Kit" now includes Printed Circuitry. You build a Printed Circuit Signal Injector, a unique servicing instrument that can detect many Radio and TV troubles. This revolutionary new technique of radio construction is now becoming popular in commercial radio and TV sets.

A Printed Circuit is a special insulated chassis on which has been deposited a conducting material which takes the place of wiring. The various parts are merely plugged in and soldered to terminals.

Printed Circuitry is the basis of modern Automation Electronics. A knowledge of this subject is a necessity today for anyone interested in Electronics.

### FREE EXTRAS

- SET OF TOOLS
- SOLDERING IRON
- ELECTRONICS TESTER
- PLIERS-CUTTERS
- ALIGNMENT TOOL
- WRENCH SET
- VALUABLE DISCOUNT CARD
- CERTIFICATE OF MERIT
- TESTER INSTRUCTION MANUAL
- HIGH FIDELITY GUIDE + QUIZZES
- TELEVISION BOOK + RADIO
- TROUBLE-SHOOTING BOOK
- MEMBERSHIP IN RADIO-TV CLUB: CONSULTATION SERVICE, FCC AMATEUR LICENSE TRAINING
- PRINTED CIRCUITRY

### SERVICING LESSONS

You will learn trouble-shooting and servicing in a progressive manner. You will practice repairs on the sets that you construct. You will learn symptoms and causes of trouble in home, portable and car radios. You will learn how to use the professional Signal Tracer, the unique Signal Injector and the dynamic Radio & Electronics Tester. While you are learning in this practical way, you will be able to do many a repair job for your friends and neighbors, and charge fees which will far exceed the price of the "Edu-Kit." Our Consultation Service will help you with any technical problems you may have.

J. Stataitis, of 25 Poplar Pl., Waterbury, Conn., writes: "I have repaired several sets for my friends, and made money. The "Edu-Kit" I paid for itself. I was ready to spend \$240 for a Course, but I found your ad and sent for your Kit."

### FROM OUR MAIL BAG

Ben Valerio, P. O. Box 21, Magna, Utah: "The Edu-Kits are wonderful. Here I am sending you the questions and also the answers for them. I have been in Radio for the last seven years, but like to work with Radio Kits, and like to build Radio Testing Equipment. I enjoyed every minute I worked with the different kits; the Signal Tracer works fine. Also like to let you know that I feel proud of becoming a member of your Radio-TV Club."

Robert L. Shuff, 1534 Monroe Ave., Huntington, W. Va.: "Thought I would drop you a few lines to say that I received my Edu-Kit, and was really amazed that such a bargain can be had at such a low price. I have already started repairing radios and phonographs. My friends were really surprised to see me get into the swing of it so quickly. The Troubleshooting Tester that comes with the Kit is really swell, and finds the trouble, if there is any to be found."

### UNCONDITIONAL MONEY-BACK GUARANTEE

### ORDER DIRECT FROM AD—RECEIVE FREE BONUS RESISTOR AND CONDENSER KITS WORTH \$7

- Send "Edu-Kit" postpaid. I enclose full payment of \$26.95
- Send "Edu-Kit" C.O.D. I will pay \$26.95 plus postage.
- Rush me FREE descriptive literature concerning "Edu-Kit."

Name .....

Address .....

### PROGRESSIVE "EDU-KITS" INC.

1186 Broadway, Dept. 527AE, Hewlett, N. Y.

# BIG MONEY IN THE 4 CORNERS OF THE WORLD!

in TELEVISION, RADIO,  
ELECTRONICS, RADAR, SONAR

**CHRISTY OFFERS  
COMPLETE TRAINING!**

Investigate the Christy Complete Course. Why be satisfied with less? CTS Shop Method Home Training makes learning easy. You learn by working with actual equipment. You receive Comprehensive training from the start. Can EARN AS YOU LEARN. You become qualified to open your own Electronics Repair business or to gain high pay as a TV, Radio, Electronics, etc. Technician.

**19 TRAINING KITS INCLUDED!**

You receive a Multi-Tester, Oscillator, Signal Tracer, Oscilloscope, Signal Generator, Electronic Timer, Regenerative Radio, 24" TV set (optional) and other valuable testing equipment. **FREE BOOK AND TWO FREE LESSONS** yours for the asking! No obligation.

**CHRISTY TRADES SCHOOL**

Dept. T-1313, 3214 W. Lawrence Ave.,  
Chicago 25, Ill.

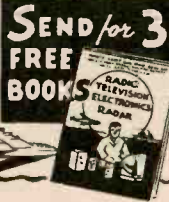

**CHRISTY TRADES SCHOOL, Dept. T-1313  
3214 W. Lawrence Ave., Chicago 25, Ill.**  
Please send me the 3 FREE BOOKS and Special Form for  
**PAYING LATER from EARNINGS MADE WHILE LEARNING.**

NAME \_\_\_\_\_ AGE \_\_\_\_\_  
ADDRESS \_\_\_\_\_  
CITY \_\_\_\_\_ ZONE \_\_\_\_\_ STATE \_\_\_\_\_



# Olson

**\* FREE**

Fill in coupon for a FREE One Year Subscription to  
**OLSON RADIO'S Fantastic Bargain Packed Catalog**  
— Unheard of LOW, LOW, WHOLESALe PRICES  
on Brand Name Speakers, Changers, Tubes, Tools, Hi-  
Fi's, Stereo Amps, Tuners and other Bargains.

NAME \_\_\_\_\_  
ADDRESS \_\_\_\_\_  
CITY \_\_\_\_\_ ZONE \_\_\_\_\_ STATE \_\_\_\_\_

If you have a friend interested in electronics send his  
name and address for a FREE subscription also.

**OLSON RADIO  
CORPORATION**

410 Forge Street Akron 8, Ohio

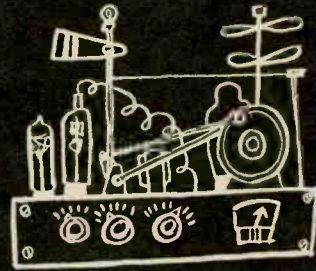

**New Gadgets,  
Instruments  
etc.**



**POCKETPHONE** is a two-way Citizens Band radio that stays under the 100 milliwatt power input limitation to the final RF amplifier. Its operators, therefore, require no FCC license at all, according to Part 15 of FCC Rules and Regulations. Manufactured by Globe Electronics, Council Bluffs, Iowa, Pocketphone weighs only 13½ ounces, is said to have an average range of about one mile, can be used with other CB installations, has a rechargeable battery and sells for \$125 each.

A \$4.50 remote TV speaker is available from Lafayette. The "Duo-Remote" has two separate volume controls, one for radio, TV or hi-fi and a second for the volume of the remote's own self-contained speaker.



# F.C.C. COMMERCIAL OPERATOR LICENSE

*Training...*

## for Jobs in Electronics

### F.C.C. LICENSE—THE KEY TO BETTER JOBS

An F.C.C. *commercial* (not amateur) license is your ticket to higher pay and more interesting employment. This license is Federal Government evidence of your qualifications in electronics. Employers are eager to hire *licensed* technicians.

### WHICH LICENSE FOR WHICH JOB?

The **THIRD CLASS** radiotelephone license is of value primarily in that it qualifies you to take the second class examination. The scope of authority covered by a third class license is extremely limited.

The **SECOND CLASS** radiotelephone license qualifies you to install, maintain and operate most all radiotelephone equipment except commercial broadcast station equipment.

The **FIRST CLASS** radiotelephone license qualifies you to install, maintain and operate every type of radiotelephone equipment (except amateur) including all radio and television stations in the United States, its territories and possessions. This is the highest class of radiotelephone license available.

### GRANTHAM TRAINING PREPARES YOU

The Grantham Communications Electronics Course prepares you for a **FIRST CLASS F.C.C. license**, and it does this by **TEACHING** you electronics. Each point is covered simply and in detail, with emphasis on making the subject easy to understand. The organization of the subject matter is such that you progress, step-by-step, to your specific objective—a first class F.C.C. license.

### CORRESPONDENCE OR RESIDENCE CLASSES

Grantham training is available by correspondence or in resident classes. Either way, you are trained quickly and well. Write, or mail the coupon below, to any division of Grantham School of Electronics. Our free booklet will be sent to you immediately.

### HERE'S PROOF...

that Grantham students prepare for F.C.C. examinations in a minimum of time. Here is a list of a few of our recent graduates, the class of license they got, and how long it took them:

	License	Weeks
Richard M. Wilhoit, 2104 Santa Paula, Las Vegas, Nev.	1st	12
Larry R. Perrine, 7 Normandy Place, Champaign, Ill.	1st	15
Marion Woolsey, 3246 Warwick, Kansas City, Mo.	1st	12
Harold W. Johnson, 5070 Hermosa Ave., Los Angeles, Calif.	1st	15
Ralph Frederick Beisner, 2128 Grand, Joplin, Mo.	1st	12
N. E. Mills, II, 110 So. Race St., Statesville, N. C.	1st	12
Dean A. Darling, 403 S. Chase Ave., Columbus 4, Ohio	1st	12
Gerald L. Chopp, 518 Audubon Road, Kohler, Wis.	1st	12

**FOUR COMPLETE SCHOOLS:** *To better serve our many students throughout the entire country, Grantham School of Electronics maintains four complete Divisions—located in Hollywood, Calif., Seattle, Wash., Kansas City, Mo., and Washington, D.C. All Divisions of Grantham School of Electronics offer the same rapid courses in F.C.C. license preparation, either by home study or in resident classes.*

Get your First Class Commercial F.C.C. License in 12 weeks by training at

# Grantham School of Electronics

HOLLYWOOD  
CALIF.

1505 N. Western Ave.  
Hollywood 27, Calif.  
(Phone: HO 7-7272)

SEATTLE  
WASH.

408 Marion Street  
Seattle 4, Wash.  
(Phone: MA 2-7227)

KANSAS CITY  
MO.

3123 Gillham Road  
Kansas City 9, Mo.  
(Phone: JE 1-6320)

WASHINGTON  
D. C.

821-19th Street, N.W.  
Washington 6, D. C.  
(Phone: ST 3-3614)

for **FREE** Booklet **CLIP COUPON** and mail  
in envelope or paste on postal card.



To: **GRANTHAM SCHOOL OF ELECTRONICS**

1505 N. Western Hollywood • 408 Marion Seattle • 3123 Gillham Rd. Kansas City • 821-19th, NW Washington

Please send me your free booklet telling how I can get my commercial F.C.C. license quickly. I understand there is no obligation and no salesman will call.

Name \_\_\_\_\_ Age \_\_\_\_\_

Address \_\_\_\_\_

City \_\_\_\_\_ State \_\_\_\_\_

I am interested in:  Home Study,  Resident Classes 08-M

MAIL COUPON NOW

**RESIDENT SCHOOL COURSES  
IN LOS ANGELES AND NEW YORK CITY**



Industry needs Electronic Technologists!

**LET RCA  
TRAIN YOU IN  
General Electronics  
Technical Writing  
TV, Communications**

Countless career opportunities are open to you in such fields as automation, guided missiles, radar, television, computers, and other industrial electronic applications.

RCA Institutes Resident Schools in New York City and Los Angeles offer you comprehensive courses that prepare you for the field of electronics you may choose. No previous technical training required. Introductory courses in Math and Physics available.

Coeducational Day and Evening classes. Free placement service. Applications now being accepted.



The Most Trusted Name  
in Electronics

® RADIO CORPORATION OF AMERICA

Send to the school nearest you

**RCA Institutes, Inc., Dept. EIR-80**

350 West Fourth Street Pacific Electric Building  
New York 14, N. Y. 610 S. Main St., L.A. 14, Calif.

Please send me your FREE catalog of Resident School courses.

Name \_\_\_\_\_

Address \_\_\_\_\_ (PLEASE PRINT)

City \_\_\_\_\_ Zone \_\_\_\_\_ State \_\_\_\_\_

For Home Study Courses See Ad On Opposite Page

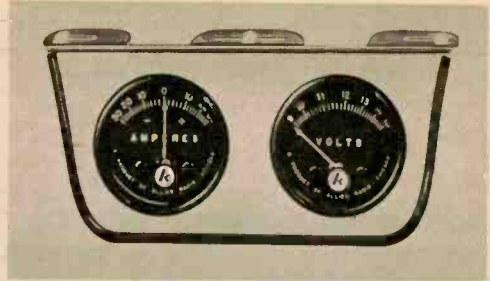

AMMETER-VOLTMETER KIT for cars and boats with 12V systems has vibration-proof pilot lights. Voltmeter reads 9-15 volts and ammeter reads 30-0-30 amps. It is Knight-kit 83 Y 711, priced at \$10.75.



BROADCAST AND MARINE BAND transistorized radio by Toshiba costs \$59.50 from Transistor World Corp., 52 Broadway, N. Y. 4, N. Y. It is pocket-size, has two antennas—one a telescoping 10-section rod.

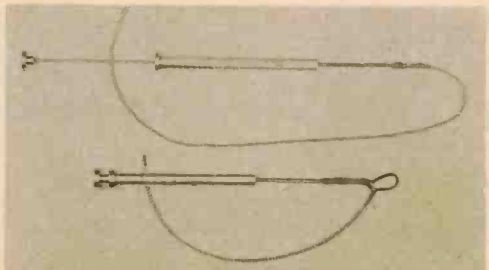

LEAD EXTRACTOR is a new tool to provide a safe, quick way of ejecting insulated leads through the shields of braided wire. It comes in five color-coded sizes from Macdonald & Co., Glendale 7, Calif. and costs \$4.25.





# LET RCA TRAIN YOU IN ELECTRONICS

RCA Institutes, one of the world's leading electronic technical schools, offers a Home Study Course in . . .

## ELECTRONICS FOR AUTOMATION

. . . Now you have four comprehensive courses for your electronic training . . . from basic electronic theory to the more advanced principles of color TV and Automation.

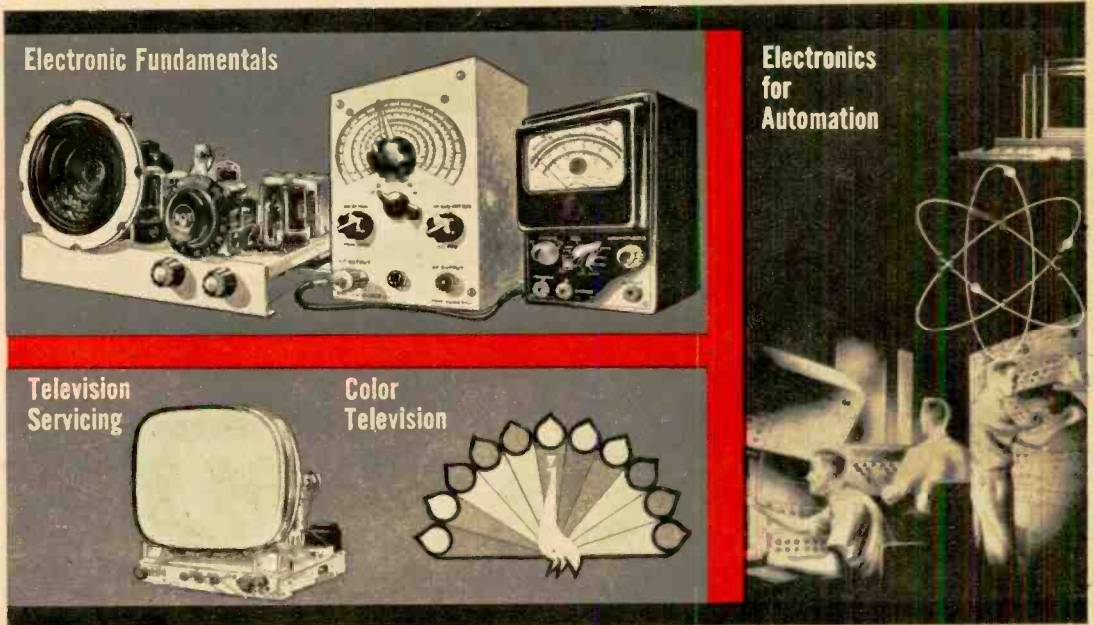

Send for our  
64 page Home  
Study Catalog

**FREE!**

FOR RESIDENT  
SCHOOL COURSES  
SEE AD ON  
OPPOSITE PAGE



Practical work with the very first lesson. Pay-as-you-learn.  
You need pay for only one study group at a time.

**RCA INSTITUTES, Inc.** Home Study School, Dept. E1-80  
A Service of Radio Corporation of America  
350 West Fourth Street, New York 14, N. Y.

Please rush me your FREE illustrated 64-page book "Your Career in Electronics," describing your home training programs. No obligation. No salesman will call.

Name ..... Age .....

Address ..... Please print

City ..... Zone ..... State .....

Veterans: Enter discharge date .....

**CANADIANS** — Take advantage of these same RCA courses at no additional cost. No postage, no customs, no delay. Send coupon to: RCA Victor Company, Ltd., 5581 Royalmount Ave., Montreal 9, Quebec  
To save time, paste coupon on postcard.

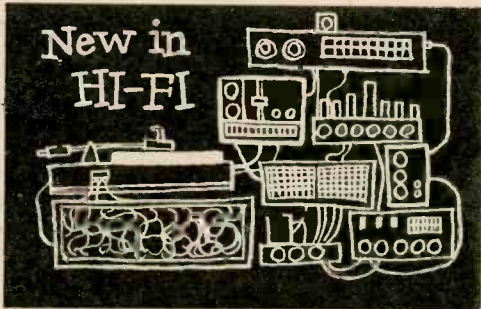

Mass. Called model 314, it retails at \$114.95 and has a multiplex output as well as Scott's silver plated front end.

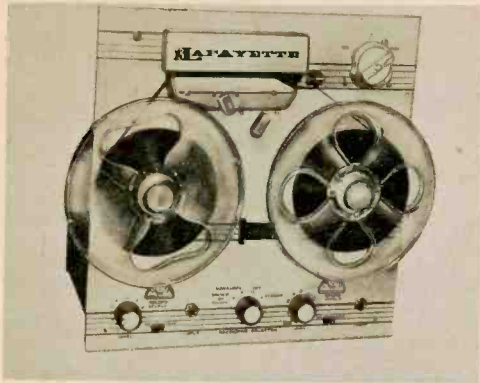
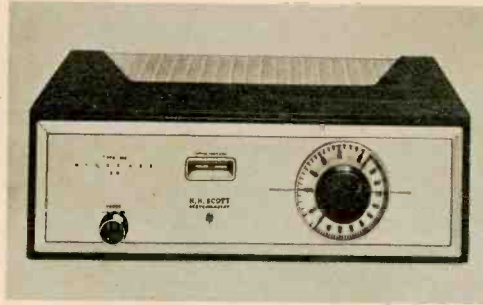

**INTEGRATED TAPE DECK** from Lafayette Radio, 165-08 Liberty Ave., Jamaica, N. Y., has a separate recording preamp with individual VU recording level meters for each stereo recording channel. In combination with a component stereo system it can play  $\frac{1}{2}$  or  $\frac{1}{4}$  track tapes and record  $\frac{1}{4}$  track monophonically or stereophonically from discs, radio or mike. Price: \$239.95.



**BRITISH 2-SPEED TURNTABLE** with a hysteresis synchronous motor has been announced by Ercona Corp., 16 W. 46th St., N. Y., N. Y. Called the Connoisseur, it plays both  $33\frac{1}{3}$  and 45 rpm records. Motor mechanism is mounted outside the turntable rim to reduce hum pickup by the cartridge due to magnetic radiation of the motor. The price of this stereo unit is about \$59.50.

**FM TUNER** with 2 mc detector and limiter bandwidth is available from H. H. Scott, 111 Powdermill Rd., Maynard,

## New! LAFAYETTE HE-15 Citizens Band 11 Meter SUPERHET TRANSCEIVER



Completely Wired  
**NOT A KIT**  
**64.50**  
only 2.00 down

- 5 Crystal Controlled Transmitting Positions • Complete with Channel 9 Transmitting Crystal • Anyone Over 18 can operate
- Planetary Vernier Tuning • High Output Crystal Microphone

HE-15 Factory Wired and Tested (less antenna).....	Net 64.50
HE-19 Whip Antenna For Short Range.....	Net 3.95
HE-16 Power Supply For 12 Volts.....	Net 11.95
HE-18 Power Supply For 6 Volts.....	Net 11.95

Not Superregenerative but SUPERHET

FOR DESCRIPTIVE BROCHURE — WRITE TO ► LAFAYETTE RADIO DEP'T. EI 165-08 LIBERTY AVE. JAMAICA 33, N. Y.





# Are You Interested In Electronics - TV - Radio?

CARL E. SMITH,  
E. E., President

then you will want to know

## What IS The FCC?

It's amazing what the future holds for you in this modern world of electronics. Let me send you the entire story—FREE!

- How to pass the FCC Exam
- Successful Electronic Training

I can train you to pass the Valuable FCC exam in a minimum of time if you have any practical experience and a fair knowledge of mathematics.

CARL E. SMITH, E.E., President

How You Can Get a Valuable  
**FCC COMMERCIAL LICENSE**  
Your Passport to Future Security  
Get These Free



### These Three Booklets Tell You

- 1 Where to apply to take FCC Examinations.
  - 2 Scope of knowledge required.
  - 3 Necessary FCC exam preparation.
  - 4 Positive knowledge check.
- And additional data of great value.

**Get Your FCC  
Commercial License -  
or your money back**

### Your Guarantee

The Master Course in Electronics will provide you with the mental tools of the electronics technician and prepare you for a First Class FCC License (Commercial) with a radar endorsement. When you successfully complete the Master Course, if you fail to pass the FCC examination, you will receive a full refund of all tuition payments.

**Start Building  
For a Lifetime  
Profession**

- Employers make job offers every month!
- Your FCC ticket is recognized by most employers in the Electronics field as proof of your technical ability.
- Pave the way for Your Share of the better things in life.

**Cleveland Institute of Electronics**

Accredited by the  
National Home Study Council

Desk EI-23, 4900 Euclid Ave., Cleveland 3, Ohio

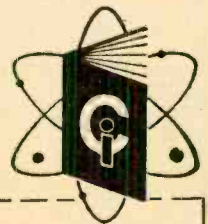

Please send Free Booklets prepared to help me get ahead in Electronics.  
I have had training or experience in Electronics as indicated below.

- |   |   |  |
|---|---|--|
| <input type="checkbox"/> Military           | <input type="checkbox"/> Amateur Radio      | <input type="checkbox"/> Telephone Company |
| <input type="checkbox"/> Radio-TV Servicing | <input type="checkbox"/> Broadcasting       | <input type="checkbox"/> Other .....       |
| <input type="checkbox"/> Manufacturing      | <input type="checkbox"/> Home Experimenting |  |

In what kind of work are you now engaged?.....

In what branch of Electronics are you interested?.....

Name..... Age..... Address.....

City..... Zone..... State.....

EI-23

# QUICKLY CUT HOLES

in metal, plastics,  
hard rubber...

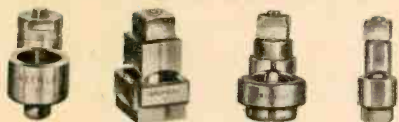

## GREENLEE CHASSIS PUNCHES

Make smooth, accurate openings in 1½ minutes or less... for sockets, plugs, controls, meters, panel lights, etc.

Easy to use... simply turn with wrench. Many sizes and models. Write for literature.



**GREENLEE**

GREENLEE TOOL CO. 2015 Columbia Ave., Rockford, Illinois

## ONE CENT SALE

**BUY ONE AT OUR REGULAR LOW PRICE AND GET THE SECOND FOR ONLY 1¢ MORE**

**CITIZENS BAND TRANSMITTER** (27 MC) 5 watt chassis, complete with crystal, \$14.99 each, two for \$15.00.

**CITIZENS BAND RECEIVER** chassis tunable through all 22 channels. Complete with audio amplifier. \$9.99 each, two for \$10.00.

**AMATEUR BAND TRANSCEIVER** (144-148 MC) chassis with dual VHF triodes for walkie-talkie radiophone. \$9.99 each, two for \$10.00.

**TRANSCEIVER TRANSFORMER:** Mike to grid input and plate to low impedance headphone output. Good for telephone handsets, \$1.99 pair, two for \$2.00.

**SIGNAL BOOSTER** chassis for 27 MC. High gain (20DB) double tuned RF pentode amplifier. Improves performance of any Citizen Band receiver. Complete with tube \$11.99 each—2 for \$12.00.

**COILED CORD** 4 conductor 11" telephone cord. Extends to over 4 ft. .99 each, two for \$1.00.

**KIT OF PARTS** for AM-FM VHF radio receiver. Tunable from 80-200 mc. which includes U. S. satellite frequencies. \$6.99 each, two for \$7.00.

**TRANSISTOR AUDIO AMPLIFIER** gives 50X voltage gain on low level signals. Operates on 1½ volts. \$3.99 each, two for \$4.00.

**CONVERTER** (crystal controlled) for 27 MC Citizens Band. Adapts any standard broadcast radio to 27 MC band. Tunes all 22 channels. Complete with tubes and crystal \$14.99 each, 2 for \$15.00.

### ALL MERCHANDISE GUARANTEED

Limited Quantity—No Literature or Catalog

Remit in full, include sufficient postage. No C.O.D.'s.

## VANGUARD ELECTRONIC LABS.

Dept. EL-8

Factory & Mail Order; 190-48 99th Ave., Hollis 23, N. Y.

Retail Store; 196-23 Jamaica Ave., Hollis 23, N. Y.



**KIT OR WIRED**, that's how Arkay's RPA 7 record changer is available. It plays all size records, mixed or otherwise. Price: Kit, \$31.50; wired \$52.50. 88-06 Van Wyck, Jamaica, N. Y.



**NEW STEREO ARM** by Shure Bros., Inc., 222 Hartrey Ave., Evanston, Ill., is called the Professional. No soldering is required to install the arm; one end of the furnished cable plugs into the arm, while the other end plugs into amplifier. Price for 12" arm is \$29.95; 16", \$31.95. They are designed to accept any universal stereo cartridge, as well as Shure's M7D and M3D.



**TWENTY-SEVEN CONTROLS** on the Fisher Radio 400-CX stereo master control do everything the audiophile would ever want to do, including "sonic null balancing" and achieving any desired degree of stereo separation (from zero to full). Price: about \$199.50 from Fisher, 21-21 44th Dr., Long Island City 1, N. Y.



**AT  
LAST!**

# RADIO-TV and ELECTRONICS TRAINING

**.... AT A PRICE  
YOU CAN AFFORD!**



**\*21 INCH**  
Receiver Kit included

Yes, this great course costs far less than any training of its kind given by other major schools! Radio-Television Training School will train you for a good job in Television or Industrial Electronics — **AT HOME IN YOUR SPARE TIME.**

Think of it — a complete training program including over 120 lessons, Fourteen Big Radio-Television Kits, Complete Color-TV Instruction, Unlimited Consultation Service... **ALL at a really big saving to you.** How can we do this? Write to us today... and find out!

And what's more — you can (if you wish)  
**OPEN YOUR OWN RTS-APPROVED AND  
FINANCED RADIO-TV SERVICE SHOP**

**We Want Many More Shops This Year**  
This 38 year old training organization — called RTS, that's Radio-Television Training School — wants to establish a string of Radio-TV Repair Shops in principal cities throughout the U. S. So far, a great many such shops are **NOW IN BUSINESS AND PROSPERING.** We are helping and training ambitious men to become future owners and operators of these shops in all areas.

**FOR UNSKILLED  
INEXPERIENCED MEN ONLY —  
WE TRAIN YOU OUR WAY!**

We must insist that the men we sign up be trained in Radio-TV Repair, Merchandising and Sales by our training methods—because **WE KNOW** the requirements of the industry. Therefore, we will **TRAIN YOU**... we will show you how to earn **EXTRA CASH**, during the first month or two of your training period. **YOU KEEP YOUR PRESENT JOB. TRAINING TAKES PLACE IN YOUR OWN HOME, IN YOUR SPARE TIME!**

**COMPLETE  
COLOR  
INSTRUCTION  
INCLUDED**

you build these  
and other units

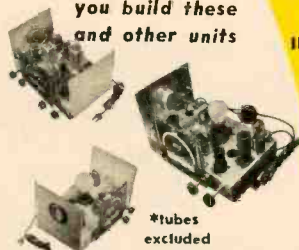

\*tubes  
excluded

## RADIO-TELEVISION TRAINING SCHOOL

815 East Rosecrans Avenue,  
Los Angeles 59, California

Est. 1922



**ACT  
NOW!**

Get your free book on the  
**FAMOUS RTS BUSINESS PLAN**  
find out how you can open  
**A REPAIR SHOP OF YOUR OWN**

We supply and finance your equipment

When you are ready and qualified to operate one of our RTS-Approved TV Repair Shops **WE WILL SUPPLY AND FINANCE EVERY BIT OF EQUIPMENT YOU NEED TO GET STARTED** plus an inventory of parts and supplies. In other words we will stake you... **AN OFFER NEVER MADE BEFORE BY ANY TRAINING ORGANIZATION.** Under the RTS Business Plan you receive:

1. An electric sign for the shop front.
2. Complete laboratory of test equipment.
3. Letterheads, calling cards, repair tickets, etc.
4. Basic inventory of tubes, parts, supplies.
5. Complete advertising and promotional material.
6. Plans for shop arrangement.
7. Instructions on how to go into business.
8. Continuous consultation and help.
9. The right to use RTS Seal of Approval, and the RTS Credo.
10. The right to use the Famous Trade Mark.



RTS' Membership in The Association of Home Study Schools is your assurance of Reliability, Integrity, and Quality of Training.

**ALL  
THESE  
FREE!**



**CUT OUT AND MAIL — TODAY!**

### RADIO-TELEVISION TRAINING SCHOOL

815 East Rosecrans Avenue, Dept. E1-860  
Los Angeles 59, California

SEND ME FREE — all of these big opportunity books — "Good Jobs in TV-Electronics," "A Repair Shop of Your Own" and "Sample Lesson." I am interested in:

- Radio-Television       Industrial Electronics (Automation)

Name \_\_\_\_\_ Age \_\_\_\_\_  
please print

Address \_\_\_\_\_

City & State \_\_\_\_\_  
300

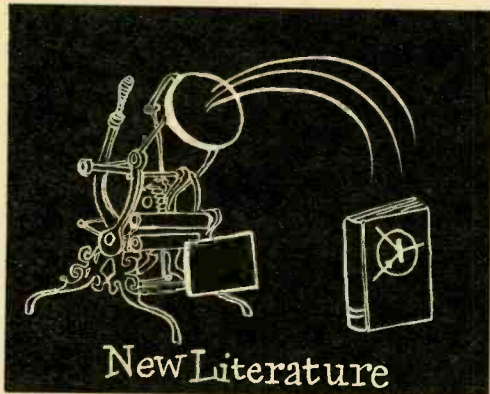

Detailed and illustrated information is contained in a new paperback from Gernsback Library (No. 59) called "Servicing Record Changers," by Harry Mileaf. It has a section on turntables and cartridge and pickup arms. Price: \$2.90 . . . 136 pages of circuits for audio amplifiers has been printed in England by Mullard and is available from International Electronics Corp., 81 Spring Street, N. Y. 12, N. Y., for \$2.50. Included are power amplifiers and preamps for both mono and stereo.

New catalogs come from East Coast Radio and TV Co., Miami, Fla.; Zack Electronics, 1422 Mark Street, San Francisco, Calif.; Hughes Peters Inc., 481 E. 11th Ave., Columbus 3, Ohio (parts and equipment for broadcasters, industry, radio and TV technicians); Arrow Electronics, Inc., 65 Cortlandt St., New York City (hi-fi, ham); Carolina Radio Supply Co., Inc., 221 W. Washington St., Greenville, S. C.

"Servicing the Vertical Sweep System" has just been published by Stancor, 3501 W. Addison St., Chicago 18, Ill. Booklet contains practical hints on how to locate defects in vertical deflection systems of TV sets, etc. It was prepared in part by EI author Milt Kiver and is available free from Stancor . . . The sixth edition of Centralab Packaged Electronic Circuit Guide contains complete replacement data covering over 250 equipment brands and over 1400 replacement applications. Free from Centralab . . . 160 pages of "Transistor Projects" skips over theory and gets down to build-it projects. Gernsback Library No. 89, \$2.90.

## Build the Best CITIZENS BAND TRANSCEIVER . . . **EICO**



#760 (117 VAC) less bracket: Kit \$59.95. Wired \$89.95  
 #761 (117 VAC & 6 VDC): Kit \$69.95. Wired \$99.95  
 #762 (117 VAC & 12 VDC): Kit \$69.95. Wired \$99.95

Highly reliable; exemplary electronic, mechanical, industrial design. Powerful 5-watt (as defined by FCC) crystal-controlled transmitter & extremely sensitive, selective superhet receiver with RF stage & noise limiter. Built-in speaker, detachable ceramic mike. Pre-set & sealed crystal oscillator circuit elements. To change channels, just change crystals — no adjustments needed. Built-in variable "pi" network matches most popular antennas. Portable whip & roof antennas available. No exams or special skill needed — any citizen 18 years or older may obtain station license by submitting FCC form, supplied free by EICO.



**Build the Best 6-TRANSISTOR RADIO RA-6**  
 Kit \$29.95 Wired \$49.95  
 includes FET, less 9V battery

High sensitivity & selectivity. New plug-in type transistors. Big-set volume & tone. 4" x 6" speaker; push-pull audio. Built-in Ferrite rod antenna. Pre-aligned RF & IF transformers. Planetary vernier tuning. Earphone jack for private listening. Attractive tan leatherette case, retractable handle. Compact: 8½" w, 4½" h, 2½" d. Only 3 lbs.



**90-WATT CW TRANSMITTER #720**  
 Kit \$79.95 Wired \$119.95

\*U.S. Pat No. D-184,776

"Top quality" — ELECTRONIC KITS GUIDE. Ideal for veteran or novice. 90W CW, 65W external plate modulation. 80 through 10 meters.



**HIGH-LEVEL UNIVERSAL MODULATOR-DRIVER #730**  
 Kit \$49.95 Wired \$79.95

Cover E-S \$4.50  
 Delivers 50W undistorted audio. Modulates transmitters having RF inputs up to 100W. Unique over-modulation indicator.



**New Code Practice Oscillator #706**  
 Kit \$8.95 Wired \$12.95

Rugged battery-operated transistor oscillator circuit, built-in speaker. Front panel has flashing light, phone jack, pitch control (500-2000 cps), external key terminals, "temporary" key. Panel switch selects Tone, Light, or both Tone & Light. 6½" h, 3¾" w, 2¾" d.



**GRID DIP METER #710**  
 Kit \$29.95 Wired \$49.95

Includes complete set of coils for full band coverage. Continuous coverage 400 kc to 250 mc. 500 ua meter.

Compare — Judge for yourself — at your neighborhood EICO dealer. For FREE catalog on over 70 models of easy-to-build professional test instruments, hi-fi and ham gear, fill out coupon on Page 24.



Add 5% in the West. ©1960

3300 N. Blvd., L. I. C. I. N. Y.



**IMPORTANT: For the man who wants to make big money in Radio-Television!**

# ONLY SPRAYBERRY TRAINING IN RADIO and TELEVISION

**OFFERS YOU ALL OF THESE VITAL NEW ADVANTAGES  
TO HELP YOU EARN MORE MONEY FROM THE START!**

## NEW BUSINESS BUILDERS

... through these practical proven plans and ideas we help you make plenty of extra money in spare time while training.

## NEW TRAINING EQUIPMENT

... the famous Sprayberry Training kits have been newly engineered by our staff to offer you the latest in Radio-TV Service Techniques!

## NEW TRANSISTOR COURSE

... literally millions of new transistor radios are being used. We show you how to make money fixing them!

## NEW HIGH FIDELITY

... there's big money to be made installing and servicing Hi-Fi units. Your Sprayberry training now offers you this valuable and profitable preparation!

### TRAIN AT HOME—SPARE TIME

WITH THESE

## 25 BIG COMPLETE KITS of PARTS & EQUIPMENT

You learn Radio-TV Servicing the best way... the practical way... testing and assembling these modern kits of equipment.

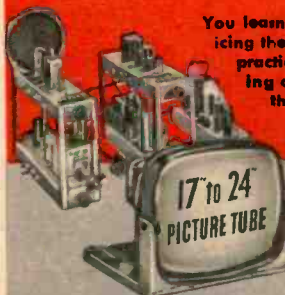

17" to 24" PICTURE TUBE

The new Sprayberry Training Television Receiver, built and tested in 5 sections.

Now offered... this fine modern oscilloscope.



You build this powerful two-band super-heterodyne radio receiver.



You build the new Sprayberry tester—a complete 18-range Volt-Ohm-Milliammeter test meter.



**FREE** These two big new books are yours free! Find out what Radio-Television offers you... and let us show you how easily you can learn, even without previous experience of any kind. Rush **COUPON** today!

The field of Radio-Television Servicing is such a fast moving industry that the best jobs and biggest incomes always go first to the man with the most modern, complete and up-to-date training. Thanks to constant revision and improvement... Sprayberry Training helps you earn more from the start... and keeps you earning more in the months and years ahead!

Make no mistake! All radio-television training is not alike. The basic purpose behind Sprayberry Training is to prepare you as rapidly and as surely as possible... to make top money servicing Radio and Television sets and equipment. This is where the big money has been for years... and will continue to be in the years ahead.

It's important for you to know that for over 30 years... Sprayberry Training has been preparing ambitious men for success in this interesting and profitable kind of work. Our school has helped hundreds to qualify for the best jobs... or to get started in profitable businesses of their own. Today our student rolls are the largest in our school's history... because the need and demand for Radio-Television Service Technicians has never been more urgent.

### Just \$6.00 Starts You

To encourage more men to enter Radio-Television at once... to help fill the great need for trained men... we're making it easier than ever before to start training. Just \$6.00 enrolls you. This liberal offer is naturally limited. Get the facts now

and consider enrollment while these favorable terms are available to you.

### KEEP YOUR JOB... while learning

Under the Sprayberry Plan you train entirely at home in spare time. You combine the most modern lesson training with fascinating and invaluable practical work with 25 big kits of parts and equipment that we supply. You get the equivalent of years of shop practice... and you can train as fast or as slowly as you wish. We help you make excellent spare time money while learning... and everything you receive—lessons, books, manuals, equipment—all yours to keep!

This is the Radio-Television industry's most modern and up-to-the-minute training. Sprayberry is the one school that gives you personalized attention and takes a real interest in your progress. Remember... just \$6 starts you! Mail the coupon today. Let the facts speak for themselves. Let us send you our new catalog and sample lesson... and prove the kind of opportunity that Sprayberry training can open up for you.

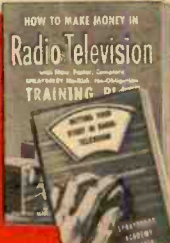

### MAIL COUPON - No Salesman Will Call

SPRAYBERRY ACADEMY OF RADIO-TELEVISION  
DEPT. 120-N, 1512 W. JARVIS AVE., CHICAGO 26, ILL.  
Please rush all information on your ALL-NEW Radio-Television Training Plan. I understand this does not obligate me and that no salesman will call upon me. Include New Catalog and Sample Lesson FREE.

NAME \_\_\_\_\_ AGE \_\_\_\_\_

ADDRESS \_\_\_\_\_

CITY \_\_\_\_\_ ZONE \_\_\_\_\_ STATE \_\_\_\_\_

## SPRAYBERRY ACADEMY OF RADIO-TELEVISION

Dept. 120-N, 1512 West Jarvis Ave., Chicago 26, Ill.

the experts say  
**your BEST BUY**  
 is **EICO**...

EICO, 3300 N. Blvd., L.I.C. 1, N.Y. E1-8

Show me HOW TO SAVE 50% on 70 models of top-quality:  HI-FI  TEST INSTRUMENTS  "HAM" GEAR  Send FREE Stereo HI-Fi Guide.  Send FREE Short Course for Novice License.  Send FREE Catalog & name of neighborhood EICO dealer.

Name .....  
 Address .....  
 City ..... Zone ..... State .....

ADD 5% IN THE WEST

...in  
**STEREO and MONO HI-FI**



**STEREO Dual Amplifier-Preamplifier HF81**  
 Kit \$69.95.  
 Wired \$109.95.  
 "Excellent" — SATURDAY REVIEW; HI-FI MUSIC AT HOME.



**STEREO Dual Preamplifier HF85**  
 Kit \$39.95.  
 Wired \$64.95.  
 "Extreme flexibility" — HI-FI REVIEW  
 a bargain!



**STEREO Dual Power Amplifiers:** New 100W HF89: Kit \$99.50  
 Wired \$139.50  
 70W HF87: Kit \$74.95. Wired \$114.95.  
 28W HF86: Kit \$43.95. Wired \$74.95.



**NEW! STEREO Automatic Changer/Player 1007** (.7 mil diamond, 3 mil sapph dual styl) \$59.75 incl. FET.



**Mono Power Amplifiers** (60, 50, 35, 30, 22, 14-Watt; use 2 for Stereo) from Kit \$23.50. Wired \$41.50.



**Mono Integrated Amplifiers:** (50, 30, 20, 12-Watt; use 2 for Stereo) from Kit \$34.95. Wired \$57.95.



**FM Tuner HFT90**  
 Kit \$39.95\*.  
 Wired \$65.95\*.  
 Cover \$3.95.  
 "One of the best buys" AUDIOCRAFT

\*Less Cover. Kit \$39.95. F.E.T. incl.



**AM Tuner HFT94**  
 Kit \$39.95. Wired \$65.95. incl. Cover & F.E.T.  
**2-Way Bookshelf Speaker System HFS1** complete with factory-built cabinet: Kit \$39.95  
 Wired \$47.95



**NEW! COMPLETE STEREO DUAL AMPLIFIER AF-4**  
 Kit \$38.95  
 Wired \$64.95

TRUE Hi-Fi quality to drive hi efficiency speakers to concert volume.

...and in  
**TEST INSTRUMENTS**



**New Power & Bias Supply for Transistorized Eqt. # 1020**  
 Kit \$19.95  
 Wired \$27.95  
 \* Patent Pending



**Miniaturized Multi-Signal Tracer # 145A**  
 Kit \$19.95.  
 Wired \$28.95.



**Vacuum Tube Voltmeter # 221**  
 Kit \$25.95.  
 Wired \$39.95.



**Peak-to-Peak VTVM # 232 & Uni-Probe**  
 Kit \$29.95.  
 Wired \$49.95.



**TUBE & CRT FIL. Tester # 612**  
 Kit \$3.95.  
 Wired \$5.95.  
 Fast-checks radio/TV tubes, pilot lamps, etc.



**1000 Ohms/Volt V-O-M. # 536**  
 Kit \$12.90.  
 Wired \$14.90.



**5" Push-Pull Scope # 425**  
 Kit \$44.95  
 Wired \$79.95.



**DC-5 MC Scope # 460**  
 Kit \$79.95.  
 Wired \$129.50.

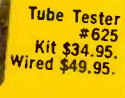

**Tube Tester # 625**  
 Kit \$34.95.  
 Wired \$49.95.



**RF Signal Generator # 324**  
 Kit \$26.95.  
 Wired \$39.95.



**Series/Parallel R-C Combination Box # 1140**  
 Kit \$13.95. Wired \$19.95  
 1350 Combinations!



**6V & 12V Battery Eliminator & Charger # 1050**  
 Kit \$29.95. Wired \$38.95.  
 Extra-filtered for transistor equipt. # 1060  
 Kit \$38.95. Wired \$47.95



**R-C Bridge & R-C-L Comparator # 950B**  
 Kit \$19.95.  
 Wired \$29.95.

© 1980 ELECTRONIC INSTRUMENT CO., INC., 33-00 N. BLVD., L.I.C. 1, N.Y.

IN STOCK! Compare, take them home — right "off the shelf" — from 2000 neighborhood dealers. Over 2 MILLION EICO instruments in use throughout the world.

See Page 22 for the BEST BUYS in CITIZENS TRANSCIVERS, "HAM" GEAR and TRANSISTOR RADIOS.



# behind the scenes with electronics at the **1960 Political Conventions**

More goes on here than meets the eye of the home viewer—walkie-talkies, creepie-peepies, video tape, and hundreds of technicians.

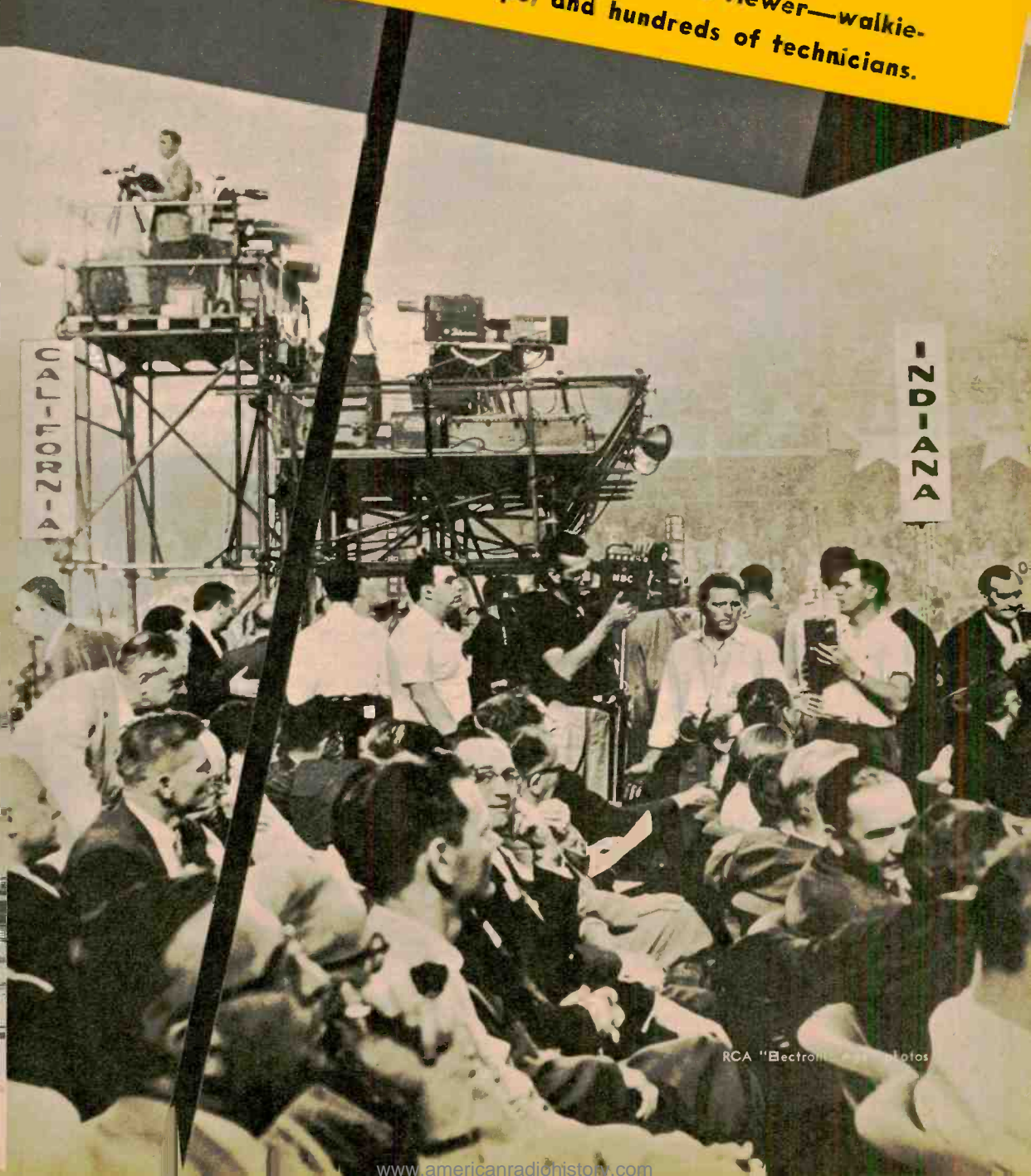

RCA "Electronics" Photos



Program directors in "on-the-air" control room not only call the shots for their own network, but also keep jealous eye on the competition.



NBC's Huntley-Brinkley team are just two of thousands of newsmen on hand to bring full gavel-to-gavel coverage of the conventions.

AS this issue of *Electronics Illustrated* hits the newsstands, the United States finds itself in the grip of a quadrennial madness known far and wide as National Political Convention time. On July 11, thousands of Democratic delegates, alternates and would-be candidates (the number of candidates often seems to equal the number of delegates) swarmed into the Los Angeles Sports Arena, both followed and preceded by thousands of newsmen, cameramen and technicians. In two weeks the political battleground shifts across the Rockies and Great Plains to Chicago, where the Republican Party Convention will be called to order.

The National Conventions may or may not pick the best men for this nation's highest offices, but one thing is certain: the conventions get the best news coverage Americans can possibly expect or hope for.

Since the 1948 conventions, television has been on the scene with a fantastic array of electronic gear peeping here, there and everywhere—the result of months of planning, hard labor and millions of dollars spent by the networks. In 1952, television had over \$4-million in equipment alone at Chicago. NBC,

one of three major networks, managed to mobilize more than twenty cameras.

But this year will be the biggest yet for TV and politics. Delegates will be projected into some 46-million television homes from coast to coast by more than 70 live television cameras ranging from shoebox-sized "creepie-peepies" carried by reporters prowling the Sports Arena floor, to cameras located high in the rafters reaching out for "cathedral shots." With video tape now firmly entrenched in television, important events will not be missed because a camera was covering an equally important and simultaneous event.

At both conventions the networks will have on hand more than 1000 newsmen and technicians with enough cameras, microphones, video tape units, control centers and newsrooms to make up at least a half-dozen completely equipped television stations. Much of the equipment and layout will be new this year, such as the complex and versatile convention "control center," which is said to have more electronics "on board" than a modern aircraft carrier. From this control center one television editor can handle his network's coverage with the precision and efficiency of a pier boss





Legman on floor uses wireless mike for local description of fast-breaking event, while video engineer (above) monitors TV picture density.

assigning tasks to his longshoremen . . . and do it at electronic speeds.

At Los Angeles, the on-camera commentators work, for the most part, from a broadcast booth high above the convention floor. NBC commentators, for instance, will be in direct two-way communication with a specially-designed layout covering about 10,000 square feet under the Arena stands. The area includes a master control console, studios for quiet interviews, film processing facilities, and a complete newsroom.

Twenty reporters outside the Arena will be on tap using walkie-talkies, miniaturized wireless microphones and creepie-peepies to pass along developments likely to take place in hotel rooms, ballrooms, train stations, etc.

The creepie-peepie had not been perfected four years ago and floor reporters were pretty much restricted to using walkie-talkies for voice with long-range cameras zooming in for the video. In the fluid crowds, TV cameramen often had a hard time finding the man on the floor with the walkie-talkie and the interesting interviewee.

Back in 1952, the year that Univac first predicted the election results, Democratic Convention Chairman Sam Rayburn, speaker of the House of Representatives, made the delegates well

**Here is another view of a convention control room, with newsroom in background. Newsmen do their best to bring order out of chaos.**

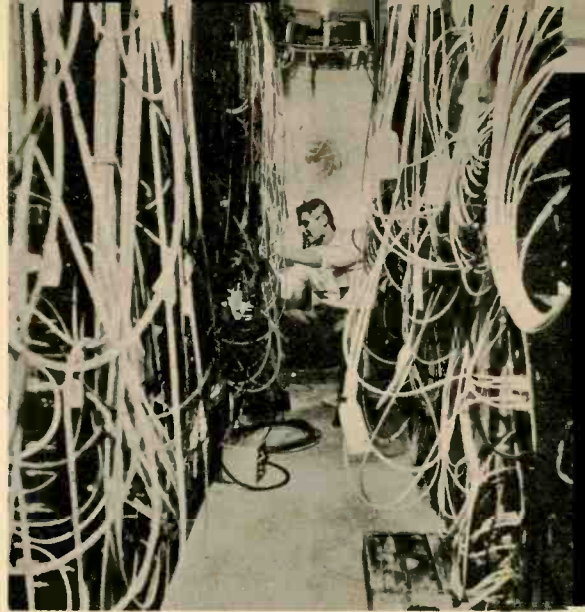

**Several complete network repair shops are set up at convention site. Above, a technician checks out some of hundreds of miles of cable.**

aware that their candidates were being viewed by more people in one hour on TV than they could reach in three solid years of old-style whistle-stopping—so would parading delegates with placards and balloons kindly refrain from obstructing the TV camera's view of the speaker at the rostrum. A leaflet was circulated to warn delegates that a camera lens might zoom in on them at any moment without their knowing it.

The TV directors don't like such warnings, for the most exciting feature of "live" politics for the home viewer is spontaneity—the candid shot that humanizes the candidate, the delegate, the hitherto unseen public figure, catching him in an expression that all at once reveals his personality to the voter.

Broadcasting's recent penetrating and complete coverage of politics has created new interest and excitement that has been reflected in an ever increasing number of eligible voters going to the polls. In 1920, the campaign year before the start of radio coverage (and the first year of women's suffrage), only 43 percent of potential voters actually voted. In 1952, television's first big presidential campaign, a whopping 63 percent of eligible voters cast their ballots. In 1960, with more television coverage, we can look for a new record turnout.





Amateur and professional Scuba divers will find this receiver-less rig a boon to underwater efficiency. System weighs 10 pounds. At left Scubacom amplifier-speaker unit is strapped to air tank. The mask shown at right contains the microphone and a push-to-talk button. Range is 150 feet in all directions.

## Voice Communications ... Underwater!

**T**HE hottest news for skin divers this summer is the first complete underwater voice communications system that isn't priced for millionaires alone. Scubacom, as it's called, is made by Electro-Voice, Buchanan, Mich., and has an underwater range of up to 150 feet—plenty far if you stick to the buddy system—and operates down to 120 feet. The system consists of two basic components. The combination mask-microphone houses a special microphone and a press-to-talk button and can be used in conjunction with any standard eye-and-nose diving mask (after removing the standard Scuba mouthpiece and barrel assembly).

The speaker-amplifier is strapped to the air tank and receives signal voltages from the mike-mask. The amplifier circuit is conventional, but miniaturized. The audio output (500-2500 cps) is coupled to the speaker, which contains a circular bladder to equalize pressure for linear diaphragm operation. Due to the non-directional pattern of sound waves in water, it is not necessary for the speaker to be aimed. And the sounds can be heard without any receiving devices—other than human ears.

Two standard 6-volt pressurized underwater batteries, such as "Aqualite," provide the necessary power for the rig.

The performance ratings of Scubacom are said to be actual performance ratings and not laboratory-calculated. The mask and harness are made of Neoprene and natural rubber, with exposed metal hardware of brass and aluminum treated against corrosion.

The price: \$210. 

# Two New Battery

## Motorola



Top-mounting controls at left are horizontal and vertical holds, brightness, contrast. At right, channel selector with concentric fine tuning, range switch, volume. Antenna telescopes.

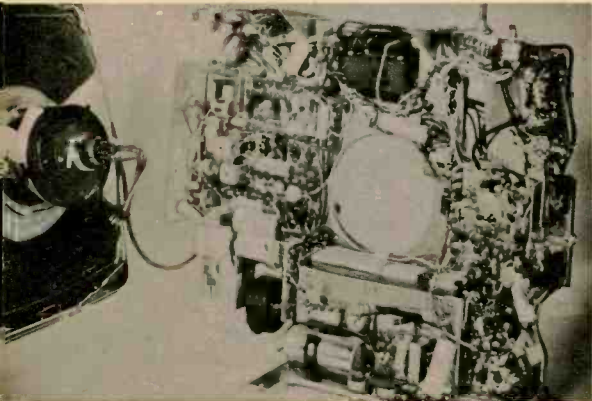

Above: Six screws separate Astronaut's chassis from 19" picture tube. Components are handwired. Below: Three high-frequency transistors are visible in this close-up of tuner.

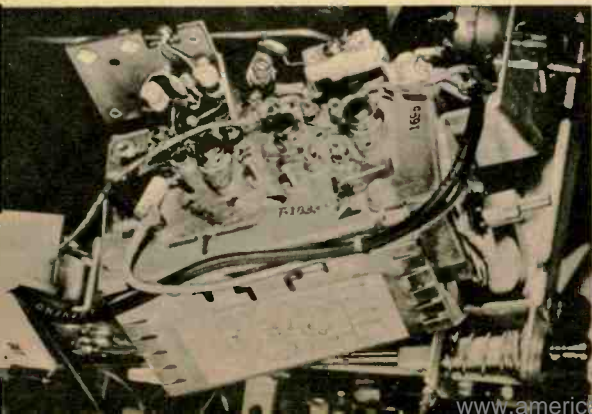

**F**IRST American direct-view battery operated portable television set comes from Motorola, and it's a whopper! It has been tabbed the "Astronaut" and facts available at press time are listed below.

**SIZE:** 15.5" high, 18" wide, 12 $\frac{3}{4}$ " deep  
**WEIGHT** (including battery): 40 lbs.  
**PICTURE TUBE:** 19" (19AFP4), a modified 19XP4 CRT with following characteristics:

Filament: 12.6 V @ 150 ma

Screen (G2): 100 V

Cathode drive: 50 V for cut-off

**POWER REQUIREMENTS:** 100-120 VAC @  $\frac{1}{3}$  amp. or 20 VDC @ 1.5 amp.

**POWER SOURCES:** 117 VAC line or silver cadmium cell with:

5-6 hour operating cycle

500 recharge cycles (minimum)

Recharge time of 3 hours for each discharge hour

Constant voltage delivery until end of discharge cycle

No damage due to complete discharge

Recharged when line cord is plugged into AC outlet. Relay cut-out automatically prevents over-charging

One year factory guarantee

**CIRCUIT FEATURES:**

22 transistors

12 diodes

3-stage tuner with hi-pass filter

3-stage IF amplifier

2-stage video amplifier

2-stage amplified AGC

2-stage transformer-coupled audio amplifier

15 KV flyback-type high voltage supply

**SENSITIVITY** (mid-channel): 15 microvolts

**AVAILABILITY:** This summer

**PRICE:** \$275 without energy cell (\$88).

With the energy cell, ideal for "patio living." Otherwise a very compact big-screen portable receiver.

*Electronics Illustrated*



# Operated TV Sets

## Sony

**T**HE first Japanese entry into the direct-view portable TV market is this Sony transistorized set, somewhat smaller than the one on the opposite page and not yet available.

**SIZE:** 6¼" high, 8" wide, 8¾" deep

**WEIGHT** (including battery): 16 lbs.

**PICTURE TUBE:** 8" CRT with "smoked glass" face to eliminate glare out-of-doors. Tube has 1" neck diameter as opposed to usual 1½" neck.

**POWER REQUIREMENTS:** 100-120 VAC @ 1/5 amp. or 12 VDC at .9 amp.

**POWER SOURCES:** 117 VAC line or "red acid" battery with:

3 hour operating cycle

10-12 hour recharge cycle

300 playing hours battery life

2 recharge methods: (1) remove battery unit, plug into wall; (2) "floating" charge with battery unit intact, cord in wall outlet and AC and OFF keys depressed

Replacement battery will retail for about \$5, somewhat lower in cost than present nickel or silver cadmium batteries

**CIRCUIT FEATURES:**

23 transistors

14 diodes

3-stage tuner

3-stage IF amplifier

2-stage video amplifier

2-stage audio amplifier with discriminator

AGC

12-15 KV high voltage supply

Automatic temperature control for vertical output transistor

**SENSITIVITY:** 100 microvolts

**AVAILABILITY:** Late fall or early winter

**PRICE:** Approx. \$200

Soon it will be impossible to get away from television anywhere. "Little Brother" and you will be watching each other wherever you go. 📺

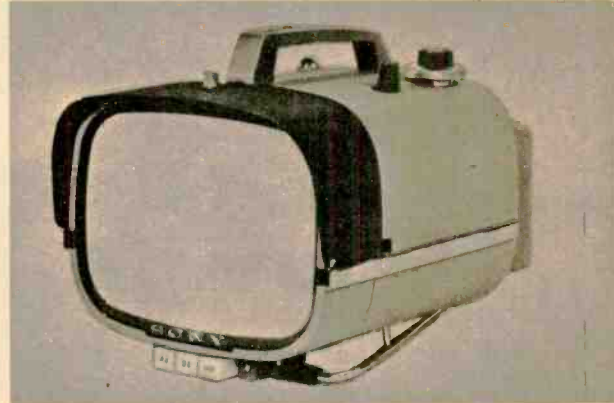

Eight-inch Sony screen has smoked glass face plate, and is hooded to keep out direct light. Channel selector and volume are top-mounted. AC, DC, OFF are pushbuttons at front.



Low-cost battery is in unit that may be unplugged from set for charge. Four knobs at rear are brightness, vertical, horizontal and video gain. Below, note phone size of set.



# A Lie Detector

By Harry Kolbe

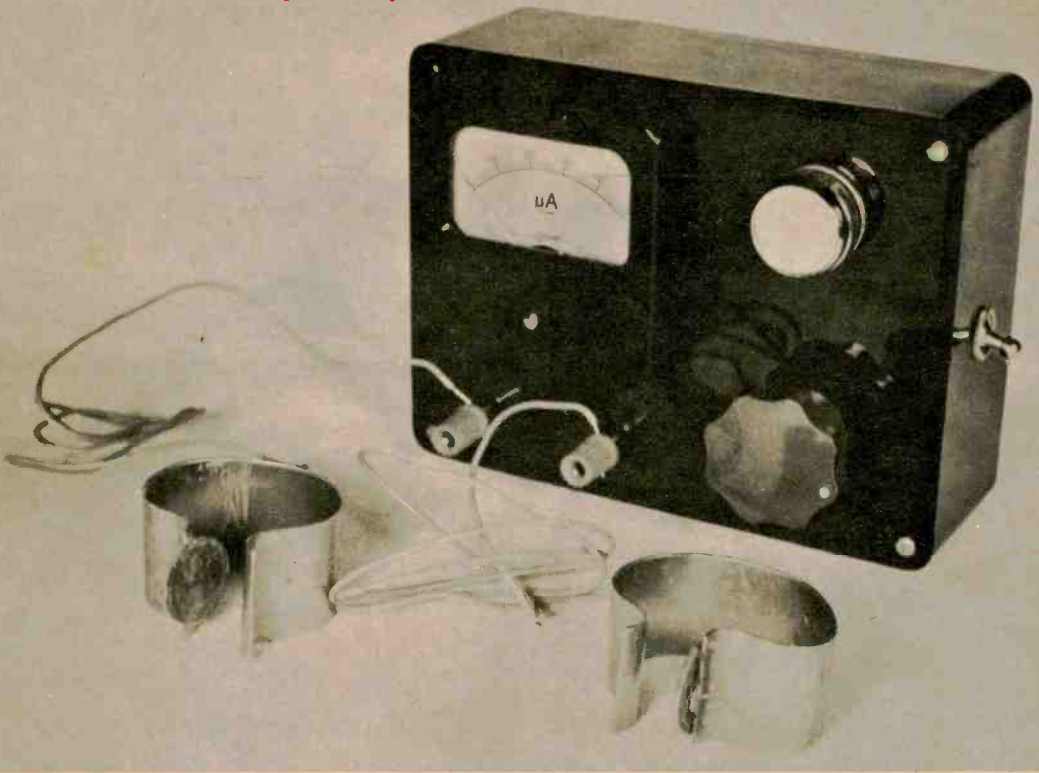

**Meter your emotions with this super-sensitive transistorized skin resistance detector device.**

**S**O you say you worked late at the office last night. It may ordinarily be possible to sell your wife on this story. But if you were really out with the boys and the little woman hooks you up to this little lie detector, it will definitely be "no sale."

The commercial "polygraph" type of lie detector is beyond the capabilities and pocketbook of the home experimenter. Fortunately, however, there is a physiological factor which can be easily and inexpensively measured by the amateur. This factor is skin resistance or G.S.R. (Galvanic Skin Resistance) as it is called by the psychologists. G.S.R. is an extremely sensitive barometer of emotional activity and therefore an excellent indicator of deception.

Of the various methods for measuring G.S.R., the most accurate is the Wheatstone bridge connected to a sensitive galvanometer. However, the high cost of a galvanometer rules out its use for our purpose. Instead, our lie detector uses an inexpensive meter preceded by two stages of transistor amplification. This results in an indicator at least as sensitive as an expensive galvanometer.



Since the G.S.R. never stays constant, but varies, it takes a great deal of experience and practice to be able to interpret the difference between normal variation and a change due to telling a lie. To make this task easier, a second indicator has been incorporated into the circuit. After the subject's skin resistance has been brought to proper calibration point on the meter, the second indication, the lamp, (PL1) which is turned on by the relay (RY1) in the collector circuit of Q2, will ignore variations unless they exceed a 5% drop in G.S.R. (The telling of a lie usually causes a 5-10% drop in G.S.R.) When the bridge is unbalanced by 5% in the downward direction, RY1 closes and turns on the light. This should occur between 2 and 5 seconds after the subject has lied.

The first step in construction is the preparation of the panel. Drill holes for and mount meter M1, pilot light assembly PL1, J1 and J2 and balance pot R3. Switch SW1 is mounted in the side of the case. The two transistor amplifier is built on a  $2\frac{1}{16}$ " x  $3\frac{3}{8}$ " perforated phenolic board. The amplifier board is mounted directly on the back of the meter and is held in place by the two meter terminal screws. Make the proper connections between the various

components and batteries which are taped down in the cabinet. Construction is completed by mounting the front panel to the case.

As an extra gimmick, you can hand letter or type a small transparent disc of thin paper to be inserted in the pilot lamp assembly cap. Then when the lamp lights it will illuminate from behind a comment such as SEZ YOU or TILT or some similar statement.

Now for the electrodes—these warrant special attention. We could use just two pieces of metal held by a rubber band on each palm. However, you would find that after you have set the instrument to the subject's skin resistance, the meter would begin to drift in a direction indicating increasing skin resistance. You might try to follow the drift but eventually you would come to the extreme end of R3. This happens at the point of contact between skin and electrode because the direct current between the electrodes through the skin causes electrolysis to occur. In more common terms, the current ionizes the salt present in the skin perspiration and deposits a layer of ions on the surface of the electrode which increases the electrode resistance as the ion layer gets thicker. To prevent this, we must construct non-polarizing electrodes known

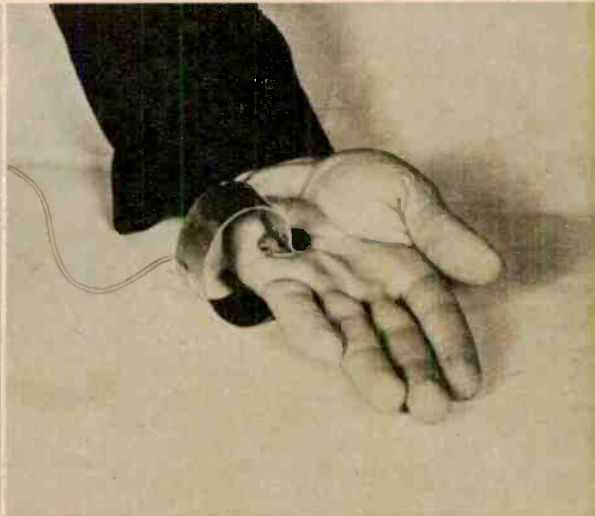
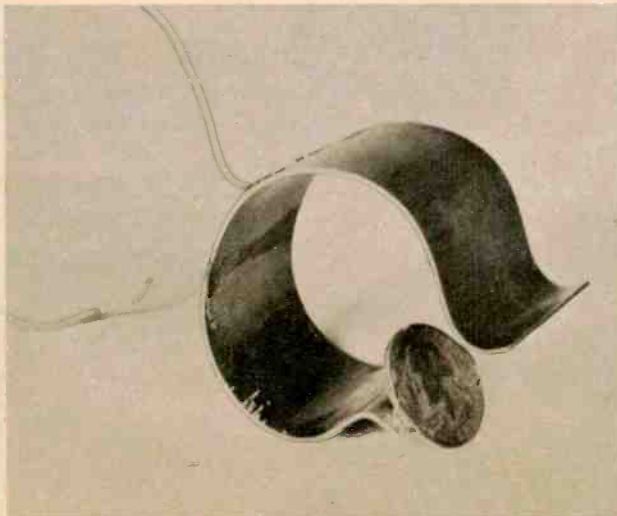

**C clamps made of brass or copper use silver pieces as electrode contacts. Above right, the C clamp electrode is shown properly adjusted to hand palm.**

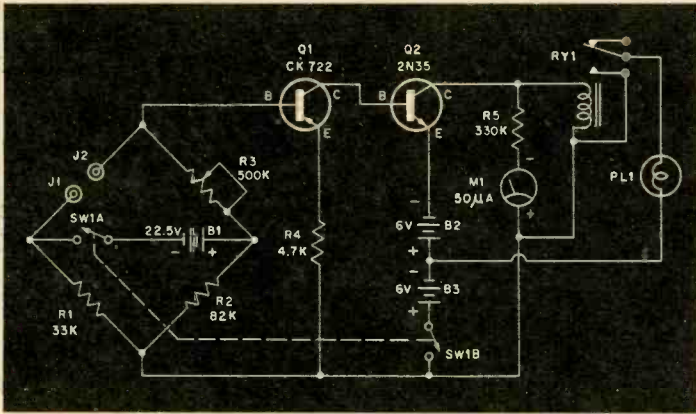

A Wheatstone bridge circuit balanced by R3 effectively calibrates the unit. J1 and J2 are the electrode terminals. Microammeter M1, may be as small as desired.

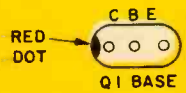
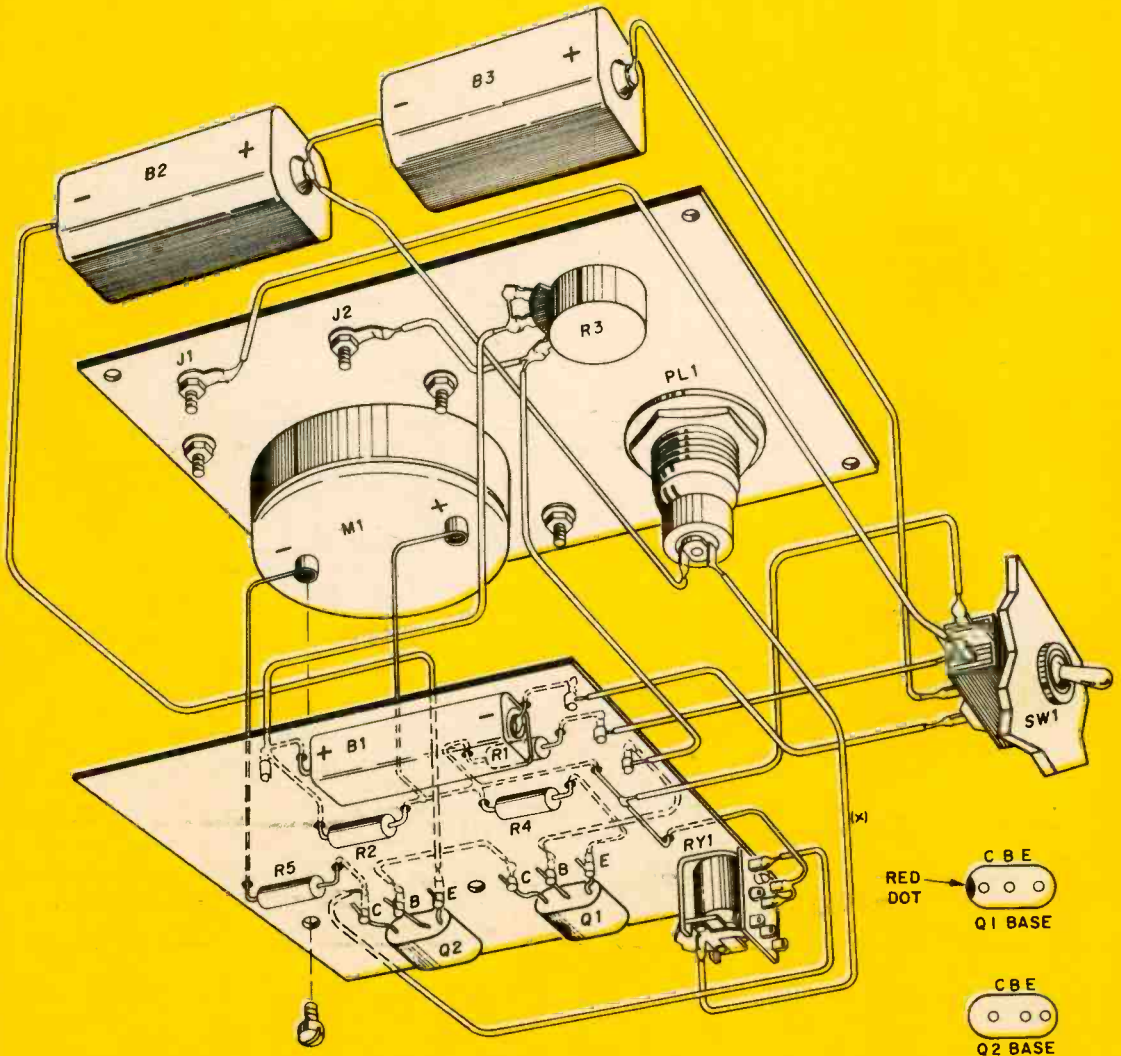



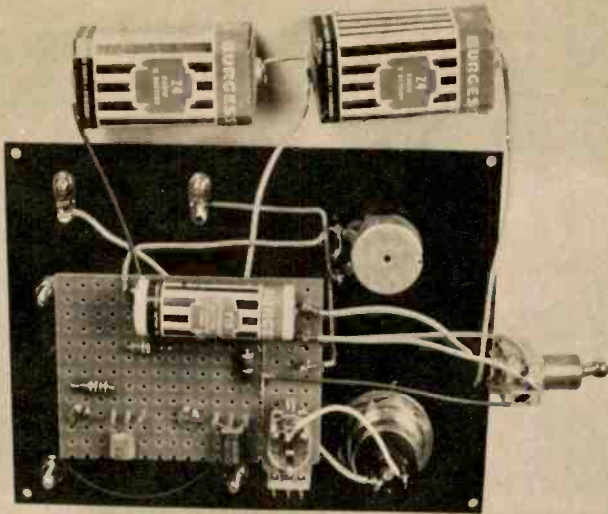

Bottom view of Bakelite cover. Miniature relay RY1, fits nicely on the perforated board. Two 6 volt batteries B2, B3, above cover, rest in main case not shown in photo.

technically as a silver-silver chloride type. They are prepared as follows:

Two silver pieces (25c size) are used as the electrode contacts. First solder them to the C clamps. The C clamps are made by bending two 1¼" x 6" strips of brass, copper or similar material into a C and then bending up the ends of the C as shown in the photo. Solder wires to the back of the C clamps close to the silver. These wires serve as the connections between the detector and the electrodes. Carefully paint the back of the electrode, solder joint and the half of the C clamp attached to the electrode with nail polish or coil dope. Now treat each silver electrode as follows: steel wool the unpainted side of each piece until shiny. Immerse the silver and only that part of the C clamp which is covered with paint into a solution of salt water in a glass container. Attach the wire from the C clamp to the positive terminal of 1.5V or 6V battery. The negative terminal of the battery is connected to another piece of silver by a clip lead. Partially immerse this silver in the salt water being careful not to immerse any part of the clip lead. Electrolysis will now occur and cause a deposit of purple-gray silver chloride on the positive electrode. Allow the process to carry on for 15 minutes. Withdraw the electrode and set aside to dry taking care not to touch the silver chloride deposit.

Repeat the process with the second electrode. After the electrodes are dry, very carefully coat them with a thin layer of electrode paste. The electrode paste is made by mixing equal parts of glycerine and bentonite (hydrated aluminum silicate) which is obtainable from your local drugstore. Dilute the mixture with a weak salt solution (one teaspoon in a pint of water) till it reaches the consistency of putty. You can store the paste in a jar. After each use of the detector a new layer of paste is needed. You should also reverse the electrode connections to the detector after each use. This process may sound

[Continued on page 104]

#### PARTS LIST

##### Resistors—½ watt, 10%

- R1—33,000 ohms
- R2—82,000 ohms
- R3—500,000 ohm potentiometer
- R4—4,700 ohms
- R5—330,000 ohms

##### Transistors

- Q1—CK722
- Q2—2N35

##### Batteries

- B1—22.5 volt (Burgess Y-15 or equiv.)
- B2, B3—6 volt (Burgess Z4 or equiv.)
- M1—50 microamp meter movement (size and type optional)
- SW1—DPST toggle switch
- SW2—DPDT toggle switch (optional, see text)
- PL1—6.3 V pilot light assembly with #50 bulb (Dialco No. 314001-437, clear)
- RY1—5000 ohm, 1.5 ma, relay (Lafayette "Little Jewel")

- Misc.—2 5-way terminal posts, perforated phenolic board 2 7/16" x 3 3/8", Brass or "Nugold" or other spring metal strips 1 1/4" x 6" (available at craft shops), coil dope or nail polish, flea clips, etc.

# Loudhailer-Intercom for the Boatman

By Len Buckwalter

**Nautical voice communication over great distances is made possible by combination public-address trumpet and sound amplified "big ear" pickup.**

**T**HE unit shown here grew out of a kind of electronic "payola" between the author and one of his yachting friends. The arrangement was simple: "You take me out on the boat this summer, and I'll build you a power megaphone." But the design quickly grew from a simple 1-transistor job to a sensitive, versatile *two-way* system.

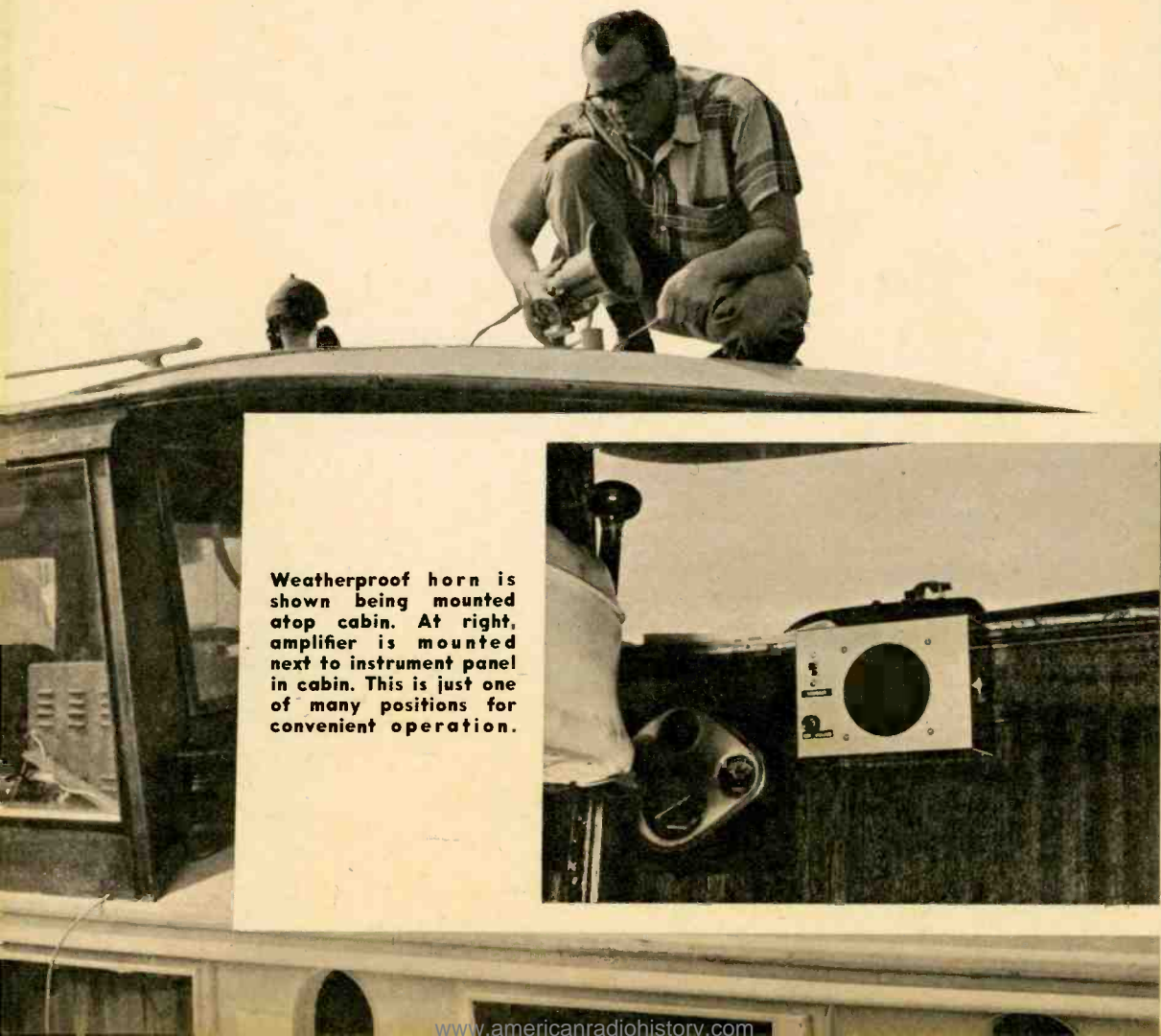

Weatherproof horn is shown being mounted atop cabin. At right, amplifier is mounted next to instrument panel in cabin. This is just one of many positions for convenient operation.



As a loudhailer, it is perfect for directing mooring maneuvers, dock landings and communications with other boats. However, when the talkback or *talk-listen* switch (SW1) is flipped to the *listen* position, the outside speaker horn becomes a sensitive "ear" with important safety features. While running in foggy or foul weather the captain has difficulty hearing fog horns, bells and other warning signals—the rumble of the engine inside the cabin tends to mask them. Without this unit, one of the crew had to stand watch up on the bow and shout back instructions. And of course, the *listen* feature has many other uses in small-craft handling.

### Construction

Building the unit starts with cutting a 3½" hole in the front panel of the cabinet. A 4¼" piece of perforated board is placed over the hole, and the speaker bolted in place. The talkback switch, volume control, binding posts and large power transistor are then mounted. Note that J1 and J3 are insulated from the cabinet and J2 and J4 are grounded.

The builder must use *utmost care* in mounting the power transistor (TR4). It has to be insulated from the cabinet by a thin mica washer, sometimes

packed with the transistor. To avoid piercing the mica washer, remove the burrs from the four mounting holes drilled in the metal cabinet before bolting TR4 in place. The two mounting screws must be insulated from the cabinet by two fiber washers inserted into the screw holes. These washers can those removed from J1 and J3. The only other precaution is to grasp the transistor leads with a long-nose pliers during soldering to draw the heat away.

The rest of the circuit is wired to a piece of 5½" x 3¼" perforated board bolted or glued to the speaker frame. The speaker specified in the Parts List is already drilled with two holes. Before screwing the board down, note that one screw should have a solder lug under its head, while the other holds one lip of transformer T2. If the speaker used has no predrilled mounting holes, an extra ground wire must be run from the solder lug to a convenient ground point on the cabinet.

A buss bar (#18 tinned wire, approx.) serves as a convenient ground for most of the components. Ground is made through the speaker frame, so be certain that at least one of the speaker screws on the front panel cuts through the paint and makes contact with bare metal of the cabinet.

Side view of unit reveals how perforated sub-chassis fits on top of the speaker frame.

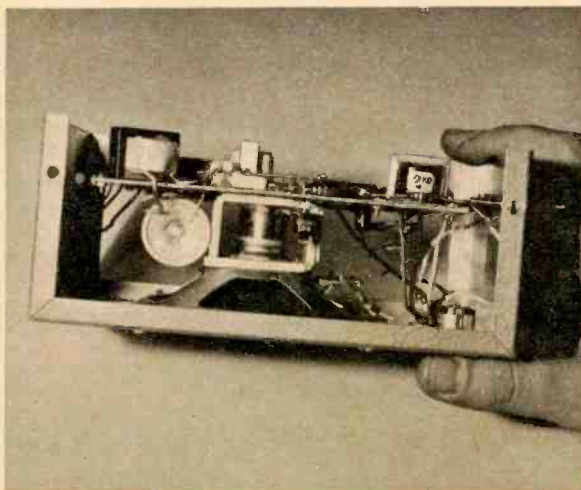

Completed unit. Perforated board protects speaker. Knob is volume control, power switch.

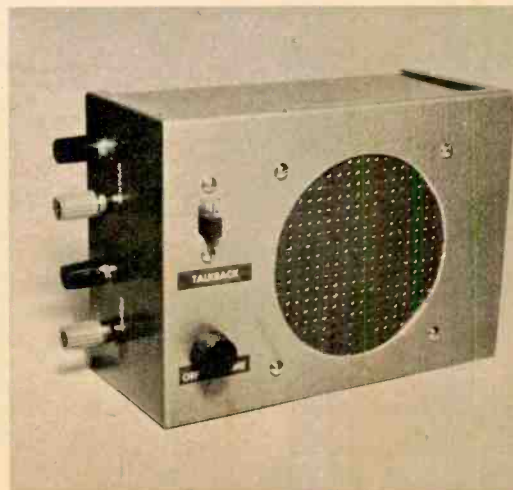

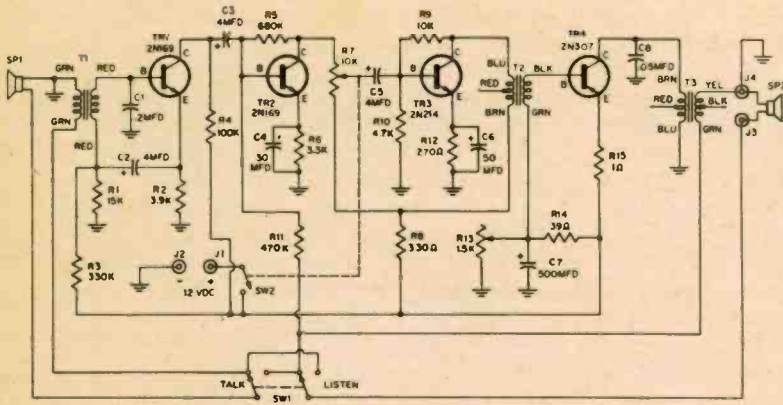

Value of resistor R11 may have to be changed if too much gain results in howl. See text for details. Schematic shows 12 volt requirement but 6 volts may be used.

### Adjustment

After all components have been wired into place, there are two points of adjustment; resistor R11 and control R13. Hook up the outside speaker and connect a milliammeter (at least 0-500 ma) in series with the positive battery lead. To prevent howling feedback, locate the outside speaker in another room and

close all doors. Insert a screwdriver into R13's slot and turn on the power. Quickly adjust for a 200 ma meter reading. This setting is a good compromise between distortion and audio power. Output will be just under two watts, which gives a surprising amount of volume—especially when an efficient horn-type speaker is used.

Letters (X, Y, Z) indicate lead connections. TR4 must be insulated from chassis as shown.

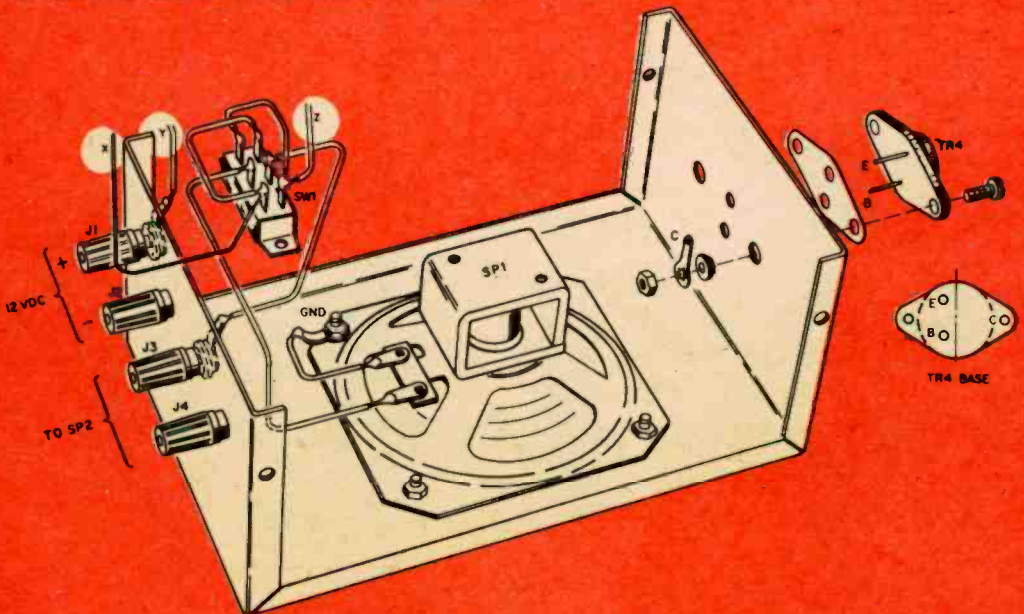



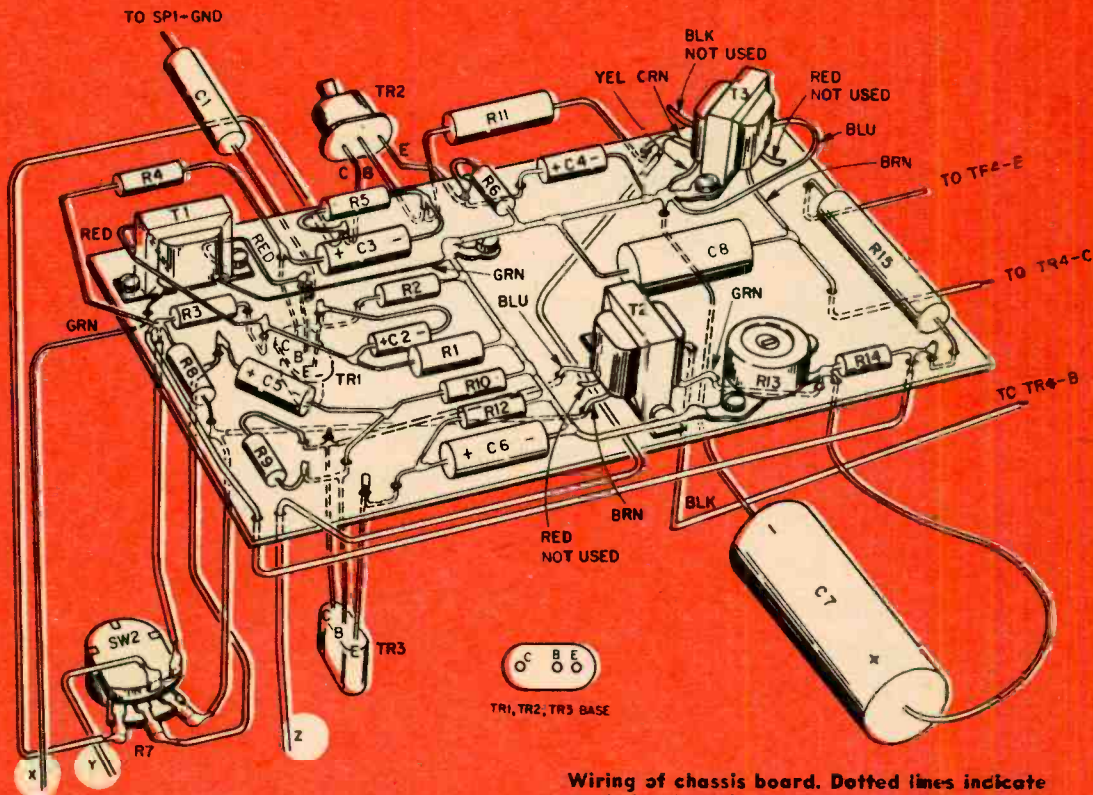

Wiring of chassis board. Dotted lines indicate the below board wiring. Some leads are shown longer than necessary for sake of clarity.

Flip SW1 up and advance the volume control to full on. If the outside speaker remains quiet, the second adjustment does not have to be made. But, if it breaks into a high-pitched howl, resistor R11 (470,000 ohms) will have to be changed to a somewhat lower value (430,000 ohms, etc.). Don't lower its resistance too much or the gain of the amplifier will fall. In any case, before changing R11 be sure that the whistling howl is not due to acoustic coupling between the external speaker and the small one in the cabinet—keep them away from each other.

### Operation

Although designed for 12-volt operation, the unit will operate on 6 volts DC. Although volume dropped slightly, there was still plenty of reserve for most applications. The only change required is a readjustment of R13 to bring TR4's current back up to 200 ma.

[Continued on page 111]

### PARTS LIST

- Resistors**—1/2 watt, 10% unless otherwise noted  
 R1—18,000 ohm R4—100,000 ohm  
 R2—3900 ohm R5—680,000 ohm  
 R3—330,000 ohm R6—3300 ohm  
 R7—10,000 ohm volume control with switch SW2  
 R8—330 ohm R11—470,000 ohm  
 R9—10,000 ohm R12—270 ohm  
 R10—4700 ohm  
 R13—1500 ohm wirewound control (Mallory FI-1.5K)  
 R14—39 ohm  
 R15—1 ohm, 2 watts
- Capacitors**  
 C1—.2 mfd, low-voltage paper or ceramic  
 C2, C3, C5—4 mfd, 6-volt electrolytic  
 C4—30 mfd, 6-volt electrolytic  
 C6—50 mfd, 6-volt electrolytic  
 C7—500 mfd, 25 volt electrolytic  
 C8—.05 mfd. 200 volt or higher paper or ceramic
- Transformers**  
 T1—3-4 ohm to 2000 ohm voice coil (Argonne AR-93 or equiv.)  
 T2—1000 ohm to 100 ohm (Argonne AR-136 or equiv.)  
 T3—4E ohm to 4 ohm (Thordarson TR-8)
- Transistors**  
 TR1, TR2—2N169, TR3—2N214, TR4—2N307
- SPI—Standard 4" speaker, 3.2 ohm voice coil  
 J1, J2, J3, J4—5-way binding posts (J1 and J3 insulated)  
 SP2—Weatherproof horn speaker, 4-ohm voice coil (University MIL-A type)  
 SW1—DPDT slide switch  
 SW2—SPST on R7  
 Misc.—Four binding posts, Bud Minibox 7"x5"x3" (CU2108-A), solder lugs, perforated board, etc.

# El visits NAFEC where they plan for Skyways of the Future



By Myron B. Gubitz

**The electronic "big push" is on toward safe, sure and efficient travel in our jet-laden air lanes.**

**T**HE American public will stand for nothing less than absolute safety in our more-and-more crowded skies. You're the public—and in aviation matters your representative is the Federal Aviation Agency, created just two years ago to play traffic cop and traffic expert for our vast national airways system. What has been done in the past two years to make air traffic control and air safety more reliable—especially in the face of ever-growing commercial, military and civilian aviation activities? What's on the line electronically, and what's yet to come?

In order to answer these questions, *Electronics Illustrated* took a trip down the New Jersey coast to a spot near Atlantic City—the sprawling 6000-acre National Aviation Facilities Experimental Center (NAFEC), operated by the FAA to develop the most advanced electronic equipment possible for safe and efficient air traffic control.



NAFEC's nearly 600 scientific and technical people work in more than 100 buildings and have three runways at their disposal along with a host of their own aircraft for test flying. A number of experimental runway lighting systems have been installed, and the field is dotted with many different types of radar antennas.

In brief, NAFEC is a proving ground where techniques and equipment developed by private industry and government agencies are tested and evaluated. Here is the future of aviation today.

### Data Processing Central

Top-priority project at NAFEC is to give machines those things that they do best (data processing, monitoring, computing, etc.) and give to man those things which he does best (decision-making).

General Precision, Inc., the contractor, has come up with a DPC capable of printing and processing 1,600 ever-changing flight progress reports per hour; checking 440 pilot-filed flight plans and storing the information contained in up to 1000 plans per hour, and can set up 90 arrivals and departures every 60 minutes.

You may ask: Of what value is the flight plan and progress data once a plane is in the air? Well, suppose two planes have

**Left: At NAFEC some 48 consoles feed simulated individual plane movements into unique data processing computer in realistic program of air traffic control designed to evaluate new gear. Right: Computer memory drum is checked. It stores flight data such as plane speed, altitude, weather.**

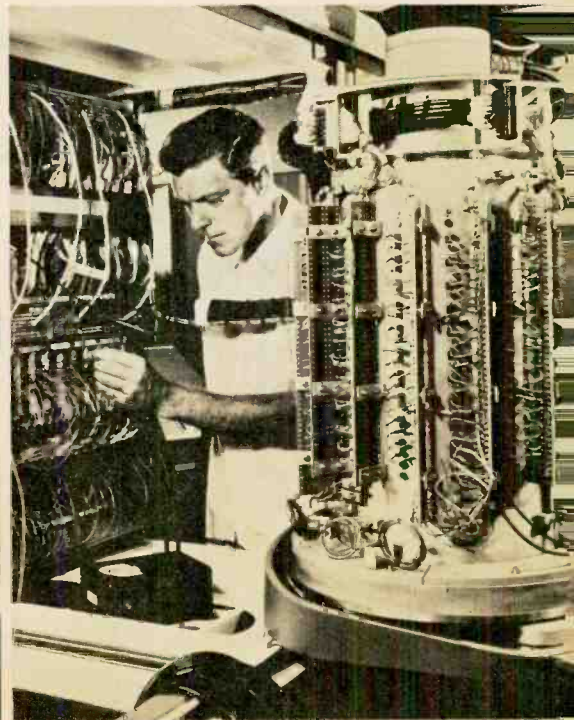
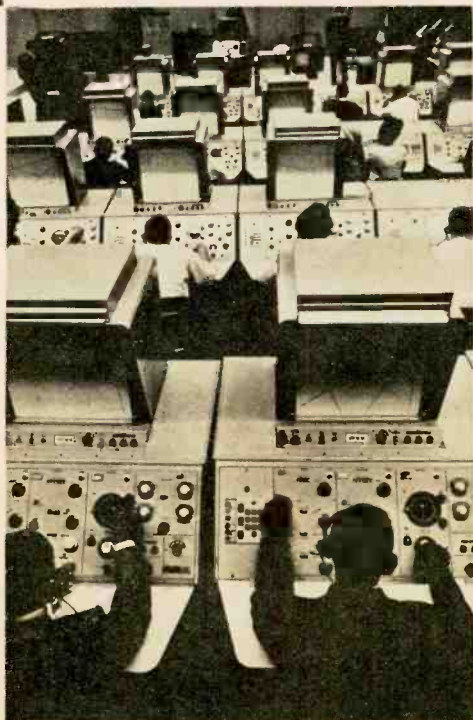

conflicting routes. That is (if they stick to their flight plans), they will be over the same spot at the same time at the same altitude. This means mid-air collision or a near miss that can age a man 10 years in as many seconds. But with the quick efficiency of electronic computation in DPC, and clean-cut electronic displays of data, the air traffic controller will have a visual picture of routing conflicts some 30 minutes before the conflict becomes a crash or near miss. DPC will also provide alternate routing information to be passed on to the pilots involved. By providing constantly up-dated sequential information, time-wasting holding patterns (stacking) in terminal areas can be replaced by an orderly flow of air traffic into and out of major terminals.

The heart of DPC is a large, solid-state digital computer designed and built by Librascope Division, General Precision, Inc.

Precise information as to type, speed and altitude of aircraft, the wind direction and velocity, departure and estimated arrival times at specific check-

points all can be fed into the computer's 16 magnetic memory drums for instantaneous electronic comparison, computation and readout in the form of visual displays, teletype messages, and "flight strips" to back up the electronics with printed information on flights—information which can be handled manually.

All in all, Data Processing Central has some thirty consoles, each with a distinct control or information function, such as the *Precision Approach Radar Console*, *Sequence Console* (with a charactron-tube display which allows a controller to sequence arrivals and departures to avoid "stacking"), *High Resolution Closed-Circuit TV* (to display up-dated flight strips of the next five arrivals at the *Local Control Console* position) and a *Ground Control Console* (which takes over final direction of the aircraft, and through which the flight plan may be cancelled and removed from the computer).

A flight processed through DPC goes something like this: The pilot files his flight plan. If he does so by voice, a controller [Continued on page 100]

**Flight data entry machine quickly integrates pilot's flight plan into air traffic control system. Operator types flight plan at console and it is automatically fed to computer memory.**

**One of many computer readouts is punched paper tape being checked by programmer at console. It takes only a half-second to search through a quarter-million pieces of ATC data.**

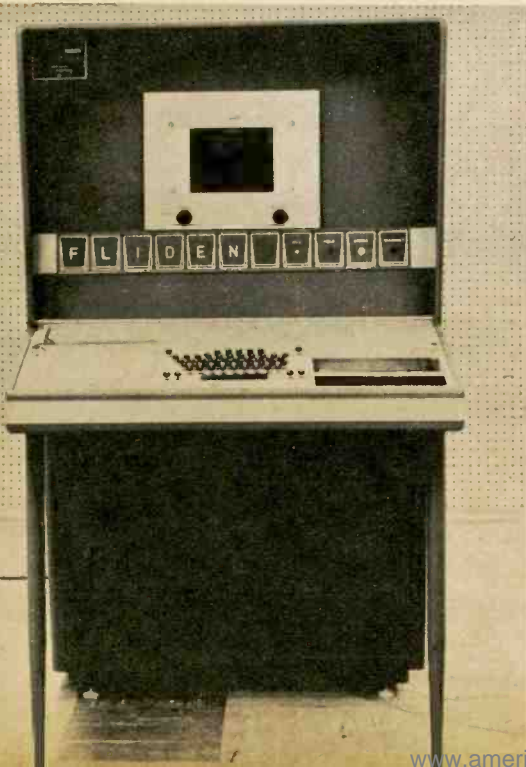



At right is hectic scene in present ATC with controllers manually "tracking" aircraft, updating strips by hand. Below is new automatic controller's console with computer-printed flight strips.

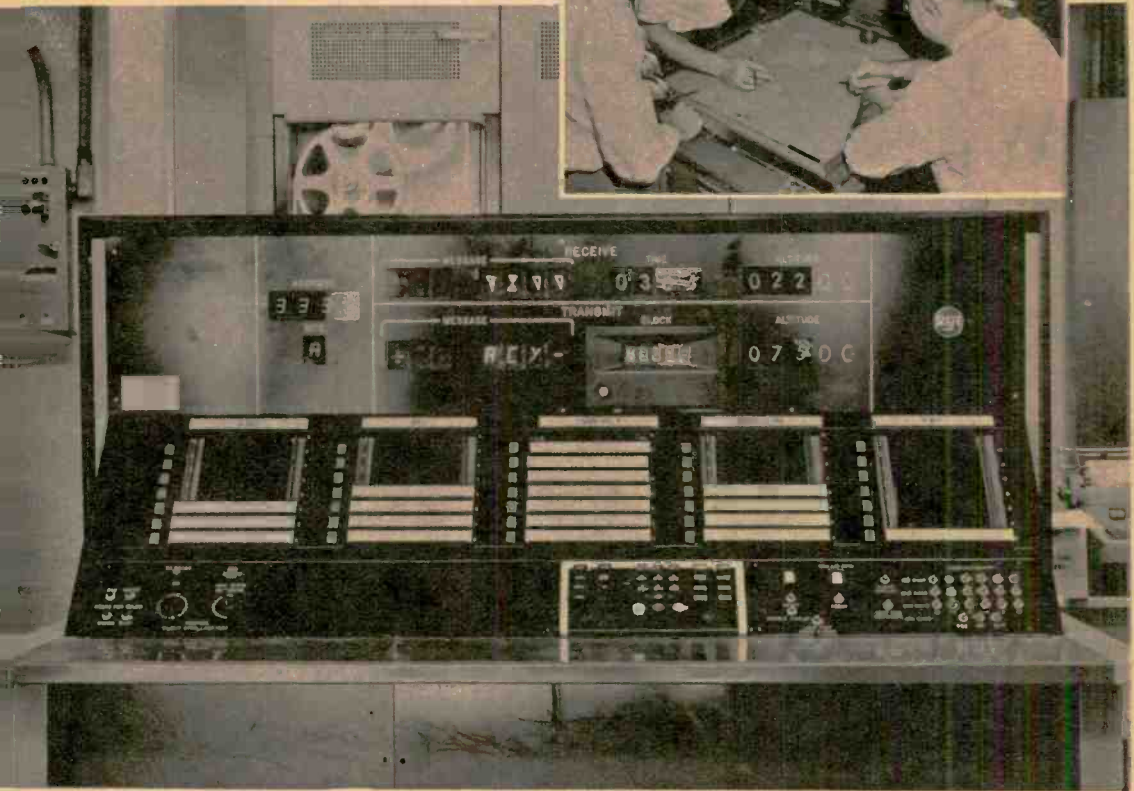

Airborne AGACS display: Incoming messages appear in slot at top. Messages to ground appear in lower slot. Pilot selects message by turning dial at right, presses "report" button and the rest is entirely automatic.

Doppler VOR antenna now under test is expected to improve the accuracy of VHF range stations by which transcontinental aircraft can navigate with radio signal comparisons. Old VORs were subject to reflection problems.



# Transistorized Theremin

**Conduct with semi-conductors!**

**Portable instrument plays through any AM radio.**

**I**N science-fiction and horror movies the arrival of the flying saucers, the entrance of the monster, and the blast from the death ray, are usually emphasized by the weird, semi-musical tones of a theremin. In addition, theremins are frequently used to enhance portions of orchestral music, or as solo instruments. For less than ten dollars, and with a few hours work, you can construct a portable transistorized theremin that will operate with any standard AM broadcast band receiver. If the receiver is also portable, the theremin can be taken almost anywhere. The com-

**By Ronald Benrey**

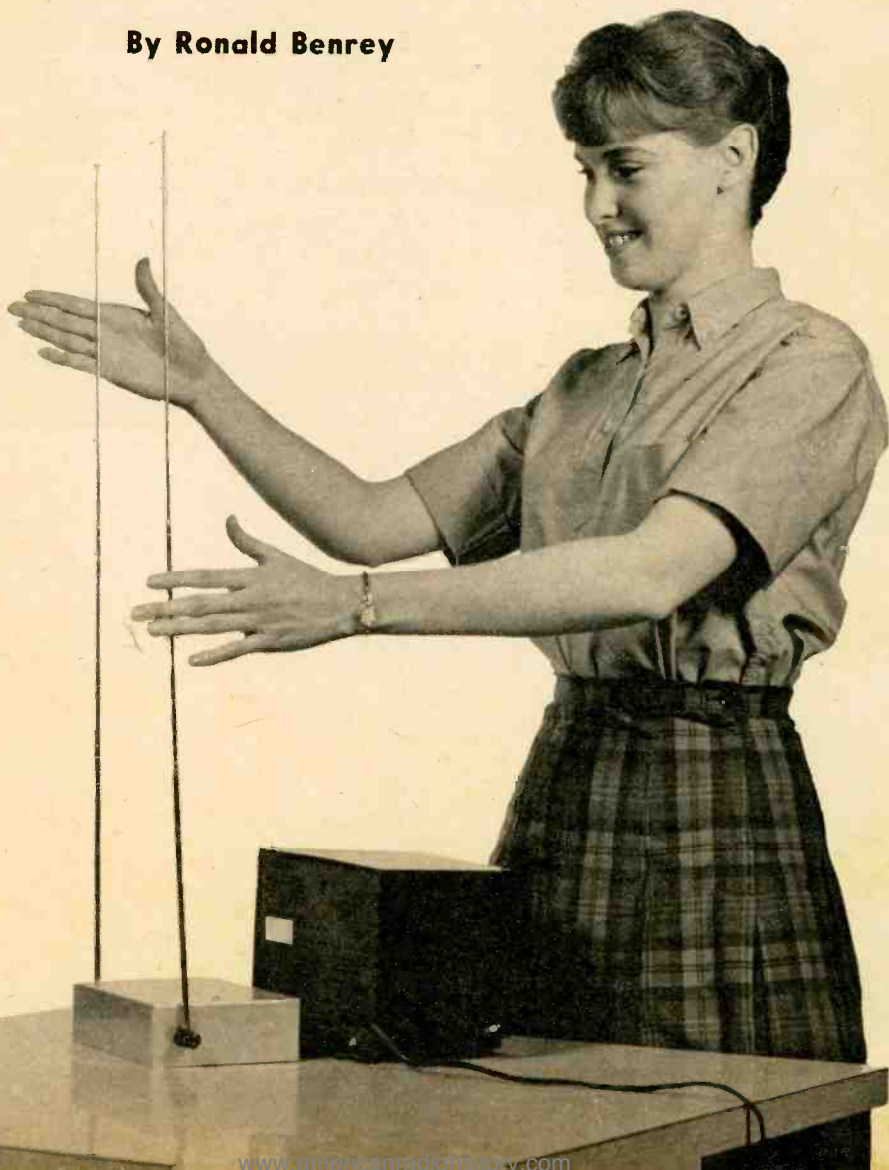



pleted instrument can be used either to produce sound effects for home movies, tape recordings, etc., or, with practice, as an actual musical instrument.

### Construction

The theremin is constructed on a perforated Bakelite board with flea clips used as terminal points. All connecting leads should be short and direct.

Transistors Q2 and Q3 (both 2N1264) are tetrode drift transistors and have a fourth lead, and a shield, in addition to the collector, base, and emitter. In this circuit however, the shield lead is *not* used, and should be cut short.

A standard 7" x 5" x 2" aluminum chassis with bottom plate is used as a cabinet. The board after wiring is mounted in a standard aluminum chassis with long bolts and 1/2" spacers. Be sure that no part of the wiring on the bottom of the perforated board comes in contact with the aluminum case, and try to keep the loop sticks in the approximate center of the chassis.

The two antennas are mounted with the aid of standard insulated five-way binding posts. As supplied, the antennas come with threaded bases that screw into the supplied sockets. The sockets are not used, however, and the threaded protrusions are inserted into the hole in the binding post shaft, and the binding post tightened.

After the perforated board is mounted, run a wire from the ground "buss-bar" to one of the mounting bolts, (at point marked "gnd. lug") so that the chassis is grounded to the aluminum case.

### Theory

Transistors Q2 and Q3 operate as two independent low power RF oscillators. They are set at two different frequencies, differing by a low audio frequency. When these different frequencies are received, the difference frequency is detected and amplified, and appears as a "squeal." Each antenna is connected to one loopstick, making the circuit very

**Bottom view of unit. All components fit on perforated board except toggle switch and the antenna 5-way terminal posts. J1, J2. Use short leads.**

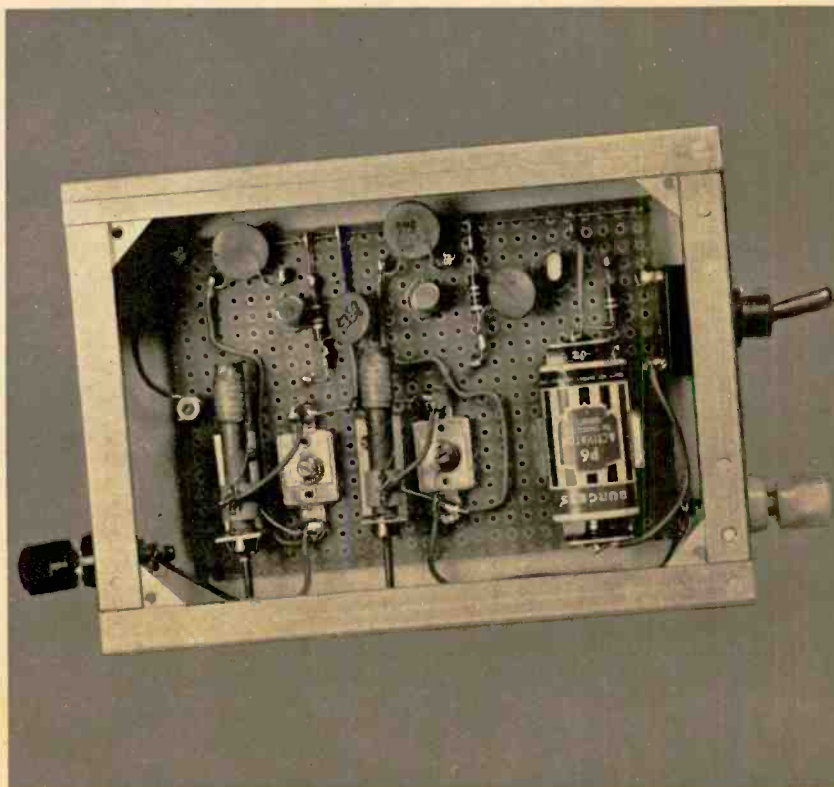

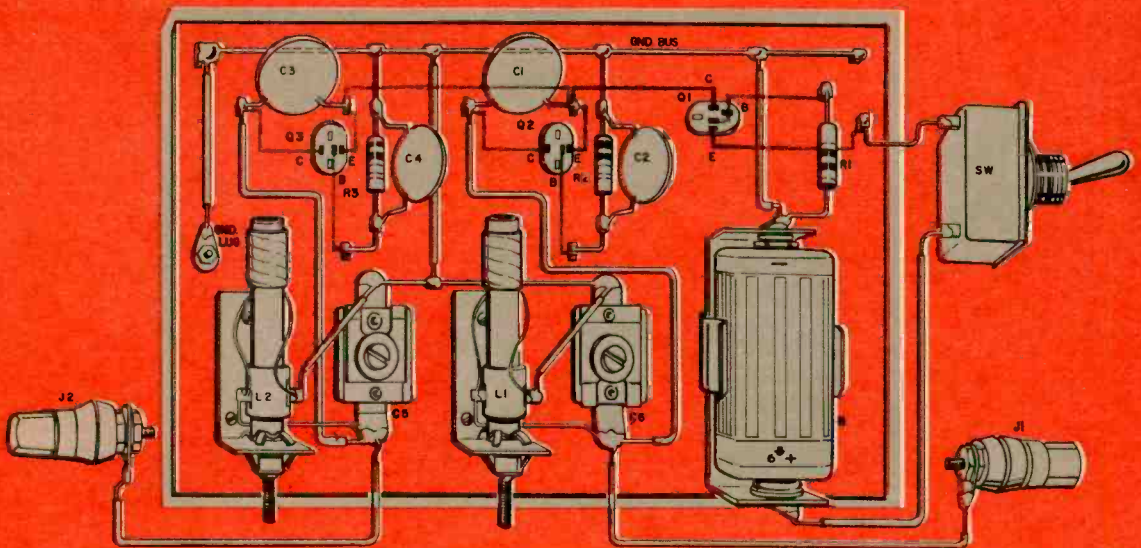

Transistors Q2 and Q3 have an unused shield lead between collector and base. All wiring is insulated from chassis. Ground the buss-bar to one of the mounting bolts.

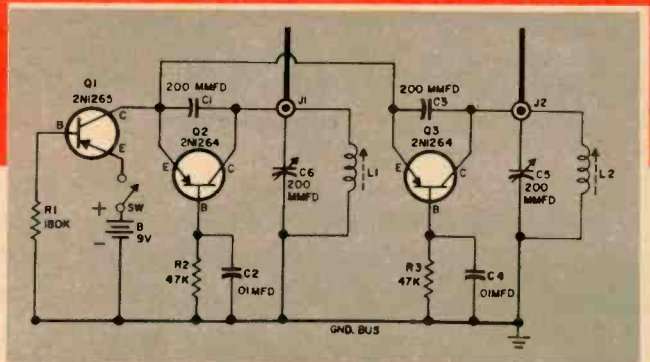

sensitive to "body" capacitance. If a hand is brought near either antenna, the frequency of the oscillator changes, changing the difference frequency, and hence the frequency of the "squeal."

### Operation

Place the completed instrument close to a standard radio tuned to a clear spot near the center of the dial. Fully extend the antenna and lay the instrument on its side so as to have access to the perforated chassis. Both loopsticks should have the ferrite cores set about half-way in. With an insulated alignment tool adjust C6 until you hear a hissing noise on the radio. Now, adjust C5 until you hear a loud whistle. There may be several adjustment points where you will hear a whistle. Pick the loudest.

Now, carefully adjust C5 to obtain the lowest pitch. The instrument is now ready to be played.

By manipulating your hands around the antennas you can produce many sound effects. The most pleasant tone  
[Continued on page 111]

### PARTS LIST

- R1—180,000 ohms, 1/2 watt
- R2, R3—47,000 ohms, 1/2 watt
- C1, C3—200 mmfd disc ceramic
- C2, C4—0.1 mfd disc ceramic
- C5, C6—9, 180 or 200 mmfd trimmer capacitors
- Q1—2N1265 transistor
- Q2, Q3—2N1264 transistor
- L1, L2—ferrite loop antenna
- B—9 volt battery (Burgess P6 or equiv.)
- SW—SPST toggle switch
- J1, J2—five-way binding posts
- Aluminum chassis and bottom plate 7"x5"x2"
- Misc.—2 whip antenna (Lafayette F-343), battery clip, transistor sockets, perforated Bakelite board 3 1/2"x5 1/4", flea clips, hardware





## *citizens band* **Alignment Generator**

**By Herb Cohen**

**W**ITH the widespread use of super-regenerative receivers on the Citizens Band, a need arises for a low-powered alignment generator. Anyone who has tried to align his receiver using his transmitter signal has found that the receiver overloads if within a hundred feet of the transmitter. This makes receiver alignment a difficult and tedious job—and virtually impossible to do properly in your home workshop. Even aligning the receiver from an RF signal generator becomes a touch-and-go process since the differences between the signal generator setting and your transmitter's crystal may be just enough to give faulty CB reception.

The alignment problem was solved rather easily by the construction of a low-powered Citizens Band crystal oscillator with low enough power to be put next to the receiver without overloading it. Use the crystal from the transmitter to insure exact alignment to the receiver.

The entire circuit can be built in less than an hour and is housed in a clear plastic case. The most expensive part is the transistor (TR) which sells for less than two dollars and has an alpha cut-off of 100 mc. A mesa transistor, the OC 171, is the first such unit to be mass-produced so cheaply.



To insure accurate alignment of the receiver, the transmitter crystal is used to tune the 1-transistor signal generator.

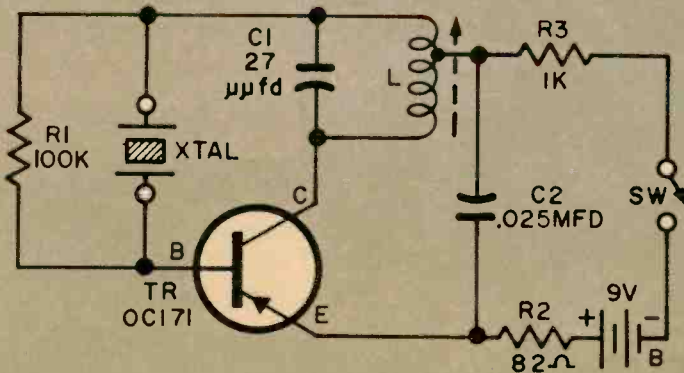
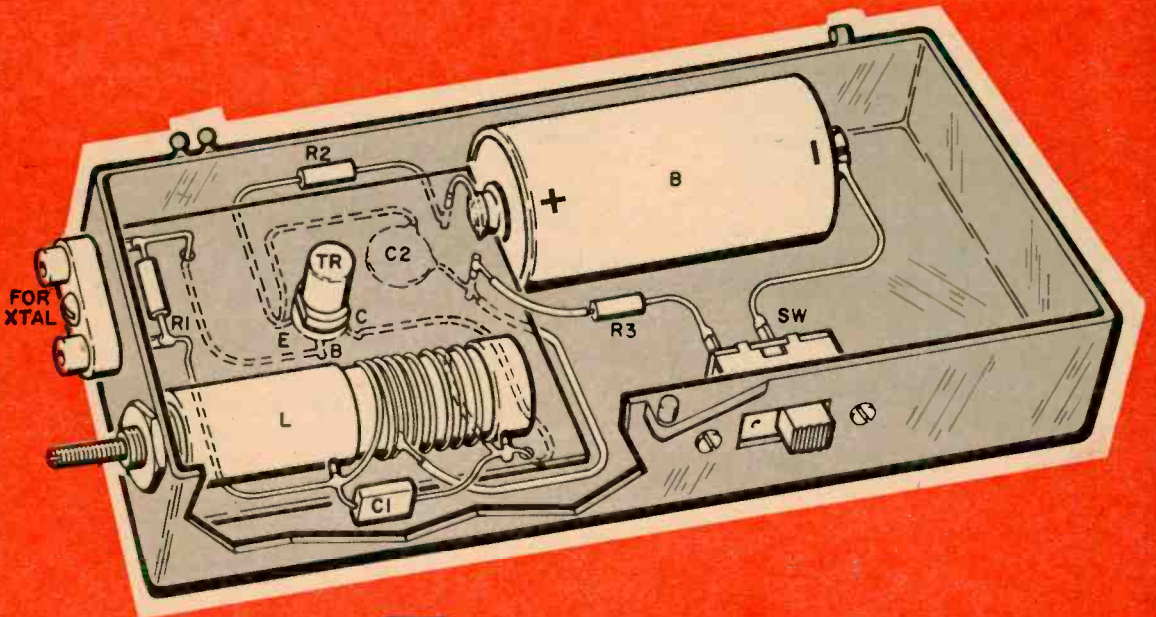

Shield lead (S) of transistor (TR) is cut short and not used. Because of long life, battery (B) is soldered directly into the oscillator circuit. The Amperex OC171 although in a cylindrical case has inline lead setup.



## Construction

A piece of perforated board is cut to  $1\frac{5}{8}$ " x  $1\frac{7}{8}$ " and the transistor socket mounted in its center. After the components are soldered in place, the board is fitted into a  $4\frac{3}{4}$ " x  $1\frac{1}{8}$ " plastic box. The crystal holder is mounted on the outside of the box so its two lugs are on top of the circuit board. Be sure to allow enough room for the coil form to be mounted next to the crystal holder.

Stiff wire is used as solder terminals to connect the battery into the circuit and no battery holder is necessary. Before the battery is permanently connected into the circuit, the oscillator coil must be tuned to the crystal frequency. The crystal should be placed in its holder and a 5 or 10 ma meter should be connected in series with the battery line. The circuit will draw about 4 ma when not tuned. The coil slug is then adjusted until the current dips sharply indicating the point of resonance. Once the coil has been adjusted to maximum dip, the meter is removed and the battery connection soldered.

When mounting sockets, switches, coils, etc., on plastic boxes certain precautions should be taken when making the mounting holes. To avoid splitting

the box, it's a good idea to first make a small hole with a heated ice pick or awl, and then ream it slowly to size with a hand reamer.

If desired, a small pad of  $\frac{1}{4}$ " foam rubber or the equivalent may be glued to the top cover of the plastic cabinet. This will serve to keep the components in place and provide a certain amount of shock protection. The edges of the cabinet may be sealed with Scotch cellophane tape to prevent tampering.

The circuit is a basic Hartley oscillator with a collector-to-base feedback network. The crystal is placed in the base circuit to control the frequency of signal to the base. Resistor R2 is placed in series with the circuit to serve as a current-limiting resistor.

### PARTS LIST

- R1—100,000 ohm,  $\frac{1}{2}$  watt, 5%
- R2—82 ohm,  $\frac{1}{2}$  watt, 5%
- R3—1000 ohm,  $\frac{1}{2}$  watt, 5%
- C1—27 mmfd (mica)
- C2—.025 mfd (disc ceramic)
- TR—Transistor OC 171 (Amperex)
- SW—SPST slide switch
- XTAL—Crystal from your transmitter plus matching socket
- L—9 turns of #14 wire tapped 3 turns from end; wound on National XR-50 coil form
- B—9V. battery (Eveready #226 or the equiv.)

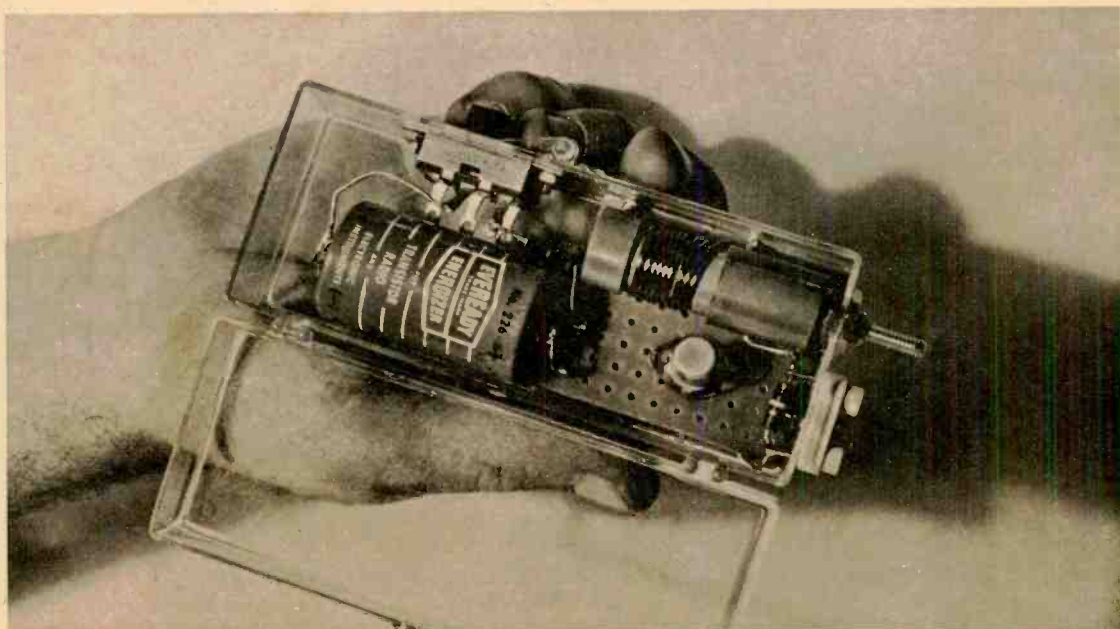

Anchored in about 2,000 fathoms with a special slack line anchor system, 20' x 10' weather station goes on the air every six hours with up-to-the-minute information from most remote ocean areas.

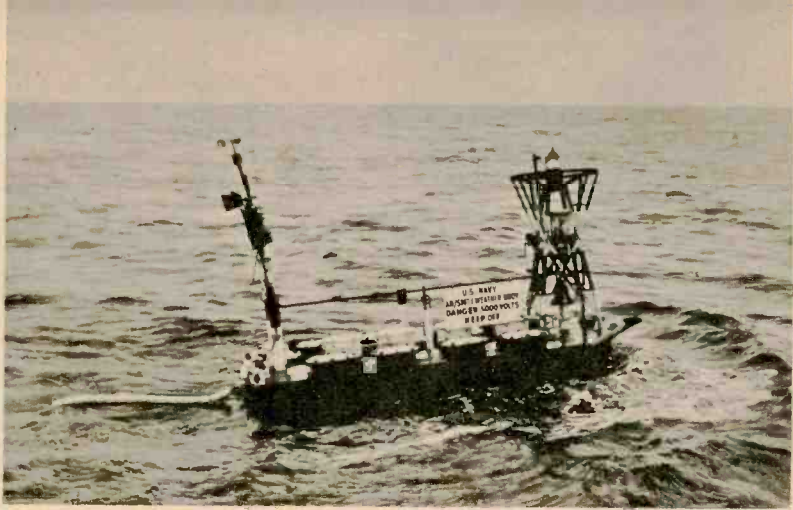

## Weather At Sea

SHIPS and intercontinental planes need accurate and timely marine weather information no matter where they go. That's why, if you look real hard, you may see a bobbing buoy anchored in some remote ocean area—and it isn't just bobbing for apples. It's the U. S. Navy's new automatic weather station which transmits in code at regular intervals the air and water temperatures, speed and direction of surface winds, and the local sea-level barometric pressure.

The master timer, a chronometer, is rewound by a small electric motor during each transmission period. Contacts on the hour and minute hands of the chronometer ener- [Continued on page 109]

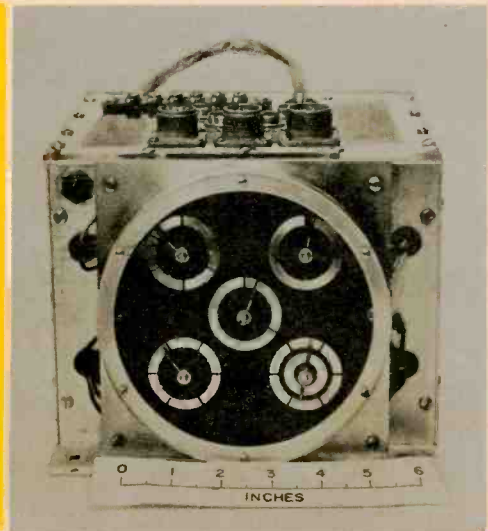
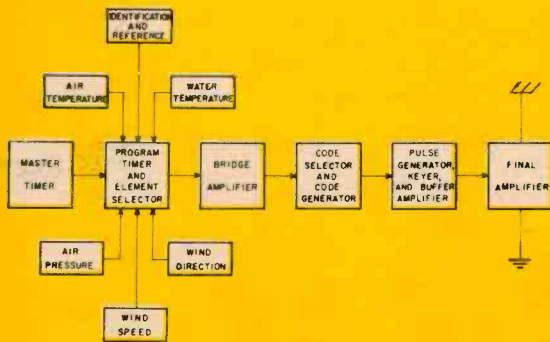

Above is block diagram of the various electronic elements contained aboard the weather station. Power is from batteries below decks.

This is the program timer and element selector. Its circular switches see that the weather transmissions go on air in a precise manner.



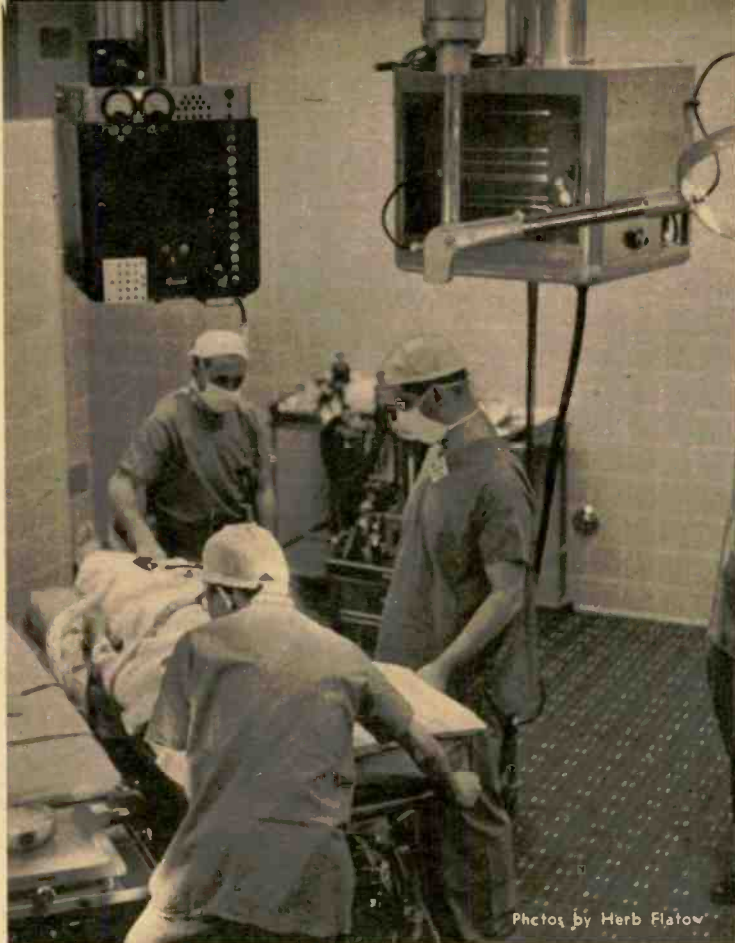

## Surgery of the Future .. Today!

**The pictures here were taken especially for this magazine so you, our readers, might see medical-electronics' latest advance in the war on disease.**

**T**HE electronics engineer is a very important member of the neurosurgical operating team at New York City's St. Barnabas Hospital. A unique operating room, part of the hospital's new surgical center for chronic diseases, makes full use of electronics. Delicate brain surgery is performed here by doctors whose skilled fingers and talent are aided every step of the way by precision electronics. The surgeon has an eight-channel oscilloscope monitor above the operating table which records visually the patient's heart waves (EKG), brain waves (EEG), muscle-waves (EMG), blood pressure, pulse, neurological stimulation pulses, heart sounds and nerve impulses. From a special panel, nearby facilities are available for almost any kind of surgical procedure—remotely-controlled electrocautery and electro-cutting, X-ray, timing devices and communications with the electronics room which overlooks the operating room.

"Cold sleep" (hypothermia) can be induced electronically. Closed-circuit TV may view the operation. Oxygen analyzing gear, tape recorders and about 100 additional electronic helpers monitor, record and provide for the surgeon's and patient's needs.

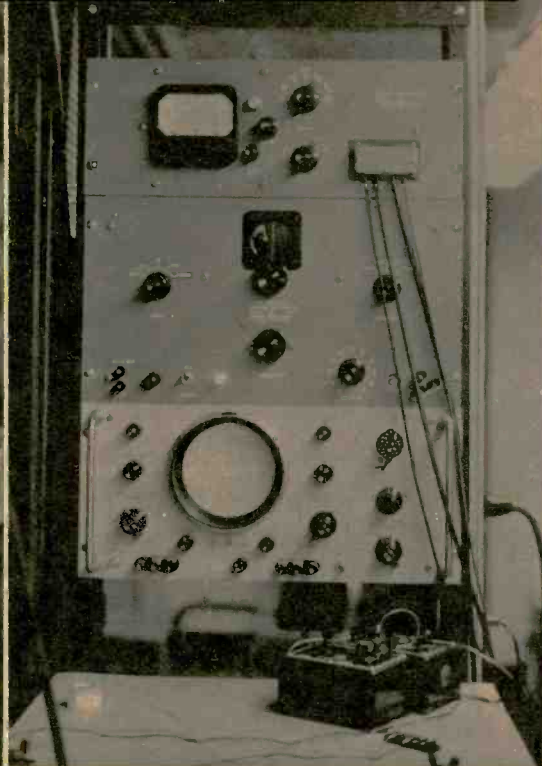
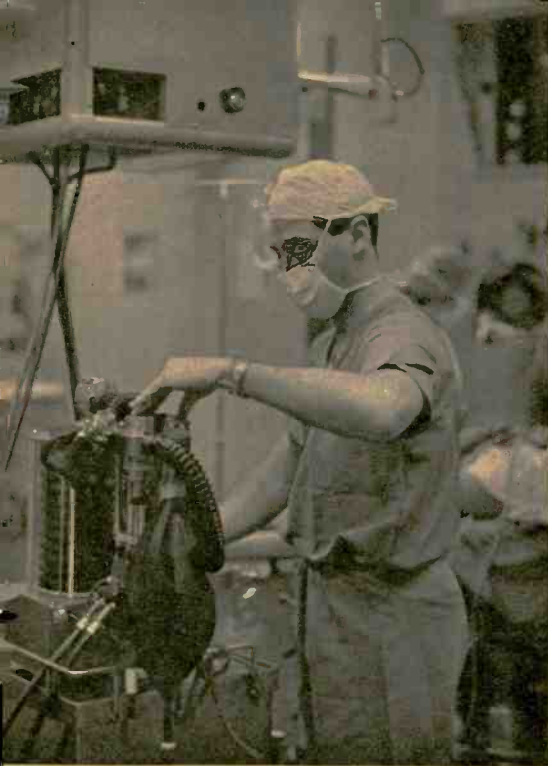

Left, assistant prepares portable aspiration and resuscitation machine for use. It was designed by hospital's anesthesiologist with consulting engineer. At right is some of electronic test gear rack-mounted in balcony above operating room. Top unit is a VTVM; center unit, a low frequency generator; bottom instrument, an oscilloscope. These are part of electronics laboratory.

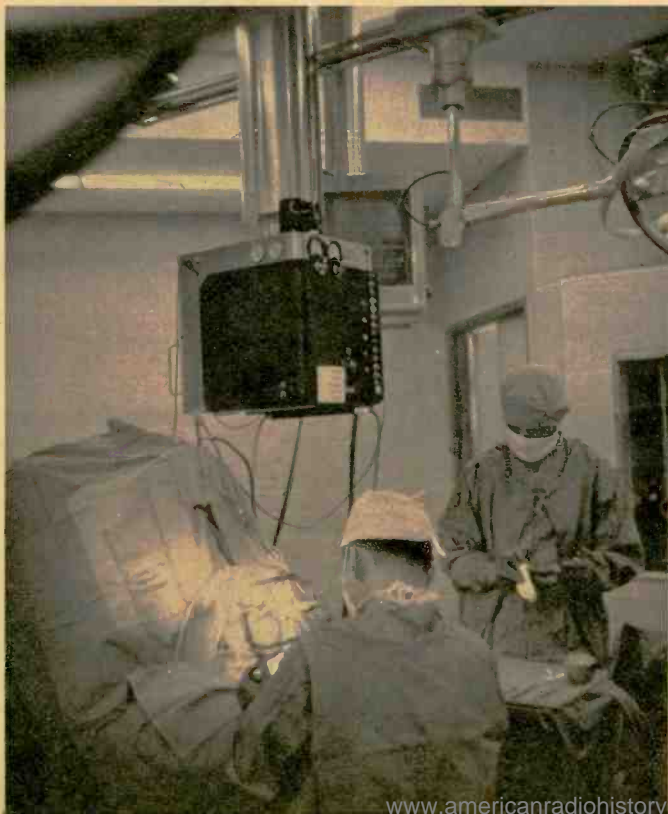

With new operating facilities, doctors at St. Barnabas can perform a new brain operation which has been 85 percent successful in correcting Parkinson's disease. Large unit on boom over operating table contains controls for almost every surgical procedure.



**This is one of three built-in remote control X-ray tubes for the frequent radiography required during brain surgery. One is mounted directly above patient, two in side walls. They are safe, precise.**

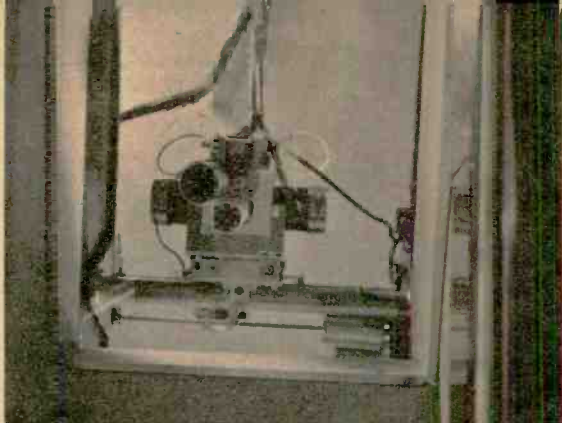

**Looking up from floor of neurosurgical operating room, one can see large bank of electronic devices which provide EEG, EKG, EMG gear, closed circuit TV and electronically Induced "cold sleep."**



**Tube is supplied to surgeon from boom-mounted instrument which contains thermostatically controlled sterile saline, electrocautery and electro-cutting probes, and mike/speaker for intercom.**

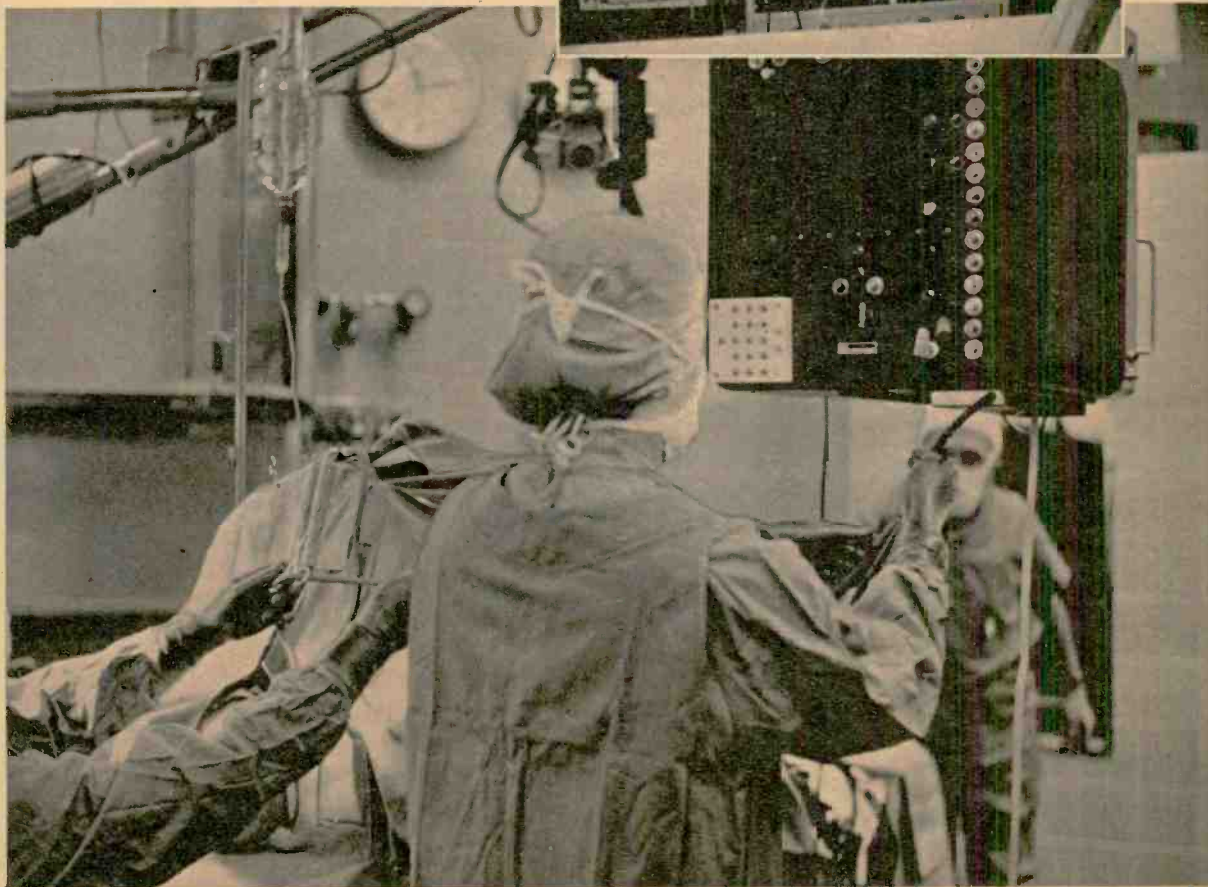

# Echo EI Echo Chamber

Echo  
Echo  
Echo

**Inexpensive gadget can add artificial echo to your high fidelity system.**

**by David Gordon**



Perforated disc with solder bead sweated in center is glued over speaker voice coil.

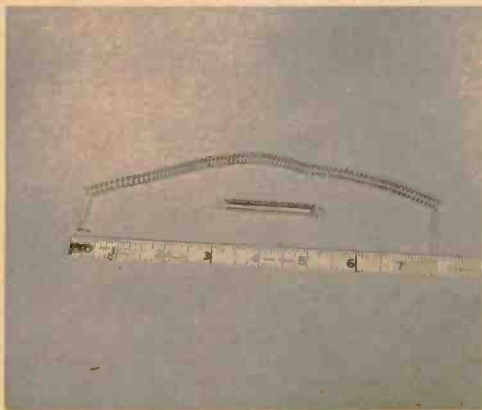

Light spring of about 2" in length is stretched as shown to make the reverb element.

**A**UDIO engineers have long recognized the value of a slight echo (they call it *reverberation*) for spicing up an otherwise "dead" recording. Therefore, there is not only a never-ending search for recording halls with good acoustic properties—which usually means the right amount of reverberation—but a number of techniques have been devised to introduce a controlled amount of artificial "reverb."

Here's the *EI* version of the artificial echo machine, which is not only inexpensive to construct, but is flexible enough to be adapted to a large number of different setups.

The basic electro-mechanical reverb unit consists of a 4" or 5" replacement type PM speaker (SPI), a small electrolytic capacitor (C7), a potentiometer (R6) a high output crystal cartridge (Xtal) and a spring. These assorted components are assembled as shown.

Before assembly the speaker must be modified. As can be seen in the photos and drawing several sections are cut out of the cone. This is to prevent the speaker from adding its own voice to the proceedings for we only want it to serve as a driving element for the spring. A 1" perforated or screen type metal disc (a chassis ventilating hole cover) is glued to the center of the speaker. Before gluing, sweat in a layer of solder on the disc to serve as an anchor for the spring which is later soldered to it.

The spring is the most critical ele-



ment as far as the overall sound of the unit is concerned. The author's model used a standard light 2" spring permanently stretched to a length of about 7½". Don't be afraid to experiment in

your choice of springs. In general, it would appear that the lighter the spring, the better the results. Try not to mount the spring too slackly or it will tend to resonate at a low frequency of its own.

### Artificial Reverberation Techniques

**T**HERE are a variety of tricks in use by recording engineers to obtain artificial echo effects. One of the major recording companies, for example, uses an abandoned elevator shaft as an echo chamber. They place a monitor speaker reproducing the original program at the bottom of the shaft and a microphone to pick up the sound a certain distance above it. The reverberated sound picked up by the mike is then fed to an audio console which mixes the reverberated sound with the original in the desired ratio. The advantage of this technique is that the recording can be made in an absolutely "dead" studio and the exact amount of reverb desired can be added by simply setting a level control. This is a lot simpler than a repeated shifting of microphone placement in an effort to achieve the correct balance between direct and reflected pickup.

A two-mike reverb technique is also used. There, one mike directly picks up the performer and the other, further away, picks up the room acoustics. Then outputs are mixed for proper balance.

Another common echo technique requires a reverberation machine. There are several professional types available which utilize various mechanical-electronic devices including continuous-loop tape recorders and vibrating plates or springs.

The tape recorder reverb machine constantly records the signal and then after delaying it a fraction of a second, mixes it back into the original signal. The effect simulated the time delay of a normal echo situation.

On the other hand, machines using vibrating springs or plates produce what audio men refer to as "hangover." As each musical transient comes along, it "twitches" the spring or plate which then continues to vibrate after the pulse has passed. Coupled to the vibrating element is a transducer whose job it is to convert the vibrations to electrical energy; which in turn is fed to a mixer and recombined with the original sound. You may come across variations on the above techniques, but most echo devices hold to the same basic idea.

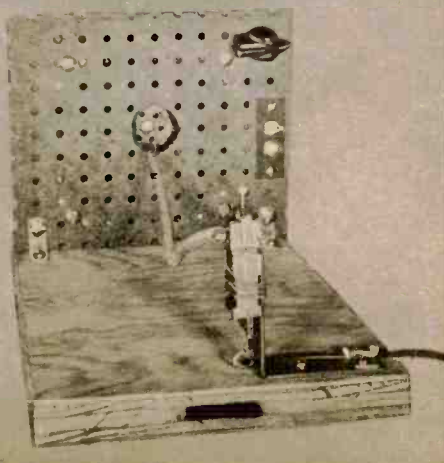

Completed electro-mechanical echo assembly. Speaker disc is seen through center hole.



Simple AC/DC amplifier used to drive separate external speaker reproducing echo effect.





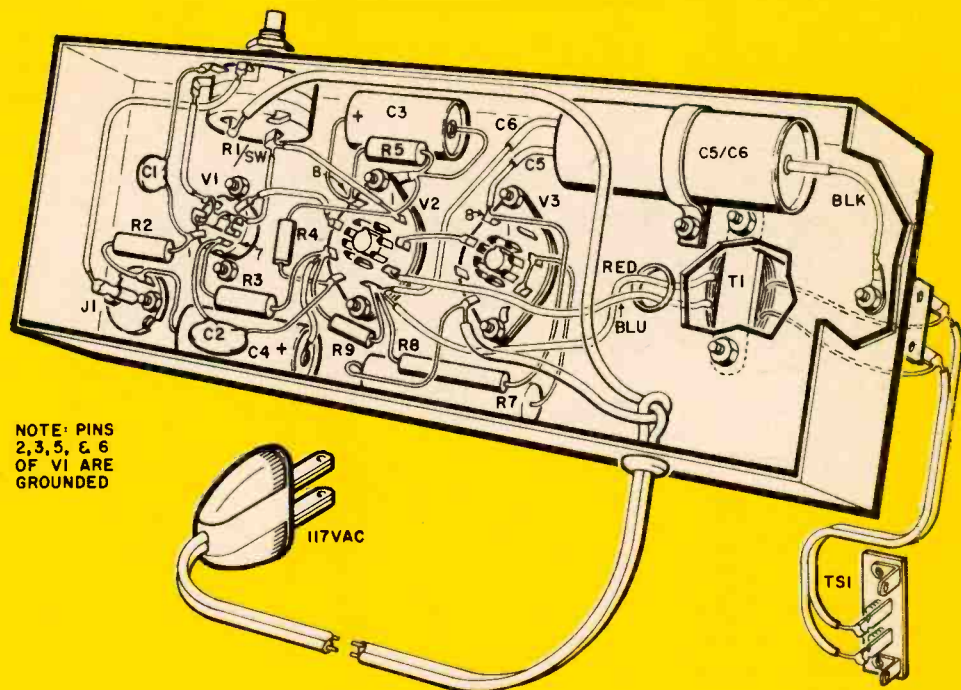

NOTE: PINS  
2, 3, 5, & 6  
OF V1 ARE  
GROUNDED

**AC/DC amplifier unit uses one 7-pin miniature tube and two octal types, Note pin numbering.**

On the other hand, if mounted with too much tension, the spring will pull the speaker voice coil out of position.

One end of the spring should be tinned and then soldered to the metal disc so that the speaker in effect pulls and pushes along the length of the spring. The other end of the spring has a small piece of buss wire (about the thickness of a phono needle shank soldered to it as shown. Make sure that when it is in place in the cartridge chuck, neither the spring nor the buss wire rubs against the cartridge proper. It may be necessary to bend the buss wire rather sharply to avoid problems.

The cartridge (Xtal) is held in place on a small brass angle bracket by a tightly wrapped rubberband. This enables it to be slid up and down for optimum positioning.

The speaker (SP1) is mounted face in on a small piece of perforated Masonite board. A 1" hole is drilled or reamed in the board to permit the spring to be soldered to the voice coil plate. On the same board are mounted the speaker drive control (R6) and the high-pass capacitor (C7).

The amplifier shown is a standard AC/DC job such as is found in small phonographs. Any standard unit sold by the mail order parts supply houses will serve nicely [Continued on page 111]

#### PARTS LIST

**Resistors—1/2 watt, 20% unless indicated**  
 R1—500,000 ohm potentiometer with switch SW  
 R2—4.7 megohms  
 R3—220,000 ohms  
 R4—470,000 ohms  
 R5—150 ohms  
 R6—50, 75 or 100 ohm wirewound potentiometer  
 R7—150 ohms, 1 watt  
 R8—1000 ohms, 4 watts  
 R9—33,000 ohms

#### Capacitors

C1—.005 mfd disc ceramic  
 C2—.01 mfd disc ceramic  
 C3—10 mfd @ 25 volts electrolytic  
 C4—20 mfd @ 150 volts electrolytic  
 C5, C6—10 mfd/40 mfd @ 150 volts dual electrolytic  
 C7—50 mfd @ 50 volts electrolytic

V1—12AT6 tube

V2—50L6 tube

V3—35Z5 tube

T1—50L6 output transformer

J1—phono jack

TS1, TS2—2 screw terminal strip

SP1—4" or 5" PM speaker modified as per text

X-TAL—high output crystal cartridge Lafayette PK-11 or Argonne AR-77 or the equivalent (3.5 volt output)

Misc.—hardware, line cord, 2 octal sockets, 7-pin miniature socket, ground lugs, etc.

Kit of prepunched amplifier chassis, 3 tube sockets, transformer T1, and potentiometer R1 is available from Edlie Electronics, 154 Greenwich St., NY 6, NY. @ \$1.75, postpaid.

# New Style in Sound

Swedish speaker system, with its unique engineering, may look like a cannon—but it sounds like hi-fi.

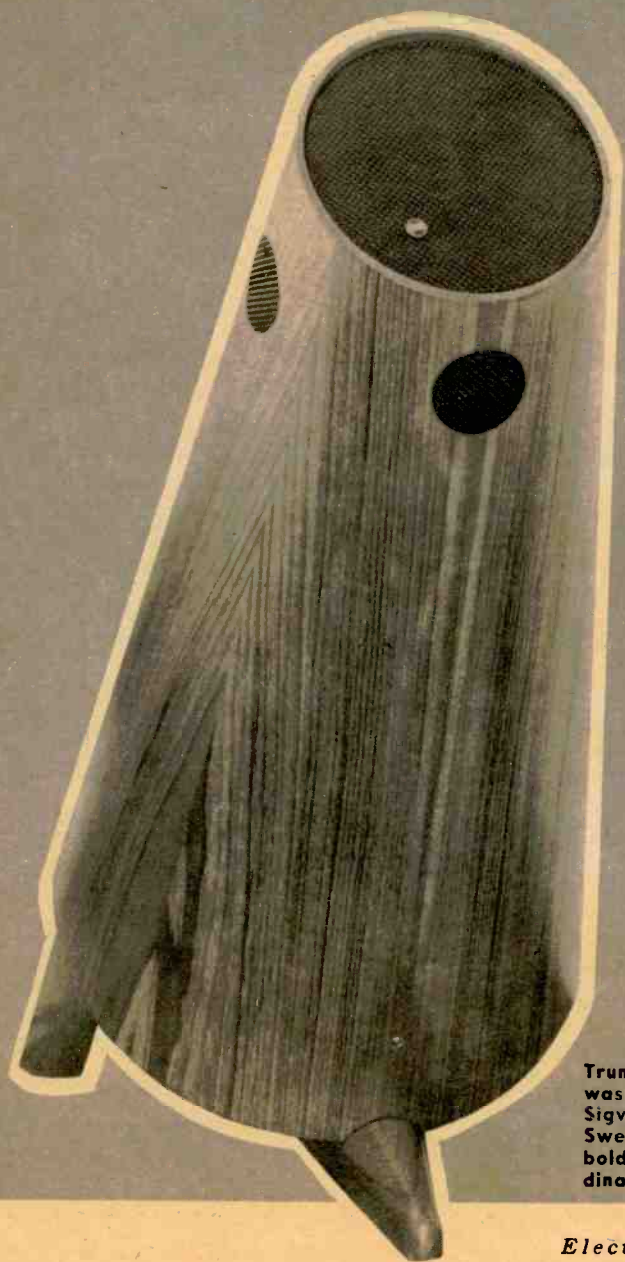

Truncated conical shape was conceived by Count Sigvard Bernadotte, son of Swedish king. It reflects bold, clean lines of Scandinavian modern furniture.



Below is the "assembly line" of Elektron Lund in Malmo, Sweden. Speakers' amplifier power supply is shown at left of other photo, while the tubes jutting out vertically (EL86/6CW5's) are the two amplifiers' output stages. Price of the Lund "1001" speaker system in the United States is about \$395.

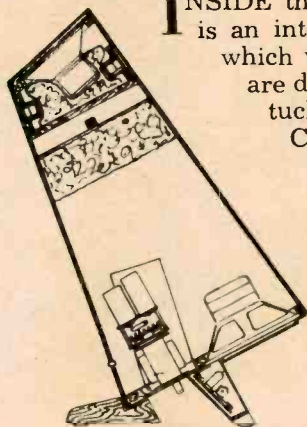
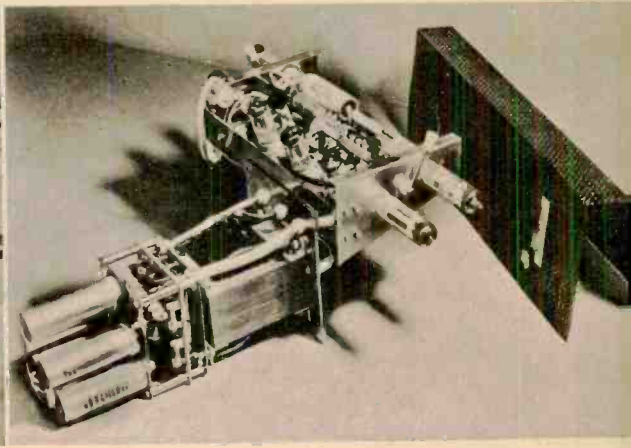
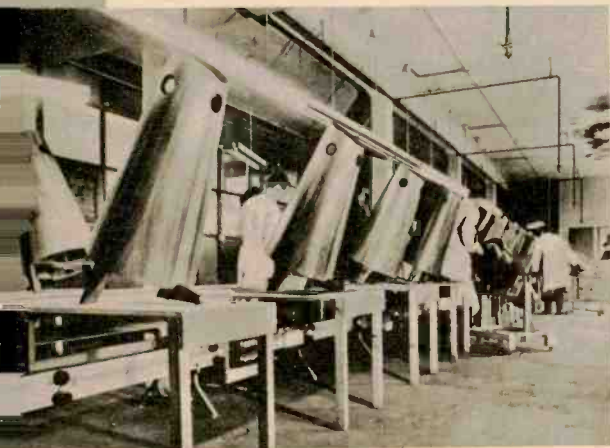

**I**NSIDE the unusual shape on the opposite page is an integrated high fidelity sound system in which woofer, midrange and several tweeters are driven by two transformerless amplifiers tucked away inside the speaker cabinet.

Called the "1001" by the manufacturer, Elektron Lund AB of Malmo, Sweden, the system departs radically from the conventional, with much engineering attention given to the elimination of the "keyhole" effect. The sound is not perceived as coming from inside the speaker cabinet, but rather seems to exist around the speaker. This feat is accomplished by placing the woofer at the bottom of the cabinet where it can radiate near one or two walls and the floor, and putting the midrange at the top, encircled by the tweeters radiating a full circle of sound. The woofer's bass reflex portion of the enclosure is isolated from the midrange and tweeter section. The midrange speaker sits in a sound absorbing medium, and radiates directly out from the "cannon's mouth."

Lund's approach is that no speaker is likely to perform at its best when driven by an amplifier with a flat frequency curve. And a truly flat speaker in itself is impossible to manufacture. The speakers in the "1001," therefore, are fed by two separate amplifiers whose frequency responses are *not* flat, but which compensate the frequency curve of the speakers so that the sound reaching the listener is basically flat. One built-in amplifier handles from 20-250 cps, and an electronic crossover sends the midrange and high frequencies to the other amplifier which goes from 250 cps to beyond the audible range. The desired response is obtained chiefly by feedback, and since the amplifiers have transformerless output stages, a very large amount of feedback can be applied—approximately 45 db. ●

# All About Strain Gages

By Steve Hahn

In today's high speed world, these small but rugged resistance measuring units warn of material failure.

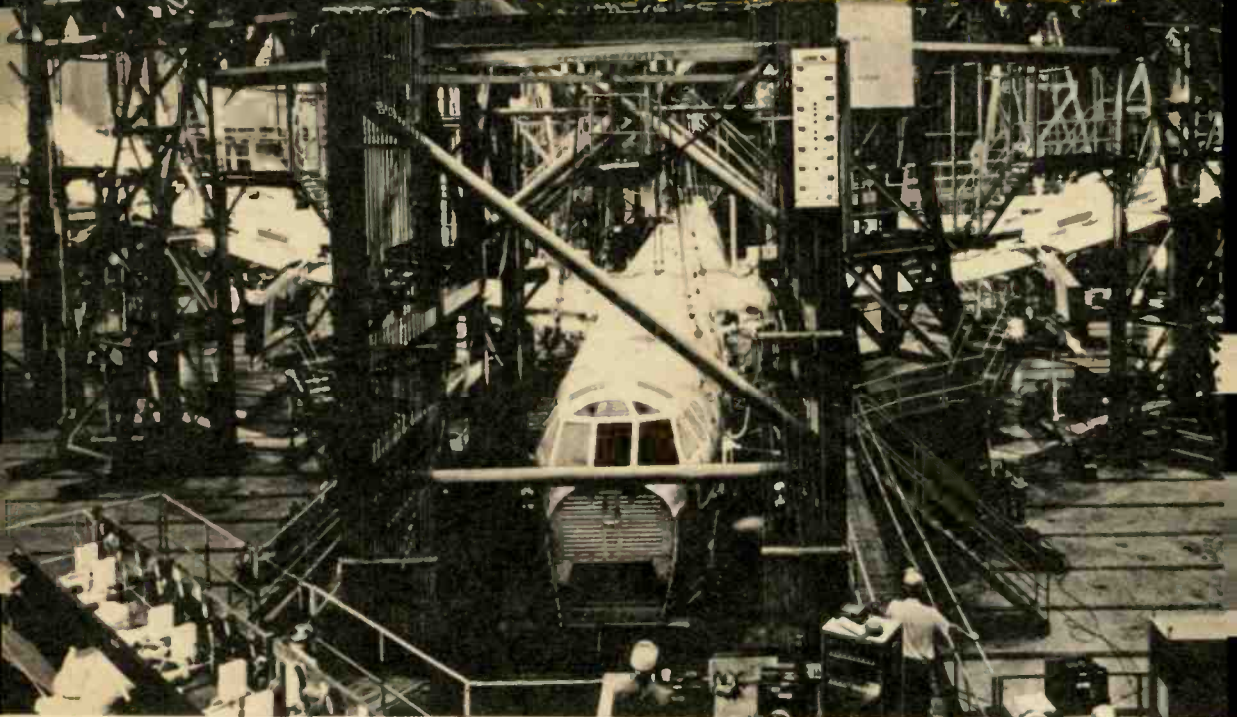

Boeing B-52G is subjected to stresses greater than those it will encounter in flight. Strain gages in wings, fuselage and tail are monitored in foreground.

**T**HERE is hardly a commercial airplane flying today which does not have a number of strain gages mounted in its wings to detect instability as a result of fatigue or operational conditions which exceed the aircraft's structural limits. Shafts and housings on high speed turbines used in the generation of power are almost always equipped with a permanent strain gage system. Critical points on these turbines are located where they are not easily accessible to operating personnel. Prior to the development of the strain gage, very serious accidents and costly breakdowns resulted because a high speed rotor would suddenly fly apart as a result of a progressively worsening dimensional instability which could not be detected until too late.

How does a strain gage work? We generally think the ability of a material to conduct electricity is a function of its resistance. Copper, a good conductor, has low resistance. Glass, a poor conductor, has a high resistance. To change electrical resistance, you either change the material involved or change the amount of



Tiny strain gages by Tatnall Measuring Systems are used in rocket and supersonic aircraft applications. The gages are of MetalFilm foil which is fixed to the base material by a special photoengraving process.

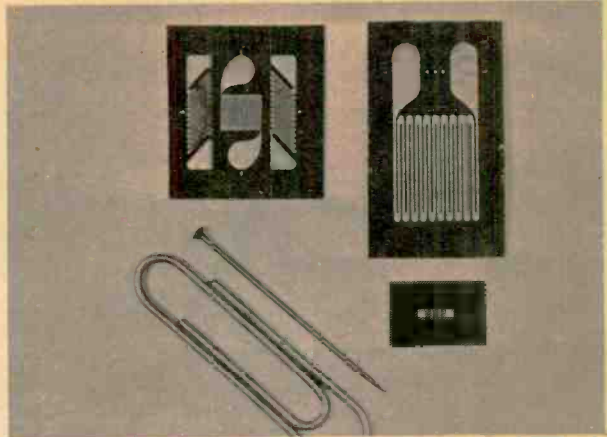

Here thin gages are bonded to underframe of truck with Eastman 910 adhesive for fast installation. The gages easily conform to the curves and irregularities of the surface of material being stress-tested.

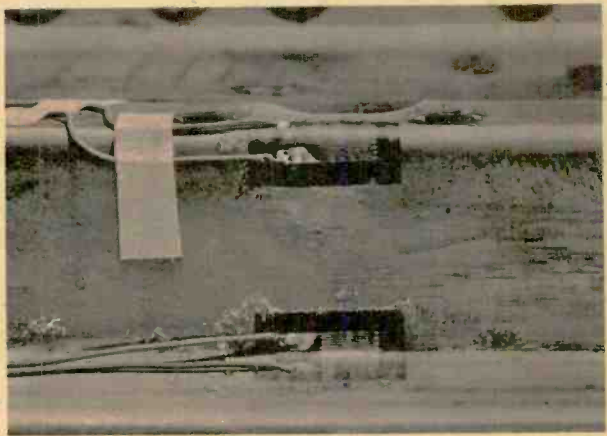

Monitored by TV (and strain gages) is a missile guidance system mounted on end of high acceleration centrifuge. Components under test are blanked out because of security classification. I-beam also is mounted with strain gages (arrow).



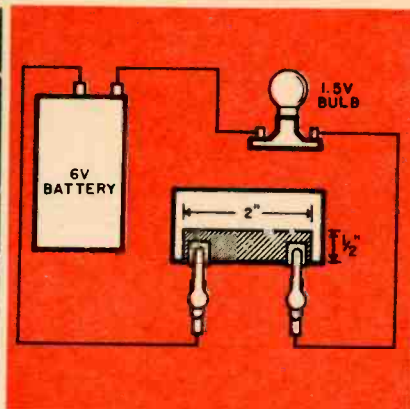

**Home-built strain gage:** Paint 2" of flexible Bakelite with  $\frac{1}{2}$ " strip of conductive printed circuit repair paint. Place two snips of aluminum foil between alligator clips and the paint at extreme ends of paint strip. Hook up circuit as shown, left. Bulb will be bright. But when Bakelite is flexed, resistance in the painted strip will change and the bulb dims accordingly.

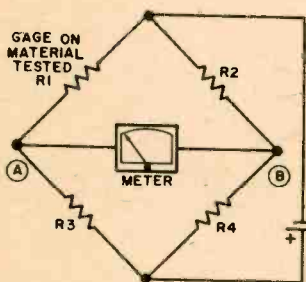

Here is a diagram of the simple Wheatstone bridge described in the text. R1, the strain gage, is attached to material to be monitored.

material. If a 3" steel finishing nail has a resistance of one ohm, two 3" nails wired in parallel will have a resistance of  $\frac{1}{2}$  ohm, while the same two nails wired in series will have an electrical resistance of two ohms.

But the electrical resistance of the nail can also be changed *without* adding or taking away material. If you physically compressed it, the resistance would decrease; if it were stretched, its resistance would increase.

This ability of some materials to change electrical resistance due to mechanical strains forms the basis of a very accurate measuring device called the electronic strain gage.

You can actually construct a simple but effective strain gage with about \$2.00 worth of components—a 6-volt battery, any flexible piece of non-conductor (such as Bakelite), a few snips of tin foil, a  $1\frac{1}{2}$ -volt flashlight lamp and socket, and some alligator clips with

leads. The only special item is a bottle of low-resistance, printed circuit repair paint, General Cement Printing Circuit Repair Paint No. 20. (See illustrations.)

Strain gage measurements play a vital part in industry. Large suspension bridges have cables whose stability must be constantly checked. They must have a certain amount of elasticity, but the elastic limit of the cable must not be exceeded. Attached to the many structural cables in the bridge at strategic points are strain gages, all feeding a master alarm circuit.

Industrial strain gages usually do not use the simple stretching principle in a series circuit illustrated here. The "gage" we used indicates stresses in only one direction. Also, the simple series circuit is not sensitive enough for

The "filament" material of these Baldwin-Lima-Hamilton strain gages is imbedded in plastic. Largest unit is little more than an inch.

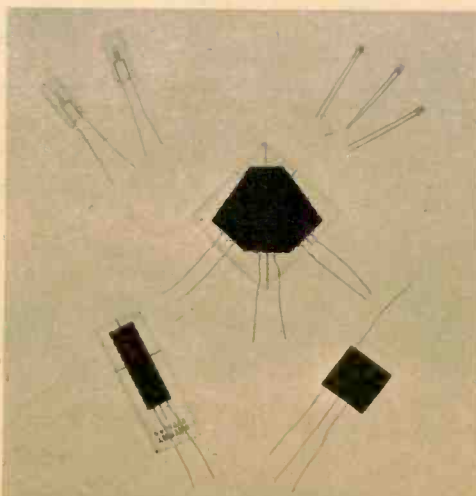



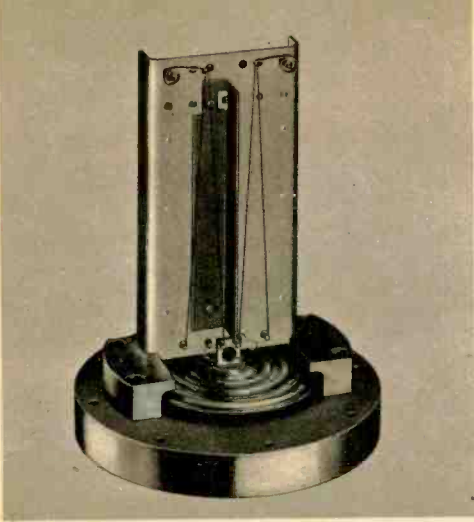

**Unbonded strain gage by Stratham Instruments has pressure transducer pickup. Transducer movement changes length of flexible wire element and its resistance as well. See text.**

delicate strain measurements in critical missile and aircraft applications.

In industrial strain gages the ratio of resistance change to mechanical strain must be as high as possible. The ratio is known as the "gage factor" and the gage wire is usually called the "filament."

Typical strain gage filaments are made of nickel or precious metals and their alloys. The choice of a specific filament material depends upon where and how the gage will be used and the kind of gage factor desired. Some common strain gage filament materials are iridium-platinum, constantan, manganese and nichrome.

The configurations of strain gages vary widely, depending again on the use. Some consist of complex patterns such as wires wound in a helix, in rosette or grid. These arrangements reflect strain changes in virtually any direction.

Strain gages are generally classified into two broad categories: "unbonded gages" and "bonded gages." In the former the filament is wound on a grid structure, usually made of inert support rods. As this grid structure is subjected to stresses and strains, the filaments stretch and compress accordingly and a resistance reading is taken.

Bonded strain gages are those in which the filament is glued on or buried in some solid material such as paper or plastic. In some versions the filament is cemented directly to the material being tested.

The bonding and mounting of strain gages is a very delicate operation in-

volving special cements and nimble fingers. The electrical characteristics of the cements and glues used must be carefully analyzed to neutralize their effects on the resistance change of the gage itself.

Where high sensitivity is required and operating environments are not severe, strain gages may be bonded to ordinary paper. The paper strain gage can then be glued to the material under test. In other applications, strain gage filaments are etched or embedded into plastic, Bakelite or one of several phenolic resins.

The most commonly used strain gage circuits are not simple series circuits, but variations on the Wheatstone bridge. (See diagram). Four resistors are used with the strain gage forming one branch of the circuit. When the resistance of  $R_1$  is equal to  $R_2$  and the resistance of  $R_3$  is equal to  $R_4$ , the voltage drop across  $R_1$  and  $R_2$  is equal and no current flows between points A and B. As soon as the resistance of  $R_1$  (the strain gage element) changes even slightly, current flows across points A and B and meter, oscilloscope or alarm circuit takes note. The direction of the current flow depends upon whether the resistance of [Continued on page 106]

**Several strain gages, smallest being 1/64" in length, are placed for fillet stress analysis in threaded attachment of aircraft component.**

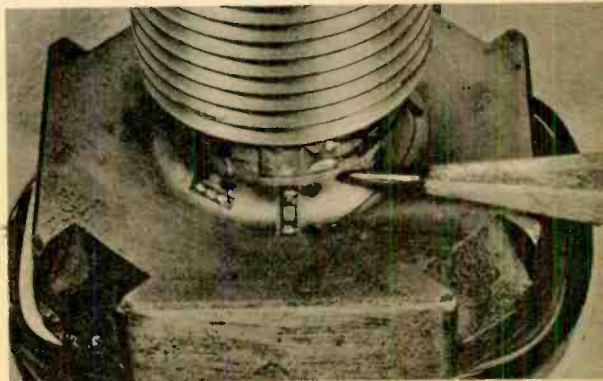

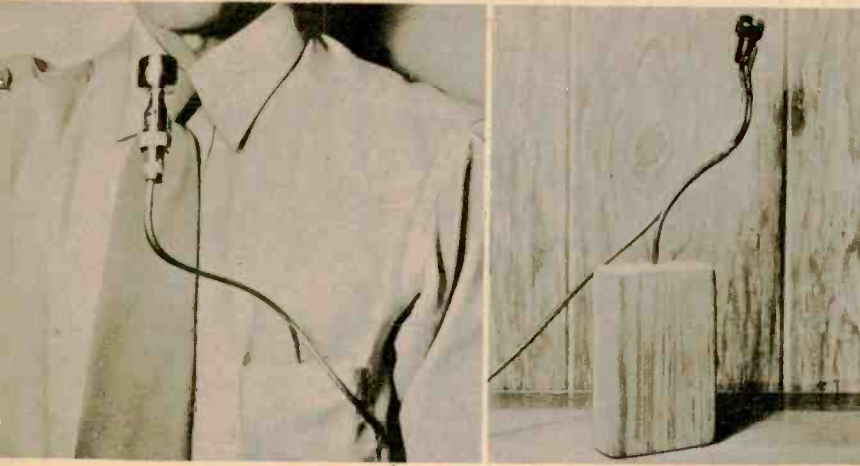

*Try  
These*

### Lightweight Mike Support

About 30 minutes work with scrap materials will give you this novel "third hand" for supporting small lightweight microphones. Drill a hole in one end of a smoothly sanded 4" x 2 1/2" x 1" wood block to a depth of about 2 1/2" with a drill slightly smaller in diameter than #10 copper wire. Drip a few drops of Duco cement into the hole and force one end of the copper wire securely into the hole. Put the wood block in your shirt or coat breast pocket, bend the copper wire to the right shape and cut it off to a convenient length. To the free end of the copper wire solder a male or female (depending on mike) cable connector. Connect free end of mike cable to the connector.

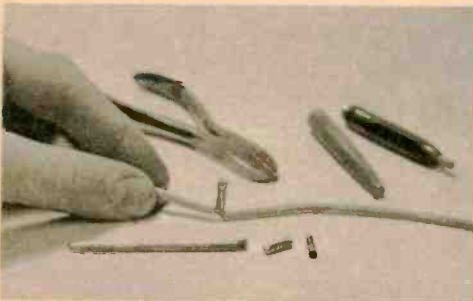

### Solderless Wire Connectors

The brass ink cartridge from an exhausted ball-pen can be cut up into several solderless wire connectors. First wash out cartridge and clip into 1" lengths. Slip over each wire splice and crimp with a diagonal cutting pliers.

### Removing Speaker Magnets

When junking damaged PM speakers salvage the magnet slugs as they have many uses around the house and shop. To remove slug, use a vise and a large nut as shown. Tightening the vise breaks the cement bond which holds the slug, sliding it to one side. Remove the speaker from the vise and pry out the slug. Never drive out the slug with a hammer as you may weaken the magnetism.

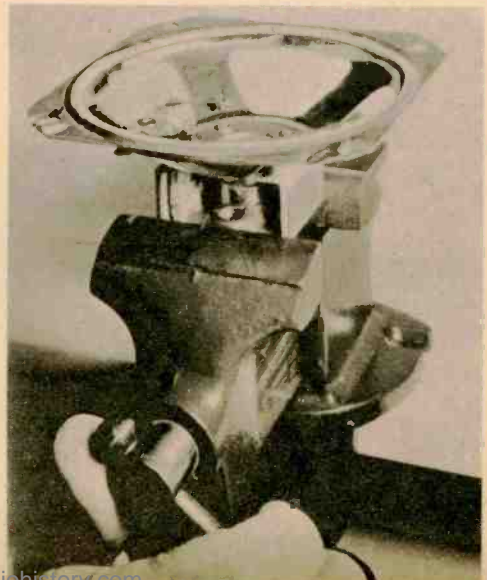



# Small Boat Electronics

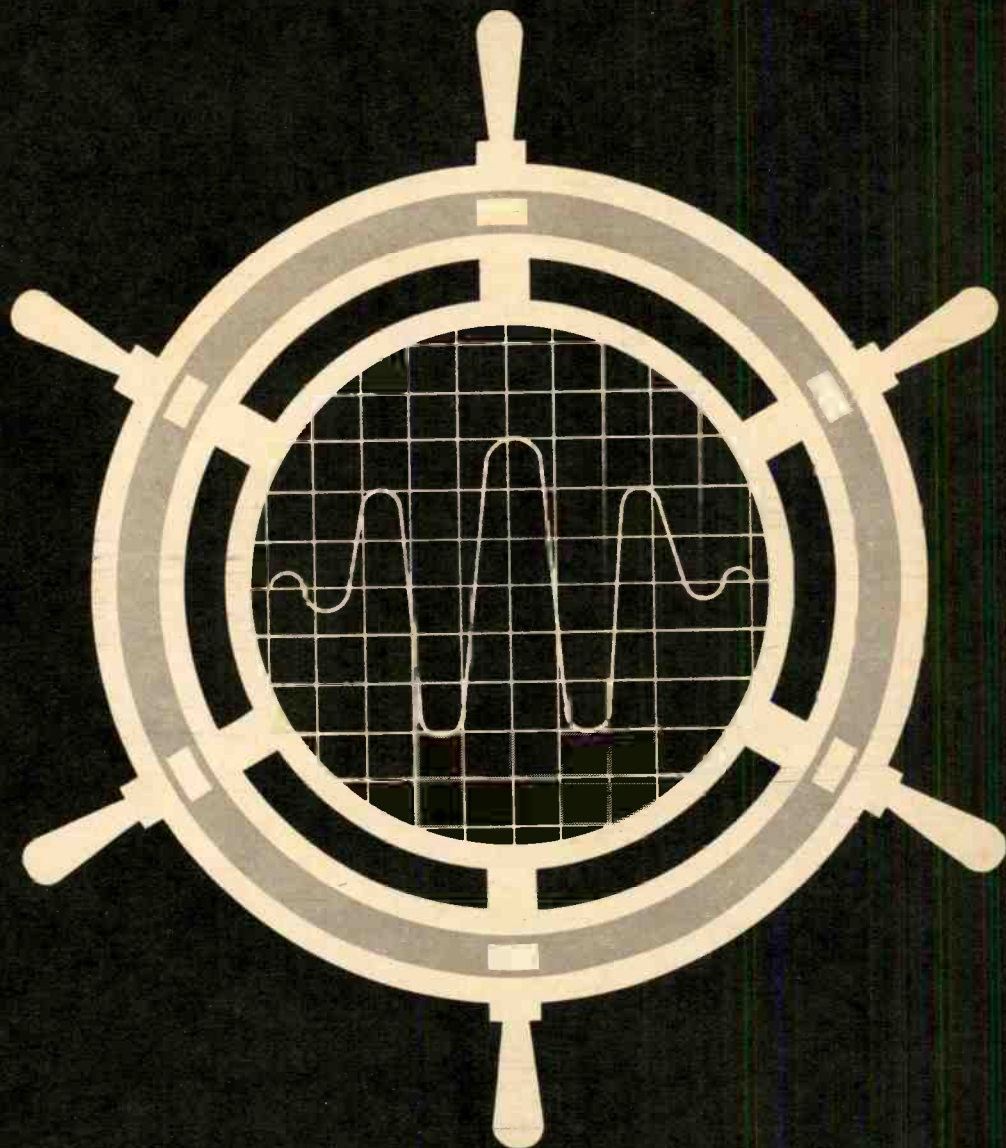

## **HOW TO INSTALL:**

**Marine Radiotelephone**

**Citizens Band Gear**

**Echo Sounders**

**Radio Direction Finders**

**Build-It-Yourself Antennas**

***plus* Manufacturers Listing**

**T**ODAY even the owner of a diminutive dinghy can avoid sailing into trouble by having a properly installed radiotelephone, a direction finder, and an echo sounder. And while these instruments once cost a fortune to own and took a crew of technicians to hook up, today you can painlessly do it yourself. This is not to say that you just tote the equipment on board, lay it down, and immediately a pink cloud of safety surrounds your boat. Marine electronic equipment and installation technique is different from any other kind, and the wise boat owner will know what must be done in advance. This special section tells you exactly what to expect and how to handle and install the gear. First, let's see what gear is available and what it can do for you.

### Marine Radiotelephone

This service was set up by the FCC for the exclusive use of boats. The frequencies are from 2-3 mc, with transmitters ranging 15 watts plate input and up. With a small boat rig, the "up" doesn't







AeroSonic 20-watt transistor Pearce Simpson Bimini has 30 watts for MB, also tunes BCB. Ray Jefferson model 535 is 35 watts, 4 channels, \$395.

go very far because battery power must be conserved; but even so, communication ranges of from 20 to 50 miles are common. In U. S. coastal and harbor waters, the Coast Guard, shore-telephone stations, and all ships, including Naval vessels, monitor the "calling and distress" frequency of 2.182 mc. In the larger ports you can connect to shore telephone lines through commercial stations at a cost of a little over \$1 per call; and wherever there are similarly equipped boats, you can talk to them. Boats carrying over six paying passengers are required by law to carry a marine radiotelephone.

The equipment itself usually consists of a single small cabinet that houses a pre-tuned and crystal-controlled transmitter and receiver and a power supply. Vibrator power supplies, to step up the six or 12 volts from the boat battery are common, while some units use transistorized power supplies. To get the calling frequency, shore telephone stations, or other boats, you shift channels by flipping a channel switch on the panel; you talk through a hand mike, and listen to the loudspeaker. A push-to-talk switch controls transmission and reception. An efficient antenna and ground are necessary.

### Citizens Radio

Suppose you do your boating on Pactola Lake in the Black Hills of South Dakota. Plenty of people do—and on other bodies of water not covered by the Marine Radiotelephone service. You don't have to be out of touch with other boats or the shore. This is one of the situations for which the Citizens Radio Service was intended. Practically everyone is familiar with the characteristics of these little "boxes" by now and the antenna systems that go with them. There is just one hitch: a single Citizens Radio transceiver is about as useless as a solid brass insulator. But if there are other similarly equipped boats around, or if you install another set in your home, or car, or on the dock, you can keep in touch as long as you stay within the roughly line-of-sight distance limits of from 10 to 20 miles or so. Like marine radiotelephones, Citizens radiotelephones require a six or 12 volt battery. Some of the less expensive types built basically for 110 volts AC operation also need a DC power pack.



**CITIZENS BAND:** Left, Multi-Products "Citi-fone" for popular Class D (5-watt limit), \$134.50. Above: A Class B transceiver (465 mc) by Vocaline.

While there are 23 channels available for Citizens use, it is recommended that all pleasure boats reserve Citizens Band channel 13 (27.115 mc) to be sure of being able to contact other boats in range in an emergency.

### Direction Finders

There are no signposts or paint stripes on waterways. You tell roughly where you are by guessing the bearings and distances of known objects and figuring your location in your head. Or you can do the job more precisely by measuring bearing angles with a sighting instrument and plotting the angles on a chart.

When landmarks are blotted out, the radio direction finder takes the place of the visual sighting instrument, aiming at radio stations whose positions are known. Just as with visual sighting, you can guess your position from the bearings or plot the bearing angles for a more accurate "fix."

A radio DF is simply a sensitive receiver equipped with a directional loop antenna and a bearing circle. Modern sets run from self-contained batteries and their loops are usually compact ferrite "sticks." There is no external wiring necessary, so installation is comparatively simple. However, there are some important qualifications, and it is necessary to calibrate the instrument to be sure of accuracy.

### Echo Sounders

Sound travels at a constant speed through the water—4800'



per second. Measure the time it takes for a sound pulse to bounce off the bottom and you can compute the depth of the water. Early echo sounders worked exactly in that manner, with an electrical oscillator in the boat's hull and a sailor with a stopwatch listening through a headset.

The modern echo sounders measure the time and translate it into depth automatically. They consist of two units: the indicator (which generates sound pulses, detects their echos and indicates the depth on a dial) and; the transducer, which is a combination loudspeaker and microphone fastened to the bottom of the boat. The equipment can be run from the boat's engine battery or, in transistorized types, from self-contained batteries. Most inexpensive indicators have a revolving flashing light to show depth, but some have a voltmeter movement with the needle showing depth instead of voltage.

### Radiotelephone and CB Installation

Proper placement is essential and the same principles apply in both marine band and Citizens radio stations. Pick a spot which is protected from rain and flying spray. In an open boat, or one with an exposed cockpit, this may call for building a cabinet or housing, or providing some form of watertight cover of wood, metal, or even waterproof canvas or plastic sheeting. Another way to lick the water problem is to mount the equipment inside the cabin or under a protective deck.

Remember that the licensee of radiotelephone equipment is responsible for its operation. You should be able to lock up the cabinet or compartment in which the gear is housed to prevent pilferage and unauthorized persons from going on the air in your absence. Some units are designed for easy dismantling, so the equipment can be taken ashore when not in use.

Also, find a location at which the battery cables and antenna lead-in and ground wire will all be as short as possible. In case no one position will satisfy these requirements, favor the one that will keep the antenna and ground leads short. Then too, the farther away from the engine, which generates electrical interference, the better.

Still another factor is to keep the set (and this goes for any other equipment, such as receivers and direction finders that have loudspeakers) at least three feet from the boat's steering compass. The magnetism of the speaker will pull the com-



Heathkit DF-3 (\$99.95) is 9-transistor radio direction finder kit for aeronautical, broadcast and marine bands.



Sonar model DF-6X 3-band RDF, \$249.50.

To be able to hear calls all you need is a remote speaker which can be wired across the voice coil of the speaker in the equipment. With a telephone having the push-to-talk switch on the microphone, wire the entire mike circuit to a three or four-terminal socket on the telephone panel and connect the microphone cord to a mating plug. Make up an "extension cable" with a plug and socket for the microphone connectors and run it from the equipment to your helm. Then, if you wish to talk from the equipment position, just plug the mike into the panel.

To talk from the helm, remove the mike from the panel socket, plug in the extension cord, then connect the mike to the helm end of the extension.

**POWER WIRING:** If there should miraculously be an outlet on your boat, you can bet your favorite tooth that the feed wire is too light. On shore, a #14 wire will take care of most equipment, but on a boat, radiotelephone efficiency may require cable of 10, 8, or 6 gage, and there are cases where wire the size of automobile-starter cable should be used.

The proper cable size will be specified in the equipment instruction book. It depends upon the battery voltage and the length of the cable run. In measuring your cable run, be generous, allowing plenty for corners and for a little slack at the ends. And it is a good idea to use wire a little heavier than called for: voltage drop in battery cables will rob a transmitter of considerable power.

Run the cables in the most protected route possible, keeping them well out of the bilge or positions where they will be exposed to moisture or abrasion. Use plastic clips and non-ferrous screws

pass needle from its correct heading.

A boat is a bouncy thing. Through-bolt fastenings or husky screws are preferable, and they must be non-corrosive bronze, Monel, or Everdur. Anything inferior will break, rust out, or look like a junk-box job.

**REMOTE CONTROL:** If the best location for the phone proves to be so far from the helm that you cannot hear or talk over the set from that point when you are handling the boat, you can install a remote control. Manufacturers of some radiotelephones can supply these ready-made. Otherwise, you can hook one up yourself.



Munston "Bay Shore" RDF has BFO. \$230.





Allen-Bradford DF-O-Matic (\$299) is portable.

to hold them in place—*never staples*. Use terminals on all cable ends. The crimp type are easy to apply. Tape the shanks and the end of the insulation with black plastic tape.

Some outboard motors have terminal boxes for the connection of external equipment. If the motor is not so equipped, and in the case of inboard engines, find the point where the main battery cables connect to the motor. One will usually be fastened under a bolt into the engine block or head; while the other connects to a heavy terminal on the starter solenoid. Connect the cables to these points. If this is not possible, connect your cables to the battery

terminal bolts. This, however, is the least desirable point of connection.

Mark the cables on both ends as to their polarity, and observe the manufacturer's instructions regarding the ground polarity. Most equipment today is set up for a *negatively* grounded system. However, there are engines which have a positive ground, and in this case you may have to make some special provision. If you have any doubts about your boat's electrical system ground polarity, set a voltmeter for the 50-100 range (to protect the meter) and hold the negative probe at a grounded point (the engine head or block) and touch the positive probe to the hot lead of your battery. If the meter reads forward, the system is negatively grounded. If it reads backward, it is positively grounded.

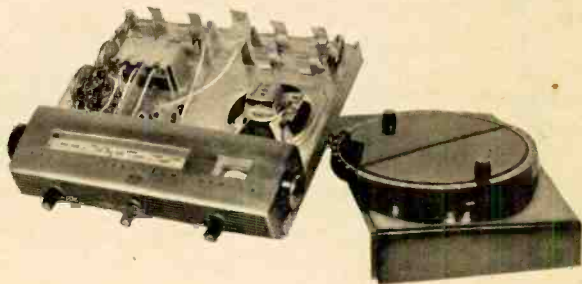

Sperry RDF (\$249) has 9 transistors.

Some telephones have a short length of battery cable attached to the set. Cut this cable to give plenty of slack to allow removal of the equipment for service, then splice it to the main cable using terminals and nuts and bolts, heavily taped for insulation. Or you can use a two-terminal junction board or electrical box available from an electrical supply store. If there is no "pigtail cable," connect the power leads directly to the equipment input terminals.

If you wish, you can fuse the power circuit. Install a single-fuse box at the engine end of the cable, using a fuse of about twice the amperage of the equipment current consumption. Connect a fuse in the "hot" line only—never in the lead which is attached to the ground or engine-block side of the battery circuit.

**ANTENNA INSTALLATION:** A proper antenna system is the



Depth indicator should be near helm in shade. Transistorized unit is Raytheon DE-708 (\$125).

most important single part of a radio-telephone installation, especially in the case of 2-3 mc marine equipment. This is because the allowable length of antenna a small boat can carry is such a small fraction of a wavelength that radiation resistance is very low—less than one ohm for the shorter antennas. Loss resistance must therefore be kept as low as possible, or the percentage of transmitter power radiated will be very small. Loss resistance is caused by “leaky” insulation, long and meandering lead-in wires, wire of too small gage, nearby metallic objects or wires which soak up power, and ground resistance.

Place your antenna as high as possible and where it will not be grabbed by passengers, or brush against objects when the boat is at a dock. With an-

tennas that are supported by a base-mounting insulator, a good site is in the center of the deck forward of the windshield, or on the cabin roof. Otherwise, stand-off insulators are used to secure the antenna to the side of the windshield or cabin structure. If the boat has a mast of some kind, side-mounting insulators can be used to secure the antenna to the mast.

One of the difficulties in marine installations is that there are so many curved and offset surfaces on a boat. It is often necessary to cut mounting blocks or pads of wood to give a flat surface on which equipment can be secured. The best material for this purpose is mahogany because it is close-grained, knot-free, easy to work, and it has good weather resistance. In fastening hardware of any kind to the outside surfaces of a boat, always use a plastic bedding compound underneath and around the screw or bolt heads. Otherwise, water may get beneath the fitting, leak through to the inside of the boat and rot the wood.

The lead-in should be heavy, plastic-insulated wire, routed as far as possible from metal railings, trim, or electrical wiring. With a low-power transmitter and heavily insulated wire, it may go into the boat through a tight-fitting hole and sealed with bedding compound. A better method of entry is to use a glass or ceramic feed-through insulator. Smear the inside of the hole with white lead or other sealer and make sure that the conducting bolt does not touch the wood.

Inside the boat, the wire should be mounted so it does not flop around. A

Bendix DR-19 depth recorder for small craft gives constant record of bottom and fish.







W. O. White echo sounder, transducer—\$155

tubing for a distance of 2". Assemble the aluminum tubing and the bakelite rod and secure with through bolts. One caution: glue a plug in the top of the upper tubing—otherwise it will fill with rainwater and soak the bakelite insulator.

Now, you can either wrap the rod with plastic-insulated wire of at least 18 gage, or mount a pre-wound commercial coil to the through bolts, connecting the coil ends to the tubings. The resonant frequency of this coil-loaded antenna should be higher than the highest frequency on which the telephone is to be operated. This can be measured with an antenna bridge.

A simple method of antenna mounting is to use ceramic feed-through insulators secured to the side of the windshield or cabin and bolted to the bottom of the 1" aluminum tubing. One of them can be used for the antenna lead-in connection.

**GROUND CONNECTION:** A marine radiotelephone will work, after a fashion, with just the engine for a ground connection. However, efficiency rises as the area of the ground connection in contact with the water is increased. For this reason, a radiotelephone performs at its maximum on a boat with a metal hull. The telephone ground terminal is simply connected to some convenient point of the hull structure. Next best is a copper sheet (such as flashing copper obtainable from plumbers or the hardware store) secured to the bottom of the hull by a generous number of "marine metal" screws. The *ground plate* can be any convenient shape, shaped to the hull lines and preferably

poor lead-in will affect the antenna tuning and the power output. Fasten the wire down with plastic clips or small ceramic stand-off insulators.

**HOME-BREW ANTENNA:** There are "package" radiotelephones that come complete with antenna and hardware. You can also make your own and obtain excellent performance.

A very effective antenna can be constructed of thin-wall aluminum tubing made of two sections: one, 1" diameter, the other, 1/2" diameter, both 6' long. Get a piece of 1" bakelite rod 1" long. Bore a 1/2" hole 2" deep in one end and have the other end machined or filed down so it is a press-fit inside the 1"

Heathkit DS-1 (\$69.95) depth sounder is completely transistorized. Note light spot reading.





**Radiotelephone goes aboard Short Wave on calm day. Careful work requires steady platform. Companionway location is protected, convenient to helm. Right, power cables are connected to starter solenoid "hot" terminal, engine block. Be wary—fireworks if you ground wrench while on hot terminal.**

located immediately under the equipment. Install a  $\frac{1}{4}$ " bronze bolt through the plate and hull, liberally calked with compound and supplied with a large washer inside for connection to the phone ground wire. Use a torch to solder the bolt head to the copper sheet. Use ground wire of the same gage as your power wiring, route it as directly as possible, and fasten it securely.

On many boats a ground plate is impracticable. In this event, bond all of the metal inside the boat, such as piping and tanks, to the engine to increase the ground area through capacitance. Your capacitance ground can be augmented by placing copper screening or a network of heavy wires in the bottom of the boat and connecting it to the engine.

(NOTE: Several manufacturers produce special ground plates or discs composed of porous metal which can be installed on the bottom or transom of a small boat.)

**TUNING:** "Package" radiotelephones require little or no tuning upon installation. For any necessary touch-up in antenna tuning, there are controls on the panel. Indicator lamps are provided to show when tuning is at peak. A good way to keep tab on your transmitter tuning and output is to connect an antenna-current meter in series with the lead-in. Use a one-ampere RF ammeter. (The RF transformer, thermocouple and meter found in surplus command set antenna boxes will also work.) If your

meter goes off-scale (miraculous!) shunt it with a loop of wire, shortening the loop as required to bring the reading down to a safe value.

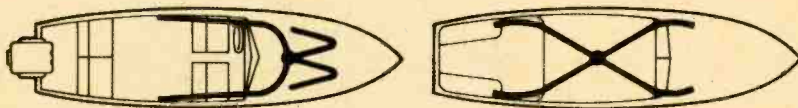

**Antenna mounting on foredeck of runabout (left) and on top of cabin boat (right). Ground plane can be added at the base of CB antenna.**



You can also make a relative output indicator from a 1N21 or similar diode and a 1-mil meter movement. Just connect the diode with the meter in parallel (watch the polarity) across a short section of the antenna lead-in wire. Start out with the diode shunting the minimum length of lead-in, then increase the length until a satisfactory reading is obtained. This will tell nothing about the actual output, but it will show from time to time if the transmitter is "up to snuff," and it makes a convenient tuning indicator.

*Before the equipment is put on the air, a licensed radiotelephone technician must check the frequency and adjustment of the transmitter and enter this information in your station log.*

### Citizens Band Antennas

The main difference between Citizens Band and Marine Band radiotelephone installation is in the antenna. A number of manu-

Mahogany block fitted for curved deck will level antenna mount. Make hole for lead-in wire and seal. Use nonferrous hardware.



Make antenna with aluminum tubing, bakelite rod for center insulator and loading coil. Use thru-bolts as shown. Coil is 2 3/4", 8 turns/inch.

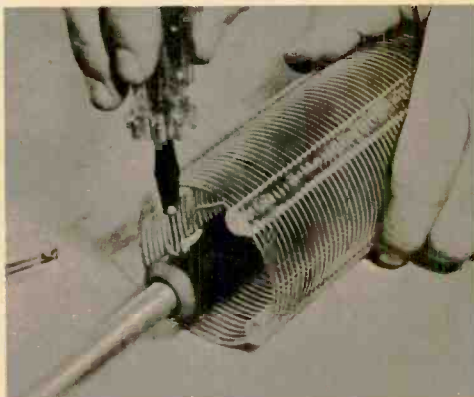

"Home brew" antenna may be secured to a base mounting insulator. Center-loading coil increases the efficiency of a short antenna.

You can bolt ceramic feed-through insulators to windshield frame or cabin side for antenna supports. Bottom feed-through serves lead-in.



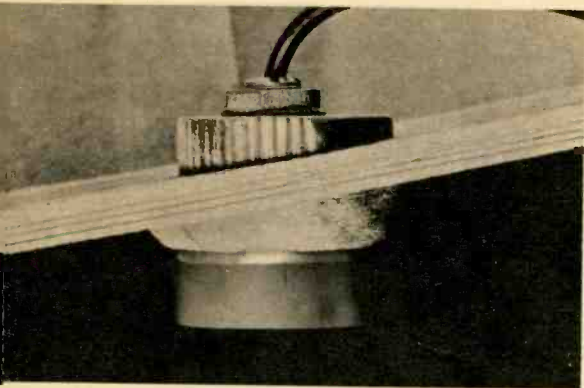

This is the way levelling blocks are used to secure transducer to sloping bottom of boat.

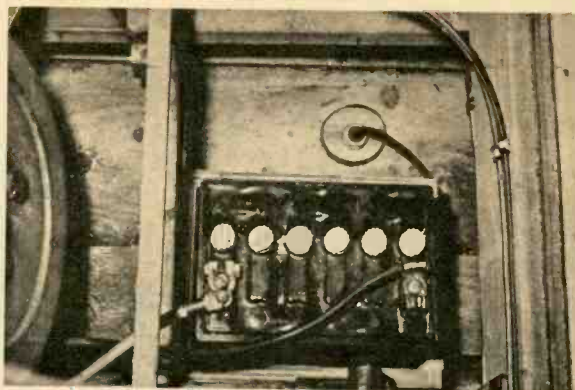

Use bedding compound on top and bottom of transducer mount. Route cable out of bilge.

factured antennas are available at a reasonable price. However, you can make your own. Use a length of aluminum  $\frac{1}{2}$ " tubing mounted on stand-off or feed-through insulators. The tubing *plus the lead-in* should total exactly 9 feet. The ground lead should be heavy, short and direct.

If a short ground lead cannot be realized, use a tubing 9' long and, at the antenna base, mount a ground screen of copper (one or two-foot square), and connect four ground-plane wires 9' long. These can be stretched out under the cabin roof or deck and folded back on themselves if necessary. Connect the antenna to the telephone with the type of coaxial cable recommended by the equipment manufacturer.

Vehicular antennas have a tendency to corrode when they are on salt water, therefore go over the antenna with a plastic spray.

### Direction Finder Installation

Since the usual small boat DF is essentially a battery-operated radio receiver, installation is not complicated, although caution should be observed with regard to protecting the equipment and securing it solidly in place. Accuracy depends upon an undistorted radio field; therefore, keep the loop well away from wiring, window screens, railings, or other metal objects.

The spot on which the DF is mounted should be level. If it is slanted one way or the other, bearing accuracy will be affected. If necessary, use a levelling block, or shim up the mounting shelf.

Next, accurately orient the DF so it is squared-off with the keel line of the boat, or else there will be a constant error in all bearings.

To insure accuracy (and also to gain practice and confidence in the instrument) it should be calibrated after installation. This simply means that you check radio bearings of a transmitter tower against visual bearings. For this operation, it is best, where possible, to bring the boat to within sight of a radio transmitting station.

Holding the boat accurately on course and heading directly for the station, tune in your signal and get a bearing on it by listening for the null or watching the swing on the meter. Then immedi-



ately sight over the loop and note if the transmitting tower is exactly in visual line with it. If not, turn the loop until it is and note the number of degrees difference, plus or minus, between the radio and the visual bearings. This is the amount of your deviation on this heading, and it must be algebraically subtracted from any subsequent radio bearing in this direction to obtain the correct angle.

There are several methods of recording deviations and the corresponding correction, but the simplest system is just to use a china marking pencil and to mark the error on the DF cabinet close to the bearing scale.

Now, steer the boat on another course 15° or 20° higher and "take another cut" on the station, again marking down any deviation found. Go all the way around the compass in this fashion. With this system, any time you take a radio bearing, the amount of correction to be applied is directly in front of your nose.

### Echo Sounder Installation

The indicator should be in sight of the steering wheel and close enough for good visibility. At the same time, it should be kept away from the compass because of the magnet in the sounder motor (or meter). It is a good idea to mount flashing-light indicators where they will not be exposed to direct sunlight (which makes them hard to read). A dimly lit cubbyhole alongside the helm might be ideal.

Electric-current requirements of modern echo sounders are small. Even so, when installing the type that is operated from the boat's battery, it is not a good idea to tap into some nearby circuit (as for the lights or horn), but rather route a separate pair of wires to the power connection at the engine. This will prevent possible overloading and fluctuating voltage as other items on the shared circuit are turned on and off. As a general rule, electronic equipment circuits should be kept separate from all others.

The location for the transducer should be carefully chosen because the range and the accuracy of the instrument depends upon it. Some compromise may be necessary, and here are the points to keep in mind:

Transistor megaphone (3¼ lbs.) is \$45 from Guest Corp., 35-04 30th St., L. I. C., New York.

Marine frequency converter (\$19.95) by Hartman makes car radio into 2-3 mc receiver.

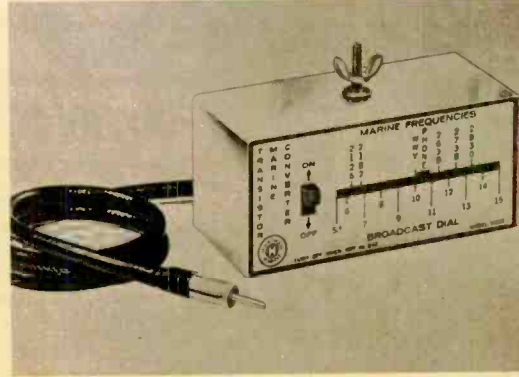
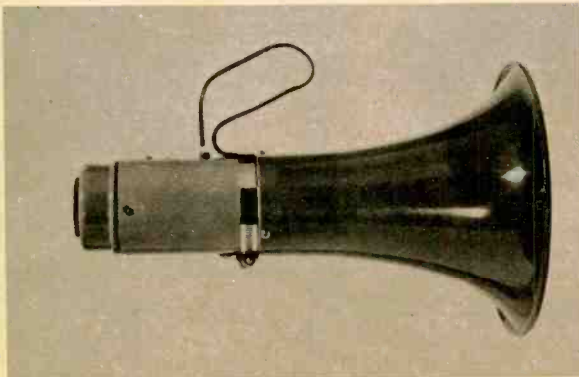

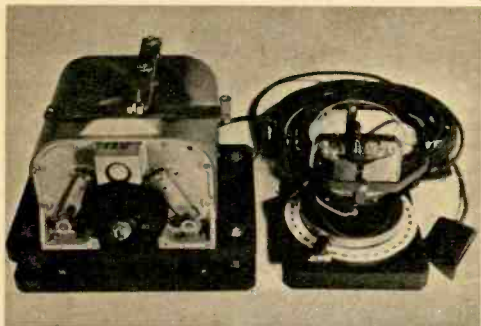

Here is automatic pilot for small craft by Hill Cunningham (about \$400 with remote control).

First of all, the transducer must be installed with the face perfectly horizontal or the sound beam will be projected downward at an angle and the echo may miss the boat completely. This calls for levelling blocks to compensate for the curve or *deadrise* (V-shape) of the hull. The outside block should be streamlined to create the least turbulence. A badly shaped block can affect high-speed boat performance.

To prevent leaks, the transducer and the blocks should be bedded in a good grade of marine bedding compound. The inside block should also be bedded down, as well as the nut and washer on

the transducer through-hull tube.

The location should be far enough aft that the transducer will always be in the water. Placed close to the bow it might come out of the water, or miss soundings due to air sweeping under the hull.

On the other hand, it should be kept away from the propeller because of the possibility of noise interference. Be certain that the point chosen will be well clear of cradle members or the trailer bed when the boat is hauled ashore. Also keep it away from other through-hull fittings that might cause turbulence.

The wooden block should be painted with bottom paint, but the face of the transducer should be kept clean. Before the boat is launched, wipe off the transducer with detergent. This will remove air bubbles underwater and hasten complete wetting of the face, necessary for sound transmission.

Clip the transducer cable up under deck beams to keep it out of the bilge and coil up and secure any excess cable. The capacitance of this cable has been figured in the design of the equipment, so none of it should be cut off.

### Electrical Noise Suppression

To obtain true satisfaction in the operation of your radiotelephone and direction finder, it will be necessary to work on electrical noise suppression. Obtain the type of resistor spark plugs recommended for your engine, or if these are not available, use external suppressors in the cable at each spark plug. A suppressor can also be connected in the ignition lead at the spark coil.

Connect a 1 mfd generator capacitor from the generator ground to the armature terminal (the heavy one). Ground capacitors should also



Transistor power inverter by RCA (DC-AC) for shipboard use of TV, power tools, etc.





Hartman Marine's remote station for topside extension of master radiotelephone is \$29.95.

mum noise reduction.

If your boat has electric windshield wipers, put noise filter capacitors across their terminals. Otherwise, they might drown out reception just when you need it the most.

Unless you are lucky, complete noise elimination may be impossible to achieve. This is the nature of the beast. All you can do is to slow down (which reduces noise) when communications are desired. And with suppressors or resistor spark plugs, you may find some lessening of engine performance at different speeds. If there should be some difference, this is the price of quiet reception.

Licenses are required for radio transmitting stations, both in the Marine Band and the Citizens Band. For the Citizens Band the station license only is required; however, for the marine radiotelephone service, both a station license and a Third Class Radiotelephone Operator's Permit must be obtained. Forms for all of these may be obtained from the Federal Communications Commission, Washington 25, D.C., local FCC field offices, or from the dealer from whom you bought your equipment. No examinations are required for an operator's permit but age and citizenship requirements must be met.

The best in electronics won't replace you, the skipper, but will enhance your boating fun and safety.

SEE MARINE DIRECTORY NEXT PAGE

be connected to the engine end of the wire which goes to the ignition key on the control panel, and across the "battery" terminals on the voltage regulator—the case to negative and the pigtail to the positive terminal.

Outboard motors equipped with alternator/rectifier battery chargers should have .5 mfd coaxial feed-through capacitors installed in the leads from the alternator under the flywheel to the rectifier. The capacitor bodies should be bolted to the motor frame.

The metal covers of outboard motors will help shield the noise, providing you bond the cover to the engine block with heavy pieces of flexible wire. There are also metal shielding covers available for inboard motors and these must be connected solidly to the engine for maxi-

A complete radar system for the small boat is offered by Raytheon for \$2195. Range is 12 mi.



## ELECTRONIC GEAR FOR THE SMALL BOAT

This chart tells you where to get more information. It does not list every type of product handled by a given company, and readers are reminded that manufacturers make frequent additions and deletions to their product lines. When writing for information, it is a good idea to specify the size of your boat. Many of these companies market large boat and ship installations, and you certainly don't need literature on a large sonar installation if you have a rowboat that only can handle a small transistorized fish finder. The makers of accessories such as power megaphones and battery packs are so numerous that space precludes our listing them here. Incidentally, fish finders and depth indicators are lumped under "Echo Sounders."

PRODUCTS COMPANY	MARINE BAND	CITIZENS BAND	DIRECTION FINDERS	ECHO SOUNDERS	MARINE ANTENNAS	AUTOMATIC PILOTS
Aerosonic Marine, Inc. 1212 Hercules Rd. Clearwater, Fla.	✓		✓	✓	✓	
Acton Laboratories Acton, Mass.		✓				
Allen-Bradford, Inc. 3181 N. Elston Ave. Chicago 47, Ill.			✓			
Allied Radio 100 N. Western Ave. Chicago 80, Ill.		✓				
Apelco Sales Corp. 213 E. Grand Ave. So. San Francisco, Calif.	✓		✓	✓	✓	✓
Bendix-Pacific 8211 Lankershim Blvd. North Hollywood, Calif.	✓		✓	✓		✓
Edo Corp. 13-10 111th St. College Point, N. Y.			✓	✓		
Electro-Voice Cecil & Carol Sts. Buchanan, Mich.		✓				
Era Dynamics, Inc. 67 Factory Pl. Cedar Grove, N. J.	✓			✓	✓	
Globe Electronics, Inc. 3417 W. Broadway Council Bluffs, Iowa		✓				
Gonset 801 S. Main St. Burbank, Calif.		✓				
Hallcrafters Co. 4401 W. 5th Ave. Chicago, Ill.		✓				
Hartman Marine Equip. Co. 30-30 Northern Blvd. Long Island City 1, N. Y.	✓		✓	✓	✓	
Heath Co. Benton Harbor, Mich.		✓	✓			
Hill Cunningham Autopilot Co. P.O. Box 8593 Fort Lauderdale, Fla.						✓
Ray Jefferson, Inc. 40 E. Merrick Rd. Freeport, N. Y.	✓	✓			✓	
Kaar Engineering Corp. 2995 Middlefield Rd. Palo Alto, Calif.	✓		✓			

PRODUCTS COMPANY	MARINE BAND	CITIZENS BAND	DIRECTION FINDERS	ECHO SOUNDERS	MARINE ANTENNAS	AUTOMATIC PILOTS
Multi-Products Co. 21470 Coolidge Hwy. Oak Park 37, Mich.		✓		✓		
Munston Mfg. & Svc., Inc. Beech Street Islip, N. Y.	✓		✓	✓		
N. Y. Marine Radio, Inc. 501 Fifth Ave. New York 17, N. Y.	✓		✓	✓	✓	
Pearce, Simpson, Inc. 2295 NW 14th St. Miami 35, Fla.	✓	✓		✓	✓	
Philmore Mfg., Co., Inc. 130-01 Jamaica Ave. Richmond Hill, N. Y.		✓				
Raytheon Mfg. Co. 101 River St. Waltham 54, Mass.	✓		✓	✓	✓	
RCA Radiomarine Products Frant & Cooper Sts. Camden, N. J.	✓	✓	✓	✓	✓	
Regency 7900 Pendleton Pike Indianapolis 26, Ind.		✓				
Rowe Industries 1702 Wayne St. Toledo 9, Ohio					✓	
Sonar Radio Corp. 3050 W. 21st St. Brooklyn 24, N. Y.	✓		✓	✓	✓	
Sperry Piedmont Co. Rt. 29 Hydraulic Rd. Charlottesville, Va.	✓		✓	✓	✓	✓
Stickell Marine Products 1616 Mt. Royal Ave. Baltimore 17, Md.			✓	✓		
Tivoli Radio & Marine Co. 414 City Island Ave. New York 64, N. Y.			✓	✓	✓	
Vocaline Co. of America Coulter St. Old Saybrook, Conn.	✓	✓				
Wilfrid O. White, Inc. 40 Water St. New York 4, N. Y.				✓		✓
Winston Electronics Div. Jetronics Industries, Inc. 4000 NW 28th Miami 42, Fla.				✓		



# Electrolytic Capacitor Checker

Metered unit provides direct leakage reading

By R. L. Winklepleck

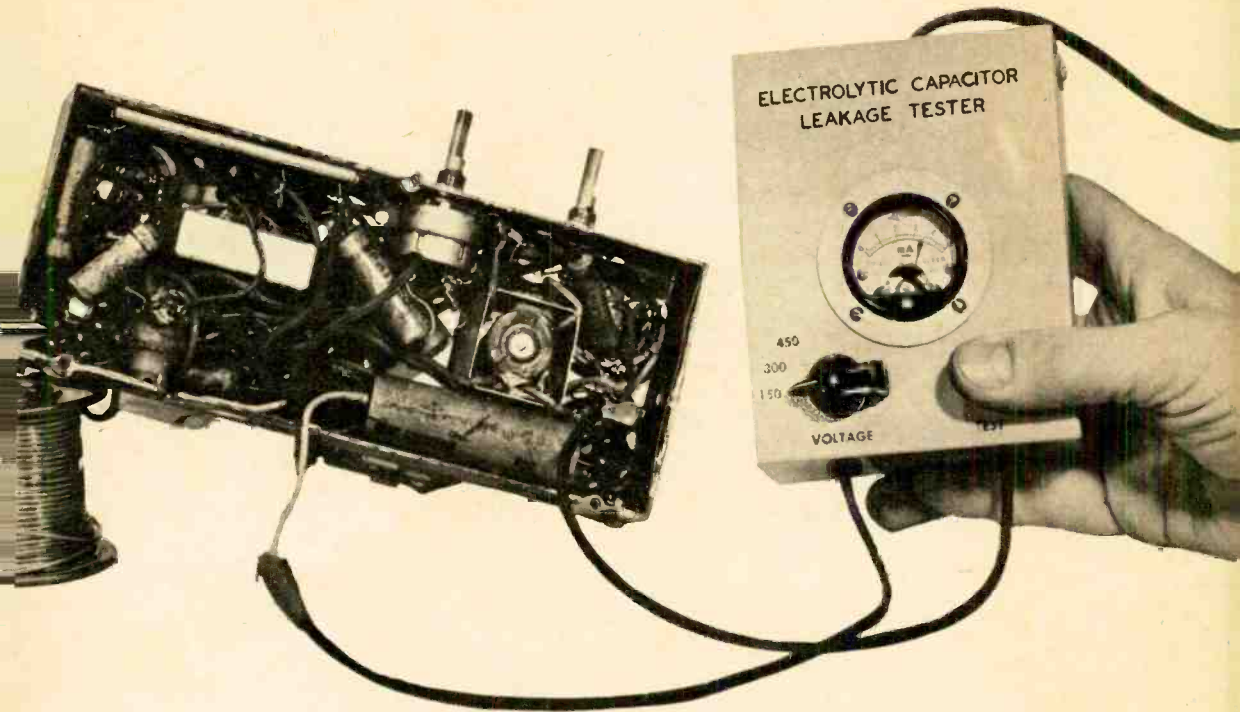

**F**OR the service technician or part-time troubleshooter, leaky electrolytics can be a headache. They frequently turn a simple repair job into a dog because they are usually located only by substitution which most of us consider absolutely the last resort.

The symptoms of leaky electrolytics are legion. It's a lucky day when it shows up as hum in the audio—even though this indication can be caused by many defects. But when we get into low voltage, marginal performance, unstable sync, distorted sound, etc., then we have problems. A lot of substitutions may be required and there always seem to be a dozen leads hung on each terminal. The picture is made even more cloudy, especially in older re-

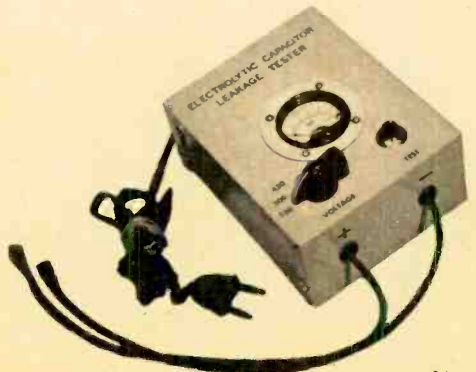

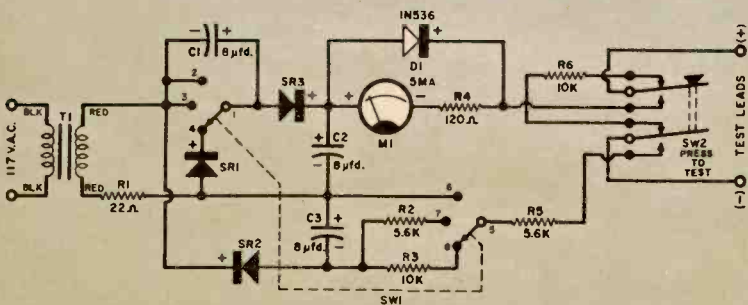
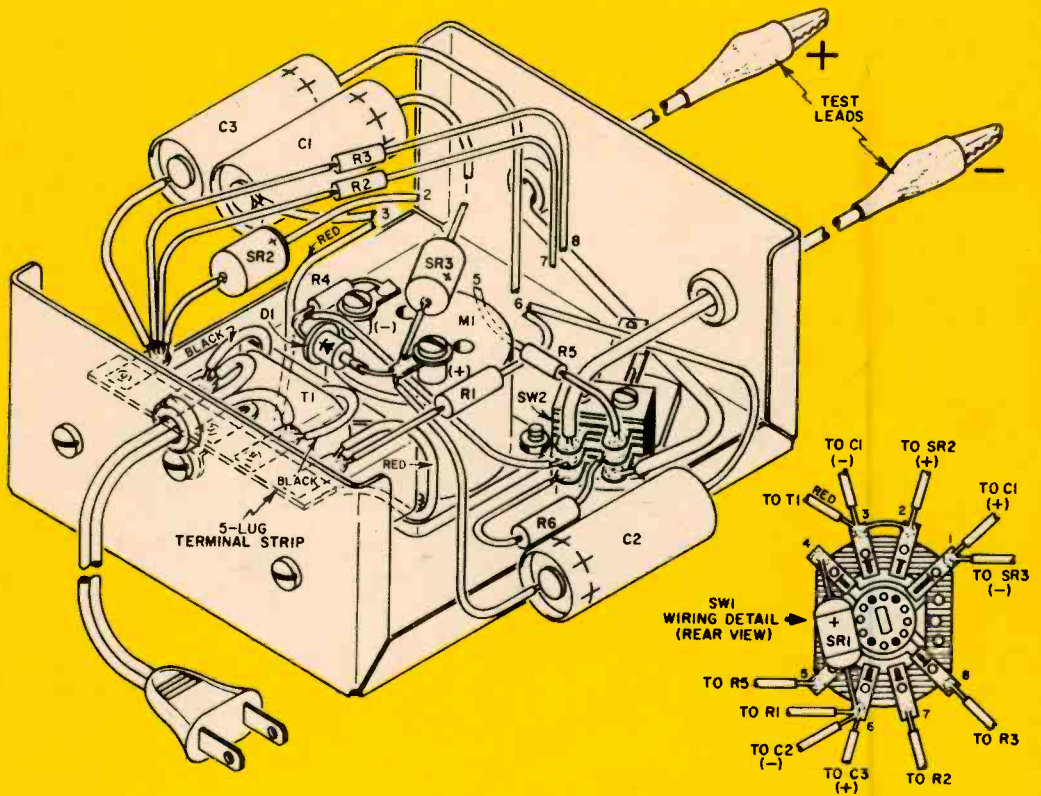

Switch SW1 above, has been lifted out of chassis for clarity. Numbered ends of wires match numbers at SW1 contacts. Observe polarities of the electrolytic capacitors, silicon rectifiers (SR1, 2, 3) and silicon diode D1.



ceivers and amplifiers, when not one but several bad capacitors contribute, en masse, to the problem.

Note that it's seldom that we're interested in the exact value of an electrolytic since they normally have wide tolerances. The much-used ohmmeter test for leakage is extremely deceptive. Not only is the applied voltage too low to "reform" the electrolyte (in which case the presence or absence of leakage is almost meaningless) but it doesn't test for high voltage breakdown, a rather frequent cause of trouble.

### Principle Of Operation

Here is a compact and inexpensive addition to your test equipment designed specifically to locate opens, shorts and leakage in electrolytic capacitors. It's simple to build, easy to use and should cost about ten dollars if all the components are purchased new. A quick look at the schematic shows that it's merely a three-level polarizing voltage supply with a milliammeter in the test capacitor circuit to indicate the presence and amount of current flow or leakage.

A transformer (T1) is provided for power line isolation. Three silicon rectifiers (SR1, SR2, SR3) and three capacitors (C1, C2, S3) can be switched by SW1 in a rather unique arrangement to provide an output of 150 volts through

a half-wave rectifier, 300 volts via a doubler and 450 volts from a tripler circuit. Resistor R1 reduces current surges which might damage the rectifiers. R2, R3 and R5, placed alternately in the circuit by SW1, levels the current flow for the three voltages.

Current through the capacitor under test is limited to 12-15 milliamperes even if shorted. The maximum current *through the meter*, however, is held to approximately five milliamperes by the silicon diode-resistor network across the meter (D1, R4). The non-linear conduction characteristic of the diode permits the meter to accurately record the

### PARTS LIST

#### Resistors

20%, 1/2-watt unless otherwise noted

R1—22 ohm, 1 watt

R2, R5—5,600 ohms

R3—10,000 ohms

R4—120 ohms

R6—10,000 ohms, 1 watt

C1, C3—8 mfd, 250 volt electrolytic capacitor

C2—8 mfd, 350 volt electrolytic capacitor

SR1, 2, 3—silicon rectifiers (Sarkes-Tarzian K-200 or the equiv.)

D1—silicon diode (1N536)

T1—power transformer, 117 V primary; 125 V secondary (Stancor PS-8415 or equiv.)

M1—0.5 milliammeter (Lafayette TM-401) or any 0.5 ma. miniature panel meter

SW1—DP 3-position rotary switch (Centralab 1472 or equiv.)

SW2—DPDT pushbutton switch (Switchcraft 1006 or equiv.)

Case—aluminum 5"x4"x3" (Minibox CU-3005A)

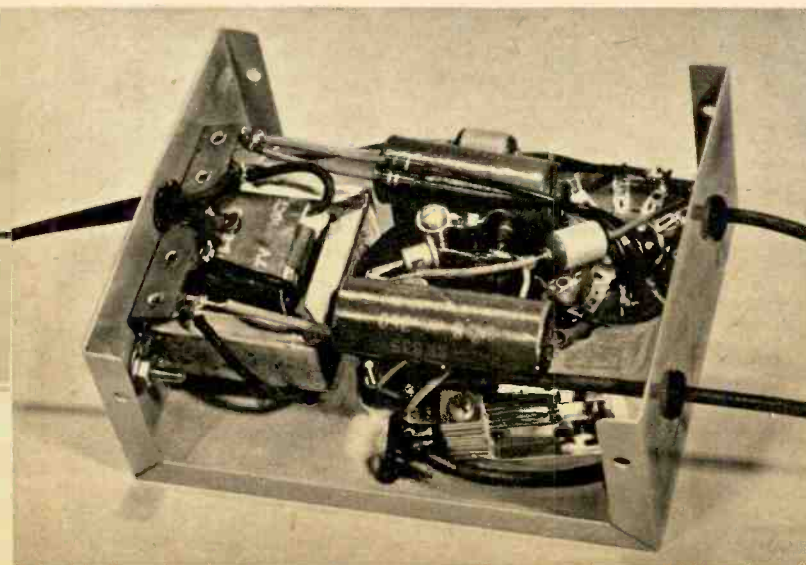

Completed unit with cover removed. Component placement isn't critical and parts may be arranged to suit the dimensions of the cabinet.

current flow to a bit over 4 ma and, very abruptly, additional current is routed through the diode. This meter protection circuit, which has many applications, is fully explained in the March, 1959, issue of *Electronics Illustrated*. SW2 discharges the capacitor being tested through R6 at the conclusion of the test. When testing large high voltage capacitors, pause a moment for this energy to be discharged before grasping the leads.

### Construction

The choice of component values is subject to considerable leeway and many usable parts are probably on hand. The physical arrangement is completely non-critical and the unit may take any convenient form. The one illustrated was built into a 5"x4"x3" miniature cabinet and it could be even smaller with more efficient utilization of the space. Since significant voltages are present, use spaghetti on bare leads and make no connections directly to the metal cabinet. The test leads are terminated in insulated, color-coded alligator

clips to indicate polarity—a very important item.

Open circuit voltages for the three positions of SW1 will be appreciably higher than the indicated 150-300-450. When a capacitor is connected, however, the voltage will fall to approximately the marked values.

### Using The Leakage Tester

To test a capacitor in circuit it's usually necessary to disconnect one lead from the circuit to secure an accurate indication: Connect the test leads carefully, observing correct polarity, and push the test button (SW2). If the capacitor is open—the meter needle will not move; if shorted or leaking excessively, the needle will swing clear over and stay there. Thanks to the protective circuit the meter will not be harmed. If, however, the capacitor is good the needle will swing over and then gradually drop back as the electrolyte reforms and the capacitor charges. All electrolytics will have a certain amount of leakage. Some [Continued on page 108]

## Small Speaker Repairs

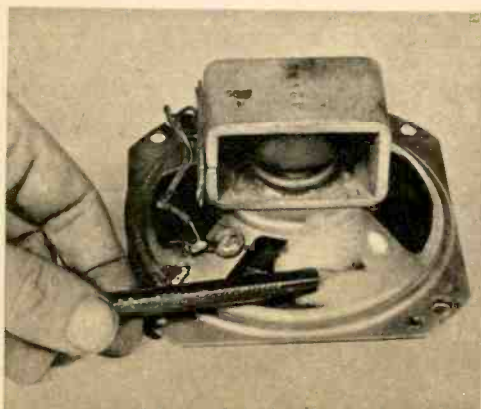

**I**F a rattle or buzz in your AC-DC radio has been traced to an off-center voice coil in the speaker, it's a good idea to try a few repair tricks before replacing the speaker. Make sure that the buzz is not caused by the flexible wire voice coil leads resting against the

speaker cone. Check to see if foreign materials may have lodged either in the voice coil gap or behind the speaker cone in the area around the corrugated voice coil centering support (spider). Try cleaning out the voice coil gap with a piece of Scotch tape.

If none of the above proves helpful, then it may be a straight case of voice coil rubbing due to a slight warp in the speaker frame or voice coil itself. In that case, try applying pressure from the rear of the cone with your fingers on one side or the other while the speaker is playing. Frequently you will find that the buzz can be eliminated with very little loss of quality. It then becomes a simple matter to stuff a small wad of cotton in between the speaker frame and cone at the point where the finger pressure cleared up the trouble. Do not put in so much cotton that the cone is excessively deformed.—Dave Gordon



# Hi-Fi Clinic

Hi-Fi questions are all answered by mail. If of general interest they will appear in this column.

## Output Tube Hum

*I own a kit-built 20 watt amplifier with push-pull 6L6's in its output. After working satisfactorily for about a year, a problem has developed. The output tubes glow blue and a hum comes through the speaker even when the volume control is turned down. I have changed the filter capacitors, but that did not help. How can I cure my problem?*

H. Svensen  
Madison, Wisconsin

You will find two kinds of blue glow in output tubes. Sometimes minerals in the glass envelope of the tube fluoresce under the impact of stray electrons. Very high power tubes will also have a barely visible blue haze in between the elements. However, it is a good bet that one or both of your 6L6's is gassy. Frequently tube checkers will not show this fault, and I would suggest that you try substituting a known good tube or tubes. You might also check to see whether these tubes are balanced. An ordinary tube tester should indicate the same approximate scale reading for both of your output tubes.

## Series or Parallel Speakers

*I intend to mount two full-range 8-ohm speakers in one cabinet. Should I parallel the connections for a total of 4 ohms or would it be best to connect the speakers in series and have a 16-ohm input impedance? My amplifier has both a 4-ohm and a 16-ohm output.*

Michael Koleman  
Binghamton, New York

In general, it's best to parallel the connections in a setup such as yours. Speakers connected in parallel tend to damp out each other's resonant points and produce a smoother over-all sound. Series connected speakers tend to emphasize resonant peaks. However, if the

speakers are a little bit bass shy or your room acoustics are not all they could be, you may find that the bass boost obtained is desirable. I would suggest that you mount the speakers and run the leads from both outside the cabinet. Now you can place the cabinet in the desired position and try both series and parallel connections without having to unseal the cabinet to switch the connections of the wires.

## Stereo Speaker Matching

*I have a large corner horn speaker system and wish to convert it to a stereo system. Space and expense problems make it impossible for me to duplicate my mono speaker. What would be the correct speaker to match it without detracting from the excellent sound I get from my present set-up?*

Thomas W. Comstock  
San Francisco, Calif.

In stereo, speakers should be matched. Naturally, the easiest way to accomplish this is to buy two identical systems. But when this isn't possible, they should be matched as to coloration; that is the frequency response and sound characteristics of the midrange and tweeters should be identical.

The reason for this is in the nature of stereo. The stereo effect largely resides in the mid and high frequencies. Therefore, if one speaker were to peak at 4,000 cps, and other at 5,500 cps, the sound would seem to jump from one speaker to another. If this drifting back and forth was not annoying to you, it would, at least, be very tiring after prolonged listening. You would tend to focus back and forth from speaker to speaker and succumb to listening fatigue.

It is impossible to suggest a speaker specifically for you. Try listening to other speakers as much and as carefully as possible. ●



# Pogo-Stick Ham Antenna

By Howard S. Pyle, W7OE

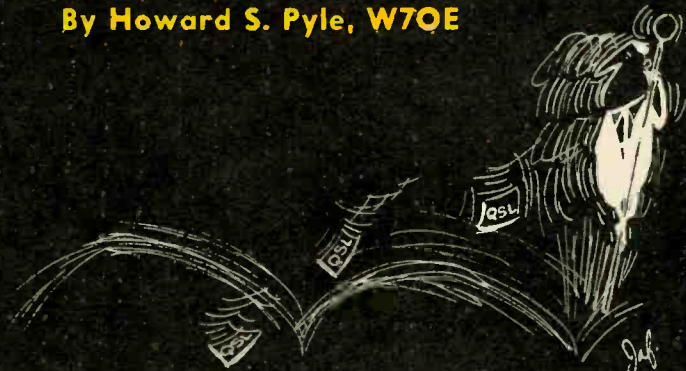

**W**HILE we call this the "Pogo Stick" to which it bears a strong resemblance, the coil at the base is *not* a spring, nor are foot-holds provided for *physical* jumps around the country! If it is properly made and adjusted, you'll jump around all right but it will be through the medium of Hertzian wave radiation!

Much has been written and still appears, on the subject of "restricted space antennas." The apartment dweller, the owner of a small city lot and others who do not have room for a conventional half-wave horizontal wire antenna, face frustration. What to do? Vertical radiators of many types have been tried; some have been successful, others have been cast aside with disappointment.

We will not attempt to theorize on POGO's characteristics, preferring to leave that for the long-bearded gentry, but if you have need for a light weight, easily built and readily erected antenna for 20, 40 or 80 meters, for use at home in a restricted space area or, if you want something you can toss on top of your car and take with you on a Field Day jamboree, POGO is your answer! Maybe you can even hang up DX records on it; I don't know. Working on 80

meter CW within a 1000 mile radius, with 35 watts average input, I get identically the same reports, night after night from the same traffic net stations, that I get when using the 130' horizontal half-wave antenna. Now, let's *build* it!

First of all, drop into your local lumber yard and pick up a 10'-12' length of warp-free and knot-free 2" x 2". Then clamp the pole in a vise and draw a pencil line centered on one side down the entire pole. Make a pencil mark crossing this line three inches from the top, or what *will* be the top of your mast. Your 2" x 2", in finish grade lumber, will actually be 1 5/8" on each face. Now, for drill holes make pencil marks spaced every 1 5/8" until you are within a foot of the opposite end of the mast.

Drill a 1/8" hole at every point where the pencil marks intersect for the length of the mast. Drill all the way through but be sure and hold the drill as nearly vertical as you can so that the holes come through on the opposite side in a reasonably straight line.

When you have finished drilling (I came up with 72 holes in a ten-foot length of wood mast), turn the mast 180 degrees and use a bit of sandpaper to smooth off any splintering which oc-



curred where your drill broke through. (If you back up the mast with scrap lumber while drilling, splintering can be minimized.

Your last hole should be about a foot up from the bottom of the pole. If the lowest frequency you want to use will be in the 75/80 meter band, you'll need about 80 feet of wire on hand. Formulas for half-wave horizontal wire antennas are valueless here as you need appreciably less wire length to reach the half wave point. The wire we used was spunglass insulated, stranded, size 18. Type "TW," No. 14, plastic covered, stranded house wire is also excellent, if you can get it; it's a bit on the rare side though. The *solid* No. 14 "TW" is readily available from any electrical dealer, but may be a little harder to weave through the holes in your mast. Again, let's not be fussy; use what you choose.

If you have a power driven table saw, you can cut two saw kerfs to a depth equal to the outside diameter of the wire you use for the full length of the mast, 180 degrees apart as shown in Fig. 2. This will enable you to flush the wire right into the pole and even fill in the kerf with a mastic compound before you paint it, if you want to go that far in an effort to convince the dubious landlord and the frowning neighbors that you are only a patriotic citizen who has erected a flagpole from which to fly the national emblem when the occasion warrants! If you can't manage a saw groove, don't worry about it.

Start one end of the wire through the last hole at the *bottom* of the mast. Pull enough wire through to insure reaching the other end with about a foot to spare, after weaving through the mast for its entire length. You can easily calculate



Fig. 1. Detail of Pogo's capacity ball at top of mast. Standoff insulator is porcelain type.

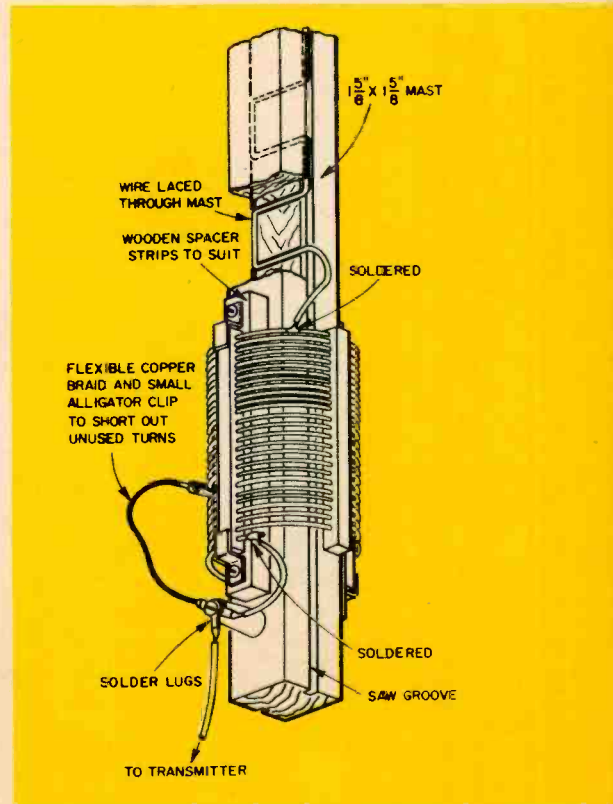

Fig. 2. Cutaway view of mast above loading coil shows lacing which goes up to top ball.

that; if you use a 1½" thick pole, you'll need 4½" of wire for each 1½" you progress toward the top.

Now you have a 'laced' configuration through the entire length of your pole (less 3" at the top and about a foot at the bottom). See Fig. 1. At the top end, mount a stand-off insulator on the end of the pole. A short, sturdy, porcelain glazed type was used. This was 2" long and 1" in diameter with a tapped hole in each end for a standard ¼ x 20 machine screw. A  $\frac{3}{16}$ " hole drilled about 1½" deep in the end of the mast, allowed a 2" long brass machine screw (¼ x 20) with its head sawed off, to be self-threaded into the mast, leaving about a half inch protruding. Smear plenty of glue on the threads before screwing into the mast and the screw will stay put. Now, the copper toilet float ball (standard thread for these is also ¼ x 20) is screwed on to the protruding screw after slipping a suitably sized solder lug over the threads, and then the ball is drawn up tight. Solder the top end of the wire which you laced through the pole to the lug under the ball and then move to the other end of the mast. Mount coil about 1' from the bottom. See Fig. 2.

Actually, that's all there is to it. Many refinements will no doubt occur to you as you progress. Paint the copper ball with gilt or aluminum paint if you like; leave it natural copper or make it red, white and blue to suit your fancy! The

entire mast itself should receive a coat of clear shellac followed by two coats of spar varnish or, if you prefer, exterior paint of any color of your choice. Just be sure that you use a rubber base or similar non-metallic paint on the mast. Lead base paints could foul up the radiation pattern!

Adjusting POGO to resonance isn't at all difficult either. Use a grid-dip meter to find the resonant frequency. By clipping onto the coil at various points, the loading can be adjusted to the frequency you desire. I work mainly between 3520 and 3565 kc, I chose the desired point of resonance as 14,140 kc which would land me right on my chosen main traffic net frequency of 3535 kcs when working 80 meters.

There you have it. Let the theorists screech their heads off and tell us "it won't work" while we practical guys do all right and then some with a simple, cheap and effective little "Pogo Stick." Maybe it won't "bounce" but it *does* push a lot of signal here, there and everywhere. You take it from there!

#### PARTS LIST

Base antenna coil, HY Q C75 (Master Mobile Mounts, Inc.)  
 Copper toilet tank float ball  
 2 Ceramic stand-off insulators  
 No. 18 spun glass hook-up wire, approx. 80 ft. required  
 2"x2" pole, length 10 ft. or more  
 Misc.—Screws, clamps, insulating sleeving, paint or varnish

Fig. 3. Three methods are shown for mounting the Pogo Stick mast. The high Q base coil permits mounting at various heights with excellent results.

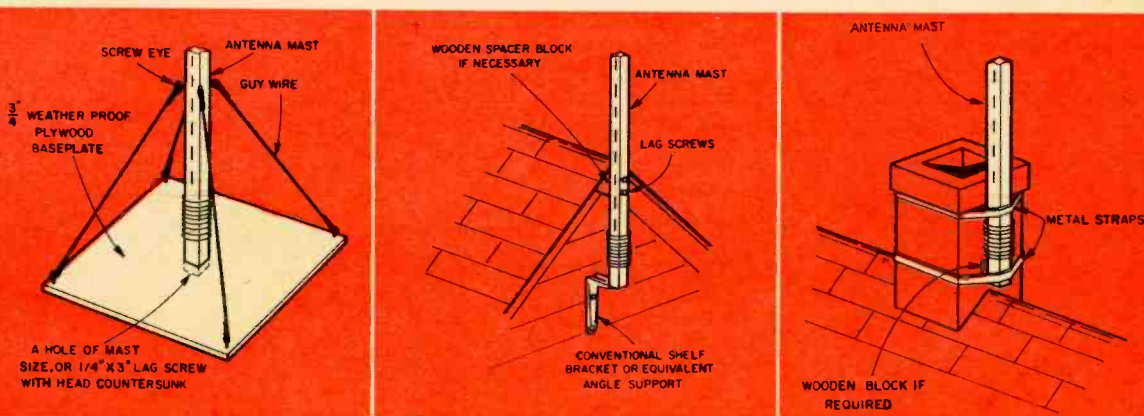





Heinrich Hertz (1857-94) was a German physicist who, in 1886, proved the existence of electromagnetic waves, measured their length and speed and showed that they could be reflected, refracted and polarized like light.



Edwin Armstrong (1890-1954) was an American electrical engineer whose inventions include the regenerative circuit (1912), the superheterodyne circuit (1918), the super-regenerative circuit (1920), FM broadcasting.

## Pioneers on Postage

Experimenters who hit paydirt: Czechoslovakia is spreading their fame far and wide through the mails.



Edouard Branly (1846-1940) was a French physicist who experimented in early reception equipment for wireless telegraphy. Among his inventions was Branly Coherer (1890) which made communication by radio practicable.



Nikola Tesla (1857-1943) was born in Austria-Hungary, but later became an American citizen. He applied the principle of a rotating magnetic field to evolve an induction motor. He also worked on arc lighting, high voltage.



Alexander Popov (1859-1905), Russian inventor, made a "filing coherer" for detecting hertzian waves in 1895. He was also the first person on record to place a wire high in the air as an antenna to trap the hertzian waves.



Guglielmo Marconi (1874-1937) sent the first radio signals across the Atlantic between Poldhu, England and St. Johns, Newfoundland in 1901. His radio inventions include a magnetic detector, horizontal directional antenna.



# milt kiver on Transistor Testing-3

Completing our series—a review  
of various commercial checkers.

**T**HIS final article in this series continues the discussion of commercial transistor checkers. Space limitations have not permitted the inclusion of every make and model now on the market. For further information write directly to the manufacturers.

## Sencore Tester

The Sencore transistor tester, Model TRC4, utilizes the same basic circuitry as the General Electric or Knight-Kit units. However, the approach to gain measurement differs in the way the circuit controls are set up for the test. Consider the simplified circuit shown in Fig. 1. A 6-volt battery and a 3 ma meter are series connected with the emitter-collector elements of the transistor under test. At the same time,  $R_1$  and  $R_2$  provide a suitable current input for the base. This current can be varied by  $R_1$ .

For any given transistor,  $R_1$  should be set so that 1.5 ma of current flows in the collector circuit and, hence, deflects the meter halfway across the scale. In order to reach this objective, Sencore furnishes a chart which indicates the proper setting of  $R_1$  for each transistor type.

On the meter scale itself, there is a broad green area on either side of the center point and if a given transistor produces a reading within this green area, it can be considered acceptable, provided it has successfully passed the previous  $I_{CEO}$  leakage test. If the needle rests on the low side, the beta value of this transistor is too low. A reading above center, of course, indicates a high beta and

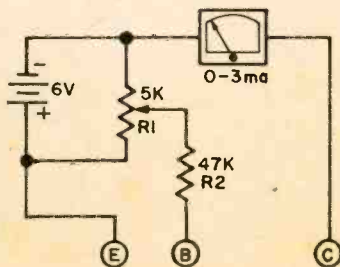

Fig. 1. Sencore varies ( $R_1$ ) to set 1.5 ma in collector circuit.



for most circuits, the higher the better.

The test chart is kept up-to-date by periodic revision by Sencore. In addition, instructions are also furnished for calculating settings for new transistors as they become available.

### EICO Model 666

The Electronic Instrument Company's transistor tester is a part of the model 666 tube checker. See Fig. 2.

### Seco Transistor Checker

The Seco Transistor Checker, Model 100, tests gain by using a regenerative pulse oscillator in which the transistor under test is the active element. See Fig. 3. In operation, the transistor is inserted into the instrument and the feedback control of the oscillator is set to its maximum position. A neon lamp, transformer-coupled to the oscillator, fires if the oscillations have sufficient amplitude, indicating satisfactory operation

of the transistor. The feedback control is then backed off until the neon lamp goes out. The dial setting at which the bulb extinguishes indicates transistor gain. The indication is only qualitative, but it is precise enough for matching transistors.

If the neon lamp fails to fire with the feedback control set for maximum feedback, either the transistor is defective or the wrong polarity is being used. Moving the NPN-PNP switch to the opposite position reverses the battery polarity. Firing of the neon bulb after the switch is moved indicates that the original position was wrong. The instrument is thus an identifier of the type (NPN or PNP) of transistor under test. (The low DC voltage in the circuit causes no harm if the wrong polarity is chosen.)

The unit tests all transistors, including power types. Many experiments have established that the relatively low

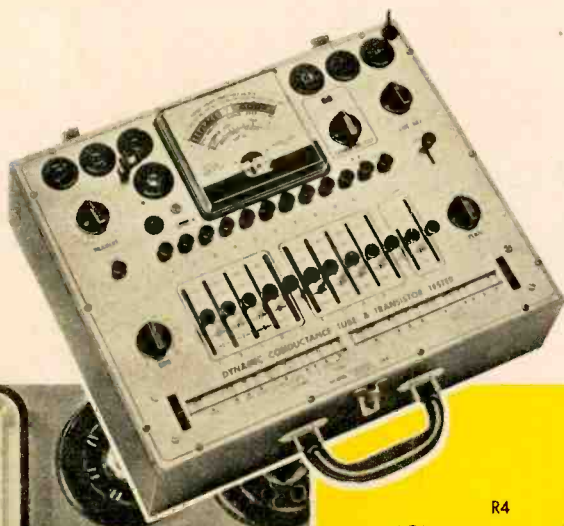

Transistor testing facilities are incorporated in the EICO model 666 tube checker. Fig. 2. Five position switch at upper right applies a DC bias voltage (E) between collector and emitter to test leakage current ( $I_{ce0}$ ), see below. To measure current gain, Beta circuit, right below, notes collector current change caused by change in base current.

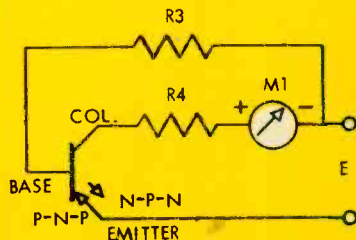
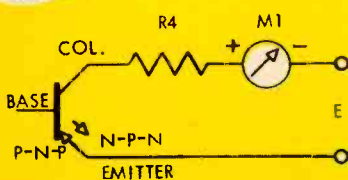
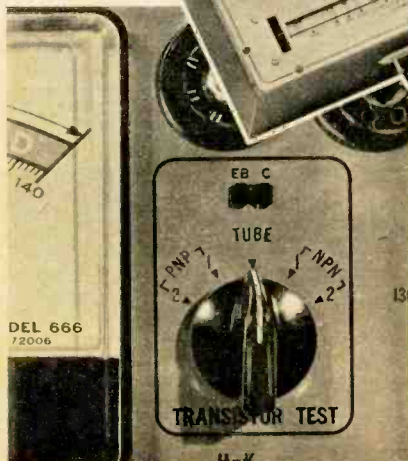

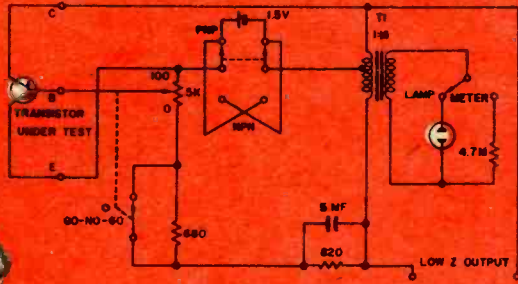
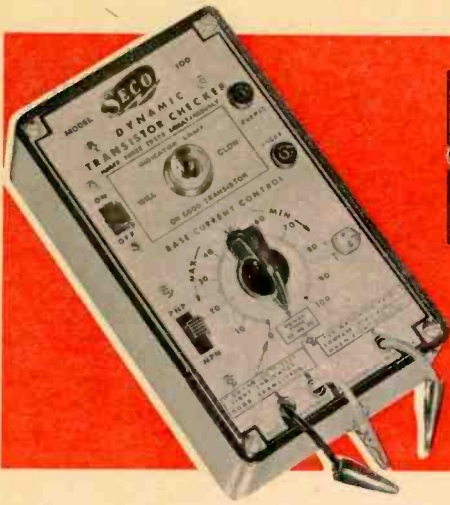



Fig. 3. Seco sets up the transistor under test in a regenerative-type pulse oscillator circuit.

input currents used in the tester produce the same gain indication on power types as higher currents. However, should it be desirable to increase the loading of the power types, a low resistance may be bridged across the output jacks.

The neon bulb fires when circuit cur-

rent exceeds 3.5 ma. In some small signal types, enough current may not be drawn to fire the bulb, even though the circuit is operating. A VTVM or an oscilloscope is then used as an indicator. Alternatively, another battery in series with the collector lead may be used to increase current. 

## Wire Connections Made Easy

**Y**OUR splicing can rival that of the experienced electronics man if you use some of his techniques. Here's a neat splicing trick that requires nothing more than a length of  $\frac{1}{4}$ " spaghetti (insulated tubing) and a little know-how. One problem, that of splicing a line cord onto the primary leads of a transformer, is duck soup when approached properly with this technique.

—Dave Gordon

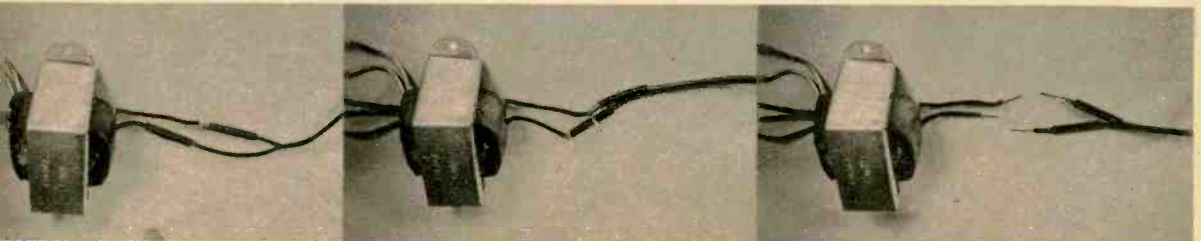

1. Cut one lead of the transformer and one lead of line cord  $\frac{3}{4}$ " longer. Strip  $\frac{1}{2}$ " of lead, slip  $1\frac{1}{2}$ " tubing over wires.

2. Twist the stripped ends of wire tightly together; long line cord lead to short transformer lead, this avoids shorts.

3. Bend the pigtails of wire back against the transformer leads, away from direction tubing will be slid over the wire.



# Electronic Brain

Have you any question on electronics? Send it in and the Electronic Brain will provide the answer.

## Underwater Metal Locator

What modifications would have to be made in the metal locator described in the September 1959 issue of E.I. to permit me to use it under water?

Wilbur Anderson  
Plattsburgh, N. Y.

As the first step, of course, you would have to enclose the entire unit, including the search coil, in a completely water-proof housing of some non-metallic material such as polystyrene or lu-

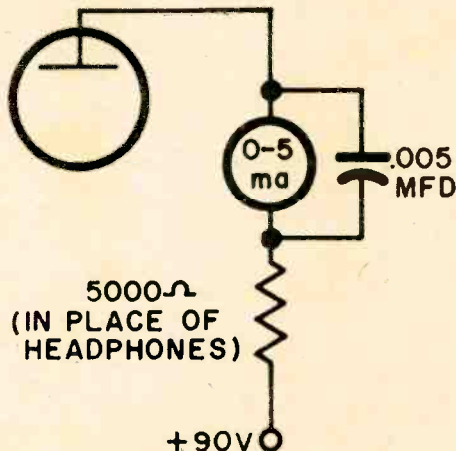

cite. The coil would have to be wound right against the front face of the plastic case so that it can be placed close to objects being tested for metallic content.

You would then have to modify the circuit to accept a meter rather than the headphones. The jack (J1) would be removed and replaced by a 5000 ohm, ½ watt resistor in series with the B+ line to the plate of the 1U4. In the same series line, a 0-5 ma meter would be connected as shown in the accompanying diagram. Using a .005 mfd bypass capacitor across the meter helps to shunt the high audio beat frequencies around the meter coil, thus providing a much sharper change in the meter reading as zero-beat is approached. The meter pro-

vides indications of average value of plate current; this value is quite different for zero-signal conditions as compared with strong-signal conditions.

## Need a Power Transformer?

I recently acquired an audio amplifier consisting of a 6SJ7, two 6V6's in push-pull, and a 5Y3 rectifier. The power transformer is missing, however. What kind of transformer should I use?

H. D. Brown  
Butler, Virginia

The power transformer you need will have four windings: (a) a 6.3 volt filament winding rated at a minimum of 2 amperes. Actually, the tubes will consume a total of 1.2 amperes, but it is best to allow a small margin of safety; (b) a 5.0 volt filament winding for the rectifier tube rated at 2.0 amperes or more; (c) a 120 volt primary winding, normally identified by black leads. The 6.3 volt winding has green leads, and the 5.0 volt coil terminates in yellow leads; (d) a high-voltage secondary winding in the vicinity of 500 volts at 90 milliamperes. This winding should be center-tapped to permit the use of a full-wave rectifier system using the 5Y3 rectifier. A transformer with a higher or lower voltage rating than this—confined to the limits of 20% more or less—can also be used. For example, if the transformer has a rating of 600 volts center-tapped, the voltages applied to the tubes will still not be excessive. If it is found that the 6V6's tend to run too hot, a 500 ohm 10 watt resistor can be connected in series with the present filter resistor or choke to reduce the voltage somewhat. A 400 volt transformer will also operate the amplifier satisfactorily, with slightly less output.

It is important when dealing with hi-fi amplifiers to have the proper B-plus voltage or the wattage output of the amplifier will suffer.

## Strobe Calibration

*I intend to build a stroboscope in the near future. I shall want to adjust the pulse repetition rate to a known frequency between 10 and 20 pulses per second. Can I make this adjustment by observing a rotating shaft with four, six, or eight sides by means of the stroboscope? The shaft will turn at a known speed.*

*Fred F. Davis, Vancouver, Canada*

It would be very difficult to calibrate the stroboscope using a symmetrical shaft of four, six, or eight sides since you could not tell the difference between the sides when the shaft's motion is "frozen" by the stroboscope light.

There is a much easier way to do this. Using a Hurst motor, or something similar, make up a wire arrow as shown in the sketch to rotate at a rate two revolutions per second. Thus, the period of

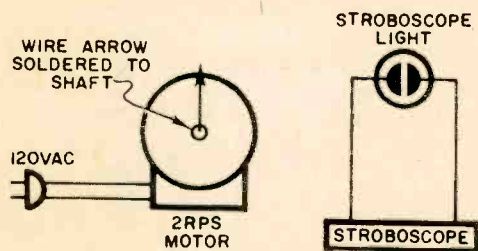

rotation will be  $\frac{1}{2}$  second per revolution.

Now illuminate the wire arrow with the stroboscope adjusted to give a very slow repetition rate. With an adjustment that makes the arrow visible in the same spot each time the strobe flashes, you then know that the repetition rate is 2 per second; if the arrow is seen at "12 o'clock" and "6 o'clock," the repetition rate is 4 per second; thus, the repetition rate is always twice the number of arrows clearly seen in the same spot each time. This will enable you to calibrate the stroboscope from a few cycles per second up to 10 or 30 cycles per second, in steps of 2 cps. For single cycle variations, it would be quite safe to assume that the halfway mark on your control knob between any two "steps-of-two" calibrations would be sufficiently correct. For example, when you have marked off 12 pulses per sec-

ond and 14 pulses per second, the 13 pulse per second adjustment would be very close to half-way between these two.

## Dry Cell Rejuvenation

*Can ordinary zinc-carbon dry cells be rejuvenated or recharged? If so, how long do they last after rejuvenation?*

*Gerhard Hees, Milwaukee, Wis.*

This is a very common question to which many conflicting and incorrect answers have appeared in print. The zinc-carbon cell is a primary cell; as such, its chemistry makes no provision for recharging in the same sense as a lead-acid or nickel-cadmium cell may be recharged. A dry cell may go dead for a variety of reasons and, under certain conditions, may be rejuvenated to extend its life. For example, excessive current drawn through the cell may cause it to polarize and become temporarily inactive. In this case, if it is allowed to stand idle for several days, its own de-polarizing agent (usually manganese dioxide) will restore it to activity once again. In some types of cells, it is possible for the electrolyte (ammonium chloride) to dry out by evaporation; such cells can be given extended life by punching a nail hole in the bottom of the zinc case and sitting the cell in a shallow bath of saturated ammonium chloride for a few days. The hole may then be sealed with wax.

The life of a dry cell may be extended by 20 to 30% by passing a very tiny direct current through it in the reverse direction. That is, a low voltage DC power supply is connected to the cell with the + of the supply going to the + of the cell, and the voltage adjusted so that a few milliamperes flow. Just why this increases the life of the cell is still not well understood since, as mentioned previously, the chemistry of the dry cell does not explain the effect.

In any case, dry cell rejuvenation methods are far from satisfactory. We often wonder whether the results justify the means. A rejuvenated dry cell is apt to give out when least expected since its action is completely unpredictable. Hence, we suggest replacement rather than attempted recharging. 



**For serious-minded men desiring higher income and status-**

CREI has developed a program of home study that is comparable in technological content to advanced residence courses in electronics. The program was developed hand-in-hand with leading companies and Government agencies contributing to the Nation's efforts in electronics, communications, missiles, and space exploration.

This CREI program in Electronics Engineering Technology may be completed in 2 to 4 years, depending on how much of your spare time you can devote to study. The courses are presented in easy-to-understand form. Our instructors will give you personal attention and assist you when you need help.

To qualify CREI graduates for advancement to key technical positions, CREI offers a complete program in electronics, including—

- Automation • Instrumentation • Industrial Electronics
- Aeronautical Electronics • Guided Missiles • Radar
- Servo-mechanisms • Computers • Astronautics • Telemetering • Communications • Electronics Manufacturing • Field Engineering

# A COLLEGE-LEVEL EXTENSION PROGRAM IN ELECTRONICS

There is a drastic need in the electronics industry for well-educated engineers and technical personnel. Although the great majority of students find ample opportunity for advancement with their present companies, CREI maintains a Placement Bureau to assist graduates and advanced students in finding more desirable positions. For many years, the demand for CREI graduates and advanced students has far exceeded the supply.

A few of the private companies and government agencies whose officials approve CREI for their own personnel:

- U. S. Navy (5,240 enrolled in extension program)
- Army, Air Force, Marine Corps, Coast Guard
- Columbia Broadcasting System
- National Broadcasting Company
- Federal Electric Corporation
- Florida Power & Light
- Pan American Airways
- United Airlines
- The Martin Company
- All America Cable & Radio
- Voice of America
- ... and many others

**QUALIFICATIONS FOR CREI.** You qualify if you have a high school diploma or equivalent, and if you have had basic electronic training and practical experience in electronics. Available to Veterans.

**CREI's Extension Division offers you a college-level home study program in electronics comparable in technological content to advanced residence courses.**

**Mail this coupon . . . today!**

**CAPITOL RADIO ENGINEERING INSTITUTE**  
 ECPD Accredited Technical Institute Curricula • Founded 1927  
 Dept. 1708-G, 3224 16th St., N.W., Washington 10, D.C.

Please send me your course outline and FREE 44-Page Book "Insurance for Your Future in the New World of Electronics" . . . describing opportunities and CREI home study courses in Advanced Electronic Engineering Technology.

- Check field of greatest interest**
- Radar, Servo and Computer Engineering Technology
  - Electronic Engineering Technology
  - Communications Engineering Technology
  - Television Engineering Technology
  - Aeronautical Electronic Engineering Technology
  - Automation and Industrial Electronics Engineering Technology

Name \_\_\_\_\_ Age \_\_\_\_\_  
 Street \_\_\_\_\_  
 City \_\_\_\_\_ Zone \_\_\_\_\_ State \_\_\_\_\_  
 Check:  Home Study     Residence School     Korean Veteran



To obtain fast, immediate service and to avoid delay, it is necessary that the following information be filled in:

Employed by \_\_\_\_\_  
 \_\_\_\_\_  
 Type of Present Work \_\_\_\_\_  
 Education: \_\_\_\_\_  
 Years of High School \_\_\_\_\_  
 Other \_\_\_\_\_  
 Electronics Experience \_\_\_\_\_  
 \_\_\_\_\_

Fathometer gets checked out before being installed in yacht, background, by George Butcher, a retired naval officer now in business for himself.



*El's money making careers in electronics*

## **There's Booodle in Boats!**

**By James Joseph**

**Selling, installing, repairing marine electronic gear, from fish-finders to radar, is now big business.**

**N**OT square-knots but square waves can put you at the helm of a career as profitably charted as George E. Butcher's. His Electronics Marine Service, berthed in Newport Beach, Calif., is running full-sail before the greatest boat boom in history.

Boats and electronics can earn you a five-figured annual income . . . and more.

"The 'more,'" grins 50-year-old Butcher, as he adjusts a yacht's fathometer, "might not make dollars or sense to your accountant, but it makes sense aplenty to you."

He means the tang of freshly-caulked oakum, the cant of sea-wet decks underfoot.

Butcher, who retired a lieutenant commander after 28 years in the U. S. Navy, is profitably launched on a second career. Dawn finds him atop a yawl's mast, installing a radar's waveguide antenna (radar's cost: \$3000-\$5000, [Continued on page 107])



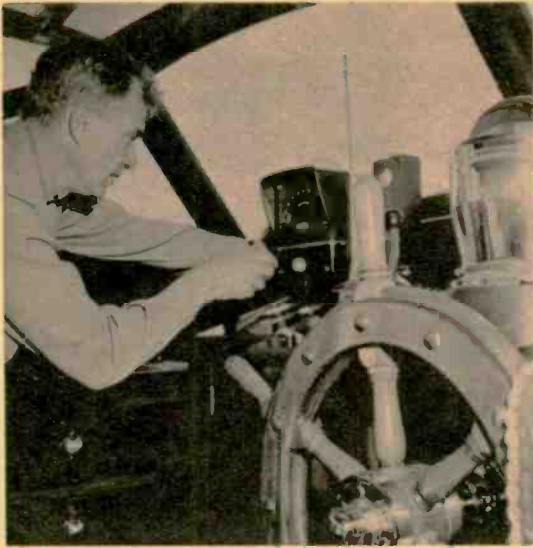

**At left, Butcher tunes up installation on bridge of luxury yacht. Some privately owned ships head seaward rigged with upwards of \$10,000 worth of electronic gear—from transistorized megaphones to radiotelephone. Small craft and their volume business are even more lucrative for the marine electronics specialist. Right, Butcher can walk from shop to berthing slips.**



**This deep-sounding fathometer is due for maintenance and adjustment. Butcher charges a minimum fee of \$6 per hour. In background is Newport Harbor, Calif.**

# FROM HEATH... MORE NEW HOBBY KITS!



AD-10 \$33.95

## STEREO RECORD PLAYER KIT (AD-10)

Made by famous Garrard of England to superb specifications. "Plug-in" cartridge feature. Rubber matted heavy turntable is shock-mounted, and idler wheels retract when turned off to prevent flat spots. Powered by a line-filtered, four-pole induction motor at 16, 33 $\frac{1}{3}$ , 45 and 78 rpm. Supplied with Sonotone STA4-SD ceramic stereo turnover cartridge with .7 mil diamond and 3 mil sapphire styli. Assembles in minutes; mechanism and vinyl covered mounting base pre-assembled, arm pre-wired. With 12" record on table, requires approximately 15" W. x 13" D. x 6" H. Color styled in cocoa brown and beige. 10 lbs.

**Mechanism Only:** Less cartridge, base and cables. Model AD-30. 8 lbs., \$22.95



AA-50 \$79.95

## HI-FI RATED 25/25 WATT STEREO AMPLIFIER-PREAMPLIFIER KIT (AA-50)

A complete 25/25 watt stereo power and control center (50 watts mono) . . . 5 switch-selected inputs for each channel . . . new mixed center speaker output . . . stereo reverse and balance controls . . . special channel separation control . . . separate tone controls for each channel with ganged volume controls . . . all of these deluxe features in a single, compact and handsomely styled unit! Five inputs for each 25 watt channel are provided: stereo channel for magnetic phono cartridge (RIAA equalized); tape head input; three high level auxiliary inputs for tuners, TV, etc. There is also an input for monophonic magnetic phono cartridge, so switched that monophonic records can be played through either or both amplifiers. The automatically mixed center speaker output lets you fill in the "hole-in-the-middle" found in some stereo recordings, or add extra monophonic speakers in other locations. Nearly all of the components are mounted on two circuit boards, simplifying assembly and minimizing possibility of wiring errors. Handsome cabinet features new "visor" effect, with vinyl-clad steel cover in black leather-like texture with gold design. 30 lbs.

AA-20  
\$34.95



AA-30 \$45.95

## ECONOMY PREAMPLIFIER KIT (AA-20)

Although these two new Heathkit models are designed as companion pieces, either one can be used with your present stereo system. The preamplifier (AA-20) features 4 inputs in each stereo channel (RIAA "mag" phono, "xtal" phono, and two auxiliary inputs). A six-position function selector switch gives you instant selection of "Amplifier A" or "Amplifier B" for single channel monophonic; "Monophonic A" or "Monophonic B" for dual channel monophonic using both amplifiers and either preamplifier: "Stereo" and "Stereo Reverse". Self-powered. (AA-20) 8 lbs.

## HI-FI RATED 14/14 WATT BASIC STEREO AMPLIFIER KIT (AA-30)

Two 14-watt high fidelity amplifiers, one for each stereo channel, are packaged in the single, compact, handsomely styled amplifier (AA-30). Suitable for use with any stereo preamplifier or with a pair of monophonic preamplifiers, it features individual channel gain controls, speaker phase reversal switch and convenient pilot light. Output accommodates 4, 8 and 16 ohm speakers. Handsome satin black expanded-metal cover, gold colored chassis. (AA-30) 21 lbs.





## ORDERING INSTRUCTIONS

Fill out the order blank below, giving us your name and address in the space provided at right. Include charges for parcel post according to weights shown. Express orders are shipped delivery charges collect. All prices F.O.B. Benton Harbor, Mich. A 20% deposit is required on all C.O.D. orders. Prices subject to change without notice. Dealers and export prices slightly higher.

QUAN.	ITEM	MODEL NO.	PRICE

Ship via  Parcel Post  Express  C.O.D.  Best Way

## FREE CATALOG

Describes over 150 different and exciting kits in Hi-Fi, Test, Ham Radio, Marine and Hobby fields. Send for yours today!



HEATH COMPANY Benton Harbor 39, Mich.

Please send my free copy of your complete catalog.

NAME \_\_\_\_\_

ADDRESS \_\_\_\_\_

CITY \_\_\_\_\_

ZONE \_\_\_\_\_

STATE \_\_\_\_\_

*first of a series designed to teach the fundamentals of electronics . . .*



EK-1

**\$19.95**

### EDUCATIONAL KIT (EK-1)

Youngsters and oldsters alike will find this kit a priceless introduction into the wonderful world of electronics. Now, at less than the cost of several standard textbooks on the subject, Heath offers a complete basic electricity course, resulting in a finished test instrument of a thousand and one uses. The EK-1 is a combination kit and text-workbook designed to teach the principles of voltage, current, and resistance—the basic “yardsticks” of electronics to students of junior high level. Adults also will find the project beneficial as a beginning or refresher course in electronics. When finished with the project the student will have learned the theory and construction of direct current series and parallel circuits, voltmeter, ammeter and ohmmeter circuits and the application of ohms law to these circuits. The completed meter will then be used to verify ohms law and the maximum power transfer theorem, one of the most important theorems in electronics. The finished kit, a practical volt-ohm-milliammeter, may be used to make measurements of voltage, current and resistance in a wide variety of applications.

Procedures for checking home appliances and automobile circuits are included with the kit. The EK-1 will serve as a prerequisite to following Heathkit Educational Kits. Get started NOW in this new and exciting series. 4 lbs.

XR-2P  
**\$29.95**  
(6 lbs.)



XR-2L

**\$34.95**

(7 lbs.)

### 6-TRANSISTOR PORTABLE RADIO KIT (XR-2 series)

Dependable portable entertainment wherever you are—wherever you go! Choose the gleaming, two-tone molded plastic model or the handsome simulated leather-and-plastic combination—both feature a gracefully curved grille in smart heige plastic. The XR-2P complements the handsome grille with a mocha colored case of high-impact plastic, while the XR-2L encases the grille in sun tan color Sur-o-Lon simulated leather. Vernier tuning control gives you smooth, precise station selection. Six Texas Instrument transistors are used for quality performance and long life; a large 4" x 6" PM speaker provides “big set” richness of tone. Ready to play after simple assembly—transformers prealigned. Six flashlight batteries used for power (500-1000 hrs.) (batteries not included).

HW-19 (10 meter)

HW-29 (6 meter)

**\$39.95**



### 10 & 6 METER TRANSCEIVER KITS

Complete ham facilities at low cost! Ideal for beginning and veteran hams for “local” net operations. Transmitter and receiver are combined in one easy-to-use instrument. Features neat, modern styling, press-to-talk transmit/receive switch, built-in AC power supply, variable gain control and built-in amplifier metering jack. Operates mobile using vibrator power supply. Microphone and two power cables included. Styled in mocha and beige. Less crystal. 10 lbs.

Vibrator Power Supplies: VP-1-6 (6v.), VP-1-12 (12v.). 4 lbs. kit; **\$8.95 ea.** Wired; **\$12.95 ea.**

**ORDER DIRECT BY MAIL OR SEE YOUR HEATHKIT DEALER\***

\*The convenience of Local Heathkit Sales and Service costs but a few dollars more.

# Skyways of the Future

Continued from page 43

enters the data into the computer via the FLIDEN (Flight Data Entry) console. If the plan comes over the teletype, it is automatically coded and entered into the central computer. The computer stores the data on its file drums, makes all necessary calculations, then activates punch-print units at various consoles to print out "hard copy" flight strips for controllers' use.

The flight strips are placed in holders in a rack at each console position. As the flight moves along and the aircraft makes position reports, the new data is fed into the computer by means of a keyboard device at a sector controller's console. This new information updates the appropriate flight strips throughout the entire system. In the course of a flight, a controller at the "Conflict Display" can tell whether the progress of the flight will lead to a position-conflict with another aircraft and can then make suggested alterations in the flight plan according to information obtained from the computer. Any such change in the flight plan causes another up-dating in all flight strips at all console positions.

At the terminal point of the flight, control is routed to the Local Control Console, where flight strips are displayed via the high-resolution TV system. Upon touch-down, control is turned over to the Ground Control Console and the flight plan terminated and erased from the computer's memory file.

## Communications

If automation of the air traffic control system is a vital need today, the same holds true for airways communications. "Clutter" on aircraft voice communications channels can be catastrophic.

In an attempt to ease the situation, the FAA awarded a study contract to RCA, the result being an experimental rapid Automatic Ground-Air Communications System (AGACS, pronounced "Ajax"). Currently under evaluation at NAFEC, AGACS uses a solid-state multiplexer to modulate UHF or VHF signals. Information from aircraft-to-ground and ground-to-aircraft can be exchanged through pre-determined message units supplemented by 4-digit numerals.

Here's how AGACS works: Routine flight instructions and advisory information from the air traffic controller are translated into pulse trains and transmitted sequentially to a particular aircraft where

the pulses are converted into a direct-reading display for the pilot. When the aircraft is interrogated from the ground by other pulses, pilot-initiated routine information is similarly translated into pulses and transmitted to the ground where the data is also converted to a direct-reading display for the ground-bound controller.

The present system has a capacity of 500 aircraft. With a basic message-handling capacity of 750 "bits" of information per second, all 500 aircraft may be interrogated and processed within two minutes.

Emergency messages can get through by a voice over-ride capability, but most significant, all automatic transmissions are accomplished over a single-frequency channel. It is obvious that, with its 500-aircraft capacity using only one channel, AGACS bids fair to greatly simplify air-ground communications.

The theory behind AGACS is "don't call us; we'll call you." That is, the controller initiates all routine communications. With a system based on the AGACS concept, the entire United States could be serviced by about nine channels, whereas it now takes about 25 channels to handle the New York area alone.

Test flights have been made at NAFEC using AGACS as the communications link. In one such flight, a 45-minute flight plan was followed during which a Grumman Gulfstream was kept on a pre-determined flight pattern solely by means of AGACS. No voice communications were used.

AGACS could be tied into the Data Processing Central. The automatically-transmitted routine messages coming from pilot to controller would be directly tied into the DPC computer and used to update an aircraft's flight progress strips throughout the DPC system.

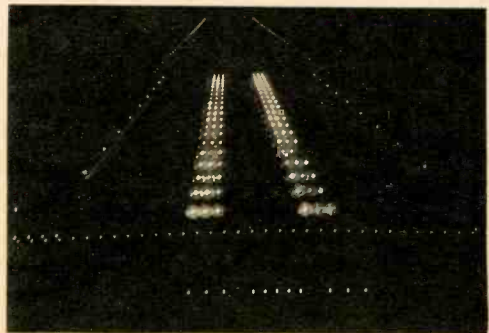

Runway light systems under tests by FAA.



## Dynamic ATC Simulators

One of the difficulties related to solving ATC problems is recreating the complexities and constantly changing patterns of dense air traffic in order to study bottlenecks and devise solutions.

Aircraft Armaments, Inc., under contract to FAA, has solved this problem with an electronic ATC simulator, recently installed and commissioned at NAFEC. The simulator has four basic elements: air target generators, radar simulators, communications, and data collection and reduction elements. The 48 target generators are operated by "pilots" who manipulate their "aircraft" (spots of light projected against airways charts on a small screen) in accordance with a pre-arranged flight plan, which is altered by a controller's instructions. The outputs of the target generators feed the radar simulators which transform the target position-data into a radar-type information which is fed to the controllers' displays.

### Radar

Since the end of World War II, radar in many forms has become one of the major tools of air traffic control. In its current efforts to modernize our ATC system, the FAA is installing increasing numbers of long-range en route radars and terminal radars throughout the country.

One sophisticated radar system under test at NAFEC is the Air Height Surveillance Radar, which is designed to provide a three dimensional display of aircraft in terminal areas, for use in conjunction with sequencing and other display aspects of the Data Processing Central.

Another, the FPN-34, has a range of about 120 miles on small targets—nearly double that of current terminal radar systems. Moving target indication (MTI) circuitry enables moving targets, even those returning a weak signal, to be clearly seen, while ground clutter disappears. Because the FPN-34 operates in a relatively low frequency (1280 to 1350 mc; L-band), weather clutter that normally obscures targets is greatly reduced.

### Automatic Landing Systems

In poor weather and low visibility, an airport's ability to accept planes for landing is seriously impaired. Aircraft are "stacked" in holding patterns above terminal area . . . a situation very wasteful of time and fuel and somewhat dangerous to boot. With jets, which consume fuel at fantastic rates, the stacking problem becomes acute.

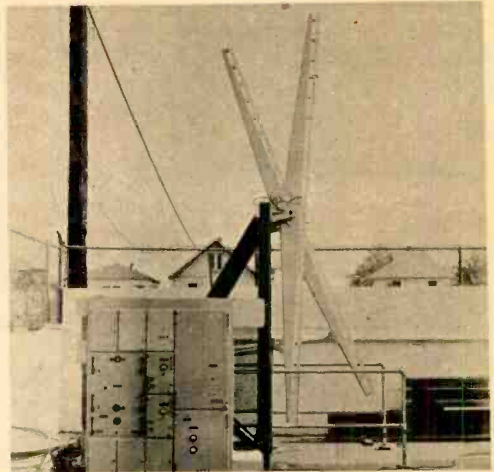

Narrow beam radar for automatic landing.

There are two basic philosophies that can be applied to an all-weather automatic landing system (ALS). One states that a ground-based system should, at a given point, take complete control of a particular aircraft and bring it automatically down to the ground. Such a system could handle a limited number of planes at a time.

The other philosophy is to develop a system which would create a "path" in space, a guided road down which any plane could be taken safely and surely, at its pilot's discretion, either by the pilot or by an autopilot. At NAFEC, tests are being run on systems based on both philosophies.

The first-mentioned approach used precision radar to track an airplane while radio transmits control instructions to the plane's autopilot. With a dual-radar setup, the system (Bell GSN-5) can handle two aircraft per minute.

A conical-scan radar locks onto an inbound plane and passes position data to a ground-based computer. The computer has been programmed with the *best landing path* of each type of aircraft. During the approach, the radar transmits position data to the computer, the computer seeks any deviations from the programmed "best" flight path, and sends corrective impulses back to the aircraft's autopilot by radio. The pilot keeps hands off the controls right down to the ground.

The Bell system offers certain obvious advantages. No special gear need be installed in the aircraft, since it functions with the standard ILS and autopilot. Also, as a built-in safety factor, the system can give a plane an automatic "wave-off" if a second plane is in danger of overtaking the first in a landing sequence.

The other design philosophy for an ALS is currently represented at NAFEC by a system known as REGAL (Range, Elevation Guidance, Approach, Landing). This is a strictly experimental system developed by Gilfillan, Los Angeles.

REGAL allows each plane to independently derive its own position information based on a ground reference signal source. The system uses a narrow beam radar which scans from a 20-degree vertical angle down to the horizon about five times each second. Every one-tenth of a degree, the beam elevation angle is transmitted to a special transceiver in the aircraft. The airborne unit, in turn, sends a pair of pulses which cause the ground transmitter to reply. By measuring the time interval between transmissions and reception of the ground reply, the airborne unit can determine the distance to the runway by converting time and speed into distance.

The REGAL system lets the pilot choose his own approach angle, flareout path, etc., or gives him the option of hooking into the autopilot and letting it take him down. Its airborne electronic unit occupies less than one-half cu. ft. and weighs less than 15 pounds.

### Airborne Electronic Navigation

For the past few years, a nationwide network of VOR's (VHF Omnidirectional Ranges) has been supplanting an older system of low-frequency ranges that had been the country's air-navigational standby for decades. The International Civil Aviation Organization (ICAO) recently selected a VOR-based system known as VORTAC to be the worldwide navigation standard. VORTACs are now being phased into the civil airways system throughout the U. S.

A problem that has always plagued the VOR systems is that of finding suitable transmitter sites. For navigational purposes, it is desirable that the transmitter be as close as possible to a main terminal airport. However, it often occurs that natural or man-made obstacles (trees, hills, buildings, etc.) cause reflection problems at the most desirable locations. Reflections cause "bends" and scalloping of the VOR signals, creating significant problems of accuracy in navigation.

The recent development of a doppler VOR system appears to be the most promising solution to the problem. The doppler VOR creates an effect in the received signal similar to the doppler effect normally associated with sound. The VOR's doppler effect is the result of relative motion of one

of two sources of radiation coming from a ground station and is accomplished by successively feeding each of 50 VHF horizontal loop antennas located at the ground station on the periphery of a circle 45 feet in diameter.

With doppler VOR, "scalloping" errors due to reflection were reduced seven-fold. The doppler system is completely compatible with present airborne receiving equipment and no modifications would be necessary to receivers.

### Collision Avoidance Systems

So far, no single in-flight collision avoidance system (CAS) has emerged capable of doing the job. Some have been based on radar, others on infrared detectors. Some attempt a relatively complete solution while others try merely to give simple proximity warning indication. Bendix has been working for some time on a CAS using a ground-reflection technique. Sperry is working on a proximity warning device, but neither has been thoroughly evaluated as yet at NAFEC.

### Bomb Detection

The phrase "mad bomber" has come to have a particularly ominous ring to the flying public. In recent months, a number of United States air accidents have been attributed to bombs brought aboard airlines by passengers with a suicidal bent. In the total aviation picture, these bombing incidents have been negligible, but in the public's mind, the need for bomb detection looms dramatically large.

The FAA has adopted a surprisingly close-mouthed attitude about any work being pursued in this direction. However, the Air Transport Association (representing the nation's schedule air carriers) has undertaken its own study program in this field. Discovering that no one person or agency has the vast range of knowledge to deal with every type of explosive or bomb that might be used, the ATA has hired the Standard Research Institute to carry out an exhaustive study of the subject. The FAA is maintaining close liaison with the ATA's Working Group on Bomb Detection.

As our air traffic control system evolves from its present inadequate status to a more sophisticated system, and as more and faster aircraft fill our nation's skies, NAFEC's job will increase in scope and importance. It promises to be one of our most valuable tools in the complex job of making air travel more efficient, economical, and above all, safer.





from stand



to hand . . . instantly



introducing the  
world's smallest  
cardioid dynamic  
microphone

**UNIDYNE III**

by

**SHURE**

**\$50<sup>00</sup>**

Professional Net

EVERYTHING YOU WANT IN A  
QUALITY CARDIOID MICROPHONE  
. . . AND THEN SOME!

Compact size . . . modern design . . .  
wide response . . . superior feedback  
suppression . . . uniform cardioid pat-  
tern . . . ruggedness . . . reliability; you  
name it, SHURE has designed it into  
the dramatic new Unidyne III.

50% SMALLER — Less than 6" x 1 1/4",  
0.6 lb.!

PERFECTION IN PERFORMANCE— moving  
coil design with truly uniform cardioid  
pick-up pattern. Response: 50 to 15,000  
cps. Up to 75% greater distances from  
sound source. Impressive feedback sup-  
pression.

MAXIMUM VERSATILITY — unobtrusive  
size, dual impedance, light weight, in-  
stant change from stand to hand, and  
wide-range response make it ideal for  
faithful reproduction of voice or music,  
indoors or out, for P.A., tape recording  
. . . anywhere fine quality is required.

RUGGED AND RELIABLE — Famous  
SHURE quality. Takes 6-foot drop-  
tests and still performs according to  
specifications!

Literature available:

SHURE BROTHERS, INC.  
222 Hartrey Ave., Evanston, Ill.

## A Lie Detector

Continued from page 35

complicated, but it pays off in results.

### Calibration

Before using the lie detector you must calibrate it so that indicator (PL1) does not react until there is a 5% decrease in resistance between electrode terminals J1, J2. To do this connect a 100,000-ohm, 5% resistor between J1 and J2. Turn the de-

tector on and adjust balance pot R3 to the point where relay RY1 just closes and turns the lamp on. Without disturbing the setting of R3, switch the instrument off and connect a 5000-ohm, 5% resistor in series with the 100,000-ohm resistor between J1 and J2. Now switch on and note the meter reading, for this is the calibration point to which you must balance out the subject's normal skin resistance. Once the balance is set at this reading, a 5% decrease in the G.S.R. will turn on the lamp.

To use the lie detector, simply clamp the electrodes to each palm of the subject as

### How a Lie Detector Works

When a conscious attempt at deception is made, you create within yourself an emotional or tension state; which shows up as an increased activation level of the autonomic nervous system. That sounds like quite a complicated mouthful. Well, let's break it down and simplify it so that those of us who are not psychologists will know what it is all about.

The autonomic nervous system is that part of our nervous system over which we have no voluntary control. It operates like a large complex self-regulating computer; its sole purpose is to keep us alive. Completely without direction from our conscious mind, it coordinates, regulates and controls the heart, breathing, body temperature, perspiration, skin resistance, digestion and about fifty other body functions which are necessary for our normal, healthy well-being. It is obvious that this system must always be operating at least at a minimum level—or minimum activation level, as the scientist would call it—or we would stop functioning.

The operating level of this system depends upon the stimuli or data which are continuously pouring in at the autonomic control center in the brain. This data originates not only from various areas inside the body, but also from the external environment. For example, when we are confronted by a situation which threatens our well-being, we experience a set of psychological and physiological changes which are

called "fear." If you can stop and analyze the various sensations, such as pounding heart, extreme alertness, increase in perspiration—to mention a few—you'll see that your body has, in effect, shifted into high gear. You are prepared to react instantly and strongly to any threatening factors in the environment. In a similar fashion, all emotions and tensions are protective mechanisms resulting from increased activation of the autonomic nervous system.

This brings us back to the case in point, lie detection. As has been mentioned previously, conscious deception results in internal tension or increased autonomic activation resulting in physiological changes. In this case, the changes are usually very subtle and not readily apparent to the observer. The lie detector is a sensitive device for detecting these minute changes.

The Keeler polygraph is the lie detector used by most of our law enforcement agencies today. It is essentially an ink-writing instrument which records breathing, fluctuations in blood pressure and associative reaction time. These changes in physiological response are all written out side by side on a long chart. Of course, the device won't ring a bell or laugh sardonically when the person being quizzed strays from the straight and narrow, but the polygraph will, in the hands of a trained person, provide a real indication whenever the subject feels he is faced with a "hot potato" question.



**BEST  
ELECTRONICS  
PROJECTS...**

**BEST  
ELECTRONICS  
FEATURES...**

**BEST  
BUY  
EI\***

Mail to  
**ELECTRONICS ILLUSTRATED**  
Circulation Dept.  
Fawcett Building, Greenwich, Conn.

**ONE YEAR \$4.00**       **TWO YEARS \$7.00**

In U. S., possessions and Canada. All other countries \$6.00 per year

NAME \_\_\_\_\_  
ADDRESS \_\_\_\_\_  
CITY \_\_\_\_\_ ZONE \_\_\_\_\_ STATE \_\_\_\_\_

**\*ELECTRONICS ILLUSTRATED**

Get Your Subscription in the Mail Today

August, 1960

## All About Strain Gages

Continued from page 63

the gage member goes up or down with respect to  $R_2$ .

After initial null balancing, a circuit of this kind is extremely sensitive and tiny changes in gage resistance can be detected. A problem in design of a strain gage enters when you consider that resistance changes not only as a result of mechanical strains, but also as a result of temperature changes. When a strain gage is used to test the dimensional stability of a turbine rotor, it might undergo a resistance change as a result of a temperature increase rather than the result of a dimensional instability.

In order to overcome the temperature sensitivity of a strain gage, a variation of the Wheatstone bridge is used in which two strain gages are employed, one in each leg of the bridge circuit. One of the gages is mounted on the material to be tested, while the other gage is mounted on another unstressed piece of the same material. The two gages are located in identical environments so that both are subjected to essentially the same temperature. If both gages feel the same temperature changes, they will reflect the same resistance changes as a result of temperature and the Wheatstone bridge remains balanced. As soon as the material being tested exhibits any stress, the first gage will indicate a corresponding change in resistance while the dummy gage will not. The bridge becomes unbalanced and a reading can be taken.

With the ever-increasing use of devices operating at fantastic speeds in extremely severe environments—such as a rocket re-entering the earth's atmosphere the simple, yet sophisticated strain gage will be a valuable ally. —

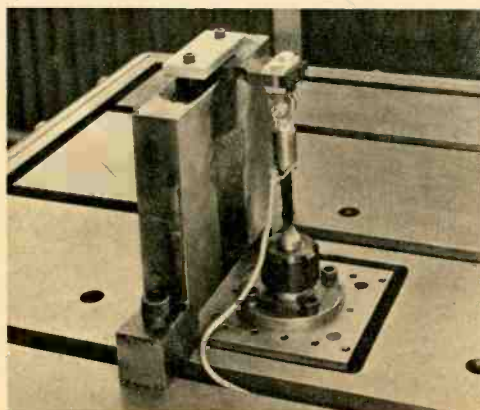

Fatigue test on metal part; gage is under tape.

shown. It is of the greatest importance that the subject's hands be clean and dry. Adjust  $R_3$  until the calibration reading is indicated by the meter. Ask the subject to keep his hands as motionless as possible. After a little practice you will be able to keep the meter adjusted to the calibration point despite the constant small variations.

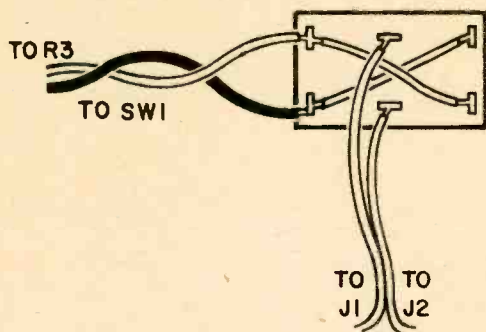

Shown is an additional switch for reversing the electrical polarity of the electrodes.

The normal variations of G.S.R. are relatively slow when compared to the rapid decrease which occurs when telling a lie. With a little experience you will instantly recognize the difference.

If the detector seems to become unreliable, or suddenly lacks sensitivity, try exchanging the terminal connections of the hand electrodes. Put the electrode wire going to J1 to J2 and vice-versa. If desired, a polarity reversing switch (SW2) may be installed as shown between J1 and SW1 and between J2 and R3.

Your questioning technique can mean success or failure in detecting deception. First tell your subject to relax, as a matter of fact, let it slip that he may fool the detector if he is relaxed as possible when telling a lie. This little trick of negative psychology usually causes the subject to try so hard not to react to telling a lie that he actually reacts far more strongly. Build up tension by asking all sorts of unimportant questions and then spring the important ones. —

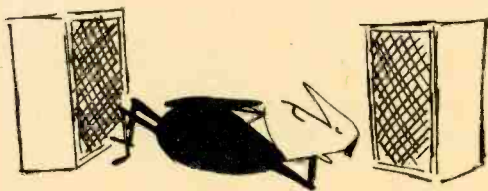



## There's Boodle in Boats!

Continued from page 97

20% of it Butcher's profit). By noon, he's under sail on a shakedown cruise calculated to test a fathometer (any of a dozen models priced \$125-\$3500). By late afternoon he's beached, so to speak, in his one-man seaside shop (its 800 square feet crammed with electronic test gear).

As a career skipper, Butcher knows the electronic "Rules of the Road": the right radio direction finder for the neophyte skipper who seldom cruises more than 50 miles offshore; the fathometer (a recorder-graph model) suited for commercial tuna clippers; the radiotelephone calculated to keep a yachting corporate executive in contact with his shore-based business.

Though Butcher, electronically speaking, has been at the helm only five years (he set up business in 1955 with a few thousand dollars), he's seen plenty of changes.

"Big and fancy boats used to be your only electronic clients," he muses. "Nowadays, a fellow is liable to tow his little outboard skiff to your shop and tell you to install one of those new, low-cost fish-finding fathometers."

Electronic marine gear, once price-tagged beyond reach of the little-boat owner, now fits almost any boat and its skipper's budget.

"Way I figure it," says Butcher, "every one of the U. S.' more than 7,800,000 boats, berthed in salt water and fresh, are electronic potentials."

Butcher, an authorized Raytheon marine-electronics dealer, serves them all, installing spanking new navigational gear and repairing the old. His service charge is a minimum of \$6 hourly.

For the weekend angler he stocks a compact, transistorized, battery-powered fish-finder whose ultrasonic beam ranges down to 120 feet and carries a budget price-tag: \$125.

For \$299.50 he'll outfit a sailboat (whether a 15-footer or a class racer) with a "Ranger" radio direction finder, its battery-run receiver and loop antenna pin-pointing shore stations and showing the way through the thickest of fogs.

"And there's not a gas-engined boat afloat," enthuses Butcher, "that's not a prospect for a low-cost life-saver—a solar-celled fume detector that's priced less than \$100, yet sniffs out dangerous gasoline fumes, then flashes an alarm to alert the skipper."

Butcher, an old-hand to brine but a relative newcomer to business, last year racked up better than \$80,000 in sales and service (sales represented 80% of his gross), and netted himself about \$12,000.

He stood, moreover, single-handedly at the helm of his own career, backed only by some \$750-worth of electronic ship-mates, among them an RF signal generator (9.5 kc to 50 mc) for trouble-shooting marine radios (cost: about \$175 surplus); a frequency meter (125 kc to 20,000 kc), also purchased surplus for \$60-\$70; a Heath-kit Q-meter, essential for measuring the Q of coils subjected to moisture.

Butcher—as can you—launched his seaside career with about \$3000. Initially, he invested \$500 in test gear (much of it shop-built or picked up from government surplus). Most of the remainder went to stock his small but busy retail sales room, which displays a dozen types of electronic gear, from fathometers to transistorized megaphones.

Even though boats are booming everywhere along salt water and fresh, economic barometer-watchers predict an even more explosive boom to come. Butcher's shop is nestled among the 8000 boats berthed in bustling Newport harbor, but opportunity lurks everywhere along our waterways. You can, in fact, all but name your career beachhead. There are more than 1100 yacht clubs and some 3900 marinas and boatyards spread from Maine to Alaska, plus more than 5000 small craft launching sites, many of them catering to fresh water skippers.

Nowadays marine electronics is a year-around business, bustling in winter when boatmen gird electronically for the summer sailing season.

To cash in on boats, you've got to know your electronics. Butcher learned his in the Navy and through correspondence courses. Also, you need at least a 2nd FCC Class Radiotelephone license. Then, too, you've got to speak the lingo of boatmen.

The FCC license permits you to install and tune marine transmitters, radiotelephones. Your license must have a ship's radar endorsement to work on radar.

As for the lingo? "Boatmen," says Butcher, "expect you, the electronic skipper, to have a feel for their problems, and it helps if you've helmed your own boat."

Ironically, Butcher owns no boat. Sheepishly, too, he admits that even after 28 years in the Navy, he still gets seasick. With it all, his seaside cash register has been ringing up an astounding gross. Recently, he installed a 70' luxury cruiser with no less than \$10,000 worth of elec-

# SOUTHERN TECHNICAL ELECTRONIC SCHOOL

**NOW OFFERS CORRESPONDENCE  
AS WELL AS RESIDENCE  
TRAINING IN ELECTRONICS**

Learn Radio and Television or Radio-communications at home and receive standard commercial electronics test-equipment to enable you to start a full-size Radio-Television service business. Pay-As-You go plan eliminates time-payment contracts. No salesman will call. Courses include test-equipment, lesson material, standard textbooks, experiment parts, and counseling service.

**WRITE NOW—FREE INFORMATION**

## SOUTHERN TECHNICAL ELECTRONIC SCHOOL

3806 West Gray St., Tampa 9, Florida

## New "Mechanical Educator" to IMPROVE MEMORY

Inability to recall names, places, facts quickly is a common, often costly, shortcoming that can now be easily overcome with the aid of a new device for mental training. This versatile new educational tool can also be used effectively in language learning, speech correction and improvement, in mastering tables, formulae—anything to be memorized—faster than ever while you sleep.

### DORMIPHONE Memory Trainer

Works for you—You learn while you sleep

- Speeds up learning processes
- Aids concentration
- Provides entertainment

Using a new recording principle, the Memory Trainer records, instantly plays back, and automatically repeats speech, music, or any spoken or broadcast material by clock control. No reels of tape to snarl or rewind. Completely portable. Ideal aid for home, school, industrial safety training use. So simple to use, children benefit—so helpful and practical, it is used by educators, psychologists, people of all ages and professions.

#### SELF-CONTAINED RECORDING CARTRIDGES

from 30 seconds to 55 minutes. Easily removed. Can be stored or "erased" instantly and re-used repeatedly. Just record, flip a switch for play-back and listen!

Write TODAY for FREE folder with complete information. Modernophone, Inc., 367-080 Radio City, New York 20, N. Y.



**MODERNOPHONE, INC.** Circle 7-0830  
367-080 Radio City, New York 20, N. Y.

Gentlemen: Please send me your FREE Booklet. I am interested in finding out all about Scientific Sleep Learning and what the Dormiphone Memory Trainer can do for me. No obligation—no salesman will call.

Name \_\_\_\_\_  
Address \_\_\_\_\_  
City \_\_\_\_\_ Zone \_\_\_\_\_ State \_\_\_\_\_  
My main interest in the Memory Trainer is for:

<input type="checkbox"/> Language Learning	<input type="checkbox"/> Speech Improvement
<input type="checkbox"/> Memorization	<input type="checkbox"/> School or College Work
<input type="checkbox"/> Sleep Learning	<input type="checkbox"/> Bridge Rules

tronics (and pocketed about \$3000 as profit). Typically, the yacht's owner ordered a 32-mile range radar (cost: \$5000); a \$2500 high-seas radiotelephone (150 watt input, 11 crystal-controlled channels, range up to 3000 miles); an extended-depth fathometer (cost: about \$560); a transistorized direction finder (price: \$300); and a dozen other navigational aids.

"Before I was through," says Butcher, "I'd even rigged the yacht's life boats with radiotelephones and with radar targets—reflectors which help radar locate small boats."

Such big installations don't come overnight, neither for you nor for marine old-hands like George Butcher. Nor are they essential to career success.

"Small jobs—\$125-\$300 installations—are the ones that add up to a year-end bonanza from boats," says one marine expert.

## Electrolytic Capacitor Checker

Continued from page 84

types, such as those designed for photo-flash use, may leak only 1 ma or less at rated voltage. Most electros, for conventional use, will leak 2 or 3 ma and still perform satisfactorily.

If the capacitor has been long unused, or if it is of high capacitance, it may take a minute or more for the leakage current to stabilize. When trouble-shooting recently used equipment, however, a reliable reading is quickly secured.

The application will determine the amount of leakage which can be tolerated. A power supply filter capacitor may leak 3.5 to 4 ma and still not overheat or significantly pull down the output voltage although this high a value usually signifies trouble ahead. A bypass capacitor, with this leakage, would show up in poor performance. Most good capacitors will fall in the 2-3 ma range.

Always make the test at the rated voltage of the capacitor or at the operating voltage if this is smaller. Watch the meter to be sure that after easing back to two or three ma it doesn't suddenly swing full scale—an indication of electrolyte breakdown. Remember that while the test is being conducted there is quite a bit of voltage on the capacitor and give it time to discharge after the test button is released.

This tester can be used for the larger non-electrolytics but, since the meter is incapable of measuring very small leakage, it will only identify opens and shorts.



## Weather at Sea

Continued from page 50

gize the power for all circuits for a three-minute period once each six hours.

The program timer and element selector consists of a group of circular switches driven by a constant speed motor. When power is first applied the selector connects a precision resistance (the identification and reference element), into a self-balancing bridge amplifier. The bridge automatically matches the reference resistance with a helical potentiometer at the bridge balance point. Physically connected to the potentiometer's shaft are the code selector and code generator switches.

The code generator is a hollow cylinder consisting of eight metal rings insulated from each other, each with a code character machined in relief on the inner circumference. A rotating contact sweeps the inside of the cylinder, touching the raised portion of each ring. The three rings selected by the code selector key the transmitter with a three-letter code group. Transmitted on 6 mc, the signals are received on standard communications receivers and decoded with a special table. The same code group is repeated several times during the 20 seconds each of the five weather variables is on the air. This allows even inexperienced operators sufficient time to copy the signal.

Local surface weather conditions are converted into resistance values which can be matched by the self-balancing bridge amplifier. Air and water temperatures are measured by thermistors, semiconductors whose resistance varies with its temperature. To code air and water temperatures each thermistor is independently connected in the self-balancing bridge amplifier and the correct three-letter code group is automatically selected for transmission.

Surface wind speed is measured by a rugged three-cup anemometer. A small magnetic generator connected to the rotor shaft provides an electrical voltage proportional to the wind speed. To convert voltage changes to resistance changes, the output of the generator is coupled to the grid of a vacuum tube. Changes in grid voltage vary the plate resistance of the tube, thus the plate resistance of the tube is proportional to the wind speed and can be measured in the bridge amplifier.

To measure wind direction accurately when the orientation of the buoy is uncontrollable and convert this measurement into a resistance value required a bit more

# MORE PICTURE POWER

new

## BLONDER-TONGUE B-24 POW-R BOOSTER



**\$24<sup>95</sup>**  
*list*

*it's a powerful booster  
... or an amplified coupler!*

**provides sharp, clear TV pictures on  
1, 2 or more TV sets with only 1 antenna**

'straight-thru' circuit provides up to 10 db gain as a powerful one-set booster

'couple-two' circuit provides up to 5 db gain (per set) as an amplified two-set coupler

'straight-thru' circuit and B-T 4-set coupler provide no-loss 4-set distribution system

Employs new frame-grid tube 6DJ8, new circuitry to achieve highest signal gain and "lower-than-cascade" noise factor. Provides full broadband amplification covering low and high VHF channels. Features "NO-STRIP" 300 ohm terminals for positive, electrical connections in seconds. Has "on/off" switch.

Improve TV reception today on 1, 2 or more TV sets with a single antenna.



Available at parts distributors. For details write:  
**BLONDER-TONGUE LABORATORIES, INC.**  
9 Alling Street • Newark 2, N. J. • Dept. E1-8

In Canada: Telequipment Mfg. Co., Ltd., London, Ont. Export: Morhan Export Corp., N. Y. 13, N. Y. • hi-fi components • UHF converters • master TV systems • industrial TV cameras • FM-AM radios.

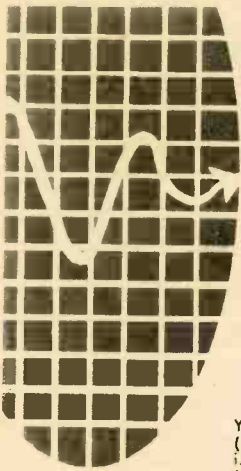

# ELECTRONICS ILLUSTRATED

## Classified Ads

Your advertisement can reach this mail-buying audience for only 35¢ per word . . . payable in advance (Check or M.O. please) . . . minimum 10 words. Closing dates are the 20th of 3rd preceding month i.e. copy for the November issue must be in our office by August 20th. Mail to ELECTRONICS ILLUSTRATED, 67 West 44th St., New York 36, N. Y. Word count: Zone number free. Figure one word: Name of state (New Jersey), name of city (New York); sets of characters as in key (14-D); also abbreviations as 35MM, 8x10, D.C., A.C.

## SAVE MONEY • ORDER BY MAIL

### • • • FOR SALE

**MONEY SAVING** Prices on tubes, TV, Radio, Transmitting and Industrial Types. New, 1st quality, guaranteed. Top name brands only. Government surplus and commercial test, lab and communications equipment in stock. Sell us your excess tubes and equipment. Unused, clean tubes of all types wanted. Send specific details in first letter. Write for "Green Sheet" catalog 25¢. Barry Electronics Corp., 512 Broadway (Dept. E1.), WA 5-7000, New York 12, N. Y.

**GOLD-SILVER DETECTORS.** Latest types. Five models including transistors. Violites for tungsten, etc. Geiger Counters. No finer instruments anywhere. Free information. Detectron, Dept. BWW, Sylmar, California.

**25 POUNDS ELECTRONIC Salvage.** \$3 plus shipping. Value Guaranteed. Raybon, 150 Rockyford Rd. NE, Atlanta 17, Georgia.

**CITIZENS BAND** Ch. 11 monitor decal for auto colorful, neat. Four for dollar. Clubs inquire. Harris, 114-D Danray Drive, Richmond 27, Virginia.

**GOVERNMENT SURPLUS**—Anyone can buy electronic equipment direct from U. S. Government. Weekly letter tells when, where and what is being offered. 3 months (13 issues) \$7.00. Government Surplus Sales, P. O. Box 6602E1, Washington 9, D. C.

**78 R.P.M. RECORDINGS.** Many types. Free lists. Collections bought, P.O.B. 155(EL), Verona, N. J.

### • • • PRINTING, MULTIGRAPHING, MIMEOGRAPHING

**RUBBER STAMP** 3 Lines pocket, \$1.00. Armstrong, 52724 Frances, South Bend 17, Indiana.

### • • • BUSINESS OPPORTUNITIES

**GROW MUSHROOMS.** Callar, shed and outdoors. Spare, full time, year round. We pay \$4.50 lb. dried. We have 29,000 customers. Free Book. Mushrooms, Dept. 315, 2954 Admiral Way, Seattle, Wash.

**VENDING MACHINES**—No selling. Operate a route of coin machines and earn high profits. 32-page catalog free! Parkway Machine Corp., Dept. 33, 715 Ensor St., Baltimore 2, Md.

### • • • MONEymAKING OPPORTUNITIES

**OUTSTANDING PROFIT** Potentials. \$10. monthly starts you in field gaining widespread acceptance. Free Brochure. Columbia, 45-09-LE Broadway, Long Island City, New York.

**GET LISTED** for life! Receive hundreds free magazines, samples, special offers. Rush 25¢, stamped, addressed envelope. Columbia, 45-09-E Broadway, Long Island City, New York.

### • • • EMPLOYMENT OPPORTUNITIES

**PRINTING - ADVERTISING SALESMEN.** Excellent moneymaking sideline selling Decalcomania Name Plates. Advertising Specialties. Sign letters, Automobile initials. Free Samples. "Ralco"-E1, Box L, Boston 19, Mass.

### • • • HI-FI

**COMPONENTS, RECORDERS.** Free Wholesale Catalogue. Carston, 125-G East 88, NYC 28.

### • • • TAPE RECORDERS

**LEARN WHILE Asleep** with your recorder, phonograph or amazing new "Electronic Educator" endless tape recorder. Details free. Sleep-Learning Research Association, Box 24-E1, Olympia, Washington.

**TAPE RECORDERS, Hi-Fi components,** Sleep Learning Equipment, tapes. Unusual values. Free catalog. Dressner 69-02 Z 174 St., Flushing 65, N. Y.

### • • • RADIO & TV

**10 DISTANCE CRYSTAL** set plans—25¢; 20 different 50¢, with Transistor experiments, catalog. Laboratories, 1131-K Valota, Redwood City, California.

**CITIZEN BAND** Pre-amplifier Kit \$12.95, wired \$22.95. Printed circuit board in color for fast assembly, increase receiver sensitivity. Dysan's Electronics, 3118 W. 48th, Los Angeles 43, Calif.

**DIAGRAMS FOR** repairing radios, amplifiers, \$1.00; television \$2.00. Give make, model. Diagram Service, Box 672-E1, Hartford 1, Conn.

### • • • INVENTIONS & INVENTORS

**HOW TO** Become Wealthy Through Inventing! Complete book containing many new and practical ideas which could be developed. Suggested methods are provided. Procedures to be followed. Pitfalls to avoid. Many other aids. Valuable musts for all beginning and experienced inventors — \$1.00. Also patent searching. Lehigh Laboratories, Dept. X, 2047 Somerset St., Philadelphia 32, Pa.

### • • • PERSONAL

**LOANS BY** Mail. \$50 To \$600 For Any Purpose. Employed men and women eligible. Confidential. 2 years to repay. Write for free loan application. American Loan Plan, City National Bldg., Dept. E1-7150, Omaha 2, Nebraska.

### • • • STAMPS & COINS

**ADULTS! LIKE** Stamps? Start your own approval business. Our free guidance shows exactly how, makes it easy, profitable. Details free. Columbia, 45-09-L Broadway, Long Island City, New York.

**FREE SET** with approvals. C-M Stamp Co., Office, 1909 Capitol Ave., Sacramento 14, California.

### • • • MUSIC

**SONGPOEMS AND** Lyrics Wanted! Mail to: Tin Pan Alley, Inc., 1650 Broadway, New York 19, N. Y.

### • • • ROCKETS

**ELECTRONICS, ROCKETRY.** Parts, plans. Pricelist 10¢ (Refundable). AMSEC, Jeffersontown, Kentucky.



ingenuity on the part of the National Bureau of Standards, who developed the buoy. A synchro-type wind vane is used to transmit the vane shaft angle to a servo system located within one of the water-proof wells in the buoy. The servo rotates the body of a gimbal-mounted magnetic compass accordingly. The compass has a slave pointer which rotates above a circular resistance strip. The result is resistance values corresponding to wind direction relative to magnetic north. A rugged, aneroid-type barometer with a slave pointer and resistance strip similar to that on the compass provides accurate measurement of air pressure.

One of these buoys, located in the Gulf of Mexico, 300 miles south of the mouth of the Mississippi River, transmitted the first warning reports of tropical storm Irene on October 7, 1959. Another was successfully anchored off the George V Coast of the Antarctic ice cap.—James R. Spencer

## El Echo Chamber

Continued from page 57

as long as it has sufficient gain. That means that the amplifier must have a 12AT6, 12SQ7, or a 12AV6 in addition to the output tube and rectifier.

Connection of the echo unit is simple enough, although there are several variations you can use. The simplest hookup requires connecting a pair of leads in parallel with the speaker leads from your amplifier to terminal TS2 on the echo unit. The shielded lead from the phono cartridge (Xtal) is connected to the input of the built-in AC/DC amplifier. This small amplifier in turn feeds an external speaker. Since both the small amplifier and external speaker will be handling only the echo signal, they need not be of particularly high quality. Make sure that the external speaker is not placed too close to the spring unit or it will agitate it acoustically and cause a sustained howl or ringing noise.

A more complicated setup, but one which does not require a second external speaker and amplifier, uses a mixer to combine the output of the crystal with the original signal source. A suitable transistorized mixer will be presented in an early issue.

As can be seen in the photos the reverb unit and the AC/DC amplifier are housed in a wooden cabinet. The exact housing is not critical, but since the amplifier does present some shock hazard, it is a good idea to recess it in an insulated cabinet as shown.

In use, the complete reverb machine can be mounted near the main hi-fi amplifier and the inexpensive external speaker is mounted near your main hi-fi speaker. Control R6 is adjusted for minimum distortion of the echo signal; its setting will depend on the volume of the main speaker. Potentiometer R1 sets the volume of the echo signal and it is adjusted by ear for the most pleasing echo balance. You'll find that program material with a continuous high level of sound will hardly show the effect of added echo. Small combos and solo instruments, however, will have an extra certain something added which will be well worth the modest investment represented by this simple echo device.

## Loudhailer Intercom

Continued from page 39

Since the unit is basically a high-powered intercom, there is no reason why the landlubber can't use it for other applications. It will operate from power supplied by dry cells or simply plugged into the cigar lighter receptacle of your car. Always be sure that polarity of the power source is correct, especially since some of the older cars have the positive battery lead grounded.

## SPECIAL

### IN SEPTEMBER EI HOW TO BECOME A HAM

## Transistorized Theremin

Continued from page 46

will result if the instrument is modulated by oscillating your hand around the point of desired pitch (a certain distance from an antenna). Volume changes can be made by shielding the antenna loop of the receiver with one hand, while varying the pitch with the other. The battery should last many hours in normal operation.

All Tubes Individually Boxed  
**UNCONDITIONALLY  
 GUARANTEED  
 FOR ONE YEAR**  
 SEND FOR FREE COMPLETE TUBE  
 LIST & ORDER BLANK. YOUR  
 INQUIRY WILL PUT YOU  
 ON OUR MAILING  
 LIST

# TELTRON SMASHES PRICES ON TUBES for '60!

## FREE



**EICO TUBE TESTER  
 MODEL 625K**  
 This brand new  
 EICO tube tester  
 is yours absolutely  
 FREE with every  
 receiving tube  
 order of \$1.00  
 or more within 60 days.

TESTS all new tubes and  
 pilot tubes. May be  
 purchased from  
 TELTRON for \$24.95.

**FREE BONUS**  
 ONE (1) YEAR FREE sub-  
 scription to ELECTRONICS  
 ILLUSTRATED PLUS ONE  
 (1) SCHEMATIC DIAGRAM  
 Of Your Choice With Every  
 Receiving Tube Order Of  
 \$3.00 Or More.

**NOTE!** If you already are  
 a subscriber to this maga-  
 zine, one (1) year will be  
 added to your subscription  
 FREE.

If Your Receiving Tube Order  
 is \$3.00 Or More, Fill In  
 This Coupon.

TELTRON "ELECTRIC" CO.,  
 428 Harrison Ave.,  
 Harrison, N.J.

Send me one (1) year FREE  
 subscription to \_\_\_\_\_  
 PLUS ONE (1)  
 FREE Schematic Diagram \_\_\_\_\_  
 (state model # of  
 radio or TV).

Name \_\_\_\_\_  
 Address \_\_\_\_\_  
 City \_\_\_\_\_  
 State \_\_\_\_\_

## SAVE ON ALL TUBES

Here's a Partial List of Most Often Used Tubes

0Z4	.45	5U4CA	.45	6BZ6	.45	7AU7	.53
1B3GT	.62	5U4GR	.48	6BZ7	.38	8AW6	.75
1D5	.69	5U8	.48	6C4	.48	8C7	.54
1G3GT	.70	5V4G	.48	6CB6	.41	8C7GT	.54
1B3	.70	5X5	.58	6CG6	.58	9UB	.90
1S5	.51	5Y3GT	.58	6CGG	.51	9CM7	.54
17A	.43	6AR4	.30	6CG8	1.63	6X5	.54
1U4	.52	6AC7	.43	6CF6	.58	9UB	.90
1U5	.51	6AF4	.65	6CG7	.48	10DE7	.79
1X2	.43	6AG5	1.82	6CM8	.54	11CV7	.49
2A4	.62	6AH6	.52	6CM7	.44	11AB5	.74
2B4	1.02	6AL5	.47	6CQ4	.58	12A7	.44
2C95	.55	6AM8	.43	6CS6	.58	12AJ6	.44
3A4	.50	6AN8	.59	6CUG	.95	12AT6	.37
3AU6	.43	6AQ5	.64	6C5	.58	12AV6	.58
3B6	.58	6AU4GT	.52	6CV7	.48	12AU7	.42
3BU8	.50	6AU5GT	.59	6DA4	.56	12AV6	.42
3BZ6	.65	6AU6	.64	6DB6	.59	12AV7	.73
3CB6	.45	6AV6	.43	6DEE	.89	12AX	.63
3DT6	.51	6AW6	.37	6DC6GT	.43	6CT	.70
3V4	.43	6AX4GT	.50	6DB6	.48	12AX7	.61
4A4	.48	6B4	.69	6DS5	.89	12AZ	.65
4BC1	.43	6B8	.56	6E8B	.69	12BA	.61
4BN5	.49	6BC5	.48	6H6	.66	12BA6	.56
4C8	.75	6BE6	.50	6J5	.47	12BE6	.46
4DEE	.51	6BF5	.46	6MG7	.38	12BE7	.63
4DT6	.59	6BG6	1.18	6SA7	.41	12CR6	.43
4A4K	.48	6B8	.56	6SC7	.45	12CR6	.43
5A03	.64	6B8J	.64	6SK7	.45	12CR6	.44
5A7S	.54	6BK7	.75	6SN7GT	.60	12DE6	.69
5B7	.54	6BL7CY	.78	6SQ7	.38	12DL6	.68
5BR6	.66	6BR4	.44	6UE	.71	12DQ7	.59
5CL6	.66	6BR5	.74	6V6GT	.76	12DS7	.63
5CQ6	.66	6BQ5	.50	6V6GT	.48	12EK6	.59
5J6	.59	6BQ6GT	.83	6W4GT	.43	12EZ6	.59
5U4G	.43	6BY6	.75	6X8	.53	12FME	.43
						12M5	.43
						12L6GT	.44

Send for FREE complete list of most often used tube types

## "USED TV"

**500 TRADE-IN TV'S**

These sets are all  
 expensive console  
 models. With little  
 or no tube replace-  
 ment these sets  
 can become excel-  
 lent sets for re-sale  
 or your own second  
 set. Sizes are: 16",  
 17" and 19". None  
 smaller. Sets ship-  
 ped FOB Harrison,  
 N.J.

**\$1495**  
 As Is

## Self-Service Tube Checkers

These reconditioned  
 console model 22  
 socket tube checkers  
 have proven their  
 worth in busy repair  
 shops. Let your tube  
 customers test their  
 own tubes. Your in-  
 vestment will be re-  
 turned in one week  
 with little effort on  
 your part. COM-  
 PLETE WITH KEY  
 FOR BOTTOM DOOR  
 AND NEON LIGHT-  
 ED HEAD.

**\$3995**

FOB Our Warehouse

## ALL TRANSISTOR PORT- ABLE RADIO KITS

No bigger than a package  
 of cigarettes, these power-  
 ful portables will amaze  
 you. Can be assembled  
 easily in 30 minutes. Kit  
 includes: handsome cabi-  
 net, transistors, printed  
 circuit, ear piece, resis-  
 tors, condensers, antenna  
 and instructions. Money  
 back, if not as advertised.  
 List value \$15.95.  
 Shipped Prepaid \$6.95

## MORE TUBE BUYS!

12SA7	.45	25CUG	.82
12SK7	.45	25L6GT	.43
12SN7GT	.56	25W1GT	.43
12SQ7	.38	25Z8GT	.36
12V6GT	.43	35Z5	.48
12W/	.43	35C5	.48
6GT	.43	35L6GT	.43
17AX/	.50	35W1	.33
4GT	.50	35Z5GT	.33
17D4	.50	50B5	.48
17DQ6	.68	50C5	.48
19AU4	.50	50H45	.59
19B6GT	1.48	50L6GT	.50
25RQ/	.82	117Z3	.33
6GT	.82	117Z6GT	.65
25CDSG	1.19		

**COMPLETE STOCK  
 OF SPECIAL  
 PURPOSE TUBES  
 AND  
 SEMI-CONDUCTORS  
 WRITE FOR  
 FREE LIST**

## New Price Schedule of Television PICTURE TUBES

PICTURE GUARANTEED FOR ONE (1) YEAR

8DP4	.95	16RP4	11.95	20DPS	15.75
10AP4	.95	16TP4	11.95	20HP	17.75
10BP4	7.95	17AP4	16.75	21ACP4	21.95
10CP4	10.75	17VP4	15.75	21ALP4	18.75
12AP4	11.75	17TP4	13.25	21AMP4	18.75
14AP4	11.95	17CP4	17.25	21BP4	21.25
14QP4	13.25	17GP4	17.95	21ATP4	19.25
14RP4	14.25	17HP4	16.49	21AUP4	19.25
16AP4	16.45	17JP4	16.49	21AVP4	19.25
16CP4	12.49	17LP4	17.48	21AWP4	18.75
16DP4	11.99	17QP4	13.25	21EP4	17.25
16EP4	11.99	17TP4	16.49	21FP4	19.25
16GP4	18.99	17TP4	16.49	21MP4	21.25
16HP4	12.49	17TP4	16.49	21R4	17.25
16KP4	11.95	19AP4	18.25	21XP4	18.75
16LP4	11.95	20CP4	15.75	21YP4	18.75

Aluminized on Any Tube. \$4.00 Extra.  
 All Picture Tubes require a deposit on tube sizes for  
 Please add an additional \$3.00 on tube sizes for  
 17". Add \$7.00 on sizes 19", 20", 21" and 24".  
 Your cash deposit will be refunded immediately  
 upon receipt of your dud prepaid.  
 Picture Tubes are shipped promptly from our  
 warehouse (the US Continent and Canada only)  
 Harrison, N. J. Price upon request.

**HEAVY DUTY  
 SOLDER GUN**  
 Professional solder  
 gun for any type re-  
 pair job. Spotlight  
 illuminates job when  
 gun is on. EXTRA  
 TIP & SOLDER  
 FREE With Each  
 Gun. Guaranteed Re-  
 placement or Serv-  
 iced One Year by  
 TELTRON. Prepaid  
 \$5.95

**FIBER FUSE  
 CLIPS...35c ea.**  
 12 for \$1.65  
 PREPAID

**RCA CHEATER  
 CORDS...39c ea.**  
 6 for \$1.95  
 PREPAID

**CHANNEL MASTER  
 CONICAL ANTENNA**  
 Local or fringe.  
 Incl. 8 elmt. anten-  
 na with crabs; 5'  
 mast alum; chlm.  
 mt. 8 stand Offs.  
 50' 300 ohm wire.  
 List \$15. \$6.95 Im-  
 mediate delivery.  
 FOB, Harrison, N.J.

**Switch-Type  
 Indoor  
 Antenna**  
 Shipped  
 Postage Paid.  
 New 6 pos-  
 sition switch for  
 use on UHF,  
 VHF color sets.  
 Neat Pkg.,  
 \$2.99.  
 Buy 6, \$2.49.

**PARALLEL PICTURE  
 TUBE BRIGHTENER...99c**  
 Series type...\$1.39

**AUTO VIBRATORS**  
 6 Volt 4 Prong  
 Universal...\$1.59  
 12 Volt 3 Prong  
 Standard...\$1.79  
 12 Volt 4 Prong  
 Standard...\$1.99

**NEW LIBERAL TERMS:** No minimum order. Free postage on all tube & parts or-  
 ders over \$5.00 in U.S.A., APO's & Territories. 25% deposit required on C.O.D's. Please  
 send approximate postage on Canadian and foreign shipments—excess will be re-  
 funded. All picture tubes and outdoor antennas shipped FOB Harrison, New Jersey.

Tubes listed may be  
 factory seconds or  
 used tubes and are  
 clearly marked.

# TELTRON ELECTRIC CO.

428 Harrison Ave. Harrison, N. J. Phone Humboldt 4-9848

Dept. E1-8



# FAWCETT HOW-TO BOOKS

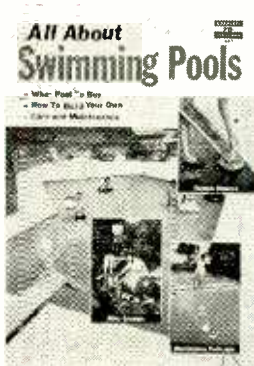
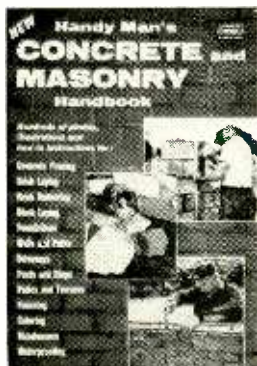

To order direct, send 75c per copy for regular edition or \$2.50 per copy for De Luxe edition to FAWCETT BOOKS, Dept. EI, Greenwich, Conn. Add 10c per copy mailing charge for all books. Specify title and number. Canadian orders cannot be accepted.

AT YOUR LOCAL NEWS-  
STAND, LEADING DRUG  
STORE, SUPER MARKET,  
HARDWARE STORE AND  
BUILDING SUPPLY DEALER

A FAWCETT  
HOW-TO BOOK 75c

Handy Man's CONCRETE and MASONRY Handbook • Photos, illustrations, how-to instructions. (No. 448)

ALL ABOUT SWIMMING POOLS • Filters, construction, care, maintenance, safety. (No. 447) Also available in hard cover edition at \$2.50 per copy.

PLYWOOD PROJECTS FOR THE HANDY MAN • Over 35 easy-to-build one panel projects. (No. 446)

SKIN DIVER HANDBOOK • Diving waters, equipment, photography, spearfishing, clubs. (No. 445)

Projects You Can Make For OUTDOOR LIVING • Wood decks, patio tile, flagstone, concrete. (No. 444)

BEN HOGAN'S POWER GOLF • Clubs, stance, grip, the swing, power, putting, iron shots, etc. (No. 443)

ARCHERY HANDBOOK • New edition, games, hunting, history, bows and arrows, practice, equipment. (No. 442) Also available in hard cover edition at \$2.50 per copy.

LANDSCAPING and LAWN IDEAS • Trees, hedges, flowers, paths, driveways, fences, patios, tools. (No. 441)

CANDID PHOTOGRAPHY • Nudes, children, birds, glamour, costumes, museums, salon section. (No. 440)

OUTBOARD BOATING HANDBOOK • 1960 boats, trailers, racing, accessories, motors, building. (No. 439)

FAMILY BOATING • Choosing a boat, motor, trailer, inboards vs outboards, used boats, navigating. (No. 438)

ELECTRONICS GUIDE • Electron theory, transistors, experiments, automation, computers, radio-TV. (No. 437)

MAN INTO SPACE • First space ship, NASA, Able-Baker flight, the future, career in astronautics. (No. 436)

Professional TV REPAIR SECRETS • TV troubles, interference, tube testers, money saving ideas. (No. 435) Also available in hard cover edition at \$2.50 per copy.

SALON PHOTOGRAPHY • Closeup portraits, still life, jungle animals, glamour, snow abstracts, nudes. (No. 434)



# THE MAN WHO KNOWS HOW

Wherever you are . . . at work, driving a car, watching your favorite team admiring a friend's workshop . . . you can always spot The Man Who Knows How. Chances are, he's a **MECHANIX ILLUSTRATED** reader. For MI is the magazine that tells you how to do things the fastest, the easiest, the expert way . . . whether it's taking care of a balky carburetor, building a cruiser, fixing up a basement darkroom, starting your own business, digging a swimming pool . . . well, you name it!

Be The Man Who Knows How! Read America's *best* how-to-do magazine!

## **MECHANIX ILLUSTRATED**

STILL ONLY 25¢!



Another Great  
**FAWCETT**  
Newsstand Buy!