

By the Publishers of  
**MECHANIX  
ILLUSTRATED**

**Special—16 Pages!**

**HOW TO FIX YOUR TV**

# **ELECTRONICS ILLUSTRATED**

APRIL • 35¢



**Build This WWI Fokker  
for Radio Control**



### **Ni-Fi:**

**EI Report on Tone Arms  
Better Sound from Small Phonos**

### **Projects:**

**Sun Powered Radio  
Numbers Game  
Radiation Monitor**

### **Ham & SWL:**

**All About 15 Meters  
Troubleshoot Your Novice Rig**

## **AN EASIER WAY TO LEARN**



You train in your own home—keep your present job while learning. Well illustrated NRI lessons teach Radio-TV-Electronic principles. You build, test, experiment with Radio-TV circuits, get actual practice with kits NRI gives you. Graduate Vagnoni at left, knew nothing about Radio when he enrolled.

## **TRAINING KITS GIVE EXPERIENCE**



You don't have to know anything about electricity or Radio to understand and succeed with NRI courses. Many successful NRI men did not finish high school. NRI trained men have been accepted for responsible positions throughout the United States and Canada. Graduate Barnett, for instance, is Chief Engineer with station KGCU.

## **THOUSANDS ACHIEVED SUCCESS THIS WAY**

For over 40 years, NRI has been training men for success. Multiple uses of Electronics in office machines and production machinery plus importance of Electronics in missiles, rockets, etc., are creating a need for more and more Electronic Technicians. Because the work is interesting and important, the pay high and the future bright, job counselors are advising men to train for a career in Electronics. National Radio Institute, America's oldest and largest home study Electronic school, is now offering complete training in Industrial Electronics as well as its courses in Radio-Television and Radio-Television Communications. Read on the next page about the special Electronic training equipment NRI furnishes at no extra cost to make training at home faster and easier.

## **CUT OUT AND MAIL POSTAGE-FREE CARD**

FIRST CLASS  
PERMIT NO. 20-R  
(Sec. 349 P L & R)  
WASHINGTON, D. C.

**BUSINESS REPLY CARD**  
NO POSTAGE STAMP NECESSARY IF MAILED IN THE UNITED STATES

**POSTAGE WILL BE PAID BY**

**NATIONAL RADIO INSTITUTE**

**Washington 16, D.C.**



**Good Spare Time Earnings**  
"I am doing very well in spare time TV and Radio. Sometimes have several TV jobs waiting and also fix car Radios for garages. I paid for instruments out of earnings." G. F. SEAMAN, New York, N. Y.



**Has Own Radio-TV Business**  
"We have an appliance store with our Radio and TV servicing, and get TV repairs. During my Army service, NRI training helped get me a top rated job." W. M. WEIDNER, Fairfax, South Dakota.

## Special Training Kits No Extra Charge

People look up to and depend on the Technician, more than ever before. New Electronic products are increasing the job opportunities for Radio-Television-Electronic Technicians. Right in your own home, in your spare time, you can gain knowledge, develop skills needed to get good jobs in this vast industry. You learn by doing. You get NRI kits developed especially to give actual practice and experience. As part of your NRI training you can get all parts including picture tube to build the 17" Television receiver and multi-use vacuum tube Voltmeter, shown at right. You use this equipment to learn Radio-TV-Electronic circuits, make tests, experiments. All equipment is yours to keep.

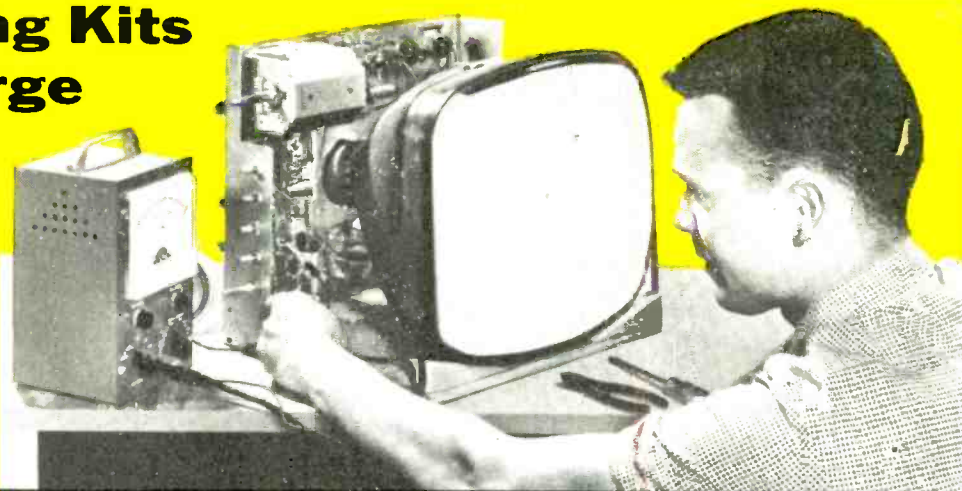

# FOR GOOD PAY TO START AND A BRIGHT FUTURE Learn ELECTRONICS Radio Television AT HOME IN YOUR SPARE TIME



**CUT OUT AND MAIL  
POSTAGE-FREE CARD**

## 64-Page Electronic Catalog FREE

**No Obligation • No Salesman Will Call**

NO STAMP NEEDED  
NRI PAYS POSTAGE

**NATIONAL RADIO INSTITUTE**  
Washington 16, D. C. ODK

Send me complete information  
without cost or obligation.  
(Please print.)

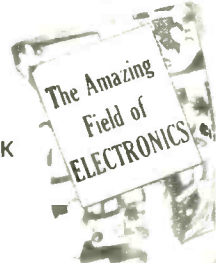

NAME .....

AGE .....

ADDRESS .....

CITY ..... ZONE ..... STATE .....

Accredited Member National Home Study Council

## You Can Start Soon Earning Extra Money in Spare Time

Many NRI students find it easy and profitable to fix sets for friends and neighbors starting a few months after enrolling. Use the Tester built with parts NRI furnishes to locate and correct Radio-TV receiver troubles. Picking up \$10, \$15 and more a week gives substantial extra spending money. Many who start in spare time soon build full time Radio-Television sales and service businesses, enjoy prestige, respect and satisfaction in this fast growing industry.

## Benefit by NRI Experience—Oldest, Largest Home Study Electronic Radio TV School

NRI's more than 40 years experience training men for success—the outstanding record and reputation of this school benefits you in many ways. NRI methods are tested, proven. Successful graduates are everywhere in small towns and big cities. Here is an investment that pays big profits soon. Each week, invest only a few hours spare time in yourself, preparing to be a Radio-TV-Electronics Technician. Invest in training to get ahead. NRI can provide the training you need.

## NRI Offers the Tested Way to Better Pay

Technical know-how brings better pay, fast advancement. Radio-TV-Electronic opportunities are great, and are increasing. NRI has devoted over 40 years to developing simplified, practical training methods. Mailing the card at left can be one of the most important acts of your life. Do it now. Reasonable tuition. Low monthly payments available. Let us send you 64-page Catalog FREE. Address: NATIONAL RADIO INSTITUTE, Dept. ODK, Washington 16, D. C.



J. E. Smith  
Founder

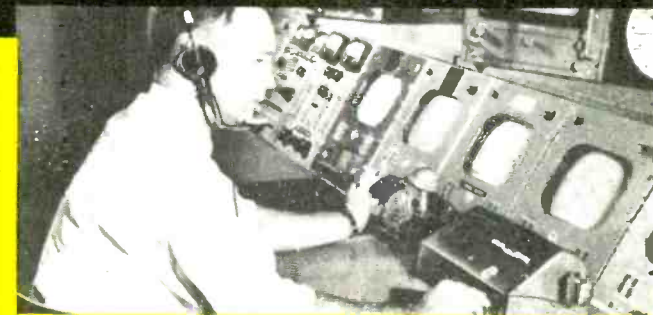

Broadcasting offers satisfying careers. Hundreds of Radio and Television stations on the air offer interesting jobs for Operators and Technicians. Police, Aviation, Two-Way Communications are expanding. Men with Radio-TV training are in demand.



A solid, proven field of opportunity for good pay is servicing the millions of Radio and TV sets now in use. Government, military, guided missile manufacturers, industry—all need Technicians. Color TV, Hi-Fi are increasing the opportunities.

# National Radio Institute

Washington 16, D. C. Est. 1914

# **knight-kits**® are years ahead...

A PRODUCT OF ALLIED RADIO

so much easier to build...so much more value



see them all in  
**ALLIED'S 1960 CATALOG**  
**FREE** send for it

**k** *BEST...by Design!*

exciting to build...satisfying to own!  
quality electronic equipment at

**SAVINGS UP TO 50%**



Y-731 Deluxe FM-AM Stereo Hi-Fi Tuner (Multiplex add-in) \$87.50  
only \$5 down



Y-774 Deluxe 40-Watt Stereo Amplifier (with Center Channel) \$78.50  
only \$5 down



Y-773 Super-Value 20-Watt Stereo Hi-Fi Amplifier...\$44.50  
only \$2 down



Y-787 FM-AM Hi-Fi Tuner (with Multiplex Jack) \$49.95  
only \$2 down



Y-737 "Ranger" Clock-Radio with "sleep" switch...\$24.95  
only \$2 down

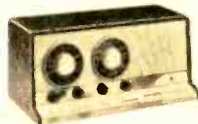

Y-258 4-Band "Span Master" Receiver (with cabinet) \$25.95  
only \$2 down



R-100 Amateur Communications Receiver (Hi-gain, with built-in Q-Multiplier)...\$104.50  
only \$5 down



Y-708 1000 Ohm/Volt Pocket Volt-Ohm-Milliammeter \$9.95



Y-713 Citizen's Band, 27 mc Transceiver...\$39.95  
only \$2 down



Y-771 5-Transistor Superhet Portable Radio (less battery) \$25.95  
only \$2 down



Y-125 Electronic VTVM (11 meg. input resistance) \$25.75  
only \$2 down



Y-143 Model "600" Tube Checker (checks over 700 types) \$32.95  
only \$2 down

see scores of other **knight-kits**

### HI-FI KITS

Stereo Preamp  
60-W Stereo Amplifier  
25-W Amplifier  
18-W Amplifier  
12-W Amplifier  
Hi-Fi Tuners  
Speaker Systems  
and others

### HOBBYIST KITS

"Space-Spanner" Radio  
"Ranger" Radios  
"Ocean Hopper" Radio  
Transistor Radios  
2-Way Intercom  
Electronic Lab Kits  
and many others

### INSTRUMENT KITS

Lab AC VTVM  
VOM's  
5" Scopes  
Tube Checkers  
Signal Tracer  
Audio Generator  
Sweep Generator  
plus many others

### AMATEUR KITS

400-Watt Transmitter  
50-Watt Transmitter  
Self-Powered VFO  
100 kc Crystal Calibrator  
Code Practice Oscillator  
Grid Dip Oscillator

**ONLY \$2 DOWN**  
on orders up to \$50;  
\$5 down on orders  
up to \$200.

There's a money-saving **knight-kit** for every need... see them all in **ALLIED'S 1960 CATALOG**

Describes the complete **KNIGHT-KIT** line in detail—the leading Buying Guide to everything in Electronics. Send for your **FREE** copy today!

**FREE**



## ALLIED RADIO

ALLIED RADIO, Dept. 75-D  
100 N. Western Ave., Chicago 80, Ill.

**SEND FREE 1960 ALLIED CATALOG**

Name

Address

City  Zone  State

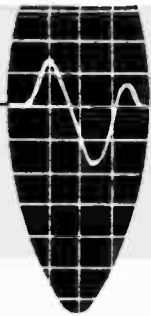

# ELECTRONICS ILLUSTRATED

April, 1960

Vol. 3, No. 4

A Fawcett Publication

## CONTENTS

### HI-FI SPECIAL REPORT

Stereo Tone Arms & Pickups ..... 29

### 16-PAGE BONUS

How To Fix Your TV ..... 65

### SPECIAL PROJECT

Radio Controlled WWI Fokker ..... 36

### BUILD-IT PROJECTS

How To Wire R/C Models ..... 42

Improve the Sound of a Small Phono ..... 46

Radiation Monitor ..... 54

All Transistor Intercom ..... 62

The Electronic Numbers Game ..... 81

Sun Powered Radio ..... 90

Milt Kiver on Tube Testers — 2 ..... 94

Build-it Course — 8, C B Rig ..... 98

Try These ..... 102

### FEATURES

El's Money-Making Ideas ..... 34

A Novice Toubleshoots His Rig ..... 48

Radiation Hazard ..... 51

Super-Sensitive TV Camera Tube ..... 57

New All-Purpose Recorder ..... 58

Spotlight on 15-Meters ..... 86

El Picturescope ..... 92

Sferics Stations Sound Out Storms ..... 104

Electronic Brain ..... 84

Hi-Fi Clinic ..... 93

CHARLES TEPFER ..... Editor

Larry Klein ..... Technical Editor

Edward Nanos ..... Feature Editor

David Kipnes ..... Assistant Editor

Murray Cooper ..... Art Editor

Lou Rubsamen ..... Art Associate

Elaine Sapoff ..... Editorial Assistant

Larry Eisinger ..... Editor-in-Chief

Phyllis Bendremer ..... Production Editor

Benita Mills ..... Assistant Production Editor

John F. Webster ..... Advertising Manager

Ralph Caigh ..... Editorial Director

James Boynton ..... Advertising Director

Al Allard ..... Art Director

Ralph Mattison ..... Associate Art Director

George W. Carl ..... Production Director

ELECTRONICS ILLUSTRATED is published monthly by Fawcett Publications, Inc., Fawcett Place, Greenwich, Conn. W. H. Fawcett, Jr., President; Gordon Fawcett, Secretary and Treasurer; Roger Fawcett, General Manager; Roscoe K. Fawcett, Circulation Director; Donald P. Hanson, Assistant General Manager.

EDITORIAL AND ADVERTISING OFFICES: 67 West 44th Street, New York 36, N. Y. ADDRESS ALL MAIL: Subscriptions, change of address, Form 3579 to Subscription Dept., Fawcett Bldg., Greenwich, Conn.; and all editorial and advertising to Fawcett Publications, Inc., 67 W. 44th St., New York 36, N. Y.

Second-class postage paid at Greenwich, Conn., and at additional mailing offices. Subscription price \$4.00 per year in the U. S. and possessions and Canada. All other countries \$6.00 per year. Foreign subscriptions and sales should be remitted by International Money Order in U. S. funds payable at Greenwich, Conn.

Printed in U.S.A. Copyright 1960 by Fawcett Publications, Inc. Permission hereby granted to quote from this issue of this magazine on radio or television provided a total of not more than 1,000 words is quoted and credit is given to the title of the magazine and issue, as well as the statement, copyright 1960, by Fawcett Publications, Inc.

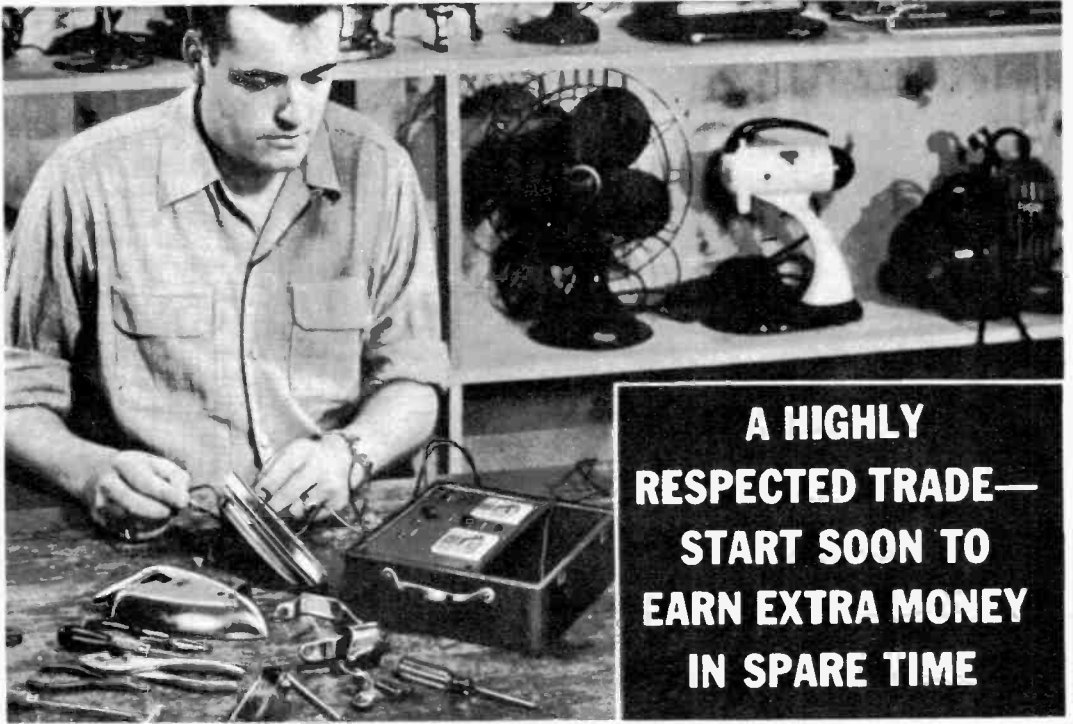

**A HIGHLY  
RESPECTED TRADE—  
START SOON TO  
EARN EXTRA MONEY  
IN SPARE TIME**

# Learn at Home IN YOUR SPARE TIME to Fix Electrical Appliances

To build a better future, get into a field where there's much important work and the security that comes from knowing a good trade. Servicing electrical appliances offers that OPPORTUNITY. Every wired home has many electrical appliances and millions and millions of new appliances are sold every year. Owners pay well to keep them in repair. That's making a fast-growing need for trained men.

## Add To Your Income Starting Soon Need For Service Technicians Increasing

Make extra money in your spare time. Start soon to fix electric toasters, fans, clocks, vacuum cleaners, and other electric appliances for your neighbors and friends. Work in your basement, garage or spare room. It's easy to increase your earning power—to pay for your training many times over—to have extra money to buy things you need.

## Learn and Earn with Multi-Use Tester Built with Parts We Send

This course includes the parts to build a portable, sturdy Appliance Tester that helps you locate electrical defects quickly and easily. You use it to learn and do actual electrical appliance repair jobs. If you want better pay learn this good trade. No need to give up your present

job. You can train at home in your spare time for only \$3.00 down and \$6.00 a month. A small price to pay for increased earnings, a more secure future. Paste coupon below on a postal or mail in envelope for free book and sample lesson. Address **National Radio Institute, Dept. KDO, Washington 16, D. C.**

**MAILING THIS  
COUPON MAY START  
YOU TO SUCCESS**

**LESSON AND BOOK  
FREE**



NATIONAL RADIO INSTITUTE, Dept. KDO, Washington 16, D. C.

Please send me Electric Appliance Training lesson and book free. (No salesman will call.)

Name ..... Age .....

Address .....

City ..... Zone ..... State .....

ACCREDITED MEMBER NATIONAL HOME STUDY COUNCIL

# A Message From the Editor

**O**UR special 16-page bonus sections, which we have included in **ELECTRONICS ILLUSTRATED** since January, have really hit the jackpot. Our circulation has reached new highs, and the letters from you relative to these sections have been pouring in. We are always hopeful that the articles in **EI** will impel you to action—make you run out and buy the parts to build the projects we describe. However, your response to the electronic computer featured in our January issue just flooded us. We now have other types of computers on the drawing boards for future publication. Some of the projects we are planning for our special 16-page section may be even more popular—we find we can for the first time present big do-it-yourself projects, the kind most magazines can't go in for because of space limitations. Whatever your special interest, there will be a 16-page special for you in **EI** in 1960.

In this issue, starting on page 29, is a report on **EI**'s exclusive test of stereo tone arms and cartridges. This is not an attempt to compare and rate every single tone arm and cartridge on the market; there are just too many listener preference factors involved to make such a rating of practical value. On the other hand, we feel that most cartridges and tone arms can be broken down into

some few basic types, and type preference may serve as a useful guide to help you buy the best for you. There was a great deal of laboratory work involved in arriving at the conclusions frankly stated in this article. I strongly recommend it to you.

**ELECTRONICS ILLUSTRATED** magazine has never attempted to be an impersonal journal. We have intentionally tried to give our magazine a personality—it's friendly, informal and not afraid to dig up the facts you need to build our projects and use electronics practically. Much of the personality of the magazine is a reflection of the personalities of the staff members—no ivory tower, arm-chair warmers here! All this to tell you that Len Buckwalter, who was our first technical editor, and influential in helping

us chart our course, has left us to rejoin the electronics manufacturing industry. Our new technical editor is Larry Klein, who may be familiar to you from articles under his byline which have appeared in other magazines. Larry is an avid do-it-yourselfer and has done important design work in many electronics areas—hi-fi, test equipment, home projects. He knows the problems—he'll be on your side.

Next month we have two very exciting features for you. One will be our special 16-page basic introduction to electronics. This



Each of these boxes housed a tone arm for our stereo tests

These men are getting practical training in . . .

# ELECTRICITY ELECTRONICS



*On Real:*

**A.C. and D.C. Motors  
Generators  
Switchboards  
Controllers  
Modern Appliances  
Automatic Electronic  
Control Units**

*(Shown at left—Instructor explaining operation and testing of a large Motor Generator in our A.C. Department.)*

# TELEVISION RADIO ELECTRONICS

*On Real:*

**Television Receivers  
Black & White and Color  
AM-FM and Auto Radios  
Transistors—Printed  
Circuits—Test Equipment**

*(Right — Instructor helping students check the wiring and trace circuits of television receivers.)*

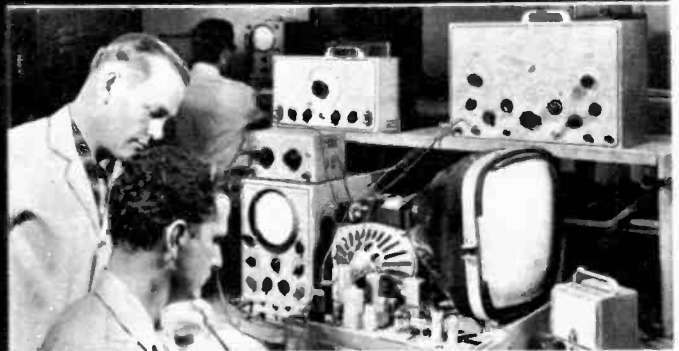

## Train in the NEW SHOP-LABS of COYNE

**Largest, Oldest, Best Equipped School of Its Kind in the U.S.**

Prepare for your future now in today's top opportunity field. Don't be satisfied with a "No Future" job. Train the Coyne way for a better job in a field that offers a world of opportunities in the years ahead.

**You train in Chicago**—the Electrical and Electronic Center of the World—on real equipment. Professional and experienced instructors show you how, then you do practical jobs yourself. No previous experience or advanced education is needed.

**FINANCE PLAN:** Enroll now, pay most of tuition after graduation. Part-time employment help for students.

Mail coupon or write to address below for free book—"Guide to Careers". Whether you prefer Electricity, Television-Radio or Combined Electronics Training, which includes both fields, this book describes all training and gives facts to Vets and Non-Vets.



### Mail Coupon or Write for FREE Book

Book comes by mail. No obligation and no salesman will call.

Mail coupon below in an Envelope or paste on a Postal Card or write Address given and Free book, "Guide to Careers", with information will be sent to you by return mail.

**COYNE ELECTRICAL SCHOOL**  
Dept. 40-8C, New Coyne Building  
1501 W. Congress Pkwy., Chicago 7, Illinois

Send BIG FREE book and details of all the training you offer. However, I am especially interested in:

Electricity       Television       Both Fields

Name \_\_\_\_\_

Address \_\_\_\_\_

City \_\_\_\_\_ State \_\_\_\_\_

*(I understand no Salesman will call)*

**B. W. Cook, Jr., Pres.** **COYNE** **ELECTRICAL SCHOOL** **Founded 1899**

**CHARTERED AS AN EDUCATIONAL INSTITUTION NOT FOR PROFIT**  
1501 W. CONGRESS PARKWAY, CHICAGO 7 Dept. 40-8C

**ELECTRICITY ★ RADIO ★ TELEVISION ★ REFRIGERATION ★ ELECTRONICS**

# SHORT CUT TO TELEVISION REPAIRS

No. 1

No. 2

**Fix TV sets twice as fast! Eliminate unnecessary testing!**



**PIX-O-Fix TV Trouble Finder Guides**  
Only \$2 for the two.

Just turn the dial of the pocket-size Ghirardi & Middleton PIX-O-FIX Television Trouble Finder Guide! When the picture in the PIX-O-FIX "window" matches the screen image on the TV receiver you're repairing, presto! . . . you've got your clue!

PIX-O-FIX then shows the likely causes of the trouble. Next, it indicates the receiver section in which the trouble has probably happened. Then it gives you step-by-step repair instructions.

PIX-O-FIX is not a toy. It is a truly professional guide that can save you loads of time, help you do better work. Two different PIX-O-FIX units, No. 1 and No. 2 cover 48 different TV troubles—just about everything you're likely to be called upon to fix.

No. 1 identifies 24 common troubles and gives 192 causes and 253 remedies for them. No. 2 covers 24 more difficult troubles. Together, they are a comprehensive guide to quick picture analysis servicing of any TV set. Only \$2. Use coupon.

## FIX OLD RADIOS IN A JIFFY!



**Don't throw old radios away! Let this giant manual show you how to fix them fast—and right!**

Just look up the how-to-do-it data on that old radio you want to fix!

Four times out of 5, this giant, 3½ pound, 744-page Ghirardi RADIO TROUBLESHOOTER'S H A N D -

BOOK gives exactly the information you need to fix it in a jiffy. Tells what is likely to be causing the trouble . . . shows how to fix it. No useless testing. No wasted time. Handbook covers practically every radio receiver model made by 202 manufacturers between 1925 and 1942. Using it, even beginners can easily fix old sets which might otherwise be thrown away because service information is lacking. With a few simple repairs, most of these old sets can be made to operate perfectly for years to come.

Included are common trouble symptoms and their remedies for over 4,800 models of old home, auto radios and record changers: Airline, Apex, Arvin, Atwater Kent, Belmont, Bosch, Brunswick, Clarion, Crosley, Emerson, Fada, G-E, Kolster, Majestic, Motorola, Philco, Pilot, RCA, Silvertone, Sparton, Stromberg and dozens more. Includes hundreds of pages of invaluable tube and component data, service short cuts, etc.

**PRACTICE 10 DAYS FREE!**

Dept. PR-40, RINEHART & CO., Inc.,  
232 Madison Ave., New York 16, N.Y.

Send book(s) checked below for FREE EXAMINATION. In 10 days, I will either send price shown (plus postage) or return books postpaid and owe nothing. (Save! Send cash with order and we pay postage. Same 10-day return privilege with money refunded.)

PIX-O-FIX TV Trouble Finder Guides Nos. 1 and 2 (\$2 for the two.)  RADIO TROUBLESHOOTER'S HANDBOOK (\$6.95)

Name \_\_\_\_\_

Address \_\_\_\_\_

City, Zone, State \_\_\_\_\_

Outside U.S.A.—Cash with order only. Money-back guarantee.  
PIX-O-Fix \$2.50; Radio Troubleshooter's Handbook, \$7.45.



Larry Klein, new EI Tech. Editor at workbench

is, in effect, a condensation of the very popular "ABC's of Electronics" course which we published in our first issues. We've had many requests to reprint this series now that many of our early issues are no longer available. This review will be helpful to novices as well as electronic oldtimers.

The second big item in our May issue will be a report on the so-called hi-fi consoles made in this country and abroad, and which are sold in radio and television stores throughout the country. Are they really hi-fi? Are they worth the money? You'll get our frank answer in pictures and prose.

Next month we will also bring you the continuation of the Citizens Band Build-It project, Milt Kiver's analysis of quick check and auxiliary tube testers, an inexpensive dynamic microphone with a built-in transistor preamp, other build it projects, and our regular, popular features, the Electronic Brain and Hi-Fi Clinic.

See you then!

*Charles Tupper*

*P.S. Talk about excitement, we here at EI can barely contain ourselves. We are now preparing a unique free gift for every EI reader, to be included in our June issue. We won't tell you what it is now, but believe me it will be more than one dollar's worth!*

C. T.





In Spare Time at Home—Prepare for a Better Job—or  
Your Own Business in One of the Many Branches of

# ELECTRONICS

You build and keep this valuable Vacuum Tube VOLT METER

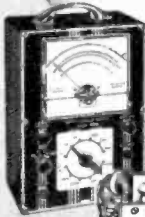

You build and keep this 5-inch COLOR OSCILLOSCOPE — almost a "must" for TV servicing.



## RADIO - TELEVISION - RADAR

If you are seeking a better job or a business of your own, the appealing field of Television-Radio-Electronics offers REAL PROMISE!

In this fast-growing field, trained Electronic technicians find many good-paying, interesting jobs in manufacturing, installing, operating, servicing. Equally important is the fact that these are GOOD JOBS—offering the kind of a future that an untrained man often dreams about.

No previous technical experience or advanced education needed. Prepare for this profitable field in your spare time at home, or in our modern Chicago or Toronto Laboratories. Nothing else like it! Send for FREE details.

### EARN WHILE YOU LEARN

After you get part of DeVry Tech's training with equipment at home, you may then in your spare time, begin to earn real money servicing Radio and Television sets.



### HOME MOVIES . . .

. . . make important points crystal clear. Speeds your learning. It's almost like having an instructor at your side!

### MILITARY SERVICE

If you are subject to military service, the information we have should prove very helpful. Mail coupon today.



**21 INCH**

Build and keep this BIG DeVry Engineered TV set—easily converted to U.H.F. (DeVry offers another home training, but without the TV set.)

## COLOR TV

DeVry Tech's program also includes training in Color Television

## Your GUIDE

### to Profitable Job Opportunities

- TV-Radio Broadcast Technician
- Color Television Specialist
- Radar Operator • Laboratory Technician
- Airline Radio Man • Computer Specialist
- Quality Control Manager
- Your Own Sales & Service Shop
- . . . PLUS MANY OTHERS

### YOU GET THE SAME EMPLOYMENT SERVICE

that has helped thousands of our graduates toward fine careers in Electronics.



You work over

**300**

Learn-By-Doing projects

Build over 300 practical projects from many shipments of Radio-Electronic parts. You build and operate TV-Radio circuits . . . wireless microphone . . . and many other major projects—all designed to provide outstanding practical experience at home.

Send for **FREE BOOKLET TODAY!**



Accredited Member of National Home Study Council

"One of North America's Foremost Electronics Training Centers"



# DeVRY TECHNICAL INSTITUTE

CHICAGO 41, ILLINOIS

**ACT NOW!** Get information-packed publication FREE! Mail coupon today.

### DeVRY TECHNICAL INSTITUTE

4141 Belmont Ave., Chicago 41, Ill., Dept. E1-4-Q

Please give me your FREE booklet, "Electronics in Space Travel," and tell me how I may prepare to enter one or more branches of Electronics.

Name \_\_\_\_\_ Age \_\_\_\_\_

PLEASE PRINT

Street \_\_\_\_\_ Apt. \_\_\_\_\_

City \_\_\_\_\_ Zone \_\_\_\_\_ State \_\_\_\_\_

2041 Canadian residents address DeVry Tech of Canada, Ltd. 626 Roselawn Ave., Toronto 12, Ontario

# Electronics in the news

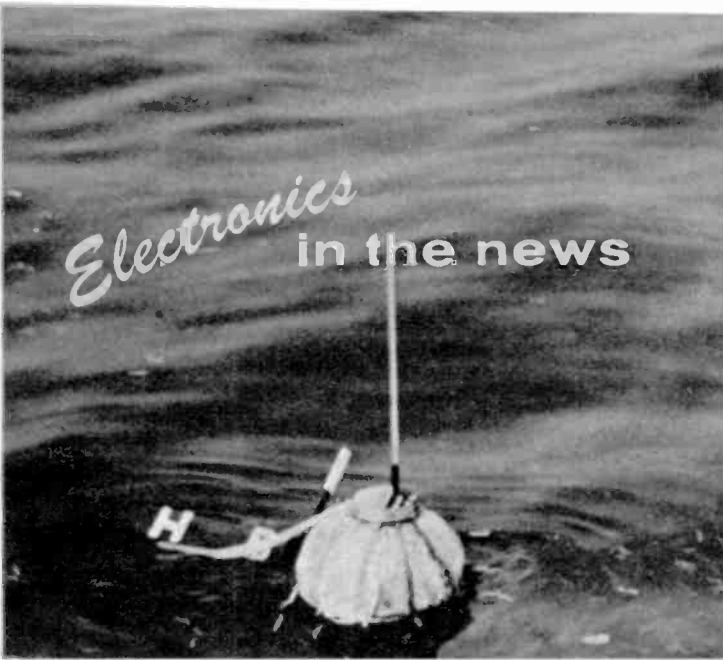

With transmitter signaling and dye marker spreading, capsule floats serenely awaiting boat.

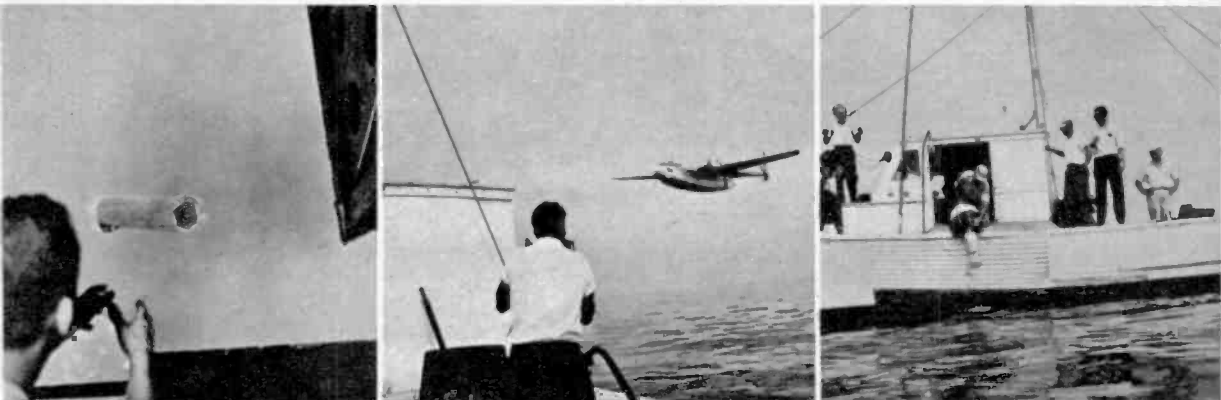

A missile is zooming back to earth. Suddenly . . . radio blackout. Important information lost. To remedy this situation, Avca has developed a capsule which would be released by the missile during its downward plunge. An actual test (above) involves dropping the capsule from a plane and the capsule parachuting to the ocean. A search plane picks up its signal and guides a pickup boat to the location. Photo right, delicate tape recording mechanism.

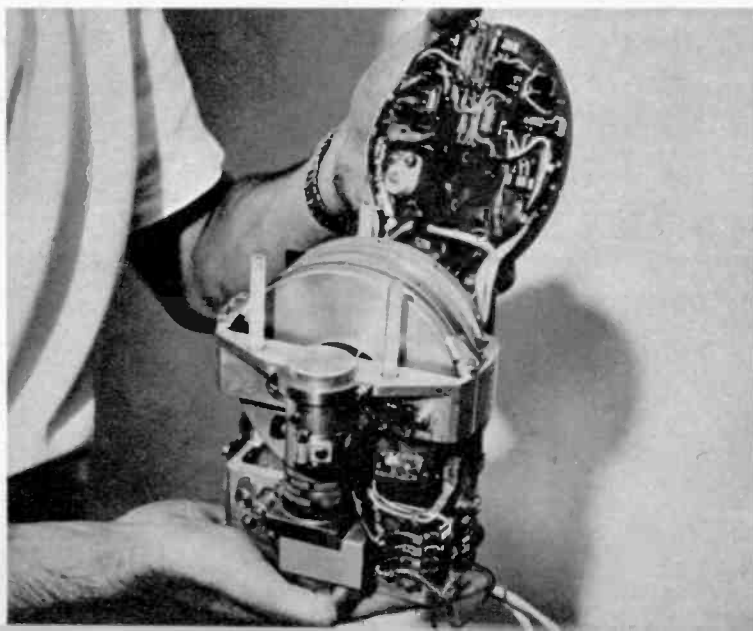

# HOW WOULD YOU LIKE TO BREAK INTO ENGINEERING STARTING NEXT MONTH?

Your start in Engineering could mean higher pay, more interesting work, a real chance for advancement. Here's how to do it—fast!

A career in Engineering may be closer than you think, whatever your age or education or present job.

You know about the tremendous demand for engineers and technicians. But do you know how easy it is to get the training that will qualify you for this vital work, and how quickly you can advance?

## First Step Wins Job Consideration

The moment you enroll for a course in Engineering you're in a position to change your job. I. C. S. Engineering Courses, for example, start you off with Basic Mathematics and Drafting. Most employers are quick to accept men who start technical training.

## Your Advancement Is Rapid

Your interest, your determination, your willingness to spend free hours improving your-

For Real Job Security—Get an I. C. S. Diploma!

self all work in your favor. But your mastery of engineering subjects is what wins you the biggest boosts.

The I. C. S. method makes it possible for you to learn while you earn, to qualify yourself for upgrading step by step—from Draftsman to Detail Designer to Engineering Technician to full-fledged Engineer. It's a plan fitted to your needs, with personalized instruction and guidance, and, if you like, regular progress reports to your employer.

## Mail Coupon for Free Books

If you are seriously interested in a fresh start in an opportunity-packed field, then mark and mail the coupon today. We'll send you three free books—(1) the 36-page career guide "How to Succeed," (2) Opportunity outlooks in your field of interest, (3) sample lesson (Math) demonstrating I. C. S. method.

Accredited Member,  
National Home Study Council

I. C. S., Scranton 15, Penna.

## INTERNATIONAL CORRESPONDENCE SCHOOLS



BOX 14574C, SCRANTON 9, PENNA.

Without cost or obligation, send me "HOW TO SUCCEED" and the opportunity booklet about the field BEFORE which I have marked X (plus sample lesson):

### ARCHITECTURE and BUILDING CONSTRUCTION

- Air Conditioning
- Architecture
- Arch. Drawing and Designing
- Building Contractor
- Building Estimator
- Carpenter Builder
- Carpentry and Millwork
- Carpenter Foreman
- Heating
- Sign Lettering
- Plumbing
- Reading Arch. Blueprints

### ART

- Commercial Art
- Magazine Illus.
- Show Card and Sign Lettering
- Sketching and Painting

### AUTOMOTIVE

- Automobiles
- Auto Body Rebuilding and Refinishing
- Auto Engine Tuneup
- Auto Technician

### AVIATION

- Aero-Engineering Technology
- Aircraft & Engine Mechanic

### BUSINESS

- Accounting
- Advertising
- Business Administration
- Business Management
- Cost Accounting
- Creative Salesmanship
- Managing a Small Business
- Professional Secretary
- Public Accounting
- Purchasing Agent
- Salesmanship and Management
- Traffic Management

### CHEMICAL

- Analytical Chemistry
- Chemical Engineering
- Chem. Lab. Technician
- Elements of Nuclear Energy
- General Chemistry
- Natural Gas Prod. and Trans.
- Petroleum Prod. and Engr.
- Professional Engineer (Chem)
- Pulp and Paper Making

### CIVIL ENGINEERING

- Civil Engineering
- Construction Engineering
- Highway Engineering
- Professional Engineer (Civil)
- Reading Struc. Blueprints
- Sanitary Engineer
- Structural Engineering
- Surveying and Mapping

### DRAFTING

- Aircraft Drafting
- Architectural Drafting
- Drafting & Machine Design
- Electrical Drafting
- Mechanical Drafting
- Sheet Metal Drafting
- Structural Drafting

### ELECTRICAL

- Electrical Engineering
- Elec. Engr. Technician
- Elec. Light and Power
- Practical Electrician
- Practical Lineman
- Professional Engineer (Elec)
- HIGH SCHOOL
- High School Diploma

### MECHANICAL and SHOP

- Diesel Engines
- Gas-Elec. Welding
- Industrial Engineering
- Industrial Instrumentation
- Industrial Metallurgy
- Industrial Safety
- Machine Shop Practice
- Mechanical Engineering
- Professional Engineer (Mech)
- Quality Control
- Reading Shop Blueprints
- Refrigeration and Air Conditioning
- Tool Design
- Tool Making

### LEADERSHIP

- Industrial Foremanship
- Industrial Supervision
- Personnel-Labor Relations
- Supervision

### RADIO, TELEVISION

- Good English
- High School Mathematics
- High School Science
- Short Story Writing
- General Electronics Tech.

### INDUSTRIAL ELECTRONICS

- Industrial Electronics
- Practical Radio-TV Engr'g
- Practical Telephony
- Radio-TV Servicing

### RAILROAD

- Car Inspector and Air Brake
- Diesel Electrician
- Diesel Engr. and Fireman
- Diesel Locomotive

### STEAM and DIESEL POWER

- Combustion Engineering
- Power Plant Engineer
- Stationary Diesel Engr.
- Stationary Fireman

### TEXTILE

- Carding and Spinning
- Cotton Manufacture
- Cotton Warping and Weaving
- Loom Fixing Technician
- Textile Designing
- Textile Finishing & Dyeing
- Throwing
- Warping and Weaving
- Worsted Manufacturing

Name \_\_\_\_\_ Age \_\_\_\_\_ Home Address \_\_\_\_\_

City \_\_\_\_\_ Zone \_\_\_\_\_ State \_\_\_\_\_ Working Hours \_\_\_\_\_ A.M. to P.M.

Occupation \_\_\_\_\_

Canadian residents send coupon to International Correspondence Schools, Canadian, Ltd., Montreal, Canada. . . . Special low monthly tuition rates to members of the U. S. Armed Forces.

prepare for your career in

# ELECTRONICS ELECTRICAL ENGINEERING RADIO-TV COMPUTERS

and other fields of

## ELECTRICAL ENGINEERING

At MSOE, you can equip yourself for a career in many exciting, growing fields: MISSILES • RADAR • AVIONICS AUTOMATION • RESEARCH DEVELOPMENT • ELECTRICAL POWER • ROCKETRY

When you graduate from the Milwaukee School of Engineering, you are prepared for a dynamic career as an Electrical Engineer or Engineering Technician. Under a faculty of specialists, you gain a sound technical education in modern, completely equipped laboratories and classrooms. As a result, MSOE graduates are in great demand and highly accepted by industries nationally.

At MSOE, you will meet men from all walks of life and all parts of the country — some fresh out of high school or prep school, others in their twenties — veterans and non-veterans.

You can start school in any one of four quarters and begin specializing immediately. Engineering technicians graduate in 2 years with an Associate in Applied Science degree. For a Bachelor of Science degree in Engineering, you attend 4 years. A 3-month preparatory course also is available.

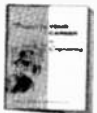
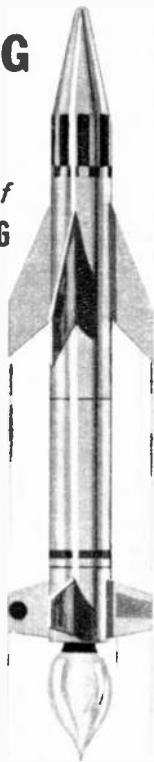

### FREE CAREER BOOKLET!

If you're interested in any phase of electronics, radio or television, be sure to look into the programs of study offered by the Milwaukee School of Engineering. Just mail the coupon.

## MILWAUKEE SCHOOL OF ENGINEERING

Dept. EI-460, 1025 N. Milwaukee St.  
Milwaukee, Wisconsin

Please send FREE Career Booklet. I'm interested in  
 Electronics  Electrical Power  Television  
 Mechanical Engineering  Radio  Computers  
 Electrical Engineering  Industrial Electronics

PLEASE PRINT

Name..... Age.....

Address.....

City..... Zone..... State.....

I'm eligible for veterans education benefits

MS-125

## ...News

Bendix-Pacific has developed a new, anti-skid braking system to help avoid runway accidents. High-speed aircraft land so rapidly that they sometimes swerve, rupture tires, etc., under abrupt braking. This new system utilizes skid detectors on the plane wheels. As the plane lands, the pilot presses his foot pedal and lets the detectors decide how rapidly the airplane should be stopped. This allows the system to select the correct braking pressure for the pilot according to the condition of the runway. Of course, a manual control which eliminates the system and allows the pilot to have full control of the airplane in emergencies is provided in the cockpit.



A new electronic plant protection system linked to an automatic nerve center has been introduced by Minneapolis-Honeywell. It can perform all the policing duties now handled by a staff of guards. The system includes noise and motion detectors, an electronic fence, TV cameras, magnetic switches that unlock gates from the control center, fire detectors and alarm switches. When any type of security violation occurs, the guard at the main control panel receives an audible signal (by horn, bell, buzzer) and a visual alarm (by lighted switches). To identify the particular trouble area, the guard looks to a panel which contains lights that indicate the particular area in which the emergency exists.

**NOW!**  
at a price  
you can afford!

# MAKE MORE MONEY in TELEVISION RADIO-ELECTRONICS

**BETTER...MORE COMPLETE...LOWER COST...  
WITH NATIONAL SCHOOLS SHOP-METHOD  
HOME TRAINING!**

**BETTER...** Training that is proved and tested in Resident School shops and laboratories, by a School that is the **OLDEST** and **LARGEST** of its kind in the world.

**MORE COMPLETE...** You learn **ALL PHASES** of *Television-Radio-Electronics*.

**LOWER COST...** Other schools make several courses out of the material in our **ONE MASTER COURSE**... and you pay more for less training than you get in our course at **ONE LOW TUITION!**



These  
**two FREE** books will  
show you how!

You get all information  
by mail... You make  
your own decision... at  
home! **NO SALESMAN  
WILL CALL**

## TOP PAY... UNLIMITED OPPORTUNITIES LIFETIME SECURITY CAN BE YOURS!

You are needed in the Television, Radio, and Electronics industry! Trained technicians are in growing demand at excellent pay—in **ALL PHASES**, including Servicing, Manufacturing, Broadcasting and Communications, Automation, Radar, Government Missile Projects.

**NATIONAL SCHOOLS SHOP-METHOD HOME TRAINING**, with newly added lessons and equipment, trains you in your spare time at home, for these unlimited opportunities, including many technical jobs leading to supervisory positions.

**YOU LEARN BY BUILDING EQUIPMENT WITH KITS AND PARTS WE SEND YOU.** Your National Schools course includes thorough *Practical training—YOU LEARN BY DOING!* We send you complete standard equipment of professional quality for building various experimental and test units. You advance step by step, perform more than 100 experiments, and you build a complete TV set from the ground up, that is yours to keep! A big, new TV picture tube is included at no extra charge.

**EARN AS YOU LEARN.** We'll show you how to earn extra money right from the start. Many of our students pay for their course—and more—while studying. So can you!

### RESIDENT TRAINING AT LOS ANGELES

If you wish to take your training in our Resident School at Los Angeles, the world's TV capital, start NOW in our big, modern Shops, Labs and Radio-TV Studios. Here you work with latest Electronic equipment - professionally installed - finest, most complete facilities offered by any school. Expert, friendly instructors, personal attention, Graduate Employment Service, Help in finding home near school - and part time job while you learn. Check box in coupon for full information.

**LESSONS AND INSTRUCTION MATERIAL ARE UP-TO-DATE, PRACTICAL, INTERESTING.** Every National Schools Shop-Method lesson is made easy to understand by numerous illustrations and diagrams. All instruction material has been developed and tested in our own Resident School Shops, Laboratories and Studios.

**SEND FOR INFORMATION TODAY**... it can mean the difference between **SUCCESS** and failure for you! Send for your **FREE BOOK** "Your Future in Television-Radio-Electronics" and **FREE Sample Lesson.** Do it **TODAY**, while you are thinking about your future. It doesn't cost you anything to investigate!

### GET THE BENEFITS OF OUR OVER 50 YEARS EXPERIENCE

Approved for  
GI Training



**NATIONAL SCHOOLS**  
Los Angeles 37, Calif.

### YOU GET...

- 19 Big Kits—**YOURS TO KEEP!**
- Friendly Instruction and Guidance
- Job Placement Service
- Unlimited Consultation
- Diploma—Recognized by Industry
- **EVERYTHING YOU NEED FOR SUCCESS!**

**SHOP-METHOD HOME TRAINING  
COVERS ALL PHASES OF INDUSTRY**

1. Television, including Color TV
2. Radio AM & FM
3. Electronics for Guided Missiles
4. Sound Recording and Hi-Fidelity
5. FCC License
6. Automation and Computers
7. Radar & Micro-Waves
8. Broadcasting and Communications

## NATIONAL TECHNICAL SCHOOLS

WORLD-WIDE TRAINING SINCE 1908

### MAIL NOW TO

NATIONAL TECHNICAL SCHOOLS, Dept. R4Y-30  
4000 S FIGUEROA ST LOS ANGELES 37, CALIF.  
Rush free TV-Radio "Opportunity" Book and sample  
lesson. No salesman will call.

NAME \_\_\_\_\_ AGE \_\_\_\_\_  
ADDRESS \_\_\_\_\_  
CITY \_\_\_\_\_ ZONE \_\_\_\_\_ STATE \_\_\_\_\_

Check if interested **ONLY** in Resident School training at Los Angeles  
**VETERANS:** Give date of Discharge \_\_\_\_\_



**YOU  
SAVE MORE!  
YOU  
SERVICE BETTER  
with...  
EMC  
TEST  
EQUIPMENT**

**PRECISION MADE** to assure highest quality...  
**LOWEST POSSIBLE PRICES** with the most  
advanced engineering techniques guaranteed.

**Model 206—Mutual  
Conductance Tube Tester**

Checks mutual conductance on a calibrated microhmo and "reject-good" scale. Checks tube for gas content. Complete switching flexibility. Tests tubes for noise. Model 206P, with hand rubbed oak carrying case, \$83.50. Model 206C, sloping counter case, \$79.50. Model CTA, cathode ray tube adaptor, \$8.50.



**Model 104—Voltmeter**

Features a 4 1/2", 50 microampere meter, with 3 AC current ranges and 3 resistance ranges to 20 megohms. Specifications...  
DC Voltage: 5 ranges (20,000 ohms per volt): 0 to 6-60-300-600-3000 volts. AC Voltage: 5 ranges (1,000 ohms per volt): 0 to 6-60-300-600-3000 volts. DC Current—3 Ranges: 0 to 6-60-600 ma. AC Current—3 ranges: 0 to 30-300 ma: 0 to 3 amps. 3 Resistance Ranges: 0 to 20K, 0 to 200K, 0 to 20 megs. 5DB Ranges: -4 to +67 DB.

Model 104, with carrying strap: Wt. 2 lbs. 5 oz. Size: 5 1/4" x 6 3/4" x 2 7/8", \$26.95; Kit, \$19.95. Model HVT, 30,000 volt probe for \$7.95.

**Model 204—Tube-Battery-  
Ohm Capacity Tester**

Emission tube tester. Completely flexible switching arrangement. Checks batteries under rated load on "reject-good" scale. Checks condenser leakage to 1 meg. Checks resistance up to 4 megs. Checks capacity from .01 to 1 mfd. Model 204P, illustrated, \$55.90. Model CRA, Cathode ray tube adaptor, \$4.50.



Yes, tell me more, send me **FREE**—a detailed catalog of the complete EMC line. EL-4

NAME \_\_\_\_\_  
ADDRESS \_\_\_\_\_  
CITY \_\_\_\_\_ STATE \_\_\_\_\_

**EMC** Electronic Measurements Corp.  
625 B'way, New York 12, N. Y.  
Ex. Dept. 370 B'way St., New York 13, N. Y.

**...News**



The Glaser-Steers Corporation has marketed a new stereo 4-speed record changer that incorporates many of the features they introduced with the GS-77. The GS-400 is priced at \$47.50 including the Glaser-Steers all aluminum arm without cartridge. Complete specifications available from manufacturer at 155 Oraton Street, Newark, New Jersey.



Television's exploring eye has found a new world to investigate... that of submarine life. As reported by Commercial Fisheries Abstracts, TV is a versatile tool for fishermen. UTV (Underwater Television) may be used to observe underwater habits of lobsters, etc., and the size of the fisherman's catch may be determined at any time. Cost of the rig is about \$3,500.



A unique customer guarantee has been made by the manufacturers of the new Triton magnetic recording tape. They will replace any reel of their tape found "deficient in performance or characteristics for any reason whatsoever, or in any way not as represented" with a reel of any American-made brand of the same type. The Triton tape, although slightly higher in price than competing brands, is enclosed in a hermetically sealed polyethylene bag. The tape is available in acetate and Du Pont Mylar in a wide range of sizes and types.

# BUILD 16 RADIO CIRCUITS AT HOME

Reg. U.S.  
Pat. Off.

with the New Deluxe  
PROGRESSIVE RADIO "EDU-KIT" ®

only  
**\$22.95**



## A Practical Home Radio Course

Now Includes

- ★ 12 RECEIVERS
- ★ TRANSMITTER
- ★ SIGNAL TRACER
- ★ SIGNAL INJECTOR
- ★ CODE OSCILLATOR

- ★ No Knowledge of Radio Necessary
- ★ No Additional Parts or Tools Needed
- ★ EXCELLENT BACKGROUND FOR TV
- ★ School Inquiries Invited
- ★ Sold in 79 Countries

**YOU DON'T HAVE TO SPEND  
HUNDREDS OF DOLLARS FOR A RADIO COURSE**

The "Edu-Kit" offers you an outstanding PRACTICAL HOME RADIO COURSE at a rock-bottom price. Our Kit is designed to train Radio & Electronics Technicians, making use of the most modern methods of home training. You will learn radio theory, construction of a professional miner, how to service radios. You will work with the standard type of punched metal chassis as well as the latest development of Printed Circuit chassis.

You will learn the basic principles of radio. You will construct, study and work with RF and AF amplifiers and oscillators, detectors, rectifiers, test equipment. You will learn and practice code, using the Progressive Code Oscillator. You will learn how to practice trouble-shooting, using the Progressive Signal Tracer, Progressive Signal Injector, Progressive Dynamic Radio & Electronics Tester and the accompanying instructional material.

You will receive training for the Novice, Technician and General Classes of F.C.C. Radio Amateur Licenses. You will build 16 Receiver, Transmitter, Code Oscillator, Signal Tracer and Signal Injector circuits, and learn how to operate them. You will receive an excellent background for Television, Hi-Fi and Electronics.

Absolutely no previous knowledge of radio or science is required. The "Edu-Kit" is the product of many years of teaching and engineering experience. The "Edu-Kit" will provide you with the best education in Electronics and Radio, worth many times the complete price of \$22.95. The Signal Tracer alone is worth more than the price of the entire Kit.

## THE KIT FOR EVERYONE

You do not need the slightest background in radio or science. Whether you are interested in Radio & Electronics because you want an interesting hobby, a well paying business or a job with a future, you will find the "Edu-Kit" a worthwhile investment. Many thousands of individuals of all

ages and backgrounds have successfully used the "Edu-Kit" in more than 79 countries of the world. The "Edu-Kit" has been carefully designed, step by step, so that you cannot make a mistake. The "Edu-Kit" allows you to teach yourself at your own rate. No instructor is necessary.

## PROGRESSIVE TEACHING METHOD

The Progressive Radio "Edu-Kit" is the foremost educational radio kit in the world, and is universally accepted as the standard in the field of electronics training. The "Edu-Kit" uses the modern educational principle of "Learn by Doing." Therefore you construct, learn schematics, study theory, practice trouble-shooting—all in a closely integrated program designed to provide an easily-learned, thorough and interesting background in radio.

You begin by examining the various radio parts of the "Edu-Kit." You then learn the function, theory and wiring of these parts. Then you build a simple radio. With this first set you will enjoy listening to regular broadcast stations, learn theory, practice testing and trouble-shooting. Then you build a more advanced radio, learn more advanced theory and techniques. Gradually, in a progressive manner, and at your own rate, you will find yourself constructing more advanced multi-tube radio circuits, and doing work like a professional Radio Technician.

Included in the "Edu-Kit" course are sixteen Receiver, Transmitter, Code Oscillator, Signal Tracer, and Signal Injector circuits. These are not unprofessional "breadboard" experiments, but genuine radio circuits, constructed by means of professional wiring and soldering on metal chassis, plus the new method of radio construction known as "Printed Circuitry." These circuits operate on your regular AC or DC house current.

## THE "EDU-KIT" IS COMPLETE

You will receive all parts and instructions necessary to build 16 different radio and electronics circuits, each guaranteed to operate. Our Kits contain tubes, tube sockets, variable, electrolytic, mica, ceramic and paper dielectric condensers, resistors, tie strips, coils, hardware, tubing, punched metal chassis, Instruction Manuals, hook-up wire, solder, etc. In addition you receive Printed Circuit materials, including Printed Circuit chassis, special tube sockets, hardware and instructions. You also receive a useful set of tools, a professional electric soldering iron, and a self-powered Dynamic Radio & Electronics Tester. The "Edu-Kit" also includes Code Instructions for Radio Amateur License training. You will also receive lessons for servicing with the Progressive Signal Tracer and the Progressive Signal Injector, a High Fidelity Guide and a Quiz Book. You receive Membership in Radio-TV Club, Free Consultation Service, Certificate of Merit and Discount Privileges. You receive all parts, tools, instructions, etc. Everything is yours to keep.

## PRINTED CIRCUITRY

At no increase in price, the "Edu-Kit" now includes Printed Circuitry. You build a Printed Circuit Signal Injector, a unique servicing instrument that can detect many Radio and TV troubles. This revolutionary new technique of radio construction is now becoming popular in commercial radio and TV sets.

A Printed Circuit is a special insulated chassis on which has been deposited a conducting material which takes the place of wiring. The various parts are merely plugged in and soldered to terminals.

Printed Circuitry is the basis of modern Automation Electronics. A knowledge of this subject is a necessity today for anyone interested in Electronics.

## FREE EXTRAS

- SET OF TOOLS
- SOLDERING IRON
- ELECTRONICS TESTER
- PLIERS-CUTTERS ● ALIGNMENT TOOL
- WRENCH SET
- HIGH FIDELITY GUIDE & QUIZZES
- CERTIFICATE OF MERIT
- TESTER INSTRUCTION MANUAL
- TELEVISION GUIDE & QUIZZES
- TELEVISION BOOK & RADIO TROUBLE-SHOOTING BOOK
- MEMBERSHIP IN RADIO-TV CLUB
- CONSULTATION SERVICE FCC AMATEUR LICENSE TRAINING
- PRINTED CIRCUITRY

## SERVICING LESSONS

You will learn trouble-shooting and servicing in a progressive manner. You will practice repairs on the sets that you construct. You will learn symptoms and causes of troubles in home, portable and car radios. You will learn how to use the professional Signal Tracer, the unique Signal Injector and the Dynamic Radio & Electronics Tester. While you are learning in this practical way, you will be able to do many a repair job for your friends and neighbors, and charge fees which will far exceed the price of the "Edu-Kit." Our Consultation Service will help you with any technical problems you may have.

J. Statalis, of 25 Poplar Pl., Waterbury, Conn., writes: "I have repaired several sets for my friends, and made money. The 'Edu-Kit' paid for itself, I was ready to spend \$240 for a course, but I found your ad and sent for your Kit."

## FROM OUR MAIL BAG

Ben Valerio, P. O. Box 21, Magna, Utah: "The Edu-Kits are wonderful! Here I am sending you the questions and also the answers for them. I have been in Radio for the last seven years, but like to work with Radio Kits, and like to build Radio Testing Equipment. I enjoyed every minute I worked with the different kits; the Signal Tracer works fine. Also like to let you know that I feel proud of becoming a member of your Radio-TV Club."

Robert L. Shuff, 1534 Monroe Ave., Huntington, W. Va.: "Thought I would drop you a few lines to say that I received my Edu-Kit, and was really amazed that such a bargain can be had at such a low price. I have already started repairing radios and phonographs. My friends were really surprised to see me get into the swing of it so quickly. The Troubleshooting Tester that comes with the Kit is really swell, and finds the trouble, if there is any to be found."

## UNCONDITIONAL MONEY-BACK GUARANTEE

**ORDER DIRECT FROM AD—RECEIVE FREE BONUS  
RESISTOR AND CONDENSER KITS WORTH \$7**

- Send "Edu-Kit" Postpaid. I enclose full payment of \$22.95.
- Send "Edu-Kit" C.O.D. I will pay \$22.95 plus postage.
- Rush me FREE descriptive literature concerning "Edu-Kit."

Name .....

Address .....

## PROGRESSIVE "EDU-KITS" INC.

1186 Broadway, Dept. 522AE, Hewlett, N. Y.

**MORE  
PICTURE  
POWER**  
new  
**BLONDER-TONGUE  
B-24  
POW-R  
BOOSTER**



**\$24<sup>95</sup>**  
*list*

*it's a powerful booster  
...or an amplified coupler!*

**provides sharp, clear TV pictures on  
1, 2 or more TV sets with only 1 antenna**

'straight-thru' circuit provides up to 10 db gain as a powerful one-set booster

'couple-two' circuit provides up to 5 db gain (per set) as an amplified two-set coupler

'straight-thru' circuit and B-T 4-set coupler provide no-loss 4-set distribution system

Employs new frame-grid tube 6DJ8, new circuitry to achieve highest signal gain and "lower-than-cascade" noise factor. Provides full broadband amplification covering low and high VHF channels. Features "NO-STRIP" 300 ohm terminals for positive, electrical connections in seconds. Has "on/off" switch.

Improve TV reception today on 1, 2 or more TV sets with a single antenna.



Available at parts distributors. For details write:  
**BLONDER-TONGUE LABORATORIES, INC.**  
9 Alling Street • Newark 2, N. J. • Dept. EI-4

In Canada: Teleequipment Mfg. Co., Ltd., London, Ont. Export: Morhan Export Corp., N. Y. 13, N. Y. • hi-fi components • UHF converters • master TV systems • industrial TV cameras • FM-AM radios

...News



A test oscillator, designed for fast, easy alignment and troubleshooting of RF, IF and detector sections of FM tuners and receivers is sold as a kit by the Heath Company of Benton Harbor, Michigan. The FMO-1 features switch-selection of fixed frequencies of 90, 100 and 107 mc and a 400-cycle tone signal. The 10.7 mc sweep oscillator has a variable sweep width from 200 kc to over 1 mc for IF alignment. All test frequencies (except the sweep circuit) are fixed. A 10 mc crystal-controlled oscillator incorporated in the FMO-1 is used to calibrate the instrument. Further specification available from the manufacturer.



A radar school for sea captains has been started in London to teach them all the tricks and quirks of a radar screen. The purpose is to learn to avoid "radar-aided crashes," as the captains call them. The basis of their training is a series of simulated voyages across two radar screens. The screens show five other vessels on different courses in the same neighborhood. In a thick fog the captains must pick their way through in safety. To complicate matters, a tricky coastline such as the Gibraltar Straits is also fed onto the screen. In all the weeks of training at Sir John Cass College, only one "collision" has occurred.



# Do you WISH you were EMPLOYED in ELECTRONICS?

## F.C.C. LICENSE—THE KEY TO BETTER JOBS

An F.C.C. *commercial* (not amateur) license is your ticket to higher pay and more interesting employment. This license is Federal Government evidence of your qualifications in electronics. Employers are eager to hire *licensed* technicians.

## WHICH LICENSE FOR WHICH JOB?

The **THIRD CLASS** radiotelephone license is of value primarily in that it qualifies you to take the second class examination. The scope of authority covered by a third class license is extremely limited.

The **SECOND CLASS** radiotelephone license qualifies you to install, maintain and operate most radiotelephone equipment except commercial broadcast station equipment.

The **FIRST CLASS** radio telephone license qualifies you to install, maintain and operate every type of radiotelephone equipment (except amateur) including all radio and television stations in the United States, its territories and possessions. This is the highest class of radiotelephone license available.

## GRANTHAM TRAINING PREPARES YOU

The Grantham course covers the required subject matter completely. Even though it is planned primarily to lead directly to a first class FCC license, it does this by **TEACHING** you electronics. Some of the subjects covered in detail are: Basic Electricity for Beginners, Basic Mathematics, Ohm's and Kirchhoff's Laws, Alternating Current, Frequency and Wavelength, Inductance, Capacitance, Impedance, Resonance, Vacuum Tubes, Transistors, Basic Principles of Amplification, Classes of Amplifiers, Oscillators, Power Supplies, AM Transmitters and Receivers, FM Transmitters and Receivers, Antennas and Transmission Lines, Measuring Instruments, FCC Rules and Regulations, and extensive theory and mathematical calculations associated with all the above subjects explained simply and in detail.

## OUR GUARANTEE

If you should fail the F.C.C. exam after finishing our course, we guarantee to give additional training at **NO ADDITIONAL COST**. Read details in our free booklet.

# Get Your First Class Commercial F.C.C. LICENSE QUICKLY!

## CORRESPONDENCE OR RESIDENCE CLASSES

Grantham School of Electronics *specializes* in F.C.C. license preparation. Correspondence training is conducted from Hollywood, Seattle, Kansas City and Washington; also, resident **DAY** and **EVENING** classes are held in all four cities. Either way, by correspondence or in resident classes, we train you quickly and well.

**This booklet FREE!**

This free booklet gives details of our training and explains what an F.C.C. license can do for your future.

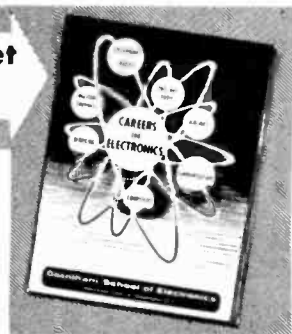

## HERE'S PROOF...

Grantham students prepare for F.C.C. examinations in a minimum of time. Here is a list of a few of our recent graduates, the class of license they got, and how long it took them:

Name	Address	License	Weeks
Robert J. Conley	129 W. 46th St., New York 36, N. Y.	1st	14
W. R. Smith	1335 E. 8th St., Long Beach, Calif.	1st	12
Howard E. Martz	301 S. Penn. St., Fairmount, Ind.	1st	24
John W. Dempsey	Box 55, Rising Sun, Md.	1st	12
Donald H. Ford	Hyannis Rd., Barnstable, Mass.	1st	12
Richard J. Falk	2303 Helman St., Bremerton, Wash.	1st	22
Denson D. McNulty	1117 N. Houston St., Amarillo, Texas	1st	9
James D. Hoagh	400 S. Church St., East Troy, Wisc.	1st	12
Odie B. Perry, Jr.	Rt. #3, Zebulon, N. C.	1st	12
Milton C. Gee	Rt. #1, Washington, N. J.	1st	11

# Grantham School of Electronics

- Hollywood Division**  
1505 N. Western Ave.  
Hollywood 27, Calif.  
(Phone: HO 7-7727)
- Seattle Division**  
408 Marion Street  
Seattle 4, Wash.  
(Phone: MA 2-7227)
- Kansas City Division**  
3123 Gillham Road  
Kansas City 9, Mo.  
(Phone: JE 1-6320)
- Washington Division**  
821-19th Street, N. W.  
Washington 6, D. C.  
(Phone: ST 3-3614)

## MAIL COUPON TO SCHOOL NEAREST YOU

(Mail in envelope or paste on postal card)

 **TO: GRANTHAM SCHOOL OF ELECTRONICS**  
1505 N. Western Hollywood • 408 Marion Seattle • 3123 Gillham Rd. Kansas City • 821-19th, NW Washington

Gentlemen:  
Please send me your free booklet telling how I can get my commercial F.C.C. license quickly. I understand there is no obligation and no salesman will call.

Name \_\_\_\_\_ Age \_\_\_\_\_  
Address \_\_\_\_\_  
City \_\_\_\_\_ State \_\_\_\_\_

I am interested in:  Home Study,  Resident Classes 08-D

**RESIDENT SCHOOL COURSES  
IN NEW YORK AND LOS ANGELES**



Industry needs Electronic Technicians!

# Let RCA train you in Advanced Electronics

This is the college-level training you need to work with professional engineers on research, development, or production projects in such fields as: automation, guided missiles, radar, television, computers, and other advanced electronic applications.

RCA Institutes Resident Schools in New York City and Los Angeles offer this comprehensive course that prepares you for any field of electronics you may choose. Other courses in TV and General Electronics, Radio and Television Servicing.

Classes start four times each year. Applications now being accepted.



## RCA INSTITUTES

SCHOOLS OF TELEVISION & ELECTRONIC TECHNOLOGY

A Service of Radio Corporation of America

Another Way RCA Serves Education Through Electronics

Send to the school nearest you!

**RCA Institutes, Inc., Dept. EIR-40**

350 West 4th Street  
New York-14, N. Y.

Pacific Electric Building,  
Los Angeles 14, Calif.

Please send me your FREE catalog of Resident School courses.

Name \_\_\_\_\_ (PLEASE PRINT)

Address \_\_\_\_\_

City \_\_\_\_\_ Zone \_\_\_\_\_ State \_\_\_\_\_

For Home Study Courses See Ad On Opposite Page

## ...News

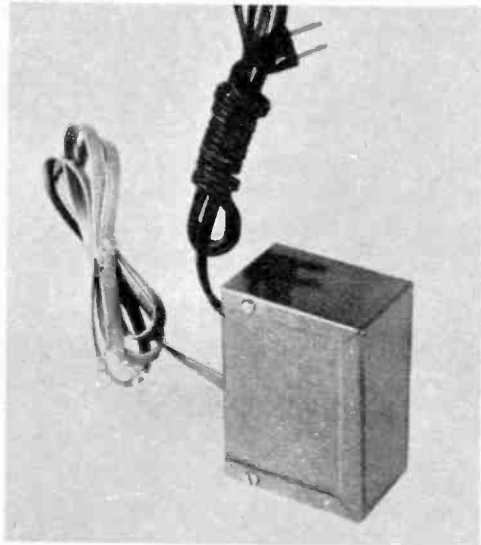

A device said to improve the reception of a TV set, especially if you live in fringe areas, has been put on the market by the TV Booster Co. Priced at \$4.98 or \$5.98 for the deluxe model, the booster plugs into any wall socket and connects to your TV antenna to improve your reception. Dept. 6, 403 Market St., Newark, New Jersey.

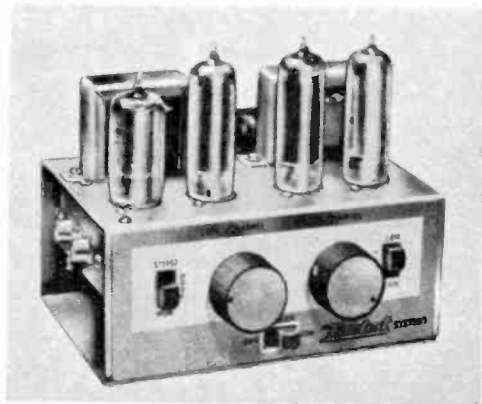

Lafayette has introduced a new low-priced stereo amplifier, the TruTest Stereo/5. Rated at 5 watts, this fully-wired amplifier is priced at \$10.45 and is a compact 4½" x 5½" x 4½". Lafayette, 165-08 Liberty Avenue, Jamaica 33, New York.



# LET RCA TRAIN YOU IN ELECTRONICS

*RCA Institutes, one of the world's leading electronic technical schools, offers a Home Study Course in . . .*

## *ELECTRONICS FOR AUTOMATION*

. . . Now you have *four* comprehensive courses for your electronic training . . . from basic electronic theory to the more advanced principles of color TV and Automation.

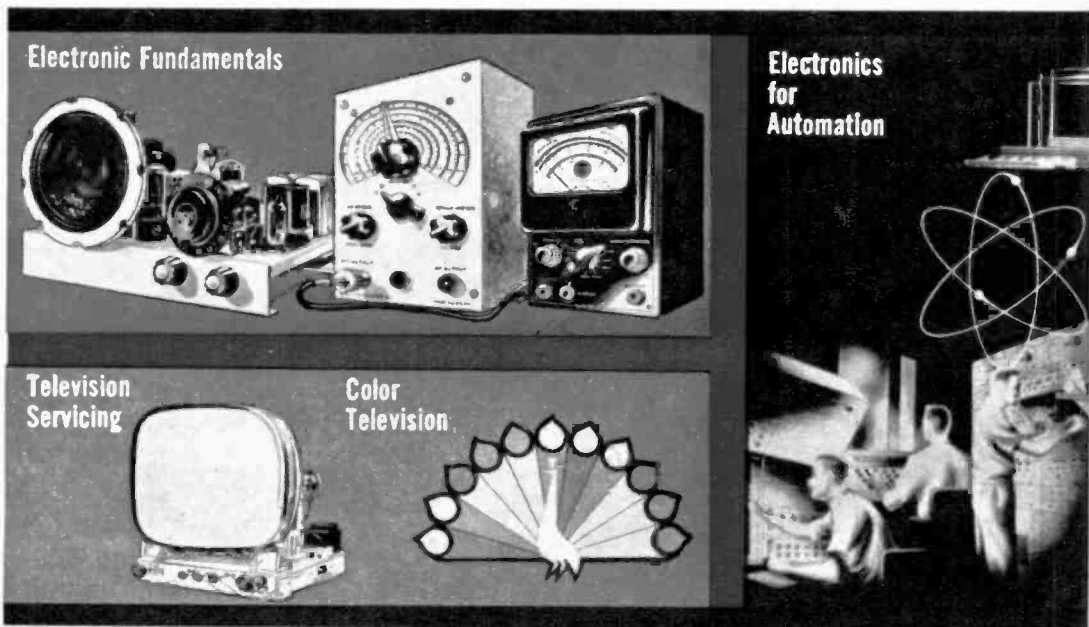

Send for our  
64 page Home  
Study Catalog

**FREE!**

FOR RESIDENT  
SCHOOL COURSES  
SEE AD ON  
OPPOSITE PAGE

ANOTHER WAY RCA SERVES EDU-  
CATION THROUGH ELECTRONICS



Practical work with the very first lesson. Pay-as-you-learn.  
You need pay for only one study group at a time.

**RCA INSTITUTES, Inc.** Home Study School, Dept. EI-40

A Service of Radio Corporation of America

350 West Fourth Street, New York 14, N. Y.

Please rush me your FREE illustrated 64-page book "Your Career in Electronics,"  
describing your home training programs. No obligation. No salesman will call.

Name  Age

Address  Please print

City  Zone  State

Veterans: Enter discharge date

**CANADIANS** — Take advantage of these same RCA courses at no  
additional cost. No postage, no customs, no delay. Send coupon to:  
RCA Victor Company, Ltd., 5001 Cote de Liesse Rd., Montreal 9, Quebec  
To save time, paste coupon on postcard.

# Here's HOW TO GET YOUR START in Radio-TV-Electronics!

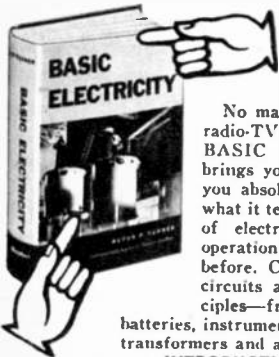

Now you'll really understand circuits—components—equipment!

No matter what you want to do in radio-TV-electronics, this big 396-page **BASIC ELECTRICITY** Manual brings you the down-to-earth training you absolutely must have. Backed by what it teaches, you'll find every detail of electric-electronic procedure and operation far clearer to you than ever before. Covers the entire field—from circuits and currents to 'phone principles—from tubes to transistors to batteries, instruments & measurements; motors; transformers and all the rest. Also includes 61-page **INTRODUCTION TO ELECTRONICS**. More than 300 pictures make subjects doubly clear. Price \$6.50.

**10-DAY FREE TRIAL!**

Dept. PR-40, RINEHART & CO., Inc.,  
232 Madison Ave., New York 16, N.Y.

Send **BASIC ELECTRICITY** home training manual for 10-day **FREE** Examination. If I like book I will then send \$6.50 (plus postage) in full payment. Otherwise I will return book and owe nothing. (SAVE! Send \$6.50 with order and we pay postage. Same 10-day moneyback guarantee.)

Name \_\_\_\_\_

Address \_\_\_\_\_

City, Zone, State \_\_\_\_\_

Outside U.S.A. \$7.00 cash. 10-day money back guaranter.

# Olson

**\* FREE \***

Fill in coupon for a **FREE** One Year Subscription to **OLSON RADIO'S Fantastic Bargain Packed Catalog** — Unheard of **LOW, LOW, WHOLESAL** PRICES on Brand Name Speakers, Changers, Tubes, Tools, Hi-Fi's, Stereo Amps, Tuners and other Bargains.

NAME \_\_\_\_\_

ADDRESS \_\_\_\_\_

CITY \_\_\_\_\_ ZONE \_\_\_\_\_ STATE \_\_\_\_\_

If you have a friend interested in electronics send his name and address for a **FREE** subscription also.

**OLSON RADIO CORPORATION**

406 Forge Street Akron 8, Ohio

## ...News

In the midst of all the ayes and nahs about the subject, the Electronic Industries Association has asked the FCC to establish a National Stereophonic Radio Committee to determine the best stereophonic system and recommend standards for the industry. Most firms are waiting for Justice Department approval before they will participate for fear of being cited under anti-trust laws.

One proposal the EIA is trying to put into effect is requiring packaged electronic parts to be marked with the country of origin even if the importer repackages the parts. Requiring imported parts to be so marked even though they are used in a final assembly is another of their endeavors.

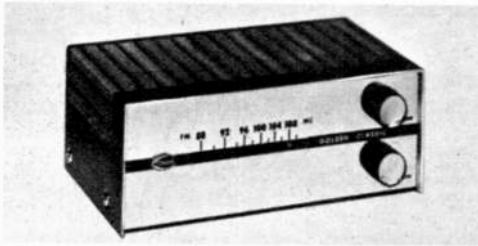

This FM tuner, now being marketed by Olson, has been designed with a built in power supply and tape recording output jack. It incorporates an AFC circuit and 3.5 microvolt input for 20 db of quieting sensitivity. The RA-338 is available from Olson at 260 South Forge, Akron, Ohio at \$35.95.

Educational closed-circuit television is making its appearance in Connecticut with the help of CBS. Initiating the system in the Springdale School in Stamford, that city's Board of Education says "the Stamford Educational TV Workshop has been established for the purpose of providing a springboard for the improvement and enrichment of the education of our children in this city." The complete installation is being supervised by CBS Laboratories.



Accredited by the National Home Study Council

good training  
doesn't cost . . .  
it pays!

# How To Get an



Get Your FCC License  
Quickly

## Your FCC License or Your Money Back

### Get all 3 FREE

**We Guarantee**  
To Train You While You Receive  
**Your FCC License**  
—or Your Money Back

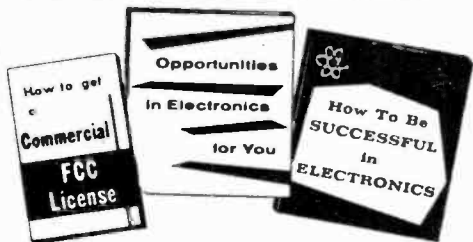

**Cleveland Institute of Electronics**

The Master Course in Electronics will provide you with the mental tools of the electronics technician and prepare you for a First Class FCC License (Commercial) with a radar endorsement. When you successfully complete the Master Course, if you fail to pass the FCC examination, you will receive a full refund of all tuition payments.

**Cleveland Institute training results in job offers like these:**

#### Radio Operators

TWA has opportunities for radio operators with a 2nd class license or better. Must be able to type at least 35 wpm. Free transportation for self and family. Vacation and many other benefits.

#### Electronic Technicians

Goodyear Aircraft Corp. has openings for electronic technicians, to work as assistants to engineers on developmental electronics projects such as missile systems, radar, antennas and analog computers.

### And our trainees get good jobs

"Investment in training really pays off"

"I am now employed by the Western Electric Company as an electronic tester. My status as a student of Cleveland Institute was an important factor in my being employed. Knowledge gained through the course has proved amazingly helpful and affords me a feeling of complete confidence."

T. E. Spence, Greensboro, N. C.

### Cleveland Institute of Electronics

4900 Euclid Ave.

Desk EI-19

Cleveland 3, Ohio

Desk EI-19, 4900 Euclid Ave., Cleveland 3, Ohio

Please send Free Booklets prepared to help me get ahead in Electronics. I have had training or experience in Electronics as indicated below:

<input type="checkbox"/> Military	<input type="checkbox"/> Broadcasting
<input type="checkbox"/> Radio-TV Servicing	<input type="checkbox"/> Home Experimenting
<input type="checkbox"/> Manufacturing	<input type="checkbox"/> Telephone Company
<input type="checkbox"/> Amateur Radio	<input type="checkbox"/> Other _____

In what kind of work are you now engaged? \_\_\_\_\_

In what branch of Electronics are you interested? \_\_\_\_\_

Name \_\_\_\_\_ Age \_\_\_\_\_

Address \_\_\_\_\_

City \_\_\_\_\_ Zone \_\_\_\_\_ State \_\_\_\_\_

EI-19

# BIG MONEY IN THE 4 CORNERS OF THE WORLD!

in TELEVISION, RADIO,  
ELECTRONICS, RADAR, SONAR

**CHRISTY OFFERS  
COMPLETE TRAINING!**

Investigate the Christy Complete Course. Why be satisfied with less? CTS Shop Method Home Training makes learning easy. You learn by working with actual equipment. You receive Comprehensive training from the start. Can EARN AS YOU LEARN. You become qualified to open your own Electronics Repair business or to gain high pay as a TV, Radio, Electronics, etc. Technician.

**19 TRAINING KITS INCLUDED!**

You receive a Multi-Tester, Oscillator, Signal Tracer, Oscilloscope, Signal Generator, Electronic Timer, Regenerative Radio, 24" TV set (optional) and other valuable testing equipment. **FREE BOOK** and **TWO FREE LESSONS** yours for the asking! No obligation.

**CHRISTY TRADES SCHOOL**

Dept. T-813, 3214 W. Lawrence Ave.,  
Chicago 25, Ill.

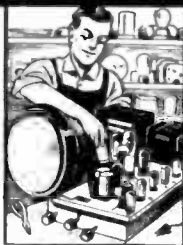

**SEND for 3  
FREE  
BOOKS**

CHRISTY TRADES SCHOOL, Dept. T-813

3214 W. Lawrence Ave., Chicago 25, Ill.

Please send me the 3 FREE BOOKS and Special Form for  
PAYING LATER from EARNINGS MADE WHILE LEARNING.

NAME \_\_\_\_\_ AGE \_\_\_\_\_  
ADDRESS \_\_\_\_\_  
CITY \_\_\_\_\_ ZONE \_\_\_\_\_ STATE \_\_\_\_\_

## FREE!

H. H. Scott Helps You  
**PLAN FOR STEREO**  
With New Hi Fi Guide  
and Catalog



H.H. Scott Inc., 111 Powdermill Road, Dept. E1-4, Maynard, Mass.

Rush me your **FREE Hi Fi Guide** and catalog to help me plan my stereo system.

Name \_\_\_\_\_  
Address \_\_\_\_\_  
City \_\_\_\_\_ State \_\_\_\_\_

...News

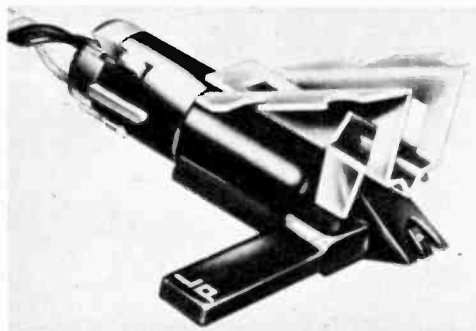

Sonotone Corporation is selling a new ceramic stereo cartridge, the "10 T" for \$6.45, including the mounting bracket and with the standard 0.7-mil, 3-mil turnover sapphire tips. It is also available with a sapphire-diamond combination at \$16.50. The high output of half a volt eliminates the need for preamplifiers. The cartridge uses a fuse-clip type mounting bracket and a jack-in type terminal plug which remains fastened to the tone arm wires. Sonotone Corp., Elmsford, New York.

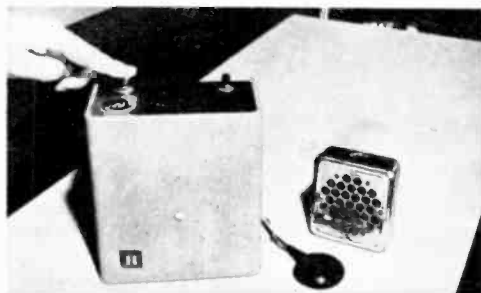

Young children and unguarded pools can often be a tragic combination. With this fact in mind, Minneapolis-Honeywell developed an alarm so sensitive it can detect a hand splashing in the water. Priced at about \$200 the system includes a sensing element submerged approximately a foot below the water surface and the alarm which can be located up to 100 feet from the pool. Full information is available from Minneapolis-Honeywell, 2747 Fourth Avenue South, Minneapolis 8, Minnesota.

**AT  
LAST!**

# RADIO-TV and ELECTRONICS TRAINING

**.... AT A PRICE  
YOU CAN AFFORD!**



**\*21 INCH**  
Receiver Kit included

Yes, this great course costs for less than any training of its kind given by other major schools! Radio-Television Training School will train you for a good job in Television or Industrial Electronics — **AT HOME IN YOUR SPARE TIME.**

Think of it — a complete training program including over 120 lessons, Fourteen Big Radio-Television Kits, Complete Color-TV Instruction, Unlimited Consultation Service ... **A&L at a really big saving to you.** How can we do this? Write to us today ... and find out!

And what's more — you can (if you wish)  
**OPEN YOUR OWN RTS-APPROVED AND  
FINANCED RADIO-TV SERVICE SHOP**

**We Want Many More Shops This Year**

This 38 year old training organization — called RTS, that's Radio-Television Training School — wants to establish a string of Radio-TV Repair Shops in principal cities throughout the U. S. So far, a great many such shops are **NOW IN BUSINESS AND PROSPERING.** We are helping and training ambitious men to become future owners and operators of these shops in all areas.

**FOR UNSKILLED  
INEXPERIENCED MEN ONLY —  
WE TRAIN YOU OUR WAY!**

We must insist that the men we sign up be trained in Radio-TV Repair, Merchandising and Sales by our training methods—because **WE KNOW** the requirements of the industry. Therefore, we will **TRAIN YOU** ... we will show you how to earn **EXTRA CASH**, during the first month or two of your training period. **YOU KEEP YOUR PRESENT JOB. TRAINING TAKES PLACE IN YOUR OWN HOME, IN YOUR SPARE TIME!**



Get your free book on the  
**FAMOUS RTS BUSINESS PLAN**  
find out how you can open  
**A REPAIR SHOP OF YOUR OWN**

*We supply and finance your equipment*

When you are ready and qualified to operate one of our RTS-Approved TV Repair Shops **WE WILL SUPPLY AND FINANCE EVERY BIT OF EQUIPMENT YOU NEED TO GET STARTED** plus an inventory of parts and supplies. In other words we will stake you **AN OFFER NEVER MADE BEFORE BY ANY TRAINING ORGANIZATION.** Under the RTS Business Plan you receive:

1. An electric sign for the shop front.
2. Complete laboratory of test equipment.
3. Letterheads, calling cards, repair tickets, etc.
4. Basic inventory of tubes, parts, supplies.
5. Complete advertising and promotional material.
6. Plans for shop arrangement.
7. Instructions on how to go into business.
8. Continuous consultation and help.
9. The right to use RTS Seal of Approval, and the RTS Credit.
10. The right to use the Famous Trade Mark.



you build these  
and other units

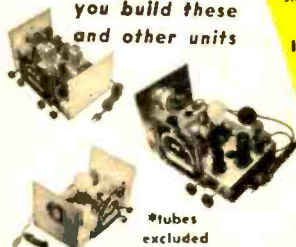

\*tubes  
excluded

## RADIO-TELEVISION TRAINING SCHOOL

5100 S. VERMONT AVENUE  
LOS ANGELES 37, CALIFORNIA

Est. 1922



**ACT  
NOW!**

**CUT OUT AND MAIL — TODAY!**

### RADIO-TELEVISION TRAINING SCHOOL

5100 S. Vermont Avenue, Dept. E1-400  
Los Angeles 37, California

SEND ME FREE — all of these big opportunity books — "Good Jobs in TV-Electronics," "A Repair Shop of Your Own" and "Sample Lesson." I am interested in:

- Radio-Television       Industrial Electronics (Automation)

Name \_\_\_\_\_ Age \_\_\_\_\_

Address \_\_\_\_\_

City & State \_\_\_\_\_

300



RTS' Membership in The Association of Home Study Schools is your assurance of Reliability, Integrity, and Quality of Training.

**ALL  
THESE  
FREE!**



# RADIO SHACK FLASH!

Send Coupon for Latest  
**FREE**  
**ELECTRONICS CATALOG**  
 plus every new issue for 1960



For the newest and best in electronics equipment—stereo, hi-fi, ham radio, tapes—mail coupon today for Radio Shack's latest FREE 312 page catalog. Also get every new edition for next 12 months, Free. Satisfaction guaranteed or your money back. Mail coupon now.

Radio Shack Corp., 730 Commonwealth Ave.,  
 Boston 17, Mass. Dept. 6000

Send FREE Electronics Catalog—Also every new issue for 12 months, a full year's subscription Free.

Name \_\_\_\_\_

Address \_\_\_\_\_

Postoffice \_\_\_\_\_ Zone \_\_\_\_\_ State \_\_\_\_\_

or City \_\_\_\_\_

**DON'T** buy, remodel  
 or build until you've  
 read Today's Home



Latest information on  
 Financing—Exteriors  
 Interiors—Airconditioning  
 Electricity—Humidity  
 Kitchens—Bathrooms

A Fawcett Publication 50¢



Special Section—  
**SWIMMING POOLS**—How YOU can own one  
 planning—construction—equipment

## ...News

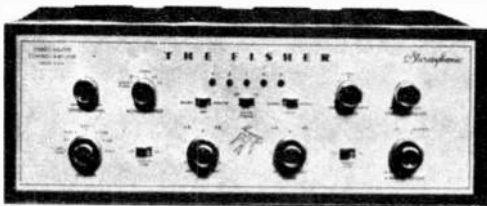

Fisher Radio is now marketing their X-22 Stereo Master Audio Control, successor to the X-101. Featuring three channel stereo, the X-22 is priced at \$229.50. Complete specifications are available from Fisher Radio, 21-21 44th Drive, Long Island City 1, N. Y.



A UCLA research team reports that electromagnetism may be used to stimulate the conscious human brain, produce mental, emotional and hormonal responses, and stimulate nerves, muscles and other irritable tissues. The team has been able to stimulate frog nerves and exercise frog muscles by placing them in an alternating magnetic field. Visual and other sensory effects were induced in human subjects by electromagnetic fields adjacent to the skull. The use of electromagnetically-induced eddy currents to stimulate or inhibit limited brain areas, if practical, could be done without surgery in a conscious subject, and would greatly facilitate exploration of how the brain controls human behavior.



A complete guide to U. S. FM and FM-AM radio stations is available to the readers of *ELECTRONICS ILLUSTRATED* from Blonder-Tongue Laboratories, Inc. The listings, which are arranged alphabetically by states and cities for easy reference, have both the call letters and frequency of each station. To obtain this folder, write to Blonder-Tongue Labs., 9 Alling Street, Newark, N. J., and ask for form FMS-10-129. For fastest service, mention that you learned about this new radio guide in *EI*.



**IMPORTANT: For the man who wants to make big money in Radio-Television!**

# ONLY SPRAYBERRY TRAINING IN RADIO and TELEVISION

offers you all of these vital new advantages to help you earn more money from the start!

## NEW Business Builders

... through these practical proven plans and ideas we help you make plenty of extra money in spare time while training!

## NEW Training Equipment

... the famous Sprayberry Training kits have been newly engineered by our staff to offer you the latest in Radio-TV Service Techniques!

## NEW Transistor Course

... literally millions of new transistor radios are being used. We show you how to make money fixing them!

## NEW High Fidelity

... there's big money to be made installing and servicing Hi-Fi units. Your Sprayberry training now offers you this valuable and profitable preparation!

### TRAIN AT HOME—SPARE TIME

WITH THESE **25 BIG COMPLETE KITS of PARTS & EQUIPMENT**

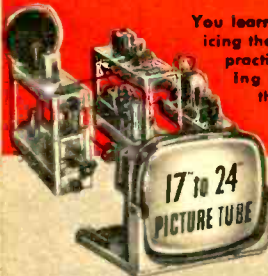

You learn Radio-TV Servicing the best way... the practical way... testing and assembling these modern kits of equipment.

◀ The new Sprayberry Training Television Receiver, built and tested in 5 sections.

Now offered... this fine modern oscilloscope.

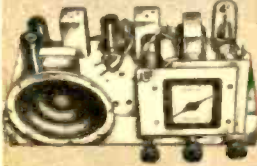

◀ You build this powerful two-band super-heterodyne radio receiver.

You build the new Sprayberry tester—a complete 10-range Volt-Ohm-Milliammeter test meter.



**FREE** These two big new books are yours free! Find out what Radio-Television offers you... And let us show you how easily you can learn, even without previous experience of any kind. Rush COUPON today!

**SPRAYBERRY ACADEMY OF RADIO-TELEVISION**  
Dept. 120-J 1512 West Jarvis Ave., Chicago 26, Ill.

The field of Radio-Television Servicing is such a fast moving industry that the best jobs and biggest incomes always go first to the man with the most modern, complete and up-to-date training. Thanks to constant revision and improvement... Sprayberry Training helps you earn more from the start... and keeps you earning more in the months and years ahead!

Make no mistake! All radio-television training is not alike. The basic purpose behind Sprayberry Training is to prepare you as rapidly and as surely as possible... to make top money servicing Radio and Television sets and equipment. This is where the big money has been for years... and will continue to be in the years ahead.

It's important for you to know that for over 30 years... Sprayberry Training has been preparing ambitious men for success in this interesting and profitable kind of work. Our school has helped hundreds to qualify for the best jobs... or to get started in profitable businesses of their own. Today our student rolls are the largest in our school's history... because the need and demand for Radio-Television Service Technicians has never been more urgent.

### Just \$6.00 Starts You

To encourage more men to enter Radio-Television at once... to help fill the great need for trained men... we're making it easier than ever before to start training. Just \$6.00 enrolls you. This liberal offer is naturally limited. Get the facts now

and consider enrollment while these favorable terms are available to you.

### KEEP YOUR JOB... while learning

Under the Sprayberry Plan you train entirely at home in spare time. You combine the most modern lesson training with fascinating and invaluable practical work with 25 big kits of parts and equipment that we supply. You get the equivalent of years of shop practice... and you can train as fast or as slowly as you wish. We help you make excellent spare time money while learning... and everything you receive—lessons, books, manuals, equipment—all yours to keep!

This is the Radio-Television industry's most modern and up-to-the-minute training. Sprayberry is the one school that gives you personalized attention and takes a real interest in your progress. Remember... just \$6 starts you! Mail the coupon today. Let the facts speak for themselves. Let us send you our new catalog and sample lesson... and prove the kind of opportunity that Sprayberry training can open up for you.



### MAIL COUPON - No Salesman Will Call

**SPRAYBERRY ACADEMY OF RADIO-TELEVISION**  
DEPT. 120-J, 1512 W. JARVIS AVE., CHICAGO 26, ILL.

Please rush all information on your ALL-NEW Radio-Television Training Plan. I understand this does not obligate me and that no salesman will call upon me. Include New Catalog and Sample Lesson FREE.

NAME \_\_\_\_\_ AGE \_\_\_\_\_

ADDRESS \_\_\_\_\_

CITY \_\_\_\_\_ ZONE \_\_\_\_\_ STATE \_\_\_\_\_

## ONE CENT SALE

BUY ONE AT OUR REGULAR LOW PRICE AND  
GET THE SECOND FOR ONLY 1¢ MORE

**CITIZENS BAND TRANSMITTER** (27 MC) chassis complete with crystal. \$12.49 each, two for \$12.50.

**TRANSMITTER** similar to above but with 5 watt RF stage instead of 1 watt. \$14.99 each, two for \$15.00.

**CITIZENS BAND RECEIVER** chassis tunable through all 22 channels. Complete with audio amplifier. \$9.99 each, two for \$10.00.

**AMATEUR BAND TRANSCEIVER** (144-148 MC) chassis with dual VHF triodes for walkie-talkie radiophone. \$9.99 each, two for \$10.00.

**TRANSCEIVER TRANSFORMER:** Mike to grid input and plate to low impedance headphone output. Good for telephone handsets, \$1.99 pair, two for \$2.00.

**TELEPHONE HANDSET** with push-to-talk switch. \$5.99 each, two for \$6.00.

**MICROPHONE** High output 200 ohm carbon with terminal lugs. \$1.49 each, two for \$1.50.

**COILED CORD** 4 conductor 11" telephone cord. Extends to over 4 ft. .99 each, two for \$1.00.

**KIT OF PARTS** for AM-FM VHF radio receiver. Tunable from 80-200 mc, which includes U. S. satellite frequencies. \$6.99 each, two for \$7.00.

**TRANSISTOR AUDIO AMPLIFIER** gives 50X voltage gain on low level signals. Operates on 1½ volts. \$3.99 each, two for \$4.00.

**CONVERTER** (crystal controlled) for 27 MC Citizens Band. Adapts any standard broadcast radio to 27 MC band. Tunes all 22 channels. Complete with tubes and crystal. \$14.99 each, 2 for \$15.00.

**TRANSMITTER CRYSTALS** in holders. Assorted frequencies for experimenters. Bag of 10 only \$1.49, two bags for \$1.50.

### ALL MERCHANDISE GUARANTEED

Limited Quantity—No Literature or Catalog

Remit in full, include sufficient postage. No C.O.D.'s.

**VANGUARD ELECTRONIC LABS.** Box 12-EL-4  
Melis 23, N. Y.

## TV ON THE BLINK?

Learn how you can fix almost all TV breakdowns quickly and easily using professional trouble-shooting techniques. Hundreds of money saving, step-by-step repair hints, pictures and diagrams.

## PROFESSIONAL TV REPAIR SECRETS

75 cents  
On sale at  
your favorite  
newsstand

FB #435



Mail orders to: FAWCETT BOOKS,  
Dept. E1-4, Greenwich, Conn. Add  
10 cents per copy to cover mail-  
ing. Sorry, no Canadian orders.

## ...News

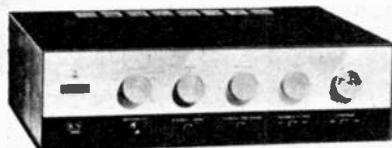

A 40-watt stereo amplifier including a stereo separation control to provide continuous variable transition from stereo to monophonic reproduction has been put on the high fidelity market by Allied Radio. This Knight KN-740 is priced at \$99.50 and is available from 100 N. Western Avenue, Chicago, Ill.

In those distant BS (Before Stereo) days when all hi-fi attention was riveted on getting the most from monophonic records, one of the best, most expensive and trickiest record pickups was the cat's-whisker light FM cartridge made by Weathers Industries. This was not for the masses but for the truly erudite hi-fier. Then stereo came and with it the hectic introduction of stereo cartridges, some assuredly not hi-fi. The conversion of the FM pickup proved to be a difficult task, so Weathers marketed a high quality ceramic pickup. Now comes word that the stereo FM pickup may make its appearance soon—in fact, laboratory models of the FM cartridge have already been whispering sweet promises in the ears of Weathers' engineers. All devoted hi-fiers will look forward to production models with interest.

A newly discovered source of radio interference is unshielded heaters that use radio waves to fuse plastic together. The FCC is having a difficult time tracking culprits because as the plastic melts, the radio frequency changes. Most troubled by this interference are radio navigation aids used by airplane pilots and police communications.

Miracle of the year! At last! A TV Booster for everyone!

# TV Booster Makes All TV Sets Work Better

Improve TV reception! Our wonderful new device can improve reception from any TV antenna now available to consumers anywhere. For the first time you can enjoy really high class viewing at really low cost. This wonderful new device called TV BOOSTER will cost you nothing to run. No operating expenses whatsoever. Uses no electricity. Completely safe and it never wears out. Once applied you never have to see or touch it again. For the best reception you've ever seen at next to no cost, we guarantee greatly improved results. All stations in your viewing area can be better seen and you'll get the clearest pictures you have ever dreamed possible, sold on money back guarantee!

## Give Your TV Set A Boost

You spent a fortune on your set and are spending even more repairing it. Every single year your TV repair bill gets larger. Every single year your reception gets worse, and worse, and worse. Is this a vicious cycle? No! Too often it's the fault of your TV antenna! If you live indoors, you probably have a cheap three-foot long rabbit ears antenna. With the two three-foot long pieces of wiring sticking out unsightly like a rabbit's ears. If you own your own home or live in an apartment you probably have a so-called large antenna on top of your roof, the cost to install it was probably about one third over and above the cost of your set or about \$100.00. And so what happens? Along comes a storm and down comes the poor antenna, after the storm you turn on your set and the whole mess with hazy pictures is back again maybe worse!

## Now: New Living TV Viewing

There is something that will help. Think of it! For years you've had to see washed out hazy pictures on your TV screen but now you can use an antenna that's not 3, not 30, but hundreds of feet long. Now don't get alarmed. Your antenna is already in your house. The wires in the walls will give your TV a boost you want and need so badly. All you need to put your house wiring to work for you is a little time, about two minutes. One magnificent simple device

called TV BOOSTER can do this for you at an amazing low price of \$4.95. Use the wires in the walls of your home or apartment to boost your TV reception.

## Start Using Electronic Components That Put Pleasure Into TV Viewing!

The wiring in your home spreads out in every direction and can be put to work for you. These wires in your home pick up radio and TV signals from all directions in the same manner that radar picks up signals from thousands of miles away, it makes a wonderful TV booster.

## Start Getting Maximum Pulling Power From Your Housewiring with TV Booster! Or Your Money Back.

It works on any year, make or model TV set ever made. We guarantee you must be 100% satisfied or you get every cent back! It must boost your TV reception or your money back.

## Amaze Your Family With Super TV Reception

To connect the TV BOOSTER to your set takes only about 2 minutes and a screwdriver. You don't even get your hands dirty. You simply plug it into the nearest electric socket and connect its wires to your set and it's connected forever—anyone can do it. Just unscrew your present antenna wires. Slip on the wires of TV BOOSTER and plug in its cord. Use your TV antenna and your TV BOOSTER. Now turn on the weakest channel, try reversing the plug and leave it in the socket in the way you get the clearest brightest picture. That's all there is to it! Every other channel will show you an amazing difference from pictures you have seen before—you will enjoy better sound, and more living pictures than you have ever seen before. You'll begin to enjoy living TV better than you've ever dreamed possible or you get every cent back. Try it—you are the sole judge. Your money back if not thrilled with results.

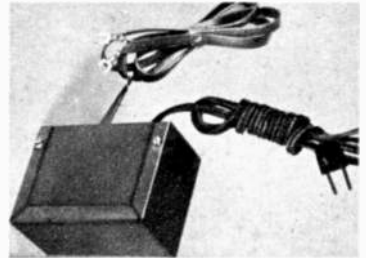

## From The Latest Advancement In Radar Electronic Research To You The Tops In TV Boosters!

Now with the latest developments of Electronic Radar Research comes breathtaking TV reception—Living TV so wonderful you'll say you can't believe your eyes. Send today for the miracle TV BOOSTER that will improve all television sets and turn them into Living TV. TV BOOSTER is sold only by mail and is not sold in stores. Don't delay—try it on our money back guarantee—send for it Today. Mail Coupon Now.

**TV BOOSTER CO. Dept. 149  
403 Market St., Newark,  
New Jersey**

Rush my TV BOOSTER to try at your risk. I must be 100% satisfied or I can return it after a full week's trial and get my money back—I am to be the sole judge. I enclose \$4.95 cash, check or M.C., send postage prepaid. (I save up to 75c postage by sending full payment with my order.) I must be delighted with the reception of every single channel in my area or I get my money back.

I enclose \$5.95 send Deluxe Model.

NAME .....

ADDRESS .....

CITY..... STATE.....

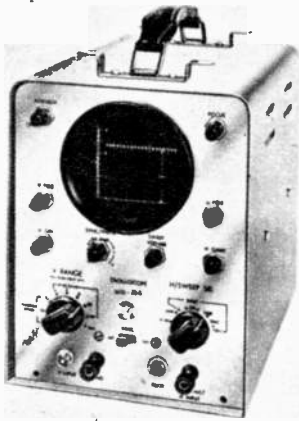

RCA is featuring a new portable oscilloscope in kit and wired units. WO-33A has a 3-inch screen and manufacturer maintains assembly is fairly easy. Kit is \$79.95 and \$129.95 for the wired model. Complete specs available from RCA at 30 Rockefeller Plaza, New York City.

Some tenants in a luxury apartment building in New York said recently closed circuit TV was no substitute for a husky elevator operator when it comes to tangling with muggers in elevators. The Elba Management Co., which manages the apartment building arranged for the installation of the closed circuit TV camera in the elevator to be monitored by the doorman, but tenants complained to the local rent administrator that they were not assured that the proposed closed-circuit TV system would work properly. At press time no decision had been reached.

British scientific instrument makers expect to boost sales to the USSR by holding an exhibition in Moscow. About 36 manufacturers have already agreed to participate.

With the addition of stations in Baltimore and Washington, D. C., WQXR will become the largest FM network in the United States.

Build the Best **CITIZENS BAND TRANSCEIVER** ... **EICO**



- =760 (117 VAC) less bracket: Kit \$59.95. Wired \$89.95
- =761 (117 VAC & 8 VDC): Kit \$69.95. Wired \$99.95
- =762 (117 VAC & 12 VDC): Kit \$69.95. Wired \$99.95

Highly reliable; exemplary electronic, mechanical, industrial design. Powerful 5-watt (as defined by FCC) crystal-controlled transmitter & extremely sensitive, selective superhet receiver with RF stage & noise limiter. Built-in speaker, detachable ceramic mike. Pre-set & sealed crystal oscillator circuit elements. To change channels, just change crystals — no adjustments needed. Built-in variable "pi" network matches most popular antennas. Portable whip, rear bumper & roof antennas available. No exams or special skill needed — any citizen 18 years or older may obtain station license by submitting FCC form, supplied free by EICO.



Build the Best **6-TRANSISTOR RADIO RA-6**  
Kit \$29.95    Wired \$49.95  
includes FET, less 9V battery

High sensitivity & selectivity. New plug-in type transistors. Big-set volume & tone: 4" x 6" speaker; push-pull audio. Built-in Ferrite rod antenna. Pre-aligned RF & IF transformers. Planetary vernier tuning. Earphone jack for private listening. Attractive tan leatherette case, retractable handle. Compact: 8½" w, 4½" h, 2½" d. Only 3 lbs.



**90-WATT CW TRANSMITTER #720**  
Kit \$79.95    Wired \$119.95

"U.S. Pat No. D-184,776

"Top quality" — **ELECTRONIC KITS GUIDE**. Ideal for veteran or novice. 90W CW, 65W external plate modulation. 80 through 10 meters.



**HIGH-LEVEL UNIVERSAL MODULATOR-DRIVER #730**  
Kit \$49.95    Wired \$79.95

Cover E-5 \$4.50  
Delivers 50W undistorted audio. Modulates transmitters having RF inputs up to 100W. Unique over-modulation indicator.



**New Code Practice Oscillator #706**  
Kit \$8.95    Wired \$12.95

Rugged battery-operated transistor oscillator circuit, built-in speaker. Front panel has flashing light, phone jack, pitch control (500-2000 cps), external key terminals, "temporary" key. Panel switch selects Tone, Light, or both Tone & Light. 6½" h, 3¾" w, 2¾" d.



**GRID DIP METER #710**  
Kit \$29.95    Wired \$49.95

Includes complete set of coils for full band coverage. Continuous coverage 400 kc to 250 mc. 500 ua meter.

Compare — judge for yourself — at your neighborhood EICO dealer. For **FREE** catalog on over 70 models of easy-to-build professional test instruments, hi-fi and ham gear, fill out coupon on Page 28.



Add 5% in the West. ©1960

3300 N. Blvd., L. I. C. 1, N. Y.

## ...News

### New Bulletins and Catalogs . . .

Airex Radio Corp. has published a catalog containing hi-fi and stereo equipment in all price ranges. Free from 64 Cortland St., New York, New York.

"Servicing Transistor Equipment" recommends tools and equipment for use in servicing transistors. Helpful hints also given. Available from CBS Electronics, Information Services, 100 Endicott St., Danvers, Mass.

Edmund Scientific Co. is offering a 128-page catalog filled with information on new math, scientific and optical items. Technical data and war surplus items are included. For prompt receipt of "Industrial Equipment Catalog and Guide to Math, Science and Optics," write to Edmund Scientific, Barrington, New Jersey, and mention that you saw the offer in *EI*.

The new line of stepper motors and pulsed stepping devices has been incorporated into a catalog made available by the A. W. Haydon Company, 232 North Elm Street, Waterbury, Conn.

Hoffman Electronics has introduced a new semiconductor applications report, "Applying Thermal Characteristics of Silicon Diodes." It may be obtained from Semiconductor Div., Hoffman Electronics Corp., 1001 Arden Drive, El Monte, Calif.

A catalog describing dials, drives and mechanisms has been introduced by National. Bulletin 59-6 is free from National, Malden, Mass.

H. H. Scott has published two new catalogs, one featuring their "Stereo-master High Fidelity Components for 1960" and the other describing "How to Use Stereo Components in Your Decorating Plans." Both illustrated booklets available from H. H. Scott, Inc., 111 Powdermill Road, Maynard, Mass. Mentioning *EI* will result in quick service.

"A New Era of Sylvania Electronic Tubes" is the title of a new catalog describing prototypes of the electron tube of tomorrow. Copies may be obtained from Sylvania, 1100 Main Street, Buffalo, New York.

**FREE** it's value-packed...  
SEND FOR IT!

# ALLIED'S MONEY-SAVING 1960 ELECTRONIC SUPPLY CATALOG

**SAVE ON EVERYTHING IN ELECTRONICS**

ONLY \$2 DOWN on orders up to \$50; only \$5 down on orders up to \$200; \$10 down over \$200.



**Largest Selection—Lowest Prices**

Send for the most widely used buying guide to everything in Electronics for Builders, Experimenters, Hi-Fi fans, Amateurs, Servicemen and Engineers. Save on:

- KNIGHT-KITS®—Best in Build-Your-Own
- Everything in Stereo Hi-Fi
- Hi-Fi Music Systems and Components
- Tape Recorders & Phono Equipment
- TV Tubes, Antennas, Accessories
- Parts, Tubes, Transistors
- Everything in Tools & Technical Books
- Amateur Station Equipment
- Public Address & Paging Systems
- Latest Test & Lab Instruments

SAVE on everything in Electronics at ALLIED—get fastest service, expert personal help, guaranteed satisfaction. Send today for your FREE 1960 ALLIED Catalog.

our 39th year



**SEND FOR FREE CATALOG**



**ALLIED RADIO**

- ALLIED RADIO CORP., Dept. 86-D
- 100 N. Western Ave., Chicago 80, Ill.
- Rush FREE 1960 ALLIED Catalog.

Name \_\_\_\_\_

Address \_\_\_\_\_

City \_\_\_\_\_ Zone \_\_\_\_\_ State \_\_\_\_\_

the experts say  
**your BEST BUY**  
 is **EICO**...

EICO, 3300 N. Blvd., L.I.C. 1, N.Y. EI-4

Show me HOW TO SAVE 50% on 70 models of top-quality:  HI-FI  TEST INSTRUMENTS  
 "HAM" GEAR.  Send FREE Stereo Hi-Fi Guide.  Send FREE Short Course for Novice License.  Send FREE Catalog & name of neighborhood EICO dealer.

Name \_\_\_\_\_  
 Address \_\_\_\_\_  
 City \_\_\_\_\_ Zone \_\_\_\_\_ State \_\_\_\_\_

ADD 5% IN THE WEST

...in  
**STEREO and MONO HI-FI**



**STEREO Dual Amplifier-Preamplifier HF81**  
 Kit \$69.95.  
 Wired \$109.95.  
 "Excellent" — SATURDAY REVIEW; HI-FI MUSIC AT HOME.



**NEW! STEREO Automatic Changer/Player 1007** (7 mil diamond, 3 mil sapph dual styl) \$59.75 incl. FET.



**FM Tuner HFT30**  
 Kit \$38.95\*  
 Wired \$85.95\*  
 Cover \$3.95.  
 "One of the best buys" AUDIOCRAFT.

\*Less Cover, F.E.T. incl.

**AM Tuner HFT34**  
 Kit \$39.95. Wired \$85.95, incl. Cover & F.E.T.  
**FM/AM Tuner HFT82**  
 Kit \$38.95. Wired \$94.95. Includes Cover & F.E.T.



**STEREO Dual Preamplifier HF85**  
 Kit \$39.95.  
 Wired \$64.95.  
 "Extreme flexibility" — a bargain! — HI-FI REVIEW



**Mono Power Amplifiers** (60, 50, 35, 30, 22, 14-Watt; use 2 for Stereo) from Kit \$23.50. Wired \$41.50.



**2-Way Bookshelf Speaker System HFS1** complete with factory-built cabinet: \$39.95.



**STEREO Dual Power Amplifiers: New 100W HF89.** Kit \$99.50. Wired \$139.50.  
 70W HF87: Kit \$74.95. Wired \$114.95.  
 2RW HF86: Kit \$43.95. Wired \$74.95.



**Mono Integrated Amplifiers:** (50, 30, 20, 12-Watt; use 2 for Stereo) from Kit \$34.95. Wired \$57.95.



**NEW! COMPLETE STEREO DUAL AMPLIFIER AF-4**  
 Kit \$38.95  
 Wired \$64.95  
 TRUE Hi-Fi quality to drive hi efficiency speakers to concert volume.

...and in  
**TEST INSTRUMENTS**



**New Power & Bias Supply for Transistorized Eqpt. #1020\***  
 Kit \$19.95  
 Wired \$27.95  
 \* Patent Pending



**Miniaturized Multi-Signal Tracer #145A**  
 Kit \$19.95.  
 Wired \$28.95.



**Vacuum Tube Voltmeter #221**  
 Kit \$25.95.  
 Wired \$39.95.



**Peak-to-Peak VTVM #232 & Uni-Probe (pat. pend.)**  
 Kit \$29.95.  
 Wired \$49.95.



**New TUBE & CRT FIL. Tester #612**  
 Kit \$3.95.  
 Wired \$5.95.  
 Fast-checks radio/TV tubes, pilot lamps, etc.



**1000 Ohms/Volt V-O-M #536**  
 Kit \$12.90.  
 Wired \$14.90.



**5" Push-Pull Scope #425**  
 Kit \$44.95  
 Wired \$79.95.



**DC-5 MC 5" Scope #460**  
 Kit \$79.95.  
 Wired \$129.50.

**Tube Tester #625**  
 Kit \$34.95.  
 Wired \$49.95.



**RF Signal Generator #324**  
 Kit \$26.95.  
 Wired \$39.95.



**Series/Parallel R-C Combination Box #1140**  
 Kit \$13.95. Wired \$19.95  
 1350 Combinations!



**6V & 12V Battery Eliminator & Charger #1050**  
 Kit \$29.95. Wired \$38.95.  
 Extra-filtered for transistor equip. #1060  
 Kit \$38.95. Wired \$47.95.



**R-C Bridge & R-C-1 Comparator #9508**  
 Kit \$19.95.  
 Wired \$29.95.

IN STOCK! Compare, take them home — right "off the shelf" — from 2000 neighborhood dealers. Over 1 MILLION EICO instruments in use throughout the world.

© 1960 ELECTRONIC INSTRUMENT CO., INC., 33-00 N. BLVD., L.I.C. 1, N.Y.

◀ See Page 26 for the BEST BUYS in CITIZENS TRANSCEIVERS, "HAM" GEAR and TRANSISTOR RADIOS.

# Stereo Tone Arms and Pickups

- Test Results
- Buyers' Guide

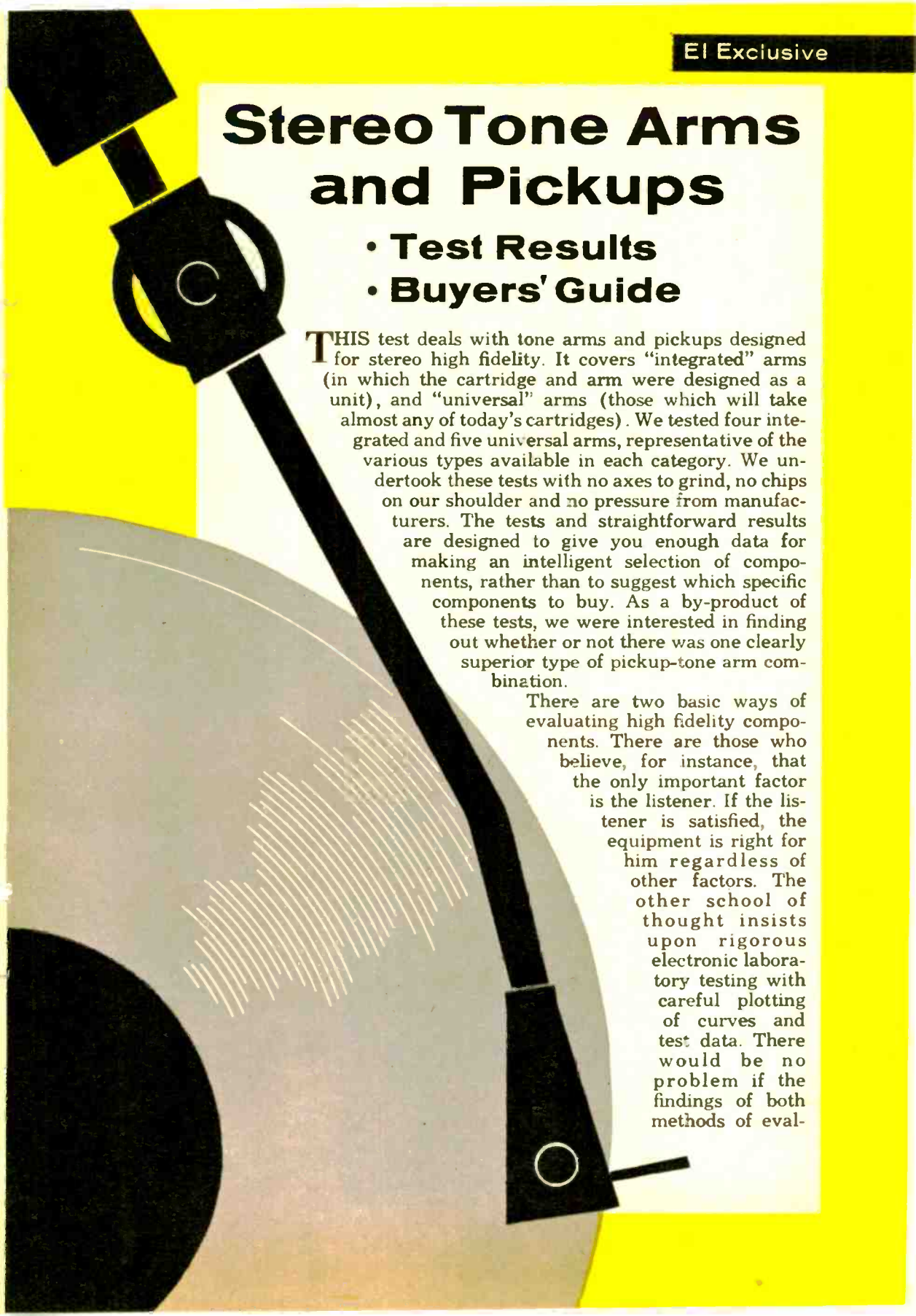

**T**HIS test deals with tone arms and pickups designed for stereo high fidelity. It covers "integrated" arms (in which the cartridge and arm were designed as a unit), and "universal" arms (those which will take almost any of today's cartridges). We tested four integrated and five universal arms, representative of the various types available in each category. We undertook these tests with no axes to grind, no chips on our shoulder and no pressure from manufacturers. The tests and straightforward results are designed to give you enough data for making an intelligent selection of components, rather than to suggest which specific components to buy. As a by-product of these tests, we were interested in finding out whether or not there was one clearly superior type of pickup-tone arm combination.

There are two basic ways of evaluating high fidelity components. There are those who believe, for instance, that the only important factor is the listener. If the listener is satisfied, the equipment is right for him regardless of other factors. The other school of thought insists upon rigorous electronic laboratory testing with careful plotting of curves and test data. There would be no problem if the findings of both methods of eval-

Four pickup-tone arm combinations are being tested in an A, B, C, D comparison for channel separation and frequency response. Each arm is mounted on a separate weighted base that is isolated as far as possible from the turntable. They are playing the same groove of the same record. Output is fed to preamp, oscilloscope and VTVM.



Technical test data is recorded in laboratory by EI consulting engineer who checks performance of each combination with aid of a special selector box.



uation concurred, but unfortunately for the consumer, this is not always the case.

We feel that the performance of high fidelity components can be described accurately by using listener's opinions as well as graphs. The test data speaks for itself and the intelligent reader will be able to correlate this lab information with his individual type-of-sound preferences to come up with a safe choice.

It is important to note that the pickup is really a transducer and the tone arm is its housing. The pickup-arm combination is not unlike the speaker-enclosure combination since the pickup acoustically couples with the arm in the same manner a speaker acoustically couples with the cabinet. The end results are not solely determined by one member, but by the *combination* of the two.

In our tests, variables were reduced to the barest minimum and each combination was evaluated under identical test conditions. For example, in our final listening tests, four pickups were mounted so that all played the same groove on the same record simultaneously through the same amplifier-speaker equipment. Each could be

instantaneously switched. All arm-cartridge combinations were mounted in accordance with the manufacturer's instructions and loaded electrically as suggested by the manufacturer. (In the case of the Weathers, a network was included to make this constant amplitude device a constant velocity system.) The varying output levels of each cartridge were properly equalized through the use of individual attenuators. Great care was taken to keep the equipment level at all times to assure optimum groove "hugging."

### Hum Susceptibility Test

One of the most often encountered high fidelity problems is removing and preventing electrostatic or magnetic hum pickup. Both types occur in low-level devices, especially in cartridges and the cables which go from the cartridge to the preamplifier. The hum is usually 60 cycles, but may contain 120 cycles and additional harmonics. Hum can be dealt with to some extent by attenuating the response below 60 cycles through the use of tone controls and filters, but this also results in the removal of desirable bass program material.

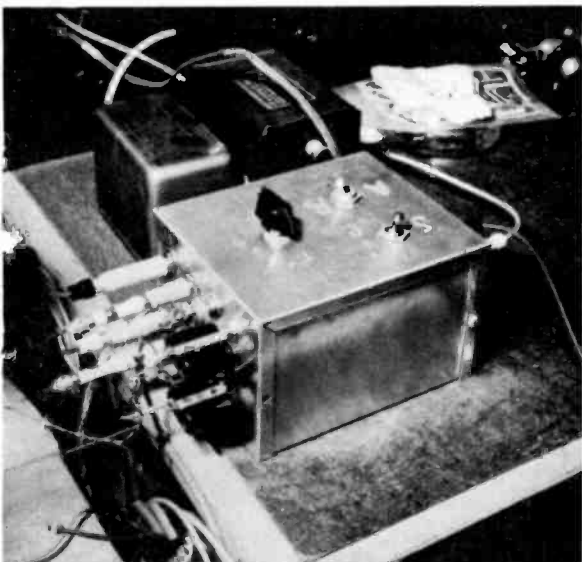

Selector box allows choice of any one of four combinations being tested and selects either Channel A, Channel B or A-plus-B. Box contains proper loading networks for equalizing levels.

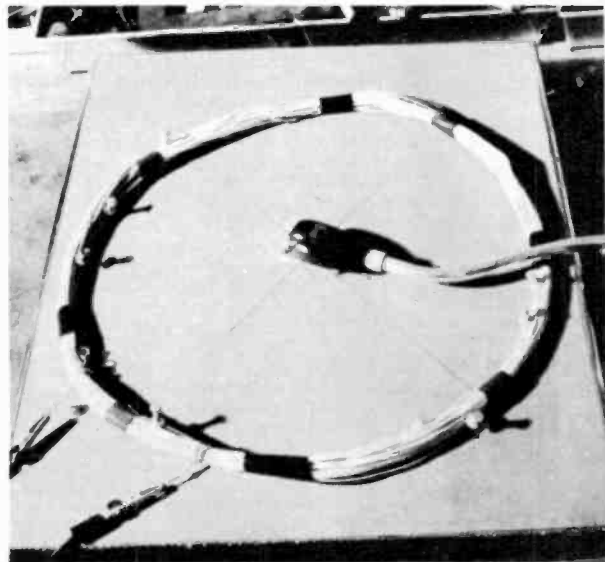

For the hum susceptibility test, cartridges remained in their arms. The cartridge was placed in the center of a uniform magnetic field induced by large coil shown in photo.

## El Buyers' Guidelines

In buying a tone arm-cartridge combination, it is often difficult to make extensive in-the-store tests. But one test you can make is to listen for what we'll call "chatter." Turn the amplifier off. Place the tone arm and cartridge on a revolving record. Do you hear the recorded material without electronic amplification? In other words, is the arm working like an old-fashioned record player? This is "chatter." If its level is high, consider the combination improperly designed or matched. In normal use it will most likely result in excessive needle and record wear. Ideally, the needle should constantly be in touch with the groove walls, which would cut chatter (mechanical vibration) down to a minimum. In poorly designed combinations the needle may actually bounce out of the groove and then fall back again, causing unwanted distortion, record and needle wear.

Manufacturer's specifications with regard to tracking pressure may be misleading. Tracking pressure alone is not necessarily an indication of needle and record wear. A pickup-arm combination which may track at 1 gram, but is improperly designed for compliance, may cause considerably more wear and eventual distortion than a properly designed cartridge tracking at four grams. The "chatter" listening test will pinpoint this undesirable condition.

More than in other areas of high fidelity, price differences are not so much an indication of quality. The basic materials used are all within striking distance of each other in terms of price. What counts is ingenuity of design.

The battle still rages over light mass tone arms (tubular design) versus heavy mass tone arms (shell types). Our tests have shown

that one is not to be preferred over another. Each, when properly designed and used with a compatible cartridge, can give acceptable to excellent service.

In theory one would think that integrated tone arm and cartridge combinations would be unbeatable in performance. Our tests have indicated that integrated combinations are not necessarily better than carefully selected universal components.

Reproduced on this page are charts showing our laboratory test results with regard to hum susceptibility, channel separation and listener preference. For test procedure, see text. For additional helpful information, see the General Comments section toward end of text.

**CARTRIDGE—TONE ARM COMBINATIONS TESTED**

Cartridge—Tone Arm	Cartridge Type	Price (approx.)
Grado "Custom" cartridge with Grado "Microbalance" arm	Moving Coil	\$32 \$30
Shure "M3-D" cartridge ESL "S-1000" arm	Moving Magnet	\$45 \$35
Pickering "Unipoise-Fluxvalve" integrated arm	Variable Reluctance	\$50
Dynaco B&O "TA-12" integrated arm and cart.	Moving Magnet	\$50
GE "VR-225" cartridge Garrard "TPA-12" arm	Variable Reluctance	\$27 \$20
Weathers "MC-1-D" integrated arm and cartridge	Piezoelectric	\$56
Heath Stereo Cartridge (see note 1) Audax (Rek-O-Kut) "KTS-12" arm (kit)	Moving Magnet	— \$15
Fairchild "SM-1" cartridge with Fairchild "SA-12" arm	Moving Magnet	\$35 \$35
London-Scott "Model 1000" integrated arm and cartridge	Variable Reluctance	\$90

Note 1: The Heath Stereo Cartridge and the Fairchild SM-1, look very much alike physically and appear to be the same cartridge after comparison of test results. Heath has since ceased marketing this particular cartridge.

HUM SUSCEPTIBILITY TEST RESULTS (see note below)	CHANNEL SEPARATION TEST RESULTS (1000 cycle sine wave signal in Channel A only—see note)	LISTENING PREFERENCE SURVEY RESULTS (based upon 20 individuals with varied backgrounds)
Cartridge-Tone Arm AC Volts RMS	Cartridge-Tone Arm Separation	Cartridge-Tone Arm Liked Most Liked Least
Weathers int. .... negligible	Grado comb. .... -32 db	Grado comb. .... 6 0
Dynaco B&O int. .... .24	Pickering int. .... -26 db	Dynaco B&O int. .... 5 0
Grado comb. .... .31	Shure-ESL comb. .... -24 db	Shure-ESL comb. .... 4 2
Heath-Audax comb. .... .78	Dynaco B&O int. .... -18 db	Weathers int. .... 2 3
Fairchild comb. .... .81	GE-Garrard comb. .... -15 db	London-Scott int. .... 2 1
Shure-ESL comb. .... .94	Heath-Audax comb. .... -15 db	GE-Garrard comb. .... 1 0
GE-Garrard comb. .... .96	Fairchild comb. .... -14 db	Fairchild comb. .... 0 3
London-Scott int. .... 2.90	London-Scott int. .... -13 db	Heath-Audax comb. .... 0 3
Pickering int. .... 3.20	Weathers int. .... -10 db	Pickering int. .... 0 8
Note: In some instances the arm and manner of mounting have a beneficial shielding effect. All cartridges were tested in arms specified, and the results hold true only for the specific combinations. The same cartridge in another arm may give very different results.	Note: A special stereo test disc was used to feed a 1000 cycle tone to Channel A with Channel B unmodulated and the gain on the preamplifier was adjusted so that the VTVM at its output read zero db with the selector switch set to Channel A. The switch was then thrown to the silent Channel B and the new lower VTVM reading indicated the amount of crosstalk.	Note: Two listeners failed to hear any differences between any of the systems.

While it is up to the manufacturer to make his pickups hum-proof, the user must do his part by following good grounding and tone arm positioning practice.

To check susceptibility to magnetic hum of the nine cartridges under test, we used a multi-turn 12" loop connected to a voltage regulated source of 60 cycle AC. The loop was set to produce that a comparatively low level hum field (comparable to those encountered in actual installations) to allow the hum bucking characteristics of the cartridges to come into play. The pickup was positioned in the exact center of the loop and a resulting magnetic hum reading was taken in RMS volts on an audio VTVM. The gain on the preamplifier was adjusted in such a manner that when the hum field was collapsed, the VTVM needle returned to zero, thereby compensating for any noise or electrical

hum present in other components. Each cartridge was wired for a monophonic signal, in accordance with the manufacturer's instructions. All cartridges were tested in their arms since in some instances the arm and manner of mounting have a beneficial shielding effect.

### Channel Separation

Channel separation is the ability of the cartridge to separate the signals of stereo Channel A from stereo Channel B. Complete channel separation is impossible, nor is it desirable. Most engineers agree that stereophonic effects are not discernible at very low frequencies and consequently, channel separation down there is pointless. Also, there is obviously some mixing of sound in any live performance due to the acoustical properties of the studio. And regardless of some recording company

[Continued on page 108]

Degree of channel separation varied widely. A 1000 cycle tone is fed to Channel A and what happens in Channel B is noted on scope. If there is no input to Channel B, output should be zero or a straight line. Photo 1 shows Grado with 1000 cycle tone in Channel A. Grado Channel B (photo 2) is flat, shows extreme channel separation.

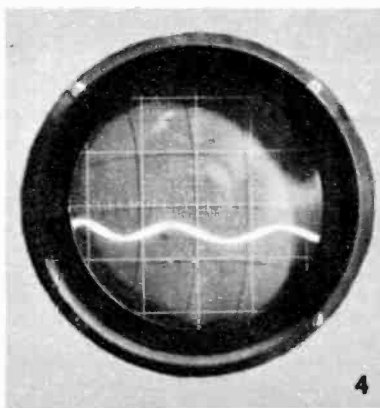
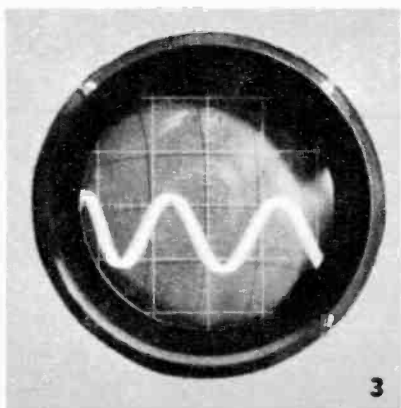
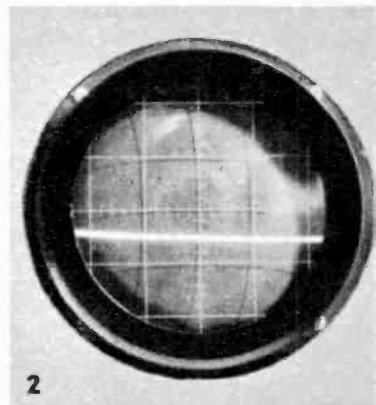
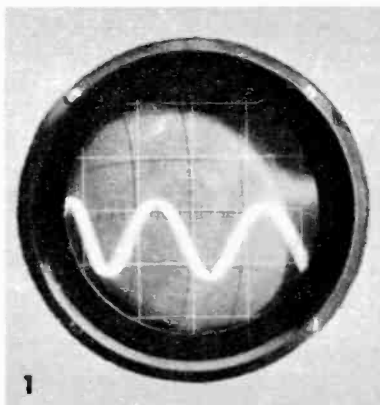

By comparison, photo 3 represents the Weathers with 1000 cycle tone in Channel A, and photo 4 shows extent of cross-talk in its companion Channel B. With regard to scope photos, broadness of trace is due to broadening of focus to obtain more light, plus surface noise on record. Amplitudes remained constant during tests.

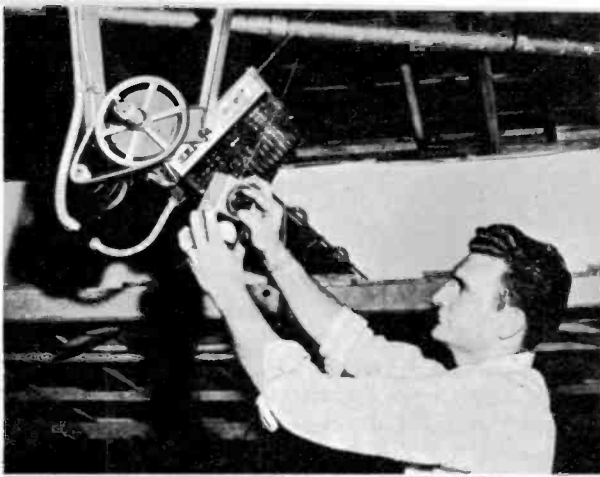

**Servicing a previously installed door opener, Bob Miller checks receiver's alignment with a shop-built absorption meter indicating peak frequency.**

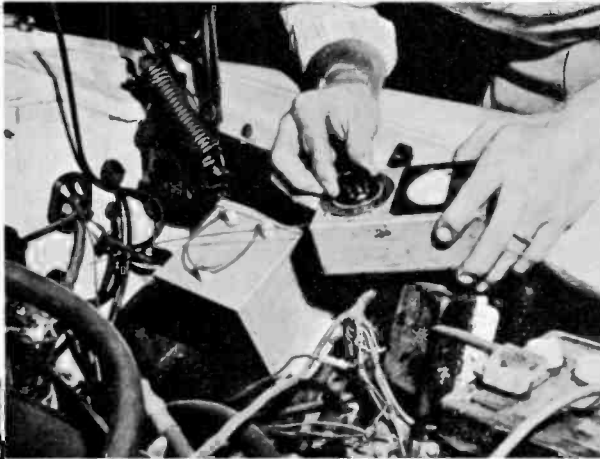

**Most cars have transmitters installed under hood, although new transistorized units clip onto sun visor. Antenna is usually run to front bumper.**

**Fair weather or foul, homeowner need not leave his car to open door. He just pushes button. Parking on hill while opening door is hazardous.**



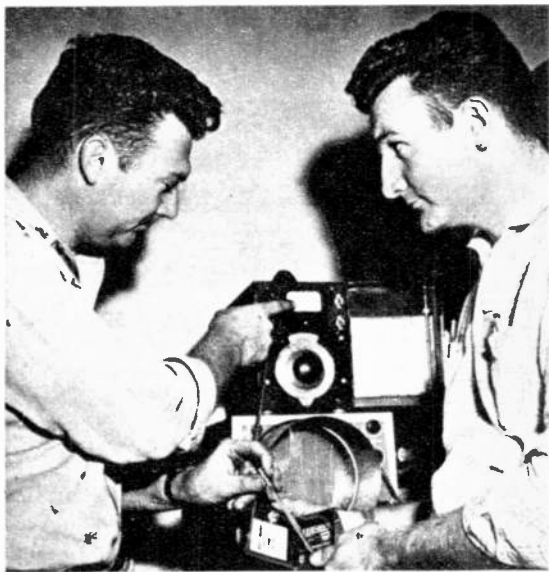
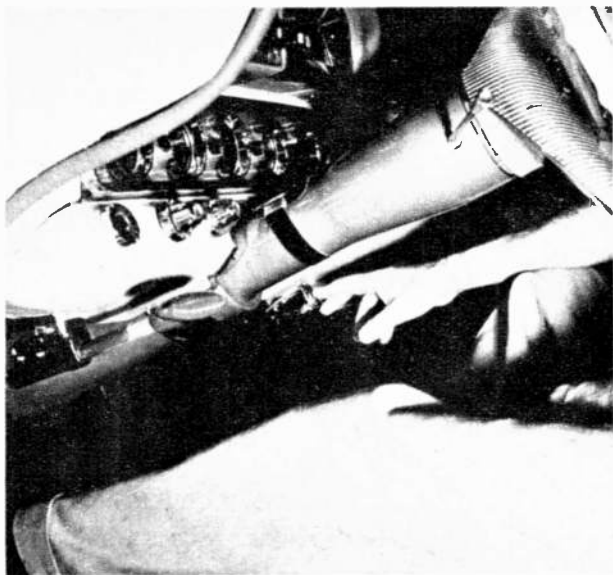

Just a push of this dash-mounted transmitter button sends short-range signal to receiver which actuates door-lifting motor inside garage. At right, the enterprising Miller brothers check out a transistorized transmitter in their repair shop. By installing and servicing garage door openers in homes and industrial locations, they have carved a very comfortable career.

*El's money-making careers in electronics*

## Push Button Garage Doors

By James Joseph

You can forge your own career in electronics if you have an eye for opportunity—like the Millers.

**E**LECTRONICS can open profitable doors for you—garage doors—as they have for Robert and Richard Miller. Their Electronic Door Service in Los Angeles will show a \$100,000 gross this year after only four years in business!

Yes, garage doors can be your open-sesame to a career in electronics. They can, that is, if you're a fellow with a knack for radio circuitry and an eye for opportunity—the U. S. boasts some 20-million garage doors.

Young Bob and Dick Miller set up a service business of their own in 1956 with a meager \$2000 (all the cash they had) and began opening doors.

"Whoever designed the garage door must have had a soft place in his heart for the electronic specialist," says 24-year-old Bob. Heavy and often cumbersome, garage doors strain many a homeowner's back—and humor. No one likes to race from the comfort of his car, through rain, sleet and snow to open the garage door.

Radio-controlled, however, garage [Continued on page 119]

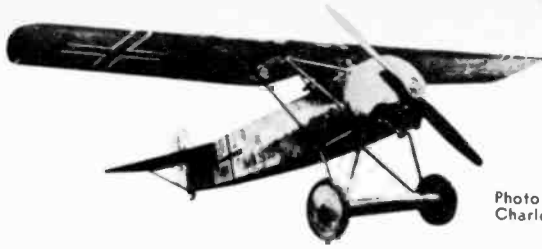

Photo courtesy  
Charles Donald collection

## *build a radio controlled* **W.W. I Fokker**

**By Walter A. Musciano**

**A joy to build, this true scale model of the famous  
"Flying Razor" handles superbly on radio control**

**O**NE of the most fascinating aspects of electronics and of model building is that both can be combined hobbywise. This is the radio controlled operation of model boats, airplanes and cars which has become one of the fastest growing hobby-sports in recent years. The ability to maneuver your craft at will literally puts you in the "driver's seat" and, therefore, the hobbies of electronics and model building become a challenging sport as well. Radio control projects range from the elementary single channel affairs which control the direction and, at times, the speed of the

**Author is shown with a typical single-channel radio control transmitter. Unit operates at 26.9-27.2 mc (depending on crystal) to achieve full control.**

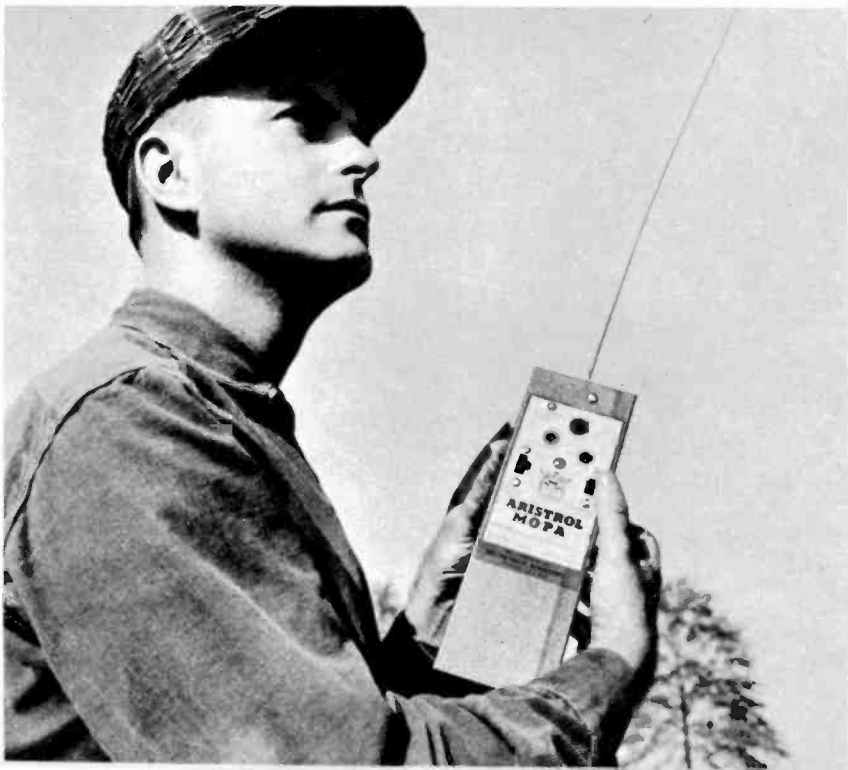

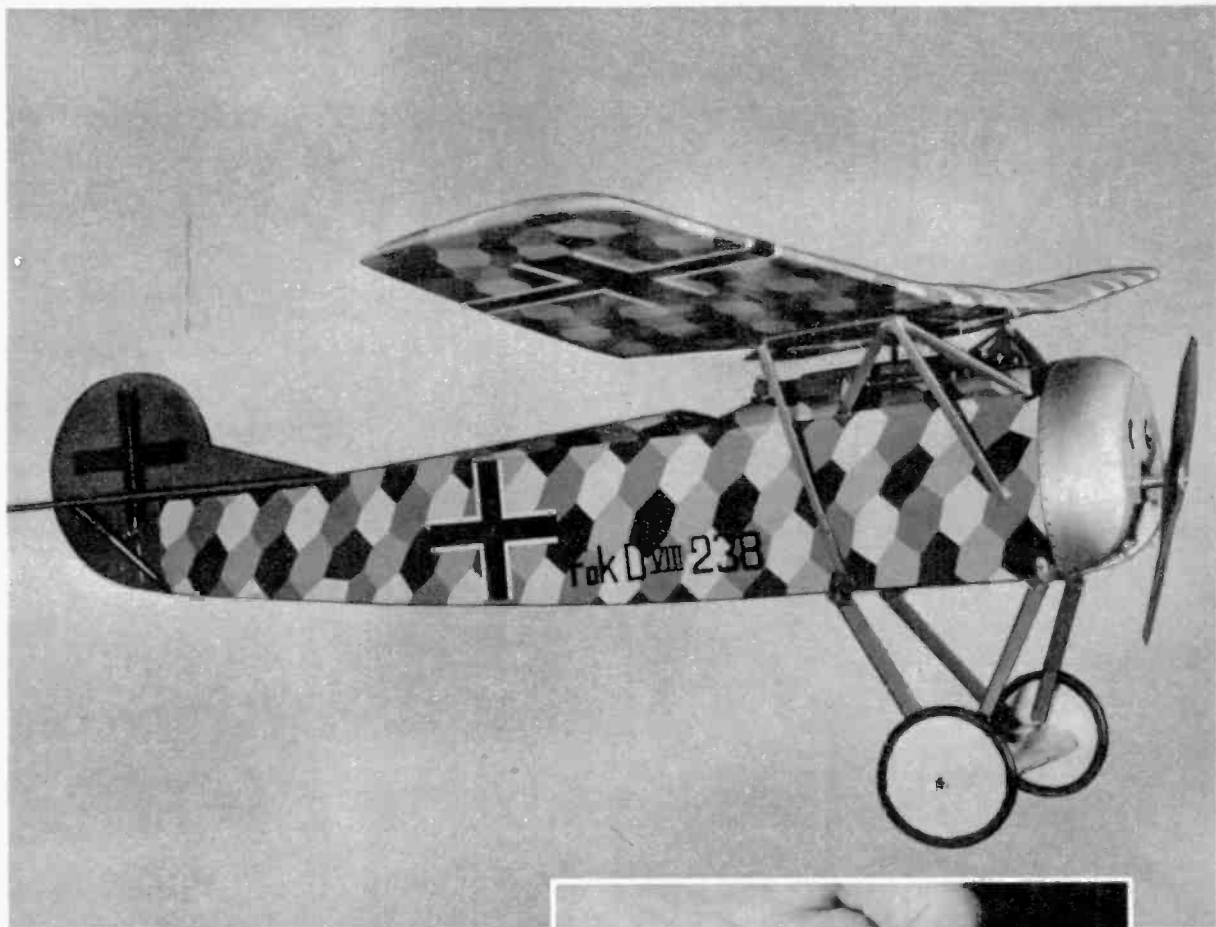

Attention to detail is obvious from photo. Camouflage coloring of D-8 is duplicated. Compare model with real thing (upper left). Note machine guns.

Commercial miniature receiver uses printed circuit board. Compact construction is used to achieve light weight.

A small multi-meter will be required to check out battery voltages and RC units. A thorough pre-flight check is necessary.

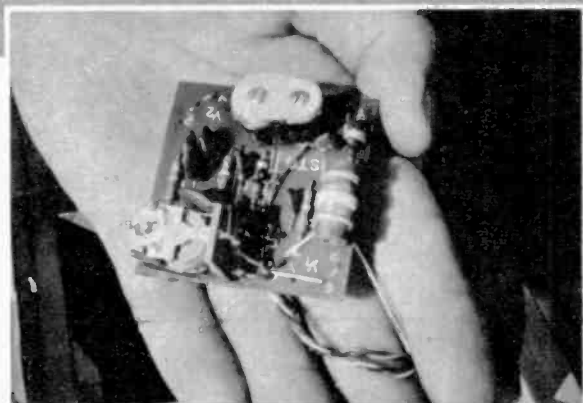

FULL SIZE PLANS of the FOKKER are available from the Plans Dept., *Electronics Illustrated*, Greenwich, Connecticut, for \$1.50. Request EI-3.









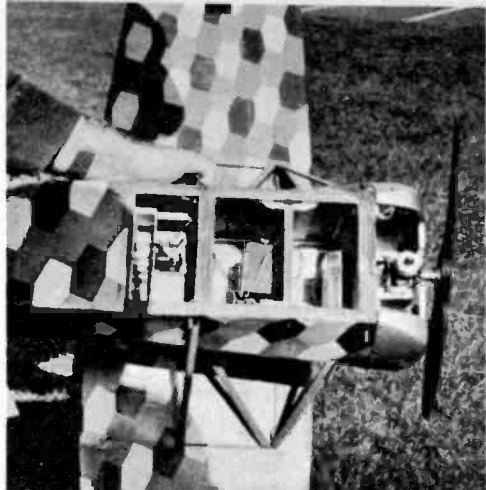
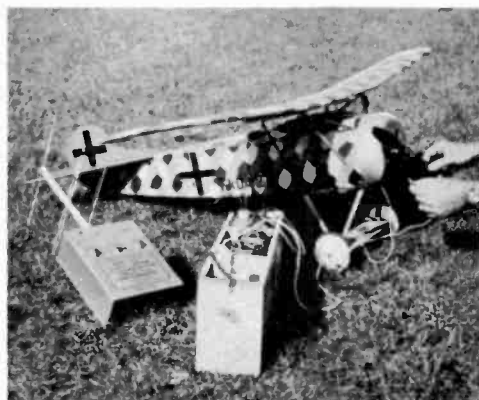

Photo above, bottom view, cover removed. From left to right are the escapement, receiver, and battery compartments.

Upper right. Author is shown installing the antenna behind cockpit on fuselage. Cement silk patches over antenna anchors.

At right, engine is started. Transmitter shown here and on cover is a two-channel unit being used for experimental purposes.



model up to the vastly complex multi-channel systems which not only control the speed and direction but can operate auxiliary equipment. Here we shall deal only with the basic single channel control equipment as it can be applied to a model airplane of fairly simple construction.

This Fokker D-8 is a sound design which should present no flight problems (we were looking for carefree fun and are not interested, in this case, with experiments). Also, the fact that this model is a scale replica adds a touch of realism. This model combines simplicity of construction with ample space for receiver, tank, batteries and escapement.

It is important to use simple, light-weight, but reliable equipment in RC models. The rudder actuator is a "Babcock Mark 2" self neutralizing compound escapement, however any similar light-weight equipment can be used if the reader desires.

The control of the Fokker D-8 is ac-

complished by moving only the rudder. This not only controls the direction of the flight but, when properly used, can control the general altitude of the craft. When the transmitter spring switch is depressed the rudder swings to the left, and the model turns in that direction circling as long as the switch is held in the depressed position. When the transmitter switch is released the rudder returns to neutral and the model flies straight. The next time the switch is depressed, however, the rudder will swing in the opposite direction and turn the model to the right. This sequence control is no disadvantage because if two consecutive right turns are desired it is very simple to press the switch two times in rapid succession; the rudder will slip to the left for so short a time that it will not affect the flight path of the model. The escapement is powered by a long rubber band loop which is wound prior to each flight. When the escapement receives an impulse from

the radio receiver it allows the twisted rubber to rotate it one half revolution. This actuates the rudder via the torque rod. When the button is released the escapement completes the revolution and returns the rudder to neutral.

The direction of rotation of the vast majority of model engines in the world today causes the airplane to tend to veer and roll to the left. Continuous application of left rudder will, therefore, cause the model to execute a slow sharply banked spiral which will make it lose altitude. The model can be made to climb by leaving the rudder in the neutral position. The forces are arranged so that under normal power the craft climbs slowly, especially when flying into wind.

A few words regarding the full sized plane upon which our model is based may be of interest to the reader before we begin the building instructions of our 1½" to the foot scale replica. The Fokker D-8 was one of the last production fighting planes used by the German Air Service during the first World War. This harmless looking airplane combined speed with maneuverability and provided excellent visibility for the pilot. Powered by a 110 horsepower engine it attained a speed of 140 miles per hour. The design was so sleek when

compared to the biplanes and triplanes of that era that when it dived from the direction of the sun it was practically invisible. This characteristic caused it to earn the nickname of "Flying Razor." Armament consisted of two Spandau machine guns mounted atop the fuselage directly in front of the pilot within his reach. Slight structural difficulties delayed production and at the time of the Armistice only a few Staffels were equipped with the D-8. The color scheme and markings on our model duplicate the personal D-8 of Lt. Udet, Germany's second leading ace of WWI.

Before construction is started the plans must be enlarged to full model size by using the graphic scale provided on the plans. This task can be eliminated by purchasing the full size plans from *Electronics Illustrated's* plan service.

Trace the sides of the body onto 1/16" sheet balsa and cut these to shape with a sharp single edge razor blade. Make two sides and be sure to cut the notches for the bulkheads as shown. Now trace and cut the bulkheads to shape from the specified material. The plywood is easily cut with a simple coping saw. Drill the holes in the plywood as shown.

Place bulkheads "D," "E," "F," and

[Continued on page 112]

#### FOKKER D-8 LIST OF MATERIAL

No. Reqd.	Size	Material	Use
3	1/16"x3"x36"	med. balsa	fuselage sides, top & bottom; wing leading edge covering
3	3/32"x3"x36"	med. balsa	wing ribs; stab. ribs; bulkheads; cowl
2	3/32"x6"x12"	plywood	fuselage bulkhd., mounting pads
1	3/16"x2"x36"	hard balsa	wing spar, fuselage reinforcing
1	3/16"x2"x36"	soft balsa	axle wing; stab. tips, fin; rudder
2	1/4"x3/4"x36"	med. balsa	wing trailing edge
2	1/8"x3/8"x36"	hard balsa	wing leading edge, aux. spars
1	1/8"x1/2"x18"	med. balsa	stabilizer trailing edge
1	3/16"x3/16"x36"	hard balsa	stab. leading edge & spar, hatch reinforcing
1	1/4"x1/4"x36"	hard balsa	torque rod
1	3/32" dia. x 18"	music wire	wing mount
1	1/16"x4"x6"	plywood	wing joiners
1	1/4"x3"x36"	soft balsa	wing tips; cowl
1	1/16" dia. x 36"	music wire	landing gear;
1	1/16" i.d. x 12"	alum. tubing	rudder hinge; torque rod bearing
1	.049" dia. x 36"	music wire	wing mount; torque rod; rudder hinge
1	36"x36"	Aristo-Craft silk	covering material
1	.025" dia. x 36"	music wire	antenna; wing strut tension piece
1	8 oz.	clear dope (Aero Gloss)	model finishes
1	4 oz.	white dope	" "
1	1 oz.	red dope	" "
1	1 oz.	silver dope	" "
1	1 oz.	blue dope	" "

**Miscellaneous**—Acme or equal fuel tank; clear plastic fuel line; tube Ambroid cement; plastic wood, fine and very fine sandpaper; soft thin copper wire; washers; 1/4" round head wood screws; nuts and bolts; straight pins; thread; single edge razor blades; .049" aluminum sheet if beam mounted engine is used; single channel tone transmitter and receiver; self-neutralizing escapement; slide switches; low voltage color coded wire; jacks; engine; propellers; batteries; Acme battery boxes for two pen cells, one pen cell, and one 22½" V. battery; camel hair brushes 1/2" wide.

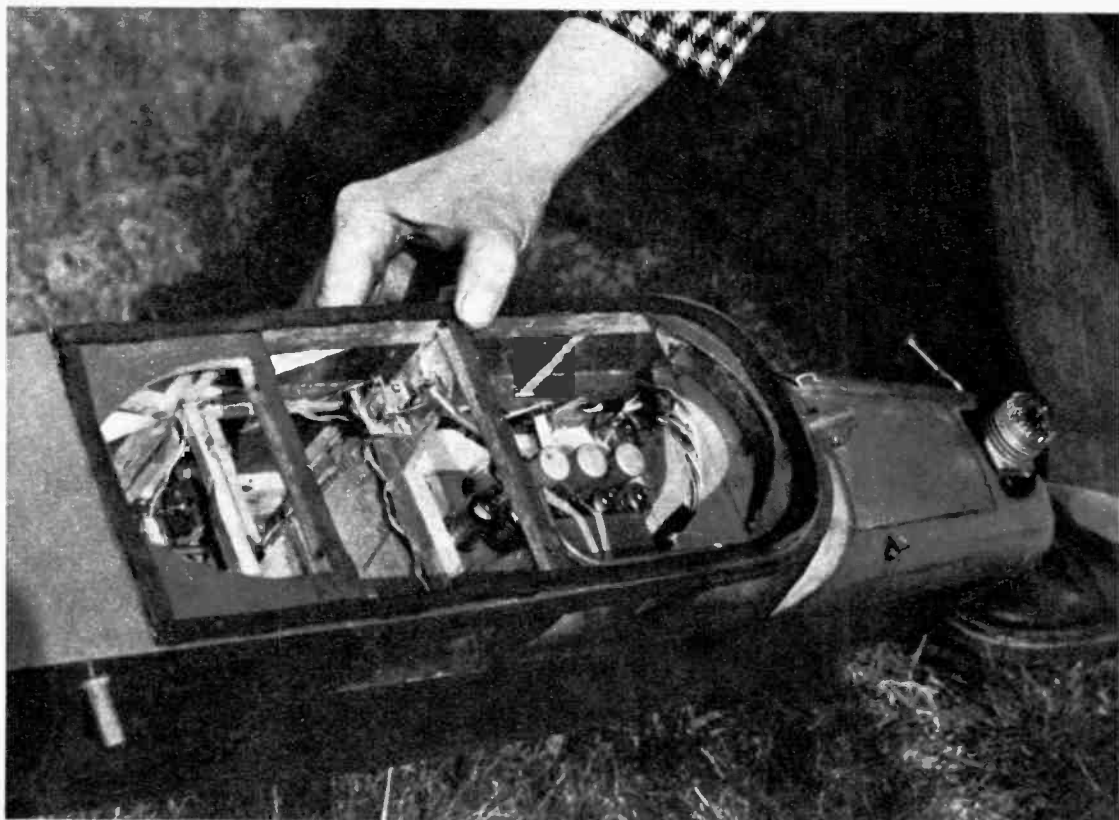

Neat, well-planned installation in plane permits maximum accessibility of radio gear. Receiver is up front, with escapements mounted at rear of cabin.

# How to Wire R/C Models

By William Winter

**Increase the reliability of your radio-controlled boat or airplane by using this layout technique.**

**T**HE biggest problem in radio-control today—and, oh, what a king-sized headache it is, is the simple business of connecting wires to batteries, receivers and actuators. More articles have been written for the beginner than you can find in the national “slicks” on balancing the budget (yours) or raising junior from blocks to Sputniks. The reader always comes back, “Yes, but how do I put in the escapement?” When it comes to solving this problem, the experts come up with nothing but “resin” joints—and you know what that means!

Electronic equipment may be amazing but abbreviated schematics with arrows pointing “to relay contacts,” etc. (they went thataway) leave some of us with smoking iron poised in hand. Where do you put the switches, jacks, pots the batteries? How



After measuring model to be wired, a diagram is drawn on board over which wiring is placed. Staples hold wires in position.

Small pieces of rubberized black electrical tape slide under the cable and wrap around it. The harness is now lifted from board.

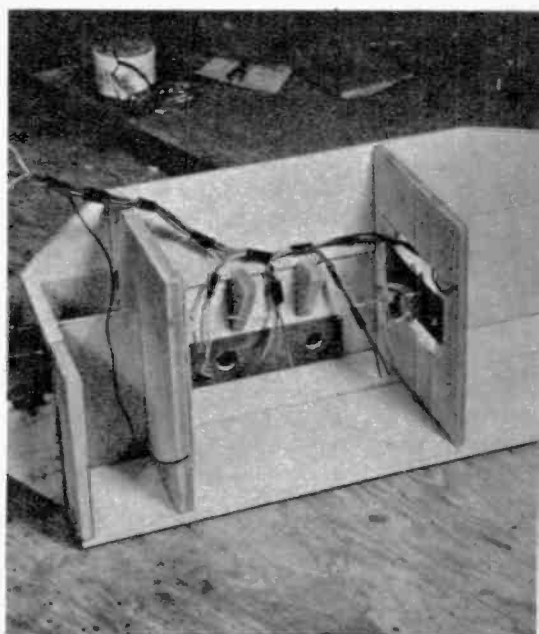
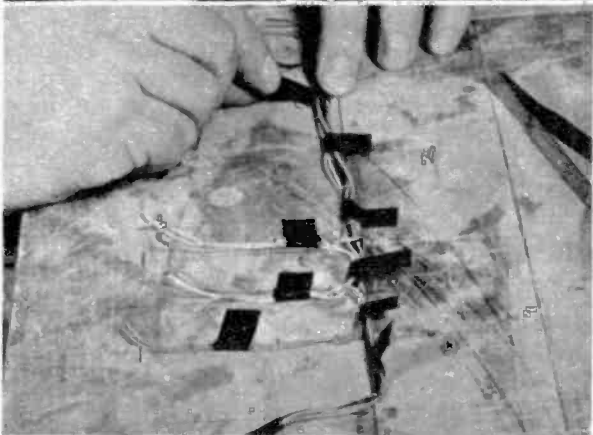
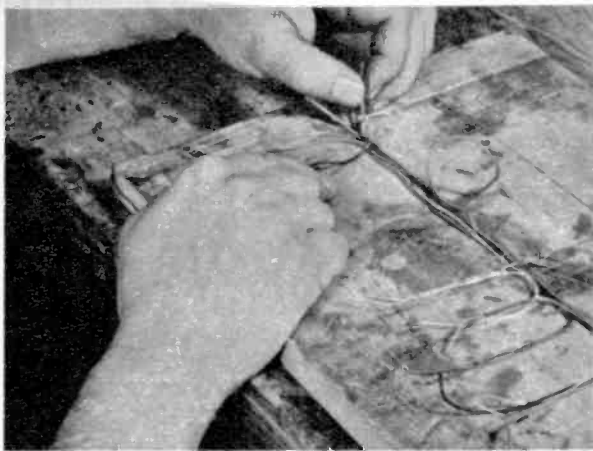

Wire ends are stripped for soldering. Place harness in position and note where branches must pass through holes in bulkheads before soldering.

do you get the wires from here to there? This leads to the application of a great axiom: a straight line is the shortest distance between two points. Take one wire, solder an end in place, then make a bee-line and solder the other end. A dozen soldered joints later and the results are incredible. Radios misbehave, wires break off, planes fly off into the wild blue yonder and boats climb on shore.

The proper starting point, of course, is tools and materials. (If this is old hat to you, meet us a few paragraphs below.) The pictures show typical use of a quick-heat soldering gun. The gun is ideal when a great many joints are to be soldered. Its tip is cold until the trigger is held, then the tip heats up in a matter of seconds. The gun even has a couple of small "headlights" which illuminate dark corners. Also useful is a pencil iron by Ungar (there are others) which has interchangeable tips that screw into the tool just as a flashlight bulb screws into its socket. The very thin point shown gets plenty hot for ordinary wire joints or splices. The larger tip gets hot enough to solder  $\frac{1}{8}$ -

inch steel rod! A capacity of 25 to 37 watts is ample. The gun must be used carefully, especially with fine wire.

Wire should not be thicker than No. 22, usually is thinner, but not less than No. 26. No. 24 is ideal. Like thread, the larger numbers denote thinner or smaller diameters. Multistrand wire should be used; sixteen to 19 strands is about right.

Color coding is important. It makes the wiring job easier, speeds up the inevitable tracing and retracing when you wonder if an error was made. When trouble shooting, you can read voltages because of the colors or check continuity and resistances with a test set. Six black wires vanishing through a bulk-head or partition aren't exactly a help when you can see only the ends—and which end goes with which?

Assign the colors for the same voltages on every job you do: red for B plus, yellow for A plus, green or black for minus, orange and brown for actuator circuits. Assign the colors to the same numbered pins on all jobs you do. Standardize. If more wires are required

[Continued on page 115]

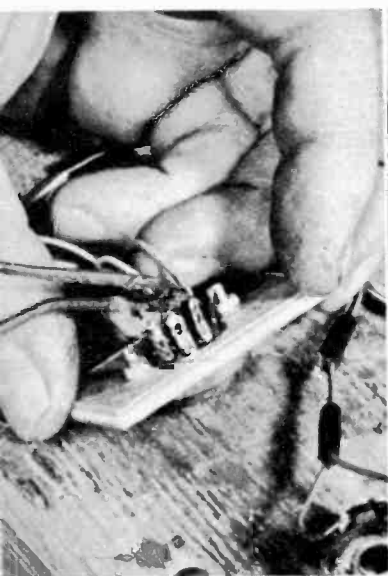

Switches, jacks, etc. can be soldered to harness before being placed in model. Base will glue to framework.



When impossible to solder part to harness before installation, slack on cable permits easy access.

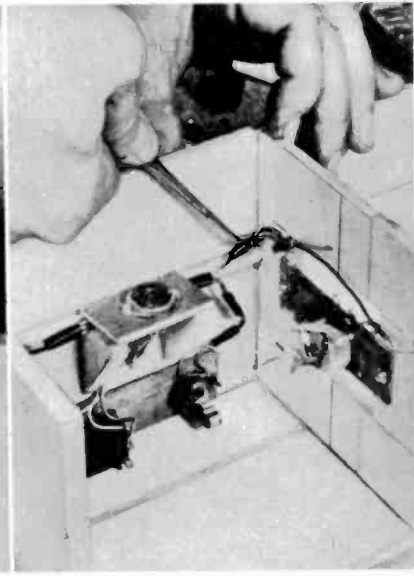

The harness is installed and secured by staples or spot gluing. Allow some slack to prevent vibration failure.

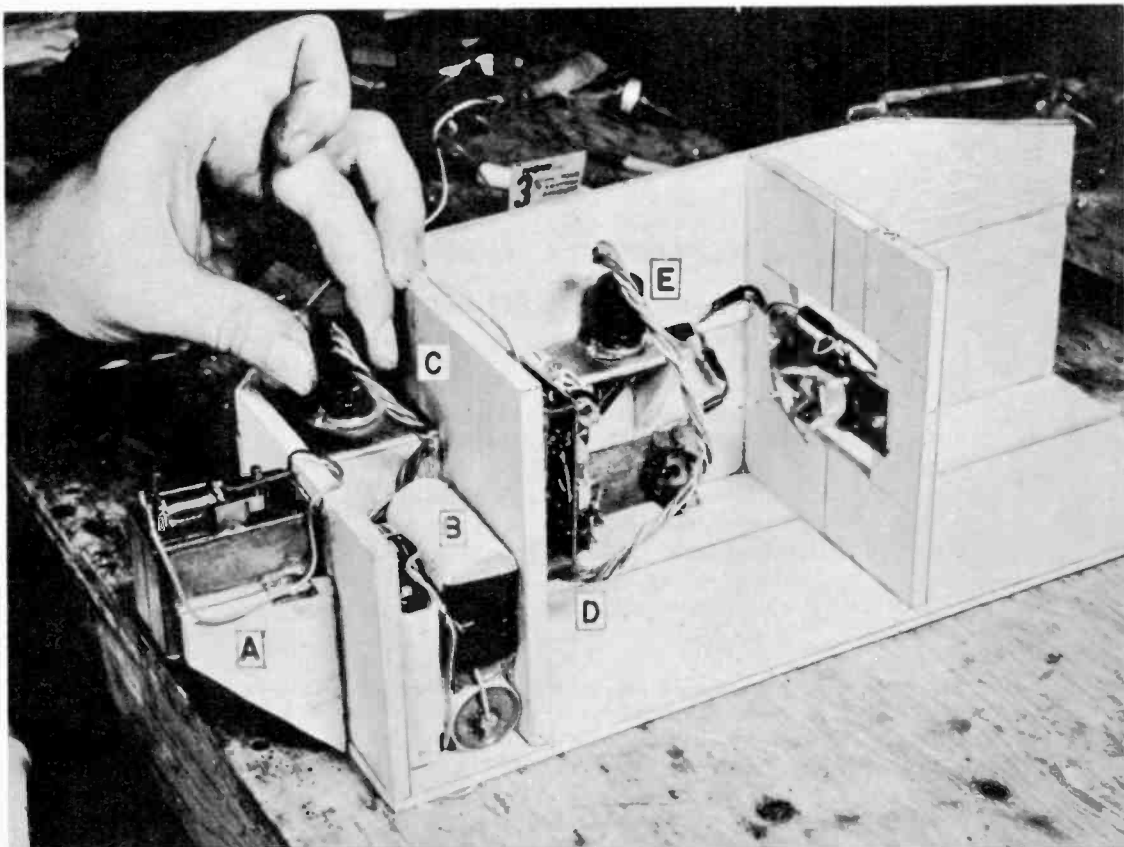

Completed wiring includes; A—motor control escapement (on gas tank), B—battery pack, C—battery supply plug, D—receiver, E—plug for receiver cable.

Receiver, at left, is mounted on plywood board which can be easily slid in and out of cabin.

Necessity of potentiometer in model can be eliminated by mounting it on rear of meter.

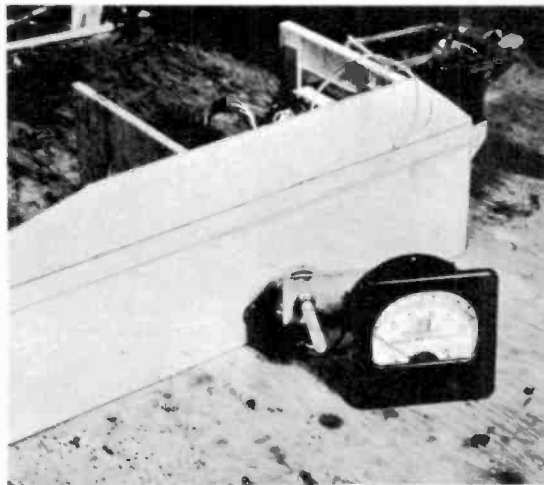

# Improve the Sound of a Small Phono

By Art Trauffer

**Large speaker, feedback resistor, capacitor changes—try these expedients for better sound.**

**T**HE increasing popularity of high-fidelity may make you dissatisfied with sound from your small record player. The space and cost limitations of these units have naturally reduced their audio quality. However, it is a simple matter to add a larger speaker and make some changes and additions, which will greatly improve their sound.

In Fig. 2 the closed-circuit jack is mounted in a  $\frac{3}{8}$ " hole by small angle bracket. When this is done, choose a good low-cost 12" extended range speaker from [Continued on page 122]

**A typical small home record player. Fidelity of this unit was greatly improved by using the large auxiliary speaker and baffle at its left.**

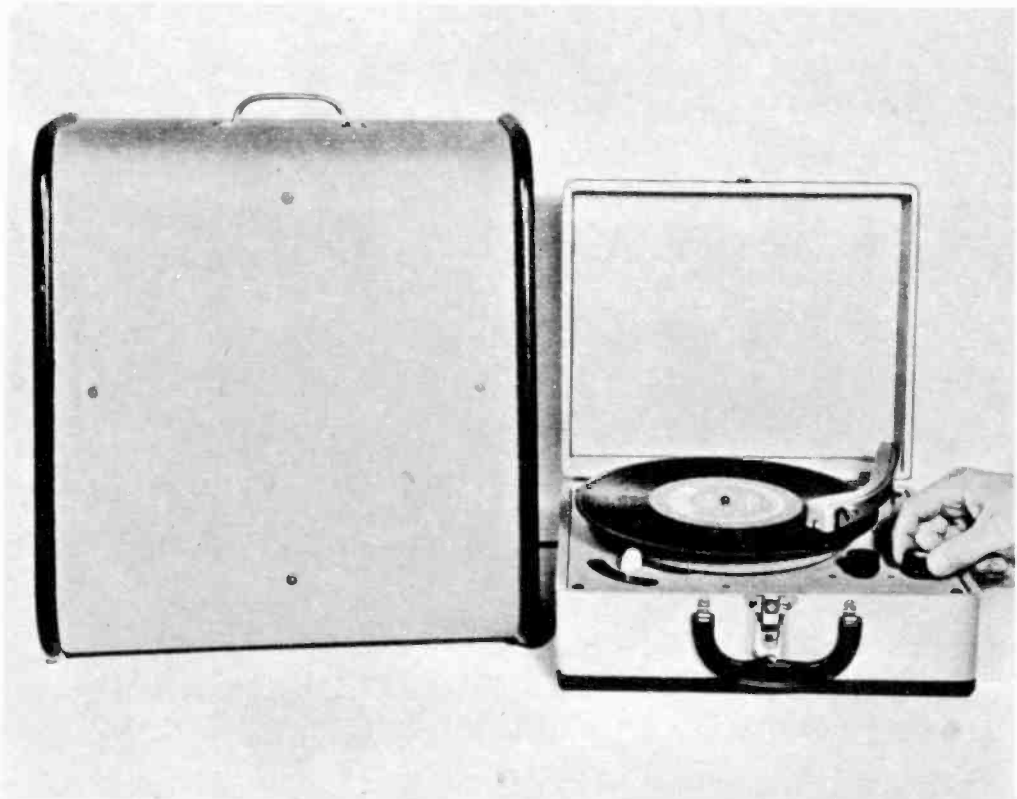



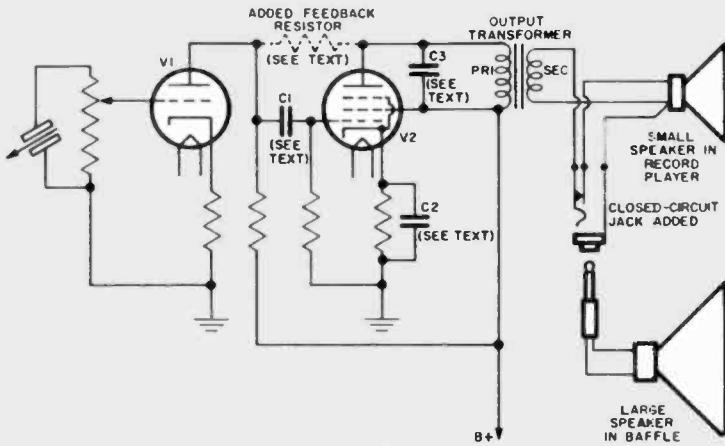

Fig. 1. A two-stage audio amp. Increasing value of C1 and removing C2 will improve frequency response and lower the distortion. Auxiliary speaker is removable.

Photo shows an extended range 12 inch speaker mounted in baffle. It is plugged into jack in the rear of the portable phonograph. Any size speaker or baffle may be utilized.

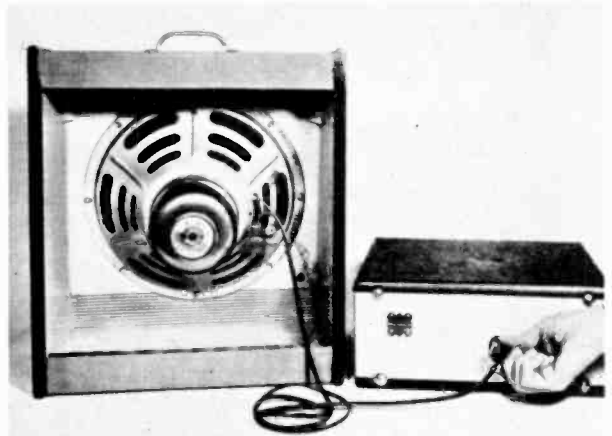
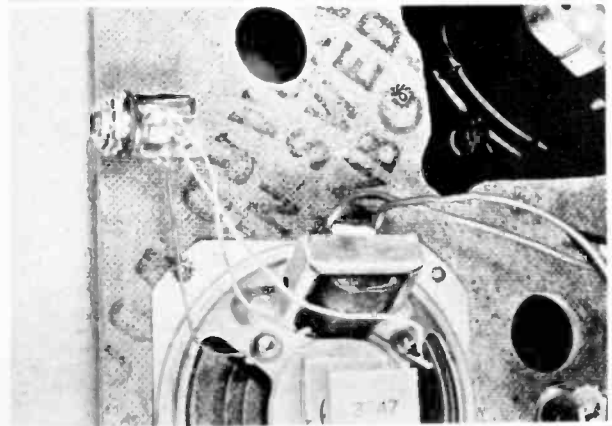

Fig. 2. At upper-left is the closed-circuit jack mounted on motor board with a brass angle bracket. Its leads are connected as shown in the schematic. Diagram at top of this page.





# A Novice Ham Troubleshoots His Rig

By Carole F. Hoover, K9AMD

**You don't always need a raft of test gear. Often simple tools and common sense will do the trick.**

**T**HERE comes a day in the life of every ham when his trusty transmitter coughs, gasps, and just sits there unable to wheeze out a single "CQ." While a veteran radioman usually can track down the trouble in a few effortless minutes, it can be a frustrating experience for a Novice.

Often without much in the line of tools, test equipment or experience, the Novice ham finds himself knocking on the door of

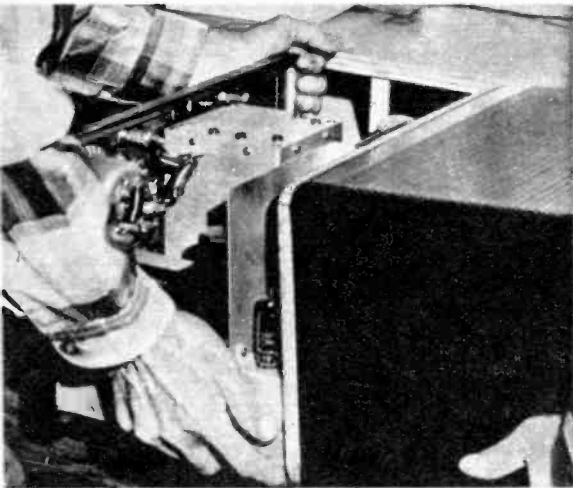

Here Vince, KN9RDV, slips his ailing rig out of case to get a good look at the tubes and lesser components. Be certain AC plug is out of wall.

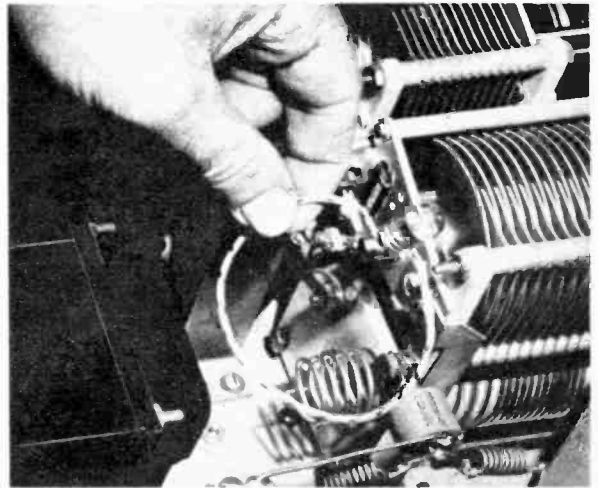

Checking for the presence of RF is easy with a small bulb on a loop of wire held near the plate tank of the oscillator, buffer or final stages.



A cracked crystal is frequently the culprit of a Novice rig. Since crystals generally protrude from the rig, they often come in for much more than their rightful share of unintentional bumps. Never toss them onto hard surfaces such as the top of a table or transmitter cage.

Gently tapping the side of a tube while watching the plate meter will sometimes show up loose elements or intermittent breakdowns.

When checking plate voltage with meter (transmitter power on), it is important for safety's sake to ground the negative probe.

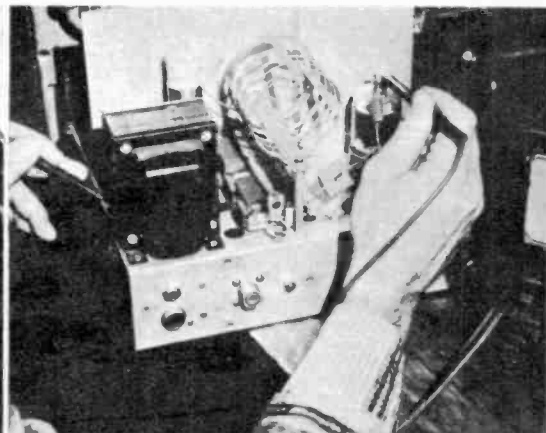
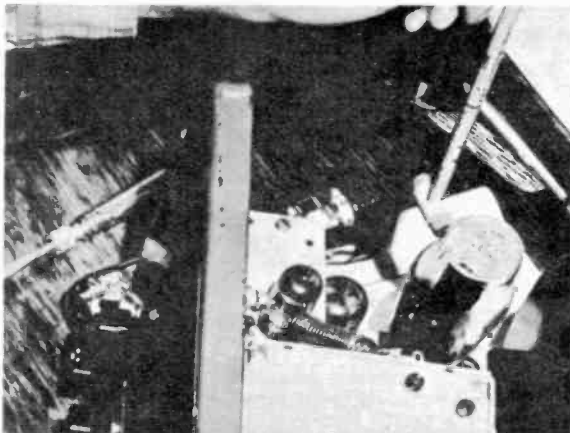

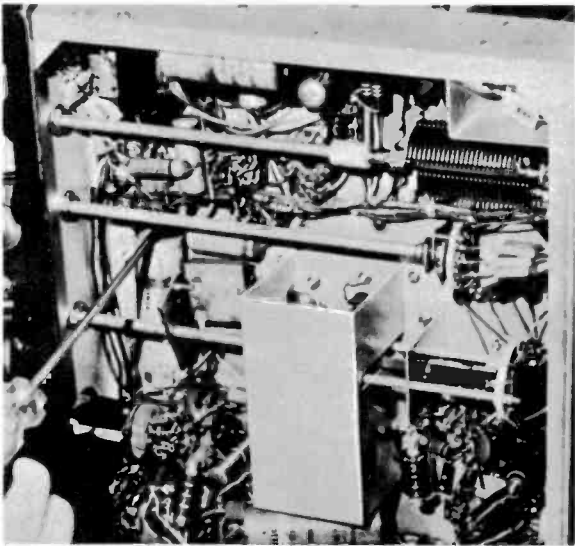

**"Stop, Look and Listen."** Here a high voltage bushing (right) broke down and shorted out to chassis. Traces of carbon are seen on chassis.

a more experienced amateur and asking for help.

Well, believe it or not, a raft of wrenches and a mess of test gear is nice, but not always necessary in troubleshooting. Beyond a certain point, a voltmeter is necessary, but there are several diagnostic short-cuts you can take to service your own transmitter if you will just "Stop, Look, and Listen" instead of diving into the rig pulling tubes and cutting connections.

For instance, ask your ears for a clue. Did you hear anything unusual when the transmitter quit? The sizzling, frying sound of an arc might point to a short-circuit, and although it may not be so (after all, these are tips, not certainties), you would do well to look for a short right away. A loud hum or the groan of an overloaded transformer may toll the death of a capacitor in the power supply.

If you didn't hear anything, perhaps your nose picked up the acrid smell of hot rubber. Check for an overheated power cord. A whiff of blistered resistor will remind you of an upset polecat, although discolored resistors may still function properly.

Touching an insulated screwdriver first to the chassis, then to filter capacitor will discharge the component, keep you from getting a jolt.



The next step is to face the ailing rig bravely and start looking. First, turn the power switch on and check pilot lights and meters. If there's no sign of life, you have no AC line voltage, probably due to a blown fuse, a loose or broken connection in the line cord, a defective AC switch, or an unpaid electric bill.

If the rig appears normal from the front, take a good look at the tubes. A cold tube with unlighted filaments is easily spotted. Loose elements or intermittent break-downs will sometimes show up by tube-tapping. With a tiny rubber-tipped tool (such as a screwdriver with a grommet on the business end), gently tap the side of the tube while watching the plate meter of the rig. If the meter jumps around, you've probably found the culprit. Incidentally, there's no law against substituting tubes just to make sure they aren't defective.

A blown fuse can mean a bum rectifier tube. Try this shortcut: Remove the rectifier from its socket and replace the blown fuse before turning the plate on a second time. If the new fuse doesn't blow, replace the old tube. If the fuse blows even without the rectifier tube in

[Continued on page 118]

# RADIATION HAZARD

By E. M. Delman

**Are you aware of radiation danger from fallout, X-rays, wastes? Do you know where dangers lurk?**

**T**HE insidious thing about radiation is that any exposure less than the huge dosage that produces quick death cannot be felt by the human senses. You can be blasted by dangerous radiation for hours, days, even years and never know it. What's more, the genetic effect is cumulative—the possible harm to unborn generations of each exposure adds on top of that of earlier exposures.

The only way to know if you are being submitted to harmful radiation is if you carry a radiation detector, film badge or a small ionization chamber. Generally only workers handling radioactive materials wear film badges, which turn cloudy when exposed to radiation. The same holds true for the ionization chamber. Film badges were the fortunate

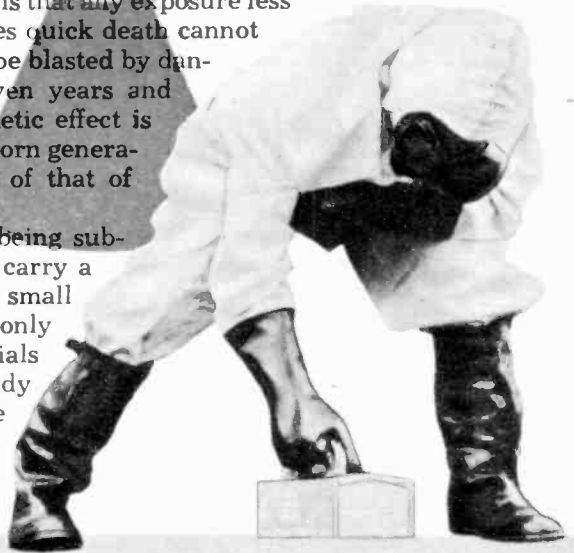

Emergency team from AEC's Hanford Works is prepared to measure contamination should it get out of control of the hundreds of radioactive isotope users in the Northwest. Below, team at Rochester checks laundry for "spill."



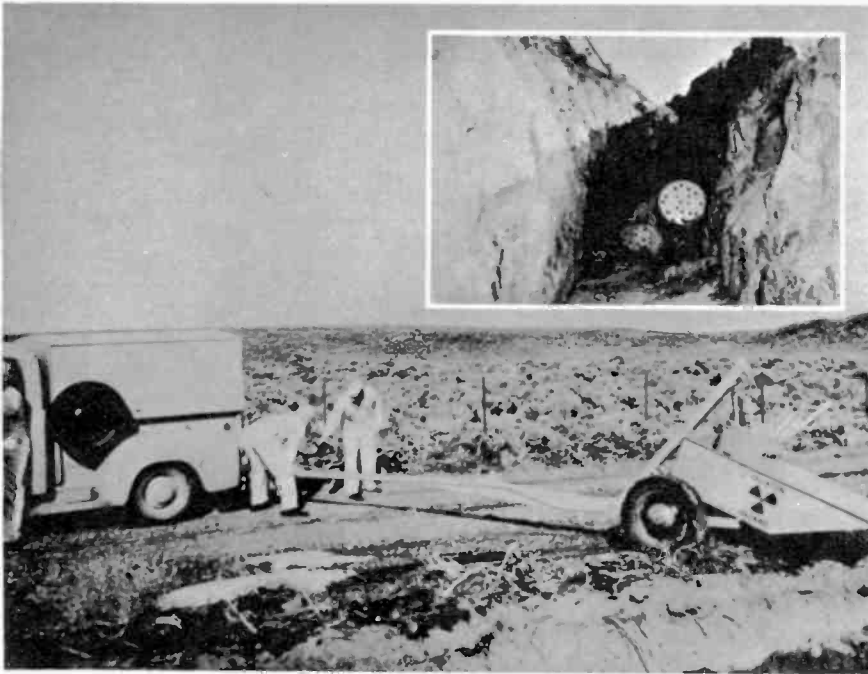

Transportation and disposal of radioactive wastes is becoming more and more of a problem with number of users on increase. Below ground burial, such as that shown here at reactor test station in Idaho, is one method of getting rid of the unwanted radiation.

Radioactive contamination can be spread in many ways and preventive measures are rigidly enforced by AEC. At Oak Ridge, workers wear special shoe covers to check contamination.

At Picker Research Center in Cleveland, glass wall five feet thick shields technician using robot manipulators to load highly radioactive isotope into heavy lead container for transportation.

Strange unit below is a mobile shield developed at Argonne National Labs in Illinois to permit safe handling of irradiated targets taken from their powerful experimental cyclotron.

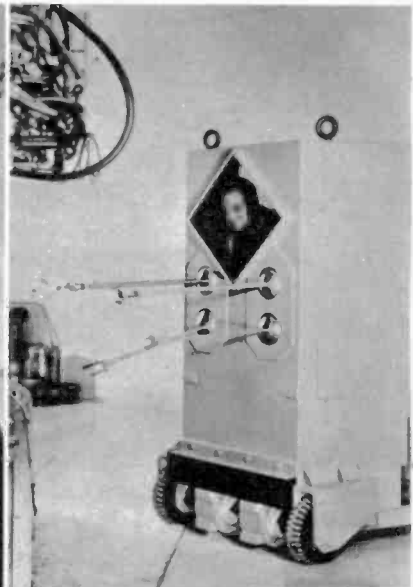
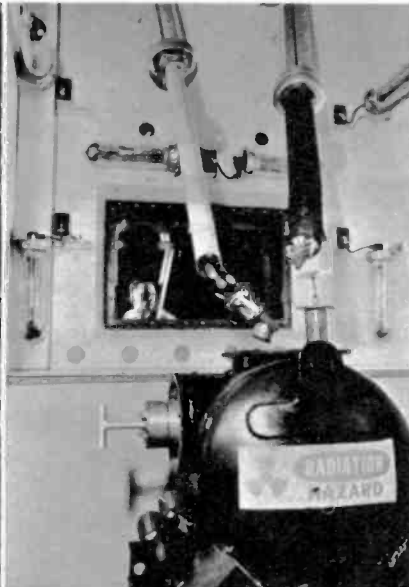

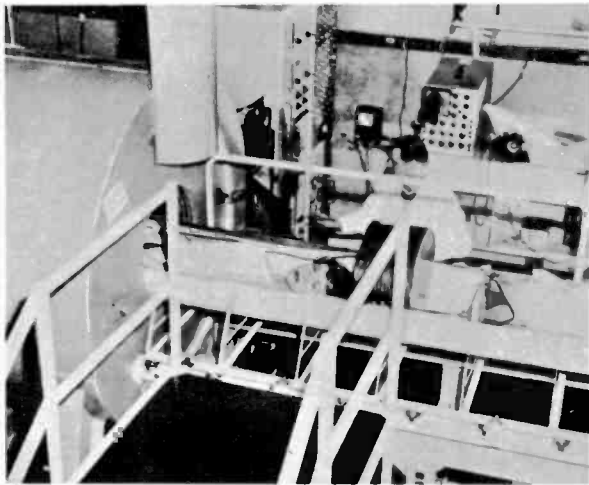
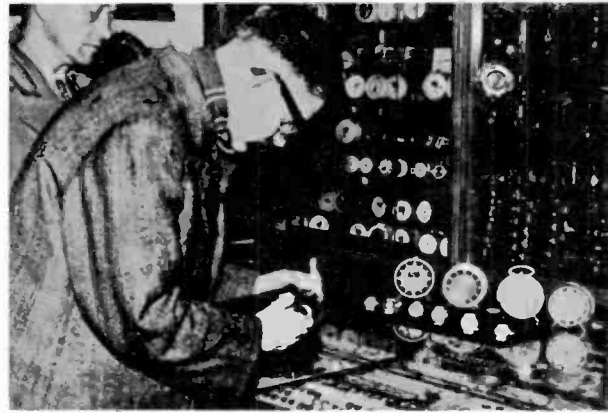

Every precaution is taken by AEC to protect workers and public against dangerous radiation. Here young lady submits to hand and foot radiation counter.

Recent scare involving leading Swiss watch maker has had international repercussions. Amsterdam investigators above, check for dangerous timepiece.

Electronic apparatus, left, is used at Los Alamos to detect and measure small amounts of radioactive material within body. Woman is moved inside counter.

means by which the world recently learned about one shocking example of negligence in handling radioactive material.

The situation came to light when two Atomic Energy Commission inspectors checked a laboratory that develops the exposed film in the badges. Badges coming from one client showed excessive radiation, indicating that every person in the client's employ might be receiving dangerous radiation.

Investigation with a radiation detector quickly showed that the radiation was limited to one man who handled all the badges. It came from his Rolex watch, which gave off about the *maximum* permissible dose.

The source of the radiation was strontium-90 on the bezel around the dial. As

a result of this discovery, the A.E.C. and the Rolex company are making strenuous efforts to get back every one of hundreds of the "Rolex GMT Master Watches" now inside the United States.

Incidents like this can be expected to multiply in the coming decade because every day more and more radioactive materials are being used on farms, in factories, hospitals and space vehicles.

There are three categories of damage caused by radiation: 1. immediate bodily injury; 2. somatic damage to the cells, which may not show itself for years and; 3. genetic damage, or damage to the reproductive cells, which may show up in your unborn children, grandchildren and so on.

The possible sources of radiation that  
 [Continued on page 124]

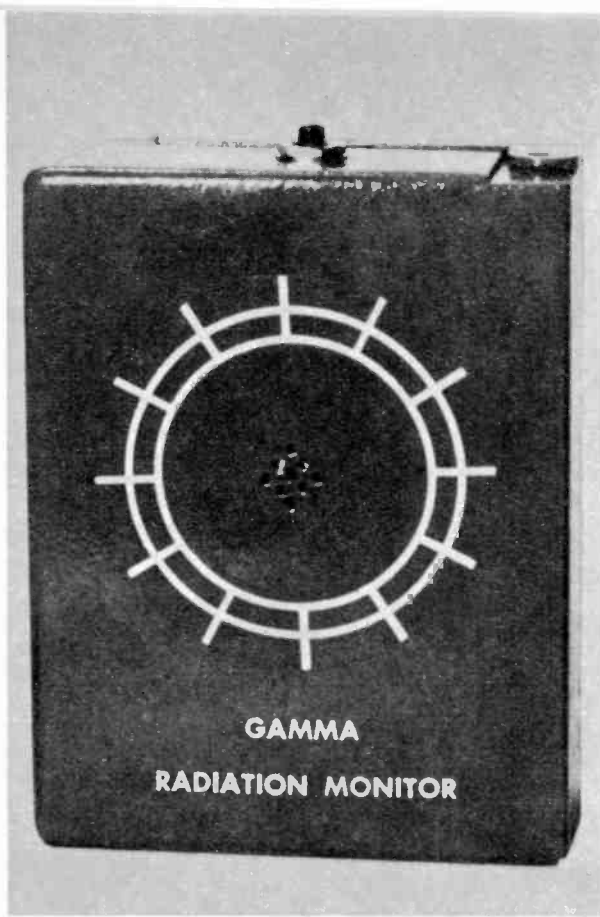

Neat appearance and small size keynote this little gem. The small holes in the center are openings for the tiny "speaker."

Completed unit is shown below with cover removed. The disk capacitor seen at center, hides the earphone speaker from view.

*build a*  
**Radiation Monitor**

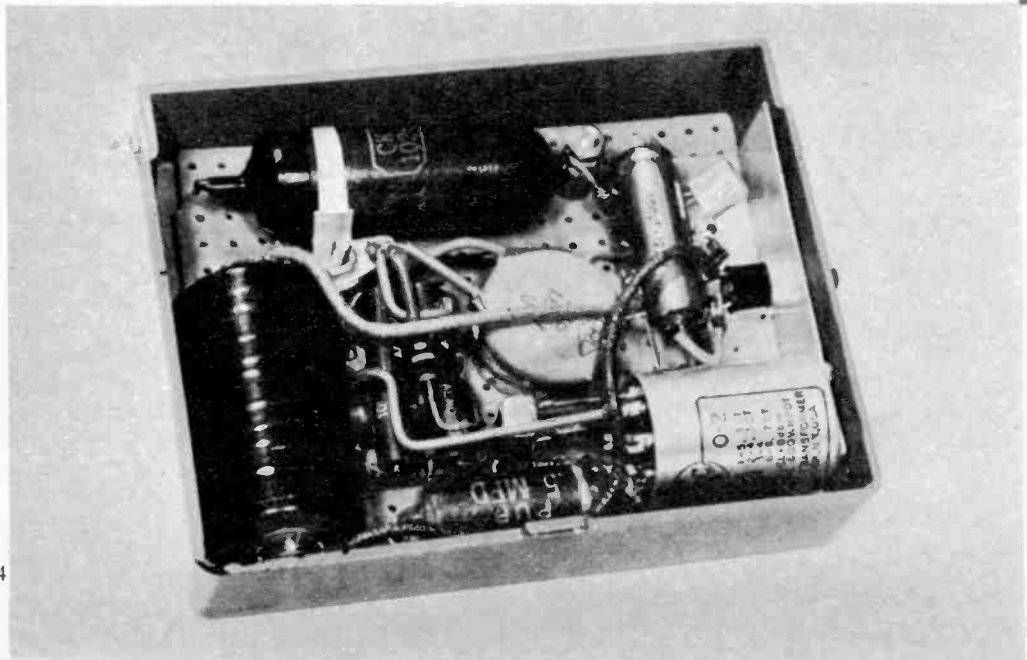



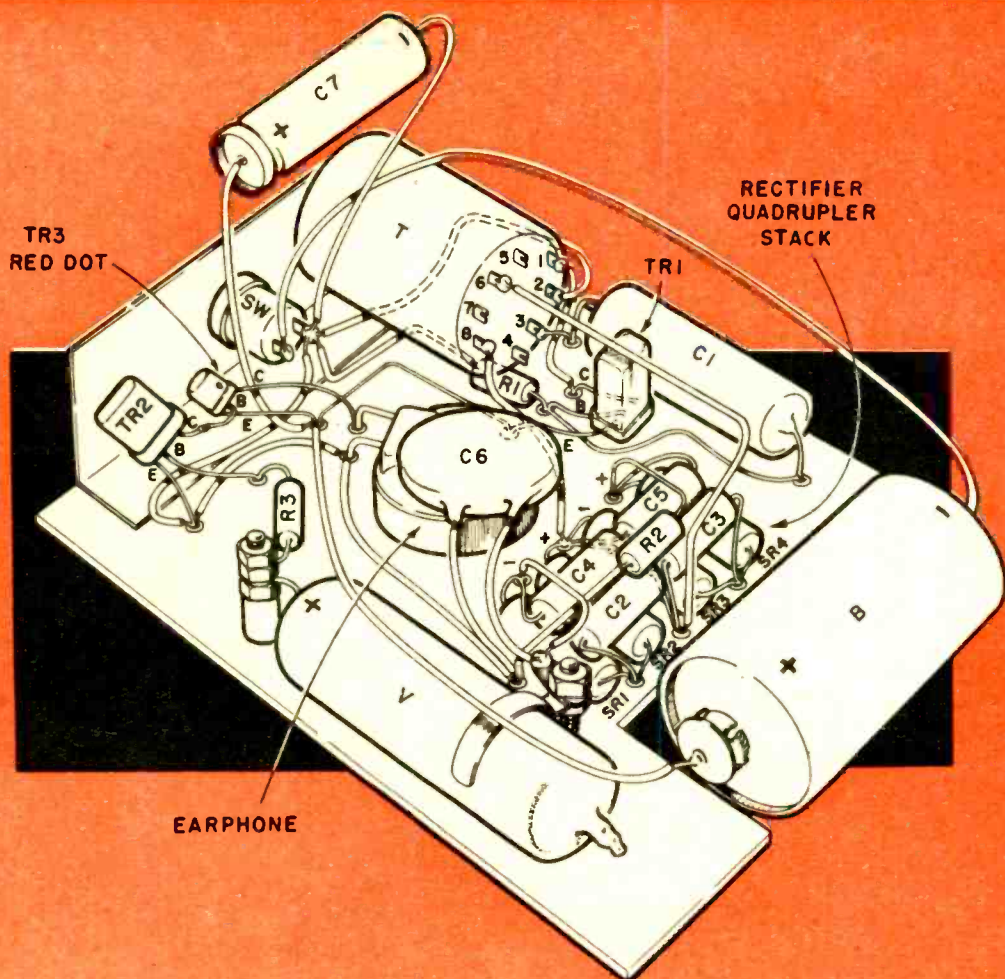

By R. L. Winklepleck

**This unusual device is vest-pocket size; compares favorably with commercial gamma-ray counters.**

**T**HE office of Civil and Defense Mobilization and the Atomic Energy Commission have both gone on record favoring a small battery-powered radio and an equally small sensitive radiation detector for every family. There isn't, however, a radiation level indicator yet on the market which is entirely suitable. Thus, if you'd like to have your own indicator you'll have to build it; and this need not be complicated nor fabulously expensive.

The radiation level monitor described here has about the same size and cost of a small transistor radio. A standard transistor battery is used at about the same current drain.

Actually, there's nothing new nor unusual about the circuit.

The power supply is a 300-cycle Hartley-type oscillator using a high-alpha transistor (TR1) and a subminiature transformer (T). The stepped-up AC at the secondary of the transformer is further boosted with a compact voltage quadrupler-rectifier and filtered by R2-C6. The output of the power supply exceeds one thousand volts (open-circuit) with a fresh battery and drops to about 800 volts when the battery voltage falls to six volts. The oscillator draws approximately ten ma. from the battery—about the same as a 6-transistor radio with the volume up—so battery life is excellent. Since the high-voltage output current is only a few microamperes, both a VOM and a VTVM will load down the circuit too much for a correct voltage reading. You can assume the output voltage is correct, however, if the oscillator is operating. Remember that even at a low current a 1000 volts has a nasty sting, so be careful.

The radiation detector is an inexpensive Geiger-Muller tube sensitive to gamma and high-energy beta radiation. It is rugged, is not damaged by over-voltage and produces a useable output over an operating range of 800 to 1100 volts. The tube normally is non-conducting but, each time it is penetrated by a particle of gamma radiation, the internal halogen gas ionizes briefly to produce a current pulse through the associated circuit. The frequency of the pulse is an indication of radiation intensity.

A two-stage, direct-coupled, transistor amplifier is used to raise the audio level of the pulses so they may be heard even in noisy locations. A very sensitive

7500-ohm impedance earphone is used which produces a signal loud enough to be heard with the phone mounted in the cabinet.

All components have been selected to give dependably good performance in a small package. The model shown here is built into a plastic box measuring 1 1/4" x 3 1/4" x 4 1/4" outside dimensions.

A 3" x 4" piece of phenolic perforated board is used as the component mounting base. An L-shaped scrap of aluminum is mounted on one end to receive the switch and the transformer. A rectangle of board is cut from the opposite end to accept the battery which is held in place by the other components and attached to the circuit with snap fasteners. The G-M tube is held by a metal strap designed for holding a power resistor. This strap is in contact with the tube's external graphite coating which serves as the tube's cathode. The anode

[Continued on page 120]

#### PARTS LIST

- R1—10,000 ohm resistor 1/2 watt
- R2—100,000 ohm resistor 1/2 watt
- R3—10 megohm resistor 1/2 watt
- C1—.5 mfd 200-volt capacitor
- C2 thru C5—.01 mfd miniature capacitors 400 volts (Aerovox P83Z or equiv.)
- C6—.015 mfd disc capacitor 1600 volt
- C7—100 mfd 12-15 volt electrolytic capacitor
- TR1—Transistor CK721
- TR2—Transistor 2N35
- TR3—Transistor CK754
- V—G-M tube CK1026 (Raytheon)
- SR1—Selenium rectifier U10HP (International Rectifier)
- TI—Miniature transformer (UTC 0-2)
- SW—SPST pushbutton switch
- B—Battery 9 volt (Eveready # 226 or equiv.)
- Misc.—Earphone 7500 ohm (Lafayette MS-260), plastic case, phenolic board

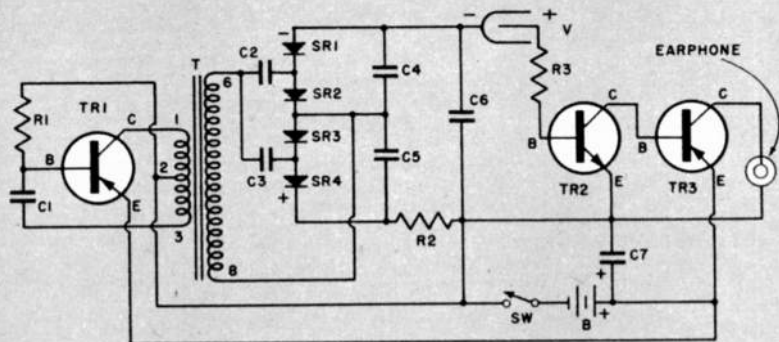

Carefully note wiring and polarity of rectifiers (SR1-4). The signal is from V-TR2.



New image orthicon TV camera tube is pointed out to General Electric executive by Dr. Peter Wargo, right. It operates on far less light than ordinary tubes.

## Super-Sensitive TV Camera Tube

The GL-7629 is not only brighter, but much better in the depth of focus department. These off-the-screen pictures show difference. At right represents GL-7629.

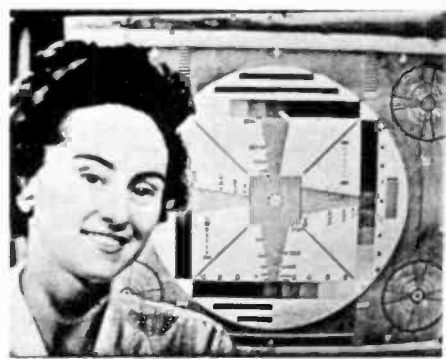
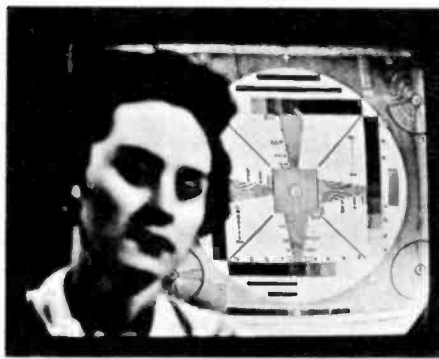

Night scene at airport serves to illustrate how new tube can be used to cover after-dark events. Note how GL-7629 picture, right, also takes in hangar and terminal area in the distant background.

**C**OLOR TV of night baseball? Impossible, you say. Too dark for color TV. But you're wrong! General Electric's new image orthicon tube, GL-7629, interchangeable with standard camera tubes, needs only 1/10 to 1/20 the light required by standard cameras. That means color TV under normal lighting and black-and-white TV under sub-normal lighting. The extreme sensitivity comes from a new high-gain, thin-film magnesium oxide target some 2-millionths of an inch thick—100 times thinner than conventional tube targets. What's more, there's no "stickiness" or "burn-in" of the previous image after the scene changes. WLW-T tested the tube in basketball colorcasts and plans to colorcast ten Cincinnati Redlegs night baseball games.

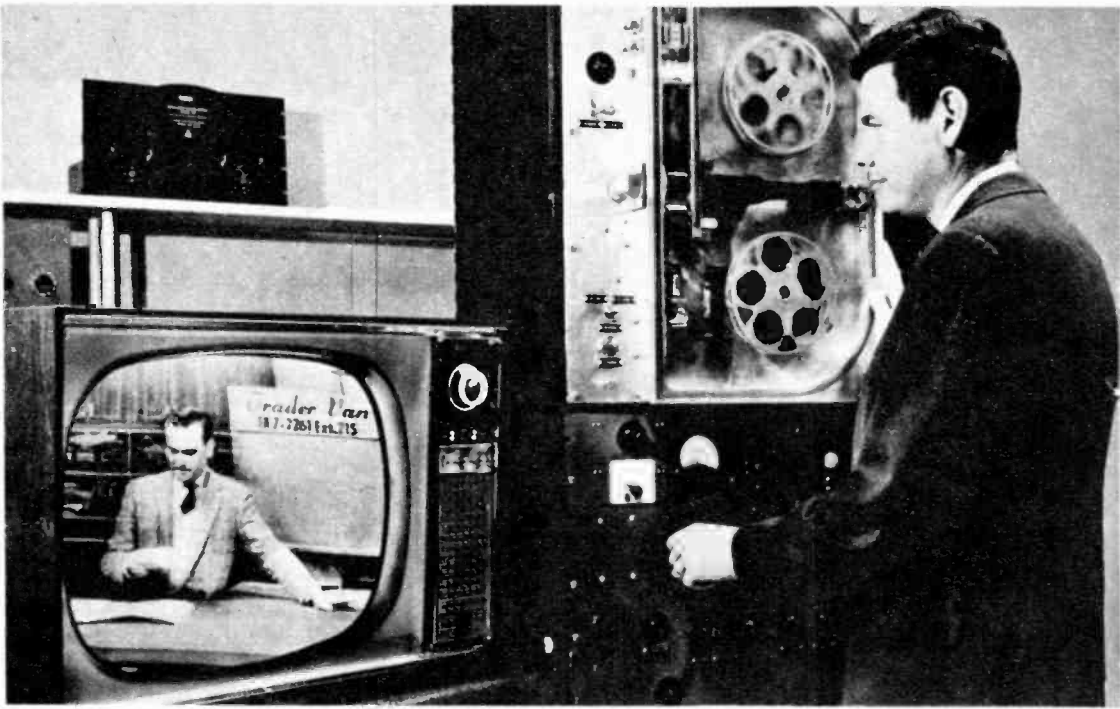

TV picture on monitor set is being fed into TPR recorder at right where it is transformed into tiny wrinkle patterns on special transparent film in vacuum.

*tape and film move over for*

## **New All-Purpose Recorder**

**By Donald C. Hoefler**

**M**MAGNETIC recording, which for a decade has reigned supreme as *the* method of storing sound and (more recently) video, may soon be knocked down a peg or two. And motion picture film, which is essentially the same as it was 70 years ago, may be faced with a similar situation. A new method of recording has appeared on the scene, and while it bears some resemblance to each of its predecessors, it may yet prove to be superior to both of them.

The new system, a product of General Electric Research Laboratory, is called thermoplastic recording, or TPR for short. Like magnetic tape, it provides instantaneous playback of either sound or picture. It is erasable and can be reused. And like photographic film, it can store 100 times more information than the same amount of tape.

TPR records pictures in either black-and-white or color, and these can be reproduced directly through a video system, or through a standard projector with only slight modification. When light strikes the TPR surface at an angle, pictorial information can be read with the naked eye. And since the ultimate cost is

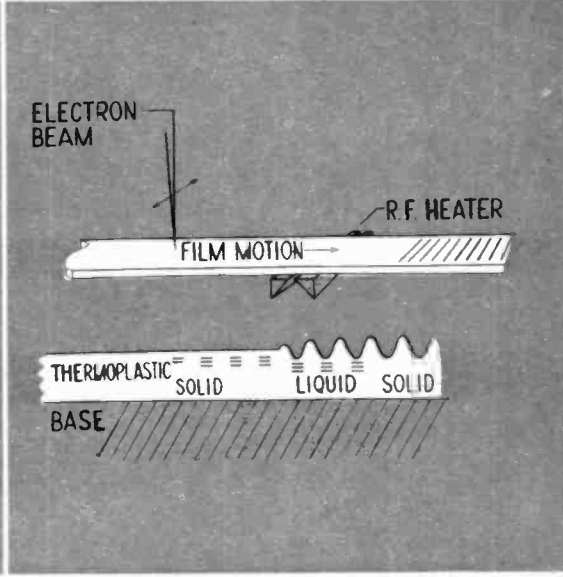
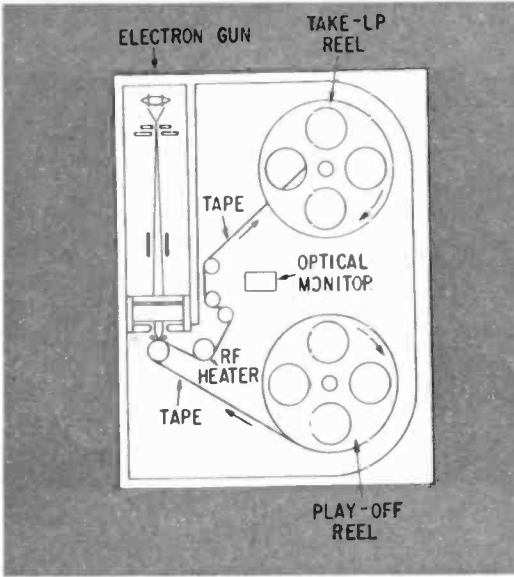

Diagram, above left, shows layout of recorder. At right is diagram of process charging thermoplastic with electron beam to record images in form of ripples.

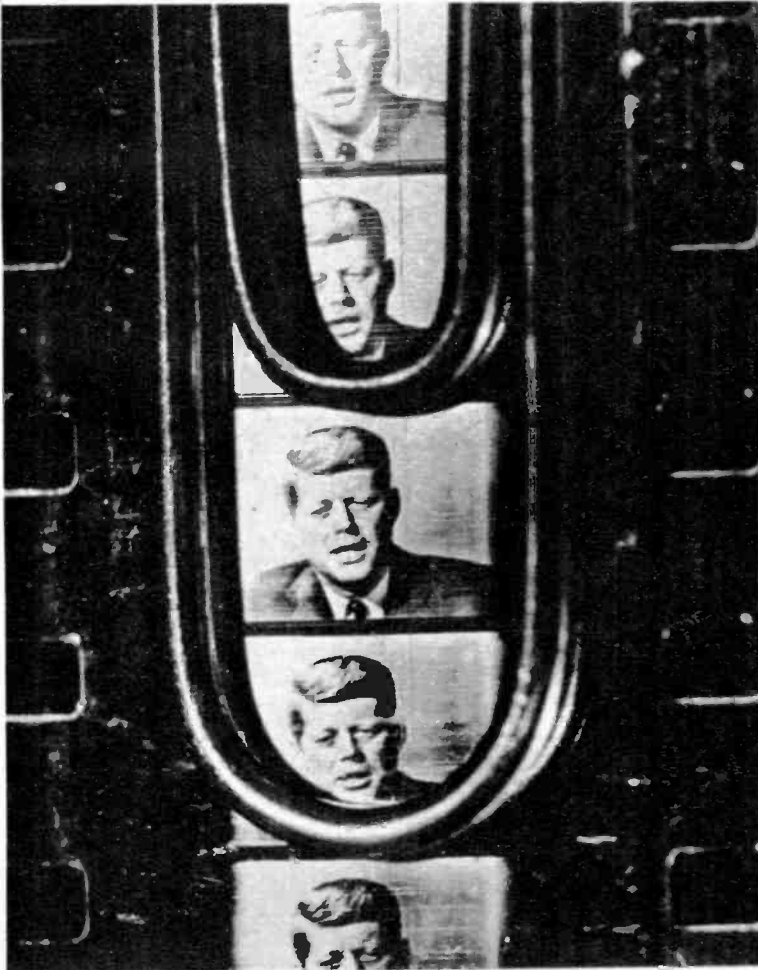

When ordinary light strikes TPR wrinkles at an angle, the image may be read with the naked eye. Each frame is less than 1/4-inch wide. The wrinkles, caused by the electrons trying to seek neutral layer below viscous plastic, may be smoothed out for re-use of the tape.

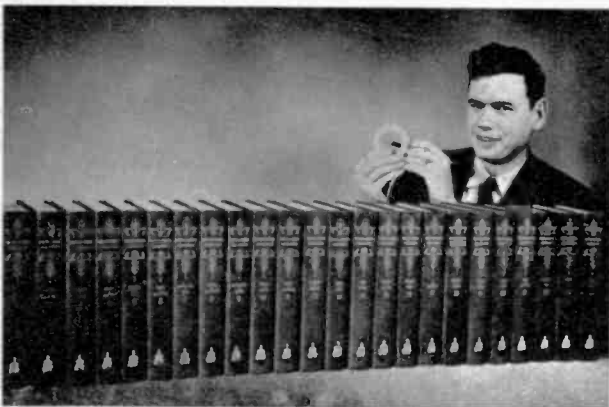

All two-dozen volumes of Encyclopedia Britannica can be recorded on one reel of TPR tape.



Projection of TPR image can be achieved with simple optical system and series of gratings.

Thermoplastic tape moves from feed reel, bottom, past electron gun, heating unit and an optical monitor to the take-up reel, top.

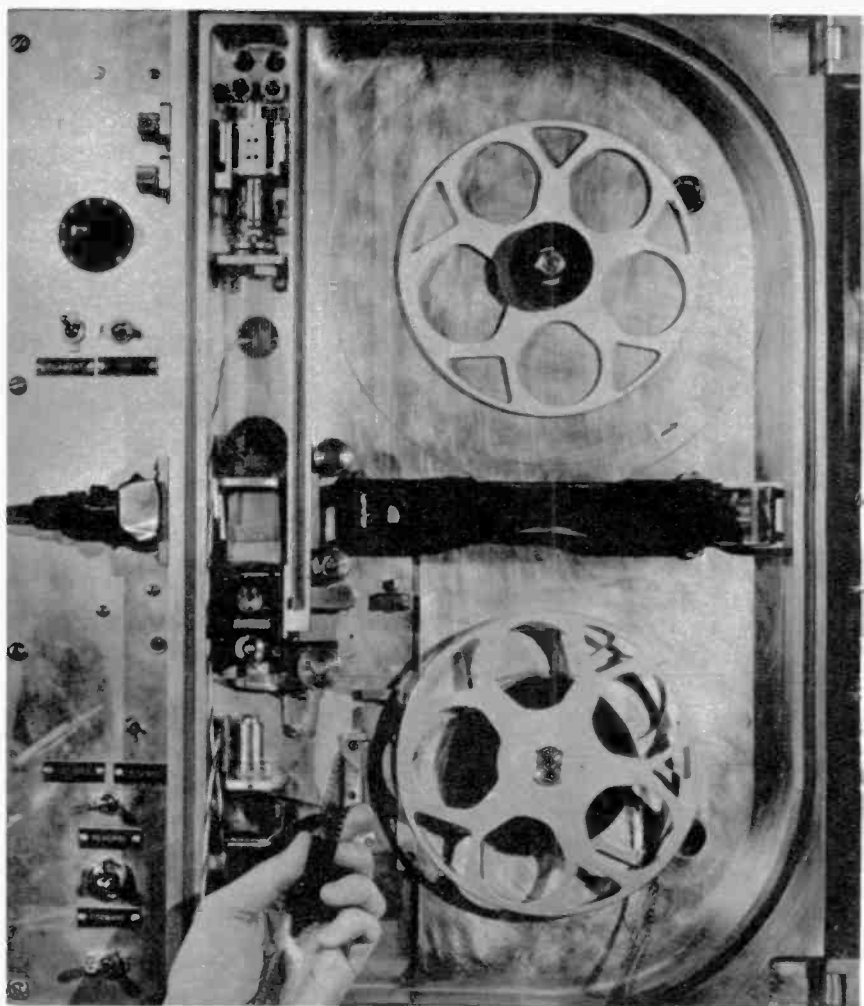

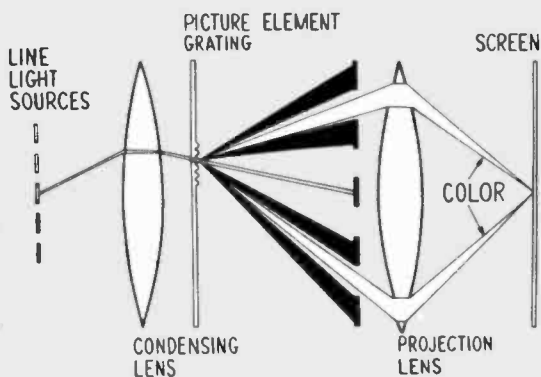

For TPR color, film wrinkles act as prisms to break up white light. Rays of color then pass through a partial filter grating and are recombined on the screen in proper proportion.

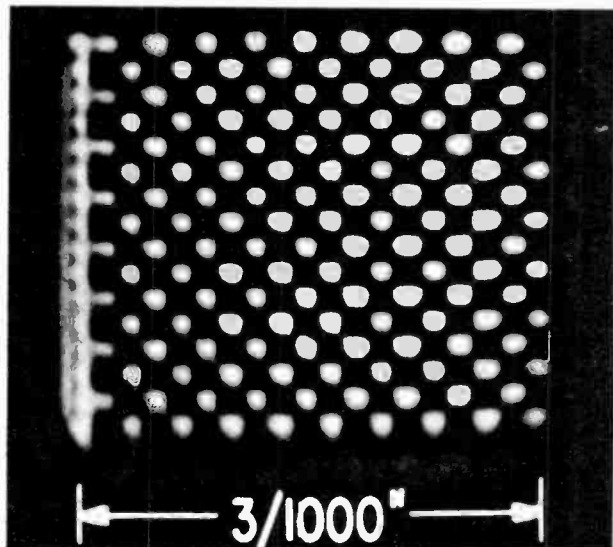

With digital computer binary system, light and dark squares in above pattern could represent "0" and "1", making it possible to record 40-million "bits" of information per square inch.

expected to be quite low, TPR may become tomorrow's hi-fi, home movies and off-the-air recorder all rolled into one!

Recording is in the form of small waves or ripples on the surface of a plastic tape which looks somewhat like film. These ripples are formed by an electron beam, which scans across the surface of the film, very much like the beam which "draws" the picture on the face of a TV tube. The input to the recorder may be an audio or video signal or both, much like that used in magnetic tape recording, while the output image on the film is somewhat like that on a photographic film. Pictures on the film can be projected immediately, or the images can be played back as audio or video and there is no darkroom work or other processing involved.

The recorder physically resembles a professional tape recorder. But in place of the recording head there is an electron gun, and in place of the playback head there is an optical monitor. The entire unit is enclosed in a high vacuum because the electron gun must operate in a vacuum. The electron beam strikes the film directly.

The film actually is a three-layer sandwich with a plastic base similar to

that of standard movie film. Next comes a thin, transparent coating of an electrically conductive material, and finally a layer of thermoplastic. The thermoplastic surface is bombarded with a beam of electrons from the gun. The thermoplastic takes on a charge under bombardment with a pattern of excess electrons on its surface corresponding to the modulation of the beam from the gun.

Now we have a capacitive effect, or a static attraction between the thermoplastic surface, which has an excess of negative electrons, and the middle conducting layer of the sandwich, which is at ground potential. Then if the charged thermoplastic were a viscous liquid, it would deform into ripples as the electrons try to reach the electrically neutral ground layer.

In TPR, the charged material is made viscous temporarily by a radio-frequency (RF) heater which induces a voltage into the conducting layer, getting it hot enough to melt the thermoplastic layer right next to it. The negative electronic charges in the thermoplastic, attracted to the transparent conducting coating, depress the

[Continued on page 120]

*E I reports on first*

# All-Transistor Intercom Kit

**Easy to build battery-operated unit handles up to five slave stations with special remote-call circuits.**

**T**ODAY, when intercoms are becoming almost as common as radios, a new unit really has to have an extra "gimmick" or two to deserve special notice. The new Heathkit intercom qualifies easily for the "something special" category.

First of all, it's transistorized and has a whopping (for transistors) 1-watt output. The master unit's three-stage amplifier is powered by eight size "C" cells. On the front panel are five slide switches which handle from one to five remotes and another slide switch which shifts from "net" communication between master

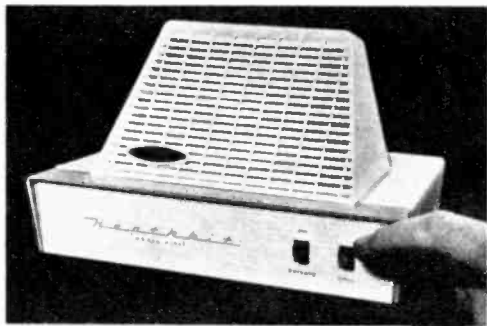

Modern styling of the blue and white plastic cabinets of the completed slave and master units are shown in the photos at left and below.

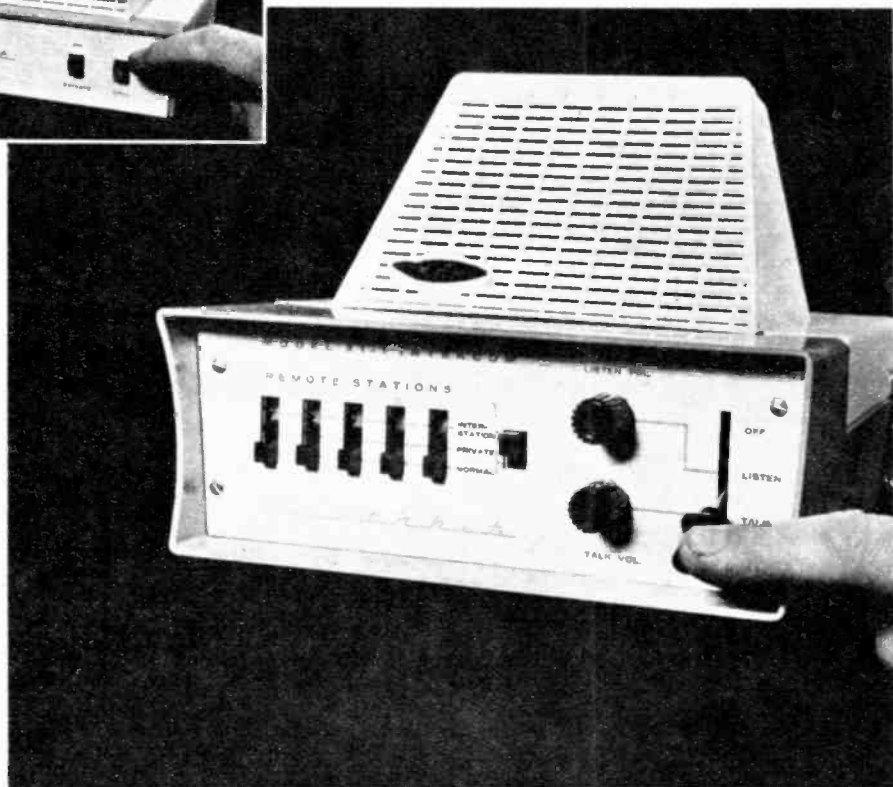



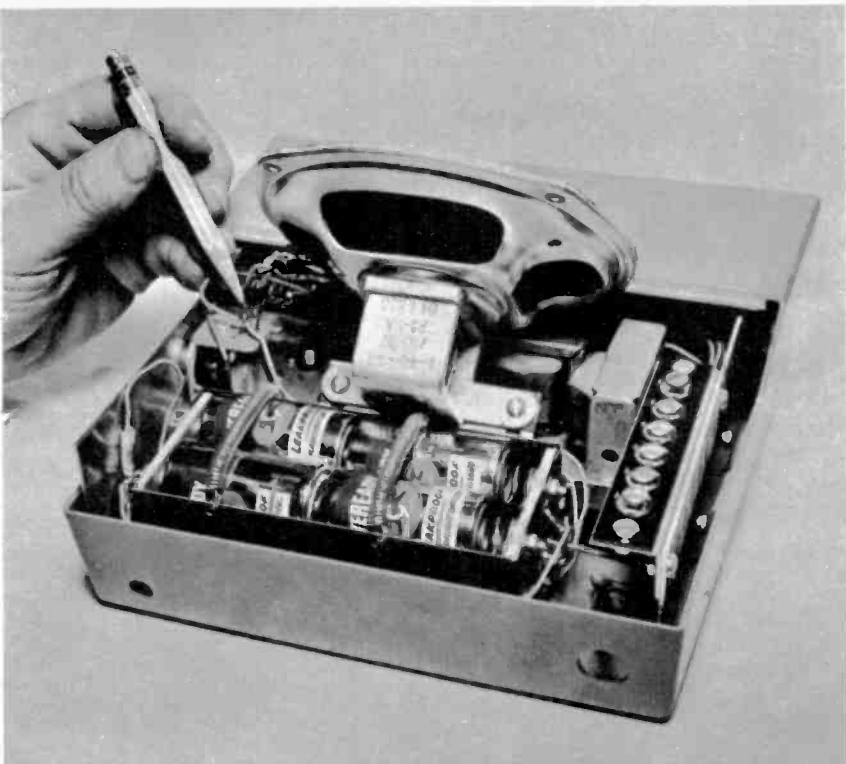

Batteries are installed in place in special clamp holder along the rear edge of the master unit.

Up to five different slave units may be connected to master's screwtype terminal board.

Open chassis and miniature components insure ease of wiring. A small hot iron should be used.

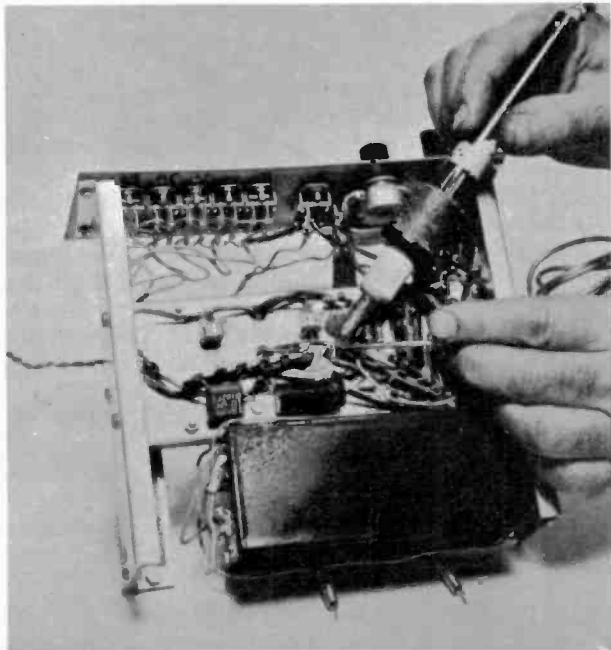
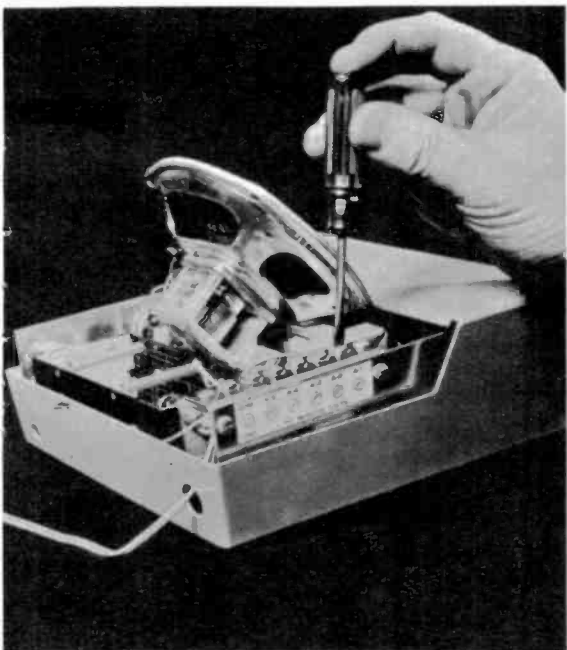

Finger points to 9 volt battery in remote unit. Two sections of plastic cabinet snap together.

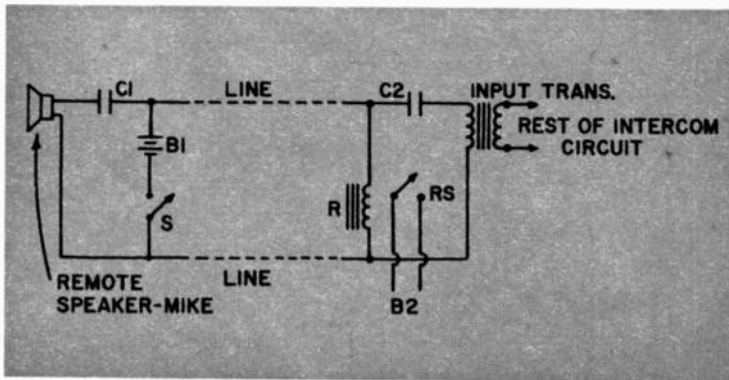
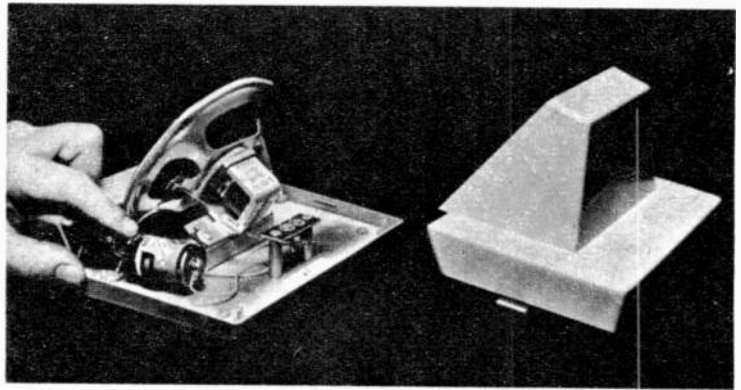

Special circuit used in remote switching. See text for circuit details.

and remotes to inter-communication *between remotes*. There's separate volume controls for talking and listening and on-off switching which is part of the spring-return "listen-talk" switch.

Each remote unit contains a 10 mfd capacitor (C1), a nine volt battery (B1), and a momentary-contact slide switch (S). In the simplified schematic above (all control switches omitted) the master is shown at the right in its *listen* mode. Across the line is the winding of relay R, and in series with the primary of the input transformer is another 10 mfd capacitor, C2. The contacts of the relay, RS, are normally open and go to B2, the master's eight batteries.

With the master turned off, B2 is open and the system is entirely dead. However, when the person at the remote presses down on S, DC from B1 goes over the line and energizes R, causing contacts RS to close. The amplifier springs to life instantly, and anything said over the remote is now reproduced in the master's speaker.

Capacitors C1 and C2 prevent the DC of B1 from going through the remote speaker and input transformer. However, the capacitors offer little impedance to voice frequencies.

At the master end, the winding of R offers a high impedance to voice frequencies, and they therefore flow through C2 into the transformer.

The arrangement is beautifully simple, foolproof, and absolutely free of all shock hazard. This is much more than can be said about the hot-chassis AC-DC intercoms sold as "baby sitters."

Heath says that the system is good for about a mile of separation between master and remote. This is far in excess of normal intercom requirements. Your *EI* reviewer tried it with 50 and 500-foot lengths of No. 20 solid wire, with only a slight volume drop on the longer loop. The speaker-mikes are 45-ohm units made especially for intercom service.

Overall sensitivity is almost embarrassingly high. With a remote unit at the

[Continued on page 109]

# How To Fix Your TV

Television troubleshooting can be easy! A systematic approach, a little knowhow, some sensible precautions, and you can tackle most TV troubles like an expert.

## CONTENTS

<b>Your TV Set</b> .....	<b>66</b>
<b>First—Adjust!</b> .....	<b>69</b>
<b>Troubleshooting Chart</b> .....	<b>70</b>
<b>All About Tubes</b> .....	<b>73</b>
<b>A Filament Checker</b> .....	<b>76</b>
<b>Picture Tube Brightener</b> .....	<b>78</b>
<b>Fuses and Their Location</b> .....	<b>79</b>
<b>Tuning the Front End</b> .....	<b>80</b>



## YOUR TV SET

As the local authority on electronic matters, do you have to mumble excuses when a friend asks you to have a look at his ailing TV? Or even worse, do you have to haul your *own* set to the repair shop when something minor goes wrong? Well, fret no more; in the following pages *ELECTRONICS ILLUSTRATED* presents a concise, up-to-the-minute and to-the-point guide to TV troubleshooting which will take care of the majority of your TV trials and tribulations.

Remember you have a reassuring statistic on your side; eight out of ten TV troubles are the result of defective tubes or some other easy-to-remedy cause.

### Each Section and What it Does

In common with most electronic equipment, a television receiver is made up of sections, each of which makes a unique contribution.

#### The Antenna

All the broadcast TV signals are picked up by the antenna and sent down the transmission line to the tuner. An outdoor antenna is always more effective than the indoor type although in strong signal areas indoor antennas are adequate.

A defective antenna system can result in a complete loss of picture with snow in evidence on the screen, or weak, snowy picture, or a picture with ghosts.

#### The Tuner

Known also as the "front end" the tuner selects the channel. Both the picture and sound RF signals pass through the tuner and are amplified. The RF frequency is reduced to a lower frequency called the intermediate frequency, or simply IF. The two tubes usually found in the tuner are the RF amplifier and oscillator-mixer.

If either of the front end tubes fails or if a defect develops in their associated circuits, both picture and sound are lost, but the light (raster) on the screen remains.

#### The IF and Video Amplifiers

Your set has two to four tubes whose job is to amplify the picture and sound IF signal.

Past the IF amplifier we find the video detector employing a tube or diode. At this detector circuit the picture and sound signals are sent on their separate ways. Failure of the detector or IF tubes or components will result in loss of picture and loss of sound:

The video section consists of the video amplifiers, the automatic gain control (AGC) circuits, and the picture tube or CRT. There are one or two video amplifier tubes which amplify the video signal on its way to the CRT.

The AGC tubes and circuits provide automatic control of the amount of video signal developed at the video detector. When these circuits are working well, it's unnecessary for the viewer to readjust the contrast controls as he switches from a strong to a weak channel or vice versa.

A failure of the video amplifiers will cause you to lose the pic-



ture, but not the screen raster, and not necessarily the sound.

Troubles in the AGC circuits may give effects varying from an extremely black picture to a complete loss of picture. AGC defects may also cause a reversal of light values, leading to an unstable picture which looks like a photographic "negative." A harsh buzzing in the sound will sometimes accompany AGC troubles. Contrast brightness and AGC controls are in this section.

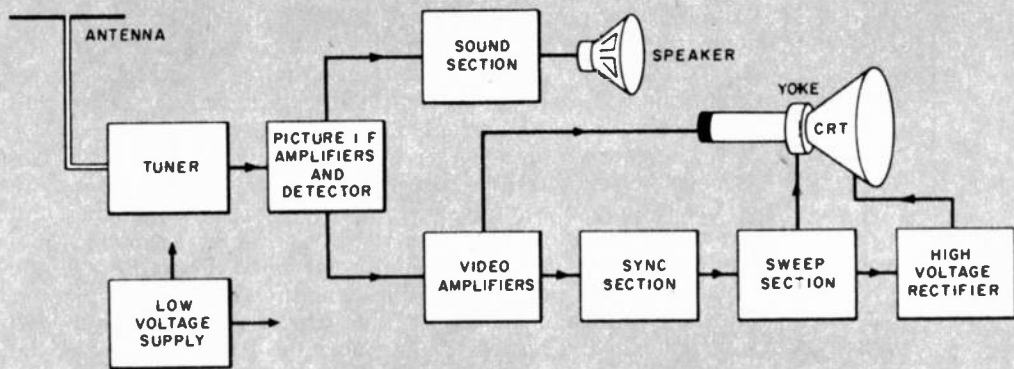

Block diagram of typical TV receiver. Each section has one or more tubes.

### The Sweep Section

As its name indicates, this circuit's job is to move the electron beam across the face of the CRT. The picture on your television screen is "traced" out by a moving spot of light which "starts" at the upper left hand side of the screen and rapidly moves in a straight line across the screen to the right. It then snaps back to the left hand side of the screen and traces out another straight line just below the first. The entire picture is "scanned" in 525 lines, 30 times per second in a process so fast that the eye cannot perceive the motion.

This scanning process takes place whether a picture (video) signal is coming in or not. In the absence of a video signal the uniformly lighted screen is called the "raster." The video signal intensity modulates the scanning spot and a picture results.

This section's tubes are the vertical (vert.) oscillator, vert. amplifier or vert. output, horizontal (horiz.) oscillator, horiz. discharge, horiz. output, and damper.

The controls and adjustments associated with this section are: Vert. Hold, Height, Vert. Linearity, Horiz. Hold, Width, Drive, Horiz. Linearity.

Troubles in the sweep tubes or circuits may result in:

- (1) Horizontal line of light through the center of the screen
- (2) Completely dark screen
- (3) Picture or raster which does not fill the screen completely
- (4) Improper picture or raster dimensions

### The Synchronizing Section

Your TV receiver's sweep circuits must be properly synchronized with those of the camera at the broadcast studio to insure

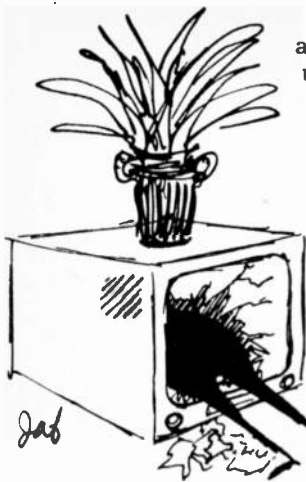

a stable picture. Synchronization (Sync) circuit troubles show up as:

- (1) Picture rolls vertically
- (2) Picture "tears" horizontally
- (3) White and dark areas on the screen with or without slanting lines, but no stable picture.

### High and Low Voltage

The High Voltage (H. V.) rectifier circuit which generates voltages ranging from 12,000 to 16,000 volts derives its energy from the horiz. output amplifier. That is why failure of the horiz. oscillator, horiz. output tube, damper or high voltage rectifier will result in a completely dark screen. The sound will not usually be affected.

The low voltage power supply furnishes B+ plate and screen voltages required by the tubes in the set. There are two basic types of supplies; one uses a power transformer and vacuum tube rectifier. The other does not employ a power transformer and utilizes metallic (selenium or silicon) rectifiers. Some sets however, use both the metallic rectifier and a transformer.

Complete failure of the low-voltage supply will result in a dead set, with no picture, no raster and no sound. Partial failure of the power supply may cause hum, low volume, or a shrunken picture.

### The Audio Section

This section is fed by the frequency modulated audio signal coming from the video detector (or sometimes from the video amplifier). The signal is amplified, demodulated, amplified again and is fed to the loudspeaker.

The tubes in this section are called: audio IF amplifier, audio detector, audio amplifier, audio output.

Audio circuit defects may cause complete loss of sound, distorted sound or weak sound.

Rear chassis view of a late model receiver using a printed circuit-board. Note the separate power supply (top) and the tuner chassis.

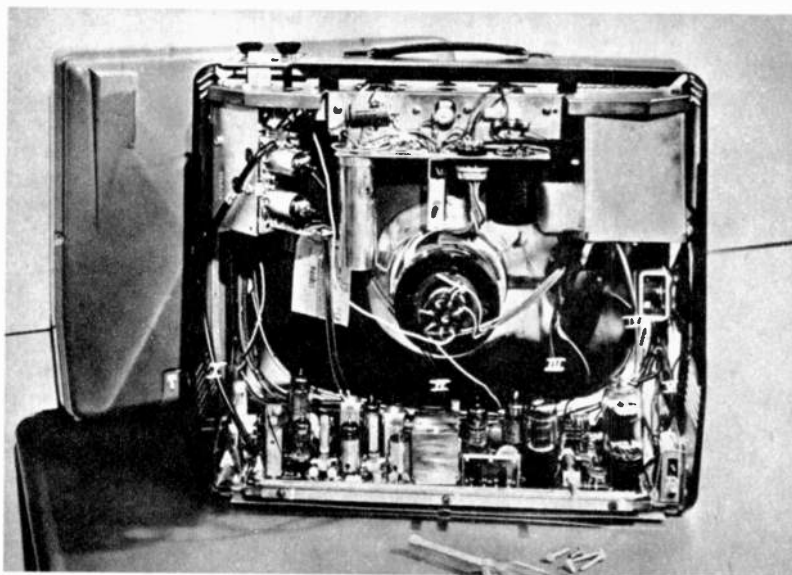

## FIRST ADJUST

Before "pulling" tubes, or more radical measures, it would be a good idea to first try resetting the "service" controls. Normal tube and component aging will frequently cause picture distortion that can be eliminated by simple readjustments.

Size and linearity adjustments may be labelled: (1) *vert. size or height*; (2) *vert. linearity*; (3) *horiz. size or width*; (4) *horiz. drive or drive*.

If the picture does not fill the screen vertically, or if the people on the screen have compressed heads and long legs, or very long heads and short legs, the *height* and *vert. linearity* adjustments should be reset. If the picture does not fill the screen horizontally, the *width* and *drive* adjustments require resetting.

### Caution

Don't turn any control or adjustment unless it is labelled and you know what its effect will be. Before you try any horizontal frequency adjustment (in the back of your set), mark the position of the control. Vary it on either side of this initial position. If this does not restore picture stability, return the control to its original setting. This precaution applies also to other service adjustments.

The procedure for getting correct dimensions requires first that you select a non-operating channel on which you see only the illuminated screen (*raster*) without a picture. A close look at the screen will reveal bright horizontal scanning lines. Reduce the setting of the *brightness* control if necessary. If the lines are not uniformly spaced or if the raster does not fill the screen completely, set the *height* and *vert. linearity* adjustments until the proper vertical dimensions and linearity are obtained. Now switch to an operating channel. The picture should fill the screen with the proper proportions. A slight touch-up may be necessary. For horizontal width reset the *drive* and *width* controls.

If you cannot fill the screen completely or dimension it properly with the size and linearity adjustments, one or more tubes in the sweep section of your set may be defective, or your picture may be off center. We will discuss these possibilities and their cure later.

A simple check to determine if the size and linearity adjustments are properly balanced, is to observe the shape of a circle when it is flashed on the screen. If it is not a good circle, but is excessively elongated or elliptical, the size and linearity adjustments require resetting. In all of these settings remember that perfection is not going to be achieved and you will have to make some compromise with perfect linearity.

### Centering Adjustments

Your set may have separate controls marked *vert. cent*, *horiz. cent*, or a single shaft extending from the back labelled "centering." This controls the positioning of the raster both vertically and horizontally.

Another type of centering control is the "ring





### Picture Rolls

Adjust the vertical hold control until picture "locks in." Check sync amplifier, sync separator, sync clipper, vertical oscillator and all other tubes so named to be in the vertical circuit.

### No Horizontal Sync

Adjust horizontal hold and/or horizontal frequency control until picture stops "tearing." Check sync separator, sync clipper, horizontal AFC and all other tubes in horizontal circuit.

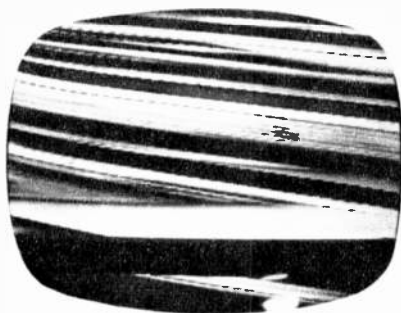

### Insufficient Height

Adjust height, vertical size or vertical linearity controls. These tubes may be weak: vertical oscillator, vertical output and low voltage rectifier.

### Hum In Picture

One or more of the following tubes may be defective: mixer-oscillator, RF amplifier, video detector, and video amp. producing 60 cycle hum bars.



### No Raster—No Sound

Low voltage rectifier, open tube filament on series string filaments, defective power transformer in parallel filaments, house fuse, line fuse and line cord and built-in circuit breaker.

### No Picture—No Sound—Raster OK

Oscillator-mixer, RF amplifier, video detector, sound detector, video amplifier, and AGC amplifier. In addition, check all video and sound IF (intermediate frequency) tubes.



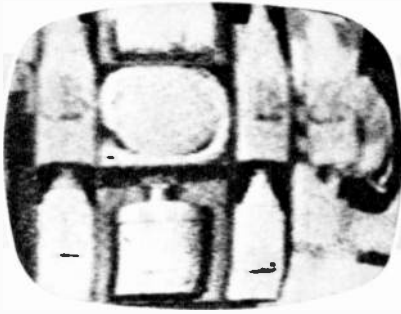

### Snow In Picture

Adjust AGC or local-distant switch. Check RF amplifier, IF amplifier and mixer-oscillator tubes. If these tubes are ok, make a thorough check of your antenna including the 300-ohm line to set.

### Picture Not Centered

If the picture is partially off the screen then you can adjust this with a centering control. This control usually consists of two levers on the neck of the picture tube which are rotated.



### Insufficient Width

If picture shrinks on both sides you may adjust the horizontal drive and width controls. Assuming this doesn't succeed, then check the horizontal oscillator, horizontal output, and damper tubes.

### No Vertical Deflection

A thin white line across the face of the picture tube indicates a failure in the vertical circuit. Check the vertical oscillator, vertical multiplier, and vertical output tubes to correct this defect.

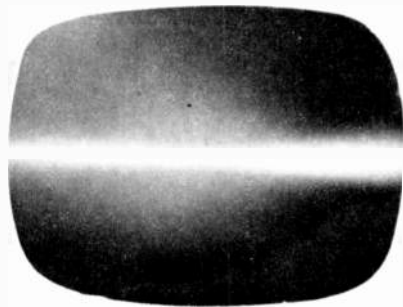

### No Raster—Sound OK

Horizontal oscillator, horizontal output, damper, high voltage rectifier and fuse, picture tube.

### Double Picture

Check out antenna and horizontal-drive control.

**No Picture—Sound OK—Raster OK**  
Video amplifier, IF amplifier, and AGC amplifier.

### No Sound or Distorted Sound—Picture OK

Sound IF amplifier, audio detector and audio amplifier.



type" with centering tabs. This is mounted on the neck of the picture tube, right next to the yoke. For proper centering either rotate the ring as a whole or adjust the tabs.

### Picture or AGC Adjustment

This may be a continuously variable control or a switch labelled, *Local-Distance*, *Fringe* or *Range*. Its purpose is to adjust the sensitivity of the TV set to the strength of signal that is being received. It operates in conjunction with the *contrast* control. If it is a switch, receiver gain is increased in the *Distance* or *Fringe* position. If it is a continuously variable control, rotation in a clockwise direction increases the contrast of the picture.

The proper procedure for adjusting a variable AGC control is to select the strongest channel in your area and turn the AGC control in a clockwise direction, to the point where objects in the picture start to bend. Then back off the AGC control just enough to remove the bend and leave normal reception.

An alternate procedure is to select the weakest channel in your area. Set the contrast control  $\frac{3}{4}$  of the way up in the direction of greater contrast. Turn the AGC control to the point where you just get "snow" in the picture. Then back off the AGC control until the snow just disappears.

You may find that the procedure for setting the AGC control on the strongest or weakest channel may not be the best setting for one or more of the other channels. In that case a compromise setting may be required for best results in your set.

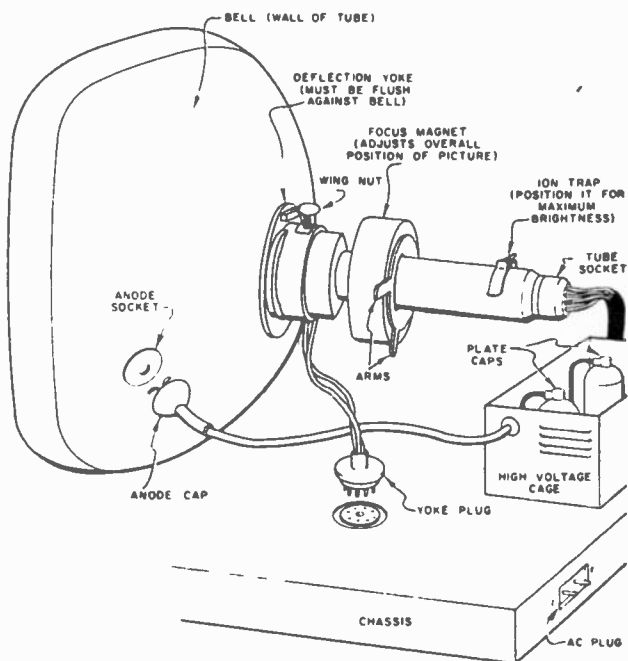

### CAUTION!

All areas shown in white on this drawing may have residual high voltage or be fragile. Anode socket and cap, and plate caps in high voltage cage, must be shorted to ground according to the text and other illustrations. Picture tube bell and neck must not be struck, scratched or strained in any manner.

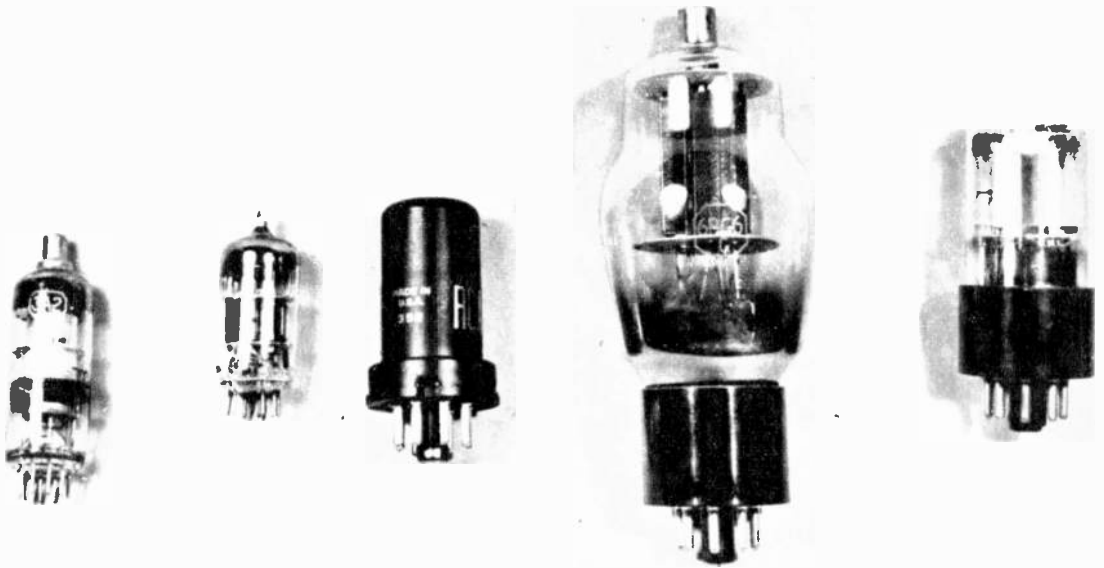

Some of the various tube types encountered in a standard receiver.

### ALL ABOUT TUBES

If adjustment of the service controls doesn't eliminate the difficulties, then you're going to have to dig a little deeper into the set. As we stated earlier, tubes are the most frequent trouble sources so let's check them as our next step.

Tubes go bad in several ways. Their filaments may blow out. They may grow weak or they develop leakage or shorts. In any case, replacement is the cure.

Before removing the back cover of the TV receiver, make sure the set is unplugged. If the antenna terminal strip is screwed to the cover, it should be unmounted before the cover is removed. The line cord is connected to the TV chassis by means of an *interlock* plug which pulls out of a two-pin socket on the chassis when the rear cover is removed. You'll need a "cheater" cord (available at your parts supply house) to let you operate the set with the back cover off.

With the rear cover off all the tubes will be visible except for those in the high voltage cage. Some of the miniature tubes have a cylindrical metal shield around them which must be removed before the tube can be unplugged. You do this (depending upon the type of shield) by pulling straight up, or by pushing down on the shield, twisting it counterclockwise about 30° and then pulling it straight up.

If you have difficulty removing the 5U4 tube because of the metal spring clip around the tube base, try pressing down on both



Preferred method of discharging the high voltage components involves use of a jumper lead and an insulated screwdriver.

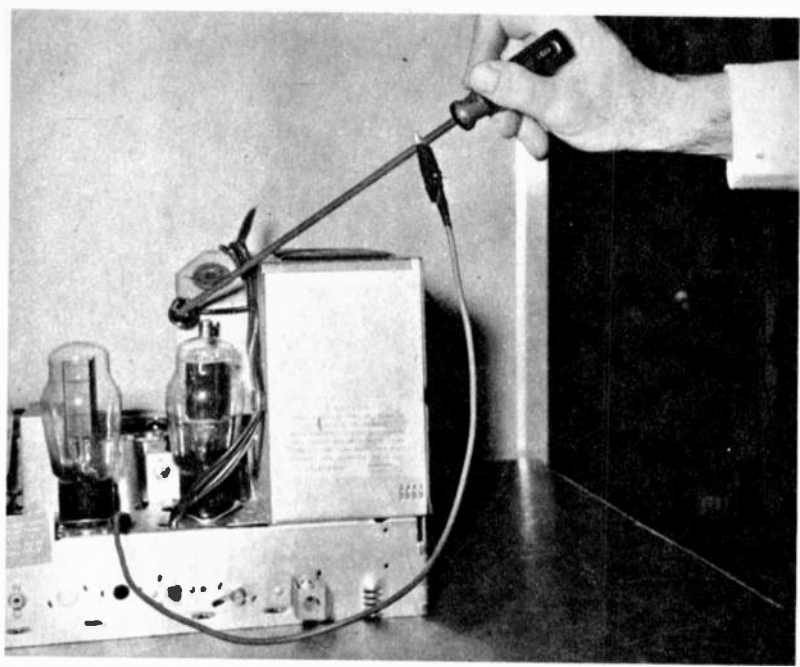

parts of the retaining spring and pull the tube straight up.

You'll find tubes with metal or glass shells of various sizes. Each of the tube types have a special base-pin arrangement that will fit only the socket designed for it. With rare exceptions you'll find only three types of tube bases (and sockets) used. They are the 7-pin miniature, 9-pin miniature and octal.

The area of wide spacings between the tube pins on the miniature types is your guide to the way they fit into their socket. The center key on the 8-pin octal tubes fits into the slot inside the center hole in its tube socket. In removing a tube from its socket, lift straight up and rock very gently or you may break the center key of the octal or bend the pins of the miniatures. *Never force a tube*; if it does not fit into the socket easily, the tube pins are bent out of line or you're trying to put it in the wrong type socket.

The perforated metal enclosure (usually in the rear on the right side of the chassis) is the high voltage cage. Lurking within it is the high voltage transformer and the one or more tubes associated with it. The cage cover is secured by  $\frac{1}{4}$ " hex-head sheet metal screws and a  $\frac{1}{4}$ " Spintite wrench will be required to remove them.

The tubes with top caps inside this cage develop the very high voltage required by the picture tube. They all have spring or ceramic cap clips which must be slipped off before the tubes can be removed.

Since these high voltage tube caps may retain a charge even after the power is off, it's a good idea to discharge them before getting to work. You can do this by clipping one end of a jumper lead (a length of insulated wire with an alligator clip at each end) to the metal shaft of the screwdriver and the other end to the chassis. Now hold the screwdriver by its insulated handle and touch the blade to the high voltage cap. A slight spark will indicate discharge of the tube. Follow the same procedure with the other high voltage tubes including any capped tube outside the cage. It's also a good idea to touch the screwdriver to the coating of the picture tube.

## Tube Filaments



Filaments are connected in series, in parallel or in a series-parallel combination. A series tube filament connection is like a string of Christmas tree lights, if one of the tube filaments burns out, and all the tubes go dead.

In a straight parallel-connected set (which always has a power transformer) one or more filaments may burn out without affecting the others.

If a series set goes dead, the trouble *may* be due to a bad tube. In a parallel filament set, however, if none of the tubes light, the trouble *cannot* be due to a single tube.

## Tube Testing

One technique is to remove the whole batch from their sockets (carefully marking the tube number alongside the socket if your set does not already have some sort of guide) and cart them off to your local repair shop or do-it-yourself tube tester. It can get pretty tedious though to run a complete check on 15-20 tubes when all you are interested in is the one blown tube in your series-string receiver. An easy way out is to buy a complete set of replacement tubes for times of trouble. A complete set of tube replacements excluding the picture tube will cost you about \$20-\$25 from the mail-order parts suppliers. And since your TV set probably has several duplicate tubes you need buy only one of each tube type found in your receiver.

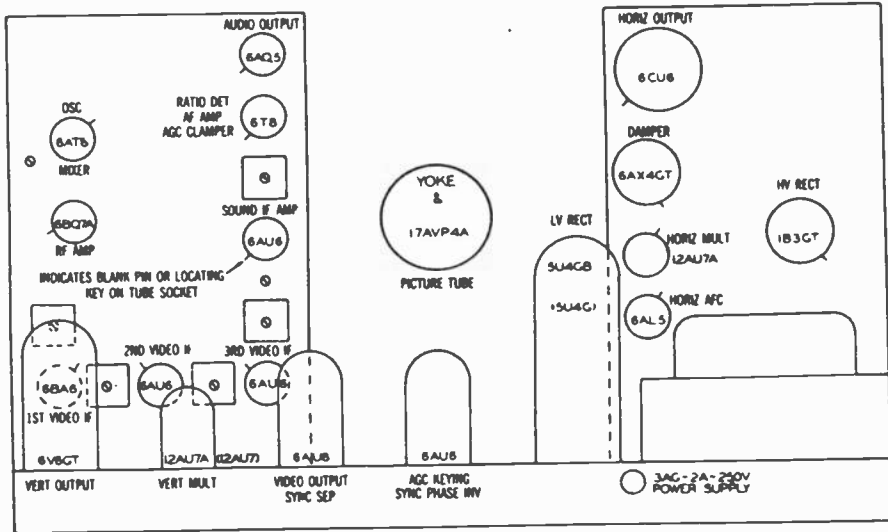

OCTAL

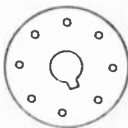

Tube layout (such as is found on a label pasted somewhere in the rear of the set) of a horizontal-vertical type chassis. Tube pin arrangements are below.

## A DO-IT-YOURSELF FILAMENT CHECKER

A very simple, and highly recommended solution to the problem of testing your tubes is the purchase or construction of a tube filament checker. Several companies have inexpensive kits or wired units. For those who want to "roll their own," here's how.

A pair of 1½-volt penlite cells connected in series, a #49 bulb and pilot light assembly, four sockets, and some type of cabinet are all you need to assemble a simple quick-check filament tester. You just plug the tubes in the tester one at a time and if the tube's filament is good, the tester's pilot lamp will light.

You can check the filament of the picture tube (CRT) by connecting two test leads from the tester (one to each of the screw-type antenna terminals). Touch the test leads to pins 1 and 12 of the CRT. A good filament will cause the pilot light to glow.

Fuses can be tested by placing them across the 2-terminal strip so that the metallic ends of the fuse touch the two contacts.

**Tube sockets and other components shown may be arranged to suit cabinet and panel used. Bulb may be mounted in grommet instead of pilot assembly.**

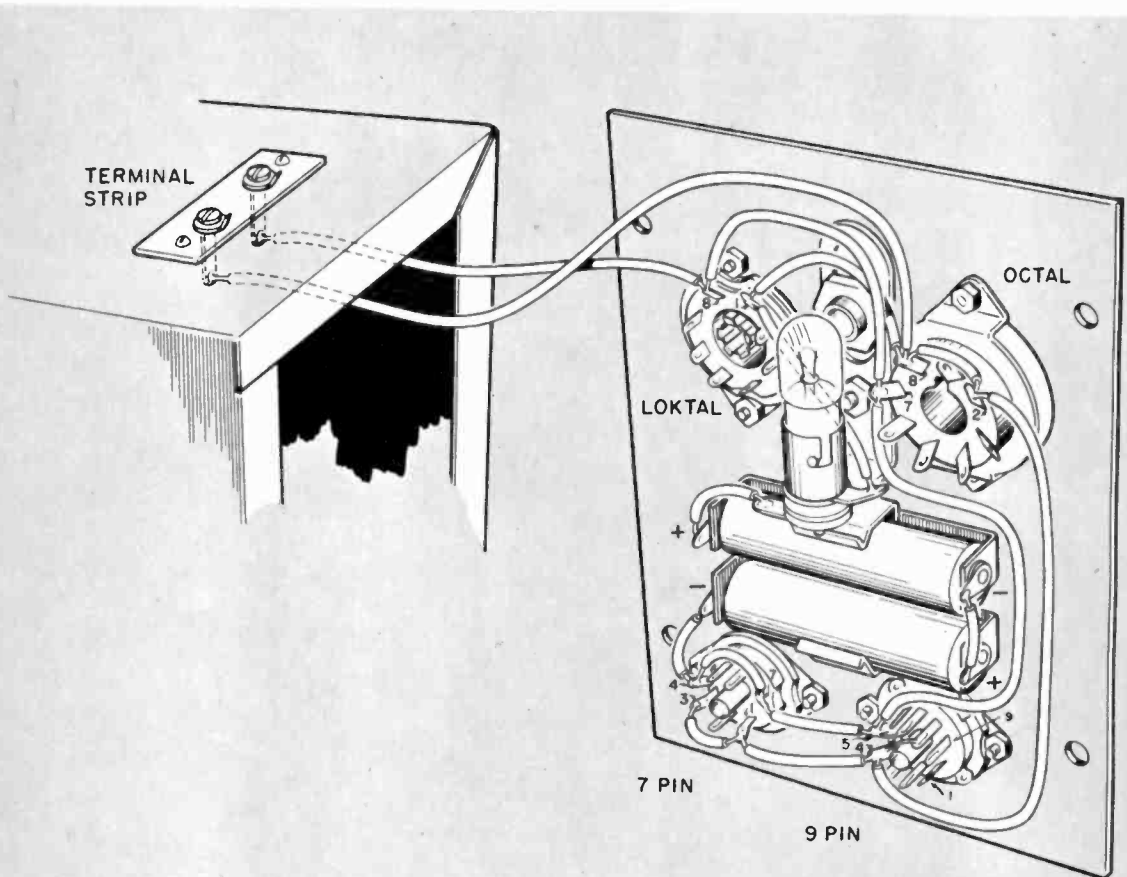

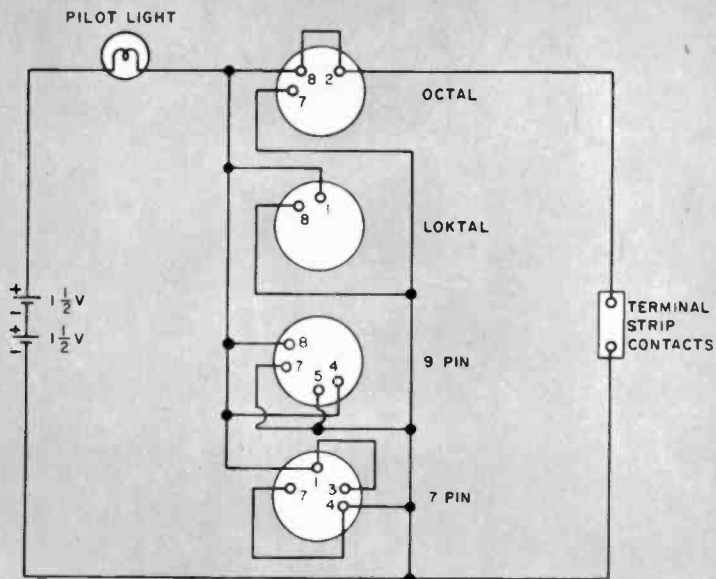

Schematic of filament checker shown at left. Only pins numbered are used.

Black crackle finished cabinet was used in the author's model. The home constructor may use a wood, plastic or metal cabinet as is convenient.

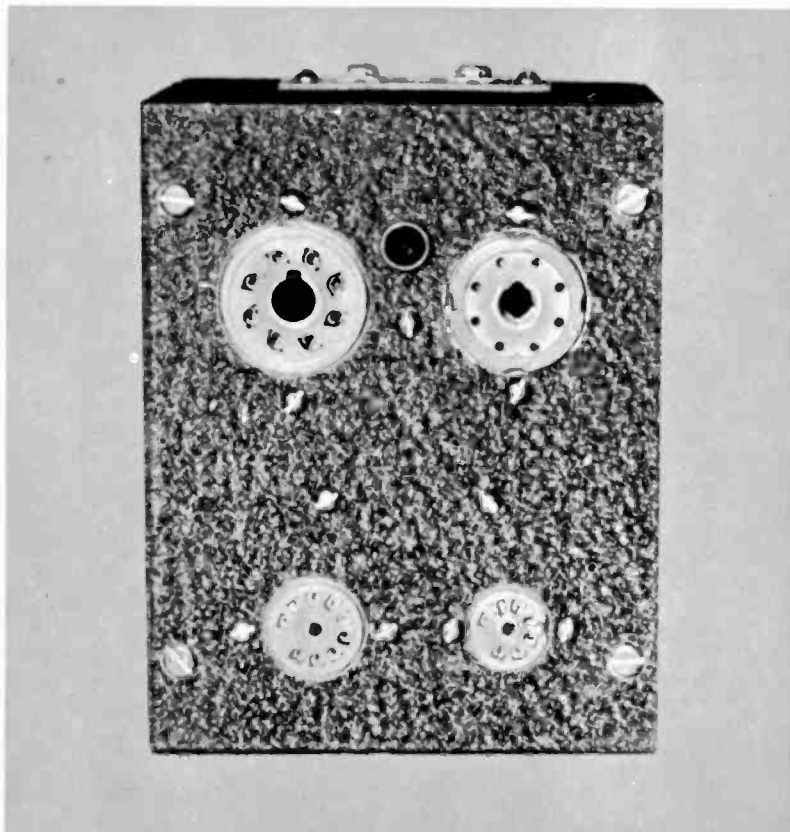

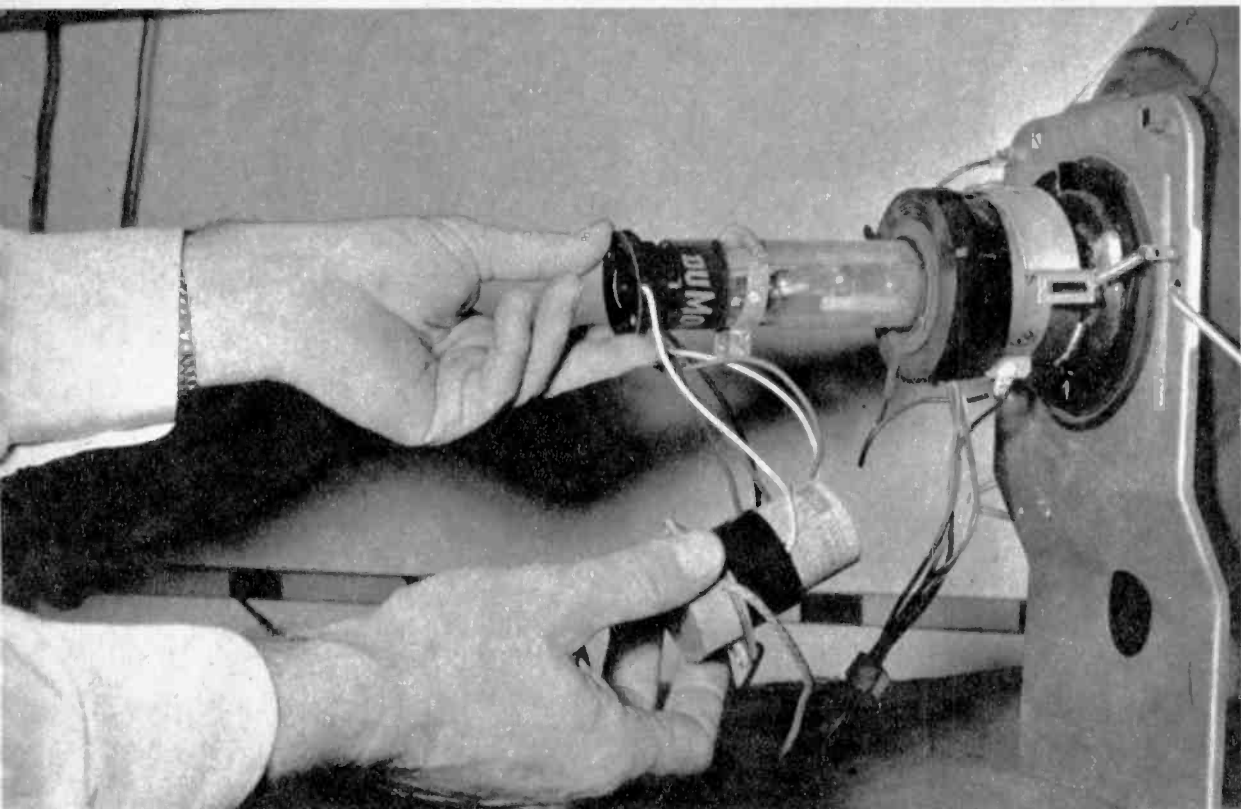

**Before installing a picture tube brightener, make sure you have the correct type, depending upon whether your receiver has series or parallel filaments.**

### **PICTURE TUBE BRIGHTENER**

A picture tube brightener or rejuvenator, installed when required, may extend the life of your picture tube for an appreciable time. You may need a brightener if your picture tube is old and if the picture is dim at the maximum brightness and contrast control settings, but otherwise normal. To make sure you buy the proper type of brightener for your set tell the parts store clerk the following information: the make, model number, and the number of wires (5 or 6) in the socket assembly which plugs onto the base of your picture tube. Installing the rejuvenator is a relatively simple job—just follow the instructions supplied with it. Be careful not to pull on or change the position of the small metal band (the ion trap) which is clipped around the neck of the picture tube, close to the base. For if you change its position you will lose brightness, contrast and part of the picture. Readjustment of the ion trap is a simple procedure. While observing the screen rotate the trap and simultaneously slide it by fractions of an inch along the neck of the tube until the best picture is achieved.

Before adding a picture tube brightener, try to determine whether or not other tubes are functioning properly. Check the horizontal-oscillator, agc, sync, and video amplifier tubes.



## FUSES AND THEIR LOCATION

Like the electrical circuits in your home, most TV receivers are protected by fuses. TV fuses are small glass cylinders with a metal cap at each end. A thin metal filament, spring, etc., inside burns out if the current flow through the fuse exceeds its rating. You'll find fuses in two different circuits: low voltage power line and in high voltage circuit. The low voltage power line fuse which when it blows, cuts off power from the entire set. No picture, no sound, and the tubes don't light. However, if your set goes completely dead, as just described, don't immediately rush to the conclusion that the line fuse is to blame. There are other possible causes for this condition which we will discuss later.

The line fuse may be housed in a black plastic post type holder on the rear apron of the chassis. The rating will be found stamped on one of the end metal bands reading something like 3AG-2A-250V. This number identifies the fuse completely, and a replacement may be ordered. Many late model sets have push-button circuit breakers instead of line fuses. Check the manual.

Another place where the line fuse may be found is on the chassis in a clip holder located near the low voltage rectifier.

The second fuse protects the high voltage transformer. When it blows the picture tube goes dead, but the sound will continue and the tubes remain lit. Again, if your symptom is a dark screen, a blown high voltage fuse is just *one* of the possible causes.

The high voltage fuse is sometimes found in a clip holder inside the high voltage cage and is accessible only after the cage cover has been removed. Or it may have "pig tail" leads like a capacitor or resistor and be soldered directly into the circuit beneath the chassis. In that case, the chassis must be removed from the cabinet before the fuse can be checked.

Once you have located your set's fuses and determined their rating, it would be well for you to buy a spare of each type for use if the occasion should require it.

Several types of fuses used in both AC line and other portions of circuit. Device at bottom center is used to adapt pigtail fuse to standard type.

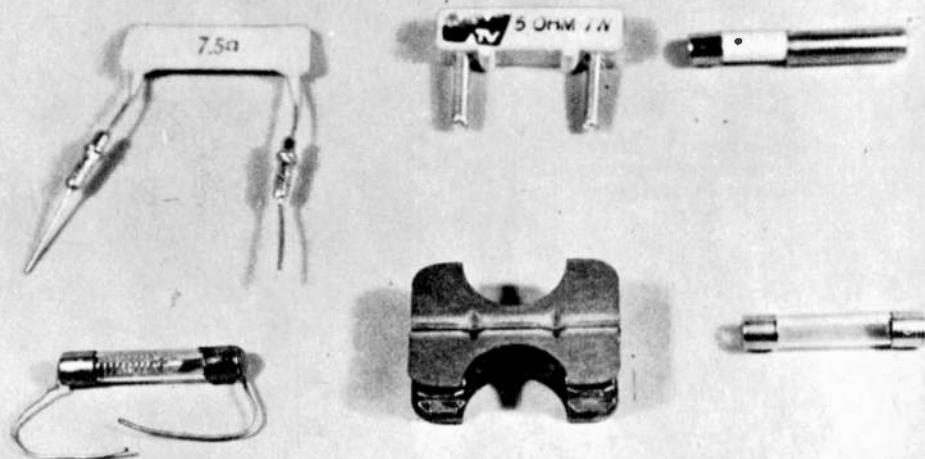

## TUNING FRONT END

The tuning section of the set is encased in a separate housing, known appropriately as the tuner. It includes the RF amplifier, oscillator and mixer circuits. A change in the oscillator tuning range can result in a loss of picture, sound, or both. These symptoms usually occur in older sets because of tube aging and the effects of temperature and humidity. A simple screwdriver adjustment is usually all that is necessary to vastly improve your sound and/or picture reception.

In some receivers oscillator "touchup or alignment" may be accomplished without removing the set from the cabinet. First remove the channel selector and fine tuning knobs. Then take off the escutcheon on which the channel numbers are inscribed. Two or more small circular openings will then be visible. The RF oscillator adjustment screw will appear in the bottom hole. The top opening is an overall adjustment which affects all channels. The fine tuning control must be set in its midpoint position and left there until alignment has been completed.

Begin with the highest channel. Insert a long shafted non-metallic screwdriver (available at parts stores) into the proper opening and carefully adjust the oscillator screw for a compromise of optimum sound and picture. Only a few turns in one direction should be necessary to achieve this. Once the highest operating channel in your area is properly adjusted, switch to the next lower operating channel and repeat the procedure until all channels have been satisfactorily adjusted. If you have removed the cabinet from the set, it is a good idea to clean the contacts on the tuner with carbon tetrachloride.

In the event that the above procedure does not apply to your particular tuner consult your instruction manual for further information.

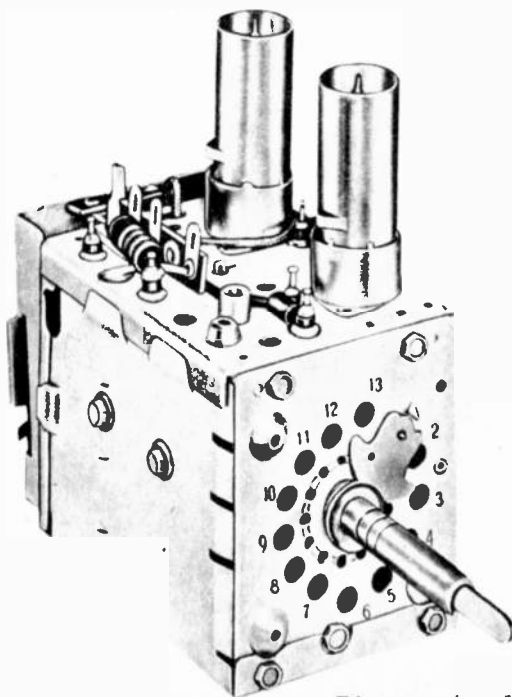

Typical cascode tuner. About the shaft are holes permitting fine balancing of each channel.

# Electronic Numbers Game

By Jack Cadden

Here is an educational game that will keep the kids occupied for hours. It uses crystal diodes.

**T**HIS game is really a miniature computer. It is easy to build using eight 1N34A diodes, and can also help the youngsters brush-up on simple addition involving three-digit totals.

The game is played like this: Pointers on the three dials can be set to any combination of digits. The player must now select a combination which adds to the total indicated by one of the neon lamps at the bottom of the front panel. As an example, let's assume that when the game is switched on, the neon lamp corre-

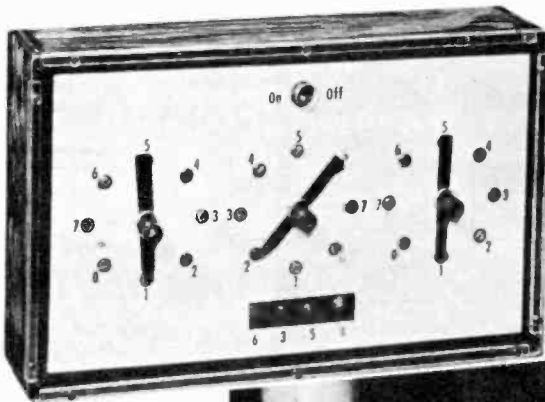

Completed unit at left is covered with a Lucite face. Three sets of numbered brass bolts provide the switch contacts. At bottom center, neon lamps are seen.



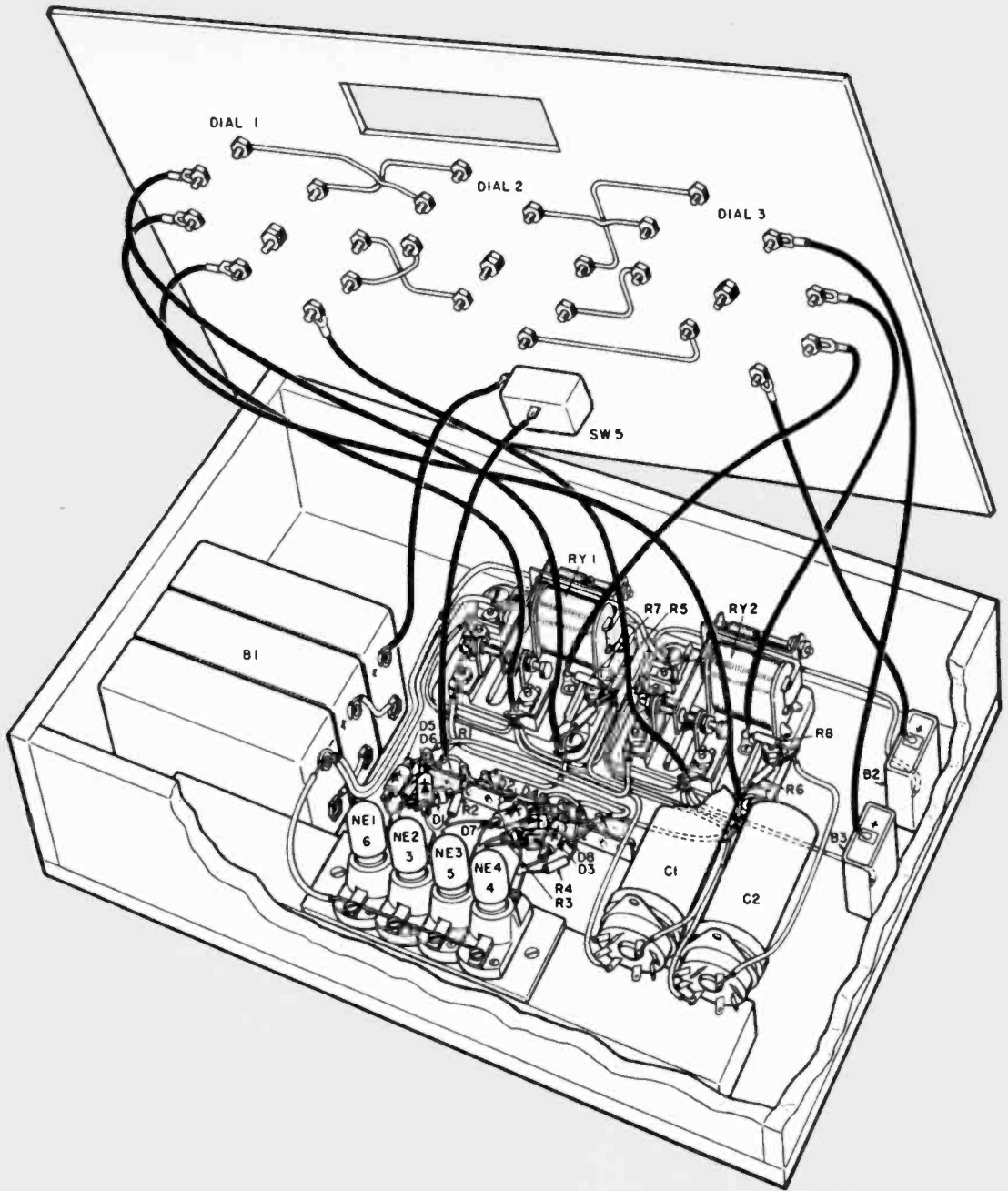

Follow wiring guide during construction. When in doubt refer to schematic. Diode matrix can be seen above neon lamps. Wire top panel switches last.

spending to the sum 5 lights. The object then is to set the proper combination of numbers on the three dials which adds to that sum. Of the many possible combinations which will add to 5, only one is "correct," and that one will cause the

"5" neon lamp to extinguish, and another one to light. If the lamp corresponding to the sum 3, say, then lights, the game is continued by setting various combinations which add to 3, until the proper one again extinguishes the lamp

and ignites another. When the fourth and final combination is found, the game begins again.

Electronically the game consists of switching circuits with a diode matrix and neon lamp indicators. A diode matrix is a well-known method of selecting one of several circuits and indicating which one was selected by means of a neon lamp. The circuits comprise the two relays in series with the circuits formed by the selector switches.

The "switches" representing each of the four possible selector switch combinations are shown as SW1, SW2, SW3, and SW4 in the schematic. The actual sequence of relay operation is as follows: Activate relay No. 1, activate relay No. 2, open relay No. 1, and open relay No. 2. When the main switch (SW5) is turned off, both relays are in unenergized states. When SW5 is turned on and the first desired combination of numbers is found, relay RY1 is energized by the 22.5-volt battery connected through the 6800-ohm resistor (R5). The contacts of RY1 are connected so that its coil is now in series with the 135-

volt (B1) battery through a 27,000-ohm resistor. This locks in the relay and it will hold until the coil circuit is broken. This occurs when the next combination is found, in effect closing SW2 and shorting out relay coil No. 1.

Each coil has a 100 mfd, 25-volt electrolytic can or tubular capacitor connected across it. This causes the game to "think" for about *four seconds* after each positioning of switches *before it indicates* whether the proper combination has been made. If such a time delay is

[Continued on page 117]

#### PARTS LIST

R1, R2, R3, R4—27,000 ohm—all resistors 1/2 watt  
 R5, R7—6800 ohm  
 R6, R8—1000 ohm  
 C1, C2—100 mfd 25 volt electrolytic capacitor  
 D1-D8—Diodes (1N34A or 1N38)  
 NE1-NE4—Neon Lamps (NE45)  
 RY1, RY2—Relay (Kurman 310002/42Y)  
 SW1-SW4—(See Text)  
 SW5—SPST toggle switch  
 B1—135-volt battery; (3 45-volt batteries connected in series, XX30 Burgess or equiv.)  
 B2, B3—22 1/2-volt battery (Burgess U15 or equiv.)  
 Misc.—Lucite (8" x 14"), fiber rods (3), Box 13 1/2" w x 3 1/2" h x 8 1/2" d (approx.)

Heavy lines below indicate one of several circuit paths possible with panel switches.

Cabinet with cover removed. Three 45v batteries wired in series are seen at left.

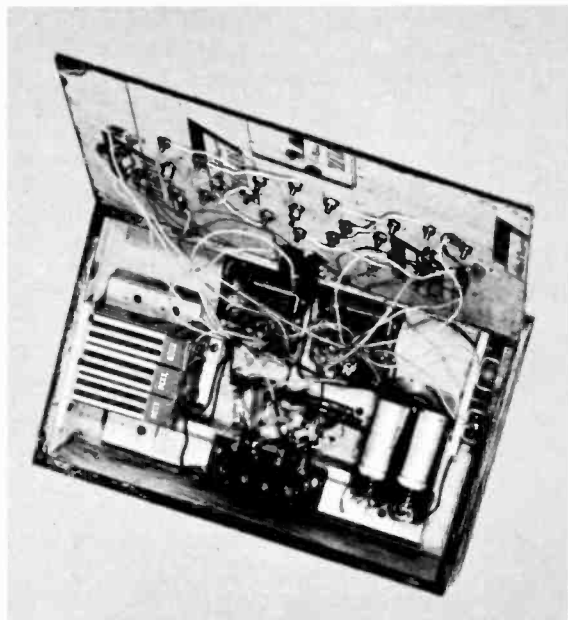
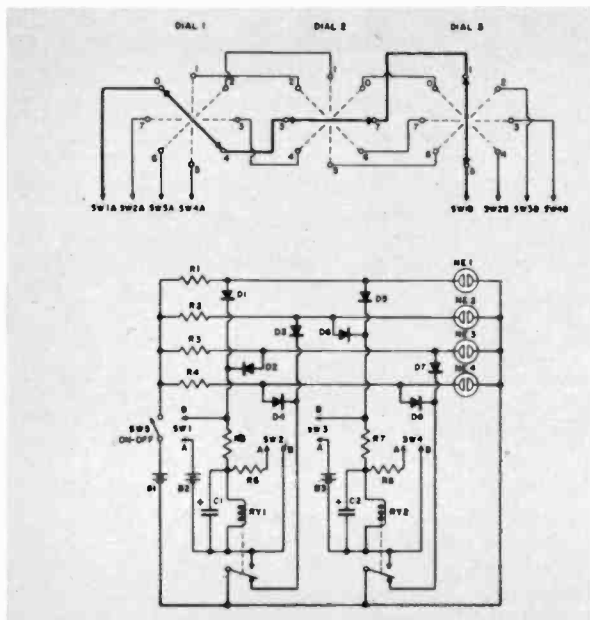

# Electronic Brain

Have you any question on electronics? Send it in  
and the Electronic Brain will provide the answer.

## Isolation Transformer

Can two 6-volt filament transformers be used for AC isolation as well as to provide 6 volts for the filaments of one or more tubes hooked up in a parallel arrangement.

Steven Rose, Eureka, Cal.

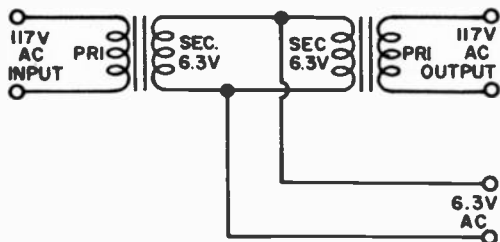

Yes, this is a rather popular way to avoid the purchase of a single isolation transformer for low-power purposes. One can buy inexpensive transformers that handle up to 20 ma (such as the Stancor type PS-8415) for around \$2.00. Such transformers generally have 6.3 volt filament windings as well.

To get around the use of such a transformer, many hobbyists make use of a pair of spare 6.3 volt filament transformers as shown in the diagram in the so-called "back-to-back" circuit. Here, the current drain limitation is imposed on the system by the original current drain in the primary of each of the transformers when they are used in the normal fashion. For example, a pair of 6.3 volt @ 2 ampere transformers can deliver 117 volts (rms) at about 75 ma without apparent overheating. In this way, one can often save money and get higher current output without additional expense.

## TV to FM

Can you tell me how to convert an old television receiver into an FM receiver?

John Morris, Stanhope, N. J.

The standard FM broadcast band ranges from 88 to 108 mc. This band lies

between the frequencies of Channel 6 and Channel 7 in the TV portion of the radio-frequency spectrum.

The television set you mention in your letter has a wafer-switch tuner that cannot tune between channels, otherwise you could receive FM broadcasts without making any changes in the receiver at all.

To enable you to listen to FM, it would be necessary to add a very tiny, two-gang FM variable capacitor across both the oscillator tuning coil and the RF tuning coil of the Channel 7 group right at the tuner mechanism. It would not do to have wire leads more than about one inch in length connecting these components. To make the controls more available, you might run bakelite extension shafts outward to your panel from the tuning capacitors. Once the capacitors are connected in place, you will have to do a little bit of minor realigning of the tuning slugs in the Channel 7 coils to cover the entire FM band.

## Transformer Sound

I can hear a local broadcast station by placing my ear near the top of an old radio with neither earphones nor loud-speaker connected! How can this be?

A. Ortin, Meriden, Conn.

If you examine the radio chassis, you should find an output transformer screwed to the top metal surface. As the audio signal passes through this transformer, the rapidly reversing magnetic field it produces tends to move the iron laminations, composing the transformer core, with respect to each other. If the transformer laminations are properly potted and screwed together tightly, this effect is unnoticeable. Old transformers tend to loosen; their potting compound also tends to deteriorate. This gives the laminations freedom to move.

As they vibrate at the same frequencies as the audio currents in the windings, they produce the sound you hear. The chassis top may act as a resonator.

## 24A Tube

Many old radios used a tube called a "24A." Can you tell me what they are and how they are used, what heater voltage is required, and what the pin connections are?

John Balliett, Muncy, Pa.

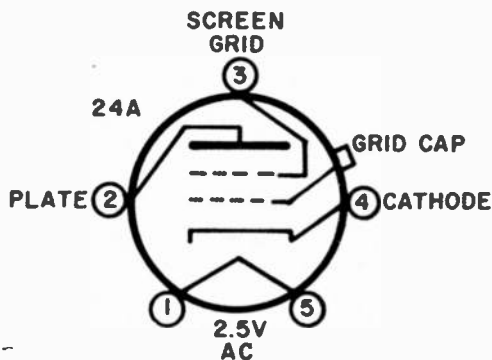

The 24A is one of the original tetrodes or screen-grid tubes. It contains a 2.5 volt filament requiring 1.75 amperes, an indirectly heated cathode, a screen grid, and a control grid, in addition to the plate.

It was used particularly as an RF amplifier and as a biased detector; prior to the development of this tube, all RF amplifiers contained triodes that had to be neutralized to prevent them from oscillating. The 24A made this ticklish process unnecessary.

The pin connections are given in the accompanying diagram. The tube requires a five-pin socket; in addition, the control grid connection is brought out to a metal cap on top of the glass envelope.

### CB Antenna

At present, I am using a half-wave dipole, center-fed with 52 ohm coaxial cable (50 ft. long) as a transmitting antenna on the Citizens' band. How can I improve the range of the antenna?

Robert Trogden, Hammond, Indiana

There are two important factors that must be considered in erecting and utilizing transmitting antennas. First, is the energy from the transmitter getting to the antenna; and second, is the antenna radiating efficiently.

The center impedance of a half-wave dipole is about 72 ohms. This impe-

dance should be closely matched—especially when you are using low power—by the transmission line. A 52-ohm cable represents almost a 30% mismatch to an accurately cut dipole. This does not mean that you have to replace your cable; it merely suggests that you ought to try to improve the impedance match by fanning out the ends of the coaxial cable to form a so-called "delta-match" termination. The amount of fanning required can either be calculated or determined by trial-and-measurement with a field strength meter.

How are you coupling your transceiver tank coil to the transmission line? Your question does not give this information. Coupling at this point, however, is extremely important and must be set up very carefully for optimum energy transfer.

May we recommend the most recent edition of the ARRL handbook for full details on delta-matching and the construction of three and four element beam antennas?

### Built-in Antenna

Can you provide me with information whereby I might replace my present outdoor radio antenna with a built-in indoor type? The radio I use is a 5-tube superheterodyne type.

Charles E. Ryan,  
South Norwalk, Conn.

A very satisfactory substitute for an outdoor antenna on the broadcast band is a high-efficiency "loopstick" that is broadly tuned to the desired band. We can recommend the Meissner ferrite antenna coil, type 14-9015. This coil has an adjusting slug that will enable you to tune for optimum pickup over the entire broadcast band.

Mount the coil in any convenient place, preferably on the fiber back of the receiver, keeping it as far from the chassis as you can. Connect a 150 mmfd mica capacitor across its terminals. Then join one terminal to the antenna input connection of the receiver and the other terminal to the chassis through a 0.01 mfd paper capacitor.

Tune the slug of the coil for maximum response at or near the high frequency end of the broadcast band. ●



*spotlight on:*

## **15-Meters**

**By C. M. Stanbury II**

**Novices: Here's a DX band open to all! Often at the mercy of sunspots, the frequencies between 21 and 21.45 mc represent a victory for ham radio.**

**L**AST month we described the champion of DX bands—20 meters. Now let's look at the challenger. The 15 meter band represents one of the few major victories for amateur radio since World War II. The 1950's have seen 160 meters dwindle to almost inactivity and 11 meters go down the drain in the United States, despite a last minute and somewhat abortive attempt to turn the latter into a Citizen's Band. In return for these lost frequencies, the 450 kc between 21000 and 21450 kc have been allocated to the ham.

A fair swap? We'll let you judge for yourself. Not too long ago, the ham had only two long range bands, 20 and 10 meters. Of the two, 20 was usually superior. Dead spots caused by complete skip-ping are frequently encountered on 10. On the other hand, 15 meters is at present nearly always open during daylight hours (except during ionospheric disturbances) and, as a matter of fact, the average daytime working range averages out even better than 20 meters.

### **Skip and MUF**

The Maximum Usable Frequency over any path is determined first by the amount of ionization in the reflecting layer, and secondly by the angle of incidence between the radio wave and the layer. As the distance from the transmitter to receiver increases to the maximum hop distance, the angle of incidence *decreases*. As this angle decreases, the MUF goes *up*.

Considering propagation via the F2 layer (the upper layer of the F-region and the ionosphere), we can, for example, choose distances of 2500 and 4000 miles. The maximum hop distance for this layer is approximately 2500 miles, thus our second example will require two hops, each 2000 miles. But the fact that it takes just one hop to cover 2500 miles in the first instance results in a



smaller angle of incidence, and a higher MUF. Stating the relationship then, the longer the *hop*, the higher the maximum usable frequency.

Ionization of the F-region has a pronounced effect on the 15 meter band. First, when the sunspot count goes up, so does ionization and MUF. Time of day is a factor. MUF's are highest around 1400 local standard time. For our purposes we must consider time at point of contact between the radio wave and the F2 layer. If there is more than one point (multi-hops), ionization must be sufficient at *each* point to permit reflection.

Next, season of the year: The F2 layer, as you've probably gathered, is the key layer for 15 meters. It behaves in a manner opposite to all other layers. It is actually *more* ionized in winter. Summer is a peak period for the others.

Finally, we have proximity to the magnetic poles. MUF in polar regions is considerably less than in those areas near the Equator. With skipping such a vital factor in the 21 mc region, tropical and semitropical stations have a slight edge. The same advantage is not noticeable on the 20 meter band.

### Operating on the Band

For the first time in this series we find a large portion of the band open for phone operations, almost half. As A3 (phone)

**Restricted to CW (radiotelegraph) on 15 meters, the Novice who builds his code speed to a respectable level has a fair chance to work foreign hams.**



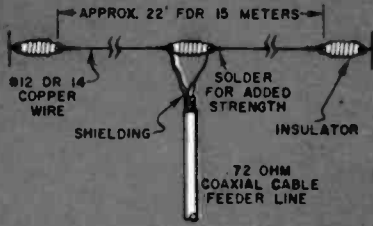

Easy to construct half-wave dipole is shown at left. It has little or no directionality. Note 22' length of half-wave.

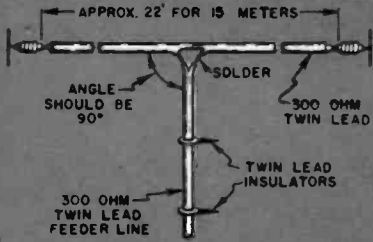

The simple folded dipole is also a popular antenna. It does the job when a ham can't afford to buy or build a beam.

The cubical quad antenna is commercially available. Unit below, the Cubex Mk III, is designed for 10, 15 and 20 meters.

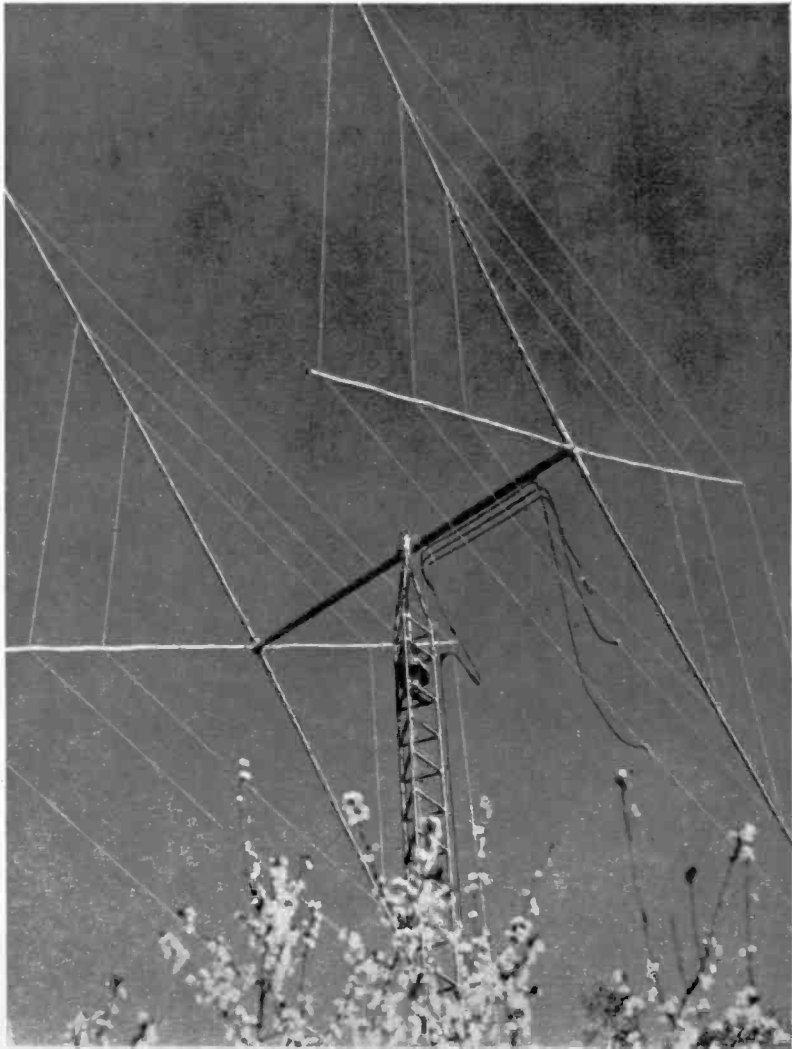

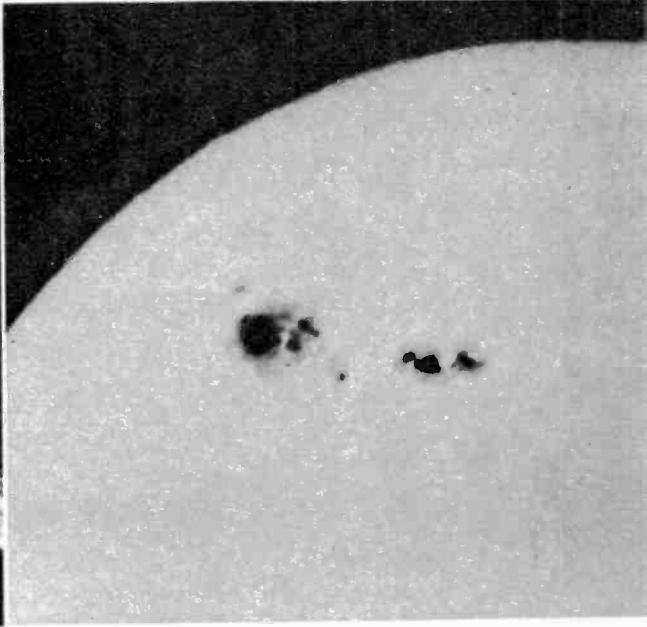
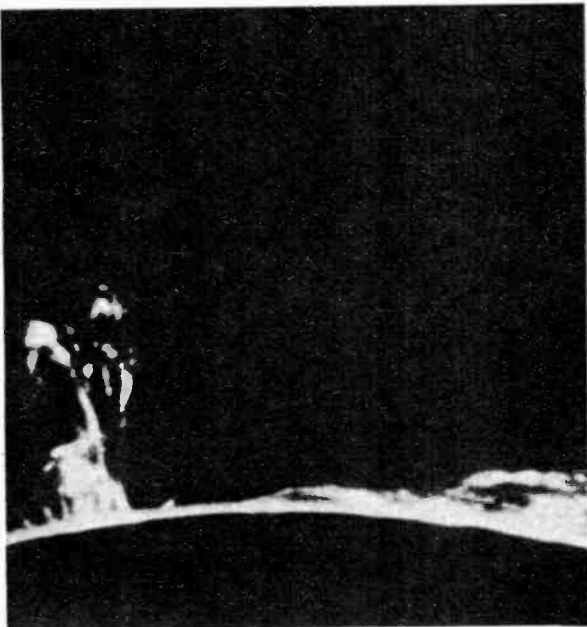

Solar flares (left) and sunspots (right) increase ionization of the F-region. Increased ionization tends to mean better reflection for 21 mc radio signals.

requires approximately ten times the bandwidth necessary for CW, we cannot help but wonder why a larger portion of the lower frequency bands has not been allocated for voice transmissions. However, the purpose of this series is not to second guess the FCC.

With a wide phone band and QRM (man-made interference) reduced by skipping, 15 meters is definitely tops for single sideband DX transmission in the U.S. SSB does not attract DX stations when the band is crowded. Foreign SSB operators usually prefer 20 meters where they have 14300-14350 kc virtually to themselves. On 15 meters, American single sideband stations usually cluster in the upper 50 kc while foreign SSB operators are pretty well scattered throughout the phone portion of the band and must fight it out with standard phone transmitters.

The pattern of foreign phone stations working on U.S. CW frequencies is, for the most part, also followed up on 15 meters, especially when overseas operators do *not* wish to work American stations. In this connection a "rare stations" net has been founded by HH2Z on 21200

kc. Purpose of this net is to allow these stations to work other rare ones without "K" or "W" interference.

As you've probably gathered, the pros and cons of 15 versus 20 meters can be argued from here to eternity, but one distinctive feature 15 has over 20 is a set of Novice frequencies. It is a big one, 150 kc, and it represents the newcomer's chance to work the rare or semi-rare stations. A good directional antenna can boost his effective power to a competitive level. Of course, a great deal depends upon the operating skill of the individual Novice.

Beam antennas are often too complex for the Novice to construct and tune and are frequently too expensive for him to purchase ready-made. However, there are other directional arrays, such as a cubical quad, which can provide satisfactory results. But whether it is a beam, quad or simple dipole, the Novice has a chance, provided he can attract the DX operator's attention. There have been instances where Novices, using CW, of course, have worked foreign hams using phone. But these opportunities won't do

[Continued on page 117]

# *E I* assembles a **Sun-Powered Radio**

This unusual kit using a 2-transistor reflex circuit will operate on either solar or penlite batteries.



Layout of parts supplied with kit prior to assembly. Small parts are in bags in foreground.

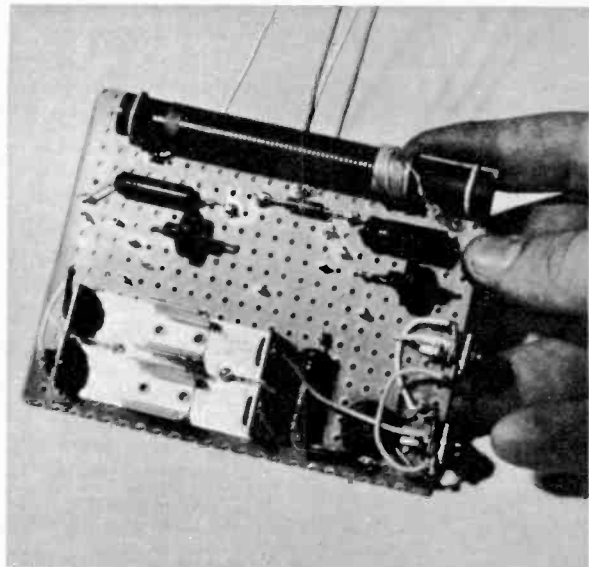

Top of perforated board. Note loopstick antenna at top edge, battery clip at lower left.

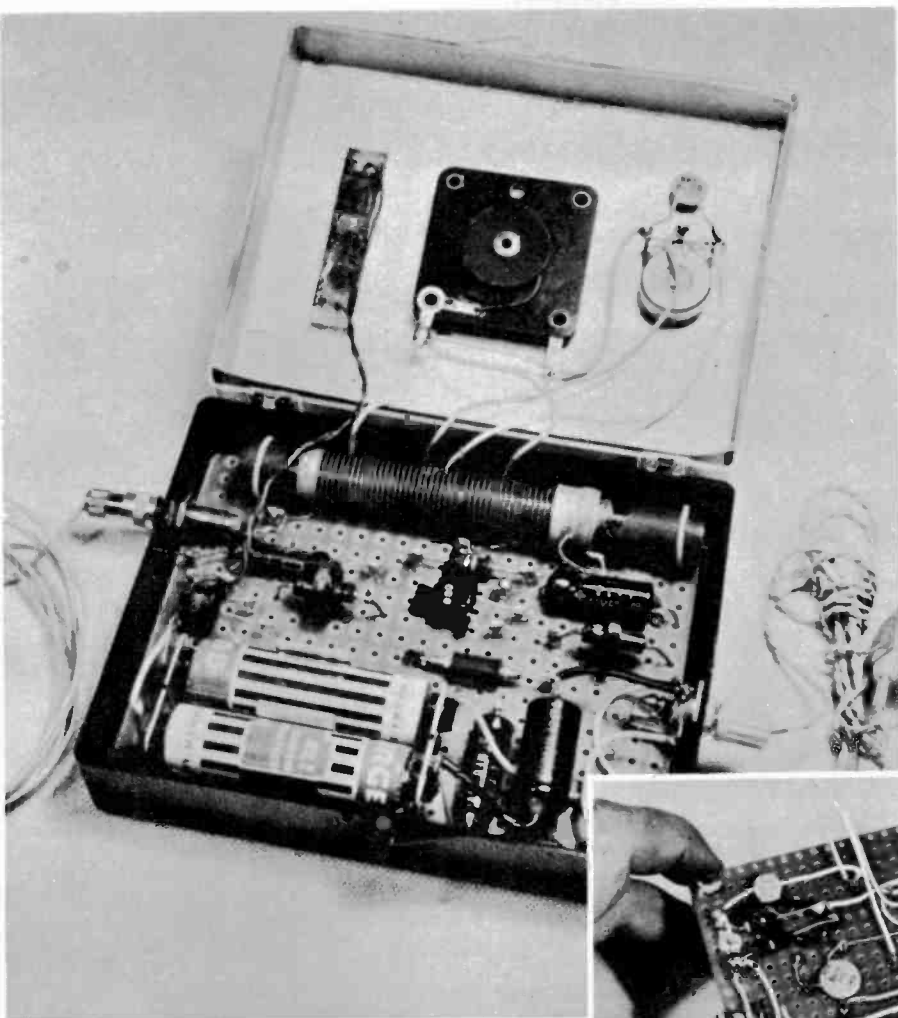

Above, wired model, case open. Note sun battery mounted at upper left, with tuning capacitor beside it. At right is underside of perforated board, where wiring is done.

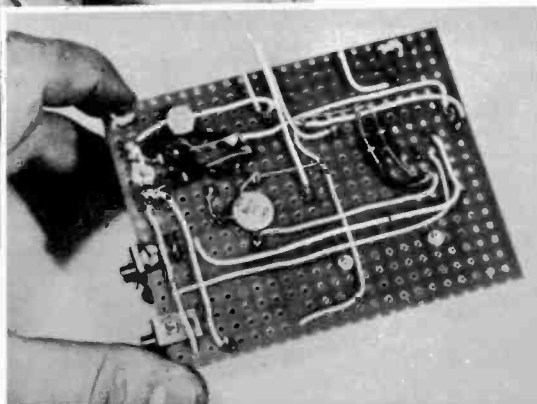

**"SUNFLEX"**—a word synthesized from "sun" and "reflex"—describes two basic features of this little receiver: its 1"x¼" silicon solar battery generates voltage when placed under strong light, and powers a 2-transistor reflex circuit.

Actually, the solar battery is augmented by two penlite cells: the set will play in total darkness if need be. The type of power supply is simply selected by plugging the earphone into one of two jacks along the side of the plastic case. These jacks serve two purposes; to supply a signal to the earphone, or to switch in the desired source of power.

The reflex circuit is remarkably sensitive. Two transistors are made to do the job of three. Broadcast band frequencies are amplified by the first transistor, detected into audio by a diode, then fed back to the transistor for additional amplification. But, such extreme simplicity has its drawback. Since there is only one tuning circuit

[Continued on page 127]

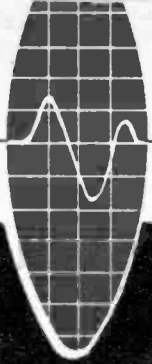

## E I Picturescope

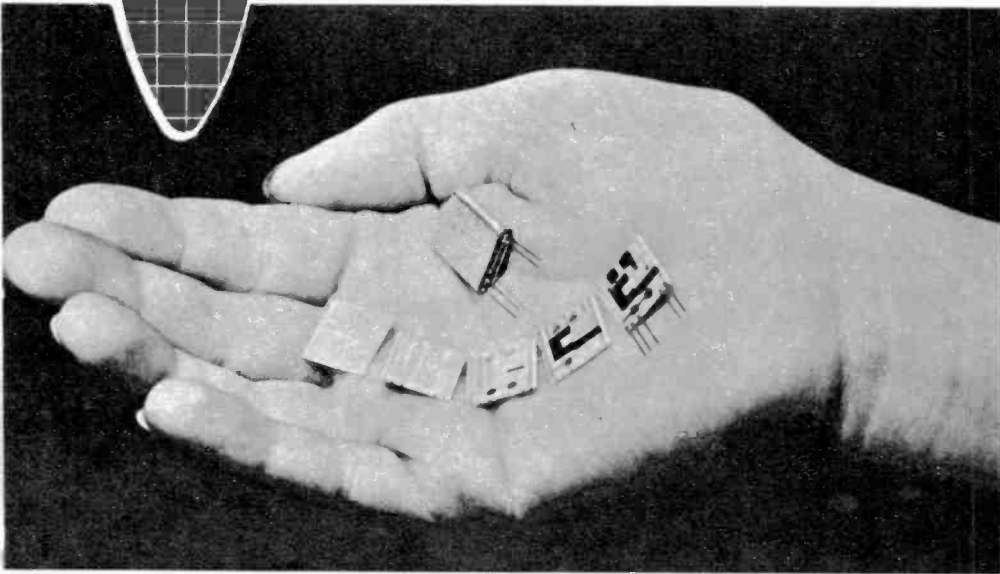

A new photo process is enabling the Army to pack five times more electronics into their missiles. Held in hand are steps for making binary counter. Left to right: Plastic base wafer; wafer with screened wiring; holes are sandblasted; resistors are printed on; capacitors, semi-conductors and leads are inserted.

This boy in Hamburg, West Germany, is having fun with "Astro-Man," a remotely controlled green plastic robot that can be made to walk forward, backward, turn around and lift modest weights simply by pressing one of four buttons. Price overseas is about \$4.



# Hi-Fi Clinic

Hi-Fi questions are all answered by mail. If of general interest, they will appear in this column.

## Adding A Tuning Eye

I would like to add a tuning eye tube to my tuner so I can get sharper tuning. Can you show me how?

R. J. Prichard  
Boston, Mass.

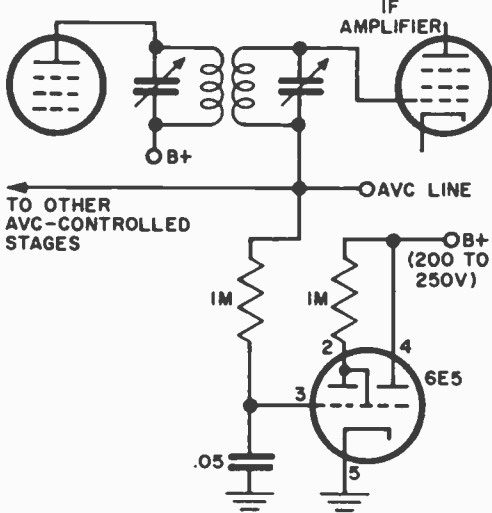

Not hard at all. Connect the target plate directly to B+, the triode plate through a 1 meg resistor to B+, ground the cathode, and tie the grid to the AVC line through 1 meg. Bypass the grid. The rest is carpentry.

## Pickup Impedance Matching

How can I match a ceramic cartridge with a recommended load rating of 2 megohms to amplifiers with input circuits of 500k and 100k?

J. R. Julianelle  
Danielson, Conn.

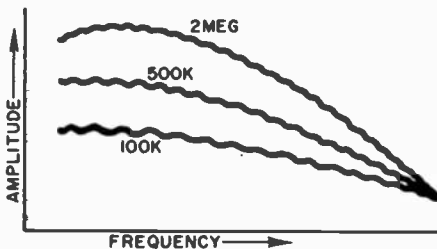

The characteristic of a crystal-ceramic cartridge will vary with a changing load about as shown. The higher the load, the greater the output—especially at the lower end. There is no significant increase in distortion as a result of varying the load impedance, so you may strap the cartridge down as you wish so long as you compensate for loss of bass.

This can be done in two possible ways; change the amplifier's input resistor to a higher value (try 2 megohms) or adjust the bass boost if the amplifier has tone controls.

## Stereo Woofer

My stereo tape outfit has small speakers, and I would like to add a large speaker (single) for low frequencies only without disturbing the existing speakers. How can I do it?

L. van Leeuwen  
Twisp, Wash.

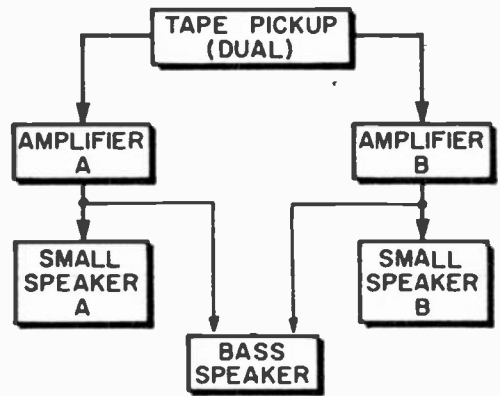

The simplest technique for adding a bass speaker is to connect it across the amplifier outputs from the 4, 8 or 16 ohm tap of one amplifier to the same tap on the other.

If you have a copy of the Dec. '59 *Electronics Illustrated*, look over the story entitled "Convert To 3-Channel Stereo." It gives details on filling the "hole-in-the-middle."

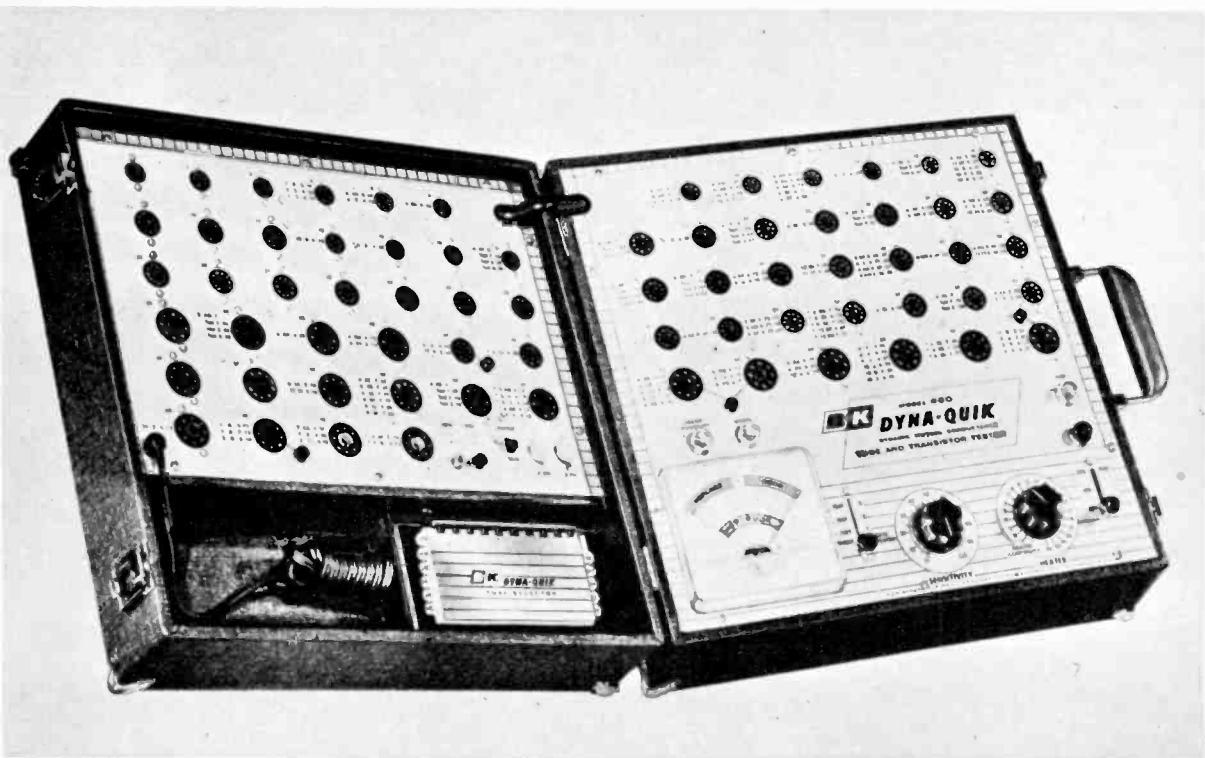

Fig. 1. A quick-type dynamic mutual conductance tube and transistor checker. Tube sockets and settings are chosen via index in the compartment.

## Milt Kiver on Tube Testers-2

Included is a general operating procedure for tube testing and information on quick-test checkers.

**I**N spite of the wide variety of tube testers on the market, their general appearance and operational features are greatly similar. Each contains a large indicating meter, a variety of tube sockets to accommodate the different types of tubes currently employed, and a series of switches and levers to establish the proper operating conditions for each different type of tube.

The meter face is divided into several easily distinguishable areas. At the upper end of the scale, the dial segment is marked "Good" and any tube that brings the needle here can be considered satisfactory. Just below the "Good" section, in the center of the scale, there is a much narrower section containing a question mark. Tubes that produce indications within this sector are in the doubtful category. They may continue to function satisfactorily but they are not providing as much current or as high a mutual conductance as tubes of this type normally should. In



most instances, when a tube produces a reading in this doubtful sector, it is advisable to replace it. The final section of the dial at the lower end, is marked "Bad" or "Replace" and any tube that produces a reading here is far enough under par to warrant immediate replacement.

On most of the tube testers that the reader is likely to encounter, the operating voltages are brought to the tube terminals by lever-type controls. Since the maximum number of pins on receiving tubes is nine, there will be at least nine individual levers to position. Frequently there are several additional levers to help set up some auxiliary circuits in the tester.

In addition to the levers, one or more rotary controls are also found. For example, a rotary selector switch is always employed to establish the proper filament voltage for the tube under test. Another rotary control establishes the load into which the tube operates; a third might regulate the amount of line voltage fed to the instrument. Line voltage variations will directly affect the amount of current produced by a tube being tested and this will affect its meter reading. If line voltage is low, the meter indication will likewise be low, perhaps falsely indicating a defective tube when in fact the tube is OK. A high line voltage will cause meter readings to be too high, perhaps adding enough to a weak tube to have it give a "Good" reading. Thus, it is important that exactly

**Fig. 2. A completely automatic checker utilizes pre-punched plastic cards. Matrix of 2 printed circuit boards is activated by cards and a power lever.**

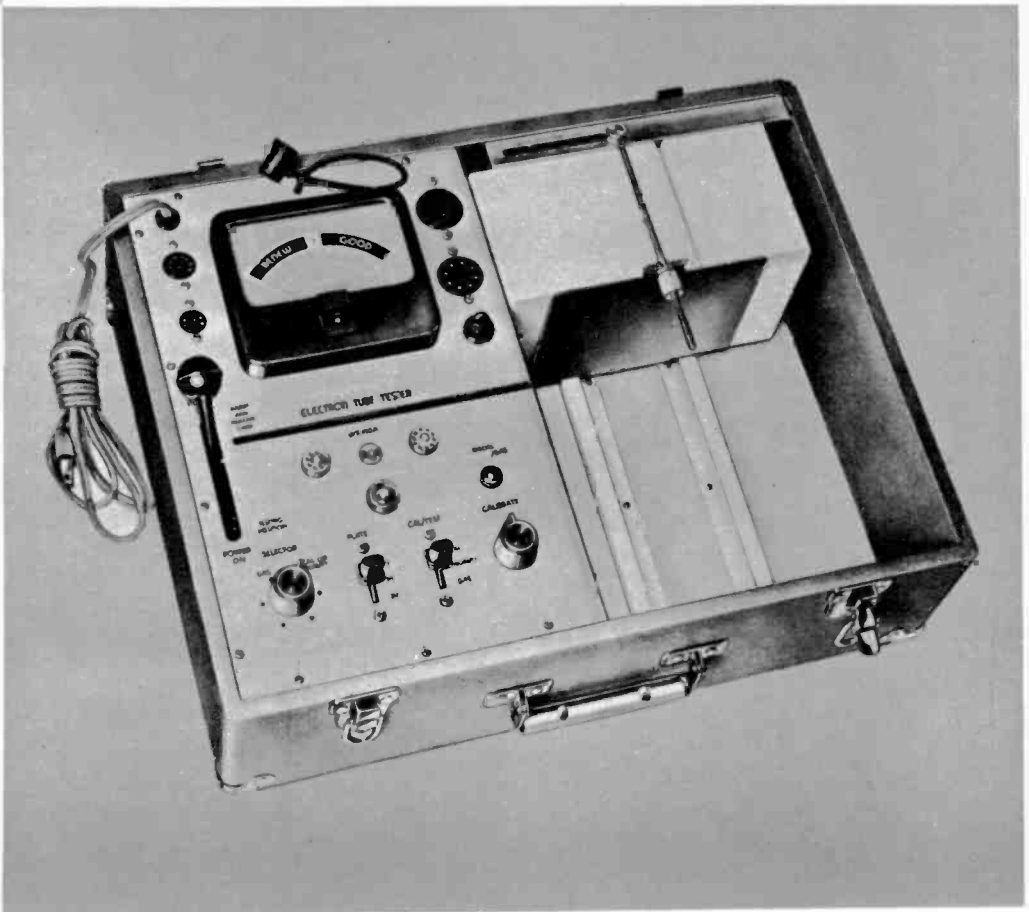

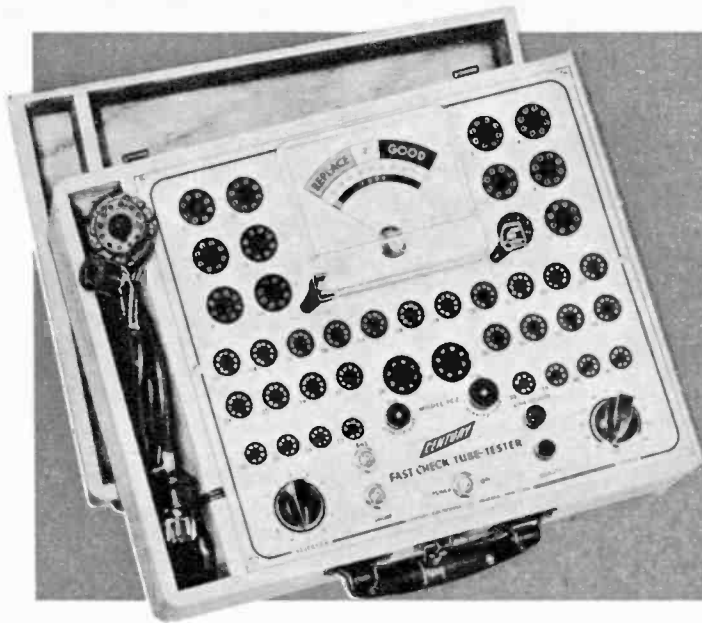

This model fast check tube tester has only two controls to set. In the compartment at left is a TV picture tube test adapter and rejuvenator.

Below is a tube tester which can check 5 tubes of the same type individually by rotating a tube bank switch on the panel.

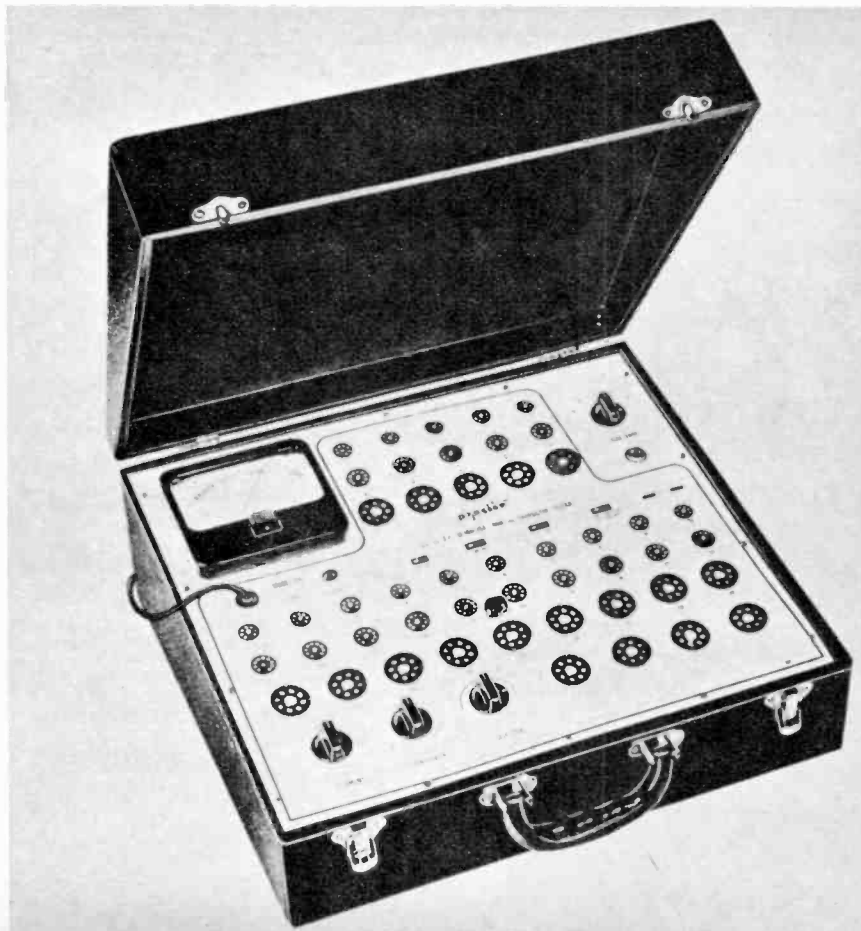

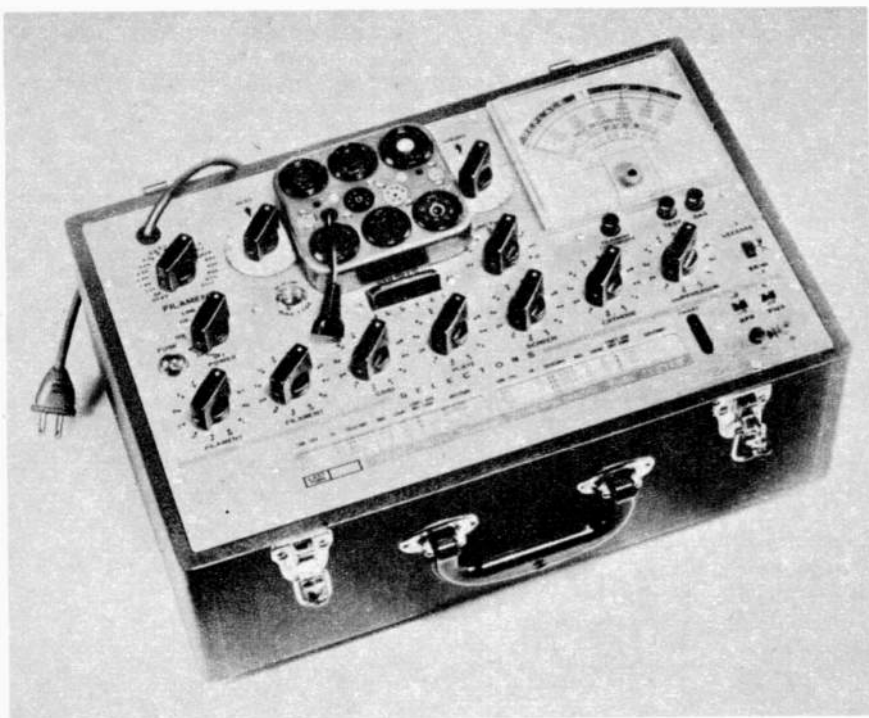

A sensitive five inch meter reads directly in micromhos. Roll chart groups the most commonly used tubes separately for faster reading and testing.

the right amount of line voltage be used to power the unit.

In spite of the fairly large number of controls found on even the simplest tube checker, these instruments are simple to set up and easy to operate.

Here is a general outline of the procedure normally suggested. While it will not apply to any specific instrument, it will indicate the steps to take and this will be followed in some form by every commercial tester on the market.

The first step is *not* to place the tube into the tester. The first step is to set the various operating controls to the proper positions for the tube under test. An indispensable part of each checker is a roll chart which lists the control settings for each given tube type. The chart is rotated until the desired tube is found. From this, the various controls are then set as indicated. Once this is done, the power is turned on and the line-voltage control is adjusted until the meter needle lines up at the specific reference point established for this purpose. Now the tube is inserted into the proper socket. If the tube contains a grid or plate cap, a suitable clip is attached to

this element. This is important, otherwise proper results will not be obtained. The tube is then permitted to warm up, generally for a period of two or three minutes. Then, and only then, is it ready to be tested.

The first test to perform is the shorts test. This is usually made with a four or five position rotary switch. The switch is advanced one position at a time and at each point the response of a neon bulb or other indicator is observed. If no short is indicated, the control is moved to the next position, etc. It is important that this test be carried out before the actual tube test is performed. This is a precautionary move, designed to prevent excessive current which a shorted tube may produce from passing through (and damaging) the meter. It is generally a good idea to tap the tube during the shorts test in order to reveal loose elements which may short under vibration. If a neon lamp is employed as the shorts indicator, it will frequently flash momentarily as the switch is moved to a new position. The flashes represent the discharge of a blocking capacitor in a  
[Continued on page 110]

# the EI

## Build-It Course-8

Part 8 continues the construction of a Citizens Band rig. Here is the RF oscillator-amplifier.

**T**HE RF oscillator-amplifier fulfills two important functions in the Citizens Band rig. The oscillator portion generates the operating frequency—the amplifier builds it up to a useful power level, in this case, just below the legal limit of five watts.

The heart of the oscillator is a quartz crystal. It displays an important quality known as the *piezo-electric* effect. If the crystal is physically squeezed, a voltage is generated. Conversely, when a voltage is applied across the crystal, it exhibits a mechanical strain.

Now, apply a voltage, and quickly remove it. The crystal will continue to vibrate, setting up a train of alternating voltages. These waves soon die out due to the friction in the crystal material. If these resistances were overcome, the crystal would gen-



Completed rig is at left. Mike is plugged into jack near the right edge. Below is underside of RF osc.-amplifier sub-assembly. See wiring guide on p. 99.

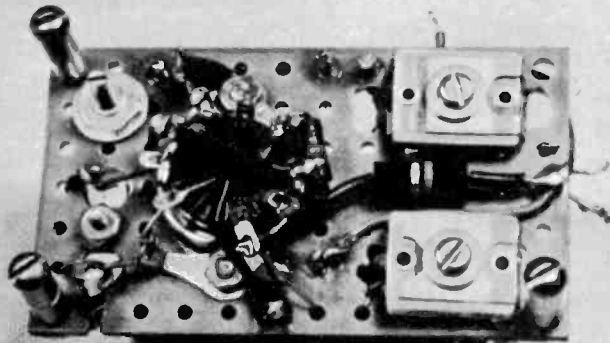

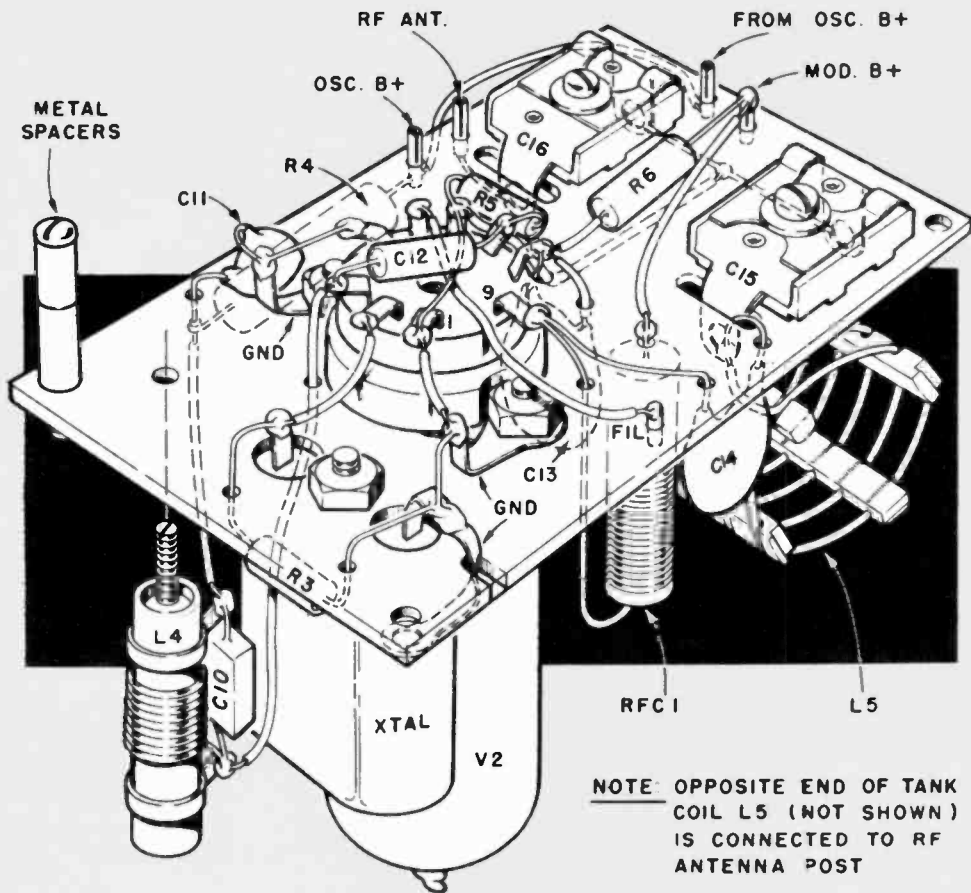

L4 in wiring guide is shown removed from sub-assembly for clarity. The external connections to this oscillator-amplifier board will be detailed in a future article.

Topside of the sub-assembly. Tube has been removed from its socket at center and is visible near top edge. The crystal is at lower right.

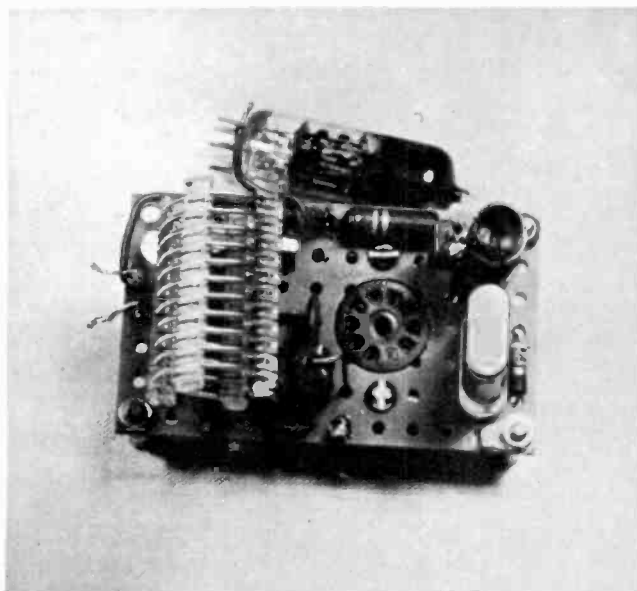

# HOW RF OSCILLATOR-AMPLIFIER WORKS

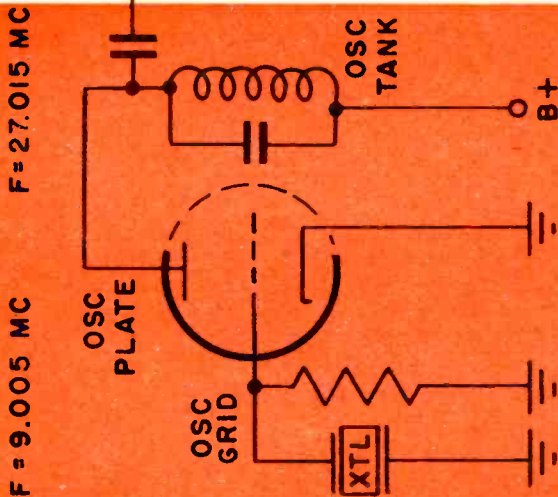

First half of the tube is the oscillator. As described in the text, its purpose is to determine the transmitter's frequency. The crystal's vibrations generate voltages that swing the grid in a negative and positive direction. Electrons emitted from the tube's cathode are retarded or accelerated by the grid voltage in synchronism with the vibrating crystal. A sustained oscillation occurs as energy is fed back to the crystal through the capacitance between the oscillator plate and grid. Since this is a third overtone crystal, the oscillator tank (consisting of a coil and capacitor) is tuned to three times the operating frequency of the crystal. Here, the crystal is cut for 9,005 mc, which yields an output of 27,015 mc. The tank shunts the harmonics to ground.

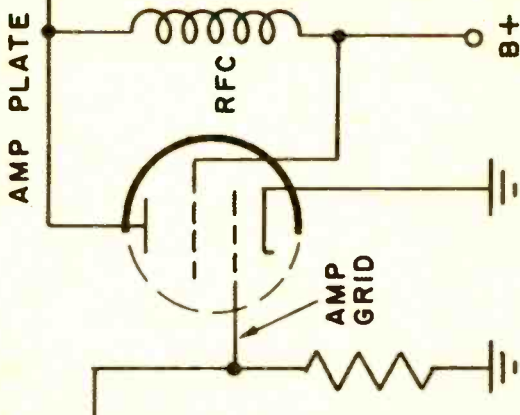

The tube's second section is a radio-frequency amplifier. Signal voltage at 27,015 mc appears on the grid and controls the large flow of electrons from the cathode. Amplified radio-frequency energy flows in the plate circuit. Note that the plate voltage (from B+) is applied through RFC, a radio-frequency choke coil. RFC opposes the flow of RF and prevents it from returning to ground through the power supply. The high positive B+ voltage, however, is unimpeded. Voice modulation will be applied to RF amplifier at the B+ point by the modulator (to be described in the next article). Changes in plate voltage of the RF amplifier are keyed by a speaking voice.

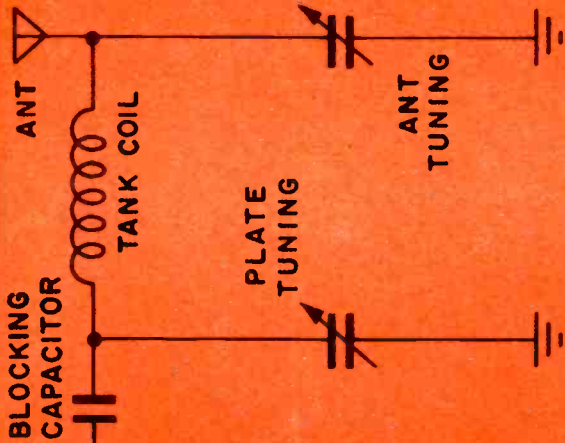

The modulated RF signal passes through the blocking capacitor. This capacitor keeps B+ voltage from entering the antenna tuning circuit. The tank coil and plate tuning capacitor form a resonant circuit at 27,015 mc. When tuned to this frequency, maximum RF energy is extracted from the RF amplifier tube. The antenna tuning capacitor acts to load the antenna. This is a pi-network antenna tuning circuit. Its chief advantage is that an antenna of random length can be used; the antenna tuning capacitor will resonate it. In practice, it is best to keep the antenna as close to eight feet as possible. This length (1/4-wave) will permit maximum antenna radiation, with little dissipation of power in the antenna tuning circuit.

RF osc.-amplifier schematic. Input and output connections are shown along bottom. They connect to small flea clips or posts in model.

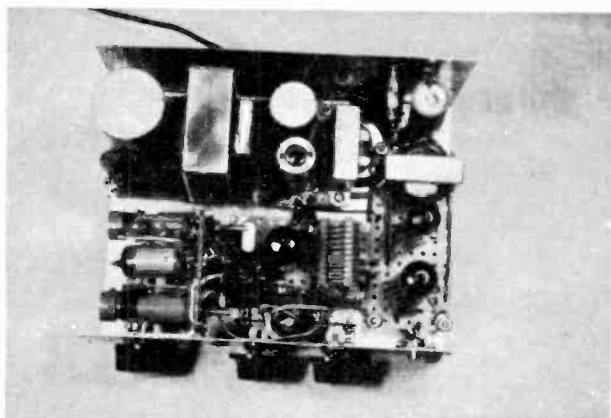
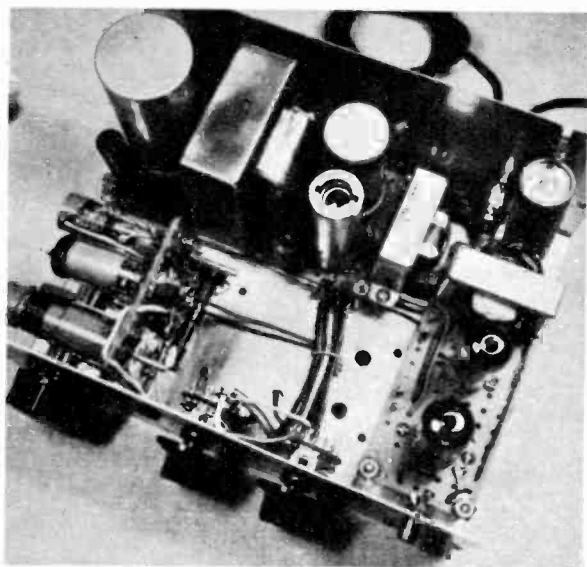
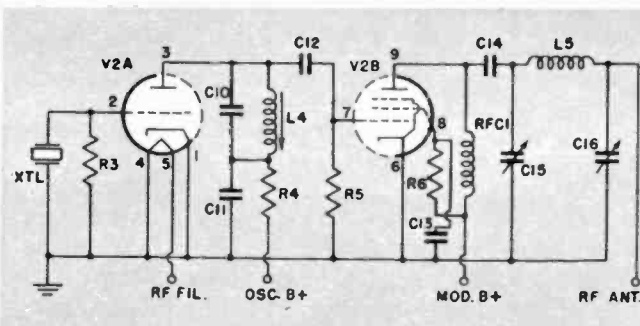

RF sub-assembly is shown mounted in place in above photo. Modulator is located at right.

Top view with cover removed is at left. The space at center is for the RF sub-assembly.

erate a sustained and stable oscillation.

During the discussion of basic oscillators, in previous articles in this series, the principle of feedback was shown to be one prerequisite for any oscillator. The feedback in this circuit occurs from the plate of the tube to its grid. The capacitance between these electrodes provides the path through which energy is returned to the crystal to restore losses.

Crystals permit the design of extremely stable oscillators. They are ground and lapped to fine tolerances. Generally, as the quartz material is made smaller, the crystal's operating frequency rises. There is an attendant disadvantage here. In the region of 27 megacycles, the crystal becomes extremely fragile; capable of only conducting tiny currents. In practice, they are

[Continued on page 123]

#### PARTS LIST

- C10—15 mmfd mica capacitor 500 volt
- C11—.002 mfd ceramic capacitor 600 volt
- C12—5 mmfd mica capacitor 500 volt
- C13—.005 mfd ceramic capacitor 600 volt
- C14—330 mmfd ceramic capacitor 600 volt
- C15—2.7-30 mmfd compression trimmer capacitor (Arco 461)
- C16—9-180 mmfd compression trimmer capacitor (Arco 463)
- R3—47,000 ohm resistor 1/2 watt
- R4—22,000 ohm resistor 1 watt
- R5—27,000 ohm resistor 1/2 watt
- R6—15,000 ohm resistor 1 watt
- L4—Oscillator coil. Wind 15 turns of #24 enamel wire on Cambridge Thermionics LS3-30 mc coil form
- L5—Output tank coil. Cut 11-turn section from a B&W 3010 Miniductor
- XTL—Crystal, third overtone 4type, .005% tolerance
- V2—6AU6 tube
- RF—Radio frequency choke (Ohmite Z-50)
- Misc.—9-pin tube socket with no centerpost, crystal socket (Lafayette CS-7), four 6-32x1" machine screws and nuts, metal spacers to hold board 11/16" above bottom of metal case. Perforated board sub-chassis 1 7/8" x 3 3/16" cut from Vector board listed in previous article, 3 lockwasher-type solder lugs, flea clips

*Try These*

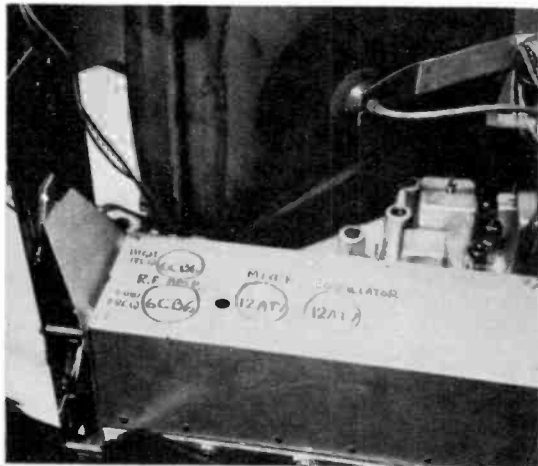

### Tube Marking

Hidden or shielded tubes are often overlooked while servicing your TV set. Mark their position with a grease pencil as shown above.

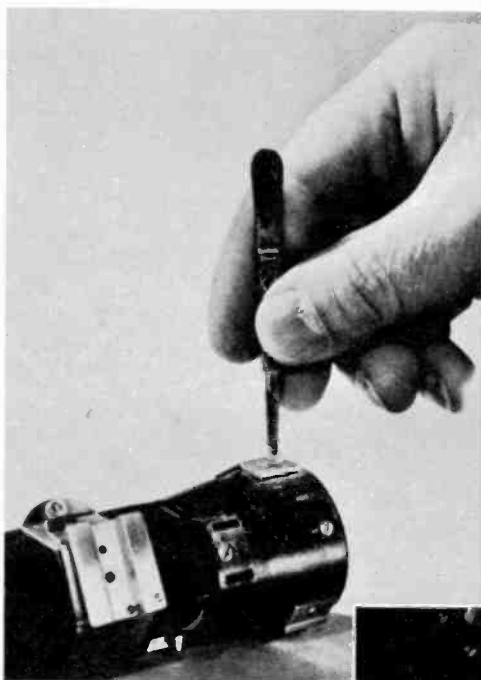

### Start Screws With Tweezers

By starting tiny screws with a pair of tweezers you needn't worry about stripped threads or loss. File down tweezer tips for snug fit.

### Pencil Tips For Soldering

The various multi-purpose screw-on tips normally used with a pencil soldering iron are handy for guns too. Just slip them over gun's tip (shown at right cutting Lucite strip).

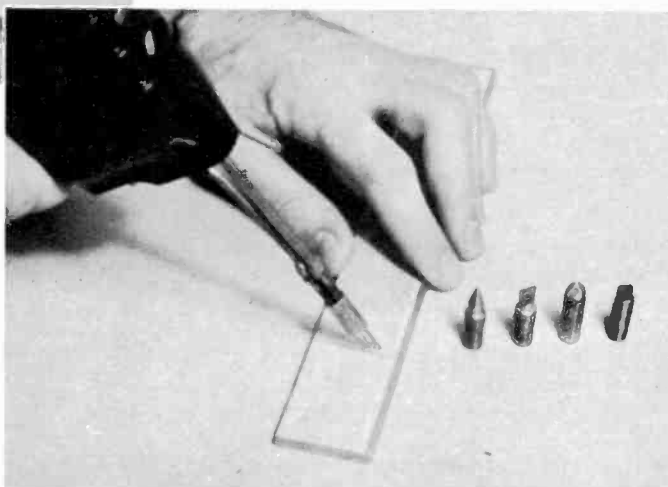



# Compare your job, your age your pay, with that of men who enroll at CREI



... then consider how handicapped you'll be without the knowledge of advanced electronics engineering technology which CREI teaches via home study

Men can stand still—or lose their jobs—even in a growing industry. They're doing it now in the fast-growing electronics industry. Companies actively seeking men with advanced technological knowledge are simultaneously firing mediocre men.

CREI students (more than 20,400 are currently enrolled) keep pace with electronics progress—and are eagerly sought by employers who offer solid opportunities for rapid advancement.

We analyzed the backgrounds of men who enrolled for CREI advanced electronics home study in a recent month. Compare yourself:

- 62% were civilians. 38% were in the Armed Services.
- Of the 62% who were civilians, 35% were electronic technicians, lab technicians, engineering aides, research assistants, electronic specialists, and similar high-rated electronics engineering men.
- Average pay: \$435 per month (range: \$300 to \$900). Average age: 28. Median age: 26. Previous formal electronic training varied from six months to more than a year.
- 9.4% of the civilians were technical representatives—field engineers who were school- or factory-trained to help install, maintain, service and teach the use and operation of electronic equipment. Average pay: \$525 per month. Median age: 28.
- 6.5% of the civilians held college degrees, most in a field more or less related to electronics (engineering,

physics, chemistry, etc.). These men were not in basic electronic work. Reason most often given for enrollment: to supplement job-know-how with better understanding of electronics.

• The remainder of the civilians were small groups of small percentages.

Even if you compare favorably with new CREI enrollees now, how do you think your salary will compare with theirs a year from now? Five years from now?

Qualify for positions which require advanced electronics education—while retaining your present job—via CREI home study. Meet your family responsibilities while gaining knowledge of electronic engineering technology so essential for career advancement. College degree is not essential. If you have had basic electronic education, practical experience in electronics, and a high school education, you can probably qualify. Use coupon below to find out, or write CREI, Dept. 1704-G, 3224 16th St., N.W., Wash. 10, D. C.

CREI RESIDENCE SCHOOL IN WASHINGTON, D. C.

For those who can attend classes, CREI operates full time residence school. Day and evening classes start at regular intervals. Qualified graduates earn AAS degree. Electronics experience not required for admission.



## Get This New Fact-Packed Booklet—It's Free!

### CAPITOL RADIO ENGINEERING INSTITUTE

ECPD Accredited Technical Institute Curricula • Founded 1927  
Dept. 1704-G, 3224 Sixteenth St., N.W., Washington 10, D. C.

Please send me your course outline and FREE illustrated Booklet "Insurance for Your Future in the New World of Electronics" . . . describing opportunities and CREI home study courses in Practical Electronic Engineering Technology.

- CHECK FIELD OF GREATEST INTEREST
- Radar, Servo & Computer Engineering Technology
  - Electronic Engineering Technology
  - Communications Engineering Technology
  - Television Engineering Technology
  - Aeronautical Electronic Engineering Technology
  - Automation and Industrial Electronics Engineering Technology

Name \_\_\_\_\_ Age \_\_\_\_\_

Street \_\_\_\_\_

City \_\_\_\_\_ Zone \_\_\_\_\_ State \_\_\_\_\_

Check:  Home Study  Residence School  Korean Veteran

To obtain fast, immediate service and to avoid delay, it is necessary that the following information be filled in:

Employed By.....

Type of Present Work.....

Education:

Yrs. High School.....

Other.....

Electronics Experience.....

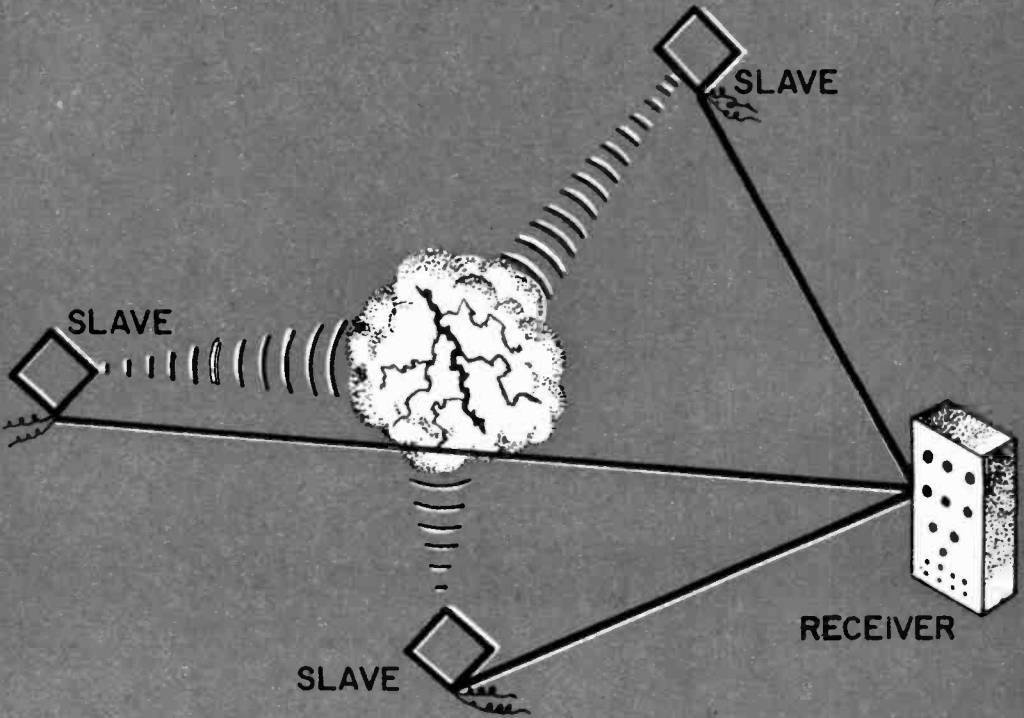

Multi-frequency lightning flash emissions are picked up by crossed loop antennas of static direction finder. Data is sent to master station for fix.

# Sferics Stations Sound Out Storms

By Myron B. Gubitz

**E**DUCATED guesses claim an average of 44,000 thunderstorms occur on our planet each day. In these there are some 20-million lightning strokes, each acting as a radio transmitter, sending out static on all frequencies. This static is called atmospherics, hence the term "sferics" to denote the Air Force's world-wide network of stations that triangulate on the radio noise in an effort to pinpoint unseen storms thousands of miles away.

The USAF's Air Weather Service (AWS) maintains three sferics-tracking networks: the Atlantic Net, which covers an area from Newfoundland to Florida and from Washington, D. C., to Azores; the "Tornado" Net, with its master station in Kansas City, Mo., guarding the Great Plains region; and the Pacific Net, monitoring the Pacific and Far East.

To get a clear idea of how a sferics network operates, let's see how a bolt of lightning over the North [Continued on page 122]

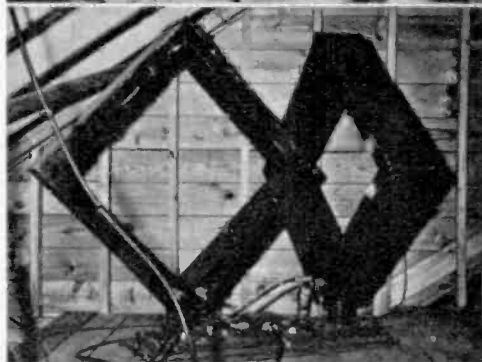
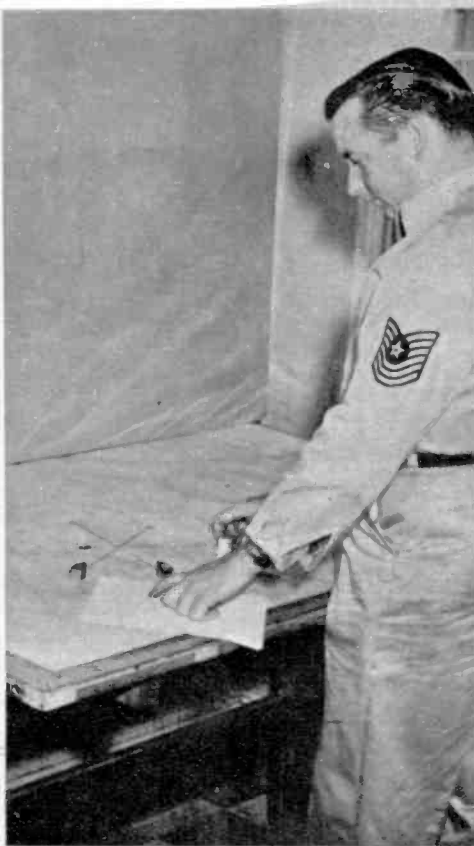

Azimuths sent to master station at Andrews AFB, Washington, D. C., by several slave stations are plotted by M/Sgt. Roy Connolly. Intersection of lines gives a fix.

Film, top right, is reviewed at master station. Each flash can be identified by a recorded time signal transmitted by WWV. Time is accurate to 1/100th of a second.

Crossed loop antenna system is used to determine exact direction of sferics discharge. One loop is generally oriented north-south, while the other faces east-west.

First rack contains timing unit two receivers, one a spare. Next panel has cathode ray indicator, amplifiers, receiver and rectifier. In foreground is camera setup.

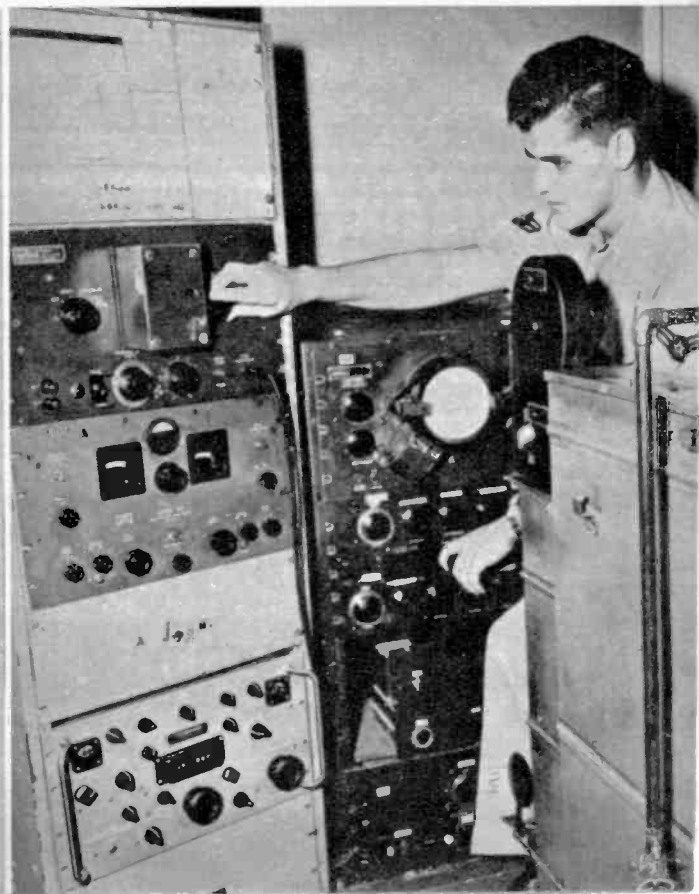

# NOW YOU CAN HAVE YOUR CHOICE OF CENTURY'S UNIQUE Peak-to-Peak VACUUM TUBE VOLT METERS

Model VT-10  
LINE OPERATED

WITH LARGE EASY-TO-READ 6" METER

Model VT-1  
BATTERY OPERATED

featuring the sensational new  
**MULTI-PROBE** (Patent Pending)

No extra probes to buy! The versatile  
MULTI-PROBE does the work of 4 probes

- ① DC Probe ② AC-Ohms Probe  
③ Lo-Cap Probe ④ RF Probe

No longer do you have to cart around a maze of entangled cables, lose time alternating cables or hunting for a misplaced probe. With just a twist of the MULTI-PROBE tip you can set it to function as either a DC Probe, AC-Ohms Probe, Lo-Cap Probe or RF Probe.

## LINE OPERATED

Ideal for use on the test bench. Designed to run cool under continuous operation... Line isolated.

## BATTERY OPERATED

Completely portable... Invaluable wherever line connection is undesirable or unavailable... Unique circuitry assures low battery drain.

## FUNCTIONS OF VT-1 and VT-10

**DC VOLTMETER**... Will measure D.C. down to 1.5 volts full scale with minimum circuit loading, and give accurate readings of scale divisions as low as .025 volts... Will measure low AGC and oscillator bias voltages from .1 volts or less up to 1500 volts with consistent laboratory accuracy on all ranges... Zero center provided for all balancing measurements such as discriminator, ratio detector alignment and hi-fi amplifier balancing.

**AC VOLTMETER**... True Peak-to-Peak measurements as low as 3 volts of any wave form including TV sync, deflection voltages, video pulses, distortion in hi-fi amplifiers, AGC and color TV gating pulses... Scale divisions are easily read down to .1 volts... Measures RMS at 1/20th the circuit loading of a V.O.M.... Unlike most other V.T.V.M.'s there is no loss in accuracy on the lowest AC range.

**ELECTRONIC OHMMETER**... Measures from 0 to 1000 megohms... Scale divisions are easily read down to .2 ohms... Will measure resistance values from .2 ohms to one billion ohms... Will detect high resistance leakage in electrolytic and by-pass condensers.

**RF and IO-CAP MEASUREMENTS**... With these extra VT-1 functions you can measure voltages in extremely high-impedance circuits such as sync and AGC pulses, driving saw tooth voltages, color TV gating pulses, mixer output levels, I.F. stage-by-stage gain and detector inputs.

**NEW**



Model VT-10  
**\$58.50**  
Net

TERMS: \$14.50 within 10 days. Balance \$11 monthly for 4 months.

## FEATURES OF VT-1 and VT-10

- New advanced pentode amplifier circuit
- Large 6" 100-microampere meter, many times more sensitive than meters used in most V.T.V.M.s
- Simplified multi-color easy-to-read 4-scale meter
- No heat operation assures stability and accuracy
- Amplifier rectifier circuit with frequency compensated attenuator — a feature found only in costly laboratory instruments
- Meter completely isolated
- Hand-crafted circuitry eliminates the headaches of printed circuitry
- 1% resistors used for permanent accuracy
- Rugged gray hammertone steel case provides necessary shielding and eliminates plastic case drawbacks of cracking or melting
- Deep brushed long lasting etched aluminum panel
- Matching cover protects instrument face — snaps on and off instantly.



Model VT-1  
**\$58.50**  
Net

TERMS: \$14.50 within 10 days. Balance \$11 monthly for 4 months.

## SPECIFICATIONS OF VT-1 and VT-10

- DC Volts — 0 to 1.5/6/30/150/300/600/1500 volts
- AC Volts (RMS and Peak-to-Peak) — 0 to 3/12/60/300/1200 volts
- Ohms — to a billion ohms, 10 ohms center scale — RX1/10/100/1K/10K/100K/1M
- RF — Peak reading demodulator supplied for use on all DC ranges
- Zero Center — available on all DC volt ranges with zero at mid-scale
- Decibels — from -10 Db to +10/22/35/50/62 based on the Dbm unit; 0Db = 1mW in 500 ohms
- Impedance — 11 megohms DC, 1 megohm AC, 10 megohms Lo-Cap
- Input Capacity — 130 mmfd. RMS, 250 mmfd. Peak-to-Peak, 25 mmfd. Lo-Cap

Model  
CT-1

# IN-CIRCUIT CONDENSER TESTER

Here is an IN-CIRCUIT CONDENSER that DOES THE WHOLE JOB! The CT-1 actually steps in and takes over where all other in-circuit condensers fail. The ingenious application of a dual bridge principle gives the CT-1 a tremendous range of operation... and makes it an absolute 'must' for every serviceman.

## in-circuit checks:

- ✓ Quality of condensers ever with circuit shunt resistance... (This includes leakage, shorts, opens, intermittents)
- ✓ Value of all condensers from 200 mmfd. to .5 mfd.
- ✓ Quality of all electrolytic condensers (the ability to hold a charge)
- ✓ Transformer, socket and wiring leakage capacity

## out-of-circuit checks:

- ✓ Quality of condensers... (This includes leakage, shorts, opens and intermittents)
- ✓ Value of all condensers from 50 mmfd. to .5 mfd.
- ✓ Quality of all electrolytic condensers (the ability to hold a charge)
- ✓ High resistance leakage up to 300 megohms
- ✓ New or unknown condensers... transformer, socket, component and wiring leakage capacity

## OUTSTANDING FEATURES

- Ultra-sensitive 2 tube drift-free circuitry
- Multi-color direct scale readings for both quality and value... in-circuit or out-of-circuit
- Simultaneous readings of circuit capacity and circuit resistance
- Built-in hi-leakage indicator sensitive to over 300 megohms
- Cannot damage circuit components
- Electronic eye balance indicator for even greater accuracy
- Isolated power line
- Deep brushed long lasting etched aluminum panel
- Housed in sturdy gray hammertone finish steel case... comes complete with test leads



Model CT-1  
**\$34.50**  
Net

TERMS: \$9.50 within 10 days. Balance \$5 monthly for 5 months.

# 10 DAY FREE TRIAL ON CENTURY INSTRUMENTS OF YOUR CHOICE

See for yourself at no risk why thousands of servicemen all over the country selected CENTURY test equipment above all others. Send for instruments of your choice without obligation... try them for 10 days before you buy... only then, if satisfied, pay in easy-to-buy monthly installments — without any financing or carrying charges added.



Housed in hand-rubbed oak carrying case — complete with MULTI-HEAD

Model CRT-2  
**\$57.50** Net

TERMS: \$13.50 within 10 days. Balance \$11 monthly for 4 months.

## Model CRT-2 CRT TESTER-REACTIVATOR

### TESTS, REPAIRS and REACTIVATES

- ALL BLACK AND WHITE PICTURE TUBES (including 110° tubes) ... from 8" to 30", whether 12 pin base, 8 pin base, 14 pin base ... and the very latest 7 pin base.
- ALL COLOR PICTURE TUBES ... Each of the red, green and blue color guns is handled separately.

#### CHECK THESE EXCLUSIVE FEATURES

- ✓ THE MULTI-HEAD (Patent Pending) ... A SINGLE PLUG IN CABLE AND UNIQUE TEST HEAD — A tremendous advance over the maze of cables and adapters generally found with other testers.
- ✓ WATCH IT REACTIVATE THE PICTURE TUBE — You actually see and control the reactivation directly on the meter as it takes place. This allows you for the first time to properly control the reactivation voltage and eliminates the danger of stripping the cathode of the oxide coating. It also enables you to see whether the build-up is lasting.
- ✓ CONTROLLED "SHOT" WITH HIGHER VOLTAGE FOR BETTER REACTIVATION — Stronger than any found in other testers — high enough to really do the job — yet controlled to avoid damage to the picture tube.
- ✓ UNIQUE HIGH VOLTAGE PULSE CIRCUIT — Will burn out inter-element shorts and weld open circuits with complete safety to the picture tube.

THE CRT-2 DOES ALL THIS RIGHT IN THE CARTON, OUT OF THE CARTON OR IN THE SET

- |            |   |
|------------|---|
| TEST       | <ul style="list-style-type: none"> <li>• For quality of every black and white and color picture tube, employing the time proven dynamic cathode emission test principle.</li> <li>• For inter-element shorts and leakage up to one megohm. Separate short test provided for each element in the picture tube.</li> <li>• For life expectancy.</li> </ul>  |
| REPAIR     | <ul style="list-style-type: none"> <li>• Will clear inter-element shorts and leakage.</li> <li>• Will weld open elements.</li> </ul>  |
| REACTIVATE | <ul style="list-style-type: none"> <li>• The "SHOT" (high voltage controlled pulse) method of reactivation provided by the CRT-2 will restore picture tube to new life in instances where it was not possible before. The high voltage is applied without danger of stripping the cathode as you always have perfect control of the high voltage pulse.</li> <li>• The "BOOST" method of reactivation also provided by the CRT-2 is used effectively on tubes with a superficially good picture but with poor emission and short life expectancy. It will also improve definition, contrast and focus greatly and add longer life to the picture tube.</li> </ul> |

- ✓ VISUAL LIFE TEST — Enables both you and your customer to see the life-expectancy of any picture tube right on the meter ... helps eliminate resistance to picture tube replacement when necessary.
- ✓ SPECIAL LOW SCREEN VOLTAGE TUBES — Will handle new type picture tubes with special low voltage of approximately 50 volts.
- ✓ SEPARATE FILAMENT VOLTAGES — including the very latest 2.35 volt and 0.4 volt types as well as the older 6.3 volt types.
- ✓ NEW 'SF' PICTURE TUBES — Accommodates the different base pin connections of this new type picture tube.



Housed in hand-rubbed oak carrying case complete with CRT ADAPTER

Model FC-2  
**\$69.50** Net

TERMS: \$14.50 within 10 days. Balance \$11 monthly for 5 months.

## Model FC-2 FAST-CHECK TUBE TESTER

Simply set two controls ... insert tube ... and press quality button to test any of over 900 tube types completely, accurately ... IN JUST SECONDS!

The FAST-CHECK enables you to cut servicing time way down, eliminate unprofitable call-backs and increase your dollar earnings by selling more tubes with very little effort on your part. You make every call pay extra dividends by merely showing your customer the actual condition and life expectancy of the tube. The extra tubes you will sell each day will pay for the FAST-CHECK in a very short time.

**PICTURE TUBE TEST ADAPTER INCLUDED WITH FAST-CHECK**  
Enables you to check all picture tubes (including the new short-neck 110 degree type) for cathode emission, shorts and life expectancy ... also to rejuvenate weak picture tubes.

#### RANGE OF OPERATION

- ✓ Checks quality of over 900 tube types, employing the time proven dynamic cathode emission test. This covers more than 99% of all tubes in use today, including the newest series-string TV tubes, auto 12 plate-volt tubes, OZ4s, magic eye tubes, gas regulators, special purpose hi-fi tubes and even foreign tubes.
- ✓ Checks for inter-element shorts and leakage.
- ✓ Checks for gas content.
- ✓ Checks for life-expectancy.

#### SPECIFICATIONS

- No time consuming multiple switching ... only two settings are required instead of banks of switches on conventional testers
- No annoying roll chart checking ... tube chart listing over 900 tube types is located inside cover. New listings are added without costly roll chart replacement
- Checks each section of multi-section tubes and if only one section is defective the tube will read "Bad" on the meter scale
- 41 phosphor beryllium tube sockets never need replacement
- 7-pin and 8-pin straighteners mounted on panel
- Large 45° D'Arsonval type meter is the most sensitive available, yet rugged — fully protected against accidental burn-out
- Special scale on meter for low current tubes
- Compensation for line voltage variation
- 12 filament positions
- Separate gas and short jewel indicators
- Line isolated — no shock hazards
- Deep brushed long lasting etched aluminum panel.

**NOTE:** The Fast-Check positively cannot become obsolete ... circuitry is engineered to accommodate all future tube types as they come out. New tube listings are furnished periodically at no cost.

**MAIL FREE TRIAL COUPON TODAY!**

### CENTURY ELECTRONICS CO., INC.

- |                          |  |         |
|--------------------------|--|---------|
| <input type="checkbox"/> | Model VT-10 Vacuum Tube Volt Meter ... \$14.50 within 10 days. Balance \$11 monthly for 4 months.        | \$58.50 |
| <input type="checkbox"/> | Model VT-1 Battery Vacuum Tube Volt Meter ... \$14.50 within 10 days. Balance \$11 monthly for 4 months. | \$58.50 |
| <input type="checkbox"/> | Model CT-1 In-Circuit Condenser Tester ... \$9.30 within 10 days. Balance \$5 monthly for 5 months.      | \$34.50 |
| <input type="checkbox"/> | Model CRT-2 CRT Tester-Reactivator ... \$13.50 within 10 days. Balance \$11 monthly for 4 months.        | \$57.50 |
| <input type="checkbox"/> | Model FC-2 Fast-Check Tube Tester ... \$14.50 within 10 days. Balance \$11 monthly for 5 months.         | \$69.50 |
- Prices Net F.O.B. Mineola, N. Y.

111 Roosevelt Ave., Dept. 404, Mineola, N. Y.

Yes, I want to take advantage of your 10 day FREE try-before-you-buy offer. Ship on approval the instruments I have checked. After I have tried the equipment for 10 full days I will either send you the down payment and agree to pay the balance in the monthly payments shown, or I will return the units and owe nothing.

Name

Please print clearly

Address

City

State

Continued from page 33

practices, no symphony hall has a sound-proof wall right down the middle of the orchestra, nor do we have such a baffle through the middle of our heads.

How much separation is needed and at what frequencies? Some say as little as 8 db separation gives good stereo effect, while others feel at least 20 db minimum separation is required in the 1000 cycle and up region. Bearing these concepts in mind, we employed a stereophonic test record in which a 1000 cps tone is cut in Channel A with Channel B unmodulated. In order to reduce the variables to a bare minimum, a switch was wired in such a manner that either Channel A or Channel B could be fed to the preamplifier and VTVM.

The differences encountered were astounding. In evaluating these results, it should be remembered that pronounced channel separation may not always be desirable. In addition, these tests were carried on at one important frequency, 1000 cps, and a pickup which has a low channel separation figure at that frequency *may* do better, let us say, at 3000 cps. If necessary, you as a listener can reduce high channel separation with a "blend" or "phantom channel" control. In pickups having little channel separation, however, there's almost nothing that can be done when pronounced separation is wanted.

### Frequency Response and Distortion

Our tests indicate that frequency response variations, such as wave-shape distortion and peaking at particular frequencies, show up as distinct colorations in the actual sound. Paradoxically, however, some listeners like highly-colored sound, even when they are shown graphically that distortion (non-linearity) is in the system of their choice.

From time to time we see pseudo-technical high fidelity literature sarcastically pointing out the fact that few persons can hear above 15,000 cps, so why market equipment with responses up to 50,000 cps?

We ran a special test in which we used two models of the same cartridge, a

standard one with a response to 30,000 cps and a special job said to have a 40,000 cps response. Obviously no one can hear 30,000 or 40,000 cycles, and yet, during an A-B comparison test of both cartridges in the same type arm and using an excellent stereophonic record ("The Pee Wee Russell Story," Counterpoint CPST 562) eight out of ten listeners clearly described a marked difference in smoothness and clarity. Seven out of the ten preferred the 40,000 cycle version. Here was definitely an instance where published specifications and very clean oscilloscope response to the limits of measurement *concur*red with the listening results.

But this is not always the case. For example, in our sine wave response tests we found that the London-Scott unit had pronounced sine wave distortion in the 4000 to 9000 cycle region. This distortion led to a unique kind of coloration which appealed to quite a few listeners. Those cartridges which tested as having marked peaks in the middle and upper frequencies were *always* spotted by the listeners as giving brilliant, impressive coloration to the sound and most listeners thought this a desirable form of distortion.

### Listening Tests

Twenty people were selected at random. Their age groups ranged from teenagers to elderly retired persons and their occupations and degree of musical sophistication also varied widely. Each system received the same handicaps. Four pickup-arm combinations were mounted so that they all played the same record groove simultaneously. A selector switch was used to feed any one of the four combinations to the playback system, which consisted of a Marantz amplifier system and KLH speakers.

The individual being tested was required to do two things: First, he was asked to describe the sound which each combination arm and pickup produced; second, he was asked to pick the combination which he personally preferred, as well as the combination which he liked least of all.

Once this data was established for four separate systems, the first choice and the last choice remained in the setup

while the middle two were removed and replaced with two new combinations. This test was run through the nine units until each listener had selected the combination he liked best, the combination he liked least, as well as fully describing the sound of *all* nine units.

A number of stereophonic and monophonic records were used, each for an equal amount of playing time.

Only two of the twenty test listeners failed to hear any noticeable differences between the nine systems. The other 18 all heard very marked differences and had very marked preferences and dislikes. This definitely points up the need for a buyer to listen before he selects.

Since listeners and the interviewer frequently spent a full hour of listening, one of the most neglected aspects of high fidelity component evaluation began to rear its head, the factor of *listener fatigue*. In the first few minutes of the test a number of listeners had a tendency to pick as their first choice those combinations having a kind of theatrical brilliance. However, after repeated listening to the same combinations, these listeners changed their opinions and picked as their first choice a system with a smoother, silkier more linear sound. This change of preference was so pronounced in some instances that the pickup-arm combination initially selected as the preferred in the first five or ten minutes often, after half-an-hour of listening, was relegated to the end of the list. When a change of preference was indicated, combinations originally eliminated were reinstated for new comparisons.

#### General Comments

On the whole, no major difficulties were encountered in mounting any of the arms, or mounting the cartridges (in the non-integrated arms). But in the integrated Weathers arm, the cartridge kept sliding out of its clip during normal use. This happened with several samples of this unit. In addition, the clearance between the Weathers cartridge and the record is so small that dust that collects beneath the rear portion of the cartridge case sometimes lifts the needle out of the record grooves.

In the case of the GE cartridge, (one

sample tested), the grounding strap for the cartridge case did not make contact with the pin connector, resulting in considerable hum. Quite a bit of scraping, pushing and bending was necessary to achieve good contact between the strap and the unit push-in pin.

A more serious difficulty was encountered with the Audax arm shell. This shell is too small to accommodate many of the popular cartridges and it becomes impossible to mount some of these cartridges properly without shorting the output pins.

The wire supplied with the B & O, Grado, Scott and Audax arms is neither stripped nor tinned. It is not an easy matter to strip back the insulation on extremely thin wires without injuring the cables. Soldering tends to melt the thin insulation and causes shorts involving the shielding braid. It would be very helpful if these arms were supplied with standard RCA-type phono jacks factory-soldered to the wires at the output end as is the case with the Pickering, Fairchild, and Weathers arms. Virtually all modern preamplifiers have RCA-type phono fittings and for those few exceptions, adapters are available. ●

### All-Transistor Intercom Kit

*Continued from page 64*

front door of his house, your reviewer can easily hear the conversations of people about forty feet away!

The amplifier itself is quite straightforward. The switching is a bit tricky, but is under the full control of the person at the master unit.

For baby sitting, the system can be set so that the baby can be heard at any or all the other remotes in the house. This hook-up will appeal very strongly to mothers who may have to traipse from the main floor kitchen to the basement, while junior snoozes upstairs.

As a construction job this intercom kit is apple pie easy. Even a rank beginner can tackle this 3-4 hour job with confidence. Each remote unit can be done in fifteen minutes or less. The master kit costs \$28, a remote \$7.00 (less batteries). Definitely a Good Buy. ●

## Tube Testers—2

Continued from page 97

short check circuit; once the discharge is completed, the glow disappears. A short is indicated only when the neon tube continues to glow, as long as the short switch is in this particular position.

A leakage test, if provision exists for it, should also be made before the actual tube test is initiated. Gas checks, when available, can also be made at the same time.

After a tube successfully passes all of the foregoing tests, it is ready for the mutual conductance or emission check. This is performed by depressing a button or pulling a lever into position. Read the final position of the meter needle.

### Quick-Test Checkers

For servicemen who have a considerable number of tubes to check, conventional tube testers, with their multiple switches, present a time problem. A television receiver with 13 to 20 tubes will require 30 minutes for a complete check and, during a service call, it is good practice to check every tube so that all those that are weak or which contain leakage will be detected and replaced. To meet this condition, several equipment manufacturers have come up with tube checkers which are so designed that tubes can be checked in one-fifth the time ordinarily required. This is accomplished by designing the instrument so that only one or two knobs need be positioned for a tube check. One popular quick-test checker is shown in Fig. 1. Here the proper socket for the tube is found and then the heater switch and a control labeled "Sensitivity" are set to the indicated positions. After this, the tube is inserted into the proper socket and a four-position knife switch is manipulated for short, gas, leakage, and general operating checks. With an instrument of this type, it is possible to check a complete television receiver in about 15 minutes.

Another approach to quick tube testing is through the use of punched cards. See Fig. 2. A series of cards is provided with the tester and when a tube is to be

checked, the proper card is selected and placed in a slot. By means of the holes which the card possesses, the instrument is set up to provide all the proper voltages for the tube, including the filament voltage. After this, one or two test switches are manipulated, indicating the condition of the tube.

### Pitfalls To Avoid

While tube checkers are very easy to set up and use, there are a number of precautions that must be observed if the proper indications are to be obtained.

1) Never insert the tube into the checker until everything has been set up correctly. *Double check.*

2) Set the roll chart to the proper tube. Be careful of tubes that possess closely similar designations. For example, it is very simple to set the tube chart for a 6CH6 when a 6CH8 is desired.

3) Many tubes perform several functions. For these multi-purpose tubes, the roll chart will indicate a separate set of settings for each section. It is important that all sections of the tube be checked in order to obtain a complete picture of its operating capabilities.

4) Make certain the filament voltage control is set to the proper value. This is perhaps the most critical of all the controls. Filament switches will contain anywhere from 10 to 20 values and because it is necessary to accommodate all of these in the rotation of a switch, the values are positioned very close together. Thus, it is very simple to misjudge the setting of this control by one position, and if the difference between this new setting and the previous one is great enough, it is readily possible to completely destroy the tube.

5) Be sure to recheck the setting of all levers and rotary controls before the test button is depressed.

6) When any operating test is made, make certain the proper button is depressed.

7) Always check for shorts and leakages before the operating test. This will prevent the development of a large surge of current in the case of a short.

8) Always check the line voltage adjust control and make certain it is set to the proper value. 





## Look what \$29<sup>95</sup> buys in high fidelity equipment!

*A complete 14-watt hi-fi rated amplifier-preamplifier combination in one attractively styled unit . . . and at less than half the price you would expect to pay!*

Learn how you can "build-it-yourself" and save 50% or more on the world's finest high fidelity equipment. Send today for your **FREE** Heathkit catalog—or see your nearest authorized Heathkit dealer!

### 14-WATT HI-FI RATED AMPLIFIER KIT (EA-3)

From HEATHKIT audio labs comes an exciting new amplifier . . . New Styling, New Features, Brilliant Performance! Designed to function as the "heart" of your hi-fi system, the EA-3 combines the pre-amplifier and amplifier functions into one compact package with an

honest 14 watts of high-fidelity-rated power, capable of driving the most demanding systems, and all the necessary controls for precise blending of sound reproduction to your individual taste. Clearly marked controls give you finger-tip command of bass and treble "boost" and "cut" action, switch selection of three separate inputs, "on-off" and volume control. A hum balance control is also provided. **ORDER YOUR EA-3 TODAY!** . . . a few hours of easy kit building fun will earn you a lifetime of hi-fi pleasure! Shpg. Wt. 15 lbs.

**NOTE THESE OUTSTANDING SPECIFICATIONS:** Power output: 14 watts, Hi-Fi; 12 watts, Professional; 16 watts, Utility. Power response:  $\pm 1$  db from 20 cps to 20 kc at 14 watts output. Total harmonic distortion: less than 2%, 30 cps to 15 kc at 14 watts output. Intermodulation distortion: less than 1% at 16 watts output using 60 cps and 6 kc signal mixed 4:1. Hum and noise: mag. phono input, 47 db below 14 watts; tuner and crystal phono, 63 db below 14 watts.

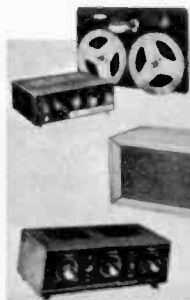

Complete line of monophonic stereo-tape recorders . . . from \$39.95

Finest quality hi-fi speaker systems . . . from \$34.95

Everything for stereo Amplifiers . . . from \$29.95

World's finest monophonic amplifiers . . . from \$15.95

### HEATH COMPANY

 a subsidiary of Daystrom, Inc.

Benton Harbor 39, Michigan

Please send the latest Free Heathkit Catalog.

NAME

ADDRESS

CITY  STATE

All prices F.O.B. Benton Harbor, Mich. Prices and specifications subject to change without notice.

*Continued from page 41*

"G" between the fuselage sides in the notches and apply model airplane cement to all joints. When this is dry add the remaining bulkheads "H," "I" and "J" and pull the sides together at the fuselage rear. Again, apply cement to these joints.

The landing gear is bent from  $\frac{1}{8}$ " dia. music wire. Follow the dimensions on the plans when bending the wire. The material is tough and springy therefore grip the pliers firmly. The wire is easily broken by repeated bending; it cannot be cut. Bind the joints with soft fine wire, however, and do not use aluminum wire. Single strands of standard electrical multi-strand wire can be used for this purpose. When all landing gear components are in perfect alignment the joints should be well soldered. Sew the landing gear assembly to the plywood bulkheads, using the holes previously drilled. Use plenty of heavy thread and apply several coats of model airplane cement to the sewn area.

Repeat the identical procedure for bending and assembling the wing struts as was previously described for the landing gear. When installing the completed assembly it is most important that the upper portion, on which the wing rests, is at the proper angle.

The stabilizer, fin and rudder are constructed at this time. The former is built as a framework while the latter two are cut from soft sheet balsa.

Do not apply cement to the ribs and spar of the stabilizer. Lay the silk on the structure and press the edges against the cemented portions of the structure at the same time stretching it with the fingers to eliminate wrinkles. Repeat this procedure with the other side and, when both sides are covered, the excess silk can be carefully trimmed away with a razor blade.

Wet a wad of absorbent cotton and gently drag this over the silk covering until all of the silk is wet. This will shrink the silk. When dry, brush on two coats of clear dope.

Sand gently, and firmly cement the

covered stabilizer to the fuselage. Sandpaper the fin and rudder and hinge the fin to the rudder. The hinge is made by slipping the wire through the tubing and then bending it. Use strips of silk and cement to hold the tubing to the fin. The wire is pressed into the rudder and cemented with strips of silk over the attachment. Cement the fin to the fuselage and stabilizer at this time.

The escapement is installed next. This is screwed or bolted to a piece of thin plywood which is cemented to the bulkhead as the plans illustrate. The escapement is connected to the rudder via a "torque rod" made from balsa wood and wire. This must pass through a perfectly aligned tubing bushing at the fuselage rear and this is installed now. Cut the tubing to length and slip it through a hole drilled for this purpose. Apply plenty of cement to the forward end to secure the tube in place and reinforce this with "Plastic Wood." Bend the wire positions of the torque rod except for the front bend of the rear wire. Solder the forward wire into the hole in the slotted lever which is supplied with the escapement. Attach this to the escapement and then bind the wood portion of the torque rod to the front wire with thread. Slip the rear wire into the tube and then carefully bend the front end of the wire. Bind this to the wood rod and check the movement of the rear "U" bend of the torque rod. This must be vertical when the escapement is neutral. Smear plenty of cement over the thread binding.

A loop of  $\frac{1}{4}$ " flat brown rubber provides the motive power for the rudder escapement. This must be wound or checked after every flight of long duration. The rubber loop is wound from the rear of the fuselage with an inexpensive hand drill in which a wire hook has been fitted. The winding is accomplished via a square wood plug in the fuselage side at the rear and this plug is fitted with a wire winding loop.

The receiver plug socket should now be bolted in place after all the wiring has been soldered to it.

The fuel tank is a commercial item which can be purchased at any hobby shop. Cut the plywood tank pad

# NEW! Lafayette 50 Watt Complete Stereo Phono System



LAFAYETTE LA-250A

COMPLETE STEREO SYSTEM  
**184.50**

## COMPONENTS

LAFAYETTE LA-250A 50-WATT AMPLIFIER .....	99.50
NEW GE VR-22 (.7 MIL) DIAMOND STEREO CARTRIDGE ...	24.45
GARRARD RC 121/11 STEREO CHANGER .....	41.65
LAFAYETTE WOOD CHANGER BASE .....	3.95
2- LAFAYETTE SK-58 FAMOUS FREE EDGE .....	59.00
12" COAXIAL SPEAKERS @ 29.50 .....	

REGULAR CATALOG PRICE ~~228.95~~

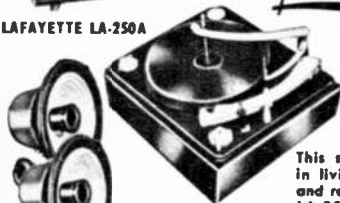

GARRARD RC121/11  
WOOD BASE



NEW GE  
VR-227



LAFAYETTE  
SK-58

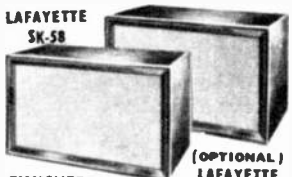

(OPTIONAL)  
LAFAYETTE  
ELIPTOFLEX

FINISHED  
ON 4-SIDES

**YOUR GUARANTEED BEST STEREO SYSTEM BUY!  
You Save 44.05**

This superb system will add a new dimension in living to your home with all the excitement and realism of a live concert. The new Lafayette LA-250A, 50-watt stereo amplifier (25 watts each channel) forms the heart of this outstanding stereo hi-fi phonograph music system—the features, versatility and advanced circuitry of this unit are second to none. Also included is the famous Garrard RC121/11 Intermix 4-speed automatic record changer with full manual or automatic operation supplied with your choice of stereo cartridges—the new GE VR-22 (.7 Mil) diamond stereo cartridge, Pickering 371-7D (.7 Mil) diamond stereo cartridge, Shure M7D (.7 Mil) diamond stereo cartridge or the new Electro-Voice 31 MD7 (.7 Mil) diamond stereo cartridge. Supplied with the Lafayette wood base cut for the RC121 in your choice of finishes. These outstanding components are coupled

with the 2 famous free edge Lafayette SK-58 12" Coaxial speakers with built-in crossover network and brilliance level control. System supplied with plugs, cables and simple instructions. Shpg. wt., 67 lbs.

**HF-670 HI-FI STEREO PHONO SYSTEM** with choice of cartridge and mahogany, walnut or blond changer base (please specify) 17.45 down 12.00 Monthly .....Net 184.50

**HF-671** Same as HF-670, but with 2 Lafayette Eliptoflex Series Bookshelf Enclosures (please specify finish). Shpg. wt., 143 lbs. 22.99 Down, 15.00 Monthly .....Net 247.50

**HF-675 Stereo AM-FM-Phono System.** Same as HF-670 but including the new Lafayette LT-50 stereo tuner. Shpg. wt., 85 lbs. 28.75 Down, 17.00 Monthly .....Net 299.50

# LAFAYETTE'S FREE CATALOG!

## 308 GIANT SIZED PAGES

The Complete Catalog Featuring  
"The Best Buys In The Business"



FOR THE NEWEST AND FINEST IN  
STEREOPHONIC HI-FI EQUIPMENT AND SYSTEMS

- TAPE RECORDERS ● PUBLIC ADDRESS SYSTEMS
- AMATEUR EQUIPMENT ● INDUSTRIAL SUPPLIES
- MINIATURE COMPONENTS ● RADIO & TV TUBES AND PARTS
- EXCLUSIVE LAFAYETTE TRANSISTOR & HI-FI KITS

Send for Lafayette's FREE Catalog—the most complete, up-to-the-minute electronic supply catalog crammed full of everything in electronics at our customary down-to-earth money-saving prices.

### Leaders in Hi-Fi

The most complete selection and largest stocks of hi-fi components and systems—available for immediate delivery at the lowest possible prices. Save even more on Lafayette endorsed "best-buy" complete systems.

NEW YORK  
100 SIXTH AVENUE  
NEW YORK 13, N. Y.

JAMAICA  
145-08 LIBERTY AVE.  
JAMAICA 33, N. Y.

BOSTON  
110 FEDERAL ST.  
BOSTON 10, MASS.

NEWARK  
24 CENTRAL AVE.  
NEWARK 2, N. J.

PLAINFIELD  
139 W. 2nd ST.  
PLAINFIELD, N. J.

**FREE!**  
308 GIANT  
SIZED PAGES

CUT OUT  
AND PASTE  
ON POST  
CARD

LAFAYETTE RADIO  
P.O. BOX 222  
JAMAICA 31, N. Y.  
DEPT. E1D-6

Name.....  
Address.....  
City..... Zone..... State.....



with coping saw and screw the tank to it, using small round head wood screws. File off the points of the screws as they protrude on the other side of the plywood. Attach flexible, transparent plastic tubing to the three tank connections. Lead the filling and overflow lines to a point above the top of the fuselage and the engine feed line through the hole in the plywood bulkhead. Be certain the latter is long enough to reach the engine fuel connection. Cement the tank plywood pad to the fuselage. Seal the fuel tank connections with tape to keep dust out of the tank.

The fuselage bottom is now covered with  $\frac{1}{16}$ " sheet balsa.

Use very soft sheet balsa for the fuselage top. Sandpaper the balsa well to reduce the thickness to about  $1/20$ ". Bend the wood to fit the shape of the fuselage top.

The three fuselage fairing strips are now cemented to each side of the fuselage and, when the cement is dry, they are covered with silk and treated the same as the stabilizer.

Cut the cowl rings "A," "B" and "C" from soft balsa wood. Cement them together under pressure of heavy books or flat iron. Round off the nose and sand the rest of the cowl smooth.

A hatch must be cut into the fuselage bottom to facilitate access to the receiver, batteries and escapement. Assemble the hatch as shown on the plans and do not forget to cement the stiffeners to it. Also note the grain direction. When this is complete use the hatch as a template to cut a hole in the fuselage bottom. Discard the piece cut out of the bottom and then reinforce the edge of the opening with strips of balsa. Use a strip of cotton fabric about  $\frac{3}{8}$ " wide to serve as a hinge for the hatch. Cement this to the hatch and bottom. A strip of clear cellophane tape can be used to hold the hatch in the closed position. This should be renewed often. The landing gear axle wing is optional. Wheels are held in place by a washer soldered to the axle.

The first step in wing construction is the spar assembly. Cement the four joiners to the three spar pieces and, while this is drying, the ribs can be cut

to shape. The wing is assembled in three panels on the single spar. Cut the plan and rearrange it to form one continuous wing drawing. Pin the center section ribs onto the plan in an upright position. Place the spar in the notches in the ribs. Hold in place with pins. Cut the leading edge to length and slip this into the rib slot. The trailing edge is notched as shown to fit the ribs. Apply cement to this structure and when dry remove the pins and lift the frame off the table. Now, lay one of the spar halves, left or right, onto the plans over the ribs for that wing panel and continue to assemble the structure as previously described for the center section. During this operation the other end of the spar will be in the air extending several inches above the table so be careful not to break it off by inadvertently pushing it. Repeat the process for the other wing panel. Add the wing tips and auxiliary spars at this time and recement all joints. When dry the trailing edge and wing tips should be carefully sanded to fit the wing ribs.

The upper surface of the wing forward of the spar is covered with sheet balsa as the plans indicate. This is accomplished in three separate installations; one for each wing panel. Cut the sheet balsa about one inch too long and cement it to the spar. Hold in place with straight pins until dry. Apply plenty of cement to the ribs and leading edge and then quickly press the balsa covering to them, again holding in place with straight pins until dry. Repeat this for all three panels. When the cement is thoroughly dry, remove the pins and carefully trim away the excess sheet balsa. Sandpaper the entire structure.

The wing is covered with silk in the same manner as previously described for the stabilizer. When covering it is important that the silk extends over the balsa covered leading surface up to the leading edge.

The entire model should receive a total of five coats of clear dope including all wood portions. Two additional coats of colored dope will provide a good appearance with a minimum of weight.

Place the engine in position on the mounting pad and mark off the bolt

holes. Drill through the pad and bulkhead and bolt the engine in place with steel bolts. Smear cement over the nuts in the fuselage interior to prevent them from loosening. Connect the fuel line and install the cowl with a few drops of cement. The selection of powerplant depends partly upon the skill of the builder. If the model is built with care, and therefore is light and clean, a powerful engine of .049 cubic inch displacement or a conventional .074 cubic inch powerplant can be installed. Purchase an engine which does not have an attached fuel tank. Carve the cowl interior to clear the engine.

The correct balance of the model is partly governed by the location of the batteries. It is suggested that the batteries be installed in commercial battery holders and the wiring should be soldered to these. The wing must be strapped in place firmly with rubber bands during the balancing procedure. When the correct balance has been obtained, the batteries and battery holders can be firmly installed by screwing them to plywood pads and then cementing these to the bulkheads. The radio receiver must also be in place when balancing. This can be installed in a number of ways, however the mounting must be completely vibration and shock-proof. One of the most popular methods of mounting the receiver is to strap it against a bulkhead with four rubber bands. A pad of foam rubber at least  $\frac{3}{4}$ " thick is located between the receiver and the bulkhead. Cement the rubber to the bulkhead. Hooks for the rubber bands must be provided on the bulkheads as shown. These are bent from thin music wire and firmly attached to the plywood bulkhead. The receiver wiring plugs into the socket previously fitted.

The model must be very carefully tested before powered flight is attempted. Once the model balances correctly it should be hand glided over tall soft grass. This is first accomplished by running into the wind holding the model by the fuselage at shoulder height, just behind the balance point and releasing it gently now and then to check its reactions. If all appears well it can then

be launched with a gentle and smooth push, aiming at a spot on the ground about forty feet away. Carefully observe the glide. These tests should be repeated many times until the glide is steady and flat. If the model zooms up and stalls; add a sliver of hard wood between the wing trailing edge and the wing mount. If the model tends to dive add the sliver under the leading edge of the wing. Modify the thickness of the silver as required by test glides.

The engine should be pointing downward about two degrees (downthrust) and to the right about one degree (right thrust to counteract torque) before powered flight is attempted. Inserting thin washers between the engine and the bulkhead can accomplish this adjustment on bulkhead mounted engines.

First flights should be conducted on a very calm day. Check the radio equipment thoroughly, even with the engine running. Once the engine is running smoothly the model can be hand launched into the wind, in the same manner as was used for test glides, with the rudder neutral. Do not try to control the model immediately. Allow it to climb to a safe altitude of at least fifty feet. When the engine finally stops try to maneuver the model so it will land while heading into the wind.

If the plane did not climb at all remove a slight amount of the downthrust; and if it tended to climb too sharply almost to the stalling point add a bit of downthrust. If the model controls appear too sensitive remove the rudder pin and replace it in a lower position. Reverse this procedure if the controls are not effective enough. ●

## How To Wire R-C Models

*Continued from page 44*

for additional voltages, such as bias, assign additional colors.

Plan the job. It will be found that planes, boats and cars are essentially similar. Always, there is the receiver, the battery supply and from one to perhaps, five actuators. What differs is the distances between compartments—to balance a boat, for example, may call

for moving the batteries a considerable distance from the receiver. Battery sizes vary vastly; a boat or a car has no weight problem and usually no space problem, so that big wet cells frequently can be used for long life and continuous running. Think of the system in terms of compartments or areas: batteries, the receiver, the actuator (s). Switches, jacks, pots, etc., are located for convenience—where you can use them without disassembling the model.

**Step One:** Study the manufacturer's schematic for hooking up the receiver. What batteries are required? And, therefore, how many pins should be on a plug, or soldering lugs on a socket? On his schematic, write in the colors you assign the necessary leads. How many jacks, sockets, etc., are required.

**Step Two:** Visualize your boat, plane, or car, and the positions of the various items of equipment. Make a sketch showing all required objects (this can be as crude as a cave dweller's painting of a prehistoric monster). Decide where you want to put such items as switches. Now draw in the various wires shown on the schematic. For example, starting with the red wire for B plus, it usually runs from the battery to a meter jack—sometimes through a switch as well, thence to the receiver. You will automatically note whether one or more wires go through a switch—you may need a double-pole single throw switch to cut or open two circuits.

**Step Three:** Install major items, such as escapements and servos. The beginner almost always now puts in place all switches, jacks, etc. This can be rough, for soldering will have to be done in cramped quarters.

The best procedure is to prepare the mounting holes, or supports for these items, but to leave the parts on the bench! Measure off the distances between these items and transfer the measurements to a two-dimensional pattern or diagram on a clean board. Using this pattern, you can cut all the correctly colored wires to their approximate lengths. Allow extra wire to reach any interior mounted item. By bending straight pins (cut off the heads) into small staples (like croquet hoops)

you can assemble all the wiring at once, like a harness. If the harness must go around corners, plan, then measure the "detours" and allow for them.

**Step Four:** Remove the staples, and place the harness in the model. Slide the jacks, switches, and pots (if any) through their respective holes and secure their locking nuts. Portions of the harness that must pass through partitions naturally cannot be soldered until they are threaded through previously prepared holes. Finally, the various loose ends that remain are led to appropriate terminals on actuators or a still-loose socket and are soldered.

The wiring harness, or individual wires, should not hang free inside the model. Use U-shaped bent-pins to hold the harness against walls, bulkheads or other convenient structural members. When the system is found to be working properly, place drops of glue to insure that the wires don't fall free again.

Installation of wiring is simplified if done early in the construction of the model, before the boat deck is finished, or before the top and bottom of the airplane fuselage is closed in.

On any model having an internal combustion engine for power, vibration must be guarded against. Wires usually break off at battery boxes, at the point of attachment to switches, etc., and almost never well out on the wire. Don't stretch wires tightly at the soldered joint but leave enough excess to form a small, pigtail which absorbs vibration. This pigtail may bend back to touch the model framework and, in such cases, can be glued down. Beneath sockets, wires should be pigtailed and, if practical, fastened to nearby structure.

Parallel wires, as from the receiver to plug, should always be twisted to form a cable. Wrap with a narrow piece of electrical tape close to the plug. To solder wires to the contact lugs on a socket inside the model, leave the wires extra long, insert them through the hole in which the socket will mount, solder them in place, then insert the plug. Any retaining rings, or rubber covers that go under sockets, or over plugs, will have to be slipped in place over the wires before the soldering is done. ●

## 15 Meters

Continued from page 89

him much good if he can't get his speed up. Experienced CW men find a slow sender tedious to work. No definite standard can be laid down in this respect, but 10 w.p.m. would be a good 15 meter minimum to shoot for.

The past four years, during which time 15 meters has really come into its own, has been a period of high sunspot activity, and sunspots mean a high MUF. But this count is now dropping and will continue to drop until approximately 1965. As this happens, 15 will become less effective for DX. Openings will be short, dead periods will last for days, or even weeks.

This band has a second drawback. Most hams are ordinary guys who work eight hours a day for a living. Unfortunately, the 15 meter band is most often open during the working day. While this has nothing to do with radio technique, it certainly is a factor for many amateurs.

The 15 meter band was once the champion TVI (television interference) band. Remember the old TV sets? Do you recall what the IF (intermediate frequencies) were? That's right, 21 mc! Amateurs transmitting on the 15 meter band, extending from 21 to 21.45 mc, could hardly help but raise havoc on TV sets. This is no longer the case since the television set manufacturers long ago switched their IF sections to 41 mc, safely out of the amateur bands. Now, except for a few older TV sets still operating, the ham on 15 meters doesn't have to worry too much about TVI, providing he observes the rudiments of good transmitting practice. ☉

## Numbers Game

Continued from page 83

not used, chance contacts made in searching for the right combination would sometimes trigger a change without the proper combination actually being achieved.

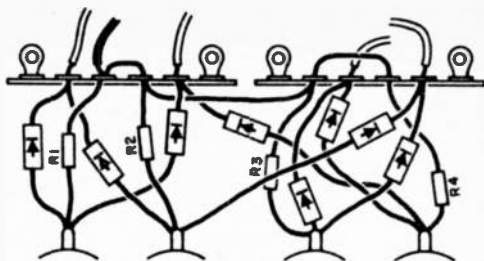

Detail of the wiring of the diodes to the terminal posts. See page 82 for overall view.

## Construction Details

The top panel board can be plywood, Masonite hardboard, Bakelite, or other insulating material. It is about 8x14 inches. Three circles are scribed to a suitable diameter and eight equally spaced holes drilled around the circumference of each. A brass 8-32 bolt with the head flattened is inserted into each hole. The holes can be tapped to receive these bolts, or nuts and lock washers can be used to secure them on the under side of the panel. Solder lugs can be slipped under the washers at the same time to facilitate wiring. The switch arm holes are drilled in the center of each circle. The switch arms are phosphor bronze.

**"WATCH FOR BIG SURPRISE  
IN JUNE EI"**

They are pointed at one end, and a hole is drilled in the center of each. Fiber rods about 1" long by  $\frac{3}{8}$ " diameter are drilled lengthwise through their centers and the holes are countersunk at one end. These fiber sleeves are then glued to the switch arms, taking care to line up the holes. The countersunk ends of the sleeves should be up. The switch arm assemblies are then lined up over the pivot point holes in the top panel and bolts are inserted through the fiber sleeves and panel. On the bottom of the panel a washer is placed over each pivot bolt, followed by a short coil spring, and is locked using two nuts. This construction permits the switch arms to be easily rotated and still maintain good contact while riding over the bolt heads.

Panel switch wiring is straightforward. The box should be about 3½" deep. The neon lamps must be mounted so that they will be close to the top panel, just beneath the lamp holes.

After affixing the top panel, a transparent Plexiglas panel is mounted ⅜ to ½ inch above it. This completely covers the switch parts to prevent the possibility of slight shocks. Clearance holes in the plexiglas permit the switch handles to stick through.

## A Novice Ham

*Continued from page 50*

its socket, then the power transformer should be checked. If the plates of the rectifier glow red, you may have a shorted filter capacitor.

Should all this tapping and testing turn up nothing but a cluster of good tubes, you have at least established that the AC power supply, as well as the filament transformer providing voltage to the tubes, are operating properly.

After noticing lack of grid drive, Vince, KN9RDV, discovered his oscillator wasn't working. He switched crystals and found that the rig loaded normally again. A crystal crack can develop from a number of electrical reasons, but a common cause of failure is rough handling or dropping it on the floor.

If the plate current reading is too high, the trouble may be a defective component in the plate tank, or perhaps a grounded or open connection in the antenna. A quick way you can check your antenna is with an incandescent lamp bulb of approximately the same wattage as the input to the final stage of the rig. The bulb is wired to the transmitter's output. If this "dummy load" lights and the rig tunes as usual, reconnect your antenna and look for a broken connection or an unsoldered wire.

If the plate current meter acts like a Mexican jumping bean when holding down the key, perhaps the contacts of the band switch are dirty and sticky. A little housecleaning with a few drops of carbon tetrachloride or a commercial liquid cleaner will generally solve the

problem. Another cause of a signal cutting in and out might be a dirty key or an open lead. If you use carbon tet, be sure the room is well ventilated.

A small neon bulb or a flashlight bulb on a loop of insulated wire is all you need for another test which may help pin down the trouble. If the bulb lights when you hold it near the plate tank of the oscillator, you know RF (radio frequency) is present, and you can move on to the buffer stage and finally the plate tank itself to check for output. Hold the glass portion of the bulb and watch out for exposed voltages. Another simple way to make sure the oscillator is operating is to listen for its signal on your receiver.

At this point it certainly won't hurt to glance over the smaller components for traces of carbon or other signs of high voltage arcs. Discolored bands of red, green, or yellow on a resistor, or tiny bubbles on its surface show it was overheated. Although, as we indicated earlier, a discolored resistor may be perfectly okay, a definitely *bad* resistor usually goes hand in hand with a defective capacitor or a nearby shorted tube.

If all this patient peering and checking hasn't turned up a thing that looks suspicious, it's time for a cup of coffee, a look at TV, or to take a walk.

There are now two things left to do. You can either join the Turn-It-On-And-Wait-For-Smoke school, or you can invest in a volt-ohmmeter. Following smoke signals may be effective, but it's not too practical unless you want to replace half the parts in the transmitter instead of one or two. Besides that, a volt-ohmmeter is a darn handy piece of gear to have around the shack. Available from \$14 up, you're sure to find the meter well worth the investment. Most hams agree that a 20,000 ohms-per-volt model will give the best service.

Filter capacitors can retain charges big enough to set you back on your heels, even when the line cord is disconnected and the transmitter is without power. So both meter and master will be safer if an insulated screw-driver is used to discharge these capacitors to chassis ground before anything else is done.



Measuring the voltages on the plates and screens of the tubes must be done with the power on, but don't make a move with the positive lead of the meter until the negative lead is grounded to the chassis. Then keep your paws in the clear and let the probes take the tickles.

If you have reason to suspect that a resistor is open or a capacitor shorted, you can use the volt-ohmmeter to check each one. By following the schematic slowly and carefully, you can be sure not to miss any in the suspicious stage. This testing is done with the power off, but again you will be wise to discharge any "sleeping" charges in the capacitors before getting started. To be absolutely certain you are checking only one component at a time, unfasten one end of each resistor or capacitor and then *remember to resolder* it when you're through.

If, after checking, tapping, and testing everything you can think of, the rig is still out of whack, don't rip your ham ticket to shreds. Just call another ham—(via telephone, if necessary), one who's been through this particular mill himself. Don't ever be ashamed to holler "Uncle." After all, there'll be a "next time," and maybe then you can shoot your own trouble. Better still, you can help another Novice in need. ●

### Push-Button Garage Doors

*Continued from page 35*

door opening (and closing) involves nothing more strenuous than pushing a button. The button—usually on a car's dash—triggers an under-hood transmitter whose crystal-stabilized frequency (typically 27.255 mc, tone-modulated by 5 kc) reaches a few hundred feet. Picked up by a receiver (often mounted inside the garage), the signal actuates a motor ( $\frac{1}{3}$  to  $\frac{1}{2}$  hp) which opens the door while the driver is still snug behind the wheel.

Such reasonable convenience (transmitter, receiver and opener are priced under \$200) has become a common household gadget and is no longer considered a luxury.

Hundreds of apartment building

owners now radio-control their garage doors—installing a transmitter (cost: \$30-\$50) in every tenant's car. Many an industrial door is pushbutton actuated, for safety's sake and to take the load off air-conditioning (open warehouse doors let in warm air).

Electronic door opening's potential is still larger yet. One of the Millers' fire house jobs ran to three figures. Automated, too, are the heavy, lead-lined doors of hospital X-ray rooms.

Many a plant radio-controls its loading dock to thwart pilferage. Fork-lift trucks also have transmitters installed. Without stepping from his lift, a warehouseman can open and close a dozen doors.

Business pours in for the Millers—as it can for you—via architects who specify electronic doors in their plans, builders who call the Millers in as subcontractors, and small ads in the phone book's classified section.

## "WATCH FOR BIG SURPRISE IN JUNE EI"

Explains Dick, "Most jobs are bid through contractors or builders. Only about 25 percent come through somebody seeing our ad in the phone book."

Whatever your choice—direct or contract selling—you've got to start as did the Millers. You must stake out an operational domain. The Millers' domain is a wide residential-commercial area in West Los Angeles where \$20,000-up homes—the likeliest door-opening candidates—predominate. Industry is also booming. Hilly terrain makes parking to open the garage door hazardous. Architects and builders are eager to automate homes and plants with new electronic ideas.

Having staked their operational hub, the Millers wrote to several manufacturers of electronic door openers—among them Scientific Products, Inc., Detroit (whose radio-controlled "operator" includes a safety clutch to prevent doors from closing on moppets or the family fido); Multi-Products Co., Oak Park, Mich. (which makes a low-cost,

transistorized transmitter that clips to a car's sun visor); and Door Masters, Inc., Santa Monica, Calif. (whose self-locking unit opens-closes via a friction roller).

"Overnight," grins Bob, "we found ourselves a distributor for Scientific Products—without putting up a penny."

Nor, in fact, did the Millers have to agree to buy a specific number of units, though it was to their advantage to buy as many as possible because their discount increases when, for example, they buy six units (discount 40-50%) rather than two (25% discount).

On a typical \$300 residential installation, the Millers figure to net \$50-\$100. Profits, though, don't end with the installing. Whenever a homeowner buys a new car, the transmitter must be removed from the old, installed in the new (job: \$10).

With three half-ton pickups and a modest \$60-a-month office, the Millers take turns in the shop (outfitted with \$2000 worth of electronic test gear) and may, in a week's time, service, install and repair as many as 50 openers.

"Right now," says Bob happily, "we're expanding. We're looking for dealers, guys who'd like to get either into the retail or service end of door automation."

Either way, you'll find every garage door owner and many a factory a hot prospect. •

## Radiation Monitor

Continued from page 56

pin emerging from one end of the G-M tube can be slipped into a  $\frac{1}{16}$ " hole drilled in a 6-32 machine screw brought through the circuit board and a nut is tightened down against it. A small metal clip from a broken 7-pin tube socket may also be used for the anode connector. The earphone snaps into a hole of the correct size in the circuit board.

All the other components are soldered to metal eyelets inserted in the punched board. To conserve depth nothing protrudes from the back of the board. All wiring is done on the component side and the machine screws used are flat-

head and countersunk. All the rest of the wiring may be point-to-point. Be careful not to overheat any of the components while soldering and always use a heat sink when soldering transistors.

With wiring completed, several small holes are drilled in the plastic box opposite the earphone position and a larger hole is drilled in one end to accept the pushbutton switch shaft. Slip the circuit assembly into the box and a retaining nut on the switch shaft will hold everything in position.

Hold the box to your ear and press the switch and you should faintly hear the 300-cycle note of the power supply. Soon you'll hear a loud, sharp click indicating that a *gamma* particle has entered the G-M tube. This so-called background count is irregularly spaced with several clicks sometimes coming almost too fast to count and then one or two at a time spasmodically. The background count will vary by time and regions. Some of the radiation is coming from outer space and some is produced by man. Hold a watch or clock with a luminous dial close to the G-M tube and the clicks will really rattle.

After you've found that the monitor is working satisfactorily, the chassis should be removed from the case. Protect the switch, earphone, battery snaps and the strap across the G-M tube and thoroughly spray both sides with transparent insulating lacquer. This prevents high-voltage leakage if the chassis becomes moist or dirty and adds greatly to the unit's dependability.

For a while you'll probably check radiation intensity several times daily and may even use it to check for the presence of uranium in some interesting looking rocks. The battery will last for a long time even under conditions of frequent use. It's a good idea to keep a fresh battery on hand, however, because you never know when you'll need it. •

## New All-Purpose Recorder

Continued from page 61

surface of the thermoplastic into ripples, which are cooled immediately and frozen onto the film.

To erase the film the thermoplastic is re-heated to a viscous liquid at which point the charges leak off causing the surface tension on the face of the film to smooth out to its original form. The film is now reusable.

How are these ripples converted back into sound or picture? In a standard projector a plane light source is formed into a beam by a condensing lens. This beam, in passing through a film of varying density, becomes shaded by the denser areas of the film. This shadow picture is then focused on a screen by means of the projection lens.

In TPR, the light source is converted into a series of parallel beams by means of a grating. By placing another grating ahead of the projection lens and by aligning the two gratings so that the beams are focused onto the bars of the second grating by the condensing lens, the screen remains black.

But when a rippled surface is placed in front of the condensing lens, some of the rays are bent slightly so that they now pass through the bars of the second grating instead of hitting them. The grating bars act like a variable shutter which allows light to pass through to the screen whenever the film has ripples. The result is a black-and-white picture from a perfectly transparent, but rippled, piece of film.

For color pictures, the ripples on the film act like many tiny prisms. That is, the ripples split up the white light into the three primary colors. The slots between the bars are made small enough so that only one of the primary colors can pass through. These bars therefore make up a subtractive system, cutting out those components which are not needed at a particular point on the screen. But since most color images we see are really combinations of two or more of the primary colors, it is possible for each of the components to get through the bars as needed, and then to recombine additively on the screen. The grating system is sort of a super traffic cop, permitting just the right amount of each primary color to get through to its proper place on the screen.

Hi-fi sound signals or video informa-

tion can be reproduced through an electronic system rather than an optical one. The modulated light beam is simply converted to an electronic signal by standard photoelectric techniques similar to those used in TV cameras and sound heads of film projectors.

What about fidelity? Well, with a track 1/10 inch wide (which is about the same as half-track magnetic audio tape), and an operating speed of 5 inches per second (which is slower than the 7½ ips used on most home tape recorders), the system checks out as having a *bandwidth and resolution better than that needed for video recording!* This is super hi-fi.

Possible applications are plentiful. Somewhat like microfilm, TPR could store entire libraries of books, drawings or business records. Since it can record information in digital form, it can control the operation of automated machinery and guided missiles.

**"WATCH FOR BIG SURPRISE  
IN JUNE E!"**

For defense applications, it is possible to modify the display so that certain parts of the projected picture can be highlighted and others toned down. This could be most useful in the display of radar information, where targets could be emphasized and the background minimized. And it will now be possible to record intercepted enemy radar signals, which has previously been impossible because of the bandwidth limitations of existing equipment.

Integrated displays of information from various sources can be shown simultaneously and compared. In airborne anti-submarine warfare, for example, an operator could see all at once the outputs of a number of sensing devices, such as radar, sonar, infrared, and other detecting and tracking inputs.

These are just a few of the many potential applications of this amazing new tool that combines the best features of tape and film and improves on them for good measure. ●

## Sferics Station

*Continued from page 105*

Atlantic is recorded and translated into usable information.

In a small building at Pepperell Air Force Base, Newfoundland, a static direction finder (SDF) is reacting to the storm, picking up the static. The SDF consists of at least one pair of crossed loop antennas, identical amplifiers, a cathode ray tube indicator and a photographic recorder. The electromagnetic waves caused by the lightning ultimately appear as flashes on the cathode ray screen. A camera, operating without a shutter and with a continuous reel of film, records these flashes.

A single station cannot determine the distance of a static discharge, since there is no ranging equipment. At the precise moment the static is recorded at one station, similar instruments at four other sferics stations in the Atlantic Net are making recordings, timed to within 1/100 of a second of each other by signals from WWV.

The films of the sferics discharges made at all the stations are quickly developed and the strength and azimuth of the flashes are computed at the slave stations. This information is then transmitted to the master station. There the azimuths are plotted to a point of intersection. This is called triangulation.

The operation of all three sferics nets is essentially the same. In the Summer of 1959, however, automatic telemetering equipment was installed at the stations of the Tornado Net. This enables the signals received at the slave stations to be piped into the net control station in Kansas City for automatic plotting and fix determination. This net is designed to provide the population of the Great Plains area with maximum advance warning of tornado activity.

Sferics discharges can be fixed with reasonable accuracy up to about 2000 miles. In addition to the Air Force's work with sferics, the British maintain a network in England. The Swiss used sferics for meteorological data when they were isolated from the rest of Europe during World War II.

The chief value of sferics tracking is in obtaining data from areas where there is otherwise a lack of adequate weather information—such as over the vast ocean stretches. It is a valuable adjunct to regular ship and aircraft reports and meteorologists hope that, in time, there will be enough sferics networks in operation so that static discharges anywhere on earth will be detected and pinpointed almost immediately. ●

## Improve Sound of Small Phono

*Continued from page 47*

the many currently available on the market. A baffle can be easily constructed from plywood or purchased for a nominal sum.

Referring to diagram Fig. 1, coupling capacitor (C1) can be replaced with a larger unit to extend low-frequency response. In most small record players C1 is about .002 mfd. Replace it with a .05 mfd., 400 volt, paper capacitor.

If the output tube (V2 in Fig. 1) uses a cathode bypass capacitor (C2), you can add a degree of inverse feedback to improve frequency response and lower distortion, by simply removing the ca-

### "WATCH FOR BIG SURPRISE IN JUNE E!"

pacitor! When you have removed the cathode resistor's bypass capacitor (C2) you will find that you have lost a little volume, but the reproduction should be noticeably clearer.

If your amplifier has enough gain, you can add more inverse feedback by connecting a fixed resistor from the plate of V2 to the plate of V1, as shown. Try a 750,000 ohm 1 watt resistor (the writer often uses 500,000 ohms here). The smaller the value the greater the feedback. If you add the feedback resistor remove the output tube's plate bypass capacitor (C3), otherwise you will have too great a cut in high-frequency response. In some cases, adding the feedback resistor from the plate of V2 to the plate of V1 will result in feeding too much AC hum to the grid of V2, and in that case you have to omit the feedback resistor altogether. ●

## Build-It Course—8

Continued from page 101

ground to about 12 megacycles. For higher frequencies, *overtone* operation is used.

Crystals designed for overtone operation oscillate in layers. They produce waves of a fundamental frequency and multiples of it. The Citizens Band rig described here uses the third overtone.

It's a good idea to closely follow the model shown in the illustrations during construction. The dimensions of the perforated board should be the same as those given in the parts list. The various assemblies were carefully sized so they would fit into the metal cabinet with no difficulty. Don't permanently mount any of the sub-assemblies until they've all been built.

The parts list suggests no specific crystal frequency, the choice being left to the builder. Part 19 of the FCC's rules lists all of the Class D CB frequencies. Be certain that the selected crystal is designed specifically for use in this band and has a tolerance of .005%. Inexpensive surplus crystals will not work properly and could cause off-frequency operation.

The output coil (L5) is a commercially available item, though slightly modified. It is a B&W unit with sufficient turns removed from it to leave an 11-turn section. Leave two 1/2-inch leads protruding from the ends of the coil for mounting purposes. These wires are soldered to the tabs of capacitors C15 and C16. Once this is done, bend the coil away from the perforated board about 1/4-inch to prevent the coil turns from shorting out against other wires.

The various input and output connections to this sub-assembly are made to flea clips inserted at the points shown in the diagrams. The clips may be eliminated, if desired, by looping the wire after it has passed through a hole in the perforated board.

Tune-up of the RF oscillator-amplifier will be described in the final article of this series since the power supply and modulator (next month) must first be completed.

 **YOU NEED THIS**

# FREE GIANT 1960 B-A CATALOG



**204 KING-SIZED PAGES**

**EVERYTHING IN RADIO TV AND ELECTRONICS**

**100'S OF NEW ITEMS LISTED HERE FOR 1st TIME**

**21 PAGES OF BARGAINS NOT IN ANY OTHER CATALOG**

**BURSTEIN-APPLEBEE CO.**  
Dept. EI, 1012 McGee St., Kansas City 6, Mo.  
 Send Free 1960 B-A Catalog No. 601.

Name \_\_\_\_\_  
Address \_\_\_\_\_  
City \_\_\_\_\_ State \_\_\_\_\_

**SEND FOR IT TODAY**

## CUT HOLES IN 1-1/2 MINUTES

(OR LESS)

with Greenlee Chassis Punches



Many sizes . . . quickly make smooth, accurate holes in metal, hard rubber, or plastics . . . for sockets, plugs, controls, meters, panel lights, etc. Easy to use, simply turn with a wrench. Write today for free literature.



**GREENLEE TOOL CO.**

1783 Columbia Avenue, Rockford, Ill.

**GREENLEE**

## Radiation Hazard

*Continued from page 53*

can cause this triple-threat damage are nuclear warfare, testing of nuclear weapons, radioactive wastes, accidental leakage or destruction of an atomic power plant, careless handling of radioisotopes in industry, X-ray machines, and high-voltage, projection-type TV.

If you are exposed to beta particles, which do not have great penetrating power, the damage is generally confined to your skin.

Alpha particles have no damaging effect on the skin and are only considered dangerous when taken internally.

In contrast, gamma rays are extremely penetrating. If the whole body is exposed to gamma rays, then the aftereffects may be anything from a weary feeling to death if the dose is large enough.

Man is more sensitive to radiation than most other animals, and embryo tissue is the most sensitive. Many of the pregnant women caught in the Hiroshima and Nagasaki atom bomb blasts tragically gave birth to mongoloid idiots and otherwise defective babies.

Since only a comparatively small number of people actually work with radioactive materials, there isn't too much of a threat to the general population from this direction. Assuming that there are no atomic wars, the second biggest danger comes from X-ray machines. Thousands upon thousands of X-ray machines are in use in hospitals, doctors' and dentists' offices and in industry.

In general, doctors and X-ray technicians are learning to limit X-rays to that part of the body under examination, taking care not to expose the rest of the body, particularly the reproductive organs, to possibly harmful rays.

Industrial X-ray machines used to check castings and other parts are almost always safe, and are kept that way by insurance companies and unions.

Since X-rays are generated by directing high-voltage electron beams at targets, any device that operates by high voltage is a potential source of X-rays.

So far we have shown what can happen to living tissue if it is exposed to *outside* radiation. If the radiation material ever gets into the body, the situation is much worse. Back in the early 1920's, a watch factory in New Jersey employed young girls to paint the hands and numerals of watches and clocks with radium. To keep the brushes pointed, the girls repeatedly wet the tips with their lips, each time swallowing a tiny bit of radium. Eventually, nearly all of the girls developed cancer of the bones, and many of them died as a result.

If the body is given an opportunity to heal between exposures to outside radiation, particularly if the doses are small, it can stand an awful lot of radiation over a long time. As a result, the authorities have been able to set maximum limits of daily exposure for workers handling radiation. As long as the safety limits are not bypassed, there is very little chance of illness or damage to body tissues.

Unfortunately, there are no safety limits or "threshold" levels for genetic damage. Even the slightest X-ray or gamma-ray exposure produces some damage to the chromosomes or heredity bearing parts. This damage or rearrangement of the chromosomes produces the strong possibility of mutations, or sudden changes, in the children of those exposed. Unfortunately, the overwhelming majority of such mutations appear to be undesirable.

And, of course, fallout from earlier nuclear tests is still raining down on us and our food supply. Several experts have predicted a steady increase in leukemia, cancer of the blood, among infants due to strontium-90 fallout showing up in milk fed to babies.

In the coming decades one of the great possible sources of undesirable radiation will be radioactive wastes. These wastes consist of used atomic fuels and residues left over in making new fuel elements. Even though these wastes are not concentrated enough to be used as atomic fuels, they can be dangerous to mankind.

There have been four suggested ways to get rid of the dangerous wastes: Stor-

age in underground tanks; burial in abandoned mines, dry oil wells, quarries, or caves; dumping on the ice caps or the uninhabited regions of permafrost; burial in drums in stagnant ocean deeps or deep sea muds and; shooting the wastes into outer space via rockets.

So far, the first is the commonest method in the United States. Even at the present beginning stages of atomic energy, the Federal Government has spent \$75,000,000 for storage tanks for radioactive wastes. As soon as atomic energy goes into high gear, storage tanks will cost too much to handle the volume.

Since the second atomic bomb was dropped on Nagasaki 15 years ago, no atomic weapons have been fired in anger. But by 1970 there is every reason to believe that any industrialized nation will be able to make and use nuclear weapons.

All this means that here is a much greater chance of nuclear war. Even if America manages to stay out of some strangely localized atomic war, the fall-

out is sure to reach the United States. The Office of Civil Defense and Mobilization has recommended that every home be equipped with a small radiation detector, such as the one on page 54.

In the next few years, the more immediate atomic danger is from testing. Even if the present tenuous agreement banning nuclear tests is formalized and extended, some smaller nation not a party to the ban will want to try out its noisy new toy.

Atomic power plants offer little radiation danger. Since their atomic fuel is not in concentrated, compact form as in a bomb, atomic power or research reactors are unlikely to explode like a bomb. If all the numerous safety devices on a reactor failed, it would most likely melt down like a candle before it would explode.

Leakage is a more likely possibility and this would soon set off alarms that would shut down the plant until the leak was plugged.

The greatest deterrent to radiation

## TUBE REPLACEMENT GUIDE

EVERYONE who uses vacuum tubes NEEDS this new 1960 Expanded Edition TUBE GUIDE.

Contains over 2700 substitutes for over 1500 tubes, including radio & TV receiving tubes, tubes used in Hi-Fi & Stereo, foreign tubes and TV picture tubes.

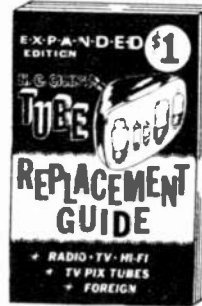

All tubes suggested for substitution have characteristics similar to those they are to replace, FIT INTO SAME SOCKET & NEED NO WIRING CHANGE.

Two chapters cover complete listing of TV Pix tube replacements including newest 110° tubes.

Substitutes given for over 225 foreign tubes. Last chapter lists transistor substitutes. The only complete GUIDE featuring all

receiving tube substitutions WITHOUT SOCKET CHANGING OR REWIRING. This valuable book will save you TIME & MONEY and permit operation of your set even though original tubes are unobtainable.

Guaranteed Money Back in 5 Days if Not Satisfied

\$1 Post-paid

RUSH COUPON NOW!

M. G. CISIM, Consulting Engineer—Dept. E1-14  
Amagansett, N. Y.

Enclosed find \$1. Rush TUBE REPLACEMENT GUIDE.

Name \_\_\_\_\_

Address \_\_\_\_\_

City \_\_\_\_\_

Zone \_\_\_\_\_ State \_\_\_\_\_

"WATCH FOR BIG SURPRISE IN JUNE E!"

Read America's

# LIVELIEST

How-To-Do Magazine!

GUTSY new-car tests by the famous Tom McCchill

INGENIOUS money-making ideas by men who cashed in on them

SPRIGHTLY, homespun tips for hunters and fishermen

EXCITING home workshop projects by the top men in the business

PLUS

Dozens of other LIVE.Y features

## MECHANIX ILLUSTRATED

25¢ At All Newsstands

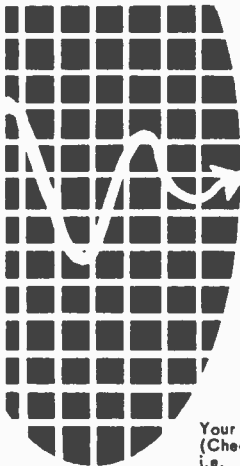

## ELECTRONICS ILLUSTRATED

Classified Ads

Your advertisement can reach this mail-buying audience for only 35¢ per word . . . payable in advance (Check or M.O. please) . . . minimum 10 words. Closing dates are the 20th of 3rd preceding month i.e. copy for the July issue must be in our office by April 20th. Mail to ELECTRONICS ILLUSTRATED, 67 West 44th St., New York 36, N. Y. Word count: Zone number free. Figure one word: Name of state (New Jersey), name of city (New York); sets of characters as in key (14-D); also abbreviations as 35MM, 8x10, D.C., A.C.

### SAVE MONEY • ORDER BY MAIL

#### • • • FOR SALE

**MONEY SAVING** Prices on tubes, TV, Radio, Transmitting and Industrial Types. New, 1st quality, guaranteed. Top name brands only. Government surplus and commercial test, lab and communications equipment in stock. Sell us your excess tubes and equipment. Unused, clean tubes of all types wanted. Send specific details in first letter. Write for "Green Sheet" catalog—25¢. Barry Electronics Corp., 512 Broadway, (Dept. E1.), WA 5-7000, New York 12, N. Y.

**GOVERNMENT SELLS:** Surplus Electronics; Test Equipment; Oscilloscopes; Transceivers; Jeeps; Boats; Aircrafts; Misc.—Send for U. S. Depot Directory & Procedure \$1.00. "Government Surplus Sales," Box 425-EL, Nanuet, N. Y.

**BUY WHOLESALE.** Catalog 50¢, refundable. P. H. Tracy Co., Box 4453-E5, Lincoln 4, Nebr.

#### • • • EMPLOYMENT OPPORTUNITIES

**PRINTING - ADVERTISING SALESMEN.** Excellent moneymaking sideline selling Decalomania Name Plates. Advertising Specialties. Sign letters, Automobile initials. Free Samples. "Ralco"—El, Box L, Boston 19, Mass.

#### • • • BUSINESS OPPORTUNITIES

**GROW MUSHROOMS.** Cellar, shed and outdoors. Spare, full time, year round. We pay \$4.50 lb. dried. We have 29,000 customers. Free Book. Mushrooms, Dept. 315, 2954 Admiral Way, Seattle, Wash.

**WHOLESALE IMPORTS.** 200 free Japanese, European sources; complete, \$2.00. Mashburns' Importico, Box 202, Asheville, N. C.

**VENDING MACHINES—**No selling. Operate a route of coin machines and earn high profits. 32-page catalog free! Parkway Machine Corp., Dept. 33, 715 Ensor St., Baltimore 2, Md.

#### • • • HI-FI

**UNUSUAL BUDGET** Values. Tape recorders, tapes and Hi-Fi components. Send for package quotations and free catalogue. Budget Hi-Fi Distributors, 83-06 Victor Ave., Elmhurst, N. Y.

**PHONOGRAPH RECORDS** cheap, post-paid, Catalogue. Paramount, Box 2026-K, Pine Castle, Florida.

#### • • • TAPE RECORDERS

**TAPE RECORDERS,** Hi-Fi components, Sleep Learning Equipment, tapes. Unusual values. Free catalog. Dressner 69-02 Z 174 St., Flushing 65, N. Y.

**HI-FI, RECORDERS.** Free Wholesale Catalogue. Carston, 125-G East 88, N. Y. C. 28.

#### • • • RADIO & TV

**10 DISTANCE CRYSTAL** set plans—25¢; 20 different 50¢, with Transistor experiments, catalog. Laboratories, 1131-K Valota, Redwood City, California.

**DIAGRAMS FOR** repairing radios, amplifiers, \$1.00; television \$2.00. Give make, model. Diagram Service, Box 672-El, Hartford 1, Conn.

**NEW BOOK (Mobile Hi-Fi) Tape** Recorders, Stereo, F-M, etc. \$5.00. Ekaradio, 650 N. Fair Oaks, Pasadena, California.

**KITS EXPERTLY** Wired And Calibrated. Specialty Is Instruments. 3971 Austin Drive, Cincinnati 30, Ohio.

#### • • • ELECTRICAL SUPPLIES & EQUIPMENT

**POLYSTYRENE FEEDER** Line Spreaders,  $\frac{3}{8}$ "x $\frac{1}{2}$ "x6" — .05¢. Sparks, Box 476, Gainesville, Texas.

#### • • • MISCELLANEOUS

**IDENTIFY YOUR** equipment. 50 decal transfers \$1.00. 3 lines. A&B Services, Box 147A Kittery, Maine.

#### • • • PERSONAL

**LOANS BY** Mail. \$50 To \$600 For Any Purpose. Employed men and women eligible. Confidential. 2 years to repay. Write for free loan application. American Loan Plan, City National Bldg., Dept. EL-3150, Omaha 2, Nebraska.

#### • • • STAMPS & COINS

**THREE BRILLIANT** uncirculated Mexican silver dollars \$1.00. Universal Services, Box 675, San Antonio 6-P4, Texas.

#### • • • DETECTIVES

**DETECTIVES—WORK** Home—Travel. Experience unnecessary. Detective Particulars free. Write, Wagner, B-125 West 86th, New York 24.

#### • • • MUSIC

**ACCORDIONS—SAVINGS** to 50%. Free trial. Trades accepted. Free catalog. Accordion Manufacturers, Dept. 40-EL, 2003 Chicago, Chicago 22.

**SONGPOEMS AND** Lyrics Wanted! Mail to: Tin Pan Alley, Inc., 1650 Broadway, New York 19, N. Y.



damage is a well-informed general public. Proper control of radiation, one of mankind's greatest blessings in disguise, costs money and effort. It's up to you to make sure that time and effort is spent to protect you, your family and the next generation.

## Sun Powered Radio

Continued from page 91

(variable capacitor and loopstick), selectivity is poor on strong stations that are within a few kilocycles of each other. This effect can be minimized somewhat by rotating the set so the loopstick favors the selected station. Unplugging the external antenna also reduces the strength of an overlapping station.

The building of the Sunflex receiver takes about six hours. In type, its construction falls somewhere between a printed circuit board and point-to-point wiring. Nineteen "flea clips" are pressed into holes in a perforated board and components are soldered to them.

Solder tends to flow from one end of the clip to the other. This should be prevented by using a minimum amount of solder on these joints. Otherwise, you'll find it difficult to slide the transistors and diode into the clips that have leads connected to their opposite ends. If this does happen, grasp the transistor lead with a long-nose pliers, heat the clip and slide the lead into it. Hold the pliers firmly on the lead until the joint cools, to prevent damage to the transistor.

The KT-132 can be considered a Good Buy—if the novelty of "free power from the sun" is especially attractive to you. It's an item guaranteed to evoke plenty of "ooh's" and "ah's" from friends: just wave a hand over the solar cell and the radio "magically" goes on and off, proving that Old Sol is the actual source of power. But remember, penlite batteries, with no assist from solar cells give long hours of playing time.

Price of the KT-132 is \$11.95. The solar battery is a separate catalog item (MS-240) that sells for \$7.75.

# MICRO

ELECTRON TUBE

INTRODUCES FOR THE FIRST TIME  
ANYWHERE A SELECT STOCK OF USED  
TUBES AT A FABULOUS LOW PRICE

# 37

ea.

FOR any TUBE LISTED

**\$35 PER HUNDRED ASSTD.**

ALL TUBES SENT POSTAGE PAID  
Please send 25c handling for orders under \$5. Send 25% deposit on C.O.D. orders. Send approximate postage on Canadian and foreign orders.

# MICRO

ELECTRON TUBE CO. Dept. EI-4, P. O. Box 55 Park Sta., Paterson 3, N. J.

- Each and every tube is tested in our own laboratory for mutual conductance and life test.
- We guarantee FREE replacement for one year of any tube purchased from us which fails to function efficiently under any or all operating conditions. Prompt refunds are made on any defective merchandise.
- The advertised tubes are not necessarily new, but may be electrically perfect factory seconds or used tubes—each is clearly so marked.

6A2	5X8	6BH6	6SF8	7Z4	1966G
6A2A	5Y3GT	6B7G	6SF7	12A5	1916
1A7GT	5Y4G	6B7E	6SJ7	12A5S	1976
1B3GT	6A5	6B7F	6SL7	12A7	24A
1W4G	6A6	6B7GT	6SL7GT	12A7G	25A5
1W5GT	6A8A	6B8	6SN7GT	12A8	25BQ
1L4	6A7	6B9	6SQ7	12A9	25D6
1L6	6A7A	6B9GT	6ST	12AV	25G0T
1L8	6A8	6C0	6S7	12AU7	25W4GT
1Q6GT	6A8T	6C1	6T4	12AV6	25Z
1R4	6A944GT	6C2	6T6	12AV7	25ZG
1T4	6A9	6C3	6U8	12AX4GT	26
1U4	6A9S	6C4	6V6	12AX7	26A5
1U5	6A9S	6C5	6X4	12AZ7	26B
1V2	6A17	6C6	6X6GT	12B4	26C
1X2	6A19	6C6G	6X6	12BA6	26D
2A3	6A20	6C6G	6X8	12B6	26E
2A7G	6A20	6C7	6Y6	12B6G	26F0T
2B6S	6A20T	6C7A	7A4/XXL	12B7	26G4
2B6S	6A20T	6C7A	7A5	12B7G	26Y4
2B7G	6A20T	6C7A	7A5	12B7GT	35Z6GT
2C90	6A20T	6C7A	7A5	12B7T	37/44
2C7A	6A20T	6C7A	7A5	12C8	42
2C90	6A20T	6C7A	7A5	12C8A	42
2L7A	6A20T	6C7A	7A5	12C8B	42
3B4	6A20T	6C7A	7A5	12C8C	42
3V4	6A20T	6C7A	7A5	12C8D	42
4007A	6A20T	6C7A	7A5	12C8E	42
4B7	6A20T	6C7A	7A5	12C8F	42
4B7	6A20T	6C7A	7A5	12C8G	42
4B7	6A20T	6C7A	7A5	12C8H	42
4B7	6A20T	6C7A	7A5	12C8I	42
4B7	6A20T	6C7A	7A5	12C8J	42
4B7	6A20T	6C7A	7A5	12C8K	42
4B7	6A20T	6C7A	7A5	12C8L	42
4B7	6A20T	6C7A	7A5	12C8M	42
4B7	6A20T	6C7A	7A5	12C8N	42
4B7	6A20T	6C7A	7A5	12C8O	42
4B7	6A20T	6C7A	7A5	12C8P	42
4B7	6A20T	6C7A	7A5	12C8Q	42
4B7	6A20T	6C7A	7A5	12C8R	42
4B7	6A20T	6C7A	7A5	12C8S	42
4B7	6A20T	6C7A	7A5	12C8T	42
4B7	6A20T	6C7A	7A5	12C8U	42
4B7	6A20T	6C7A	7A5	12C8V	42
4B7	6A20T	6C7A	7A5	12C8W	42
4B7	6A20T	6C7A	7A5	12C8X	42
4B7	6A20T	6C7A	7A5	12C8Y	42
4B7	6A20T	6C7A	7A5	12C8Z	42
4B7	6A20T	6C7A	7A5	12C8AA	42
4B7	6A20T	6C7A	7A5	12C8AB	42
4B7	6A20T	6C7A	7A5	12C8AC	42
4B7	6A20T	6C7A	7A5	12C8AD	42
4B7	6A20T	6C7A	7A5	12C8AE	42
4B7	6A20T	6C7A	7A5	12C8AF	42
4B7	6A20T	6C7A	7A5	12C8AG	42
4B7	6A20T	6C7A	7A5	12C8AH	42
4B7	6A20T	6C7A	7A5	12C8AI	42
4B7	6A20T	6C7A	7A5	12C8AJ	42
4B7	6A20T	6C7A	7A5	12C8AK	42
4B7	6A20T	6C7A	7A5	12C8AL	42
4B7	6A20T	6C7A	7A5	12C8AM	42
4B7	6A20T	6C7A	7A5	12C8AN	42
4B7	6A20T	6C7A	7A5	12C8AO	42
4B7	6A20T	6C7A	7A5	12C8AP	42
4B7	6A20T	6C7A	7A5	12C8AQ	42
4B7	6A20T	6C7A	7A5	12C8AR	42
4B7	6A20T	6C7A	7A5	12C8AS	42
4B7	6A20T	6C7A	7A5	12C8AT	42
4B7	6A20T	6C7A	7A5	12C8AU	42
4B7	6A20T	6C7A	7A5	12C8AV	42
4B7	6A20T	6C7A	7A5	12C8AW	42
4B7	6A20T	6C7A	7A5	12C8AX	42
4B7	6A20T	6C7A	7A5	12C8AY	42
4B7	6A20T	6C7A	7A5	12C8AZ	42
4B7	6A20T	6C7A	7A5	12C8BA	42
4B7	6A20T	6C7A	7A5	12C8BB	42
4B7	6A20T	6C7A	7A5	12C8BC	42
4B7	6A20T	6C7A	7A5	12C8BD	42
4B7	6A20T	6C7A	7A5	12C8BE	42
4B7	6A20T	6C7A	7A5	12C8BF	42
4B7	6A20T	6C7A	7A5	12C8BG	42
4B7	6A20T	6C7A	7A5	12C8BH	42
4B7	6A20T	6C7A	7A5	12C8BI	42
4B7	6A20T	6C7A	7A5	12C8BJ	42
4B7	6A20T	6C7A	7A5	12C8BK	42
4B7	6A20T	6C7A	7A5	12C8BL	42
4B7	6A20T	6C7A	7A5	12C8BM	42
4B7	6A20T	6C7A	7A5	12C8BN	42
4B7	6A20T	6C7A	7A5	12C8BO	42
4B7	6A20T	6C7A	7A5	12C8BP	42
4B7	6A20T	6C7A	7A5	12C8BQ	42
4B7	6A20T	6C7A	7A5	12C8BR	42
4B7	6A20T	6C7A	7A5	12C8BS	42
4B7	6A20T	6C7A	7A5	12C8BT	42
4B7	6A20T	6C7A	7A5	12C8BU	42
4B7	6A20T	6C7A	7A5	12C8BV	42
4B7	6A20T	6C7A	7A5	12C8BW	42
4B7	6A20T	6C7A	7A5	12C8BX	42
4B7	6A20T	6C7A	7A5	12C8BY	42
4B7	6A20T	6C7A	7A5	12C8BZ	42
4B7	6A20T	6C7A	7A5	12C8CA	42
4B7	6A20T	6C7A	7A5	12C8CB	42
4B7	6A20T	6C7A	7A5	12C8CC	42
4B7	6A20T	6C7A	7A5	12C8CD	42
4B7	6A20T	6C7A	7A5	12C8CE	42
4B7	6A20T	6C7A	7A5	12C8CF	42
4B7	6A20T	6C7A	7A5	12C8CG	42
4B7	6A20T	6C7A	7A5	12C8CH	42
4B7	6A20T	6C7A	7A5	12C8CI	42
4B7	6A20T	6C7A	7A5	12C8CJ	42
4B7	6A20T	6C7A	7A5	12C8CK	42
4B7	6A20T	6C7A	7A5	12C8CL	42
4B7	6A20T	6C7A	7A5	12C8CM	42
4B7	6A20T	6C7A	7A5	12C8CN	42
4B7	6A20T	6C7A	7A5	12C8CO	42
4B7	6A20T	6C7A	7A5	12C8CP	42
4B7	6A20T	6C7A	7A5	12C8CQ	42
4B7	6A20T	6C7A	7A5	12C8CR	42
4B7	6A20T	6C7A	7A5	12C8CS	42
4B7	6A20T	6C7A	7A5	12C8CT	42
4B7	6A20T	6C7A	7A5	12C8CU	42
4B7	6A20T	6C7A	7A5	12C8CV	42
4B7	6A20T	6C7A	7A5	12C8CW	42
4B7	6A20T	6C7A	7A5	12C8CX	42
4B7	6A20T	6C7A	7A5	12C8CY	42
4B7	6A20T	6C7A	7A5	12C8CZ	42
4B7	6A20T	6C7A	7A5	12C8DA	42
4B7	6A20T	6C7A	7A5	12C8DB	42
4B7	6A20T	6C7A	7A5	12C8DC	42
4B7	6A20T	6C7A	7A5	12C8DD	42
4B7	6A20T	6C7A	7A5	12C8DE	42
4B7	6A20T	6C7A	7A5	12C8DF	42
4B7	6A20T	6C7A	7A5	12C8DG	42
4B7	6A20T	6C7A	7A5	12C8DH	42
4B7	6A20T	6C7A	7A5	12C8DI	42
4B7	6A20T	6C7A	7A5	12C8DJ	42
4B7	6A20T	6C7A	7A5	12C8DK	42
4B7	6A20T	6C7A	7A5	12C8DL	42
4B7	6A20T	6C7A	7A5	12C8DM	42
4B7	6A20T	6C7A	7A5	12C8DN	42
4B7	6A20T	6C7A	7A5	12C8DO	42
4B7	6A20T	6C7A	7A5	12C8DP	42
4B7	6A20T	6C7A	7A5	12C8DQ	42
4B7	6A20T	6C7A	7A5	12C8DR	42
4B7	6A20T	6C7A	7A5	12C8DS	42
4B7	6A20T	6C7A	7A5	12C8DT	42
4B7	6A20T	6C7A	7A5	12C8DU	42
4B7	6A20T	6C7A	7A5	12C8DV	42
4B7	6A20T	6C7A	7A5	12C8DW	42
4B7	6A20T	6C7A	7A5	12C8DX	42
4B7	6A20T	6C7A	7A5	12C8DY	42
4B7	6A20T	6C7A	7A5	12C8DZ	42
4B7	6A20T	6C7A	7A5	12C8EA	42
4B7	6A20T	6C7A	7A5	12C8EB	42
4B7	6A20T	6C7A	7A5	12C8EC	42
4B7	6A20T	6C7A	7A5	12C8ED	42
4B7	6A20T	6C7A	7A5	12C8EE	42
4B7	6A20T	6C7A	7A5	12C8EF	42
4B7	6A20T	6C7A	7A5	12C8EG	42
4B7	6A20T	6C7A	7A5	12C8EH	42
4B7	6A20T	6C7A	7A5	12C8EI	42
4B7	6A20T	6C7A	7A5	12C8EJ	42
4B7	6A20T	6C7A	7A5	12C8EK	42
4B7	6A20T	6C7A	7A5	12C8EL	42
4B7	6A20T	6C7A	7A5	12C8EM	42
4B7	6A20T	6C7A	7A5	12C8EN	42
4B7	6A20T	6C7A	7A5	12C8EO	42
4B7	6A20T	6C7A	7A5	12C8EP	42
4B7	6A20T	6C7A	7A5	12C8EQ	42
4B7	6A20T	6C7A	7A5	12C8ER	42
4B7	6A20T	6C7A	7A5	12C8ES	42
4B7	6A20T	6C7A	7A5	12C8ET	42
4B7	6A20T	6C7A	7A5	12C8EU	42
4B7	6A20T	6C7A	7A5	12C8EV	42
4B7	6A20T	6C7A	7A5	12C8EW	42
4B7	6A20T	6C7A	7A5	12C8EX	42
4B7	6A20T	6C7A	7A5	12C8EY	42
4B7	6A20T	6C7A	7A5	12C8EZ	42
4B7	6A20T	6C7A	7A5	12C8FA	42
4B7	6A20T	6C7A	7A5	12C8FB	42
4B7	6A20T	6C7A	7A5	12C8FC	42
4B7	6A20T	6C7A	7A5	12C8FD	42
4B7	6A20T	6C7A	7A5	12C8FE	42
4B7	6A20T	6C7A	7A5	12C8FF	42
4B7	6A20T	6C7A	7A5	12C8FG	42
4B7	6A20T	6C7A	7A5	12C8FH	42
4B7	6A20T	6C7A	7A5	12C8FI	42
4B7	6A20T	6C7A	7A5	12C8FJ	42
4B7	6A20T	6C7A	7A5	12C8FK	42
4B7	6A20T	6C7A	7A5	12C8FL	42
4B7	6A20T	6C7A	7A5	12C8FM	42
4B7	6A20T	6C7A	7A5	12C8FN	42
4B7	6A20T	6C7A	7A5	12C8FO	42
4B7	6A20T	6C7A	7A5	12C8FP	42
4B7	6A20T	6C7A	7A5	12C8FQ	42
4B7	6A20T	6C7A	7A5	12C8FR	

# SHIPPED ON APPROVAL NO MONEY WITH ORDER — NO C. O. D.

## Superior's New Model 70 UTILITY TESTER® FOR REPAIRING ALL ELECTRICAL APPLIANCES and AUTOMOBILE CIRCUITS



Model 70—UTILITY TESTER  
Total Price...\$15.85—  
Terms: \$3.85 after 10 day trial,  
then \$4.00 monthly for 3 months,  
if satisfactory. Otherwise return, no  
explanation necessary.

### As an electrical trouble shooter the Model 70:

- Will test Toasters, Irons, Broilers, Heating Pads, Clocks, Fans, Vacuum Cleaners, Refrigerators, Lamps, Fluorescents, Switches, Thermostats, etc.
- Measures A.C. and D.C. Voltages, A.C. and D.C. Current, Resistances, Leakages, etc.
- Will measure current consumption while the appliance under test is in operation.
- Incorporates a sensitive direct-reading resistance range which will measure all resistances commonly used in electrical appliances, motors, etc.
- Leakage detecting circuit will indicate continuity from zero ohms to 5 megohms (5,000,000 ohms).

### As an Automotive Tester the Model 70 will test:

- Both 6 Volt and 12 Volt Storage Batteries • Generators • Starters • Distributors • Ignition Coils • Regulators • Relays • Circuit Breakers • Cigarette Lighters • Stop Lights • Condensers
- Directional Signal Systems • All Lamps and Bulbs • Fuses • Heating Systems • Horns • Also will locate poor grounds, breaks in wiring, poor connections, etc.



### INCLUDED FREE This 64-page book—practically a condensed course in electricity. Learn by doing.

Just read the following partial list of contents: What is electricity? • Simplified version of Ohms Law • What is wattage? • Simplified wattage charts • How to measure voltage, current, resistance and leakage • How to test all electrical appliances and motors using a simplified trouble-shooting technique. • How to trace trouble in the electrical circuits and parts in automobiles and trucks.

Model 70 comes complete with 64 page book and test leads

**\$15<sup>85</sup>**  
Only

## Superior's New Model TV-50A GENOMETER

### 7 Signal Generators in One!

- ✓ R.F. Signal Generator for A.M. ✓ Bar Generator ✓ Marker Generator
- ✓ R.F. Signal Generator for F.M. ✓ Cross Hatch Generator
- ✓ Audio Frequency Generator ✓ Color Dot Pattern Generator

This versatile All-Inclusive GENERATOR Provides ALL the Outputs for Servicing:  
A.M. Radio • F.M. Radio • Amplifiers • Black and White TV • Color TV



Model TV-50A GENOMETER...  
Total Price...\$47.50  
Terms: \$11.50 after 10 day trial, then  
\$6.00 monthly for 6 months if satisf-  
actory. Otherwise return, no explana-  
tion necessary.

**R. F. SIGNAL GENERATOR:** The Model TV-50A Genometer provides complete coverage for A.M. and F.M. alignment. Generates Radio Frequencies from 100 Kilocycles to 80 Megacycles on fundamentals and from 60 Megacycles to 180 Megacycles on powerful harmonics.

**VARIABLE AUDIO FREQUENCY GENERATOR:** In addition to a fixed 400 cycle sine-wave audio, the Model TV-50A Genometer provides a variable 300 cycle to 20,000 cycle peaked wave audio signal.

**MARKER GENERATOR:** The Model TV-50A includes all the most frequently needed marker points. The following markers are provided: 189 Kc., 262.5 Kc., 458 Kc., 600 Kc., 1000 Kc., 1400 Kc., 1800 Kc., 2000 Kc., 2500 Kc., 3579 Kc., 4.5 Mc., 5 Mc., 10.7 Mc. (3579 Kc. is the color burst frequency).

**BAR GENERATOR:** The Model TV-50A projects an actual Bar Pattern on any TV Receiver Screen. Patterns will consist of 4 to 16 horizontal bars or 7 to 20 vertical bars.

**DOT PATTERN GENERATOR (FOR COLOR TV):** Although you will be able to use most of your regular standard equipment for servicing Color TV, the one addition which is a "must" is a Dot Pattern Generator. The Dot Pattern projected on any color TV Receiver tube by the Model TV-50A will enable you to adjust for proper color convergence.

**CROSS HATCH GENERATOR:** The Model TV-50A Genometer will project a cross-hatch pattern on any TV picture tube. The pattern will consist of non-shifting, horizontal and vertical lines interlaced to provide a stable cross-hatch effect.

The Model TV-50A comes absolutely complete with shielded leads and operating instructions. Only

**\$47<sup>50</sup>**

# USE APPROVAL FORM ON NEXT PAGE ▶

We invite you to try before you buy any of the models described on this and the following pages. If after a 10 day trial you are completely satisfied and decide to keep the Tester, you need send us only the down payment and agree to pay the balance due at the monthly indicated rate.

## NO INTEREST OR FINANCE CHARGES ADDED!

If not completely satisfied, you are privileged to return the Tester to us, cancelling any further obligation.

MOSS ELECTRONIC, INC.

Dept. D-722 3849 Tenth Avenue, New York 34, N. Y.

# TRY FOR 10 DAYS

before you buy!

then if satisfactory pay in easy, interest free, monthly payments. See coupon below.

SUPERIOR'S  
NEW  
MODEL 83



**Model 83—C.R.T. Tube Tester**  
Total Price **\$38.50**  
Terms: \$8.50 after 10 day trial, then \$6.00 monthly for 5 months if satisfactory. Otherwise return, no explanation necessary.

## C.R.T. TESTER

Tests and Rejuvenates **ALL** PICTURE TUBES

### ALL BLACK AND WHITE TUBES

From 50 degree to 110 degree types  
—from 8" to 30" types.

- Model 83 is not simply a rehased black and white C.R.T. Tester with a color adapter added. Model 83 employs a new improved circuit designed specifically to test the older type black and white tubes, the newer type black and white tubes and all color picture tubes.
- Model 83 provides separate filament operating voltages for the older 6.3 types and the newer 8.4 types.
- Model 83 employs a 4" air-damped meter with quality and calibrated scales.
- Model 83 properly tests the red, green and blue sections of color tubes individually—for each section of a color tube contains its own filament, plate, grid and cathode.
- Model 83 will detect tubes which are apparently good but require rejuvenation. Such tubes will provide a picture seemingly good

### ALL COLOR TUBES

Test ALL picture tubes—in the carton—out of the carton—in the set!

but lacking its proper definition, contrast and focus. To test for such malfunction, you simply press the rej. switch of Model 83. If the tube is weakening, the meter reading will indicate the condition. Rejuvenation of picture tubes is not simply a matter of applying a high voltage to the filament. Such voltages improperly applied can strip the cathode of the oxide coating essential for proper emission. The Model 83 applies a selective low voltage uniformly to assure increased life with no danger of cathode damage.

Housed in handsome portable Saddle Stitched Texon case—complete with sockets for all black and white tubes and all color tubes. Only

**\$38<sup>50</sup>**



**Model TW-11—Tube Tester**  
Total Price **\$47.50**  
Terms: \$11.50 after 10 day trial, then \$6.00 monthly for 6 months if satisfactory. Otherwise return, no explanation necessary.

Superior's

New Model  
TW-11

## STANDARD

## PROFESSIONAL

# TUBE TESTER

• Tests all tubes, including 4, 5, 6, 7, Octal, Lockin, Hearing Aid, Thyatron, Miniatures, Sub-miniatures, Navals, Subminars, Proximity Fuse Types, etc.

• Uses the new self-cleaning Lever Action Switches for individual element testing. All elements are numbered according to pin-number in the RMA base numbering system. Model TW-11 does not use combination type sockets. Instead individual sockets are used for each type of tube. Thus it is impossible to damage a tube by inserting it in the wrong socket.

• Free-moving built-in roll chart provides complete data for all tubes. Printed in large easy-to-read type.

**NOISE TEST:** Phono-jack on front panel for plugging in either phones or external amplifier detects microphonic tubes or noise due to faulty elements and loose internal connections.

**EXTRAORDINARY FEATURE**  
**SEPARATE SCALE FOR LOW-CURRENT TUBES** Previously, an emission-type tube testers, it has been standard practice to use one scale for all tubes. As a result, the calibration for low-current types has been restricted to a small portion of the scale. The extra scale used here greatly simplifies testing of low-current types.

Housed in handsome, Saddle-stitched Texon case. Only

**\$47<sup>50</sup>**

We invite you to try before you buy any of the models described on this page, the preceding page and the following pages. If after a 10 day trial you are completely satisfied and decide to keep the Tester, you need send us only the down payment and agree to pay the balance due at the monthly indicated rate.

### NO INTEREST OR FINANCE CHARGES ADDED!

If not completely satisfied, you are privileged to return the Tester to us, cancelling any further obligation.

**SEE OTHER  
SIDE**

CUT OUT AND MAIL TODAY! ▶

#### MOSS ELECTRONIC, INC.

Dept. D-722 3849 Tenth Ave., New York 34, N. Y.

Please send me the units checked on approval. If completely satisfied I will pay on the terms specified with no interest or finance charges added. Otherwise, I will return after a 10 day trial positively cancelling all further obligation.

Model 70... Total Price \$15.85  
\$3.85 within 10 days. Balance  
\$4.00 monthly for 3 months.

Model 83... Total Price \$38.50  
\$8.50 within 10 days. Balance  
\$6.00 monthly for 5 months.

Model TV-50A... Total Price \$47.50  
\$11.50 within 10 days. Balance  
\$6.00 monthly for 6 months.

Model 77... Total Price \$42.50  
\$12.50 within 10 days. Balance  
\$6.00 monthly for 5 months.

Model TW-11... Total Price \$47.50  
\$11.50 within 10 days. Balance \$6.00  
monthly for 6 months.

Model 79... Total Price \$38.50  
\$8.50 within 10 days. Balance  
\$6.00 monthly for 5 months.

Name .....

Address .....

City ..... Zone ..... State .....

All prices net, F.O.B., N. Y. C.

# SHIPPED ON APPROVAL NO MONEY WITH ORDER — NO C.O.D.



**Model 77—VACUUM TUBE VOLT-METER.** Total Price . . . \$42.50  
Terms: \$12.50 after 10 day trial, then \$6.00 monthly for 5 months if satisfactory. Otherwise return, no explanation necessary.



**Model 79—Super Meter**  
Total Price \$38.50  
Terms: \$8.50 after 10 day trial, then \$6.00 monthly for 5 months if satisfactory. Otherwise return, no explanation necessary.

Superior's  
New  
Model 77

## VACUUM TUBE VOLTMETER WITH NEW 6" FULL-VIEW METER

Compare it to any peak-to-peak V. T. V. M. made by any other manufacturer at any price

- Extra large meter scale enables us to print all calibrations in large easy-to-read type.
- Employs a 12AU7 as D. C. amplifier and two 9006's as peak-to-peak voltage rectifiers to assure maximum stability. • Meter is virtually burn-out proof. The sensitive 400

**AS A DC VOLTMETER:** The Model 77 is indispensable in Hi-Fi Amplifier servicing and a must for Black and White and color TV Receiver servicing where circuit loading cannot be tolerated.

**AS AN ELECTRONIC OHMMETER:** Because of its wide range of measurement leaky capacitors show up glaringly. Because of its sensitivity and low loading, Intermittents are easily found, isolated and repaired.

**AS AN AC VOLTMETER:** Measures RMS values if sine wave, and peak-to-peak value if complex wave. Pedestal voltages that determine the "black" level in TV receivers are easily read.

micro-ampere meter is isolated from the measuring circuit by a balanced push-pull amplifier. • Uses selected 1% zero temperature coefficient resistors as multipliers. This assures unchanging accurate readings on all ranges.

### SPECIFICATIONS

- DC VOLTS—0 to 3/15/75/150/300/750/1,500 volts at 11 megohms input resistance.
- AC VOLTS (RMS)—0 to 3/15/75/150/300/750/1,500 volts. • AC VOLTS (Peak to Peak)—0 to 3/40/200/400/800/2,000 volts.
- ELECTRONIC OHMMETER—0 to 1,000 ohms/10,000 ohms/100,000 ohms/1 megohm/10 megohms/100 megohms/1,000 megohms. • DECIBELS: -10 db to +18 db. +10 db to +38 db. +30 db to +58 db.
- All based on 0 db = 006 watts (6 mw) into a 500 ohm line (1.73v). • ZERO CENTER METER—For discriminator alignment with full scale range of 0 to 1.5/7.5/37.5/75/150/375/750 volts at 11 megohms input resistance.

Comes complete with operating instructions, probe leads, and streamlined carrying case. Operates on 110-120 volt 60 cycle. Only **\$42.50**

SUPERIOR'S  
NEW MODEL 79

## SUPER-METER

WITH NEW 6"  
FULL-VIEW METER

A Combination VOLT-OHM MILLIAMMETER

Plus CAPACITY, REACTANCE, INDUCTANCE & DECIBEL MEASUREMENTS  
Also Tests SELENIUM & SILICON RECTIFIERS, SILICON & GERMANIUM DIODES

The model 79 represents 20 years of continuous experience in the design and production of SUPER-METERS; an exclusive SICO development. It includes not only every circuit improvement perfected in 20 years of specialization but, in addition includes those services which are "musts" for properly servicing the ever-increasing number of new components used in all phases of today's electronic pro-

duction. For example with the Model 79 SUPER-METER you can measure the quality of selenium and silicon rectifiers and all types of diodes — components which have come into common use only within the past five years, and because this latest SUPER-METER necessarily required extra meter scale, SICO used its new full-view 6-inch meter

### SPECIFICATIONS:

- D.C. VOLTS: 0 to 7.5, 15/75/150/750/1,500. • A.C. VOLTS: 0 to 15/30/150/300/1,500/3,000. • D.C. CURRENT: 0 to 1.5/15/150 Ma. 0 to 1.5/15 Amperes. • RESISTANCE: 0 to 1,000/100,000 Ohms. 0 to 10 Megohms. • CAPACITY: .001 to 1 Mfd., 1 to 50 Mfd. • REACTANCE: 50 to 2,500 Ohms. 2,500 Ohms to 2.5 Megohms. • INDUCTANCE: .15 to 7 Henries, 7 to 7,000 Henries. • DECIBELS: -6 to +18, +14 to +38, +34 to +58. The following components are all tested for QUALITY at appropriate test po-

tentials: Two separate BAD-GOOD scales on the meter are used for direct readings. All Electrolytic Condensers from 1 MFD to 1000 MFD. All Germanium Diodes. All Selenium Rectifiers. All Silicon Diodes. All Silicon Rectifiers.

Model 79 comes complete with operating instructions, test leads, and streamlined carrying case. **\$38.50**  
Use it on the bench—use it on calls. Only

# TRY FOR 10 DAYS BEFORE you buy! THEN if satisfactory

pay in easy, interest free, monthly payments. See coupon inside.

We invite you to try before you buy any of the models described on this and the preceding pages. If after a 10 day trial you are completely satisfied and decide to keep the Tester, you need send us only the down payment and agree to pay the balance due at the monthly indicated rate. (See other side for time payment schedule details.)

**NO INTEREST  
OR FINANCE  
CHARGES ADDED!**

If not completely satisfied, you are privileged to return the Tester to us, cancelling any further obligation.

**SEE OTHER  
SIDE**

CUT OUT AND MAIL TODAY!

FIRST CLASS

Permit No. 61430

New York, N. Y.

VIA AIR MAIL

BUSINESS REPLY CARD

No Postage Stamp Necessary if Mailed in the U. S.

POSTAGE WILL BE PAID BY —

MOSS ELECTRONIC, INC.

3849 TENTH AVENUE

NEW YORK 34, N. Y.