

electronic service dealer

the official publication of the california state electronics association

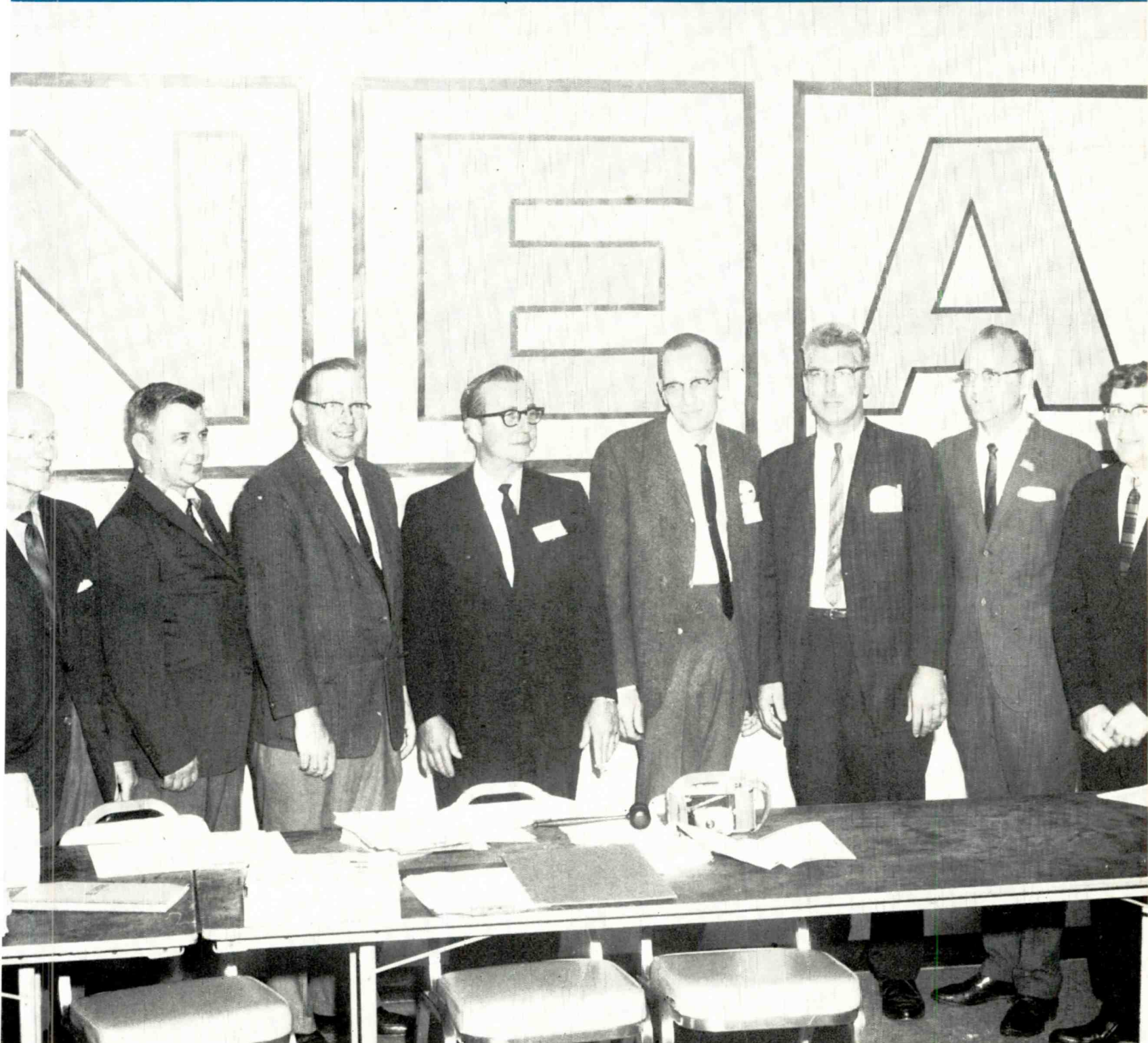

NEA CONVENTION HI-LIGHTS

First UHF/VHF/FM 2-83 antenna
that really works in fringe areas

New
Winegard
Chroma-Tel
CT-100



NEW! Model CT-100 \$52.50

Winegard's sensational new CT-100 Chroma-Tel has 29 elements in all. And they're all working to provide the finest all-band reception (UHF-VHF-FM) even in difficult fringe areas.

In addition to those 29 elements, the CT-100 incorporates a unique matching network that guarantees maximum signal transfer to the downlead—and on all channels 2-83 plus FM. Gives sharpest color and black & white reception.

And like all Chroma-Tels, it has Winegard's exclusive Chroma-Lens Director System (intermixes both VHF and UHF directors on the same linear plane without sacrificing

performance) . . . and our Impedance Correlators (special phasing wires that automatically increase the impedance of Chroma-Tel's elements to 300 ohms).

That's Winegard's new CT-100 Chroma-Tel. Bigger and better. But not too big. The full-line of Winegard Chroma-Tels still offers half the bulk; half the wind loading; half the truck space; and half the weight of all other all-band antennas—and at much lower prices. No wonder Winegard Chroma-Tels (now 4 models) are the hottest performing, hottest selling all-band antennas on the market! Better call your Winegard distributor or write for Chroma-Tel Fact Finder 242.

Model CT-40 \$17.50

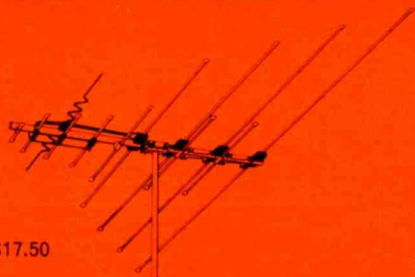

Model CT-80 \$27.50

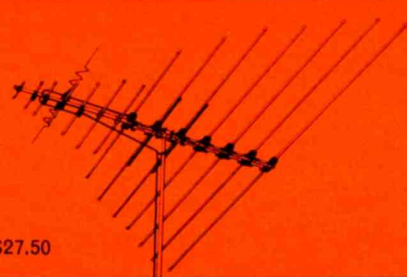

Model CT-90 \$37.50

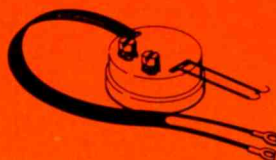
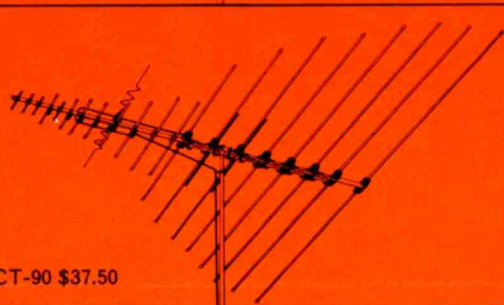

FREE!

Every Winegard Chroma-Tel, including the new CT-100, comes complete with free CS-283 UHF-VHF Signal Splitter. Hangs behind set and separates UHF and VHF signals coming from antenna to the two pairs of set terminals.



electronic service dealer

STAFF:

DONALD J. MARTIN
Publisher and Managing Editor
CSEA Press Secretary

A. DIANE POWELL
Associate Editor

FRANK BURNS
Business Manager

JIM KIRBY
Art & Cover Director

Vol. 6 / No. 5

September, 1966

CSEA EDITORIAL ADVISORY BOARD AND OFFICERS

President
PAUL E. FORT, JR.

Vice President
HUGH WILKINS

Secretary
OAKLEY DEXTER

Treasurer
CAPP LOUGHBORO

Immediate Past President
DARRELL PETSVAL

BOARD OF DIRECTORS

Zone A
DARRELL PETZWAL

ZONE B
NORMAN JAMES
LARRY SCHMITT
OAKLEY DEXTER

ZONE C
AL CHESSER

ZONE D
MEL HAURY

ZONE E
LLOYD KAUN

ZONE F
CAPP LOUGHBORO
VIRGIL GAITHER
HUGH WILKINS

ZONE G
PAUL E. FORT, JR.

BOARD OF DELEGATES

Chairman
VIRGIL GAITHER

Vice-Chairman
OAKLEY DEXTER

Secretary
RAY MERREL



CALIFORNIA STATE
ELECTRONICS ASSOCIATION, INC.
JIM WAKEFIELD
Executive Director
5154 No. Palm Ave.
Fresno, Calif. 93704
227-1587
Sacramento Phone: 482-0706

Electronic Service Dealer is published monthly at 2930
W. Imperial Hwy., Inglewood, Calif. Phone: 755-5261
by Associated Publications.

Entered as controlled circulation
at Los Angeles, California.

FEATURES

- 8 Associations . . . What's in it for me?
- 10 NEA Convention Highly Successful—
Betz New President
- 19 Recommendations for Converting Early Color
Television Receivers to Use New Picture Tubes

DEPARTMENTS

- 4 LETTERS
- 5 EDITORIAL
- 7 CSEA NEWSWIRE
- 9 PRESIDENT'S MESSAGE
- 21 NEW PRODUCT
- 23 TRADE/TALK
- 26 CLASSIFIED ADS

COVER:

Newly Elected Officers of the National Electronic Associations are shown here following the election last month in Winston-Salem, North Carolina. Left to Right: John Graham, Secretary from Columbus, Ohio; M. D. Tedrow of Winston-Salem, North Carolina; Arthur Van Sicklin of Wapping, Connecticut; Ray Demonbrum, Treasurer, from Louisville, Kentucky; John Betz, President, from Waterloo, Iowa; Clement Raffauf, Louisville, Kentucky; Wilford Carden, Hutchinson, Kansas, and Dick Glass, Past President, Indianapolis, Indiana.

LETTERS

Dear Don:

Due to the purchase of a local service dealer's stock and equipment, I have a quantity of surplus items we would like to advertise and sell.

The following items are offered to the highest bidder, all or in part:

- 1—B & K model 700 mutual cond. tube checker
- 1—Mercury model 1000 tube checker
- 1—Eico auto radio battery eliminator, with ripple filter
- 1—Mallory auto radio battery eliminator
- 1—B & K model 350 C.R.T. checker
- 1—B & K model 500 tube checker, with #510 and #610 adapters

Sam's Photofacts, no. 480 thru 806 in 5 drawers, (Apr. 60 thru Mar. 66)

Rider's T.V. manuals, vol. 1 thru 27
Rider's Manuals, vol. 2 thru 16, also vols. 18, 19, 23.

I would appreciate running the above in the Electronic Service Dealer.

Yours truly,
Ben Leff

Editor's Note:
Happy to do so!

Gentlemen:

I am very interested in subscribing to your publication. I understand, however, that the

only way to receive it is to belong to the California State Electronics Association. Is this true? If not, I would appreciate it if you could send me some information telling me how to go about subscribing to it.

Thank you.

Sincerely,
Ray Steele

Editor's Note:

Not true Ray . . . although it is the official magazine of CSEA it is independently owned and operated. If you are a member of CSEA there is no cost to the publication since it is part of your dues. However, if you wish to subscribe you can do so by sending a check for \$3 for one year and \$5 for two years.

Cheers Don:

It is too bad we didn't start something like this years ago. There is no doubt about it, the service industry has priced itself (too low) right out of business in most cases. The customers were banging to get in and we sat there last year and lost money. The future is getting a little brighter and maybe yet we will have an electronic service profession. With correct charges for good work we can not help but attract the type of people we can all be proud of in the service business.

Ralph Johannot

Dear Sir:

Every dealer is interested in how much to charge the customers for service calls and repair work. Many of my friends quit the service business after having \$3,000 to \$4,000 in charge accounts that seemed unable to collect. Maybe we need a good article on collections.

The only way I have been able to beat this credit racket is through a home made sign I put up some time ago. "No charge accounts—you pay before taking set." Needless to say I don't have the same amount of business as those offering credit but we can keep ahead and pay the overhead.

Richard Gregg
Gregg Radio TV, Rialto

Dear Don:

Your follow up article on service call charges is terrific. We have been charging pretty close to these prices for some time but feel if everyone gets on the band wagon we are going to end up with a real profession and something to offer young men to come into the industry. In my opinion it is the only way in which we will ever be able to compete with Industry and service companies in competition for technicians. Keep up the good work.

Howard Singer

Dear Don:

Just a note to let you know that your editorial in August really hit the bull's eye in Orange County as you stated. There was additional note that just came up that I thought you might like to know and that is that the local RCA Service Company has raised their prices to \$12.95 for color service calls. I don't know for sure whether or not this is nation wide but their policy is usually the same for all areas. Personally, I feel this industry is really going to come of age and be able to attract the needed technicians. Thanks for your help.

Miles Sterling, Electro TV
Garden Grove, California

(Continued on Page 26)

TUNER REPAIRS

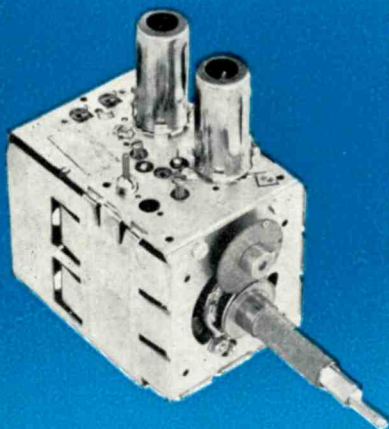

\$9.50

FOR COMPLETE OVERHAUL

Includes ALL parts (except tubes)
ALL labor on ALL makes

24-HOUR SERVICE with FULL YEAR WARRANTY

Sarkes Tarzian, Inc., largest manufacturer of TV and FM tuners, maintains two completely-equipped Service Centers to serve YOU. Both centers are staffed by well-trained technicians in this specialized field and are assisted by engineering personnel to assure you of FAST, DEPENDABLE service.

⊕ Tarzian-made tuners—identified by this stamping—received one day will be repaired and shipped out the next. A little more time may be required on other makes. Every channel is checked and re-aligned per manufacturer's specifications, not just the channels which might exist in any given area.

You get a 12-month guarantee against defective workmanship and parts failure due to normal usage. Cost to you is only \$9.50 and \$15 for UV combinations, including all labor and parts except tubes. No additional costs. No

hidden charges. All tuners repaired on approved, open accounts. You pay shipping. Replacements on tuners beyond practical repair are available at low cost.

When inquiring about service on other than Tarzian-made tuners, always send TV make, chassis and Model number. Check with your local distributor for Sarkes Tarzian replacement tuners, parts, or repair service. Or, use this address for fast factory repair service.



SARKES TARZIAN, INC.
TUNER SERVICE DIVISION

See your distributor,
or use this address

10654 Magnolia Blvd.,
North Hollywood, Calif.
Tel: 769-2720

MANUFACTURERS OF TUNERS... SEMICONDUCTORS... AIR TRIMMERS... FM RADIOS
AM-FM RADIOS... AUDIO TAPE... BROADCAST EQUIPMENT

electronic service dealer EDITORIAL



DON MARTIN

\$10.00 & \$12.50 Service Calls Orange County Report

\$10.00 for Black & White service calls and \$12.50 for Color seems to be a matter-of-fact now in Orange County. It's believed that about 85% of the service dealers in the county will be charging the new rates by the middle of this month (September).

Out of the nearly 200 service dealers in the area, we have received reports of only two shops which were definitely against the \$10.00 and \$12.50 fees. It is expected, however, that between 25-30 (15%) will wait to see the others' success before they follow suit.

In a quick survey of 38 dealers, taken just before press time, we have received the following results:

24 of the dealers made definite statements that they will be charging the \$10.00 and \$12.50 rates by mid-September.

8 others are already charging these fees.

6 dealers said, in varying statements, to the effect that they would like to wait until later in the fall and then decide.

Dunlap Appliance in Costa Mesa has been charging \$11.05 for Black and White and \$12.05 for Color since about the first of August (exactly the same as General Electric). They report that the new rates have not presented any problems. According to his statement, he feels that "Any dealer who isn't charging these rates is throwing his money down the drain."

Every dealer who has been charging \$10.00 and \$12.50 has been very happy with the results. According to their reports, the customers have either taken the price rise in stride with everything else that is going up these days; or the customer had no idea that the prices had even changed. Most of these shops have stuck exactly to the \$10.00 and \$12.50 figures.

Listed below are the 32 dealers in Orange County who, in our 38 shop survey, have stated that they are now charging the new rates, indicated by an asterisk (*); or have stated that they are definitely going to the \$10.00 and \$12.50 rates by mid-September.

Ace TV, Anaheim
Al's TV Mart, Garden Grove
Ball TV, Anaheim
Buena Park Color TV Center, Buena Park
Buena Park TV & Radio Service, Buena Park
C & M TV, Garden Grove
*Chapman TV, Garden Grove
Dan's TV, Costa Mesa
**"Doc" Stiner, Orange
*Dunlap Appliance, Costa Mesa
*Electro-TV, Garden Grove
Frank Curren TV Service, Anaheim
Harbor Blvd. TV, Santa Ana
*Henderson Appliance, Costa Mesa

Mac's Radio & TV Service, Santa Ana
Musikal Sound Center, Orange
Norm's Radio & TV, Orange
Ohio TV, Anaheim
Olson & Crawford TV & HiFi, Fullerton
*Plaza TV, Santa Ana
Plaza TV, Tustin
*Plaza TV, Westminster
Ray's Mobile TV, Westminster
*Robinson's House of Magnavox, Orange
Sound & Video, Tustin
Springdale TV, Huntington Beach
Teleworld, Fountain Valley
Tip Top TV Electronics, Santa Ana
Tustin Radio & TV, Tustin
TV Town, Orange
Vic's TV, Placentia
Weber's Home Appliances, Anaheim

This is just what has happened in the Orange County area of Southern California and only indicates a portion of the over-all story. We have received calls from throughout Los Angeles indicating they are going to go along with this type of realistic pricing as we suggested. We have received numerous requests for additional copies of the magazine and a fantastic number of requests for additional subscriptions. All in all, we have processed close to 100 requests and the end doesn't seem in site. We may be all wrong but it looks as if the service industry, at least in California, is tired of not making any money and are going after a realistic profit for a complete and honest service performed.

Dan Weston Moved Up

Dan Weston, chief of the Bureau of Electronic Repair Dealer Registration, has been reassigned as Deputy Assistant of the entire Department of Professional and Vocational Standards. Although, I am sure there will be disagreement, in my opinion Dan did an outstanding job of starting the BERDR and of setting up the framework under which it now functions. He is a fine young man with a great future and we wish him all the luck in the world in his new position. We have had no indication as to who his replacement will be but will keep you advised as soon as an appointment is made.

Antenna Promotion

Although we have not personally seen the Institute for Better TV Reception's local promotional TV spots, indications are that it is doing a pretty good job. Dealers indicate that antenna sales are going well and distributors seem satisfied with the results. Local Channel Master distributors tied in with the promotion by running an additional program on Channel 5 and, we understand, others have

(More on Next Page)

worked out similar programs or promotions to stimulate antenna purchases in August.

Oops! Your Quality Is Showing

First of all, let me state that I am not a technician and know very little about the operation of any electronic equipment let alone Television but there is a reoccurring argument from dealers all over the state that the quality of new merchandise being placed on the market leaves a lot to be desired.

Our first indications of this came up at the State convention where several dealers in an off hand conversation stated that many of the well-known manufacturers were sacrificing quality for quantity. That there seemed to be more interest in number of units than in the number of working units.

This was recently brought more into focus by a joint meeting of the Ventura chapter with Zone F representatives. One of the prime targets of these members was the lack of action on the part of CSEA to do anything about the quality of products being placed on the market. This action resulted in a special meeting of the Zone in August and the placing of the subject on the agenda for the State board of directors meeting in September.

At the same time, we received a communication from Northern California that this is very much of interest in their area as well and that they hope the State Association will draft a resolution and send it on to those manufacturers they feel are most guilty of this type of poor product. It is also planned to send a copy of this resolution to all major newspapers and Television networks to see if there isn't some way to bring this to the atten-

tion of the general public much in the same manner as the Nader report on the auto industry.

As I said before, I am not a qualified technician but if this is actually fact we will do everything we can to bring this to the attention of the right people. However, on the other hand, we have been told that the service dealers are not using the right equipment or the right analysis in repairing current merchandise and are burying out complete circuits in an attempt to locate problems without following the manufacturer's literature. I would be anxious to hear more on this from our readers.

Highly Successful NEA Convention

The entire story of the recent NEA convention in North Carolina is covered in this issue of ESD but I felt a few more words might be in order.

In my opinion, this was the finest convention of its kind ever held in this country and demonstrated active participation by everyone. Every delegate seemed to have a job of participating in a panel, introducing a speaker, as a committeeman, or what have you. It was through this type of complete participation that success was possible. Too many times the show is run by one man or a group of a few individuals. In North Carolina a few weeks ago this was not the case. I know that under the direction of Dick Glass that this was a planned move because it couldn't have come by accident. He took a back seat throughout the convention and only took the microphone on occasion.

Another big factor in the success of this convention was the recognition of work done by all active people in NEA.



**Helps
stop
ghosts!**

**Zenith Quality
Wavemagnet®
Indoor TV Antenna**

Designed for finest all-channel (2 to 83) reception in color or B&W. Special network provides stepped-up basic dipole impedance, resulting in lower voltage standing wave ratio than ordinary VHF indoor antennas . . . cuts down snow, reflections and ghosts. Two full-size UHF loops, one behind the other, develop an unusually high front-to-back ratio (equal to that in many outdoor antennas), remarkably reducing ghosts and man-made interference. Order as Part Number 973-56 from your Zenith distributor!

*Built to the quality standards
of Zenith original parts*

ZENITH
®

The quality goes in before the name goes on



CSEA NEWS WIRE

A ROUND-UP OF STATE AND LOCAL NEWS OF THE CALIFORNIA STATE ELECTRONICS ASSOCIATION

The Zone "F" Council's public relations committee under the direction of Harry Midkiff is in the process of forming an overall program and needs the assistance of one person from each chapter in order to coordinate the overall effort. Anyone interested should contact him as soon as possible since he wants to kick the program off in September.

ESD ESD ESD

The annual Zone "B" day at the Dexter's was a great success, according to late reports. Oakley, a CSEA Board Member and former Zone President, holds this annual outing at his home in Larkspur. All zone delegates, their wives and children were invited to attend with full use of the Dexter Pool, outstanding food and a short business meeting filling the day.

ESD ESD ESD

Operation Spotlight's progress was described by Hugh Wilkins at the last Zone F meeting and plans are in the offering to continue the program as soon as all of the buys are worked out.

ESD ESD ESD

A delegation of Zone F members recently visited the Ventura chapter in order to discuss mounting problems of communication between the chapter and the Zone. The members of the Ventura chapter felt that much more should be done in spearheading a drive to demand better quality control of new electronic products and urged the Zone to take formal action. The meeting was so successful that it may set the stage for a series of such meetings between zone delegates and individual chapters throughout the area.

ESD ESD ESD

Northern California dealers seem opposed to and locals with the general idea being to carry type of uniformity among CSEA members everyone did agree that a dealer should depend on individual programs. However, from all of his employees and that all members had a clean and professional appearance of their advertising and promotions. All shops should carry the CSEA bug in all

ESD ESD ESD

Norman James, President of the ACTRA chapter, has urged all members to become affiliated with NEA as soon as possible in order to give the local and state association an active voice on a national level. It becomes more and more evident that what takes place in Chicago or New York does have a direct effect on local people. He cited the recent Chicago investigation of the service industry and indicated the effect it had had on local customers. Larry Schmitt, CSEA Director, advocated that all local shops should be brought into CSEA as soon as possible before any great effort is made to make them members of NEA. Only through a strong state group can there be a strong national group. NEA dues are \$1 per month and payable through the State office of CSEA.

ESD ESD ESD

Hugh Wilkins, President of the Los Angeles Chapter of CSEA was recently named the most outstanding local association President by the National Electronic Associations. The award was presented at the Association's national convention in North Carolina and was accepted by Don Martin, Publisher of ESD, for Wilkins. The beautiful plaque was then presented to Wilkins at the last Zone "F" meeting.

ESD ESD ESD

Others singled out by NEA for special awards were Oakley Dexter, Mike Fusaro, Willard Gravel, Ralph Hoy, Wade Nelson, Emmett Mefford, Howard Singer, and Ralph Johonnot for their work as national committee Chairmen. A special award was made to Darrell Petzwal as a National Director of NEA and to Ralph Johonnot as a National Vice President. Newly elected President of CSEA, Ed Fort also received recognition as a NEA State President.

ESD ESD ESD

Three local Southern California Distributors were also honored by NEA during the convention with special recognition awards being given to Andrews Electronics in Burbank, Hurley Electronics in Santa Ana and Inglewood and to RCA Victor Distributing Corp. in Los Angeles. These awards were for outstanding service to the Independent Electronic Service Dealers and Technicians.

ASSOCIATIONS . . .

WHAT'S IN IT FOR ME?

Are you a member of the Association? Why not?

We should all be interested in the answer.

It is easy for me to say you should belong because we are in this together. Know your fellow service dealer. Pull your share on the oars. Hang together or hang separately.

You couldn't care less. You have your own problems.

You will want to join us when I show you it pays; it will make you successful beyond your fondest expectations. You will make money when you are still young enough to enjoy it—raise your family with pride.

Furthermore, you will be looked at with new respect, both in your community and in your industry. That is, if you qualify.

Now, are you interested?

Of course you are. I am talking your language. But you are skeptical. Show me, you say.

Not everybody can belong to the Association. To qualify you must first have a place of business open to the

public in a bona fide business district. It will pay you to get out of that low-rent garage.

Secondly, you must have the usual test equipment necessary to do a good repair job. If you don't have a multimeter, tube tester, signal generator and scope you don't belong with us. You won't make enough to eat and pay your dues too.

Third, you are required to have technical personnel qualified to handle this equipment. Enough said.

Fourth, you are required to carry insurance which is adequate for the protection of your customers. This means truck insurance, public liability, workman's compensation—those things the ordinary, prudent man wouldn't be without.

Finally, you are pledged to a code of ethics and sound business practices. These are defined both by the Association and the Better Business Bureau. And you are required to observe this code so long as you are a member.

So, how will the Association make you money? CSEA will get you better-paying customers and more of them.

The Association has a job of regularly educating the consuming public about the meaning of the CSEA emblem. Thus if Jones wants a truly qualified technician to work on his color set or solid-state stereo, he looks for the people displaying the bug. They were examined and found to meet the test.

On the other hand, Smith has a junky old set which he would like to have fixed as cheaply as possible, on credit too. He will likely choose some unobtrusive outfit that is in it for the experience. Because of the low price he is prepared to be unhappy with the service.

In any town you will find a fair number of people who believe it pays to obtain the best service available. They are willing to meet whatever price is necessary to get it, and their credit is good. Will you get these customers? Or will you settle for the others?

Mr. Prospective Member, maybe you didn't know what an elite group the Association is composed of. This group, as you can see, is particularly well equipped to meet the needs of the consuming public.

Frankly we need to do a better job of making these facts known to the public. And when the public is sharply aware of CSEA qualifications wild horses and pussy cats couldn't keep you away. And if you qualify we want you.

HEALTH AND LIFE PLAN

FOR

California State



Electronics Association

FOR INDIVIDUALS AND DEPENDENTS

BENEFIT:

**SURGICAL, HOSPITAL AND AMBULANCE
ACCIDENTAL DEATH AND DISMEMBERMENT
ADDITIONAL ACCIDENT EXPENSE BENEFITS**

**X-RAY AND LABORATORY
MAJOR MEDICAL EXPENSE BENEFITS**

GROUP LIFE INSURANCE

DISABILITY BENEFITS

CONVERSION PRIVILEGE

MONTHLY RATES

Employee or Employer.....	\$ 7.55
Family of Two.....	14.72
Family of Three or More.....	20.40

Benefits provided by

California Physicians'

INSURANCE CORPORATION

720 CALIFORNIA STREET
SAN FRANCISCO, CALIFORNIA 94108
(415) 781-4633

dm



Robert L. Martin

N. KEN KEEP

"THE EMBLEM OF SERVICE"

DELMAR INSURANCE AGENCY
P. O. BOX 4262 • Fresno 4, California • Phone: AMherst 8-4261



PRESIDENT'S MESSAGE

By ED FORT

As I write this article, the new Board of Directors has not yet had its first board meeting; however, when you read this, the September 11th meeting in Los Angeles will have already been concluded.

For now, then, let me just mention a few things that are happening throughout the state.

To begin with: a word on self-certification. Those who passed the exam in San Diego have become California's first Certified Technicians—the first of many. Their certificates were mailed this week from our state office.

Another event of interest to the industry is the litigation currently in process in the city of Santa Barbara. It is a civil action, in small claims court, brought against a Registered shop by a disgruntled customer claiming damages. The suit is based upon evidence compiled in a report made out by the investigator for the B. E. R. D. under its informal complaint provisions. I will not go into details at this time except to state that it was

thought to be sufficiently important to industry welfare that Jimmy Wakefield, CSEA executive director, was present at the hearing. The problem presented by this litigation will also receive a high priority at the September board meeting.

It has been said that timing is one of the most important ingredients for success. And this axiom has seldom been demonstrated more forcefully than by last month's editorial by Don Martin regarding service call prices. In the past we have seen article after article after article proving that the T.V. industry is tremendously underpaid—and each had little or no effect. The reaction to Don's article has been nothing short of miraculous. Throughout the state, firms—both CSEA and non-member—have suddenly raised their prices (instead of talking about why they can not) and have reported no adverse effects. It would appear, from this activity, that the time was right. The shop owner has suddenly realized that it is possible to make a profit and still remain in business.

**CSEA BOARD OF
DIRECTORS MEETING
SEPTEMBER 11th
LOS ANGELES, CALIFORNIA**

Make Your Own Reservations

ORIGINAL



**FACTORY
REPLACEMENT
PARTS
FOR T.V.
& RADIO**

- DELCO AUTO RADIOS
- RCA
- ZENITH
- GENERAL ELECTRIC

**PLUS—THE BEST LINES
OF GENERAL
REPLACEMENT PARTS**

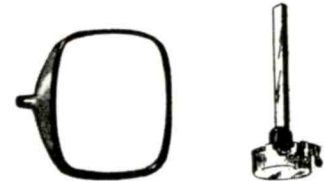

ANDREWS

ELECTRONICS
1500 W. BURBANK BLVD.
BURBANK, CALIF.
TH 5-3536 ST 1-3120
VI 9-6014



JOHN BETZ
N.E.A. President

N. E. A. CONVENTION HIGHLY SUCCESSFUL—BETZ NEW PRESIDENT

by Don Martin

Fabulous, Fantastic, Sensational, are only a few of the adjectives used to describe the second annual convention of the National Electronic Associations held late last month in Winston-Salem, North Carolina.

Over 300 delegates, their wives and children came from all over the United States by car, air, camper, and covered wagon to invade this quiet little community nestled in the hills of North Carolina in spite of the air strike that made long-distant travel virtually impossible.

Rufus "Duke" Wilson, Chief of the General Trade Restraint Division of the Federal Trade Commission summed up the general opinion of the convention when he stated, "in my opinion, this group has really come of age in just one year and is undoubtedly one of the finest trade associations I have ever dealt with over the years." Mr. Wilson had been a guest speaker at the group's first national convention held last year in Chicago.

The feeling of true friendship, cooperation and genuine interest in the problems of the home entertainment service industry was very much in evidence throughout the four-day event. Eighteen State Associations, representing thousands of individual service dealers, were represented with delegates from as far north as Connecticut and as far south as Georgia. From as far east as North Carolina and as far west as California . . . all with one purpose in mind . . . to build a true national association that believes in and will work for the benefit of the home entertainment service industry.

Convention Begins Early

Early delegates to the convention had a special treat in store for them as President Dick Glass of NEA took over the gavel of the organizational meeting of the ETA of North

Carolina. After the adoption of the group's by laws, the election of the new associations took place with Paul Cartrette being named as President. At lunch, the new group of officers were inducted as leaders of this organization and were then welcomed in as members of NEA. This luncheon was hosted by one of Winston-Salem's top distributors, the Womack Co., Inc. A special message of thanks to many of the area's distributors was made by Dave Drage of Bethania who stated that, "without the help of the distributors, and a new light of cooperation between them and the dealers, the organization could not have been formed." At the same time, Paul Cartrette announced the formation of the ladies auxiliary and congratulated them for the outstanding job they had done in organizing the registration, entertainment, etc. for the four day convention. Mrs. Ruby Drage and Mrs. Daisy Reed were given a special thanks by Cartrette.

Hot President's Race

All through the convention a wild battle was waged for the office of NEA President with leading candidates including Leon Howland of Indiana, Pete Fabbi of Michigan and John Betz of Iowa plus a wave of favorite sons making their presence known. Slogans, signs, banners, too shameful to mention here, and special effects all contributed to a lot of fun as well as serious consideration as to who would lead this group over the next 12 months.

In the final count John Betz of Iowa was unanimously elected after the first ballot had been counted and many states began switching their support to Betz. All in all, eleven men had been nominated for this position as well as many candidates for other offices indicating a real interest in true representation and leadership. This is a real departure from



Mr. Rufus "Duke" Wilson, Chief of the Division of Consumer Restraint of the Federal Trade Commission, is shown here during his presentation before the NEA delegates. Wilson suggested that "when in doubt . . . ask for an interpretation to be sure."

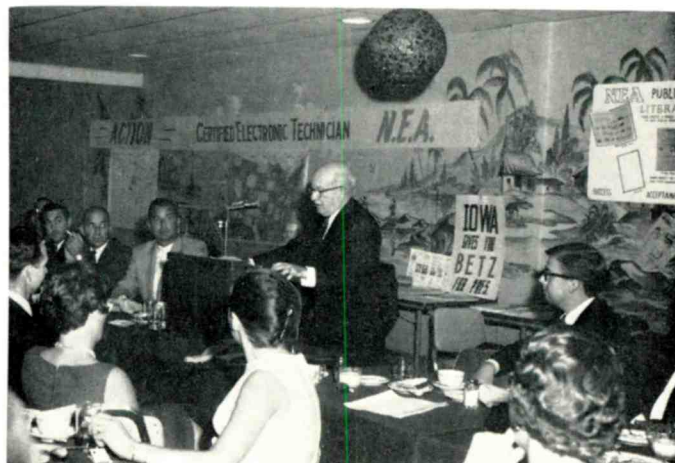

Mr. M. L. Finneburgh, Sr., Chairman of the Board of the Finney Company, was the keynote speaker at the second annual National Electronic Associations Convention last month. His inspirational talk will be presented in future issues of ESD.

the selection system of a nominating committee and one slate of officers. All during the first days of the convention, delegates had an opportunity to nominate a person he felt would make a good office holder in NEA and it proved to be an outstanding hit.

Other officers elected to top positions in the organization included: Vice Presidents, Leon Howland of Indiana; Will Carden of Kansas; Darrel Petswal of California; Clem Raffauf of Kentucky; Art Van Sicklin of Connecticut, and M. D. Tedrow of North Carolina. Secretary of NEA for the next year will be John Graham of Ohio and the Treasurer will be Ray Demonbrum of Kentucky. All State Association member Presidents are automatically on the Board of Directors or their appointed representative will be allowed to vote in their absence.

Convention Program Resume

As for the convention program itself, it began with the installation of the new ETA officers of North Carolina and was immediately followed by the NEA open golf match. 18 players ? ? ? took part in this contest of skill and stamina with scores ranging from 74, by Bobby Creek of Clemmons, North Carolina, to a high score of 188. We won't say who it was but he would have made a better president than a golfer. Even Vince Lutz, from Missouri, only shot a 127 for his first time out, so it was a good thing Leon Howland was in the last foursome. We understand by the time he got in all the chicken at the bar-b-que was gone. By the way, this outstanding outdoor event was sponsored by Electronic Wholesalers, Inc. of Winston-Salem.

Ray Jones, of the local ETA, was the most outstanding host of all . . . an accomplished golfer, he gave his clubs to one of the other fellows so he could play and then followed everyone around the course with cold beer and soft drinks in the 100 plus heat.

Golf winners received many prizes, but heading the list was a complete set of clubs and a golf bag furnished by Philco and the Brown Rogers Dixon Co. Other prizes were donated by the Womack Company, Inc. The Golf Match itself was sponsored by Zenith through their local distributor, Allison Erwin of Charlotte, North Carolina. That evening there was a Get Acquainted Party sponsored by the Mac Victor, Inc., distributors.

Second Day Events

On Friday morning the convention really got underway with a breakfast sponsored by Alliance Mfg. Co. of Alliance Ohio. Felix Camp represented the firm reviewed CATV and explained many of the controls that are being brought to bear on this industry. Following this and a film of CATV was a series of panel discussions regarding manufacturer, distributor and dealer relations, extended warranties, etc. Mr. Forest Belt, editor of Radio-Electronics Magazine, was guest moderator and did an excellent job of controlling the controversial issues.

At lunch, which was sponsored by JFD Electronics and their representative, Ivey Redmond, Mr. Rufus "Duke" Wilson made an outstanding speech on the part government had and must play in protecting small businessmen and the consumer from restraint of trade under the free enterprise system. His remarks will be presented in future issues of ESD but his presence at the convention and his active participation was a great factor in its success.

Apprenticeship Discussed

That afternoon a special session on the apprenticeship program, the participation of the office of Job Training and the Bureau of Apprenticeship Training provided an outstanding program and real insight into the future of the labor problems in the servicing of home entertainment products.



Of particular success was the series of panel discussions presented by NEA during the convention. This one, on dealer-distributor-manufacturer relations was moderated by Forest Belt, far left, of Radio Electronics Magazine. Other panelists included: Fred Haddad of Connecticut, Ray Demonbrum of Kentucky, and E. J. Gaiden, national service manager for Motorola. Standing is NEA Secretary John Graham.

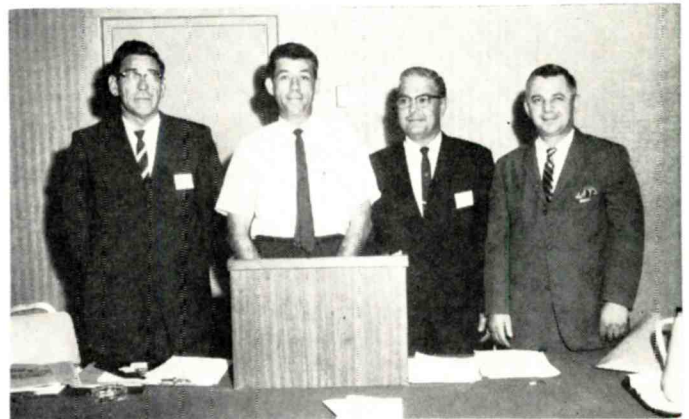

During the NEA convention the Electronic Technicians Association of North Carolina was formally created. The election of officers included the above men: Roscoe Sicheloff, Paul Cartrette the new President, R. S. Sanders and M. D. Tedrow.



A real old fashioned southern Bar-b-que started things off right as you can see in the above candid. A warm, friendly atmosphere prevailed throughout the convention and this informal gathering was a major part of the reason.



The Golfers ? ? ? ? that's what the man said, show victory smiles as they gathered for this picture. Scores ranged from 74 to 188 for the sixteen that took part in the NEA open.

Mr. Gregory Barkoukis, the NEA-OJB co-ordinator acted as chairman and introduced Mr. Jack D. Currie of the U.S. Department of Labor. They outlined the function of both division in helping to provide future technicians and outlined the program as it is now working in several parts of the United States.

Finneburg Speaks

That evening the Southeastern Radio Supply Co., Inc. of Greensboro, North Carolina, sponsored a cocktail party prior to hearing Mr. M. L. Finneburg, Sr.'s keynote address. The dinner, sponsored by Philco, was a buffet and added greatly to the relaxed atmosphere of the evening. To be able to give true justice to Mr. Finneburg's address would be impossible, but we will try to reprint much of it in future issues of ESD. His approach to the service industry, as well as the country, was a thing of beauty. Many of the delegates had heard him speak over the years but there was absolute silence throughout the presentation and a standing ovation followed. Mr. Finneburg was presented a special citation of merit from NEA as well as a Kansas Golden Key for his service to the Association and the industry in general. Everyone agreed it was a truly inspirational presentation with a message for everyone regardless of his walk in life. Mr. Fred Barber, program Director for WGHP-TV in Highpoint, North Carolina, followed Mr. Finneburg and did an excellent job of outlining the part color programming will play in the next few months.

Later that evening several of the men took the NEA certification examination even though it ran into the early hours of the morning before they completed the test.

Shanafelt Addresses Group

Lysle Shanafelt, Manager Sales Coordinator for the Electronic Component and Devices of RCA, was the top speaker at the Saturday morning breakfast and addressed the delegates on the future of the Electronic Service Business. Mr. Shanafelt talked about some of the history behind color television and how RCA pioneered and developed compatible color television along with developments to be expected in the future. He warned of the need for education and stressed the very future of those in attendance depended upon their own ability to keep ahead of technical developments in color receivers.

Following Mr. Shanafelt was Mr. Doyle Thompson, chief engineer for WFMY-TV of Greensboro, N. Carolina, who outlined the many new cameras and technical equipment being developed and purchased by stations throughout America to bring better color pictures to the individual home receivers.

(Continued on Page 17)



Although only a few hours old, the ETA of North Carolina had something like 38 members and 38 members of NEA. At the same time, the group had taken the NEA certification examination and 34 of these men are now certified by NEA as top electronic technicians.

FOR WORLD'S BEST RECEPTION

USE

FINCO ANTENNAS

Proudly Distributed By

PHILCO CORP.

Important

Announcement:

FINCO ANTENNAS are sold and guaranteed by the Parts and Service Department of PHILCO CORPORATION. Engineering tests by PHILCO have proved that these high quality designed antennas are the performance leaders in their field . . . All FINCO Combination UHF/VHF antennas are complete with a Hi-Quality "Splitter" having a list price of \$3.50.

PHILCO, famous for quality the world over, is proud of this association. Enjoy success with quality products from PHILCO and FINCO Antennas . . . Visit your Philco Parts Stores in Los Angeles, Portland, Phoenix, San Francisco and Seattle.

VHF

UHF

FM

wherever in
the world...
the world's
best reception

FINCO

All Band

COLOR
VE-LOG

FINCO MODEL
UVF

16

Eleven UHF
Elements
channels
14 thru 83
Five VHF
Elements
channels
2 thru 13
FM-monaural
stereophonic
Only one downlead
required
Gold Corodized

LIST

30⁵⁰

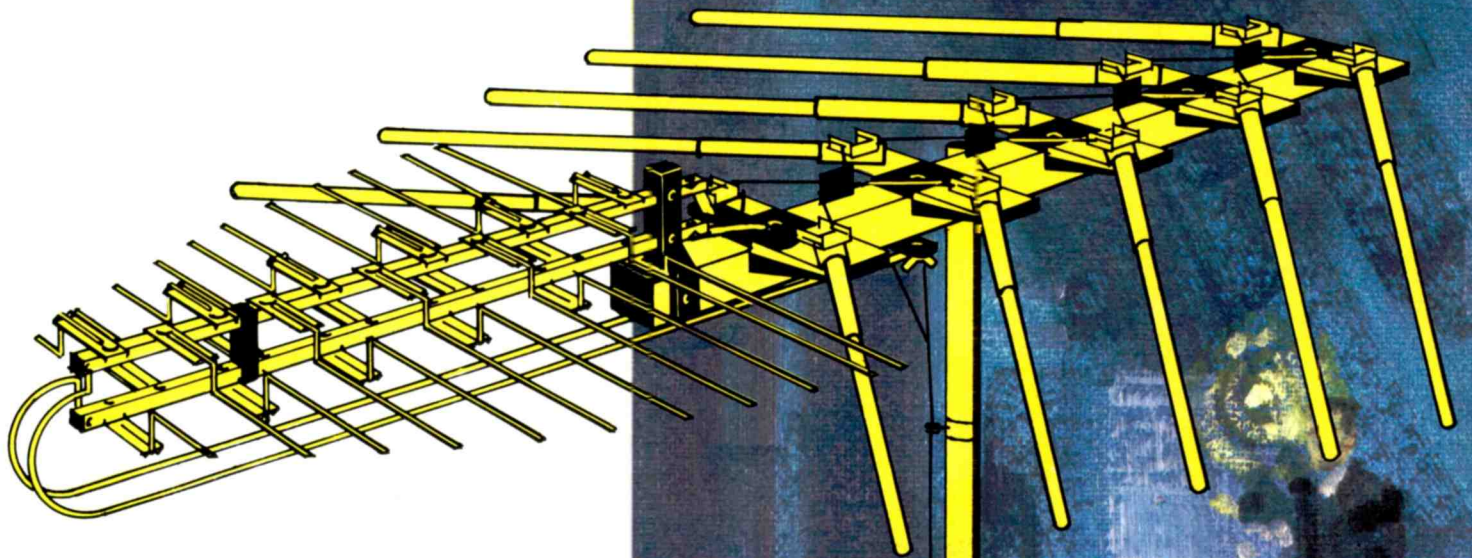

**MODEL NO. UVF 16
LOCAL AND SUBURBAN**

ENGINEERED FOR THE FUTURE!

1. UHF SECTION. Revolutionary New Step-staggered, Log Configured, Sensitized UHF Frontal Design. Rugged perfected performance.

2. METAL (HEAVY ALUMINUM) REINFORCED INSULATOR INSERT CUP AND HEAVY DUTY RIVET! Finco's new large heavy duty polystyrene insulators now are reinforced by a unique heavy aluminum shield to give quadruple strength for supporting positive positioned snap-in triple-thick elements. An added exclusive feature is the snug fitted aluminum cup for extra support to the oversize aluminum rivet—truly a life-time assembly!

3. BACK-UP BRACKET AND SQUARE BOOM. FINCO'S exclusive aluminum back-up bracket adds triple strength to the riveted assembly of 1" heavy duty square boom to the aluminum shielded polystyrene form fit element bracket, making the boom non-crushable!

4. FINCO'S EXCLUSIVE TRIPLE THICK SLEEVED ELEMENTS. Not only does the new FINCO VE-LOG feature the finest extra heavy walled aluminum tubing for its elements, but to assure mechanical design superior to ordinary antennas, a triple thick sleeve assembly is used for assurance plus strength to combat destructive high winds and wet snows. First a die stamped bracket with triple strength aluminum rivet, then a long oversized outside sleeve shell plus the aluminum element itself. FINCO invites competitive comparison!

5. LOCK TITE NO-TILT SADDLE BRACKET. Because FINCO pioneered the heavy duty square boom, because FINCO developed the back-up bracket to eliminate boom crushing, because positioned cleats assure sag-free positive direction of the antenna, and because FINCO brackets are rustproofed, therefore, FINCO'S boom-mast bracket is the finest and most trouble-free available!

6. FINCO'S EXCLUSIVE DOUBLE CONTACT TO DRIVE LINE. Never before has there been designed such a positive, vibration-free, non-corrosive contact for perfect drive line support and electrical continuity. An ingenious all aluminum die stamped double clip with preformed rivet cup and spring tension jaws for permanent trouble-free contact completion to be found on no other antenna!

7. CONTINUOUS ONE PIECE DRIVE LINE AND EXCLUSIVE AIR INSULATED HIGH IMPACT POLYSTYRENE CROSS-OVER SPACER.

No more jointed drive lines as commonly used on other antennas! FINCO proudly presents the first continuous one-piece heat treated aluminum rod cross-over drive line assembly! No possibility of loose connections, shorts or broken drive line sections. One continuous non-breakable piece of rod criss-crossed thru an amazingly efficient polystyrene snap-lock spacer featuring the finest of all insulation against short-outs. A center air insulator space built into each spacer. One piece drive lines plus air insulated spacers, plus triple elements, plus metal shielded brackets, plus positive snap-in element guides, plus FINCO'S heavy duty square boom, plus UHF-VHF-FM reception and you have America's antenna design of tomorrow!

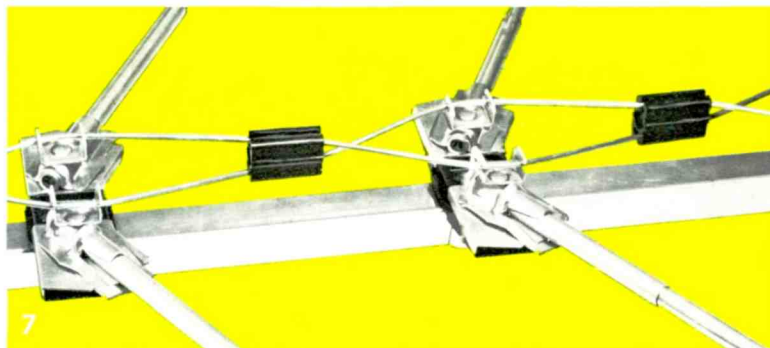
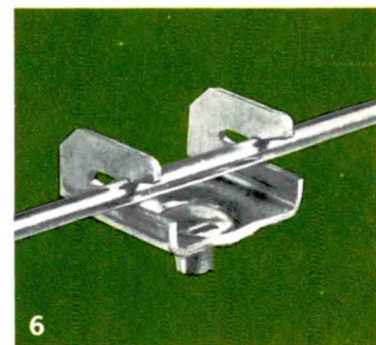
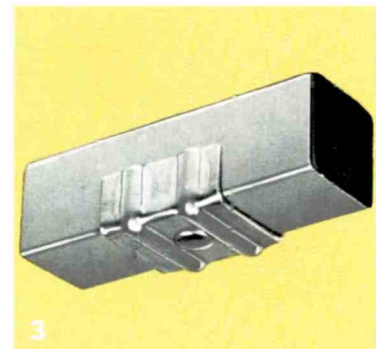
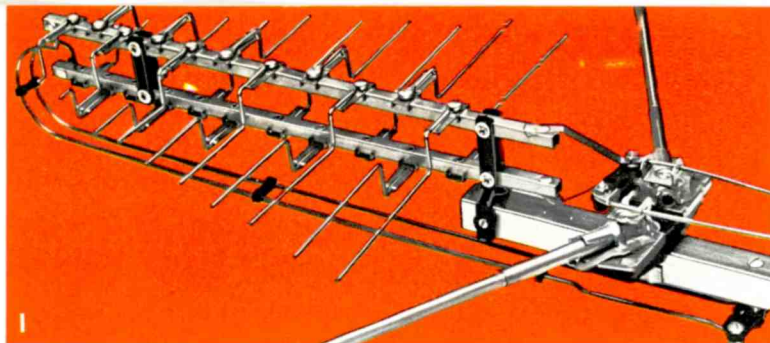

Prices and specifications subject to change, exclusive international representative: Rocke Int. Corp., 13 E. 40th St., New York 16, N. Y., U.S.A. Cables "ARLAB".



THE FINNEY COMPANY

34 WEST INTERSTATE STREET, BEDFORD, OHIO 44014

REPUTATION
ENGINEERING
LEADERSHIP
PERFORMANCE

FINCO MODEL
UVF

18

Eleven UHF
Elements
channels
14 thru 83
Seven VHF
Elements
channels
2 thru 13
FM-monoaural
stereophonic
Only one downlead
required
Gold Corodized

LIST

42⁵⁰

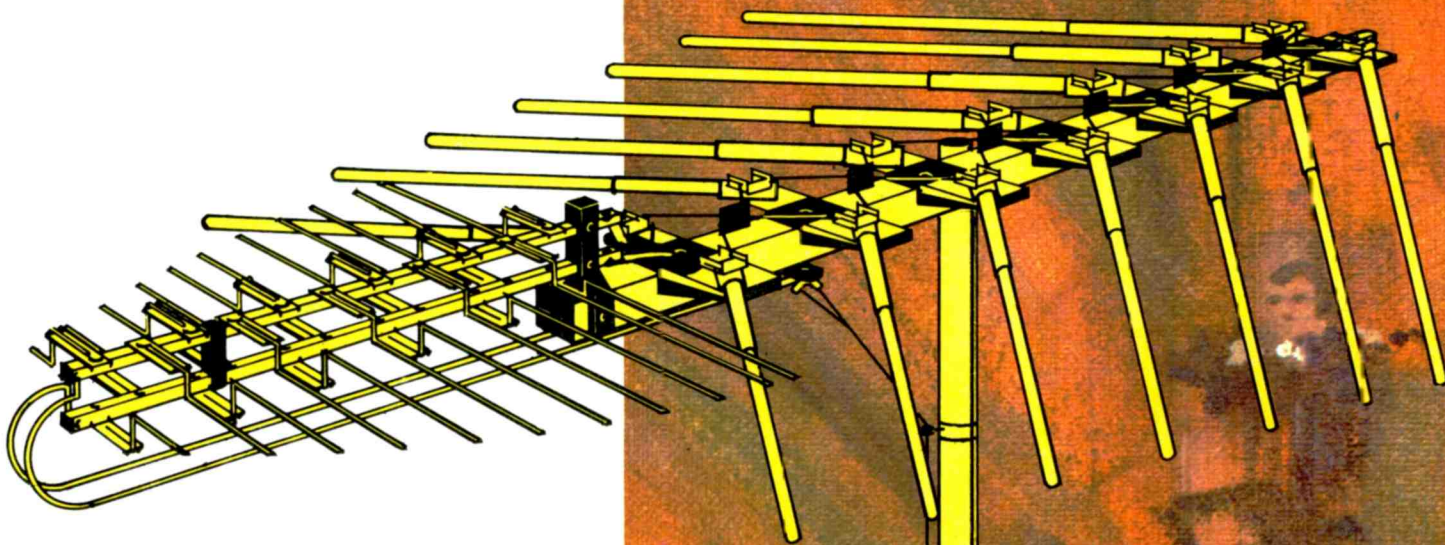

MODEL NO. UVF 18
SUBURBAN AND NEAR FRINGE

FINCO MODEL
UVF

24

Fifteen UHF
Elements
channels
14 thru 83
Nine VHF
Elements
channels
2 thru 13
FM-monoaural
stereophonic
Only one download
required
Gold Corodized

LIST

59⁹⁵

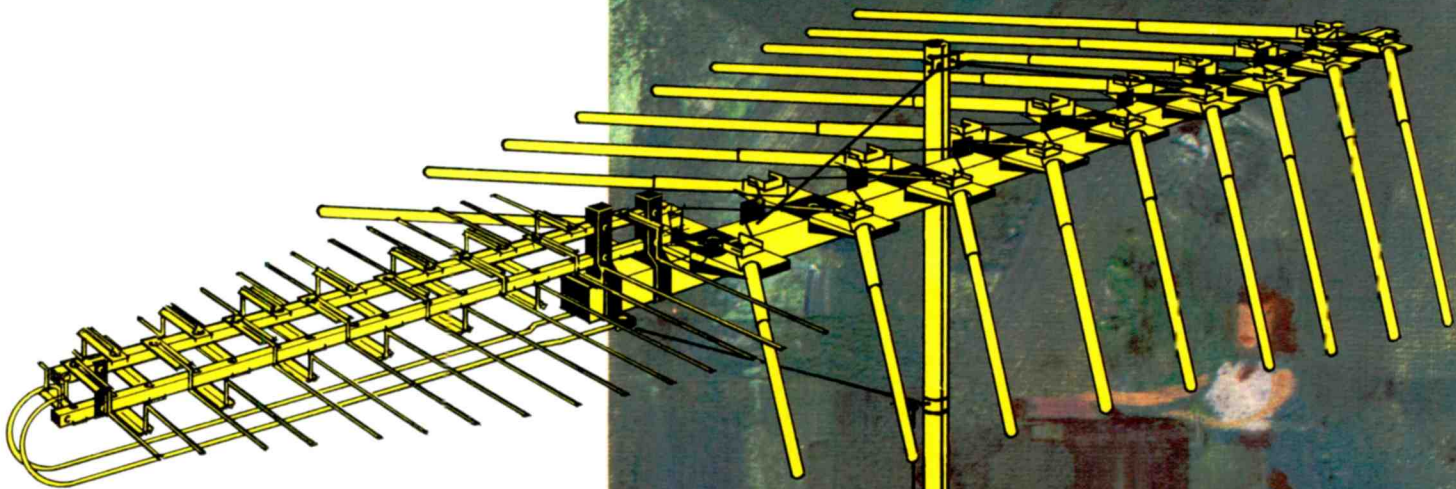

MODEL NO. UVF 24
NEAR AND DEEP FRINGE

FINCO

All Band

UHF·VHF·FM

COLOR VE-LOG ANTENNA

The introduction of the superlative new all band Color-Ve-Log Antenna represents a true breakthrough into a field of antenna design and performance heretofore considered as only a possibility of the future.

Combining . . .

- the growing allocation of ultra high frequency TV channels,
- established very high frequency television,
- dramatic color and black and white perfection.
- astoundingly rich, full bodied stereophonic FM reproduction.
- sharp, clear monophonic FM sound . . .

all captured at their best by the antenna that stands alone in performance and warranty . . . the FINCO

All Band UVF Series!

RESEARCH

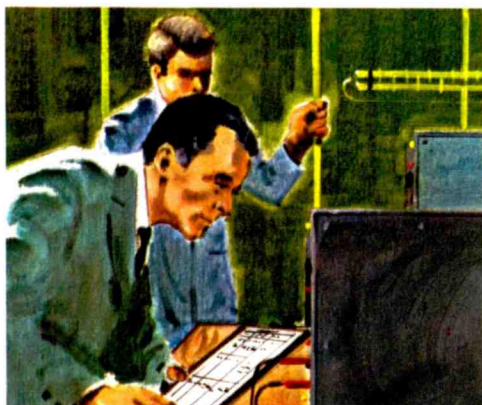

TESTING



ENGINEERING

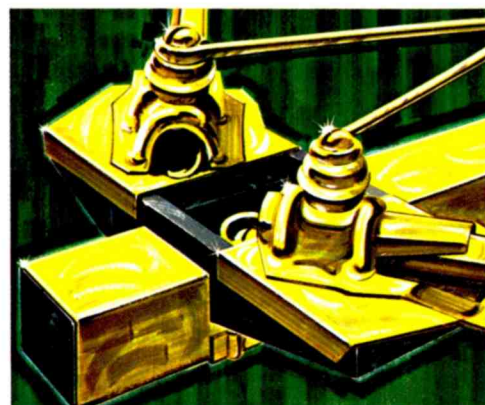

NEA CONVENTION

The annual awards luncheon followed a lengthy morning business session with President Dick Glass making personal presentations to National Committeemen, State Association officers, etc. as well as special citations to top distributors throughout the United States that had been nominated by local groups. The lunch was sponsored by Sylvania Electric Products.

That afternoon came the big election campaign and the final tally of top winners for national office in NEA.

Annual Banquet

The NEA annual Banquet was held on Saturday evening following a cocktail party sponsored by the Howard W. Sams Company of Indianapolis. Mr. Bill Renner, who was to personally host the event, was unable to get plane reservations and his regrets were made known at the Banquet itself.

Mr. Gordon Burns, Customer Relations Director for the General Electric Company, was introduced by M. C. Don Martin, Publisher of the Electronic Service Dealer Magazine and he, in turn, introduced Mr. Ollie Halttunen, Manager of Distributor Sales for the General Electric Company. Mr. Halttunen addressed the jam packed main dining room of the Sheraton Inn on the subject of the real future of electronic service. He did a resume of many of the things that have already been developed and others that almost seem impossible to conceive. He predicted that the electronic technician has a future second to none and that it won't be too long before he will be servicing refrigerators, ranges, washers, dryers, etc. The transistor is here to stay and when it comes to anything electronic there is only one profession that can provide the service necessary to do the job.

Following his presentation, President Dick Glass was introduced to the group and he presented the NEA top awards for the nation's outstanding State President, State Vice President, National Vice President and National Committee Chairman. Mr. Paul Cartreet of ETA of North Carolina was named as the top State President, and

Following his presentation, President Dick Glass was introduced and awarded NEA's top plaques for outstanding service on a local, state and national basis. Winner as the top State President in the Country was Paul Cartreet of ETA of North Carolina. The most outstanding local chapter president award went to Hugh Wilkins of the Los Angeles chapter of the California State Electronics Association. The most outstanding National Vice President's award went to M. D. Tedrow of ETA of North Carolina and the most outstanding national committeeman award went to Howard Bonar of Iowa.

The nation's top state publication award was presented by Ed Carroll of Indiana and the award went to Pete Fabbri for the TSA Michigan Magazine and its deceased editor for many years, Hal Chase.

Paul Lecoy then came forward and congratulated Dick Glass for his outstanding leadership over the past two years and awarded him a gavel as a reminder of his office and a plaque recognizing his great contribution to NEA and the industry as a whole.

The grand banquet was sponsored by General Electric Company and the dance that followed was sponsored by General Cement Company.

On Sunday, a brunch, sponsored by the Winegard Company, was held immediately following an adult only hang-over party at 7:30 a.m., sponsored by the Winston-Salem, North Carolina, Chamber of Commerce and their executive director Charles Dugan. The Chamber, the night before, had also made a special presentation to Pete Fabbri for his efforts

in making this convention an outstanding success. Their VIV plaque (Very Important Visitor) is presented to a person who has demonstrated outstanding leadership and goodwill towards their community. Fabbri was the national convention chairman while Dick Taymer of Winston-Salem acted as local convention chairman.

At Brunch, the guest speaker was Hal Essex of WSJS-TV of Winston-Salem who reiterated the important position of the service industry in providing good color reception. This was followed by additional committee awards and the report of the Resolutions Committee.

Resolutions

The following resolutions were adopted by the Convention delegates and they include:

1. To thank all Manufacturers, Distributors and NEDA representatives for their support and attendance at this second annual convention.

2. To thank ETA of North Carolina and their newly formed auxiliary for their outstanding hospitality and good will to the over 300 delegates from some 18 states.

3. To thank the Chamber of Commerce of Winston-Salem, North Carolina, for their outstanding hospitality, to Mayor Red Benton for his fine remarks on the opening day, and to all merchants who contributed to the success of this convention.

4. To thank the management and personnel of the Sheraton Motor Inn for their outstanding efforts in making this convention such a fine affair.

5. To commend the Electronic Service Dealer Magazine finest magazines in the country devoted to the service industry.

Industry Resolutions

Aside from these normal resolutions of thanks, the Board of Directors of NEA took the following stand on national issues:

1. To re-affirm the NEA standing in regards to CATV. This includes an endorsement of CATV systems wherever it is needed to provide a signal. That any CATV franchise should include a clause preventing the sale or service of TV receivers, and that it should be regulated by Federal legislation to protect the broadcasters and program developers.

2. To congratulate the Television Broadcasting Industry for their efforts to improve, through new equipment and training, the quality in color television broadcasting and to further thank the three representatives from the major networks for addressing this national NEA convention.

3. To establish a committee of NEA representatives to work as a team to further a mutual method of communication between the service industry (NEA) and the Electronic Industries Association (EIA) for the benefit of establishing standards of serviceability.

4. To promote a national movement toward the universal certification and an apprenticeship program in order to establish standards of excellence in workmanship and ability among home entertainment service technicians, dealers and companies.

5. To strive for unexcelled excellence in servicing home electronic products and to set an example, by all NEA members, for the industry.

6. To set the third annual NEA convention for August of 1967 at Des Moines, Iowa.

The final "get-away" lunch followed the presentation of resolutions and this was sponsored by the Jerrold Electronics Company. Guest of honor at this luncheon was Mr. and Mrs. Jerry Norman and family of five children. Mr. Norman was the winner of NEA's top prize in the membership contest. The winner received a free trip to the convention for he and his wife. The Normans live in Winston-Salem, North Carolina.

Now in one handbook...the service information you need for 12 makes of color TV sets



TABLE OF CONTENTS

- INTRODUCTION
 HOW TO USE THIS HANDBOOK
 ABBREVIATIONS USED IN THIS HANDBOOK
- Section 1. CHASSIS INDEX
 CHASSIS LAYOUTS
 - Section 2. PURITY ADJUSTMENTS
 - Section 3. CONVERGENCE ADJUSTMENTS
 STATIC CONVERGENCE (general)
 DYNAMIC CONVERGENCE (specific)
 - Section 4. BLACK-AND-WHITE SETUP ADJUSTMENTS
 - Section 5. PHASE AND MATRIX ADJUSTMENTS
 - Section 6. COLOR AFPC FIELD ADJUSTMENTS
 - Section 7. MISCELLANEOUS ADJUSTMENTS
 - Section 8. FUSES AND CIRCUIT BREAKERS
 - Section 9. TEST EQUIPMENT FOR COLOR TV SERVICING
 - Section 10. RECEIVING TUBES FOR COLOR TV

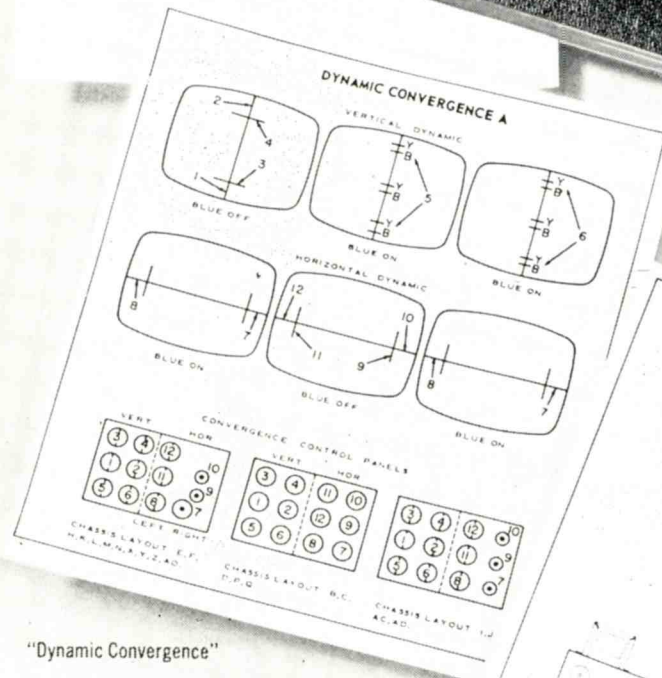

"Dynamic Convergence"

Just look up the chassis number of the set you are working on in the CHASSIS INDEX and you will be guided to the proper sections of the 140-page RCA Color TV Service Handbook. All the information is based on the manufacturer's own service notes. You'll want to carry a copy in your tube caddy on every color TV service call.

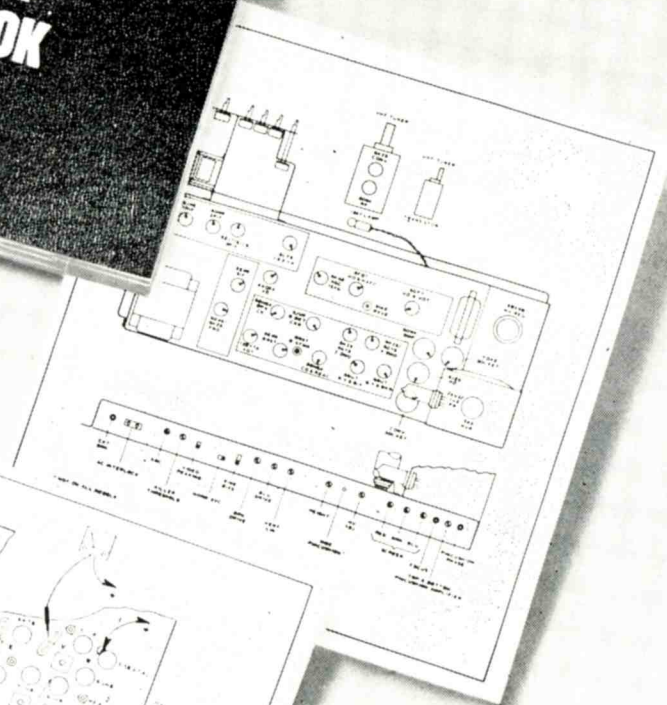

"Color AFPC Field Adjustments"



"Chassis Layouts"

TO KEEP UP WITH COLOR, SEE YOUR RCA DISTRIBUTOR ABOUT GETTING THE RCA COLOR TV SERVICE HANDBOOK (1A1553).

RCA ELECTRONIC COMPONENTS AND DEVICES, HARRISON, N. J.



The Most Trusted Name in Electronics

RCA's personal quality performance program aims for missile-type reliability in commercial receiving tubes. Under this program thousands of RCA people have pledged to strive for error-free performance so that when you replace with RCA receiving tubes you're sure of a satisfied customer.

ELECTRONIC SERVICE DEALER

RECOMMENDATIONS FOR CONVERTING EARLY COLOR TELEVISION RECEIVERS TO USE NEW PICTURE TUBES

Courtesy of RCA Victor Distributing Corp.
Los Angeles, California

Early 21-inch color television receivers may be converted to use newer color picture tubes if the following general procedures are followed. The types of conversions are divided into three general categories—converting receivers designed for metal color picture tubes for use with all-glass color picture tubes converting receivers designed for early all-glass color picture tubes for use with tubes utilizing all-sulfide phosphor-dot screens, and converting receivers designed for all-sulfide color picture tubes for use with tubes employing rare earth in the phosphor-dot screen. Conversions can be made combining all three of these categories.

CONVERSION FROM A METAL TUBE TO AN ALL-GLASS COLOR PICTURE TUBE

Conversion of color television receivers using an RCA-21AXP22 or RCA-21AXP22A to use an RCA-21CYP22A is most effectively accomplished by using an RCA-12B101 conversions kit which is available from franchised RCA Parts and Accessories Division distributors. This kit, primarily designed for use in RCA color television receivers, includes the necessary hardware and detailed, step-by-step instructions for all the required electrical and mechanical modifications.

CONVERSION TO A COLOR PICTURE TUBE TYPE UTILIZING AN ALL-SULFIDE SCREEN

Conversion of color television receivers using an RCA-21CYP22 or RCA-21CYP22A to use an RCA-21FBP22 can be easily accomplished. The 21FBP does not have a second high-voltage (anode) terminal on the funnel like the 21CYP22 or 21CYP22A thus eliminating the need for the 56,000-ohm current-limiting resistor used on these early tubes. The single anode terminal on the 21FBP22 is located approximately 3 inches closer to the yoke than the terminals on the 21CYP22 or 21CYP22A. Depending on the mounting arrangement used for the 21CYP22 or 21CYP22A, minor mechanical changes may be required to prevent corona or arc-over from the anode terminal to the grounded hardware. Magnetic shields, pull-up type mounting harnesses or yoke supports normally can be "notched" and insulated with appropriate plastic sheeting held in place by plastic electrical tape to achieve the desired high-voltage insulation. A cup-type high-voltage insulator should be used at the picture-tube end of the high-voltage lead.

The more uniform phosphor efficiencies of all-sulfide phosphors require a relative reduction in the video drive to the red gun in the 21FBP22 color picture tube. A 21FBP22 should operate satisfactorily in a chassis originally designed for a 21CYP22 or 21CYP22A if the blue-gun and green-gun cathode leads are connected to the red drive take-off point. A 2700-ohm resistor is usually present in the red-gun cathode circuit. In such cases, the blue and green leads should be tied to the amplifier side of this resistor as shown in the figure.

CONVERSION TO A COLOR PICTURE TUBE TYPE EMPLOYING A RARE EARTH IN THE SCREEN

An RCA-21FBP22A (employing rare earth in the phosphor-dot screen) may be substituted directly in receivers

originally equipped with or modified to use an RCA-21FBP22 all-sulfide color picture tube. If satisfactory high-light tracking is not obtained, the red cathode-lead connection should be interchanged with either the blue or green cathode-lead connection, as required.

CHROMA CIRCUIT CONSIDERATIONS

Subjective tests have shown that commercially acceptable color pictures can be obtained without any modifications to the chroma circuits for all of the above conversions. Minor differences in the chromaticities of areas in the pictures can only be detected through a side-by-side comparison by trained observers.

SHUNT REGULATOR MODIFICATIONS

When any of the above conversions are made, it is recommended that the following two parts be added to the shunt regulator circuit if the shunt regulator and the color picture tube heaters are connected to the same transformer winding, providing they are not already installed. These parts will lessen the possibility of picture-tube damage in the event of high-voltage cascade arcing. An 0.1-microfarad, 600-volt capacitor should be installed between one side of the shunt-regulator heater and ground, and a 1000-ohm resistor should be placed between the shunt-regulator cathode and B+.

GENERAL CONSIDERATION

In any picture-tube mounting changes, be sure that all metal parts and the picture-tube external conductive coating are grounded to the chassis.

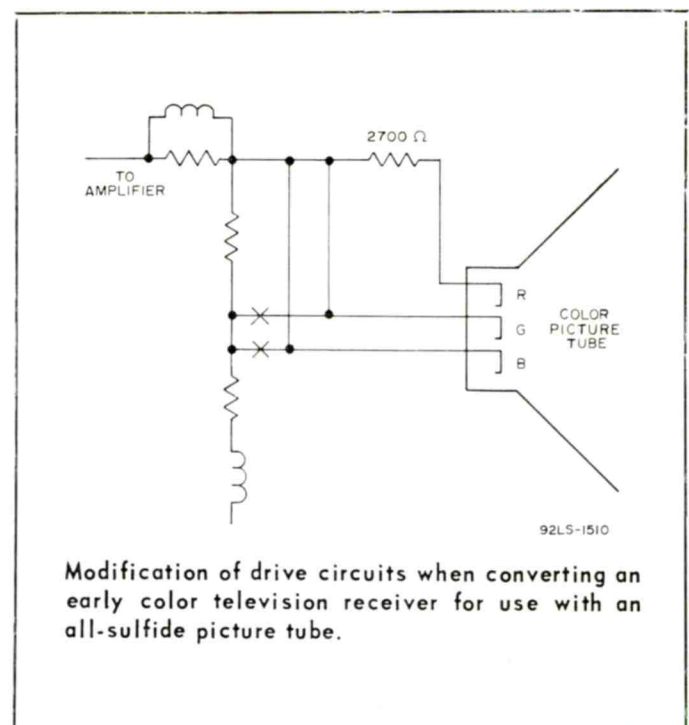

Modification of drive circuits when converting an early color television receiver for use with an all-sulfide picture tube.



**Every time
you sell an RCA
TV antenna
you buy
customer confidence.**

Customers feel better about buying from you, when they know you sell antennas with the first name in color and black & white TV.

Your profit is assured, too, when your antennas have the RCA Mark of Quality. That's because you sell a brand, rather than a price. And, the RCA brand identifies the leader in TV station equipment, TV receivers, and TV satellite equipment for outer space. Therefore, the customer expects *this* brand to identify outstanding TV antenna performance. It does.

There's an RCA antenna for every reception area. For maximum profit and performance, sell the top of RCA's complete line. RCA COLOR-SCAN outdoor antennas bring all VHF, UHF and FM signals to suburban and fringe areas. The RCA COLOR-MARK II is unsurpassed in indoor antenna performance (VHF, UHF and FM) -- and its styling is in a class by itself.

Have your RCA Distributor give you the profit picture on RCA antennas. It's as beautiful as the TV picture your customer gets when he buys them.

RCA PARTS AND ACCESSORIES, DEPTFORD, N.J.



The Most Trusted Name
in Electronics.

CALECTRON

San Francisco: 33 Gough Street, MA 1-3400
Fresno: 2930 Butler Avenue, 268-8411
No. Sacramento: 330 Commerce Circle, 922-5885

RCA VICTOR DISTRIBUTING CORP.

Los Angeles: 6051 Telegraph Road, 723-6661
San Diego: 820 West "F" Street, 234-6316
San Fernando Valley, 781-6501
Pasadena and Burbank, 246-8373
San Gabriel Valley, 443-6907
Long Beach, Downey, 639-6950
Inglewood, Redondo, 675-4401
Orange County, (714) 521-6700
Whittier, Alhambra, 728-7295

PRODUCT NEWS

Conducted by A. Diane Powell, Associate Editor



NEW MERCURY COLOR GENERATOR PROVIDES EXTRAORDINARY TROUBLE SHOOTING FLEXIBILITY

The Model 1900 Solid State Color Generator just introduced by Mercury Electronics Corp., 315 Roslyn Road, Mineola, New York provides every essential feature needed to install and service Color TV. The solid state circuit has been engineered to produce instant, stable, reliable patterns.

The unit boasts some exclusive features that will be greatly appreciated by the technician. A line width adjuster enables the serviceman to select the vertical and horizontal line thickness or dot size of his choice. All calibrations can be made rapidly without removing unit from cabinet.

Separate horizontal and vertical bars swiftly indicate area of misconvergence and saves time by showing technician where to start. A crystal controlled keyed rainbow color display is provided to test and adjust color circuits.

The Model 1900 connects easily to the tv antenna, thus eliminating the need of opening set to make most tests. There is a high RF output on channels 3, 4 or 5. The unit is factory set at channel 3, and adjustments for channel 4 or 5 are made easily without removing unit from cabinet.

Additional features are: Color level control to check color sync circuits-Color coded gun killer switches conveniently located on panel-Lead piercing clips for quick and positive grid connections-Voltage regulated transistor and timer circuits to assure stable operation under wide voltage ranges-Line isolated to prevent shock hazard-Convenient storage

compartment for all cables. Power requirements . . . 117 volts, 50-60 cycles, 3 watts. The Model 1900 Color Generator is available through parts distributors at only 89.50. There is no additional charge for gun killers.

COLORSCOPE

G.C. Electronics Co., Rockford, Illinois announced last week a new Color T.V. service aid that should find wide acceptance among color servicemen. Intended primarily for use in color dot convergence, the colorscope magnifies the color dots to such an extent that a higher accuracy can be obtained in dot convergence than was previously possible with the naked eye. In addition to magnifying the color dots the colorscope allows the serviceman to perform dot convergence entirely from the back of the T.V. set, saving much time over previous methods. A single suction cup holds the colorscope over any chosen point on the face of the CRT.

According to S. B. Valiulis, GC President, "The Colorscope aids in such precision adjustment of the colors that even the untrained eye can see a remarkable improvement in clarity and accuracy of colors."

REPLACEMENT CRYSTALS AVAILABLE FROM IR

International Rectifier, El Segundo, California, has introduced a revolutionary line of replacement crystals for color television sets. The company is already the principal supplier of focus and boost replacements for color TV.

Each crystal in the new line is produced to the identical specifications of the original set manufacturers requirements, thus assuring the dealer service technician of an exact replacement in both physical and electrical specifications.

The new line — exclusive with International Rectifier — is comprised of five crystals, CY-1, 2, 3, 4 and 5, which are replacements for all crystals in use in all makes and models of color TV sets. They have a resonant frequency of 3579.545 kc. The capacitance in picofarads for CY-1, 2 and 5 is 7.0; CY-3 has a capacitance of 3; and CY-4 capacitance is 4.6.

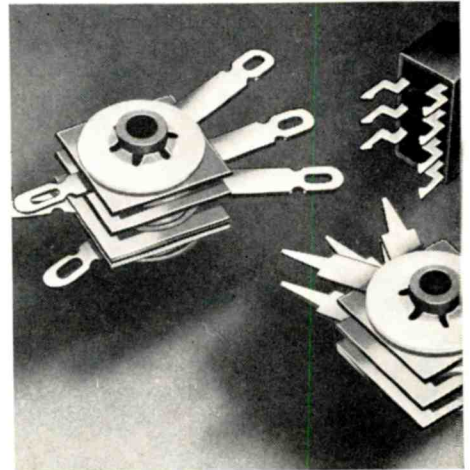

4 NEW EXACT REPLACEMENT COLOR TV RECTIFIERS FROM TARZIAN

Four new exact replacement selenium convergence rectifiers for color TV have been announced by the Semiconductor Division of Sarkes Tarzian Co.

These convergence rectifiers are exact replacements for the following manufacturer's models: Tarzian Type S-855 replaces Admiral 93B53-2, Emerson 817-149, General Electric M128J753, Hoffman SR-37, Motorola 48D66653A, Muntz, Packard Bell, RCA 1370990, Philco 34-8058, Setchell Carlson, Sylvania 13-17569, Warwick (Sears) 86-55-3, Wells Gardner (Ward, Grant) 41-001, Westinghouse 29V031, Tarzian Type S-420 replaces Zenith 212-25, Tarzian Type S-798 replaces Zenith 212-63, Tarzian Type S-781 replaces Admiral 93C1-21 and Admiral 93C1-20.

101 WAYS BOOK DETAILS LATEST METHODS FOR USING OSCILLOSCOPES

Oscilloscopes have changed considerably during the past several years. Wide-band "scopes" are now standard equipment and the trigger sweep "scope" — which was formerly a laboratory curiosity — can now be found in the better-equipped service shops.

In short, the uses of the "scope" in electronics servicing continues to grow.

(Continued on Next Page)

NEW PRODUCTS

Consequently, this newly revised working handbook in the popular "101 Ways" series will be especially helpful to servicemen.

101 WAYS TO USE YOUR OSCILLOSCOPE, by Robert G. Middleton, shows the latest methods for using an oscilloscope for faster, more proficient servicing . . . including those for the newer types of "scopes." Tells how to make waveform tests and how to analyze the waveforms produced by defective circuits.

CENTRALAB PUBLISHES PEC INTEGRATED CIRCUIT REPLACEMENT GUIDE

A new 20-page PEC Integrated Circuit Replacement Guide and Catalog has just been published by Centralab, the Electronics Division of Globe-Union Inc.

The valuable reference lists 209 different PEC integrated circuits that are currently available from electronic parts distributors. These devices have extensive application in radio, TV, and hi-fi equipment. Complete schematics including values of the specific components in these RC network circuits are shown.

The catalog is indexed by type of circuit as well as by circuit function. There are detailed alphabetical listings of 191 manufacturers with 1600 replacement applications in equipment using these circuits. A cross reference to other manufacturers of packaged circuits is included.

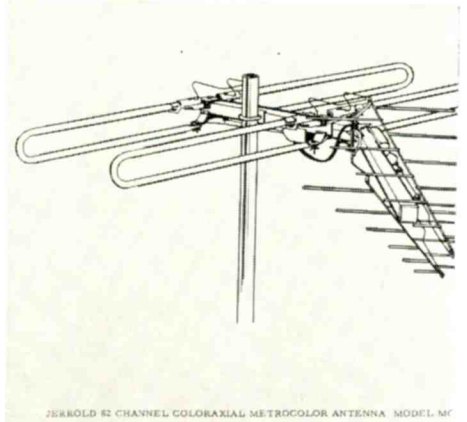

NEW JERROLD METROPOLITAN ANTENNAS DEBUT

Jerrold Electronics has announced two new antennas designed specifically to wipe out color ghosts in metropolitan areas.

The new METROCOLOR series antennas feature a hybrid coupler phasing harness which results in a very high front-to-back ratio.

In metropolitan areas there is usually more than enough signal. Therefore, technicians have traditionally installed inexpensive, low gain antennas.

The problem, however, is that metropolitan TV sets are troubled by "ghosts." Ghosts are actually reflected signals. The transmitter signals bounce off a tall building or hill and arrive at the antenna a little late. Thus, the viewer sees a faint outline to the right of the image from the direct signal. In many metropolitan areas, multiple ghosts are not uncommon.

Ghosts have been widely tolerated on black & white sets. A bothersome nuisance, they've been considered a necessary evil by many viewers.

But color has changed the picture. Even the faintest of color ghosts stands out like a sore thumb. Most viewers find color ghosts absolutely intolerable.

The new Jerrold Metrocolor antennas minimize ghosts by rejecting reflected signals. Formerly, this was possible only with an expensive, high gain fringe-type antenna. But the Metrocolor antennas actually have as much ghost killing power as a high gain antenna.

Further, Metrocolor antennas are matched for use with Coloraxial cable. Shielded Coloraxial cable not only keeps interference out, but it prevents line ghosts.

Jackson

...IT'S THE FINEST



is \$234.95
too much to pay for a
TUBE TESTER?

It can be too much if you have little use for a tube tester. But if you are a technician on the go, who believes an investment in top equipment is a sound investment in your own skill, ability and livelihood, then the Model 658-1 DYNAMIC OUTPUT TUBE TESTER is your greatest bargain. No other tube tester available makes so many accurate tests on more tubes, so quickly. Makes a true rectifier test, handling high current types with ease • tests grid leakage up to 80 megohms • heater current on series string tubes • heater continuity without warm-up • indicates striking point and operating range for regulator and reference tubes • provides the right sensitivity for triple shorts sensitivity test on each tube • dynamic test for eye tubes • accurate test on all 12-volt hybrid tubes • famous Jackson life-line test. Among the many extraordinary features of the Model 658-1 is the brilliant *dynamic output principle*, providing the most valid kind of test for amplifiers, by considering the entire output curve of the tube—not just a small portion. Fast push-button sequence switching makes set-up time less than tube warm-up time. Convenient angled view zig-zag color coded roll chart is read right on the panel. Don't settle for less than the ultra reliability of the Model 658-1.

*Model 658-1 DYNAMIC OUTPUT TUBE TESTER...Net...\$234.95

See your Jackson distributor, or write for catalog

JACKSON ELECTRICAL INSTRUMENT COMPANY

35 Windsor Avenue, Mineola, New York 11501

Export: Morhan Exporting Corporation
458 Broadway, New York 13, N.Y.

IF IT'S A JACKSON...IT'S THE FINEST



JERRY BALASH APPOINTED WESTERN SALES MANAGER FOR JFD ELECTRONICS

Brooklyn, New York — Mr. William Ciancy of JFD Electronics has just announced the appointment of Jerry Balash as regional sales manager for the Distributor Sales Division. Mr. Balash will be responsible for coordinating sales of JFD antennas and accessories in the west, southwest and southeast sections of the United States. Balash is the former manager for Blonder Tongue Labs and has experience as a distributor and manufacturer's representative.

PACKARD BELL LOSES APPEAL ON BERDR REGISTRATION

Sacramento, California—Packard Bell Eletronics Corp. has lost its fight to avoid registering under the California Electronic Repair Dealer Registration Law. The long fight, that began almost three years ago, was climaxed when the Supreme Court refused to hear the case which upholds the appellate court's decision that they must register under the law.

Packard Bell contended that they were operating under the State Contractor's license and therefore did not have to register with the new Bureau. A lower court upheld their contention but this was reversed by the appellate court in an action brought by the State of California.

TV Industry Urged To Launch Program To Train Young Men As Electronic Technicians

FORT WORTH, Texas—The television servicing industry must launch an all-out effort to urge young men to become electronic technicians if it is to meet successfully the new product challenges of tomorrow, the Texas Electronics Association was told recently.

Paul B. Garver, General Manager, RCA Parts and Accessories, told the Association's 14th annual Clinic and Fair that "this business of attracting young people into this profession is pretty dependent upon the image you create in your community.

"Today's challenges can be tomorrow's opportunities if we take the Positive Approach," Mr. Garver told the 750 delegates to the three-day meeting at the Green Oaks Inn.

"Young men usually decide to become doctors or lawyers because they know a successful doctor or lawyer well enough to have a high degree of respect for him as a professional and as an individual," he said. "Unless you create the same kind of an image in your community you will not attract the young people to your profession."

Mr. Garver also suggested that television servicing organizations and dealers talk to teachers in local high schools and trade schools about the opportunities that exist for young people in this fast-growing field.

He pointed out that the consumer electronics industry is enjoying "phenomenal growth and the opportunities it is still presenting are equally phenomenal. The future I am sure holds new developments which will be as revolutionary to the industry as the development of color television."

"It appears as though we are on the threshold of an age when we will become not just television servicemen but electronic technicians," he said. "Billions of dollars are being spent each year in the development of highly sophisticated electronic gear which will have an ultimate effect on your business."

As examples of future opportunities for the electronic servicing technician he pointed to recent progress of electronics in the fields of data processing, printing, medicine, transportation and education.

Mr. Garver said the shortage of qualified technicians can be partially solved by a better utilization of available skilled personnel. He urged his audience to take



SO. CALIF. DISTRIBUTOR WINS G.E. CONTEST

REDONDO BEACH, Calif. — Arthur Duhammel of Bay Electronics accepts a General Electric portable tape recorder from Richard Kling as his prize for winning a contest conducted by G.E. at the recent National Electronics Show in San Francisco.

The contest, sponsored by G.E.'s Electronic Component Sales Operation, involved guessing the number of General Electric electronic components displayed in a glass-enclosed box the shape of the G.E. exhibit at the show.

Duhammel, owner-manager of Bay Electronics, had the closest guess of the several thousand people who attended the show.

Kling, Los Angeles district distributor sales manager for G.E.'s ECSO, presented the prize to Duhammel at his store here, 2315 Artesia Blvd. On hand to add his congratulations was (left) Robert E. Gianinni, Western Zone manager for ECSO.

advantage of the experience of manufacturers who have "learned to use skilled personnel only for skilled work and to have work which can be done by people of lesser skill done by others, and to have the equipment and inventories available for the greatest efficiency.

"The electronics industry is moving forward at a rapid pace," he concluded. "It requires continued development, capability and maturity on the part of the manufacturer, the distributor and the servicing dealer."

HEFTY JOINS STAFF AT MARSHANK CO.

Marshank Sales Company, Southern California electronic representatives, announce the addition of John Hefty to their staff as a field sales engineer.

For the past eight years John Hefty was associated with West Valley Electronic Sales in Canoga Park, California and for the past four of these years managed their branch operation in Granada Hills, California.

Marshank Sales is primarily involved in sales to sound and high fidelity accounts as well as sales to distributors and the retail market.

This pioneer representative firm is now in its 47th year of business.

ERA TRADE DIVISIONS INSTALL NEW OFFICERS

The Audio and Distributor Trade Divisions of ERA's Southern California Chapter recently installed officers for six-month terms ending in December. "Sort of a 'lame duck' session," states Chapter President Larry Courtney, "the interim term will bring trade divisions in line with the Chapter's calendar year."

Elected Chairman for the Audio Divi-

sion was MIKE STOBIN, owner of the Mike Stobin Company located in Van Nuys. Stobin has been active in Division committee work over the past year as well as a firm backer of audio and hi-fi show activity.

HERB BECKER is the Chairman of the Distributor Division. Becker, President of Herb Becker, Inc., has served on several committees and was the Vice Chairman last year. Herb has been prominent in WESCON's Manufacturer/Distributor/Representative conferences for many years.

Other officers elected by the Audio group include Pete Morris, partner in Morris-Tait Associates, as Vice Chairman; and Dick Schnepf, Carter & Rossney Associates, as Treasurer. The Distributor Division elected Harold Shomler, W. Bert Knight Company as Vice-Chairman; Bill Wallace of Wallace and Wallace as Secretary; and David Muir of David Muir Company as Treasurer.

Southern California was selected as ERA's "Chapter of the Year" for 1965 by the national body at its Palm Springs conference during January. The Audio and Distributor division programs and activities in promoting representatives and their customers was a major factor in the Chapter's attaining this distinction.

ASSOCIATED RADIO EXPANDS; MOVES MT. VIEW STORE

San Francisco, Calif. — Associated Radio Distributors of San Francisco have enlarged their San Francisco operation by adding over 1500 square feet to the second floor of their present store.

According to Eric Ledin, vice president of the firm, we have made this addition in order to carry larger inventories for our dealers. At the same time, he announced the moving of the Mountain View store to 2150 East Middlefield road and the Vallejo store to 1340 Tennessee Street. Harold Burts is manager of the Mountain View branch and Don Bennett is manager of the Vallejo operation for Associated.

ADAMS MOVES FROM ZENITH; NAMED V.P. AT STANDARD KOLLSMAN

Chicago.—John H. Adams has been elected Vice President of Marketing for the T. V. Tuner Division of Standard Kollsman Industries Inc., Melrose Park, Illinois. Adams replaces A. Svanascini who resigned May 1, 1966.

Announcement was made by J. P. Tumminaro, General Manager of the Tuner Division.

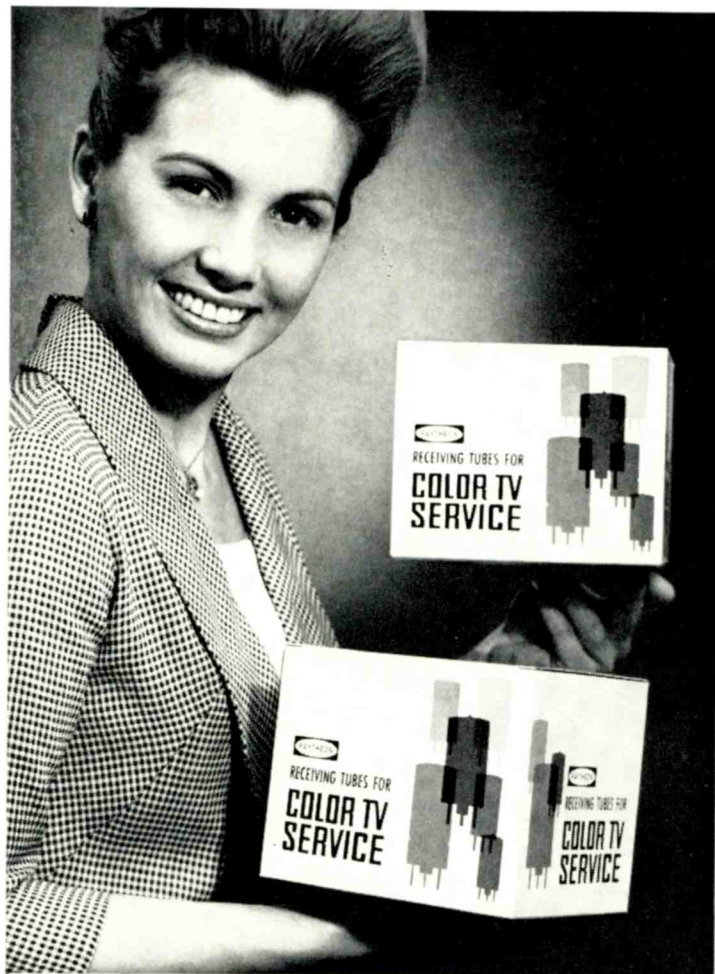

Brighten your profit picture— with Raytheon's new color tube kits

Both pack 25 of the most popular tubes for color TV service. You'll use them fast—because they're selected for sales now in the fast-growing color tube market.

Ask your distributor for Raytheon color kits now—and the price that packs more profit into every pack.

RAYTHEON

ELECTRONIC SERVICE DEALER

Prior to joining Standard Kollsman Industries, Adams was General Manager of the parts and accessories division of Zenith Sales Corporation. He also has been associated with Central Electronics, Div. of Zenith Radio Corp.; The Kleinschmidt Division of Smith-Corona Marchant Inc.; The Rola Company of Cleveland and the Muter Company of Chicago.

Adams is a Director of the Association of Electronic Manufacturers, a member of the American Marketing Association and the Radio Old Timer's Club.

He is the father of three girls and three boys. His eldest son, Norman Jr., is a senior at San Jose State College, majoring in physics.

James is also noted for his deep interest in the welfare of all people. In concluding every meeting of the Alameda County Television and Radio Association, he calls for better understanding among all men, and, specifically regarding the TV service industry itself, for unity, mutual helpfulness, and fair treatment of the industry's customers. Those who know him and his deeds well consider him not only a competent and ethical business man, but a man of sterling stature.

SAMS BOOK PINPOINTS TUBE-CAUSED TV TROUBLES

As the majority of servicemen know, most TV troubles are caused by faulty tubes. Therefore, by linking the various symptoms with specific tubes, the majority of TV receivers can be repaired in minutes.

In this newly-revised edition of TV TUBE SYMPTOMS & TROUBLES, well-known author Bob Middleton, first explains what each section of a TV set is supposed to do—and what happens when it doesn't. Further, he points out the reason why variations in circuit design can result in similar symptoms for different defects.

A handy tube trouble chart lists the most common troubles and the specific tubes causing them. Many photos of actual TV picture-tube trouble displays help the reader identify which tubes are at fault. The photo section is arranged by symptoms, minimizing the time required to look up a specific trouble.

In addition, valuable information concerning both black/white and color receiver tubes, and those used in hybrid (tube and transistor) TV receivers is given. This book will help the reader to quickly find most tube-caused TV troubles.

Copies are available from electronics parts distributors and bookstores throughout the country, or from the publisher.

PARTS DISTRIBUTOR PLEADS GUILTY TO CONSPIRACY

On information supplied through the Bureau of Electronic Repair, Los Angeles office, a search of the premises of JSH Electronics Company, 8549 Higuera Street, Culver City, California, was held by members of the Bureau, the Attorney General's Office, Sheriff's Department, and other law enforcement agencies; and the result of that search led to the sentencing on July 28, 1966, of

N & S Investment, Inc., owners of JSH Electronics Company, on conspiracy.

Evidence taken at the time of the search included marking devices, electronic tubes with old brand names partially washed off, and new brands placed over them. The company is a general parts supply house majoring in industrialelectronics and shipping world wide. The Bureau of Electronic Repair stated that frequently dealers and consumers supply information that may lead to investigations in the general electronics field.



test equipment has to be good...HERE'S PROOF!

NOW, Mercury gives you
a full **ONE YEAR**
GUARANTEE*
on all their test instruments



*Most test equipment manufacturers give only a 90 day guarantee

...we make this offer because we know the engineering and quality that goes into our units

Mercury goes further than other test equipment manufacturers and offers you a one year unconditional guarantee covering parts and workmanship on all their equipment. We back up our products this strongly because we make every unit with exceptional care. Specially trained inspectors check the wiring in various stages of production to assure strict adherence to specifications. Before Mercury equipment is shipped it is given a thorough final factory test to assure long lasting, trouble-free service for you. You can count on Mercury test equipment to meet your servicing needs, save valuable time and make money for you.

See the complete Mercury line at your parts distributor... or write for catalog



ELECTRONICS CORPORATION

315 Roslyn Road, Mineola, N. Y. 11501

In Canada: William Cohen Corp.

Export: Morhan Exporting Corporation
458 Broadway, New York 13, N. Y.

Mercury produces a wide range of test equipment

- Color Generator
- VTVM
- Tube Testers
- VOM
- Component Substitutor
- CRT Tester Reactivator
- In-Circuit Capacitor Tester
- Signal Generator
- Self-Service Tube Testers
- Wire-it-yourself Kits

A COOL H.O.T.* MEANS LONGER LIFE

The horizontal output tube as employed in color television sets requires very high efficiency from this tube. In this type of high-efficiency circuit, the plate dissipation of the tube rises to 8-to-10 times normal if drive is removed from the horizontal output tube. Under a "no-drive" condition, the horizontal output tube may become permanently damaged in 10 or 20 seconds.

In view of the above, the service technician is urged to pay special heed to the following "Don'ts":

DON'T remove the horizontal oscillator tube with power applied to the color-TV receiver.

DON'T turn the set back on immediately after replacing the horizontal oscillator tube. The oscillator tube is cold and, in the time required for it to heat up, the output tube can be damaged. (The oscillator tube can also be heated up in a tube checker.)

DON'T reapply power until the horizontal output tube has cooled.

DON'T short out any overload devices or fuses. Quick-acting protective devices are the best protection for the horizontal output tube.

DON'T remove the horizontal output tube plate-cap to protect the tube or to kill the high voltage. Screen-grid and/or screen-grid circuit component damage may result.

DON'T forget to adjust the efficiency coil according to the manufacturer's instructions whenever the horizontal output tube is replaced (see manufacturer's service data and adjust to recommended cathode current).

*Horizontal Output Tube 6JE6.

LETTERS

(Continued)

Dear Don:

This is a list comprised by Vavra Radio & Television, 4290 41st street, San Diego, Calif. of items stolen from their shop recently. Also there are tubes and caddies being stolen out of unlocked trucks when repairmen are on service calls and the trucks are parked in the back of the shop. We urge that all shops keep their trucks locked when not in use. Thank you for your cooperation.

Zenith 12" Transistorized Portable TV & Battery Pack
Model #R1290L
Serial #5449145
Battery Pack #B129L

Zenith Portable Color 19" Television
Model #4100L
Serial #3758517
Base #CT180-4W

Sharp 12" Portable Television
Model 12PQ2
Serial #01710

Zenith AM/FM Table Radio
Model #N725
Serial #3215414

Zenith Solar Transistor Radio
Model #R555W
Serial #526884

Zenith Transistor Radio (Black)
Model #R500CN
Serial #512006

RCA Transistor Radio (Cream)
Model #RGG22N
Serial #50850526

Royal Portable Typewriter

Thank you for any assistance you may give us.

Sincerely,

Richard Schuricht, Sec.-Tres.
CSEA Chapter 13
836 Broadway
Chula Vista, Calif. 92011

CLASSIFIED ADVERTISING

T.V. Sales & Service Business

Home - Business Combination
on Beautiful Clearlake.
Well Established — Profitable
Write P. O. Box 154
Lucerne, Lake County, California.

FOR SALE

TV BUSINESS — Well established in rentals, sales and service in lively small town close to Castle Air Force Base. Have good lease with low rent. Have been in business over 8 years. Must sell due to poor health.

BUD'S TRADING POST
P. O. Box 403 — Winton, California
358-2851

TV tech. Permanent for right man. Pd vac. Health Ins. 42 hr. wk. Salary \$125 + per wk. Color exp. a must. Co. est. 15 yrs. Call or write for appt. Torrey 6-8816, Robt. Whitmore & Co., Inc., 10466 E. Alandra Blvd., Bellflower, Calif. Los Angeles area.

HUNDREDS OF WORKING

USED LATE MODEL THIN LINE—PORTABLES

Low shipping costs anywhere

TV brokers WE 1-6622

4920 W. Pico, L.A. 19, California

CHANNEL MASTER

DISTRIBUTED IN CALIFORNIA BY:

ANDREWS ELECTRONICS

1500 W. Burbank Blvd.
TH 5-3536

ASSOCIATED RADIO DIST.

1583 Howard St.
San Francisco, HE 1-0212
IN

Palo Alto: DA 3-3173
San Mateo: FI 5-3575
Vallejo: MI 3-4531

HURLEY ELECTRONICS

2101 N. Fairview, Santa Ana, 638-7220
IN

Inglewood: 679-2276
Ontario: YU 6-6538
San Bernardino: TU 5-0721
Long Beach: HE 6-8268
Oxnard: HU 3-0133
Oceanside: SA 2-7694

KIESUB CORP.

311 W. Pacific Coast Hwy.
Long Beach 591-1335 & SP 5-1428
IN

Anaheim: KI 7-3527 & 865-0688
Bakersfield: FA 7-5535
Oxnard: HU 3-9541
San Bernardino: TU 5-6807
Van Nuys: ST 1-3930

MILLER'S RADIO & TV SUPPLY

530 East 8th Street
Oakland, TE 4-9185
IN

San Jose: CY 5-6818
Santa Rosa: LI 2-5423
Walnut Creek: YE 4-3000

NORCAL ELECTRONICS

1115 "R" Street
Sacramento, 442-9041

WESTERN RADIO & TELEVISION SUPPLY CO.

1415 India St., San Diego
BE 9-0361

The first completely new antenna concept in years...

CHANNEL MASTER[®] ULTRADYNE series

COLOR
ENGINEERED

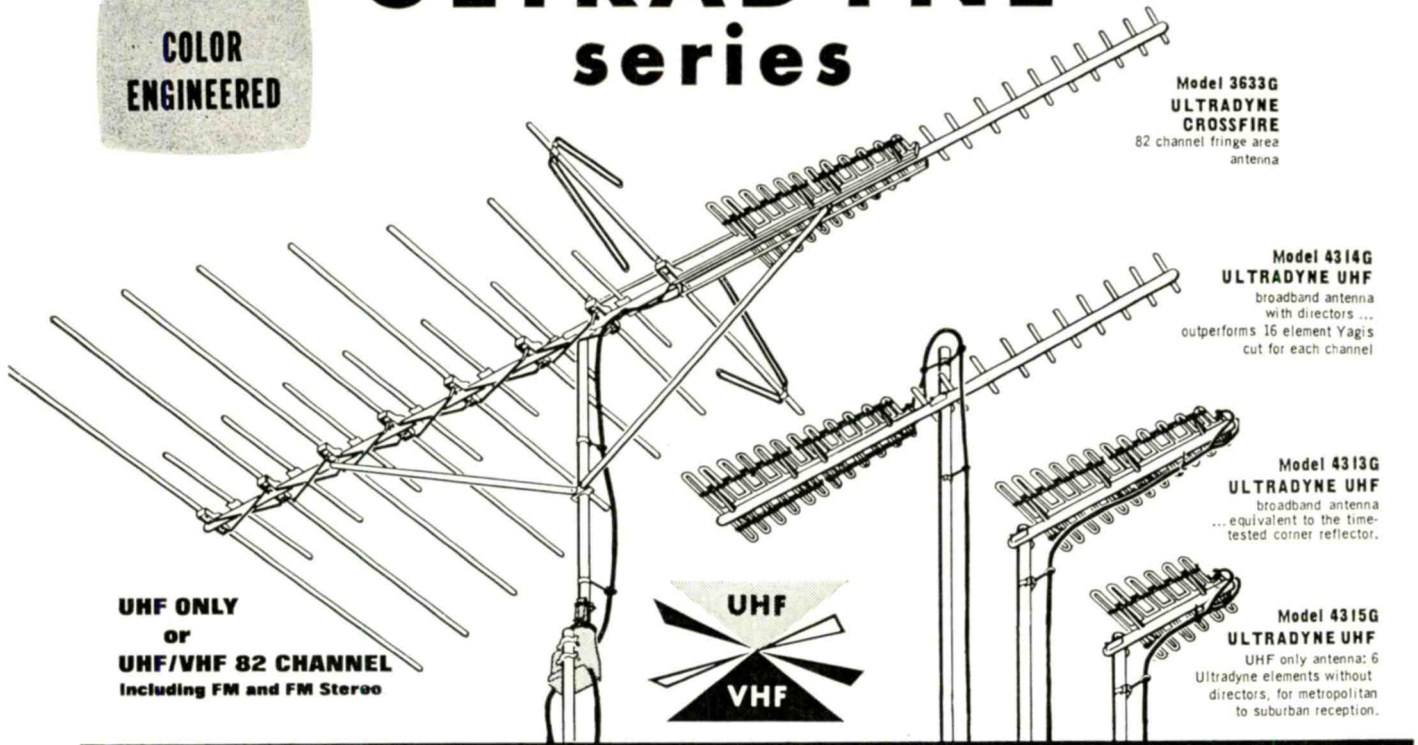

Model 3633G
ULTRADYNE
CROSSFIRE
82 channel fringe area
antenna

Model 4314G
ULTRADYNE UHF
broadband antenna
with directors ...
outperforms 16 element Yagis
cut for each channel

Model 4313G
ULTRADYNE UHF
broadband antenna
... equivalent to the time-
tested corner reflector.

Model 4315G
ULTRADYNE UHF
UHF only antenna: 6
Ultradyne elements without
directors, for metropolitan
to suburban reception.

UHF ONLY
or
UHF/VHF 82 CHANNEL
Including FM and FM Stereo

BREAKTHROUGH!

Six new ULTRADYNE CROSS-FIRE antenna models provide the first high gain FM and FM Stereo performance ever attained in an 82 channel TV antenna. Channel Master's exclusive, patented Tri-Band Directors make it possible. All ULTRADYNE series antennas feature the famous EPC golden coating.

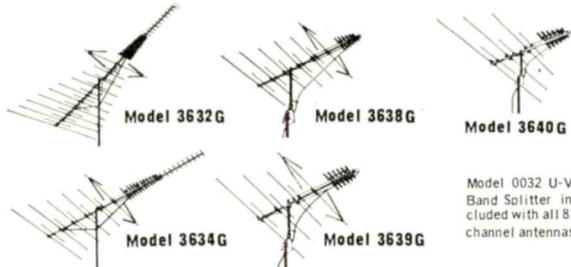

BREAKTHROUGH!

The amazing electronic ghost-killing power of Channel Master's famous Coloray antenna is now combined with the ULTRADYNE principle to create an 82 channel antenna for superb color reception as well as FM and FM Stereo in ghost-plagued areas.



COLOR AGE BREAKTHROUGH!

Model for model, new ULTRADYNE CROSS-FIRES are the highest gain, highest front-to-back ratio 82 channel antennas ever developed. Unprecedented acceptance has made Channel Master Color Crossfires the best-selling VHF-FM antennas in TV history. Now, in combination with the ULTRADYNE UHF antenna, new standards of 82 channel performance are achieved.

"Built-In" 300 ohm impedance actually makes the ULTRADYNE function as a length of 300 ohm transmission line at VHF. This eliminates the need for an antenna coupler when the ULTRADYNE is used in conjunction with any 300 ohm VHF antenna such as Channel Master's Famous Color Crossfires (models 3617G, 3610G, 3611G, 3612G, 3613G, 3614G, and 3615G).

BREAKTHROUGH!

Fantastic front-to-back ratios... over 15:1 across the entire UHF band.

BREAKTHROUGH!

Three separate United States patents and two patents pending cover the exclusive design features of Channel Master's new ULTRADYNE series. No other antenna line incorporates such important technical advances. Yes, from the standpoint of gain, front-to-back ratio, impedance, construction simplicity and versatility, no other antenna comes close to the ULTRADYNE series. No wonder the entire industry knows that the truly significant advances in antenna design traditionally come from...

BREAKTHROUGH!

Obsoletes so-called log periodic antennas. ULTRADYNE antennas, employing an entirely new principle, have higher gain than any log periodic antenna type on the market.

BREAKTHROUGH!

Unique construction. Two stamped aluminum sections make up the entire driven element section of the antenna. This means precise control of dimensions and the elimination of connection and corrosion problems.

CHANNEL MASTER ELLENVILLE, NEW YORK
World's Largest Manufacturer of TV/FM Reception Equipment

Buy Philco tubes and send your kids back to school brighter.

You already know how good Philco Star Bright 20/20 Picture tubes and Star Light Receiving tubes are. If you didn't, you wouldn't depend on them as you do. And enjoy such outstanding customer satisfaction.

But now, Philco has a way for you to shed some light on another area. Your kids and their schooling. It's a special back-to-school offer, and it works like this.

When you buy either 55 receiving tubes or two picture tubes, you get a free, beautifully bound Webster's New World Dictionary. Or a handsome executive-type attaché case.

If you buy 110 receiving tubes or four picture tubes, you can get both the dictionary and the

attaché case—or a Lloyd student lamp, a high-intensity light that's good for the eyes and maybe the grades.

Our offer applies to students of all ages. Grade schoolers or graduate students. But it expires on September 30, 1966, because, after all, it is a back-to-school deal and, by that time, everybody will be back in the classrooms.

So if you've never helped your kids with their studies, and you'd like to, now's your big chance. It'll give you pleasure to know that your business helped your kids make the grades. See your Philco Parts Distributor and learn all the details. Matter of fact, he'll give you a great-looking ball-point pen just for stopping by.

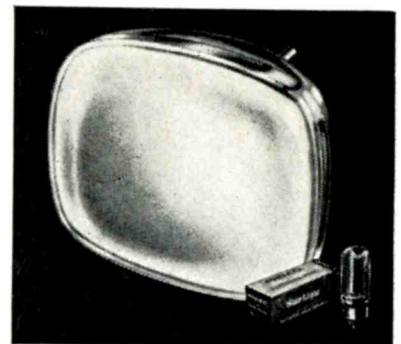
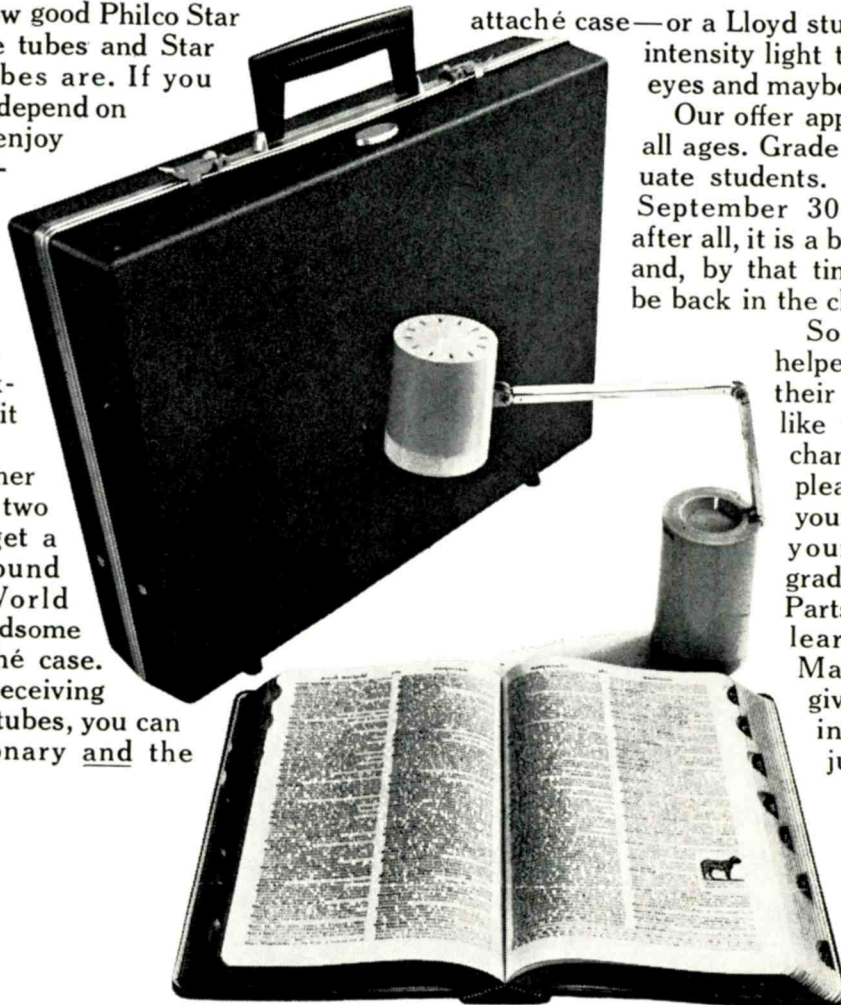

PHILCO
A SUBSIDIARY OF *Ford Motor Company*

PHILCO PARTS STORE
6393 E. Washington Blvd.
L.A. 22, RA 3-0345

PHILCO PARTS STORE
6150 Mission Gorge Rd.
San Diego, 283-6545

PHILCO PARTS STORE
701 Sixteenth St.
San Francisco, MA 6-1717

PHILCO PARTS STORE
1891 W. Roosevelt St.
Phoenix, AL 8-3965