

electronic

Vol. 6, No. 3

July, 1966

service dealer

the official publication of the california state electronics association

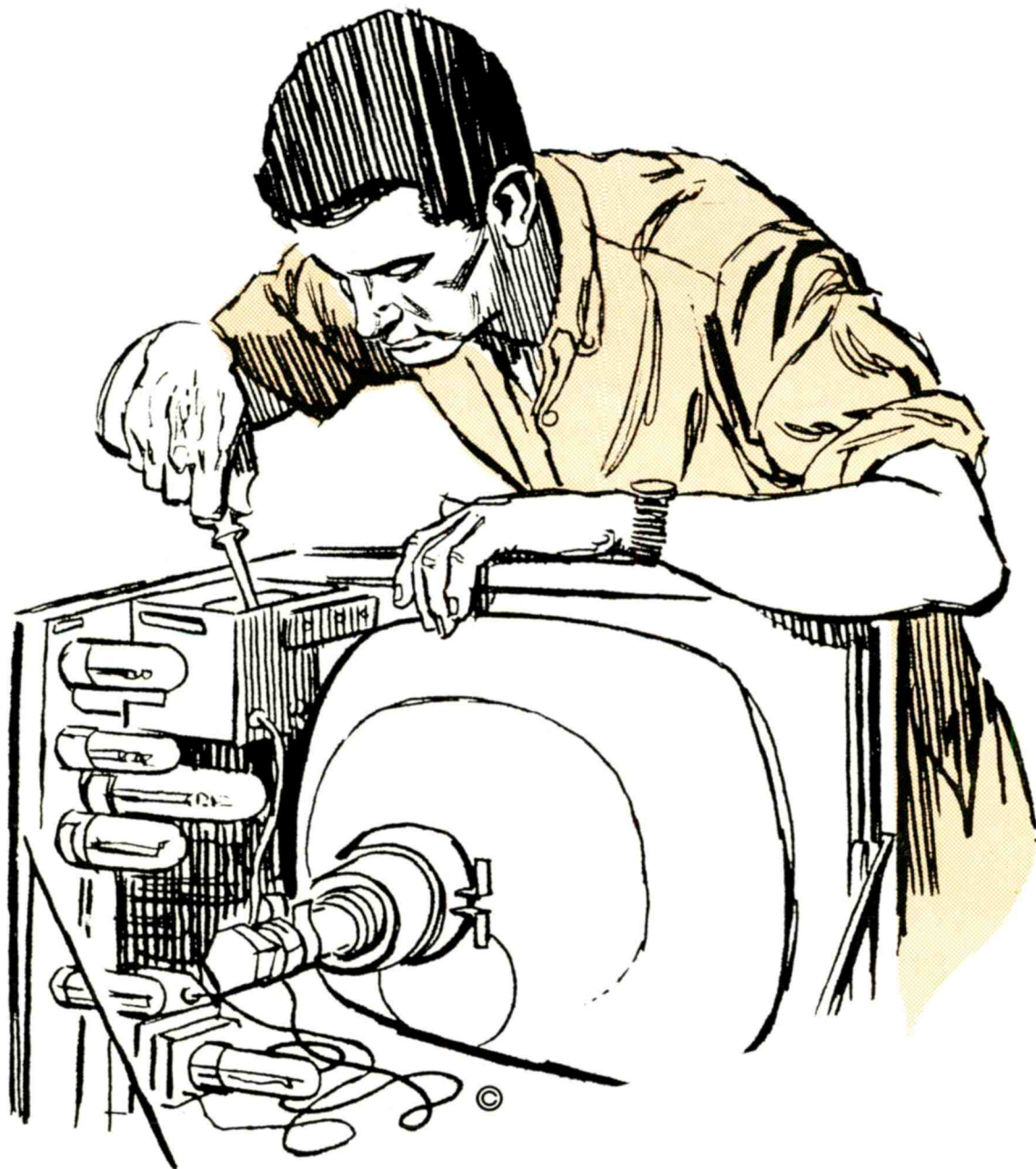

TOMORROW'S IMAGE OF THE TELEVISION SERVICE INDUSTRY

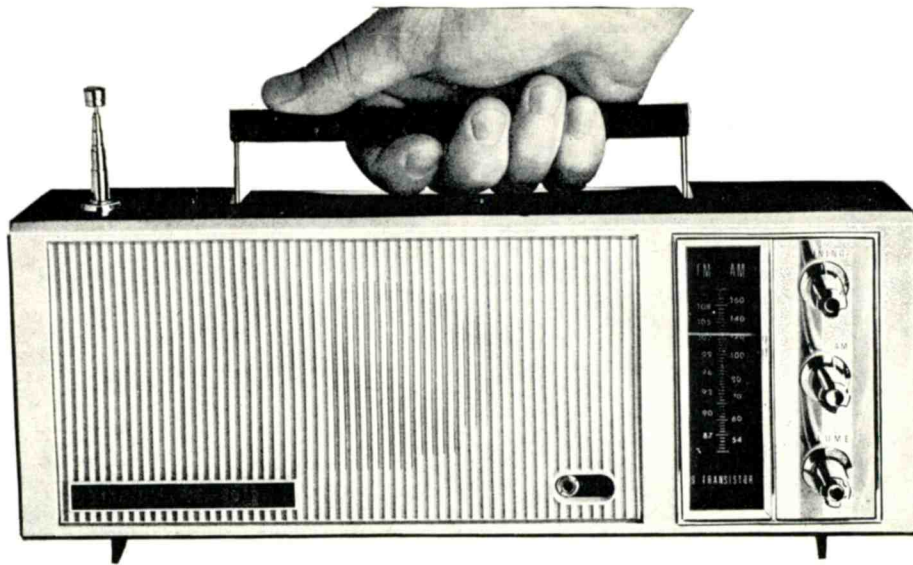

With emergency standbys like this...

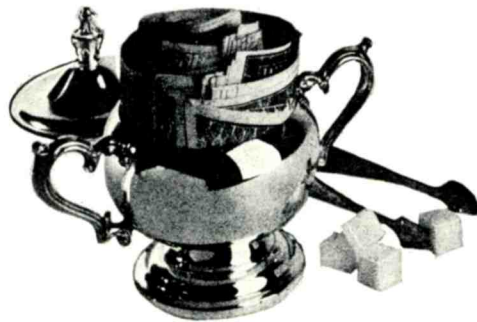

you've got it made!

Sugar. Cabbage. Gravy. Dough.

Call it what you like—the money you'll make on this solid state Channel Master FM/AM portable should taste mighty sweet.

It's battery-powered with 4 "D" cells which lead a long and charmed life. So a listener can always bank on it to play anywhere and anytime. (Great for power blackouts):

Most happily, it's an AC plug-in table model, too. So you don't lose the guy who prefers it that way.

But no matter how he turns it on, he can depend

on the most marvelous FM to pour out. (It has 9 transistors, a 6" speaker, and a telescoping FM antenna.)

And the radio looks just as nifty as it sounds and handles.

All of which is why Model 6463 has been streaking like a best-seller since we introduced it last December.

You can't beat it as a top-profit standby.

And you can say the same for these three Channel Master old reliables.

Emergency or no emergency.

CHANNEL MASTER Home 'n Room Portables

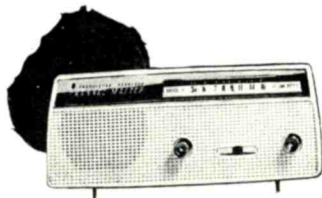

Model 6510, 6-transistor table portable.



Model 6515, 8-transistor super-fringe portable complete with accessories.



Model 6506, 6-transistor personal portable complete with accessories.

...and another thing you can bank on:

If any Channel Master transistor radio proves defective within 120 days, we will replace it with a new one, instantly, FREE.

© 1966, Channel Master Corp., Elmsville, N.Y.

DISTRIBUTED IN CALIFORNIA BY:

ASSOCIATED RADIO DIST.

1583 Howard St.
San Francisco, HE 1-0212
IN
Palo Alto: DA 3-3173
San Mateo: FI 5-3575
Vallejo: MI 3-4531

KIESUB CORP.

311 W. Pacific Coast Hwy.
Long Beach 591-1335 & SP 5-1428
IN
Anaheim: KI 7-3527 & 865-0688
Bakersfield: FA 7-5535
Oxnard: HU 3-9541
San Bernardino: TU 5-6807
Van Nuys: ST 1-3930

MILLER'S RADIO & TV SUPPLY

530 East 8th Street
Oakland, TE 4-9185
IN
San Jose: CY 5-6818
Santa Rosa: LI 2-5423
Walnut Creek: YE 4-3000

NORCAL ELECTRONICS

1115 "R" Street
Sacramento, 442-9041

WESTERN RADIO & TELEVISION SUPPLY CO.

1415 India St., San Diego
BE 9-0361

HURLEY ELECTRONICS,

2101 N. Fairview, Santa Ana, 638-7220
In: Inglewood, 679-2276; Ontario, YU 6-6638; San Bernardino, TU 5-0721
Long Beach, HE 6-8268; Oxnard, HU 3-0133; Oceanside, SA 2-7694

electronic service dealer

STAFF:

DONALD J. MARTIN
Publisher and Managing Editor
CSEA Press Secretary

A. DIANE POWELL
Associate Editor

FRANK BURNS
Business Manager

JIM KIRBY
Art & Cover Director

VOL. 6/NO. 3

JULY, 1966

CSEA EDITORIAL ADVISORY BOARD AND OFFICERS

President
PAUL E. FORT, JR.

Vice President
HUGH WILKINS

Secretary
OAKLEY DEXTER

Treasurer
CAPP LOUGHBORO

Immediate Past President
DARRELL PETSWAL

BOARD OF DIRECTORS

Zone A
DARRELL PETSWAL

ZONE B
NORMAN JAMES
LARRY SCHMITT
OAKLEY DEXTER

ZONE C
AL CHESSER

ZONE D
MEL HAURY

ZONE E
LLOYD KAUN

ZONE F
CAPP LOUGHBORO
VIRGIL GAITHER
HUGH WILKINS

ZONE G
PAUL E. FORT, JR.

BOARD OF DELEGATES

Chairman
VIRGIL GAITHER

Vice-Chairman
OAKLEY DEXTER

Secretary
RAY MERREL



CALIFORNIA STATE
ELECTRONICS ASSOCIATION, INC.
JIM WAKEFIELD
Executive Director
5154 No. Palm Ave.
Fresno, Calif. 93704
227-1587
Sacramento Phone: 482-0706

Electronic Service Dealer is published monthly at 2930
W. Imperial Hwy., Inglewood, Calif. Phone: 755-5261
by Associated Publications.

FEATURES

- 12 NEW MAJOR HEALTH & LIFE INSURANCE
PLAN ANNOUNCED FOR ALL CSEA MEMBERS
- 17 CSEA HOLDS ANNUAL CONVENTION—FORT
ELECTED NEW PRESIDENT
- 19 TOMORROW'S IMAGE OF THE TELEVISION
SERVICE INDUSTRY
by Larry Conroy of Universal Television
- 21 INDUSTRY PROMOTIONS TO HIT IN AUGUST
(TRADE/TALK)
- 23 NATIONAL ELECTRONIC ASSOCIATION'S
NEWS AND VIEWS

DEPARTMENTS

- 4 EDITORIAL
Mixed Emotions On New Show
Dealer Day Also Fails
New CSEA Leadership
- 6 LETTERS
- 7 CSEA NEWS WIRE
- 11 PRESIDENT'S MESSAGE
- 12 TRADE/TALK
- 24 CLASSIFIED ADVERTISING

Entered as Controlled Circulation at
Los Angeles, California



MIXED EMOTIONS ON NEW SHOW

Disappointment was pretty evident during the NEW show and exhibits last month in San Francisco and it may take some real effort to put together the reasons why so many distributors stayed away from the exhibit area.

There was no doubt that distributor attendance was very good from other parts of the country but it seemed as if the western distributors did not find a "close range" program of any great interest.

One manufacturer told me that they did over 60% of all their business the first two hours the show was open and from then on it was almost wasted effort. It is true that the show was packed the first morning it opened but from then on you could have shot off a canon in any aisle without hitting more than two or three.

There is a great amount of money invested in this show and it is a shame that it is not thoroughly viewed by the people who should be taking the interest. Why then is the show area ignored except for a token view the first morning and a rush for home?

One good reason could be just plain changing times. The industry is much more competitive today than ever before in history. Manufacturers now have full representation all over the country in the form of rep firms. On top of this they have regional sales forces and factory men working the distributor's customers. Everyone is keyed to increasing business and by the time a distributor gets to such an event as NEW he has the "sold out" sign hanging around his neck.

The profit forum was generally a good program and provided some interesting and important information. The hospitality rooms did a land office business and North Broadway had its share of roaming romeos. The only ones that seem to suffer were the exhibits and we had the idea that this was the main reason for such a program.

Last year's program in New York was met with a great deal of success with the grumbling kept to a minimum. Maybe a western location is not in the cards since the number of distributors is sparse by comparison. We never could understand the first western show being held in San Francisco, except for its central location in the west, but I am afraid that Los Angeles would have its problems as well.

Plans now indicate that the Show Corporation will move its show back to Chicago next year and then head again for the West in the form of Las Vegas. Maybe a move to the glamour city will be a good one but don't look for distributors to hang around the booth area any more than two hours the first morning . . . if they get up that early.

DEALER DAY ALSO FAILS

Dealer Day at NEW was also a failure as dealers did not take advantage of the great opportunity, with the exception of RCA Victor Distributing Corporation's "Day at the NEW show" promotion that brought over 150 people to San Francisco from Los Angeles. A few of the other local L. A. distributors

also had a trip promotion going but other than that the local Bay area dealers stayed away.

The only logical reason I can think of for the lack of interest was the cost to get in. It just doesn't make sense to charge dealers to attend such a show when they are direct customers to the majority of exhibitors. It is a lot like charging a dealer an admission fee to enter a distributor's facility.

When we were operating the Pacific Electronic Trade Show, which was also a big disappointment, we sent out free tickets to everyone and anyone. In fact, the first year we even bound free tickets into ESD in order to build attendance. The first year, and anyone can tell you, the freeway was stacked solid with dealers wanting to attend the Great Western exhibit center to view the show. The only problem was that this show was really not fish nor fowl. Most of the exhibits were industrial and after the dealers took one look they never came back the following two years.

I wish that I knew the answer or that someone did. It is possible that everyone is about showed out including the manufacturers and the poor guys that have to man these booths. The distributors, the dealers, the manufacturers and even the magazine publishers may need some time off from attending Association, business and other meetings in order to get a deep breathe before starting all over again.

NEW CSEA LEADERSHIP

Last month we witnessed some dramatic changes in the leadership of the State wide California State Electronics Association. New faces made their presence known on the Board of Directors through the declining to run of several old timers.

In Southern California we saw Virgil Gaither replace Emmett Mefford who had been a director for many years and also State President. In Northern California we saw Larry Schmitt and Oakley Dexter replace Mike Fusaro and Lee Hoy. All of these men are fine individuals who have done an outstanding job for their local associations and CSEA. Each has contributed much to the industry and a loss of one man's thinking will be picked up by the fresh new approach that always comes with new energy and vigor for a new job.

At the same time, it was interesting to see the election of three Southern California dealers to top positions. In the past there has always been a north-south type of alignment but this was not evident at this year's convention. Ed Fort is an outstanding individual who will lead with strength and direction. Hugh Wilkins has already demonstrated his ability to organize and promote a plan or program. Capp Loughboro from Ventura has done a fine job as secretary and represents the dealers on the BERDR. Oakley Dexter is truly a fine individual with an outstanding background in Association work as well as being a business success in Northern California. The most important point is that all four of these men have the ability, the know how, and the personality to be President of CSEA. The organization is truly fortunate to have this caliber of men to lead the Association in 1966-67.

Indispensable!

*The brand-new
RCA RC-24
receiving tube
manual*

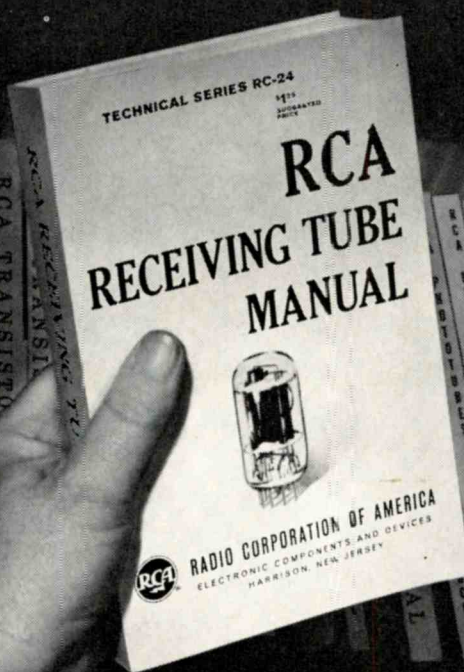

Complete-authoritative

*A must in every
technical library*

A must on every work bench

*More compact and easier
to read than ever before*

Technical design and applications data on more than 1200 receiving tubes. Check these NEW features and improvements not included in previous editions:

- ✓ Additional data on 100 new tube types
- ✓ Revised circuits section with new, simple format
- ✓ Updated picture tube characteristics chart
- ✓ Revised and updated Applications Guide
- ✓ New tube index section for ready reference
- ✓ Data section on active types only. (Discontinued and replacement types appear in a separate section.)
- ✓ Additional text material on TV in the tube applications section

Everyone concerned with electronics needs this manual... service technicians, engineers, radio amateurs and hobbyists. Order yours today from your nearest Authorized RCA Distributor.

Only \$1.25*

*Suggested Price

RCA Electronic Components and Devices, Harrison, N.J.



The Most Trusted Name in Electronics

LETTERS

Dear Mr. and Mrs. Hoy:

This is to inform you that Edwin Wicander is the recipient of the first scholarship award which was established in memory of your son, Stanley. The award was presented at the Memorial Day Assembly held here last Friday.

Edwin has been an outstanding student at the College. He is majoring in Geology and his plans are to continue his education at San Diego State College. While serving as a laboratory assistant in the Geology Department, faculty members became well acquainted with him and rated him highly.

Edwin has great financial need and the award will be greatly appreciated.

Sincerely,
Irwin P. Diamond
Dean of Students

Editor Note: We printed this letter so that all those who contributed to this scholarship fund would have an opportunity to know who was receiving its benefits.

Dear Mr. Martin:

On the second page of the enclosed "Re-

port to Members" of this Bureau, you will find that I cribbed a bit of your material from the May issue of your publication. I hope the item meets with your approval.

For your information, our "Report" goes to some 1,500 business and professional men and state, county and city officials as well as the other 135 BBBs thruout the world.

Sincerely yours,
Executive Vice President
Donald S. Hopkins

Editor's Note: Here is the item.

TELEVISION SERVICE CALLS—It is not within the purview of the Better Business Bureau to state how much should be charged for a TV service call. However, because we receive frequent complaints from disgruntled customers who feel they have been charged too much, it might be worthwhile to review the costs to the service company in making a \$5.50 service call. A service truck will make an average of six calls a day for a gross of \$33.00. The truck is driven an average of 80 miles at a cost of 15¢ a mile for a cost of \$12 per day and the service man is paid \$3.00 an hour or another \$24 a day for a total daily cost of \$36, or a net loss of \$3.00 a day. Certainly some profit is made from the sale of tubes, but the additional costs of equipment, bookkeeping, advertising, rent, utilities, etc. tend to make the \$5.50 service call a losing proposition. Industry sources expect TV service calls to raise in the near future to \$7.50 for black and white and \$8.50 for color. Needless to say, at these prices the customer has a right to demand EXPERT service and chances are, because the service companies can afford to hire better men and buy better equipment, he'll GET expert service.

Dear Don:

In response to your April Editorial "What's In A Tube Size," I feel compelled to give my answer and would like it printed for all to read.

Serves them right . . . Hooray for the F.T.C. They tried a deception and got caught. "Common practice," indeed!

As a service dealer with ethics I have been informing all my clients that have or hope to have color television sets the truth about the true size of rectangular television color picture tubes and their relation to 21" round color picture tubes. I have been doing this ever since I found out about it from the magazine "Radio-Electronics" (Jan. 1965, pg. 77). This is just another example of malpractices of many electronic home entertainment equipment manufacturers. The service dealer and service technician have in large part acquired their mostly undeserved "blemished" status with the public because of extravagant claims by manufacturers. I believe that most technicians have serviced at a personal sacrifice trying to make dangerous (to the technician), time consuming (what service dealer can say he does a good thorough job and gets fully paid for it nearly all the time), inadequate (poor service accessibility) designs perform as claimed by the manufacturer.

The trouble with the F.T.C. ruling is that they did "ignore the obvious" and did not require picture tube size designations by the viewable picture width.

Sincerely,
Kenneth L. Skilling

Dear Don:

Could I obtain 100 copies of your editorial "The Futility of the Service Call Charge"? It's the best darn article I've seen in a long time.

Ralph Singleton.

Editor's Note: Don't have copies but you have my permission to reprint the article.

TUNER REPAIRS

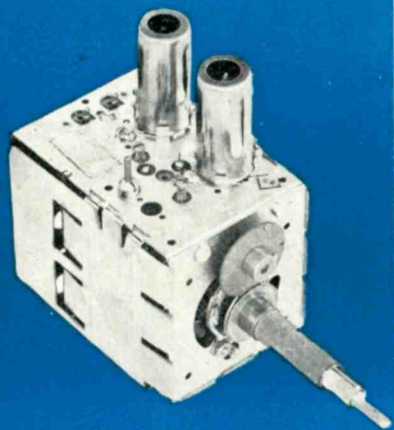

\$9.50

FOR COMPLETE OVERHAUL

Includes ALL parts (except tubes)
ALL labor on ALL makes

24-HOUR SERVICE with FULL YEAR WARRANTY

Sarkes Tarzian, Inc., largest manufacturer of TV and FM tuners, maintains two completely-equipped Service Centers to serve YOU. Both centers are staffed by well-trained technicians in this specialized field and are assisted by engineering personnel to assure you of FAST, DEPENDABLE service.

⊕ Tarzian-made tuners—identified by this stamping—received one day will be repaired and shipped out the next. A little more time may be required on other makes. Every channel is checked and re-aligned per manufacturer's specifications, not just the channels which might exist in any given area.

You get a 12-month guarantee against defective workmanship and parts failure due to normal usage. Cost to you is only \$9.50 and \$15 for UV combinations, including all labor and parts except tubes. No additional costs. No

hidden charges. All tuners repaired on approved, open accounts. You pay shipping. Replacements on tuners beyond practical repair are available at low cost.

When inquiring about service on other than Tarzian-made tuners, always send TV make, chassis and Model number. Check with your local distributor for Sarkes Tarzian replacement tuners, parts, or repair service. Or, use this address for fast factory repair service.



SARKES TARZIAN, INC.
TUNER SERVICE DIVISION

See your distributor,
or use this address

10654 Magnolia Blvd.,
North Hollywood, Calif.
Tel: 769-2720

MANUFACTURERS OF TUNERS... SEMICONDUCTORS... AIR TRIMMERS... FM RADIOS
AM-FM RADIOS... AUDIO TAPE... BROADCAST EQUIPMENT



CSEA NEWS WIRE

A ROUND-UP OF STATE AND LOCAL NEWS OF
THE CALIFORNIA STATE ELECTRONICS ASSOCIATION

The Zone "B" Council of CSEA, in the Bay Area, has set forth certain policies in regards to action of the group in the future. The Council agreed to submit any recommendations they might have, in writing, to all Board of Director members. That any requests concerning action by the State's Executive Secretary should be submitted through the Chairman of the Zone B Council and that plans should get underway within the near future to insure a complete CSEA convention program for next June.

ESD ESD ESD

A special communication was sent out last month by Executive Secretary James Wakefield asking all members to notify his office concerning all activities by CATV firms throughout the State. Although CATV is needed in many areas throughout the State, it is felt that the service industry must stand tight on regulations regarding their franchise. Many chapters have been able to insert legislation in the franchise that prohibits the function of service on the part of any firm receiving a CATV franchise and, it is felt, everything should be done to continue this practice wherever and whenever franchises are being considered.

ESD ESD ESD

Outstanding cooperation has been achieved between the Santa Rosa TV Association and the Pacific Gas and Electric Company regarding the interference in TV reception sometimes caused by loose wires, cross bars, etc. on power poles. A meeting was set up between officials of both groups with an agreement reached that whenever suspected faulty wires are discovered the Utility is to notified and prompt action taken. The chapter reports that in all cases so far the work has been taken care of immediately by P. G. & E.

ESD ESD ESD

The new Board of Directors of the California State Electronics Association has taken formal action to O.K. an agreement for insurance coverage with the California Physicians Insurance Council to take effect on August 1st. A run down on coverage is included in a special article in this month's issue of ESD. The program actually increases the benefits now enjoyed by participating members at less cost. The plan was organized and developed by Emmett Mefford past board member from Riverside.

ESD ESD ESD

The North San Diego County Chapter of CSEA recently presented a certificate of appreciation to Hurley Electronics. Ron Wilson, representing Hurley's, thanked the group for this award and assured them that they will always try to cooperate with the independent service industry. During the same meeting a report was made on the recent certification tests and an explanation made of test results. Ed Fort, who organized the test program, stated that the test was being changed to a multiple choice and would be available for dealers to take it within the near future.

ESD ESD ESD

The Zone F. Council of CSEA has written the State Board of Equilization regarding the status of sales tax on service contracts and in warranty parts. This seemed to be a common problem of whether or not sales tax should be charged for this type of work. A report is to be made at the next meeting.

ESD ESD ESD

Zone F Council of CSEA has decided against participation in the Los Angeles County Fair in September. Committee Chairman Harry Midkaff reported to the Council that in his opinion a full year-around program of public relations was more important than a one shot deal at the Pomona Fair. The committee also felt that there were too many other projects under way at this time for the group to do the kind of job necessary. The Zone Directory will also be discontinued for this year.

ESD ESD ESD

The Zone's Television Audience Poll was also discussed at some length with Hugh Wilkins being asked to evaluate the program and to make recommendations for the expansion of the rating poll. Although the results of the first poll have been completed the report has not been made available. ESD will try to present this material in the next issue.

ESD ESD ESD

The next Board of Directors meeting has been set for September 11th in Los Angeles. This will be the first regular meeting of the new Board and further details will be furnished by the State office.

ESD ESD ESD

The Zone "B" Council of CSEA will hold their annual outing November 19th aboard the Harbor Princess in San Francisco Bay. The favorite Bay Area attraction features a short trip to the Galleon Restaurant in Alameda for dinner and dancing.

ESD ESD ESD

Art Blumenthal has just been elected as the new President of the TSDA of San Mateo County, a chapter of CSEA. Blumenthal takes over from outgoing president Larry Schmitt who was recently elected to the Board of Directors of the State Association.

ESD ESD ESD

Lee Hoy has just been elected as the President of Zone B with Wes Keys named as Vice President and Ken Deedler as Secretary. All three officers have been active in CSEA for many years with both Hoy and Keys being past Directors of the State Association.



***Brighten
your profit picture—
with Raytheon's
new color tube kits***

Both pack 25 of the most popular tubes for color TV service. You'll use them fast—because they're selected for sales now in the fast-growing color tube market.

Ask your distributor for Raytheon color kits now—and the price that packs more profit into every pack.



**TWIN
TRANSISTOR**

SUPER RED-HEAD



ZOWIE!

FABULOUS NEW
TV ANTENNA AMPLIFIER
TAKES **4** TIMES
GREATER SIGNAL
INPUT!



HOLY MATRIMONY!
WHAT WILL WINEGARD
COME UP WITH NEXT?

**FANTASTIC!
READ THE
SENSATIONAL
DETAILS! ➡ ➡**



Robert L. Martin
 DELMAR INSURANCE AGENCY
 P. O. Box 4262
 Fresno, California

NEW HEALTH AND LIFE INSURANCE PLAN ANNOUNCED FOR CSEA MEMBERS

Beginning August 1, 1966, the California State Electronic Association will undergo a change of its Health and Life Insurance Program. This will be brought about as a result of lengthy investigation by your Insurance Committee into the availability of plans on today's market.

Recognizing today's rapidly rising medical expenses, the Executive Board authorized the Insurance Committee to initiate a detailed study to determine how best to serve you, the members. To arrive at this, your committee made a

asked other insurance companies to make their recommendations. It is with considerable pride that we are able to present, at this time, a plan of coverage that has passed the rigid inspection and endorsement of both your Insurance Committee and all of the Board of Directors. We feel confident that you, after reviewing your new plan, will be equally satisfied and will appreciate the length of time and effort your legislators have spent in obtaining the best possible complete study of your present plan and

erage for its members.

The basic difference between the new and the existing program is the addition of a base plan to supplement the Major Medical Coverage. We have been able to accomplish this and at the same time reduce the cost in almost all cases. We have included Life Insurance and once the plan is in existence and the initial sign-up accomplished, we will offer supplemental life (guaranteed issue) up to \$10,000 and disability income.

On or about July 1, 1966, you will receive your sign-up kits. We urge you to take advantage of the initial period of sign-up, as those who are now members or employees of members of this association will have immediate protection including pre-existing conditions.

This new program will be underwritten by the California Physicians Insurance Corporation, with offices throughout California. Our office, along with all C. P. I. C. Offices, will endeavor to the best of our ability to make this the most successful and beneficial program to you. However, to obtain maximum stability in this program, it will necessitate a reciprocal effort between C. S. E. A. and our offices. In view of this, we will be in close contact with your president, executive secretary and all chapter offices. We urge you to use our facilities. This plan will be administered by your C. S. E. A. Fresno Office.

FAMOUS ZENITH QUALITY TUBES for greater reliability, longer life



TV Picture Tubes

A complete line of more than 200 top-quality tubes. For color, black-and-white, or special purposes.

Zenith black & white replacement picture tubes are made only from new parts and materials except for the glass envelope in some tubes which, prior to reuse, is inspected and tested to the same high standards as a new envelope. In Color tubes the screen, aperture mask assembly and envelope are inspected and tested to meet Zenith's high quality standards prior to reuse. All electron guns are new.

"Royal Crest" Circuit Tubes

A full line of more than 875 tubes . . . the same quality tubes as original Zenith equipment. Your assurance of the world's finest performance.

Order all genuine Zenith replacement parts and accessories from your Zenith distributor.



BUILT TO THE QUALITY STANDARDS
 OF ZENITH ORIGINAL PARTS



The quality goes in before the name goes on®



Guide to

COMPLETE RECEPTION

with

RCA ANTENNAS

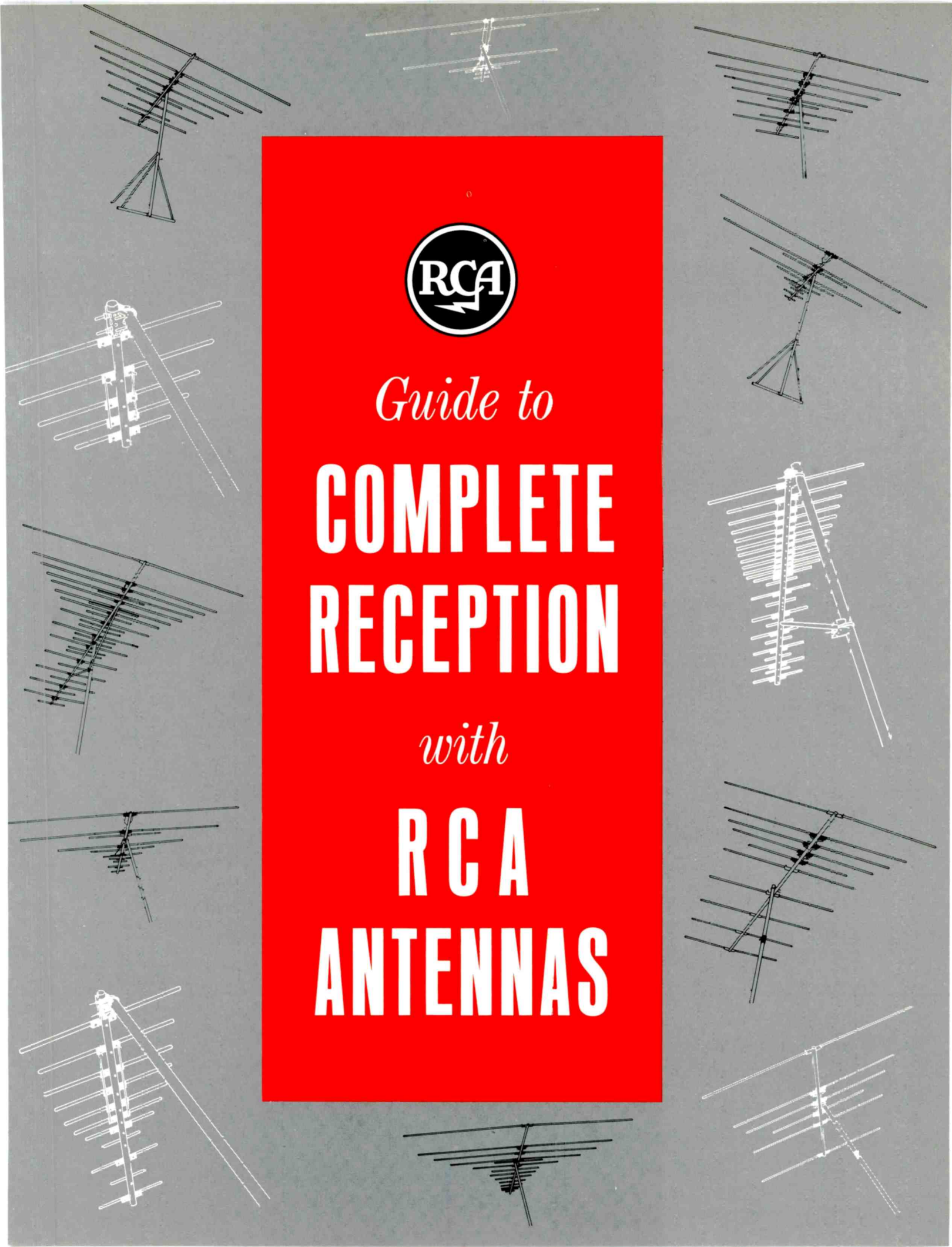

RCA

OUTDOOR ANTENNA

FACT SHEET

The engineering developments that have gone into the design of these antennas add a new dimension in TV reception quality and enjoyment. This full line of "top performance" antennas enables the entire market to be covered with the selection of the appropriate antennas.

The following features apply to some or all of RCA's Outdoor Antenna line:

- Excellent weather resistance obtained by employing the latest techniques in gold color finishes.
- Ultra-compact design.
- Highly efficient due to extremely low VSWR.

- Larger antennas have special FM feature that enables reception to be tailored to the area's needs.
- The 150 series UHF antennas have an "add on" feature allowing them to be attached to an existing VHF antenna lead in without use of a separate coupler.
- Most combination UHF/VHF antennas include a model 10A135 splitter to separate the UHF signal from the VHF at the receiver.

Their superior performance assures customer satisfaction on VHF, UHF, and FM, Color or Black & White TV. RCA Tops Them All in Presenting The Complete Picture.

VHF/FM OUTDOOR ANTENNAS

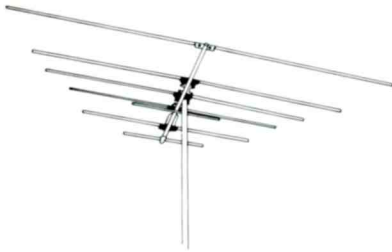

10B1010

Elements	7
Double Elements	0
Total Active Elements	7
Longest Element	110"
Boom Length	43"
Boom Support	—

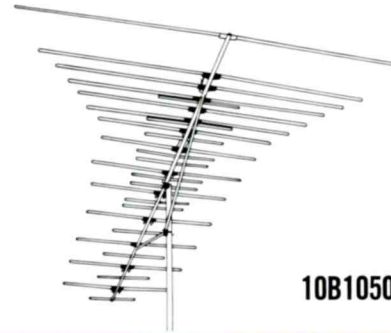

10B1050

Elements	27
Double Elements	6
Total Active Elements	33
Longest Element	110"
Boom Length	192"
Boom Support	Yes

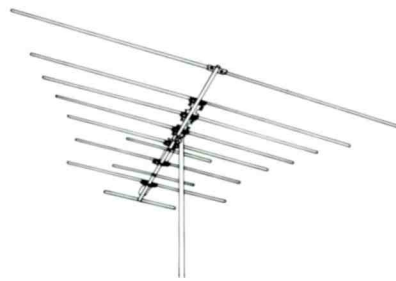

10B1020

Elements	10
Double Elements	1
Total Active Elements	11
Longest Element	110"
Boom Length	62½"
Boom Support	—

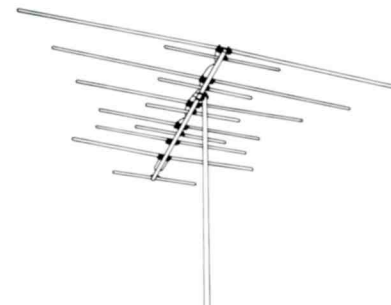

10B200

Elements	10
Double Elements	1
Total Active Elements	11
Longest Element	97½"
Boom Length	62½"
Boom Support	—



10B1030

Elements	14
Double Elements	1
Total Active Elements	15
Longest Element	110"
Boom Length	82¼"
Boom Support	—

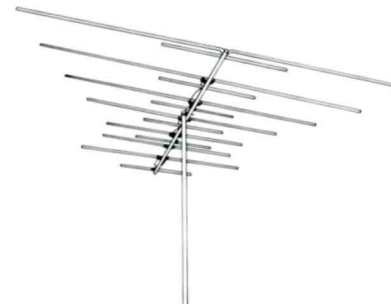

10B300

Elements	12
Double Elements	1
Total Active Elements	13
Longest Element	110"
Boom Length	79¾"
Boom Support	—

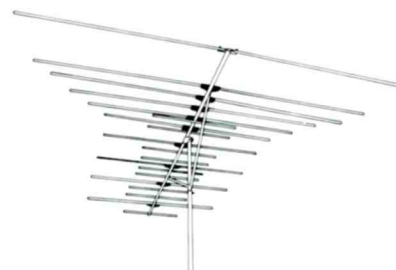

10B1040

Elements	19
Double Elements	3
Total Active Elements	22
Longest Element	110"
Boom Length	112"
Boom Support	Yes

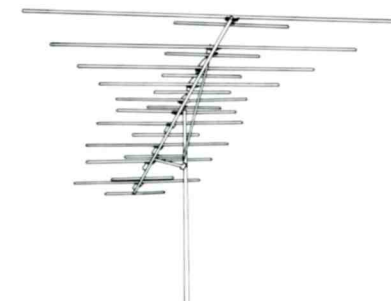

10B400

Elements	15
Double Elements	4
Total Active Elements	19
Longest Element	110"
Boom Length	131¾"
Boom Support	Yes

VHF/UHF/FM OUTDOOR ANTENNAS

UHF OUTDOOR ANTENNAS

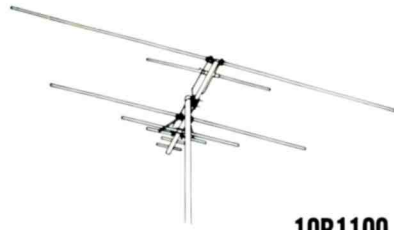

10B1100

Elements	7
V&U Elements	V = 4 U = 3
Double Elements	V = 0 U = 1
V&U Active Elements	V = 4 U = 4
Total Active Elements	8
Longest Element	81½"
Boom Length	29¾"
Boom Support	—

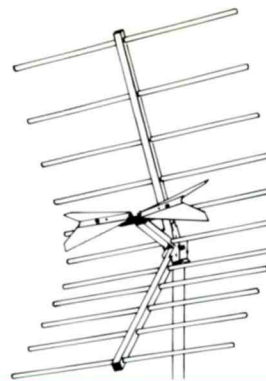

7B140

Elements	12 *
Double Elements	*
Total Active Elements	*
Width	22"
Height	30"
Boom Support	—

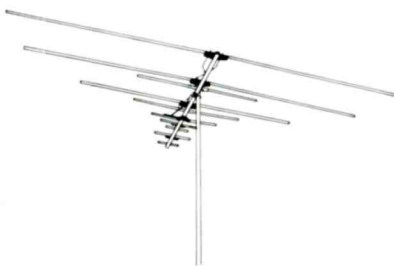

10B1110

(Coupler—U/V Splitter Included)

Elements	10
V&U Elements	V = 5 U = 5
Double Elements	V = 0 U = 3
V&U Active Elements	V = 5 U = 8
Total Active Elements	13
Longest Element	93"
Boom Length	41"
Boom Support	—

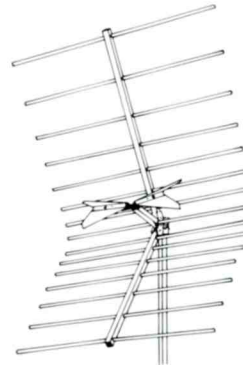

7B141

Elements	16 *
Double Elements	*
Total Active Elements	*
Width	28"
Height	38"
Boom Support	—

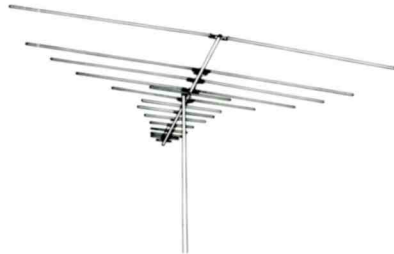

10B1120

(Coupler—U/V Splitter Included)

Elements	14
V&U Elements	V = 8 U = 6
Double Elements	V = 0 U = 5
V&U Active Elements	V = 8 U = 11
Total Active Elements	19
Longest Element	110"
Boom Length	72½"
Boom Support	—

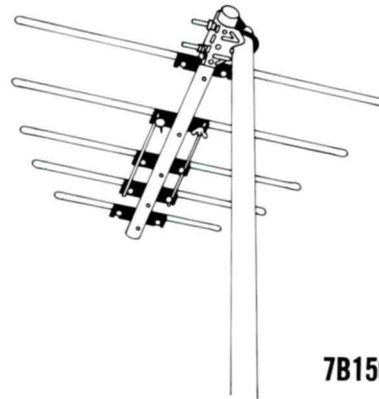

7B150

Elements	5
Double Elements	5
Total Active Elements	10
Longest Element	21"
Boom Length	18¼"
Boom Support	—

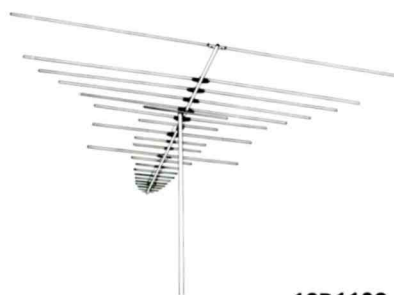

10B1130

(Coupler—U/V Splitter Included)

Elements	21
V&U Elements	V = 11 U = 10
Double Elements	V = 1 U = 9
V&U Active Elements	V = 12 U = 19
Total Active Elements	31
Longest Element	110"
Boom Length	94"
Boom Support	—

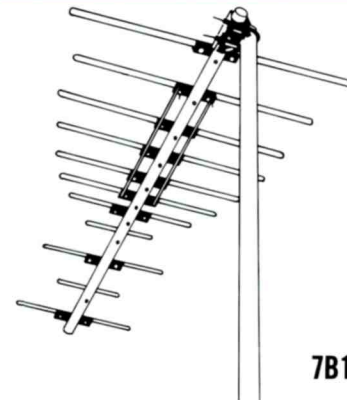

7B151

Elements	11
Double Elements	9
Total Active Elements	20
Longest Element	21"
Boom Length	39¼"
Boom Support	—

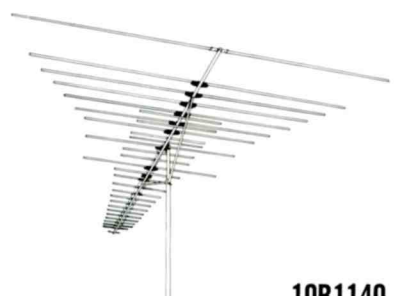

10B1140

(Coupler—U/V Splitter Included)

Elements	29
V&U Elements	V = 16 U = 13
Double Elements	V = 2 U = 12
V&U Active Elements	V = 18 U = 25
Total Active Elements	43
Longest Element	110"
Boom Length	138½"
Boom Support	Yes

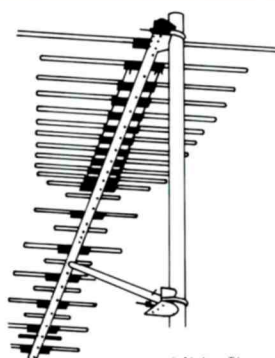

7B152

Elements	24
Double Elements	18
Total Active Elements	42
Longest Element	22¼"
Boom Length	82"
Boom Support	Yes

* Note: These are aperture reflector type antennas in which the performance cannot be judged by the number of "Elements." Performance is more proportional to overall capture area as indicated by height and width.

FM OUTDOOR ANTENNAS



10C450

Elements	6
Double Elements	0
Total Active Elements	6
Longest Element	66"
Boom Length	60 1/4"
Boom Support	—

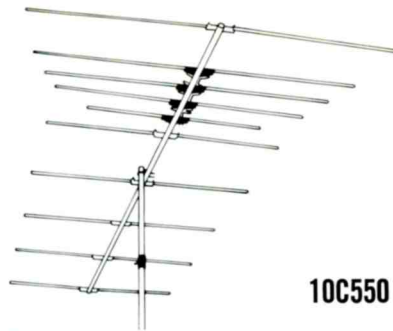

10C550

Elements	10
Double Elements	0
Total Active Elements	10
Longest Element	66"
Boom Length	129 1/2"
Boom Support	Yes

OUTDOOR ANTENNA KITS



10B1011
(Kit version of 10B1010)

Elements	7
Double Elements	—
Total Active Elements	7
Longest Element	110"
Boom Length	43"
Boom Support	—

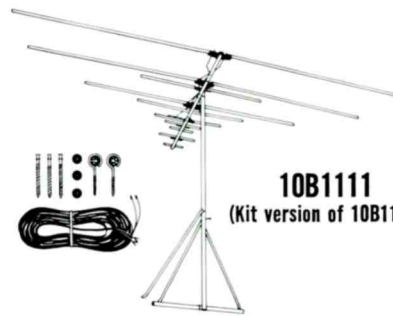

10B1111
(Kit version of 10B1110)

Elements	10
V&U Elements	V = 5 U = 5
Double Elements	V = 0 U = 3
V&U Active Elements	V = 5 U = 8
Total Active Elements	13
Longest Element	93"
Boom Length	41"
Boom Support	—



10B1021
(Kit version of 10B1020)

Elements	10
Double Elements	1
Total Active Elements	11
Longest Element	110"
Boom Length	62 1/2"
Boom Support	—



10B1121
(Kit version of 10B1120)

Elements	14
V&U Elements	V = 8 U = 6
Double Elements	V = 0 U = 5
V&U Active Elements	V = 8 U = 11
Total Active Elements	19
Longest Element	110"
Boom Length	72 1/2"
Boom Support	—



10B1101
(Kit version of 10B1100)

Elements	7
V&U Elements	V = 4 U = 3
Double Elements	V = 0 U = 1
V&U Active Elements	V = 4 U = 4
Total Active Elements	8
Longest Element	81 1/2"
Boom Length	29 3/4"
Boom Support	—

RCA PARTS and ACCESSORIES

2000 Clements Bridge Road
Deptford, New Jersey 08096



THE MOST TRUSTED NAME IN ELECTRONICS

CALECTRON

San Francisco: 33 Gough Street, MA 1-3400
Fresno: 2930 Butler Avenue, 268-8411
No. Sacramento: 330 Commerce Circle, 922-5885

RCA VICTOR DISTRIBUTING CORP.

Los Angeles: 6051 Telegraph Road, 723-6661
San Diego: 820 West "F" Street, 234-6316

San Fernando Valley, 781-6501
Pasadena and Burbank, 246-8373
San Gabriel Valley, 443-6907

Long Beach, Downey, 639-6950
Inglewood, Redondo, 675-4401
Orange County, (714) 521-6700
Whittier, Alhambra, 728-7295



DARREL PETSVAL (left) Hands over the gavel to new CSEA State President Ed Fort of San Diego.

CSEA HOLDS ANNUAL CONVENTION FORT ELECTED AS NEW PRESIDENT

The tenth annual convention of the California State Electronics Association was held last month at the Jack Tar Hotel in San Francisco with Ed Fort of San Diego being elected as the new State-wide President.

The annual event was held in San Francisco to take advantage of the National Electronic Week Show that was being held the same week at the Convention Center Civic Auditorium.

A special President's "Early Bird" cocktail party was held on Friday evening with two local Los Angeles Distributors acting as host for over 150 delegates and their wives. Andrews Electronics of Burbank and Hurley Electronics of Inglewood provided the refreshments and received a special thanks from the Association for taking such an interest in the State convention.

On Saturday the old Board of Directors met to conclude the pending business of the Association and to act as a nominating committee for new State officers. Following this part of the program the Board recessed to hear a presentation by Mr. David A. Coolidge, Supervisor in the Electronics Section of Parks Job Corp Center in Pleasanton.

Mr. Coolidge explained the work of the Job Corp center and the program that has been set up to train young men

for careers in the electronic service industry. The program is divided into four parts and begins with a basic course in electronic parts assembly. After a student completes this portion he moves into Basic Electricity on into Basic Electronics and Radio Repair and then into Television repair in both black and white and color.

Although the program is only a year old, Mr. Coolidge indicated that some 50

students are expected to complete the basic electronics and radio repair and should be ready for television work within the next few months. The entire program takes close to two years to complete and there is a definite possibility that these people will be seeking service work within the not too distant future.

The Association itself has offered their services in placing these new men with-

(Continued on Page 18)



THE NEW BOARD OF DIRECTORS OF CSEA include (left to right) Norman James, Al Chesser, Oakley Dexter, Ed Fort, Hugh Wilkins, and Larry Schmitt.

CONVENTION CANDIDS



in the industry and have also offered to extend the self certification test to these students so that they can become certified technicians.

Mr. Jack Phillips, Manager of Parts and Accessories Division of Calctron Corporation in San Francisco, was the featured speaker at the afternoon's session and reviewed the Television Industry as the Industry with a second chance. Phillips, a former service dealer and past President of the San Francisco chapter of CSEA, talked straight from the shoulder on a level that was understood by everyone in the audience. He discussed many of the mistakes that were made by the service dealer and indicated that the time was right to make money in the service of home entertainment products. According to Phillips, the future has never been brighter and with the more sophisticated circuits being built into more and different products there is no limit to the earnings a good businessman can make during the next ten years.

A very stimulating series of questions and answers developed following his formal presentation with all angles being studied and viewed. Of particular importance was the consensus of opinion that the future is faced with more and more factory service with the independent, as we know him today, evolving into a specialist in a particular product line.

On Sunday morning the general session of the Association was held with the election of new officers being of prime importance.

A report from the nominating committee included two names for State President. The two men recommended for consideration were Ed Fort, Board member from San Diego and Larry Schmitt, Board member from San Mateo. Nominations were then opened from the floor with Hugh Wilkins of Los Angeles being nominated. At this moment Larry Schmitt asked to have his name removed from the nominations leaving Fort and Wilkins as the candidates. Fort was then elected as the new State-wide President.

Following this election, Hugh Wilkins was re-elected Vice President and Oakley Dexter of Larkspur was named as the new Secretary. Capp Loughboro of Ventura was re-elected as Treasurer.

Later in the afternoon the new Board of Directors met and signed a new contract with the California Physicians Insurance Corporation for a State-wide Health and Life Plan.

In reviewing the new plan it was learned that the Association members will now receive much more coverage than through their previous carrier and

(Continued on page 24)

AT ALL CONVENTIONS there is a mixture of social and business sessions. These pictures were taken during much of the activity including the board meetings and business sessions to the annual banquet and installation program.

TOMORROW'S IMAGE OF THE TELEVISION SERVICE INDUSTRY

By Larry Conroy

Universal Television, Los Angeles



A couple weeks ago on a very popular television program called, "Gilligan's Island," watched by millions of viewers all around the country, the main character, Gilligan, suggested another character who plays the part of a millionaire that they call in a television service technician to help them out with one of the problems that they'd run into. The millionaire answered, "overtime I can afford, golden time I can afford, but television serviceman time, *nobody* can afford." This got loud yoks from the television studio audience and we can be sure that it got plenty of laughs from the nationwide viewing audience. Why did they get laughs? Because everybody expects to be overcharged and even exorbitantly charged for any type of television service today. This is a good illustration of today's image of the television service industry. After many years of trying very hard to clean up the industry through legislation, through self-help programs, through training programs and many many dollars having been spent, the only people that know about it are the people within the industry itself. The public still goes on feeling that this is the type of service they're going to get; overpriced and generally unsatisfactory. We're looked on as the greatest band of crooks since Jesse James went out of business. And I know of many people who would like to vote us in to brand new headquarters. Happens to be a little island out there on San Francisco Bay that hasn't been doing much for the last few months. Going hand in hand with this poor image is the public's unfortunate ignorance of what goes into the training of a television technician and into the servicing of today's sets, of the money spent to keep him trained and at the top of his professional knowledge.

TV Only A Piece of Furniture You Plug In

The average customer thinks of the television set as a piece of furniture which they plug into the wall and out of it comes sound and pictures in glorious, living color and black and white and high fidelity sound. And because they spend X number of dollars for it, it should never fail. This is the only kind of education that they can receive about this business and comes to them from the advertising that they get now. They still look upon the television or the high fidelity unit as being another appliance in the home, like a toaster or any other small unit that they've purchased in the store and plug in and expect it to work for year after year. This, *we* know, is not the case. This, *we* know, takes training. This, *we* know, takes a well qualified man, who expects to be paid well for his services and who will run into problems that have never been encountered before in the American home. This poor image coupled together with this lack of knowledge on the part of the public gives us a problem. And it's a big problem. Not only does it create constant

friction, it also creates a situation which we face today as our main reason for our need for a new image in tomorrow's service industry. The problem is what I call "the new vanishing American." The vanishing American used to be the American Indian. Now he's the television service technician. Why is he a vanishing American? Why doesn't he want to be a television service technician anymore? Well, let's face a few facts. Who wants to go through the training that it takes to bring him up to the level of being even a bottom-of-the-ladder technician, one who'll require on-the-job training, who will then have to face two or three years more in an apprenticeship position with constant training ahead of him, many nights of study and after all of this, continue to go into the home, and be looked on as being, in many cases, an outright crook, and to be called a crook, and to face the abuse and the problems that he does in the home, when with the same type of training, he can go into the allied electronic fields, such as any of the space age technology programs or computer electronics, make as much, if not more money working a nice, comfortable, 5-day week in air-conditioned, well-lit offices and not have to face any of the grief that he would as a T.V. service technician. Why should he? There's really not much reason, unless he's a very dedicated soul. Color television sales have leaped upward and are continuing to climb. The number of technicians to service them has lept downward and is continuing to drop. You all know of this problem, but we haven't tried very much to eliminate it. Many people have run off in their own individual directions, and, perhaps have made some sort of impression. But the strength of the industry as a whole is needed. We can change this situation and we *must* change it. In October of 1965, I realized the problem was getting out of hand and I wrote to a state agency, asking if they would be able to provide us with any help. They referred me to another agency, who in turn referred me to another agency, who in turn referred me to another agency, who in turn referred me to another agency, who in turn referred me back to the original people I had first contacted. Well, after this happy little roundelay, I finally, in sheer desperation, wrote directly to President Johnson. I told him that with the unemployment situation the way it was in this country, and with the great need to re-educate people into new technical positions, we should be the prime recipients of federal or state funds. Well, my office was so filled with investigators, I thought I might be under intensive investigation by the C.I.A. for a while and I had my gear and equipment packed, ready to be sent to Vietnam. North Vietnam. However, it did bring about one thing. We had a series of meetings with the top manufacturer's representatives and service representatives together with the

(Continued on Next Page)

state and federal agencies in Los Angeles and it was decided that the state and federal people would, through their offices, run a series of approximately 20 schools, running 44 weeks apiece to re-educate what might be called the cream of the crop of the unemployed, who would be selected through aptitude tests and re-trained as television and high-fi technicians, or at least trained in the basics of television and high-fidelity service. After a couple more weeks, however, it turned out that there would be no funds available until July, and this being back last December, I decided that there wasn't much future in waiting. I met with the California State Electronics Association with the working name of T.U.B.E.S. This to stand for—"Towards Universally Better Electronics Services." The association to be formed from those industries directly associated with and related with the television and high fidelity service of today.

What is T.U.B.E.S.?

These industries being our own service industry, the manufacturers who make the television sets and who must have them kept in good condition to continue selling them and there's *nothing* worse for them than the customer who says, "I'll never buy another Magnavox, or another Philco, or another G.E.," simply because he received poor or insufficient service. The advertising agencies who depend on the sponsors for their bread and butter and the sponsors themselves are dependent upon the television sets to present their products in the customer's home. An illustration of how important the television service industry is to the sponsor is perhaps the old Newport cigarette commercial. One man was retained—a \$30,000 a year man to find the bluest water in the United States for the background for Newport commercials. And it really brought excellent results. But if that blue water comes out looking purple on the television screen, all that money is completely down the drain. It depends on the service industry to make sure that it does come out looking good. The networks depend on the manufacturers and the sponsors and the advertising agencies to bring them the sponsors, so they may operate as profitable organizations. With a hard look at these allied industries, we find that all of them are dependent, to a considerable amount on the television service industry. All of that talent, and all of the money, all of the time that is spent in network broadcasting, advertising and sales has done a wonderful job for the increase of color television sales alone, for instance. They have built a wonderful picture. But without the T.V. service industry it can be likened to building an athlete without a left foot. We are that left foot. And we're a damned important left foot. The reason for T.U.B.E.S. is to create a source of funds to launch a strong and continuing public relations campaign to strengthen and improve our image. A good example of exactly what public relations means to a company is a quotation from the Englander Company, a subsidiary of Union Carbide Company, who say, "Public relations to us, basically, is trying to make people in general more aware." Very important item, being aware. To think favorably about people and products, rather than to push sales of any specific product line. That's exactly what we need: to make people in general more aware. The idea of T.U.B.E.S. was received very enthusiastically. But we needed one item which was common to all the industries and would be a focal point to draw all together in this all-out push to form an organization that could educate the public, support technical training schools, create a better image of the television service industry, to interest future technicians into our industry, to frankly lure them away from the other electronic industries, as they have been directed away from us. And I think we *found* that focal point in the television audience poll. This came about as a result of a conversation that Mr. Hugh

Wilkins of C.S.E.A. had a few years back with an executive of N.B.C. The executive suggested that the television service industry could do a lot more for all related industries by taking an in-the-home poll of the viewing habits of the individual customers we service. They would then be getting the reaction of all those people who are really interested in television, who were interested in high fidelity, who were interested in FM toward their programming. They would know *exactly* what programs were watched and their time slots. And also, we could offer a check-out for the sponsors on the type of job that any one particular commercial was performing by taking spot checks before and after any particular commercial was run on a saturation basis.

Tap Tried in Los Angeles

The television audience poll program was tried in the Los Angeles area, running for the week of April 15 this year. It was quite successful. The results have been tabulated and at the present time are ready for distribution to those interested. However, the Los Angeles Chapter of C.S.E.A. has put all the money that they possibly can into this project. More *is* needed from the industries I have mentioned to retain a top public relations organization, which we have and who have already done a good job announcing the program and spreading word of our needs. I appeared on C.B.S. on the Big News in Los Angeles with amazing results, had articles written in the New York Times and several newspapers around the nation that have brought tremendous interest in these problems, and also strengthened the fact that ours is not a local problem, but a nationwide problem, and something which must be licked immediately. Tomorrow's image of the television service industry must be one which is far and away from the current idea of the handyman who comes into the home with his hat on one side, somewhat dirty jacket, a bunch of tools and a great, big bill ready to present to the customer. It *must* be changed, it *can* be changed, and a united effort can do it. It must be made evident that the television serviceman is a well-trained, educated man. A man of high technical knowledge and qualifications who is there to work on a highly complicated piece of electronic equipment, the most complicated piece of equipment that has ever been put into the American home, one which does and will need service, that *will* have breakdowns, that *will* have failures in them and those failures can be taken care of by competent organizations of technicians anywhere in California or the nation.

Image Built by Sensationalism

The image we have at present is built up because of the thing that sells newspapers: sensationalism. And when you are able to put out a headline, such as was put out in California not too long ago, when after many months of investigation, 20 service organizations were checked out for dishonest dealings; 20 organizations representing a fraction of one percent of all the service organizations in California were indicted and 19 were convicted for fraudulent activities. The headline that came out the next day was, "19 Out of 20 Television Companies Dishonest." Partially true, definitely sensational but misleading, once again, giving the idea to the average customer that television service is a crooked operation and one to be watched, not looked towards. We *can* change this image. We can change it by better public relations and better education of the public. The plumbers have done it wonderfully through their program of P.I.P.E. We can do it through T.U.B.E.S. Everyone's help is needed—*everyone's*. Ours is a *present* industry. It is very much a *future* industry. The future of the industry and tomorrow's image depends on *you*, depends on all of us. Let's make it a glowing image to be proud of.



AMBERG NEW V.P. OF SERVICE CORP. OF AMERICA

John E. Amberg, 49, former Admiral distributor for the Pacific Northwest, has been named Vice President, Marketing for Service Corporation of America, Los Angeles based TV, Stereo, and Major Appliance Service Organization.

In announcing the appointment, Carl Duffy, President of the firm, also revealed that Amberg has also become a major stockholder in the California corporation.

Duffy said that Amberg would be in complete charge of the firm's marketing functions which will include sales of service contracts, planned expansion of SCA to other West Coast and national markets, advertising, and general promotion.

EDISCO SETS ANNUAL GOLF TOURNEY FOR AUGUST 28

Fred Roehrig, President of Edisco, a San Francisco parts distributor, has just announced that the Riverside Golf and Country Club in San Jose will be the scene of the annual Edisco Golf Tournament and will be held on August 28th.

The annual outing is always a lot of fun with the complete facilities of the Club being turned over to Edisco. Wives, girl friends and children are invited to participate, and take advantage of the club's swimming pool and recreational area.

Last year close to 70 dealers participated in the tournament with Carl Boshers of Millbrae being defending champion from last year. Bill Grayson, of Edisco, is tournament chairman and he can be reached at 5901 Mission Street in San Francisco.

Better TV Reception and "What Else Needs Fixing" to Boost Summer Sales

Over 850 service dealers throughout Southern California have already signed up for the American Institute for Better TV Reception promotion program that kicks off next month, according to Jack Carter, local chairman.

The program details are scheduled to be released at a special "kick-off" at the Hollywood Palladium at 7:30 p.m. on July 20th. All dealers who have signed up for the program will be invited to attend with their wives to hear how virtually every television station in Southern California will be helping to sell better antennas.

Robert Mullen, National Chairman of the AIBTR in Washington, D.C., says that the Los Angeles program will be the biggest and best of any staged thus far nationally. The Institute, in its second year, has developed a format used in other market areas whereby the local T.V. stations supply public interest spots to familiarize the consumer with the need for better TV reception through better antennas. With color set sales running at twice the 1965 rate, and Southern California being one of the top markets, this should have a profound effect on this Fall's business. Utilizing the Western Union operator 25 Program will insure the dealer that the consumers requesting information as to where an antenna can be purchased will be directed to their stores.

The local AIBTR Board consists of the local representatives of the sponsoring manufacturers. Dealer sign forms are available at all leading electronic parts distributors. Any dealer who has not yet signed up is invited to do so immediately.

The kick-off party at the Palladium will feature many top entertainment personalities as well as station executives and AIBTR representatives. The evening will be both entertaining and informative and is free to all participating dealers.

Although all plans are not completed, it is anticipated that every Television Station in Southern California will carry eight spot announcements per day for every day in August directed at selling better TV reception through a quality top performing outdoor antenna.

At the same time, the Electronic Industries Association will kick-off its na-

PHILCO RECEIVES "FRIEND" AWARD

Philco Parts and Service Department has been named as one of the winners in the annual NATESA "Friends of Service." The award was made at the Spring conference of the Association in St. Louis and was received by Hobart Ballou, Philco's national parts and service manager.

I. R. STERN NAMED TO REP GELOSO AUDIO

The I. R. Stern Company, Burbank, California representative firm, has been named as the new representative in Southern California, Hawaii and Southern Nevada for American Geloso Audio Division.

JOHN CARNEY TAKES OVER SALES POST AT ANTENNACRAFT

John Carney, former mid-west representative for Antennacraft of Burlington, Iowa, has just been named as the new national sales manager for the firm. The announcement of his appointment was made during the recent NEW show in San Francisco.

tional program of "What else needs fixing," according to Walter Goodman, chairman for the activity.

The Distributor Products Division of EIA is the sponsor and it is planned as a year around continuing program of education to ask for additional sales. Manufacturers, Distributors and Dealers are all asked to participate in whatever way they feel will do the job. EIA has produced window banners, store banners, pocket protectors, tube caddies, truck signs, etc., all aimed at the simple question of "What else needs fixing."

Both of these programs are designed at increasing dealer sales of service or product to the consumer. Any increase in dollar volume will automatically increase the profit picture for a service dealer. These promotions are designed to sell products but in selling them the dealer makes more profit. Every effort should be made to take full advantage of both of these outstanding consumer promotions.

Trade Talk

(Continued)

BUREAU STATISTICS INDICATE DECLINE IN CONSUMER COMPLAINTS SINCE 1964

The latest statistics released by the Bureau of Electronic Repair Dealer Registration indicates that the consumer complaints continue to decline at a rapid rate.

With over 7,000 complaints received since the Bureau went into action the first year showed that the average

monthly complaints received was 387. In 1965 this average was cut almost in half with the average complaints per month declined to 183. So far in 1966 the latest figures indicate that a further reduction is evident with the first few months average at 154.

At the same time, figures indicate that the number of conciliations is increasing with fewer and fewer complaints ending in the courts. The first year records indicated that the Bureau average about 21¼ conciliations closed per month which went all the way to 11-1/6 per month in 1965 and is working at a record rate of 22 per month so far in 1966.

When the Bureau was established it was felt that the most important work they could do was to catch the crooks. Full scale labs have been set up in both Northern and Southern California and the Bureau has been sending out coded sets to suspected fraudulent dealers. In 1964 the Bureau averaged about 1 set per month, but this was raised to three in 1965 and is now working at a rate of 7 sets per month. Through this method complete evidence has been obtainable and, for the first time, criminal convictions achieved.

DUNLAP OPENS NEW STORE IN SAN JOSE

Dunlap Electronics has just opened a new branch store in San Jose, according to Pat Dunlap, President of the multi-store electronic parts distributor.

The new facility is located at 244 Race Street in San Jose and opened for business on June 15th.

HERB FISCHER MOVES TO EDISCO IN S.F.

Herb Fisher, formerly with Associated Radio in San Francisco, has joined EDISCO of San Francisco in the same capacity. He officially joined the firm on June 15th.

RCA EXEC URGES TV SERVICEMEN TO KEEP PACE WITH DEVELOPMNTS

The nation's television servicemen were urged last month to "retread yourself as often as necessary just like the physician or engineer" to keep pace with new developments in consumer electronics.

The advice came from Paul B. Garver, General Manager, RCA Parts and Accessories, in the keynote address at the Tri-State Council of the Television Servicemen's Association's Telegram 66 convention at the Traymore Hotel. Approximately 250 independent servicemen and their wives from New Jersey, Delaware and Pennsylvania were present.

"The consumer appreciates the improved performance of products using new techniques," Mr. Garver said. "He is equally appreciative of the serviceman who understands, accepts and can repair the product using the newest developments."

Mr. Garver said he was referring to such new developments as circuit boards and integrated circuits.

"The introduction of new techniques into the manufacture of television sets has not reduced the demand for qualified technicians," he said. "The increase in use of television sets has placed a demand on technicians. This demand has far overshadowed any reduction in service caused by the improved reliability.

Jackson

...IT'S THE FINEST

Ask
30,000 servicemen
what they think
about their
Model 648
DYNAMIC
TUBE TESTER

Over 30,000 Model 648 Tube Tester owners are Jackson's greatest boosters. They speak with authority, because they have used the Model 648 right in the field and found it provides more accurate checking of all tube types. *It's a fact!* Thousands of Model 648s are providing more years of service than any other tube testers in its price class as it is completely versatile for all new and old tube types. Jackson engineers have designed the tube socket layout to simplify changing, thereby practically eliminating obsolescence. Model 648 owners particularly appreciate the exclusive color keyed panel and push-button sequence switching which makes set-up time less than warm-up time... the angled view zig-zag exclusive color-coded roll chart conveniently located on upper part of panel. Why not put the Model 648-1 to work now? You too will become its greatest booster.

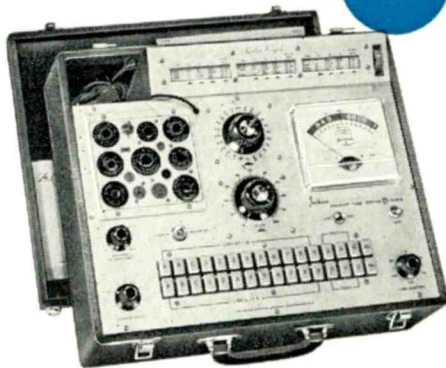

Model 648-1
DYNAMIC TUBE TESTER \$179⁹⁵_{Net}

Check all the Model 648-1 features at your Jackson distributor, or write for catalog

JACKSON ELECTRICAL INSTRUMENT COMPANY
35 Windsor Avenue, Mineola, N.Y. 11501

In Canada: William Cohen Corp.

Export: Morhan Exporting Corporation
458 Broadway, New York 13, N.Y.

IF IT'S A JACKSON...IT'S THE FINEST

NEWS & VIEWS

PAUL LECOY RESIGNS AS V.P. OF NEA

Paul Lecoy, long time booster of NEA and a major contributor to the Service Industry, has resigned his position as East Central Vice President of the National Association of Electronic Service Dealers.

The resignation of Lecoy was accepted during the last meeting of the NEA board with a great deal of regret. "Paul is one of our greatest assets and we are deeply grateful for his many contributions over the years," stated Dick Glass, President of NEA. His resignation was due to ill health and business pressures.

FTC REQUESTS TSA OHIO TO RESCIND ACTION ON RCA SERVICE COMPANY

The Federal Trade Commission has requested the TSA Ohio to withdraw its resolution in th fall of 1964 regarding the alleged action of RCA and RCA Service entering the sales and service of television receivers to motels and hotels.

Although here is still great concern throughout the country on institutional sales and service, the TSA Ohio has agreed to rescind this action due to the interpretation by others of the TSA resolution and the understanding that has brought about the study of the motel-hotel sales service problem.

WINSTON-SALEM, NORTH CAROLINA TO BE SCENE OF NEA CONVENTION AUGUST 18-21

Certification and apprenticeship programs were the highlights of the NEA board of directors meeting held in Wichita late last month.

Reports from all over the central part of the United States indicated that the NEA approved self certification examination and certificate presentations were well accepted and of great benefit. During the three day meeting, 13 Kansas members of NEA were awarded their certificates indicating they had passed the multiple choice technical examination. At the same time, an additional 20 members took the occasion to take the examination and are awaiting results.

The major portion of the program was the presentation of the new NEA-OJT apprenticeship program that is now underway. Jerry Bar-koukis, former president of NEA, and the new National Apprenticeship coordinator, went over in detail the contract between NEA and the Bureau of Apprenticeship Training. He outlined what was expected of local associations in order to qualify for the OJT program and that he was available for aid in setting up their programs.

The second "leadership Training School" sponsored by NEA was well attended with top service dealers from all over the country taking part in particular segments ranging from "Planning a year's program" to "When to remove your local president from office."

CERTIFICATION-APPRENTICESHIP PROGRAMS HIGHLIGHT WICHITA NEA BOARD MEETING

13 NEA DEALERS RECEIVE CERTIFICATION AT RECENT NEA BOARD MEETING

Thirteen members of the National Electronic Associations were awarded certification certificates at the recent meeting in Wichita.

The certificates were awarded by Certification chairman Howard Bonar after these men successfully passed the approved certification examination and were eligible for this honor. At the Wichita meeting, nine more members took the examination under the supervision of the Apprenticeship and Training committee.

In other parts of the country, nine men took the examination in Elkhart, Indiana in early May, three in Warsaw, Indiana and several in Fort Wayne. These exams were given under the supervision of Northern IESA Vice-President Clyde Smeltzer who is now the newly elected President of the FESA in Fort Wayne.

Jack Hughes, representing the Wichita Credit Bureau and author of the book "How to Organize and Operate a Trade Association," was the key speaker at the Saturday night banquet. He spoke on personal improvement habits as they are needed in the service business.

A special thanks was given to the Kansas Electronic Association and its Wichita Chapter for taking on the job of setting up this Board meeting and for turning out during the three days of activities. A special thanks was given by President Dick Glass to Rolla Swan and Bob Hermreck of the Wichita chapter and to Larry Premer, President of KEA.

The new Sheraton Motor Inn in Winston-Salem, North Carolina will be the scene of the 1966 national convention of the National Electronic Associations.

Pete Fabbri, President of TSA Michigan, is general convention chairman and he reports that tentative plans are already completed and urges all interested members to make plans to attend as soon as possible.

Over 350 delegates are expected to attend the three day event with reports being made by every major committee from all over the country. The annual election of officers will highlight the program on Sunday with three outstanding men being nominated for the office of President. Jack Betz, President of TSA of Iowa, Leon Howland and Pete Fabbri, President of TSA Michigan are all experienced men in association work and will provide outstanding leadership in the year to come.

Annual presentation of awards and prizes will also be presented to the "Outstanding State President," "Outstanding Local Association President," "Outstanding NEA Committee Chairman," "Outstanding Officer of NEA," "Outstanding Editor," and others. The association will also present awards to national manufacturers or distributors demonstrating outstanding service to the electronic service industry.

FABBRI, HOWLAND, BETZ NOMINATED FOR NEW NEA PRESIDENCY

Pete Fabbri of Michigan, Leon Howland of Indiana and Jack Betz of Iowa have been nominated for the office of President of the National Electronic Associations and will campaign for the position at the national convention to be held August 18-21 in Winston-Salem, North Carolina.

The announcement of their nomination was made last month at the quarterly board meeting of NEA held in Wichita, Kansas as part of the general program. All three candidates have been a part of NEA since its formation several years ago and all are equally qualified to do an outstanding job of leading the national service organization.

In the next issue of NESD we will run a personal resume of each candidate along with a list of candidates for other top NEA offices.

SEMI-ANNUAL ACTIVITY REPORT

TOTAL CURRENT REGISTRATIONS (Renewal Still in Process)	6,327
TOTAL COMPLAINTS FILED	1,319
COMPLAINTS CLOSED	1,965
COMPLAINTS PENDING	624
REASONS FOR CLOSING COMPLAINTS	
CRIMINAL PROSECUTION	42
ADMINISTRATIVE ACTION	
a. Compliance Achieved	1,649
b. No Jurisdiction	36
c. Informal Adjustment	75
d. Registrations Revoked	72
e. Registrations Suspended	0
f. Insufficient Evidence	55
g. Service Dealer Out of Business	41
h. Could Not Contact Complainant	20
i. Settled By Small Claims Court	17
REGISTRATION REVOCATIONS	5
REGISTRATION SUSPENSION	1
REGISTRATION DENIED	1
REVOCATIONS PENDING WITH ATTORNEY GENERAL	6
REVOCATIONS PENDING WITH DIVISION OF INVESTIGATION	16
CRIMINAL PROSECUTIONS	
COMPLAINTS FILED BY DISTRICT ATTORNEY	13
CONVICTIONS	5
ACQUITTALS	1
CASES PENDING	7
DISTRICT ATTORNEY CITATION HEARINGS	31
NOTICES OF VIOLATIONS SERVED	91
CASES REFERRED TO DIVISION OF INVESTIGATION	857
INVESTIGATIONS COMPLETED	699
INVESTIGATIONS PENDING	158
INVESTIGATIONS PENDING CUMULATIVE	253

CONVENTION CONTINUED



PAST PRESIDENT DARRELL PETSVAL and his wife were the guests of honor at the annual convention banquet.

issue or the next. Just as a means of comparison to those who now have the Woodman policy, the new rates will be \$7.55 for single employee or employer, \$14.72 for family of two and \$20.40 for family of three or more per month. The program includes the same major medical as the Woodman plan plus an immediate schedule, without deductible, hospital coverage. There is also a \$1,000 life insurance policy and there is a no-medical sign-up period that will be explained in direct bulletins or in future articles.

On Sunday evening the annual banquet was held at the Jack Tar hotel with over 250 delegates, wives and guests in attendance.

Don Martin, publisher of ESD, was M.C. and installing officer. He welcomed all, installed the new Board of Directors and introduced Hugh Wilkins who, in turn, introduced Mr. Larry Conroy, Vice President and General Manager of Universal Television of Los Angeles. Mr. Conroy, who made a special one day trip north to address the delegates, reviewed the industry and spoke out on "tomorrow's image of the TV Service Industry". Mr. Conroy's presentation was so well received that we are printing the entire speech, as it was made, in this issue of ESD.

In conclusion, if there was one main theme of this convention it would have to be summed up with the word "flexibility". The service industry is not going to be able to take a status quo position. It is going to have to make changes, bend with the pace of American business and make its own place in the future.

The problems of bait advertising, telephone book listings, \$2 housecalls, industry crooks, license laws, legislation, etc. are going to have to take their place in history and make room for technical skills, good business, specialty products and a lot of hard work.

CLASSIFIED ADVERTISING

T.V. Sales & Service Business

Home - Business Combination
 on Beautiful Clearlake.
 Well Established — Profitable
 Write P. O. Box 154
 Lucerne, Lake County, California.

FOR SALE

TV BUSINESS — Well established in rentals, sales and service in lively small town close to Castle Air Force Base. Have good lease with low rent. Have been in business over 8 years. Must sell due to poor health.

BUD'S TRADING POST
 P. O. Box 403 — Winton, California
 358-2861

Technician Wanted
 430 Broadway
 King City, Calif.
 385-5625

HUNDREDS OF WORKING
 USED LATE MODEL
 THIN LINE—PORTABLES

Low shipping costs anywhere

TV brokers WE 1-6622
 4920 W. Pico, L.A. 19, California

"BENCH TECHNICIAN"
 for Stereo and hi-fi components.
 Must understand transistors.
 Top Pay for right man.
 7706 Melrose Ave., Hollywood
 937-4410

PURCHASE AS LITTLE AS \$10.00

IN OUR STORE & TAKE HOME A FREE GIFT!!

PHILCO'S
'66
FESTIVAL OF
VALUES

**Phone . . . Write . . . Come in—
We've got the best deal ever!!!**



**DELUXE FISHING EQUIPMENT • GOLFING NEEDS • ALL TYPES OF
OUTDOOR SPORTING EQUIPMENT • TOYS • PERFUMES, COLOGNES
AND SPORTSWEAR FOR HER • TRAVEL NEEDS • HOUSEWARES •
TOOLS • MEN'S WEAR • CAMERAS • HUNDREDS OF ITEMS TO
CHOOSE FROM... ACT NOW!**



**WIDEST SELECTION IN TOWN...
CASH IN TODAY!!**

PHILCO THE SERVICEMAN'S FRIEND FOR 38 YEARS

PHILCO PARTS STORE
6393 E. Washington Blvd.
L.A. 22, RA 3-0345

PHILCO PARTS STORE
6150 Mission Gorge Rd.
San Diego, 283-6545

PHILCO PARTS STORE
701 Sixteenth St.
San Francisco, MA 6-1717

PHILCO PARTS STORE
1891 W. Roosevelt St.
Phoenix, AL 8-3965



You can choose from 94 great gifts, if you're "Mister Right"—the independent service dealer who carries Sylvania tubes.

Nobody but Sylvania makes this offer. And the "rules" are a snap!

You get Sylvania Means Business (SMB)-Mister Right dealer certificates from your participating distributor. One certificate for every \$12.50 worth of Sylvania receiving tubes you buy. And one for every picture tube—SILVER SCREEN 85®, color bright 85™ or COLOR SCREEN 85.

The more certificates you earn, the more gifts you can

choose from. Check the selection with your Sylvania distributor. He'll give you an order form for prizes, too.

So start stocking up now—for prizes and for profits. Sylvania Means Business.

Sylvania Electronic Tube Division, Electronic Components Group, Seneca Falls, New York 13148.

SYLVANIA
SUBSIDIARY OF
GENERAL TELEPHONE & ELECTRONICS GTE