

# Electronic Design<sup>®</sup> 10

VOL. 26 NO.

FOR ENGINEERS AND ENGINEERING MANAGERS — WORLDWIDE

MAY 10, 1978

**The DPM picture is changing.** In an 'old-time' meter, the norm was an out-and-out failure. Now the problems are more subtle. All the digits show, but are the

readings accurate? Do the latest meters tell the truth? Find out where their faults are hidden. Focus on digital panel meters. The story begins on page 90.



**\* A CHANGE IN  
SUBSCRIPTION POLICY  
BEGINS WITH THIS ISSUE**

**TURN TO PAGE 45  
FOR COMPLETE  
INSTRUCTIONS**

# Bourns Modular Pots...

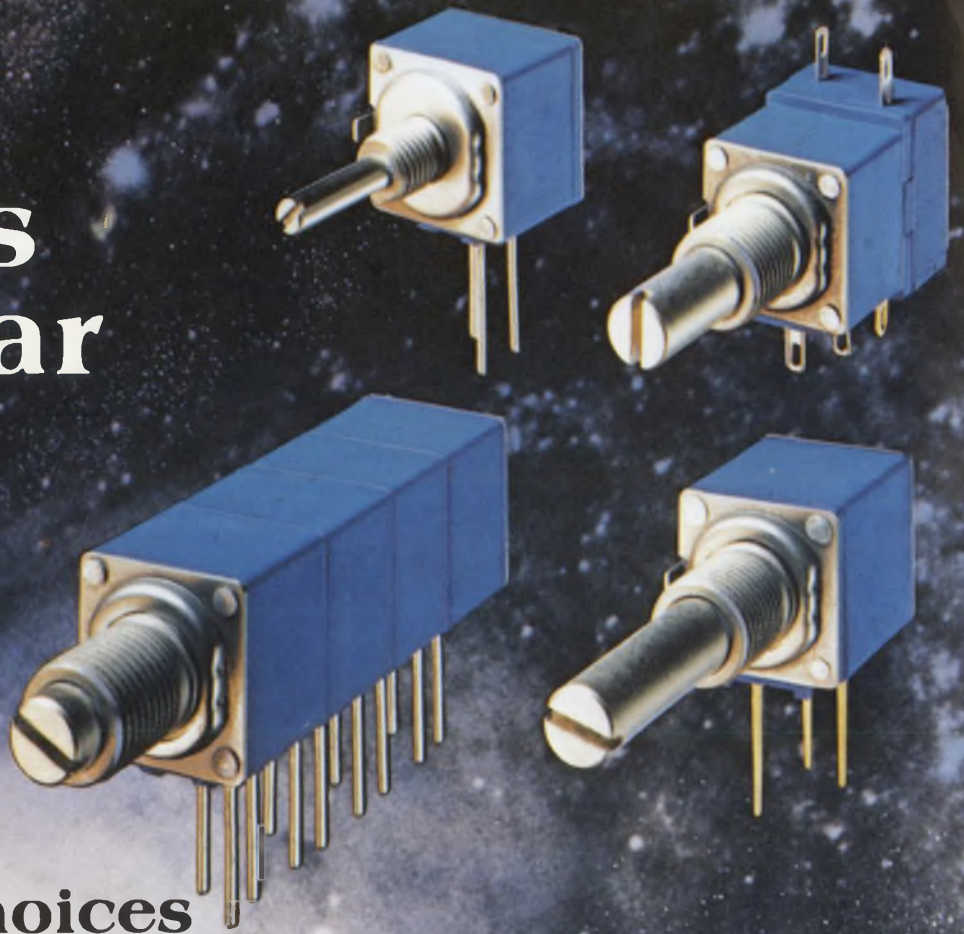

## A Galaxy of Design Choices

### A BILLION DESIGN CHOICES:

(1) Precision potentiometers, semi-precisions, panel controls or switch modules, (2) Cermet, conductive plastic or wirewound elements, (3) Linear tapers, CW or CCW audio tapers at various tolerances, (4) A wide selection of bushings and single or dual concentric machined shaft options, (5) Gangable up to four cups, (6) PC pins or solder lugs, and (7) A wide range of resistance values. We offer the broadest line of modular pots and switches available anywhere.

**PRECISIONS** — Model 83/84 10-turn wirewounds with modular construction and PC pins. A Bourns exclusive.

**SEMI-PRECISIONS** —  $\pm 1\%$  to  $\pm 2.5\%$  zero-based linearity range achieved by laser tailoring. The Model 87/88 fills the gap between low-performance controls and high-cost precisions. Another Bourns exclusive.

**PANEL CONTROLS** — Economical Model 81/82 single turn pots with independent linearity of  $\pm 5\%$  and low 1% CRV.

**SWITCHES** — Click them. There's a touch of class. The Model 85/86 combines Bourns modular pots with optional rotary switches. Modular switches have low contact resistance and a positive action detent at CW or CCW end.

And, there's more: Consistently smooth, quality feel, regardless of model or modular configuration (torque range of only .3 to 2.0 oz.-in.); Bourns quality; competitive pricing; and universal flexibility. Send today for your new catalogs on the Model 80 family of modular pots and switches. . . . Reach for a star from the Bourns Galaxy.

**TRIMPOT PRODUCTS DIVISION, BOURNS, INC.**, 1200 Columbia Avenue, Riverside, CA 92507. Phone: 714 781-5122 — TWX 910 332-1252.



**BOURNS**®

Until now, waveform generators only produced shapes like sines, squares, triangles and ramps. If you needed an unusual waveform, you were out of luck. But that was before ARB. Now you can draw the shape you need, and our new Model 175 Programmable Arbitrary Waveform Generator (ARB) will reproduce it.

You have a  $256 \times 255$  point grid to work with. Time is in one axis, amplitude the other. Simply program the waveform you're



looking for, either at the front panel or remotely via the GPIB bus. The ARB stores your waveform for duplication at the frequency and amplitude you select. The output can be continuous or triggered.

You can also use just a specific

portion of the waveform, or pack several waveforms along the grid and call up only the one you need.

If you believe there's more to life than sines, squares, triangles, and ramps, you're ready for the ARB. So order one. And start drawing. Wavetek San Diego, 9045 Balboa Ave., P.O. Box 651, San Diego, Ca 92112. Tel: (714) 279-2200; TWX 910-335-2007.

**WAVETEK®**

# Our new ARB can generate any waveform you can draw.

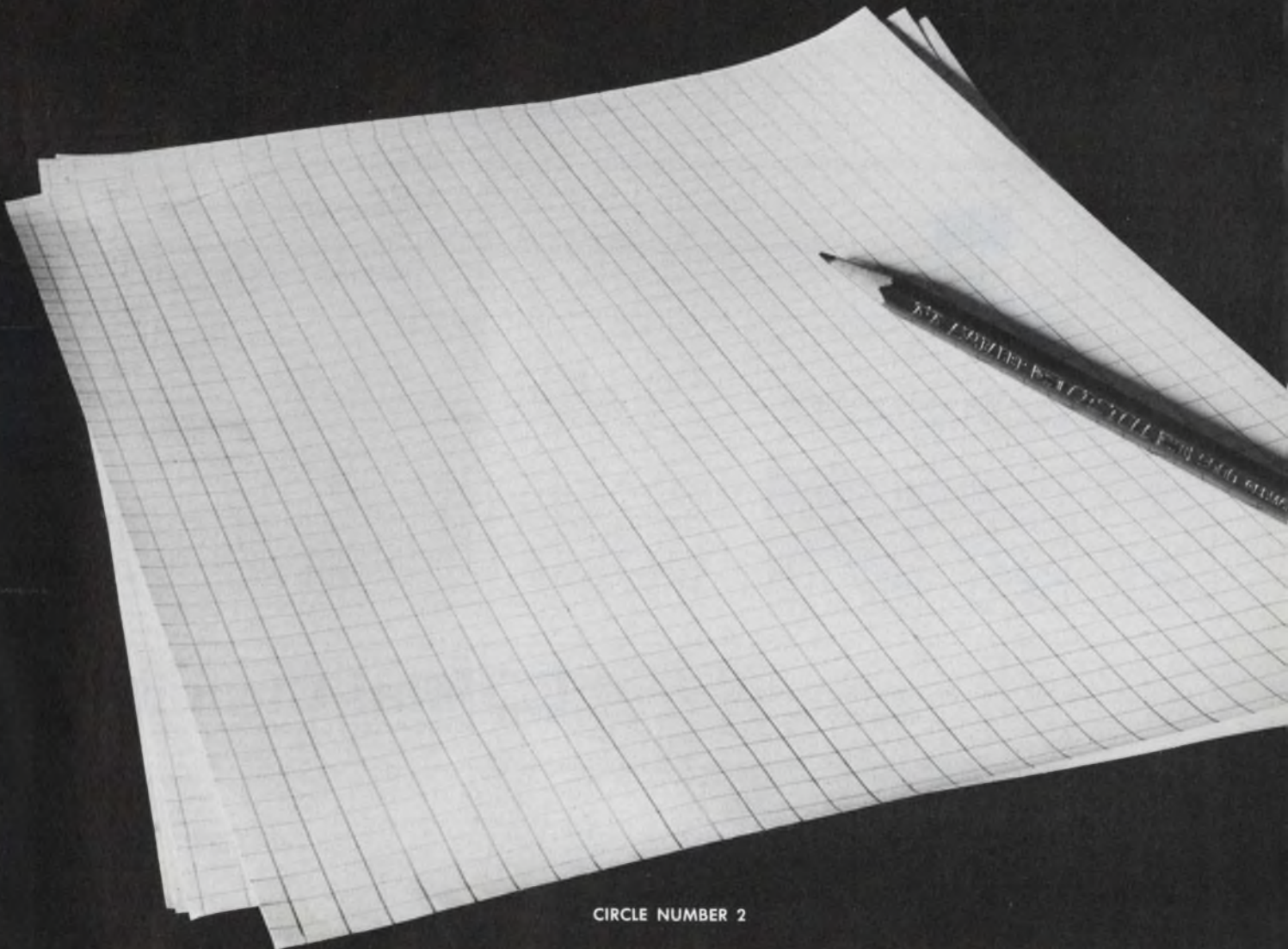

# Introducing the SMALLEST BROADBAND MIXERS available!

## 40 kHz - 2 GHz

### \$11.95

Model TFM-2  
\$11.95 (6.49)

**ACT NOW TO IMPROVE YOUR SYSTEM DESIGNS,**  
Increase your packaging density, and lower your costs . . .  
specify Mini-Circuits new microminiature TFM series. These tiny units,  
0.5" x 0.21" x 0.25" the smallest off-the-shelf Double Balanced Mixers  
available today, cover the 40 kHz - 2 GHz range and offer  
isolation greater than 45 dB and conversion loss of 6 dB.  
Each unit carries with it a 1-year guarantee by MCL. Upgrade  
your new system designs with the TFM, rapidly becoming the  
new industry standard for high performance at low cost.

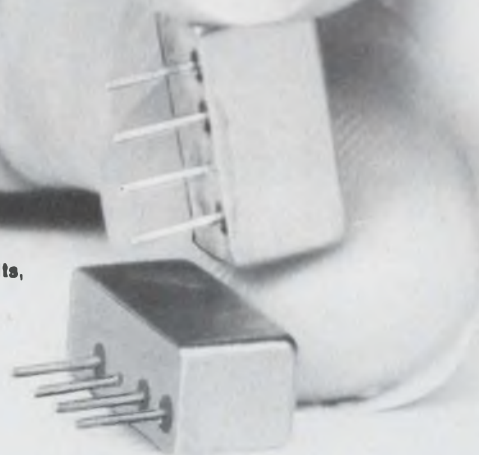

<p>Actual size</p>	Model TFM-2	1-1000 MHz	\$11.95
	Model TFM-3	0.04-400 MHz	\$19.95
	Model TFM-4	5-1250 MHz	\$19.95
	Model TFM-11	1-2000 MHz	\$39.95
	Model TFM-12	800-1250 MHz	\$39.95

40 kHz      0.1 MHz      1 MHz      10 MHz      100 MHz      1 GHz      2 GHz

#### Simple mounting options offer optimum circuit layout.

Use the TFM series to solve your tight space problems. Take advantage of the mounting versatility—plug it upright on a PC board or mount it sideways as a flatpack.

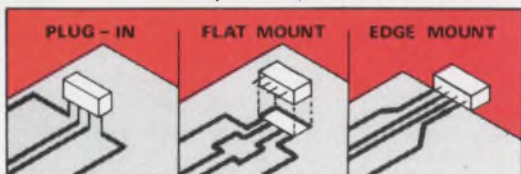

Model No.	Frequency Range MHz			Conversion Loss dB		Isolation dB												Quantity	Price		
	LO	RF	IF	Total Range		Lower Band Edge to one Decade Higher			Mid Range			Upper Band Edge to One Decade Lower									
				Typ	Max	LO-IF	LO-RF	LO-IF	LO-RF	LO-IF	LO-RF	LO-IF									
TFM-2	1-1000	1-1000	DC-1000	6.0	7.5	7.0	8.5	50	45	45	40	40	25	35	25	30	25	25	20	6-49	\$11.95
TFM-3	0.4-400	0.4-400	DC-400	5.3	7.0	6.0	8.0	60	60	55	40	50	35	45	30	35	25	35	25	5-49	\$19.95
TFM-4	5-1250	5-1250	DC-1250	6.0	7.5	7.5	8.5	50	45	45	40	40	30	35	25	30	25	25	20	5-49	\$19.95
TFM-11	1-2000	1-2000	5-600	7.0	8.5	7.5	9.0	50	45	45	40	35	25	27	20	25	20	25	20	1-24	\$39.95
TFM-12	800-1250	800-1250	50-90	—	—	6.0	7.5	35	25	30	20	35	25	30	20	35	25	30	20	1-24	\$39.95

Signal: 1 dB compression level +1 dBm Impedance: all ports 50 ohms Total input power 50 mW Total input current peak 40 mA Operating and storage temperature: -55°C to +100°C Pin temperature 510°F (10 sec)

World's largest manufacturer of Double-Balanced Mixers

## Mini-Circuits

MINI-CIRCUITS LABORATORY  
A Division of Scientific Components Corp

2625 East 14th Street Brooklyn, New York 11235 (212) 769-0200  
Domestic and International Telex 125460  
International Telex 620156

**International Representatives:** □ **AFRICA:** Alitra (PTY) Ltd P.O. Box 9813, Johannesburg 2000, S Africa □ **AUSTRALIA:** General Electronic Services 99 Alexander Street New South Wales Australia 2065 □ **ENGLAND:** Dale Electronics Dale House, Wharf Road, Frimley Green, Camberley Surrey □ **EASTERN CANADA:** B.D. Hummel, 2224 Maynard Avenue, Utica, NY 13502 (315) 736-7821 □ **FRANCE:** S.C.I.E. - D.I.M.E.S. 31 Rue George - Sand 91120 Palaiseau France □ **GERMANY, AUSTRIA, SWITZERLAND, DENMARK:** Industrial Electronics GMBH 6000 Frankfurt/Main Klüberstrasse 14 West Germany □ **INDIA:** Gaekwar Enterprise, Kama Mahal, M.L. Dananukar Marg, Bombay 400 026, India □ **ISRAEL:** Vecronics, Ltd., 69 Gordon Street, Tel-Aviv, Israel □ **NETHERLANDS, BELGIUM, LUXEMBOURG:** Cormex Veldweg 11, Hattem, Holland

□ **NORWAY:** Datamatik AS, Ostlensjoveien 62, Oslo 6, Norway □ **SINGAPORE & MALAYSIA:** Electronics Trading Co. (PTE) Ltd., 87 Bukit Timah Road, Singapore 9, Malay Peninsula □ **SWEDEN:** Integrad Elektronik AB, Box 43, S-18251, Djursholm, Sweden

**U.S. Distributors:** □ **NORTHERN CALIFORNIA:** PENN-STOCK Co., Foothill Office Center, 105 Fremont Avenue, Los Altos, CA 94022 (415) 948-6533 □ **SOUTHERN CALIFORNIA, ARIZONA:** Crown Electronics, 11440 Collins Street, No. Hollywood, CA 91601 (213) 877-3550  
**NEW YORK: MICROWAVE DISTRIBUTORS COMPANY**  
61 Mall Drive, Commack, NY 11725 516 543-4771

R32/Org

CIRCLE NUMBER 3

ELECTRONIC DESIGN 10, May 10, 1978

## NEWS

- 35 **News Scope**
- 38 **Chips, systems, and design:** An early look at the National Computer Conference in Anaheim, CA.
- 42 **Flat cold-cathode TV tube** may be the long sought answer to the CRT.
- 52 **Ferromagnetics and ferroelectrics** supply heat, cold and electricity.
- 59 **Washington Report**
- 
- 68 **Electro 78**—A special report on this year's big show in Boston.

## TECHNOLOGY

- 90 **Focus on DPMs:** Digital panel meters work longer than they used to, but that just gives you more time to worry about the truthfulness of their readings.
- 100 **Put memory into your card reader** and send data down the line serially. You'll be able to do parity checking and you'll save on cabling and hardware.
- 108 **Upgrade your switchers analytically.** Use equivalent circuits to avoid cut-and-try stabilization and ripple suppression for switch-mode regulation loops.
- 116 **Keep your rectifiers cool** by calibrating and monitoring the forward voltage drop. Then you can watch junction temperature—and prevent burnouts.
- 120 **Analyze, don't estimate, phase-lock-loop** performance of type-2, third-order systems. You can do the job with a programmable-calculator in 48 steps.
- 124 **Build hardware that keeps working.** Right along with functional performance, design the reliability and maintainability into your equipment.
- 130 **Ideas for Design:**  
Avoid losing data when line power returns to a battery-backup RAM system.  
If you want a high-accuracy zener, specify time stability, not tempco.  
Reset digital circuits reliably with a power-on pulse generator.  
Binary counter allows a pseudorandom generator to run without interruption.

## PRODUCTS

- 139 **Modules & Subassemblies:** Instrumentation amplifier has its gain programmed digitally.
- 146 Micro/Mini Computing
- 162 ICs & Semiconductors
- 170 Instrumentation
- 175 Components
- 186 Data Processing
- 188 Packaging & Materials
- 194 Power Sources

## DEPARTMENTS

- 65 **Editorial:** Goodbye, Charlie and Jack: a new lineup
- 7 Across the Desk
- 198 Application Notes
- 198 New Literature
- 204 Vendors Report
- 212 Employment Opportunities
- 221 Advertisers' Index
- 222 Information Retrieval Card

**Cover:** Cover design by Art Director, Bill Kelly. Prints courtesy of: Analog Devices, Analogic, Ballantine Laboratories, Datel Systems, Fairchild Instrumentation, Newport Laboratories and Weston Instruments.



**DON'T FORGET TO SEND IN YOUR SUBSCRIPTION RENEWAL FORM — SEE PAGE 45**

THE COMPLETE 16-BIT CPU TAKES ONLY 8 Am 2900 PARTS & A HANDFUL OF MSI & SSI.

REPLACE THE SSI/MSI WITH THE Am 2904 LATER.

MIL-STD-883 FOR FREE.

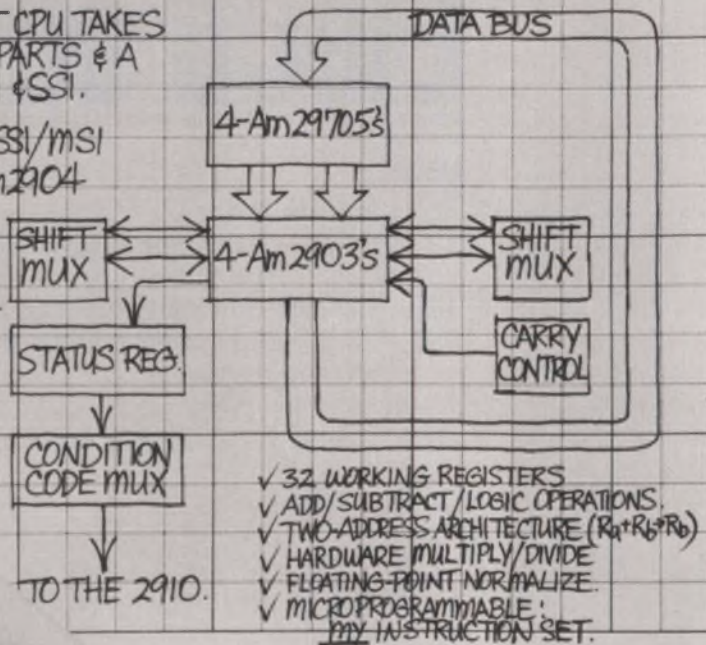

Advanced Micro Devices continues its advanced course in microprogrammable microprocessing.

Step by step, function by function, month by month, we'll show you how to build a fast, powerful microprogrammed machine.

And on December 31, 1978, you'll know what we know. As it turns out, that's quite a lot.

### CHAPTER THREE: THE CPU, PART ONE.

The Central Processing Unit is where all arithmetic functions take place.

The CPU consists of an Arithmetic Logic Unit, working registers, circuits to control the

# BUILDING A MICROCOMPUTER, CONTINUED.

shifting of registers and storage for the results.

Two parts in the Am2900 family are designed to combine all those functions on one chip, or slice. (Each chip is a 4-bit wide vertical slice of the CPU.)

### **THE SLICE.**

Advanced Micro Devices' Am2901A and new Am2903 are 4-bit CPU slices with sixteen internal working registers, two-address architecture, multi-function arithmetic logic unit and shifting logic.

### **THE SUPERSLICE.™**

And if that's not enough, hang on. The Am2903's register file is expandable. If sixteen registers aren't enough, add as many working registers as you want and still retain the two-address architecture.

If two-address architecture isn't enough, we made three-address operation possible in the Am2903.

For those of you who hate using SSI and MSI, we put all the extra hardware to do 2's complement multiply and divide right inside the chip.

### **BUILD YOUR LIBRARY. FREE.**

Each of these monthly messages is backed by a ton of theory and applications information.

Chapter Three shows all the details—complete designs, timing diagrams and tradeoffs. Send in this coupon and we'll send you Chapter Three and tell you how to get the whole book.

Advanced Micro Devices	5/10/78/ED
901 Thompson Place	
Sunnyvale, California 94086	
I want to build a microcomputer this year. Sign me up.	
Name _____	
Title _____	
Mail Stop _____	
Company _____	
Address _____	
City _____ State _____ Zip _____	

## **Advanced Micro Devices**



Multiple technologies. One product: excellence.  
901 Thompson Place, Sunnyvale, California 94086  
Telephone (408) 732-2400

Next chapter, DMA.

# economy

We became the world's largest manufacturer of SCR power supplies by offering higher quality at lower prices.

In a word: economy. In another word: value.



One- and three-phase rack-mounted power supplies from 500 to 10,000 watts. Call TOLL FREE 800-631-4298 for complete information and prices, or write for our catalog.



**ELECTRONIC MEASUREMENTS INC.**  
405 Essex Road, Neptune, N.J. 07753  
Phone: (New Jersey) 201-922-9300. TOLL FREE 800-631-4298  
Specialists in Power Conversion Equipment

CIRCLE NUMBER 5

## Publisher

William Maass

## Associate Publisher

George Rostky

## Editor

Laurence Altman

## Managing Editors

Ralph Dobriner  
Michael Elphick

## Senior Editors

Stanley Runyon  
Stephen E. Scrupski

## Associate Editors

Sid Adlerstein  
Nicholas Bodley  
Dave Bursky  
Morris Grossman  
Gene Heftman  
Andy Santoni  
Max Schindler

## Contributing Editors:

Jules H. Gilder, Alfred D. Gronner,  
Sidney Moskowitz, Nathan Sussman

## Editorial Offices

### Headquarters

50 Essex St.  
Rochelle Park, NJ 07662  
(201) 843-0550  
TWX: 710-990-5071  
(HAYDENPUB ROPK)  
Cable: Haydenpubs Rochellepark

### East

Jim McDermott, Eastern Editor  
P.O. Box 272  
Easthampton, MA 01027  
(413) 527-3632

### West

8939 S. Sepulveda Blvd., Suite 414  
Los Angeles, CA 90045  
(213) 641-6544  
TWX-1-910-328-7240

Dave Barnes, Western Editor  
465 S. Mathilda, Suite 302  
Sunnyvale, CA 94086  
(408) 736-6667

## Editorial Production

Marjorie A. Duffy, Production Editor  
James Keane, Copy Editor

## Art

Art Director, William Kelly  
Richard Luce, Anthony J. Fischetto

## Business Manager

Thomas E. Vachon

## Production

Manager, Dollie S. Viebig  
Edward J. Grimm, Nancy Hurey

## Circulation

Director, Barbara Freundlich  
Senior Assistant, Gail Stone

## Information Retrieval

Paula Greenleaf

## Advertising Promotion

Director, William Hussey  
Assistant, Judith Nappo

## Reprints

Maxine Sassano



# Across the desk

## Nothing to the inventor

It was never proposed to assign title to patents to the inventors in government-sponsored R&D, but to assign the title to their employers (Washington Report, ED No. 3, Feb. 1, 1978, p. 47). American engineers' inventions come generally under the "master-servant" doctrine of English common law. Japan, Germany, and Sweden do recognize inventions as something beyond the call of duty, and their laws require royalty payments to the individuals. Russia rewards inventors with "Certificates of Authorship."

A sample of \$4.3-billion worth of Defense R&D contracts was found to have produced 537 patents, or one patent per \$8-million spent—about one invention per 400 man-years. The Government policy of zero recognition for inventions—either to the inventor or to the company—has, it seems, been interpreted to mean "Uncle Sam doesn't want inventions."

L. T. Fleming

Innes Instruments  
Box 5216  
Pasadena, CA 91107

## Get exact 50% duty cycle

I would like to point out that in Fred Chitayat's Idea for Design, "Dc-to-Ac Power Inverter Drives Ac Cooling Fans" (ED No. 1, Jan. 4, 1978, p. 158), a simple change to the circuit allows the duty cycle to be trimmed to exactly 50%.

Though the idea has been around for awhile, it has yet to find its way into the manufacturer's literature. In the circuit, capacitor  $C_1$  charges through  $R_1$  and  $R_2$ , and discharges through  $R_2$ . The original values result in a duty cycle of about 51%, admittedly insignificant

for many applications.

However, if a diode is added across  $R_2$ , and  $R_1$  is made equal to  $R_2$ , then  $C_1$  will charge through  $R_1$  and the diode, and discharge through  $R_2$ . If  $R_1$  is made variable, it can be adjusted to about 300 k $\Omega$  so that the switching times of not only the 555 timer but also the transistors in the circuit can be compensated for. And that's how you get a duty cycle of exactly 50%.

Raymond K. Ferris  
Supervisor

Actron  
700 Royal Oaks Dr.  
Monrovia, CA 91016



Stop fooling around. It's time to renew your free subscription to ELECTRONIC DESIGN. Turn to page 45.

(continued on page 26)



**DON'T FORGET TO SEND IN YOUR SUBSCRIPTION RENEWAL FORM — SEE PAGE 45**

Electronic Design welcomes the opinions of its readers on the issues raised in the magazine's editorial columns. Address letters to Managing Editor, Electronic Design, 50 Essex St., Rochelle Park, NJ 07662. Try to keep letters under 200 words. Letters must be signed. Names will be withheld upon request.

## BUILDING YOUR OWN POWER SUPPLY?

### Think Twice!

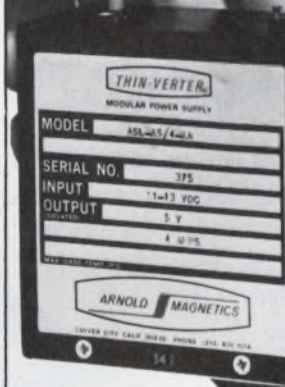

### Think "DESIGN-AS-YOU- ORDER"

Think of the expense and time involved in designing and building your own power supply, and how those resources can be applied to designing and building other components.

Now think about the exclusive Arnold Magnetics "Design-As-You-Order" system. You simply order your custom power supply from proven "off-the-shelf" sub-modules... no engineering charges, no lost design time. Just fill in our "easy-to-use" specification form, we'll do the rest. Your miniaturized, high efficiency power supply arrives encapsulated and pre-tested.

See if these parameters meet your needs:

- Inputs: Single or dual; 60Hz, 400Hz, 12VDC, 28VDC, 48VDC and 115VDC.
- Regulated Outputs: single or isolated multiple; 5 to 300VDC.
- Line and load regulation to 0.1%.
- Power: 3—160 watts (up to 3.9 watts/in<sup>3</sup>).
- Other catalog power supplies with outputs to 5000VDC and power to 200 watts.
- Capability to design and build to your special needs.

Send for a free "Design-As-You-Order" Power Supply Kit today!



## ARNOLD MAGNETICS CORPORATION

11520 W. Jefferson Blvd.  
Culver City, Ca. 90230 • (213) 870-7014

# What engineering about using micro

Microcomputers are changing the competitive picture in hundreds of industries, in thousands of applications.

Designers are using microcomputers to create new products, even new markets. Microcomputers are breathing new life into existing products and providing competitive advantages in both price and performance.

For management, there's an added challenge. What's the most *profitable* way to take advantage of the microcomputer revolution? Should you start from scratch, dedicating time and resources to component-level design? Or should you take advantage of fully assembled and tested "computers-on-a-board"?

You didn't have a choice until just two years ago. That's when we introduced the first single board computer. Like "super components," single board computers have made it easy to add intelligence to any system.

Sheer economics is one reason why. Up to 1,000 systems a year, you're money ahead with single board computers. That's based on a tradeoff formula that carefully considers amortized development and testing expenses, as well as direct material and labor costs.

Then, when production volume makes it more economical for you to switch to components, we'll provide all you need to do the job yourself—manufacturing drawings, pc artwork and a volume source for all the essential LSI components.

Time saved is another important reason single board computers make sense. You're into production sooner, without time spent developing the computer sub-system. Your engineers can go directly to the design of application-dependent hardware.

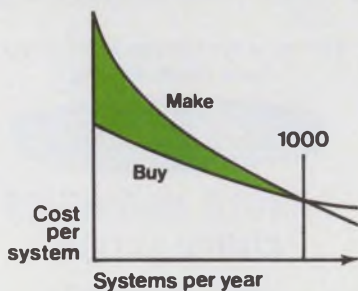

# managers should know computers profitably.

RMX-80™ Real-time Multitasking Executive gives you a head start in software development, without the need to reinvent system software for every application. Intel® our microcomputer development system, speeds application software development. It puts PL/M and FORTRAN-80 (ANS FORTRAN 77) high-level programming languages and a macro-assembler at your command. And supports full text editing, relocation and linkage capability. In-Circuit Emulation, with symbolic debugging, provides a diagnostic window

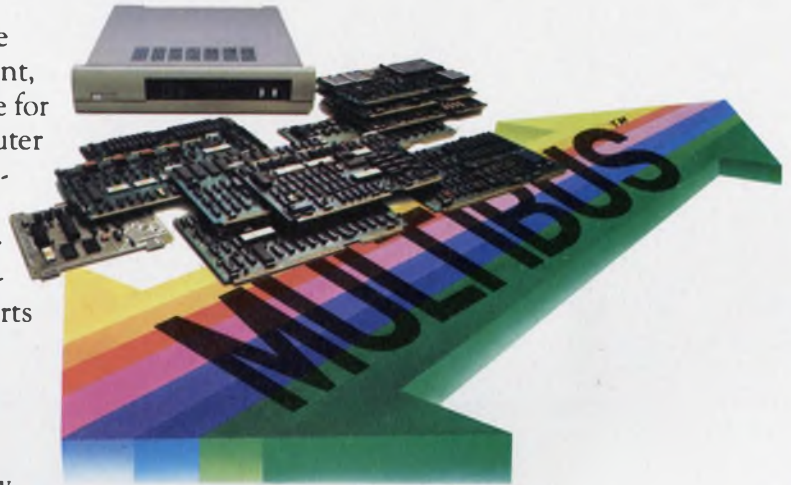

into your prototype to speed and simplify system development.

Our growing selection of iSBC™ products gives you the flexibility to tailor a system to your specific application, without compromise. Choose one of our five single board computers, starting at \$99.\* There's a full selection of memory expansion boards, communication interface boards, digital and analog I/O boards, mass storage systems and a high speed math processor. Or you can start with one of our packaged System 80's.

You're assured of the highest reliability when you build your system around an Intel single board computer. For example, MTBF for our iSBC 80/10 is 91,739 hours at 25°C. Ask for your copy of our iSBC Reliability Report.

There's also the security of Multibus™, the multi-processing bus architecture we developed for single board computers. Multibus has become such a widely accepted industry standard that today there are over a hundred Multibus-compatible products available from 42 independent companies. And Multibus is your guarantee of compatibility with future Intel iSBC products.

Get started with our comprehensive iSBC System Configuration Kit. It's a catalog of Intel single board computer products, with detailed configuration instructions and worksheets to help you define the optimum iSBC solution for your needs.

For your kit, or for on-site assistance in configuring and pricing your iSBC system, contact your Intel representative or distributor. Or write: Intel Corporation, 3065 Bowers Avenue, Santa Clara, California 95051. Telephone: (408) 987-8080. In Europe contact: Intel International, Rue du Moulin a Papier, 51-Boite 1, B-1160, Brussels, Belgium. Telex 24814. In Japan contact: Intel Japan, K.K., Flower Hill-Shinmachi East Bldg. 1-23-9, Shinmachi, Setagaya-ku, Tokyo 154. Telex 781-28426.

## intel® delivers.

FOR ISBC CONFIGURATION PLANNING KIT CIRCLE NUMBER 7

FOR PRICING AND CONFIGURATION ACCT. CIRCLE NUMBER 8

\*iSBC 80/04, domestic U.S. price, 100 quantity.

# STABILITY FOR THE UNSTABLE ENVIRONMENT

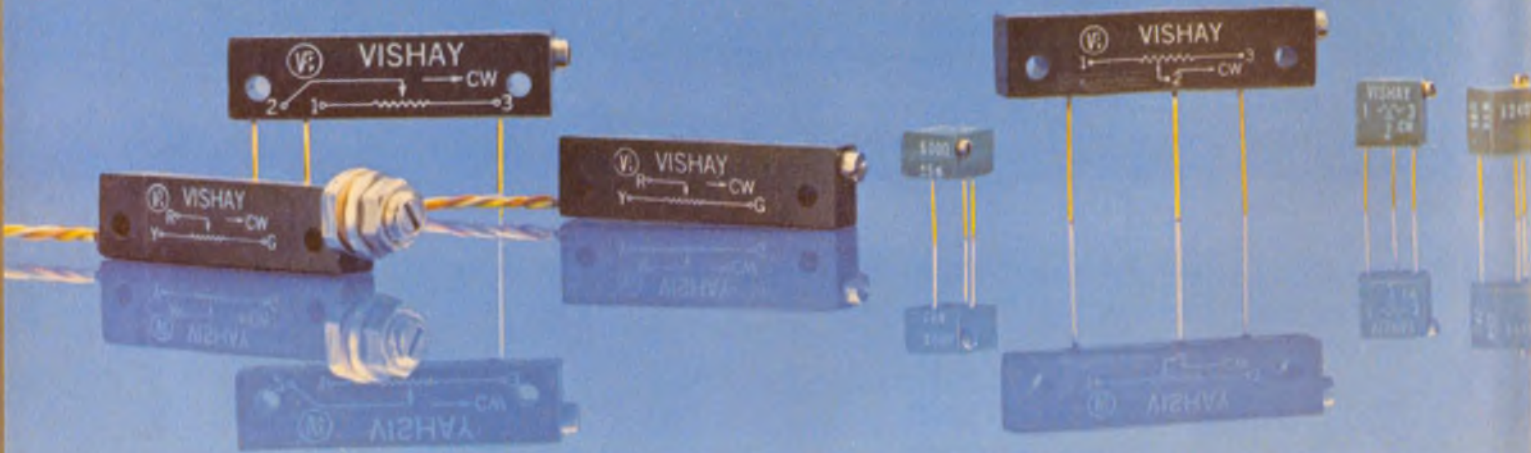

Vishay trimmers give you the solid stability that you'd expect only from a precision fixed resistor.

**Stability 1% max  $\Delta R$  after 10,000-hr 85°C load-life test.** Substantially thick ( $>2.5\text{-}\mu\text{m}$ ) virgin Bulk Metal<sup>®</sup> alloy resistance element, with extremely hard, mirror-like planar surface, won't wear from wiper travel, won't experience chemical etch in corrosive environments. Effectively sealed against moisture.

**Setting stability 0.5% max  $\Delta R$  after shock and vibration.** Superior mechanical design keeps settings on value

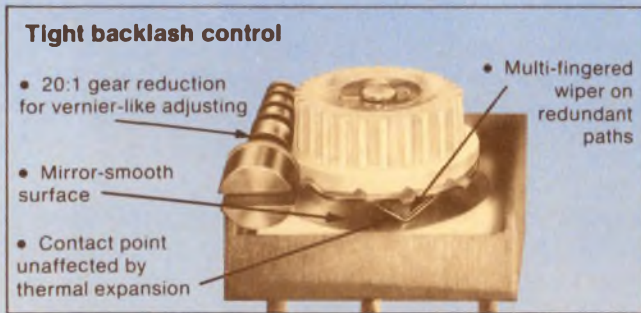

through time and rough service by eliminating stored energy (potential backlash) in the wiper and adjusting mechanism.

**TCR of 10 ppm/°C lets you cut circuit-error budget.** Vishay's well-known and unique temperature-compensation effect produces a gently parabolic TCR curve through the entire Mil range from  $-55^{\circ}\text{C}$  to  $+150^{\circ}\text{C}$ . This predictable and repeatable tempco allows you a tighter

error budget, lets you design for lower-cost components elsewhere in the circuit.

**TCR characteristics of Vishay trimmers**  
(End-to-end resistance change with temperature)

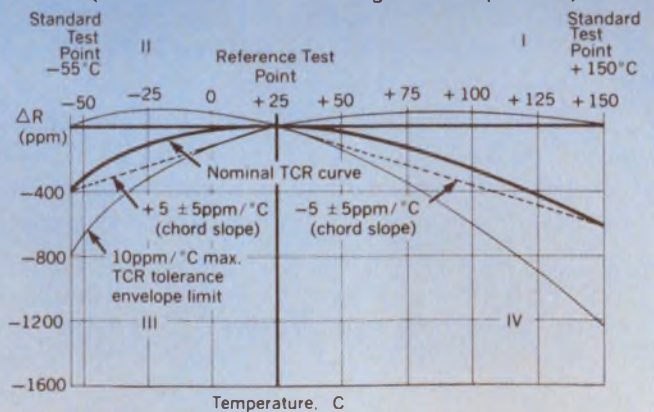

**Designed to meet or exceed MIL-R-39035 Char. H requirements.** Settability of 0.01% typical, 0.05% max.

Redundant current paths enhance settability and virtually eliminate catastrophic failure. Unmeasurable hop-off. Very low noise. Pin configurations for  $\frac{1}{4}''$  sq,  $\frac{3}{8}''$  sq,  $\frac{3}{8}''$  rd,  $\frac{3}{4}''$  rect,  $1\frac{1}{4}''$  rect. Call or write Vishay Resistive Systems Group, 63 Lincoln Highway, Malvern, PA 19355; (215) 644-1300; TWX 510-668-8944.



**Passive components aren't necessarily inactive—specify Vishay.**

# MOTOROLA OMNIBUS

Looking ahead in all technologies.

Motorola Semiconductor Group • CMOS • Small-Signal • RTL/DTL/HTL • TTL • Memories • MECL • Multiples • Chips • Power • Mil Units • MPU • Opto • Linear • RF • Thyristors • FETs • LSI

## One-inch square bridge meets small space, cost design requirements.

Introducing MDA2500—the single-phase, full-wave bridge rectifier answering customers' calls for a small, low-cost package handling 25 A, 50–400 V which replaces four DO-5s at a fraction of the price.

It's just 1" square—about 20% less in area than most competitive 25 A bridges.

It's assembled with a low-cost, high-reliability Motorola standard: the button rectifier. Buttons have been proven in millions of hours of operation in the harshest environment of all—under the hood of an automobile. Conservative design and ratings give

improved operating margins for lower operating temperatures, longer life.

Installation is easy because the mounting base is electrically isolated and terminals accept standard 1/4" slip-on terminals. Performance includes low  $V_F$  for power dissipation of less than 45 W @ 25 A, 1500 V isolation, 400 A surge (others are only rated 250–300 A) and fast recovery availability. UL recognition is pending.

We even offer a low-profile configuration. Pricing is just \$2.00 for a 200 V unit, \$2.10 for the 400 V type, 100-up. **A**

## Motorola rounds out quad family

Besides offering the new, state-of-the-art quad op amp/comparator combo, Motorola is now a source for the LM148/248/348 series of quad op amps.

The four independent op amps feature 741-like true differential inputs, low-input offset and input bias currents, pin-compatibility with MC3503 and LM124, internal frequency compensation and low supply current (0.6 mA/amplifier).

The series can be used in active filters and high impedance buffer amplifiers as well as any general-purpose op amp applications. The devices can also be employed wherever amplifier matching and/or high packing density is important.

Motorola now offers more of the most popular quad types including single supply, dual supply, automotive and Norton-equivalent types.

100-ups are 87¢ for the plastic, 0° to 70°C unit, \$3.65 for the -55° to 125°C device. **E**

## New CMOS MSI and LSI for microcomputers

### Receiver-Transmitter

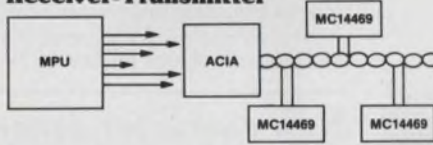

The MC14469 is a serial Addressable Asynchronous Receiver-Transmitter designed to transmit upon receiving a digital signal. It receives two 11-bit words serially, one for address and one for command. It transmits two 11-bit words, each with eight data bits. 128 units can be interconnected on one set of lines in simplex or full duplex.

One of the incoming words contains the address, which is decoded and compared with the address set on the address pins. With a matched address and correct parity, the command bits are then decoded and can be used to select the data to be transmitted, or to provide data for the remote location. Data handling at rates up to 4800 Baud between the remote A/D converters, microprocessors, or digital transducers, and a master computer or microprocessor, is a key application for this low-power CMOS device. Supply voltage range is 4.5 V to 18 V.

The 100-up plastic unit price is \$9.53. **B**

### Low-Cost A/D Converter

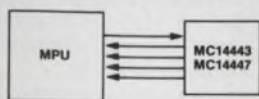

The MC14443 and MC14447 are a pair of six-channel, single-slope 8-bit A/D converter subsystems for microprocessor-based data and control systems. Each contains an

N-channel analog multiplexer with decoder, precision voltage-to-current converter, ramp circuit, and comparator.

The only difference between the two is that the MC14443 has an open-drain N-channel output and the MC14447 has the standard B-Series P- and N-Channel pair.

In a system with processors such as the MC6800, MC141000, or MC3870, the processor provides the addressing, timing, counting and arithmetic to complete the full A/D converter. A system of this type contains features like automatic zeroing, multiplying, and reference correction of six analog channels.

The MC14443 and MC14447 provide low-cost, 16-pin A/D interface at 100-up prices of \$3.17. **C**

### Display Driver



The MC14495 is a CMOS MSI BCD-to-Seven Segment Hexadecimal Latch/Decoder/Driver that features bipolar NPN output drivers. The alphabet display uses the standard seven-segment display with upper case A, C, E, and F, and lower case b and d. An additional output signals when the alpha is being presented.

With a 5 V supply, the MC14495 can interface with LED seven-segment drivers without exterior resistors. It provides the functions of a four-bit storage latch, finding applications as display driver for MPU systems, instruments, and computers.

Its \$1.99 for the plastic part, 100-up. **D**

## MC3448AL/AP to fulfill GPIB interface destiny

Destined to be the industry standard bidirectional bus transceiver between TTL or MOS logic and IEEE standard instrumentation bus (488-1975), often referred to as GPIB, these quad three-state parts combine with MC68488 NMOS handshake controller to provide all necessary interface.

Each driver/receiver pair forms the complete interface between the bus and an instrument. Either the driver or the receiver of each channel is enabled by its corresponding send/receive input with the disabled output of the pair forced to a high impedance state. An additional option allows the driver outputs to be operated in an open-collector or active pull-up configuration.

The receivers have input hysteresis to improve noise margin and their input loading follows the bus standard specs.

The unit also protects the bus from unwanted data or interference during power up/down or power off. Operation from a 5 V supply is standard.

Besides these unique features the '3448 offers high impedance inputs, 600 mV typical receiver hysteresis, 15–20 ns typical prop times and no bus loading when power is removed.

The MC3448A represents a big cost-saving over doing the same function with individual ICs and, where hysteresis isn't required, the IC costs are similar with assembly and space savings accruing to the '3448.

Our new king-of-the-hill is from stock. **F**

## Motorola introduces more RF technical knockouts in modules, mobile & microwave.

### Get Au for the price of Al

Our new generation gold linear CATV hybrid lineup is priced equally and, in some cases, less than aluminum. The new MHW1171/1172 units are just \$27.50 and \$30.50, 100-up!

The family of 10 represents one of the most diversified and complete collections of hybrids available. Spec'd for MATV and CATV applications, they're available with gains from 12-34 dB. The Motorola case 714-01 is the CATV industry standard.

And they've got state-of-the-art linearity, and a wider temperature range (-60° to 100°C) than comparables. All use ultra-low distortion, push-pull cascode circuitry to achieve 40-300 MHz bandwidth, flat response and super-low distortion products.

Aluminum's out, gold is in! **G**

### Get your mobile in overdrive

... with new 30 and 40 W MRF844/846 UHF transistors 100%-tested to withstand highline supply, RF overdrive and 10:1 VSWR.

A standard Motorola spec!

Characterized for C amplifiers in FM mobile two-way, these 900-MHz units are common-base, internally-matched CS-12 packages with input matching optimized for 100-MHz instantaneous bandwidth. They offer 6 and 5.2 GPB (dB) and complement an existing 1-20 W family.

Ruggedness combined with high gain and 806-947 MHz bandwidth make the devices industry performance leaders for public safety, mobile telephone, industrial and transportation services as well as the upcoming cellular systems for handheld and mobile radio in the 1980s.

... OR with the only industry 470-MHz units guaranteeing ruggedness at both high-line and overdrive ... MRF641/648.

The '648 offers state-of-the-art 60-W output. Both offer load mismatch capability at 20:1 VSWR, all phase angles, at 16 V and 50% overdrive. That's unbeatable.

The industry-standard 0.5" CQ package is characterized with large signal impedance parameters; minimum gains are 4.4 and 7 dB with efficiency rated at 55%. Design them into FM, UHF mobile and fixed station equipment for just \$13 and \$25. **H**

## Motorola presents an economical 10-bit DAC

Nobody makes higher value 10-bit DACs than the MC3410/3410C/3510 series.

These are low-cost, high-accuracy, laser-trimmed, monolithic D/A converters that, like their MC1408 series predecessors, provide the logic-controlled switches, the R-2R resistor ladder network and output termination networks.

Output buffer amp and ref voltage have been omitted to allow greatest system speed (settling time is 250 ns typical, multiplying input slew rate is 20  $\mu$ A/ $\mu$ s typical), flexibility and lowest cost.

Relative accuracy is, of course  $\pm 0.05\%$  maximum. Noninverting digital inputs are TTL- and CMOS-compatible (from 5 to 15 V CMOS), output voltage swing is +0.2 to

### Cascadable amplifiers take price drop

If you've been paying \$40-\$50 apiece for hybrid amplifiers in TO-12 packages—STOP! We've got the new MWA110/120 devices here for just \$6.50 and \$7 (1-99).

These 400-MHz hybrids are complete units ready to go in 50-ohm microstrip circuits. They're cascadable, ready for series connection without bandwidth shrinkage.

Providing flat response over 6 octaves of bandwidth, they offer 13 dB min gain, 4.5 and 6 dB noise figure, 1-dB min compression of -3 and +6.7 dB,  $\pm 1$  max flatness over -20° to 125°C and VSWR (input/output) of 2:1. **J**

### 4.5 GHz @ 50 mA from Motorola

Here's a lineup of microwave transistors ideally suited for low-to-medium power amplifiers requiring high gain, low noise figure and low IMD.

The BFR96/MRF961 are three- and four-lead plastic devices designed for use in broadband MATV/CATV amplifiers. MRF962 uses a hermetic, stripline ceramic package and is intended for hi-rel, high-gain use.

The hermetic MRF965 in TO-46 makes an excellent VHF/UHF Class C driver amplifier for several hundred milliwatts power out.

All use the same state-of-the-art microwave chip (BFRC96) featuring fine-line geometry, ion-implanted arsenic emitter and gold top metallization. **K**

### New Selector Guide

Motorola now offers its newest *RF Selector & Cross-Reference Guide* ... 20 pages of data including power transistors with outputs to 150 W for 1.5 MHz to 1 GHz; small-signal transistors with  $f_t$  to 6 GHz; linear hybrids for CATV/MATV; power amps for VHF/UHF up to 30-W output; package dimensions, cross-referencing and latest pricing. A short-form complement to the new *RF Data Manual*, it offers an at-a-glance look at a wide gamut of advanced-technology, high-quality RF devices. Yours on your company letterhead.

-2.5 V and all categories are guaranteed monotonic across temperature. The ref amp is internally compensated and output current ranges from 0 to 5 mA.

No one makes a direct replacement and most SC majors don't make a 10-bit DAC at all. The ones that do are almost always overpriced so Motorola can really offer you the best deal all around in 10-bits.

The MC3410C, incidentally, is a 9-bit unit which can be a rock-solid replacement for those 8-bit devices you've just been getting by with. And its only a few cents more.

Use it in industrial control and MPU-based systems and save a bundle.

100-ups are \$4.95, \$7.95 and \$13.95. **L**

## Two pounds of RF data from Motorola



The heavyweight supplier of RF transistors, Motorola, announces another technical knockout—the new RF Data Manual complete with data sheets, application notes and cross-references.

The two-pound, 736-page volume describes RF devices with outputs to 150 W for commercial, military, aircraft, marine and ham bands from 1.5 MHz to 1 GHz, as well as linear hybrid amplifier modules for CATV/MATV and GP use, power hybrids up to 30 W in VHF/UHF and small-signal transistors with  $f_t$  values to 6 GHz.

Detailed application information includes impedance matching networks, mechanical RF construction techniques, biasing, reliability, noise figure and gain optimization procedures, mounting, heat sinking and discussions of SSB linearity, broadbanding and power combining. Specific amplifier configuration articles include actual printed board layouts.

It's available from your franchised Motorola distributor for just \$1.75 a pound.

## New character generators need only single +5 V power supplies

As the leader in character generators, Motorola introduces a new solution for character display, this time with the MCM66700 and MCM6670 mask-programmable horizontal-scan families.

Both feature fully static operation, complete TTL compatibility, three-state outputs, fast access time (350 ns max), and each uses only a single +5 V power supply.

The MCM66700 series is a pin-for-pin replacement for all eleven patterns of the earlier MCM6570, and many have on-board shifted characters. MCM66700s contain 128 characters in a 7 x 9 matrix, with programmed versions for ASCII shifted and unshifted, math symbols, alphanumeric control, Japanese, and British, French, German, and European, shifted. They are also CMOS and microprocessor compatible.

The MCM6670 displays 128 characters in a 5 x 7 matrix. It's available in both plastic and ceramic 18-pin packages. Corner pins are used for the  $\pm 10\%$  +5 V supply. The MCM6674 is a version preprogrammed with alphabet and math symbols.

Mask charges, and minimum order quantities of 250 pieces, apply to the custom program MCM66700 and MCM6670 types. Preprogrammed versions are available from Motorola and authorized Motorola distributors. No minimums apply. **M**

# LSI to Glue ... and Memories, too

## All you need for TTL microprogrammable processors

Motorola is unique when it comes to providing what it takes to design and build your high-speed TTL microprogrammable processor. We're the only ones who has it all\*, and it's all off the same Schottky process for uniformity, reliability, and lower over-all component cost.

\*The MC2901A 4-bit slice and our other M2900 Family industry-standard LSI functions, for sequencing, number crunching, and interface.

\*Memories, for microprogram storage, with your option of 2K, 4K, or 8K PROMs, or even RAMs.

\*LSTTL "glue," a whole family of over 100 SSI and MSI functions for logic and interface, to bind your system together for your specific application.

The MC2901A is the familiar plug-in replacement that shows greatly improved performance over the 2901 4-bit slice in higher speed, reduced power supply current, increased noise immunity, and increased low-level output current. A new M2900 Family 4-bit slice, the MC2903, with easy register file expansion and no loss of speed or flexibility is scheduled for third quarter availability.

Additional M2900 Family LSI for your processor system includes the MC2909 and MC2911 microprogram sequencers, I/O

sequencer functions MC2905-7, MC2915A-17A, and the MC2918 register file. The MC2910, planned for mid-year, is a new 12-bit wide microprogram controller that can address up to 4096 words of microcode.

Among the memories, the MCM93415 and MCM93425 1K RAMs, and the 4K MCM7641 and MCM7643 three-state PROMs are available now, and due to be joined by a large group of additional industry-standard PROMs: 2K MCM7620, 21—MCM7640 and 42 4K (open-collector output)—and 8K MCM7680, 81. All are planned for availability by July.

These Motorola PROMs are pin-compatible replacements for industry-standard PROMs and ROMs. All have common dc performance and programming.

As for LS, let it suffice to suggest that among the more than 106 SSI and MSI parts available now, and the more than 150 parts to be available by year's end, we have what your processor system requires. The 74LS240 series, bus-oriented octal line drivers and quad receivers, and the 74LS365A hex buffers are typical examples.

We can save you money when you buy it all here, by packaging your orders to get lower, large-quantity prices in play. Come to Motorola, where we've got it all. **N**

## Diode guide reflects 20 years of knowhow

The right device for nearly every application is listed and cross-referenced in the new *Motorola Rectifier/Zener Diode Selection Guide & Cross-Reference*.

Included are rectifiers, bridges, Schottky and fast recovery units, high voltage diodes/stacks and high current devices. Also zener, TC and precision reference diodes, amplifying and current regulator diodes, low-voltage regulators, transient suppressors and optional variations. Without a doubt the most complete publication of its kind and it's yours on company letterhead request.

## Motorola opens op amp/comparator game with 2 pair

The MC3405/3505 offer an economical quad function with a twist. Two of the four devices are op amps and the other two voltage comparators. An industry first.

The op amps are internally compensated, have true differential inputs and are equivalent in performance to MC3403/3503. The comparators provide low offset voltages with low power consumption and are similar to LM339/139. The circuit offers 3-36 V single supply and +1.5-+18 V split supply operation plus low current drain. Both are capable of common-mode inputs down to the negative supply.

It's a useful, versatile building block in automotive, consumer and industrial designs including PWM, window comparator, squelch circuit for AM or FM, LS to CMOS interface with hysteresis, high/low limit alarm and zero crossing detector with temperature sensor.

The MC3405/3505 is available in two temperature ranges in plastic (P) or ceramic (L) 14-pin packages. The '3405 has a specified operating ambient range of 0° to 70°C and the '3505 is spec'd from -55° to +125°C.

Input offset voltage is typically 2 mV and power supply current is typically 2.5 mA.

100-up pricing is MC3405P, \$1.15; MC3405L, \$1.50; and MC3505L, \$7.50. **Q**

## Plastic Triac saves 30% over old metal TO-5

Here's a low-cost, drop-in replacement for those old, TO-5 2.5 A (RMS), 3 mA sensitive-gate RCA T2300 Series Triacs that have been around since year 1.

It's tested and spec'd for the same electricals and available in TO-5 pin circle.

There's an actual 30% price saving over RCA, too—the Motorola T2300PB is just 70¢ and the T2300PD is only 87¢, both 100-up.

Time-tested design and materials add up to reliability documentation that's really impressive for plastic units like these. Power

cycling at extreme  $\Delta T$  operation shows over 43 million cycles resulting in an estimated MTTF of over 3 million cycles. Blocking life tests are equally impressive and a variety of other tortures proves glass-passivated thyristor die and greatly improved molding compound afford a reliability level that easily meets industrial and consumer requirements.

Other series, the T2301P and the T2302P, are available with IGT spec'd at 4 mA and 10 mA, respectively. **P**

## MOTOROLA OMNIBUS Looking ahead in all technologies.

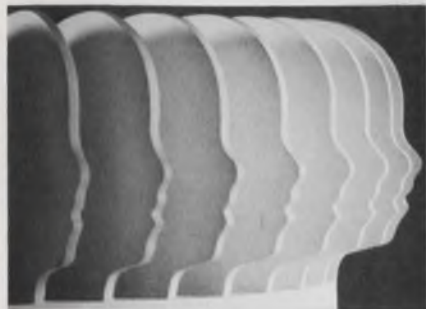

(Coupon Missing?) Send inquiries to:  
Department LDC, Motorola Semiconductor  
Products Inc., PO. Box 20912  
Phoenix, AZ 85036

(Please Check Only The Items You're Interested In:)

- |  |  |   |
|--|--|---|
| A <input type="checkbox"/> MDA2500       | F <input type="checkbox"/> MC3448A/AP          | L <input type="checkbox"/> MC3410C/3510     |
| B <input type="checkbox"/> MC14469       | G <input type="checkbox"/> MHW1171/1172        | M <input type="checkbox"/> MCM66700/6670    |
| C <input type="checkbox"/> MC14443/47    | H <input type="checkbox"/> MRF844/846, 641/648 | N <input type="checkbox"/> TTL, LSI to Glue |
| D <input type="checkbox"/> MC14495       | J <input type="checkbox"/> MWA110/120          | P <input type="checkbox"/> T2300PB          |
| E <input type="checkbox"/> LM148/248/348 | K <input type="checkbox"/> Microwave           | Q <input type="checkbox"/> MC3405/3505      |

For complete product itineraries, fill in and send to:  
Motorola Semiconductor Products Inc., P.O. Box 20912, Phoenix, Arizona 85036

Please have salesman call ( ) \_\_\_\_\_

Name \_\_\_\_\_ Title \_\_\_\_\_

Company \_\_\_\_\_ Address \_\_\_\_\_

City \_\_\_\_\_ State \_\_\_\_\_ Zip \_\_\_\_\_

SEMICONDUCTOR OR CORE. EMM is the only memory company that can assess your needs impartially and recommend the solution best for your application. Either technology - semiconductor or core - is available in our industry standard MICROMEMORY 3000 family or in a custom design. **JUST THE RIGHT SIZE.** Proven EMM memories are available in capacities from 8K bytes to 128K x 22 bits on a single board. Or we can package them in a chassis with self-con-

tained power supply. **ANY SPEED YOU NEED.** Why pay for speed you can't use? Or settle for less than you need? With our wide range of systems and choice of technologies, we can give you just what you should have.

Call us for more details, or send for our free brochure "Core or Semiconductor - Let Your Application Make the Choice"



## Memory problems? EMM can help.

### Semiconductor or core

### Just the right size

### Any speed you need

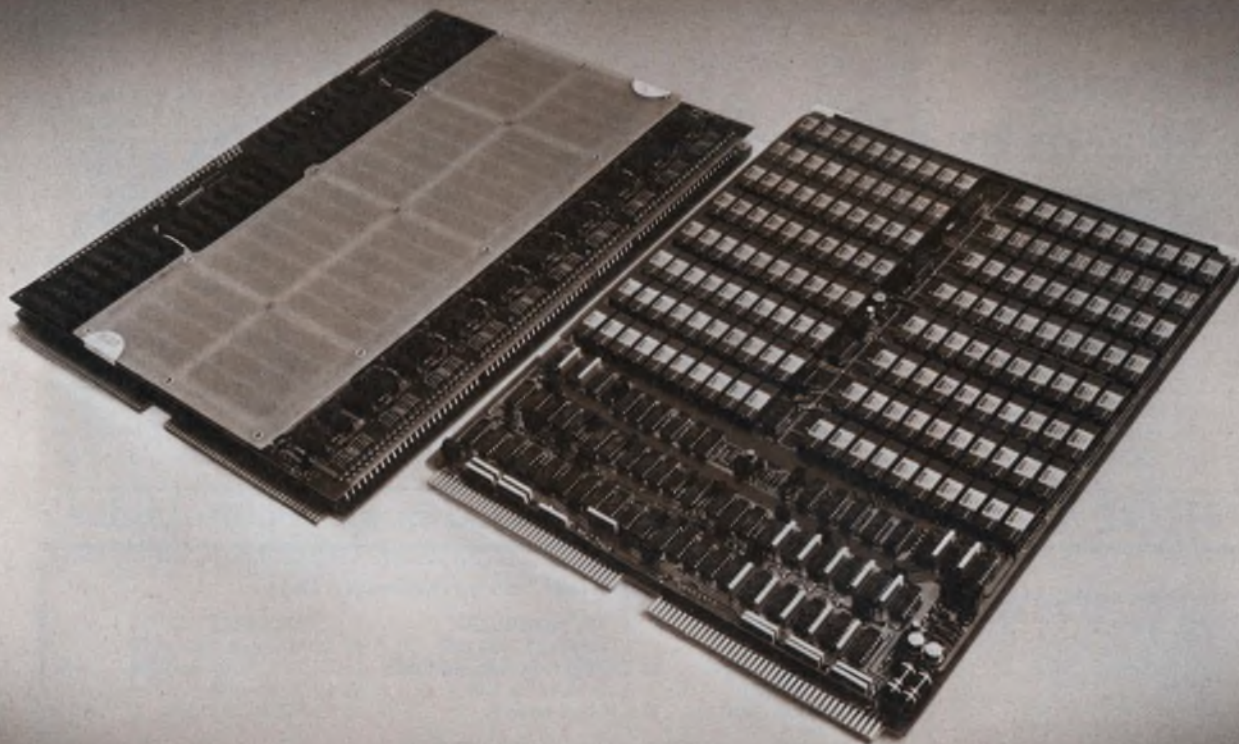

**Commercial Memory Products**, a Division of Electronic Memories & Magnetics Corporation  
12621 Chadron Avenue • Hawthorne, California 90250 • Phone (213) 644-9881

See us at Booth 1327 at the NCC show, Anaheim, CA, June 5-8.  
CIRCLE NUMBER 10



# Want mass terminations for I/O interconnecting? We have the widest choice.

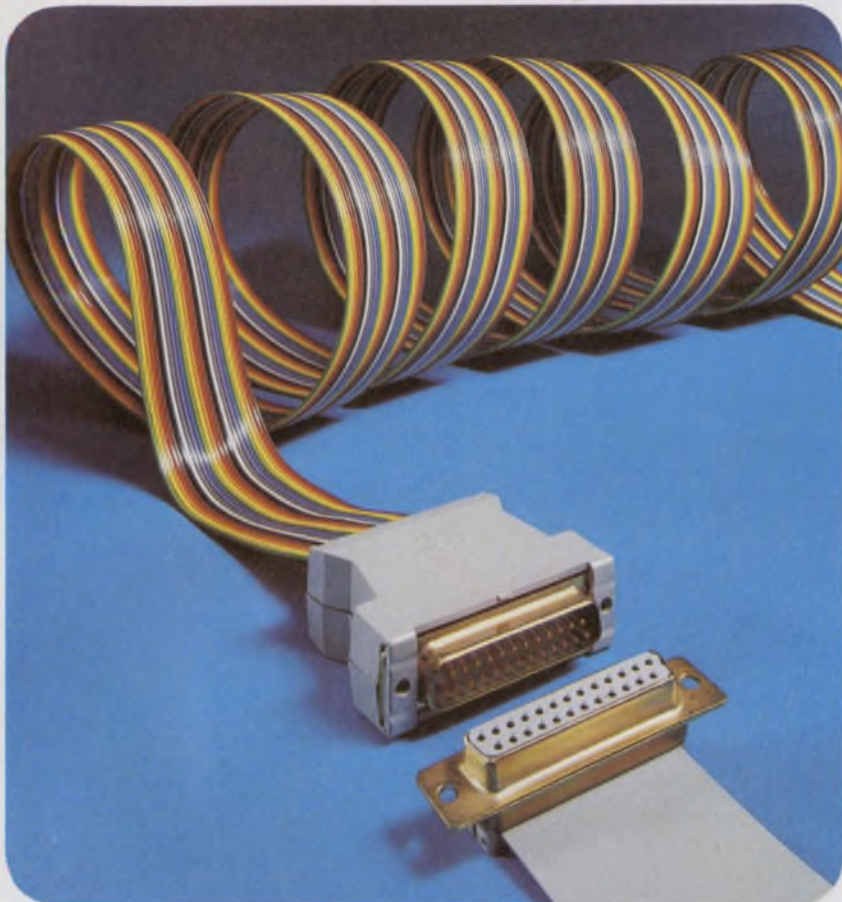

Now Scotchflex brand DELTA Connectors bring the proved labor-savings of 3M's mass termination system to subminiature connections. DELTA series components include pin and socket connectors, junction shells, 25-conductor flat cable and strain relief clips. These system assemblies interface directly with all other industry standard "D" series subminiature connectors. They're also compatible with all connectors in our complete Scotchflex line.



A family of Scotchflex male plug connectors is now available in sizes from 10 to 50 contacts to mate with Scotchflex socket connectors for T-tap or mid-span connections or rack and panel applications.

"Scotchflex" is a registered trademark of 3M Co.



Our broad line of Scotchflex socket connectors includes a variety of 12 different sizes and center spacings to fit standard wrap panels and custom configurations. Also offered are Scotchflex card-edge connectors in sizes for 20 to 50 conductors.

Only 3M offers you so wide a choice of mass terminating flat cable and system components for fast, economical assembly of I/O interconnections between modules or sub-assemblies in your equipment designs. Plus off-the-shelf availability from experienced distributors, and the unmatched experience of the people who pioneered electronic mass terminations.

For more information on Scotchflex products call 612-733-3350.

## Scotchflex<sup>®</sup> systems from 3M. The source.



See our  
catalog in EEM,  
page 2256

# “Simplicity is the key to advanced fiber optic terminations. That’s why OPTIMATE connectors light the way.”

Meaningful progress in fiber optics technology is no longer hampered by impractical termination techniques. Today, AMP innovation is opening the way for an expanding array of applications.

We are especially proud of the unique contributions of our OPTIMATE line. These connectors have made universal termination possible for a wide variety of fiber optic cable. And they do it simply, quickly and with highly repeatable accuracy. Single optic fibers, as small as .004", can be terminated and OPTIMATE connectors incorporate a resilient material which ensures optical centering. Precise, accurate polishing is easy and fast, thanks to a simple adaptor.

There are more OPTIMATE contributions...such as providing for the intermixing of fiber optics with conventional power or signal cable in a wide range of standard housings. And more are on the way. Because we at AMP have over 2,000 people involved in research, development and engineering

activities alone. And because we are committed to the same kind of leadership in fiber optics that we have achieved in other termination areas.

For more information on our OPTIMATE line, just call Customer Service at (717) 564-0100. Or write AMP Incorporated, Harrisburg, PA 17105.

1. Few parts to assemble.



2. Simple, proven crimp.



3. Accurate polishing.





**AMP has a better way  
...Fiber Optics**



**To help you innovate, two  
OPTIMATE Kits are available:**  
just connectors, cable and tooling,  
or complete with active devices  
and predrilled circuit boards  
for construction of optical links  
with TTL or CMOS input/output.

For information on other  
fiber optic contacts for inter-  
mixing in standard connectors,  
please call Customer Service at  
(717) 564-0100.

AMP is a trademark of AMP Incorporated

**SEE US AT  
ELECTRO, BOSTON**

**AMP**  
INCORPORATED

CIRCLE NUMBER 12

# Trace quality. GOULD/Brush Recorders have it.

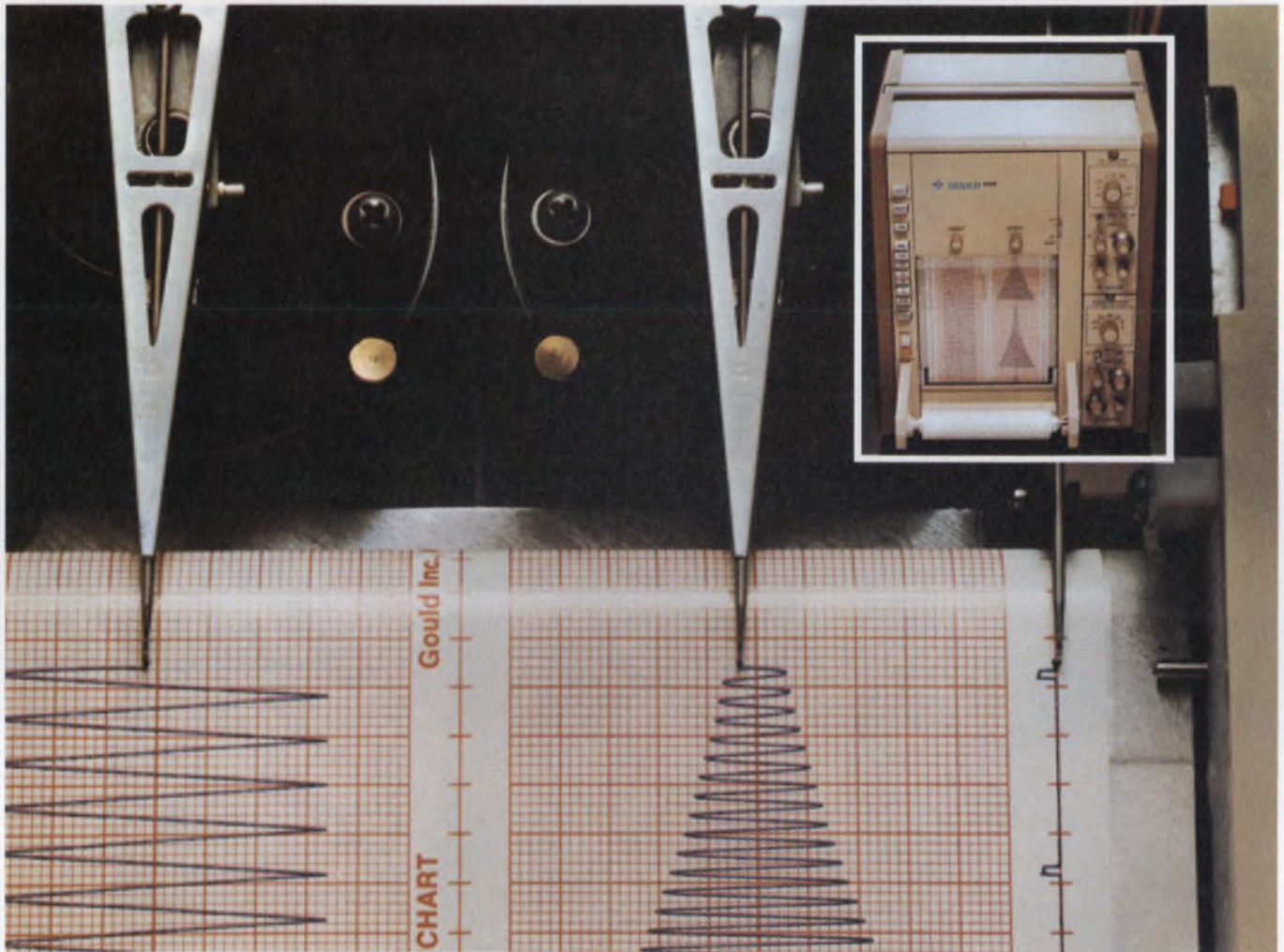

## Regardless of pen velocity.

The exclusive GOULD pressurized fluid writing system assures you constant width traces regardless of pen velocity. The ink is injected into the paper and is wiped dry instantly by the high pen pressure seal. In combination

with GOULD low cost chart paper, your traces are permanent. They won't fade or deteriorate as do other writing methods.

An event that may only occur once demands the highest trace quality you can buy . . . GOULD.

For more information write Gould Inc., Instruments Division, 3631 Perkins Ave., Cleveland, Ohio 44114. Or Gould Allco S.A., 57 rue St. Sauveur, 91160 Ballainvilliers, France.

For brochure, call Gould toll-free at (800) 325-6400, Ext. 77.  
In Missouri: (800) 342-6600

CIRCLE NUMBER 13

 **GOULD**

ELECTRONIC DESIGN 10, May 10, 1978

# Precision quad op amps. *Precision.*

PMI's new OP-09 and OP-11 are pin-compatible with the un-precision quads now on the market.

The quad op amp has finally come of age. With the introduction of the OP-09 and OP-11, PMI has made it a truly workable reality. Consider:

## Low $V_{OS}$ and other goodies.

Since quads can't be nulled—there aren't enough pins available—the user is at the mercy of whatever input offset voltage ( $V_{OS}$ ) he happens to get. PMI refined the manufacturing process to get  $V_{OS}$  under control. We came up with the lowest  $V_{OS}$  of any quad op amp made today.

At the same time, we gave the OP-09 and OP-11 the highest gain and the lowest drift of any quad op amp. We expanded bandwidth, reduced offset and supply current, and increased the slew rate. Here it is in black and white:

## OP-09/OP-11 Features

	TYP.	MIN./MAX.
• Low $V_{OS}$	0.30 mV	0.5 mV MAX.
• Low offset current	8.0 nA	20 nA MAX.
• Low supply current (Total for all 4)	3.5 mA	6 mA MAX.
• Voltage gain	250K	100K MIN.
• Slew rate	1.0 V/ $\mu$ S	0.7 V/ $\mu$ S MIN.
• Matched positive and negative slew rate for low distortion.		
• Bandwidth		2.0 MHz MIN.

## We make them match.

Another important advantage: we guarantee that all four op amps will match in terms of  $V_{OS}$  and CMRR. Here's how we specify them:

## Matching Characteristics

Parameter	Symbol	OP-09A/E OP-11A/E			OP-09B/F OP-11B/F			Units
		Min	Typ	Max	Min	Typ	Max	
Input Offset Voltage Match	$\Delta V_{OS}$	—	0.5	0.75	—	0.8	2.0	mV
Common Mode Rejection	$\Delta CMRR$	—	1.0	20	—	1.0	20	$\mu$ V/V
Ratio Match		94	120	—	94	120	—	dB

(Match exists between all four amplifiers)

DUAL INSTRUMENTATION AMPLIFIER 2 OP AMP DESIGN  
(1/2 CIRCUIT SHOWN)

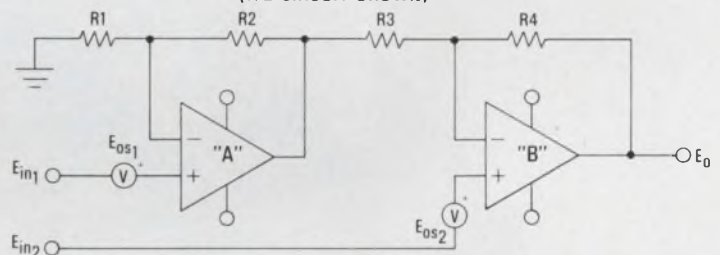

These matching dc characteristics should interest you. They reduce distortion, improve system performance, and simplify your design. But that's not all.

We've given all four op amps symmetrical positive and negative slew rates—an important thing to keep in mind for audio system design.

It's fair to say that the OP-09 and OP-11 are the most accurate, most advanced and the only precision quad op amps on the market. And they are on the market—available now, today.

Like to check one out? Be our guest. Just drop us a line on your company's stationery, telling us if you'd prefer an OP-09 (4136 pinout) or an OP-11 (148/4741 pinout). We'll be glad to send literature and a sample.

Precision Monolithics Incorporated  
1500 Space Park Drive  
Santa Clara, California 95050  
(408) 246-9222.  
TWX: 910-338-9222  
Cable MONO.



CIRCLE NUMBER 14



# CIRCUITS FOR THAT



**Save space, save time, save system  
cost with Intersil counting  
and timing microcircuits.**

# SYSTEMS COUNT.

For event timing, unit counting and frequency generation, Intersil has a line of circuits second to none. You get solid state reliability and size reduction, plus the time- and money-saving benefits of just the right product for your job... from Intersil.

## VERSATILE LOW POWER COUNTER.

**7208** is a 7-digit frequency, unit or period counter which directly drives an LED display. For a unit counter, add a display, 2 resistors, a capacitor and control switches.

## BATTERY OPERATED CMOS COUNTER/TIMERS.

**7215** industrial counter/timer has four functions (start-stop, split, taylor and time-out) and times up to 59 minutes, 59.99 seconds.

**7205** has split, taylor and reset functions for timing to 59 minutes, 59.99 seconds.

**7045A** times up to 23.99999 hours. All the above counters directly drive an LED display.

## EXTERNALLY SETTABLE COUNTER/TIMER CIRCUITS.

**8240** is one of a family of programmable counter/timers which generate long pulse widths with inexpensive RC components. Each circuit contains an oscillator and divider flip flops. Pin connections on the **8240** select an output pulse width from 1 RC to 255 RC.

**8250** can be used with thumbwheel switches to count from 1 to 99.

**8260** counts 1 to 59 for timing seconds, minutes or hours.

## LOW COST PRECISION TIMERS.

**555** generates time delays from microseconds to hours, with the addition of only one resistor and a capacitor.

**556** contains two **555s** in a single package.

## CMOS QUARTZ CRYSTAL FREQUENCY GENERATORS.

**7207** Frequency Counter Timebase (.01 and .1 second count window) or the **7207A** Frequency Counter Timebase (.1 and 1 second count window) provide all the gating, store and reset signals necessary to expand the **7208** into a frequency counter.

**7209** is a versatile high frequency clock generator with a divide-by-8 output stage for a 5 Volt system.

**7038A** is a micropower oscillator, frequency divider and output driver for 3 Volt synchronous motors. The **7038B** is designed for 1.5 Volt synchronous motors.

**7213** is a versatile oscillator, divider and waveshaping circuit providing various outputs including 1-second and 1-minute pulses.

**7049A** and **7050** are oscillator circuits which include a divider chain, output one-shot and output buffer for 1.5 Volt stepper motors.

**7051A** is a clock circuit for 12 Volt synchronous motor applications.

## CMOS CUSTOM CIRCUITS.

We can develop custom CMOS LSI circuits for your special counting and timing applications. Consult your local sales office listed below for information or, return the coupon below.

## INTERSIL SALES OFFICES:

CALIFORNIA: Sunnyvale (408) 744-0618, Carson (213)

532-3544 • COLORADO: Denver (303) 750-7004

FLORIDA: Fort Lauderdale (305) 772-4122 • ILLINOIS:

Hinsdale (312) 986-5303 • MASSACHUSETTS: Lexington

(617) 861-6220 • MINNESOTA: Minneapolis (612) 925-1844

NEW JERSEY: Englewood Cliffs (201) 567-5585 • OHIO:

Dayton (513) 866-7328 • TEXAS: Dallas (214) 387-0539

CANADA: Brampton, Ontario (416) 457-1014

## INTERSIL FRANCHISED DISTRIBUTORS:

Advent/Indiana • Alliance Electronics • Arrow Electronics  
CESCO • Century Electronics • Component Specialties  
Components Plus • Diplomat/IPC • Diplomat/Southland  
Elmar Electronics • Harvey/Binghamton • Intermark Electronics  
Kierulff Electronics • LCOMP • Liberty Electronics  
R.A.E. Ind. Elect. Ltd. • RESCO • Schweber Electronics  
Sheridan • Zentronics

# INTERSIL

Analog Products — Low Power

10710 N. Tantau Avenue, Cupertino, CA 95014

Tel: (408) 996-5000

TWX: 910-338-0171

Gentlemen:

Please send me your product literature on device #'s \_\_\_\_\_

\_\_\_\_\_ Please send me your new Mark Twain Poster.

Name \_\_\_\_\_

Company \_\_\_\_\_

Address \_\_\_\_\_

City \_\_\_\_\_

State \_\_\_\_\_

Zip \_\_\_\_\_

ED051078

# TAKE A TEST DRIVE.

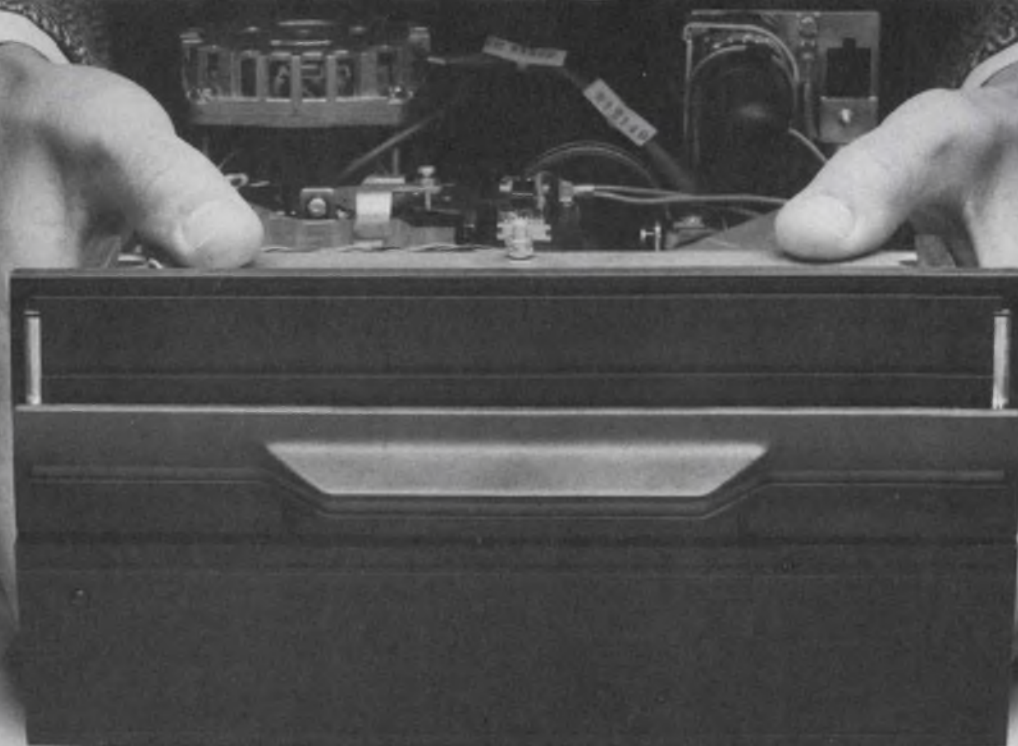

Introducing the Memorex 552 Dual-Head Flexible Disc Drive—  
and a great way to find out just how great it is:

Just give us a call and we'll loan you one of our new 552's. So you can test it in your systems, under the conditions important to you. So you can confirm for yourself the 552's 1600 kilobyte capacity, 3 msec access time, and high reliability. So you can see for yourself the benefits of all the features Memorex builds in for better performance, greater versatility, operating ease, and reduced cost of lifetime ownership.

If a dual-head drive is more than you need; our 550 single-head, double density drive may be just the one you need. All the features you've come to expect as industry standard, plus some others that are setting new standards. Like the fastest access time of any single-head drive. And fast conversion of our 550 to dual-head, because of the near total parts commonality with our 552. Unique features that make the 550 a uniquely-effective performer. Take one of our test units and you'll see just how well the 550 performs.

To get your evaluation unit, just call the Memorex office nearest you, or write us at General Systems Group (OEM Division), San Tomas at Central Expressway, Santa Clara, CA 95052.

We'd be pleased to have you test our drives, because we're confident you'll be pleased with the results.

## MEMOREX

BOSTON (617)890-0700; NEW YORK (201)325-0164; DETROIT (313)354-4511  
LOS ANGELES (714)557-4330; DALLAS (214)258-3510; SAN FRANCISCO (408)987-1373



# If we ship you our 100,001st instrument, WE'LL SHIP YOU OUT TOO!

Last month Data Precision reached a major milestone with the production of our 100,000th instrument. We also delivered the 100,001st unit to one of our stocking representatives. It will be purchased by someone this month. If that lucky someone is you, we'll be sending you on the shipboard adventure of a lifetime!

#### Here's How It Works

Only our president knows the serial number of that very special instrument, and he'll be watching for the return of a warranty card bearing that number. If you've purchased our 100,001st instrument, you'll win an exciting 6-day Windjammer cruise for two. Or \$1000 cash. Or a Model 3500. Those who purchase the next five units, numbers 100,002 through 100,006, will win a Model 175.

#### You're Always A Winner With Data Precision

Now you have another excellent reason to buy Data Precision, although excellent reasons are never in short supply here. We lead the industry in pioneering advances that have reduced the size, circuit complexity, and cost of digital instruments. As our 100,000 unit success attests our equipment is very highly regarded.

#### Join The Celebration

Our 100,000th unit will be on display at Electro '78, where we'll be giving away a number of instruments and much more. So be sure to stop by Booths 2224-26-28 and help us celebrate.

And if you're thinking about buying a Data Precision instrument, now is certainly the time. Because the first of our second hundred thousand could turn up with you, and you could be sailing.

Employees and families of Data Precision and its advertising agency, sales representatives and distributors are not eligible. Offer void wherever prohibited or restricted by law. All federal, state and local regulations apply.

Data Precision Corporation,  
Audubon Road,  
Wakefield, MA 01880, USA,  
(617) 246-1600.  
TELEX (0650) 949341.

 **DATA PRECISION**  
...years ahead

CIRCLE 15 FOR DEMONSTRATION

CIRCLE 17 FOR ADDITIONAL INFORMATION

Visit us at Electro '78 at Booths #2224-26-28

# The ICEMAN is Here!



# Motorola introduces a cooler-running, longer-lasting, lower-cost power supply.

## ICEMAN.

ICEMAN's here with superior triple-output design for M6800 MPU and other logic designs.

ICEMAN's here with reputable specs and reasonable expectations.

ICEMAN's here with heat-busting reliability.

ICEMAN's here with correct balance between hardware and performance.

ICEMAN's here with lower prices.

ICEMAN's here, about time.

### What Others Say

Every MPU power supply source says the same thing—"at 50°C, our supply will operate at 100% of rated output power." And many show, or describe, a derating curve like this on their data sheet:

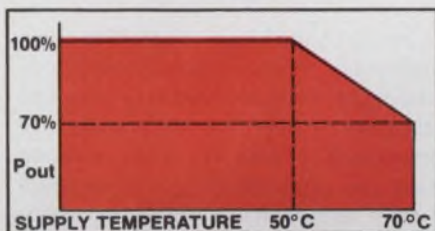

But shown or described, the curve doesn't really tell you anything about the unit. Because the devices inside that unit may be operating a whole lot hotter than the supplier, or you, thinks. Even at 50% efficiency, 50% of input power will be dissipated by the supply itself.

As industry observers have noted, many manufacturers aren't even able to meet their own derating curves. At least for extended periods. And their supplies may not be able to deliver 100% of multiple rated voltages and currents simultaneously at rated temperatures.

That 100% looks reassuring. But 100% of what? 5 V @ 6 A? 12 V @ 1 A twice? Some? All? None?

### What Motorola Says

Run it cooler and run it longer. All power transistors have a maximum  $T_J$ . Usually, it's 200°C for discrete, series-pass hermetics.

And, if you plot device life vs  $T_J$ , you'll get this curve:

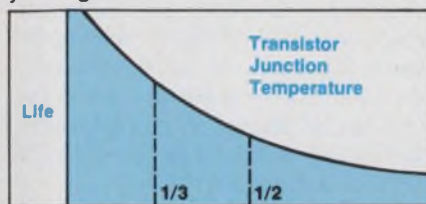

It's obvious. The cooler the device, the longer it lasts.

Where the supply designer operates on this curve is up to him.

But the secret of our success is conservative guardbanding—and we know no device should operate continuously at more than 75% of its maximum  $T_J$  to meet customers' reliability expectations. A 200°C-rated TO-3 or TO-66 should be no hotter than 150°C. A 150°C-rated plastic unit should run at 110°C or lower.

And that's where we design them to operate in ICEMAN supplies.

At 100% of  $P_{out}$  (all outputs simultaneously) our power transistors will be at 75% of their maximum  $T_J$ .

No ifs, ands or buts.

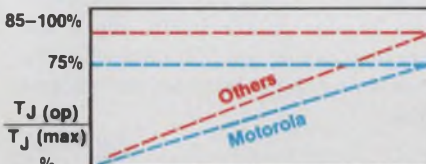

Units in other supplies will be at 85%, 95%, 100% . . . or even higher. And you can't do that to a power transistor and expect it to live long.

Our pedal's not to the metal.

### How We Keep 'Em Cool



ICEMAN supplies furnish 50% to 100% more square inches of heat sink area than comparables. Power transistor locations are spread over a much greater area, heat is dissipated faster, more efficiently, the supply runs cooler and more reliably.

ICEMAN design furnishes power devices with more of what they're looking for—enough heat sink to take care of heat dissipation and keep  $T_J$  out of catastrophe.

Vendor	$P_{out}$ (Watts)	Sq. In. Per Watt	% of Motorola
Motorola	17.2	5.33	100
Company A	17.5	2.48	46.5
Motorola	36.8	3.13	100
Company A	46.0	1.65	52.7
Company B	39.0	2.14	68.3
Motorola	54.0	3.18	100
Company B	70.8	1.49	46.9
Company C	60.0	1.51	47.5

### Better, Standard OVP

Besides standard foldback current protection with the MC1723, ICEMAN supplies furnish the latest OVP technology using Motorola's MC3423 and the 2N6504 SCR. The '3423 senses overage, rapid-fires the SCR and shorts the supply output forcing it into current limiting or opening fuse or breaker. Turn-on propagation is just 0.5ms preventing SCR failure from incomplete firing. Threshold is resistor-adjustable.

### ICEMAN's Bottom Line

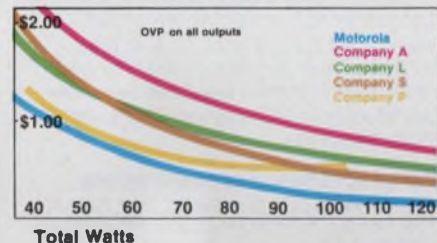

Quality and technology are not expensive at Motorola. Our PLT800, 810, 820, 840/841, 2, 4, 6 and 15 A supplies are lower-priced-per-watt than any other nationally-known manufacturer based on latest published data.

For more information on ICEMAN, contact Motorola Subsystem Products, P.O. Box 29023, Phoenix, AZ 85038, (602) 244-3103.

Or, circle the reader number. ICEMAN. Cool, man.



**MOTOROLA INC.**



## ICEMAN'S Available

... from these authorized Motorola distributors. Contact them about Motorola's 2, 4, 6 and 15 A triple output power supplies for MPU and other logic-related applications. Or call Motorola Subsystem Products, (602) 244-3103.

### Manufacturers' Representatives

Boston • New England Tech. Sales	(617) 272-0434
Cedar Rapids • Dy-Tronix Inc.	(319) 377-8275
Chicago • Sumer	(312) 991-8500
Cleveland • McFadden	(216) 381-8070
Columbus • McFadden	(614) 459-1280
Dallas • P.J. Scanlon Co. Inc.	(214) 231-4661
Denver • Barnhill Five	(303) 426-0222
Detroit • McFadden	(313) 278-2038
Ft. Wayne • McFadden	(219) 485-2526
Houston • P.J. Scanlon Co. Inc.	(713) 496-1170
Indianapolis • McFadden	(317) 896-5070
Kansas City • Dy-Tronix Inc.	(816) 373-6600
Los Angeles • Ed Landa Co.	(213) 879-0770
Milwaukee • Sumer	(414) 259-9060
Minneapolis • Comstrand Inc.	(612) 571-0000
Philadelphia • TAI	(215) 627-6615
	(609) 854-3811
Portland • J.J. Backer	(503) 297-2174
Rochester • T-Squared	(716) 381-2551
Salt Lake • Barnhill Five	(801) 292-8991
San Francisco • Quadrep Inc.	(408) 733-7300
Seattle • J.J. Backer	(206) 285-1300
St. Louis • Dy-Tronix Inc.	(314) 731-5799
Syracuse • T-Squared	(315) 463-8592

### Distributors

Baltimore • Pioneer-Standard	(301) 948-0710
Boston • Cramer	(617) 969-7700
Chicago • Newark	(312) 638-4411
Cleveland • Pioneer-Standard	(216) 587-3600
Dallas • Hall-Mark	(214) 234-7400
Los Angeles • Liberty	(213) 322-8100
New York • Schweber	(516) 334-7474
San Francisco • Elmar	(415) 961-3611
St. Louis • LCOMP St. Louis	(314) 291-6200



**MOTOROLA INC.**

CIRCLE NUMBER 18

## Across the desk

(continued from page 7)

### Remember this

By sheer accident, while working on more conventional microcomputer applications, I developed a revolutionary single-chip UV EPROM microprocessor. It's made on an exceptionally low-yield mirror substrate, while the chip has an intense ultraviolet source for erasing the mirror image of the UV EPROM software.

Probably the most unstable processor available, this exceptional circuit executes three to 3-million double complements per hour, depending on how it feels. This inherent nonpredictability makes the chip ideal for random synchronization of real-time microcomputers in applications like the control of plane, train and bus arrivals in major cities.

The 317-bit UV EPROM can be used interchangeably with the dangling 316-bit unalterable RAM. For added convenience, an on-chip power source can be recharged by rubbing one's feet on a dry carpet and touching pin 41.

The address and antidata bus of the 40-pin package use a tridirectional scheme in which any combination of the 20 pins on the north side of the package can be used for data while the remaining pins become the address bus.

*Jim Lewis*  
President

Micro Logic Corp.  
100 Second St.  
P.O. Box 213  
Hackensack, NJ 07601



Have you noticed all the asterisks in this issue? We hope you'll notice that they are supposed to remind you to renew your free subscription by filling out the card on page 49.

### Count us in

Digital Scientific Corporation is pleased to advise ELECTRONIC DESIGN of our advanced microprogrammable minicomputers, which are capable of data-base management. Your mini/micro article in ED No. 2, Jan. 18, 1978, p. 24, included a table of

minicomputer and microcomputer companies. Not only will our advanced systems allow you to sort among the 95 companies listed, they will also allow you to insert the following additional entries:

Digital Scientific Corp:  
Microcomputer systems—yes  
Microcomputer development systems—yes  
Minicomputer systems—yes  
Other products—yes

Digital Scientific  
11425 Sorrento Valley Rd.  
San Diego, CA 92121

*J.J. Gormley*  
Vice President  
Technology

Digital Scientific Corp.

CIRCLE NO. 317

### Private symbol goes public

About a year ago I invented the following symbol for monolithic Darlingtontons as a private convenience:



In that time I have found it to be an extremely concise means for differentiating between monolithic devices and discretetes, where the differences are important. (These are more common than you might think, given manufacturers' propensity for including goodies like nichrome ballast resistors and fast turn-on flyback diodes.)

In fact, I have found my symbol convenient enough to warrant bringing it to the attention of a wider audience. I would very much like to know what your readers think of it.

*Richard W. Bowser*

R.W.B. Research Co.  
5648 Pierce  
Omaha, NE 68106

### New Books

**Digital Continuous-System Simulation**—G.A. Korn and J.V. Wait, Prentice-Hall, Englewood Cliffs, NJ 07632, 212 p. \$15.95.

CIRCLE NO. 318

**Computer Storage Systems & Technology**—R. Matiek, John Wiley & Sons, One Wiley Drive, Somerset, NJ 08873, 667 p. \$29.95.

CIRCLE NO. 319

# There's a Simpson DPM that's right for your application

## All Simpson DPM's feature:

- 0.1% accuracy
- 3-1/2 digit readout
- Automatic zero and polarity
- Dependable LSI circuitry
- Choice of 120/240 V AC or 5 V DC operation
- Panel cutout 1.682" x 3.622". Adaptors available for IEC/DIN and other domestic cutouts
- Input/output edge connector included
- Full 200 hour burn-in
- Backed by the Simpson one-year warranty



## The Dedicated DPM

New Series 2860—high performance at a low price

from **\$4940\***

- 9 stock ranges available
- Bright 0.43" LED readout

## The Systems DPM

Deluxe Series 2850—printer/computer interfacing capability and options for custom applications

**\$92\***

- 9 stock ranges
- Specials available including AC ranges
- Choice of 0.43" LED or 0.55" planar gas discharge display
- BCD output standard

• 100-lot OEM prices

Available From  
Electronic Distributors  
Everywhere

Write for Bulletin P612  
containing complete  
technical specifications.



Model 2850



Model 2852

### SIMPSON ELECTRIC COMPANY

853 Dundee Avenue, Elgin, Illinois 60120

(312) 697-2260 • Cable SIMELCO • Telex 72-2416

IN CANADA: Bach-Simpson, Ltd., London, Ontario

IN ENGLAND: Bach-Simpson (U.K.) Ltd., Wadebridge, Cornwall

IN INDIA: Ruttonsha-Simpson Private, Ltd., Vikhroli, Bombay

CIRCLE NUMBER 19



KATY INDUSTRIES



INDUSTRIAL  
EQUIPMENT  
GROUP



# DATA I/O PROGRAMS

**You can program every commercially available PROM on a Data I/O Programmer. What does that mean to you?** First of all, it means design freedom.

You can incorporate state of the art micro-processor and PROM technology in your designs with the assurance that the Data I/O PROM Programmer will meet your needs.

Second, it means security. You'll be able to designate second and third source PROM suppliers and know that you can program their devices.



# THEM ALL.

Third, it means money. You won't have to purchase, or build, a new programmer every time you use a new PROM. You'll also be able to shop for best supplier prices.

If you'd like more good reasons for selecting a Data I/O universal PROM Programmer, send for our free PROM Programming Handbook. Simply contact Data I/O Corporation, P.O. Box 308, Issaquah, WA 98027 or phone toll free 1-800-426-9016.

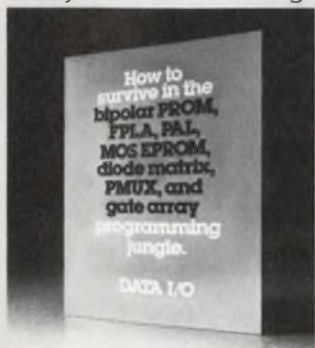

# DATA I/O

When you hop a plane to troubleshoot 8080, 6800, 6502 or Z-80 software, grab our new

# Micro Bus Analyzer™



... because all  $\mu$ P-based systems need help.

E-H's new MBA-1, designed and priced (at \$1000) for field service software debug, has a giant memory that can trap 128 32-bit words at clock rates to 5MHz.

But your field service guys had better hide it from your engineering and QC people, because the MBA-1 is flexible and versatile enough for their purposes, too.

It's a simple diagnostic tool. Takes an accurate snapshot of critical system software information while the micro-processor is running in its regular socket. You can step ahead 96 words or back up 32 from your *trap* condition. In RUN mode, it will generate a scope trigger every time it passes the *trap* condition to let you study it more thoroughly.

Unless people stop making programming mistakes, software will always need fixing. Our MBA-1 is a 12-lb under-your-seat solution to finding what needs fixing. Probes are available at about \$200 for 8080, 6800, 6502 and Z-80 systems. Ask us about the probe you need. We're working on a bunch more. Write or call, or use the reader service number for the data sheet. If you want to order one, hell, call us *collect*. E-H International, Inc., 515 Eleventh Street, Oakland, CA 94607. Phone: (415) 834-3030 TWX: (910) 366-7258





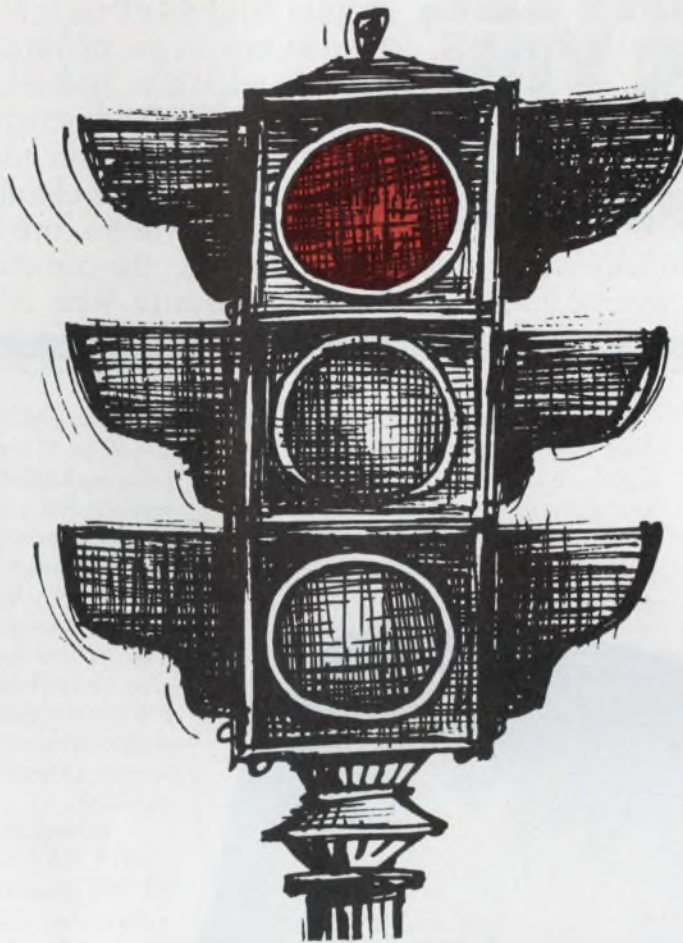

# STOP

## BE INFORMED ABOUT ELECTRONIC DESIGN'S NEW RENEWAL POLICY

A new policy that concerns **every Electronic Design** qualified subscriber begins with this issue. Do **you** know when your free subscription expires? Many people don't. To clear up this confusion we're asking **everyone** to renew just once a year . . . **NOW**. Your cooperation will put all subscribers on the same renewal cycle — May to May annually. All it takes is 3 minutes of your time. Avoid cancellation. Insure uninterrupted copies of **Electronic Design** and its GOLD BOOK. Fill in and mail your free subscription renewal form **RIGHT NOW**.

**YOUR FREE SUBSCRIPTION RENEWAL FORM  
IS BOUND IN THIS SPECIAL RENEWAL ISSUE.**

SEE PAGES 45-50.

# FORTUNATELY, AMI GIVES YOU REMOTE CONTROL.

Even monstrous control problems can be tamed with our two new transmitter/receiver circuits. And they'll do it for less than any other devices on the market. That can give your toys, television, traffic light, phone system, burglar alarm, industrial control, security or paging system a giant edge over the competition. Our chips eliminate parts needed in other systems, use less power and are more stable in extreme temperatures. Somehow you'd expect the company that's been making MOS longer than anyone else to give you more control. Well, AMI's done it again.

The S2600 Encoder and S2601 Decoder form a 31-command remote control chip set with keyboard inputs, oscillators, analog and digital receiver outputs all on board. Simply adding a transducer at each end gives you control via radio frequency, infrared, ultrasonic or hardware transmission.

The CMOS Encoder dissipates only 20 mW. Its 40 kHz square wave output is pulse modulated, eliminating the need for very accurate, expensive external crystals. Every 38.4 milliseconds, it can transmit a 12-bit message. (It will go faster if you like.)

The P-channel decoder has eleven outputs. Analog capability is provided by three independent outputs which each allow up to 64 distinct DC levels for controlling motor speed, volume, brightness or similar electronic proportional control settings. Other special outputs are also provided.

With all these advantages, the price is just \$13.50 for the two-chip set in plastic (100-999 quantities). So if you're remotely interested in controlling your market, write to AMI Marketing, 3800 Homestead Road, Santa Clara CA 95051. Or call (408) 246-0330. Maybe we can give your product a new lease on life.



**AMI**  
AMERICAN MICROSYSTEMS, INC.



## Our family gives you a flat answer.

Our new flat cable connector family has both standard and stackable sockets, PCB connectors and headers, all designed for lowest total applied cost.

In socket connectors our BA Series gives you a low profile package with the option of either open or closed cover design for both end-cable and through-cable applications.

Our BD Series stackable socket line concept permits stacking two connectors on a wire-wrappable post.

For direct solder applications our BC Series handles PCB connector needs.

Featured with the product family is a simple universal termination system designed for minimum tooling cost.

For your header applications our low profile BB Series line is available for both vertical and right-angle mounting in solder or wire-wrappable designs.

Contact GTE Sylvania, Connector Products Operation, Box 29, Titusville, PA 16354. Phone: 814-589-7071.

Remember, good connections run in our family.

**GTE SYLVANIA**

# CAN A TRIMMER THAT'S AN OVERACHIEVER BE PRICED AT 24¢\*...

## OURS IS.



**Mepco/Electra's New  
Series 8017 Single Turn 3/8"**

**Cermet Trimmer** is just that—an over-achiever to answer your design problems.

- best uniformity of rotational torque
- rotational torque is "silky smooth"
- longest angle of electrical travel
- CRV less than 1%
- broadest resistance range
- stronger mechanical and electrical lead connections
- superior strength in the side adjust version to prevent bending while adjusting
- low cost—24¢\*each

In stock, now. For further information, write or

**"Call M/E", Mepco/Electra, Inc.,**  
P.O. Box 82927, San Diego,  
CA 92138, (714) 453-0353.



## Minifloppy-disc drive does more on less power

How do you halve the power consumption and improve the performance of a standard minifloppy disc drive? You transfer most of the functions of the drive electronics to the computer's processor.

Apple Computer Inc. does this by modifying a standard SA 400 drive from Shugart Associates (Sunnyvale, CA). The drive is used with the Cupertino-based company's mainframe processor, the Apple II.

The number of integrated circuits in the drive electronics has been cut from 19 to 4 by transferring a majority of the functions to the computer's processor. This modified drive was shown at the Mini/Micro Computer Convention in Philadelphia last month.

In the system, data are transferred between the computer and the disc slowly enough for the computer's microprocessor to handle most control and formatting tasks, says Steve Wozniak, Apple's research and development vice-president.

Much of the electronics in the Shugart unit is there to make the drive compatible with a variety of CPUs, says Wozniak. Apple's circuitry can be simpler because it has to interface only with the Apple computer. One design objective was to power the drive from the computer's power supply, instead of incorporating a power supply in the drive.

Among the pieces left out in Apple's drive are the infrared emitter and detector, which tell the drive the disc's rotational position. This is needed for hard-sectored operation, where the drive finds data stored on the disc by its physical location. In the Apple soft-sectored format, the controller locates data from what it is reading, which allows more data to be stored on each disc.

In addition, power to the disc drive board is cut whenever the drive motor stops, which reduces standby power demand by 4 W.

At the same time, access time is improved by changing the way the

magnetic read head is moved. In the Shugart drive, a sequence of pulses moves the head to the selected track at a fixed 40 ms/track. In the Apple drive, the head accelerates from one position until it is halfway to the next, then decelerates to the proper track. This is possible, Wozniak explains, because the Apple drive's controller always knows which track it is looking for.

The disc drive with a controller board is priced at \$595. Additional drives are \$495. The controller board, which plugs into the Apple mainframe, can handle two drives. Deliveries are scheduled to begin in June.

## Laying out ICs, PC boards may be computer-aided

Soon, even the initial layout of integrated circuits and printed-circuit boards may be done directly on computer-aided-design terminals. And the first CAD system to do it could very well come from Calma (Sunnyvale, CA).

Today, virtually all ICs and PC boards begin as art drawn by hand, using various drafting aids. Only after these originals are digitized do the labor-saving benefits of CAD come into play. A computer produces the variety of IC photomasks, PC-board artworks and drilling tapes which are optimized for performance, size, placement, routing and spacing. It also provides parts lists, connect lists, wire lists and N/C tapes to drive insertion machines and backplane wiring equipment, as well as schematics and other documentation.

Calma's GDS-II CAD system does all this, too, but also makes it easy to originate the artwork on the CRT screen.

"A true design system should not require you to type or look away from the screen," says John Claiborne, Calma's product manager for IC applications. "It should be easy to learn, and should prompt you and help you

if you forget. The graphics screen should show you what you're doing, displaying all moves and changes instantly."

First GDS-II and VMD shipments are planned for September, 1978, and final versions will go in January, 1979.

## Multivalued logic boosts chip density

Chip designers are taking advantage of every advance in processing and fine-line lithography to pack more circuitry on a chip. But getting pattern geometries below two and three micrometers requires expensive projection aligners and E-beam and X-ray lithographic equipment to do the job. Moreover, as the chips get more complex, the real estate taken by the metal interconnections expands from 30 to 50% or more of the chip area.

One way to overcome these limitations is to use multivalued logic, which employs levels of 0, 1, 2 and 3 or more, instead of binary levels of 0 and 1. For a given set of fabricating rules, this technique promises to either double the number of functions per LSI chip or halve chip size for the same number of functions.

How to implement  $4 \times 8$  multilevel threshold gates that will reduce the number of devices required by a full binary adder by half will be revealed by Professor K.W. Current of the University of California, Davis, at the forthcoming Eighth International Symposium on Multiple-Value Logic (Rosemont, IL, May 24-26).

"We decided to get around the LSI density problem by leaving the technology alone and changing the way the signal is processed," he notes.

In Current's system, the logical voltages are converted to logical currents that produce voltage levels of 0.4 V across load resistors for a logical increment. These can easily be converted to binary ECL outputs.

For medium-speed, high-density logic, Dr. T.T. Dao, head of logic and systems research at Signetics, Sunnyvale, CA, will describe an I<sup>2</sup>L version of multilevel arithmetic logic in an advanced development stage. Signetics is using I<sup>2</sup>L for a four-level full adder that nevertheless will be compatible with binary inputs and outputs. Density savings are in on-chip circuits.

The multivariable logic is a hybrid of digital and analog, but closer to digital, says Dao. Whereas analog logic

has an infinite number of levels, the multivariable approach limits the number to a few discretets.

Signetics will offer this multivalued logic first in a chip that has binary inputs and outputs, so that the logic can be used with current binary technology.

## Minicomputer can run IBM 370 software

A new minicomputer may enable OEMs building small data-processing systems to cash in on the large amount of existing IBM 370 software as well as on the large pool of programmers familiar with the 370 system. The Two Pi/V32, a 32-bit computer built around the 2900 series bit-slice microprocessors, is the first mini with microcode to run the standard 370 instruction set, according to its maker, Two Pi Company Inc. (Sunnyvale, CA).

Now entering production in the company's Santa Clara facility, the V32 also has about 40 kbytes of control store available for microprogramming additional features. A microcode assembler helps with writing such microprograms.

The V32 is also the first OEM mini with a built-in refrigerated air cooling system, says the company, a subsidiary of U.S. Philips Corp. This not only improves its reliability significantly, but also eliminates the need to operate in an air-conditioned room.

The basic system has 256 kbytes of main memory, which can be expanded to 4 Mbytes—about four times the capacity of the nearest IBM equivalent, the 370/138.

CIRCLE NO. 315

## Computer-power use cut by balancing delay times

The power consumed by a computer system can be cut to a minimum by making the delay time of its integrated circuits one-third that of the system, says a researcher at Hitachi Ltd.'s Central Research Laboratory in Tokyo.

Hitachi's Tsuneyo Chiba made his discovery by drawing a series of curves for power density as a function of circuit delay time at a number of system delay times. The minimum power density falls along the straight line corresponding to allotting one-third of the system delay time to circuit delays.

The curves, published in April's

*IEEE Transactions on Computers*, are based on three assumptions: The system delay time is the circuit delay time plus the packaging delay time; packaging delay per gate is inversely proportional to the square root of the effective packaging density of gates on a card; and the power-delay product is constant for a given semiconductor technology.

The curves and other factors are balanced to obtain the highest possible logic speed in Hitachi's HITAC M-170 and M-180 computer systems. The speed relationship can be used, says

Chiba, while considering thermal and packaging density restrictions.

Chiba also notes that the most obvious way to increase packaging density, larger-scale integrated circuits, faces two hurdles: the part-number problem and gate-pin restrictions. A great many part types, each with unique circuitry, are required in a computer system. "About 60 to 80% of the total gates can be covered by a comparatively small number of types," says Chiba, "However, the remaining 20 to 40% aren't suitable for LSI packaging."

## System performance rises as memory costs fall

With memory capacity getting higher and dynamic RAM chips getting faster, the cost of main memories in data-processing systems will continue to go down 30% a year—as system performance goes up.

Over the last five years, the price per byte of main memory systems has dropped fourfold to 3.1 cents per byte, according to Hewlett-Packard's Data System Div. (see table). As a result, designers can use their memory budgets for main-memory storage of more powerful operating systems as well as for implementing higher-capac-

ity application systems. And with the additional memory, they no longer need expensive software preparation in assembly language to save memory.

Increased memory density and speed mean a smaller price tag. Like many memory suppliers, HP is incorporating the highest-density 16-k dynamic RAMs on its newest boards. Because of this, an HP 650-ns RAM board containing 128 kbytes costs under \$1000. And a 350-ns 128-kbyte board costs \$1350—a far cry from the \$4300 price tag of a 1974-vintage 650-ns, 16-kbyte board of the same size.

## Dynamic RAM system cost—Performance trends

Year	Chip		Board		Cost		Number of boards per 128-kbyte system
	capacity (bits)	speed (ns)	capacity (bytes)	speed (ns)	per byte (cents)	per 32 kbytes (\$)	
1974	4-k 22-pins	350	16-k	650	13.4	4300	8
1975	4-k 22-pins	350	16-k	650	9.3	3000	8
1976	4-k 16,18 pins	250	32-k	650	6.5	2100	4
1977	4-k 16-pins	250	32-k	350	5.0	1600	4
	4-k 16-pins	150	32-k	350	6.5	2100	4
	16-k 16-pins	250	128-k	650	5.0	1600	1
1978	16-k 16-pins	250	128-k	650	3.1	1000	1
	16-k	150	128-k	350	3.9	1250	1

Source: Hewlett-Packard

# It takes a lot more than bright to be best.

Brite-Lite LED lamps have a way of dimming people's enthusiasm for other brands. It starts with the fact that Brite-Lites are 25x (50 mcd vs. 2 mcd) brighter. But there really is more than meets the eye to Brite-Lites.

## Consider the games people play —with your money.

They range from "We'll have that number in next month" to "Your order will be two weeks late." We don't play those games. Our record for prompt, on-time delivery is light years ahead of other LED manufacturers— foreign or domestic. You get exactly what you're looking for, in transparent or translucent red, amber or green. Brite-Lites are from 1.6 to 28 volts and 10 to 35 milliamps.



**Do you want promises or proof?** As you probably know, claims of LED brightness and reliability are a dime a dozen. So these facts should be quite illuminating: On the average, Brite-Lites last over 100,000 hours. That's 10 times longer than incandescents. Yet Brite-Lites equal many incandescents in brightness, while also providing solid-state durability. This remarkable quality has been proven during countless tests and on-line applications.

**When you're really plugged into LED's, you'll get in touch with us.** If you're planning to use LED's, then do some comparison shopping. Separate proven fact from fancy. This way, you're sure to make the right choice. Which means you're sure to call us.

## PROVEN BETTER AND BRIGHTER THAN THE REST



303 NORTH OAK STREET, INGLEWOOD, CA 90301  
TELEPHONE (213) 677-6166 • TWX 910-328-7205

CIRCLE NUMBER 25





## Chips, systems, and design: An early look at NCC

Design and applications information abound in the technical sessions at the upcoming National Computer Conference to be held June 5 to 8 at the Anaheim (CA) Convention Center. Key topics at NCC: semiconductor memories and microprocessors, dedicated LSI and VLSI chips, computer-aided design, computer peripherals and computer architecture.

In semi memories, look for the latest crop of static and dynamic RAM, CCD, and bubble memories. In computer-aided design, look for the newest techniques for handling the most complex ICs, while peripheral system designers can see the latest in continuous media mass storage devices, printers, displays and voice processing equipment.

### Semis have come a long way

"Semiconductor RAMs began to challenge magnetic core memories when RAMs stored only 1 kbit on a chip," says Lewis M. Terman of IBM's T.J. Watson Research Center (Yorktown Heights, NY) who will chair NCC memory Session 57. "And we're talking

about 64-k RAMs." Moreover, according to Terman, charge-coupled devices and magnetic bubble memories "have reached a stage where the prospect of solid-state mass storage is at hand." Indeed, the whole future of semiconductor RAMs will be projected at the session by Andy Varadi of National Semiconductor (Santa Clara, CA) and J. Egil Juliussen of Texas Instruments Inc. (Dallas, TX) will do the same for bubbles and CCDs.

The incompatibility of RAMs from different manufacturers will be the topic at Session 47 of J. Reese Brown of Burroughs Corp. (Piscataway, NJ). Brown will look into establishing standards to lower the cost of building and testing computer-memory systems. Moreover, CCDs and bubbles should help lower memory costs because their small cell structures allow high densities on a chip.

Ever increasing device densities resulting from new VLSI techniques will be the highlight of a paper in Session 48 by Ron Whittier of Intel Corp. (Santa Clara, CA). Another aim is to add more functions to microprocessor CPUs, says Federico Faggin of Zilog Corp. (Cupertino, CA), chairman of Session 48.

Increased density made it possible to

build not only semiconductor memories but also hand-held calculators, Faggin goes on. "Since then, memories have continuously increased in complexity, resulting in dramatic reductions in cost per bit," he says. Calculator chips having evolved into microprocessors are now combined with memory to make microcomputers. Prices have dropped so far already that the major cost in microcomputers will soon be the packaging and distribution. So the only way to improve the price/performance ratio is to increase the intelligence in the  $\mu$ C. "This increase," says Faggin, "can take the form of higher memory capacity, greater CPU power and increased input/output capability."

### Automating IC designs

One problem to overcome in designing larger-scale chips is the time it takes to design, debug, and correct new chip layouts. One promising solution, to be described at Session 6, is computer-aided layouts.

"The design of integrated circuit masks using manual techniques is very tedious, time-consuming, and often subject to errors because of the precise design rules that must be followed

**Andy Santoni**  
Associate Editor



# ON THE BENCH, THE MOST ADVANCED DVM. IN SYSTEMS TOO.

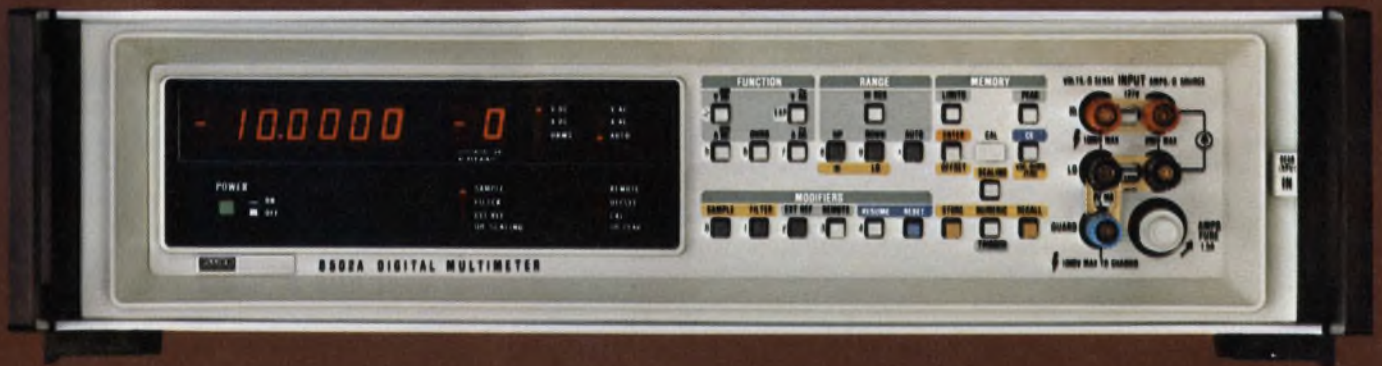

The new 8502A digital voltmeter—the precision DVM just right for both systems *and* bench applications.

It's right because it brings all the power of the 8500A, the world's most advanced system DVM, to the front panel.

Press SCALING and enter any multiplier to scale volts, ohms or amps to temperature, percent, engineering units, or any scale of convenience. Press OFFSET and add or subtract any numerical value to set your prescaled units to the right reference point.

$Y=AX+B$

If you're looking only for a good/bad indication, use LIMITS and key in both high and low tolerance values on any function. After that you'll get a friendly "Hi, Pass or Lo" reading at full accuracy.

The 8502A remembers its highest and lowest readings. Leave it unattended on a stability test, for example, then touch PEAK, HI and LO later to observe the amount of drift that occurred.

Want 6½-digit resolution? Press HI RES and get it on all functions. This lets you utilize the full instrument accuracy — 6 ppm on DC volts.

The 8502A is fast—up to 250 readings/second on the bench, 500/second in a system. This speed is put to work to provide noise rejection through digital averaging. Adding analog filtering gives you up to 100 dB NMR.

Calibration memory is a Fluke exclusive that saves time and money.



Without removing the voltmeter or taking off covers, simple recalibration is done from the front panel in a few minutes. Lab calibration is recommended only once a year if calibration memory is used.

The five FUNCTION pushbuttons are evidence of another exclusive. Besides volts and ohms, the 8502A can have AC and DC current capability installed, a feature not available in any other precision DVM.



We even provide diagnostic error codes to keep you out of trouble by identifying programming mistakes and hardware errors.

For systems use, we offer more interface options than anyone: IEEE 488, RS-232 or full parallel. And, a switchable front/rear input option is available.

U.S. base price: \$2595.

For more information, contact any one of the more than 100 Fluke offices or representatives, worldwide. In the U.S., CALL (800) 426-0361, TOLL FREE. Residents of the U.S.A. and all countries outside Europe, contact: John Fluke Mfg. Co., Inc., P.O. Box 43210, Mountlake Terrace, WA 98043, U.S.A. Telex: 32-0013.

In Europe, contact Fluke (Nederland) B.V., P.O. Box 5053, Tilburg, The Netherlands. Telephone: (013) 673973. Telex: 52237.

CIRCLE NUMBER 26 FOR LITERATURE

6104-8002



CIRCLE NUMBER 27 FOR DEMONSTRATION

## Plenty of products, too

Technical sessions aren't all that's happening at NCC. Over 300 firms at more than 1300 booths will exhibit a wide variety of products to bring engineers up to the minute on computer-related hardware.

A 1-k-by-8 static RAM is the second static RAM from EMM/SEMI (Phoenix, AZ) structured with a byte output compatible with 8 and 16-bit microprocessors. The Model 16 PROM programmer from Data I/O (Issaquah, WA) simultaneously programs up to 16 MOS PROMs in parallel, with data from a master PROM. The M-910 PROM programmer from Pro-Log (Monterey, CA) is for production-line duplication, listing, and verification of programs.

The Vector 1++ microcomputer from Vector Graphic (Westlake Village, CA) is an 18-slot mainframe aimed at small business systems, as is a new system from Perkin-Elmer's Interdata Division (Tinton Falls, NJ). Rair Microcomputers of London will introduce 8085-based microcomputers with priority interrupts and DMA, integral single or dual minifloppy-disc drives, up to 64 kbytes of RAM, dual serial I/O ports operating up to 19,200 baud, and software.

CRT display modules for OEM terminal makers include the M4408 from Motorola Data Products (Carol Stream, IL), which can display more than 6300 characters—a full typewritten page worth. Among the CRT terminals are the Chromatics (Atlanta, GA) CG, an eight-color, 512 × 512 machine built around a Z-80 CPU, and including memory and I/O structures. Datamedia (Pennsauken, NJ) will show a buffered APL terminal compatible

with major communications protocols. The Delta 7000 from Delta Data Systems (Cornwells Heights, PA) is a programmable video-display terminal built around the TI TMS9900. Intelligent Systems (Norcross, GA) will display its Intecolor 8001G, a 48-line by 80-character graphics terminal for process control applications. Princeton Electronic Products (North Brunswick, NJ) will unveil its Model 8500M graphic display terminal, which uses a microprocessor to generate conics, rotation and grey scale. And Tektronix' Information Display Group will bring to NCC its 4025 terminal, which allows scrolling of both alphanumerics and graphics.

Among the newest printers at NCC will be the LP400 heavy-duty 300 LPM line printer with graphics option from Compagnie Internationale Pour L'Informatique Cii Honeywell-Bull (Waltham, MA). A 300-LPM "band" line printer will be in the booth of Data Printer (Cambridge, MA). And General Electric's Data Communications Division (Waynesboro, VA) will introduce a new line of printers.

Vadic (Sunnyvale, CA) will present its 50 Series of small, low-cost modems for applications from 0 to 1200 bps. And ComData (Skokie, IL) will have modems starting at \$150.

Computer Power Systems (Long Beach, CA) will show its PowerMite MK II power center, a distribution system for small computer systems. Elgar (San Diego, CA) has a new uninterruptible power system to keep computer systems from crashing when utility companies cut power. And Nova Electric (Nutley, NJ) will show a line of voltage-regulating transformers.

during mask layout," says Charles Gwyn of Sandia Laboratories (Albuquerque, NM), chairman of Session 6. "In recent years, many computer aids have been developed to generate custom IC mask layouts automatically for a range of fabrication technologies and design philosophies."

Gwyn lists four techniques for computer-aided IC layouts: the master slice approach with fixed cell locations, standard cells, various-sized rectangular cells and connecting arbitrarily-shaped components that have been described in shorthand in a manually generated layout. A technique for automatic-wiring LSI chips will be de-

scribed by Ning Nan and Michael Feuer of IBM Corp. (Hopewell Junction, NY), and an automatic layout program for even higher-density VLSI devices by Al Feller of RCA's Advanced Technology Laboratories (Camden, NJ).

Computer-aided design and analysis of digital hardware or software is the theme of Session 14. A method called Sara supports multilevel design of concurrent hardware or software systems, says William M. van Cleemput of Stanford University (Stanford, CA). Verifying that a real system will work requires accurate models that the computer can process, since "the design of real concurrent systems depends upon

the validity of system models."

Automated-design systems are useful for more than circuits and software, says Thomas J. Reno of General Motors Corp. (Warren, MI). At Session 18, Reno will describe a low-cost graphics system for body tooling that helps GM engineers prepare programs for numerically controlled machines. And the role of interactive graphics in design automation will be covered by Carl Machover of Machover Associates Corp. (White Plains, NY).

### Putting it on-screen

But the biggest interactive problem confronting computer-systems designers is the one between users and computers. In CAD systems, intelligent graphics terminals make it easier to see the design as the computer sees it, and to make changes with convenient controls like joysticks and light pens. Lower terminal prices resulting from incorporating microprocessors and other large-scale ICs into terminals are bringing these advantages to terminal users such as small-business and other commercial users.

But the ultimate user interface with computers—by voice—will be covered at Session 80. Several universities and equipment vendors are pressing for reliable voice-input computer terminals to meet the needs of industrial and government users, particularly for speaker identification and verification.

Besides terminals, major peripheral devices to be highlighted include printers and mass-storage systems. At Session 65, Donald Swatik of Computer Peripherals Inc. (Rochester, MI) will track trends in printer technology, both impact and nonimpact, with special emphasis on electro-photographic and ink-jet nonimpact printers. The evolution of magnetic-disc memory technology to meet the growing need for mass storage will be traced by David Conway and Thomas Muran of Magnetic Peripherals Inc. (Bloomington, MN) at the same session.

Another magnetic-storage evolution will grace the agenda at Session 57 where Steven Puthuff of Memorex Corp. (Santa Clara, CA) will describe the growth of large magnetic-storage technology. "The fixed and moving-disc memory technology continues to improve with significant reduction in the cost per byte," says session chairman Terman, "and thus provides an elusive and moving target to the solid-state mass-storage technologies." ■■

# READ THESE TEN CHAPTERS. AVOID CHAPTER 11.



- I want to see how a computer vendor can help me. Send me your book today.
- I'm too busy to read another book. Have your salesman come and show me the way.

Name \_\_\_\_\_  
Title \_\_\_\_\_  
Company \_\_\_\_\_  
Department \_\_\_\_\_ Phone \_\_\_\_\_  
Address \_\_\_\_\_ City \_\_\_\_\_  
State \_\_\_\_\_ Zip \_\_\_\_\_

Data General, Westboro, MA 01581, (617) 366-8911. Data General (Canada) Ltd., Ontario.  
Data General Europe, 59-65 rue de Courcelles, Paris, France. Data General Australia, Melbourne (03) 82-1361.



ED 510

We make computers that make sense

© Data General Corp., 1977

# Flat cold-cathode TV tube may be the long-sought answer to the CRT

"Someday your color TV picture tube will be a large thin panel that hangs on the wall like a picture."

Predictions like that have circulated since the 1950s. Since then, various flat-panel technologies have been tried, then abandoned for being too costly, too power-hungry, or too complex to produce. But the goal may be in sight this time with a flat-panel system using new cold-cathode technology.

The display system, being developed by RCA Laboratories (Princeton, NJ), has a 480 × 500 matrix-addressed array of feedback electron-multiplier cells—240,000 current sources that can energize as many as 960,000 color dots on the screen.

## Big is better

Aimed at 30 × 40-in. TV displays only 1 1/2 in. thick, the system combines photomultiplier-like electron sources (see box), a multiplexed array

**Dave Barnes**  
Western Editor

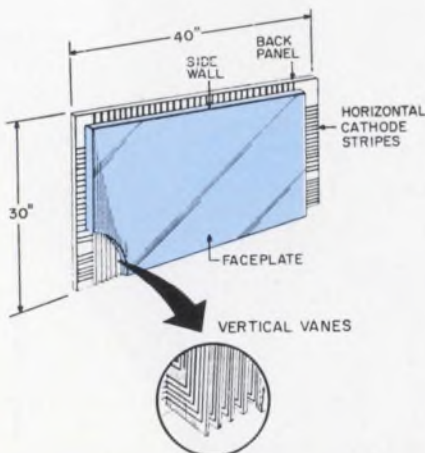

This feedback-multiplier TV-display tube is in a viewing position. Its vertical vanes are internal glass platelets with metalized electrodes that form the feedback-multiplier cells.

structure, and a mixture of fabrication techniques for mass production.

The special techniques required to fabricate the feedback multiplier display to typical 1-mil tolerances have been developed, tested and demonstrated. Both scaled and actual-sized models of display sections have been built, using methods and processes that can be extended to the mass production of full-size panels.

Calling the project "preliminary research results," RCA's John A. van Raalte, who co-invented the display system, points out that many problems remain to be solved, and that an eco-

nomically viable product is still years away.

The cold-cathode display can be much larger than a standard CRT because it is self-supporting. A CRT has no internal supports, and external air-pressure loading makes it unfeasible to build CRTs larger than about 30 inches diagonal. But the flat-panel's face plate is supported every inch by thin glass vanes inserted between modules, each consisting of 12 vertical multiplier vanes. In addition, the matrix structure eliminates the standard CRT problems of overscan and pincushion or barrel distortion.

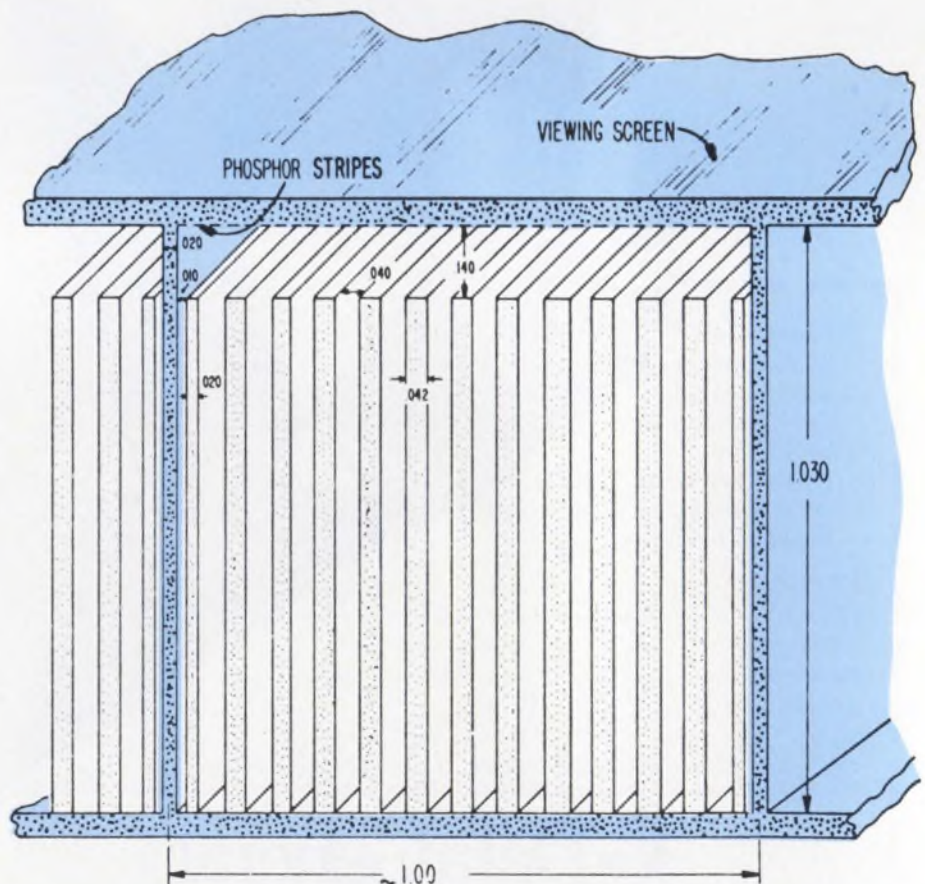

One of 40 display modules is shown in this top view of a display cross-section. Each module consists of 13 platelets, between which 12 columns of feedback-multiplier cells are formed.

# 4 filters in 1

Model 3202 offers two independent low-pass or high-pass channels or single channel band-pass or band-reject from 20 Hz to 2 MHz.

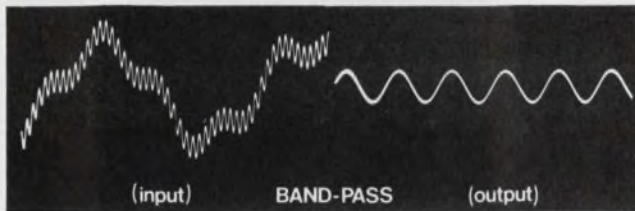
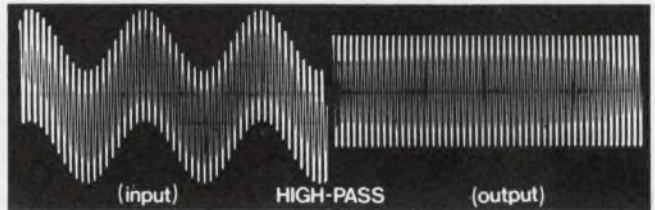
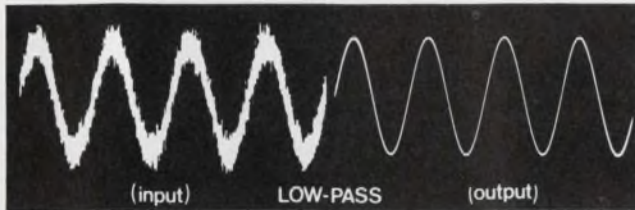

For only \$950, Model 3202 provides the flexibility essential for complex frequency or time domain measurements.

**FUNCTIONS:** Low-pass—direct coupled with low drift.  
High-pass—upper 3 dB at 10 MHz. Band-pass—continuously variable. Band-rejection—variable broad band or sharp null.

**TWO RESPONSE CHARACTERISTICS:** (1) Fourth-order Butterworth or (2) simple R-C (transient free).

**ZERO-dB INSERTION LOSS:** All-silicon amplifiers provide unity gain passband response. 24 dB per octave slopes per channel extend to at least 80 dB.

**90-dB DYNAMIC RANGE:** Low hum and noise (less than 100 microvolts) eliminate costly preamplifiers.

For fast action, call: (617) 580-1660

TWX: 710-345-0831, Krohn-Hite Corporation  
Avon Industrial Park, Avon, MA 02322, U.S.A.

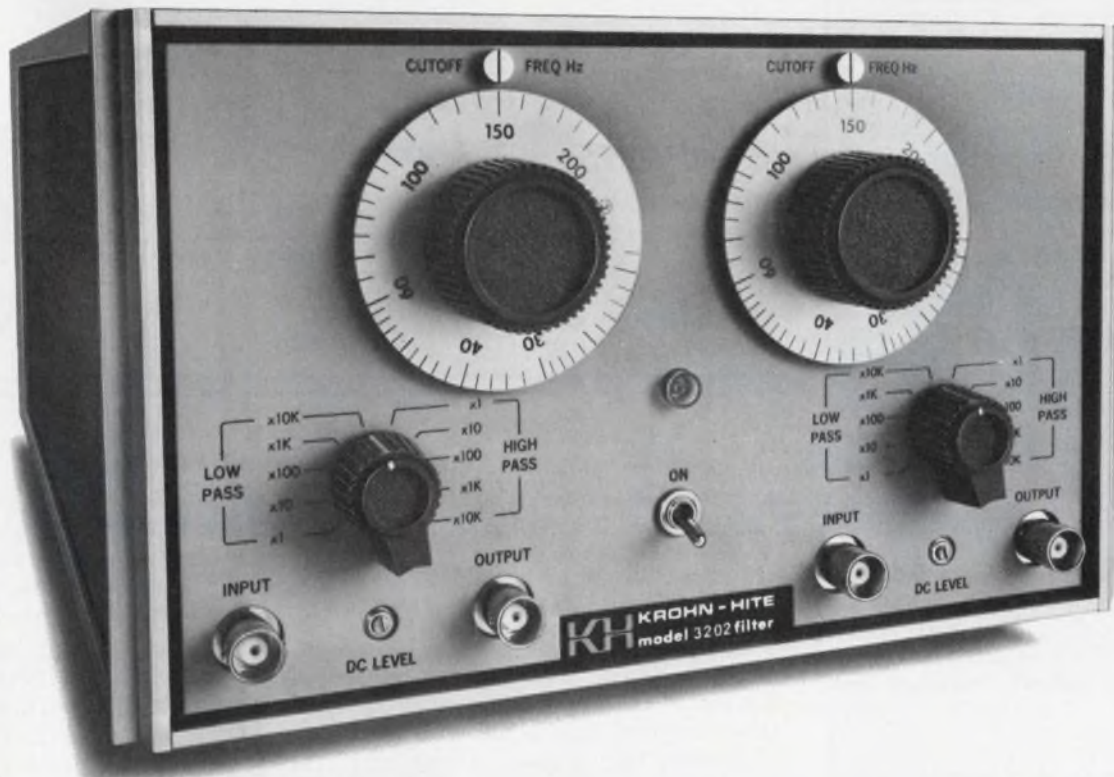

**KH KROHN-HITE CORPORATION**

Avon Industrial Park, Avon, MA 02322. (617) 580-1660

CIRCLE NUMBER 29

SALES OFFICES: ALA., Huntsville (205) 534-9771; ARIZ., Scottsdale (602) 994-5461; CAL., San Jose (408) 292-3220, Inglewood (213) 674-6850; COL., Denver (303) 773-1218; CONN., Canton Center (203) 525-7647; FLA., Orlando (305) 894-4401; GA., Atlanta (404) 455-1206; HAWAII, Honolulu (808) 941-1574; ILL., Arlington Hts. (312) 394-3380; IN., Fort Wayne (219) 485-0845; KS., Lenexa (913) 888-0215; LA., Lafayette (318) 984-3516; MD., Towson (301) 321-1411; MASS., Wakefield (617) 245-5940; MICH., Southfield (313) 569-4497; MINN., St. Paul (612) 645-5816; MO., St. Louis (314) 731-5400; N.M., Albuquerque (505) 255-2330; N.J., Cherry Hill (609) 482-0059; N.Y., Elmont (516) 488-2100, Rochester (716) 328-2230, Syracuse (315) 437-6666, Vestal (607) 785-9947; N.C., Burlington (919) 227-3639; OHIO, Chesterland (216) 729-2222, Dayton (513) 434-8993; OKLA., Tulsa (918) 299-2636; ORE., Portland (503) 297-2248; TEX., Dallas (214) 661-0400, Houston (713) 688-1431; UTAH, Sandy (801) 942-2081; VA., Falls Church (703) 573-8787; WA., Bellevue (206) 454-3400; CANADA, Montreal, Quebec (514) 341-7630, Ottawa, Ontario (613) 235-5121, Toronto, Ontario (416) 445-9900, Vancouver, British Columbia (604) 253-5555, Halifax, Nova Scotia (902) 454-8321, St. John's, Newfoundland (709) 726-2422.

## The CRT— tough to bring down

Many flat-panel display technologies are struggling to capture some of the marketplace now dominated by the conventional cathode-ray tube. But, CRTs still offer desirable features like very low cost, simple addressing, high speed, high resolution, good contrast and color, high luminous efficiency, and long life.

Some new technologies have attempted to attack the CRT where it is strongest: in the fast-analog TV domain and in the 10-to-27-in. size range. But Society for Information Display experts agree that to do that, a display would need both better performance and lower cost—a tall order.

Instead of a head-on attack, RCA and others are targeting display needs to sizes greater than 30-in. diagonal or smaller than 12-in., where the CRT is really vulnerable.

At the 1976 SID conference, Zenith described a flat-panel design somewhat like the RCA approach, but with thermionic cathodes.

Northrup's Digisplay—remember when?—used a planar-area cathode, and switched the electron beams on and off with digitally addressed aperture plates. Although it offered most of the features of both CRTs and flat panels, it cost more than a conventional CRT and couldn't be adapted readily to large sizes.

But Texas Instruments describes a small display similar to the Digisplay at SID this year. (It should be similar. It's based on technology 11 purchased from Northrup.) The full-color flat CRT device, still in research, delivers 100-ft-L white, 76,800 pixels, and 10 shades of gray for only 25-W—and it needs only 205 addressing connections.

Despite technical and mechanical difficulties, attempts to reshape the CRT itself into a flat scanning-beam display continue. A scanning electron-beam unit using a linear electron gun along one edge of the screen was recently patented by RCA.

The flat-panel picture is inherently stable, registered, rectangular, and perfectly interlaced, according to van Raalte. The new design concept will ultimately produce TV pictures of outstanding quality, he goes on, and the quality will suit home viewers of mov-

## Two alternatives

Two electron-source cell designs have been built and tested for flat-panel display use at RCA. Both designs have the cell structure shown, but one uses ion feedback and the other uses photon feedback.

The ion-feedback multiplier (IFM) contains low-pressure gas, while the optical-feedback multiplier (OFM) is a hard-vacuum tube in which ultraviolet photons leave the target phosphor on the anode and return to the photocathode, which closes the feedback loop.

Electron multiplication in both versions is similar to that in conventional vacuum-tube photomultipliers: An electron leaving the cathode (left) accelerates to the first dynode (an electrode held at 200 V) and, since the dynode material has a secondary emission ratio greater than one, causes several electrons to be emitted.

The beam current is multiplied by the secondary-emission ratio at each successive dynode, as the grow-

ing beam zig-zags toward the phosphor-covered anode. Current builds up until space-charge saturation occurs, which reduces the loop gain to one and stabilizes the anode current.

Exponential current buildup in the IFM, using  $10^{-4}$  torr of helium and a loop gain of 20, has a typical time constant of 26 ns. This is fast enough to provide the square 1- $\mu$ s 3-mA current pulses needed for the flat-panel system.

At the same loop gain, the OFM version has an even faster time constant for current buildup—1.5 ns.

To ensure both fast current buildups, very small background or "start-up" currents are provided by mixing long-time-constant and short-time-constant materials. In the IFM, slow-decay xenon is mixed with the helium; in the OFM, slow-decay phosphor is mixed with the display's basic cerium-doped lanthanum phosphate phosphor.

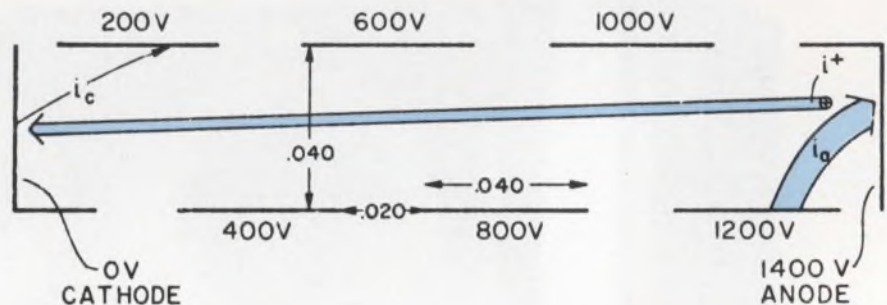

ies and slides. But van Raalte also points out some problems in converting today's research to what could be tomorrow's product.

### Uniformity—a problem?

For one thing, the brightness over this matrix display's screen area will have to be more uniform than that over a standard CRT screen, or else its images won't look as good. Keeping brightness equal all the way across a CRT isn't necessary, since the eye is insensitive to gradual—less than 1%—changes in brightness. Being gradual, the CRT's typical center-to-edge brightness variations can approach two-to-one and remain acceptable (see "Designing a Large-screen Display,"

ED No. 5, March 1, 1978, p. 24).

In the flat-panel display, the chance for abrupt changes in brightness in adjacent areas is built-in, since there are many separate sources of beam current. These will have to be balanced to within 1% and kept in balance.

RCA has a solution, not yet borne out in full-scale operation, but described in one of three papers on the system at the Society for Information Display Symposium in April in San Francisco.

Uniformity of brightness can be obtained by anode sensing, a technique in which an external amplifier provides negative feedback from the screen electrode (anode) to the modulator electrode inside each cell.

Computer simulation of anode sens-  
(continued on p. 51)

---

---

AN IMPORTANT  
**ANNOUNCEMENT  
TO EVERY  
Electronic Design  
SUBSCRIBER**



---

---

**A NEW POLICY THAT AFFECTS YOUR  
SUBSCRIPTION BEGINS WITH  
THIS ISSUE.**



SEE FOLLOWING PAGES .

---

# ANNOUNCING ELECTRONIC DESIGN'S FREE

Do you know when your free subscription to **Electronic Design** expires? Most of you don't . . . and it's our fault!

In the past, we have inundated you with renewal forms to the point of utter confusion. SO WE'RE STARTING A NEW RENEWAL POLICY EFFECTIVE WITH THIS ISSUE.



## **RENEW JUST ONCE A YEAR . . . NOW**

So that everyone will know when his free subscription expires, **everyone** who wants to continue receiving **Electronic Design** and its GOLD BOOK must renew annually with the first issue in May . . . NOW . . . WITH THIS ISSUE.



## **YES, WE MEAN EVERYONE**

In order to make our new policy fair and effective, we're asking **everyone** to cooperate. Yes, this means **you** — even if you renewed only a few months ago, or if your subscription just started. Sorry about that . . . but there are advantages that make it worth your while.



## **WE WON'T BOTHER YOU FOR A FULL YEAR**

With **every** subscriber on the same renewal cycle (first issue of May 1978 to last issue of April 1979) **everyone** will know when his subscription is up for renewal.



## **IT ONLY TAKES 3 MINUTES OF YOUR TIME**

We've simplified the renewal form. It should take only 3 minutes of your time to fill it in completely and drop it in the mail. In return, you insure uninterrupted service for a full year.



## **HELP US TO SERVE YOU BETTER**

The next 12 months are going to be exciting and challenging. There's a lot going on in electronics technology . . . and there's a lot going on in **Electronic Design**. Sign on now. Don't miss a single one of the next 26 issues. Don't miss the 1978-79 GOLD BOOK. You can't beat the price (FREE!) . . . you can't beat the quality of this massive information package. All it costs is 3 minutes of your time. Once a year. **NOW.**



---

---

# A CHANGE IN SUBSCRIPTION RENEWAL POLICY

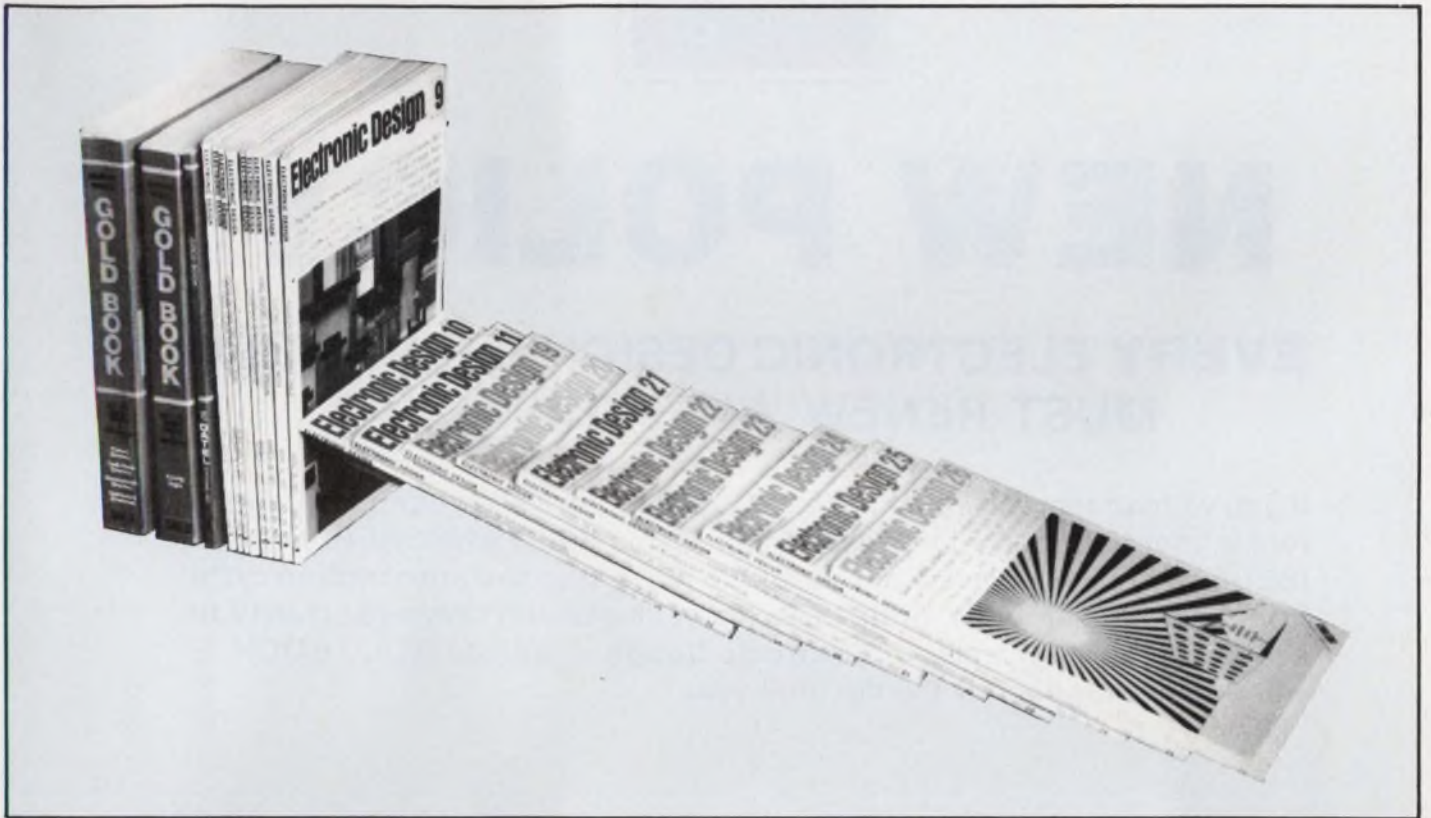

---

---

**YOUR ANNUAL RENEWAL  
APPLICATION FORM  
APPEARS ON PAGE 49 (OVERLEAF)  
PLEASE MAIL IT TODAY!**

---

---



# NEW POLICY

## EVERY ELECTRONIC DESIGN SUBSCRIBER MUST RENEW WITH THIS ISSUE

If you've read the preceding pages, you'll see why it's to your advantage to renew your **free** subscription NOW. This is your **FIRST ANNUAL RENEWAL ISSUE**. We're asking every subscriber to join a standard subscription cycle from May 1978 through April 1979. It's your one and only opportunity to continue receiving copies of **Electronic Design** — and the **GOLD BOOK** — without interruption for the next full year.

HERE IS YOUR ANNUAL RENEWAL FORM  
FILL IT IN COMPLETELY AND  
**MAIL IT IMMEDIATELY**

1. Peel off mailing label from front cover of this issue and affix to address grid on free renewal form at right.
2. You must answer all questions.
3. Detach entire form at perforation, fold in half as indicated. Seal or tape all edges for mailing. Do not staple, please.
4. Affix proper postage and mail today.

ing indicates that the method will meet the target specifications: 1% spread in brightness at 100 foot-lamberts, and 10% spread at 1 ft-L—both in spite of a 20% spread in multiplier output before correction. But there is a price to pay for this solution.

The feedback amplifier must have some fine capabilities: 106-dB open-loop gain flat to 49 kHz, with a roll-off of 6 dB per octave to 40 MHz. Such performance from a dc amplifier tends to be expensive. Fortunately, with the multiplexing method used in the flat display system, only 40 such circuits—one per module—are required to control the whole tube.

Each anode-sensing modulator circuit delivers processed and sampled video to one of the 40 modules across the line, and successively modulates each of the module's 12 elements four times. Since the National Television System Committee time standard is about 66  $\mu$ s, more than 1- $\mu$ s dwell time is available for each element.

During line time, all 40 modules work at once, each painting its own inch of the line. The input video signal comes from a line buffer that stores an entire line of video information and makes it available to the modulators as needed.

Five hundred cathode stripes define the 500 lines of the TV picture. They are addressed sequentially as each new line is ready to be displayed.

Along each horizontal line, there are 1920 vertical color phosphor stripes, successively red, green, blue, etc. The current from each of the 480 elements is deflected to strike one of the stripes.

Inside the display, four stripes of phosphor can be excited by each element so each electron multiplier drives not one pixel, but 1-1/3. This overlap is why the horizontal resolution is essentially as good as the vertical resolution, as required by NTSC standards, and with about as many elements to handle the 40-in. width as to handle the 30-in. height.

### The big picture

In operation, a horizontal line is addressed by switching its cathode electrode to an appropriate voltage, so that ion feedback discharges occur at only those points along the vertical vanes crossed by that cathode. Additional electrodes between the lines on the vertical vanes ensure that only one multiplier element—for the right line—is "on" at a time.

Display performance depends large-

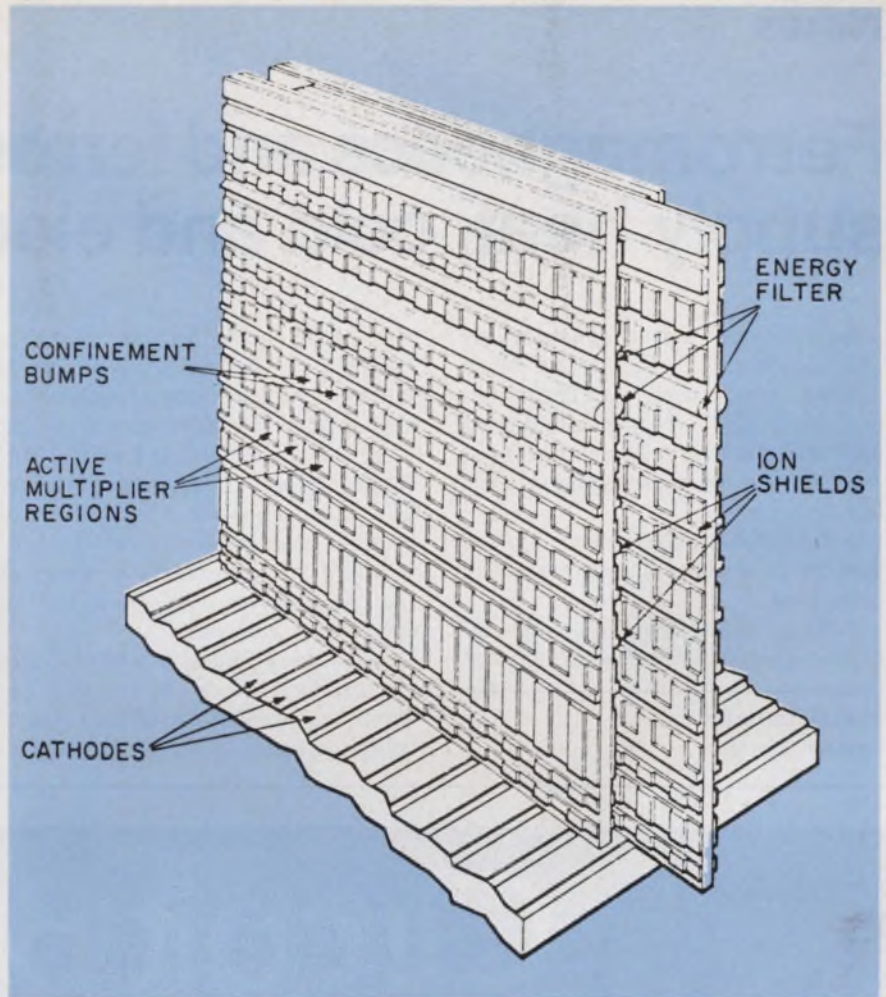

These platelets, or vanes, have confinement bumps to isolate separate picture lines. All electrodes in a column are bused together.

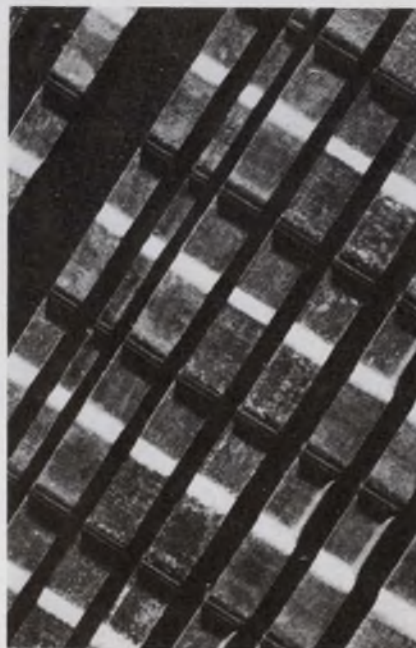

Formed strips of aluminum-magnesium foil, bonded to the platelets and activated after assembly by oxidation, form a layer of magnesium oxide, which is a good secondary emitter.

ly on ion-shield bumps, energy filters, and electroding structures that permit only particles of the desired types to pass through the feedback multiplier cell (see sketch). Ion-shield bumps prevent spurious discharges that otherwise would result from ion feedback onto dynodes.

Extraction and low-voltage modulation of the space-charge-limited beam occurs in the three-bumped energy-filter-and-modulation region of the cell. The beam then passes through deflection and focusing electrodes while being accelerated to the phosphor screen.

RCA's modulator and focus-electrode designs reportedly provide 100:1 modulation of the beam with a 40-V video signal. Over the full range of modulation, beam size remains 0.004 in. at the half-maximum points, considerably smaller than the beam spot of conventional CRTs. The flat-panel design requires the smaller spot because there is no shadow mask to prevent spill-over onto other-color phosphors.■

# Ferromagnetics and ferroelectrics supply heat, cold and electricity

Some things old—magnetocaloric and electrocaloric effects—are being applied, along with the latest ferromagnetic and ferroelectric materials and concepts, to breed something new:

- Efficient magnetic cooling or heating systems.

- A solid-state electrostatic system that can generate ac electricity directly from heat.

Known but neglected, the magnetocaloric effect is now being exploited at

**Jim McDermott**  
Eastern Editor

the NASA Lewis Research Center in Cleveland to produce temperatures as low as  $-13$  F for potential applications that include refrigeration and cooling large computers, and as high as  $131$  F for heat pumps aimed at space heating. The magnetocaloric effect is a reversible increase or decrease in temperature of ferromagnetic material that results when a magnetic field is applied or removed.

Also known and also neglected, the electrocaloric effect—as well as its inverse, the pyroelectric effect—is now being pressed into service by the De-

partment of Energy to convert such heat as solar radiation into 60-Hz electrical energy. The former effect is the temperature change that results in a polarized ferroelectric material when a change occurs in its electrical field. The latter is the change in negative and positive polarized charges that occurs when temperature changes.

### The idea isn't new

It's been known for 30 years that weak paramagnetic salts and magnetic field strengths on the order of 20 kilo-

# Circuit Breakers

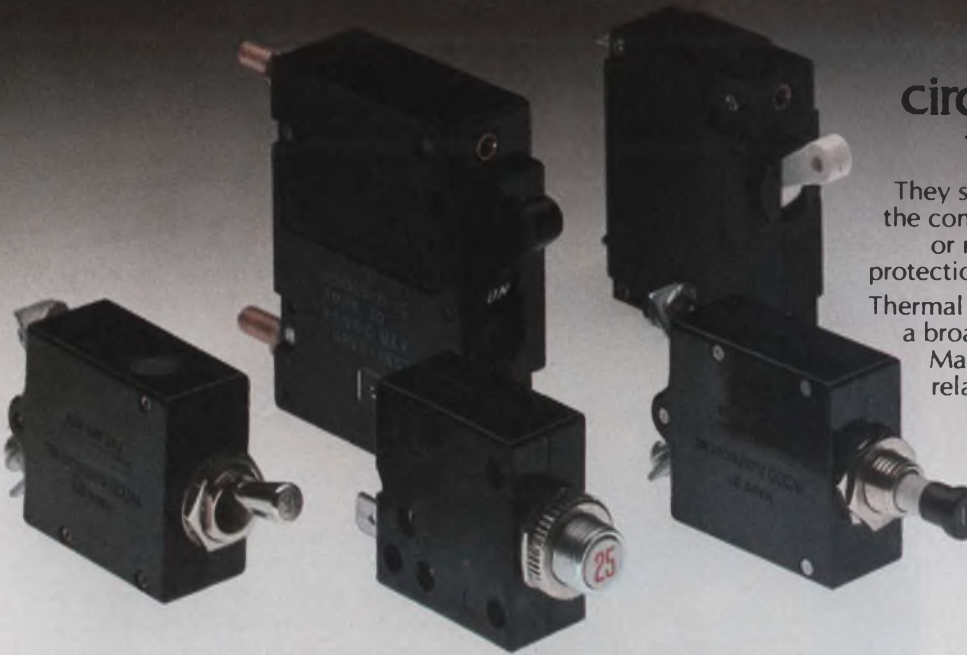

Potter & Brumfield circuit breakers know when to say no!

They say no to overcurrents and faults until the condition is corrected, even if the toggle or reset button is held in manually. Extra protection against mechanical or human error!

Thermal and magnetic hydraulic models offer a broad range of current ratings and styles. Magnetic models feature series, shunt or relay trip; auxiliary switch; instantaneous or time delay trip, and multi-pole units with toggle or rocker operation.

P&B circuit breakers are not one-shot throwaway devices. Save! Say no to fuses and call or write Potter & Brumfield Division, AMF Incorporated, 200 Richland Creek Dr., Princeton, IN 47671. 812/386-1000.

# Potter & Brumfield

CIRCLE NUMBER 30

gauss (kG) could be combined for cooling—but only within a few degrees of absolute zero. So until now, a practical room-temperature magnetocaloric system has been awaiting the advance of technology and the right material. First, the ferromagnetic material to be used must have a strong, interatomic interaction with a magnetic field to increase its apparent strength many times. Second, the material's Curie point must be close to room temperature to get the greatest magnetocaloric effect.

A third requirement is that the magnetic fields be quite a bit stronger than can be attained with conventional electromagnetics.

The discovery of all the required ingredients was a stroke of luck. Seeking a system to provide cryogenic cooling for space propulsion and power at NASA Lewis, Gerald V. Brown, chief of the Magnetics and Cryophysics Branch found, instead, the ingredients for a room-temperature system having

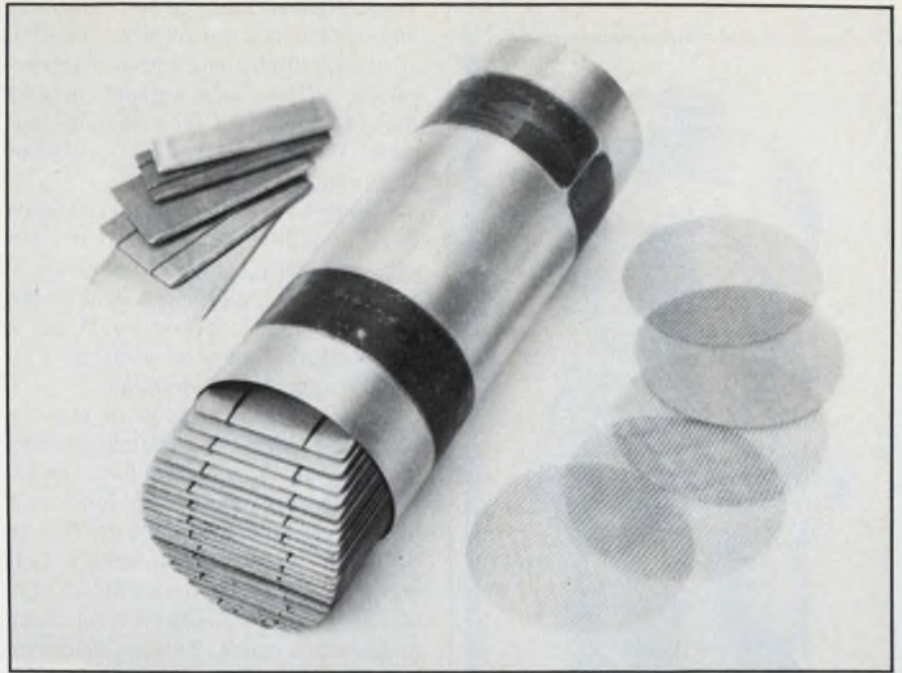

This working element of the magnetic cooling system is a 2-in. stainless-steel cannister containing stacks of 40-mil gadolinium plates. The plates have spaces between them for fluid flow. The wire screens smooth out the flow pattern.

...and other solutions to your tough design problems are found in P&B's growing product line.



**New low-cost ECT hybrid AC relay.** Reed-triggered triac switches 2 to 32 amps. Now with AC or DC input. Life to 10 million operations. Has built-in snubber for loads of .40 P.F. or greater. UL-CSA rated.



**New Sealed R50 PC board relays.** Flow solderable and immersion cleanable! Low-profile 2 and 5 amp. models permit high density packaging. UL recognized. Many SPDT and DPDT models directly compatible with TTL, CMOS and HTL buffers. Terminal spacing for 0.1" grid.



**CMOS controlled CG time delay.** Standard delays range from 0.1-1 sec. to 10-100 min. Delays to one year or more available. Repeatability is typically .05% for DC units, 0.1% for AC, including the first cycle! DPDT contacts rated 10 amps at 120V AC. Delay on operate, interval on or delay on release models.



**Long-life S11L DC solenoid.** Shock-dampened operation extends life for tough vending machine, machine tool control and photocopy machine applications. Pull-on-operate 6, 12 and 24 volt continuous duty coils. Insulation: Class A 105°C.

CIRCLE NUMBER 31

CIRCLE NUMBER 32

CIRCLE NUMBER 33

CIRCLE NUMBER 34

Electronic accuracy through mechanical precision.



## variable capacitors

...made by Johanson. Quality without compromise is our target in the design and manufacture of capacitors in sizes, mounting configurations and capacitance values to meet every application. Perhaps that's why—for more than three decades—superior variable capacitors have been synonymous with the name Johanson, where standards of excellence always come first.

The heart of this trimmer consists of a one piece integral contact drive mechanism press fitted to concentric rotor tubes (U.S. Patent No. 3,469,160).



The standard of excellence!

*Johanson*

MANUFACTURING CORPORATION  
Rockaway Valley Road  
Boonton, N.J. 07005  
(201) 334-2676, TWX 710-987-8367

CIRCLE NO. 35

broad applications. His ferromagnetic material turned out to be gadolinium, a rare-earth element with a magnetocaloric effect substantially greater than other common ferromagnetic materials (see Fig. 1). And its Curie point is at room temperature.

Stronger external magnetic fields were already at hand, with modern superconducting magnets producing 70 or 100 kG. By applying a field on the order of 70 kG, Brown could get a temperature change of about 25 F in a 2-lb capsule of gadolinium.

The final step needed to make a practical room-temperature cooling system was to somehow take the 25-F temperature increase and increase it to 100 F or greater. Brown did this by devising a regeneration system that accumulated the temperature change of a single magnetizing cycle for many magnetizing cycles. This approach has produced a 144-F spread in the present system.

### Regenerator uses gadolinium

Brown's regenerator is a vertical column of fluid in which a temperature gradient is built up and stored. The working magnetocaloric material is an assembly of stacked, separated gadolinium plates with gaps for the fluid to flow through and improve the heat transfer between the gadolinium and the fluid (see photo). At the top, or hot end, of the column, a heat-transfer coil removes the heat of magnetization (see Fig. 2). At the bottom, or cold, end, a transfer coil is attached to the thermal load to be cooled.

The refrigeration cycle begins by applying a superconducting magnetic field of 70 kG and maintaining the temperature of the gadolinium element. The temperature is held constant by removing the heat due to magnetic temperature rise by means of the heat-transfer coil. Then the gadolinium—a constant 70 kG around it—moves to the bottom of the regenerator.

There, the field is removed and cooling occurs. As the gadolinium element passes upwards through the column, but without magnetization, a temperature gradient occurs within the regenerator. As each cycle is repeated, the gadolinium arrives at the bottom colder than in the previous one. The demagnetization at the bottom further lowers the temperature. As the rare-earth element is again lifted to the top, the regenerator is cooled even more.

As the cycles continue, and the lower end gets colder and the higher end gets

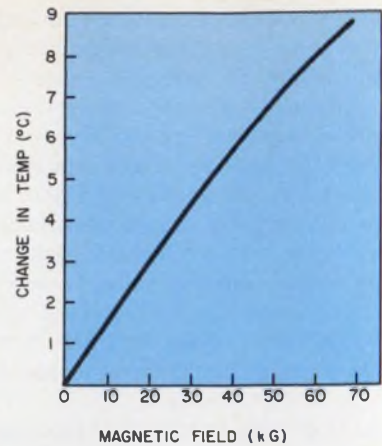

1. Applying a strong magnetic field changes the temperature of gadolinium. The variation of temperature with field shown above was obtained in NASA experiments.

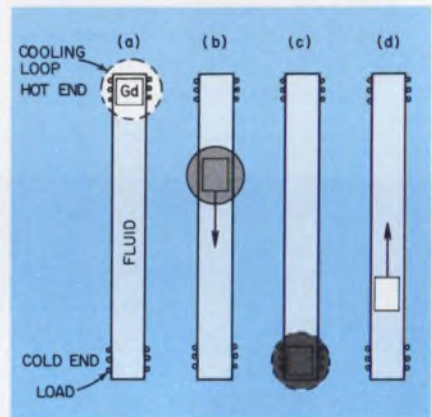

2. A magnetic heating-cooling cycle is obtained with a gadolinium working element that exchanges heat with a working fluid. The dotted circle (a) represents an increasing field while that in (c) is a decreasing field. For operation, see text.

hotter, the temperature gradient in the liquid goes up. The cold-end temperatures will decrease until a thermal load is connected to the bottom heat-transfer coil.

The latest version of the thermomagnetic refrigerator produces a 144-F temperature span ranging from 248 K (-13 F) to 328 K (131 F).

Brown foresees practical reversible machines being developed with efficiencies on the order of 45% of Carnot—the maximum theoretical efficiency any refrigerator system could have.

With the experimental setup, about 60 W of refrigeration is obtained in about 12 in.<sup>3</sup>, or 5 W/in.<sup>3</sup> of a 2-lb gadolinium working element. But losses with the prototype are high. With optimum heat transfer from the

gadolinium, the same-size element could produce upwards of 10 kW of cooling, or about 1 kW/in.<sup>3</sup>, says Brown.

One way to improve the heat transfer will be to form the working element as a screen of fine wires or very thin plates. The plates currently used are 40 mils thick, which severely limits the machine's running speed.

### Electricity from heat

Meanwhile, something that is more than a possibility is electricity directly from heat. An electrostatic heat engine being developed for the Dept. of Energy promises to convert thermal energy directly into ac without going through the intermediate mechanical systems required with present generators. The key is a combination of electrocaloric and pyroelectric effects.

The "solid-state heat engine," being developed by Power Conversion Technology in San Diego, can be powered from relatively low-temperature sources like solar energy, geothermal wells and waste heat from power plants. It is designed to convert heat to electricity by rapidly exposing wafer-thin ferroelectric capacitors to 120-Hz cycles of heating and cooling.

The thin capacitors have a low-enough thermal time constant to follow the heating and cooling and reverse the polarization and state of charge on them in the same time sequence.

While Power Conversion Technology concentrates on the mechanical and thermodynamic structure of the heat engine, ferroelectric capacitor materials are being evaluated, under a DOE contract, by Dr. David Payne, associate professor of ceramic engineering at the University of Illinois (Urbana).

"The best candidates for the Power Conversion Project are single or polycrystalline ferroelectric ceramics," says Payne. "Because it's difficult to get large single-crystal slices, it may be necessary to make thin-layers of polycrystalline material."

Temperature ranges for the materials are limited to about 350 C, maximum, so the frontrunners are the PLZT compounds and the lanthanum-modified lead zirconia titanates, which have highest spontaneous polarizations and electrocaloric coefficients.

For heat stages around 100 C barium titanate compositions may prove satisfactory. These are currently being evaluated for polarization intensity, random polarization and fast switching time for polarization reversal. ■

## ELECTRONIC INDUSTRY DECISION MAKERS:

# 6 WAYS TO IMPROVE YOUR PRESENT LED MOUNTING SYSTEM

## CLIPLITE™



PAT. PEND. U.S. & FOREIGN

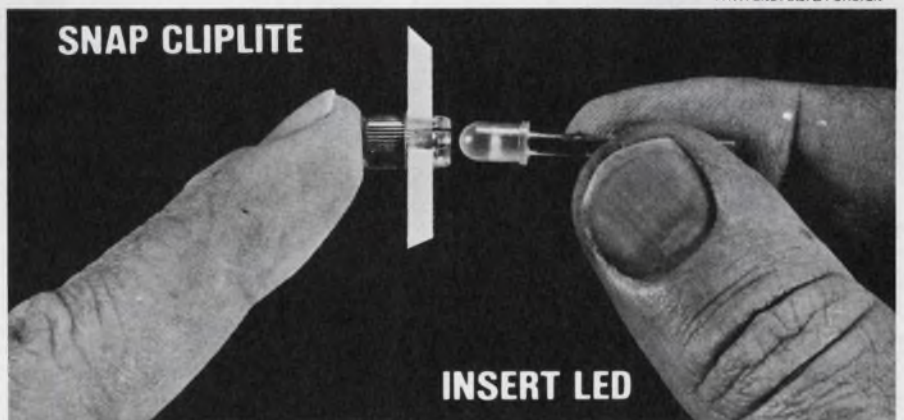

- 1. EASIER TO INSTALL** — Simple 2-step mounting requires no tools. Just snap CLIPLITE into panel hole and insert LED. That's all there is to it. . . . installs in just 6 seconds!
- 2. LOWER ASSEMBLY COST** — including installation and labor, you save 20% per unit.
- 3. 100% GREATER VISIBILITY** — CLIPLITE provides 180 degrees visibility using a point source LED and is 5 times brighter than normal diffused LED. Comes in 5 colors, red, amber, green, yellow and clear.
- 4. SECURE LED MOUNTING** — No LED back-out.
- 5. TOTAL LED PROTECTION** — CLIPLITE completely encloses LED.
- 6. MOISTURE SEALS** — No more worries about spilled liquids or water damage. No more logic failures due to static electricity.

Cliplites are also available in Incandescent and Neon models.

**SPECIAL OFFER!**

**PLACE YOUR TRIAL ORDER TODAY**

<b>Special Pricing for Trial Order Only</b>		ED5-8
<b>PLEASE SHIP:</b>	<input type="checkbox"/> 100 CLIPLITES \$10.00	<input type="checkbox"/> LITERATURE
<b>NAME</b> _____	<b>COMPANY</b> _____	
<b>ADDRESS</b> _____		
<b>CITY</b> _____	<b>STATE</b> _____	<b>ZIP</b> _____
 <b>VISUAL COMMUNICATIONS COMPANY</b> P.O. BOX 986 EL SEGUNDO, CALIFORNIA 90245 (213) 822-4727		



Model	Frequency (MHz)		No. of Digits	Sensitivity	Period, T.I.A., Ratio & Totalize	Trigger Level			Programmability	RF Shielding	Battery Option	LF Multiplier Option	Base Price (U.S. List)
	Direct	Prescaled				Auto	Adjust	Fixed					
9015	100		9	25mV	*	*	*		*		Standard	\$2,995 00	
9035	100	512	9	15mV	*	*	*		*		Standard	\$3,495 00	
9510	500	1250	8	25mV	*		*					\$1,295 00	
9514	500	1250	8	25mV	*	*	*		*			\$1,995 00	
9901	50		6	10mV	*			*				\$ 675 00	
9903	50		7	10mV	*		*			*		\$ 850 00	
9905	50	200	8	10mV	*			*				\$ 795 00	
9913		200	8	10mV				*			*	\$ 395 00	
9915	60	520	8	10mV				*	*		*	\$ 650 00	
9917	560		9	10mV				*	*		Standard	\$ 895 00	
9919		1100	8	10mV				*	*	*	*	\$1,095 00	
9921	560	3000	9	10mV				*	*	*	*	\$1,995 00	



**A new force  
in the expanding universe  
of counters.**

*Our combined technologies now give you a broader selection of performance characteristics than any other counter source in the world.*

If you purchase counters, there is a name you must consider to get the best measurement value for your company's dollar.

The name is Racal-Dana. We are the new force in frequency measurement, with a complete range of practically priced, working solutions to your measurement needs.

Racal-Dana not only developed the world's first microprocessor controlled timer-counter, but today also offers the least expensive  $\mu$ P unit at under \$2000.

We offer 12 totally unique frequency measurement instruments, for as little as \$400 or as much as \$4000. Each gives you more performance for every measurement dollar.

Call or write today. Put the force to work for you.

Racal-Dana Instruments Inc., 18912 Von Karman Avenue, Irvine, CA 92715. Telephone: 714/833-1234.

**RACAL-DANA**  
**RACAL**

FOR DEMONSTRATION CIRCLE NO. 37  
FOR LITERATURE CIRCLE NO. 98

# Dearborn now has 'R' level approval on these MIL metallized polycarbonate capacitors



**(A) MIL Style CHR01** (per MIL-C-39022/9). Capacitance values from .001 to 22.0  $\mu$ F. Voltage ratings from 30 to 400 WVDC.

**(B) MIL Style CHR10** (per MIL-C-39022/10). Capacitance values from 0.010 to 22  $\mu$ F. Voltage ratings from 50 to 600 WVDC.

**(C) MIL Style CRH** (per MIL-C-83421). Capacitance values from .001 to 22.0  $\mu$ F. Voltage ratings from 30 to 400 WVDC.

Based on more than 23,000,000 unit hours of testing, these MIL style hermetically-sealed capacitors have performed with less than .01% failure to gain 'R' Level Approval.

Like other metallized polycarbonate capacitors in the Dearborn family, these capacitors feature excellent capacitance stability, low temperature coefficient and high insulation resistance.

Write for complete technical data or application engineering assistance.

**Dearborn electronics division**  
SPRAGUE ELECTRIC COMPANY  
LONGWOOD, FLORIDA 32750  
SALES OFFICES: 347 MARSHALL ST., NORTH ADAMS, MASS. 01247

**SPRAGUE**  
THE MARK OF RELIABILITY

a  
**General Cable**  
subsidiary

FOREMOST IN FILM CAPACITORS

## Two new navigation systems may dominate future civil needs

Two navigation systems currently in development will become the dominant aids for ships, aircraft and pleasure boats over the next 15 to 20 years. They will supplement and, in some cases, replace the hodge podge of present systems—according to a new study by the Department of Transportation.

One is a microwave landing system (MLS) being developed for the international civil-aviation community, and the other is the Defense Department's Navstar global-positioning satellite system, according to DOT's third National plan for Navigation. The first of the series was issued in 1970, and the second in 1972.

The MLS is expected to replace the instrument landing system (ILS) in operation at commercial airports since the 1940s. Unlike the ILS, the microwave landing system will allow aircraft to approach airports from many directions at the same time, notes the DOT report. And its signals will be less susceptible to the effects of terrain.

The heated competition between the American time-reference scanning beam system and the British Doppler-based system is now over. The International Civil Aviation Organization has selected the American system, developed by Texas Instruments and Bendix.

Navstar is envisioned as a navigation aid for civilian planes and ships en route but, according to the report, it's not accurate enough for aircraft landings.

Other navigation systems are discussed in the DOT Plan:

- Loran-C, a long-range marine navigation aid, should cover all U.S. coastal areas as well as the Great Lakes by early 1980. It will replace Loran-A, developed during World War II.

- Omega, which will end up being an eight-station worldwide navigational system, is used by ships and some airlines during overseas flights to provide accuracies within two to four miles. Seven stations are operating, and the eighth is scheduled to open in Australia in late 1980.

- VOR-DME, the basic inflight navigation system for aircraft traveling within the continental United States, should continue to be used until an alternate system is developed and deployed, possibly in the 1990s.

- Radio beacons, used primarily by private aircraft and recreational boaters, will go on indefinitely because of their high use and low cost.

## Carter okays \$1-billion flying command

A \$1-billion plan to outfit six modified Boeing 747 jumbo jets to serve as flying military command posts has the go-ahead from President Carter.

The jets, known as Advanced Airborne Command Posts (AABNCPs), are intended to replace smaller EC-135 flying command posts—essentially, modified Boeing 707s—which go by the code name Looking Glass. Four of the advanced aircraft were approved by previous presidents, but the Pentagon had been holding up funding for the last two AABNCPs, which threatened to delay the program

and push up costs (see ED No. 7, March 29, 1978, p. 59).

President Carter flew in the first AABNCP, the E-4A, shortly after he took office and declared that the aircraft was too expensive. He recently changed his mind, however, after Defense Secretary Harold Brown argued that the AABNCPs would not only provide greater capability than the Looking Glass aircraft, but would permit the Air Force to retire 17 of them.

Under the plan approved by the President, an additional \$15-million will be made available to prime contractor Boeing (Seattle) to continue the program without interruption. All six aircraft will be built to the E-4B configuration with advanced, nuclear-resistant avionics and will join a reduced fleet of 25 EC-135s. Secretary Brown considers this aircraft mix the strongest to have in the event of nuclear war.

The aircraft will permit the commander-in-chief of the Air Force's Strategic Air Command to direct nuclear retaliatory strikes and, serving as the National Emergency Airborne Command Post, will enable the President and other high government officials to exercise command from the air in case of a nuclear war.

## Europeans opt for European comsats, launchers

The European Space Agency has approved a system of four of its own operational communications satellites, which should be placed into geostationary orbit by European launch vehicles beginning in late 1981. The first of the four is expected to go up using the Ariane launch vehicle.

These European Communications Satellites (ECSs) will replace the Operational Test Satellite (OTS) comsats being launched for the European agency by the National Aeronautics and Space Administration (NASA). The first of those satellites, OTS-1, failed to achieve orbit last Sept. 14 after its Delta launch vehicle malfunctioned: The second, OTS-2, was due to go up in late April.

Initially, the ECS series will provide a capacity of 5000 telephone circuits, but will work up to 20,000 by 1990. The European comsats will use the ground stations built for the American comsats, and will operate on an uplink frequency of 11 GHz and a downlink frequency of 14 GHz rather than on the typical American frequencies of 4 and 6 GHz. The higher frequencies are less susceptible to radio interference in the congested European environment.

**Capital capsules:** The Air Force and Navy have decided to outfit their Sparrow air-to-air and ship-to-air missiles with **an advanced monopulse seeker that is not only less susceptible to electronic jamming than the present pulsed Doppler seeker, but is also the first air-to-air missile to employ an on-board digital processor.** Although the monopulse concept originates with Marconi, Ltd., a British firm, an American firm was sought to develop the new system. Raytheon beat General Dynamics in a competition in which each firm submitted five prototype seekers for evaluation. . . . The Department of Energy's Argonne National Laboratory has awarded Eagle-Picher Industries (Joplin, MO) \$1.1-million to develop **an advanced lithium-metal sulfide battery to power an electric vehicle.** The goal is to produce a 40 kilowatt-hour battery capable of running an instrumented van at up to 45 mph. The new battery is expected to provide greater power density than conventional lead-acid batteries. Delivery is scheduled for some time next year.

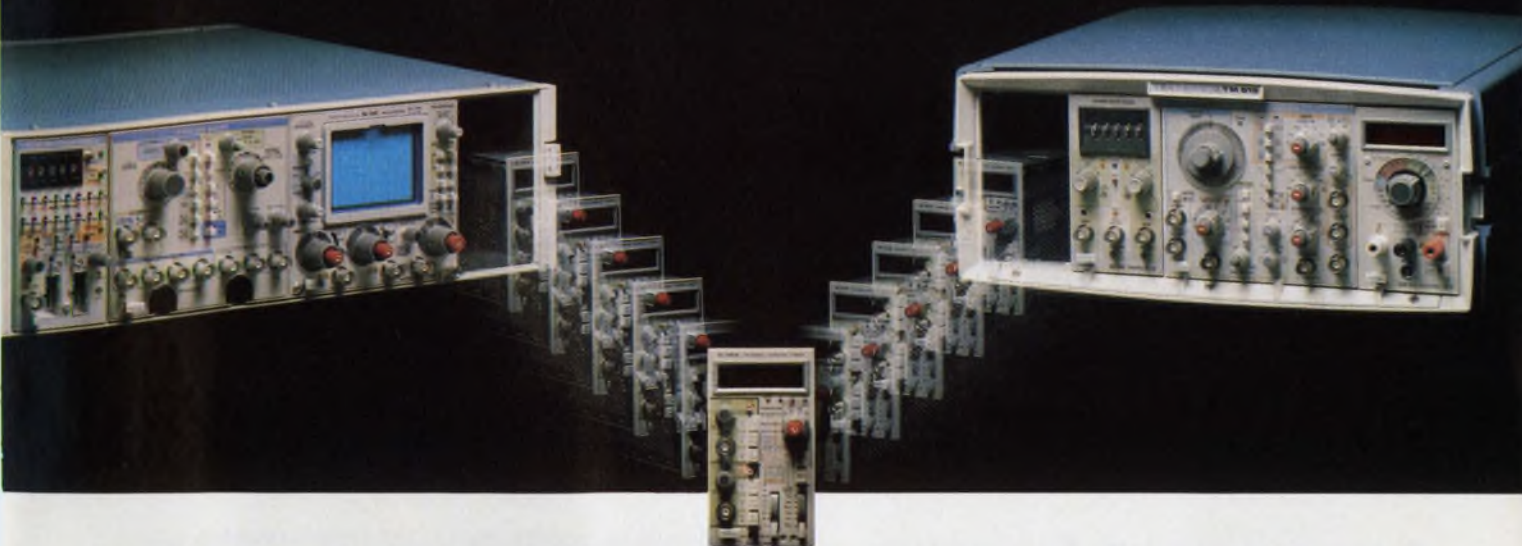

# Stock Exchange.

If you want the highest return for your instrument dollar, take a look at the unmatched value of an electrically configurable TM 500 test and measurement system from Tektronix.

Not only do you get Tektronix' bluechip performance and reliability, but also the convenience and versatility of plug-in instrumentation, at a very reasonable cost.

If your applications are diversified, TM 500 gives you the power to configure literally thousands of plug-in combinations, all mechanically compatible in your choice of TM 500 mainframes.

There are nearly 40 different plug-ins to choose from, in eight major categories:

DMMs	Oscilloscopes
Counters	Logic Analyzers
Generators	Word Recognizers
Amplifiers	Power Supplies

A single mainframe accommodates up to six plug-ins. Switching your system around from one application to another is just a matter of a simple stock exchange. Slip one plug-in out, slide another one in.

If your applications are growing, a TM 500 system is a wise investment. You can update your system or add on new performance capabilities to your initial TM 500 system without buying another mainframe. Since all plug-ins are powered through the mainframe, you won't be paying for an unnecessary power supply component with every new instrument you buy.

TM 500 go-anywhere mainframes come in six different versions for benchtop, rackmount, rollcart or on-the-road engineering.

Another long-term advantage is, as new standards are set in electronics, new instruments will be added to the TM 500 family — like our 40 MHz function generator with log sweep, phase lock, AM and FM capabilities and a long list of added dividends.

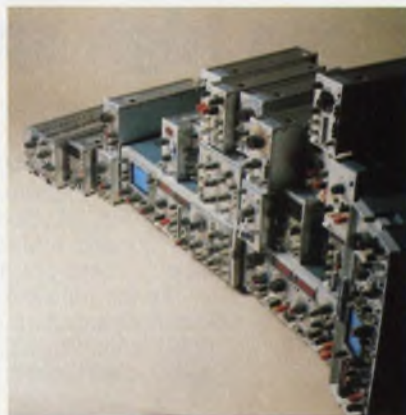

Your investment is further protected by Tektronix Long-term Product Support Program and worldwide over-the-counter service.

So, if you're in the market for accurate, reliable instrumentation, take stock of what TM 500 has to offer. In convenience, versatility and economical performance, TM 500 pays big dividends.

## TM 500 Designed for Configurability

Ask your Tektronix Field Engineer to assemble a portfolio of TM 500 instrumentation for you, or write for a copy of our TM 500 concepts brochure. Tektronix, Inc., P.O. Box 500, Beaverton, Oregon 97077. (503) 644-0161, Ext. 5283. In Europe: Tektronix Limited, P.O. Box 36, St. Peter Port, Guernsey, Channel Islands.

**Tektronix**<sup>®</sup>  
COMMITTED TO EXCELLENCE

# Four new Motorola system development tools

**for MPU, bit-slice,  
and single-chip  
microcomputers.**

A quartet of recently introduced system development tools from Motorola Microsystems keeps Motorola's product line in harmony with the unmatched versatility of the processors they support.

The EXORciser II\* Development System improves on the original EXORciser\* without making it obsolete. MACE 29/800\* extends the EXORciser's capability to systems using bit-slice architecture. The 3870 Emulator and 14 1000 Simulator are EXORciser-based development tools for single-chip microcomputers.



## EXORciser II develops high-speed systems.

EXORciser II does everything the EXORciser does, adds a couple of neat new wrinkles, and operates at twice the speed. The key to the high speed is the new MPU II module, which includes both the system clock and the 2.0 MHz MC68B00 MPU. The clock circuit generates your choice of 1.0, 1.5, or 2.0 MHz signals, so the EXORciser II supports the full range of M6800 Family microprocessors.

DEbug II provides EXORciser II with a dual memory map. This capability dedicates a full 64K memory

map to EXORciser II, and creates a second 64K map in which you may implement your system. EXORciser II I/O can be accessed from either memory map.

The EXORciser II includes 32K of RAM, power supply, RS-232 port, selectable Baud rates from 110 to 9600, and a Macro Assembler/Editor. Optional modules also are available.

As for software, EXORciser II operates with all Motorola standard resident software packages; FORTRAN, COBOL, MPL, BASIC and Macro Assembler/Linking Loader.

\*Trademark of Motorola Inc.



## MACE develops ultra-high-speed systems.

MACE 29/800 minimizes the time and trouble of producing microprograms for systems based on bit-slice families like Motorola's high-speed M2900 and ultra high-speed M10800. The MACE 29/800 includes an EXORciser bus-compatible interface module and an EXORciser-resident software package that translate all microprogramming tasks into M6800-oriented operations.

The Write Control Store (WCS) in which your microprogram will reside is expandable in both depth and width. Ratios range between 8K words by 16 bits and 2K words by 112 bits, with intermediate configurations selectable in increments of 2K words or 16 bits. A maximum of seven WCS modules can be used.

MACE 29/800 is available as a separate unit for those who already have an EXORciser, terminal, and printer, or as a complete development station.

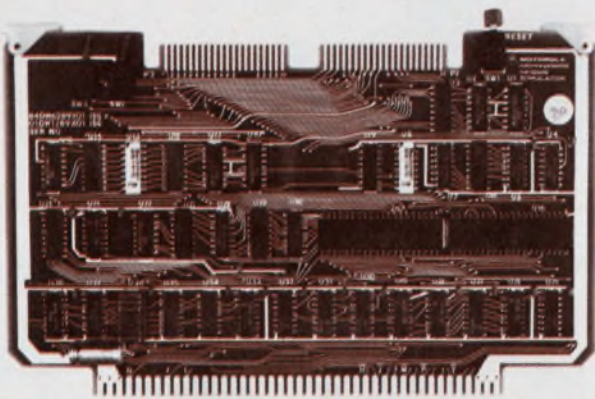

## MC14 1000 Development System provides microcomputer simulation.

The 14 1000/1200 Simulator is an EXORciser-based system development tool for debugging designs using the new MC14 1000 series CMOS single-chip microcomputers. Complete software requirements are met, including cross assembler, loader, and debug package.

This module provides complete simulation of the proposed MC14 1000/1200 system hardware characteristics, for correction of problems prior to initiation of final production masks.

For additional information on any of Motorola's EXORciser or EXORciser-based system development tools, complete the coupon or write your request for specific information to Motorola Semiconductor Products Inc., P.O. Box 20912, Phoenix, AZ 85036.

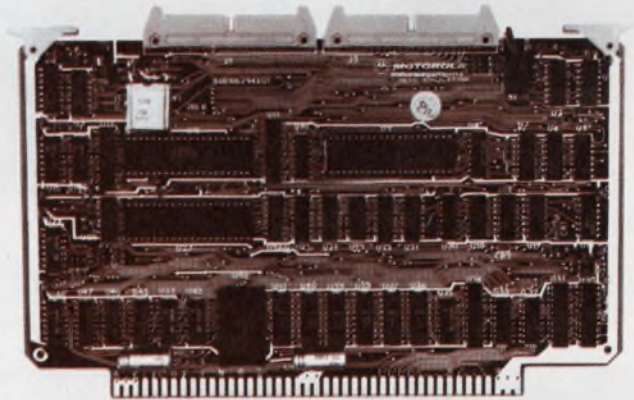

## MC 3870 Development System provides real-time emulation.

The 3870 Emulator is another plug-in extension of the EXORciser. It provides real-time emulation of the MC3870 single-chip microcomputer.

The EXORciser-resident Cross Assembler converts your 3870 source statements into an executable program. After this program is debugged, it's stored in a 2K EPROM for final evaluation. With the EPROM inserted in the socket provided, the emulator module can operate independently of the EXORciser.

To: **Motorola Microsystems**  
P.O. Box 20912, Phoenix, AZ 85036

I have an immediate requirement for microsystem development tools. Please contact me as soon as possible. Please send me technical information on:

- EXORciser II                       MACE 29/800  
 3870 Emulator                       14 1000/1200 Simulator

Name \_\_\_\_\_ Title \_\_\_\_\_

Company \_\_\_\_\_ Dept. \_\_\_\_\_

Address \_\_\_\_\_ Phone \_\_\_\_\_

City, State, ZIP \_\_\_\_\_



# MOTOROLA

## Semiconductor Group

# When you need LEDs or more than LEDs...



Dialight is the first place to look. We can help you do more with LEDs... because we've done more with them.

Discrete LEDs come in a variety of sizes, shapes, colors (red, yellow, green in clear or diffused), with or without built-in resistors.

Low cost logic state fault indicators for trouble shooting complex circuits. Designed for close density PC board mounting.

High-brightness bi-color LEDs (red/green) suitable for go/no-go situations. Designed with unique

lenses for the extra visibility you'll want for your most critical applications.

Snap-in mounting LED indicators reduce labor cost. Available in red, yellow or green with or without built-in resistors.

Whatever you need in LEDs, Dialight's probably got it already. For your free 60-page selector guide and listing of our nationwide stocking distributors, contact us today.

**DIALIGHT**  
A North American Philips Company

## Dialight meets your needs.

Dialight, 203 Harrison Place, Brooklyn, N.Y. 11237 (212) 497-7600

CIRCLE NUMBER 42



# Editorial

---

## Goodbye, Charlie and Jack

For seven great years I've had the opportunity to write to the most influential people in the most important industry in the world. Through my buddies, Charlie and Jack, I've been able to get things off my chest about practices I hated in our industry—and practices I loved. Let me tell you—it was fun. I loved talking to you and hearing from you.

I'm going to miss that as I move on to broader responsibilities as Associate Publisher of ELECTRONIC DESIGN.

Larry Altman is the new Editor of ELECTRONIC DESIGN, and we're delighted to have him with us. Larry comes from the Far East—across the Hudson River—where, as Senior Editor of ELECTRONICS magazine, he earned the respect of the entire electronics community. He holds impressive editorial and engineering credentials.



Associate Publisher

## Rostky, Scrupski and Altman.....a new lineup

Those who read mastheads will notice several significant changes on ours. Editor George Rostky moves up to the new position of Associate Publisher of ELECTRONIC DESIGN. George is the most experienced and one of the most respected editors in the electronics press. We will now be able to apply his 25 years of technical and market savvy to planning and developing all aspects of our publication.

Our new Editor is Larry Altman, who was Senior and then Managing Editor of ELECTRONICS magazine. As an award-winning journalist and as a senior electronic design engineer, Larry has been directly involved in the dramatic growth of electronic technology as it spread from an aerospace and communications-oriented group of companies to the broad assembly of electronics-based enterprises that today dominate the industrial world. His reporting on developments in electronic technology—ranging from industrial and communications equipment to semiconductors, microprocessors and mini/micro computer systems—has earned him an outstanding reputation among both his fellow design engineers and fellow journalists. I believe he is uniquely qualified to lead our editorial staff.

Also joining the staff is Senior Editor Steve Scrupski. We are particularly pleased to have Steve come home. Having started his 16-year editorial career with us, Steve has gone on to develop a breadth of technical knowledge unequaled in electronics journalism.

These moves are part of our continuing commitment to make ELECTRONIC DESIGN the most helpful information source for electronic design engineers and engineering managers.

Publisher

# The single chip analog computer.

A versatile, new  
computational IC that's  
accurate and easy  
to use,



The AD534 Analog Multiplier,  
from \$16 in 100s.

The Analog Devices' AD534 Analog Multiplier. A new, monolithic, laser-trimmed, four-quadrant analog multiplier destined to smash the myth that analog multipliers are more complex than the computing function they solve.

The AD534 has a guaranteed maximum multiplication error of  $\pm 0.25\%$  without external trims of any kind. This level of accuracy you'd normally expect to find only in expensive hybrids or bulky discrete modules. Excellent supply rejection, low temperature coefficients and long-term stability of the on-chip thin film resistors and buried zener reference preserve the AD534's accuracy even under the most adverse conditions.

The AD534 is the first general purpose, high performance analog multiplier to offer fully differential high impedance operation on all inputs. And that's what gives the AD534 its amazing flexibility and ease of use.

The AD534 is a completely self-contained, self-sufficient multiplier which can generate complex transfer functions very close to theoretical. Our active laser trimming of thin film resistors on the chip to adjust scale factor, feedthrough and offset allow you to plug in the AD534 and run it virtually without adjustment.

In addition to straightforward implementation of standard MDSSR functions (multiplication, division, squaring and square rooting), the AD534 simplifies analog computation (ratio determination, vector addition, RMS conversion); signal processing (amplitude modulation, frequency multiplication, voltage controlled filters); complex measurements (wattmeters, phasemeters, flowmeters) and function linearization (transducers, bridge outputs, etc.) You can set up the AD534 to perform complex calculations by using various feedback arrangements to manipulate the AD534 transfer function of  $(X_1 - X_2)(Y_1 - Y_2) = 10(Z_1 - Z_2)$ .

## and use,

### In Frequency Multiplication.

Nonlinear circuits which accept sinusoidal inputs and generate sinusoidal outputs at two, three, four, five or more times the input frequency make use of trigonometric identities which can be implemented quite easily with the AD534 as shown. For this frequency doubling circuit the output should be AC-coupled to remove the DC offset resulting from the trigonometric manipulation.

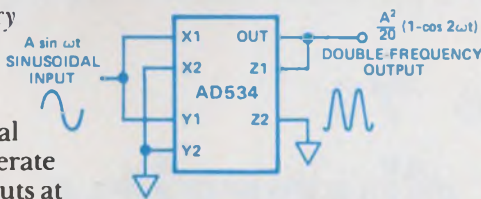

*In Ratio Computing.* The percentage deviation function is of practical value for many applications in measurement, testing and control. The AD534 is shown in a circuit that

## and use,

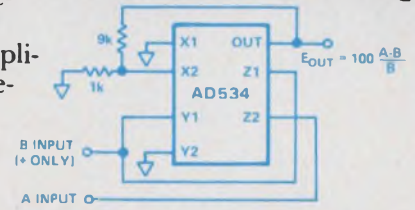

computes the percentage deviation between its two inputs. The scale factor in this arrangement is 1% per volt although other scale factors are obtainable by altering the resistor ratios.

## and use,

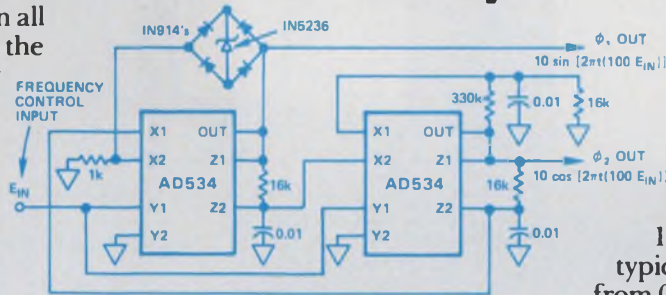

### In Sine Wave Function Generation.

The voltage controlled 2-phase oscillator uses two AD534's for integration with controllable time constants in a feedback loop. The frequency control input,  $E_{IN}$ , varies the integrator gains, with a sensitivity of 100Hz/V and frequency error typically less than 0.1% of full scale from 0.1V to 10V.

### In a Voltage Controlled Filter.

The output voltage, which should be unloaded by a follower, responds as though  $E_c$  were applied directly to the RC filter but with the filter break frequency proportional to the input control voltage (i.e.  $f_0 = \frac{E_c}{20\pi RC}$ ). The frequency response has a break at  $f_0$  and a 6dB/octave rolloff.

## and use.

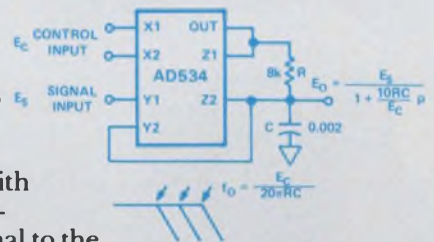

These uses of our new Single Chip Analog Computer, the AD534, are only the beginning. For the big picture call Doug Grant at (617) 935-5565. Or write for a copy of our new Multiplier Application Guide and the data sheet on the AD534.

**ANALOG DEVICES**

The real company in analog computation.

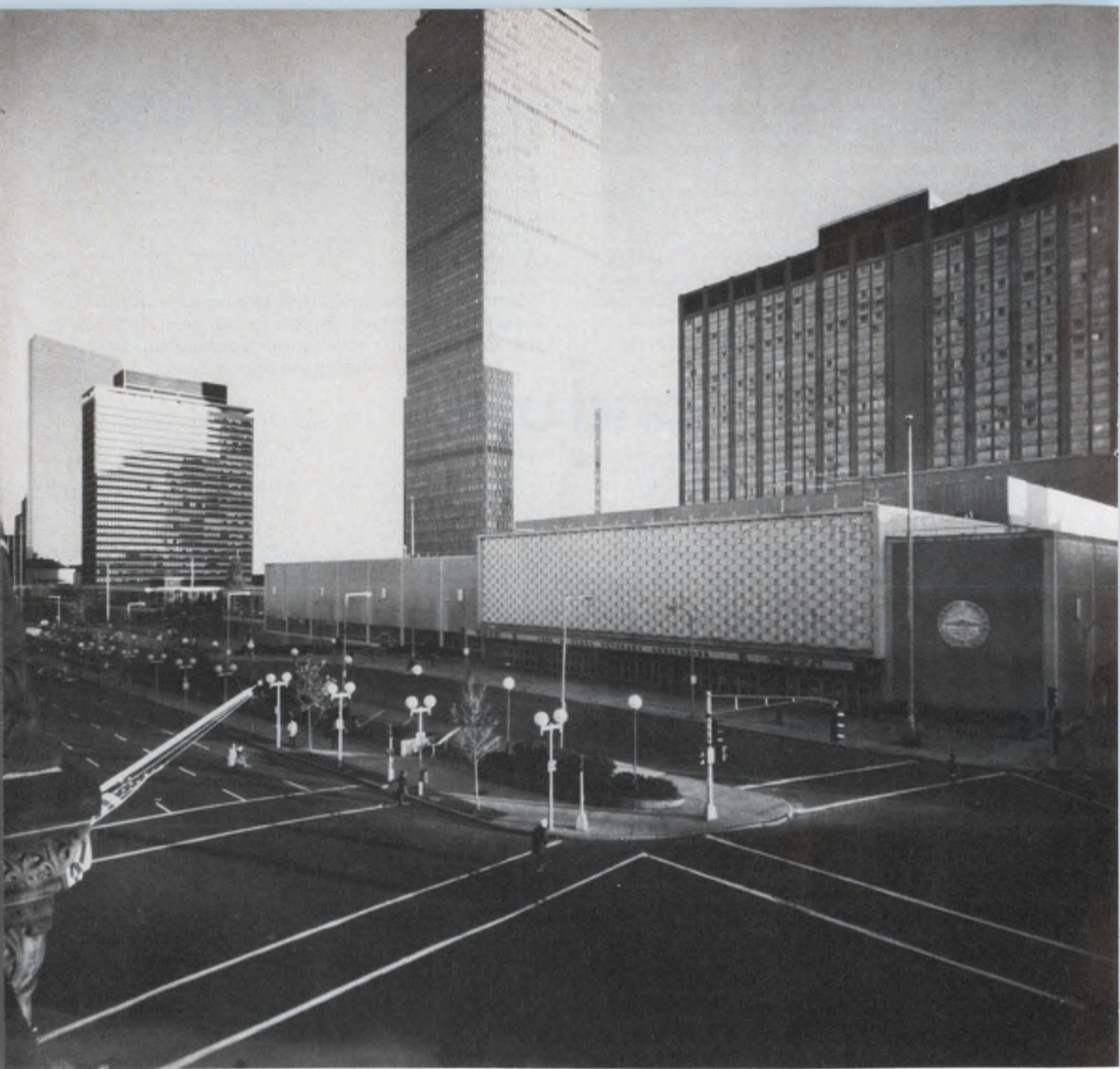

**Electro '78**  
**Direction, diversity**  
**mark this year's show**



“**L**ook ahead,” proclaims this year’s Electro—the IEEE international convention and product exposition—and the exhibitions and diverse technological program will echo and re-echo the theme.

Electro '78 will be held May 23-25 in Hynes Veteran's Auditorium as well as in the Sheraton Boston next door. The three-day convention is expected to attract 25,000 visitors who will view the products of 349 companies in over 658 booths.

Many will flock to hear the latest technical presentations on subjects ranging through automatic test equipment to microprocessors, data-base memory development, home computing and fiber-optic data links.

The technical program consists of 35 half-day sessions and a special Wednesday evening session with the intriguing title, “New Electronic Methods for Medical Diagnosis and Treatment Using the Human Energy Field: A new Beach-head for Scientific Discovery.”

Some of the more down-to-earth technical papers are offered in Session 4, “Bridging the Analog-to-Digital Gap,” and Session 14, “Microprocessor Applications in NASA.” Both sessions point to a host of new intelligent peripheral  $\mu$ C components and systems that are affecting the architecture of small  $\mu$ C-instrumentation systems and large-scale mini-

computer test systems.

How to test microprocessor and  $\mu$ P-based products continues to plague designers and users alike. Sessions 3, 9, 11, 17 and 22 will attempt to supply effective answers.

In communications, the action these days is in fiber-optic systems, with reliability and performance improving almost weekly. Nevertheless, some problems do remain, notably losses incurred in splicing individual fibers, and differences in fiber parameters. The ups as well as the downs of optical communications will be discussed in Session 29.

The new generation of semi memories is coming out with more options and capabilities than ever before. Session 27 will help designers choose the right one for their specific application.

Sessions 16 and 23 will focus on computer peripherals rather than on the computer itself. This is particularly true at the consumer end, where designers are trying to develop hard-copy devices, mass-storage media, communications interfaces, and sense and control components for the new wave of home computers.

These Electro articles were written by Associate Editors Andy Santoni and Jim McDermott.

**Microprocessors/Microcomputers**

Smart peripherals simplify a/d and improve both  $\mu$ C and mini setups..... 70

**Test and Measurement**

How to test  $\mu$ Ps and  $\mu$ P products—a good question looking for answers..... 75

**Memories**

Now there are many good memories, but choosing is getting confusing..... 77

**Communications**

Fiber-optic systems reach for GHz but losses are still a big problem..... 81

**Computers**

Computers in the home are only as good as their peripherals..... 85

# Smart peripherals simplify a/d and improve both $\mu$ C and mini setups

Intelligent peripheral  $\mu$ C components and systems are bringing new, simpler ways to acquire and convert analog data into digital form. Not only that, but these low-cost hybrid and monolithic components, which talk directly to  $\mu$ Ps and  $\mu$ Cs, are producing an evolution in the architecture not only of small  $\mu$ C instrumentation systems, but also of large-scale mini-computer test systems like the ones applied in space-vehicle dynamic structural analysis.

Just what these new analog peripheral components are, how they're changing architectures, and what the newer instrumentation architectures will look like are highlighted in two sessions at Electro 78: Session 4 on "Bridging the Analog-to-Digital Gap," and Session 14 on "Microprocessor Applications in NASA."

### New interfaces change architectures

The hardware to perform accurate analog data acquisition and conversion was, until not too long ago, physically large and demanded a great deal of power. Cost, size and power requirements for most systems kept data-acquisition and conversion hardware, as well as its interface to minicomputers, in the central-processing area, Stephen Harward, product line manager for Burr-Brown Research Corp. (Tucson, AZ), points out at Session 4 in "A New View of Architecture and Partitioning in Data Acquisition and Control Systems."

But now, microcircuit hybrid and monolithic peripherals have been produced that are tiny and intelligent enough to move the analog conversion and computation circuitry out to the sensor locations. Preprocessing done at the sensor site cuts down on the volume of data to be transmitted to the central location, Harward notes. More important, digital transmission of data from the sensor to the central location markedly improves noise immunity.

Indeed, with components now available, a complete data-acquisition and control system, including preprocessing and storage of data, can be put on a small PC card. Examples are single-chip computers like the 8048 family, the 3870, and others that operate from a single power supply voltage and are self-contained. Not only do these components have on-chip program and data storage, but their architectures very often



**These 8080 microcomputers incorporated at NASA test sites** change system architecture by centralizing, not distributing, the minicomputers the 8080s feed.

eliminate the need for support chips. What's more, the price, in volume, can be less than \$10 each.

Sweeping advances have also taken place in hybrid and monolithic circuitry, which can now convert analog signals to digital equivalents with as much as 16-bit accuracy. For bus interfacing, many of these are available with three-state output buffers. Virtually all the 16-bit, and some of the 8 and 10-bit resolution devices, are integrating types, with con-

version times up to several hundred milliseconds.

Successive-approximation a/d converters, with 10 to 50- $\mu$ s conversion times, are available with three-state output control that enables codes longer than eight bits to be sent out in two bytes of data on an 8-bit bus.

Because they're small and don't take much power, these new components make signal conditioning at the sensor feasible, Harward says. For example, an intelligent remote-sensor processing station can be provided by a complete minisystem consisting of a Burr-Brown MP-22 chip, an 8048 single-chip  $\mu$ C, and a 4-bit latch—and all on half a 4  $\times$  6-in. PC card. The MP-22 is a complete hybrid data-acquisition system already interfaced to a  $\mu$ C bus and a control bus. This kind of system also permits local control at the sensor, in addition to remote operation.

The MP-22 is one of the most advanced hybrid microperipheral data processing devices, says Harward, with its 16-channel analog multiplexer; adjustable gain instrumentation amplifier; complete 12-bit successive-approximation a/d converter; and interface, timing and control logic. These features make the MP-22 directly compatible with some microprocessors without additional interfacing, and with virtually all other  $\mu$ Ps after one or two simple logic chips have been added.

The MP-22 can be accessed not only by conventional I/O techniques, but also by a new feature—memory mapping. In memory-mapped operation, the computer accesses the Burr-Brown chip just as it would a memory. Each channel in the MP-22 has its own address, which the computer addresses as if it were part of the system's RAM.

### Hybrid d/a and a/d's add interfacing

Up to now, monolithic and hybrid d/a and a/d converters have been available without interfacing circuitry on the chip. Adding interfacing chips would produce a full-sized computer board array. However, two new intelligent microperipherals bring this problem down to single-package size: they are self-contained hybrid data converters by Micro Networks Corp., Worcester, MA. Described at Session 4 by Robert Calkins, manager of circuit development, in "Simplify Analog I/O Design—Design It with Low Cost Microcomputer-Compatible Components," the MN3500 is a 12-bit, 32-pin voltage-output d/a converter and the MN5500 is a 12-bit, 40-pin multirange a/d converter. These devices, which are  $\mu$ P-compatible, contain the interface circuitry including address decoding, timing and control logic as well as the a/d and d/a elements.

Both the MN3500 and MN5500 can mate directly with the 6800, 8085 and Z80 and just about any 8-bit  $\mu$ C, says Calkins, because they can be addressed like a standard I/O device, or as with Burr-Brown's MP-22—like a memory address, by means of memory map-

ping. A chip-select type of architecture permits both Micro Networks converters to be used as building blocks in large, distributed multichannel systems. The data transfer, using a bit-parallel, word-serial format, is consistent with 8-bit processors. To simplify mating with advanced microcomputers, handshaking signals are also generated.

One significant feature of the MN5500 a/d converter is a 12-bit latch for holding the a/d data. The 12-bit data are transferred in two 8-bit bytes by means of

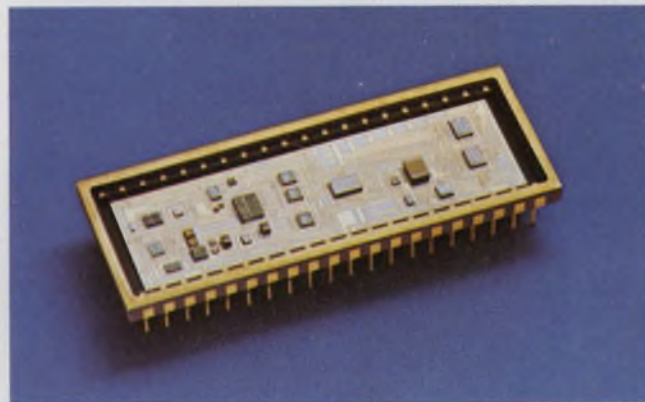

**Local control of data acquisition at the sensors** is provided by new hybrid components like this d/a microperipheral interface package, the MN5500 by Micro Networks.

a three-state conversion signal. A conversion is initiated by writing a dummy word at the base address of the a/d. After conversion, the "end-of-conversion" signal line latches the output data into the 12-bit latch. This information can now be read by addressing the two memory locations used by the a/d.

This 12-bit latch allows a software interrupt to initiate the data transfer. And with this type of output interface, another conversion may begin before the a/d data are read out.

### Monolithic a/d makes its bow

Indeed, these hybrid microperipheral devices have monolithic competition—the first single-chip monolithic data-acquisition system, the 15-mW ADC0816 from National Semiconductor, Santa Clara, CA. Following the microperipheral data-acquisition device trend, this 5-V, single-supply device can replace as much as \$100 to \$200 worth of hybrid and discrete component analog boards for \$20 (in 100 quantities). Fabricated with an ion-implanted high-density, metal-gate CMOS process and housed in a 40-pin package, the ADC0816 has a single 28,000 square-mil chip that includes a true 8-bit a/d converter with Tri-State latched outputs. According to John Jorgensen, National's CMOS design manager, who gives an in-depth look at the device and its use in "A Monolithic

Data Acquisition System—Its Design and Application,” the chip also contains a 16-channel expandable multiplexer with address input latches, provisions for handling external signal conditioning and all the logic control needed for interfacing the ADC0816 to all standard microcomputers.

The ADC0816 duplicates the classic structure of a data-acquisition system on a single chip, and performs a conversion in 50  $\mu$ s. Radiometric design makes the chip essentially adjustment-free, says Jorgensen. Moreover, the linearity and accuracy are equal to that of most hybrid and discrete equivalents and better than that of the simpler monolithic a/d chips.

At 25 C, the linearity, zero error and full-scale errors are each no more than  $\pm 1/2$  the least significant bit (LSB). While the total unadjusted error is typically

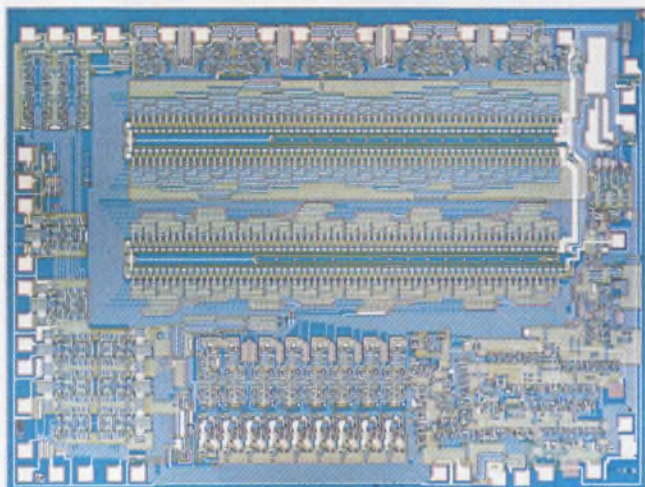

**The first single-chip monolithic data-acquisition system,** the ADC0816 by National Semiconductor, has an 8-bit a/d, a 16-channel multiplexer and microprocessor-interface logic. It performs a conversion in 50  $\mu$ s.

$\pm 1/4$  LSB, the absolute accuracy—the sum of total unadjusted error and quantization error—is guaranteed to be less than  $\pm 1$  LSB.

The heart of the single-chip system, its 8-bit a/d converter, is divided into three sections: a 256-step resistor-ladder network, a chopper-stabilized comparator, and a successive-approximation register. High and drift-free accuracy in the comparator is achieved with chopper-stabilization, even though this is difficult to implement.

The chopper-stabilized comparator converts a dc input signal into an ac signal, which is then fed through high-gain ac amplifiers, where its dc level is restored. This technique limits the amplifier drift, since drift is a dc component not passed by the ac filter. As a result, the entire a/d converter is insensitive to errors due to temperature change, long-term drift and input offset.

To prevent oscillations that might occur in a closed-loop feedback control system using the ADC0816, a

256-step (256R) ladder network, rather than a conventional R/2R ladder, is incorporated on the chip. The reason is the 256R network's inherent monotonicity. A nonmonotonic relationship can introduce phase shifts and produce oscillations that may be catastrophic. In addition, the chip's 256R network does not cause variations in the reference voltage.

The chips can perform without the use of external components when applied in radiometric sensing applications, such as with potentiometer strain gauges, thermistor bridges and pressure transducers. In these systems, only the change in parameter is measured rather than the absolute value. Consequently, the 0816 can operate without an external voltage reference, and the transducers are connected directly into the multiplexer inputs. For absolute measurements, a standard voltage reference must be added to the system.

Architectural changes are also affecting mini-computer systems. While microcomputers go one way, minicomputers are going quite another.

### Minicomputers centralized

Minis used in large test and instrumentation systems have traditionally been decentralized so that each mini is close to its assigned task. The primary reasons have been system simplicity and low cost. But microprocessors and intelligent microperipherals have produced an about-face in that architecture at NASA Lewis Research Center in Cleveland, where research test facilities are scattered over a 340-acre area. Here, minicomputers have been gathered in a central location, and microprocessors and microcomputers successfully process and feed test information that is gathered in different areas back to minicomputer central.

The reason for the change in minicomputer-system architecture, says Robert L. Miller, chief of data system development, is increasing software costs, even as minicomputer hardware prices continue to decline.

“We found that programmer costs were rising because of the time required to service the various locations at which the minis were distributed. We found we could save programmer time by concentrating the minis in one spot,” says Miller, who discusses the new architecture at Session 14 in “Escort: 1A Data Acquisition and Display System to Support Research Testing.”

Minimum down time was also a goal. “Our task here at Lewis is research testing on power and flight systems for aeronautics and space. Some of those systems tests are very costly. Wind tunnels, for example, cost thousands of dollars an hour to operate. And we don't want to shut a test down because some computer component fails,” Miller explains.

With the minis centralized and manned during test,





# BENDIX BRISTLE BRUSH BUNCH.

## Opens new horizons for PCB design.

70%-90% Reduction in Mating and Unmating Forces

- simpler board support systems
- fewer damaged boards

### Extended Circuit Count Potential

- up to 400 Bristle Brush contacts per connector



### Extensive Product Line

- mother board, daughter board, input/output, PC receptacle body styles
- 2-, 3-, and 4-row configurations
- 90° and straight PC, solderless wrap, crimp removable, willowy tail terminations

For complete information, contact The Bendix Corporation, Electrical Components Division, Sidney, New York 13838.



**Bendix**

CIRCLE NUMBER 44

**See us at Electro '78, Booth 708-709, May 23-25, Boston, Massachusetts.**

a system that goes down can be quickly pulled off the line and another mini or a plug board quickly substituted. Where discs are being used during a test, they can be readily transferred to the substitute system.

Another important concern is to be able to install a system for testing and have it running quickly. With custom-designed systems incorporating mini-computers at the test facility it was not unusual for one, even two, years to pass from initial requirement review until the test system was procured and the minicomputer was installed, debugged and running.

This prohibitive delay has been cut down to a brief two weeks by incorporating a microcomputer at each test site along with standardized  $\mu$ C packages with programmed, predesigned and pretested options.

The 8080 is used for standardization, Miller points out, because it is a stable design and looks like it will be around for the next 10 years or so, which is the expected useful life of the test systems using them.

As it now stands, the architectural configuration at Lewis Research consists of 8080 microcomputers located at the various test sites, and a pool of centrally located minicomputers, PDP-11s.

Three levels of PDP-11 are being used to satisfy different computing power requirements. One advantage of assigning a particular PDP-11 model to a job according to processing requirements is that the software is upward-compatible. So if the computing power must be increased in the middle of a test run, it's only a matter of plugging into the next higher-level PDP-11.

### PPS-8s run 100-Mbit bubble memories

Microprocessors are also being used in a variety of esoteric developments at other NASA Research Centers. At Langley in Hampton, VA, for example, problems with "the most failure-prone component in U.S. spacecraft"—magnetic tape recorders—is being solved by the development of a microprocessor-controlled solid-state data recorder using magnetic bubble domain memories as the storage medium. In addition to overcoming reliability problems the  $\mu$ P-controlled approach has given increased flexibility and improved the over-all system, according to William A. Howle, Jr., assistant project manager at Langley.

"For instance," says Howle, who will detail the recorder development at a Session 14 paper: "A Microprocessor Controlled Solid-State Data Recorder," "the new device can look like a quasirandom access memory. That is, you can look at the data in blocks, rather than go through an entire tape sequence. Also, you can store portions of the data in an area and protect that data. Then you can use the rest of the storage as a conventional recorder, somewhat like permanent RAM storage.

"This same philosophy can be used to eliminate bad storage areas. Suppose, for instance, you have a failure

in one of your bubble cells. The  $\mu$ P can instruct the controller to make those cells look transparent to the user. The system can be programmed to skip that defective cell address and not recognize it."

The data recorder is a multichannel system, so four separate record and playback functions can go on simultaneously as long as the address limitations are remembered.

The solid-state recorder, as Howle described it, has four serial-data channels, each controlled by a Rockwell PPS-8  $\mu$ P. Total storage capacity is 100 Mbits. The bubble memories are Rockwell 100-kbit domain chips. The system can be configured as either one channel providing 102.4 Mbits, two serial channels

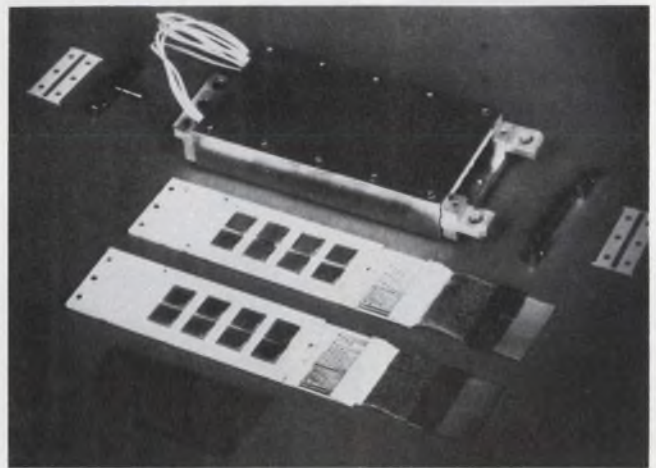

**Four PPS-8  $\mu$ Ps control four independent bubble-memory channels** in this NASA 102.4-Mbit solid-state recorder, which replaces tape machines. One of the channels is shown here. Total rate for all channels is 2.4 MHz.

providing 51.2 Mbits each, or four channels providing 25.5 Mbits each.

Input/output buffers enable the external system connected to a channel to clock data in and out at any data rate from 0 to 12 MHz for any single channel. In the four-channel configuration, the total rate for all channels is 2.4 MHz.

The firmware for controlling the PPS-8 is located in two  $2k \times 8$  RAMs. Three programmable I/O data controllers interface the PPS-8 to the rest of the system. A core-storage memory array is used to maintain the status of the recorder when it is in an unpowered state. Variables stored here include read and write pointers, command status, and cell status. A ROM sequencer stores all the control sequences required to read, write, erase and address-align the bubble memory storage subsystem.

A ROM sequencer produces timing and control pulses required to access the data storage subsystem. Read, write and erase sequences are stored in the ROM. ■■

# How to test $\mu$ Ps and $\mu$ P products —a good question looking for answers

It's getting tough to tell which sessions at Electro cover instrumentation and which cover computers. Just look at the test and measurement session topics at this year's conference: Testing microprocessor-based products, microprocessors in instrumentation, computer-automated testing, and digital logic testing.

Microprocessors have been supplying more and more answers to design questions. But a big question remains unanswered: How do you test microprocessors and the end products that use them? Unfortunately, that question is a lot easier to ask than it is to answer. You won't find simple, direct answers at Electro.

What you *will* find are some approaches to microprocessor testing that should lead to definitive answers sometime soon.

One response, to be disclosed at Session 3, is a test plan developed by Peter Hansen of Teradyne Inc. (Boston, MA) to test a microprocessor-based board. The board, an Intel SBC80/20 single-board computer, is enough like other  $\mu$ P boards for the plan to apply to more than this single product.

"What we have is a very wide range of component types which can be assembled to form a wide range of functions, and all of it can end up in a most perplexing way on the printed-circuit card that we're trying to test," says Hansen, adding: "I wish that I could stand up here and tell you that there is a simple answer to this problem."

Hansen doesn't guarantee that bad boards won't get by or that some good boards won't fail his test. But it is a straightforward approach to a rather complex problem, and it does promise to minimize the number of bad boards that get out.

The central-processor chip is removed either physically or by setting all its lines to the high-impedance state. The test system is inserted in its place to control the board under test. The non-CPU section is tested by traditional means, including automatic pattern generation for devices that have been modeled.

The CPU is then activated and tested for gross faults using a manually-generated program that executes a few basic  $\mu$ P instructions. The entire board is then run at full speed to approximate actual system operation. The resulting test is reasonably complete.



**It takes more than one  $\mu$ P to digitize a transient.** In Tektronix' 7912, there's a processor in each plug-in and two more in the mainframe.

This last step, functional testing, is important, says Nick Wells of Digital Equipment Corp. (Acton, MA). "The key is to functionally test the module as closely as possible to its functional end use and not to test every possible combination of states that each module element can take." At Session 3, Wells describes testing a product that is 65% bus-oriented and more than 80% medium and large-scale integrated circuitry.

"This module has enough functionality contained on it that it can be viewed and tested almost as if it were a complete computer peripheral, less only a very few I/O pieces," says Wells. The module can be checked by a dedicated tester that consists of hardware and software building blocks.

The same test concept is used with other  $\mu$ P-based products so that only a few building blocks have to be changed for each product. This reduces development cost and time for module testers.

The tester, Wells explains, is basically a micro-processor and memory whose bus attaches to the bus of the module under test, takes control of the bus, and electrically replaces the  $\mu$ P of the unit under test. Interface is via a bed-of-nails fixture that contains probes pneumatically operated to contact the non-component side of the board.

First, the board's clock is checked, then the bus is examined for stuck-at-one and stuck-at-zero faults. The memory is checked by reading ROM and writing and reading RAM. Then communications circuits are checked. A dedicated test section of the tester then looks at specific portions of the module. Finally, the system releases control to the unit under test, and self-contained ROM confidence tests are run. Total average module test, diagnosis and repair time, says Wells, is 10 to 15 minutes.

### Testers tell more than pass/fail

But test and repair aren't all an automatic test system is good for, says Michael Salter, product marketing manager at GenRad Inc. (Concord, MA), at Session 9. "An ATE system can provide numerous process feedback mechanisms," he says. At the same session, Boris DeBussy, manager of software marketing at Faultfinders Inc. (Latham, NY), agrees that "reporting and analysis of failure trends can be used for correcting consistent manufacturing discrepancies and for isolating above-normal component failure rates."

Session 9 chairman Dick Stein, new product manager at Computer Automation's Industrial Products division (Irvine, CA), says, "By capturing failure data and mapping successful repair action to recurring process or component faults, the full measure of payback can be realized from ATE."

Computer-automated testing isn't limited to digital circuits, either. Two sessions at Electro attest to that.

Session 11 focuses on computer-aided testing of analog circuits. "Computerized modeling of analog circuits and networks continues to be the neglected area," says session chairman Fred Liguori of the Naval Air Engineering Center, Lakehurst, NJ. "Fortunately, there are still a few stouthearted people who have not given up on analog circuit modeling or succumbed to the lure of the much simpler problem of digital circuit modeling."

One researcher, Heinz Schreiber of Grumman Aerospace Corp. (Bethpage, NY) and the State University of New York at Stony Brook, uses a piecewise constant waveform first to drive an analog network to an initial state, then to step it through a control sequence that returns the network state to zero. The driving signal, called the complementary signal, has step amplitudes that not only are functions of the poles of the network but also constitute a fault signature that can be related to drift failure element values.

Automated microwave measurements are the subject of Session 17. Here, Thomas Dowling and Richard



Testing  $\mu$ P boards is a challenge, and the answer comes from automatic test systems like this Teradyne L135. Price starts at a mere \$150,000.



You can tell just how hot  $\mu$ Ps are with digital thermometers like Fluke's processor-controlled units. Microprocessors here control, and are part of, the a/d converter. They also handle I/O and message data.

Conti describe the operation of an automated antenna test facility at Raytheon Co.'s Missile Systems Division (Bedford, MA). And J.O. Taylor of MIT's Lincoln Laboratory (Lexington, MA) describes a technique for making measurements at frequencies from 26.5 to 37.0 GHz using a modified Hewlett-Packard automatic network analyzer.

### Microprocessors in instruments

Where minicomputers form the heart of many large automatic test systems, microprocessors are becoming more and more common in smaller, bench-top and rack-mount instruments. The latest in microprocessor-controlled instrumentation is the topic of Session 22 at Electro this year.

A Mostek single-chip MK3870 microcomputer handles the analog circuit control and the digital portion of the a/d converter in a pair of digital thermometers from John Fluke Manufacturing Co. Inc., Mountlake Terrace, WA. The  $\mu$ P also makes it possible for the thermometers to store maximum and minimum readings, display the difference between the reading and a set point, compare a reading to a limit value and

activate alarms, and communicate data to peripherals.

One microprocessor isn't enough in another instrument to be described at Session 22. In a transient digitizer from Tektronix Inc. (Beaverton, OR), "the nature of the tasks to be performed dictated a multiprocessor approach," says Robert Bretl. In the digitizer's mainframe, data processing and output routines require high throughput, yet have to run in parallel with several other functions such as monitoring the sweep speed and duty factor to protect the digitizer's display screen from burn-out.

"This would have been more than a full-time, full-speed task for any single MOS monolithic processor that would be on the market for the foreseeable future," says Bretl. So a 6800-type microprocessor was used in each plug-in for the digitizer to handle front-panel operations and an IEEE-488 interface. A second 6800 is in the mainframe itself to control internal operation and monitor sweep speed and duty factor. A 2900-based microprogrammable processor is a memory controller that provides the bulk of the data-processing capabilities for the instrument.

Another instrument that uses a microprocessor for data processing and IEEE-488 interfacing is the Model 1687 1-MHz impedance meter from GenRad. Here, the availability of the low-cost memory and processors permit the use of a technique that had been too expensive: One voltmeter measures the drop across

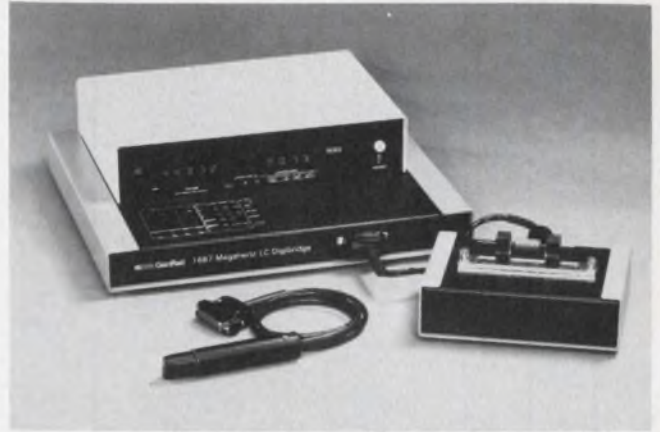

**Sort out Ls and Cs** with a microprocessor-controlled bridge like this GenRad 1687. There's a five-digit readout and 10 limit-comparison bins for sorting.

the unknown resistor and a precision resistor in series.

The value of the known resistor is stored in ROM and applied by the microprocessor to calculating the unknown from the voltmeter measurements, which are stored in RAM. For ac measurements, complex voltage ratios must be resolved; they require a phase-sensitive detector and at least two voltage measurements for each impedance—with precise 90° relative phase shifts.■

## Memories

# Now there are many good memories, but choosing is getting confusing

With memory circuits offering more and more options and capabilities, designers are finding themselves hard-pressed to choose the right ones for their applications. The fast-growing selection is fast growing confusing. Help is offered at Electro's Session 27.

Semiconductor RAMs, ROMs, UV EPROMs and other circuits all promise to be faster and less expensive. The reason? A technology called VMOS. "In all these devices, VMOS offers the highest density and considerable performance improvements," says Chris Peterson of American Microsystems Inc. (Santa Clara, CA). In static RAMs, for example, VMOS can reduce die sizes from 25,000 square mils to 14,000 or 15,000 square mils for a 4-kbit device. "In addition, VMOS memory circuits are fast, having speeds equivalent to memories using bipolar and short-channel NMOS technologies," says Peterson.

V grooves can be used to make ROMs, too. A cell is formed by the intersection of bit and word lines

and the location is programmed by the presence or absence of a V groove. If a groove is present the bit line is connected to ground through a VMOS transistor. So when the word line is raised high, the transistor turns on and pulls the bit line low. If no groove is present, the bit line remains high.

The density of this layout is limited only by the widths of the bit and word lines, says Peterson. Using this technique, a 64-k VMOS ROM has been built in a 29,000-square-mil space. Cell area is only 0.21 square mils, considerably smaller than most NMOS ROM cells.

A polysilicon floating gate added to the basic ROM structure turns it into an ultraviolet erasable programmable ROM cell. Programming is accomplished by injecting electrons onto the floating gate, which raises the threshold voltage. Once this is above 5 V, the transistor will not turn on when the word line is raised to 5 V. So the bit line stays high.

## Timetable to the technical sessions at Electro/78

MAY 23, 1978 TUESDAY		MAY 24, 1978 WEDNESDAY		MAY 25, 1978 THURSDAY	
10 am	2 pm	10 am	2 pm	10 am	2 pm
<b>1</b> Looking Ahead at High Density Packaging	<b>7</b> Engineering Management Tools for Improved Effectiveness	<b>13</b> ABC's of Financing a Growing High Technology Business	<b>19</b> Professional Concerns for Today's Engineer	<b>25</b> Upward Mobility & Career Development for Women Engineers	<b>31</b> Latest Techniques and Design for Solid-State Communications
<b>2</b> Software: The Key to Using Microprocessors	<b>8</b> Small Package/Large Performance: 16-Bit Microcomputer	<b>14</b> Microprocessor Applications in NASA	<b>20</b> Examining Single-Chip $\mu$ P Products	<b>26</b> Microprocessors as Manufacturing Support Tools	<b>32</b> Minis & Micros: Convergence on the Same Market
<b>3</b> Testing $\mu$ P-Based Products	<b>9</b> Using ATE More Effectively	<b>15</b> A Corporate Commitment to Service: Before You Build It, Service It	<b>21</b> Computer Applications in Public Utility Control Centers	<b>27</b> New Generation Memories: Greater Speed or Higher Density	<b>33</b> Energy Saving Through Infrared Technology
<b>4</b> Bridging the Analog-to-Digital Gap	<b>10</b> $\mu$ P Interfacing: Today & Tomorrow	<b>16</b> The Home Computer & Its Peripherals: A Look into the Future	<b>22</b> $\mu$ P Applications in Instrumentation. How Smart is Smart?	<b>28</b> Advances in Radar Technology	<b>34</b> Civilian Applications of Radar
<b>5</b> Recent Advances in Computer Aids to Circuit Design	<b>11</b> Computer-Aided Test Design for Analog Circuits	<b>17</b> Automated Microwave Measurements	<b>23</b> Computer Graphics: From False Start to Boom	<b>29</b> Optically Guided Wave Transmission Systems	<b>35</b> Industrial Applications of Optical Communications
<b>6</b> Searching for Future Electronics Applications	<b>12</b> Memories for a Low-Cost Computer System	<b>18</b> Logic Measurement & Development Products	<b>24</b> Energy: Crises & Challenges	<b>30</b> Technology for Non-Invasive Monitoring of Physiological Phenomena	



## **HONEYWELL'S 5600E. ITS MONITOR METERS ASSURE THAT YOU WON'T COME BACK EMPTY-HANDED.**

When you take the versatile 5600E to the field you have the best possible chance of getting the data you need. Because built-in meters let you monitor your record and reproduce signals right on the spot. In fact, you can view two inputs or outputs or simultaneously monitor the input and output of any channel.

Conventional recorders require that you set up, calibrate and then carry along a reproduce amplifier for every channel to be monitored. But with the 5600E, a single reproduce amplifier can be used to monitor all channels.

So if you need up to 32 channels of laboratory-quality record or reproduce capability in a single compact unit, call Darrell Petersen at (303) 771-4700. He can help you choose the wideband or intermediateband configuration that best meets your requirements.

Or write for technical data sheets on the 5600E and a free illustrated brochure that describes all of Honeywell's magnetic tape systems, oscillographic recorders and signal conditioning modules.

Honeywell Test Instruments Division, Box 5227, Denver, CO 80217.

**WE'LL SHOW YOU A BETTER WAY.**

# **Honeywell**

CIRCLE NUMBER 45

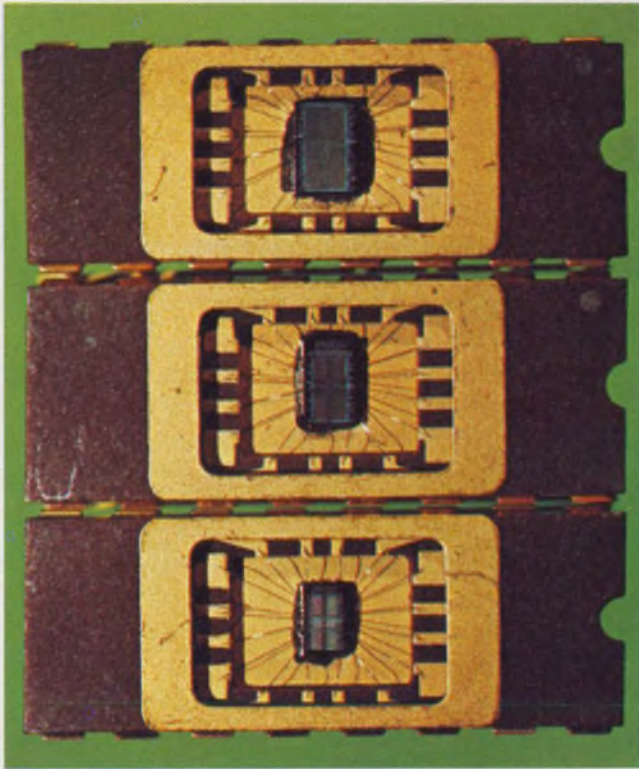

**VMOS shrinks static RAMs.** These three AMI 1-k static devices went from 100 to 83 to 66 mils on a side, while access times dropped from 45 ns to 35 to 25.

Erasure is accomplished by exposure to UV light. This raises the energy level of the electrons trapped on the floating gate, and they can escape.

A VMOS EPROM cell occupies half the area of its NMOS equivalent, says Peterson. Thus, a 16-k VMOS EPROM occupies 18,600 square mils, compared to about 30,000 square mils for the NMOS version.

#### VMOS shrinks dynamic RAMs

VMOS can also help save a great deal of space in dynamic RAMs, Peterson goes on. Here, the VMOS transistor accesses a buried capacitor that sits directly under it. When the word line is raised to 5 V, the transistor turns on and dumps stored charge onto the bit line so that the memory reads out a "1."

VMOS dynamic RAM cells enjoy a 2:1 advantage in density over double-poly dynamic RAM cells, says Peterson, adding that the storage area of the VMOS dynamic RAM cell is actually greater than its surface area, and has the largest charge capacity per unit surface area. "The efficiency of the cell (storage area/surface area) is 160%, where the double-poly cell is 30%—60% at most if an extra implant is used."

But RAMs, VMOS or otherwise, are not the ticket when low-cost storage is a necessity.

#### CCDs cost less

Charge-coupled-device memories are being used in applications ranging from large computer hierarchical memories to point-of-sale terminal look-up files,

where they offer lower cost than RAMs and higher performance than discs, says Kirk MacKenzie of Intel Corp. (Santa Clara, CA).

"All these applications have in common the need for very low-cost memory storage," says MacKenzie. Knowing that the ball is in their court, CCD manufacturers are pursuing several approaches to come up with the *lowest-cost* CCD that will be most compatible with market needs.

The most fundamental variation so far, the length of the memory loop, affects over-all device performance and system architecture. A device can be made with a few long loops, or several shorter loops, and each approach has its advantages and disadvantages, says MacKenzie.

Long-loop CCDs are generally implemented with a serial-parallel-serial organization, in which a single loop consists of a high-frequency input register, a high-frequency output register and a low-frequency parallel array. The parallel section, where most of the bits are located, operates at a significantly lower frequency than the I/O registers which substantially cuts power consumption.

In a typical short-loop CCD, a single loop consists of a short, straight path for moving charge. Power is reduced by using an internal multiplexing scheme to reduce the actual shift frequency of the array. In Intel's 2464 CCD, four 64-bit registers are multiplexed to create one 256-bit loop, and the array shifts at only 250 kHz for an effective shift rate of 1 MHz.

Another difference between available short and long-loop devices—and a big one—is clocking. The

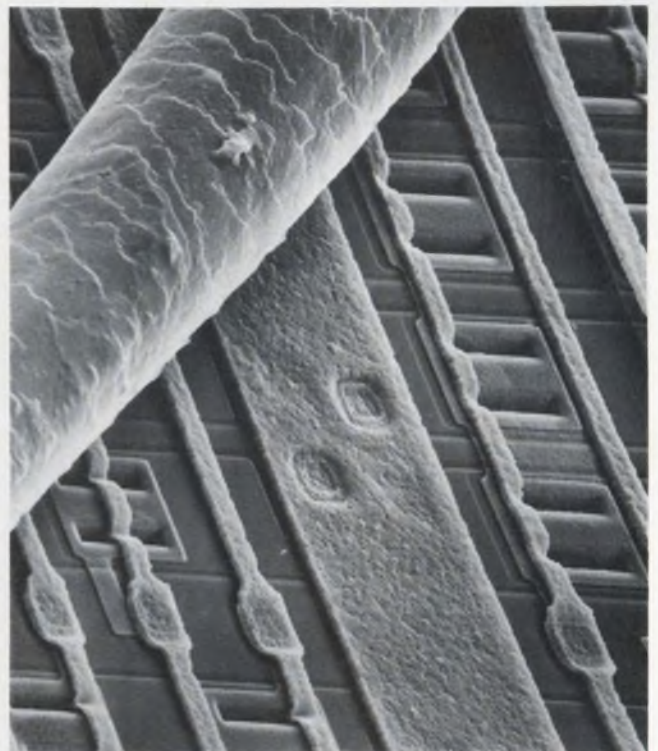

**Using three dimensions,** VMOS shrinks memory cells until eight fit in the cross-section of a human hair. This photo is a 10,000-time enlargement from AMI.



2464 requires only two low-frequency nonoverlapping, TTL-level shift clocks, where long-loop CCDs require either two or four high-capacitance, cross-coupled MOS-level shift clocks. The latter also demand bipolar drivers to achieve 5-MHz rates, and that means higher cost and power consumption.

Long-loop devices do have the edge in data rates, MacKenzie admits: typically, 5 MHz compared to 2.5 MHz. This can be important in small, high-performance applications where tying devices in parallel to improve data rates may not do it.

But short-loop devices have a wider dynamic operating range—65 kHz to 2.5 MHz vs. 1 MHz to 5 MHz. And latency time, how long it takes to get to the first desired bit, is 128  $\mu$ s—a far cry from the long-loop's typical 410  $\mu$ s.

### Bipolars are easy to use

But suppose the important consideration isn't low cost, but speed combined with easy use.

One group of memories is not only getting faster, but offers ease of use as one of its most attractive

features: bipolar RAMs, says Tom Goodman, manager of applications engineers at Fairchild Semiconductor (Mountain View, CA). "Timing is simple, speed is very fast, and a single power supply is required," he explains. "Power-supply decoupling practices for bipolar RAMs are similar to those for MSI logic."

But as easy as bipolar RAMs are to use, says Goodman, some basic system-design errors are still committed, and frequently. Using a high-speed Schottky part to drive long lines and assuming the output of the device is stable until the next state change is completed are two big ones.

"The Schottky negative-going edge is so fast that, with a long line, a significant undershoot can occur, says Goodman. "Memory input glitch diodes may see peak currents greater than 100 mA—considerably in excess of the typical 8 to 12-mA specification."

As for timing, "Sometimes designers assume that data from the preceding cycle remain valid, then switch instantaneously to the new state," Goodman observes. "The outputs of most memories, however, go through several intermediate phases before settling into the new state." ■■

## Communications

# Fiber-optic systems reach for GHz but losses are still a big problem

Field-trial optical-communications systems throughout the world are demonstrating a reliability and performance exceeding even the highest hopes of their designers. The ceiling on system performance—it's now in the 100-MHz region and promises to reach into the GHz region—is being pushed upwards by continuing improvements in the performances of individual system elements: optical fibers, optical-fiber cables, emitters and detectors.

Nevertheless, problems continue to slow development. Both the ups and downs of optical-communications components will be examined at Electro '78 Session 29, "Optical Guided Wave Transmission: Components."

### Fiber splicing and losses

Present limitations on system performance stem from one thing, from losses incurred in splicing the individual fibers as well as losses due to differences in fiber parameters, says C.M. Miller, supervisor of



The key to long-range optical communication systems lies in continuing improvements in optical fibers and cables, such as this new Siecor six-fiber structure.

## Technical session order form

Please send me the following Electro 78 technical session preprints at \$3.00 per session (average: four papers per session), plus \$1 mailing charge per complete order. I understand this order will be mailed to my address within three weeks after receipt. Offer good until Dec. 1, 1978.

Session No.	Quantity	Session No.	Quantity
1		19	
2		20	
3		21	
4		22	
5		23	
6		24	
7		25	
8		26	
9		27	
10		28	
11		29	
12		30	
13		31	
14		32	
15		33	
16		34	
17		35	
18		SES	

All Electro 78 sessions will be available on audio tape cassettes below. Price is \$8.50 each or six for \$46. Indicate tape requests by session number and include remittance as noted.

No. \_\_\_\_\_

Total Sessions × \$3 = \$ \_\_\_\_\_

Evening Session × \$5 = \$ \_\_\_\_\_

Tape Cassettes × \$8.50 = \$ \_\_\_\_\_

Plus \$1 Mailing Charge = \$ \_\_\_\_\_

Total Cost = \$ \_\_\_\_\_

Make check payable to Electro 78 and mail with this form to:

**Electro 78**  
**999 North Sepulveda Blvd.**  
**El Segundo, CA 90245**

Date \_\_\_\_\_

Name \_\_\_\_\_

Firm \_\_\_\_\_

Street Address \_\_\_\_\_

City, State, Zip Code \_\_\_\_\_

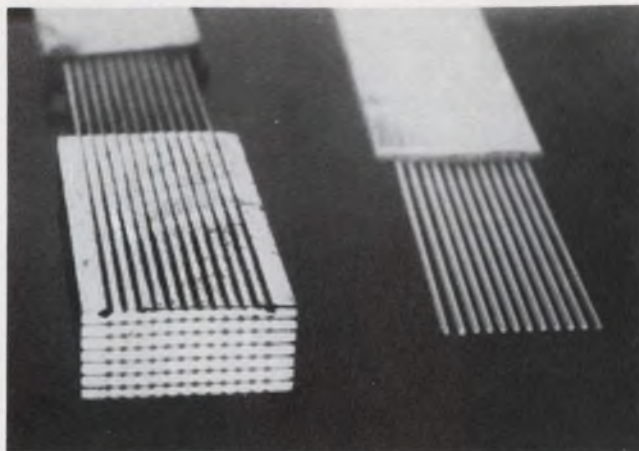

**Single and multiple optical fibers can be spliced several ways.** Multiple fibers in Bell Telephone ribbon cable are spliced with the fixture shown here.

the Exploratory Optical Fiber Splicing Group at Bell Telephone Laboratories (Norcross, GA) in "Optical Fiber Connecting."

Basic system design is going to be greatly affected, because, generally speaking, the losses in splicing optical systems can compound to a sizable portion of the end-to-end loss. Miller believes that connecting losses are probably going to be as much as 50% of the total losses. In a non-fiber-optic communication system, on the other hand, the connection losses are negligible compared to the media loss.

Both single-fiber and fiber-bundle connectors are being produced by a number of U.S. companies. But multiple-single-fiber connection technology is still a hand-crafted art. An example of this "art" is Bell's special array-splicing technique (see photo). Fiber-optic cable is designed around a multielement fiber ribbon, and a Bell-invented system that makes splicing relatively easy.

A number of techniques for splicing fibers have been developed, with most of them using a butt-joint configuration. A simple, end-to-end butt joint not only is the easiest-to-fabricate method of joining optical fibers, but also gives the lowest loss. The fibers are aligned by precision grooves, pins or tubes. Once aligned, the fibers are held together or welded to form permanent splices.

Welding is a recent hardware advance that works well and contributes to lowering losses, according to Miller. Fiber ends are aligned and heat is applied either by an electric arc, a plasma torch or a laser. A Japanese electric-arc welder is the first commercial system available.

With welding, it doesn't matter if the fiber has a step index or graded index. The fuse' ends, if properly made, have no added bulk at the splice, which is almost undetectable.

But even as optical-fiber connection losses are reduced to a few tenths of a dB by sophisticated splicing techniques, other losses will remain difficult to minimize. Such losses come from intrinsic fiber mismatches resulting from fiber-manufacturing vari-

# The function of this function generator is to make your job easier.



B&K-PRECISION  
Model 3010 \$175

If you stop and think about it, the function of any generator *should be* to make your job easier. When we at Dynascan designed our new Model 3010 function generator, that's exactly what we had in mind.

How did we achieve this? The 3010 was designed inside and out to be convenient and fast to use, and to provide years of trouble-free operation.

The 3010 generates all of the popular waveforms you're most likely to need, at only \$175. In addition to generating square, sine and triangle wave outputs, the unit offers a fixed TTL square-wave output. Sine-wave distortion is less than 1% and triangle-wave linearity and square-wave symmetry are a near perfect 99%. A convenient row of reliable pushbuttons provides fast, error-free selection of the appropriate range and output waveform.

For a chance to have your day run a little smoother, contact your local B&K-PRECISION distributor for immediate delivery or a demonstration.

The stable voltage-controlled oscillator (VCO) of the 3010 is varied on each range by the front-panel frequency control, or the VCO external input. A 0 to 5.5 volt ramp applied to the VCO external input will provide a 100:1 output frequency change. In this way, the 3010 can be used as a sweep generator for response tests. Other features that will help your job run smoothly include: .05% stability, a variable DC offset control for engineering and quality control applications, a convenient tilt-stand handle, and a detailed 38-page operations manual.

Because the B&K-PRECISION Model 3010 covers from 0.1Hz to 1MHz in six ranges, you'll probably be able to use it in more applications than you first guessed. These include IF response tests, test-instrument linearity measurements, transducer tests and digital clock-pulse substitution.

**B&K PRECISION** **DYNASCAN CORPORATION**

6460 West Cortland Street, Chicago, Illinois 60635 • 312 / 889-9087  
In Canada: Atlas Electronics, Ontario • Int'l. Sls: Empire Exporters, Inc., 270 Newtown Road, Plainville, L.I., NY 11803

CIRCLE NUMBER 46

ations in the core-profile parameters—core radius, index of refraction variations, and the shape of the core profile. Even if mismatch losses are reduced in the future, Miller believes that optical connection losses will still contribute much more to end-to-end system losses than do conventional, wired-system connectors.

### LEDs better up to 50 Mbits/s

One problem that can be solved more satisfactorily is how to get substantially higher yields than can be drawn from solid-state-laser emitters. For systems requiring bit rates less than 50 Mbits/s and fiber-coupled powers in the tens of microwatts, LEDs are superior to lasers, says R.B. Lauer, of GTE Laboratories (Waltham, MA), in "High-radiance LEDs for Optical Communication Systems."

Better yields aren't the only advantage. LED driving circuitry is not as complex as laser-diode circuitry, Lauer notes. And LEDs have much longer operating lifetimes because their output decreases gradually over a period of time. Once laser diodes have aged enough to drop below the threshold level, the output abruptly decreases by several orders of magnitude.

Another thing: Laser-diode output is very temperature-dependent. For this reason even more complex circuitry is needed to monitor the output continuously in real time and to compensate for changes in output with device temperature by varying laser drive current.

LEDs aren't nearly as temperature sensitive. A change of a few degrees means a decrease (or increase) of just a few tenths of a milliwatt.

High-radiance (Al, Ga) As/GaAs LEDs of the type first described by Burrus of Bell Laboratories have proved the most suitable for coupling optimum power into a fiber. This double-heterostructure LED has been produced in quantities for General Telephone and

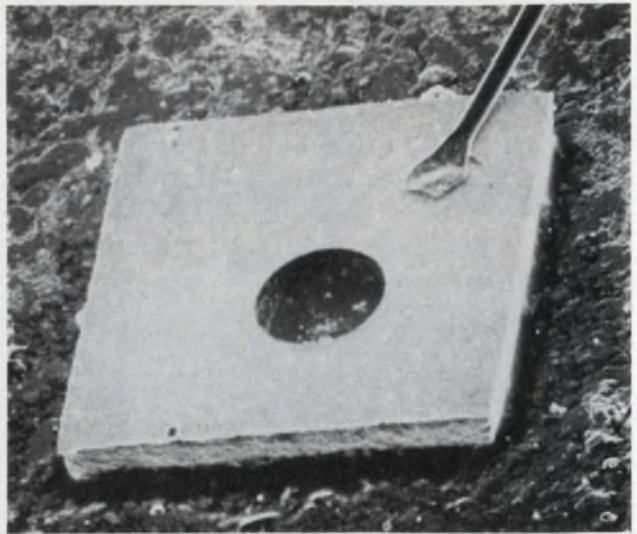

The best emitters for optical communication systems up to 50-Mbits/s are Burrus-type diodes, like this General Telephone and Electronics diode chip.

Electronics, is being used in experimental telephone systems in California and Hawaii, and is being installed in Belgium, Lauer reports. The Belgium installation will operate at 41 Mbits/s.

The double-heterostructure LED was chosen for GTE's systems because it improves device efficiency and also increases optical power output. The diodes are formed by sawing the LED wafer into  $0.5 \times 0.5$  mm<sup>2</sup> chips. Each chip is epoxy or indium-die-mounted with the epitaxial side down on a TO-5 copper header for heat dissipation. The fiber is then positioned over the maximum radiation intensity and epoxied into place.

For easy use in a variety of situations, emitter packages are available with standard BNC connectors and with both fly leads and polished-capillary end pieces.

The double-heterostructure LEDs are coupled to 2-meter lengths of graded-index fiber whose nominal numerical aperture is 0.16. Optical output as a function of drive current agrees closely with the theoretical maximum efficiency. Lauer points out that for these devices, there isn't much room for further improvement.

To evaluate the reliability of these LEDs, two groups of devices are under test at General Telephone and Electronics. One group is being operated at 50 mA (2.5 kA/cm<sup>2</sup>) and a peak of 50% duty factor, while a second group is being operated at 75 mA (3.7 kA/cm<sup>2</sup>) and the same duty factor. The 50% duty-factor operation corresponds to the greatest average power that the devices will dissipate when operated with digital pulse-code modulation techniques.

The first group has operated over 8000 hours without its performance degrading. The second group began to show a small decrease in output at 7000 hrs. Accelerated aging studies predict a mean-time-to-failure of over 200,000 hours for devices operated at 75 mA, 50% duty factor.■

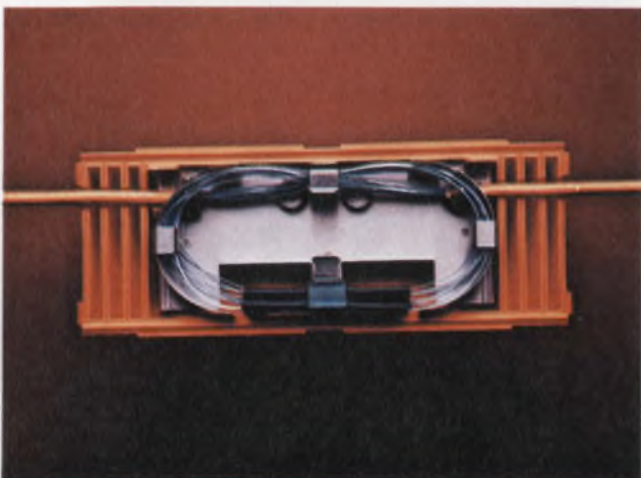

Optical cables are spliced in this field-junction box, by Siecor. The fibers are centered in V-shaped grooves for precise alignment, and bonded together by a quick-set adhesive. A plastic sleeve protects the joint.

## Computers

# Computers in the home are only as good as their peripherals

With computers these days, it's not so much which computer you use as what you have hooked up to it. This is especially true for computers aimed at consumers. Not surprisingly, then, the focal point at the Electro '78 computer sessions is not computers themselves, but peripherals.

At the consumer end, "the challenge to peripheral designers is to develop add-ons to the new wave of computers that have comparable performance per dollar ratios as the machines to which they are to be connected," says Steven Leininger, project manager at Tandy Advanced Products (Ft. Worth, TX) at Session 16. "Now that at least one manufacturer is delivering a computer system for less than \$600," he adds, "the need for peripherals to enhance and expand the capabilities of this new class of systems is apparent." Consumers' demands are being heard.

The kinds of peripherals that are needed for home use, says Leininger, are hard-copy devices, mass-storage media, communications interfaces, and sense and control components.

"The ideal hard-copy device for the consumer/small-business environment would be a low-cost device that prints with typewriter quality on standard paper," says Leininger. "While many fine printers

exist today, most users find it difficult to justify buying a \$3000 printer for use on a \$600 computer."

Leininger speculates that the most exciting computer peripherals for the developing home computer market will be system add-ons that allow all aspects of the household environment to be monitored and controlled by a home computer. Indoor and outdoor temperature, light, and security factors such as fire, freeze, and breaking and entering could all be monitored by computer, says Leininger.

To gain acceptance in the consumer market, peripherals will have to be reliable, cost-effective, and have UL recognition, Leininger goes on. A "wish list" of home-computer peripherals includes a \$300 printer, a 10-Mbyte mass-storage system, and a \$10 remote-controllable air damper that would allow the home computer to regulate the weather inside the house.

### Memory is the bottleneck

Of the restraints to the growth of home computers, perhaps the most restraining is memory, says Dennis Speliotis of Advanced Development Corp., Lexington, MA. The typical system will require a memory of  $10^7$  to  $10^9$  bits, enough to store several thousand pages of information plus several high-level language compilers and other special programs and data.

The average access time to any record should not exceed a few seconds and the throughput rate should be 0.1 to 1 Mbit per second, says Speliotis. And the most critical parameter is cost—it shouldn't exceed about 0.2 millicents/bit.

Will one of the new developing technologies—magnetic bubbles, charge-coupled devices, and electron-beam-addressed memories—provide the solution?

"The answer is a very certain No," says Speliotis. None can provide low enough cost. Magnetic recording comes the closest to meeting the cost and performance objectives, and offers the best potential for the proposed mass-storage device, he adds. But it's currently too expensive.

As for the computer itself, Jerry Wasserman of Arthur D. Little Inc. (Cambridge, MA) writes a somewhat different scenario than is popular among hobby computerists. They see the computer as an



**Home computers** like this Radio Shack TRS-80 require low-cost peripherals. Consumers would balk at paying more for the peripheral than for the computer itself.

PRICE/PERFORMANCE	IMPACT PRINTERS	PEN PLOTTERS	NON-IMPACT				
			ELECTROSTATIC	THERMAL	INK-JET	ELECTRO-PHOTOGRAPHIC	FILM
SPEED - PRINT PLOT	30CPS-1000LPM -----	----- UP TO 40 IN/SEC.	1000 LPM 2 IN/SEC.	100 CPS 20 SEC/PAGE	92 CPS .04 IN/SEC.	13,000 LPM 17 IN/SEC.	----- 200 IN/SEC.
RESOLUTION (POINTS/INCH)	100	500	100 & 200	50	127 PLOT 250 PRINT	300	2000
QUALITY	FAIR	EXCELLENT	GOOD	FAIR	GOOD	GOOD	EXCELLENT
RELIABILITY	FAIR	FAIR	EXCELLENT	GOOD	?	FAIR	GOOD
VERSATILITY IMAGE SUBSTRATE	LIMITED  STOCK & CUSTOM FORMS	LINE GRAPHICS, COLOR  ANY	ANY B/W INCL. HALF TONES  BOND, & TRANS- LUCENT PAPER	LIMITED  THERMAL PAPER	ANY  ANY	B/W LINE GRAPHICS  PLAIN PAPER	ANY  FILM
COLOR	NO	YES	NO	NO	YES	NO	YES
GRAY-SCALE	NO	NO	YES	NO	YES	-----	YES
COST - SYSTEM (\$K)	1 - 100	22 - 40*	30 - 50*	1 - 5	45K*	100 - 300	150 +
CONSUMABLES	1/2¢/FT <sup>2</sup>	1/2¢/FT <sup>2</sup>	2¢/FT <sup>2</sup>	1.7¢/FT <sup>2</sup>	1/2¢/FT <sup>2</sup>	1/2¢/FT <sup>2</sup>	50¢/FT <sup>2</sup>

\*COMPARISONS ARE FOR 22 x 34 INCH (D-SIZE) DRAWING CAPABILITY.

There are all kinds of printers to solve all kinds of computer output problems. The most promising technolo-

gy for the widest range of applications is electrostatic printing, says Alan Dawes of Versatec.

extension of the video game, Wasserman says. But he believes that unless home computers are better aimed to meet consumer needs, the hobby computer boom will end—and soon.

The major stumbling block is programming, says Wasserman. "It is difficult to accept that a world that has been unable to provide enough software engineers to satisfy the needs of industry will suddenly inspire the vast number of nonmathematically-oriented people to learn a new discipline just to play games or even to educate themselves."

Wasserman hopes the computer will evolve as a command and control device for the home, responding to consumers' real needs. The computer could minimize energy use, provide security, cut water use, and simplify cooking.

### Distributed processing at home

But so could something else. The functions that could be performed by a central computer in the home could also be performed by microprocessors in each home appliance—one in the hot-water heater, another in the oven, and others in the other appliances throughout the house. The cost of microprocessors has come down enough to make distributed intelligence possible and economical. Distributed processing could become as commonplace in the home as it is now becoming in commercial installations, and for the same reason—flexibility.

One problem area common to home and commercial computers is hard-copy output. At Session 23, Alan Dawes of Versatec (a Xerox Company), Santa Clara, CA, describes the needs for hard-copy devices and some approaches to providing them.

### Providing hard copy

"Ideally, a digital hard-copy device should conserve the versatility of handwriting," says Dawes. It should be able to draw any image with one recording instrument—and be fast, reliable, reasonably priced and quiet—to meet most needs.

Electrostatic writing seems to hold the greatest promise because of its inherent simplicity, says Dawes. A slightly conductive paper, coated with a dielectric film, passes beneath a conductive stylus. A rear electrode is placed behind the paper, and a voltage difference above 300 V is applied so that some charge transfer takes place. A colloidal suspension of carbon is applied to the paper, and the black-carbon particles migrate to the charged areas. The particles are fixed as the paper dries.

Thermal and ink-jet printing offer some special benefits to some applications, says Dawes. Conventional impact printing and pen plotters will continue to serve other applications best. No one process will capture all opportunities. Those that get the most, however, will be the simplest and most versatile in rendering information visible. ■■

New from Centralab...

# MPS PUSHBUTTON SWITCHES

A new miniature modular building block system that offers microprocessor control designers more of what they need.

To meet the special digital and analog needs of today's  $\mu$ P-based controls, Centralab offers design engineers a whole new system of modular pushbutton switch building blocks. We call it MPS—integrated Modular Panel System. MPS saves PC board and panel area and simplifies front panel design, cuts assembly costs, reduces back-panel space requirements, and meets the digital-analog needs of  $\mu$ P-based controls. Check these space saving, cost-cutting features.

## Simplify front panel interface.

All MPS switches regardless of function, are uniform in size, simplifying design and selection of front panel hardware. They have high volumetric efficiency, occupying .505" x .388" PC board area and require only .608" of space between PC board and front panel.



Cut assembly costs.

MPS switches may be mounted on the front panel, and are designed for automatic wave soldering installation and PC board cleaning. Insert molded terminals prevent flux and solder wicking and contact contamination. Integral PC board stand-offs provide for efficient board cleaning.

## Meet analog and digital needs.

MPS switches are available with momentary, push-push and interlocking actions, with a long-life contact system that switches both digital and analog signals. To accommodate critical signal requirements, housings are high-insulation molded plastic with UL 94V-0 rating.

## Available options.

Optional installations include ganged assemblies, front-panel mounting and wire-wrapping.



All MPS pushbutton switches are built to Centralab's highest quality standards (see specifications at right). They're priced as low as 41 cents in 1,000 quantity. For full technical details, samples and quotation, call (515) 955-3770, or write to the address below.



**CENTRALAB**

ELECTRONIC DIVISION  
GLOBE-UNION INC.

P.O. Box 858  
Fort Dodge, Iowa 50501

CIRCLE NUMBER 47



## Built To Centralab Quality Specs.

MPS Pushbutton Switches combine compact size, low cost and highest quality throughout.

- Silver or gold inlay wiping contacts for long-life and low-contact resistance.
- Less than 2 milliseconds contact bounce.
- SPST, SPDT, DPST, and DPDT switch contacts.
- Printed circuit, DIL socket or wire-wrap terminations available.
- 2.5 to 3.5 oz. actuation force (momentary).
- Choice of button interface — square or blade shaft (shown) — permits use of a variety of Centralab and industry standard buttons and keycaps.
- 10, 15, 20 or 25mm center-to-center spacing.

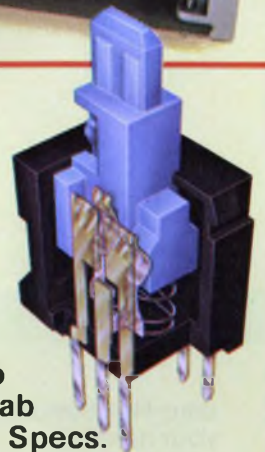

# CABLEGRAMS FROM



## Now you can mass terminate twisted pair cables.

Spectra-Strip's Twist 'N' Flat Cable is great when you need reduced crosstalk and fast, low-cost, mass termination. In applications like high speed computer and communication equipment using digital techniques.

Our standard Twist 'N' Flat comes with 26 solid or 28 stranded AWG wire. The twisted section is 18" and parallel section is 2" with conductors on .050" centers. Custom configurations are available that vary the wire gauge, pitch and length of the twisted and parallel sections. You also get the same crosstalk characteristics of our Twisted Pair Cable.

Twist 'N' Flat. Another unique idea patented by Spectra-Strip.

CIRCLE NUMBER 241

## Ultra-Flex Bonded Cable bends with your needs.

Our Ultra-Flex Bonded Planar Cable is designed for constant or frequent flexing. With all the advantages of our standard Bonded Planar Cable — excellent controlled bonding, easy separation for breakouts, and standard termination techniques used for hook-up wire.

What's more, continuous flexing won't damage or alter electrical, mechanical, or physical properties. It features up to 105°C temperature PVC insulation, a size range from 16 to 30 AWG, and up to 105 strands per conductor.

Try our Ultra-Flex. We think you'll find us pretty flexible.

CIRCLE NUMBER 242

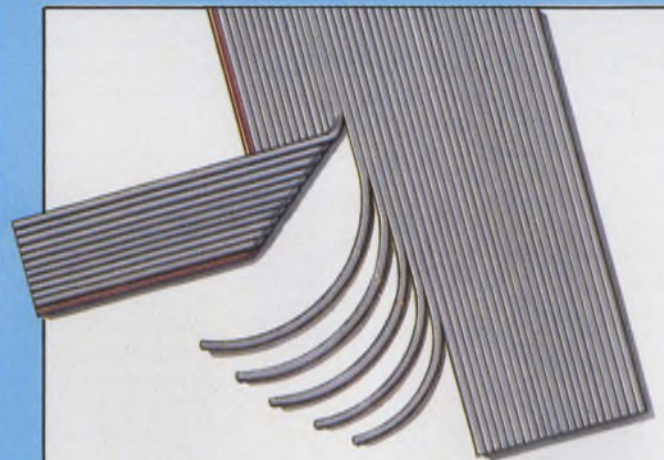
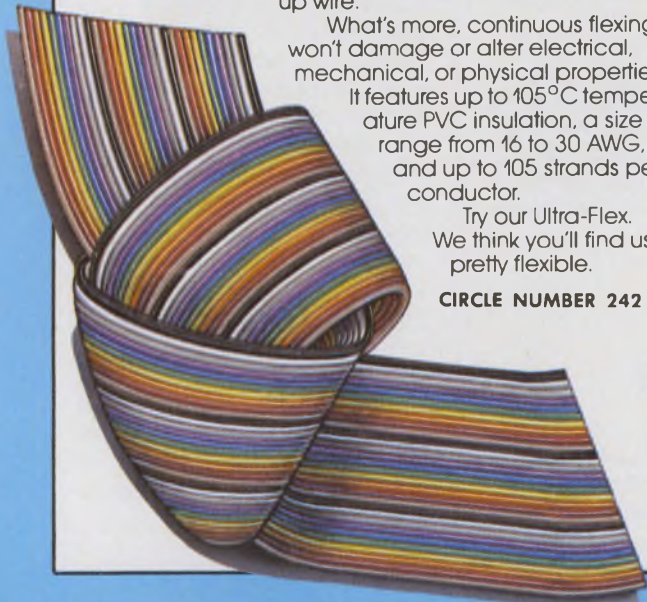

## Spectra-Zip gives you mass termination. And fast, easy breakouts.

For general purpose interconnection from calculators to computers, Spectra-Zip Laminated Planar Cable offers you economy. Reliable performance. Weight and space savings. Controlled electrical characteristics. And low-cost termination.

Spectra-Zip's convenient double contour feature lets you assemble IDC connectors on either cable surface. And assures you of easy, uniform breakouts. Every time.

CIRCLE NUMBER 243



# SPECTRA-STRIP.

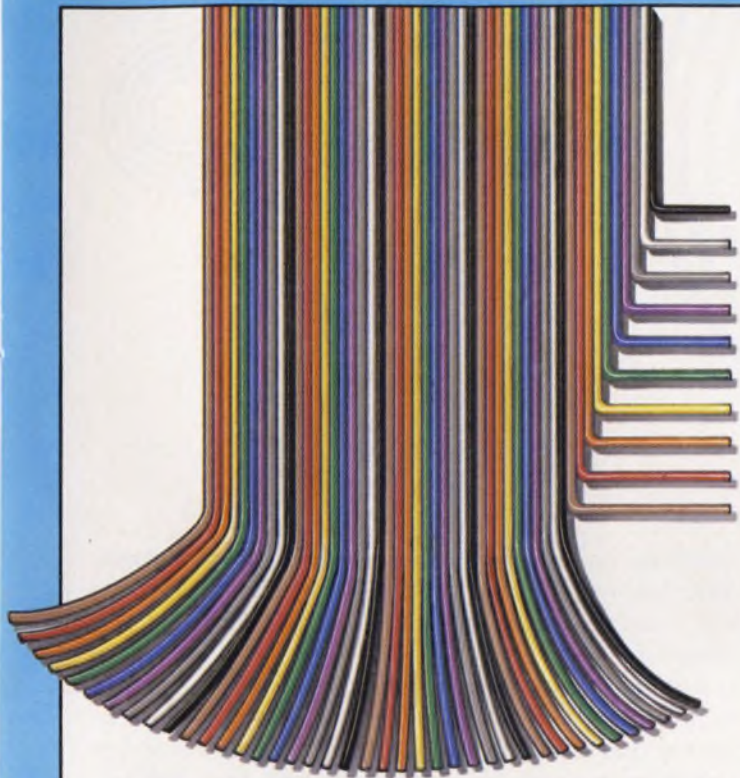

## Our 3C Color Coded Cable gives you predictable performance.

Our 3C Color Coded Cable is just right for digital and signal transmission applications. It's designed for use with many labor-saving termination techniques, including Spectra-Strip IDC Connectors.

3C Cable's precise control of critical design and manufacturing parameters provides important predictable electrical benefits — such as impedance, capacitance, crosstalk, and attenuation. Cable comes in sizes up to 64 conductors, with a tear feature for easy conductor breakouts.

And it's brought to you in living color.

CIRCLE NUMBER 244

## Spectra-GP Ground Plane Cables. For reduced crosstalk and increased shielding.

Our Spectra-GP Ground Plane Cables give you the greatest variety of configurations available anywhere. You can choose our standard Gray Cable. Or our Color Coded Cable. You can even get it in a Twisted Pair configuration.

Spectra-GP is perfect for interconnection applications where reduced crosstalk and increased shielding is needed. And it's perfect for computer and communications equipment that use high-speed techniques for switching and data transmission.

Add to this features like precise conductor spacing for controlled electrical characteristics. Parallel conductors that mate with standard IDC connectors for low-cost termination. And available drain wire construction.

Obviously, our Spectra-GP Cables give you a lot more to choose from.

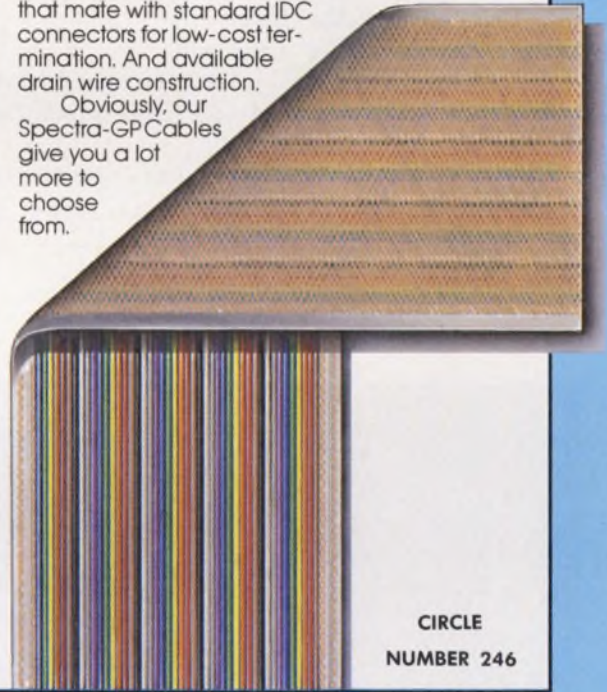

CIRCLE  
NUMBER 246

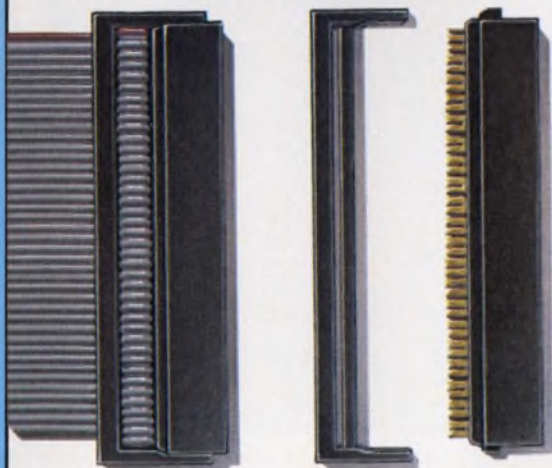

## At Spectra-Strip, we'll give you the right connection.

We also make a lot more than ribbon cables

We make a wide range of IDC connectors, headers, and other ribbon cable connectors. Complete planar systems, including standard interconnects and custom assemblies, are our specialty.

Our experience in cable design, development and assembly lets us give you a wider range of planar systems than anyone. In fact, you could call us generalists in an industry full of specialists.

Nobody has a greater variety of ribbon cables and connectors than we do. Nobody.

And we intend to keep it that way.

CIRCLE NUMBER 245

# SPECTRA-STRIP

ALL WE DO IS KEEP EVERYTHING TOGETHER.

P.O. BOX 415, GARDEN GROVE, CA 92642  
(714) 892-3361

an **Eltra** company

# FOCUS

on  
Digital  
Panel  
Meters

You still have to worry about reliability when you set out to buy a digital panel meter. But the traditional concern—"How long will the DPM keep working?"—has been overshadowed—though not totally replaced—by "How reliable are the readings?"

You can't completely forget about possible instrument failure. But lower parts counts, lower power

consumption, and more extensive testing have reduced that problem. Now you have more time to consider the readings you'll be making—and there's lots to consider.

Not that manufacturers of simple, voltage-reading digital panel meters—or even of fairly complex instruments that measure temperature, pressure or other engineering units—are going to be all that helpful.

**Andy Santoni**  
Associate Editor

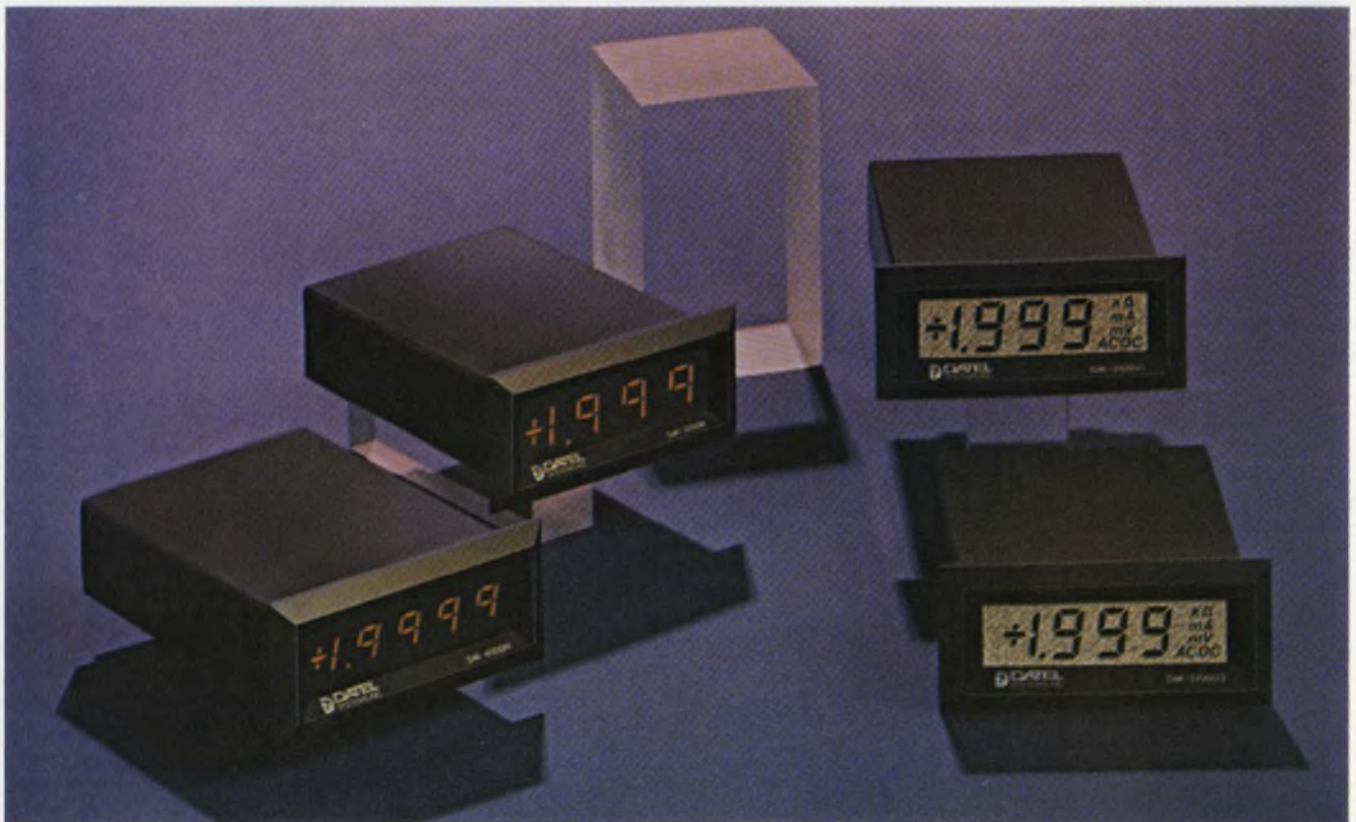

**Small size and low price** have always been the goals of digital-panel-meter makers and users. These diminutive

Datel units are only about 2 1/2 in. wide, 1 in. high, and 3 1/4 in. deep. Prices start below \$30 in 100s.

Data sheets, when you can get them, are filled with specifications and test conditions, but rarely with the particular information you need to determine how well an instrument will work in your application.

"There's a lot of hype in this business," says Bernard Gordon, chairman of the board of Analogic Corp. It's up to you to cut through the overblown claims and figure out how a DPM will do in the real world.

### Is it true?

Take accuracy. What you're really interested in is how far the reading on the meter may wander from the value you're trying to measure—regardless of whatever ambient conditions or noise may be around. You shouldn't have to measure all these perturbations and factor them in every time you take a reading.

You can factor in all the error-producing factors just once—if you have all the specifications. And, as always, the specifications should be taken under worst-case conditions since you cannot guarantee that your instrument will meet "typical" performance standards.

You'll also want to be sure your DPM will maintain its accuracy from day to day. How often does it require calibration to meet its stated specs? It makes no sense to design a product to need calibration no more than once a year, then incorporate a DPM that has to go back to the cal lab every 30 days. Worse yet, some DPM suppliers don't specify long-term accuracy at all. Ask for it.

### Temperature changes wreck readings

Some suppliers don't say much about temperature, either. The accuracy they claim may be attainable only at one temperature—room temperature, somewhere below normal room temperature, or wherever a manufacturer was able to get the best performance. What you really should know is the worst-case accuracy over the temperature range your product is likely to encounter. That may be stated as an accuracy at one temperature and as a temperature coefficient, or as a single spec covering a range of temperature.

Temperature effects are most important for products that are going to be moving from place to place, especially outdoors. Humidity, too, can affect portable instruments enough to make readings meaningless, so see if your supplier will guarantee operation over a reasonable humidity range. "Reasonable" may be as high as 90% if you expect to work outdoors.

### Readings shouldn't wander

Even the most efficient DPMs consume some power and generate some heat, so sensitivity to ambient temperature isn't the whole story. How stable is the reading if the internal temperatures of the unit are changing? More important, how long does it take the instrument to warm up? It takes a few minutes for

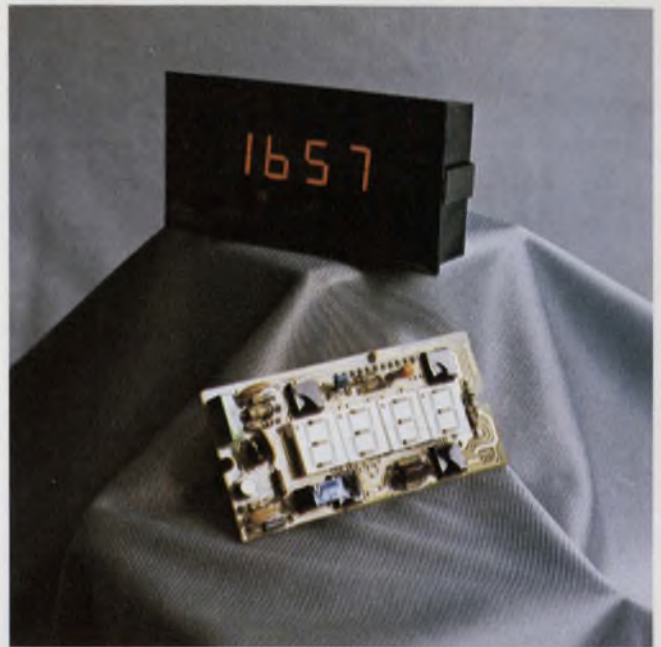

**One board holds all** in Fairchild's low-cost DPM. Integrated circuits are bonded directly to the board, which also holds discretes and displays. Behind-panel depth is only 3/4 in.

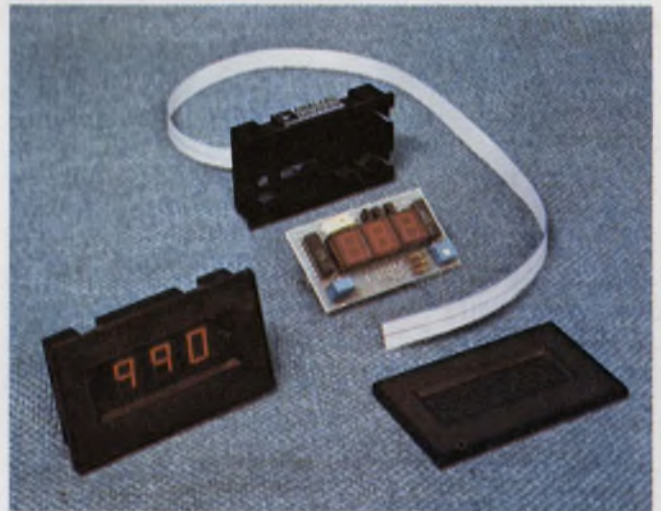

**A single integrated-injection-logic chip** is at the heart of Analog Devices' three-digit Model 2026. The chip is available separately for do-it-yourself OEMs.

the innards of most instruments to rise from room temperature to a stable operating temperature, and readings taken during this period are unreliable.

Few manufacturers spell it out, but the time it takes for an instrument to stabilize can be very important to you, especially if you (or your customer) don't leave the meter on all the time.

Readings can wander too if the power-supply voltage varies. With the possibility of power brownouts increasing, or simply with operation from batteries, resistance to power-supply fluctuations can be important.

Check especially for stability with no measuring input voltage. Many applications call for making an



For process-control applications, DPMs like these LFE units include signal-conditioning and direct readout in engineering units. Meter relay-like setpoints are available.

adjustment until the meter reads zero, and that's next to impossible to do if the reading is jumping from +1 through 0 to -1 and back again.

On the other hand, the problem might be that you've chosen a meter with too much resolution. A 1-mV full-scale, 3 1/2-digit (1999-count) instrument, if you could buy one, changes one count in the least-significant digit for every 1- $\mu$ V change in the signal to be measured, so you couldn't very well expect to adjust a signal for a reading of precisely 0.000 if the signal itself wandered by a few microvolts. Unnecessary resolution costs unnecessary dollars—a 4 1/2-digit instrument costs about 50% more than a similar 3 1/2-digit device—so don't buy more resolution than you really need.

Don't forget, either, that a 3 1/2-digit meter actually has the same resolution as a 4 1/2-digit meter with a decade-higher full-scale range. Readings of 19.99 V on the 3 1/2-digit and 199.99 V on the 4 1/2-digit have the same 0.01-V resolution, so the less expensive instrument may be good enough if the range of input voltage is small.

Above all, remember that resolution isn't the same as accuracy. Don't be embarrassed if you forget—it's the most common error made when specifying any digital product. But just because a digital panel meter can resolve 0.1 V doesn't mean it can do so accurately. A 3 1/2-digit meter that has error sources adding up to more than 1% of full-scale has a least-significant digit that is meaningless—it can read any value, regardless of what it is measuring, and still be within resolution and accuracy specs.

Note the expression "full-scale." Most DPM sup-



You can color your DPM display any way you like with a transmissive LCD display and color filters. These Ballantine DPMs are made under license from Tekelec Airtronic.

pliers specify accuracy as a percentage of full scale plus a percentage of reading, then add any temperature or other effects. Others specify the allowable variation in the least-significant digit. That's the same thing—if full-scale is adequately defined.

#### So what is it?

Some manufacturers say a 3 1/2-digit instrument has a 100.0-V full-scale range, then add an "overrange" of 100% for a maximum reading of 199.9 V. In another case, the overrange may be 20% above a 100.0-V full-scale, so the maximum reading is 120.0 before the instrument's readings become unreliable. Yet another variation has more than 100% overrange so that the maximum reading may be 299.9 V, 399.9 V, or even 699.9 V. The safest way to specify full-scale is to specify count. That way, for example, you'll know a 100.0-V instrument can accurately measure a 120-V line. Ask for a "3 1/2-digit (1999-count)" instrument, and you should get what you need. Otherwise, you may be in for a surprise.

Speaking of definitions, try to use the term "accuracy" correctly. Accuracy and correctness are synonymous—so a meter with an accuracy of 1%, say, can be incorrect by 99%. A better term is "uncertainty," since that's what you're trying to determine—"How uncertain am I of this reading?" An uncertainty of 1% is the same as an accuracy to within 1%—but not the same as an accuracy of 1%.

#### Does it keep working?

Even though reading reliability has become the paramount concern, you can't stop there. It's still possible that the instrument you choose—no matter how dependable the information it gives—won't work long enough for you to appreciate its accurate readings.

Fortunately, this is not nearly the concern it used to be. "The industry for years was notorious for

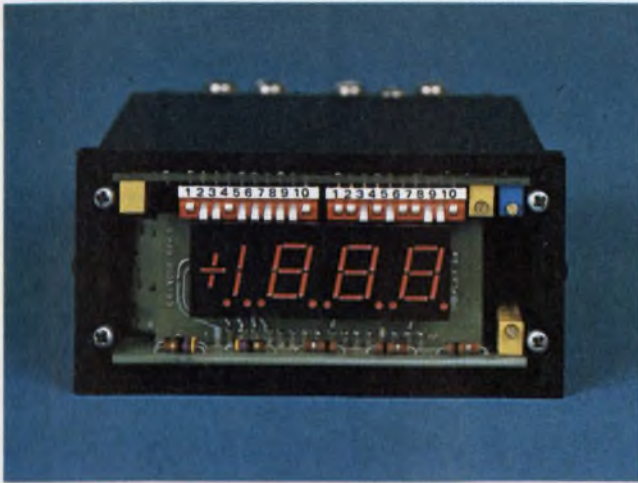

**Programming controls, accessible through the front panel,** tailor the Analogic AN2573 digital rate indicator. Switches select data averaging and other functions.

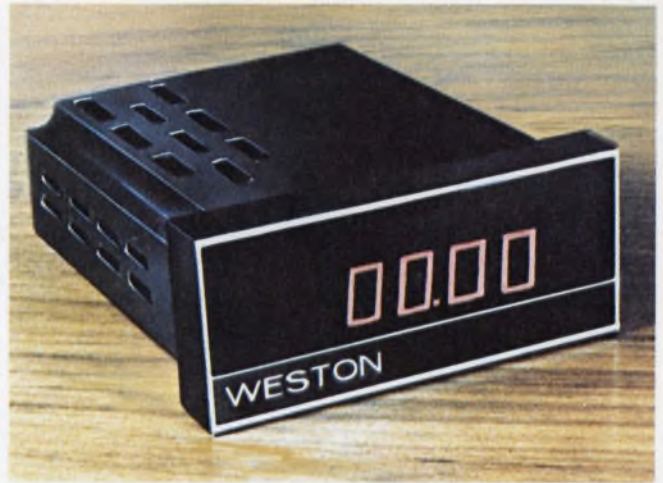

**Zero means zero** on Weston's 4 1/2-digit Model 2470. The unit has  $\pm 1$ -count stability at zero over a 0 to 50 C operating range, and no dead band at zero.

quality," recalls Michael J. Ryan, product specialist in display and control instruments at LFE Corp. In the old days, instruments would die shortly after the first time they were turned on.

Times have changed. The major DPM makers have put a lot of effort into improving instrument reliability. Maybe that's why they've become the major manufacturers. But there are still things to look for to make sure you don't get a DPM that's going to fall apart.

Check power consumption first. DPMs are very compact these days, so there isn't much room for air to circulate and dissipate heat. If the instrument draws more than a couple of watts, it may heat up enough to shorten its life considerably. Or you may have to provide external means—fans or heat sinks—to cool the box. These can add substantial costs to your design. At any rate, you shouldn't have to supply the crutches for an ailing panel meter.

Naturally, the power consumption you measure should be worst-case. Consumption can vary with ambient temperature and humidity, line voltage and input signal—and greatly with the number of display-digit segments lit. Don't settle for a single, simple number without qualifiers.

If you can get a sample of an instrument like the one you're planning to buy, get into it and check the temperature of the power transformer. It should be warm to the touch, but it shouldn't burn your fingers. Hot transformers don't live long, and may shorten the life of other components mounted nearby.

If the DPM's case has holes for heat dissipation, take care in selecting a mounting location. You don't want contaminants falling through the holes and shorting out internal lines.

If the case is plastic, look out for fragile tabs that can break off and leave the meter dangling in midair. If you're going to use the meter in an environment that demands protection against EMI, buy one with a metal case or a plastic case with a metalized coating

that shields.

The standard interface with a digital panel instrument is through a card-edge connector. That's good enough for most applications. But if you expect to change input leads often, or need a fairly heavy-gauge wire, look for screw terminals instead. If the card-edge is better for your needs, check to see that the fingers are gold-plated to prevent corrosion.

#### Preconditioning cuts failures

There are some things you can't see that affect DPM reliability. Most important is how much testing the manufacturer does to weed out "infant mortality" and out-and-out failures.

Some DPM makers simply assemble the instrument—or have it assembled for them—then perform a perfunctory functional test to make sure it works. When they say "works," they mean the digits light up, though not necessarily in any meaningful way, or for long. So ask your prospective supplier exactly what he means by testing.

The most careful suppliers test all the components that go into the meter, test each board going inside as it is assembled, then burn in the completed meter. Only then, after a final test and calibration, is the meter prepared for shipment. All that effort virtually assures the meter will work.

Be careful, though, to find out what a supplier means by "burn in." Some simply turn the meter on at room temperature and with no input signal, and leave it on just a few hours. It's better to use a controlled-temperature chamber and operate the meter at a high ambient, better yet to have an input signal exercising the meter's circuitry. Even better still, burn-in should include varying the temperature and the input voltage over the instrument's rated ranges. Whatever is done, the manufacturer's burn-in cycle should last at least a day.

One performance spec that doesn't mean much is



Neither rain nor sleet nor boiling water shall stay the Velonex ruggedized DPM from the swift completion of its

appointed measurements. It's designed to meet military specifications. Warranty is two years.



**Digital processing** allows the 7000 Series DPM from Dynamic Sciences to work with any nonlinear transducer. It can even handle double-valued functions.

mean time between failures. The MTBF is almost always calculated from theoretical formulas that have little real meaning. And Analogic's Gordon notes that a 20-year MTBF implies a failure rate of about 5%—much too high for a component you're using in a system, despite the relatively high MTBF figure. It's better to look at the failure data the manufacturer has compiled. Gordon claims that one Analogic model has had a failure rate of less than 0.7% in the 15 months since the instrument was introduced.

But suppose your meter fails. Can it be repaired? For that matter, should it?

If a low-cost (under \$39 or so) DPM fails, "throw it away," advises Fred Katzmann, president of Ballantine Laboratories Inc. It's probably cheaper to buy another \$39 meter than to take the time—and money—to repair a broken unit. And the supplier of a low-cost meter probably won't want to fix it either, says Katzmann. But check the warranty. If it's still in effect, press for a free replacement.

#### Maintaining your meter

More expensive instruments should be repairable in the field or, at least, at the manufacturer's plant. To make sure the instrument you're planning to buy can be maintained, look for modularity and working space. It's almost impossible to unsolder a suspect IC or display without destroying it in the process. Plug-in display boards, displays and ICs make it much simpler to track down a fault and, once located, to repair it. And while small size has always been a design goal in DPMs, overly dense packaging will frustrate your attempts to probe the interior of a failed meter.

Modularity also extends to options like BCD outputs. If you're planning to use the DPM as part of a feedback loop or data-acquisition system, you'll want to be able to get data out of the instrument in a format that's most convenient for downstream processors.

It may even be valuable to buy a DPM with field-installable interface boards—you can add or change the board for different end uses.



**Take your choice of features** in digital-panel meters. Working with 240-V lines? See Electro Numerics' 3999-count full-scale range (lower left). Tekelec's LCD units draw little power (left). The tiny Non-Linear Systems DPMs are priced from less than \$50 (above left). Action Instruments adds process-oriented circuitry to Data Tech DPMs (above right). Distributors can tailor Simpson DPMs to specific applications (right). Newport Labs' Series 214 DPM draws about a watt, costs about \$32.50.

Check carefully to make sure digital outputs are compatible with your system. At one time, TTL-compatible outputs were the norm in DPMs, but higher-density, large-scale MOS chips have changed that. As a result, some DPMs now have digital interfaces with voltage swings of 12 V instead of the TTL standard 5 V.

### Check the output

And even TTL-compatible outputs have problems. Ask about fanout: How many inputs can the DPM's output drive? Just as important, how long a cable can you connect between the DPM and the next input? An instrument that can drive only one low-power TTL load within a few inches of the output won't be worth much in a process-control system where cable lengths are measured in yards. But it may be good enough in a benchtop instrument, where the DPM's output is processed further on an adjacent board.

Consider also how long the data remain available. If the DPM doesn't include output latches, the data may disappear before your circuitry can grab them. You'll have to design—and pay for—your own output latches.

Check the format of the data. Some DPMs feed information out serially, and leave you to perform a serial-to-parallel conversion. Others multiplex the data from each digit, so you have to unscramble the signals. It may cost more for you to perform these functions than to buy a more expensive DPM, with these facilities built-in. In addition, multiplexed data take longer to update, so take some delays into account in your designs.

Worry about delays at the instrument's input termi-

nals, too. To help cut the meter's susceptibility to noise, most manufacturers mount an RC-filter network at the instrument's input. True, this cuts down on an instrument's gyrations in response to spikes and noise signals, but it also slows response to changes in the input signal that you may want to measure.

Look for a settling-time spec that's compatible with your needs. In a control system, the rest of your components may not be able to react quickly enough to take advantage of a fast-settling DPM, and the lack of input filtering may make the instrument overly sensitive to noise and normal-mode signals. The settling-time spec should refer to the normal-mode rejection ratio, since input filtering affects both.

Common-mode rejection ratio and common-mode voltage are two more specs you'll have to study carefully. As with any voltage measurement, common-mode voltage has to be referred to some zero point—earth ground, signal ground or some other point. The differences can be substantial—a maximum common-mode voltage to signal ground is usually tens of volts and a maximum common-mode voltage to earth ground usually hundreds of volts.

There's another reason for checking grounds carefully. A digital panel instrument has lots of points marked "ground," and they may or may not be the same. Measurement-input low, digital circuit ground (usually for the BCD conversion circuitry), analog ground (for the instrument's power supply), and case or earth ground are all part of a DPM's circuitry. Some of these grounds may be tied together somewhere else in your system, so tying them together again inside the DPM may create a ground loop that can throw off your readings. "You can't say 'a ground is a ground

## DPI? DPM? DPI? DPI?

What's a DPM? If you think the answer to that question is simple, think again.

Back in the old days (a couple of years ago, at least), you could define a DPM fairly simply, as a voltage or current-measuring device that was small and had a single full-scale range. If you wanted to change ranges, you had to add external switching or, at least, get inside the box to reconnect jumpers or flip switches. A DPM differed from a digital multimeter (DMM) and a digital voltmeter (DVM), which had front-panel switches for range changing.

Inside a DPM, there was often enough room to wire some special-purpose circuitry so that the device read out directly in different units of measure—temperature, time, and so on. The instrument then became a digital thermometer or a digital clock/timer. For some process-control applications, these upgraded devices were called digital-process indicators (DPIs), a name you still see sometimes.

Meanwhile, back at the other end of the scale are simple readout devices, with no measurement circuitry of their own. These are also called DPIs—for digital panel indicators. Sometimes, the lowest-cost, simplest DPMs were called digital panel indicators, and sometimes the phrase was used derisively to characterize a DPM that performed so poorly it wasn't really a meter, "just an indicator."

Now there's another "DPI" to worry about: the digital panel instrument. Functionally, it's about the same as a digital-process indicator. The major difference is that its specialized circuitry is added by a DPM maker, not by an OEM buyer or a specialty firm. Digital-panel instruments include digital thermometers, digital clock/timers and even some devices—such as small, panel-mountable printers—that have no relation to other DPMs except for packaging.

What's the best way to refer to these devices? It depends on how you look at it.

You can say—rightly—that since the DPM is the ancestor of everything referred to as a DPI, "DPM" is the general term and the others are subcategories. Or you can say that a DPM is really a digital-panel voltmeter or a digital-panel ammeter, and that these two categories, along with digital-panel thermometers, digital-panel counters, digital-panel printers and the like, are classes of digital-panel instruments. All that remains is for "digital-panel indicator" to mean a readout device with either low-performance or no measurement circuitry, and "digital-process indicator" to mean a DPI that is aimed at specific applications in process-control systems.

For now, make sure you know what your supplier means by "DPI," at least until all the definitions are sorted out.

is a ground'," says George Greenfield, new-product development engineer for digital panel meters at Weston Instruments.

If you're going to be taking measurements across points that aren't referenced to earth ground, make sure the meter has true differential inputs. You can't measure across one leg of a three-phase power line, for example, with an instrument that has the low side of its measuring terminals tied to earth ground.

Check the instrument's input impedance, too. It may vary enough with temperature changes to affect measurements significantly, as well as create problems in the circuitry under test. And find out if the DPM's inputs are buffered to prevent signals from feeding out of the instrument and into the unit under test.

Some instruments have high enough offset currents to drive your external equipment haywire. Weston's Greenfield suggests shorting the meter's input terminals through a large-value resistor to check for bias currents; the meter should read no more than a couple of counts out of a 1999 full-scale.

Greenfield also suggests that you check for reversal error with a battery hooked up one way then the other. If the meter's readings don't agree except for sign, the inversion circuitry may be faulty. That could cause problems when the signal passes through zero: The instrument might not be able to track cleanly, which

makes it difficult to adjust for zero readings.

Keep asking questions. For example, how does the instrument sample the input signal?

### Take enough samples

Sampling at the line frequency helps cut the effects of line-generated noise, but be sure the sampling period is appropriate for the line frequency where the instrument will be operating. Rejection of 60-Hz signals doesn't help much in a 50-Hz environment.

Very high sampling rates don't help much either if the settling time is high. Low-speed front ends make high-speed sampling meaningless.

You may want to vary the sampling rate to handle different conditions. In this case, look for a DPM with external clock controls or an external clock input.

Your product may have to operate with varying ambient lighting, too, so be sure that the DPM's display has the right brightness. The most common DPM display type, light-emitting diodes, are bright enough for most applications, but even the best LEDs get washed out in direct sunlight. If you expect ambient light always to be high, choose instead a liquid-crystal display that operates in the reflective mode. Such a display also consumes less power than a LED.

Transmissive LCDs, which have segments that turn



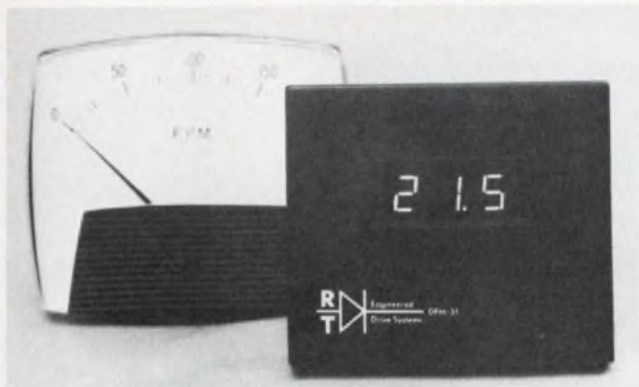

**Replacing analog meters** is another long-sought goal of DPM makers. This unit, from R.T. Engineering Service Inc. (Mansfield, MA) incorporates an Analog Devices DPM in a package designed to fit analog-meter slots.

clear when on, can be back-lighted with an incandescent lamp to make them very bright. The tradeoff is the higher power consumption of the lamp. Nevertheless, LCDs are becoming more popular in DPMs as their prices become more competitive with LED prices.

Digital-panel instruments themselves are getting to be less expensive, especially simple, voltage-reading digital-panel meters. The shift to large-scale integrated circuits has just about been completed now, so any more drastic price reductions on that score are unlikely. But LCD prices are falling. And DPM manufacturers are coming up with more efficient, less costly

manufacturing techniques.

For example, a digital-panel meter just developed by Fairchild Camera and Instrument Corp.'s Instruments and Systems Group contains "chip and wire" packaging. Four IC dice, a handful of discrete devices, and the display are mounted on a single PC board, with interconnects made directly to the board. Eliminating the IC packages cuts size as well as cost. Fairchild's present line uses LED displays, but "chip and wire" DPMs with LCDs are on the way.

Low-cost DPMs use LSI chips that you can buy to build your own instrument. The I<sup>2</sup>L chips in Analog Devices' three-digit 2026, for example, are available separately. Semiconductor suppliers, too, sell DPM chip sets.

As a result, Ballantine's Katzmann foresees users of low-cost DPMs taking on the task of designing the meter themselves. He calls excitement over low-cost DPMs "a supernova: brilliant but temporary."

That's why many DPM firms have chosen to stay away from the low-cost end of the market and concentrate on higher-priced, feature-oriented instruments. Going for hundreds of dollars, these DPMs offer custom interfaces to tie into systems for measuring temperature, pressure, and other parameters besides dc voltage. And the reading comes to you directly in engineering units like °C, psi, and gal/min.

The choice is up to you. You can get almost anything you want, but only if you know what you want—and you ask for it. ■■

## For more information

Not every manufacturer of digital-panel meters has been cited in this report, nor have all the variations of DPMs been described in detail. Moreover, not all firms make all types of DPMs. For more information, circle the appropriate number on the reader-service card and consult the GOLD BOOK.

Action Instruments Co. Inc., 8601 Aero Dr., San Diego, CA 92123. (714) 279-5726. (James J. Pinto) **Circle No. 501**

Amplicon Electronics Ltd., Lion Mews, Hove, East Sussex, United Kingdom. Brighton (0273)720717. **Circle No. 502**

Anadex Instruments Inc., 9825 De Soto Ave., Chatsworth, CA 91311. (213) 998-8010 (Kenneth A. Mathews) **Circle No. 503**

Analog Devices Inc., Box 280, Norwood, MA 02062. (617) 329-4700 (Steve Castell) **Circle No. 504**

Analogic Corp., 1 Audubon Rd., Wakefield, MA 01880. (617) 246-0300 (Robert M. Shipione) **Circle No. 505**

Ballantine Laboratories Inc., Box 97, Boonton, NJ 07005. (201) 335-0900 (Marty Crowley) **Circle No. 506**

California Instruments (Cimron), a Norlin Technology Co., 5150 Conroy St., San Diego, CA 92111. (714) 279-8620. (Don Chilcoat) **Circle No. 507**

Chauvin Arnoux, 190 Rue Championnet, 18 Paris, France. 252 8255 **Circle No. 508**

Control & Readout Ltd., Timerlaine Estate, Decoy Rd., Dominion Way, Worthing West Sussex, BN14 8 ND, United Kingdom. 090 320 7116 **Circle No. 509**

Data Tech Div. of Penril Corp., 2700 S. Fairview St., Santa Ana, CA 92704. (714) 546-7160 (Robert E. Britton) **Circle No. 510**

Datel Systems Inc., 1020 Turnpike St., Canton, MA 02021. (617) 828-8000 (Lawrence D. Copeland) **Circle No. 511**

Dynamic Sciences (Digilin), 16150 Stagg St., Van Nuys, CA 91406. (213) 893-6341 (Roger Swire) **Circle No. 512**

Electro-Numerics Inc., 1811 Reynolds St., Irvine, CA 92714. (714) 549-8821 (Philip E. Beaudoin) **Circle No. 513**

Electroplan Ltd., Box 19, Orchard Rd., Royston, Herts. SG8 5HH, United Kingdom. Royston (0763)41171. **Circle No. 514**

Exel Electronics Ltd., Wolterton Rd., Branksome, Poole BH12 1LR, United Kingdom (0202)767373. (E. V. Newman) **Circle No. 515**

Fairchild Camera & Instrument Corp., Instrumentation & Systems Group, 1725 Technology Dr., San Jose, CA 96110. (408) 998-0123 (Don Purkey) **Circle No. 516**

Farnell Instruments Ltd., Sandbeck Way, Wetherby, West Yorkshire LS22 4DH, United Kingdom. (0937) 63541. (Peter Harland) **Circle No. 517**

Gossen GmbH, Nagelsbachstrasse 25, D-8520 Erlangen, West Germany. (09131)827-1. **Circle No. 518**

Gralex Industries Division of General Microwave Corp., 155 Marine St., Farmingdale, NY 11735. (516) 694-3600. (Harold Steinberg) **Circle No. 519**

Industrial Timer Corp., subsidiary of Esterline Corp., U.S. Highway 287, Parsippany, NJ 07054. (201) 887-2200 (David Day) **Circle No. 520**

Integrated Photomatrix Ltd., The Grove Trading Estate, Dorchester, Dorset, United Kingdom. Dorch 3673. **Circle No. 521**

International Microtronics Corp., 4016 E. Tennessee St., Tucson, AZ 85714. (602) 748-7900. (Otto Fest) **Circle No. 522**

LFE Corp., Process Control Div., 1601 Trapelo Rd., Waltham, MA 02154. (617) 890-2000. (Michael J. Ryan) **Circle No. 523**

Metrix Instrumentation Division, ITT Instruments and Components, Chemin de la Croix Rouge BP 30, F 74010 Annecy Cedex, France. (50) 528102. **Circle No. 524**

Nationwide Electronic Systems Inc., 1536 Brandy Pkwy., Streamwood, IL 60103. (312) 289-8820. **Circle No. 525**

Newport Laboratories Inc., 630 E. Young St., Santa Ana, CA 92705. (714) 540-4914. (Mike McGaughy) **Circle No. 526**

Non-Linear Systems Inc., Box N, Del Mar, CA 92014. (714) 755-1134. (Ben W. Fisher) **Circle No. 527**

Orbit Controls Ltd., Lansdown Industrial Estate, Gloucester Rd., Cheltenham GL51 8PL, United Kingdom. (0242)26608 (P. Vlack) **Circle No. 528**

Simpson Electric Co., 853 Dundee Ave., Elgin, IL 60120. (312) 261-8000. (Irv Linker) **Circle No. 529**

Takeda Riken Ind. Co. Inc., 1-32-1 Asahi-cho, Nerima-Ku, Tokyo, Japan. 03-930-4111. **Circle No. 530**

Tekelec Instruments Division, 6 Rue Louis Pasteur, (F) 92100 Boulogne, France. (1)604-81-42 (Rene Gervais) **Circle No. 531**

United Systems Corp. (Digitec), 918 Woodley Rd., Dayton, OH 45403. (513) 254-6251. (Richard Dale) **Circle No. 532**

Velonex Division of Varian Associates, 560 Robert Ave., Santa Clara, CA 95050. (408) 244-7370. (George Obinger) **Circle No. 533**

Weston Instruments Division of Schlumberger/Sangamo Weston Inc., 614 Frelinghuysen Ave., Newark, NJ 07114. (201) 242-2600. (P. Mark Rehnberg) **Circle No. 534**

Liquid Xtal Displays <sup>INC</sup> offers  
**pacesetting  
performance**

**95%**  
HUMIDITY

**30 ON**  
ms

**+83°C**

**70 OFF**  
ms

**-15°C**

- **extended temperature ranges**
- **greater environmental stability**
- **exceptional speed of response**

## Liquid Xtal Displays are setting new standards

LXD's new generation of LCDs is now available with extended operating temperature ranges — up to +182°F (83°C). With response times of 100 ms total (T on plus T off). And with a temperature-humidity specification of 95% relative humidity at 50°C for 30 days.

For night use, we have a new integral Videobrite panel backlight.

Interested? See us at Electro '78 booths 1906 and 1907.



**Liquid Xtal Displays <sup>INC</sup>**

SUBSIDIARY OF DICKEY-john CORPORATION  
24500 HIGHPOINT ROAD • CLEVELAND, OHIO 44122  
TELEPHONE 216/831-8100 • TELEX 98-5442

CIRCLE NUMBER 48

# Think PPG electronic glass. And your imagination runs free.

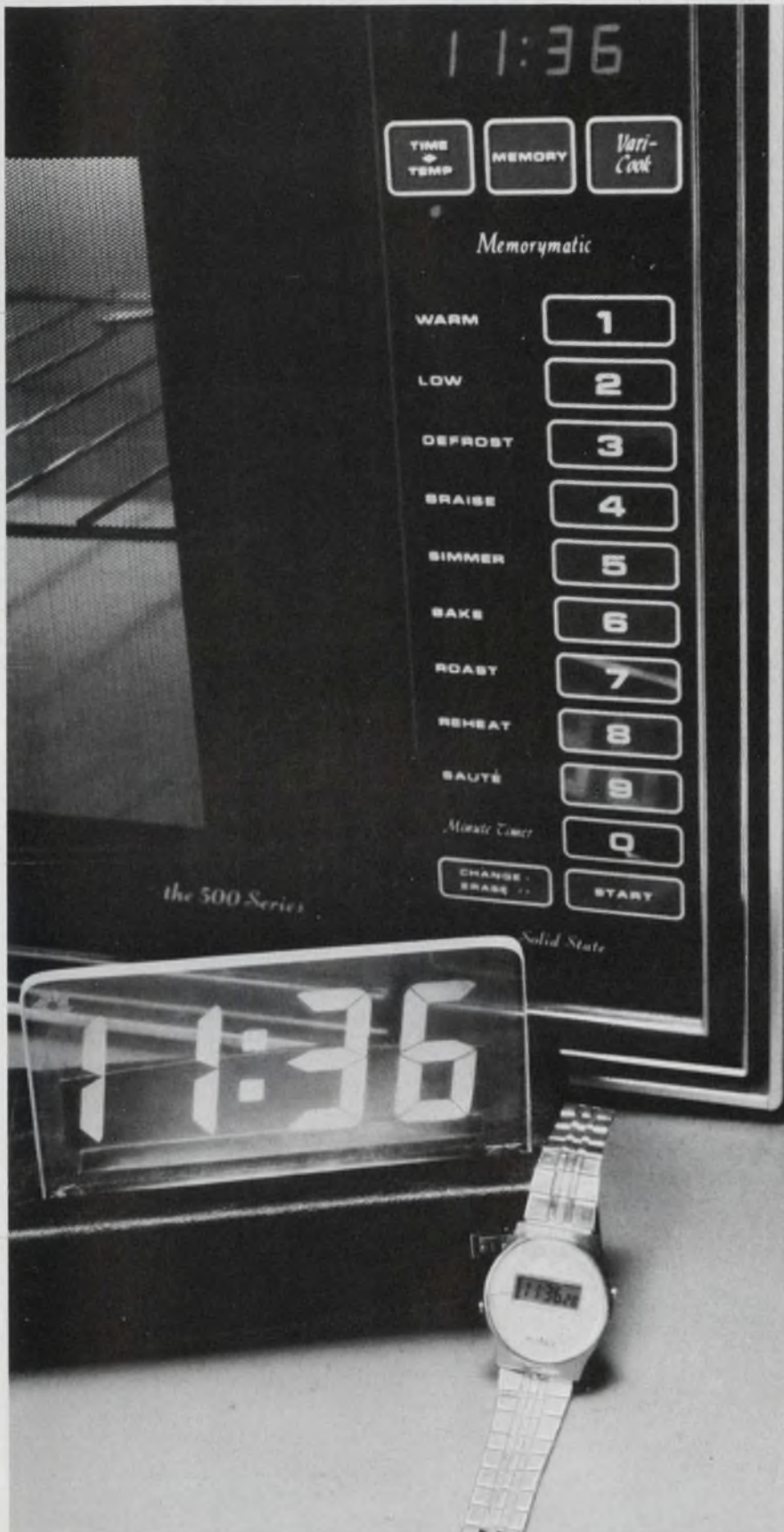

Designers and engineers are realizing the almost infinite possibilities of touch-control panels and visual display devices. Made more efficient and more reliable with the sleek beauty of PPG electronic glasses.

PPG Nesa<sup>®</sup> and Nesatron<sup>®</sup> glass. They can replace practically any electromechanical device.

PPG electronic glasses are coated with a permanent, transparent, electrically conductive metallic oxide. They let you join the smooth elegance of glass with the dazzling magic of solid-state circuitry.

A touch of the finger activates any switch on a touch-control panel. Since there are no moving parts, there's nothing to break off or wear out. They place a sealed surface between the user and the electronics. And they will give you the freedom to create an absolutely stunning product.

Some obvious possibilities: Automotive controls, telephones, vending machines, calculators, microwave ovens, instrumentation controls. The list goes on as far as your imagination can take it.

Let's talk about the ways you can put PPG electronic glass on your drawing boards. Send us the coupon today.

PPG: a Concern for the Future



INDUSTRIES

Industrial Glass Products  
PPG Industries, Inc.  
One Gateway Center  
Pittsburgh, Pa. 15222

- Please send me more information on how I can enhance my designs with PPG electronic glass.
- Please have a representative contact me.

Name \_\_\_\_\_

Company \_\_\_\_\_

Title \_\_\_\_\_

Street \_\_\_\_\_

City \_\_\_\_\_

State \_\_\_\_\_ Zip \_\_\_\_\_

Telephone \_\_\_\_\_

# Technology

**Put memory into your card reader** and send data down the line serially. You'll be able to do parity checking and you'll save on cabling and hardware.

Design a serial card reader with on-board memory and error flags, and you'll avoid cumbersome, bulky cables and expensive I/O sections. With temporary storage to read the data cards (Fig. 1), serial data can be transmitted to a CPU at 9300 baud, complete with start and stop bits.

The reader tests parity first as the card data are read into memory, again as they are transferred from memory to the UART, and once more as they travel from the UART to the transmission line—this time in serial form. All the while, data are being read back into the reader. Additional checks are made for framing and overrun errors.

Transmission status is reported to the data terminal

sending the message via the same coaxial signal line. Any number of data cards can be read into the unit prior to transmission, provided the number of characters, less NULLs, equals 255 or less.

A common diode block-and-lamp assembly senses data as the card passes through (Fig. 2). All nine reader channels are identical.

The LM139 comparators in Fig. 2 are medium-speed, TTL-compatible units requiring only 5 V at about 1 mW per gate (bias circuits excluded). Noise immunity is provided with  $\pm 5$  mV of hysteresis. The comparator, coupled to a 7413 Schmitt trigger by a 22- $\Omega$  resistor and a bypass diode, provides zero-crossover protection for the 7413 input, as well as a squelch circuit to dampen ringing.

A NULL-delete circuit samples the outputs of the 7413s (Fig. 3). Bits 1 through 8 are inverted and applied to the eight inputs of a 74LS30, which acts as an OR

**Robert J. Stetson**, Engineer, Storage Technology Corp., 10 Clay Court, Aurora, IL 60538

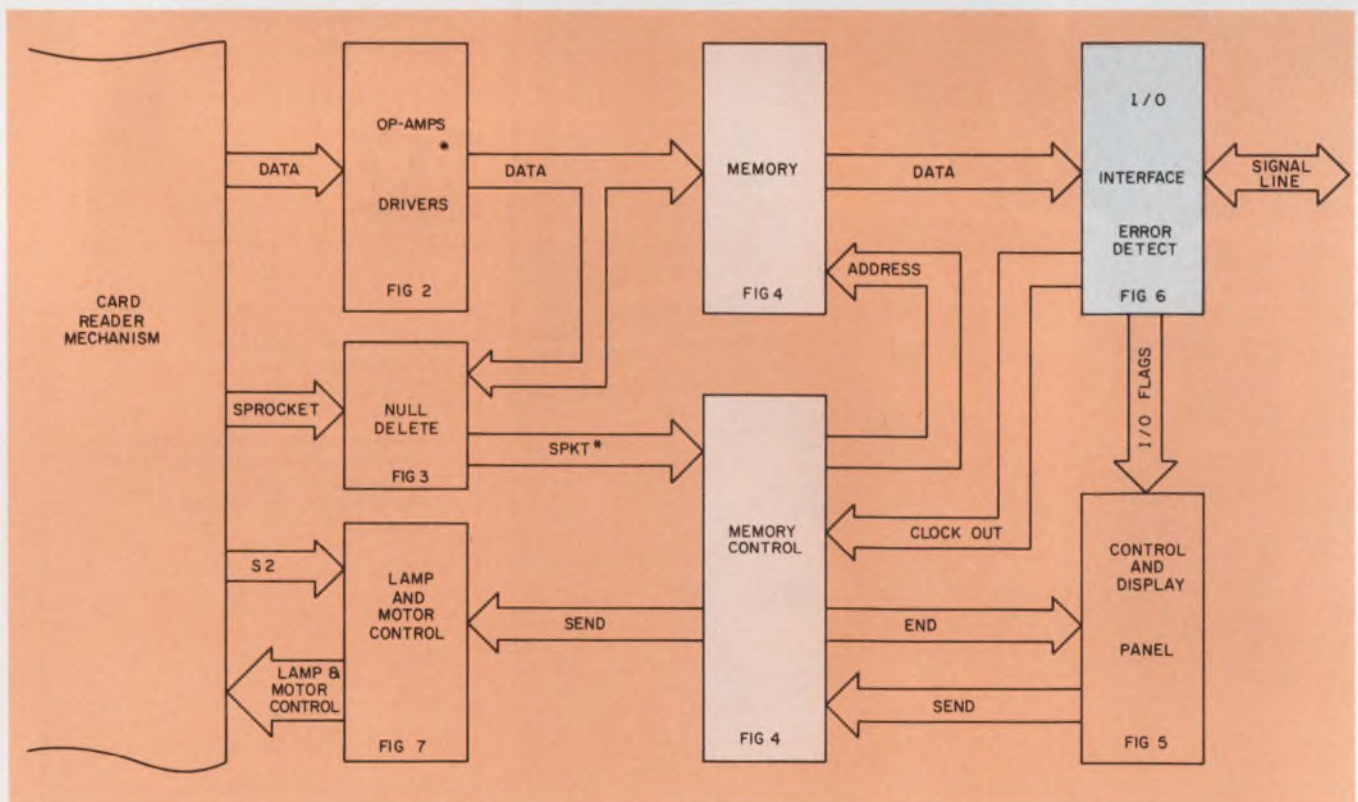

1. **Internal memory in a card reader** accepts parallel input data, delivers serial data, and simplifies the I/O design.



gate with the inputs normally high. The output of the 74LS30 goes high when any bits or combination of bits are ONEs. Only a NULL prevents the BIT SPKT signal from being gated through the 74LS08 to become BIT SPKT\*. Because the NULL suppresses the bit sprocket, it is kept from reaching the memory.

The memory in Fig. 4 loads data from the 74LS01s, which are driven by the 7413 drivers in Fig. 2. Bits B<sub>10</sub> through B<sub>70</sub>, when connected to the 74180 parity-generator chip, generate  $\overline{B8}$ . An exclusive-NOR gate tests parity during the loading of memory and sets the parity-error (PE) latch. This occurs when the parity generated by the 74180 differs from parity-bit 8, which is read in from the data card. Thus, the card data as well as the circuits are tested during loading at the memory input.

When data are read, BIT SPKT\* fires the 8T22 for 1  $\mu$ s to advance the address to the next byte location. Because the sprocket holes in the data card are almost half the size of the data holes, there is no danger of race conditions during BIT SPKT\* time.

### Completing the read cycle

Once the desired number of data cards have been read, depress the send pushbutton (Fig. 5) to fire the 8T22 for 1  $\mu$ s and set the send latch. Then,  $\overline{SEND}$  goes low to disable the 74LS01's gating data bits, B<sub>1</sub> through B<sub>n</sub>, and forces NULLs to appear on memory inputs D<sub>0</sub> through D<sub>7</sub>. Also,  $\overline{SEND}$  goes low to the Master-Reset (MR) to enable the UART (Fig. 6).

When SEND goes high at the 74LS74s in Fig. 6, it enables the timing shift registers to generate CLK

0 from the 8T22 timer. (It also resets a latch to turn off the card-feed motor and optical card-reader lamp.) Signal CLK 0 advances the memory address until 256 addresses are loaded, including those loaded from data cards. The load cycle ends by writing NULLs into all the remaining addresses. When memory steps from address 1111 1111 to 0000 0000, A<sub>7</sub> goes low and fires the 8T22 for 1  $\mu$ s to generate END.

### Entering the transmission cycle

Signal END steps the T input of the 74LS74 from the receive mode to the send mode, and sets the Send\*

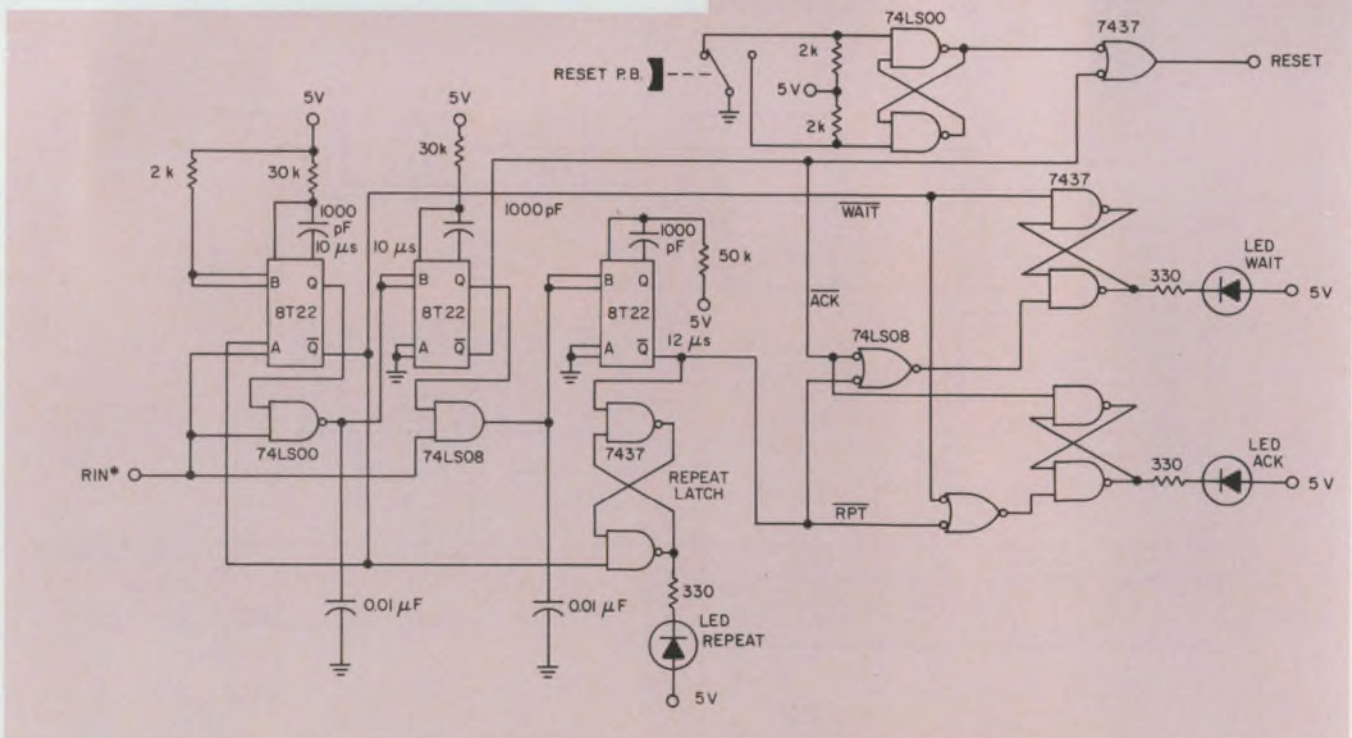

5. After all cards have been read, the send pushbutton shuts down the feed motor and read lamp, and sets up

the sequence to switch from the receive to the send mode. The 8T22 fires for 1  $\mu$ s.

latch. This switches the 82208 memory from the write to the read mode and enables outputs D<sub>0</sub> through D<sub>7</sub> to drive the data lines.

With the contents of address 0000 0000 on D<sub>0</sub> through D<sub>7</sub>, the data drivers (74LS266s) place the contents of memory on B<sub>10</sub> through B<sub>8</sub>. The 74LS266s are exclusive-NOR gates with one input tied to ground. In this configuration, the circuit acts as an inverting driver. Bits B<sub>10</sub> through B<sub>7</sub> serve as the transmitter-register inputs (TR<sub>1</sub> through TR<sub>7</sub>) of the UART, where they are clocked out of TR<sub>0</sub> as serial data. The bits also go to the 74180 parity generator to generate  $\overline{B8}$ .

An exclusive-NOR compares parity bit B<sub>8</sub> from

memory with the generated parity bit  $\overline{B8}$ . Thus, data parity is tested as data are read, from the memory output to the point where the data enter the UART. But only bits 1 through 7 are read into the UART, which generates a new bit (8) along with one start bit and two stop bits. The 8T26 line-transmitter/receiver drives data out of TR<sub>0</sub> to the coaxial send/receive line.

The TR<sub>0</sub> signal also couples back into the UART on RIN, where it is tested for proper parity in the receive side of the UART. As a result, any possible overrun error or framing error is detected. In this way, the UART and associated support circuits are tested, with each data byte, for error or malfunction out to the line driver.

Signal CLK 0 cycles the data out of memory until the address counter cycles around to 0000 0000. At that time, END is again generated on the negative transition of A<sub>7</sub>; END also toggles the 74LS74 to switch the 8T26 from the send to the receive mode. The next 74LS74 is toggled, by Qs going high again, to generate END\*.

Signal END also resets both the Send Latch and Send\* latch, which restores MR of the UART high and clears the 74LS74 located in the UART timing-support shift registers. The 74LS09 data gates are enabled again to read cards, and the memory switches from the read to the write mode.

### Getting a message-status reply

After a 256-character data transmission, consisting of data and the appropriate number of NULLs, the

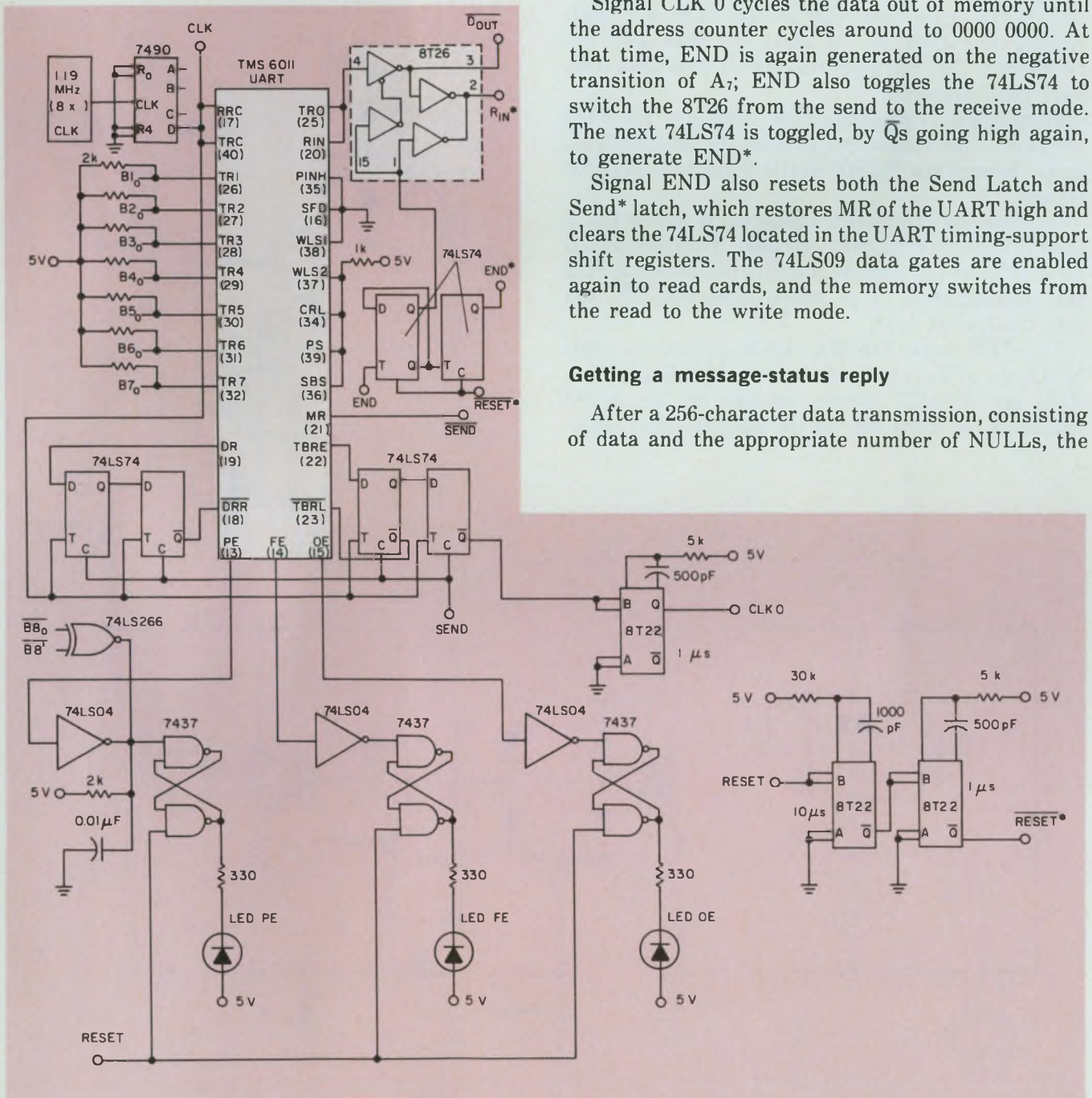

6. Data parity is tested again as information leaves the memory and enters the UART. The CPU acknowledges or

rejects the data by feeding back a series of NULL signals. A transmitter-receiver feeds the coax output.

CPU sends back a single NULL to indicate a WAIT. Signal RIN\* fires the first 8T22 only, to set the Wait latch. This tells the operator that the CPU possesses the data and to await evaluation.

When the CPU completes the successful transfer of data from the input memory, it makes one of two responses: It may acknowledge data by sending two successive NULLs back over the signal line to the card reader; or it may reject the data by sending back three successive NULLs.

For an affirmative response, RIN\* fires the first 8T22 for 10  $\mu$ s. Approximately 7  $\mu$ s later, the second NULL gates through the 74LS00 to fire the second 8T22 also for 10  $\mu$ s. This generates a RESET and an ACK, which sets a latch to light the acknowledge LED. The WAIT signal goes high before ACK, and, with RESET remaining on the latch, the Wait LED extinguishes. The operator now knows that good data have been processed.

For a negative response, RIN\* fires the first 8T22 for 10  $\mu$ s. Approximately 7  $\mu$ s later, the second NULL gates through the 74LS00 to fire the second 8T22 for 10  $\mu$ s.

Because the  $\bar{Q}$  output is connected to one of the A inputs, the first 8T22 can't retrigger. The third NULL gates through the second 74LS00 to fire the third 8T22 for approximately 12  $\mu$ s, which generates  $\bar{RPT}$  and sets the Repeat latch.

The  $\bar{RPT}$  resets the Wait latch, set on the third NULL, as well as the Acknowledge latch. Remember, ACK and RESET\* were generated on the second NULL in the same way as the acknowledged reply.

The card-reader lamp turns on along with the motor when you insert the data card. A microswitch, with an arm extended into the path of the data card, makes contact to ground (Fig. 7) to set the latch and turn on the lamps and motor (through a reed relay and triac). (A noise-suppression network is recommended in the triac circuit.) A straightforward power supply develops 5 V for the logic and -12 V for the UART.

Shop around for a transport mechanism—a model that can read both cards and tape can automatically read and transmit tape 255 bytes at a time with only minor design changes. ■■

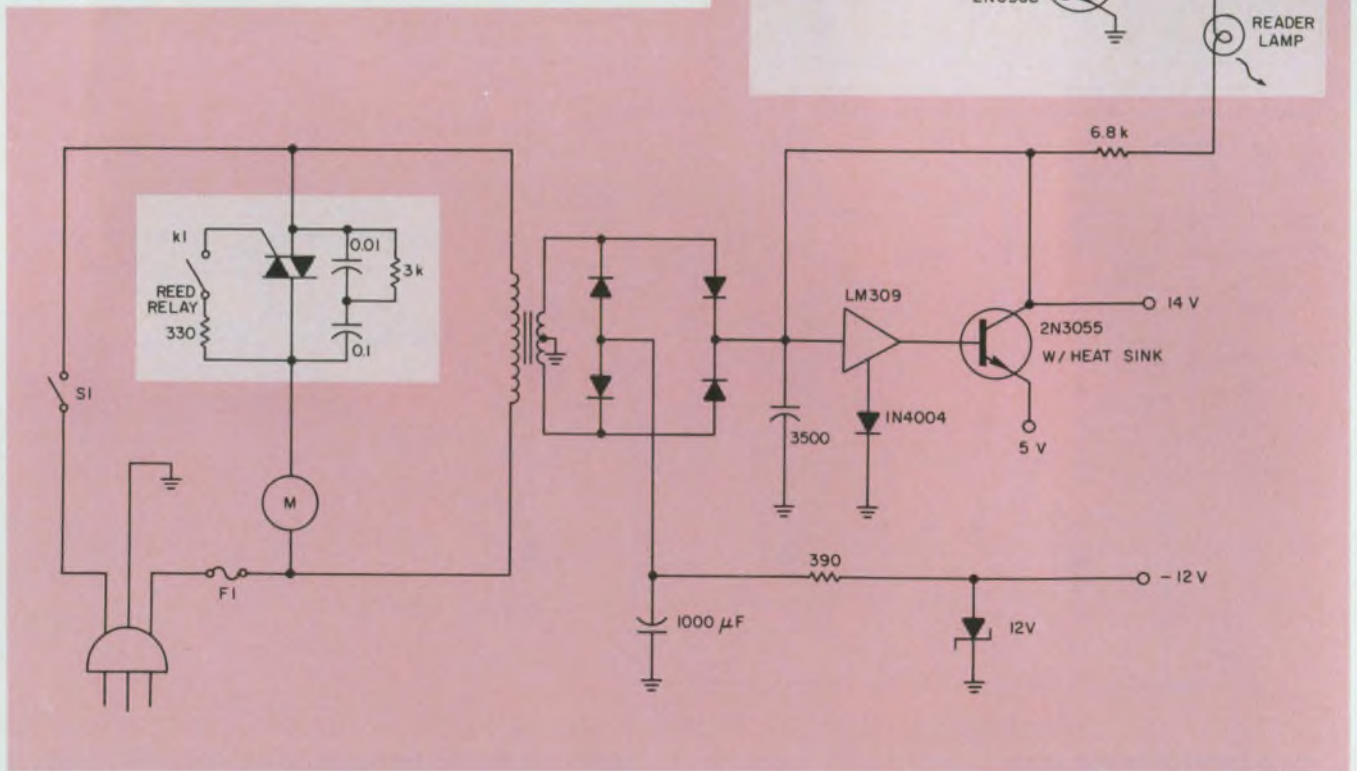
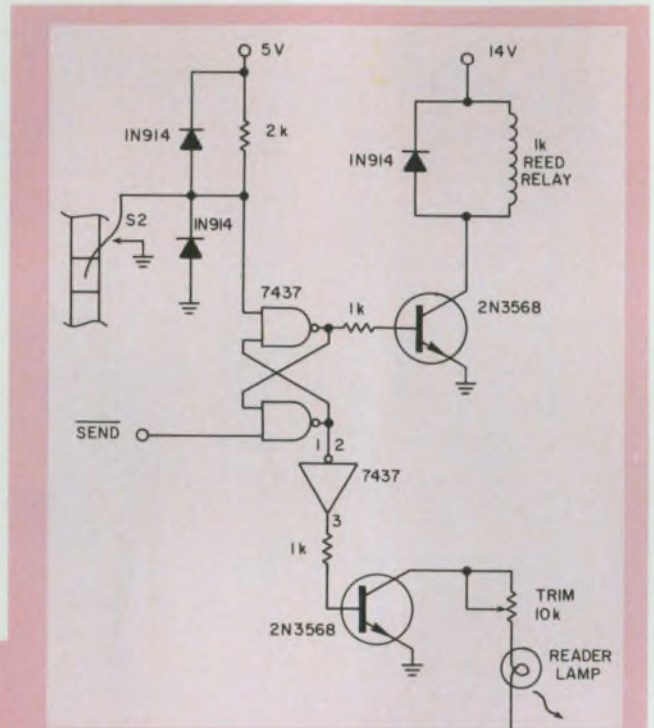

7. Power-supply and motor-control circuits are straightforward. The R-C across the triac suppresses noise.



# TAKE A CLOSE LOOK AT THESE BURROUGHS PLASMA DISPLAY BREAKTHROUGHS.

Easier to read

Greater brightness

Improved contrast

Larger matrix dot

Broader horizontal  
viewing angle

Lower power  
requirements

Cost effective  
design

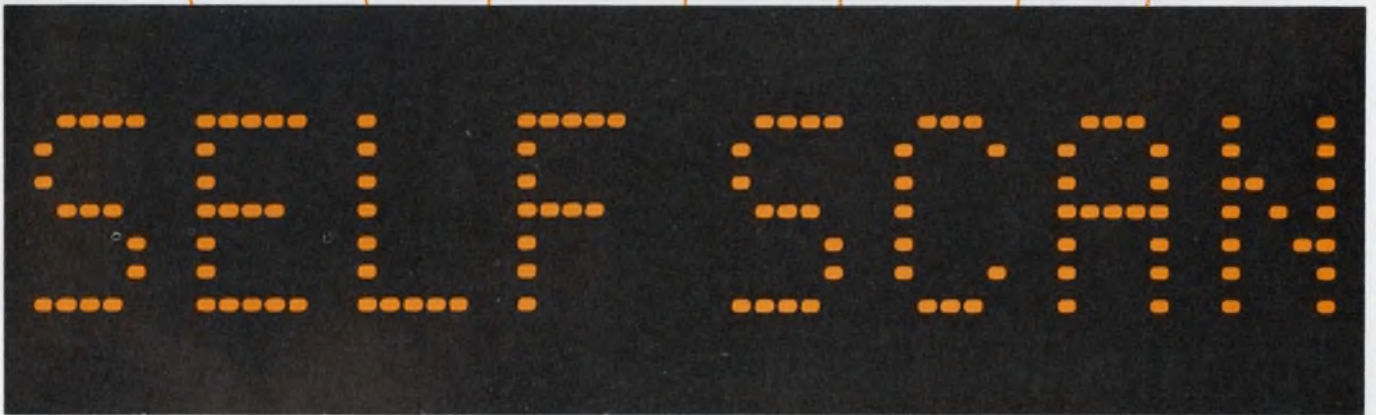

The new Burroughs SELF-SCAN® II single register gas plasma panels are breakthroughs in visibility and readability, making them ideal for all types of applications — from audience information displays to instrumentation applications. They are digitally addressed to interface easily with microprocessors and computers.

Only 15 connections are required. These new units complement Burroughs' standard line of single register 16 and 32 character plasma displays.

The Burroughs SELF-SCAN II 1 x 20 and 1 x 40 displays. Certainly worth looking into.

Burroughs Corporation, Electronic Components Division, P.O. Box 1226, Plainfield, New Jersey 07061. Telephone (201) 757-5000. SELF-SCAN displays are available nationwide through our distributor, Hamilton/Avnet Electronics.

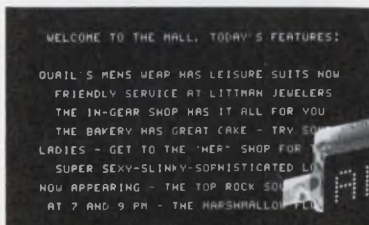

New 1 x 20 panel can be stacked and butted together to give a contiguous large audience information display of any number of characters.

New 1 x 40 panel for instrumentation, data terminals, computers and hundreds of other applications.



You can see the difference

## Burroughs



SELF-SCAN is a registered trademark of Burroughs Corporation.

CIRCLE NUMBER 50 FOR GENERAL INFORMATION

CIRCLE NUMBER 51 FOR DETAILED SPECIFICATIONS

# Introducing a new and a new low in

Fairchild has a brand new family of 3-terminal positive voltage regulators that offers you several advantages:

A new low-cost, easy-mounting package.

**Lowest cost half-amp on the market.**

We've built a low-cost version of our popular  $\mu$ A78M regulator: The  $\mu$ A78C. It's designed for applications with less critical parameters and tight cost restrictions. It would be ideal for many consumer electronics products.

The  $\mu$ A78C comes in both the

# VOLTAGE REGULATORS

A new low-cost regulator.  
An old, reliable regulator in a new package.

**The small bend that saves big bucks.**

Our new U1C package has a small bend at the mounting end. It allows you to mount the regulator anywhere you like. With fewer thermal junctions, better heat dissipation and increased performance.

It costs less than the TO-220. It fits in the same mounting holes. And it's a lot more convenient to work with than the TO-202.

Of course, we have much more to offer you than a new package. We also have some new products to put into it.

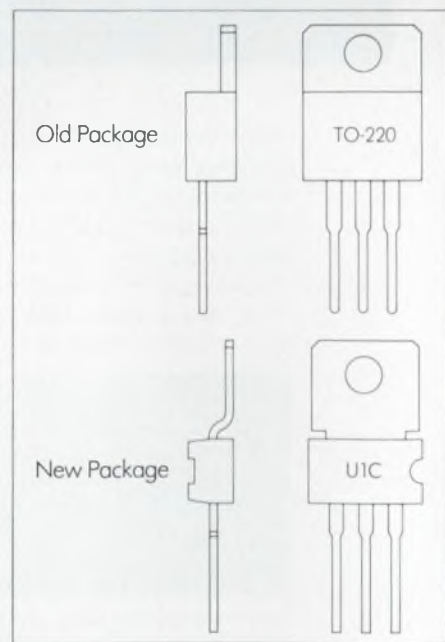

# high in packaging pricing.

bent tab and straight tab TO-202 configuration. Either way, it only costs you forty-five cents in quantities of 100. That makes it the lowest priced 1/2-amp positive voltage regulator on the market.

The  $\mu$ A78C series is available in nine voltage options (8, 10, 12, 15, 17, 18, 20, 22 and 24 volts).

## New shape for an old friend.

We've also put the  $\mu$ A78M in these new low-cost packages. It comes in seven versions, ranging from 5 V to 24 V. Like the  $\mu$ A78C, it features internal current limiting, thermal shutdown and safe area compensation, making these devices practically indestructible.

The  $\mu$ A78M is designed primarily for industrial applications. The 100-piece price is fifty cents.

## New ideas from a proven source.

The U1C package and  $\mu$ A78C series are just a small sample of the regulator technology available to you from Fairchild.

We invented the first IC voltage regulator in 1966. We invented the first 3-terminal regulator in 1972. We invented the  $\mu$ A78M series 1/2-amp regulator in 1973. And the  $\mu$ A78L

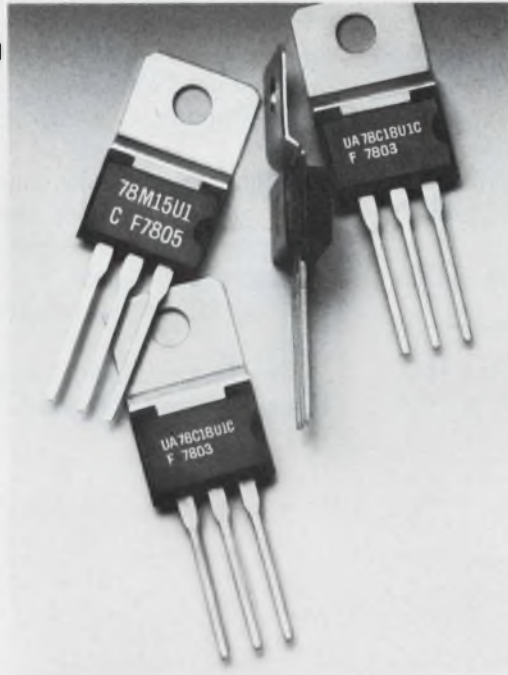

series 100 mA regulator in 1974.

Today, we are the world's leading supplier of voltage regulators.

If you have special requirements in this specialized area, please give us a call. There's a very good chance we have just what you need.

## We're here to help.

For complete information on any of our voltage regulators, contact your Fairchild sales office, distributor or representative today. Or use the direct line at the bottom of this ad. Linear Products Division, Fairchild Camera and Instrument Corporation, 464 Ellis Street, Mountain View, California 94042. Telephone: (415) 962-4903. TWX: 910-379-6435.

**FAIRCHILD**

**Call us on it.  
(415) 962-4903**

## Upgrade your switchers analytically.

Use equivalent circuits to avoid "cut-and-try" stabilization and ripple suppression for switch-mode regulation loops.

When designing switched-mode power supplies, you often have a hard time stabilizing the regulation loop and suppressing input-voltage ripple. Solutions up to now have been based on empirical data only, because there weren't any simple analytic tools available. But now, you can use recently developed linear equivalent circuits<sup>1</sup> for pulse-width regulators.

Using these linear models, together with simple

**Dr. Erich Pivik**, Engineer, and **J. Saxarra**, Engineer, AEG-Telefunken N2, Gerberstasse 35, F 15, Backnang, West Germany.

linear-network analysis, you can simulate a switched-mode supply well enough to calculate and even optimize the supply's important properties. These include:

- Phase-versus-gain characteristics under various input voltage and load conditions.
- Output-voltage response to a pulsed load.
- Input impedance.
- The influence of aging and temperature on components.

The linear models describe supplies that use constant-frequency switching ( $f = 1/T$ ) and variable-

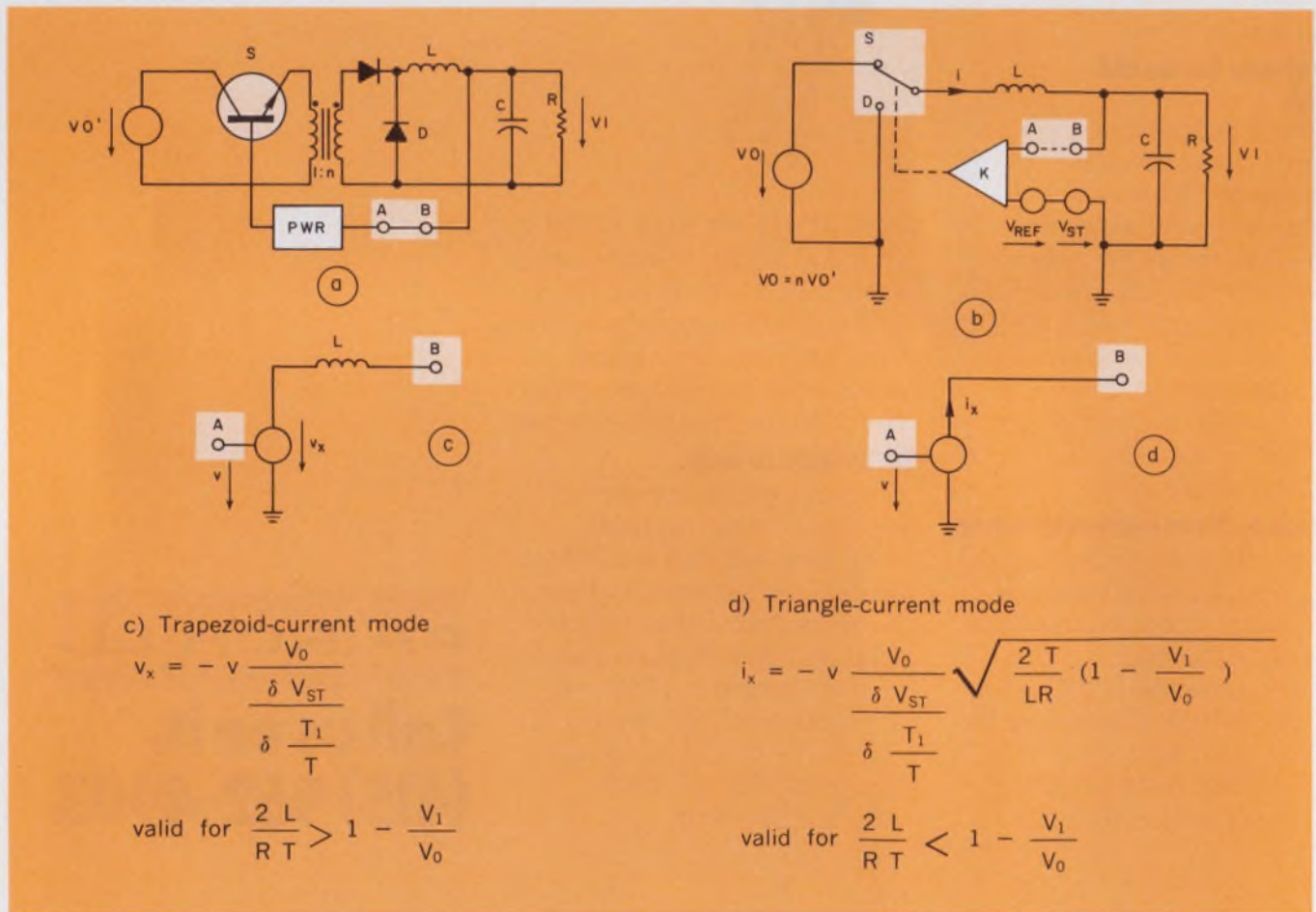

1. A down-converter switching supply (a) relies on constant-frequency switching. Varying the switching-pulse width regulates the output. The equivalent circuit for the entire supply (b) shows that the PWR responds

to a combination of voltages: output, reference and the sawtooth,  $V_{ST}$ . The response between points A and B can be simulated by an equivalent circuit for either the trapezoidal-current (c) or triangular-current (d) modes.

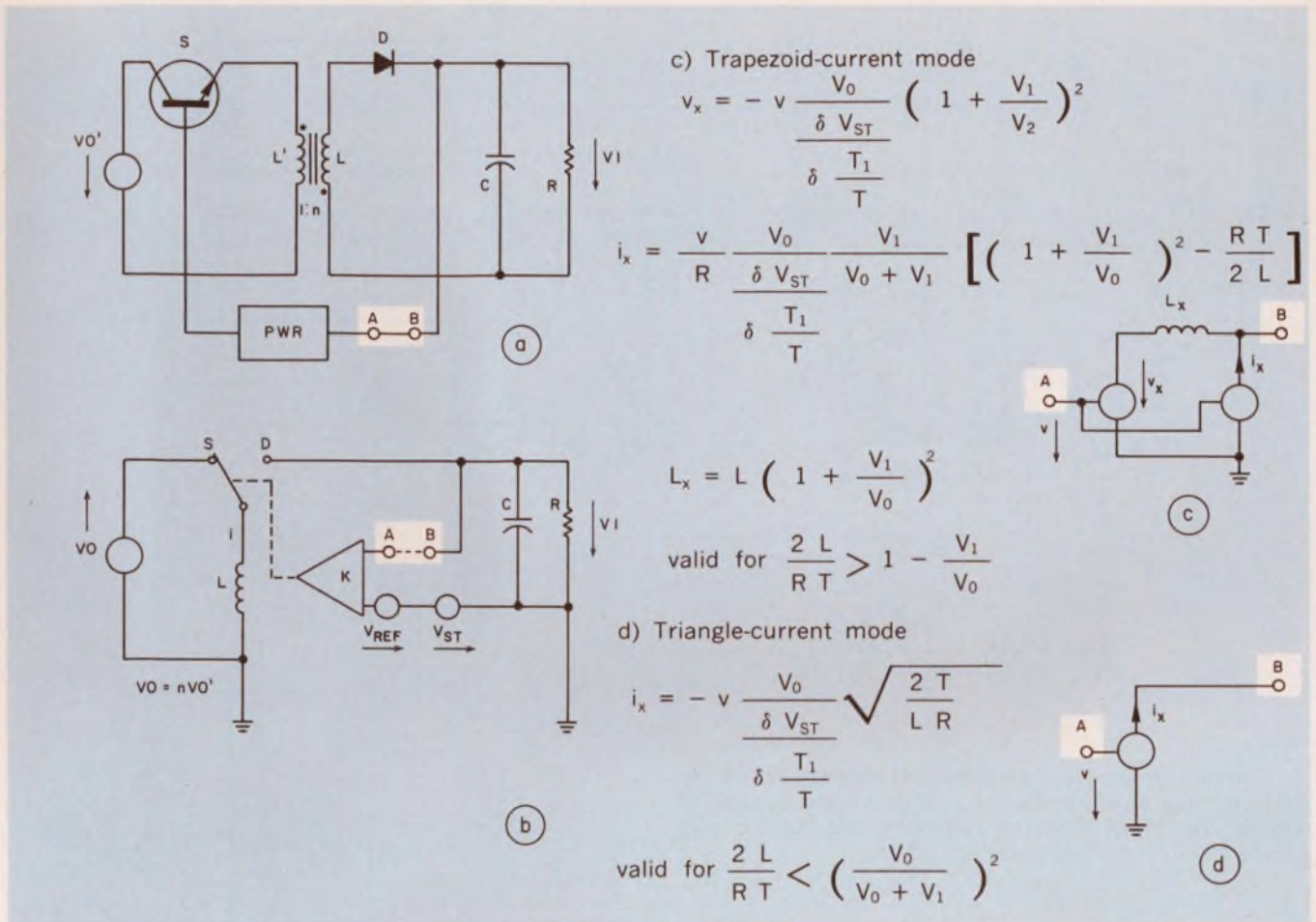

2. An up-converter switching supply (a) relies on the same combination of voltages (b), at K, as the down-converter.

Up-converters also operate in the trapezoidal (c) or the triangular (d) current modes, depending on the load.

width pulses. The pulses come from a pulse-width-regulator (PWR) circuit that compares the supply's output voltage with an internal reference.

Variable-pulse-width switching supplies use one of two kinds of switching circuits: a down-converter (Fig. 1a) or an up-converter (Fig. 2a). Each can operate in either of two output-current modes—trapezoidal or triangular—depending on load resistance.

### In the mode

In the trapezoidal mode, the current in the inductor, L, is always greater than zero; in the triangular mode, the inductor current can drop to zero. This difference makes the equivalent circuits for each mode of both converters different from one another.

3. Voltage waveforms at the comparator input (a) in the down-converter of Fig. 1b are nonlinear sawtooths. The corresponding current (b) that passes through the inductor and into the load is further smoothed by integration in the converter's output filter capacitor, C.

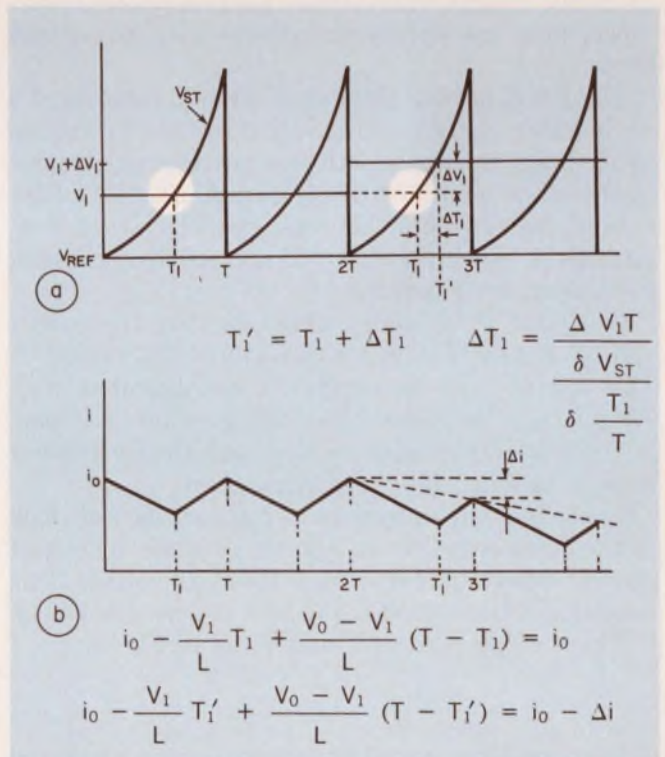

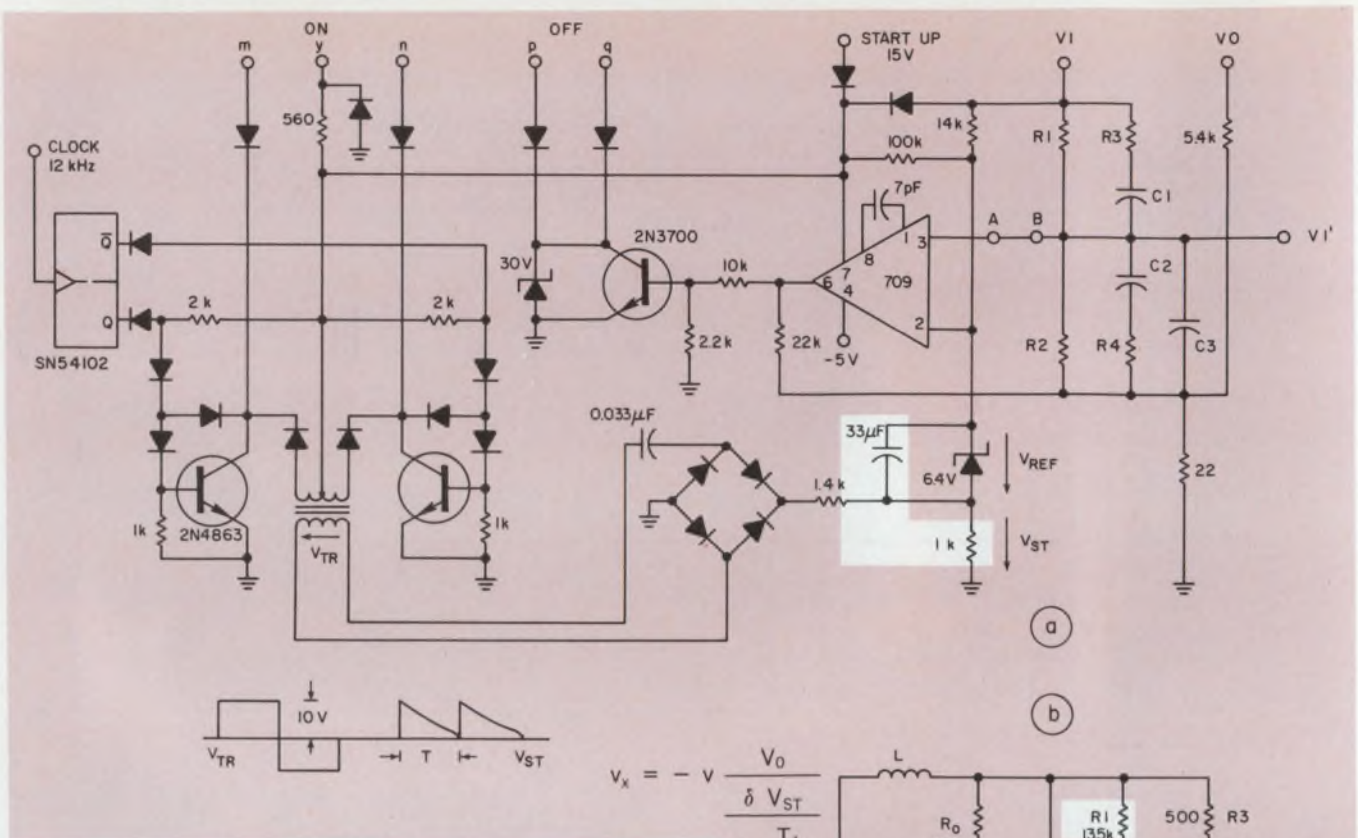

4. A nonlinear sawtooth compensates the PWR in a down-converter (a). A voltage divider, as shown in the equivalent circuit (b), often helps by balancing the output and reference voltages against each other.

The equivalent circuit for the down-converter is shown in Fig. 1b, for the up-converter, in Fig. 2b. Both these equivalent circuits assume that the components are ideal: lossless transformers with no leakage inductance, plus transistors and diodes with no voltage drops.

The PWR in both equivalent circuits consists of a comparator, K, that has the output voltage,  $V_1$ , applied to one input and a sawtooth plus the reference voltage at the other input. When the output is less than the sum of the sawtooth and reference, the switch is in position S. When the output is greater than the sum, the switch is in position D.

Capacitor C is large enough so that the output voltage is nearly constant throughout one period, T. This means that the current,  $i$ , is integrated in C. Therefore,  $\bar{i}$ , the mean value of  $i$ , goes into the load, R. This analysis leads to the equivalent-generator circuits of Figs. 1c, d and Figs. 2c, d.

To see how the equivalent circuits are derived, look at the down-converter in Fig. 1b. Assume the circuit is in its steady state with  $V_0$  as the input voltage. This condition is illustrated in the first two periods of Fig. 3. Then, using periods T and  $T_1$  as in Fig. 3,

$$\frac{V_1}{V_0 - V_1} = \frac{T - T_1}{T_1}$$

Next, open the regulation loop between A and B and

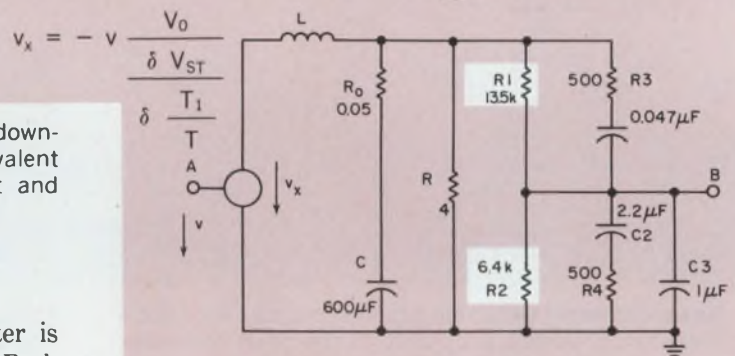

apply the dc voltage,  $V_1$ , at A. The same  $V_1$  then appears at B, which means that the circuit's steady state isn't disturbed by breaking the loop.

#### Take the A

The goal of all this is to find the transfer function, from A to B, of a small, superimposed voltage. To this end, use a small step function,  $\Delta V_1$ , as a probing function at A. Then calculate the short-circuit current and open-circuit voltage responses at B by using the linear equations shown in Fig. 3.

In this case, a short circuit at B means that  $V_B$  is equal to  $V_1$ , and both are constant. So the response to the probing function is shortened without disturbing the dc conditions.

Fig. 3 shows clearly that the short-circuit response at B decreases linearly with time, even though the sawtooth waveform (Fig. 3a) is nonlinear. Therefore, this response can be represented by a negative voltage-step source in series with an inductance. The response

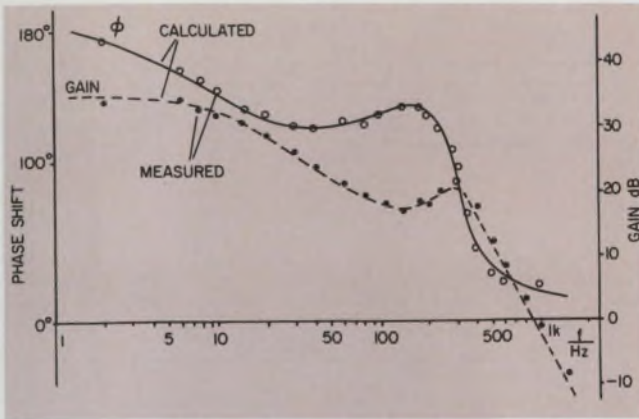

5. Calculated and measured gain and phase-shift values for the down-converter PWR of Fig. 4 correspond closely. The closeness shows that the equivalent circuit indeed represents the actual circuit.

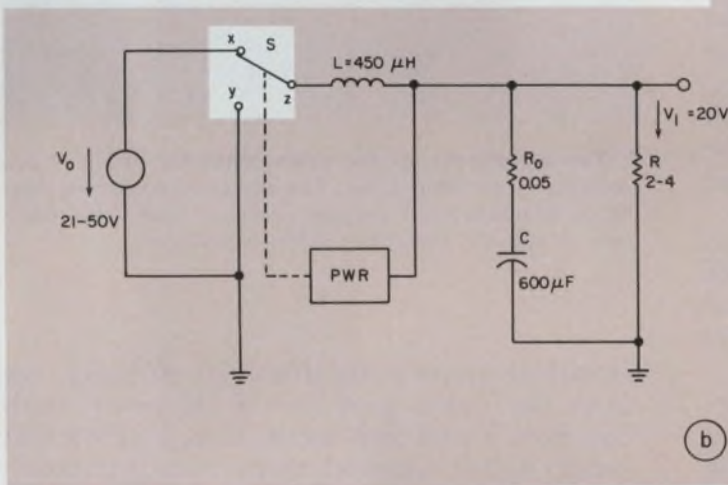

6. Ripple reduction in a down-converter (a) is most effective with the nonlinear sawtooth (1), less so with the linear sawtooth adjusted for best compensation (2), and

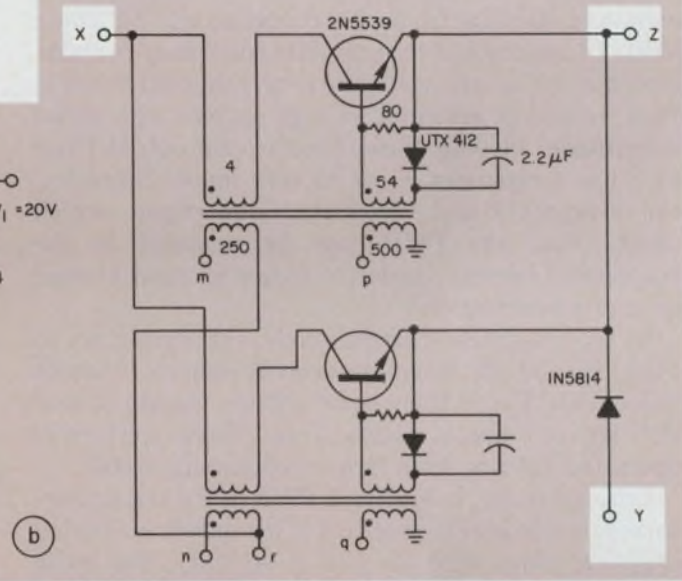
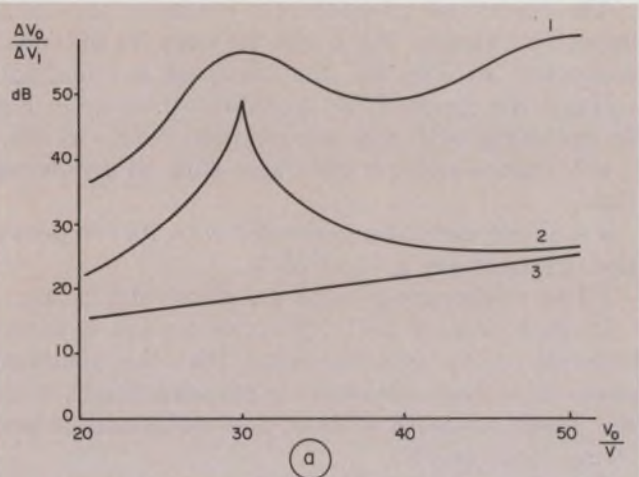

least effective with the uncompensated linear sawtooth (3). The down-converter (b), including the switch, S, is operated with all three types of PWR circuits.

to the step function applied at A can be represented by a voltage-step source at B. The slope of the sawtooth voltage,  $V_{ST}$ , in Fig. 3a is

$$\delta V_{ST} / \delta(T_1/T),$$

at the switching time,  $T_1$ . Adding the equivalent-generator circuits (Figs. 1c, d and 2c, d) to complete the equivalent circuits of Figs. 2b and 3b, ensures that they represent the actual circuits between points A and B, for all frequencies.

To appreciate its utility, put your linear model to work analyzing two improved PWR circuits.

The first of these switchers develops its improved regulation from a compensation circuit. To compensate a down-converter like the one in Fig. 1, feed-forward the PWR input voltage,  $V_0$ , using the circuit in Fig. 4a. Use nonlinear sawtooth compensation

$$V_{ST} = \frac{\beta V_1}{1 - (T_1/T)}, \quad \delta = \frac{dV_1'}{\delta V_0}$$

Though at first it may seem difficult to generate the proper time function for compensating the PWR, in most cases you'll need only the wave portion that corresponds to the input-voltage range.

This segment is easier to generate than the entire waveform. Usually, an e-function can approximate the required segment closely enough.

Fig. 4a shows how to generate the nonlinear sawtooth with an RC circuit. If needed, a decreasing sawtooth can be generated as easily as an increasing one. The up-converter of Fig. 2 can be compensated by the same sawtooth as the down-converter.

Often, a voltage divider between  $V_1$  and the comparator input serves to match the output and reference voltages. An analog preamplifier also can increase the loop gain. Fig. 5 shows the theoretical open-loop phase and gain of the equivalent circuit (Fig. 4b) of the down-converter using a nonlinear-sawtooth PWR and measured values of the actual circuit (Fig. 4a and 6b). As you can see, the actual circuit's performance closely corresponds to the theoretical model's.

The theory for output-ripple reduction also holds up well in practice. Fig. 6 tells the story for the down-converter. In Fig. 6a, the resulting output-ripple voltages are graphed for the down-converter in Fig. 6b operating with any one of three PWR circuits:

- A linear-sawtooth generator with no compensation.

- A linear-sawtooth generator with its compensation adjusted for a  $V_0$  of 30 V.

- The nonlinear-sawtooth generator of Fig. 4a.

In each case, a 1-V, 100-Hz sine wave is superimposed on  $V_0$ . Fig. 6a shows that the nonlinear sawtooth is most successful in reducing ripple, while the linear sawtooth without any compensation performs most poorly.

The second improved PWR power supply<sup>2</sup> gets enhanced stability from a 90° reduction of PWR phase shift. To understand the tradeoffs you'll have to make, first notice that the trapezoidal-current converters in Figs. 1c and 2c resemble voltage sources with series inductance. In both these circuits, the output filter at B has a capacitor, C, at its very input. Therefore, the voltages at B and A are just about in-phase—which means that the PWR may be unstable in the trapezoidal-current mode for either an up-converter or a down-converter.<sup>3</sup>

In the triangular-current mode, the converters in Figs. 1d and 2d resemble current sources without inductance. These, then, boast a phase margin of over 90° between circuit points A and B. So converters operating in this mode are exceptionally stable.

Unfortunately, operating a PWR in the triangular-current mode is only practical in low-power switching supplies. Along with the plus of stability, this mode has the minuses of low efficiency and high ripple as well as semiconductor-power problems.

On the other hand, a PWR that operates in the

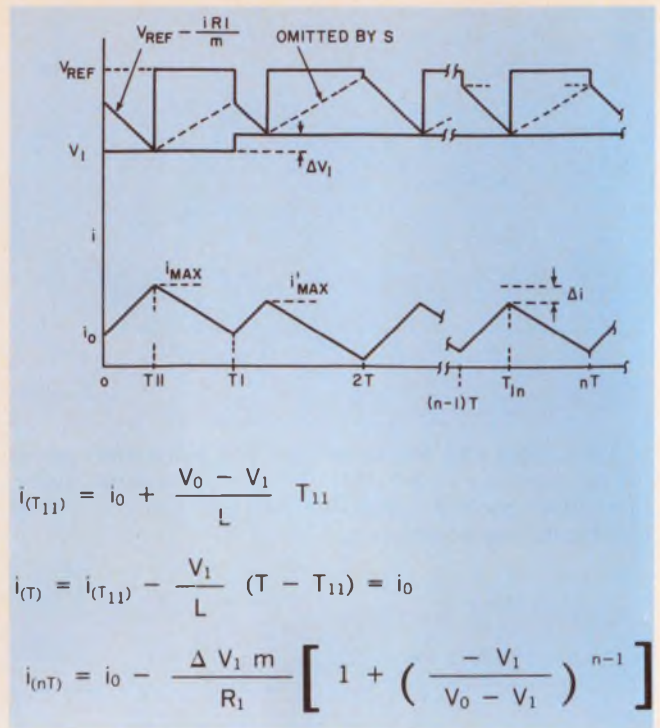

8. Two waveforms for the down-converter of Fig. 7 are plotted on one time scale. The upper trace shows how the comparator-input voltage varies in time. The lower trace shows the inductor-current waveform.

trapezoidal-current mode offers high efficiency, low ripple and makes good use of its power semiconductor. A good combination, then, is a PWR that operates in the trapezoidal-current mode, but is modified to be a current rather than a voltage source.

The down-converter circuit in Fig. 7 is an example of this combination. Here, circuit behavior is modified

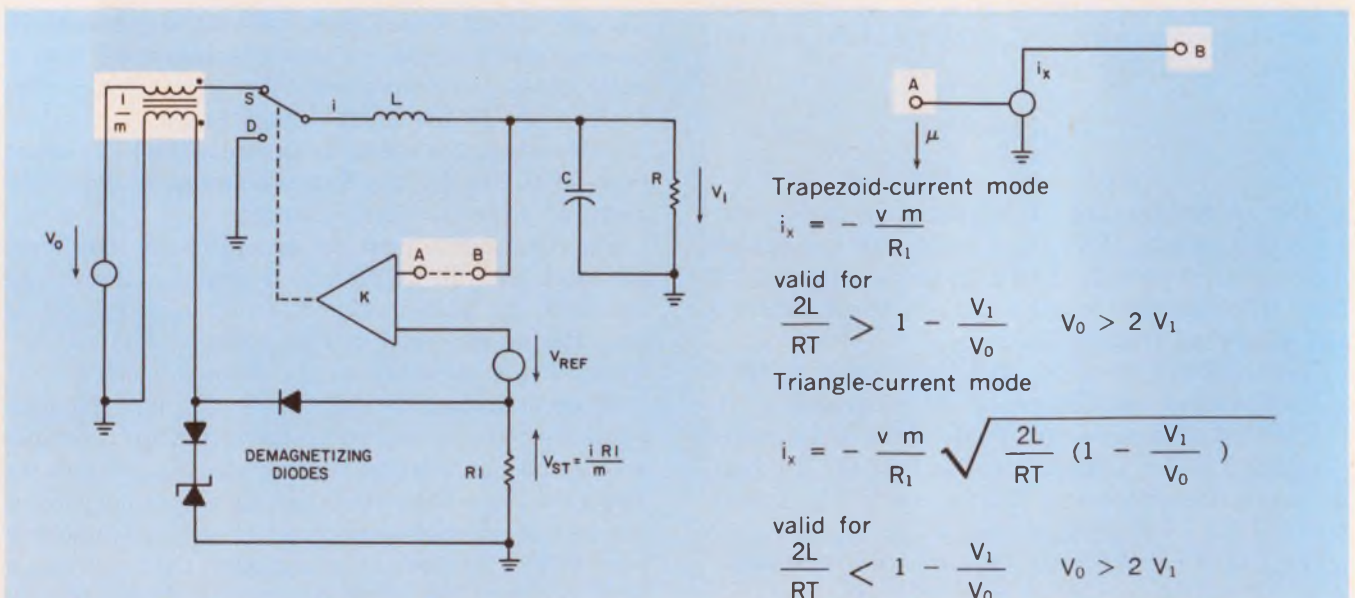

7. This down-converter combines the best features: It operates in the trapezoidal-current mode and acts as a

current source. The added transformer's primary current increases linearly with time.



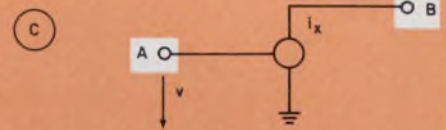
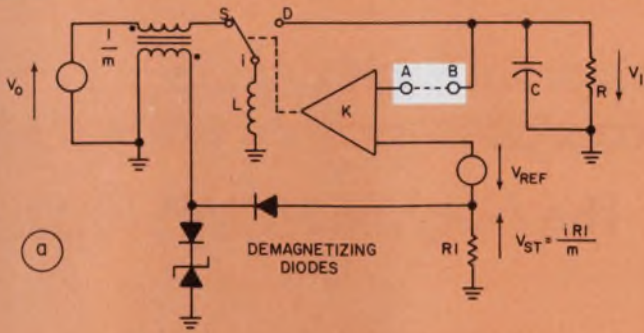

c) Triangle current mode

$$i_x = -v \frac{m}{R_1} \sqrt{\frac{2L}{RT}}$$

valid for

$$\frac{2L}{RT} < \left( \frac{V_0}{V_0 + V_1} \right)^2$$

$$V_0 > V_1$$

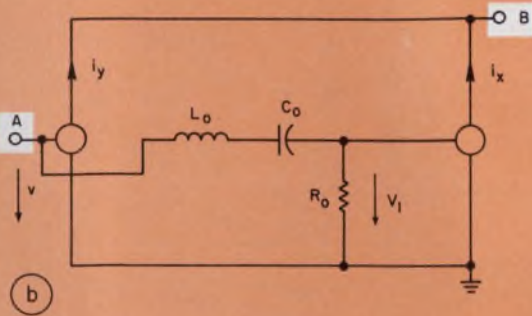

b) Trapezoid-current mode

$$i_x = \frac{V_1}{R_0} \quad i_y = -v \frac{m}{R_1} \frac{V_0}{V_0 + V_1} \quad R_0 = \frac{2 \ln \frac{V_0}{V_1}}{a} \quad L_0 = \frac{T}{a} \quad C_0 = \frac{aT}{\pi^2 + \left( \ln \frac{V_0}{V_1} \right)^2}$$

$$a = \frac{m}{R_1} \left[ \pi^2 + \left( \ln \frac{V_0}{V_1} \right)^2 \right] \left[ \frac{L}{RT} - \frac{1}{2} \left( \frac{V_0}{V_0 + V_1} \right)^2 \right] \frac{V_1}{V_0}$$

valid for

$$\frac{2L}{RT} > \left( \frac{V_0}{V_0 + V_1} \right)^2 \quad V_0 > V_1$$

### 9. An up-converter with current-proportional-sawtooth

(a) works in the trapezoidal-current mode (b), so the

by adding a transformer between  $V_0$  and the switch. The transformer-primary current,  $i$ , rises linearly. The secondary winding develops a  $V_{ST}$ , that is equal to  $i$  times  $R_1$ , divided by the turns ratio,  $m$ . This voltage develops across  $R_1$  and, of course, increases linearly with time. In either an up-converter or a down-converter, this modified  $V_{ST}$  replaces the sawtooth.

### Let's get down

To see in detail how the current-source type of converter works, look at the down-converter in Fig. 7 together with the waveforms for comparator-input voltages and transformer-primary current in Fig. 8. Notice that the current and voltages are all plotted on the same time scale, to emphasize their interaction.

Open the loop between A and B in Fig. 7 and, at A, apply a dc  $V_1$ , superimposed on a probing step voltage,  $\Delta V_1$ . The circuit response to this stimulus is shown in Fig. 8. After  $\Delta V_1$  is applied at A, the mean output current drops by  $\Delta \bar{i}$ . Neglecting second powers of  $\Delta V_1$ , Fig. 8 and its equations give

supply uses its semiconductors efficiently. The triangular mode (c) has only low-power uses.

$$\Delta \bar{i} = - \frac{V_1 m}{R_1}$$

Applying the same method to the up-converter in Fig. 9 uncovers similar behavior. Here, the response to a step function of  $\Delta V_1$  at A is a step function of current plus a damped oscillating current.

Fig. 9b gives the equivalent circuit for the trapezoid-current mode. For comparison the equivalent circuit for the triangular-current mode is shown, with its limits, in Fig. 9c. Both the down-converter of Fig. 7 and the up-converter of Fig. 9 have properties needed for high performance: trapezoidal-current-mode operation and current-source behavior. ■■

### References

1. Pivit, E., "Some Topics on the Stability of Switched Mode Power Supplies" (in German), *Frequenz* 30, No. 4, 1977, pp. 96-100; No. 5, 1977, pp. 153-156.
2. Grünsch, E., and Saxarra, J., Patent Application No. 15, 571.1, April 27, 1977, p. 27.
3. Pivit, E., "Junction Capacitances Cause Instabilities in Switched-Mode Power Supplies" (in German), *Frequenz* 30, No. 1, 1976, pp. 15-19.

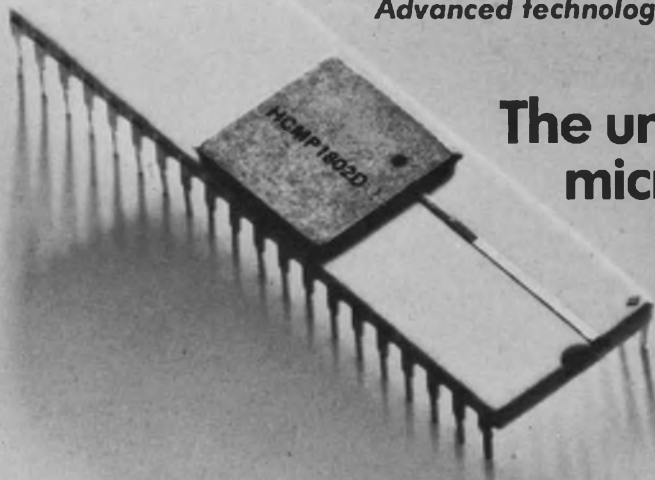

# The universal 8-bit CMOS microprocessor that does it all.

## The Hughes HCMP 1802.

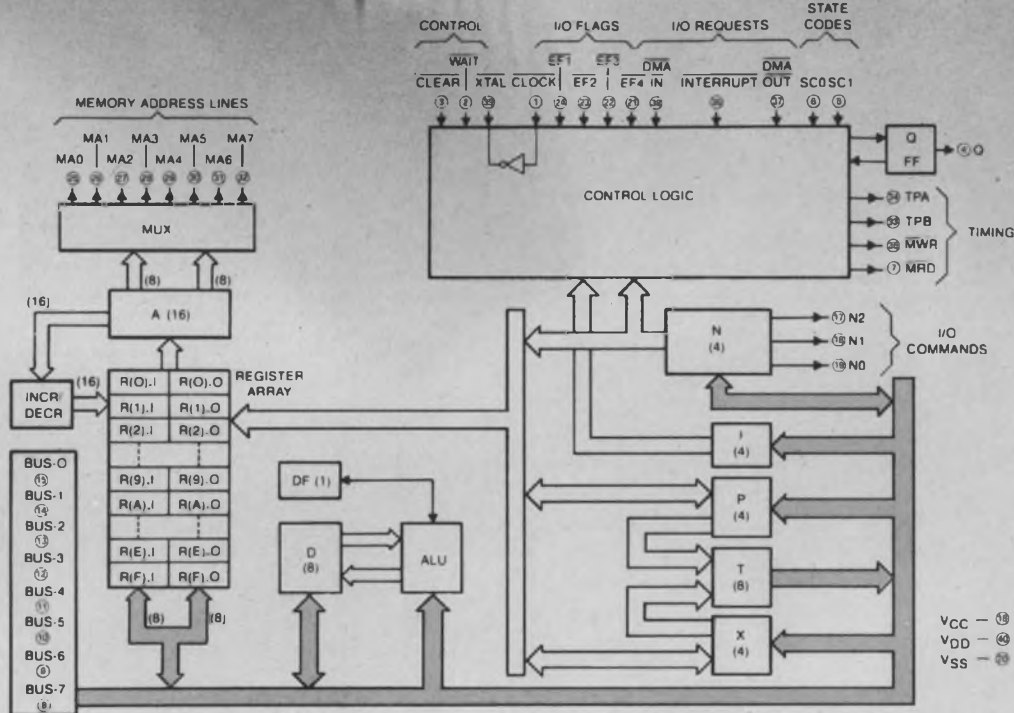

It gets the job done in everything from auto ignition controls, business machines and instrumentation, to industrial process controls and games. Even under hostile environments such as space telecommunications and geophysical data logging.

Architecturally, it has built-in direct memory access, sixteen 16-bit general purpose registers, direct interfacing to peripherals with an easily-programmed instruction set.

And being CMOS, it offers extremely low power consumption, high noise immunity, single power supply with wide tolerances, and universal

interface capability (TTL, NMOS, PMOS, etc.).

The HCMP 1802 is available now in consumer, industrial and high reliability versions. It's backed by a full complement of RAMs, ROMs and I/Os. And there are still more support devices to come.

Learn more from Gary DesRochers at (800) 854-3516 or (714) 759-2907. Or write for new 20-page brochure: Hughes Semiconductor Products, 500 Superior Avenue, Newport Beach, California 92663.

Overseas: Hughes Microelectronics Ltd.: Clive House, 12-18 Queens Road, Weybridge, Surrey KT13 9XD, England. Telephone 932-47262.



### THE 1800 MICROPROCESSOR FAMILY

NUMBER	FUNCTION
<b>AVAILABLE NOW—</b>	
HCMP 1802	CPU
HCMP 1824	32 x 8 RAM
HCMP 1831/2	512 x 8 ROM
HCMP 1833/4	1024 x 8 ROM
HCMP 1852	I/O Adapter
HCMP 1853	3 to 8 Decoder
HCMP 1856/7	Bus Buffer/Separator
HCMP 1858/9	Memory Latch/Decoder
<b>AVAILABLE SUMMER '78—</b>	
HCMP 1822	256 x 4 RAM
HCMP 1851	Prog. I/O Adapter
HCMP 1854	UART
HCMP 1855	Multi/Div. Unit
HCMP 1861	TV Interface
NOVR 441	32 x 8 Non-Volatile RAM

THE NEW Hughes Semiconductor Products

**HUGHES**

HUGHES AIRCRAFT COMPANY  
MICROELECTRONIC  
PRODUCTS DIVISION

# Opening new frontiers with electro optics

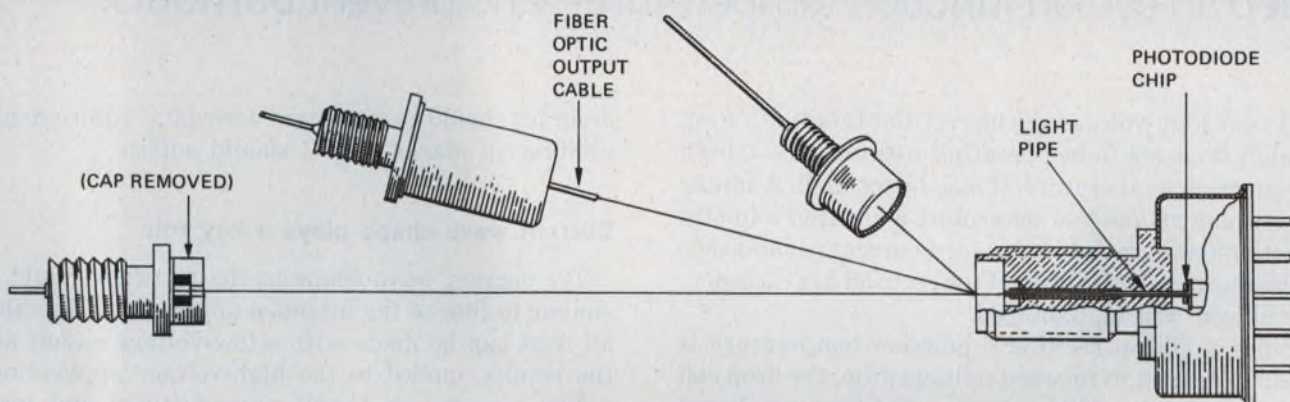

## In optical communications, RCA helps you at both ends of the line.

### Hi-speed IR emitters with removable caps for low-loss coupling.

With the cap off, you can bring your fiber or bundle right down into very close proximity to the 6-mil GaAlAs edge emitter to maximize coupling efficiency. Along with very high collection efficiency, you get 100 MHz min. analog bandwidth (C30119) or 40 MHz min. (C30123). Rated at up to 200 mA forward current for continuous operation and 1.5 A peak forward current for pulse operation, these devices are available from stock. Hermetically sealed version also available.

CIRCLE NUMBER 54

### IR emitters with output "pigtailed." We've done the coupling for you.

Here we've made your job even easier. You can now couple your fiber or bundle to a fiber optic cable extending 5 inches from the source. At the source end, we've already made an extremely efficient internal optical connection. Like the C30119, the C30133 emitter gives you 100 MHz min. analog bandwidth. It's rated at up to 200 mA forward current for continuous operation, 1 A peak forward current for pulse operation.

CIRCLE NUMBER 55

### Solid-state CW lasers: high power output for better coupling efficiency.

It takes less than a watt to get at least 5 mW of continuous lasing from these breakthrough solid-state lasers, which operate at room temperature. They have a rise time of less than 1 ns — allowing modulation rates well beyond 100 MHz. This plus small source size (13 x 2  $\mu\text{m}$  typical) and 820 nm wavelength make them especially well suited to single fibers as well as bundles. Choose either the C30130 (OP-12 package) or the C30127 (OP-4A package).

CIRCLE NUMBER 56

### Avalanche detectors now with integral light pipes for efficient coupling.

At the receiving end too, we make efficient coupling easy. With our silicon avalanche photodiodes you secure the fiber or bundle through a hole in a mating connector (also available from RCA) and screw down the sleeve. Our detectors C30903E through C30908E give you a choice of light-pipe diameters, .25mm to 1.25mm, providing broad spectral response ranges, 400 to 1100 nm typical. All offer fast response time (0.5 to 2 ns typical) and high quantum efficiency (typically 77% to 85% at 830nm). Also available: detector preamp modules and temperature compensation units.

CIRCLE NUMBER 57

If electro optics can solve your problem, remember: EO and RCA are practically synonymous. No one offers a broader product spectrum. Or more success in meeting special needs. Call us for design help or product information. RCA Electro Optics, Lancaster, PA 17604. Phone 717-397-7661. Sunbury-on-Thames, Middlesex TW16 7HW, England; Ste. Anne-de-Bellevue, Quebec, Canada; Sao Paulo, Brazil; Hong Kong.

# RCA

# Keep your rectifiers cool by calibrating and monitoring the forward voltage drop. This way you can keep an eye on junction temperature—and prevent burnouts.

If your high-voltage silicon rectifier is failing—even though it seems to be operating within specs—check the junction temperature. It may be too high. A simple measurement lets you determine a rectifier's in-situ junction temperature or forward-current capabilities. If the thermal capabilities of the rectifier are exceeded, the silicon will be damaged.

Since a silicon rectifier's junction temperature is linearly related to forward-voltage drop, the drop can serve as a monitor during testing. But first you should calibrate the diode voltage-temperature relationship. To do that, you'll need a temperature-test chamber and a constant-current supply with a control range of 1 to 5 mA.

Place the diode in the chamber, then measure and record the forward drop with a sensing current of approximately 1% of the normal operating current. If that value is too small to achieve a stable voltage reading, you can use a relay with a 99%/1% duty cycle, and a higher sensing current. Bring the chamber up to the rectifier's maximum operating junction temperature. Allow several minutes for the diode temperature to stabilize, apply the sensing current, and hold it for a few minutes to allow stabilization.

The sensing current won't be much—perhaps 1% of the normal operating current—so it will cause little internal junction heating. After the unit reaches stability, record the oven temperature and the forward voltage at the sensing current.

Select two or three oven temperatures, each at least 25 C below the last selection, and repeat the process. Plot the data obtained from these tests. The calibration curve you develop will help determine the thermal impedance.

Be sure to operate the test rectifiers in a draft-free atmosphere, and to monitor the ambient constantly about one inch away from the rectifier.

Fig. 1 shows a typical setup for running thermal impedance with the rectifier in air. The thermometer should be below the rectifier under test, and its

accuracy should be consistent with data requirements. Calibration marks of 1 C should suffice.

### Current wave shape plays a key role

The current wave shape in the rectifier should be similar to that of the intended application. Note that all tests can be made with a low-voltage circuit and the results applied to the high-voltage application.

Test circuits for a half-wave rectifier and for a single-phase, full-wave bridge are shown in Figs. 2 and 3. In both circuits, the sensing current and the simulated operational current can be applied simultaneously to the rectifier.

If the circuit doesn't permit simultaneous application, you must use a relay. With a relay, you can arrange the circuit so the rectifier operates 99% of the time with a current waveshape similar to that of the intended application, and the other 1% with the sensing current (Fig. 4). Don't forget to monitor the sensing current and voltage during the 1% calibration period.

Whether you use one of the circuits shown or a circuit of your own, the sense voltage will directly relate to the junction temperature. You can increase the simulated application current or ambient temperature by one step and hold the value until junction-temperature equilibrium is reached. Then go up one step. Repeat until the forward drop indicates that the junction has reached its maximum operating temperature. At that point, record the simulated application-current value and the forward-voltage drop during the simulated current wave.

### Getting the results

Now you can calculate the thermal impedance: Subtract the ambient temperature from the junction temperature to obtain a junction-to-ambient differential. Divide the differential by the power dissipated within the silicon to get the thermal impedance of the rectifier in °C per watt.

The added power drawn by the rectifier in blocking the high voltage can be subtracted from the forward-current power. This will reduce the forward-current limit to a safe level. (Note that switching losses, which

---

Walter Wills, Product Engineering Manager for High-Voltage Rectifiers, Varo Semiconductor, P.O. Box 676, 1000 N. Shiloh, Garland, TX 75040.

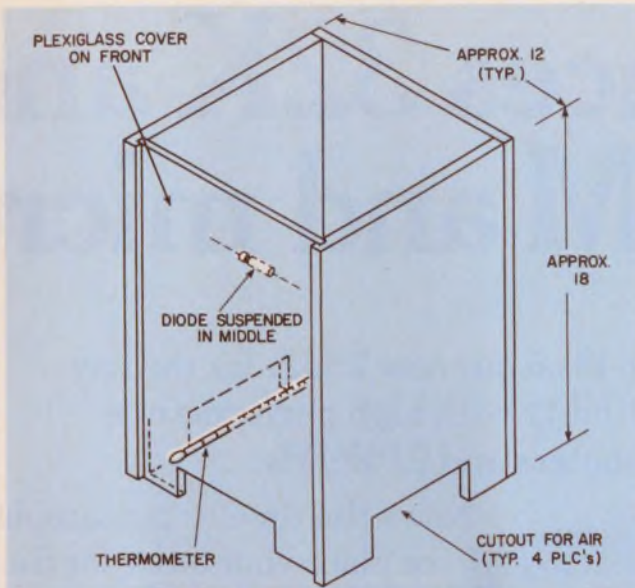

1. A rectifier test chamber for making thermal-impedance measurements in still air suspends the diode in the center and the thermometer beneath.

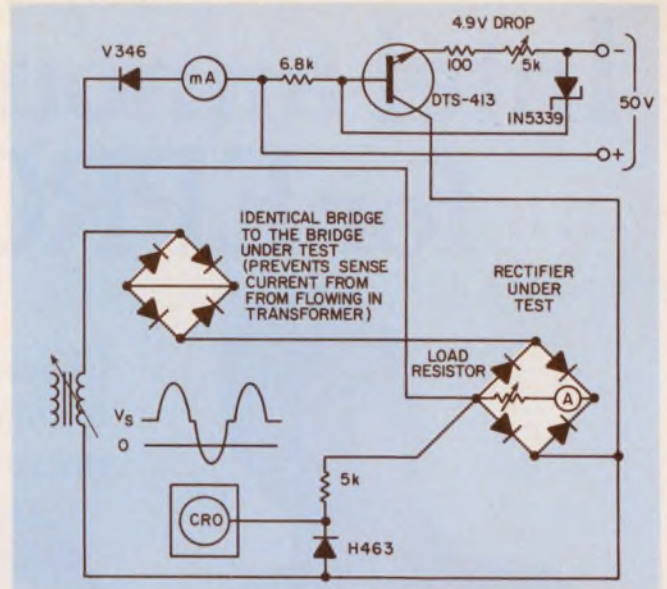

3. Acting like a full-wave bridge rectifier, this test circuit treats the diode as if it were in actual use in its intended circuit and applies sensing current as well.

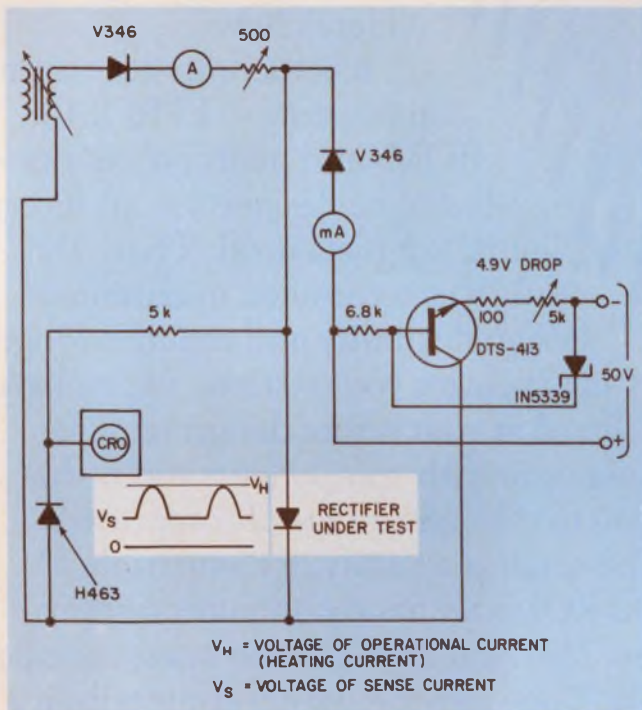

2. A typical test circuit for a rectifier intended for a half-wave-circuit application applies both sensing current and a simulated operational current.

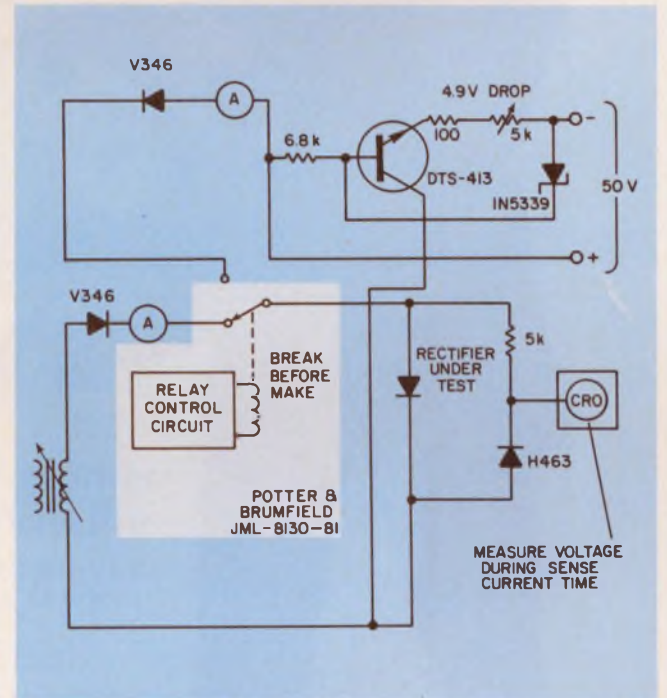

4. When sensing and operational currents can't be applied together, a relay arrangement switches to a sensing mode for 1% of the operating period.

may be significant, aren't included unless the simulated current wave shape includes such losses.) But bear in mind that thermal impedance may not be the main point of interest—it's usually the junction temperature during worst-case conditions.

If the rectifier is to be tested in an oven, you must keep the oven's air flow from cooling the rectifier package. Even small amounts of air flow add significant cooling, and this should be considered in light

of the rectifier's final application. If the rectifier is to have air flow, then the test circuit should approximate it as closely as possible, including the amount of turbulence.

All the thermal tests can be applied no matter if the rectifier is potted, in oil or in any other environment. And since you can test the rectifier in a simulated environment, you can select the best rectifier for your application. ■■

# Intel announces 32K and 64K for EPROM and micro



**Check Pin 18 on our new 2332. It's the key to compatibility with high performance microcomputers and EPROMs.**

Now's the time to get samples or place your order for the 2332 or 2364. They're our new 32K and 64K ROMs that will change the way you design your system. Here's how.

Microcomputer system components—EPROMs, ROMs and microprocessors—need to be designed as an integral unit, not piecemeal. That's the only way to provide maximum design flexibility and ensure a longer life cycle for your system. We've looked ahead at your future design requirements to provide you with components today that will enable you to take advantage of tomorrow's advances. The result is a family of compatible 5V EPROMs and ROMs for microcomputer systems.

Intel's new 2332 and 2364 are the latest members of that family. They provide system compatibility in three important ways.

First, these new ROMs have a guaranteed access time of 300 ns—fast enough to take full advantage of new, advanced microprocessors. To achieve 300 ns speed with low power dissipation, our parts are Edge-Enabled. That's where Pin 18 comes in. It provides the Chip Enable function necessary for the internal clock circuitry.

# 64K ROMs designed computer compatibility.

Second, the 2332 and 2364 are compatible with our 2716 industry-standard 16K EPROM and will be compatible with our 32K EPROM when it is introduced. Again, Pin 18 is the key. Note that Pin 18 performs the same power control function on all devices. So you can prototype with EPROMs and go directly to high density ROMs for production.

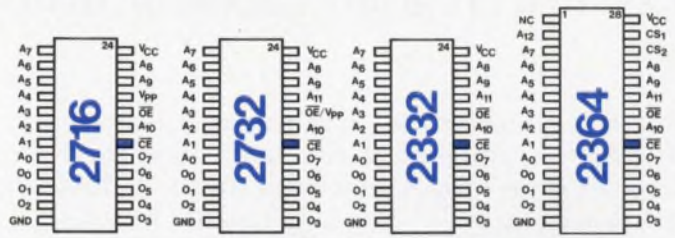

	16K EPROM	32K ROM/EPROM	64K ROM
Organization	2K x 8	4K x 8	8K x 8
Active Icc (max)	100 mA	40 mA	40 mA
Standby Icc (max)	25 mA	15 mA	15 mA
Access Time (max)	350-450 ns	300 ns	300 ns

Engineering the 2332 and 2364 for microcomputer system compatibility led us to the third important advance—the end of bus contention problems. In new multiplexed microprocessor systems, such as the MCS-85 and MCS-86, the Output Enable (Pin 20) needs to be independent of the Chip Enable (Pin 18) which is the power control and selection function. So the 2332 and 2364 have an Output Enable ( $\overline{OE}$ ) for independent control of the data bus, with no possibility of multiple device selection. And input latches on all Edge-Enabled devices allow direct interface with new multiplexed microprocessors.

Low power is essential to meet today's design requirements. We've achieved low power in our 32K and 64K ROMs that can't be matched by fully static parts. Active current of the 2332 and 2364 is 40 mA (maximum). And Intel's Edge-Enabled devices have the added benefit of using Pin 18 for the power control function. So standby current is automatically reduced to 15 mA (maximum).

To get complete details on this important and complex subject, send for our 2332/2364 applications note AP-30, "Applications of Intel's 5V EPROM and

ROM family for microcomputer systems." It provides board layout recommendations, system design applications, timing diagrams, function explanations and discusses PL/M modular software compatibility. Write: Intel Corporation, Literature Dept., 3065 Bowers Avenue, Santa Clara, CA 95051.

Or for samples of these new parts, contact your local Intel representative.

**intel delivers.**



CIRCLE NUMBER 58

Europe: Intel International Corporation S.A., Rue du Moulin a Papier, 51-Boite 1, B-1160, Brussels, Belgium. Telex 24814.  
Japan: Intel Japan Corporation K.K., Flower Hill-Shinmachi East Building 1-23-9, Shinmachi, Setagaya-ku, Tokyo 154. Telex 781-28426

## Analyze, don't estimate, phase-lock-loop

performance of type-2, third-order systems. You can do the job with a programmable-calculator in 48 steps, or less.

Phase-lock loops certainly have many uses, especially in frequency synthesizers, but exact mathematical calculation of their transfer functions is difficult. This is particularly true for type-2, third-order systems (Fig. 1), which don't produce steady-state phase errors for step-position or velocity signal inputs. However, a small programmable calculator, the HP-25, easily—and exactly—determines the complete loop transfer function in 48 steps. In addition, the program data reveals the noise reduction you can expect for the loop's voltage-controlled oscillator (VCO), as well as the loop's stability.

Most other design approaches must resort to second-order loop approximations to simplify calculations; a more exact method manually would take too long.

Unlike a type-1 loop, a type-2 loop has two *true* integrators within the loop—a VCO and an integrator/filter after the phase detector. Replacing the integrator/filter with a passive-RC, low-pass filter results in the more common type-1 response, which doesn't have the phase coherence for step and velocity inputs between the two signal inputs to the phase comparator that the type-2 has.

Moreover, a third-order loop—the order is usually determined by the transfer function of the integrator/filter ( $F(s)$ )—can reduce VCO noise substantially, without increasing reference-frequency sidebands in the output signal. These sidebands hamper simpler loop-circuit performance.

The transfer function of a generalized phase-lock loop can be represented as follows (Fig. 2):

$$\frac{\theta_o(s)}{\theta_i(s)} = \frac{G(s)}{1 + G(s)H(s)} \quad (1)$$

where, from Fig. 1

$$G(s) = (K_p)(F(s))(K_v/s) \quad (2)$$

$$\text{and } H(s) = 1/N. \quad (3)$$

The phase comparator transfer function is  $K_p$  and  $N$  is a digital counter/divider factor.

A typical integrator/filter built around an op amp (Fig. 3) has a transfer function determined by the amplifier-circuit's closed-loop gain,

$$A_{CL} = -\frac{Z_f}{Z_i}$$

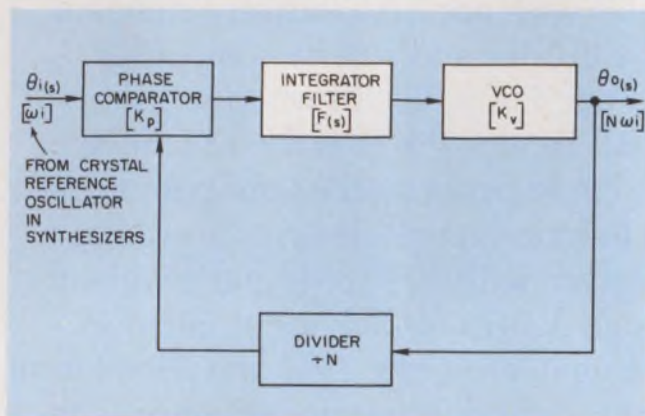

1. A type-2 phase-lock loop has two true integrators—the integrator/filter ( $F_s$ ) and the VCO ( $K_v$ ). Replacing the integrator/filter with a passive-RC network converts the circuit to a type-1 system.

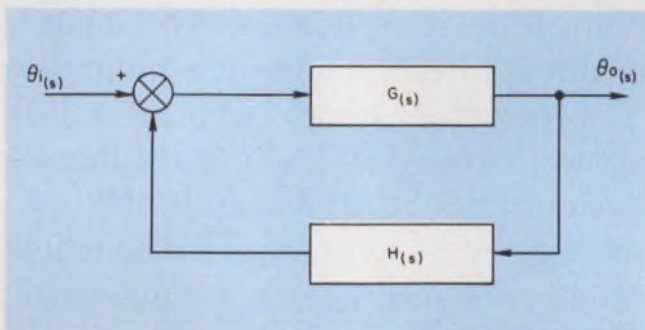

2. The phase-lock loop's generalized open-loop transfer function,  $G(s)H(s)$ , has a third-order denominator—from which the circuit's name is derived.

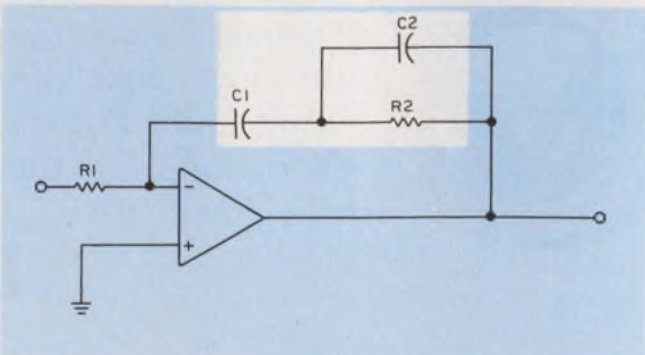

3. An integrator/filter circuit can be built with a wideband op amp and RC feedback network.

Andrzej B. Przedpelski, Vice President of Development, A.R.F. Products Inc., 2559 75th St., Boulder, CO 80301.



**Table 1. Third order type-2 PLL**

Display		Key Entry	Remarks	Registers
Line	Code			
00				R <sub>0</sub>
01	1573	(g)π		
02	61	x		
03	02	2		R <sub>1</sub> T <sub>1</sub>
04	61	x		
05	2307	STO7		
06	2403	RCL3		R <sub>2</sub> T <sub>2</sub>
07	61	x		
08	01	1		
09	1509	(g)→P		R <sub>3</sub> T <sub>3</sub>
10	2304	STO4		
11	22	R↓		
12	2402	RCL2		R <sub>4</sub>
13	2407	RCL7		
14	61	x		
15	32	CHS		R <sub>5</sub> $\frac{K_p K_v}{N}$
16	01	1		
17	32	CHS		
18	1509	(g)→P		R <sub>6</sub>
19	2404	RCL4		
20	71	÷		
21	2405	RCL5		R <sub>7</sub>
22	61	x		
23	2401	RCL1		
24	71	÷		
25	2407	RCL7		
26	1502	(g) x <sup>2</sup>		
27	71	÷		
28	2304	STO4		
29	1408	(f) log		
30	02	2		
31	00	0		
32	61	x	G <sub>jω</sub> H <sub>jω</sub>	
33	74	R/S		
34	22	R↓		
35	21	x ≥ y		
36	41	—	∠ θ	
37	74	R/S		
38	2404	RCL4		
39	1409	(f)→R		
40	01	1		
41	51	+		
42	1509	(g)→P		
43	1522	(g)1/x		
44	1408	(f) log		
45	02	2		
46	00	0		
47	61	x	e/en	
48	1300	GTO 00		
49				

where  $Z_1 = R_1$  (4)

$Z_f =$  impedance of feedback network

The transform of the feedback network is

$$Z_f(s) = \frac{s(C_1+C_2) + \frac{1}{R_2}}{sC_1(sC_2 + \frac{1}{R_2})}$$
 (5)

and the integrator/filter transfer function is then

$$F_{(s)} = - \frac{s(C_1+C_2) + \frac{1}{R_2}}{C_1R_1(sC_2 + \frac{1}{R_2})}$$
 (6)

Multiply Eq. 6 by  $R_2/R_2$ , then

$$F_{(s)} = - \frac{s(C_1R_2+C_2R_2)+1}{sC_1R_1(sC_2R_2+1)}$$
 (7)

or

$$F_{(s)} = - \frac{sT_2+1}{sT_1(sT_3+1)}$$
 (8)

where

$$\begin{aligned} T_1 &= R_1C_1 \\ T_2 &= R_2(C_1 + C_2) \\ T_3 &= R_2C_2 \end{aligned}$$

The open-loop transfer function of Fig. 2 is  $G_{(s)}H_{(s)}$ ; therefore, from Eqs. 2, 3 and 8

$$G_{(s)}H_{(s)} = \frac{s(T_2)(K_pK_v) + K_vK_p}{s^3NT_1T_3 + s^2NT_1}$$
 (9)

Note the third-order denominator, from which the circuit's name—third-order-loop—is derived. Note also the deletion of the minus sign: the circuit configuration (a phase inverter) provides the negative feedback. Both  $K_p$  and  $K_v$  are positive.

If you substitute  $j\omega$  for  $s$  in Eq. 9, you can get the equation for plotting the magnitude and phase of the circuit's open-loop gain as a function of frequency:

$$G_{(j\omega)}H_{(j\omega)} = - \frac{j\omega(T_2)(K_vK_p) + K_vK_p}{j\omega^3NT_1T_3 + \omega^2NT_1}$$
 (10)

Step	Instructions	Input Data/Units	Keys	Output Data/Units
1	Enter program			
2	Store	T <sub>1</sub>	R <sub>1</sub> ENTER	
		C <sub>1</sub>	X STO 1	
		T <sub>2</sub>	C <sub>1</sub> ENTER	
		C <sub>2</sub>	+ STO 2	
		R <sub>2</sub>	X STO 2	
		T <sub>3</sub>	R <sub>2</sub> ENTER	
		C <sub>2</sub>	X STO 3	
		(K <sub>p</sub> K <sub>v</sub> )/N	K <sub>p</sub> ENTER	
		K <sub>v</sub>	X	
		N	= STO 5	
3	Calculate	F	(f) PRGM/R/S	G <sub>jω</sub> H <sub>jω</sub>
			R/S	∠ θ
			R/S	(e/en)
4	Repeat step 3 for other values of frequency. F			

**Table 2. Calculated loop response**

Frequency Hz	Open-loop response		Loop response to VCO noise dB
	dB	/θ	
100	116.01	-179.94	-116.01
1000	76.01	-179.44	-76.01
10,000	36.06	-174.44	-35.92
94,650	0*	-139.85	3.27
100,000	-0.71	-138.58	3.30**
1,000,000	-26.25	-139.59	0.32
10,000,000	-63.21	-174.68	0.01

\*Unity-gain point    \*\*Maximum overshoot

A servo-loop damping factor that appears in lower-order loops is not defined in third-order loops. Instead you determine stability by the phase margin between -180° and the phase at a frequency where the gain is unity in the open-loop gain function,  $G_{j\omega}H_{j\omega}$ . The larger the phase margin, the more stable the system. A phase margin of about 45° produces an adequately damped loop. More than 45° means greater stability and, of course, the system may oscillate when the margin approaches zero.

**Feedback also reduces noise**

Not only does feedback determine the system's stability, but it also delineates its noise-output characteristics. When running free, the VCO is considerably more "noisy" than is the circuit's reference crystal oscillator. But the circuit's feedback loop substantially reduces the VCO's output-noise spectrum, especially, at low frequencies. This particular reduction is fortunate, because the VCO's noise output has 1/f characteristics: high-frequency noise tends to fall off without outside help, but the low frequency needs the help.

An approximate expression for the loop's output phase noise is

$$\sqrt{[(|e/e_n|)(e_c)]^2 + [(N)(e_x)]^2} \tag{11}$$

where  $e_x$  = crystal-oscillator noise.  
 $e_c$  = VCO noise.

$(e/e_n)$  = loop's response to VCO noise.

And the loop's response to the VCO noise is

$$(e/e_n) = \frac{1}{1 + G_{(s)}H_{(s)}} \tag{12}$$

Although  $G_{(s)}H_{(s)}$  determined from Eq. 9 is complex, only the magnitude of  $(e/e_n)$  from Eq. 12 is used in Eq. 11. Note: The greater the open-loop transfer function,  $G_{(s)}H_{(s)}$ , the smaller the  $(e/e_n)$ , and the lower the loop's output noise. However, note also that the reference crystal oscillator's noise contribution is multiplied by the divider constant, N, though, hopefully, the crystal-oscillator noise is low.

In addition, you can get a check on the system's stability by plotting the loop's response to VCO noise  $(e/e_n)$ , obtained from Eq. 12, versus frequency. You'll find that the curve has a high-pass response with a 12-dB/octave slope. For best stability, any overshoot at the cutoff frequency should be less than 6 dB. Of

course, lower overshoot represents higher stability.

Clearly, the loop's mathematical analysis depends mainly upon calculation of  $G_{(j\omega)}H_{(j\omega)}$  in Eq. 10.

**Now comes the program**

To make the calculator program simpler, rewrite Eq. 10 as follows:

$$G_{(j\omega)}H_{(j\omega)} = \frac{K_v K_p}{NT_1\omega^2} \left[ \frac{-j\omega T_2 - 1}{j\omega T_3 + 1} \right] \tag{13}$$

Table 1 contains the program that solves Eq. 13. It provides both the magnitude and phase angle,  $\angle\theta$ , of the open-loop response,  $G_{(j\omega)}H_{(j\omega)}$ , given  $T_1$ ,  $T_2$ ,  $T_3$ ,  $K_p K_v/N$  and frequency,  $f(\omega=2\pi f)$ . The open-loop response magnitude is given in dB and its phase in degrees. Also, the magnitude of the loop's VCO noise response (Eq. 12) is given in dB. If answers in dB aren't required, however, seven steps can be eliminated.

To see how the program works, consider a 960-MHz transmitter recently proposed for a Navy application. It calls for a phase-lock loop with the following characteristics to generate the 960 MHz:

- N = 64
- $R_1 = 10,000 \Omega$
- $C_1 = 4700 \times 10^{-12} F$
- $R_2 = 330 \Omega$
- $C_2 = 470 \times 10^{-12} F$
- $K_p = 0.25 V/rad$
- $K_v = 3 \times 10^9 (rad/s)/V$

The stable crystal-oscillator reference frequency used is 15 MHz. The frequency divider and phase comparator are built with ECL logic. From the circuit component values and transfer constants we obtain:

- $T_1 = 4.7 \times 10^{-5} s$
- $T_2 = 1.706 \times 10^{-6} s$
- $T_3 = 1.551 \times 10^{-7} s$

$$(K_v K_p)/N = 11.72 \times 10^6/s$$

The calculator program provided the results in Table 2. Note that the phase margin at unity gain corresponding to 94,650 Hz is 40.15°; thus the loop is fairly stable. Further, the loop's response to VCO noise shows a maximum overshoot of 3.30 dB at 100,000 Hz, which confirms the loop's stability (less than 6-dB overshoot). If the phase margin is too small or you want overdamped loop operation, the program allows you to check the effects of parameter changes and get the performance you want, quickly. However, keep all additional circuit poles above the area of interest, since they reduce phase margin and stability. In addition, don't ignore the effects of stray capacitances. And use a high-gain op amp with a wide frequency response and a VCO with a wide modulation bandwidth. ■■

**Bibliography**

- Dorf, R. C., *Modern Control Systems*, Addison-Wesley Publishing Co., Reading, MA, 1967.
- Gardner, F. M., *Phaselock Techniques*, John Wiley & Sons, Inc., NY, 1977.
- Phase-Locked Loop Data Book*, Motorola Semiconductor Products, Inc., Second Edition, August, 1973.
- Stout, D. F., and Kaufman, M., *Handbook of Operational Circuit Design*, McGraw-Hill Book Co., NY, 1976.

# abbott

## POWER SUPPLIES

### Come to the specialist.

We started out pretty small back in '61. But we were big on product quality and reliability. Had to be. Uncle Sam was our only customer. Over the years we stuck with our own technology. We grew. Became specialists. And we kept on improving our power supplies.

It all paid off. Just look at Abbott today.



**Militarized Power Supplies** — Our early bread-and-butter line has grown to over 1500 versions. Some we stock. Yet we're equipped to provide fast delivery on any number of high efficiency, hermetically sealed, single or dual output power supplies and switcher modules. That includes our popular 60 and 400Hz and DC versions with outputs from 3VDC to 740VDC, 1 to 250 Watts. And prices go as low as \$174 for 2-4 units.

**For Catalog Circle Card Number 90**



**Industrial Power Supplies** — Ours isn't a big line yet — only 279 models. But you won't find a better quality of OEM power modules anywhere. (It's just our hi-rel way of thinking.) We provide covered/open frame, AC to DC single, dual and triple output versions, with outputs of 5 to 36VDC, 0.5 to 320 Watts. Plus DC to AC converters with 50 to 60Hz outputs. Competitively priced? You bet. As low as \$35 for up to 24 units.

**For Catalog Circle Card Number 91**



**Transformers** — For the do-it-yourself power supply designer who wants our kind of quality for his own military, industrial and pcb application. If you're one of them, we offer over 800 standard transformers, with instructions on how to specify for your custom units. Included are 60 and 400Hz, single phase input versions. Prices start as low as \$5.10 for up to 9 pieces.

**For Catalog Circle Card Number 92**

See Power Supply Section 4000, and Transformer Section 5600, Vol. 2, of your EEM catalog; or Power Supply Section 4500, and Transformer Section 0400, Vol. 2, of your GOLD BOOK for complete information on Abbott products.

**abbott transistor**

**LABORATORIES, INCORPORATED**

General Offices  
5200 W. Jefferson Blvd., Los Angeles 90016  
(213) 936-8185 Telex: 69-1398

Eastern Office  
1224 Anderson Ave., Fort Lee, N.J. 07024  
(201) 224-6900 Telex: 13-5332



## Build hardware that keeps working.

Right along with functional performance, design the reliability and maintainability into your equipment.

Take care of your system's reliability and maintainability early—even as you design the logic and circuits. You can't start too soon or make the hardware trouble-free enough or too easy to service—especially in computers and related peripherals.

Once the equipment goes into use, excessive down time can damage your reputation. And hurt your customer's business. Equipment failures cost rightfully irate computer users more than just the time and charges for the repairs themselves. Error-recognition time, waiting-for-service time, retry time, system-reconfiguration time and the inefficiencies of abnormal operation all add to the bill, even when troubles are fixed quickly.

To reduce the failure rate (FR) of your hardware:

- Reduce the number of components—except where judicious redundancy lowers the FR.
- Derate components—but
- Don't underrate.
- Select low-FR components.
- Reduce temperature stresses: if necessary, provide cooling.
- Protect wire insulation.

Occasionally, even the best components fail or suffer damage. Then, your equipment should be easy to maintain. And it will be, if you provide the three major aids:

1. Planned packaging for easy access using

- functional modules;
  - servicing-oriented cabling,
  - cable routing,
  - quick-disconnect cable terminations; and
  - well-identified components.
2. Error indication and detection using
    - LEDs, for long life;
    - sense bits;
    - test points;
    - trapping circuits, for transient errors.
  3. Support documentation.

Well-designed packaging is the prime ingredient. Every component, no matter how good, should be easily accessible. But this is often easier said than done. An equipment's size, shape and (as in mobile equipment) weight, often constrains the packaging designer. Most often, the box size dictates the size of the components that go into it.

But when it's just a question of aesthetics, "form follows function." Use pluggable modules (field-replaceable units) whenever possible. For one thing, they speed malfunctioning equipment back into operation. Also, FRU substitution quickly isolates a problem to the level of the malfunctioning module.

### Keep things simple

Modules should be small and functionally simple. Put a test point at each functional branch. Though fault isolation is fastest with equipment made of the fewest FRUs, don't make your FRUs too large. Every component increases both the failure rate and cost of its FRU. Cram too many components in, and you'll

---

Henry B. Cary, Advisory Engineer, IBM General Products Div., San Jose, CA 95193.



1. **Slip-on terminals** that make secure connections can help save servicing time and money. In general, these

terminations should be used only on dc lines and not for high voltage or for currents over 15 A.

2. **PC-board connectors**, like this one from Amphenol, provide small probe-access holes so that the pins can be monitored while the board is in place. The malfunctioning system then becomes its own test bed.



have an expensive FRU that must be replaced often.

But if you must use large and densely populated modules, make sure each component has a very low failure rate, so that the over-all FRU performs reliably. These low failure-rate components are, of course, expensive. To make matters worse, such modules are hard (and costly) to test during production.

Problems, right? Here are the solutions. Isolate components with high failure rates from the other modules. Put troublesome components on small, low-cost, single-function FRUs.

The same goes for wiring. Hand-wired circuits tend to fail more often than printed circuits. If your equipment needs both hand and PC wiring, try to put each kind into its own FRU.

Design your cable routings while laying out components, not after. Don't put off to the last minute the design of your cabling and then just stuff the cables

into whatever space is left. Design your cable layout early and you'll be much better able to do so.

- Separate ac and dc wiring.
- Twist and/or shield internal ac lines.
- Minimize ac-wiring length.
- Isolate signal and power lines.
- Provide only a single ground-return point in the power-distribution system.
- Limit cables to only a single function, when cost allows.

But of course, like components, wiring can malfunction. Field-service technicians will smile if they find that you've installed brightly and distinctly-colored wires in discrete cables. Then they won't have to spend so much time tracing. Along the same line, try to put in several small cables instead of a single large one. Small cables help with tracking and aid isolation.

Don't let unplugging a cable—say, while isolating a fault—cause multiple functions to fail. Try to keep the signals for one function in one cable. And, to protect against misplugging cables that are close together, use different or keyed connectors. For single-wire terminations use slip-on spade terminals (Fig. 1) but never for ac power.

### Do not disturb

With discrete-wire cables, use connector housings or termination hardware like those in Figs. 2 and 3. These provide for test-probing the wire terminals without unplugging the connector. For even more checking capability, make terminal blocks and the terminal sides of circuit protectors readily accessible. Not only will you have an easier time testing, you will be able to eliminate some on-board test points.

Cables contribute heavily to those annoying "no trouble found" service calls. In fact, intermittent faults in cables have been responsible for some of the longest calls. Flat signal cables are notorious. To reduce the possibility of these intermittents, make sure that the flat cables are and remain seated.

But be careful. Holding cables in place with one-time ties often leads to servicing problems. Ties must be cut to install engineering changes or to allow fault tracking or cable tracing. Once the ties are cut they're gone forever—and the cables are left exposed.

The thing to do is anticipate. Make your cables long enough so they can be routed away from hazards. Stretching or pressing cables against sharp frame members can mean trouble. When pressed or



3. **Quick-disconnect-type connectors** from AMP mate a PC card to a cable and provide test-probe holes so the cable can be accessed while it is connected to the circuit.



4. **Exposed insulated wire** can short to the equipment frame due to "cold flowing" of the insulation. Pressing,

pinching or stretching the wire can cause this fault—often the source of troublesome intermittent failures.

squeezed, wire insulation can "cold flow," which eventually leaves an uninsulated spot as in Fig. 4. Then the wire is free to contact the frame, and cause a ground in that circuit.

But this doesn't happen all at once. The ground usually develops gradually enough that a system experiences trouble intermittently. These fitful problems are as hard to isolate as they are annoying.

Be careful when routing cables that are subject to motion. Another source of intermittent failure is weakened or fractured wires and bonds due to undue flexing. Allow adequate flexing plus secure restraints.

For circuit tracing, not only should wiring be identified clearly, but all components as well. Labels or locating decals will do the trick. Of course, the callouts on the parts and in the support documentation must be the same.

Complete and easy-to-follow support documentation should clearly identify all FRUs, test points and cable connectors. Termination points such as terminal blocks, edge connectors and ground points should be included in a complete documentation package.

But even the easiest-to-service equipment isn't satisfactory if it needs servicing constantly. Make your easily-maintainable system reliable as well.

### A stitch in time

The key to highly reliable equipment is highly reliable FRUs. To make them reliable, minimize the number of parts used for each function. Specify the components you do use so they operate well-below their rated values. This applies to all stress-sensitive parts, whatever the stress—temperature, voltage, current or power. Power-handling is usually critical for inductors, transformers and resistors; voltage for capacitors; and temperature for solid-state devices. You can usually find life-expectancy versus rated-stress data on component-specification sheets.

Resistors, run at 50% of rated power, last, on an average, seven-times longer than those run at 100% (see Table 1). And this applies to resistors of various compositions, including the popular carbon, wire-wound and deposited-carbon types.

Capacitors that must withstand only 50% of their rated voltages last from 6 to 14 times longer than units under 100% of rated voltage (Table 2). To appreciate the dramatic increase in life expectancy for silicon transistors and diodes as the junction temperatures

drop from 75 to 25 C, look at Table 3.

To get "life-of-the-machine" reliability, derate all LEDs. To prolong LED life even further, keep them cool. The cooler, the better.

Don't forget to derate incandescent lamps. Reducing the drive to a 28-V rated lamp just to 24 V can increase its life as much as six times. And brightness isn't noticeably affected by the decreased drive.

### Too much of a good thing

Derating, like all virtues, can be carried too far. Some components suffer when underrated—relays are an excellent example. Indeed, being overcautious with relay-contact current can cause more insidious problems than operating at the upper limit. Relay contacts, rated for 2 A but operated at just 50 to 250 mA, often show a marked increase in contact resistance early in life. Interestingly enough, these same contacts often perform well when operated in the low- $\mu$ A (dry-circuit) range—even for long periods.

This current sensitivity comes from arcing, but only in one current range. Arcing causes resistive organic film to build-up on the points; and milliamps aren't enough to break the film down. But in the low-microamp range, arcing is too small to cause significant film growth, so the contact resistance remains low. For low-reliability zones, unfortunately, the data aren't normally published.

Another matter that ordinarily won't get much attention is redundancy. After all, extra parts do cost money. Right? Not always. Or not as much as you think. Spare relay contacts are often available for free. And paralleling the points of critical sequencing paths, say in the power-distribution, can avoid trouble.

For a very small additional cost, redundant diodes sometimes pay off handsomely. Moreover, at little or no extra cost, one function or path can be paralleled by a more basic one at little or no extra cost. This way, equipment sometimes can deliver some performance, albeit degraded, despite a failure.

### Less is more

Component failure is, after all, the enemy of performance. Surprisingly then, an obvious method for raising system reliability—replacing high-FR units with lower-FR ones—is often overlooked. Don't assume that you must always use complex components

**Table 1. Normalized random failure rate percentages** for various types of resistors, coils and transformers as a function of power stresses at 25° C.<sup>1</sup>

Percent rated power	Percent of failures at rated power			
	Resistors			Inductors and transformers
	Deposited carbon	Wire-wound	Carbon composition	
10	3.0	3.3	2.5	13.0
20	4.5	5.0	4.0	16.0
30	6.6	7.5	6.0	20.5
40	10.0	10.5	9.0	26.0
50	14.0	15.5	13.5	32.5
60	21.5	22.2	20.5	40.5
70	31.0	32.5	30.0	51.5
80	46.0	47.0	46.0	63.5
90	66.6	70.0	68.0	80.0
100	Use component failure rates for rated power			

**Note:** For each 10-C rise in operating temperature:  
 Multiply the carbon-composition and wire-wound resistor failure rates by 2.0.  
 Multiply the deposited-carbon resistor, and the inductor and transformer failure rate by 1.5.

**Table 2. Normalized random failure rate percentages** for various types of capacitors as a function of voltage stresses at 25° C.<sup>1</sup>

Percent of rated voltage	Percent of failures at rated voltage			
	Mylar	Mica	Ceramic	Paper, polystyrene and high-stability
10	1.0	2.0	3.0	0.5
20	1.5	3.0	4.5	1.0
30	3.0	5.0	7.5	2.0
40	5.0	7.5	11.5	4.0
50	9.0	12.0	16.0	7.0
60	15.0	19.0	24.0	13.0
70	24.5	29.0	34.0	22.0
80	42.5	44.0	50.0	37.0
90	63.5	67.5	71.5	61.0
100	Use component failure rates for rated voltage			

**Note:** Multiply all capacitor failure rates by 1.6 for each 10-C rise in operating temperature.

**Table 3. Normalized random failure rates** of silicon transistors and diodes as a function of junction temperature stress.

Junction Temperature	Cumulative failures per 10 <sup>6</sup> hours	
	Transistors	Diodes
25	0.7	0.09
30	1.0	0.13
35	1.4	0.19
40	2.0	0.27
45	2.8	0.40
50	3.9	0.57
55	5.5	0.82
60	7.8	1.20
65	11.0	1.70
70	15.5	2.50
75	22.0	3.60

or assemblies, which have a greater tendency to fail.

For example, where the system permits, use unregulated rather than regulated power supplies—and as few supplies as possible. For reliability, the ideal is one unregulated supply for all the system's power. Similarly, examine all close-tolerance components with an eye to using units, with looser specifications.

Another way to prolong the life of just about every system component is to remove all excess heat. Internally-generated heat, if allowed to stagnate, raises component operating temperature. And high operating temperature usually compounds operating stresses in all electrical components.

The effect of temperature on semiconductor life is dramatic. The failure rate of power transistors doubles for each 10-C increase in junction temperature (Table 3). The useful life of LEDs falls sharply with high-temperature operation. ICs are susceptible to large changes in substrate temperature. With a 40-C rise in substrate temperature, the failure rate of the bonding to I/O pads in some LSIs may increase as much as 10 times.

Cooling, then, is often the answer. But you've got to do more than just blow air past or through the various subassemblies. When designing either the FRUs or a complete system, make sure you place your power transistors, LEDs, ICs and other temperature-sensitive components in the coolest possible environment. Do not put them near heat-generating devices or in an area where the air is dead.

### Nothing's perfect

Even with the best components, derating and proper cooling, there will be failures—though fewer, of course. Design-in error-indication and detection features and problems can be isolated quickly and down time shortened. In addition, work-in error-trapping circuitry and address-tracing aids, which you'll need, to reduce the number of "no trouble found" calls.

To make your equipment much easier to service, especially the power-distribution system, use the following:

- LEDs to indicate each successive step of a sequence, especially the sequence for power turn-on. Provide a separate indicator LED that shows if each voltage is on or off. This is a logical extension of the generally-accepted practice of using separate indicators for main-power on, dc on, and ready.

- Sense bits to indicate power failures, particularly where partial power on can make the machine appear to be operating normally. For example, sense the special voltages for servo functions, read/write circuits and biasing.

- Latches and manual resets to trap faults that cause a machine to go down.

- Test points at functional-decision branches of the logic. Make test points easily accessible so that all FRUs can be checked—especially those that are enclosed or give no visible or audible indication than their operation is other than normal. ■■

# Discover the Caribbean with the ships that discovered the Caribbean.

The tall ships. Sleek sailing vessels out of another age. Ships which were the prized personal schooners of the millionaires Onassis, Vanderbilt and the Duke of Westminster.

Now, you can sail them through the mystical Caribbean. To well-known islands as Nassau, Antigua and St. Maarten. And to places the 12 story oceanliners never touch.

To magic islands with names like Saba, Corrácoi, Anegada, Bligh's breadfruit isle, Stevenson's Treasure Island. They are all here, waiting to be discovered again. With unforgettable beaches, forgotten forts, hushed volcanoes, picturesque towns and our island friends.

Join us in your barefeet, bikinis, or shorts. Start off with your morning eye opening Bloody Mary or a hot steaming cup of coffee, and brace yourself for a day unlike any on earth. This is the sea.

A special place of rainbows, iridescent sunsets, living reefs, rainbow fish and pink and white sand beaches.



Now comes the night at sea. The silence broken by the throb of steel drums, merangue, calypso, reggae, all under an exotic Caribbean moon.

This is a Windjammer adventure like no other on earth. Join our voyage for 6 or 14 glorious, uncomplicated days aboard the tall ships. You can share for only \$300. Send the coupon for your free 'Great Adventure' booklet.

And get ready to put a lot of living in your life.



Break bread with a great bunch of guys and gals. Gorge yourself with hearty home cooked meals, washed down with evening wine.



**Windjammer 'Barefoot' Cruises**

P.O. Box 120.

Miami Beach, Florida 33139. 305/672-2213.

Cap'n Mike, Windjammer 'Barefoot' Cruises, P.O. Box 120, Dept. No. 831, Miami Beach, Florida 33139.

I'm ready. Send my free color 'Great Adventure' booklet.

Name \_\_\_\_\_

Address \_\_\_\_\_



# NOW

## A magnetic circuit breaker smaller than the others!



### Airpax T11 Snap-Action Magnetic Circuit Breaker.

Just think of the design possibilities. Here's a magnetic circuit breaker that combines power switching and circuit protection in one tiny package — about 1 cubic inch! That's smaller than any other magnetic breaker.

**Smaller Price Tag, Too.** With all its advantages, the T11 sells for under \$5.00 in small quantities. And, of course, the price goes down even further as the quantity increases.

**Replaces Three Conventional Components.** The T11 does the job of a power switch, fuse, and fuse holder — all in one tiny package — with immediate resetability. In addition, it can be operated at either dc or 50/60Hz, eliminating the need to specify, order, and stock separate units.

**Patented Snap-Action.** The T11 is the only small magnetic circuit breaker with snap-action for immediate and positive opening or closing of the contacts. This snap-action results in an increase in operational life of up to 5 times that previously available. It also eliminates possible operator "teasing" of the contacts and minimizes arcing.

**Enhances Panel Appearance.** With a choice of six attractive handle colors and a variety of mounting hardware, the T11 blends well into any panel color scheme and layout.

**Five-Year Warranty.** As with all Airpax breakers, the T11 has a five-year warranty.

**Current Ratings.** From 0.100 amperes to 20 amperes, 32V dc; 15 amperes, 120V ac, 50/60Hz; and from 0.100 amperes to 7.5 amperes, 50V dc, 250V ac, 50/60 and 400Hz.

**U.L. Recognized.** The T11 is one of the first circuit breakers to be recognized under the new U.L. Std. 1077.

**Details Available.** For further information on the new T11 snap-action magnetic circuit breaker, call your local Airpax representative or contact Airpax Electronics, Cambridge Division, Cambridge, Md. 21613. Phone: (301) 228-4600. Telex: 8-7715. TWX: 865-9655. Other factories in Europe and Japan.

# AIRPAX™

## THE PRO IN PROTECTION

CIRCLE NUMBER 59

## Avoid losing data when line power returns to a battery-backup RAM system

Line-operated systems with semiconductor RAMs that must retain their contents when power goes off use a battery to provide standby power. Sometimes, however, data in the RAM can be disturbed when power returns. Here's a circuit that ensures that when power comes back on, memory contents won't suffer.

A typical backup circuit includes gates powered by the RAM supply. The output of the power-on reset circuit should block stray write and select signals at these gates. Some reset-circuit designs, however, produce a premature output that coincides with the rising supply voltage and is high enough to enable the gates, which then pass stray signals on to the RAM.

The problem crops up in power-on reset circuits that use an active pull-down transistor at the output. Why? Because the output transistor generally isn't turned on until the supply reaches 3 V or so.

The improved circuit in Fig. 2 uses resistor  $R_8$  as a passive pull-down to keep the output low until the power-supply voltage is high enough to pull the output up solidly.

When power turns on,  $R_1$  and  $C_1$  delay the voltage rise at  $Q_1$ 's base. Transistor  $Q_1$  turns on when its base reaches a threshold, which is one base-emitter diode drop above the voltage set by divider  $R_2$ - $R_3$ . Once  $Q_1$  turns on, it turns on  $Q_3$ , which pulls up the output, and also turns on  $Q_2$  to keep the output latched high. Once the output is latched, noise greater than 3 V on the +V REG line will not unlatch the output. Diode

$D_1$  discharges  $C_1$  when power is removed, so the circuit will reset quickly.

When power goes off and +V UNREG goes toward zero volts, the power-on signal from the low voltage detector goes low, and disables the inputs to the RAM before +V REG goes out of regulation.

Although this circuit is designed for a 5-V system, it is suitable for use with higher supply voltages.

*Alan W. Barman, Senior Engineer, Bendix EECSG, 900 W. Maple, Troy, MI 48084.*

CIRCLE NO. 311

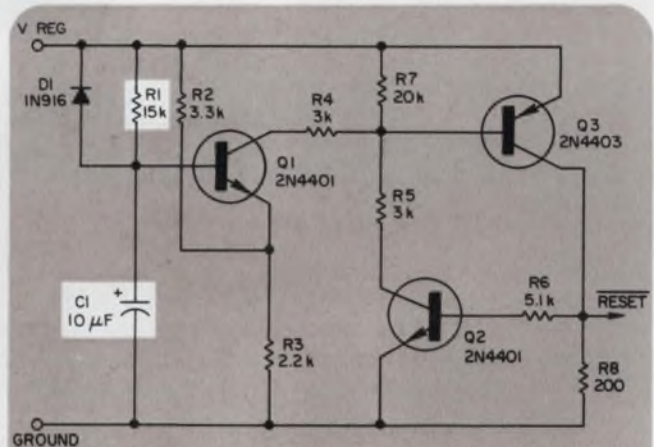

2. This power-on reset circuit has no premature output signal, and its output has a low impedance to ground when no power is applied.

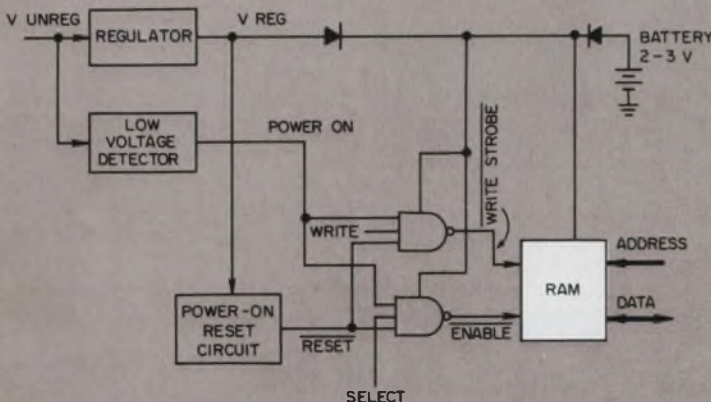

1. A battery-backup RAM circuit has gates that are powered by the battery when +V REG is off. Typical power-on reset circuits generate premature outputs,

which let stray signals on the write and select lines pass through to the RAM, and disturb its contents. Premature outputs coincide with rising voltage.

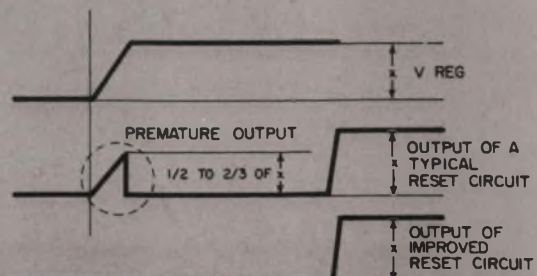

# "There's no plotter like it. My terminal easily commands any graphics."

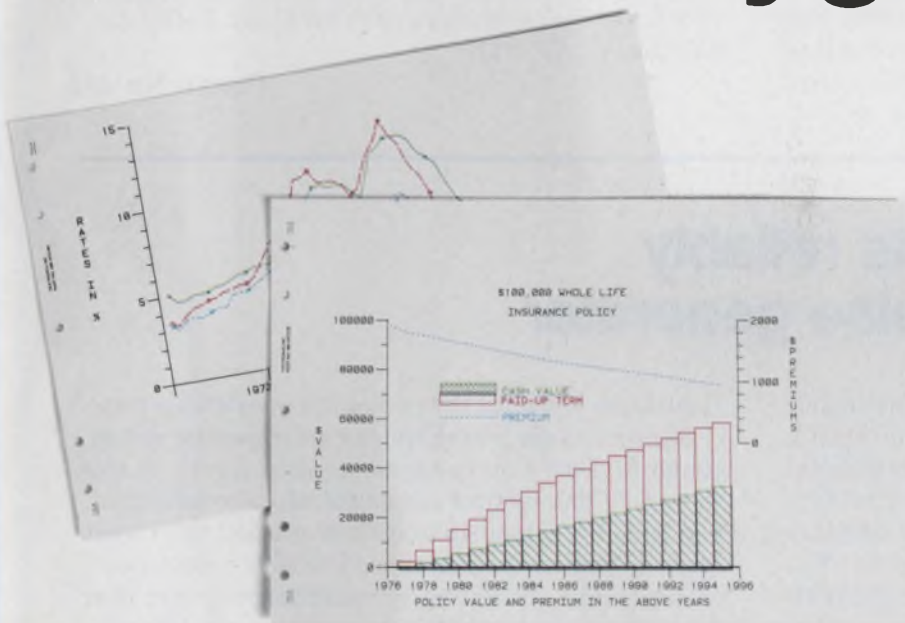

**Problem: You'd like computer graphics, but not at the price of adding more terminals.**

So you continue to use paid personnel to hand-plot charts, graphs and diagrams.

**Solution: Tektronix 4662 Interactive Digital Plotter. Plugs into most terminals for precise, multi-colored graphics.**

The 4662 plugs into almost all RS232-C or GPIB-compatible terminals. Use the 4662 to prepare graphics on paper or Mylar® polyester film for sales meetings, program presentations.

With computer accuracy and unexpected economy. Plus multiple colors from felt tip or wet ink pens.

**Easy interface to timeshare environments.**

Thanks to its built-in micro-processor, Tektronix modems, and Plot 10 software, operation is simple, accurate, and faster than any other plotter at the 4662's low price.

**Don't ask your people to do a plotter's job.** Get a graphics specialist that pays for itself. Because the 4662 is from Tektronix, the worldwide graphics leader, you're assured of exceptional reliability and fast service wherever you are. Talk to your local Tektronix Sales Engineer now.



The 4662 can draw precise plots on Mylar® polyester film or acetate, offering an especially valuable graphic assist to overhead projectors.

**Tektronix, Inc.**  
Information Display Group  
P.O. Box 500  
Beaverton, Oregon 97077  
In Europe write:  
P.O. Box 159  
Badhoevedorp, The Netherlands

## Get the 4662. Teach your old terminal new graphics.

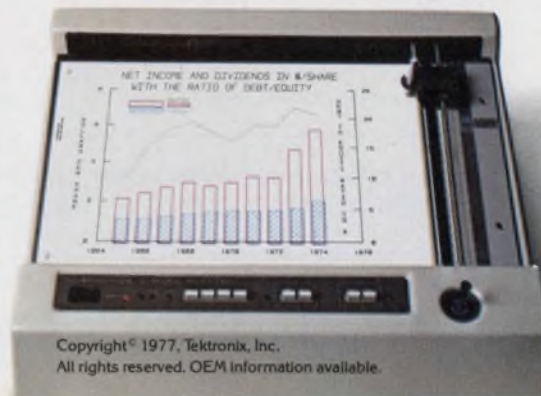

**Tektronix**  
COMMITTED TO EXCELLENCE

"See us at N.C.C., Booth # 2309"

CIRCLE NUMBER 60

Copyright © 1977, Tektronix, Inc.  
All rights reserved. OEM information available.

# If you want a high-accuracy zener, specify time stability, not temperature coefficient

Voltage reference diodes, for use in accurate a/d and d/a converters, must be able to hold their zener voltages reasonably constant for a long time to maintain the converter's accuracy. To get guaranteed time stability, either specify it, or do your own testing to verify that your device meets the requirements of the equipment. Don't think you get time stability by specifying tempco—there's no direct link between the two characteristics.

If you examine a common zener-diode family like the 1N821 to 1N829 series, you'll see tempcos ranging from 100 ppm/°C down to 5 ppm/°C. But the series

is not rated for time stability.

Fortunately, a couple of manufacturers—Motorola and Standard Reference Labs, subsidiary of CODI—offer precision reference-device families that have guaranteed voltage-time stability. Some devices are specially processed to hold the zener voltage change as low as 5 ppm over one year, or about 9000 hours.

*Ken Koep, VP/General Manager, Standard Reference Labs, Inc., subsidiary of CODI Corp., Pollitt Dr., Fair Lawn, NJ 07410.*

CIRCLE NO. 312

## Reset digital circuits reliably with a power-on pulse generator

Generate only one pulse each time  $V_{cc}$  turns on and you have a power-on reset function almost universally useful in logic circuits. Start-up procedures in a digital system are considerably simplified when control flip-flops, registers and counters automatically come up in predictable states when power is turned on. You can't depend on storage elements to be either inherently asymmetric or automatically preset.

However, the circuit in Fig. 1 can ensure circuit reset. The Q output of the 9602 retriggerable multivibrator rises with  $V_{cc}$  and stays high until the end of a quasistable period. The  $\bar{Q}$  output at first also rises with  $V_{cc}$  but only to about +2.3 V (Fig. 2). Thereafter,

$\bar{Q}$  switches low until the end of the quasistable state.

Selection of the timing resistor and capacitor values, R and C, depend on the time required for  $V_{cc}$  to rise to +4.5 V. The rise time should therefore be measured, and R and C chosen so that their product is at least twice as long as the rise time. The 9602 output pulse should persist until after  $V_{cc}$  stabilizes to ensure that the various storage elements are properly latched.

*Charles Alford, Applications Manager, Fairchild Camera & Instruments, 464 Ellis St., Mountain View, CA 94040.*

CIRCLE NO. 313

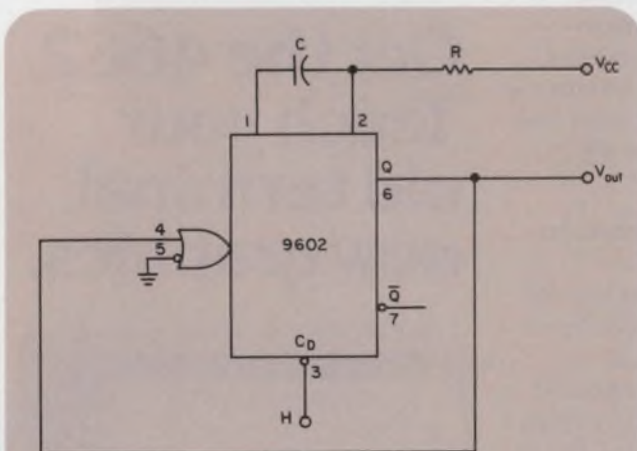

1. This retriggerable multivibrator generates a single pulse whenever  $V_{cc}$  comes on. The pulse can be made long enough to reset storage elements in digital circuits.

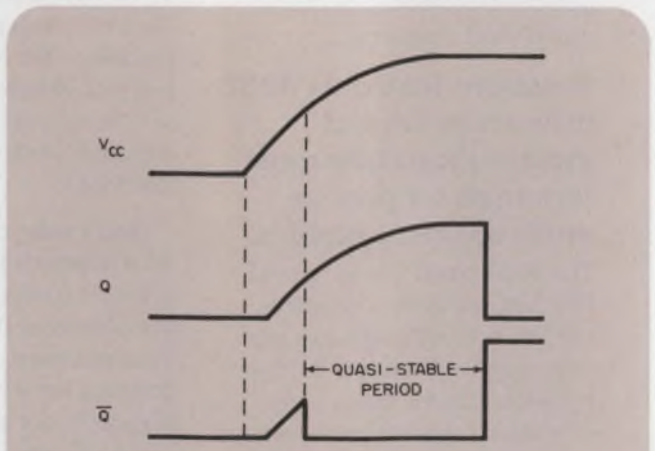

2. A single pulse from the multi's Q output rises with the applied supply voltage. The  $\bar{Q}$  output also begins to rise, but reaches only 2.3 V before going low.

# A welcome new concept in oscilloscopes

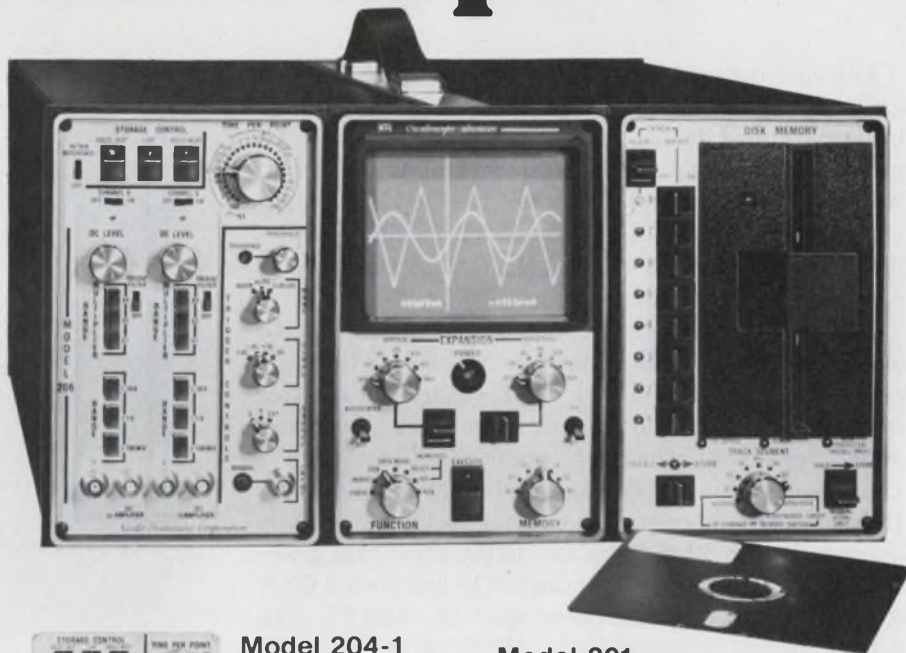

## HAVE YOU HEARD?

Digital Oscilloscopes Now Thoroughly Outperform Analog 'Scopes, both storage and non-storage, in the bandwidth range to about 10 MHz.

The improved performance appears in many ways. Accuracies from 5 to 50 times greater (depending on plug-in unit). Resolution 2 to 160 times greater. Storage that's superb; non-volatile, adjustment-free, quick, to provide from 400 to 3200 times as much stored information.

Digital oscilloscopes are easier to operate than any remotely comparable analog 'scope. And, they are amazingly versatile; doing just what you'd expect any 'scope to do, plus many extraordinarily useful measurements that are impossible with analog 'scopes.

Without question, the best digital 'scopes in the world, by a wide margin, are Nicolet's EXPLORER series oscilloscopes. There's one to meet your needs, in the models and plug-ins described below.

## THE PLUG-IN UNITS

**Each Has Touch-Button Storage Control.** Touch a button to store your choice of the next, or the last preceding, waveform. Touch another button to return to live action. All plug-ins have retroactive sweep trigger. This means that when you wish, the waveforms displayed show what preceded the sweep trigger—and also what followed. Each has conventional trigger controls, sweep speed controls, and amplifier controls. All models permit you to see live waveforms superimposed on a stored waveform for high precision comparisons. The two input models display and store both signals simultaneously.



### Model 204-1 and 204-2

These are one and two input units, with 50 ns rise times, and 10 MHz bandwidth (3 db norm). Resolution is 0.4% and accuracy  $\pm 0.5\%$  of F.S. Equivalent storage writing rate (ESWR) 50 cm/ $\mu$ sec.



### Model 206-1 and 206-2

These are one and two input units with differential amplifiers, 500 ns rise time and ESWR 5 cm/ $\mu$ sec. Resolution is 0.025%, accuracy 0.2%. Minimum observable signal amplitude 50  $\mu$ v. Sweep speeds from 500 ns to 200 sec/point.

## SEEING IS KNOWING...

To really appreciate these new digital 'scopes you have to see them in action. For a demonstration in your lab, on your bench, with your signals call Jim Bartosch at 608/271-3333 or send the reader service card for descriptive literature.

### Model 201

This unit provides two input channels, 50 KHz bandwidth, ESWR 500 cm ms, 5  $\mu$ v minimum observable signal. Other features are 5  $\mu$ v/hour; 2  $\mu$ v/ $^{\circ}$ C drift; 10<sup>9</sup> input impedance; excellent CMRR; and  $\pm 0.05\%$  accuracy and 0.025% resolution.

## MAIN FRAME

**Both EXPLORER II and EXPLORER III Provide Zoom-In Display Magnification Of Up To X64,** with numerical voltage and time values displayed for any selected point. Both have YT or XY displays and automatic vertical trace centering. They allow you to store up to 8 separate waveforms, and display one at a time or two or more superimposed. They provide pen-drive signals for pen recorders.

EXPLORER III has a third bay, which can accept either a plug-in disk recorder, or interface buss circuits, or both. Choice of IEEE 488, RS 232 or parallel 12 binary.

**NTC** NICOLET  
INSTRUMENT  
CORPORATION  
OSCILLOSCOPE DIVISION

5225 Verona Road, Madison, Wisconsin 53711  
Telephone: 608/271-3333

# Binary counter allows a pseudorandom generator to run without interruption

You can prevent a shift-register type pseudorandom generator from hanging up by adding an SN7493 binary counter to detect and correct the all-ZEROs pattern that would cause the generator to interrupt. Normally, pseudorandom generators use a decoding network to sense all-ZEROs, but with long registers the number of gates and resulting interconnections can become quite cumbersome.

The generator in the figure has a register length of 13 bits, and is built from two SN74164 8-bit shift registers. Each time a logic ONE enters the register and appears at the A output of U<sub>1</sub>, counter U<sub>3</sub> is reset, which makes it effectively count ZEROs. When a ZERO enters the register and arrives at the A output, U<sub>3</sub> is enabled and continues to count as long as ZEROs appear. But if 13 successive ZEROs show up, gates U<sub>4</sub> through U<sub>6</sub> decode the number 13 and feed a ONE to the B input of exclusive-or gate U<sub>7</sub>. And U<sub>7</sub> with a ONE on its B input and a ZERO on its A input, outputs a ONE to the register. This breaks the all-ZEROs pattern, and the circuit continues to generate pseudorandom numbers. The circuit will also start by itself when all register cells are reset to ZERO.

For a register length greater than 15 bits, two or more counters can be cascaded. And you can use counters and shift registers that work on the same edge of the clock. Then you have to decode counter state  $n-1$ , rather than state  $n$ , and make sure that

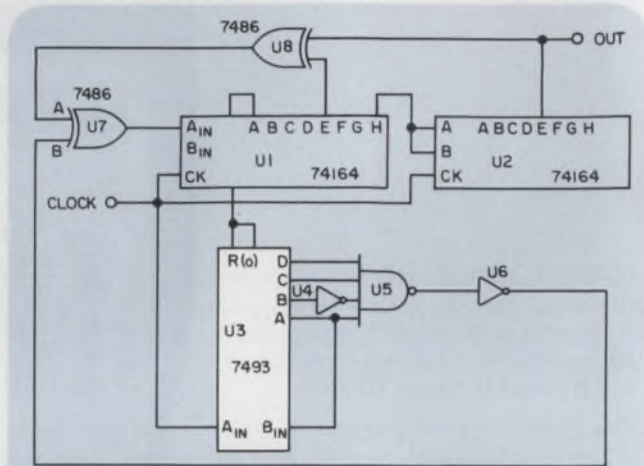

**Stop pseudorandom generator interruptions** with a binary counter that feeds a logic ONE into the shift register when too many zeros occur.

the clock pulse at the counter is not delayed with reference to the pulse at the shift register.

*Heinrich Pangratz, Dr. Techn., Institut für Datenverarbeitung, Technical University of Vienna, Gußhausstraße, 27, A-1040, Austria.*

CIRCLE NO. 314

### IFD Winner of January 4, 1978

**David Weigand**, Consulting Engineering, 904 Tyson Dr., West Chester, PA 19380. His idea "Solve Test Problems Caused by Switching-Type Power Supplies" has been voted the most Valuable of Issue Award.

Vote for the Best Idea in this issue by circling the number for your selection on the Reader Service Card at the back of this issue.

**SEND US YOUR IDEAS FOR DESIGN.** You may win a grand total of \$1050 (cash)! Here's how. Submit your IFD describing a new and important circuit or design technique, the clever use of a new component or test equipment, packaging tips, cost-saving ideas to our Ideas for Design editor. Ideas can only be considered for publication if they are submitted exclusively to ELECTRONIC DESIGN. You will receive \$20 for each published idea. \$30 more if it is voted best of issue by our readers. The best-of-issue winners become eligible for the Idea of the Year award of \$1000.

Our Model 3001 starts at \$2,980. For that you get a signal generator that's already frequency programmable with 0.001% accuracy over the 1 to 520 MHz frequency range. If you also want to program your output power, we have a programmable attenuator option available for \$500.

If you'd like to spend a little more, add our external frequency standard option for \$150. That makes the accuracy the same as your standard. Or spend another \$500 for an internal reference frequency standard with  $5 \times 10^{-9}$  day stability. But if you want to spend much more than that, you're going to have to buy some-

body else's signal generator. Count on at least \$10,000. Frankly, we think your money would be better spent buying another Wavetek Model 3001.

Here's another advantage. If you need to get on the bus (now or later), our new Model 3910 Converter makes you GPIB compatible. But before you spend anything on any signal generator, get a demonstration of our Model 3001. That won't cost you a cent.

#### SPECIFICATIONS

Frequency Range: 1-520 MHz  
Accuracy:  $\pm .001\%$   
Resolution: 1 kHz

Stability: 0.2 ppm per hour  
Output Range: +13 dBm to -137 dBm

Flatness:  $\pm 0.75$  dB  
AM Modulation: 0-90%  
FM Deviation: 0-10 kHz and 0-100 kHz

Internal Modulation Rates:  
400 Hz and 1 kHz

WAVETEK Indiana Incorporated,  
P.O. Box 190, 66 North First Avenue,  
Beech Grove, Indiana 46107,  
Phone (317) 783-3221,  
TWX 810-341-3226.

CIRCLE NUMBER 89

**WAVETEK®**

# You can pay a lot more for a programmable signal generator. But why?

ACCURACY

FREQUENCY  
1-520 MHz

VERNIER

VERNIER

OUTPUT

MODULATION

MODE

FREQ

FM kHz

AM %

CW

DC

10

90

AM

400Hz

5

50

FM x1

1kHz

0

0

FM x10

EXT

POWER

VERNIER

RF OUTPUT

SIGNAL GENERATOR

WAVETEK INDIANA

MODEL 3001

\$2,980.

\$1,000



# THE BEST VALUE IN OSCILLOSCOPES COMES IN MANY MODELS.

When you choose a Gould oscilloscope — regardless of the model — you get reliability, versatile performance and a modest price tag. All of which adds up to true value. Over the years, Gould has earned a well-deserved

reputation for building reliable instruments. Prompt, efficient service is available through a worldwide network of service centers. And all Gould oscilloscopes carry a full two-year warranty covering all parts and labor exclusive of fuses, calibration and minor maintenance. Look to Gould for your best value in oscilloscopes.

For more information contact Gould, Instruments Division, 3631 Perkins Ave.,

Cleveland, OH 44114. In Europe contact Gould Instruments, Roebuck Rd., Hainault, Essex, CB10 1EJ England.

For brochure call toll-free (800) 325-6400, Ext. 77. In Missouri: (800) 342-6600.

 **GOULD**



**Gould OS 245A**

- DC to 10 MHz
- Dual trace
- 4 inch CRT
- 5 mV/div sensitivity
- Only 11 pounds

Circle No. 141



**Gould OS 1100**

- DC to 30 MHz
- Dual trace
- 1 mV/div sensitivity
- Delayed timebase
- Channel Sum and Difference

Circle No. 143



**Gould OS 3300 B**

- DC to 50 MHz
- Dual trace
- Two independent timebases
- Mixed sweep
- 1 mV/div sensitivity
- Channel Sum and Difference

Circle No. 144



**Gould OS 260**

- DC to 15 MHz
- True dual beam
- High brightness CRT
- 2 mV/div sensitivity
- Single Sweep
- Switched X—YY

Circle No. 142



**Gould OS 4000**

- DC to 10 MHz—dual trace—digital storage (RAM)—no deterioration of stored trace—pre-trigger viewing—output to analog and digital recorders—simultaneous stored and real time viewing.

Circle No. 145





# Whatever you can conceive, Norplex can help you achieve.

While the sages of yore could only ponder the infinite, modern man literally is reaching for it.

With the advent of space-age circuitry comes the need for base materials of unexcelled reliability and consistency.

The manufacture of highest-integrity industrial laminates has been our only business for more than a quarter-century. No other company has the combined experience, technical resources, and exhaustive quality-assurance program that Norplex offers you.

At Norplex, the creative engineering and development of new products—and the

improvement of existing ones—is an ongoing process. We are continually designing and manufacturing laminates and other base materials for unique applications, helping customers find new ways to produce systems better and faster. And so we can for you.

At Norplex, imagination knows no earthly limits.

Norplex Division, UOP Inc. U.S. operations: LaCrosse, Wisconsin (World Headquarters); Black River Falls, Wisconsin; Franklin, Indiana; Postville, Iowa. European Headquarters: Wipperfürth, West Germany. Pacific Headquarters: Kowloon, Hong Kong.

CIRCLE NUMBER 62



# Half-size Amber R Relays

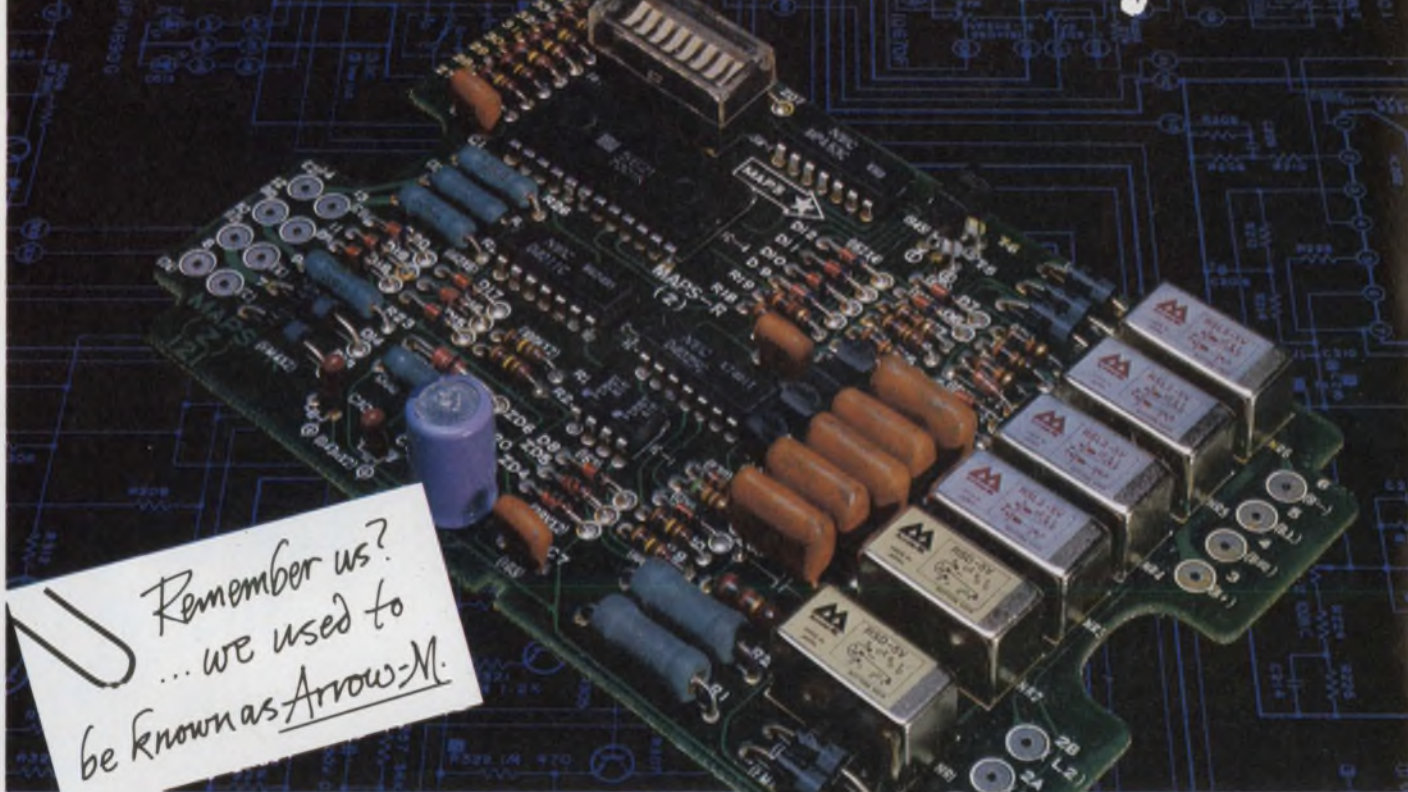

## High capacity, high sensitivity units can be driven by TTL and DTL.

*For example:* The minimum operating power for a single side stable type is 80mw, for a latching type 40mw.

- Aromat R Relays are available in 1 Form C contacts which can carry a high current capacity of 1 Ampere 20 watts, and are capable of resisting welding at higher inrush currents. The dry circuit type, which can switch current as low-level as 100uA, is available in addition to the power type.
- In addition to the standard, there are 1 coil and 2 coil latching types, which are useful for logic circuit design as a memory component.
- Not only can they be automatically wave soldered on PC boards with a high density of electronic parts, but they are simple to clean with most degreasers and detergents without affecting maximum contact reliability.

### **Relays for Advanced Technology**

More than 22 million R Relays in service around the world.



**Contact Your  
Aromat Representative  
or Distributor Today.**

**Aromat Corporation:**  
250 Sheffield Street  
Mountainside, NJ 07092  
(201) 232-4260

**Mid-Western Office:**  
311 Lively Blvd.  
Suite 1  
Elk Grove, IL 60007  
(312) 593-8535

**Western Office:**  
22010 S. Wilmington Ave.  
Suites 300 & 301  
Carson, Calif. 90745  
(213) 775-3512

# New products

## Instrumentation amplifier programs gain digitally

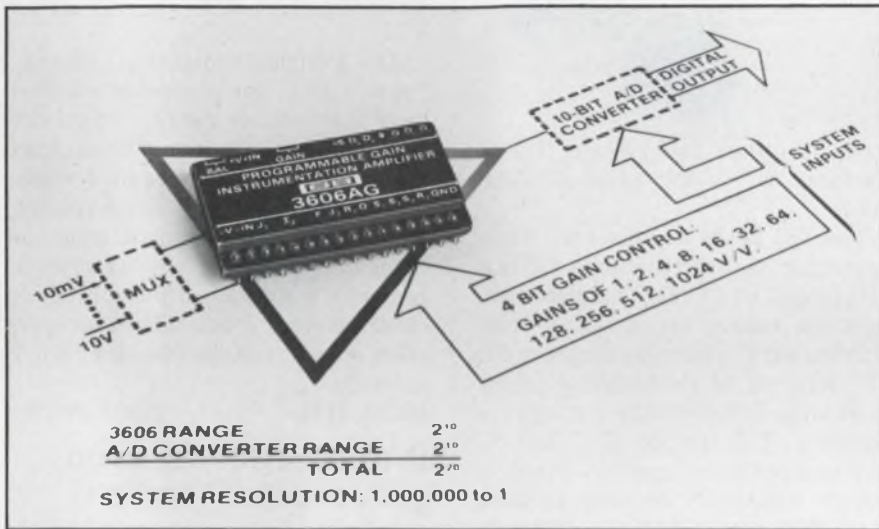

Burr-Brown, International Airport Industrial Park, P.O. Box 11400, Tucson, AZ 85734. (602) 294-1431. P&A: See text.

The first commercial instrumentation amplifier to offer digitally controlled, programmable gain is Burr-Brown's 3606. Sound good? There's more. The offset voltage almost stays put as the gain changes: At room temperature,  $E_{os}$  doesn't vary more than 25 mV—with no external adjustments. If that figure isn't good enough, you can slash it to a maximum 1 mV with just two offset adjustments.

A 4-bit TTL input varies the 3606's gain from 1 to 1024 V/V, in 11 binary-weighted steps. A latch holds the gain while the control word changes. Gain inaccuracy stays below 0.05% and non-linearity below 0.01%. Gain tempo doesn't go higher than 10 ppm/°C. A "B" version delivers even tighter figures.

Applications for instrumentation amplifiers usually require stiff specs, and the Burr-Brown instrumentation amp gives them. Apparently, performance hasn't been compromised for the gain benefits. A few examples:

Input impedance is  $10^{10} \Omega$ ;  $E_{os}$  is 2 mV max at a gain of one; 22  $\mu$ V max at a gain of 1024. And  $E_{os}$  drift is limited to 21  $\mu$ V/°C and 1.1  $\mu$ V/°C at

those two gains.

Another key spec, input bias, doesn't get beyond  $\pm 20$  nA at 25 C, with a maximum drift of  $\pm 0.03$  nA/°C over the rated -25 to 85 C. Common-mode rejection is high—100 dB min at all gains above 32, and 80 dB below. Typical input noise is specified at 1.4  $\mu$ V pk-pk, 0.01 to 10 Hz, and 1  $\mu$ V rms up to 1 kHz.

The 3606 stands alone with its packaging—a 32-pin DIP, either ceramic or a hermetically sealed metal. Size is 1.75  $\times$  1.15  $\times$  0.23 in., with 0.9 in. between pin rows.

Nominal rated output is  $\pm 12$  V at  $\pm 5$  mA. The 3606's  $\pm 3$ -dB response is 10 kHz, and full-power response is 5 kHz. Both values are typical. Settling time takes 100  $\mu$ s max for a change in gain at a fixed input level or an input change at constant gain. Required power is  $\pm 15$  V at 10 mA.

One of the main benefits of programmable gain is that you can process signals over a very wide dynamic range, yet retain resolution and accuracy. Without such capability, you may need an a/d converter that doesn't exist (see photo).

The 3606 ranges from \$51.50 to \$87.50 (both in 100s), depending on the model and the package. Delivery takes two weeks.

CIRCLE NO. 301

## Tiny isolation amp mates with 10-bit data systems

Intronics, 57 Chapel St., Newton, MA 02158. Rich Sakakeeny (617) 332-7350. \$44 (100 qty); 4 to 6 wks.

The IA184 isolation amplifier is compatible with 10-bit data-acquisition systems and is only 1.5-in. square by 0.63-in. high. The amplifier has 0.025% linearity, 126-dB common-mode rejection and 2.5-kV input/output isolation. Input noise is held to 1  $\mu$ V and 10 pA from 10 to 1000 Hz. The 1 to 1000 gain is externally programmable. An internal  $\pm 15$ -V dc, 15-mA supply in the input section is used to power an external transducer or preamplifier.

CIRCLE NO. 302

## Clock oscillators are in sealed DIPs



Northern Engineering Lab., 357 Beloit St., Burlington, WI 53105. Dick Griebel (414) 763-3591. \$15; stock to 4 wks.

CMOS and TTL oscillators are provided in glass-to-metal, DIP-compatible, welded enclosures. Covering a frequency range of 600 Hz to over 25 MHz, the standard tolerance is  $\pm 0.01\%$ , 0 to 70 C. Maximum dimensions are 0.815  $\times$  0.515  $\times$  0.2 in.

CIRCLE NO. 303

## Quad J-FET switch is housed in 16-pin DIP

HyComp, 146 Main St., Maynard, MA 01754. Norm Palazzini (617) 897-4578. \$34 (100 qty); 2 wks.

Analog switches in the HC-S310 series contain four independent spdt JFET switches connected to two common busses and are housed in 16-pin DIPs. Signals may be applied to either of the two busses or to the poles of the JFETs. FET gates are operated in a break-before-make mode and are direct driven. The HC-S310-10 has an on-resistance of 15  $\Omega$  max with input signals to  $\pm 5$  V, and less than 2-nA leakage from the signal channel in both on and off states.

CIRCLE NO. 304

# strip chart recorders

- OEM MODULES
- LOW PROFILE
- PACKAGED UNITS
- PORTABLE DC

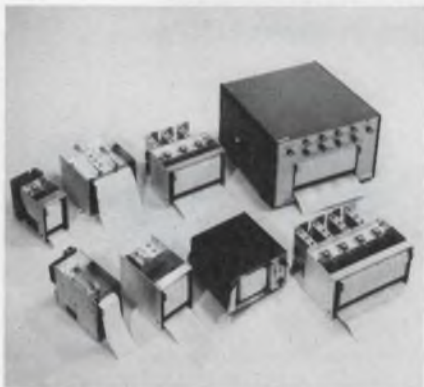

General Scannings thermal writing Strip Chart Recorders are available in a wide range of configurations and performance characteristics to meet virtually every recorder need.

You can select open-loop, velocity feedback or closed-loop operation; continuous roll or fan-feed paper; one to eight channels in channel widths of 20, 40, 50, 80 or 100mm; a variety of chart speeds; and either AC or DC operation.

Recorders can be furnished as modules for use by OEM's or fully packaged.



For complete details, circle readers' service number or write today for our full line Strip Chart Recorder Catalog.



**GENERAL SCANNING INC.**  
150 Coolidge Avenue  
Watertown, MA 02172  
TEL: (617) 924-1010

CIRCLE NUMBER 64

## MODULES & SUBASSEMBLIES

### Temperature transmitter is highly accurate



*Yellow Springs Instruments, Yellow Springs, OH 45387. (513) 767-7241. \$265.*

The YSI 2-wire temperature transmitter for use with platinum RTDs is accurate to  $\pm 0.1\%$ . Five standard-temperature ranges are available from  $-200$  to  $500$  C with other ranges to  $660$  C. Units can be field-adapted to any nonstandard range with a change of resistors. The tempo of  $0.012\%/^{\circ}\text{C}$  provides optimum accuracy throughout the  $-20$  to  $85$  C ambient operating range. The supply voltage is  $12.5$  to  $80$  V dc. The output is linear from  $4$  to  $20$  mA.

Booth 2421

CIRCLE NO. 305

### Filters operate on video signals



*Allen Avionics, 24 E. 2nd St., Mineola, NY 11501. Les Jacobson (516) 248-8080. From \$125; stock.*

A line of L-C filters includes delay-equalized NTSC lowpass filters having sharp roll-offs and good passband-delay linearity with cut-off frequencies from  $0.1$  to  $10$  MHz. Also available are NTSC rejection filters. An NTSC bandpass filter is a low-distortion unit that attenuates the luminance information in color-TV signals.

Booth 1538

CIRCLE NO. 306

### Totalizing counter has manual subtract lever



*Kessler-Ellis Products, Atlantic Highlands, NJ 07716. (201) 291-0500. \$40; 2 wks.*

An electrical totalizing counter, Type M16SL, has a manual subtract lever that reduces the count total one count for each actuation. The subtract lever feature is often required where totals must be reduced by the number of defective units removed from the production line. The counter may be equipped with manual pushbutton or electrical reset. It is available for operation on any voltage from  $6$  to  $220$  V ac or dc.

Booth 1134

CIRCLE NO. 307

### D/a converter needs no gain/offset calibration



*Hybrid Systems, Crosby Dr., Bedford, MA 01730. Larry Lauenger (617) 275-1570. \$24/\$44; 2 to 4 wks.*

Compact, ready-to-use and adjustment-free each DAC336-8, 8-bit d/a converter, includes a precision reference, ladder network, switches, output amplifier and input-storage register. The converter frees systems of costly and troublesome gain and offset-calibration requirements. The hybrid IC is pre-trimmed to  $\pm 0.05\%$  accuracy. Pin jumping allows the choice of  $0$  to  $-10$ ,  $0$  to  $+10$ ,  $\pm 5$  and  $\pm 10$ -V outputs. Only  $200$  mW is required. Other features include  $4\text{-}\mu\text{s}$  settling time,  $\pm 1/2$  LSB linearity and an accuracy tempo of  $\pm 50$  ppm/ $^{\circ}\text{C}$  from  $-55$  to  $125$  C.

CIRCLE NO. 308

Have You Mailed Your Requalification Card? See Page 45

# LH's NEW Super-MITE Switcher packs up to 67% more power in the same space!

Competitive switchers produce only 600 to 750 watts in a 5" x 8" x 11" case.

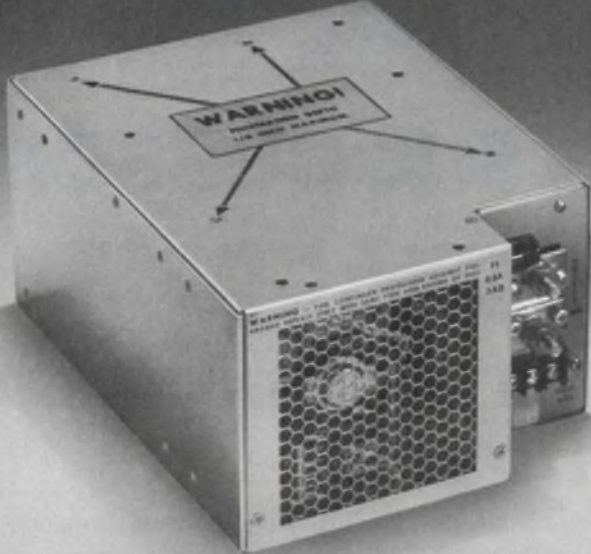

The New Super-MITE produces 1000 watts of power in a 5" x 8" x 11" case.

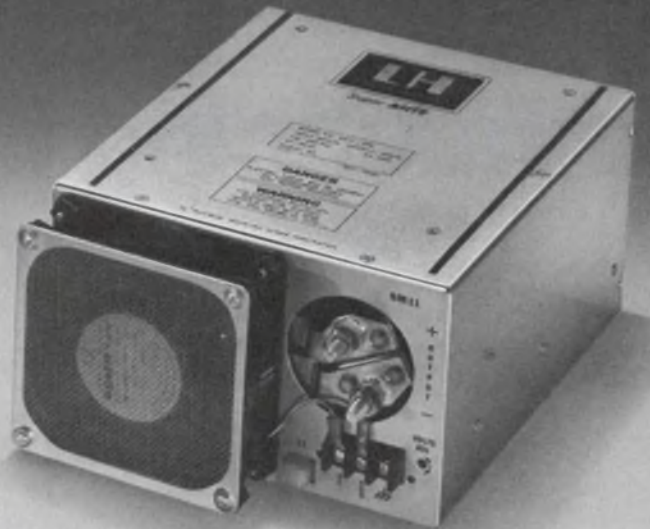

## Ideal choice for large add-on memory systems.

Designed specifically for large add-on systems, LH's new Super-MITE (SM) Series switcher produces 1000 watts in a case no bigger than competitors use for switchers producing only 600 to 750 watts. And what's more, you get:

- Choice of four single-output voltages\*: 2 V @ 225 amps, 5 V @ 200 amps, 12 V @ 84 amps, or 15 V @ 67 amps.
- Wide input range — 85 - 130 V AC or 166 - 250 V AC — for brown-out protection.
- 50-msec hold-up time if AC power fails.
- Power-fail signal triggered 40 msec after AC power loss.

- Direct paralleling of units without a master or special hookups.
- IC regulator control chip reduces component count, assures highest reliability.
- Extremely low output impedance.
- 75% efficiency (5 V unit).
- 0.4% line reg. over entire input range.
- 0.4% load reg. from zero to full load.
- 1% p-p ripple and noise.
- 2% max. deviation for a load change of 25% at 5A/ $\mu$ sec.
- 0°C to 50°C operating temperature.
- Remote automatic voltage margining (optional).
- Designed to meet UL 478.

## World's largest manufacturer of switchers!

The Super-MITE is one more milestone in LH's continuing effort to offer the most technically advanced line of single- and multiple-output switchers including open-frame models. Nobody packs more power in smaller packages or offers more desirable features including 1 through 7 outputs, up to 2.26w/in.<sup>3</sup>, up to 80% efficiency, and a 2-year guarantee — at less than 60¢/w in quantity. For price and delivery information, call or write today!



\*Three new multiple output models (2, 3, and 4) also available.



LH RESEARCH, INC.  
1821 Langley Avenue  
Irvine, CA 92714  
(714) 546-5279  
TWX 910-595-2540



# Announcing the successor to the fuse—at low-cost.

## Heinemann Re-Cirk-It protector. Just press the button to reset.

The fuse is passé.

At last there's a modern, reliable way to protect your product—Heinemann's Re-Cirk-It® pushbutton circuit protector. It protects like a fuse, is cost-competitive with fuses and fuseholders, but can be quickly reset with just a push of the button.

Re-Cirk-It trips instantaneously on short circuits, and with delay on sustained overloads. It's available in a wide range of current ratings from 0.25A through 10A. And, of course, it's UL-recognized and CSA-approved as a component circuit protector.

There's a good chance today that your product will be used by non-technical personnel who may not know a spent fuse from a dead battery. But when Re-Cirk-It trips, the button pops out, exposing a white band around the pushbutton shaft. So Re-Cirk-It forever ends the frustration of blown fuses, eliminates the danger that your customer will use a wrong size replacement,

and can save you from an expensive, unnecessary service call.

The Re-Cirk-It protector can only be electrically tripped. It can't be turned off, can't be held on against a fault, and there is no confusing mid-position trip-point. It is easily installed, and fits into the same panel space as conventional 5/8"-diameter fuseholders. And it's attractive enough to be placed on a front panel.

If you want more information, request Bulletin KD-4001. But do it now, before you or your customer blows another fuse.

#### **SPECIAL OFFER**

Send us a blown fuse and \$1.00 and we'll send you a 3A or 5A\* Re-Cirk-It to try. Send your request to Heinemann Electric Co., Special Re-Cirk-It Offer, P.O. Box CN 01908, Trenton, New Jersey 08608.

\*Other ratings available under this offer on special request.  
Offer expires December 31, 1978.



# HEINEMANN

**We keep you out of trouble.**

CIRCLE NUMBER 66

## ...and you can get breakers fast from these Heinemann stocking locations.

**California, Burlingame 94010**  
G. O. Johnson Co., Inc.  
840 Mahler Road  
(415) 697-2965

**California, Woodland Hills 91367**  
POCO Sales  
6311-F DeSoto Avenue  
(213) 999-0171  
Telex 69-1603

**Illinois, Chicago 60646**  
NEDCO Electronics, Inc.  
6232 N. Pulaski Road  
(312) 286-5565

**Maryland, Baltimore area**  
Automation Industrial Control  
9070 Chevrolet Dr., Box 627  
Ellicott City, MD 21043  
(301) 465-3616

**Michigan, Detroit area**  
Michigan Lectrols Corp.  
24301 Telegraph Road  
Southfield, MI 48034  
(313) 353-1350  
TWX 810-224-4654

**North Jersey/New York City area**  
Power/Electro Supply Co., Inc.  
P. O. Box 306  
Ridgewood, NJ 07451  
(201) 444-6990  
N.Y.C. no: (212) 964-4640

**New York, Binghamton 13902**  
Harvey Electronics, Inc.  
P. O. Box 1208  
(607) 748-8211

**North Carolina, Charlotte 28204**  
Joyce Sales Company  
P. O. Box 4245  
(704) 377-1555

**Ohio, Cleveland area**  
Radio & Electronic Parts Corp.  
6835 Cochran Rd.  
Solon, OH 44139  
(216) 248-8900

**Ohio, Dayton 45401**  
Duellman Electric Company  
131 Wayne Ave., Box 771  
(513) 461-5010

**Oregon (see Washington area)**

**Texas, Dallas 75231**  
Hall-Mark Electronics Corp.  
9333 Forest Lane  
(214) 231-6111

**Washington, Seattle area**  
J & A Sales  
7616 S.E. 24th Street  
Mercer Island, WA 98040  
(206) 232-0463  
From Portland: (503) 222-2662

# HEINEMANN

We keep you out of trouble.

© Heinemann

6850A

## MODULES & SUBASSEMBLIES

### Plasma panel displays 16 characters



Dale Electronics, P.O. Box 609, Columbus, NE 68601. (402) 564-3131. \$13.46 to \$14.63 (1000 qty). Stock.

Type PD-14A050 and PD-16A040 are alphanumeric plasma displays made up of 14 and 16 characters, respectively. The character segments are bussed together internally for multiplexed operation. The character height is 0.5 in. for the 14-character display and 0.4 in. for the 16-character display. The units operate at a typical peak current of 630  $\mu$ A/segment. Typical light output is 50 ft lamberts.

CIRCLE NO. 309

### V/f converters match logic level by resistor

Burr-Brown, P.O. Box 11400, Tucson, AZ 85734. Steve Howard (602) 294-1431. \$10.90 (100 qty).

Model VFC42 voltage-to-frequency or frequency-to-voltage converters are internally complete and need only a pull-up resistor to match TTL or CMOS-logic levels. The maximum non-linearity is  $\pm 0.01\%$  at 0 to 10 kHz with 0 to 10-V input. Drift is  $\pm 100$  ppm/C below 20 C and  $\pm 30$  ppm/C above 20 C. Model VFC52 generates 0 to 100 kHz for 0 to +10-V input with 0.05% non-linearity max. Drift is  $\pm 150$  ppm/C below +20 C and  $\pm 30$  ppm/C above 20 C. Offset and gain errors are less than 0.001% and 0.1% of full scale, respectively. A 6-decade dynamic range (0.5 Hz to 0.5 MHz) is provided. The units are in 12-pin epoxy DIPs.

Booth 2441

CIRCLE NO. 310

## Low-cost DPM displays 4-1/2 digits



Datel Systems, 1020 Turnpike St., Canton, MA 02021. Eugene Murphy (617) 828-8000. \$59 (100 qty); 2 to 4 wks.

A low-cost digital panel meter, Model DM-4100N, resolves 100  $\mu$ V in the last of its 4-1/2 digits. The meter displays analog input voltages up to a full-scale reading of  $\pm 1.9999$  V dc. The display uses red LED digits having a height of 0.5 in. The accuracy at 25 C is  $\pm 0.02\%$  of reading,  $\pm 1$  count. The meter is autozeroed, yielding a temperature drift of zero setting within  $\pm 1$  count from 0 to 50 C. The unit fits a  $0.97 \times 2.562$ -in. panel cutout and requires a +5-V supply at 350 mA.

CIRCLE NO. 320

## Hybrid op amp gets rigid tests



Teledyne Philbrick, Allied Dr., at Route 128, Dedham, MA 02026. Frank Goodenough (617) 329-1600. \$120; stock.

The -83 on the Model 1414-83 means that the hybrid op amp is inspected and tested to MIL-STD-883 Method 5004 Class B. It means that each unit has been temperature cycled 10 times from -55 to 125 C and has been burned in for 160 h at 125 C. Specifications include a settling time of 1  $\mu$ s max, initial offset voltage of 5 mV max, open-loop gain bandwidth of 8 MHz min. The slew rate is 50 V/ $\mu$ s min and common-mode rejection is 60 dB min. Output is  $\pm 10$  V at  $\pm 20$  mA.

CIRCLE NO. 321

Have You Mailed Your Requalification Card? See Page 45

## MODULES & SUBASSEMBLIES

### Thrifty solid-state tach subs for rotating type

Electro, P.O. Box 3049, Sarasota, FL 33578. (813) 355-8411. \$29.50 (100 qty); stock to 6 wks.

A low-cost tachometer (frequency-to-dc converter), Micro-Tach, is a solid-state alternate to more-costly rotating-tach generators. The tachometer oper-

ates from inputs supplied by electromagnetic sensors or any device providing sinusoidal signals and drives any conventional meter, speed-control circuit or recorder. Accuracy is  $\pm 0.5\%$  of full scale. Two series of 10 models each for either 12 or 24-V dc input cover frequencies from 15 Hz to 60 kHz (adjustable). The units furnish outputs linearly-proportional to frequency over a 0-to-5 or 0-to-10 V dc range.

Booth 1021

CIRCLE NO. 322

### Digital control meter gives adjustable trip



LFE, 1601 Trapelo Rd., Waltham, MA 02154. (617) 890-2000.

The digital control meter, Model DCM, combines solid-state switching circuits with a digital meter and has the features of an analog meter-relay and a digital panel meter. The relay trip points are adjusted by turning setpoint knobs located on the front. When a knob is depressed, the digital display monitors the setpoint level. When the knob is released, the display transfers back to monitoring the input signal. A front-panel-LED status indicator lights when a relay de-energizes. Spdt relay contacts provide closures on either side of the set point.

Booth 2323

CIRCLE NO. 323

### Pulsed-LED-beam system operates indoor/outdoor



Scanning Devices, 266 Broadway, Cambridge, MA 02139. Lou Goldenberg (617) 354-7226.

This long-range infrared pulsed-LED-beam system, Model Tx-Rx operates indoors or outdoors at distances up to 250 ft. A broad LED beam minimizes alignment problems. The units are housed in Scotchkote-coated 6 x 4 x 4-in. JIC boxes fabricated from 14-gauge steel. The units can be used in highly corrosive atmospheres. Power input is 115 V ac, 50-60 Hz. The output dpdt-relay contacts handle 5-A resistive at 115 V ac or 28 V dc. The ambient-light immunity is 10,000 ft candles. Available models include on-off, delay-on, delay-off, one-shot and double-delay.

Booth 2104

CIRCLE NO. 324

# The Interface Display

END STACKABLE  
.54" DUAL  
ALPHANUMERIC  
LED DISPLAYS



POS

MICRO-

PROCESSOR

- IEE•HERCULES Models 1784/85R - (14) uniform red segments
- 600  $\mu$ cd typical brightness, common cathode, right hand D.P.'s
- Double-DIP pin row spacing, leads on .100" (2.54mm) centers



The Display Maker

Industrial Electronic Engineers, Inc.

7740 Lemona Ave., Van Nuys, California 91405

Telephone: (213) 787-0311 • TWX 910-495-1707

- Multiplexed configuration for maximum pinout economy

- Install simply in integral, multi-digit arrays with IEE•ATLAS Display Mounting Hardware

- In stock - available through IEE Stocking Distributors at competitive prices

CIRCLE NUMBER 67



# need a precision drawn metal enclosure?



How about an **ALUMINUM** instrument cover...

or a **TITANIUM** component housing...

perhaps a pie shaped **COPPER** enclosure...

maybe a **MU-METAL** magnetic shield...

or a pure **NICKEL** battery container...

or a **BRASS** housing for micro-circuits...

even a .010 **STAINLESS STEEL** detector case.

These are only a few of the more than **1600 SPECIAL** shapes we draw in addition to over **7000 STANDARD ROUND, SQUARE and RECTANGULAR** sizes we stock. Write for a copy of our new 84 page catalog today. Yours for the asking.



# Hudson

**Tool & Die Company, Inc.**

symbol of quality since 1940

"See us at  
Booth #1408-1410,  
Electro 78"

Main Office: 36 Malvern Street, Newark, New Jersey 07105  
(201) 589-1800 TWX 710-995-4445

Florida Division: Post Office Box 2613, Ormond Beach, Florida 32074  
(904) 672-2000 TWX 810-832-6216

CIRCLE NUMBER 68

# NOW

## 4 Watts Linear 1 to 1000 MHz Only \$2700



### Model 4W1000 ULTRA- WIDEBAND AMPLIFIER

It's fact! Model 4W1000 is the only ultra-wideband, solid-state power amplifier that supplies a minimum of 4 watts of RF power from 1 to 1000 MHz. It's probably all the bandwidth and power you'll ever need.

You can use this versatile, unconditionally stable amplifier with frequency synthesizers or swept signal sources to provide high-level outputs. Applications include RFI susceptibility testing, NMR spectroscopy, antenna and component testing as well as general lab use.

Very likely, the 4W1000 will satisfy all your ultra-wideband power amplifier needs. However, if the 4W1000 offers more power than you need, consider the more economical 1W1000, priced at only \$1,250. For complete information, write or call:

Amplifier Research  
160 School House Road  
Souderton, Pa. 18964  
215/723-8181

**AR** AMPLIFIER  
RESEARCH

CIRCLE NUMBER 69

## MICRO/MINI COMPUTING

### PROM simulator expands with slave units



Sunrise Electronics, 307-H S. Vermont Ave., Glendora, CA 91740. (213) 963-8775. \$1595 (master), \$195 to \$450 (slave); 3 to 6 wks.

Permanently connected slave units are available for use with the Smarty expandable PROM programming, simulating and testing system. The master unit has a built-in 2704/08 programmer, 1 k × 8 PROM simulator-editor, RS-232C and 20-mA serial interface and punched paper-tape reader controller. The simulator includes an intelligent editor and is optionally expandable to 2 k × 8 or 8 k × 8 with 350-ns access times. An optional micro-cassette drive stores 30 1 k × 8 or 15 2 k × 8 programs in one cassette. Permanently connected personality slaves are available for all PROM families. Up to 15 slaves of the same or different types may be daisy chained to the system for single or multiple-unit programming.

Booth 2128

CIRCLE NO. 325

### Program does assembly and linking

Microtec, P.O. Box 60337, Sunnyvale, CA 94088. (408) 733-2919. \$1200.

The assembler in the 8080/8085 relocatable assembler and linking loader includes such features as conditional assembly, macro assembly and a cross reference table. The linking loader combines independently assembled relocatable object modules into one absolute module according to user commands. The object module output of the assembler is compatible with the assembler used by the Intel MDS system. Both programs are written in ANSI standard FORTRAN IV and operate on any computer with a word length greater than or equal to 16 bits.

CIRCLE NO. 326

### Memory boards employ error correcting logic

Mupro, 424 Oakmead Pkway, Sunnyvale, CA 94086. (408) 737-0500. \$605 to \$2595; 4 wks.

A line of Intel Multibus compatible memory boards contain error-correcting logic circuitry. The line includes memory sizes of 4, 8, 12, 16, 32, 48 and 64 kbytes. The 4 to 16-k boards are available with 4-k dynamic RAM. The 16-k and larger memory boards are available with 16-k RAMs. All eight sizes also come without error detection, with single-bit parity or with single-bit error correction and double-bit error detection. All error-correcting configurations are equipped with diagnostic indicators to pinpoint the memory chip in which any correctable error occurred. Each board is provided with on-board refresh of the dynamic RAM.

Booth 2017

CIRCLE NO. 327

### Disc controller handles 20 Mbytes per drive

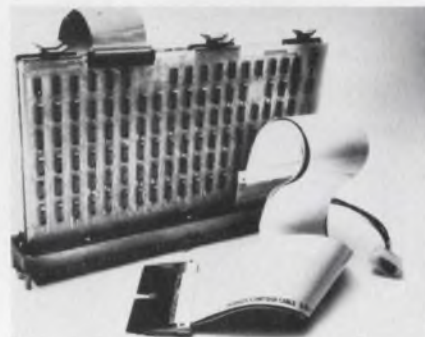

Aviv, 300 Sweetwater Dr., Bedford, MA 01730. Haim Brill (617) 275-2848. \$3000; 4 to 6 wks.

The DFC-803 imbedded controller provides modular storage of up to 20 Mbytes per drive and is compatible with PDP-11 Unibus computers as well as DEC's RK11/RK05F diagnostics. The system consists of two hex-slot boards and operates with a variety of disc drives including Diablo's Model 31 and 44, Pertec's 3000 family and CDC's Hawk and Falcon. Other features include 16-word data buffer, transfer of up to 65 kwords in a single operation, compatibility with either front or top-loading disc drives, switch-selectable platter zero and use of 2400-rpm fast-positioning drives.

CIRCLE NO. 328

Have You Mailed Your Requalification Card? See Page 45

# The Portable Data Logger

10 Analog Channels • Thermal Printer • 4-1/2 Digit DPM • 99 Min/Sec Timer

Datel has it, Model PDL-10—the portable approach to measuring, scanning and logging analog signals. It's small size allows it to be positioned near sensors and test apparatus. That means less cabling, lower noise, and lower cost. And the convenience of operating your data logger right next to laboratory equipment. Weighing only 12 lbs. (5,5 Kg), the PDL-10 is easily carried to different measurement sites.

But Datel hasn't sacrificed performance for portability. Ten input channels are provided, along with a 4-1/2 digit panel meter, a 7-column thermal printer for instant hard copy printout, scan electronics, and a 99 Min/Sec Scan Interval clock. Other features include multirange capability for each channel ( $\pm 200$  mV,  $\pm 2$ V,  $\pm 20$ V), relay-switched differential inputs, and for further flexibility, individual SKIP controls for each channel.

Thus, the user may monitor any desired number or combination of channels.

The high performance and versatility of the PDL-10, together with its small size and weight, make it ideal for bench-top operation in laboratory and industrial applications where slowly varying signals from bridge transducers such as thermocouples, strain gages, and pressure sensors are to be monitored and recorded. In addition, the excellent common-mode rejection of the PDL-10 provides high noise immunity in industrial applications.

Input connections are made through convenient screw terminals on the rear panel. Operation requires no special training or knowledge and will usually be mastered within a matter of minutes.

Send today for the free 12-page brochure detailing PDL-10's capabilities.

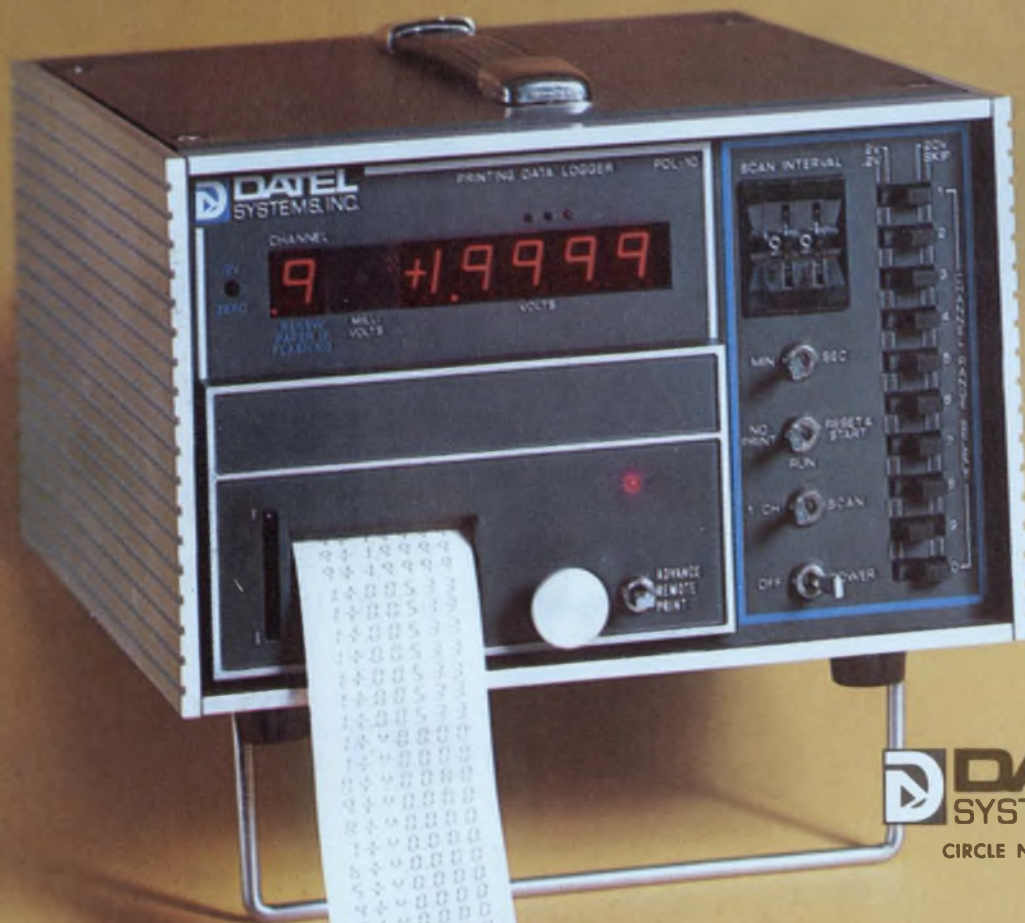

**D** **DATEL**  
SYSTEMS, INC.

CIRCLE NUMBER 70

1020 TURNPIKE STREET, CANTON, MASS 02021 / TEL. (617) 828-8000 / TWX 710348-0135 / TELEX 924461

Santa Ana, (714) 835-2751, (L.A.) (213) 933-7256 • Sunnyvale, CA (408) 733-2424 • Gaithersburg, MD (301) 840-9490 • Houston, (713) 932-1130 • Irving, TX (214) 256-4444  
OVERSEAS: DATEL (UK) LTD—TEL ANDOVER 02641 51055 • DATEL SYSTEMS SARL 620-06-74 • DATELEK SYSTEMS GmbH (089) 77-60-95

# Rogan control knobs compliment your product design

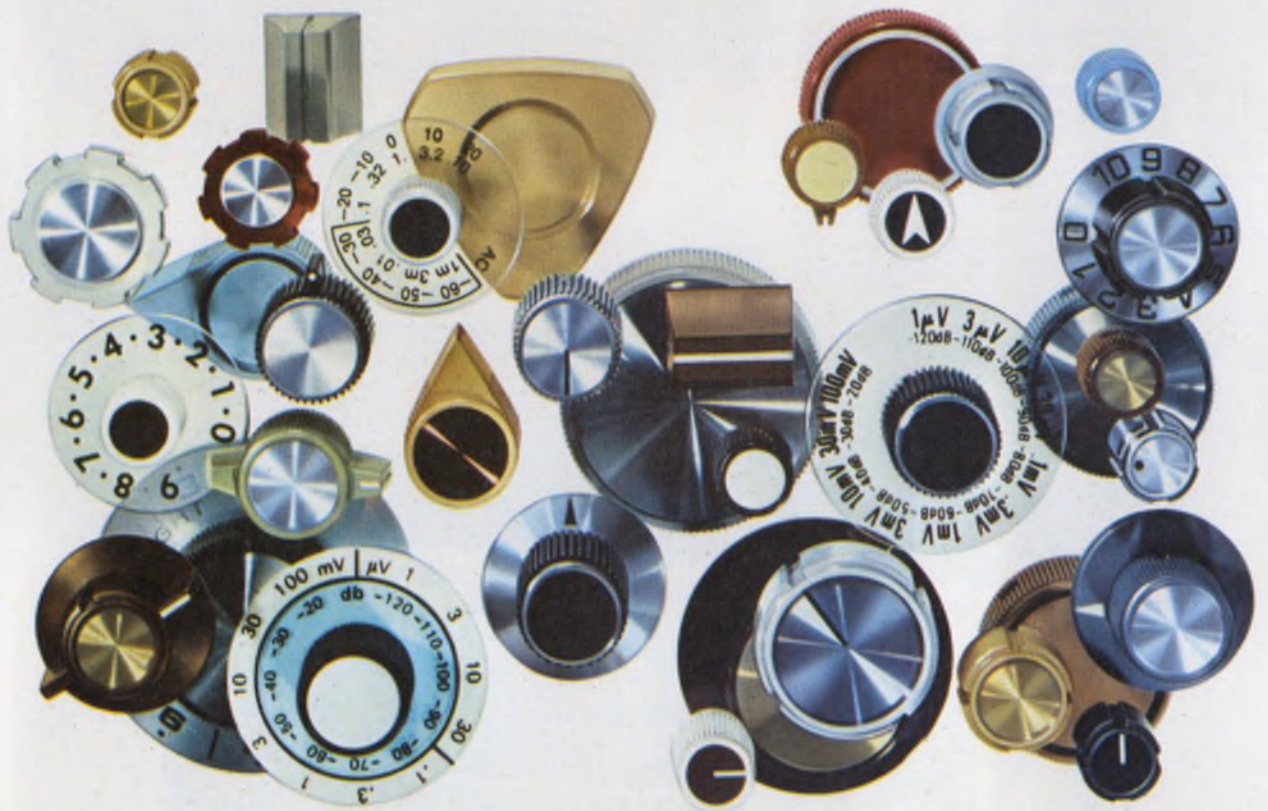

Write today for the latest edition of our catalog. Samples of particular items will be sent upon request.

**ROGAN**  
CORPORATION

3455 Woodhead Drive  
Northbrook, Illinois 60062  
Phone: (312) 498-2300  
TWX 910-686-0008  
CIRCLE NUMBER 135

# New, 16 Bit Microcircuit D/A Converter

Datel has it...



Two versions to choose from:

#### DAC-HP16BMC

- ▶ 16 Bit Binary Resolution
- ▶ 15 ppm/°C Max. Tempco
- ▶ ±0.003% Linearity
- ▶ 0 to +10V, ±5V Output
- ▶ 35 μsec. Settling Time

#### DAC-HP16DMC

- ▶ 4 Digit BCD Resolution
- ▶ 15 ppm/°C Max. Tempco
- ▶ ±0.005% Linearity
- ▶ 0 to +10V Output
- ▶ 15 μsec. Settling Time

**\$7750\***  
(100's)

Price, both versions: \$119.00\* (1-24)

\*U.S.A. domestic prices only

When high resolution and stability are demanded, Datel's DAC-HP series provides the performance — applications such as precision signal reconstruction, automatic test systems, and ultra-linear ramp generation. DAC-HP's excellent performance results from special low tempco nichrome thin-film resistors, laser trimmed for optimum linearity, and a low tempco zener reference circuit. Operating temperature range is 0 to 70C, with models available for -25 to +85 and -55 to +125C operation.

**DATEL**  
SYSTEMS, INC.

1020 Turnpike Street, Canton, MA 02021  
TEL: (617) 828-8000 TWX: 710-348-0135

Santa Ana, (714) 835-2751. (L.A.) (213) 933-7256 • Sunnyvale, CA (408) 733-2424 • Gaithersburg, MD (301) 840-9490 • Houston, (713) 932-1130 • Irving, TX (214) 256-4444  
OVERSEAS: DATEL (UK) LTD—TEL: ANDOVER (0264) 51055 • DATEL SYSTEMS SARL 620-06-74 • DATELEK SYSTEMS GmbH (089) 77 60 95

## MICRO/MINI COMPUTING

### Large memory interfaces four computers

*Electronic Memories & Magnetics, 20630 Plummer St., Chatsworth, CA 91311. Dick Shively (213) 998-9090.*

A semiconductor memory system, the SEMS-17, contains  $1.8 \times 10^6$  words  $\times$  16 bits of RAM and interfaces with

four independent external computers. The memory system holds 56 memory cards, each capable of providing 32 k  $\times$  16 bits of storage, four ANEW and two DMA interface cards; four control cards; and four error detection/correction cards. The control cards monitor system performance and relays fault information to the primary computer. A backup power source retains all data within the memory for a minimum of 5 min after primary power failure.

CIRCLE NO. 331

### Video terminal board buses into SBC 80

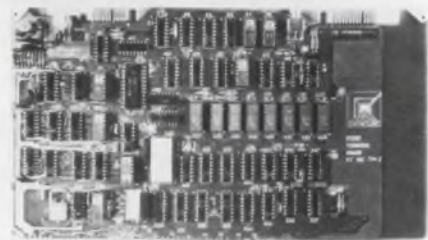

*Datcube/SMK-I, P.O. Box 405, Reading, MA 01867. Stewart Dunn (617) 944-4600. \$275 (100 qty); stock.*

The VT 103 video terminal board interfaces directly to the system bus of the Intel SBC 80 and National BLC 80 computers. The board provides a 96-character ASCII subset in  $7 \times 9$  font on a 64-character, 16-line external monitor. There is direct cursor addressing and 11 other cursor control functions. Composite and direct-drive video outputs are available. An input port provides for an optional external keyboard. Inputs for a strobe and seven data lines are provided at a 26-pin edge connector. The composite video drives a 75- $\Omega$  coaxial cable with a 1.4-V pk-pk signal and meets RS-420 standards.

CIRCLE NO. 332

## Standard Grigsby "SM-PCB" Series Rotary Switches for Plug-in Printed Circuit Boards

...save valuable time  
over hand wired  
assemblies

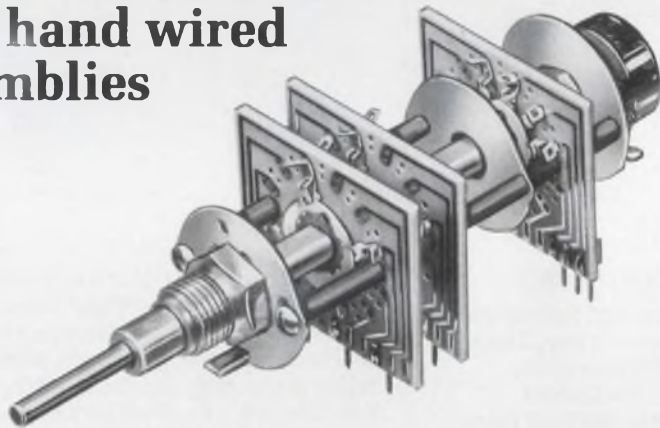

SM-PCB Series Switches handle multi-function switching with A/C line switch and for volume control applications. And, they are available with single or concentric shafts to meet your exact requirements. Printed circuit board cards also are available in various heights and materials.

For more detailed information send for the PCB 600 brochure.



**standard grigsby, inc.**

Dept. 12, 920 Rathbone Avenue  
Aurora, Illinois 60507  
Phone: 312/844-4300  
TWX: 920-232-3138

CIRCLE NUMBER 74

### PROM programmer operates in three modes



*International Microsystems, 638 Lofstrand Lane, Rockville, MD 20850. (301) 340-7505. \$1695; 4 wks.*

The Series 1000 microprocessor-controlled PROM programmer offers fully interactive operation in any of three programming modes: keyboard entry, terminal control or remote computer control. A 32-kbit buffer RAM permits fast, reliable data transfer and allows the user to edit any data in the internal RAM, from the keyboard of the programmer, prior to the actual programming operation. A 14-digit hexadecimal display gives 4 digits each of address, RAM data, and PROM data, plus a 2-digit entry and error code. Standard features include TTY and RS-232 interfaces. Personality modules are available for all standard MOS and fusible-link PROMs.

Booth 2049

CIRCLE NO. 333

# Dial-A-Voltage



SHOWN ACTUAL SIZE

## 0.005% Calibrator only \$450 (SINGLES)

Datel's Digital Voltage Calibrator, DVC-8500 comes in a mini-benchtop package, at a mini-price (\$450 in singles\*), but provides very big performance. DVC-8500 offers 4½-digit resolution and a ±19.999 volt full scale output range with ±1 millivolt accuracy (±0.005% of full scale.)

Use your DVC-8500 to calibrate A/D and D/A converters, DPM's, DVM's, Op Amps, V/F converters, and Data Acquisition Systems. A short-proof, buffered output gives up to ±25mA output current with an LED overload warning signal. The ±1.5 millivolt front panel vernier allows fine tuning of A/D and D/A bit steps.

Included are rear PC sense terminals and a choice of 100, 115, or 230 VAC inputs. A panel mounting kit is optional.

Contact Datel, or your nearest Datel Representative listed in Gold Book or EEM.

\* U.S.A. Domestic Price only.

**D** **DATEL**  
SYSTEMS, INC.

1020 TURNPIKE STREET, CANTON, MASS. 02021  
TEL. (617) 828-8000 / TWX: 710-348-0135  
TELEX: 924461

Santa Ana, (714)835-2751, (L.A.) (213)933-7256 • Sunnyvale, CA (408)733-2424 • Gaithersburg, MD (301)840-9490 • Houston, (713)932-1130 • Irving, TX (214)256-4444  
OVERSEAS: DATEL (UK) LTD—TEL: ANDOVER (0264) 51055 • DATEL SYSTEMS SARL 620-06-74 • DATELEK SYSTEMS GmbH (089) 77-60-95

# \$3.75



## Introducing LOCO II, a new crystal clock oscillator at a new low price.

For just \$3.75\* you get LOCO II. The new crystal-controlled, thick-film, DIP oscillator from Motorola.

LOCO II comes in three frequencies—16 MHz, 18.432 MHz and 19.6608 MHz. And these master clock frequencies are divisible to drive  $\mu$ Ps and baud rate generators, or a combination of baud rate generators,  $\mu$ Ps and LSI chips. All on the same micro-computer board—all from one master clock. Just think of the space that will save.

LOCO II gives you stability, too. It has a rating of  $\pm .05\%$ . That includes calibration tolerance at 25°C, operating temperature, input voltage change, load change and aging. It's the ideal size as well—.820" x .520", with a seat height of .250".

At \$3.75, when you get LOCO II, you're getting the right oscillator at the right price.

For price list, rep list and data sheet, call Barney Ill at (312) 451-1000. Or write Motorola, Component Products Department, 2553 N. Edgington, Franklin Park, IL 60131.

\*1,000 price.  Motorola and LOCO II are trademarks of Motorola Inc.



**MOTOROLA INC.**  
**Component Products**

See the new Motorola oscillator at Electro 78. May 23-25. Booth #1733.

©1978 Motorola Inc.



**MICRO/MINI COMPUTING**

**Modules interconnect sensors to  $\mu$ P systems**



Miltex, 1650 Tower Blvd., North Mankato, MN 56001. J. Wallace (507) 625-6521.

A microprocessor-system designer can select from a wide variety of Micro-interface digital and analog modules, all packaged in a standard color-coded enclosure. LEDs are visible on the top of each digital module to facilitate field troubleshooting. The modules may be used at any interface location, but are especially suited to be located near sensors, permitting the module output to be transmitted by low-cost cable to the I/O interface of the  $\mu$ P.

Booth 1302 CIRCLE NO. 334

**Analog input module mates with popular  $\mu$ Ps**

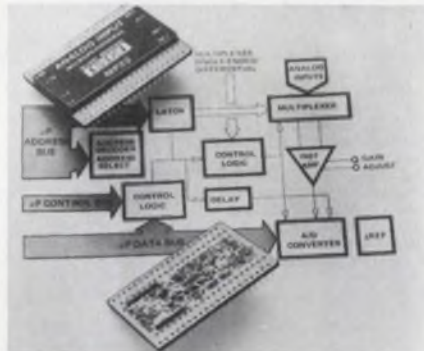

Burr-Brown, P.O. Box 11400, Tucson, AZ 85734. Steve Harward (602) 294-1431. \$245; stock.

MP22 is an analog input module that interfaces directly with 8080A, 8048, Z80 and SC/MP  $\mu$ Ps. With minimal external logic it is compatible with 6800, 650X, F8 and 8085  $\mu$ Ps, and also with PDP-8, PDP-11, Nova and Eclipse minicomputers. The unit consists of a 12-bit a/d converter, instrumentation amplifier, input multiplexer, address decoder and control logic. Interrupt, halt and direct-memory-access request signals are generated by internal logic. The MP22 accepts 16 single-ended or eight differential analog signals and the system digitizes low or high-level inputs. The conversion time is 35  $\mu$ s.

Booth 2441 CIRCLE NO. 335

**Floppy controller uses MCM6843 chip**

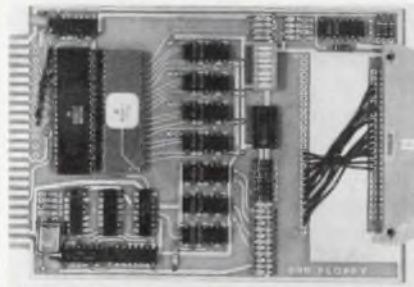

Wintek, 902 N. 9th St., Lafayette, IN 47904. (317) 742-6802. \$199.

A low cost but versatile floppy-disc controller uses the Motorola MCM6843 IC in a 4.5 x 6.5-in. module that interfaces to any full-size or mini floppy-disc drive. The module supports both hard and soft sectoring, IBM 3740 or user programmable read/write format, automatic CRC generation or checking, and programmable step and settling times.

Booth 2344 CIRCLE NO. 336

**BEGONE CURSED ALIAS**

The new Precision 616 cuts clean with programmable ease. 80 dB/octave attenuation slopes and time domain filters superior to Bessel. Up to 16 filter channels, programmable for gain and cutoff frequency. Interfaces with mini, micro or GPIB. Typical

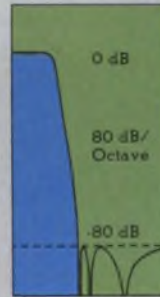

phase match is  $\frac{1}{2}^\circ$ , with worst case of  $2^\circ$ . You get performance that used to require a custom instrument, without paying a custom price. Call Don Chandler, 607-277-3550, or write for complete specs and a demonstration.



**PRECISION FILTERS, INC.**

303 W. Lincoln, Ithaca, N.Y. 14850



CIRCLE NUMBER 77

## MICRO/MINI COMPUTING

### Personal computer uses fast minidisc



Olivetti, 500 Park Ave., New York, NY 10022. Britt Tabak (212) 371-5500. From \$2300.

A 17-lb programmable minicomputer and calculator, P6040, features a fast minidisc for program and file storage and easy programming with a mini Basic language. The unit prepares, executes and debugs programs, performs diagnostic checks on syntax and logic errors and monitors the workings of its own internal components. The 2.5-in. Mylar minidisc is a little larger than a silver dollar. It has a 3-kbyte capacity and a typical program can reside on one disc. The basic system includes a 16-column alphanumeric printer, keyboard, minidisc unit, 16-character LED display, hardwired mini Basic interpreter and a 3-k random-access memory.

CIRCLE NO. 337

### Single-board computer has 4 serial I/O ports

Control Logic, 9 Tech Circle, Natick, MA 01760. Hiram French (617) 655-1170. \$950; 4 wks.

A single-board computer, Model MM1-MS, has four serial I/O ports that can communicate asynchronously at rates of 110 to 9600 baud or synchronously at data rates in excess of 50 kbaud. Processing is provided by a Z80 CPU with 1 kbytes of 2708 EPROM or 2 kbytes of 2716 EPROM and 1280 bytes of RAM. A priority interrupt controller provides interrupt capability upon receipt of data from all four ports as well as three external interrupt states.

Booth 2233

CIRCLE NO. 338

### Emulator supports 8085A $\mu$ P

Tektronix, P.O. Box 500, Beaverton, OR 97077. (503) 644-0161. \$2950 to \$3450.

When inserted in the Model 8002 or 8001 microprocessor development system, the 8085A emulator card develops, edits and tests software for the 8085A microprocessor. Using the prototype control probe, the finished bread-boarded system may be connected to the development system for in-circuit emulation, in real time.

Booth 2012, 2111 CIRCLE NO. 339

### Monitor helps program 8085 $\mu$ Ps

Spectrogram, 385 State St., North Haven, CT 06473. (203) 281-0121.

Micro Mate-85 is a hardware-connected system monitor for the 8085 microprocessor. When operating with a keyboard terminal, it provides a convenient means of examining and modifying memory locations and microprocessor registers at any point in an operating program through the implementation of addressable traps. The operating program may be started or stopped at any location or the program may be stepped one location at a time. Additionally, it provides a means of loading or punching a paper tape of memory data for microprocessor systems that do not contain a conventional peripheral I/O.

CIRCLE NO. 340

### Rigid-disc drive stores up to 29 Mbytes

Shugart Associates, 435 Oakmead Pkway, Sunnyvale, CA 94086. Ferrell Sanders (498) 733-0100. \$2550 to \$3500.

SA4000 fixed-disc drives have 14.5 and 29-Mbyte capacities (unformatted) with an optional 144 kbytes of additional head-per-track storage. The drives use Winchester read/write heads and media technology. The transfer rate is 889 kbytes/s and the average access time is 87 ms. The drives rack mount using a panel height of 5.25 in.

CIRCLE NO. 341

Have You Mailed Your Requalification Card? See Page 45



# nichicon

The pulse of the industry.

Quality capacitors for the automotive, computer, home entertainment and industrial electronic industries.

#### REPRESENTATIVES

ALABAMA  
Interep Assoc., Inc.  
(205) 881-3677  
ARIZONA  
Chaparral-Dorton  
(602) 263-0414  
CALIFORNIA (Northern)  
I<sup>2</sup> Incorporated  
(408) 988-3400  
CALIFORNIA (Southern)  
J. J. Riley Assoc.  
(213) 374-3468  
COLORADO  
Electrodyne  
(303) 759-4409  
FLORIDA (Northern)  
C Associates  
(305) 831-1717  
FLORIDA (Southern)  
C Associates  
(305) 922-5230  
GEORGIA  
Interep Assoc., Inc.  
(404) 394-7756  
ILLINOIS  
Midwest Electronic Ind.  
(312) 777-9700  
INDIANA (Northern)  
Needler Sales  
(219) 447-2123  
INDIANA (Southern)  
Needler Sales  
(317) 255-8056  
IOWA  
Midwest Electronic Ind.  
(319) 362-4410  
KANSAS  
Dy-Tronix, Inc.  
(816) 373-6600  
MASSACHUSETTS  
Betronic  
(617) 894-8400  
MICHIGAN  
Greiner Assoc., Inc.  
(313) 499-0188  
MINNESOTA  
Robert W. Marshall Co.  
(612) 929-0457  
MISSOURI  
Dy-Tronix, Inc.  
(314) 731-5799  
NEBRASKA  
Dy-Tronix, Inc.  
(816) 373-6600  
NEW JERSEY (Northern)  
Doan Assoc.  
(201) 382-2797  
NEW JERSEY (Southern)  
Omega Electronic Sales, Inc.  
(215) 947-4135  
NEW YORK (Bohemia)  
Migtra Electronics  
(516) 567-3555  
NORTH CAROLINA  
Component Sales  
(919) 782-8433  
OHIO (Cleveland)  
KW Electronic Sales, Inc.  
(216) 831-8292  
OHIO (Dayton)  
KW Electronic Sales, Inc.  
(513) 890-2150  
OHIO (Worthington)  
KW Electronic Sales, Inc.  
(614) 888-0483  
PENNSYLVANIA (Eastern)  
Omega Electronic Sales, Inc.  
(215) 947-4135  
PENNSYLVANIA (Western)  
KW Electronic Sales, Inc.  
(412) 487-4300  
TEXAS  
William Reese Assoc.  
(214) 638-6575

#### UTAH

Electrodyne  
(801) 486-3801  
WASHINGTON  
Venture Electronics  
(206) 454-4594  
BRITISH COLUMBIA  
(Vancouver)  
Venture Electronics  
(206) 454-4594

#### DISTRIBUTORS

##### West Coast

LOS ANGELES, CA  
JACO Electronics  
(213) 887-6400  
PALO ALTO, CA  
Eric Electronics  
(415) 969-4500  
SEATTLE, WA  
Bell Industries  
(206) 747-1515

##### Midwest

BEACHWOOD, OH  
Sheridan Sales Co.  
(216) 831-0130  
CHICAGO, IL  
Hall Mark Electronics  
(312) 437-8800  
CHICAGO, IL  
Midwest Electronic Ind.  
(312) 777-9700  
DALLAS, TX  
Hall Mark Electronics  
(214) 231-6111  
DALLAS, TX  
KA Electronic Sales  
(214) 634-7870  
DAYTON, OH  
Sheridan Sales Co.  
(513) 223-3332  
FARMINGTON, MI  
Sheridan Sales Co.  
(313) 477-3800  
FLORISSANT, MO  
Sheridan Sales Co.  
(314) 837-5200  
INDIANAPOLIS, IN  
Sheridan Sales Co.  
(317) 547-7777  
MINNEAPOLIS, MN  
Hall Mark Electronics  
(612) 925-2844  
OVERLAND PARK, KA  
Sheridan Sales Co.  
(913) 383-1636  
READING, OH  
Sheridan Sales Co.  
(513) 761-5432

##### East Coast

HUNTSVILLE, AL  
Hall Mark Electronics  
(205) 539-0691  
FT. LAUDERDALE, FL  
N.R.C.  
(305) 792-2600  
ORLANDO, FL  
Hall Mark Electronics  
(305) 855-4020  
HAUPPAGUE, LONG IS.  
JACO Electronics  
(516) 273-5500  
BOHEMIA, NY  
A.D.I. Electronics  
(516) 567-3555  
PHILADELPHIA, PA  
Hall Mark Electronics  
(215) 355-7300  
PITTSBURGH, PA  
Sheridan Sales Co.  
(412) 244-1640  
Canada  
DOWNSVIEW, ONTARIO  
A. E. Sales  
(416) 630-8343

Nichicon challenges you

# Just Compare!



## It's your business to know there's a difference.

We manufacture every type of capacitor including miniature and can-type aluminum electrolytics, ceramic discs, film, mica, oil-



filled—without PCB's, metallized paper and wax paper capacitors for standard or specialized applications.

### nichicon

**The pulse of the industry.**

NICHICON (AMERICA) CORPORATION  
6435 N. Proesel Ave. • Chicago, IL 60645 • (312) 679-6530  
Division of NICHICON CAPACITOR LTD., Kyoto, Japan

CIRCLE NUMBER 78

## MICRO/MINI COMPUTING

### Cross assembler works on PDP-11 or LSI-11

*Automated Logic, 2675 Cumberland Pkwy. Atlanta, GA 30339. (404) 433-0505. \$250.*

Five microprocessor MicroSeries cross assemblers are for use on DEC's PDP-11 minicomputers and LSI-11 mi-

croprocessors. The cross assemblers can be used for any of the Intel 4000 and 8000 family of processors. The assemblers run in 12 kwords of memory and enable programs to be developed using the PDP-11 with the RT-11 operating system. A companion program enables the output from the cross assembler to be shipped directly to burn-in the PROMs.

CIRCLE NO. 342

# Beauty comes in different shapes and sizes.



These smart looking Optima Accent Cases bring you a wide choice of standard sizes, colors and finishes. But in case you want to bring the world something different, you're not boxed in. We'll cut these special beauties to your own specs. With solid walnut or metal sides, sloped or vertical front panels or whatever. We ship knocked-down to save you money.

Send for our catalog. For freedom of design, we give you freedom of choice.

We make you look better

## OPTIMA<sup>®</sup>

Scientific-Atlanta

2166 Mountain Industrial Blvd. Tucker, Ga. 30084 • Tel: (404) 939-6340  
Europe: McKettrick-Agnew, Macmerry, East Lothian,  
Scotland, EH33 1EX • Telex: 72623

SEE US AT ELECTRO — BOOTHS 500, 502 & 504.

CIRCLE NUMBER 79

### Serial I/O board provides 16 ports

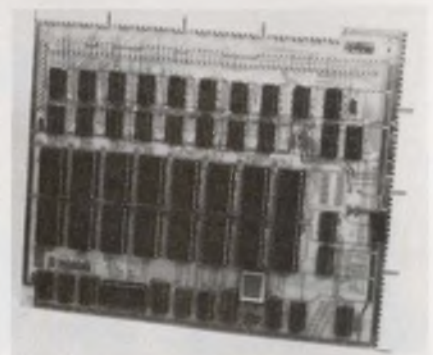

*Ohio Scientific, 1333 S. Chillicothe Rd., Aurora, OH 44202. (216) 562-3101. See text; 6 to 8 wks.*

A 16-port serial I/O board, for use on any Ohio Scientific computer, is fully assembled as the CA10-X where X specifies the number of serial ports on the board from 2 to 16. The board has RS-232 and high-speed synchronous interfaces which can be mixed in any combination. The transfer rate of each port is selectable from 75 to 19,200 baud asynchronous or 250 to 500 kbits in a synchronous mode. The board is priced at \$200 for the first two ports. It costs an extra \$50 for each additional port up to 16.

CIRCLE NO. 343

### Single-board computer boasts low cost



*Omnibyte, 2711B Curtiss St., Downers Grove, IL 60515. Greg Urban (312) 852-8320. \$237 (100 qty).*

Model 0B8001 is a low-cost single-board computer that contains a processor, memory and I/O on a 4.5 x 6.5-in. card. Included on the board are a MC6800 processor, a crystal-controlled clock, 1 kbyte of RAM, sockets for 2k/4k of PROM, serial interface with selectable baud rate, an MC6821 peripheral interface adaptor that provides 2 bytes of programmable binary I/O along with four programmable control bits. Also included are fully buffered address, data and control lines for off-board expansion, full decoding for eight pages of off-board I/O addressing and a separate 128-byte RAM for scratchpad memory.

CIRCLE NO. 344

## Z80 CPU board operates at 2 or 4 MHz

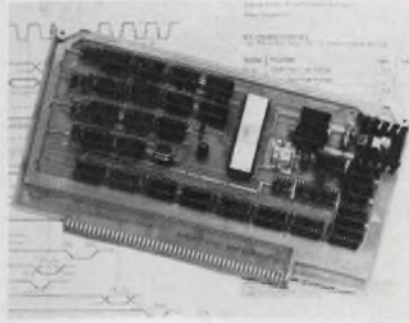

Vector Graphic, 790 Hampshire Rd., Westlake Village, CA 91361. (805) 497-6853. \$215 (assembled), \$175 (kit); stock.

The Z80 CPU board offers a fully-blocked design with on-board wait-state select, and is jumper-selectable for operation at 2 or 4 MHz. The board operates standard 8080 software without modification. All Z80 lines are fully buffered.

CIRCLE NO. 345

## Controller/formatter handles hard-disc drives

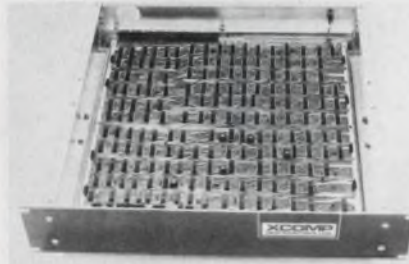

XComp, 7571 Convoy Ct., San Diego, CA 92111. John Costello (714) 560-4415. \$1260 (100 qty); stock.

The DCF10 hard-disc controller/formatter provides a cost-effective interface for microprocessor-based computer systems and conforms to industry standard 3, 6, 12 and 24-Mbyte disc drives. The disc drives may use an IBM 2315 or 5440 removable cartridge and up to three fixed platters. The DCF10 may also be used with fixed-only disc drives. Overlapping seek/restore operations are accommodated on up to four drives. The controller may be used with virtually any micro-computer by means of a universal 8-bit CPU interface.

CIRCLE NO. 346

## Disc drives handle 5 to 67-Mbyte storage



Digital Equipment, Maynard, MA 01754. Steve Kallis (617) 493-2777. \$3800 to \$23,000; 4 wks.

Three disc drives span storage requirements for a wide spectrum of computer systems. The units are the RL01, a 5-Mbyte disc; the RK07, a 28-Mbyte disc; and the RM02, a 67-Mbyte disc. The RL01 employs a removable-disc cartridge and transfers data at a rate of 512 kbytes/s. The RK07 uses a disc cartridge and has a peak data transfer rate of 538 kbytes/s. The RM02 uses a disc pack and transfers data at a rate of 806 kbytes/s. Both the RK07 and RM02 can add up to seven additional drives per controller.

CIRCLE NO. 347

## Add-in memory board plugs into DEC systems

Dataram, Princeton-Hightstown Rd., Cranbury, NJ 08512. John Gilligan (609) 799-0071.

The DR-115 single-board 16 k × 18 core add-in memory is for use with DEC's LSI-11, LSI-11/2 and PDP-11/03. The memory is also offered in an 8 k × 18 configuration. The 18-bit word length allows either parity or nonparity operation. Access and cycle times are 425 ns and 1.15 μs, respectively, and the board operates on +5 and +12 V. A DIP switch is provided for address strapping. Packaging is on a DEC quad board.

CIRCLE NO. 348

# Build better resolution, accuracy and stability... for a lot less money!

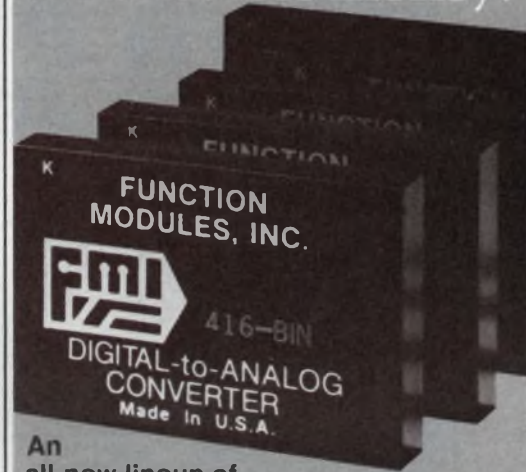

An  
all-new lineup of  
high-resolution D/A Converters

Compare these features!

- Selectable current or voltage output
- 14 and 16-bits binary available
- 4 and ±4½ digits BCD
- Low non-linearity and non-linearity drift
- 168 hours burn-in at 85°C
- Delivery off-the-shelf

You'll enjoy more resolution, accuracy and temperature stability for the price with the complete team of Intech/Function Modules high-resolution Digital-to-Analog Converters than from any others available... anywhere. Each DAC—packaged in a 2" x 3" x .4" case—has a built-in temperature-compensated reference network, ±2 ppm/°C binary or BCD weighted wire-wound resistor network, fast current switches and op-amp. Plus, every model provides optional external offset and gain adjustments, too!

MODEL	RESOLUTION	ACCURACY	STABILITY	PRICE (1-24)
414-BIN	14-Bit Binary	±0.003%	±3ppm/°C	\$156.00
416-BIN	16-Bit Binary	±0.002%	±2ppm/°C	\$184.00
416-BCD	4-Digit BCD	±0.005%	±3ppm/°C	\$167.00
418-BCD	±4½-Digit BCD	±0.005%	±3ppm/°C	\$205.00



## intech / function modules

282 Brokaw Road, Santa Clara, California 95050  
Phone (408) 244-0500 TWX: 910-338-0254

### Ask Us When You're Ready To Convert

Have You Mailed Your Requalification Card? See Page 45

Due to popular demand

# MICROPROCESSOR DATA MANUAL

is now in book form!

**ALL THE INFORMATION  
ON MICROPROCESSOR  
SELECTION AND  
SOFTWARE IN ONE  
CONVENIENT SOURCE!**

- First appeared in **Electronic Design Magazine!**
- Over 30 manufacturers represented!

**MICROPROCESSOR  
DATA MANUAL**  
Edited by Dave Bursky

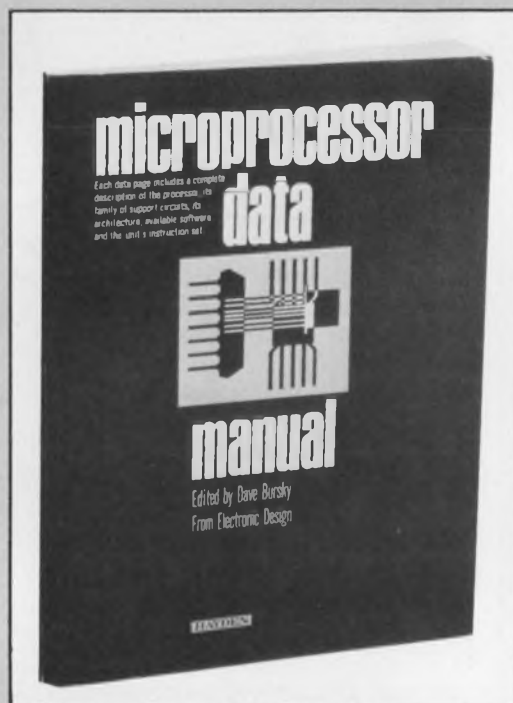

The manual includes a complete data page for each microprocessor or family of processors, with a complete description of the processor, its family of support circuits, architecture, available software, and the unit's instruction set.

**Other sections include:**

- the pitfalls to avoid when choosing a specific model;
- micro fundamentals and a glossary of terms;
- a report on floppy-disc drives;
- background information on micro selection and software.

**Make your micro  
decisions easier! Order  
your copy today!**



Send to: **HAYDEN BOOK COMPANY, INC.**

50 Essex Street, Rochelle Park, N.J. 07662

Please send me MICROPROCESSOR DATA MANUAL (#5114-X, \$7.95) on 15-day examination. At the end of that time, I will send payment, plus postage and handling, or return the book and owe nothing.

Name \_\_\_\_\_

Firm \_\_\_\_\_

Address \_\_\_\_\_

City/State/Zip \_\_\_\_\_

78-009

**SAVE MONEY!** If you send cash with order, publisher pays postage and handling. Same return guarantee. Price subject to change without notice. Offer good in U.S.A. and Canada only.



*Jim Berry*

**“Hello, J.B.... seems these guys down here in Florida  
have a new interface circuit that assures telecommunications integrity.  
Hello? Hello?”**

Next time, specify ITT North's subscriber line interface circuits.  
We have two new thick film circuits, 3081 and 3082, by number.

These telephone hybrids replace other transformer circuitry with solid state, or electronic capability. The advantages are many. The circuits are much smaller and lighter. There is better trans-hybrid loss, especially at low frequencies. You get constant resistive impedance at all four ports. There is high gain/loss stability over temperature. There is more uniform frequency response. And there is no inductive crosstalk as between transformers, which permits closer board spacing without magnetic shielding.

You will find these products have high density, power handling capability, excellent cost effectiveness, reduced logistics problems, simplified system maintenance and reduced interconnect complexity.

In short, reliability. In the long run, reliability.

So visit us when you're in Florida, or send for our brochure. Microsystems Division, ITT North Electric Co., 700 Hillsboro Plaza, Deerfield Beach, Florida 33441. Phone: (305) 421-8450. TELEX & TWX 510-953-7523.



**ITT North**

Microsystems Division

## MICRO/MINI COMPUTING

### Module transfers data between PDP-11s

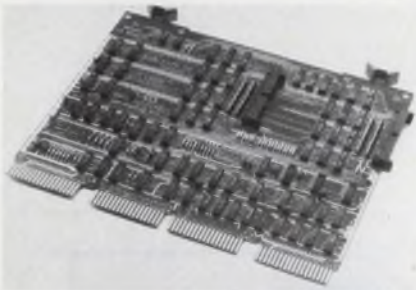

*MDB Systems, 1995 N. Batavia St., Orange, CA 92665. Gene Sylvester (714) 998-6900. \$615; 2 wks.*

The TA-528 general-purpose interface module provides for bidirectional 16-bit transfer over distances up to 100 ft between the DEC PDP-11 computer and a peripheral device, or between two PDP-11s. The module has interrupt request and control logic, address selection, input and output buffer registers and a control/status register. Line drivers and receivers are integral to the module. Convenient data exchange between two PDP-11s can be achieved by cabling two modules together. Each module maintains transparency to its host computer.

CIRCLE NO. 349

### Computer systems are based on floppy disc



*Ohio Scientific, 1333 S. Chillicothe Rd., Aurora, OH 44202. (216) 562-3101. \$1590/\$2090.*

Two fully assembled but unbundled floppy-disc based computer systems feature a 6502A microprocessor, 16 k of dynamic RAM and a full-size 8-in. floppy-disc drive and interface. Both systems have an 8-slot backplane that accommodates system expansion. The computers are available as C2-8SK which includes an RS-232 serial I/O port and Model C2-8VS which includes a 32 x 64-character video display board and a keyboard.

CIRCLE NO. 350

### Desktop computer is self-contained

*Odell Industries, 2351 Charleston Rd., Mountain View, CA 94043. Andy Nester (415) 961-1090. \$8350; 4 wks.*

System 85 is a totally self-contained desktop computer with a programmable keyboard, built-in 1920-character display, dual floppy-disc drives, communications interface and up to 64 k of RAM. The system can be adapted to handle both word and data processing applications. The computer uses Shugart floppy diskette storage devices and can be specified to include either the mini diskettes having 80,000 characters of storage or the standard-size diskettes having 200,000 character capacity. Communications can be asynchronous, bisynchronous or synchronous at rates from 50 to 19,200 baud.

CIRCLE NO. 356

### Analog output boards mate with LSI-11/2

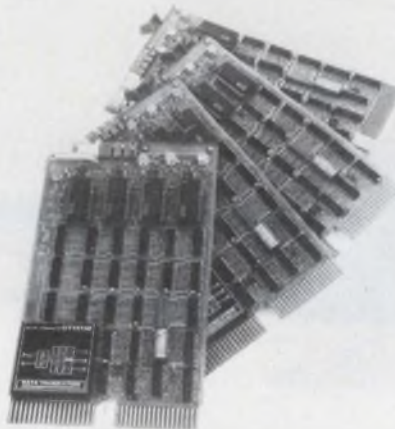

*Data Translation, 4 Strathmore Rd., Natick, MA 01760. Fred Molinari (617) 655-5300. \$495/\$695; stock.*

Two single-board analog output systems plug directly into the backplane of DEC's LSI-11/2 microcomputers. The 12-bit version, DT2766, and the 8-bit model, DT2767, have four d/a output channels on a dual-height card. Each d/a converter is fully buffered to avoid intermediate outputs. In addition, four digital outputs are available for TTL control signals. A special feature on each model is the use of read/write word and byte addressable registers, allowing full use of the PDP-11 instruction set.

CIRCLE NO. 357

## TI Distributors

- ALABAMA** Huntsville. Hall-Mark/Huntsville (205) 837-8700
- ARIZONA** Phoenix. Kierulff Electronics (602) 243-4101. R. V. Weatherford (602) 272-7144. Tempe. Marshall Industries (602) 968-6181
- CALIFORNIA** Anaheim. R. V. Weatherford (714) 634-9600. Canoga Park. Marshall Industries (213) 999-5001. El Monte. Marshall Industries (213) 686-0141. El Segundo. TI Supply (213) 973-2571. Glendale. R. V. Weatherford (213) 849-3451. Goleta. RPS, Inc. (805) 964-6823. Irvine. Cramer/Los Angeles (714) 979-3000. (714) 771-8300. Marshall Industries (714) 556-6400. Los Angeles. Kierulff Electronics (213) 685-5511. RPS, Inc. (213) 748-1271. Palo Alto. Kierulff Electronics (415) 968-6292. Pomona. R. V. Weatherford (714) 623-1261. San Diego. Cramer/San Diego (714) 565-1881. Kierulff Electronics (714) 278-2112. Marshall Industries (714) 278-6350. RPS, Inc. (714) 292-5611. R. V. Weatherford (714) 278-7400. Sunnyvale. Cramer/San Francisco (408) 739-3011. Marshall Industries (408) 732-1100. TI Supply (408) 732-5555. United Components Inc. (408) 737-7474. Tustin. Kierulff Electronics (714) 731-5711. Woodland Hills. JACO (213) 884-4560
- COLORADO** Denver. Cramer/Denver (303) 758-2100. Kierulff Electronics (303) 371-6500. Englewood. R. V. Weatherford (303) 761-5432
- CONNECTICUT** Hamden. Arrow Electronics (203) 248-3801. TI Supply (203) 281-4669. Wilshire Electronics (203) 281-1166. North Haven. Cramer/Connecticut (203) 239-5641. Orange. Milgray/Connecticut (203) 795-0714
- FLORIDA** Clearwater. Diplomat/Southland (813) 443-4514. Ft. Lauderdale. Arrow Electronics (305) 776-7790. Hall-Mark/Miami (305) 971-9280. Hollywood. Cramer/Hollywood (305) 921-7878. Orlando. Cramer/Orlando (305) 894-1511. Hall-Mark/Orlando (305) 855-4020. Palm Bay. Arrow Electronics (305) 725-1480. Winter Park. Milgray Electronics (305) 647-5747
- GEORGIA** Doraville. Arrow Electronics (404) 455-4054. Norcross. Cramer/Atlanta (404) 448-9050
- ILLINOIS** Arlington Heights. TI Supply (312) 640-2964. Elk Grove. Hall-Mark/Chicago (312) 437-8800. Kierulff Electronics (312) 640-0200. Chicago. Newark Electronics (312) 638-4411. Mt. Prospect. Cramer/Chicago (312) 593-8230. Schaumburg. Arrow Electronics (312) 893-9420
- INDIANA** Ft. Wayne. Ft. Wayne Electronics (219) 423-3422. Indianapolis. Graham Electronics (317) 634-8207
- IOWA** Cedar Rapids. Deeco (319) 365-7551
- KANSAS** Shawnee Mission. Hall-Mark/Kansas City (913) 888-4747
- MASSACHUSETTS** Billerica. Kierulff Electronics (617) 667-8331. Burlington. Wilshire Electronics (617) 272-8200. Newton. Cramer/Newton (617) 969-7700. Waltham. TI Supply (617) 890-0510. Woburn. Arrow Electronics (617) 933-8130
- MARYLAND** Baltimore. Arrow Electronics (202) 737-1700. (301) 247-5200. Hall-Mark/Baltimore (301) 796-9300. Columbia. Technico (301) 461-2200. Gaithersburg. Cramer/Washington (301) 948-0110. Kierulff Electronics (301) 948-0250. Hyattsville. Milgray/Washington (301) 459-2222
- MICHIGAN** Ann Arbor. Arrow Electronics (313) 971-8220. Detroit. Newark Electronics (313) 967-0600. Grand Rapids. Newark Electronics (616) 241-6681
- MINNESOTA** Bloomington. Arrow Electronics (612) 887-6400. Edina. Cramer/Minnesota (612) 835-7811
- MISSOURI** Earth City. Hall-Mark/St. Louis (314) 291-5350. Kansas City. LCOMP-Kansas City (816) 221-2400. St. Louis. LCOMP-St. Louis (314) 291-6200
- NEW HAMPSHIRE** Manchester. Arrow Electronics (603) 668-6968
- NEW JERSEY** Camden. General Radio Supply (609) 964-8560. Cherry Hill. Cramer/Pennsylvania (215) 923-5950. (609) 424-5993. Milgray/Delaware Valley (609) 424-1300. (215) 228-2000. Clark. TI Supply (201) 382-6400. Clifton. Wilshire Electronics (201) 340-1900. Fairfield. Kierulff Electronics (201) 575-6750. Little Falls. Cramer/New Jersey (201) 785-4300. Morristown. Arrow Electronics (609) 235-1900. Saddlebrook. Arrow Electronics (201) 797-5800
- NEW MEXICO** Albuquerque. Cramer/New Mexico (505) 243-4566. International Electronics (505) 265-6453
- NEW YORK** East Syracuse. Cramer/Syracuse (315) 437-6671. Endwell. Wilshire Electronics (607) 754-1570. Farmingdale. Arrow Electronics (516) 694-8800. Hicksville. Kierulff Electronics (516) 433-5530. Freeport. Milgray Electronics (516) 546-6000. N. J. (800) 645-3986. Hauppauge. Cramer/Long Island (516) 231-5600. JACO (516) 273-1234. Rochester. Cramer/Rochester (716) 275-0300. Rochester Radio Supply (716) 454-7800. Wilshire Electronics (716) 442-9560
- NORTH CAROLINA** Kennesaw. Arrow Electronics (919) 966-2039. Raleigh. Hall-Mark/Raleigh (919) 832-4465. Winston-Salem. Cramer/Winston-Salem (919) 725-8711
- OHIO** Cleveland. Arrow Electronics (216) 464-2000. Cramer/Cleveland (216) 248-8400. Columbus. Hall-Mark/Ohio (614) 846-1882. Dayton. ESCO Electronics (513) 226-1133. Kettering. Arrow Electronics (513) 253-9176
- OKLAHOMA** Tulsa. Hall-Mark/Tulsa (918) 835-8458. TI Supply (918) 582-8272
- PENNSYLVANIA** Huntingdon Valley. Hall-Mark/Philadelphia (215) 355-7300
- TEXAS** Austin. Hall-Mark/Austin (512) 837-2814. Dallas. Hall-Mark/Dallas (214) 234-7400. TI Supply (214) 238-6821. El Paso. International Electronics. (915) 778-9761. Houston. Hall-Mark/Houston (713) 781-6100. Harrison Equipment (713) 652-4700. TI Supply (713) 776-6511. R. V. Weatherford (713) 688-7406
- UTAH** Salt Lake City. Diplomat/Atlanta (801) 486-4134. Standard Supply (801) 486-3371
- VIRGINIA** Roanoke. Technico (703) 563-4975
- WASHINGTON** Seattle. Almac/Stroum Electronics (206) 763-2300. Cramer/Seattle (206) 575-0907. Kierulff Electronics (206) 575-4420
- WISCONSIN** Brookfield. Newark Electronics (414) 781-2450. Oak Creek. Arrow Electronics (414) 764-6600. West Allis. Hall-Mark/Milwaukee (414) 476-1270
- CANADA** Calgary. Cam Gard Supply (403) 287-0520. Downsview. CESCO Electronics (416) 661-0220. Zentrionics (416) 635-2822. Edmononton. Cam Gard Supply (403) 426-1805. Halifax. Cam Gard Supply (902) 454-8581. Kamloops. Cam Gard Supply (604) 372-3338. Moncton. Cam Gard Supply (506) 855-2200. Montreal. CESCO Electronics (514) 735-5511. Future Electronics (514) 735-5775. Zentrionics (514) 735-5361. Ottawa. CESCO Electronics (613) 729-6411. Future Electronics (613) 232-7757. Zentrionics (613) 238-6411. Quebec City. CESCO Electronics (418) 524-4641. Regina. Cam Gard Supply (306) 725-1317. Red Deer. Future Electronics (416) 677-7820. Saskatoon. Cam Gard Supply (306) 652-6424. Vancouver. Cam Gard Supply (604) 291-1441. Waterloo. Zentrionics (519) 884-5700. Winnipeg. Cam Gard Supply (204) 786-8481

Have You Mailed Your Requalification Card? See Page 45





## SCHOTTKY PROMs

# Now, 18-pin 4K Schottky PROMs from Texas Instruments. Speedy. Space-saving. Off-the-shelf.

They pack 4096-bits of memory into an industry standard 18-pin package. An extremely high-density, cost-effective approach to large, fixed memory needs. They're TI's new SN54S/74S476 and SN54S/74S477 Schottky PROMs.

Functionally and efficiently organized, 1024 words by 4 bits, they maximize board-area utilization and simplify system expansion by means of dual enables.

They're top performers. A speedy 35 ns typical, 60 ns maximum from 0° C to 70° C, and 75 ns over the full temperature range (-55° C to 125° C). They're also only \$9.30 in 100-piece quantities in plastic DIPs.

Output configurations can be either three-state (S476) or open-collector (S477).

### The wide, wide TI line

With these additions, TI now offers the widest choice of high performance 4K PROMs in 18, 20, and 24-

### TI's BROAD PROM FAMILY 0° C to 70° C Plastic

Device	Description	Price (100 up)
SN74S476N	1024 W x 4 B, 3-S, 18 Pins	\$9.30
SN74S477N	1024 W x 4 B, 0-C, 18 Pins	9.30
SN74S474N	512 W x 8 B, 3-S, 24 Pins	9.30
SN74S475N	512 W x 8 B, 0-C, 24 Pins	9.30
SN74S472N	512 W x 8 B, 3-S, 20 Pins	9.00
SN74S473N	512 W x 8 B, 0-C, 20 Pins	9.00
SN74S470N	256 W x 8 B, 3-S, 20 Pins	4.50
SN74S471N	256 W x 8 B, 0-C, 20 Pins	4.50
SN74S287N	256 W x 4 B, 3-S, 16 Pins	1.88
SN74S387N	256 W x 4 B, 0-C, 16 Pins	1.88
SN74S188N	32 W x 8 B, 0-C, 16 Pins	1.50
SN74S288N	32 W x 8 B, 3-S, 16 Pins	1.50

SN54S versions available in ceramic (J) DIPs.

pin plastic or ceramic packages with by 4 and by 8 organizations. An even dozen - plenty of options for greater flexibility and efficiency.

All TI PROMs share the same design rules and have proven programming techniques. All are Schottky-clamped for superior speed/power characteristics. All have low-current pnp inputs for interface with MOS

as well as bipolar microprocessors.

All have the proven titanium-tungsten fuse links that make programming fast and reliable. All TI PROMs are available in versions to operate over the full military temperature range.

It's a broad family growing broader. Coming soon: TI's new 1024 x 8 bit PROM in a 24-pin package (SN54S/74S478 and SN54S/74S479). Others on the way.

### Off-the-shelf delivery

TI's entire PROM family, including the newest members, are now in distributor stocks for fast delivery. And for a copy of TI's Schottky Memory brochure, write Texas Instruments Incorporated, P. O. Box 225012, M/S 308, Dallas, Texas 75265.

**TEXAS INSTRUMENTS  
MOVING AHEAD  
IN MEMORIES**

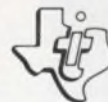

**TEXAS INSTRUMENTS  
INCORPORATED**

CIRCLE NUMBER 83

## ICs & SEMICONDUCTORS

### Inverter SCRs have high dv/dt ratings

FMC Semiconductor Products, 800 Hoyt St., Broomfield, CO 80020. Brian Bachman (303) 469-2161. See text; 3 to 4 wks.

Two lines of TO-94 size inverter SCRs in the Series 076 and 079 are rated at 70 and 80 A average and offer a choice of performance classifications

including 200, 500 and 1000 V/ $\mu$ s. The Series 076 units are available in seven 100-V incremental blocking ranges from 600 through 1200 V and with turn-off times of 10, 20 or 30  $\mu$ s. The Series 079 has six blocking ranges from 100 through 600 V with turn-off times of 10, 20 or 30  $\mu$ s. A typical Type 076 SCR with 1200-V blocking, 10- $\mu$ s turn-off and 200 V/ $\mu$ s performance is typically priced at \$40.55 in quantities of 10 to 99.

CIRCLE NO. 358

### Dual-voltage comparators boast of being first

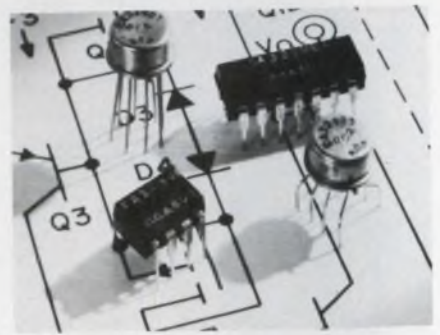

RCA Solid State, P.O. Box 3200, Somerville, NJ 08876. (201) 685-6420. \$0.99 to \$1.39; stock.

Claimed to be the first multiple-technologies dual-voltage comparators, the CA3290 series of BiMOS devices feature two independent single or dual-supply circuits on a single chip. The devices have gate-protected MOSFET (MOS) transistors in the input circuit to provide high input impedance (1.7 T $\Omega$  typical), low input current (3.5 pA typical at +5 V), and high-speed performance. The dc supply-voltage ranges from 4 to 36 V and the common-mode input voltage range is typically 1.5 V below the negative supply rail. The chips are compatible with all logic systems and operate over a temperature range from -55 to 125 C.

CIRCLE NO. 359

### IC chip controls SDLC protocol



Western Digital, P.O. Box 2180, Newport Beach, CA 92663. (714) 557-3550.

An IBM/SDLC communications circuit, the SD 1933, gives complete control of SDLC protocol. The device provides zero insertion and deletion, CRC check and generation, abort and flag insertion and delete plus invalid frame detect. Also built in is transmission error detection for CRC, underrun and overrun, diagnostics loop command, a go-ahead option for loop applications and an NRZI encode/decode option. All popular generalized computer interface control signals are present. The device operates from dc to 1.5 Mbits/s on a single +5-V supply.

CIRCLE NO. 360

◀ CIRCLE NUMBER 84 CALL ME I'M INTERESTED  
◀ CIRCLE NUMBER 85 MAIL CATALOG

# Give 'em hell.



It's a cruel world. People don't treat your equipment the way you would. But they still expect it to work.

Since you can't be there to protect it, do the next best thing. Put it in a Zero Centurion™ case. It's built to give your equipment the best possible chance of surviving. In 7 styles and over 70 sizes with 2 week delivery from stock.

Ask for a demonstration of the right case for your equipment today. Tomorrow, somebody will be giving it hell.



## ZERO

We make you look good.

Zero Corporation • Burbank, CA 213 846-4191 • Monson, MA 413 267-5561

SEE US AT ELECTRO BOOTH #105 AND #107



## Need hustle on conv./charger orders?

Dormeyer's Converter/Charger team keeps moving . . . on application assistance . . . prompt deliveries . . . service after-the-order. We can ship standard units from stock, furnish your company name on the label, or design a converter/charger to meet your special requirements.

When you need fast action on power Converter/Chargers, filtered converters, battery chargers or AC/AC plug-in transformers (all U/L Listed or recognized), just whistle for Dormeyer.

Make it easy on yourself. Write or call today for the new Dormeyer "Coach's Kit" with complete catalog to help you with your requirements.

**DORMEYER INDUSTRIES, A Division of A.F. DORMEYER MFG. CO., INC.**

3418 N. Milwaukee Avenue Chicago, IL 60641  
(312) 283-4000 TWX: 910-221-3831



"See Us At Electro/78 Booth 1727-1729"

CIRCLE NUMBER 220

# Remember comstron/adret

# and I'll give you the shirt off my back.

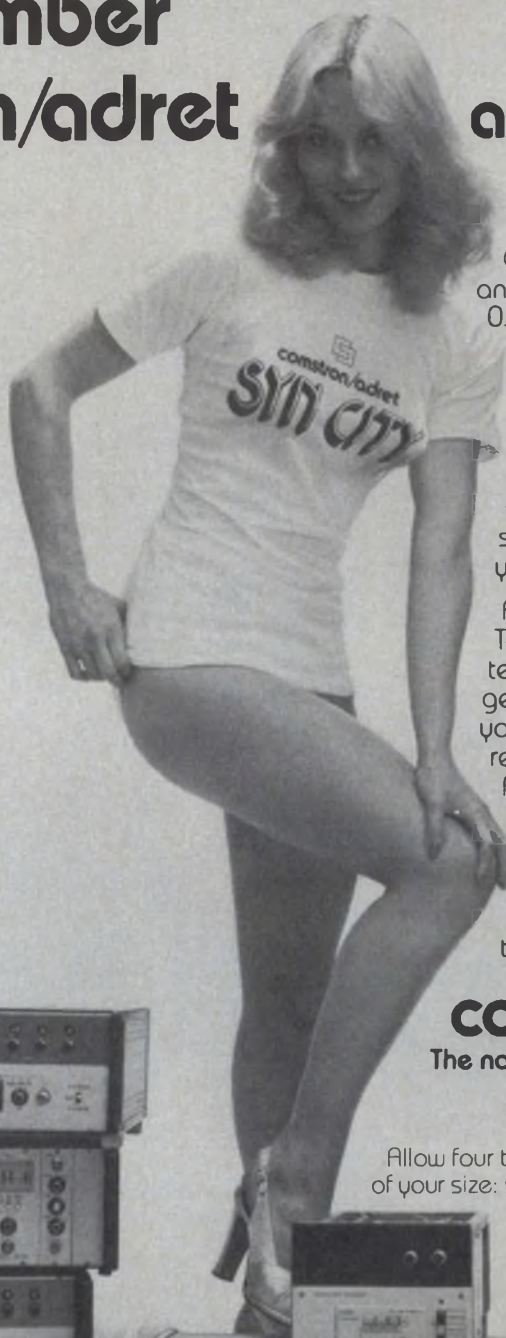

Comstron/Adret offers enough synthesizers and signal generators to be a city in itself. From 0.01 Hz to 1.2 GHz — for bench, lab, and systems, we offer more "syms" than any other company in the world.

Comstron/Adret isn't exactly a household name . . . That's why we're offering memorable t-shirts **free of charge**. You can show the world you know where to get great specs and a great price on any synthesizer you need.

All you have to do to get your free Syn City™ T-shirt is write to us on your letterhead and tell us your synthesizer and/or signal generator application. Along with the shirt, you'll receive our complete catalog. (To receive literature only, please use the Reader Service Number).

Be the first one on your block to get a genuine Syn City T-shirt. They're available only from the company with the largest selection of synthesizers in the world.

## comstron/adret

The name to remember in synthesizers.

Allow four to six weeks for delivery and please inform us of your size: small, medium, large or x-large.

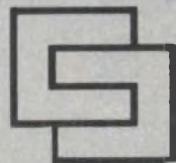

# comstron/adret

200 East Sunrise Highway, Freeport, New York 11520 • (516)546-9700 • TWX 510-225-3699

CIRCLE NUMBER 221

# Things you should know about double break switches:

Double control... greater reliability and electrical ratings with Licon® Double Break Switches!

Licon specializes in producing small, rugged, double break, snap-action switches for specific, tough jobs. That's why we think there are *unique* things you should know about *double break switches*.

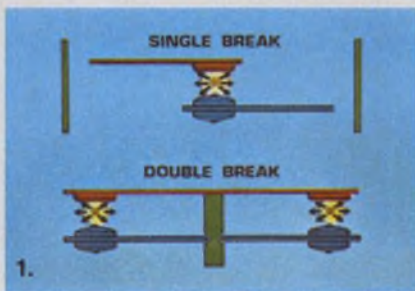

1. The Licon double break design offers twice the arc breaking and current interrupting ability with a bonus of much better heat dissipation than single break switches of similar size.

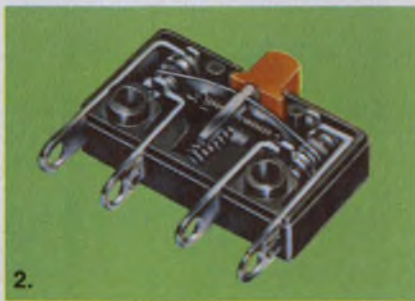

2. Coil spring snap-action mechanism extends life of switch. (Outlasts stressed blades in terms of metal fatigue.) Overcenter and compression springs are not stressed to their limits even under full overtravel as are stressed blades. Coil springs retain characteristics longer under usage than stressed blades.

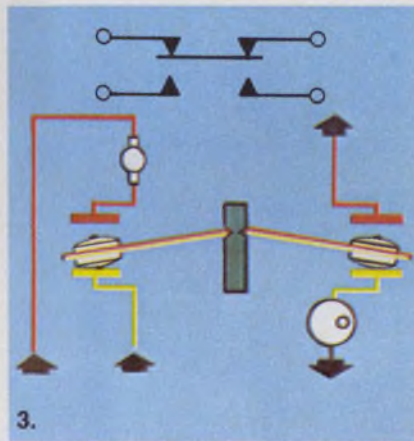

3. Dual circuit capability—with two normally open and two normally closed contacts, two isolated circuits can be controlled with one single pole Licon switch. That's a unique advantage of Form Z switching.

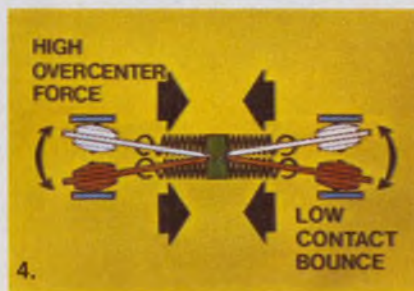

4. High overcenter force, small contact mass and short blade length maintain high contact pressure longer than usual stressed blade assemblies. This results in better resistance to shock and vibration. It also provides high contact pressure essential to low contact resistance for low level current use. Extremely short rebound time, when contacts collide minimizes bounce (mechanical) to increase (electrical) life.

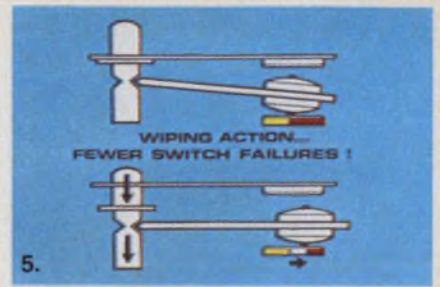

5. Wiping action helps clean away surface contamination in low level circuits, where contact resistance must be kept low. Breaks through minor contact welds that cause switch failure under high current conditions.

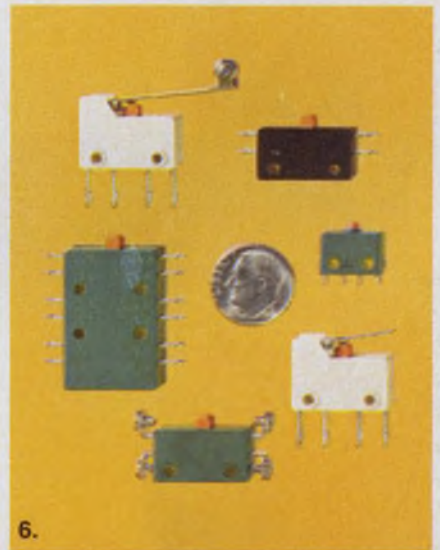

6. Licon can supply a variety of U.L. and C.S.A. Listed small double break switches with "big switch" ratings up to 20 Amps for applications where size is important.

For more control, reliability and electrical load carrying capacity and more for your money double break switch details, contact your local Licon Distributor, or call or write for Switch Catalog: Licon, 6615 West Irving Park Road, Chicago, IL 60634. Phone (312) 282-4040. TWX: 910-221-0275.



**LICON**

A DIVISION OF ILLINOIS TOOL WORKS, INC.



Littelfuse

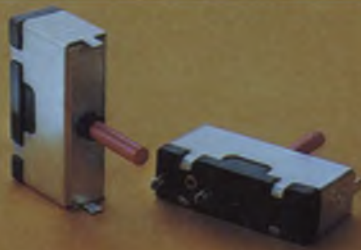

Littelfuse



Littelfuse



Littelfuse



Littelfuse



Littelfuse

# We're a whole lot more than fuses.

Everybody knows Littelfuse makes fuses...and a complete line of related devices like fuseholders, fuse clips, fuse blocks, and circuit breakers.

But that's only one side of our story. We're switches, relays, and indicator lights, too.

In fact, our Littelite line includes the widest selection of cartridge lamps and lampholders, sub-miniature and miniature lamp-holders, and Snap-mount Plastic Lites you'll find anywhere. And they're available off-the-shelf from a nationwide network of Littelite distributors.

Switches and Relays? We make all shapes and sizes, designed to fit a variety of applications—from appliances to computers.

To find out what our products can do for yours, just give us a call or send for our Catalog No. GL-77. We can show you a whole lot more than fuses.



Littelfuse



Littelfuse



Littelfuse



Littelfuse



Littelfuse



Littelfuse



Littelfuse

1927-1977 **50** YEARS

# LITTELFUSE

TRACOR

800 East Northwest Highway  
Des Plaines, Illinois 60016  
312/824-1188

CIRCLE NUMBER 223

# Welding a Reputation for Solid Quality in Controls

Deltrol builds relays, solenoids and timers that meet the expectations of serious designers for quality, performance and dependability — OUR REPUTATION DEPENDS ON IT.



## DELTRON *controls*

Division Of Deltrol Corp.

2745 South 19th Street, Milwaukee, Wis. 53215  
(414) 671-6800, Telex 2-6871

See your local distributor or send for free engineering catalog.



CIRCLE NUMBER 224

3003

# The Pick 'N' Choose Relay

972 variations of a 12 amp miracle from your Guardian Angel



**PICK** Series 1510 AC or 1515 DC.

**PICK** .187" or .205" quick connect/  
solder lug, or PC termination.

**PICK** push-to-test button versions.

**PICK** heat and shock resistant  
polycarbonate dust cover or open style  
(without cover).

**PICK** voltages from 6 to 240VAC,  
6 to 110VDC.

**PICK** the 1510 that's ideal for your application—  
and get it directly from Guardian... or from your  
Guardian Distributor.

**CHOOSE** SPDT, DPDT or 3PDT.

**CHOOSE** bracket, stud, stud-on-  
end or tapped core mount.

**CHOOSE** indicator lamp versions.

**CHOOSE** sockets with solder lug,  
.187" QC, PC or screw terminals.

**CHOOSE** contact materials from  
silver-cadmium-oxide to tungsten and  
gold alloy silver and silver alloys for special  
applications.



Your Guardian Angel has a free  
technical application bulletin waiting  
for you. Send for your Series 1510  
data today.

## GUARDIAN®

GUARDIAN ELECTRIC MANUFACTURING COMPANY • 1550 W. Carroll Avenue, Chicago, IL 60607 • 312/243-1100

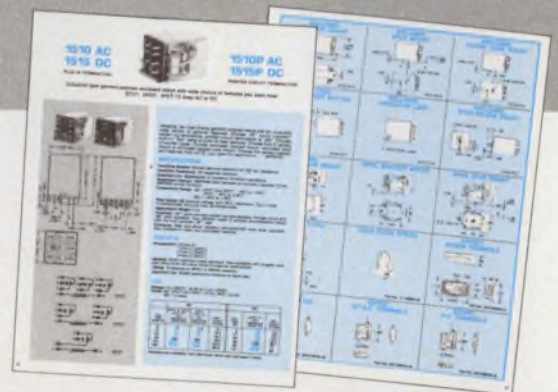





# the "Dumb Keyboard"

for smart designs



## "Dumb" can be smarter than "intelligent"

In 1975 Cortron developed and released a new keyboard principle of design that has given many design engineers a very real competitive edge. It is so simple we call it the "ABC" principle (Address Binary Code). If you haven't heard of it we suggest you read on to find out what many of your competitors are already doing. There is an alternative to the expensive "intelligent" keyboard design. We manufacture both, but we feel dumb is generally smarter.

**"ABC" principle** An address encoded keyboard simply outputs a unique 8 bit binary code for each key station. This code directly enters the main system which, through various software routines, determines what each specific key switch is and does. This provides a keyboard that is both simple and versatile. Cortron has various subsets of this principle to give the designer "trade-offs" between system and keyboard such as PROM conversion, etc. Call us before you design, so these "trade-offs" can be discussed and your information bank complete before costly designs are finalized.

**Upstroke/downstroke** We also supply a unique "ABC" for both key depression and release. Thus, not only can you determine what character, function, etc. you want, you can also control which keys auto repeat — any or all—and also which keys are mode control.

**Advantages** *Lower keyboard cost:* Eliminates electronics on board with little or no added cost to system.

*Versatile:* One basic keyboard can be customized for virtually any customer configuration with only software or PROM conversion and key top change.

*Inventory savings:* Now you can satisfy all those special foreign language and function requirements with one keyboard and a stock of key tops.

*Fast turnaround:* No more 20 week wait for a new LSI mask for the special requirements. Virtually "off-the-shelf" availability.

*Reliability:* Less electronics on keyboard means improved reliability and long term cost savings to your system.

Call us today to find out why most new designs utilize the "ABC" principle. We will explain the various "trade-offs" and costs of keyboard design and even help with your software routines, if required.

Of course, if you feel intelligent is smarter for your system, we can also aid you in those design decisions. Cortron has developed and manufactured micro-processor based keyboards using the most popular single chip microprocessors. We have the modern system development aids and staff capability which has allowed us to write the highly flexible keyboard handling routines for the cases when "intelligent" is intelligent. For full details and literature, call or write: CORTRON, A Division of Illinois Tool Works Inc., 6601 West Irving Park Road, Chicago, Illinois 60634. Phone (312) 282-4040. TWX 910-221-0275. Toll free line: 800-621-2605.



THE KEYBOARD PROFESSIONALS

# The one variable the world can standardize on.

Our new Type M conductive plastic variable resistor is hard metric. A 10 mm cube that's tiny, flexible and rugged. The MINI-METRIC is the smallest dual pot available today. Manufactured in the United States, it's dimensioned the way the rest of the world thinks. Allen-Bradley has what you need; or, it can be ordered through our distributors. Ask for Publication 5239.

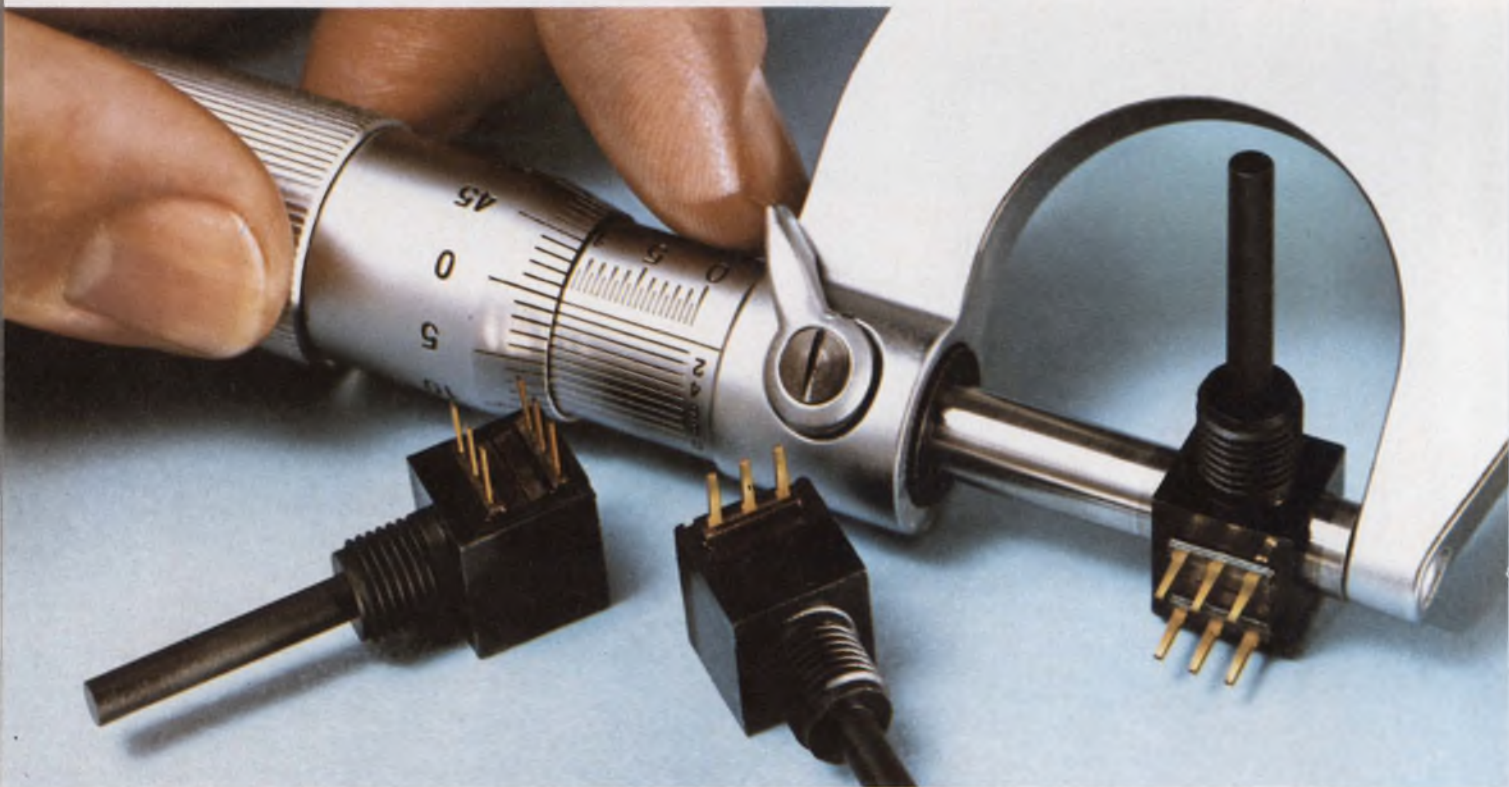
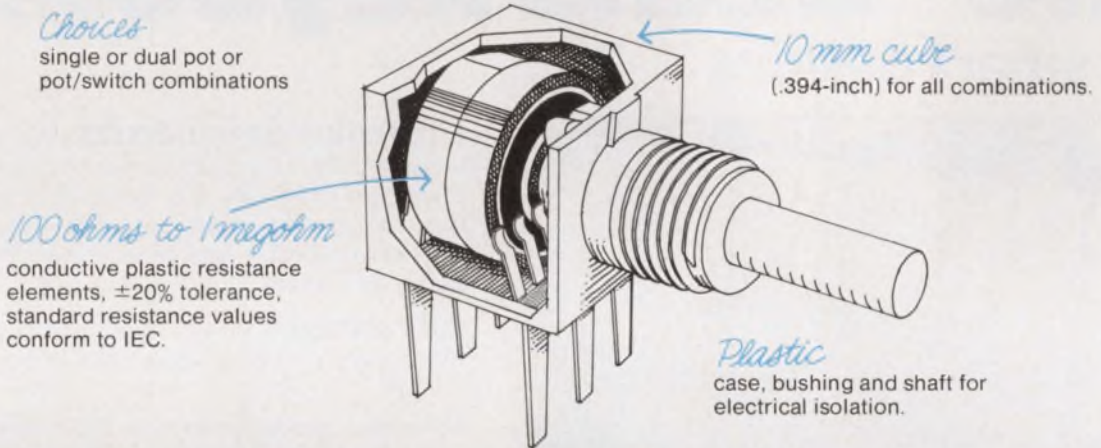

## Quality in the best tradition.



**ALLEN-BRADLEY**  
Milwaukee, Wisconsin 53204

CIRCLE NUMBER 228

## Analog multiplier doesn't cost a bundle

Raytheon Semiconductor, 350 Ellis St., Mountain View, CA 94040. (415) 968-9211. \$2.75/\$3.75 (100 qty); stock.

The RC4200 low-cost analog multiplier has a circuit that compensates for nonlinearity. At room temperature, the standard device achieves a maximum non-linearity of  $\pm 0.3\%$ , while an "A" version has a  $\pm 0.1\%$  maximum nonlinearity. The chip contains three compensated op amps and a precision log-antilog transistor array. A bandwidth of 4 MHz and a tempo of  $\pm 0.005\%$  are provided. The unit multiplies two input currents and divides by a third.

CIRCLE NO. 361

## Dual Schottky diode handles up to 25 A

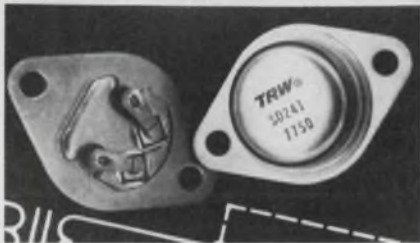

TRW Power Semiconductors, 14520 Aviation Blvd., Lawndale, CA 90260. (213) 679-4561. \$6.50 (100 qty); stock.

A single TO-3 package contains two Schottky power diode chips and allows a full-wave rectifier output of up to 20 A dc. The SD241 has a peak inverse voltage rating of 45 V and has a forward voltage drop of 0.6 V at 20 A and 125-C junction temperature.

CIRCLE NO. 362

## Low-cost op amp delivers high power

Burr-Brown, P.O. Box 11400, Tucson, AZ 85734. Dennis Haynes (602) 746-1111. \$19.80 (100 qty).

An op amp IC, Type 3573, delivers 100 W peak, 40 W continuous. The current output is 5 A peak, 2 A continuous from a supply voltage of  $\pm 10$  to  $\pm 34$  V. No external components are needed for frequency compensation and the amplifier is unconditionally stable with capacitive loads to 3300 pF. The open-loop gain is 94 dB min so that a separate preamp isn't necessary. The input stage has a 40-nA max bias current and  $10^7$ - $\Omega$  input impedance. Offset voltage is 10  $\mu$ V/ $^{\circ}$ C typical. The amplifier is in an 8-pin TO-3 package.

CIRCLE NO. 363

# Reticon announces the tunable filter on a chip

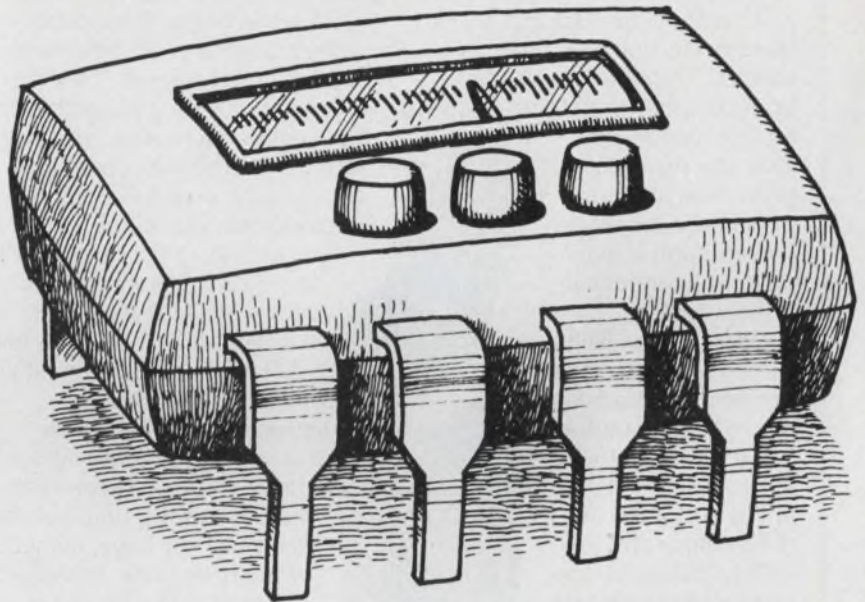

Now from Reticon the first commercially available CTD transversal filters. These devices offer electronic tunability over a 1000 to 1 range, have linear phase response so the shape of your signals wouldn't be distorted and provide attenuation of more than 50dB from unwanted signals even if they are only 3 percent away from your desired frequency. All of these features are available in a single 16-lead DIP package requiring only a single positive supply.

This family of R5602 devices are sampled data filters, each consisting of 64-stage split electrode structure. The specific frequency response required is simply obtained by programming the device with the correct tap weights. A single mask layer used in its fabrication contains all necessary response information. Currently available as standard filters are two low pass and two band pass configurations. The exact performance of each of these filters depends on the particular filter function. As an example, the R5602-3 band pass filter tunes from a center frequency of 250Hz to 250KHz with a bandwidth that is  $5\frac{1}{2}$  percent of the sample clock frequency and has a dynamic range greater than 60dB. Your particular frequency response can now also be easily and inexpensively realized in a custom device.

Everybody needs a filter, so get our data sheet and see what our filters can do for you. Contact one of our 70 salesmen or 20 distributors in our worldwide network or write directly to us.

Discover the IC's that do it all!

# RETICON<sup>®</sup>

AN  COMPANY

910 Benicia Ave • Sunnyvale, California 94086  
(408) 738-4266 • TWX: 910-339-9343

CIRCLE NUMBER 81

# Precisely yours!

## PCI snap-acting hermetically sealed "specified temp" thermostats.

You specify your temperature requirements. We meet them to a "T" with factory-set and sealed thermostats that are 100% inspected against your specifications. PCI thermostats are designed for fast response to give you maximum protection and control. Single terminal construction is available for economical installation.

**Excellent Repeatability**  
PCI thermostats retain their operating characteristics over long periods of use. In addition, temperature tolerances and standard differentials are precisely calibrated. Despite all the care and attention that go into their design and manufacture, PCI thermostats are surprisingly inexpensive. Pricing is highly competitive.

### Surface-type Thermostats

Want specifics? Take our Series 5011 surface-type thermostats. They're widely used on air and water cooled engines. They can be used for bearing protection and transmission temperature indication for overheating conditions. Can also be used for refrigeration applications. Operating temperature settings range from  $-20^{\circ}\text{F}$  to  $+525^{\circ}\text{F}$ . Standard tolerances are as low as  $\pm 5^{\circ}\text{F}$ ; standard differential is as low as  $20^{\circ}\text{F}$  with a minimum differential as low as  $10^{\circ}\text{F}$ .

### Immersion-type Thermostats

If your requirements call for immersion-type thermostats, our Series 5100 units are the answer. They have, in fact, virtually become an industry standard in the liquid cooled engine field. They can also be used in chemical baths, commercial deep fat fryers, degreasers and hydraulic systems. Models are available to give you a range of protection from  $-20^{\circ}\text{F}$  to  $+530^{\circ}\text{F}$ . Tolerances are as low as  $\pm 5^{\circ}\text{F}$  and differential as low as  $20^{\circ}\text{F}$ .



Surface type



Immersion type

Send for our Application Data Form  
**PCI thermostats...100% inspected.**

PROTECTIVE  CONTROLS INC.

A subsidiary of North American Philips Controls Corp.  
Frederick, Md. 21701 • (301) 663-5141

## ICs & SEMICONDUCTORS

### 8085A $\mu\text{P}$ upgraded to 5-MHz speed

Intel, 3065 Bowers Ave., Santa Clara, CA 95051. Rob Walker (408) 249-8027.

Completely compatible with other MCS-85 family members, the 5-MHz 8085A-2 is a selected upgrade from the standard 3-MHz 8085A. Typical instruction time in an 8085-2-based system is  $0.8 \mu\text{s}$  with a 5-MHz clock rate that can be set with a crystal or a TTL clock input. System performance overlaps that of TTL logic systems, allowing it to be used in high-performance applications.

CIRCLE NO. 364

### Uhf transistors yield low noise

TRW RF Semiconductors, 14520 Aviation Blvd., Lawndale, CA 90260. Dan Faigenblat (213) 679-4561. \$1.55 to \$1.73 (100 qty); 4 to 6 wks.

A pair of rf silicon transistors has high cut-off frequencies and low noise figures. The LT3046 and 3047 have cut-off frequencies of 3 and 3.2 GHz, respectively. Typical noise figure for the LT3046 is 2.5 dB at 200 MHz. For the LT3047, it is 1.7 dB at 500 MHz. Max collector current for the LT3046 is 200 mA and for the LT3047, 50 mA. The 3046 has a forward insertion gain of 10 dB at 400 MHz and the 3047's is 14 dB at 500 MHz. The transistors are packaged in TO-46 cans.

CIRCLE NO. 365

### Voltage regulator is in low-cost package

Fairchild Semiconductor Products, 464 Ellis St., Mountain View, CA 94042. Bill Callahan (415) 962-3816. \$0.42 (100 qty); stock.

A series of 3-terminal, 0.5-A voltage regulators,  $\mu\text{A}78\text{C}$ , is a low-cost version of the  $\mu\text{A}78\text{M}$ . The device's U1C package has a bent heat-sink tab with dimensions that allow it to be used as a direct replacement for the TO-220 package with greater convenience than the TO-202 design. The  $\mu\text{A}78\text{CXXU1C}$  is offered in nine voltage options: 8, 10, 12, 15, 17, 18, 20, 22 and 24. The XX designation determines voltage, so that a  $\mu\text{A}78\text{C12U1C}$  would be a 12-V part.

CIRCLE NO. 366

CIRCLE NUMBER 71 FOR INFORMATION CIRCLE NUMBER 72 FOR IMMEDIATE NEED

# Introducing the first Intelligent keyboard. It thinks like you do.

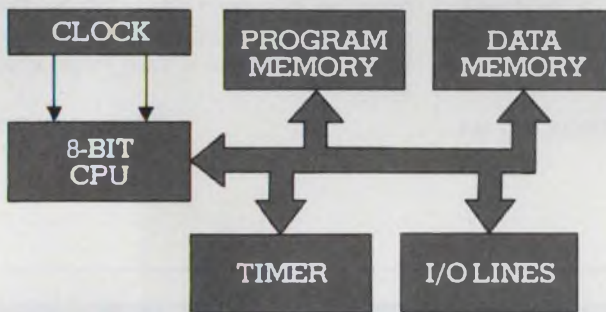

Designing a full-function keyboard for your system used to have a major problem. A full-function price.

MICRO SWITCH has changed all that with the intelligent keyboard. It's the first microcomputer-based keyboard. Ever.

Which means when you equip it with virtually every function you can think of, it still comes in for the price of a simple encoded keyboard. Because all the functions that used to require extra components are now available on a single microcomputer chip.

Besides traditional encoder functions, the chip can handle many others, such as parallel or serial data, multi-character storage and tri-stated outputs for direct data bus compatibility without using expensive I/O ports.

The intelligent keyboard can

perform more functions more efficiently because less hardware is needed. You get lower total system cost. Pin for pin compatible EPROM for faster design turnaround. Plus greater reliability since there are fewer components.

Just let us know what your particular needs are. And through MICRO SWITCH Value Engineering we'll work with you closely to create a cost effective solution that interfaces with your total system.

For more information about the intelligent keyboard, call 815/235-6600. It could be the smartest call you've ever made.



## MICRO SWITCH

FREEPORT, ILLINOIS 61032

A DIVISION OF HONEYWELL

In Europe MICRO SWITCH has keyboard application engineers in Germany, England, France and Sweden.

**50-A transistor switches fast**



General Semiconductor Industries, P.O. Box 3078, Tempe, AZ 85281. Jim Williams (602) 968-3101. \$24 (100 qty); stock.

The GSDS50020 transistor handles 50 A and has a  $V_{CE0}$  of 200 V. Peak collector current is rated at 75 A. Collector saturation voltage is typically 0.6 V and switching speeds are typically less than 1  $\mu$ s at the 50-A rating.

CIRCLE NO. 367

**Power rectifiers recover fast**



Solid State Devices, 14830 Valley View Ave., La Mirada, CA 90638. Dee Peden (213) 921-9660. \$ 0.98 to \$3.45 (100 qty).

Fast-recovery rectifiers, numbered 1N3889 to 1N3893, are 12-A units with blocking voltages of 50 to 400 V. The rectifiers have a typical reverse-recovery time of 100 ns with a maximum of 200 ns. Instantaneous forward-voltage drop is 1.5 V and maximum reverse current at 25 C is 25  $\mu$ A. Non-repetitive peak surge current is 200 A. Packaged in a D04 case, the rectifiers have an operating temperature range of -65 to 175 C.

CIRCLE NO. 368

**Ultra-fast rectifiers handle up to 6 A**

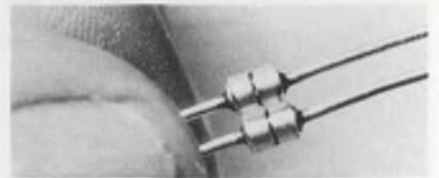

Microsemiconductor, 2830 Fairview St., Santa Ana, CA 92704. Phil Frey (714) 979-8220. \$1.90 to \$6.50 (100 qty); stock.

Two series of ultra-fast switching rectifiers provide switching speeds of 25 ns for the 2.5-A series and 30 ns for the 6-A series. The 1N5802 to 5806 series has an average rectified current of 2.5 A and a maximum surge current of 35 A (single cycle, 8.3 ms). The 1N5807 to 5811 series has an average rectified current of 6 A and maximum surge current of 125 A. Both series range in PIV from 50 to 150 V. The package is a subminiature, hermetically sealed hard-glass case with axial leads.

CIRCLE NO. 369

# New Shapes For '78

We are proud to introduce our new collection of VEROBOXES® for 1978 — consisting of seven styles in over 20 convenient sizes. Pictured here is the sloping front ABS vacuum formed box, available in two sizes (one is even big enough for a full typewriter keyboard) and the hinged, one-piece, dust-free 'Flip Top' box molded from tough polypropylene. Additionally, we are offering a new box with a battery compartment which is accessible from the outside (for both 9V and 1.5V) molded from Hi-Impact polystyrene and a strong, lightweight aluminum enclosure with black matte panels and brushed aluminum covers in three sizes. Our new 1978 catalog supplement outlining all of the specifications of these and the other new VEROBOXES is available upon request. Let us give a 'Custom' look to your company's component package.



**Vero Electronics, Inc.**  
171 Bridge Road, Hauppauge, N.Y. 11787  
Tel.: (516) 234-0400 TWX: 510-227-8890

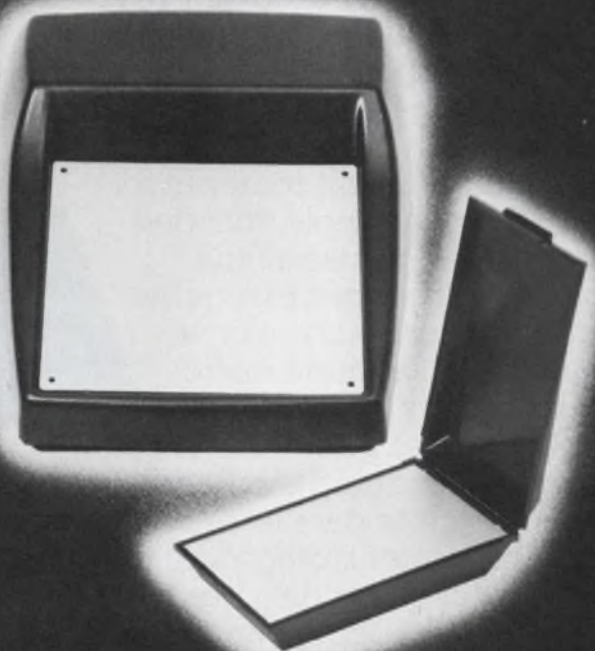

VERO LTD — SOUTHAMPTON, ENGLAND ■ VERO GMBH — BREMEN, W. GERMANY ■ VERO SA. — PARIS, FRANCE

CIRCLE NUMBER 88

## DIP Switch Line from SMK

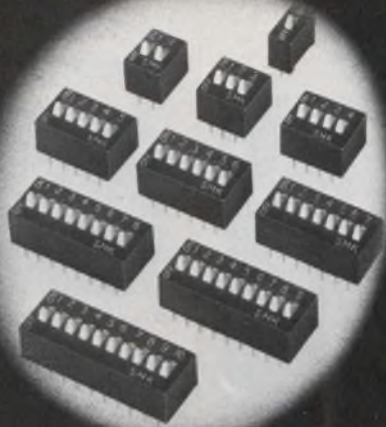

The **JS-8722 Series** is a complete line of DIP Switches, from 1 to 10 positions, featuring sealed construction to prevent flux contamination during wave soldering. A clip-type wiper design assures positive 2-sided contact to provide excellent shock and vibration characteristics.

Available in SPST configuration, the switches are rated at 24V DC at 300mA switching, resistive load, and will operate from  $-20^{\circ}\text{C}$  to  $+60^{\circ}\text{C}$ .

Typical price for a 4 position DIP Switch in 100 piece quantity would be \$1.16 each.



SMK Electronics Corporation  
of America

118 East Savarona Way Carson, California 90746

Tel: (213) 770-8915

"See Us At Electro Booth 1238"

CIRCLE NUMBER 137

## THE INCREDIBLE BEI DIVIDED CIRCLE MACHINE FOR THE ULTIMATE IN ENCODER ACCURACY



BEI accuracy begins at our code disk generating device. The BEI Divided Circle Machine presently attains pattern section centerline to centerline absolute position accuracy of better than 0.3 second of arc! BEI's commitment to accuracy is evident in every aspect of encoder design. Check these features from our absolute position series: Non-ambiguous code formats • Linear and nonlinear codes • Reference amps compensate for variations in temperature and supply voltage • Dual readout stations of Optical Resolver™ Series cancel effects of bearing eccentricity and shaft loading.

### BEI Electronics, Inc.

Controls and  
Instruments  
Division

Little Rock, Arkansas



Industrial  
Encoder  
Division

Goleta, California

Exclusive manufacturers of the **BALDWIN®** encoder  
1101 McAlmont Street Little Rock, AR 72203  
(501) 372-7351 TWX 910-722-7384

CIRCLE NUMBER 175

## Now! The higher frequency response of ink recorders and the reliability of thermal writing

Gulton's new generation of oscillographic recorders gives you clear crisp traces, 140 Hz frequency response, compact size and light weight. And they don't give you the puddles, smudged fingers and aggravation of ink recorders. Or their higher price.

Now all Gulton recorders have an eight speed pushbutton chart drive. Sturdy coaxial styli are standard, and nearly indestructible ceramic tip styli with two year guarantees are available. Automatic stylus heat compensation varies the stylus heat in proportion to the chart speed to maintain constant trace density.

With one Gulton recorder, and your choice of plug-in signal conditioners (30 are presently available), you can record volts, amps, temperature, strain, ac to dc, frequency to dc, EKG, watts, log to dc, current to dc, ac to log . . . and more.

Two, four, six and eight channel models are available for lab or field use, or rack mounting.

Write or call today for our fact-filled 16 page recorder catalog!

**gulton®**

Measurement & Control Systems Division

Gulton Industries Inc. East Greenwich, Rhode Island 02818

401-884-6800 • TWX 710-387-1500

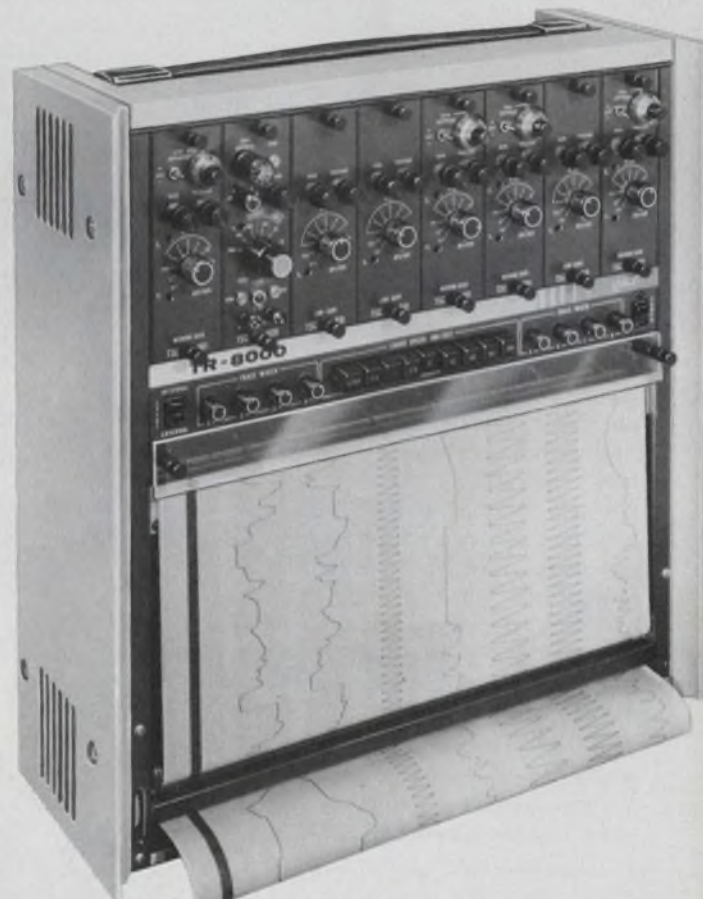

See us at Electro '78 Booth 2436-38  
CIRCLE NUMBER 136

## INSTRUMENTATION

### Scope camera allows choice of mounting



Shackman Instruments, Mineral Lane, Chesham, Buckinghamshire HP5 1NU. G.J. Bennet (02405) 4451.

The budget-priced (£130 to £160) oscilloscope camera, Model 7000, has shutter speeds from 1/125 to 1 s and an f/3.5 lens. Ten hoods are available for hand-held operation to suit almost any oscilloscope. A spacer and adapter allows the camera to be permanently mounted. The camera produces 3 1/4-in. square Polaroid pictures with no focusing.

Booth 2427

CIRCLE NO. 372

### Digital display reads temperature to 0.1°

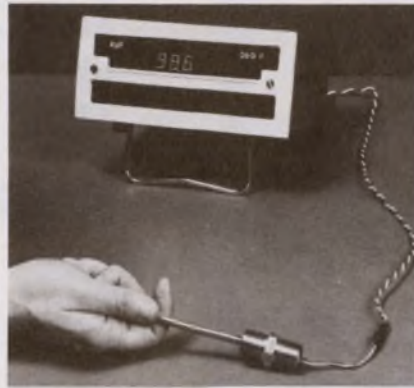

RdF, 23 Elm Ave., Hudson, NH 03051, Bob Warnick (603) 882-5195.

A digital temperature indicating system with 0.1° resolution combines a Type 21 platinum-resistance bulb with the Model 2000 digital indicator. The resolution of 0.1° is obtained from 0 to 195 F or C. Above 195° the system automatically overranges to a 1° resolution. Accuracies of  $\pm 1^\circ$  throughout the range of -200 to 1200 F are possible with the system.

Booth 2334

CIRCLE NO. 373

### Logic-state analyzer programs itself



Paratronics, 800 Charcot Ave., San Jose, CA 95131. Ira Spector (408) 263-2252. From \$1500; 6 wks.

The 32-channel Model 532 intelligent logic-state analyzer programs itself for automatic operation. Using an auxiliary memory board, the instrument stores individual tests; one in RAM and seven in PROMs. The analyzer connects to a known good system and the conditions for triggering are programmed using its keyboard. With the known good system operating and the triggering conditions satisfied, a set of data is collected by the main memory. To reproduce the test, the RECALL key causes the automatic set up of the front panel.

Booth 2237

CIRCLE NO. 374

# Only one thing beats our Super-Mini Impact Printer...

NCC '78...  
Booth  
No.1345

Why stop with the data/text versatility of our 120 cps, 20-column multiple-copy mini. It works even harder as a complete system. Teamed with its own microprocessor interface and power supply, there's virtually nothing our DMTP-3 can't handle — from telemetry to process control, from unattended system recording to providing hard-copy data terminal output, even in POS and inventory control. Mated with any ASCII system, it takes either parallel or serial input at speeds up to 16 KHz or 1200 bps.

Alone or as a system, of course, the industry's smallest alphanumeric impact printer lets you economize with ordinary adding machine roll paper.

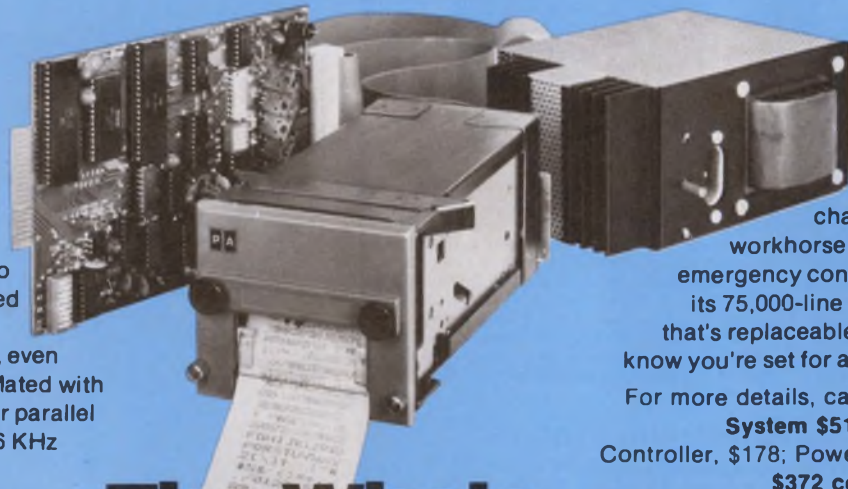

With both full alphanumerics and enhanced characters, our little workhorse calls attention to emergency conditions. And with its 75,000-line life, ink cartridge that's replaceable in seconds, you know you're set for a good, long time.

For more details, call or write today.  
**System \$510** (Printer, \$211; Controller, \$178; Power Supply, \$121);  
**\$372 complete in 100's.**

## The Whole System

CIRCLE NUMBER 93

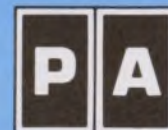

**PRACTICAL  
AUTOMATION, INC.**  
Trap Falls Road,  
Shelton, Conn. 06484  
Tel.: (203) 929-5381



# Instant Fiberoptics for your 1978 systems.

Analog-Digital-Video  
EIA NAB CCITT Interfaces  
PC Mount-Panel Mount-Low Cost

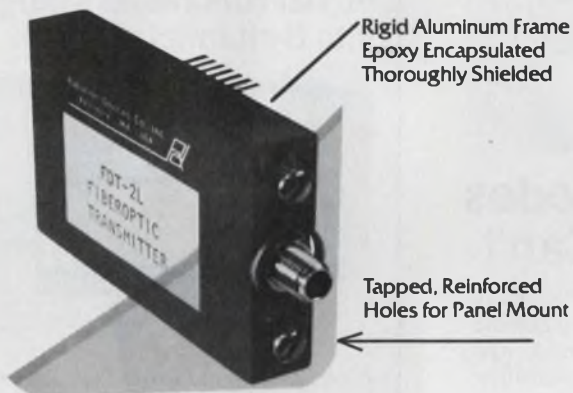
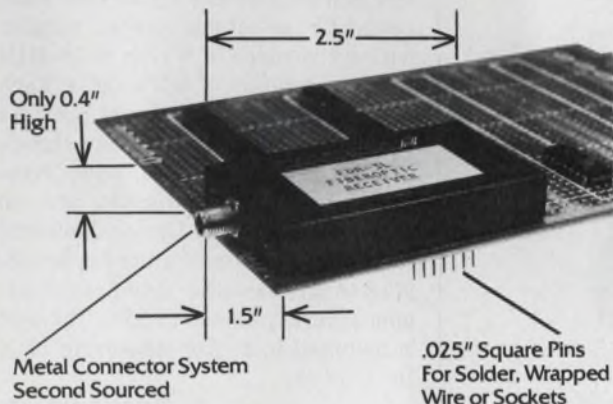

FIBERCOM™ makes low cost fiberoptic interconnected systems a NOW reality. Strengthened single fiber or bundle cable assemblies plus flexible mounting provisions, operation from centimeters to kilometers, speeds from DC to 50 MBPS, Bandwidths to 25 MHz, built-in line drivers and receivers and low power supply requirements, make your system design task a breeze.



**Fibercom™**  
**Radiation Devices Co. Inc.**  
P.O. Box 8450  
Baltimore, Md. 21234  
Phone (301) 628-2240

See us at Fiberoptic Con, May 22 & 23 Boston, Mass.

CIRCLE NUMBER 94

ELECTRONIC DESIGN 10, May 10, 1978

# 900 STANDARD PERMANENT COMPONENT MOUNTS/SPACERS

PROTECT.  
SUPPORT.  
REDUCE LABOR  
AND REWORK.  
FROM STOCK.

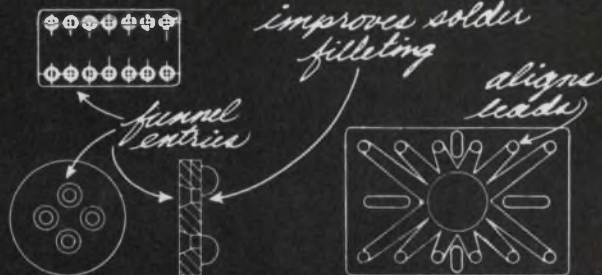

Guards components from shock, vibration and heat damage during assembly. Transistor and Capacitor mounts. Universal spacers, I.C. pads and spreaders. Molded from U.L. rated 94 V-2 material. Free catalog and prices. BIVAR, INC., 1617 E. Edinger Avenue, Santa Ana, CA 92705. (714) 547-5832.

**Bivar**

CIRCLE NUMBER 95

# 400 STANDARD WASH-AWAY COMPONENT SPACERS

SAVE ASSEMBLY  
TIME.  
REDUCE REJECTS  
& REWORK.  
FROM STOCK.

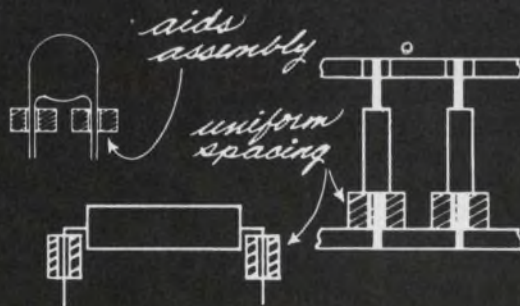

Accurately position components, protect leads, wash away in hot or warm running water without a trace of residue. Available from stock in over 400 standard sizes. Free catalog and prices. BIVAR, INC., 1617 E. Edinger Avenue, Santa Ana, CA 92705. (714) 547-5832.

**Bivar**

CIRCLE NUMBER 96

## INSTRUMENTATION

### Spectrum analyzers memorize input data

Polarad Electronics, 5 Delaware Dr., Lake Success, NY 11040. E. Feldman (516) 328-1100. \$9900 to \$11,950; 8 to 10 wks.

The 600 series rf/microwave spectrum analyzers span 100 kHz to 40 GHz. Built-in memory provides nonfading, flicker-free display storage.

It also retains data for recall at will. Precise on-screen comparisons can be made between incoming signals versus stored reference displays. An I/O memory interface provides for data storage and signal-processing accessories. Each analyzer has a 4-digit LED frequency readout, direct-reading absolute level calibrations, 70-dB dynamic range, 300-Hz to 1-MHz resolution bandwidths and phase-locked LO stabilization.

Booth 2221

CIRCLE NO. 375

### Frequency synthesizer provides 4 outputs



Syntest, 169 Millham St., Marlboro, MA 01752. (617) 481-7827. \$3388; stock to 4 wks.

The Model SI-880 multiple frequency synthesizer provides up to four independently selectable signal outputs within the range of 0.1 Hz to 16 MHz with a resolution of 5-1/2 digits. Each of the square-wave outputs provides low phase noise and spurious signals at TTL levels into 50-Ω loads. Non-harmonic spurious signals are no greater than -60 dB. Optional internal crystal reference oscillators can be supplied to provide either ±10-ppm or ±1-ppm accuracy from 0 to 50 C. The unit is mounted in a case measuring 17 × 10 × 13 in.

CIRCLE NO. 376

### Signal conditioners plug into 8-channel recorder

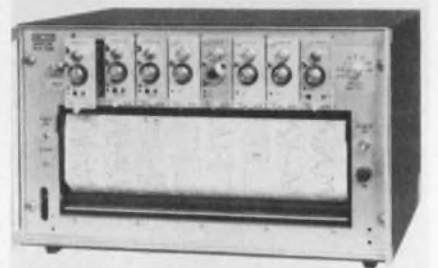

Incor Instrumentation, 144 Lamar St., W. Babylon, NY 11704. M.T. Swift (516) 643-7070. See text; stock to 3 wks.

Modules plug into the Model 3000 six or eight-channel analog recorders to provide signal conditioning. A variety of modules handle 1 μV to 500 V, thermocouples, f/v converters and the excitation for strain, load and pressure transducers. All modules contain their own power supplies. The recorders are inkless, thermal-writing types with dc to 100-Hz response on 40-mm wide channels. Multi-speed chart drives from 1 mm/h to 200 mm/s and event-timer markers are available. The 6-channel recorder is priced at \$2299; the 8-channel unit at \$3075. Signal conditioning modules are \$195 to \$430.

Booth 2334

CIRCLE NO. 377

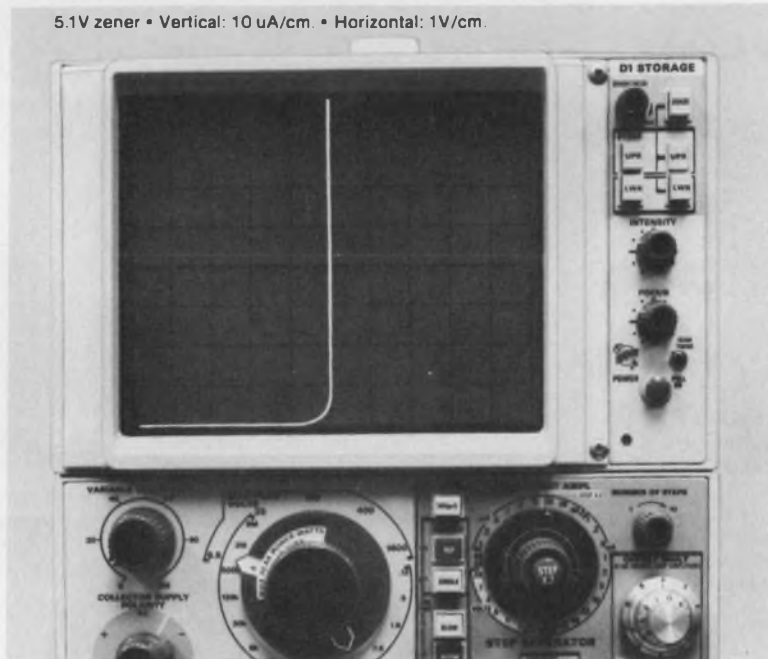

## CODI's Voltage Regulator Diodes Do the Job...Where Zeners Can't

CODI's Voltage Regulation Diodes offer voltages from 3.3V to 10V and are designed for applications where ordinary zeners can't provide an adequate combination of low noise, low leakage, sharp knee, low dynamic impedance, and reliability. Among these applications are ultra-stable regulators, low ripple series regulators, Op Amp regulators, wave shaping, and comparator references.

This CODI series of diodes from IN5518B to IN5528B are available in JAN and JANTX versions providing up to 8.2V where MIL reliability is required. They can also be supplied with 100% internal visual inspection. All diodes are supplied in hermetically-sealed glass packages. Higher voltage units are available on special request.

To find out how CODI Voltage Regulator Diodes can solve your circuit problems, call Bill Henderson, CODI Corporation, Pollitt Drive South, Fair Lawn, N.J. 07410; telephone: 201-797-3900; TWX: 710-988-2241.

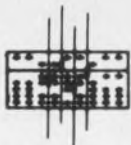

**CODI CORPORATION**

Semiconductor Products

See us at Electro/78 Booth No. 1724

CIRCLE NUMBER 97

*“Neither a borrower  
nor a lender be ...”*

**If you don't have your own  
personal copy of ELECTRONIC  
DESIGN's new 1978-1979  
GOLD BOOK, you should order  
one right now FOR yourself.**



**Just complete the order form below and mail  
it to us today. We'll gladly bill you later.**

ELECTRONIC DESIGN / GOLD BOOK  
Hayden Publishing Co. Inc.  
P.O. Box 13803, Philadelphia, Pa. 19101

412 R

Send us \_\_\_\_\_ copies of the 1978-1979 GOLD BOOK at \$30 (U.S., Canada and  
Mexico) and \$40 (all other countries).

- Bill me.  
 Bill my company. Company purchase order number \_\_\_\_\_.

NAME \_\_\_\_\_ TITLE \_\_\_\_\_

COMPANY \_\_\_\_\_ DEPT. \_\_\_\_\_

COMPANY ADDRESS \_\_\_\_\_

CITY/PROVINCE \_\_\_\_\_

STATE/COUNTRY \_\_\_\_\_ ZIP/POSTAL CODE \_\_\_\_\_

## INSTRUMENTATION

### Bench digital voltmeter includes math functions



John Fluke, P.O. Box 43210, Mountlake Terrace, WA 98043. (800) 426-0361. \$2494.

In addition to basic DVM functions, the 8502A bench digital voltmeter incorporates math functions that process input information into a format for readout. The functions include simultaneous offset values and scaling factors according to the formula  $y = ax + b$ , where  $a$  is the scaling factor,  $x$  is input data and  $b$  is the offset value. In addition, other applications are satisfied with this math package, such as percentage error. The meter provides 6-1/2-digit resolution. A variety of options is available, ranging from true rms, ac/dc current, ohms and calibration memory measurement to systems interfaces.

CIRCLE NO. 378

### Transistor checker indicates audibly



Leader Instruments, 151 Dupont St., Plainview, NY 11803. Pat Redko (516) 822-9300. \$160.

A multipurpose, portable transistor checker, the Model LTC-906, automatically tests a broad range of parameters and produces an audible tone along with the LED display to indicate good or bad performance. The instrument identifies germanium or silicon characteristics and reads out gain and leakage. Absolute metering of dc parameters is also provided.

CIRCLE NO. 379

### Function generator spans 0.1 Hz to 1 MHz



B & K Precision, 6460 W. Cortland Ave., Chicago, IL 60635. Myron Bond (312) 889-9087. \$175; stock.

Frequency coverage of the Model 310 function generator spans 0.1 Hz to 1 MHz in six ranges, with each range providing linear 100:1 frequency control. The instrument generates sine, square, TTL square and triangle waveforms. If a 0 to 5.5-V ramp is applied to the voltage-controlled oscillator input, the 3010 provides a 100:1 output frequency change. Used in this manner, the unit serves as a sweep generator. An audio signal applied in place of a ramp produces a direct fm output. The variable-output square-wave rise or fall time is 100 ns and the TTL square-wave rise/fall time is 25 ns.

Booth 2411

CIRCLE NO. 380

### Current-tracing meter isolates defective ICs



Integral Electronics, P.O. Box 286, Commack, NY 11725. Marcy Talbot (516) 269-9207. \$94.50; stock.

A current-tracing meter, Micro-prober Model 42, isolates defective ICs on assembled PC boards. Detection of random solder shorts and identification of extraneous wires in back planes and wrapped-wire assemblies is simplified with the aid of this device. The sensitivity of the current tracer, spanning a 10,000:1 range, permits effective isolation of faulty TTL, DTL, CMOS or ECL circuits. The instrument is portable and powered by a 9-V battery.

CIRCLE NO. 381

### Thrifty counter operates on portable dc power



Ballantine Labs, P.O. Box 97, Boonton, NJ 07005. (201) 335-0900. \$295; stock.

A compact, portable, EMI-proof economy instrument, the Model 5725C frequency counter, operates from any external 9 to 15-V-dc source. The instrument measures to 225 MHz and shows the result on an 8-digit LED display. A single switch selects readings in Hz, kHz and MHz over the direct count range of 10 Hz to 225 MHz or down to 1 Hz on square wave. The nominal sensitivity is 50 mV. Resolutions from 1 kHz to 0.1 Hz are obtained with four selectable gate times.

CIRCLE NO. 382

### Portable scope sports dual trace



B & K Precision, 6460 W. Cortland Ave., Chicago, IL 60635. Myron Bond (312) 889-9087. \$750; stock.

A compact portable dual-trace scope, Model 1432, has a bandwidth of 15 MHz. Vertical sensitivity is 2 mV/div and the usable response extends beyond 30 MHz. A built-in power supply operates on 117 V ac, 234 V ac, 12 V dc or optional internal batteries. Algebraic addition and subtraction of channel A and B input signals are provided to view distortion products. Nineteen calibrated sweep ranges cover 0.5  $\mu$ s to 1.5 s with  $\pm 3\%$  linearity. A 5  $\times$  magnifier extends the sweep range to 0.1  $\mu$ s.

Booth 2411

CIRCLE NO. 383

# Visit us at Electro '78 and see what our competition might be showing by Electro '79

Until now, trade shows have been easy to figure out. You'd visit one booth, and count on the others to have pretty much the same thing.

But not this year. Not since International Microsystems, Inc. developed the PROM programmer that's probably going to be the highlight of our competition's booths next year.

It's the IM 1000 Universal PROM Programmer. And it's our biggest reason for being at Electro '78.

Surprised that International Microsystems could get the jump on those other companies? Don't be. Since our inception, we've been specializing in innovation. That's how the IM 1000 came about. And while those other companies are saying "Wait til next year," we're already looking to the year after that.

But don't take our word for it. Check the chart. Then come to booth 2049 and see for yourself. See what those other companies are trying to keep up with.

## IM VS. THE COMPETITION...

Requirement Features	IM 1000	Data I/O IX	Pro-Log 90
Editing	Keyboard	Yes	Yes
	Selectable Address Field	Yes	Opt. Yes
	Visual Display (Digits)	14	6
	Internal RAM Size (Bytes)	4K	1K
Interfaces	TTY (20 ma)	Yes	Opt.
	RS232	Yes (2)	Opt.
	Switch Selectable Baud Rates	7	1
	Parity Check	Yes	Yes
Costs	Personality Modules	\$250-330	\$400
	Generic Adaptors	\$50	\$50
	Programmer Base Price	\$1695	\$1975
			\$325-450
			\$100
			\$1800



**IM** International Microsystems, Inc.  
638 Lofstrand Lane  
Rockville, Maryland. 20850  
or call: (301) 340-7505



Electro '78 booth 2049.

### Multimeter sports 5-1/2 digits



California Instruments, 5150 Convoy St., San Diego, CA 92111. Jack Kope (714) 279-8620. \$795; stock to 4 wks.

The DMM 53 is a 5-1/2-digit dc, ac and resistance meter. The meter has five ranges of dc and ac measurement plus six ranges of 4-wire resistance measurement. Accuracy on dc is 0.003% of input plus 0.005% of full scale. Accuracy on ac is 0.1% of input  $\pm 0.1%$  of full scale and resistance accuracy is 0.01% of input and 0.0015% of full scale. The multimeter is auto-ranging on all functions. The instrument has a BCD option for applications requiring external printout.

CIRCLE NO. 384

### Function gen sweeps lin/log to 200 kHz



Exact Electronics, P.O. Box 160, Hillsboro, OR 97123. (503) 648-6661. \$250; 2 wks.

Control of frequency of the Model 117 function generator is by dial or, when sweep is selected, it automatically sweeps over a 1000:1 (3-decade) range. The sweep is either linear or logarithmic. The instrument operates over a range of 2 Hz to 200 kHz in three steps. Outputs are sine, square, triangle, ramp and pulse with the main output variable up to 15 V pk-pk open circuit, 7.5 V into 600  $\Omega$ . Sweep rate can be 25 s, 250 ms or 2.5 ms. The sweep rate can be modified by applying an external capacitor to the rear panel.

Booth 2013

CIRCLE NO. 385

### Pulse generator programs remotely

Velonex, 560 Robert Ave., Santa Clara, CA 95050. George Obinger (408) 244-7370.

The Model 1012 pulse generator features complete programmability through three rear-panel connectors. Programming can be either a ground closure or an open circuit in a standard BCD format. Other formats can be provided for special applications. The instrument provides single or double pulses, internal or external trigger, one-shot and synchronous or asynchronous gating. With internal trigger, the range is 10 Hz to 9.99 MHz for single pulses and 20 Hz to 19.9 MHz for double pulses. Pulse widths are from 40 ns to 9.99 ms.

CIRCLE NO. 386

### Waveform generator sweeps wide range

Krohn-Hite, Avon Industrial Park, Avon, MA 02322. (617) 580-1660. \$295; 4 wks.

With adjustable sweep durations from 1 ms to 1000 s, the Model 1200 sweep generator provides 20-V pk-pk sine, square and triangle waveforms. The frequency range is 0.2 Hz to 3 MHz. Frequency can be swept up or down. Other features include a 1500:1 manual tuning dial, 5% fine-tune vernier, variable dc offset, external voltage-control input, a control voltage output proportional to frequency, auxiliary TTL output with less than 15-ns rise and fall, flat response of less than 0.1 dB and typical distortion of 0.25%.

Booth 2230

CIRCLE NO. 387

### Storage scope joins plug-in tester family

Tektronix, P.O. Box 500, Beaverton, OR 97077. Abe Taghioff (503) 644-0161. \$2200; 14 wks.

A bistable storage oscilloscope, the SC 503, has joined the TM 500 family of plug-in test instruments. This 10-MHz dual-trace instrument has a normal stored writing rate of 50 cm/ms and can be enhanced to 250 cm/ms by trading off storage time. Maximum storage time is 4 h. In the auto-erase mode, viewing can be varied from 1 to 10 s. The SC 503 can also be operated in nonstorage mode. Other features include 3% vertical deflection and time-base accuracy, 1-mV/div sensitivity and a full range of input modes.

Booth 2012, 2111

CIRCLE NO. 388

### Scope camera suits low budgets

Tektronix, P.O. Box 500, Beaverton, OR 97077. (503) 644-0161. \$265.

A low-cost CRT camera that fits many oscilloscopes and small monitors, the Model C-5B, uses a Polaroid pack-film back and a xenon flash unit to illuminate the graticule. The camera has an electric shutter with speeds from 0.1 to 5 s and a fixed-focus three-element f/16 lens. The CRT display can be viewed through a door without removing the camera.

CIRCLE NO. 389

### Word generator provides two channels



Dytech, 2725 Lafayette St., Santa Clara, CA 95050. (408) 241-4333. \$795; stock to 6 wks.

The Model 8000 provides dual-channel word generation with a 16-bit word-length capability for each channel. Both RZ and NRZ data are available from each word output at all times. Two rows of data-content switches provide the capability to select a binary 1 or 0 for each bit of both words. First and last bits are available for both words at all times. The instrument also provides pseudorandom binary sequencing from 7 to 65,535 bits. In this mode, word A data may be sequenced after every word A or after every complete A-B cycle.

CIRCLE NO. 390

### Frequency counters cover vhf and uhf spectrum

Davis Electronics, 636 Sheridan Dr., Tonowanda, NY 14150. (716) 874-5848. \$349.95/\$549.95.

Wide-range vhf and uhf frequency counters in the CTR-2A series measure up to 1 GHz. The Model CTR-2A-500 covers 10 Hz to 512 MHz and the CTR-2A-1000 range is 10 Hz to 1 GHz. The units include an 8-digit display, built-in preamp and prescaler, TCXO time base and automatic input. Selectable gate times are 0.1 and 1 s, and resolution is 1 Hz.

CIRCLE NO. 391

## COMPONENTS

### Slide pots convert linear motion

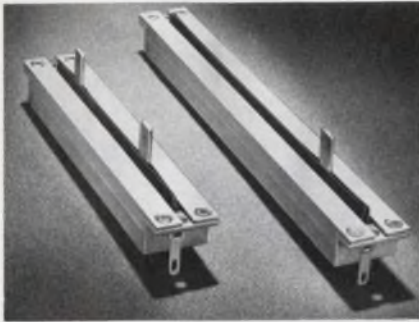

Waters Mfg., Longfellow Center, Wayland, MA 01778. Bab Waters (617) 358-2777. \$10/\$12 (100 qty).

The MM4 and MM6 linear-motion slide potentiometers provide equipment designers with a linear-motion alternative to rotary potentiometers. Linearity of the potentiometers is 1% and resistance values are 1, 5 and 10 k $\Omega$ . The stroke length is 2.6 and 4.12 in.

Booth 2518

CIRCLE NO. 392

### Transformer terminals suit solar heat controls



Dormeyer Industries, 3418 N. Milwaukee Ave., Chicago, IL 60641. (312) 221-3831.

A 30-V rms Class-2 output transformer has a variety of terminations to suit custom solar-heating control-circuit packaging. The transformer is bobbin wound with terminals primarily designed for PC mounting. However, it may be furnished with leads for channel mounting. The transformer has primary ratings of 115 and 230 V or 115/230 V. Secondary ratings are 0.6 to 24 W.

Booth 1727

CIRCLE NO. 393

ELECTRONIC DESIGN 10, May 10, 1978

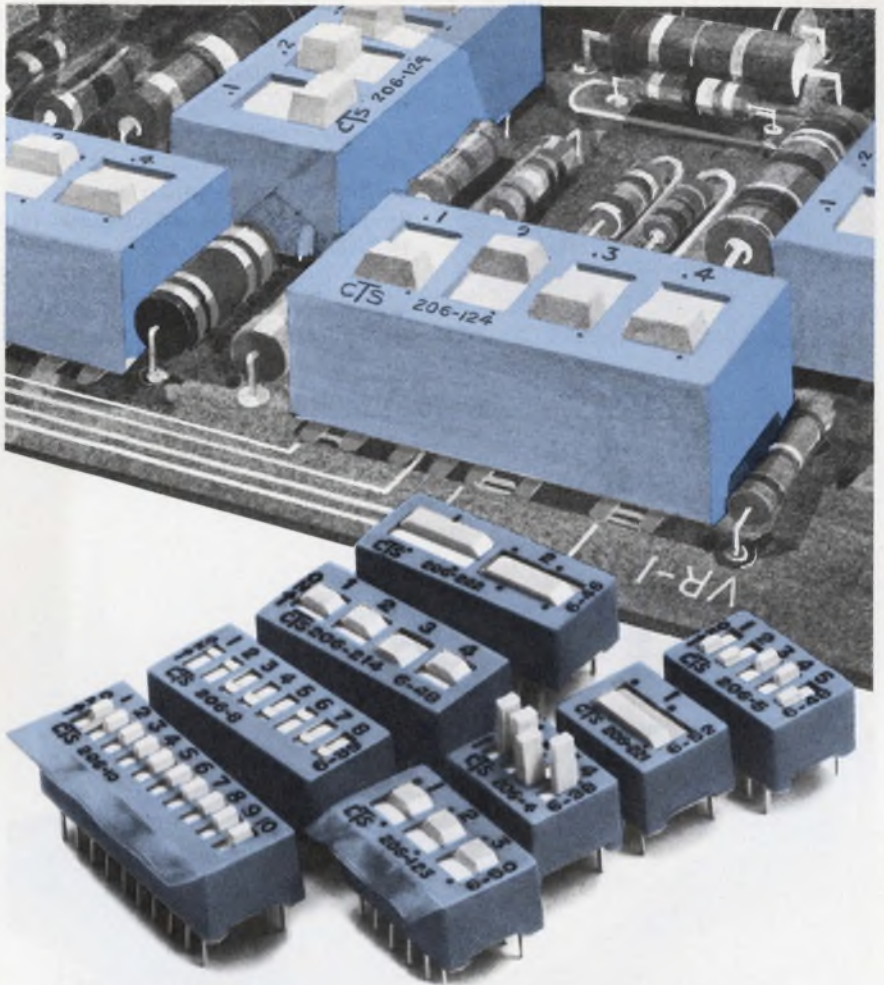

## CTS Offers You the DIP Switches You Need!

Choose from the finest line of DIP switches and options available. The CTS family of quality Series 206 DIP switches provides every imaginable electrical and mechanical configuration.

New configurations include 2 DPDT's... 2 SPST's including a 2 and a 3 circuit package... and 1 each 2 circuit SPDT and DPST switch, all in addition to the 15 standard DIP switches previously available... high (extended) or low (flush) switch actuators... and sealed versions for contaminant-free operation after flow soldering and cleaning.

All are designed for standard DIP socket insertion; feature crisp, positive *slide detent actuation*; reliable gold plated contacts and are economically priced.

CTS DIP switches are used in all areas of the electronics industry including communication, data processing, instrumentation and consumer applications. For prompt, efficient assistance for your DIP switch requirements, contact **CTS KEENE, INC.**, 3230 Riverside Avenue, Paso Robles, California 93446. Phone: (805) 238-0350.

**CTS CORPORATION**  
ELKHART, INDIANA



CIRCLE NUMBER 100

## COMPONENTS

### Coded DIP switch saves space



*EECO, 1441 E.Chestnut Ave., Santa Ana, CA 92701. (714) 835-6000.*

The Micro-DIP switch is so small that it occupies only one-half of a 14-pin IC socket. Fully-coded DIP switches are available in 10 and 16-position binary codes. The units mount directly to a PC board or insert into DIP sockets. Gold contacts are screw-driver actuated in either direction and are color-coded for easy identification.

Booth 1730

CIRCLE NO. 394

### Multi-pushbutton switch comes in many varieties

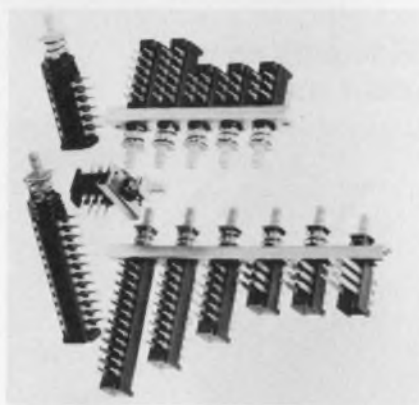

*SMK Electronics, 118 E. Savarona Way, Carson, CA 90746. (213) 770-8915.*

The JP-7000 series of multi-pushbutton switches includes interlocking, self-locking, momentary or reset types in standard 15, 17.5 or 20-mm spacing. The switches are sealed at both the rear and bottom surfaces and use Valox 94V-0 material with terminals molded and secured into the housing. Four types are available in DPDT, 4PDT, 6PDT and 8PDT with contacts rated at 300 mA at 30 V dc. There also are six different terminal configurations with lengths ranging from 6.4 to 18 mm. Up to a maximum of six switch stations can be interlocked and up to 12 switches can be mounted on the same frame.

Booth 1238

CIRCLE NO. 395

# short story

## About a 0.4" regulated 6 watt DC-DC Converter



Here's a short story with a happy ending. Tecnetics' new 100 Series low profile DC-DC converter packs 6 watts of power into a very short 0.4" case.

It's a perfect fit for tight places like between rack-mounted PC boards in computers, communications equipment, instruments, or anywhere height space is limited. This new converter is available with single or dual outputs, boasts efficiencies as high as 60%, and offers full isolation and regulation to

eliminate pick-up of noise or feedback.

Tecnetics wrote the book on state-of-the-art converters. We've been producing and improving them since 1959, so that today our catalog contains over 1000 converters, each a tale in itself. So write for our catalog and get the whole story.

And now for the happy ending we promised you: prices for the 100 Series start at \$60.00.

### 100 SERIES DC TO DC REGULATED CONVERTER

Output (VDC): 5-15	Dimensions: 2.35"L x 2.125"W x 0.40"H
Input (VDC): 5,12,24,28	Weight: 3.0 ounces Typ.
Terminals: PC type pins	Operating Temp.: -25°C to +71°C (Case)
Case: Black glass fiber-filled Diallyphthalate	

**tecnetics**® The Power Conversion Specialists P.O. Box 910,  
1625 Range Street, Boulder, Colorado 80302  
(303) 442-3837 TWX 910-940-3246

CIRCLE NUMBER 101

### NPO capacitors are QPL to MIL-C-20G

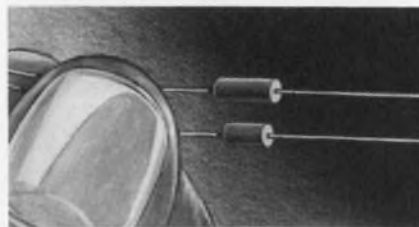

*Republic Electronics, 176 E. 7 St., Paterson, NJ 07524. George Walter (201) 279-0300. Stock to 12 wks.*

A line of tubular and radial-lead NPO capacitors is QPL approved to MIL-C-20G. The military designations are CCR05 through CCR09 and CCR75 through CCR79. The units are approved to failure-rate level M (1%/1000 h). The capacitors have a minimum Q of 1000 and a maximum capacitance change of  $\pm 0.3\%$  from -55 to 125 C. Tolerances as close as  $\pm 1\%$  are available.

Booth 1432

CIRCLE NO. 396



# METSHIELD™ Fabric. The first major advance in magnetic shielding in 50 years.



## Now in 40" widths

METSHIELD™ Fabric can help you achieve EMC in field repairs, prototype design, production equipment, and shielded rooms

Now you have such a shielding. METSHIELD™ magnetic shielding fabric — a wholly new flexible product made from Allied Chemical's METGLAS® amorphous metal alloys.

Because of its exceptional strength and flexibility, METSHIELD fabric retains its full shielding effectiveness during fabrication and use.

This reliability of performance — plus the ease with which METSHIELD fabric can be fabricated — enables you to use magnetic shielding as a preferred method to achieve electromagnetically compatible system designs. And METSHIELD fabric now comes in 40" (1 meter) widths for even greater design flexibility.

Discover how this remarkable material can help meet your shielding needs. Phone John Dismukes at 201-455-4031 or Jack Thorp at 201-455-3306. Or return the coupon.

This is the magnetic shielding product whose time has come.

Increased sales of electronic equipment, a trend toward miniaturization and intensified regulatory considerations have put increased emphasis on EMC.

Consequently, electronics manufacturers need cost-effective magnetic shielding not plagued by fabrication problems and use limitations associated with conventional nickel alloys.

-----  
Check boxes for information on METGLAS® alloys and METSHIELD™ fabric.

- Technical data
- Fabrication
- Grounding and contacting
- Other (specify) \_\_\_\_\_
- Send me sample of METSHIELD fabric

Name/Title \_\_\_\_\_

Company \_\_\_\_\_

City/State/Zip \_\_\_\_\_

Mail to: Metglas Products, Allied Chemical Corporation  
7 Vreeland Road, Florham Park, NJ 07932

-----  
 **Allied  
Chemical**  
Metglas Products

# The IC Switching Regulator that has everything!

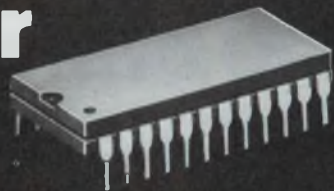

The Ferranti Model ZN1066E Pulse Width Modulator for use in: Switching Regulated Power Supplies, Motor Speed Controllers, DC/DC Converters and much more.

**Features:**

- High Efficiency
- 0-100% duty cycle control
- Zero dead time provided by on-chip logic
- Single ended or complimentary output drive
- Up to 120 mA output drive
- Output frequency adjustable to 500 KHz
- On-chip amplifiers for voltage and current control
- Short circuit protected
- 2.6 V stable reference,  $\pm 50$  PPM/°C
- Soft start capability
- Inhibit and synchronizing inputs
- Major circuit functions externally accessible

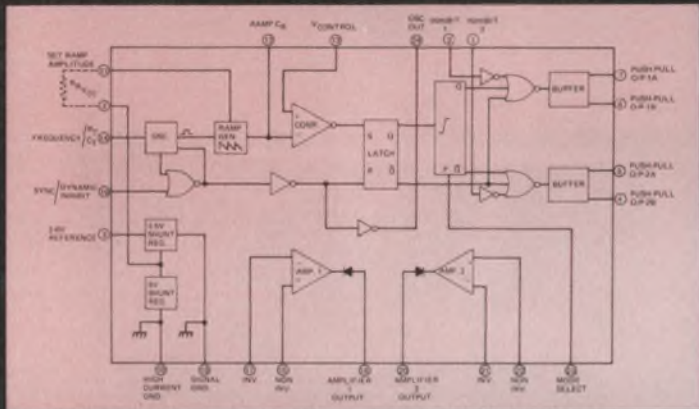

better by design



FOR COMPLETE SPECIFICATIONS, CONTACT: FERRANTI ELECTRIC, INC. / SEMICONDUCTOR PRODUCTS EAST BETHPAGE ROAD, PLAINVIEW, NEW YORK 11803 PHONE: (516) 293-8383 / TWX: 510-224-6483

CIRCLE NUMBER 103

# RESISTS

ESSEX/SUFLEX Acryflex<sup>®</sup> FR sleeving is flexible 155°C. Underwriters Laboratories listed.

- RESISTS — solvent, varnish and oil attack.
- RESISTS — flame
- RESISTS — dielectric breakdown
- RESISTS — cracking from bending when hot or cold
- RESISTS — abrasion and cut through
- RESISTS — inventory build-up because it's used for Class 105, Class 130 and Class 155 applications

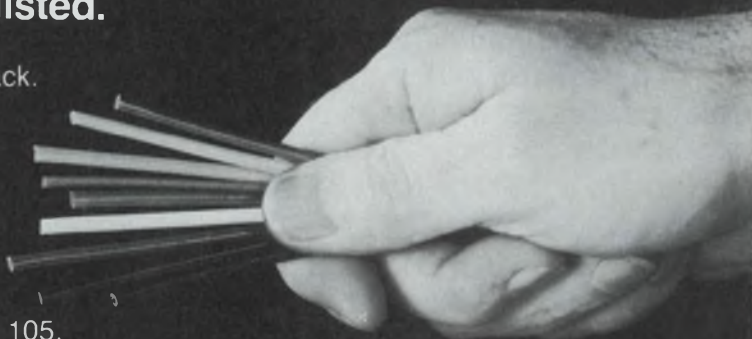

Acryflex FR — UL listed as FR-1 (VW-1) — is an outstanding sleeving for appliance, home entertainment and medical equipment manufacturers. All ASTM-D372 grades are available.



Samples, property data and prices available from 29 Essex/IWI Warehouse/Sales Centers and many independent distributors — or contact: Essex Magnet Wire & Insulation Division, Essex/Suflex, Newmarket, N.H. 03857, Phone: 603/659-5555.

CIRCLE NUMBER 104

## COMPONENTS

### Thumbwheel switch employs pushbuttons



Cherry Electrical Products, 3600 Sunset Ave., Waukegan, IL 60085. Frank Amendola (312) 689-7600. \$3.40 (1000 qty) stock to 12 wks.

Wheel indexing on the T56 bidirectional, pushbutton, thumbwheel switch is controlled by two plungers, one above and one below the legend. The switch is available in six codes including decimal, BCD, BCD plus complement and 1 common, BCD complement only, BCD with diode provision and single-pole repeating. The rating in logic-level circuits is 50-V max at 0.1 A. Maximum current-carrying ability is 1 A max.

Booth 1219

CIRCLE NO. 397

### Fuseholder meets U.S. and foreign safety specs

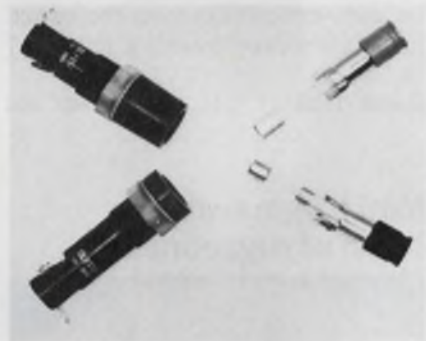

Panel Components, 2015 Second St., Berkeley, CA 94710. (415) 548-1966.

The FEU fuseholder can be used on all electronic equipment made for North American and foreign markets. It has component recognition at UL, is certified or approved by CSA, VDE, SEMKO and SEV, and conforms to IEC publications 65 and 257. All current carrying contacts are recessed or protected so that they are inaccessible when the fuse carrier is removed. The carrier is insulated so that accidental contact with a high-voltage source during fuse replacement is impossible and fuse access requires the use of a screwdriver. The holder accepts 3 AG and international 5 x 20-mm fuses.

Booth 506

CIRCLE NO. 398

### E-cores have round center legs

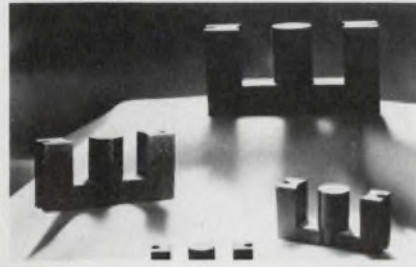

Stackpole Carbon, St. Marys, PA 15817. Don Almquist (814) 781-1234. \$0.21 to \$0.45 (1000 qty); 4 to 5 wks.

E-cores with round center legs are suitable for automatic bobbin winding. Made of Ceramag 24B, the cores may be specified in four sizes of 35, 41, 52 and 70 mm. The material is popular for switch-mode power supplies because of its low core loss and high permeability characteristics.

Booth 1122

CIRCLE NO. 399

# DIGITAL PANEL INSTRUMENTS

DIN STANDARD CASES -  
13mm LED OR BECKMAN DISPLAYS

## DPVM's

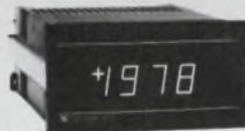

- 3½, 3¾, 4½, 4¾ digit models
- Dual slope, auto zero
- Large LED or Beckman displays
- BCD output
- Bipolar operation
- From 1µV resolution
- 100/115/230 VAC or 5V
- From \$ 49

## PYROMETERS



- J, K, T, E, B, R, S & W thermocouple models
- RTD models from .01° resolution
- 500V A to D isolation
- Digital set point alarm
- 0-1V linearized analog output
- BCD output - auto zero
- From \$185

## MONITORS



- Monitors current or voltage transmitter loops
- Displays engineering units
- True RMS converter option
- Count by 1, 2 or 5 option
- Up to 5999 counts
- Extra zero option
- From \$145

## COUNTERS



- Direct readout of RPM, frequency, time interval, period average, totalize & ratio
- High noise immunity
- Optical-coupled isolated input
- BCD output
- From \$250

## COMPARATORS



- Dual or single limit comparator
- ± 39999 or 99999 capacity
- Hi, lo, go lamps on dual comparator
- Compares parallel BCD or binary input data on front panel thumb-wheel switches
- From \$115

## SCANNERS



- Programs up to 100 channels
- Thumbwheel selection of first and last point
- Low thermal EMF or TC signals
- RTD or high level switching up to 200V
- Scans up to 100 ch/sec
- From \$350

## PRINTERS



- 9 columns expandable to 18 or 21
- Programmable 2-color printing
- Fixed or floating decimal
- Std. adding machine paper
- Small size 4½" H x 8½" W
- From \$495

# NEWPORT

Corporate Office: 630 East Young St. • Santa Ana, CA 92705 Telephone: (714) 540-4914, TWX: 910-595-1787 • Cable: Newlab, Santa Ana, CA 92705

Newport BV  
P.O. Box 7759  
Schiphol East  
The Netherlands  
Telephone: (20) 45-20-52  
Telex: 844-16347

Newport Laboratories GmbH  
D-6072 Dreieich  
Max-Planck-Strasse 13  
Postfach 102163  
German Federal Republic  
Telephone: (06103) 3741  
Telex: 04 17908 (NEWPT D)

CIRCLE NUMBER 105

## COMPONENTS

### $\mu$ P-based keyboard tailors to specific need

EECO, 1441 E. Chestnut Ave., Santa Ana, CA 92701. Scott McVay (714) 835-6000.

This microprocessor-based keyboard offers the capability of tailoring keyboard needs to specific applications.

The keyboard has 106 keys with additional keys available for expanded features. Benefits derived from this programmable unit include high operator comfort offered by its stepped arrangement and a positive response click to the operator with each key depression. The keyboard has both two-key roll-over and N-key depression.

Booth 1730

CIRCLE NO. 403

### Pushbutton switch offers 190 display options

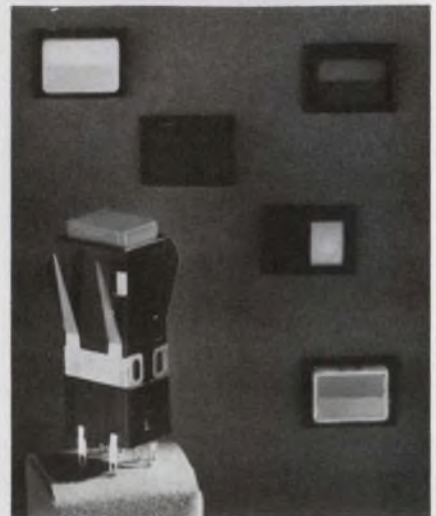

Licon, 6615 N. Irving Park Rd., Chicago, IL 60634. (312) 282-4040.

The 06 series of lighted pushbutton switches with its 190 display options allows designers a great number of switch-array possibilities. The design uses the standard T-1 $\frac{3}{4}$  flange-base bulb and is available with two lamps or a centrally located single lamp. Display modules are available in solid color, projected color, insertable and hidden legend. Other options are obtained by choosing from a variety of colored filters for full-screen, horizontal and vertical displays. The switch mounts in a panel cut-out of 0.92 x 0.7 in.

Booth 1125

CIRCLE NO. 404

### Mini toggle switches boast of ruggedness



SMK Electronics, 118 E. Savarona Way, Carson, CA 90746. (213) 770-8915. From \$1.18 (100 qty).

A line of mini toggle switches, all UL approved, features rugged construction using dialphthalate material with the terminals molded and secured into the housing. The JU 4000 switches are either SPDT or DPDT, and are rated at 6 A at 125 V ac or 12 V dc, resistive load.

Booth 1238

CIRCLE NO. 405

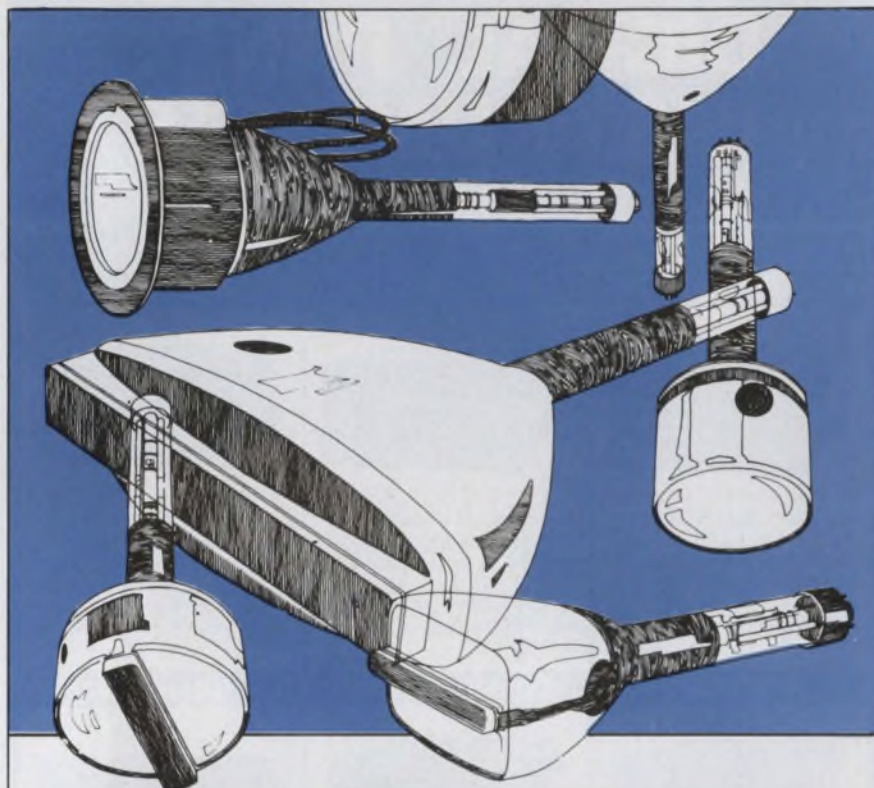

### High Resolution CRT's For Optical Systems

Thomas Electronics, Inc., is currently producing a wide range of high resolution tubes for: Optical Character Recognition, Photo Recording, Hard Copy Printout and Photo Typesetting applications. Included in this range are optical quality non-browning glass and fibre optics strips faceplate CRT's in all sizes. All of these tubes can be supplied with special screen types for improved performance, in addition to the standard phosphor screens.

For high speed printing applications, Thomas has an electrostatic charge printing tube available that consists of a strip of very fine, closely spaced wires extending through the bulb faceplate.

Complete specifications and drawings are available for the above tube types upon request. Also, we invite you to send for our New Short Form Catalog describing our full complement of CRT's for varied applications.

# THOMAS ELECTRONICS, INC.

100 RIVERVIEW DRIVE, WAYNE, N. J. 07470 / Telephone: 201-696-5200 / TWX: 710-988-5836 / Cable: TOMTRONICS

CIRCLE NUMBER 106

## Resistors shed heat through finned housings

Inter-Technical Group, P.O. Box 23, Irvington, NY 10533. (914) 591-8822.

Stable resistors in the HS series dissipate high power in a limited space through finned aluminum housings. The resistors have ratings from 5 to 300 W with resistances from 0.05  $\Omega$  to 86 k $\Omega$ . The type HSA50, rated at 68 k $\Omega$ , 50 W, has a length between terminals of 3 in. The units meet MIL-R-18546 and can be supplied with standard or noninductive windings.

CIRCLE NO. 406

## Tiny indicators provide point sources of light



Industrial Devices, 7 Hudson Ave., Edgewater, NJ 07020. (201) 224-4700. \$0.76 (1000 qty).

Tiny Glo-Dot 5100 indicators provide point light sources. Self-contained assemblies snap-fit into 1/4-in. panel openings. The lamps are red, green or yellow super-bright LEDs. Wire-lead incandescent lamps may also be used. The indicator assemblies can be used on panel thicknesses from 0.031 to 0.062 in. You merely insert them into 0.249-in. holes until they snap securely into place.

CIRCLE NO. 407

## Relays combine high capacity with sensitivity

Aromat, 250 Sheffield St., Mountainside, NJ 07092. (201) 232-4260. \$2.15 (1000 qty); stock to 8 wks.

Half-size Amber R relays switch currents up to 1 A, yet have pull-in power requirements of only 40 to 100 mW. The relays are available in 1-form-C contacts that carry 1 A, 20 W and resist welding at higher inrush currents. This dry-circuit-type unit switches current as low as 100  $\mu$ A. The relays are housed in gas-filled sealed-plastic cases.

Booth 1503

CIRCLE NO. 408

## Snap-in switch reduces assembly cost

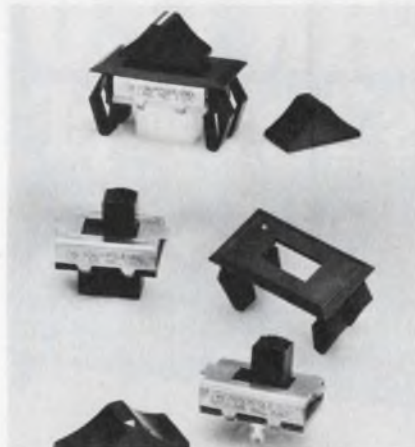

Stackpole Components, P.O. Box M, Farmville, VA 23901. Steve Smith (804) 392-4111.

A nylon snap-in adapter plate, which fits 2-position Series 20, 22 and 25 switches, reduces assembly costs by eliminating mounting hardware. Assembly time can be further reduced by specifying this snap-in mounting in combination with the S-25 push-in lead switch. Leads can be connected to the nylon switch base without tools. And special grippers prevent them from being inadvertently removed.

Booth 1122

CIRCLE NO. 409

## Dual-primary Xformers feed power supplies

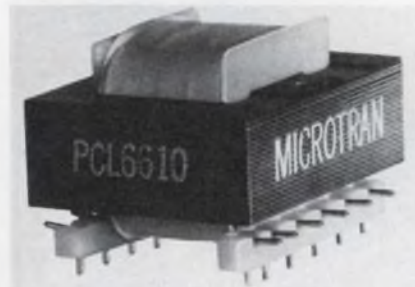

Microtran, P.O. Box 236, Valley Stream, NY 11582. (516) 561-6050. \$5.50 typical (100 qty); stock.

A series of 230/115-V, dual-primary 50/60-Hz PC power transformers encompasses 83 different units. The transformers provide step-down and isolation at power ratings of 0.8, 1.5, 4.5, 7.5 and 24 VA. Output voltages from 4.5 to 150 V and currents to 2 A are available. Units provide regulated or unregulated outputs of  $\pm 5$  and  $\pm 15$  V dc when used with transistor regulators.

Booth 215

CIRCLE NO. 410

# RF Power Amplifiers? One unit may be all you'll ever need.



If you have the ENI Model 440LA ultra-wideband solid state power amplifier, all you need is a laboratory signal generator and you've got the ultimate in linear power for such applications as RFI/EMI testing, NMR/ENDOR, RF transmission, ultrasonics and more.

Capable of supplying more than 40 watts of RF power into any load impedance, the 440LA covers the frequency range of 150 kHz to 300 MHz.

We could mention unconditional stability, instantaneous failsafe provisions and absolute protection from overloads and transients, but that's what you expect from any ENI power amplifier, and the 440LA is no exception!

Our catalog contains complete specifications on the 440LA as well as the entire line of ENI amplifiers, and is available without obligation, of course.

For further information or a demonstration, contact ENI, 3000 Winton Road South, Rochester, New York 14623. Call 716-473-6900, or Telex 97-8283 ENI ROC.

# ENI

The World's Leader  
in Power Amplifiers

Have You Mailed Your Requalification Card? See Page 45

# ION IMPLANTED Tuning Diodes 2 to 500 pF

Design in Implion® hyperabrupt and abrupt tuning diodes which offer superior capacitance swings, reproducibility and reliability. Tailored for octave or linear tuning in communications and test equipment.

Send for our catalog including selection guide and electrical characteristics as well as information on PIN diodes and low voltage avalanche zener diodes or call 617-273-1730.



CIRCLE NUMBER 108



## Instant drafting appliques

Now you can have those custom drafting appliques you need in just seconds... not days.

**Custom drafting appliques can now be produced on nearly all plain paper copiers when you use KROY REPRO MEDIA™.**

Simply load your plain paper copier with REPRO MEDIA and your original artwork, in seconds you have your own pres-

sure sensitive appliques.

### Why KROY REPRO MEDIA?

- works in nearly all plain paper copiers.
- produces sharp, dense reproductions.
- has a unique repositionable adhesive.
- accepts pencil, inks, even offset printing.

For a free sample, further information and the name of your nearest Kroy Dealer, circle the reader service card today.



Kroy Industries Inc.

### GRAPHIC SYSTEMS DIVISION

1728 Gervais Avenue, St. Paul, MN 55109, (612) 770-6176

CIRCLE NUMBER 111

## COMPONENTS

### Keyboard encodes full ASCII set

George Risk Industries, G.R.I. Plaza, Kimball, NE 69145. (308) 235-4645. \$75.95.

All 128 ASCII characters and control functions are encoded by the Model 756 keyboard. A line of accessories includes a numeric pad, custom cables and connectors. The keyboard interface allows selection of parity, positive or negative-logic data and strobe outputs, alpha-lock operation and both dc-level and pulse-strobe signals. A latching shift-lock key is included, and all outputs are TTL, DTL and MOS compatible.

CIRCLE NO. 411

### Temperature sensor highly linear



Midwest Components, P.O. Box 787, Muskegon, MI 49443. (616) 777-2605.

Tempistor is a solid-state temperature sensitive device having a highly linear tempo of resistance, +0.7%/°C. The linearity is maintained from -65 to 200 C. Zero power resistances at 25 C are available from 10Ω to 10 kΩ.

Booth 1337

CIRCLE NO. 412

### Thick-film networks need only ¼-in. space

Stackpole Components, Raleigh, NC 27610. Charles McGill (919) 828-6201.

Mini-SIP networks require only about ¼ in. on a PC board, while holding up to 28 resistors. They are available in single and dual-in-line packages with 4 to 16 pins. The height above standoff is 0.175 in. Sixty-four standard resistance values are offered, ranging from 33Ω to 270 kΩ. Standard tolerance is 2%, but 1% matching is available.

Booth 1122

CIRCLE NO. 413

WHAT DO YOU  
MEAN...“EVERYBODY  
HAS TO RENEW  
HIS SUBSCRIPTION?”

THAT'S **Electronic Design's**  
**NEW POLICY.**  
**DO IT NOW AND I**  
**WON'T BUG YOU**  
**FOR A FULL YEAR!**



**RENEW IMMEDIATELY!**

YOUR ANNUAL RENEWAL FORM APPEARS ON PAGE 49 OF THIS ISSUE

## COMPONENTS

### Mini solid-state relays handle 5 and 10 A



Theta-J Relays, 1 DeAngelo Dr., Bedford, MA 01730. Allan Mowatt (617) 275-2575. \$3.60 to \$5.00 (1000 qty); 4 to 5 wks.

JTA-1205-1 and JTA-1210-1 J-Tab miniature power relays are solid state and are rated at 5 and 10 A, respectively. The relays handle load voltages to 280 V ac. The units have 3750-V-ac input/output isolation and operate at logic levels of 4 to 8 V dc or 9 to 16 V dc with a control current of 15 mA. The relay occupies less than 0.25 in<sup>3</sup> of space.

CIRCLE NO. 414

### Thermistors offered in glass/epoxy packages



Quality Thermistor, 2096 S. Cole Rd., Boise, ID 83705. Jack Kitlinski (208) 377-3373. \$0.69 to \$0.79 (1000 qty); 4 to 6 wks.

Negative-tempco thermistors with resistance values of 100 to 500 k $\Omega$  come in four epoxy-molded styles and two glass-style configurations. The epoxy-styles approximate 1/4 and 1/2-W resistor packages and the glass units come in DO-7 and DO-35 packages. The standard temperature range is -60 to 125 C with higher temperature limits available in the glass units. Response times of the various packages vary from 3 to 12 s.

CIRCLE NO. 415

### 10-A switch offered in 11 toggle-handle styles

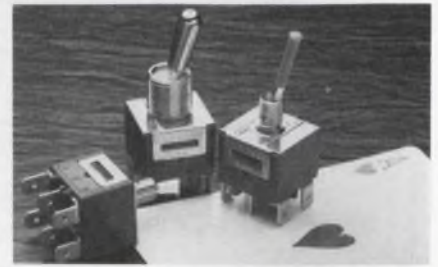

C & K Components, 103 Morse St., Watertown, MA 02172. Jim Martinec (617) 926-0800. \$2.99 (1000 qty).

Eleven different toggle-handle-actuator options are available for turning on the Model 9221 miniature 10-A switch. The switch has a small body (0.75-in. square), yet its quick-connect spade terminals are capable of accepting 10 A at 125 V ac. The actuator options include short, tall, thick, thin, round, flat and shock-proof plastic. With the exception of the plastic handle, all toggles are made of chrome-plated brass. The switches are UL, CSA and VDE listed.



CIRCLE NO. 416

## (Dis)connect!



### Heyco Nylon Terminal Bushings.

The low-cost easy way for fully insulated, quick connection or disconnection of wires through panels or housings. Choose 1, 2 or 3 terminals in 8 colors for color coding. Choice of solder, double male or crimp terminals which mate with 3/16" or 1/4" standard female quick-connect contacts. Ideal for use in control devices, motors, appliances, data processing equipment, vending machines, whatever.

 U.L. Recognized.  Approved

Free Samples on Request.

### HEYMAN MANUFACTURING COMPANY

KENILWORTH, NEW JERSEY 07033 WAUKESHA, WISCONSIN 53187  
(201) 245-2345 • TWX: 710-996-5986 (414) 542-7155 • TWX: 910-265-3668

Call Toll-Free (800) 558-0917 except from Wisconsin.  
If calling from Wisconsin use (800) 242-0985



337

CIRCLE NUMBER 112

## Special Relays — QUICKLY

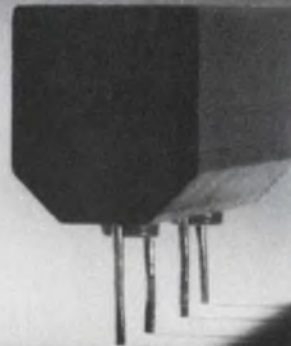

### Customer Designs Own Relay

One of our customers needed a relay to switch an Amp at 50 volts, inductive. Together we filled out an EAC application questionnaire. The result? A satisfied customer, and the specs below.

1 Amp switching current, 4 Amp surge current.  
5, 6, 12, 24, or 48 volt DC coil voltage  
switches inductive loads with little or no arc  
suppression to 50 V DC or AC  
Size is 0.4 x 0.4 x 1.0 inch.

You can design your relay too — just call, write, or twx us for your copy of the EAC application questionnaire.



## EAC Electronic Applications Company

4918 Santa Anita Avenue, El Monte, CA 91734  
213 / 442-3212 Twx 910 / 587-3351

CIRCLE NUMBER 113

ELECTRONIC DESIGN 10, May 10, 1978



# AT LAST— A STORAGE OSCILLOSCOPE WITH NO FLICKERING, FADING OR FOGGING.

If you're involved in electromechanical testing, dynamic testing, vibration analysis, transducer measurements or medical research, the Gould OS4100 is ideal for you. It not only offers outstanding performance over a wide range of frequencies but also low cost digital storage.

A dual trace digital storage oscilloscope, the OS4100 is sensitive to  $100\mu\text{V}$  per division with sweep rates as fast as  $100\mu$  sec per division. The unit employs an 8 bit x 1024 RAM with a sampling rate of 1 MHz. Thanks to Gould's unique dot joining technique, it allows meaningful trace presentations of signals beyond the frequency capability of the scope.

Outstanding features include X-Y mode plotting on the screen. Stored trigger point for use with repetitive signals or transients. High gain amplifier with noise suppression. Standard

positive, negative and bi-polar triggering.

The sum or difference of channels can be displayed with one of either of the two channel waveforms. For comparative measurements, you can store one channel and compare it against the incoming signal on the other.

The Gould OS4100 is built to Gould's demanding standards of quality and carries a full two-year limited warranty covering all parts and labor exclusive of fuses, calibration and minor maintenance.

For details, contact Gould Inc., Instruments Division, 3631 Perkins Ave., Cleveland, Ohio 44114. Phone: (216) 361-3315. Or in Europe, Gould Instruments, Roebuck Road, Hainault, Essex, CB10 1EJ, England.

**For brochure call toll free (800) 325-6400, Ext. 77. In Missouri: (800) 324-6600.**

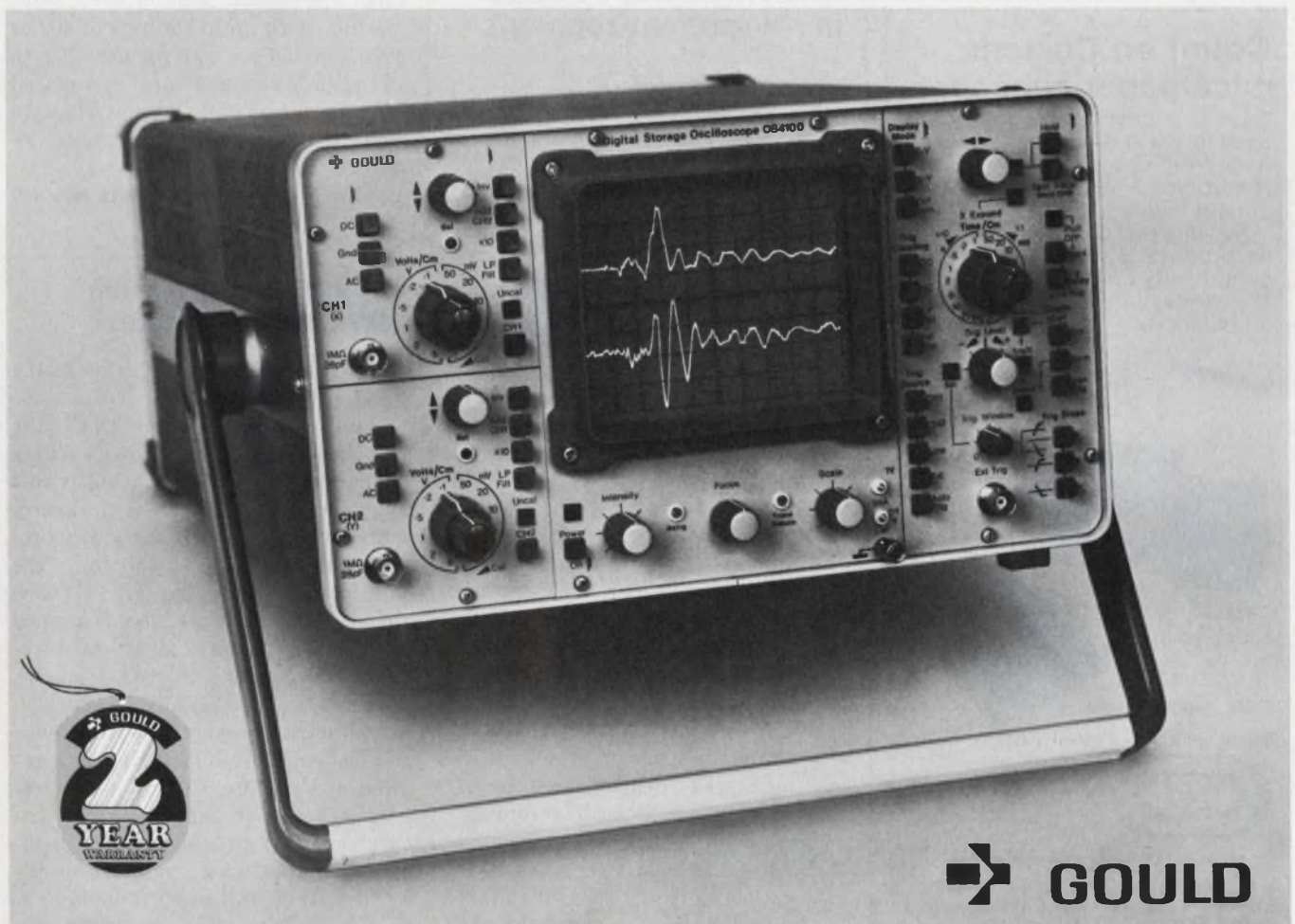

# When reliability counts



## Count on Custom mica paper capacitors

Custom mica paper capacitors are used in a wide variety of applications from spacecraft to medical electronics — areas where component failure can be fatal.

For this reason, every capacitor we produce is subjected to stringent quality control testing. After all, our customers have to count on reliability!

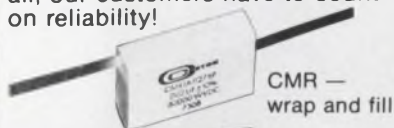

CMR — wrap and fill



CEM — epoxy molded

CER — epoxy housed

Write for FREE Techni Tips:



**CUSTOM ELECTRONICS, Inc.**  
4 Browne St., Oneonta, N.Y. 13820  
PH: 607-432-3880 TWX 510-241-8292

CIRCLE NUMBER 115

## DATA PROCESSING

### Paper-tape reader sends up to 9600 baud



Addmaster, 416 Junipero Serra Dr., San Gabriel, CA 91776. (213) 285-1121. \$625 to 725.

Model 612, a stand-alone paper-tape reader, reads 5 to 8-level tape and transmits 7 to 11 frames/char at 50 to 9600 baud. Other features include starting and stopping on character at all speeds, choice of manual control or X-on, X-off, 90 to 260-V power and even, odd or no parity. RS-232, current-loop or parallel outputs are available as is a choice of desktop or rack mounting.

Booth 2342

CIRCLE NO. 417

### Plasma display operates in Mil-spec environment



Interstate Electronics, P.O. Box 3117, Anaheim, CA 92803. (714) 772-2811. \$12,000; 13 wks.

A plasma display terminal, Model PD3000, reliably operates in airborne and shipboard Mil-spec environments. The terminal has a 20,000-ft operating, 70,000-ft nonoperating, high-altitude capability and displays high-resolution graphics with more than 4000 characters. The operating temperature range is -32 to 55 C. The unit weighs 53 lb and occupies a space of 13 x 14 x 12 in. The flat-panel display measures 8.5 x 8.5 in. Functionally modular for field maintainability, the display has an MTBF in excess of 10,000 h. An RFI-EMI enclosure is standard.

CIRCLE NO. 418

### Computer takes analog and digital at same time

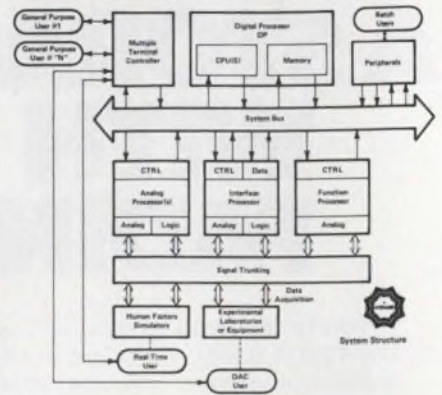

Electronic Associates, West Long Branch, NJ 07764. (201) 229-1100.

A hybrid analog plus digital computer system, called Hyshare, consists of an EAI 3200 digital computer and up to six high-speed analog processors. The analog/digital and digital/analog communications interfaces employ on-line dynamic resource allocation techniques that allow analog processors to be assigned to separate tasks, or linked together in almost any combination to meet specific application requirements. Hyshare functions as a digital, analog and hybrid system at the same time. The Model 3200 is a 32-bit word machine with up to 1 Mbyte of 600 or 900-ns cycle-time core memory. Up to 16 terminals are accommodated through the system bus interface to which all peripherals and analog interfaces are addressed.

CIRCLE NO. 419

### Multiplexer combines async and sync lines

Data General, Route 9, Westboro, MA 01581. (617) 366-8911.

A universal line multiplexer, ULM-5, combines a 4-line asynchronous with a single-line synchronous controller on a single board. It interfaces asynchronous terminals as well as a synchronous line to a host computer. The multiplexer is a 15-in. square PC board that occupies a single slot in a Nova or Eclipse chassis and is software-compatible with the ALM series asynchronous and SLM series synchronous-line multiplexers. The ULM-5 has full modem control, including auto answer, and provides CRC to assist system software in implementing synchronous-line protocols. Each asynchronous interface operates at speeds to 9600 baud, full or half duplex.

CIRCLE NO. 420

## Serial printer uses hammers not needles

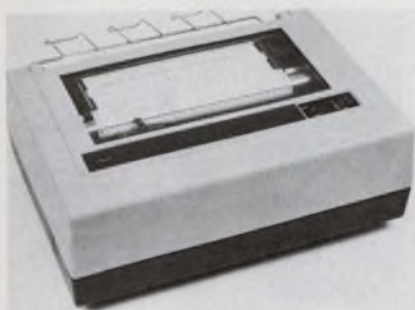

Facit-Addo, 66 Field Point Rd., Greenwich, CT 06830. (203) 622-9150.

A printhead that has hammers instead of needles or wires is used in the Model 4540 serial page printer. The printhead is based on a stored-force principle in which the print hammers are mounted on flexible arms held back by electromagnets. For each impact, the holding current is cut off and the hammer snaps forward. Using a pull-back impulse instead of a print impulse results in a small head, guaranteed to produce  $5 \times 10^8$  characters. The printer provides 12 character sets including OCR-A numerics and Katakana.

Booth 2212

CIRCLE NO. 421

## Multiplexer sends 128 channels 3000 m

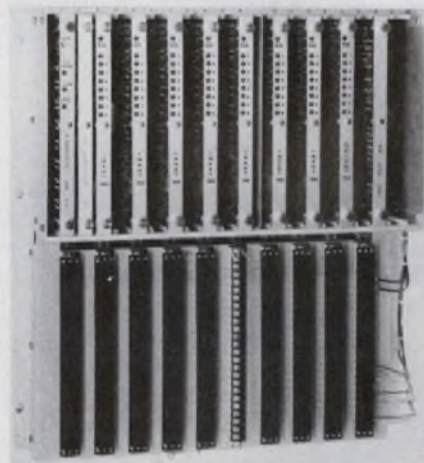

Tenor, 17020 W. Rogers Dr., New Berlin, WI 53151. (414) 782-3800.

The T-Wire industrial-grade multiplexing system consists of two units interconnected by a 3-wire cable for distances up to 3000 m maximum. T-Wire is full duplex and accepts 128 digital and 16 analog signals at each end and reconstructs those signals at the other end. The system detects and annunciates faults such as broken or shorted transmission cable or loss of system power at either end. The scan rate for a system is variable between 75 and 1200 baud.

Booth 2405

CIRCLE NO. 423

ELECTRONIC DESIGN 10, May 10, 1978

# CASES



## with a look of distinction . . .

. . . also durable and uniquely designed of extruded aluminum, trimmed with colorful vinyls, suede finish or textured epoxy paints on panels and strips. Many types and variations with modifications available.

Send for Full-Line Descriptive Literature!



the **BUCKEYE** stamping company



555 Marion Rd., Columbus OH 43207  
614/445-8433

SEE us at ELECTRO '78 — Booth #309-311  
CIRCLE NUMBER 116

## The Servo-Tek World of DC Servomotors

Wide range of permanent-magnet dc models available.

Servo-Tek's Permanent-Magnet DC Servomotors are precision made to give highly reliable performance. Their stability, high output-to-size ratio and speed range from 0-10,000 rpm with output torques to 2.0 oz-in make them ideal as prime movers in servomechanisms. Diameter 1.135 in. lengths up to 3.253 in. A unique field structure of Alnico VI results in minimized cogging (slot lock), a prerequisite to optimum servo performance. Models are available with a variety of operating voltages and with various mountings and integral gearing. Moderately priced with quantity discounts.

Be Selective.  
Turn To...

**SERVO-TEK**  
PRODUCTS COMPANY

1086 Goffle Road, Hawthorne, NJ 07506 • 201-427-3100

Servo-Tek of California, Inc.

8155 Van Nuys Blvd., Van Nuys, CA 91402 • 213-786-0690

FREE CATALOG of rotating components available.

**SERVO-TEK**  
ALL AMERICAN  
ENGINEERED

CIRCLE NUMBER 117

Just  
Published!

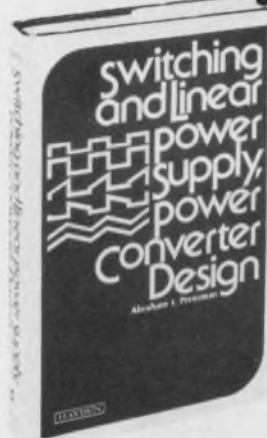

# Switching and Linear power supply, power converter Design

Abraham I. Pressman  
Raytheon Company

A "how-to-design" book  
written from a power  
supply designer's  
point of view!

Covers all the circuits, systems,  
magnetics, and thermal design  
skills essential to modern power  
supply design.

#5847-0, cloth, 384 pages, \$19.95

**ORDER YOUR 15-DAY  
EXAMINATION COPY  
NOW!** When billed,  
remit or return book.

**HAYDEN BOOK  
COMPANY INC.**  
50 Essex Street,  
Rochelle Park, N.J.  
07662



## PACKAGING & MATERIALS

### Edge connectors feature built-in strain relief

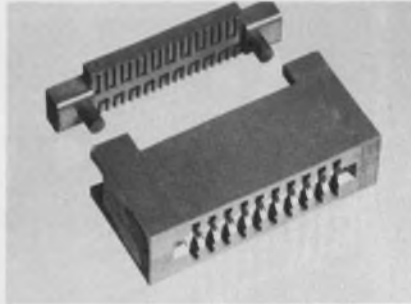

Alpha Wire, 711 Lidgerwood Ave.,  
Elizabeth, NJ 07207. (201) 925-8000.

A series of PC card-edge connectors features built-in strain relief to prevent the flat cable from being pulled out. The connectors mate with standard 0.062-in. PC boards but will also accommodate boards ranging in thickness from 0.032 to 0.075 in. They accept 28 or 30 AWG solid or stranded conductors on 0.05-in. centers and provide connections to pads on 0.1 in. centers. The connectors are available in 10 to 50 contacts, both with and without mounting flanges. The current rating is 1 A max and breakdown voltage is greater than 500 V dc.

Booth 1329

CIRCLE NO. 424

### Card rack contains blower for cooling

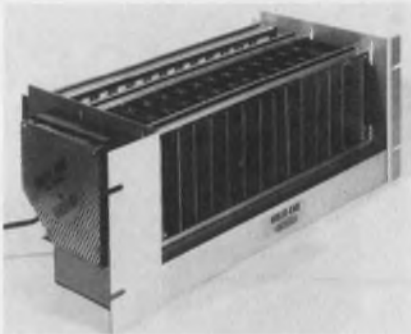

Unitrak, 8738 W. Chester Pike, Upper  
Darby, PA 19882. (215) 789-3820.  
\$99.50; 2 to 3 wks.

Kooler-Kage, for standard 19-in. cabinets has a built-in centrifugal blower and plenum chamber for cooling PC cards within the cage. The blower moves 25 cfm into a baffled plenum chamber to reduce the velocity and distribute the air over the entire area. As the cool air flows from bottom to top, displacing the heated air, each card is cooled on both sides and all cards are cooled equally. The narrow blower leaves 15 in. for card racking.

Booth 1612, 1711

CIRCLE NO. 425

### Breech-locking connector provides rugged mating



G & H Technology, 1649 17th St., Santa  
Monica, CA 90404. (213) 450-5823.

The Breech-Lok provides a rugged foolproof mating system in a miniature connector. The mechanism distributes the coupling load over solid metal locking lands, while drive threads on the inside of the coupling ring provide the mechanical advantage to mate the plug shell, contacts and interfacial seals. The EMI shielding is 70 dB at 10 GHz and standard shell types, sizes, contacts and arrangements are available.

Booth 1821

CIRCLE NO. 426

### Machine assembles wires to connectors



Molex, 2222 Wellington Ct., Lisle, IL  
60532. Ken Kufner (312) 969-4550.

The CAM 1 assembly machine semi-automatically crimps a terminal to a wire and inserts it into a connector housing. A control box monitors all machine functions including circuits desired and terminals inserted into each housing. The machine allows for any gauge wire to be terminated. An adjustable housing magazine for KK housings from 4 to 24 circuits is available for easy loading. The device handles up to 1800 insertions/h.

Booth 413

CIRCLE NO. 427

## DIP headers let you program

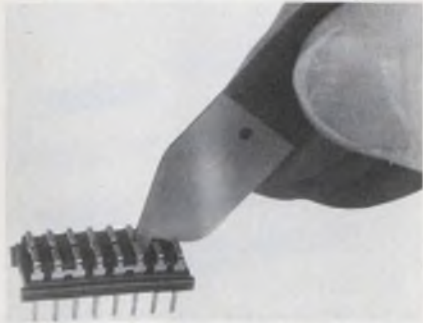

Aries Electronics, P.O. Box 231, Frenchtown, NJ 08825. (201) 996-4096. From \$0.53.

Available in 8, 14 and 16 pins on 0.3-in. centers, DIP program headers present versatility for programming within the header itself. The headers are available preprogrammed, or they can be programmed by the user with needle-nose pliers or a program-header tool to remove interconnecting sections. Adjacent pins, as well as opposing pins, are interconnected until the pre-slotted section is snapped out. A complete program can be provided by leaving or removing interconnecting sections. A snap-on cover is provided that can be marked to identify the program.

Booth 1630

CIRCLE NO. 428

## Heat dissipators add to TO-3 cooling efficiency



IERC, 135 W. Magnolia Blvd., Burbank, CA 91502. (213) 849-2481. \$0.181 (10,000 qty); stock.

The LA 363 heat dissipator, for use with all TO-3 semiconductor devices, performs up to 23% more efficiently in the higher power ranges than conventional push-on heat sinks. It attaches to the TO-3's base where most of the heat originates. The LA 363 is diamond-shaped to reduce the amount of board space it occupies.

Booth 1730

CIRCLE NO. 429

## Mini terminal strips provide 36 positions



Magnum Electric, 6385 Dixie Highway, Erie, MI 48133. (313) 848-2555.

Flexible miniature terminal strips in circuit-board, wrapped-wire, right-angle and chassis-mount versions are available with up to 36 positions. The 0.5 x 0.5-in. strip with 0.325-in. center spacing is made from UL94VO unbreakable thermoplastic. The strip is rated at 15 A, 150 V per UL1059 and uses 6-32 screws. Its chemically resistant body moldings are cored to minimize heat absorption during wave soldering.

Booth 1338

CIRCLE NO. 430

## Ribbon-cable connector cuts down on shorts



Methode Electronics, 1700 Hicks Rd., Rolling Meadows, IL 60008. (312) 392-3500.

Cable-to-board ribbon cable may be mass-terminated on 0.1-in. centers with the insulation piercing Term-Apierce connector. Straight-on and right-angle versions are available. The connectors handle double the current rating of presently available mass-termination products designed for 0.05 centers. The additional dimension practically eliminates scrap caused by shorts to adjacent conductors.

Booth 1727

CIRCLE NO. 431

for those who specify or buy wire wrap panels and cards of the pin-in-board persuasion...



**FREE BROCHURE**  
28 pages...panels, cards, frames, drawers, prices...

**EECO**

1441 E. Chestnut Avenue • Santa Ana, California 92701  
(714) 835-6000 • TWX 910-595-1550/Telex 67-8420

DISTRIBUTED BY  
**MARSHALL INDUSTRIES**  
CIRCLE NUMBER 119

Have You Mailed Your Requalification Card? See Page 45

## PACKAGING & MATERIALS

### Stock cases available off-the-shelf



W.A. Miller Co., Mingo Loop, Oquossoc, ME 04964. Dick Hunger (207) 864-3344. See text.

Stock cases and enclosures are available off-the-shelf for shipment within two weeks. A choice of over 600 sizes range from 4 × 4 to 13 × 13, with depth variations up to 12 in. in increments of 1/8. Prices start at \$35 to \$80 depending on size. Several styles of hardware are offered to suit cost and application. The cases are made of sandwich-type laminated wood with decorative plastic laminate on exposed surfaces.

Booth 109

CIRCLE NO. 432

### Contacts in DIP plugs pierce wire insulation

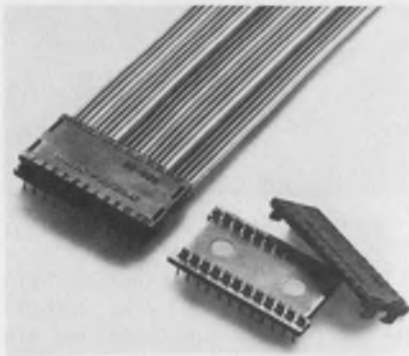

Spectra-Strip, 7100 Lampson Ave., Garden Grove, CA 92642. (714) 892-3361.

Preinstalled insulation-piercing contacts in male DIP plugs provide easy mass-termination to planar cables on 0.05-in. centers. The plug has an installed height of 0.195 in. and mates with any standard IC socket. The contacts are heat-treated phosphor bronze plated with 30 μin of gold. The cover permits cable entry from the top or side, within the over-all dimensions of the connector.

Booth 1308

CIRCLE NO. 433

### Edge connectors offer up to 50 terminals

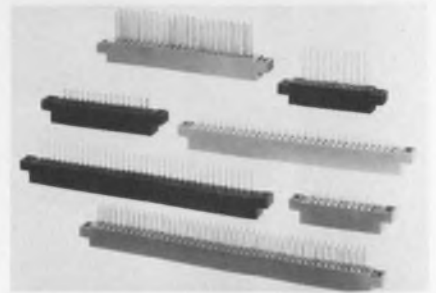

SMK Electronics, 118 E. Savarona Way, Carson, CA 90746. (213) 770-8915.

PC-board edge connectors in the S-400 series have 0.156-in. spacing and are available with 10 to 50 positions. The connectors accommodate single or double-sided boards from 1.4 to 1.8 mm thick. Body material is either polycarbonate or polysulfone. The units are available in a number of different mounting configurations and with eight different terminal types. Each contact post, position and row is numbered and removable plastic polarizing keys are available for locations on or between contact positions.

Booth 1238

CIRCLE NO. 434

# We're in Complete Control



4443

## Digital Measurement

- 3 1/2 digits, 0.1% accuracy
- The only 1" high display
- AC ranges available
- UL recognized (Model 4424)



4424-K

## Digital Control

- Unique internal digital control
- Control with signal conditioning
- Adjustable setpoints
- Plug-in display



4424

## Signal Processing

- Accepts process signals 4-20, 1-5, etc.
- Displays and/or controls Temperature Pressure Level Speed

Visit us at Electro '78, Booths 2323-2325, Boston, May 23-25.

Request your FREE 32 page Digital Process and Control Instrumentation Catalog with Application Guide Circle Reader Service Number or, contact

LFE Corporation, 1601 Trapelo Road, Waltham, Mass. 02154 617-890-2000

See LFE at Electro '78, Booths 2323-2325

CIRCLE NUMBER 109



## Cable-tie installer operates on air power

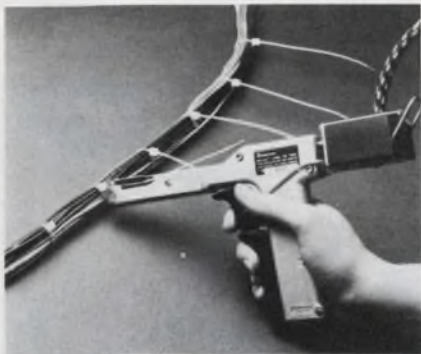

Dennison, 300 Howard St., Framingham, MA 01701. F.T. Wright (617) 879-0511.

The pneumatic Bar-Lok cable-tie installation tool reduces operator fatigue when handling miniature, intermediate and standard-size cable ties. The unit is supplied with a wear-resistant, 6-ft air hose with a quick-disconnect fitting. Once the operator has put the cable tie around the cable bundle and pulled the tie hand tight, the tool is applied to the cable-tie head. The operator pulls the tool's trigger which tightens the tie to a pre-set tension and cuts the end off in one operation.

Booth 418 CIRCLE NO. 435

## PC-card guide acts as heat sink

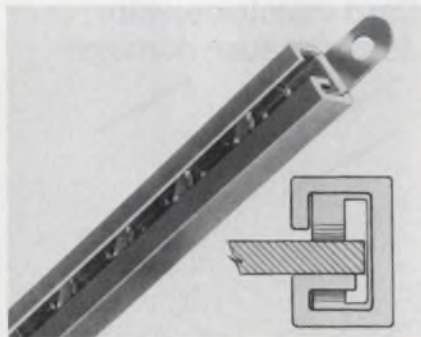

Unitrak, 8738 W. Chester Pike, Upper Darby, PA 19082. (215) 789-3820. From \$0.065/in.

Series 1000 metal PC-card guides allow exceptional heat dissipation when assembled into an aluminum heat-sink guide bar. The spring-finger action of the card guide firmly presses one edge of the card into contact with the guide bar over its entire length. A large contact area is thus used for heat transfer. Both metal card guide and guide bar can be furnished to any specified length or in 6-ft lengths for cutting and assembly.

Booth 1612, 1711 CIRCLE NO. 436

# I can show you how to find faulty intermittents fast!



Few things waste more time than locating an intermittent circuit component. Isolate off-again, on-again electronic components by quick-freezing them during testing. Remember: MS-240 Quik-Freeze® is not only a circuit cooler, but also a full-fledged freezer. It can drop surface temperature to  $-45^{\circ}\text{C}$  in seconds. A handy extension nozzle confines the chilling spray to the suspected components. Use MS-240 also to prevent undesirable heat transfer to delicate circuit elements during soldering or welding.

For further information, call or write Miller-Stephenson Chemical Co., Danbury, CT 06810 (203) 743-4447

**ms miller-stephenson chemical co., inc.**

Danbury, Connecticut 06810 (203) 743-4447

ED5W  
miller-stephenson chemical company, inc.  
Danbury, Connecticut 06810 (203) 743-4447



- Ask our Technical Director for application information
- Enclosed is \$2 for trial pack
- Send for literature and prices

I intend to use MS-240 on \_\_\_\_\_

Name \_\_\_\_\_ Title/Dept. \_\_\_\_\_

Company \_\_\_\_\_

Address \_\_\_\_\_

City \_\_\_\_\_ State \_\_\_\_\_ Zip \_\_\_\_\_

®Registered trademark

For industrial use only. Trial Unit must be sent to Company address  
LOS ANGELES • CHICAGO • DANBURY, CONN. • TORONTO  
CIRCLE NUMBER 122

# sealed high density miniature switching

for 12 to 60 poles with MIL-R-5757 protection against humidity ... sand ... dust ... moisture ... corrosion ... splash ... explosion ... built to withstand shock/vibration!

**T-bar** ENVIRONMENTALLY SEALED  
SERIES 831/931 RELAYS



12P, ST or DT 24P, ST or DT 36P, ST or DT 48P, ST or DT 52P, ST or DT 60PST

All contacts epoxy sealed in backfilled metal enclosure for ground support or shipboard applications and other hostile environments. Pulse operated magnetic latching available. Simple crimp snap-in contacts fit into single block connectors for easy wiring. 60 circuits switched in a space as small as 2 3/4" x 1 5/8" x 4 1/2".

Interested? Write or phone T-Bar today for complete facts, prices, quantity discounts.

**T-bar** INCORPORATED  
SWITCHING COMPONENTS DIVISION

141 Danbury Road, Wilton, CT 06897 • Telephone: 203/762-8351 • TWX: 710/479-3216  
CIRCLE NUMBER 123

## PACKAGING & MATERIALS

Tool easily removes pins from nylon connectors



Waldom Electronics, 4301 W. 69 St., Chicago, IL 60629. (312) 585-1212. \$2.25/\$6.70.

Extractor tools quickly and easily remove male or female pin terminals from Molex nylon connector housings. The Model HT-2285 tool handles 0.062-in. pins and the Model HT-2038 removes 0.093-in. pins. Both models have anodized aluminum handles and are spring loaded. Sure-grip replacement extractor tips are also available.

CIRCLE NO. 437

## High-Performance Amplifiers

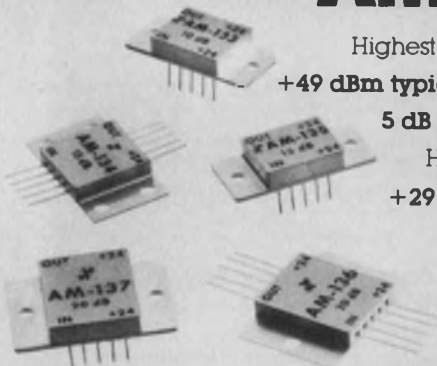

Highest Dynamic Range Available  
+49 dBm typical midband 3rd Order Intercept  
5 dB typical midband Noise Figure  
Highest Output Power  
+29 dBm typical midband  
1 dB Compression  
Frequency Range 5 - 200 MHz  
Gain 10, 15, 20, 25 or 30 dB

Ten FLAT-PACK or PLATFORM Anzac amplifiers (AM-132/133, 134/135, 136/137, 138/139, 140/141) provide the best performance available in

miniature amplifiers. Price ranges from \$135 per unit to \$195 in 1-5 quantities. ALL MODELS IMMEDIATELY AVAILABLE FROM STOCK.

Complete details in ANZAC CATALOG provided as Part 2 of the 1977-78 MICROWAVES PRODUCT DATA DIRECTORY



...the qualitative difference.

39 Green Street, Waltham, MA 02154 (617) 899-1900 TWX 710 324-6494

CIRCLE NUMBER 124

Card injector/ejector doesn't cause damage

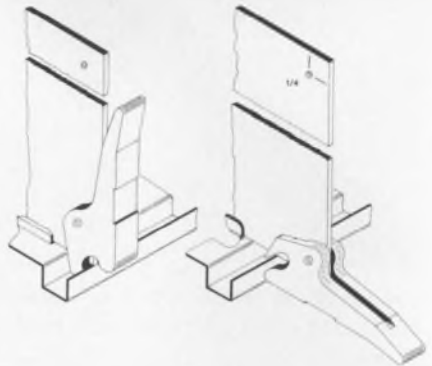

Electro-Space Fabricators, Tipton, PA 19562. (215) 682-7181.

Electro-Flex injector/ejectors provide damage-free insertion and extraction of PC boards. The units use both surfaces of a single blade to eliminate the need for close tolerances. A full 5/8-in. travel in each direction assures straight-line card movement. The units are molded of UL-approved nylon and fit boards having thicknesses of 1/16 to 1/8 in.

Booth 1304

CIRCLE NO. 438



## Door pulls go on electronic cabinets

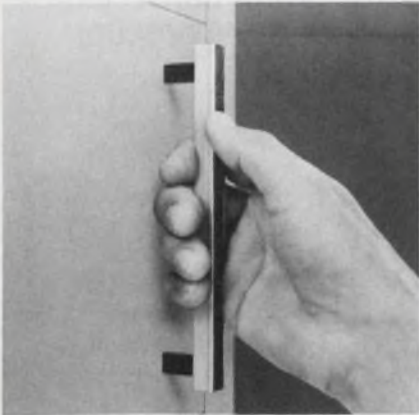

Southco, Brinton Lake Rd., Concordville, PA 19331. (215) 459-4000.

B6 door pulls come in four lengths to match the height of standard electronic modules. Each unit consists of a brush-finished, clear-anodized aluminum pull, trimmed in walnut-grained or black-pebble finish vinyls, plus two black thermoplastic stand-offs.

Booth 304

CIRCLE NO. 439

## Seals protect connectors from fluid entry

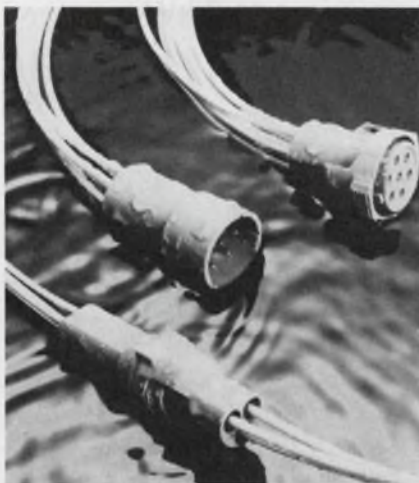

AMP, Harrisburg, PA 17105. Jim Pletcher (717) 564-0100.

Replaceable, factory-installed, rear-wire seals and fixed peripheral interfacial seals protect mated Econoseal connectors against intrusion by fluids. The polarized and keyed rigid thermoplastic housings latch together and panel mount with a simple snap ring. Available in 3, 4, 7 and 9-position sizes, these connectors accept five types of contacts to accommodate solid or stranded wire, miniature coaxial or fiber-optic cables with outside diameters from 0.07 to 0.14 in.

Booth 1111, 1211

CIRCLE NO. 440

## Connector with cable meets IEEE standard

Component Mfg. Service, Component Park, W. Bridgewater, MA 02379. (617) 580-0111.

Interface Bus is a cable assembly that is provided with both a plug and receptacle connector integrally molded at each end of the cable. It meets

requirements of IEEE 488. The cables are multiple conductor, stranded bare copper and shielded. The connectors are made of self-extinguishing thermoplastic material with permanently embedded terminations. A stacked-connector arrangement allows more than one cable to be attached to an instrument, permitting either star or daisy-chain configurations.

Booth 1615

CIRCLE NO. 441

Designing a measurement and control application without all the facts makes as much sense as hunting whales with a fishhook. You need information. All of it. From Airpax. And the only way to get all our information is to get all our catalogs. Not just Tach and Pick-up catalogs, but our Meter catalog, too.

### Mounds of meters

Our Meter catalog shows more than 50 standard ranges, functions and styles, including rectangular, medallion and edge-reading meters.

Furthermore, the Airpax thin-line movement eliminates the need for physical contacts, mirrors, prisms, and other undependable gizmos. Compact, simply designed, easy-reading meters, from Airpax. Send for our free catalog. Then you'll have the whole story.

## AIRPAX™

Airpax Electronics, Incorporated  
6801 West Sunrise Boulevard  
Fort Lauderdale, Florida 33313  
305/587-1100

A Division of North American  
Philips Controls Corporation

# If you haven't got our Meter catalog, you haven't got the whole story.

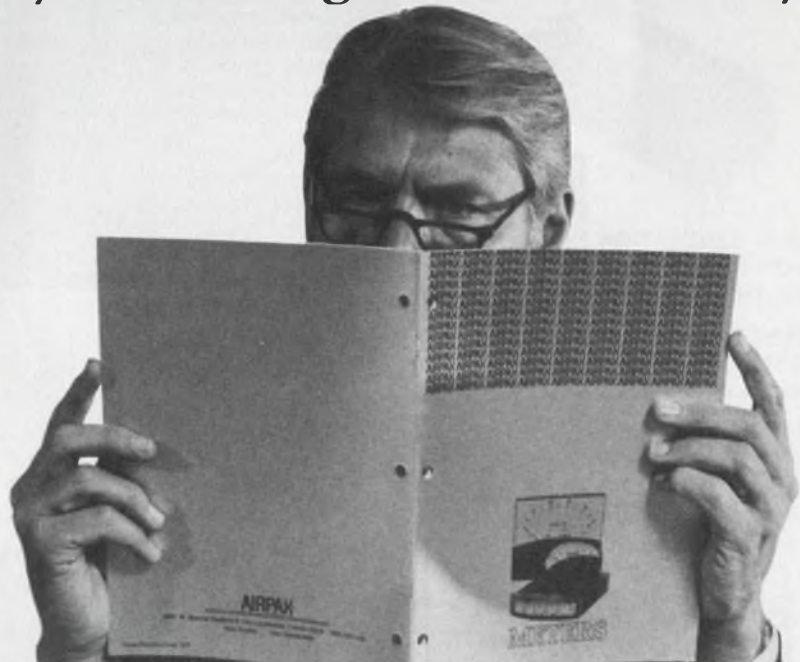

CIRCLE NUMBER 125

# ETERNACELL®

## The only complete line of Lithium Primary Batteries

There's a new technology in primary batteries. It's called the Eternacell Lithium Battery. Or Eternacell for short.

- Operating voltage 2.8 volts per cell
- -65°F to 160°F performance
- Up to 10 years shelf life
- Highest energy and volume density of any battery system
- 1/2 to 30 ampere-hour cell sizes in production quantities
- Stable voltage output

Reliable, proven in memory standby, communications, underwater power, instrumentation, alarm systems ... to name a few. Delivery, stock to 4 weeks.

Eternacell. The highest energy, longest life battery. For information write: Power Conversion, Inc., 70 MacQuesten P'kway South, Mt. Vernon, N.Y. 10550. Or call (914) 699-7333.



## Power Conversion

CIRCLE NUMBER 172

## Cost Effective Data Scanning

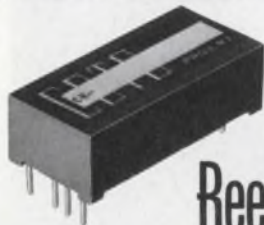

### Reed Relays

**NEW GENERATION LOW-COST, ULTRA LOW-THERMAL EMF**

- New simpler design reduces cost, maintains performance and reliability
- Switches signals to 1  $\mu$ V resolution
- Low, stable contact resistance
- High control/signal circuit isolation
- Graded and priced to the thermal offset you need ... pay no more.

Write or Call for Bulletin 10.4



**COTO-COIL COMPANY, INC.**  
59 Pavilion Ave.  
Providence, R. I. 02905  
Tel: (401) 487-4777

CIRCLE NUMBER 173

### Next generation Variable Frequency

## FILTERS

0.02 — 2,000,000 Hz.

HIGH-PASS BAND-PASS  
LOW-PASS BAND-REJECT  
BY-PASS

- Linearized Scale
- Continuously Variable
- Low Noise
- High DC Stability
- Input Signal Gain Option
- Butterworth or Min. Overshoot

AVAILABLE NOW

Contact us for further information on these Variable Filters or on our line of Fixed Frequency Active Filter Modules.



### A.P. CIRCUIT CORP.

865 West End Ave., New York, N.Y. 10025  
Tel. (212) 222-0876

CIRCLE NUMBER 174

## POWER SOURCES

### Dc/dc power converters produce three outputs



BikoR, 23970 Madison St., Torrance, CA 90505. Ron Pizer (213) 378-8284. \$438.88 (100 qty); stock to 4 wks.

Standard models of triple-output dc-to-dc converters offer a choice of +5 V dc at 25 A with  $\pm 12$  V dc at 2 A or  $\pm 15$  V dc at 2 A and +12 V dc at 15 A. Regulation is 0.2% for line and load variations. Efficiency varies from 65 to 80% depending on voltages. Other models with single and dual outputs from 5 to 250 V dc are also available. Models provide a choice of 12, 24, 48 or 115-V-dc input power.

Booth 2409

CIRCLE NO. 442

### Solid-state regulators handle up to 4 kVA



Superior Electric, 383 Middle St., Bristol, Ct 06010. Ivan Bourgojn (203) 582-9561. \$275 to \$695; stock.

Four solid-state Stabiline automatic ac-voltage regulators in the SVR series have ratings from 0.75 to 4 kVA. A unit provides a regulated output of 115 V from an input-voltage range of 100- to 135-V ac. Accuracy is  $\pm 3.5\%$  for line, load and power-factor variations. All four types have an efficiency of 95% at 60 Hz, and a correction rate of 1/2 cycle per step without overshoot or undershoot. The regulators operate in 0 to 50-C ambient. They have virtually-zero waveform distortion, are insensitive to load power factor and have virtually no effect on system power factor.

Booth 2511

CIRCLE NO. 443

Bodine's PM drive family grows-

New 32D permanent magnet Control Motors and 32D-5F right angle gearmotors, perfectly matched with Bodine speed/torque controls. Continuous duty ratings of 1/12, 1/10 and 1/8 Hp at 2500 Rpm. See your Bodine Distributor or write for Cat. CDC-PM.

## New 32-frame PM motors and garmotors!



**BODINE  
ELECTRIC  
COMPANY**

ADE (After Delivery Economies)  
make Bodine a better fhp buy

Bodine Electric Company, 2500 W. Bradley Place, Chicago, IL 60618.

CIRCLE NUMBER 126

## Relays for every reason Series MK

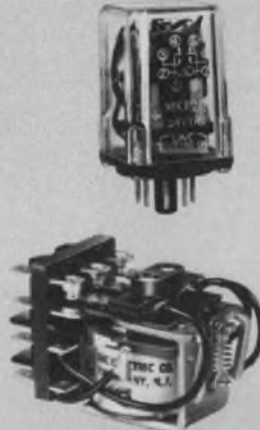

- Open, closed and hermetically sealed.
- Five individual series.
- Low profile plug-ins.
- Choice of plug-in, .110 quick connect, .187 quick connect, PC board or solder connections.
- Contact arrangements up to 3 Form C.
- Contact ratings 5 or 10 amp at 120 VAC.
- Current sensitive to 240 volts.
- Factory stock or at your nearest Line Relay distributor.

For prices and a free catalog of over 200 different relays and accessories, write or call:  
Line Electric  
U.S. Highway 287  
Parsippany, NJ 07054  
(201)887-8200  
Telex: 13-6494



CIRCLE NUMBER 127

free  
FOR  
THE  
Asking

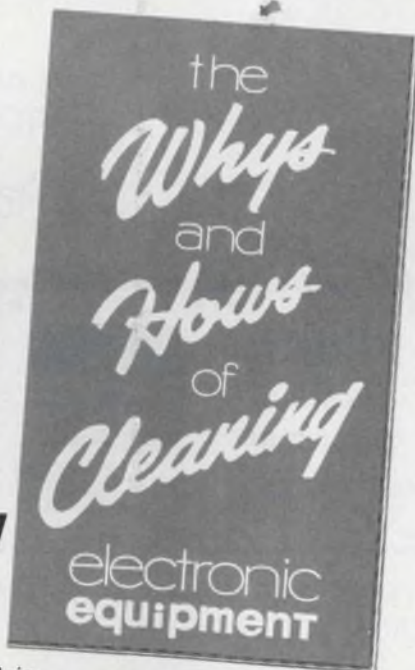

Ten minutes with this new booklet will explain the effects of dirt on equipment reliability, calibration and stability... and tell you what to do about it.

Send for your copy today.

**M.P. Odell Company**

26612 CENTER RIDGE ROAD • CLEVELAND, OHIO 44145  
TELEPHONE (216) 871-8000

CIRCLE NUMBER 128

ELECTRONIC DESIGN 10, May 10, 1978

## ADHESIVE MOUNTS

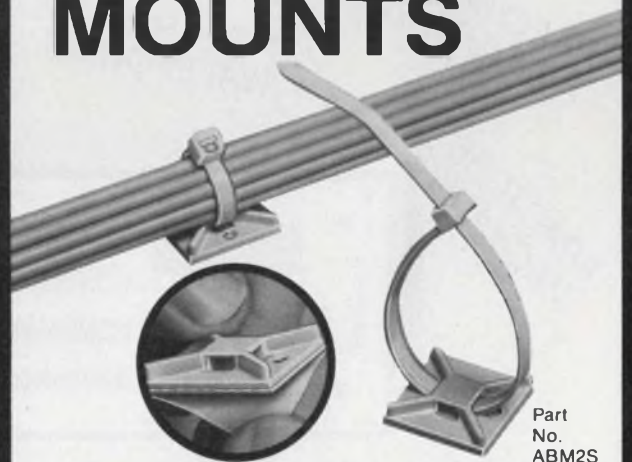

Part  
No.  
ABM2S

- Fast, convenient—pressure-sensitive, adhesive backed cable tie mounts.
- Save costly time of drilling holes.
- After applying mount to surface, insert cable tie from any of four sides of mount.
- Part of complete line of adhesive backed mounts.

Sold through Authorized Panduit Distributors

FREE  
SAMPLES



Tinley Park, Ill 60477 • Phone (312) 532-1800 In Canada: Panduit (Canada) Limited

Visit PANDUIT at Electro '78 Booth 1320-22  
CIRCLE NUMBER 129

# AP brought you solderless breadboarding. Now we've added power.

You know the AP name for the development of the first solderless breadboarding devices. First there were ACE All Circuit Evaluators. Then AP's full line of Super Strips, distribution strips and terminal strips.

Now there's POWERACE, the new Power All Circuit Evaluator. Like all AP breadboarding elements, POWERACE accepts all DIP sizes, plus TO-5's and discretes with leads up to .032". But what's most important is its capacity — *twice* that of any other power breadboard manufactured — with 256-5 tie-point ter-

minals and 16-25 tie-point buses.

Plug in to the AP distributor nearest you by calling our Toll-free number: (800) 321-9668.

**Faster and Easier is what we're all about.**



**AP PRODUCTS INCORPORATED**

Box 110 • 72 Corwin Drive, Painesville OH 44077  
(216) 354-2101 TWX: 810-425-2250



CIRCLE NUMBER 131

PRECISION LOW  
FREQUENCY RAMPS

COMPRESSION/RELAXATION  
PRECRACKING  
WAVEFORMS

SERVO ACTUATOR  
CONTROL SOURCE

CYCLIC CREEP

FRACTURE  
MECHANICS

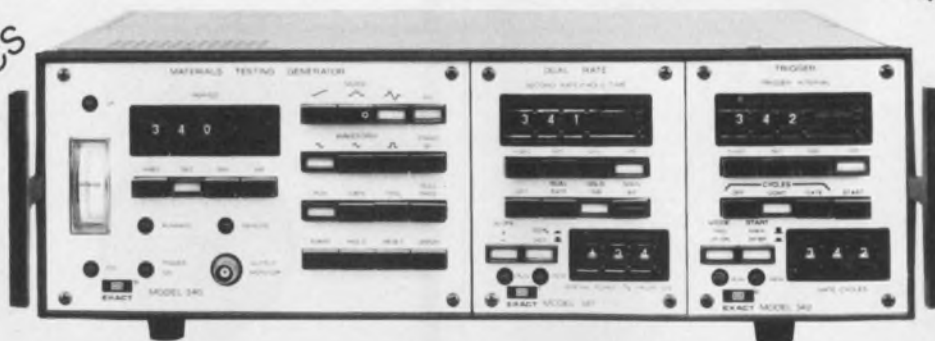

FATIGUE  
TESTING

**NO ANALOG GENERATOR CAN EQUAL THE PERFORMANCE, RELIABILITY, OR VERSATILITY OF EXACT'S 340 MATERIALS TESTING GENERATOR SERIES!!**

The waveforms are digitally synthesized from 400,000 bits. This provides 50 microvolt per step resolution for periods ranging from 100 milliseconds to 99,900 hours. Ramp, Hold at Breakpoint, Switch to Rate 2 at Breakpoint, Null Pace, Reverse Direction — these are just a few of the control signal functions produced by the 340. Whether developing a new system or upgrading an existing materials testing system, you will be dollars ahead with an Exact 340 series for signal generation.

Model 340 Materials Testing Generator	\$1400.
Model 341 Dual Rate Unit	\$ 600.
Model 342 Trigger Unit	\$ 600.



Box 160 Hillsboro, Oregon  
97123 Tel. (503) 648-6661  
TWX 910-460-8811

**EXACT electronics, inc.**

BCD and GPIB programming options are available with all units.

CIRCLE NUMBER 132

## POWER SOURCES

### Long-life lithium cells shrunk to coin size



Panasonic, 1 Panasonic Way, Secaucus, NJ 07094. Dave Berend (201) 348-7277.

A coin-size long-life lithium battery has the same profile as other coin units (0.098 in. thick) but it has a smaller diameter of 0.785 versus 0.906 in. Nominal voltage of the battery is 3-V and its capacity is in excess of 90 mAh. The cell is hermetically sealed and its shelf life is in excess of 5 yr. Price of the cell is compatible with the price for silver-oxide cells. **CIRCLE NO. 444**

### Module recharges small batteries

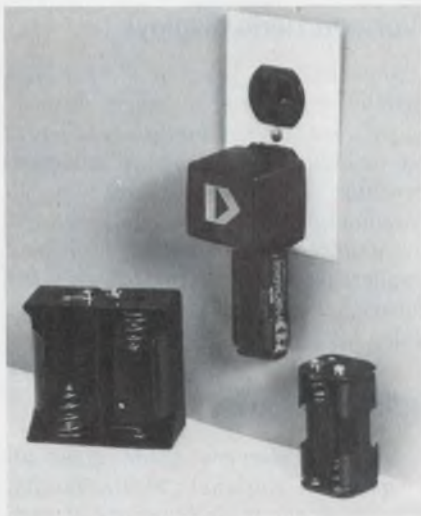

Dynamic Instrument, 933 Motor Pkway, Hauppauge, NY 11787. Dave Baum (516) 234-2900.

The modular battery charger is compatible with battery holders having snap terminals. The charger permits the low-end OEM product to become rechargeable by the addition of the modular charger and the substitution of rechargeable NiCd cells for the dry cells. The unit, which measures 1.75 x 1.75 x 1.5 in. and plugs directly into a wall socket, has snap terminals that mate with the terminals of standard-battery holders.

Booth 1637

**CIRCLE NO. 445**

# TEST YOURSELF

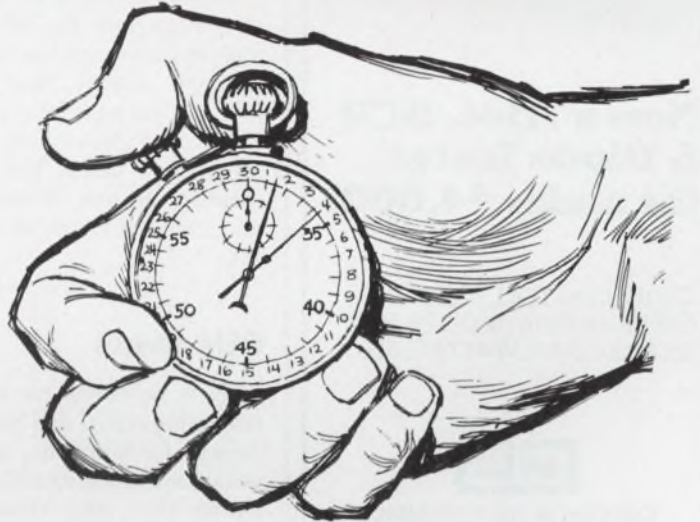

This is it . . . **Electronic Design's** first annual "Every Subscriber Renewal Issue." See details on pages 45 through 48 . . . then fill in your **FREE RENEWAL FORM** on page 49. It should take less than 3 minutes. If you don't believe us, tear out this ad and compare your score with the norms shown below.

	Par	Your Score
<b>1</b> Peel off your address label from front cover and affix to renewal form.	5 sec.	<input type="text"/> sec.
<b>2</b> Sign application and check renewal box.	2 sec.	<input type="text"/> sec.
<b>3</b> Answer questions 1 thru 6.	60 sec.	<input type="text"/> sec.
<b>4</b> Answer questions 7 thru 10.	90 sec.	<input type="text"/> sec.
<b>5</b> Tear out form, fold, tape closed, affix stamp. Mail.	15 sec.	<input type="text"/> sec.
<b>FINAL SCORE</b>	172 sec.	<input type="text"/> sec.

## IT SHOULD TAKE YOU LESS THAN 3 MINUTES!

In return, you will receive **Electronic Design** and its **GOLD BOOK FREE OF CHARGE** from May 1978 through April 1979.



## Now a Triac, SCR & Diode Tester for under \$4,000!

Get the facts TOLL FREE  
Call Bruce Rahm 800-527-4634  
(In Texas, 214-234-4173 Collect)



**Control & Information  
Systems, Inc.**

10 Spring Valley Village • Richardson, Texas 75080

CIRCLE NUMBER 133

## Over 20,000 in Use Field Proven Lab Accuracy DPM



### PM-4 \$170 0.02% Accuracy

- $\pm 1, \pm 10, \pm 100$  or  $\pm 1000V$  range.
- Auto zero & polarity.
- Programmable decimal.
- Range change capability.
- Protected input.
- 1"H x 2.5"W x 3.25"D.
- Large 0.3" LED display.



**Non-Linear Systems, Inc.**  
Originator of the digital voltmeter.  
Box N, Del Mar, California 92014  
Telephone (714) 755-1134 TWX 910-322-1132

CIRCLE NUMBER 134

## Application notes

### Semiconductor mounting

Proper mounting methods of power semiconductors for adequate cooling and optimum operation at ever-increasing circuit and device-power levels is the topic of a seven-page data sheet. The data sheet includes diagrams and tables that support and amplify the text. Westinghouse Electric, Semiconductor Div., Youngwood, PA

CIRCLE NO. 446

### OEM devices

"New Solutions for Old Problems" covers industrial and biomedical OEM devices for filtration, separation and isolation applications. Gelman Medical Device Div., Ann Arbor, MI

CIRCLE NO. 447

### Wire and cable

A Wire & Cable Handbook comes in a loose-leaf type vinyl binder and includes complete applications, specifications and configurations for five types of wire and cable. Icore International, Sunnyvale, CA

CIRCLE NO. 448

### High-speed op amps

"Integrated High Speed Operational Amplifier" explains how modern high-speed, high-stability circuits can be constructed using semi-custom IC technology. Interdesign, Sunnyvale, CA

CIRCLE NO. 449

### Mixer preamplifiers

A 16-page mixer and mixer-pre-amplifier catalog is prepared in a concise, tabular format in an attempt to present all the information at a glance. A series of easy-to-use nomographs is provided. Microwave Associates, Burlington, MA

CIRCLE NO. 450

## New literature



### Telephone-type relays

A 56-page catalog describes telephone-type relays. The addition of a relay-selection chart guides the user to the proper relay class which will fit his particular requirements. Magnecraft Electric, Chicago, IL

CIRCLE NO. 451

### Alphanumeric displays

Screened-on-glass, gas-discharge displays capable of messages consisting of up to 16 alphanumeric characters 0.5-in. high are described in a four-page brochure. Diagrams illustrate the 55 commonly used characters, segment designations, and a typical multiplex application. Beckman Instruments, Information Displays Operation, Scottsdale, AZ

CIRCLE NO. 452

### 8080A $\mu P$ family

A quick-reference guide gives an overview of National's 8080A family, describing the basic functions of each component, the pin numbers and signal names and how the components interface to National's system bus. The booklet includes a description of the 8080A CPU group, as well as its series of peripheral-control, communications, digital input/output, and memory components. National Semiconductor, Santa Clara, CA

CIRCLE NO. 453

Have You Mailed Your Requalification Card? See Page 45

# Hundred-Mega-Head

Second generation technology achieves unprecedented reliability in new 500 Series 40-column Dot Matrix Impact Mini-Printers:

- Guaranteed head life of 100 million characters continuous duty.
- Guaranteed mechanism life of 5 million print lines MCBF (mean cycles between failure).
- High printing speed: 3 lines per second (Bi-directional printing)
- Mini-size: No printer larger than 7" W x 10" D x 6" H.
- 500 Series comprises Model 522 2-stage 18-column receipt and 18-column journal with logo stamp, automatic receipt cut-off knife and 1-line validation capability; Model 542 40-column flatbed ticket or slip printer; and Model 512 40-column journal printer.
- Samples \$245 each. Deliveries begin second quarter '78.
- Developed and manufactured by world-famous SHINSHU-SEIKI (under trade name Epson).
- Represented and backed by C. Itoh Electronics, Inc.—part of the 118-year C. Itoh & Co., Ltd. world-wide trading organization.

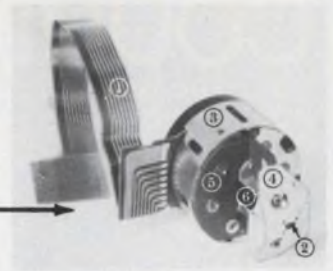
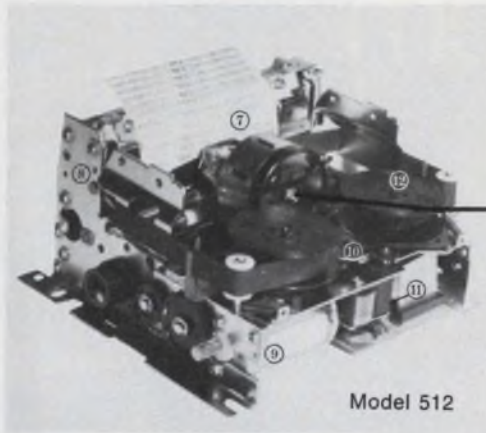

1. Ribbon connector.
2. 7 impact wires guided by jewelled bearing.
3. Special steel alloy casting.
4. Ribbon protection and guide.
5. 7 internal solenoids.
6. Dot wire holder, field replaceable.
7. Highest line slewing rate, approximately 15 lines/sec.
8. Rugged steel frame & supports.
9. 24 VDC motor (with integral timing signals assuring character uniformity) and motor control board.
10. Automatic ribbon advance & reverse, ribbon presently rated at 6 million characters.
11. Ribbon type head connector.
12. Extra long standard ribbon.



## C. Itoh Electronics, inc.

**East:**  
280 Park Avenue  
New York, NY 10017  
Call: 212 682-0420  
Telex: WU 12-5059

**West:**  
5301 Beethoven Street  
Los Angeles, CA 90066  
Call: 213 390-7778  
Telex: WU 65-2451

C. Itoh means  
excellence in printers

CIRCLE NUMBER 138

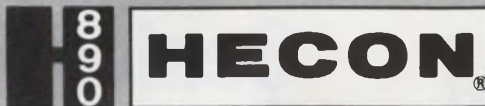

...a name you can count on  
for Electronic Counters.

A new generation of 3 Electronic Counters to solve  
your high-speed counting and controlling problems . . .



### The GO 781.100 (Counter-Controller)

Manual, remote and automatic reset. 5 digit LED Display and preset. Counts up to 5,000 cps. Adding and Subtracting Models.



### The GO 781.300 (Totalizer)

Display hold without losing count or built-in count inhibit gate. Compact size and 7 digit LED Display. Electronic or manual reset. Connection for 9v standby battery power supply.

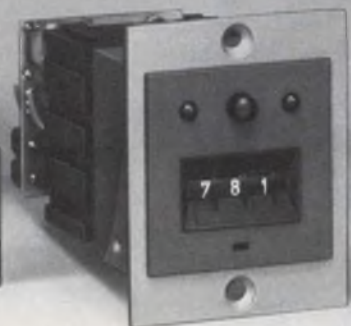

### The GO 781.400 (Controller)

For high-speed controlling requiring frequent reset. Long life expectancy. LED count/output indicators. Manual, remote and automatic reset. Counts up to 5,000 cps.

Manufacturers of: Electronic Counters  
Electromechanical Counters • Mechanical Counters  
Pneumatic Counters • Ticket & Tape Printers

**Hecon Corporation**  
31 Park Road, Tinton Falls, NJ 07724  
(201) 542-9200

**Hecon Canada, Inc.**  
80 Galaxy Blvd., Rexdale, Ontario M9W 4Y8  
(416) 675-3663

Your Hecon Distributor is listed in the Yellow Pages under Counting Machines.

CIRCLE NUMBER 139

these two Panel Meters ...  
can become 93 different measuring instruments ...

# count'em.

DC and AC Volts .....	23 models
DC and AC Current .....	20 models
DC Autoranging .....	2 models
True rms .....	8 models
Thermocouple C or F .....	16 models
RTD C or F .....	4 models
Thermistor C or F .....	8 models
Offset and Scaled .....	4 models
Process Monitors .....	8 models

and the best part is ...

You can change to any one of these models anytime. It is as simple as reprogramming the rear connector or adding one of DigiTec's exclusive adapters. Call or write for complete specifications.

These instruments are available under GSA Contract, GS-00S-27741.

DigiTec: Precision Measurements to count on

**DigiTec.**

**UNITED  
SYSTEMS  
CORPORATION**

918 Woodley Road, Dayton, Ohio 45403  
(513) 254-6251, TWX (810) 459-1728

See us at Booth 2124-26 Electro '78



CIRCLE NUMBER 251 FOR INFORMATION ONLY

CIRCLE NUMBER 261 FOR DEMONSTRATION ONLY

**VECTRON CRYSTAL OSCILLATOR  
OF THE MONTH  
ULTRA STABLE  
MODEL CO-246V**

Aging:  $3 \times 10^{-10}$ /day  
 $1 \times 10^{-10}$ /day optional  
0-50°C:  $\pm 5 \times 10^{-10}$   
Short-term:  $\pm 1 \times 10^{-10}$  optional  
Phase noise:  $< 1 \times 10^{-11}$ /second  
Oven: -145 dB/Hz at 1 KHz  
Oven: double proportional



**CLOCK OSCILLATORS**



TTL: 1Hz to 100MHz  
CMOS: 1Hz to 10MHz  
ECL: 5 to 200MHz  
Stab:  $\pm .01$  to  $\pm .0003\%$

**TCXOs**

0/+50°C: to  $\pm 1 \times 10^{-7}$   
-55/+85°C: to  $\pm 1 \times 10^{-6}$   
Aging:  $1 \times 10^{-6}$ /year  
Frequency: 60 Hz-140 MHz



**VXOs**



Dev:  $\pm .003$  to  $\pm 1\%$   
Lin: to  $\pm 1\%$   
For both low distortion and phase lock applications

**OVEN TYPE**

Aging: to  $1 \times 10^{-10}$ /day  
Freq: to 400 MHz  
Stab: to  $\pm 2 \times 10^{-12}/^{\circ}\text{C}$

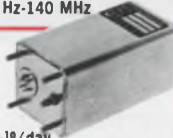

Send for your free product catalog and applications bulletin: "How to Specify Crystal Oscillators."



**VECTRON LABORATORIES, INC.**

166 Glover Avenue  
Norwalk, CT 06850  
Telephone: 203/853-4433

CIRCLE NUMBER 120

FOR IC'S, TRANSISTORS, LED'S & RELAYS

# Sealectro Sockets & Mounting Devices

The most extensive line in the industry featuring Teflon insulators, high retention precision contacts for excellent electrical, noise and mechanical characteristics. No loose hardware...units available for interference fit into chamfered chassis hole, or 1/4 turn "D" hole mounting for positive locking action. Send for new Catalog.

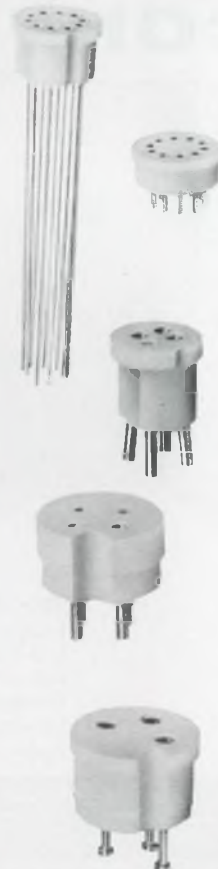

CIRCUIT COMPONENTS DIVISION  
**SEALECTRO CORPORATION**  
MAMARONECK, N.Y. 10543  
PHONE 914 698-5600 TWX 710-568-1110  
Sealectro West  
14811 Ventura Blvd., Suite 215, Sherman Oaks, Ca 91422, (213) 990-8131  
1901 Old Middlefield Way, Suite 18, Mountain View, Ca 94040, (415) 945-1212  
Sealectro Ltd., Portsmouth, Hants, England  
Sealectro S.A., Zone Industrielle Toucan Est, 83087 Toucan Cedex, France  
CIRCUIT COMPONENTS ■ R.F. COMPONENTS ■ PROGRAMMING DEVICES

CIRCLE NUMBER 121

ELECTRONIC DESIGN 10, May 10, 1978



## NEW LITERATURE

### Dual-trace recorders

Key performance features, specifications and pricing on five dual-trace oscilloscopes are found in a four-page catalog. Gould, Instrument Div., Cleveland, OH

CIRCLE NO. 454

### Trimming capacitors

Precision, miniature, piston-trimmer capacitors; fixed and variable inductors; and LC networks are described in a 24-page catalog. The catalog includes electrical and mechanical specifications, voltage ranges and dimensional information. JFD Electronic Components, Brooklyn, NY

CIRCLE NO. 455

### Detector video amplifiers

General and electrical specifications, outline drawings, features and suggested applications of detector video amplifiers are given in a 12-page catalog. Aertech Industries, Sunnyvale, CA

CIRCLE NO. 456

### CMOS 12-bit d/a converters

Specific features, block diagrams, and specifications for two  $\mu$ P-compatible d/a converters are given in a 10-page catalog. Logic diagrams illustrate 12-bit parallel loading, connection and timing for serial loading, unipolar and bipolar operation with and without a 10-V reference. Beckman Instruments, Helipot Div., Fullerton, CA

CIRCLE NO. 457

### Infrared emitters

A 24-page product guide provides tabulated data and outline configurations for infrared emitters and injection lasers. RCA Solid State-Europe, Middlesex, England

CIRCLE NO. 458

### Test accessories

Test hooks, probes, connectors, jumpers, test-lead and coaxial-cable assemblies, adapters, breadboarding and harness-board components are illustrated in a 92-page catalog. E-Z Hook, Arcadia, CA

CIRCLE NO. 459

## Semiconductors

Power-semiconductor products, including diodes, SCRs, assemblies, power modules and surge suppressors, are described in a short-form catalog. The catalog includes photos and descriptions of hardware, series numbers, package configurations, and performance specifications such as voltage range and operating temperature. FMC Semiconductor Products, Broomfield, CO

CIRCLE NO. 460

## Power supplies

A full range of power supplies are shown in a 50-page catalog. Acopian, Easton, PA

CIRCLE NO. 461

## Switches

Nine digital switches for industrial and commercial users and low-profile keyboards are featured in a six-page guide. Digitran, Pasadena, CA

CIRCLE NO. 462

## Test, measuring products

Technical specifications and illustrations of the company's test and measuring instruments are featured in a catalog. Philips Test & Measuring, Mahwah, NJ

CIRCLE NO. 480

## 4096-bit dynamic RAM

Features, electrical characteristics, and timing waveforms of the 4027 4096-bit dynamic RAM can be found in a 16-page catalog. ITT Semiconductors, Dallas, TX

CIRCLE NO. 481

## Variable transformers

A 60-page variable-transformer catalog gives ratings, dimensions, performance curves and schematic-connection diagrams in an easy-to-read, efficient format. It includes metric equivalents for universal use and easy reference. The Superior Electric Co., Bristol, CT

CIRCLE NO. 482

## In Floppy Disk systems, the powerful name is Power/Mate.

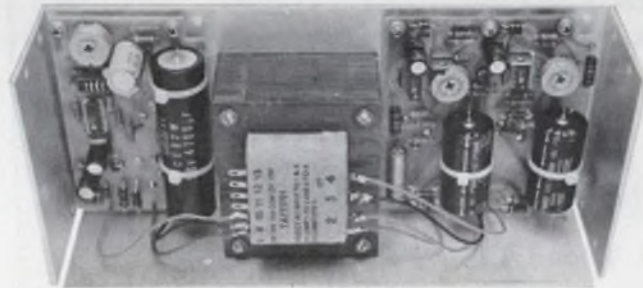

Power/Mate isn't the only company who could supply you with open frame power supplies for single and dual drive Floppy-Disk memory systems.

Yet, we're the only one many OEM's buy from.

The reason? Reliability.

Power/Mate is the world's largest supplier of power supplies.

So besides getting your unit extra fast, once it arrives you can be sure extra care has gone into building it.

After all, that's how Power/Mate got to be number one.

And pleasing you everytime you order, is how we're going to stay number one.



### POWER/MATE CORP.

514 S. River St./Hackensack, New Jersey 07601/(201)343-6294/TWX (710) 990-5023  
17942 Skypark Circle/Irvine, California 92714/(714)957-1606/TWX (910) 595-1766

The world's largest supplier of quality power supplies.

CIRCLE NUMBER 176



## NEW LITERATURE

### Thumbwheel switches

"No-hardware" thumbwheel switches are featured in a 12-page brochure. The brochure contains truth tables for all the switches, as well as functional descriptions and ratings. Unimax Switch, Wallingford, CT

CIRCLE NO. 463

### Electronic counters

A six-page selection guide summarizes specifications and characteristics of 15 counters in HP's electronic-counter line. Hewlett-Packard, Palo Alto, CA

CIRCLE NO. 464

### Measuring setups

The technology and applications of sweep-measuring setups WM-20 and WM-30 are given in a 28-page catalog. Wandel & Goltermann, Eningen u.A., West Germany

CIRCLE NO. 465

### Terminals

Technical details and plating information on all "Bullet-Nose" terminal styles and types are provided in a 12-page catalog. Seaelectro, Mamaroneck, NY

CIRCLE NO. 466

### Mask-alignment systems

Third-generation Micalign projection mask-alignment systems are detailed in an eight-page brochure. Perkin-Elmer, Electro-Optical Div., Wilton, CT

CIRCLE NO. 467

### Power supplies

Standard off-the-shelf power supplies are described in a 140-page catalog. A selection guide, features, package sizes, specifications and dimensional drawings are included. Lambda Electronics, Melville, NY

CIRCLE NO. 468

### Rental test instruments

Over 1000 electronic test instruments available for monthly rental are described in a 56-page catalog. Full specifications and monthly rates are included. Continental Resources, Bedford, MA

CIRCLE NO. 469

# ATTACK the hours of work you hate

Using spec sheets and manufacturer's catalogs to find semiconductor technical information is stealing your valuable time.

But now there's a system that can reduce your reference hours to minutes. Puts technical data on worldwide Microcomputers, Integrated Circuits, Discrete Devices and Optoelectronics components at your fingertips.

The D.A.T.A. BOOKS Electronics Information Series. D.A.T.A. engineers have successfully combined your data needs with standardized values, terms and definitions. Here are the tens of thousands of semiconductors manufactured in the U.S. and around the world — arranged by key parameters for your quick and easy comparison. Fast information that's accurate, dependable, up to date.

Just circle the reader response number. We'll send you our new 10 page brochure explaining the unique time-saving D.A.T.A. BOOK System.

## FREE

10 Page Brochure.

*Tells how you can  
eliminate the hours  
of work you hate.*

*Visit Booth 312  
Design Engineering  
Show*

# D.A.T.A. BOOKS

D.A.T.A., INC.

A Cordura Company

45 U.S. Highway 46, Pine Brook, New Jersey 07058

Telephone: (201) 227-3740

CIRCLE NUMBER 148

# For designers & prototypers... BREADBOARDING AIDS

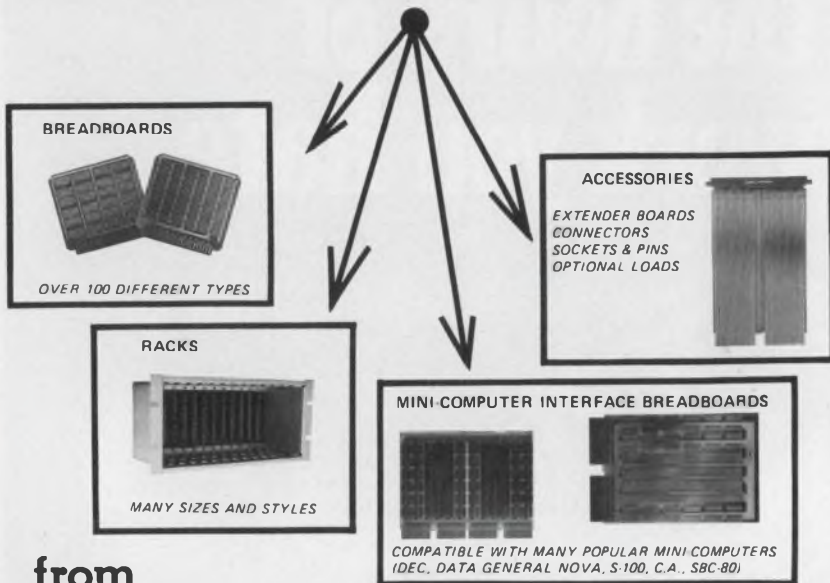

from  
**DOUGLAS ELECTRONICS**  
booth 615 **Electro 78**

718 MARINA BLVD.  
SAN LEANDRO, CA 94577  
(415) 483-8770

Circle reader service number for a FREE copy of our 32 page catalog.

**CIRCLE NUMBER 150**

# MICROPROCESSOR I/O MICROINTERFACE™ MODULES

The Midtex, Inc. Microinterface modules provide a flexible and proven industrial interface concept for users of mini-computers and microprocessor based systems. These modules provide a low cost, versatile and readily expanded and maintained method of interconnecting the input sensors and output devices to the processors.

The entire family of Microinterface modules are packaged in standard industrial type plug-in enclosures. The designs function in extremely harsh environments, making them ideally suited for industrial and process-control applications.

The Microinterface module family is comprised of a variety of standard I/O devices such as: **Digital:** AC Input, DC Input, AC Output, and DC Output; and **Analog Input:** RTD, Thermocouple, Instrumentation AMP, and DC Strain.

Other popular function modules are available in addition to those listed.

A family of rugged and pluggable mounting chassis assemblies are also available, providing for self-powered mounting of 5, 10, 16 and 25 Microinterface modules. Terminal strips and plug-in connectors facilitate interwiring.



THE TOTAL RELAY COMPANY  
**MIDTEX**

1650 TOWER BOULEVARD  
NORTH MANKATO, MINNESOTA 56001  
PHONE 507 625-6521

For a complete technical bulletin contact our nearest sales office or the factory, or circle our reader service number.

**CIRCLE NUMBER 151**

# Vendors report

Annual and interim reports can provide much more than financial position information. They often include the first public disclosure of new products, new techniques and new directions of our vendors and customers. Further, they often contain superb analyses of segments of industry that a company serves.

Selected companies with recent reports are listed here with their main electronic products or services. For a copy, circle the indicated number.

**Information International.** Distributed typesetting, electronic illustrations.

**CIRCLE NO. 470**

**Anixter.** Wire and cable; CATV components.

**CIRCLE NO. 471**

**Loral Corp.** Electronic communications and electronic-warfare systems, aerospace and nuclear components, plastic packaging.

**CIRCLE NO. 472**

**Telefile.** Computer-enhancement products.

**CIRCLE NO. 473**

**Siemens.** Components, data systems, power engineering, electrical installation, medical engineering, telecommunications.

**CIRCLE NO. 474**

**Park Electrochemical.** Electronic-circuitry materials.

**CIRCLE NO. 475**

**Lloyd's Electronics.** Audio-entertainment products, electronic calculators, home video games.

**CIRCLE NO. 476**

**Wyle Laboratories.** Electronic components, R&D.

**CIRCLE NO. 477**

**Logicon.** Defense, process systems, printing and publishing.

**CIRCLE NO. 478**

**Medtronic.** Medical devices.

**CIRCLE NO. 479**

# MUCON<sup>®</sup>

## CERAMIC CAPACITORS

# NPO

ULTRA-STABLE  
**MU-CAPS<sup>®</sup>**  
QPL to MIL-C-20F

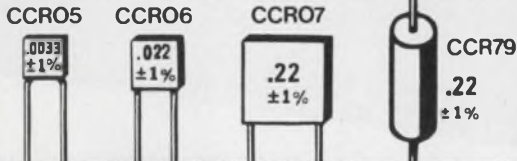

**TIGHT CAPACITANCE TOLERANCES** as low as  $\pm 1/2\%$

**CAPACITANCE** 1/2 PF. to .22 MF. | **Q GREATER** THAN 1000 | **ULTRA-STABLE**  $\pm 3\%$  max. change

write for **NEW CATALOG**

**REPUBLIC ELECTRONICS CORP.**  
176 E. 7th St., PATERSON, N.J. 07524  
201-279-0300 TWX 710-988-5908

Show Booth #1432  
CIRCLE NUMBER 152

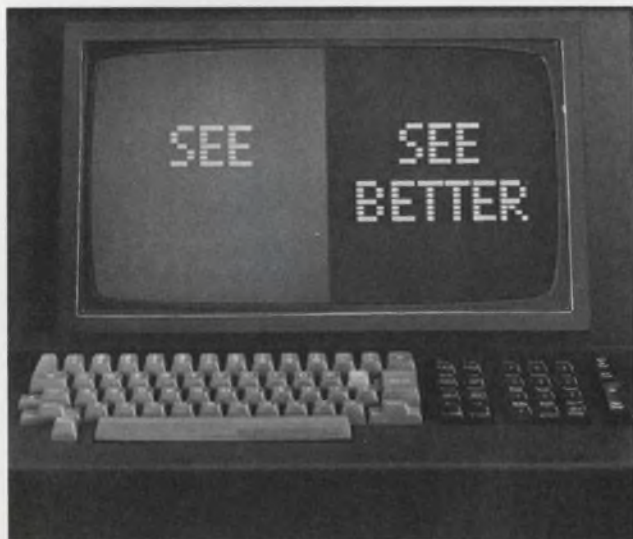

### 3M Brand Light Control Film Improves Readout Readability.

Microlouvers within the film enhance contrast, screen out ambient light. Works equally well on LED and CRT displays. For information on how you can use 3M Light Control Film in your product write: Visual Products Division, Industrial Optics, 3M Center, St. Paul, MN 55101.



CIRCLE NUMBER 154

ELECTRONIC DESIGN 10, May 10, 1978

FOR COMPUTER-CONTROLLED  
MACHINE TOOL SYSTEMS

ELECTRONIC EQUIPMENT  
ENCLOSURES

COMPUTERS • ELECTRONICS

52-7/16"

# McLEAN AIR CONDITIONERS

5000-10,000 BTU

For "closed loop enclosures". Recirculates and cools internal air. Constant clean air in contact with electronics. Highest quality refrigeration and electrical components. 20,000 hours continuous duty in ambients to 125°F. High velocity cooling for maximum heat removal. Std. cabinet mounting. Quick installation. Factory-installed gaskets seal against induction of ambient, contaminated, or polluted air. 115 or 230 volts.

SEND FOR CATALOG

**McLEAN McLEAN**

ENGINEERING LABORATORIES

ENGINEERING MIDWEST

Princeton Junction, NJ 08550 9560 Eighty-Fifth Ave. N.  
609-799-0100 • TWX 510-685-2543 Maple Grove, MN 55369 • 612-425-4747

CIRCLE NUMBER 153

# Buzzzzz.

(Write for new catalog.)



Solid state electronic MICRO-BUZZER from CITIZEN: High reliability, competitively priced with immediate delivery.

A complete range: SMB 1.5, 6, 12, 24, VDC  
RMB 3, 6, 12, 24, VDC  
IMB (Intermittent) 6, 12, VDC

## CITIZEN

CITIZEN AMERICA CORPORATION  
1710 - 22nd St.  
Santa Monica,  
CA 90404

Toll Free (800) 421-6516  
In Calif. (213) 829-3541  
TWX: (910) 343-6450

Name \_\_\_\_\_  
Company \_\_\_\_\_  
Address \_\_\_\_\_  
City \_\_\_\_\_ State \_\_\_\_\_  
Zip \_\_\_\_\_ Phone \_\_\_\_\_

CIRCLE NUMBER 155



NON-VINYL  
 NO ROUGH  
 EDGES  
 COMPACT  
 54° EDGE  
 OVER PVC  
 GREATER DESIGN  
 FREEDOM

## NEW **CABLEAGE**™

### PLASTIC WIRING DUCT

Here are a few more pluses of this unique wiring duct. Non-toxic phenylene oxide construction. More openings per foot—more total open area. Covers "pop" on. Flat wiring and flush mounting possible. Superior thermal properties. Side pins pop out to "tee in". All standard sizes. From the originator of plastic wiring duct.

MEETS ALL  
 J.I.C. STANDARDS

Approved by



**TAYLOR ELECTRIC, INC.**

DIV. OF TAYLOR INDUSTRIES, INC.  
 P. O. BOX 729 MARBLE FALLS, TEXAS 78654

CIRCLE NUMBER 158

digit for digit  
**Gralex DPM's**  
 read out best



- Easy-to-read GAS DISCHARGE DISPLAY
- Accurate 3½ DIGIT performance
- Ultra-Reliability
- Low Cost
- NEMA Interchangeability

Send for specifications or see for yourself  
 Send for FREE 30 day evaluation unit.



**GRALEX**  
 INDUSTRIES

DIVISION OF GENERAL MICROWAVE CORPORATION

155 Marine Street,  
 Farmingdale, N.Y. 11735  
 Tel: 516-694-3607  
 TWX 510-224-6406

CIRCLE NUMBER 156 FOR LITERATURE

CIRCLE NUMBER 157 FOR FREE EVALUATION UNIT



**No Frills Color.** Just the basics. If you're a black and white terminal manufacturer, the Intecolor 843 is all you need to upgrade your terminals to color.

It consists of an 8-color, 13" CRT, plus a special Analog Module System with all the circuitry necessary to perform deflection and video drive functions for the CRT. The completely self-contained circuitry is on a single printed wiring board which also generates the low voltage, high voltage and CRT bias, mounted on a sturdy aluminum frame for heat sinking the power transistors needed for the circuitry.

With our Nine Sector Convergence System, perfect color registration takes only three to five minutes. And this convenient control panel can be located anywhere for easy access.

Available in standard 262 Raster line or 400 Raster line high scan versions. If you're ready to upgrade to a color line, call 800/241-9888 toll-free for a demonstration.

Color Communicates Better

**Intelligent Systems Corp.**

5965 Peachtree Corners East, Norcross, Georgia 30071  
 PH. 800/241-9888 TWX: 810-766-1581



CIRCLE NUMBER 159

## MXO-40 Oscillators

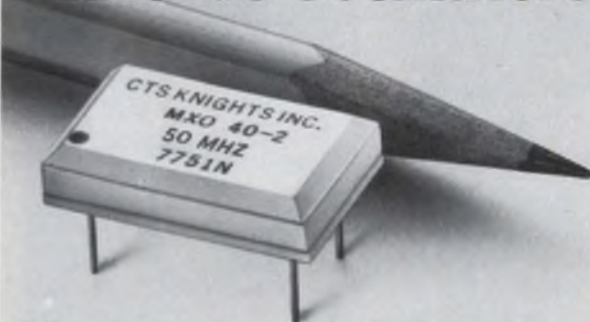

## New Extended Range: 25 MHz—60 MHz

Now there is a TTL compatible MXO-40 with a new, higher range. Without the extra cost of more circuits and external components.

Stability is  $\pm 0.01\%$  Standard. Fan Out: 10 Schottky TTL loads. Operating temp. 0-70°C. Rise and fall times: 5 nanoseconds max. Dimensions: .820" x .520" x .200" max. For full facts, use Reader Service Card or write: CTS Knights, Inc., 400 Reimann Ave., Sandwich, IL 60548.  
 Phone: (815) 786-8411.

**CTS KNIGHTS, INC.**



CIRCLE NUMBER 160

ELECTRONIC DESIGN 10, May 10, 1978

# Electronic Design

ELECTRONIC DESIGN's function is:

- To aid progress in the electronics manufacturing industry by promoting good design.
- To give the electronic design engineer concepts and ideas that make his job easier and more productive.
- To provide a central source of timely electronics information.
- To promote communication among members of the electronics engineering community.

**Want a subscription?** ELECTRONIC DESIGN is circulated free of charge to those individuals in the United States and Western Europe who function in design and development engineering in companies that incorporate electronics in their end product and government or military agencies involved in electronics activities. For a free subscription, use the application form bound in the magazine or write for an application form.

If you do not qualify, paid subscription rates are as follows: \$30.00 per year (26 issues) U.S./Canada/Mexico, \$40.00 per year (26 issues) all other countries. Single copies are \$2.50 U.S. and all other countries. The Gold Book (27th issue) may be purchased for \$30.00 U.S./Canada/Mexico, and \$40.00 all other countries.

If you change your address, send us an old mailing label and your new address; there is generally a postcard for this in the magazine. You will have to requalify to continue receiving ELECTRONIC DESIGN free.

**The accuracy policy** of ELECTRONIC DESIGN is:

- To make diligent efforts to ensure the accuracy of editorial matter.
- To publish prompt corrections whenever inaccuracies are brought to our attention. Corrections appear in "Across the Desk."
- To encourage our readers as responsible members of our business community to report to us misleading or fraudulent advertising.
- To refuse any advertisement deemed to be misleading or fraudulent.

Individual article reprints and microfilm copies of complete annual volumes are available. Reprints cost \$6.00 each, prepaid (\$5.00 for each additional copy of the same article), no matter how long the article. Microfilmed volumes cost \$23 for 1976 (Vol. 24); \$30 for 1973-75 (Vols. 21-23), varied prices for 1952-72 (Vols. 1-20). Prices may change. For further details and to place orders, contact Customer Services Dept. University Microfilms, 300 N. Zeeb Rd., Ann Arbor, MI 48106. (313) 761-4700.

**Want to contact us?** If you have any comments or wish to submit a manuscript or article outline, address your correspondence to:

Editor  
ELECTRONIC DESIGN  
50 Essex St.  
Rochelle Park, NJ 07662

# MAGNETIC SHIELDING MATERIAL

- CO-NETIC AA Alloy  
High Permeability  
.002" to .100" thick

## EXCLUSIVE

Perfection Annealed — No further anneal required if severe forming is avoided.

- NETIC S3-6 Alloy — High Saturation Induction.  
.004" to .095" thick
- Immediate Shipment from Stock

SEND FOR NEW MG-4

Material, Application & Fabrication Guide



MAGNETIC SHIELD DIV.



PERFECTION MICA CO.  
740 North Thomas Drive  
Bensenville, Ill. 60106, USA  
Phone 312 / 766-7800  
TWX 910-256-4815

*The Preferred Source  
for Magnetic Shielding  
... Since 1941*

CIRCLE NUMBER 170

Set the Pace  
with  
**Synchron**



## "600" SERIES AC TIMING MOTORS

These motors are designed both for timing and drive applications. Speeds from 600 RPM down to one revolution per week and output torque up to 40 oz. in. rated @ 1 RPM. Available in reversible and double power configurations. For immediate service please call us at-812/385-3415.

## JOIN OUR BOOK CLUB

SYNCHRON® MOTOR CATALOG gives general specifications on AC timing motors, AC clock movements, DC motors and related products manufactured by Hansen Manufacturing Company, Inc. Product literature Broadside and request card will be sent to you along with this catalog.



**Hansen Manufacturing Company, Inc.**

SUBSIDIARY OF IMC MAGNETICS CORP.  
PRINCETON, INDIANA 47670

CIRCLE NUMBER 171

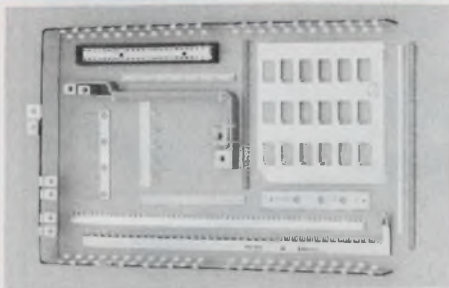

**Methode Electronics' "OMNY-Bus"® Bars** eliminate problems associated with cable harnesses. Can be soldered, welded or mechanically affixed to insulation or conducting layers. Uniform current distribution assured eliminating intermittencies, cross-talk, stray EMI. Methode has over 15 years experience in designing and manufacturing "OMNY-BUS"® Bars from 1 to 21 layers, 4" to 100' long, weighing 1/2 oz. to 200 lbs. FREE Catalog. Methode Electronics, Inc., 1700 Hicks Rd., Rolling Meadows, IL. 60003 312/392-3500.

"OMNY-BUS"® BARS

181



**ALPHANUMERIC DISPLAY, 16 Segment - Day 2 series** offers a large, bright 5/8" character that can be read in high ambient light, including direct sunlight. Rated @ 5 volts, 18ma per segment, the DAY-2 plugs into a standard 18 pin DIP socket. Withstand a wide temp. range, -55° C to +100° C. Color can be displayed w/ filters. Uniglass construction insures high reliability, 100,000 hr life rating. DAY-LIGHT DISPLAY CORP., 11 Fairfield Pl., P.O. Box 1231, West Caldwell, N.J. 07006 (201) 575-1045

184

16 SEGMENT ALPHANUMERIC DISPLAY



**Overcurrent Protector**, manual reset eliminates fuse replacement. Convenient panel mounting. 19 fractional ratings from 0.1 to 5 amp. Other models up to 400 amp. Trip-free and fool-proof, UL and CSA approved. High quality, low cost, \$1.61 ea. in 1000 lots. E-T-A Circuit Breakers, 7400 N. Croname Rd., Chicago, Ill. 60648. Tel: (312) 647-8303. Telex: 253780.

CIRCUIT BREAKER

187



**SOURIAU Sub "D" Series 8634 NORMAN-D connectors** are low cost, crimp type, w/ stamped & reeled contacts for lower install. costs; intermateable w/ all "D" connectors. SOURIAU has "D" connectors in 1-piece thermostat, 2-piece thermoplastic insulator, non-removable solder contacts, rigid & float mount shells, crimp, rear release contacts, operating temp of -55°C to +125°C qualified to MIL-C-24308. SOURIAU, INC., 7740 Lemona Ave., Van Nuys, CA 91405 (213) 787-5341.

SERIES 8634 CONNECTORS

182

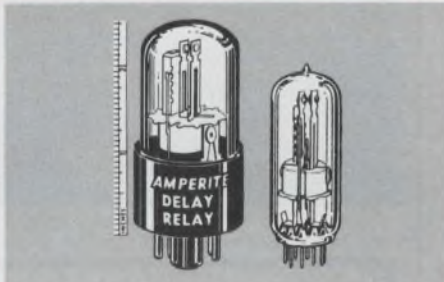

**AMPERITE THERMOSTATIC DELAY RELAYS.** For delays of 2 to 180 seconds. Low cost, long life. Hermetically sealed in glass. Not affected by altitude, moisture or climate changes. Compensated for ambient temperature changes of from -55° to +80°C. Rugged, explosion-proof, long-lived. Standard radio octal and 9-pin miniatures. Prices: Under \$5.00 ea. Send for Bulletin TR-81 . . . also CURRENT REGULATORS under \$4.00 ea. AMPERITE, 600 Palisade Ave., Union City, N.J. 07087. 201-864-9503

185

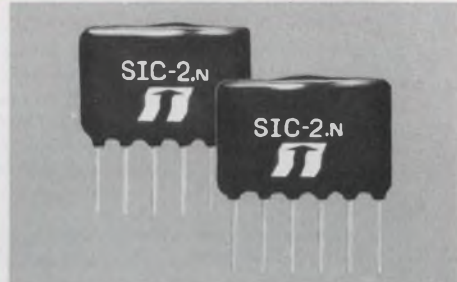

**SEIKO's LOW FREQUENCY OSCILLATING CIRCUIT SIC-2.** SIC-2 is a small, highly reliable oscillating circuit that allows you to construct a stable, compact oscillator by using it with a tuning fork. It features highly stable against temp. changes and aging and low-distortion sine wave output. Applicable for Standard oscillators, Selective calling systems, Remote control systems, Telemetry systems, Alarm systems. SEIKO INSTRUMENTS, INC., 2990 W. Lomita Blvd., Torrance, Ca. 90505 (213) 530-3400 Telex: 25-910-347-7307

L/F OSCILLATING CIRCUIT

188



**"Synchro to digital converters - 10, 12, or 14 bit output, errorless tracking up to 4 r.p.s., accuracy ±4 min. of arc ±.9LSB, resolution - 1.3 minutes, 60 or 400 Hz input, Module 2.6 x 3.1 x .82" H, Price From \$350 in qty. Other CCC products are Synchro to BCD or DC, Digital or DC to Synchro Converters, Solid State C.T.'s or CDX's, and Absolute Encoders. Send for Free Catalog & Application Notes. Computer Conversions Corp., East Northport, NY 11731 (515) 261-3300.**

SYNCHRO TO DIGITAL

183

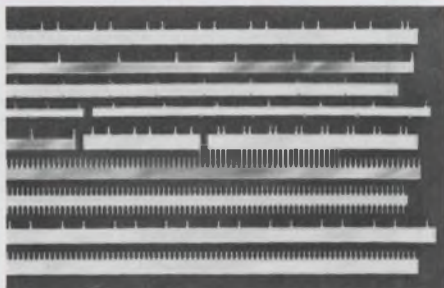

**MINI/BUS® BY ROGERS**, low-cost, low-inductance, high capacitance printed circuit board bus bars for noise reducing voltage distribution, are available in a variety of ready-to-ship designs. Prototype kits are also available from stock. Call or write Mini/Bus product specialist for a complete list. Rogers Corporation, Chandler, AZ 85224. Phone: (602) 963-4584. (EUROPE: Mektron NV, Gent, Belgium; JAPAN: Nippon Mektron, Tokyo.)

BUS BARS

186

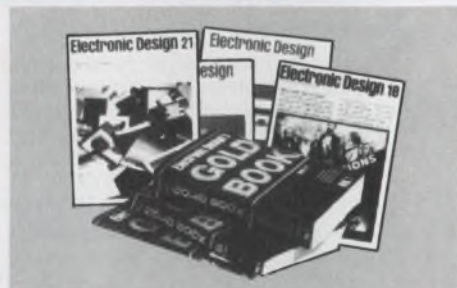

**THIS IS YOUR ANNUAL RENEWAL ISSUE . . . Turn back to the application bound into this issue and fill it in NOW. We'll extend your FREE subscription for another full year. You'll receive each of the next 26 issues and the new GOLD BOOK to be published in July. But please don't wait. RENEW TODAY!**



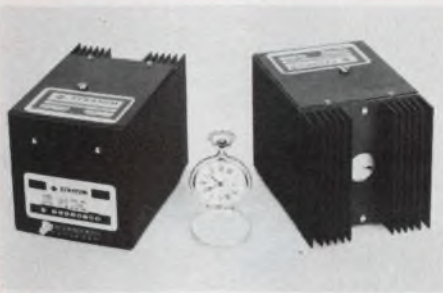

**RUBIDIUM OSCILLATORS** Series FRK are ultra stable, reliable, light (2.9 lb) small (4x4x4.5") and ideal for navigation/position location and communication systems. The unit provides 10 MHz; 5 and 1 MHz optional. Long-term stability  $1 \times 10^{-11}$ /month, short term  $1 \times 10^{-12}$ /100 sec. avg times and extremely low noise. Available commercial and MIL (radiation hardened) EFRATOM CALIFORNIA, INC., 18851 Bardeen Ave., Irvine, CA 92715 - (714) 752-2891

OSCILLATORS

189

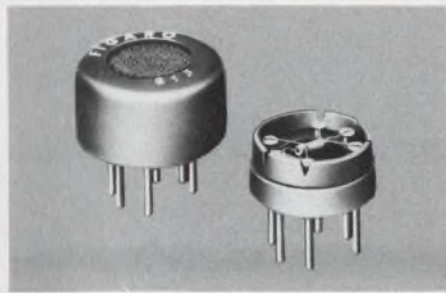

**FIGARO GAS SENSOR TGS** is a gas sensitive semiconductor. When combustible gas is absorbed on the sensor surface, a marked decrease of electrical resistance occurs. Major features of the sensor include high sensitivity, long term reliability and low cost. The applications are: GAS-LEAK ALARM, AUTOMATIC FAN CONTROL, FIRE ALARM, ALCOHOL DETECTOR, etc. Figaro Engineering Inc., North America Office-3303 Harbor Boulevard, Suite D-8, Costa Mesa, Calif. 92626 Tel: (714) 751-4103 Telex: 678396

GAS SENSOR

192

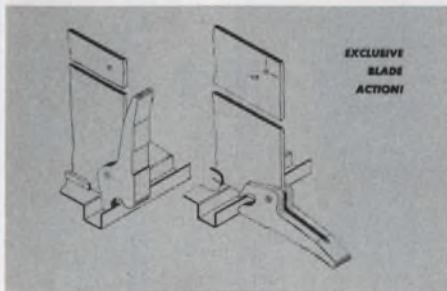

**FREE SAMPLES** of new, low-cost Electro-Flex injector/ejector for damage free insertion and extraction of P.C. boards. Unique design utilizes both surfaces of a single blade . . . eliminating need for very close tolerances. Full 5/8" travel in each direction assures straight-line card movement. Meets established industry standards for mounting. Molded in rugged UL-approved nylon for 1/16" through 1/8" boards. **ELECTRO-SPACE FABRICATORS**, Topton, Pa. 19562. (215) 682-7181

INJECTOR/EJECTOR

190

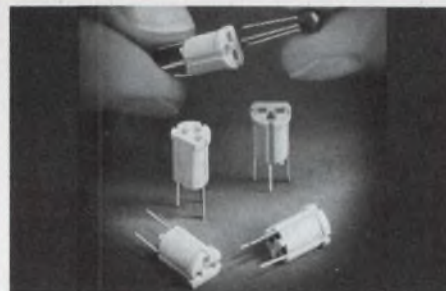

**NEW 3-LEAD TRANSISTOR SOCKETS** from Methode have an extended funnel-shaped lead-in which eliminates the need for transistor lead preforming or trimming. Also, ideally suited for automatic insertion of transistors into the socket. Contacts are reliable dual leaf cantilever type of phosphor bronze with tin plating. Insulation is flame retardant polyester rated 94VO. Methode Electronics, Inc., 1700 Hicks Rd., Rolling Meadows, IL 60008. (312) 392-3500.

3-LEAD TRANSISTOR SOCKETS

193



**LINE VOLTAGE PROBLEMS? BROWNOUT PROTECTION?** Select from the broad field-proven line of Variac® Automatic Voltage Regulators. Up to  $\pm 20\%$  correction. Regulation accuracy 0.2%. Output current from 8.7A to 85A. Input 50, 60, or 400 Hz (120 or 240V). Single and three phase. Portable, bench, wall and rack models. Militarized versions. GenRad, 300 Baker Ave., Concord, MA 01742 (617) 369-4400.

VARIAC® REGULATORS

191



**DEVELOPMENT SYSTEM — 65 ns EMULATION CAPABILITY** — Allows debugging of software and hardware in microprocessor systems. Plug into any ROM or RAM socket to verify program under actual operating conditions. Display serves as memory map. Programs can be loaded and edited in the 2KX8, 45 ns memory. Choice of ROM or RAM interface - \$1495 **ELECTRO-DESIGN, INC.**, 7364 Convoy Ct. San Diego, CA 92111 (714) 277-2471

ED5000 ROM/RAM SIMULATOR

194

## Advertising Sales Staff

Susan G. Apolant  
Sales Coordinator  
**Rochelle Park, NJ 07662**  
Robert W. Gascoigne  
Thomas P. Barth  
Stan Tessler  
Constance McKinley  
50 Essex St.  
(201) 843-0550  
TWX: 710-990-5071  
(HAYDENPUB ROPK)

## Philadelphia

Thomas P. Barth  
(201) 843-0550

## Boston 02178

Gene Pritchard  
P.O. Box 379  
Belmont, MA 02178  
(617) 489-2340

## Chicago 60611

Thomas P. Kavooras  
Berry Conner, Jr.  
200 East Ontario  
(312) 337-0588

## Cleveland

Thomas P. Kavooras  
(312) 337-0588

## Los Angeles 90045

Stanley I. Ehrenclou  
Burt Underwood  
8939 Sepulveda Blvd.  
(213) 641-6544

## Texas

Burt Underwood  
(213) 641-6544

## San Francisco

Robert A. Lukas  
465 S. Mathilda, Suite 302  
Sunnyvale, CA 94086  
(408) 736-6667

## United Kingdom-Scandinavia

Constance McKinley  
50 Essex St.  
Rochelle Park, NJ 07662  
Phone: (201) 843-0550

## Europe

W. J. M. Sanders  
S.I.P.A.S.  
Raadhuisstraat 24 - P.O. Box 25  
1484 EN Graft-de-Ryp, Holland  
Tel: 02997-1303 and 3660  
Telex: 13039 SIPAS NL  
Telegrams: SIPAS-Amsterdam  
G. Nebut  
Promotion Presse Internationale  
7 ter Cour des Petites Ecuries  
75010 Paris, France  
Telephone: 5231917, 1918, 1919

Dieter Wollenberg  
Erikastrasse 8  
D-8011 Baldham/Muenchen  
Germany  
Telephone: 0 8106/4541

Robert M. Sidel  
Technimedia International  
Via G. Fara, 30  
20124 Milan, Italy  
Tel: 65.72.765  
Telex: 25897 Utdioma

## Tokyo

Haruki Hirayama  
EMS, Inc.  
5th Floor, Lila Bldg.,  
4-9-8 Roppongi  
Minato-ku, Tokyo, Japan  
Phone: 402-4556  
Cable: EMSINCPERIOD. Tokyo

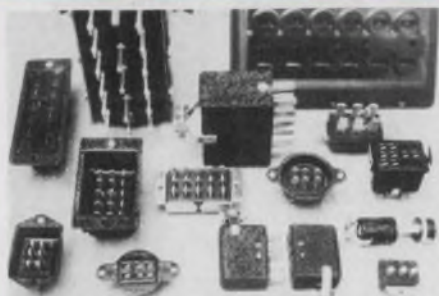

**JONES PLUGS AND SOCKETS** rated at 730VRMS and 7.5A (2-12 Contacts) and 4.5A (15-33 Contacts), these UL recognized connectors are available with 2 to 23 contacts, and in a wide variety of mounting variations. Other types rated at 1100V at 15A, 1700V at 10A, 3000V at 25A. Stocked for immediate delivery by distributors. Write for catalog. TRW Cinch Connectors, 1500 Morse, Elk Grove Village, IL 60007, 312-439-8800.

JONES PLUGS AND SOCKETS 195



**CGH Metal Glaze Resistors** from TRW operate in high ambient temperatures with excellent high voltage load stability. These thick film resistors are particularly suited for precision high voltage and high impedance applications such as voltage multipliers, X-ray equipment, and high voltage power supplies where precision tolerances and TCs are required. TRW/IRC Resistors, an operation of TRW Electronic Components, 401 N. Broad St., Phila., Pa. 19108. (215) 922-8900.

CGH HIGH VOLTAGE 198



**GAME PLAYING WITH COMPUTERS, Revised Second Edition**, by Donald D. Spencer. This volume presents over 70 games, puzzles, and mathematical recreations for a digital computer. The reader will also find brand-new "how to" information for applying mathematical concepts to game playing with a computer. #5103-4, 320 pp., \$16.95. Circle the Info Retrieval Number to order your 15-day exam copy. When billed, remit or return book with no obligation. Hayden Book Co., 50 Essex St., Rochelle Park, N.J. 07662.

GAMES-PLAYING GUIDE 201



**AUTOMATIC RLC Tester.** The GR 1657 Digibridge measures R, L, C, D and Q. 0.2% Accuracy and FIVE full digit display for R, L, and C. No calibration is ever required due to  $\mu P$  control. Selectable test frequencies of 1 kHz and 120 Hz. Selectable series and parallel measurement modes. Built-in HI-REL Kelvin test fixture handles both axial and radial lead components. GenRad, 300 Baker Ave., Concord, MA 01742, 617-369-8770.

GENRAD 196

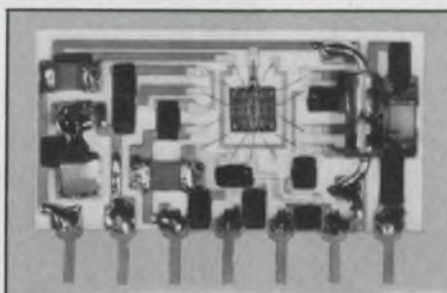

**ULTRA SMALL ACTIVE BAND PASS FILTER** fabricated using OP Amp incorporated Hybrids Circuit. Operating Voltage 1-2.5V/4-15V, Frequency Range 288.5-2800Hz, Q 180+20, 35+5 and etc. .788" x .138" x .433". By adding Feed Back Circuit of extra Diode and Capacitor, it does the job of small but reliable Oscillator. Active Filters can be tailor-made to customer's specifications. IWATA ELECTRIC CO., LTD. Mansei Bldg., 1-1-16 Sotokanda, Chiyoda-ku, Tokyo, Japan.

ACTIVE FILTER 199



Free catalog of 6800 & 8080 software. Over 40 programs available including assemblers, editors, word processors, math packages, games (including Space Voyage and Klingon Capture), and many utilities, all in assembly language. Documentation is very complete with printed source listings included. Programs range from \$3.75 to \$41.00. Technical Systems Consultants, Inc., Box 2574, West Lafayette, IN 47906 (317) 423-5465

FREE SOFTWARE CATALOG 202

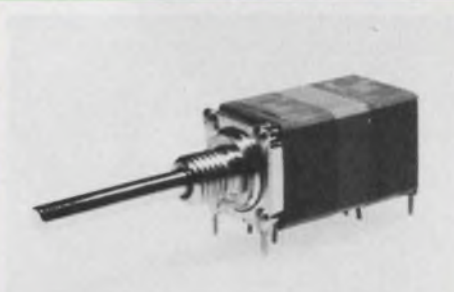

**SERIES 388 CONDUCTIVE PLASTIC, SERIES 389 CERMET PUSH DRIVE POTENTIOMETER WITH MOMENTARY SWITCH.** Single shaft must be pushed in to operate potentiometer or change momentary switch function. Free wheeling in extended position. Prevents accidental changes in critical settings. Various terminal configurations available. Cost per 1,000 series 388, \$3.90 each; series 389, \$4.05 each. Further information available from your local representative or Clarostat Mfg. Co., Inc., Washington Street, Dover, N.H. 03820

SERIES 388-389 POTENTIOMETER 197



New subminiature replaceable-lamp incandescent lights. 50% cheaper than conventional submini flange-base or bi-pin because lamp base formed for bulb's glass and lead wires permits high-speed production. Socket-and-assembly design for one-hole mounting. Flat, dome, seven colors, 2 to 28 V. Samples and specs: Industrial Devices, Inc., Edgewater, N.J. 07020.

TINY MITE 200

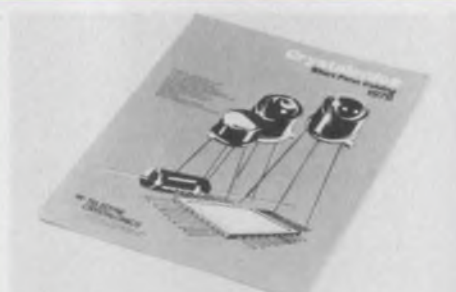

**NEW SHORT FORM SEMICONDUCTOR CATALOG FREE FROM CRYSTALONICS.** Contains specifications and technical data on representative devices from our extensive product line. Feature sections include: current regulator and varactor diodes; FET's; switching, chopping and grown junction replacement transistors; hybrid analog gates; D/A ladder switches; and custom crafted devices. Teledyne Crystalonics, 147 Sherman St., Cambridge, MA 02140. (617) 491-1670.

SEMICONDUCTOR CATALOG 203



**STOCK CASES AND ENCLOSURES, OVER 600 SIZES**, ranging from 4" x 4" to 13" x 13". Depth variations to 12" in increments of 1/8". Laminated Formica®-mahogany-Formica® construction for utmost strength and attractiveness. Prices from \$35. to \$85., less quantity discounts. Choices of hardware. Modifications if required. Prompt off-the-shelf shipments. W. A. Miller Co., Inc., 36 Mingo Loop, Oquossoc, Maine 04964. (207) 864-3344

**STOCK CASES/ENCLOSURES 204**

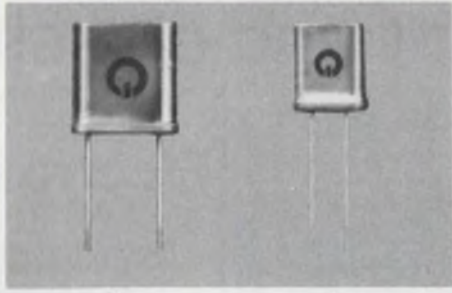

**HIGH STABILITY LOW COST QUARTZ CRYSTAL** for  $\mu$ -processor and clock oscillator. Accuracy is  $\pm 0.002\%$  at 25°C. Frequency change over -10 to +55°C is within  $\pm 20$ ppm. 1.000, 1.8432, 2.000, 2.097152, 2.4576, 3.2768, 4.0000, 5.0000, 5.0688, 5.1850, 5.7143, 6.5536, 10.0000, 18.0000, 18.4320, 20.0000, 22.1184 Immed. Dlvty. \$1.85 ea. 10 MHz up in HC-18/u; (Min. 100 pcs.) Q-MATIC CORP., 3194-D Airport Loop Dr., Costa Mesa, CA 92626, (714) 545-8233, Telex 678389

**CRYSTAL 207**



Free New catalog contains over 34,500 quality power supplies from the world's largest manufacturer, Power/Mate Corp. Power Supplies for every application including submodulars, open frame, variorated, encapsulated, laboratory & system. All units UL approved and meet most military and commercial specs for industrial and computer uses. Power/Mate Corp., 514 S. River St., Hackensack, NJ 07601 (201) 343-6294

**POWER SUPPLIES 210**



**PROGRAM LOADER . . . uses computer's existing RS232 terminal port.**

. . . A complete storage system . . . up to 109 8-bit characters/sec . . . any line speed 110 to 9600.

. . . Everything including RS232 plug and 48 inch cable in one ultra-compact rugged 5.5 lb. package . . . over 1.5 megabits/cassette.

. . . \$975.00 (USA-only) from DIGITAL LABORATORIES, 600 Pleasant St., Watertown, MA 02172 (617) 924-1680

**PROGRAM RECORDER/LOADER 205**



**TV STUDIOS & VIDEO INDUSTRY** New Allen Avionics Video & Pulse Delay Lines replace 75 ohm coaxial cable, provide a more suitable method of achieving precise short delays. The units reduce size, weight, installation cost, and save time and effort in making delay changes. Finest specs. Lowest pricing. Catalog also discusses Video Filters. See us at Electro/78, Booth 1538. Allen Avionics, Inc., 224 E. 2nd St., Mineola, N.Y. 11501, 516-248-8080.

**VIDEO DELAY LINES CATALOG 208**

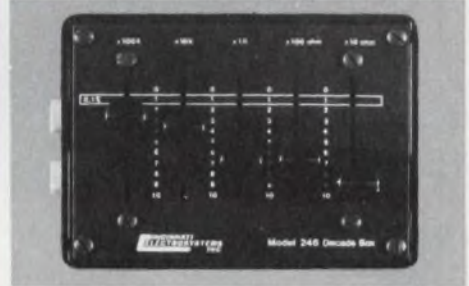

**DECADE RESISTANCE BOX Model 246** offers a selection of 1% 1/2 watt resistance values from 10 ohms to 1,111,110 ohms in 10 ohm steps. 0.1% calibrating resistors are provided at 100, 1000, 10,000, and 100,000 ohms. Five 11-position slide switches allow ease of operation. SIZE: 4" x 2-7/8" x 1-9/16" PRICE: \$34.95. CINCINNATI ELECTROSYSTEMS, 469 Wards Corner Road, Loveland, Ohio 45140, (513) 831-4347

**DECADE RESISTANCE BOX 211**



**NEW '78-'79 GOLD BOOK OFFERED AT 25% PRE-PUBLICATION DISCOUNT.** Upcoming set will contain more than 2,500 pages of information for quickly locating and specifying products used by the electronics industry. Complete with Product, Trade Name, Manufacturers, Distributors Directories and Catalog Compendium. Published in July. Reserve your copy NOW at Pre-Publication Rate of \$22.50 US, Canada and Mexico (Regularly \$30) or \$30 in all other countries (Regularly \$40).

**THE GOLD BOOK 206**



**FORM YOUR OWN MAGNETIC SHIELDS** When you need only one or two magnetic shields, save time and money by shaping your own. All it takes is a scissors and our improved Eagle alloys for magnetic shielding. We'll gladly help. Check the card in this publication and we'll send full details on Eagle foil and sheet stock. Eagle Magnetic Co., Inc., Box 24283, Indianapolis, IN 46224 317/297-1030.

**MAGNETIC SHIELDING 209**

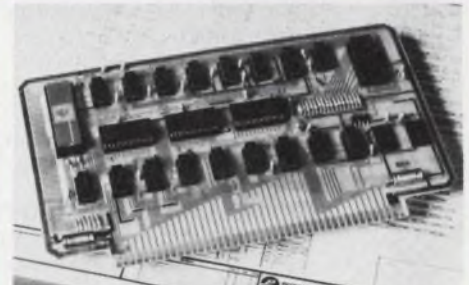

**HARDWARE MATHBOARD—RAM SAVER!!** performs logarithmic & trigonometric functions, e<sup>x</sup>, y<sup>x</sup>, multiply, add, divide, subtract, etc., etc., 8 digit mantissa, 2 digit exponent, very fast (comparable with in-system software) Compatible with M-6800 Microprocessor KITS AVAILABLE AT \$72.80, \$252, \$555. A - Board, software, full instructions B - 'A' and all components, unassembled C - Assembled, inst. manual, sftwr. pkg. WOODTRON LTD., PO. BOX 4067, STATION "C", CALGARY, ALBERTA, CANADA.

**HARDWARE MATHBOARD 212**

# Electronic Design

## recruitment and classified ads

PLACE YOUR AD AT ONLY \$55 PER COLUMN INCH IN

### Electronic Design

— GET A REPEAT AD FREE!

With our 2 for 1 plan, your net cost in *Electronic Design* is only \$27.50 per column inch, lowest among all the national newspapers and electronics media. You get a total of 165,418 exposures to OEM engineers and engineering managers (not counting 11,668 more among general or corporate managers) at only 30¢ per thousand! You can't beat the price. You can't beat the coverage and you can't beat the quality.

YOU REACH ENGINEERS WITH TITLES LIKE THESE:

- Chief Engineer • Development Engineer • Design Engineer • Project Engineer • Electronic Engineer • Engineer-Supervisor • Section Leader • Staff Engineer • Systems Engineer • Test Engineer • Standards Engineer • Master Engineer

### Electronic Design RECRUITMENT ADVERTISING RATES

15% commission to recognized agencies supplying offset film negatives. 2% 10 days, net 30 days. Four column makeup. Column width 1-3/4" x 10"

SPACE	DIMENSIONS		COST
	Wide	Deep	
One column inch	1-3/4" x 1"		\$55
2 col. in	1-3/4" x 2"		\$110
1/16 page (1/4 col.)	1-3/4" x 2-1/2"		\$137
1/8 page (1/2 col.)	1-3/4" x 5"		\$275
1/4 page (1 col.)	1-3/4" x 10" Vert		\$550
	3-1/2" x 5" Hor.		
1/2 page (2 cols.)	3-1/2" x 10" Vert.		\$1100
	7" x 5" Hor.		
3/4 page (3 cols.)	5-1/4" x 10"		\$1650
1 page	7" x 10"		\$2200

NOTE: EACH RECRUITMENT AD YOU PLACE WILL BE REPEATED FREE OF CHARGE!

## Electronic Engineers

Down-to-earth product development openings for space-age engineers

General Electric specializes in producing high-quality appliances for the home. And our continuing leadership in this competitive business is a tribute to our engineering people. Last year alone, for example, many of the new products introduced featured highly innovative applications of space-age technology. The near future will bring more breakthroughs—and that's where you can help.

and 3 to 5 years product development experience. Background must include applying the latest circuit design and micro-electronic design techniques. Join us and we'll provide you with a fully commensurate salary, famous GE benefits and stimulating assignments in an environment where individual contributions are seen and recognized. Apply now. Send your resume, including a description of your achievements and salary history to C C St. Mark, Ref 74-C.

We have several openings for professionals with a BSEE

**GENERAL  ELECTRIC**

1285 Boston Ave., Bridgeport, CT 06602  
An Equal Opportunity Employer M/F

# CCD/LSI Engineers

The opportunities you're looking for are with us in Orlando, Florida.

The Microelectronics Division of Martin Marietta Aerospace has several engineering openings in an expanding advanced technology environment. Ground has been broken on our new 50,000 square ft. microelectronics facility, which will contain the latest design, fabrication and test equipment. Individuals with the following experience are encouraged to respond.

**CCD Design Engineer**—You should have experience in the design of CCD circuits, with a basic working knowledge of CCD fabrication techniques. Experience with focal plane array is especially desirable. Your involvement will include ground-floor responsibilities for the design and specification of CCD arrays for I.R. Detectors.

**CCD Process Engineer**—The hands-on process engineer we seek should have experience in PMOS and NMOS CCD processes, utilizing polysilicon, ion implantation, and planar structures techniques. You will be involved in equipment procurement and the installation of a new pilot line. Experience in fabricating large area focal plane arrays is highly desirable.

**Bipolar LSI Design Engineer**—This opportunity for an experienced engineer requires a knowledge of bipolar processing and fabrication techniques. Experience with linear and/or I<sup>2</sup>L is very desirable. Your responsibilities will involve designing custom LSI circuits for advanced military systems.

Explore these career opportunities in greater detail by sending your resume in confidence to: Dr. David Meyer, Deputy Director of Microelectronics, Martin Marietta Aerospace, P.O. Box 5837—MP#9, Orlando, Florida 32855.

*We are an equal opportunity employer, m/f.*

**MARTIN MARIETTA**

MARTIN MARIETTA AEROSPACE

# Sales Engineer

## Microprocessor Development Systems

Experience as a design engineer, applications engineer or sales engineer working with minicomputers, minicomputer systems or microprocessor systems will provide you the opportunity to join the Tektronix sales team.

We need professionals with hardware, software and microprocessor experience. Product and sales training will be provided for you.

Applicants should have a current knowledge of digital hardware systems and assembly language programming experience. In addition, a strong interest and aptitude in customer oriented sales is necessary. BSEE or equivalent is desirable.

Competitive salary program includes incentive compensation. Benefits programs include a substantial retirement plan.

Call Mike Jones at (301) 948-7151, or send a complete resume to TEKTRONIX, INC., 2 Research Court, Rockville, Maryland 20850.

An Equal Opportunity Employer M/F/H.

**Tektronix**  
COMMITTED TO EXCELLENCE

# Project Engineers Electrical

Engineers with varying experience and length of service backgrounds sought to expand Project Engineering - Electrical Group. BSEE required.

Projects include process control, high-speed packaging automation, relay, programmable controller, mini-computer application, industrial power supply and distribution, building services.

Scope includes preliminary through final designs, oversight of consultants, contractors, equipment supplies, supervision of equipment installation and start-up.

Experienced Engineers must be capable of executing complete projects from conceptual stage through efficient production operation.

Outstanding potential for personal growth with industry leader during growth and expansion program.

We offer an excellent starting salary and outstanding benefits package as well as advancement opportunities based on your achievements. For immediate consideration, send complete resume outlining salary history in confidence to:

## Anheuser-Busch, Inc.

Manager, Salaried Employment  
Department J-4  
721 Pestalozzi  
St. Louis, Missouri 63188

An Equal Opportunity Employer M/F



## Engineers

# Boston Interviews with Technical Management May 23, 24 and 25

Our Hunt Valley complex, located in the northern suburb of Baltimore, has immediate

openings in two engineering departments.

The Nuclear Instrumentation Control Department has requirements for engineers with experience in analog and digital circuit design. Responsibilities include the development and design of instrumentation and control equipment and systems for commercial and naval nuclear programs.

Requirements:

- BSEE with minimum of 5 years design experience
- Ability to analyze designs and present results.
- Desire to apply innovative solutions to complex engineering problems

The Integrated Logistics Support Engineering Department is involved in a variety of long-term automated test projects and has needs in the following areas:

lowing: logistics models, simulation models, logistic support analysis, support equipment requirements, maintenance planning

### Software

Applicants should have BSEE and major specialization in computers or with BS in Computer Science and a knowledge of digital and analog circuit design and at least 2 years experience in one or more of the following areas:

Design and generation of analog/digital test application software

Design and generation of ATE executive and support software

### Digital Hardware Design

Responsibilities include systems specifications and design utilizing advanced microprocessors and microcomputers as applied to sophisticated electronic test problems. Minimum of 2 years experience and BSEE degree.

### Electronic Design

Requires capability in solid state electronic design. Should have at least 2 years experience in analog and digital testing of military avionics sub-assemblies. BSEE required.

### Logistics and Maintenance

Applicants should have BSEE with advanced statistics and/or numerical analysis courses with a minimum of 2 years experience in one or more of the fol-

### IF or RF Electronic Design

At least 2 years design experience involving very stable oscillators and other RF circuitry operating at X-band. BSEE degree.

**Also, professionals with electronics background are needed in the following areas:**

Field Engineering  
Engineering Writers  
Industrial Engineering  
Product Evaluation  
Test Engineering

Electromagnetic Compatibility  
Product Reliability/Maintainability  
Quality Assurance  
Manufacturing Processes

**Attractive foreign assignments are also available for your consideration.**

### Boston Interviews

To arrange a Boston interview with technical management, call

T. K. Brown  
at 617/536-5700

Tues., May 23, 10 A.M. to 8 P.M.

Wed., May 24, 10 A.M. to 8 P.M.

Thurs., May 25, 10 A.M. to 5 P.M.

If unable to arrange an interview at this time, please send resume, stating present salary, and indicating department of interest, to

R A Richmond, Dept 425  
Westinghouse  
P.O. Box 1693  
Baltimore, MD 21203

An Equal Opportunity Employer

# Westinghouse

# Come join me at Hughes and be part of the new world of electronics.

It's a good feeling to be in the vanguard of technology with employment stability through dynamic growth and diversification!

For Immediate Openings In:

#### **Circuit Design Engineers**

Experienced in RF, IF, Video, and A/D circuit design for use in Signal Processing in both airborne and space applications.

#### **Digital Logic Design Engineers**

Experienced in design and development of digital circuits using TTL, STTL, ECL and CMOS technologies.

#### **Software Development Engineers**

Experienced in the development of software for special purpose digital processors. Digital hardware background experience desired.

#### **Product Design Engineers**

Experienced in extremely high density physical and thermal designs for airborne and spaceborne signal processing.

#### **Project Engineers**

Experienced in the management of all aspects of a project including management of subcontracts and remote manufacturing facilities.

#### **Digital Module Test Engineer**

Experienced in developing software for automatically testing digital modules.

#### **Digital Associate Engineer (Non MTS)**

Having good rapport with digital logic design, logic schematics and the conversion of these to a computerized interconnect data base.

**Actual Hughes Scientific and Engineering Manpower Growth Curve**  
This chart indicates the Company's extraordinary record of growth with stability in the dynamic electronic technology industry.

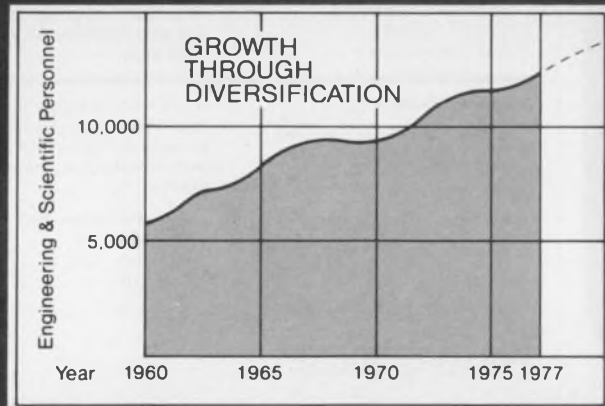

Call now—call collect: Richard Fachtmann, Assistant Manager, Signal Processing Laboratory, (213) 391-0711, Ext. 3904. Or send resume (referencing this ad) to: Professional Employment C, Aerospace Groups, 11940 W. Jefferson Blvd., Culver City, Ca 90230.

**HUGHES**

HUGHES AIRCRAFT COMPANY  
AEROSPACE GROUPS

U.S. citizenship required. Equal opportunity M/F/HC employer



## Systems/Design ENGINEERS

A **Halliburton** Company -Welex Division

Welex, the wireline service division of Halliburton Company, is assisting the energy industry in its search for and development of oil and gas resources. Welex designs and manufactures the electronic surface and subsurface equipment used in its field operations. Research is the backbone of Welex growth and is why we consider our Engineers to be so vital to the success of our operations.

We are initiating a major expansion of our technical staff and many challenging opportunities exist for Engineering Programmers and Electrical or Mechanical Engineers with recent creative experience in some of the following areas:

- Real Time Software
- Digital Circuits Assembly
- Assembly Language
- Analog Circuits
- Data Acquisition
- Microprocessors
- Graphics Displays
- Microcomputer

These permanent positions require minimum BS degree with graduate degree preferred.

Welex is headquartered in Houston, Texas, the 5th largest city in the U.S. The climate is mild and sunny on the Texas Gulf Coast, where cultural events, sports and recreational activities at nearby beaches and lakes are available year round. Houston's lower cost of living and no local or state income taxes make it more than comfortable to pursue your profession.

JOIN our team of professionals in helping this vital industry to keep AMERICA moving. If you are interested in the career opportunities we have to offer, please send resume in confidence to Employment Supervisor, Dept. ED, P.O. Box 42800, Houston, Texas 77042.

We Are An Equal Opportunity Employer M/F

A **Halliburton** Company

# Hardware/Software Engineers

Qyx is the rapidly expanding new business arm of Exxon Enterprises Inc. We've just introduced our new Intelligent Typewriter to the market.

We are seeking ambitious professionals who are attracted by a practical technical challenge. These same professionals must be willing to work long hours to develop both an exciting new concept in the word processing field . . . and their own personal advancement. Excellent positions are currently available at our facilities, located in the attractive Pennsylvania countryside, near Philadelphia. We presently have these engineering openings:

## HARDWARE ENGINEERS

- SEMICONDUCTOR MEMORY DESIGN — RAM, ROM, PROM, Board Design, Device Selection Test Methods
- FLOPPY DISK ELECTRONICS — Microprocessor experience, Motor Drive and Control, Read/Write Electronics
- DATA COMMUNICATIONS — Real Time Programming, microprocessor experience, knowledge of Modems, Protocol: TTY, BSC, SDLC.
- LOW INERTIA STEPPING MOTOR DESIGN — Drive and Control, Circuitry Design, Closed Loop Microprocessor Control.
- KEYBOARD ELECTRONICS
- DISPLAY TECHNOLOGY SELECTION/INTERFACE

## SOFTWARE ENGINEERS

- TEXT EDITORS
- DISPLAYS
- OPERATING SYSTEMS
- COMPUTER AIDED INSTRUCTION

BS/MS in Electrical Engineering/Computer Science or equivalent required for all positions. Directly related industrial experience is mandatory in most cases, but outstanding recent graduates will be considered.

Send resume, including salary history, to: Mr. G. Mathern, Qyx, Division of Exxon Enterprises Inc., P.O. Box 429, Exton, Pa. 19341. Minorities and females are encouraged to apply.

LOCAL INTERVIEWS CAN BE ARRANGED

# Qyx™

Intelligent Typewriter Systems  
A Division of **EXXON** Enterprises Inc.

We are an equal opportunity employer, m/f

## UNUSUALLY INTERESTING OPPORTUNITIES FOR EXCEPTIONALLY INNOVATIVE ELECTRONIC ENGINEERS

The Autonetics Divisions of Rockwell's Electronic Systems Group, located in Anaheim, California, is involved in a wide variety of research and development projects involving: systems, subsystems, components and devices related to ballistic missiles, tactical missiles, surface ships, submarines and satellite systems. We are seeking experienced, competent and exceptionally innovative individuals to contribute to the following assignments.

### RADAR SYSTEMS

Prefer an MS in physics plus experience in the design and development of ground-to-ground/air-to-ground target acquisition and tracking radar systems. Familiarity with millimeter wave technology and radar fire control highly desirable. Requires an in-depth knowledge of radar analysis and design techniques.

### IMAGE PROCESSING

Requires an advanced technical degree, preferably a PhD, and previous technical responsibility for analysis and application of algorithms for image processing. Experience in pattern recognition, detection, classification and information processing techniques is to be applied in missile midcourse and terminal homing guidance. Pattern recognition and analytical evaluation of the probabilistic nonlinear match processor behavior background is essential.

### ANTENNA SYSTEMS

Prefer PhD/EE and experience performing theoretical analysis and conceptual design of antenna systems for missile guidance systems, radar systems, communication systems and ECCM systems. Must be able to analyze and compute antenna patterns and performance parameters by physical optics, geometric optics and discrete array element techniques. Background in solving complex electromagnetic boundary-value problems and RF analytical model development using techniques such as geometrical theory of diffraction and method of moment is desired.

### COMMUNICATIONS SYSTEMS

We need innovative communications engineers with experience in advanced modulation/coding techniques to work on long term research and development programs in the area of secure voice transmissions. This is an ideal opportunity for versatile, dedicated engineers to make major contributions in advancing the state-of-the-art.

### SHIPBOARD DATA MULTIPLEXING

Requires appropriate degree and experience in implementation of shipboard electrical/electronic systems. Will perform system engineering duties related to the application of shipboard data multiplex systems to Navy ships. Primary responsibility will be definition/specification of functional requirements for shipboard data multiplexing systems to replace current shipboard cabling, switchboards, and signal data converters. Responsibilities will include definition of system check-out, installation certification, and operational readiness testing.

### SUBMARINE COMBAT SYSTEMS

The position requires a knowledge of the purpose, information flow, and relative worth of submarine RF communications and/or electronic surveillance equipment/systems. Will support submarine combat systems engineering efforts in performing functional analysis and developing system integration concepts for shipboard RF communications and/or electronic surveillance systems.

### DC/DC POWER CONVERTERS

Assignment will consist of the design, development and evaluation of highly efficient DC/DC power converters for use in satellite and ground electronic equipment. A thorough knowledge of switching and analog circuits, including transformers and other magnetics is required. Should be familiar with EMI requirements and preparation of related tests and performance specifications.

If you meet all of the requirements for any of the above positions, please feel free to call COLLECT, weekdays 8:AM to 4:PM

**(714) 632-1001**

To expedite your consideration, please mail resume in complete confidence to:

**Autonetics Group  
Rockwell International  
3370 Miraloma Avenue  
Anaheim, CA 92803  
ATTN: D/ED04, BA39**



**Rockwell  
International**

Equal Opportunity Employer M/F



# Think Ahead.... at the rate we're growing General DataComm may become a Golden Company of the '80's!

The 50's and 60's saw the exceptional growth and flourishing of a number of industrial companies that changed the way of life of the entire world—Xerox, Polaroid, IBM, to name just a few. With the continuing development and expansion of teleprocessing, and sophisticated improvements in the total concept and application of electronics, a good many experts anticipate this refinement will produce just a few more of the "Golden Companies"—organizations whose products, service and increasing acceptance will thrust them into the Outstanding classification . . . firms where those who got in initially on the ground floor reaped the rewards of contribution, recognition, responsibility and financial gain. General DataComm is among those few companies who are anticipated to become "Golden". You may be one of the lucky few on board then if you qualify now for some of our present engineering opportunities:

## **HIGH SPEED MODEM PRODUCTS**

Experience in logic design and digital signal processing tasks.

## **MULTIPLEXOR PRODUCTS**

Experience in TDM and digital logic design.

## **LOW SPEED MODEM PRODUCTS**

Experience in PSK/FSK/PCM/FDM analog and digital design.

## **DIGITAL SYSTEM PRODUCTS**

Experience in microprocessor and diagnostic system design.

Compensation will be commensurate with qualifications and experience plus a generous program of employee benefits.

### **BOSTON INTERVIEWS DURING ELECTRO '78**

Individuals interested in discussing these or other potential openings are invited to drop by to our Hospitality Suite at the

**Boston Park Plaza Hotel  
Park Square at Arlington Street**

**Tuesday, Wednesday & Thursday, May 23-24-25**

If you are unable to see us, please send your resume indicating area of interest and salary history and requirements, in strictest confidence to: Mr. George P. Stevenson, General DataComm Industries, Inc., One Kennedy Avenue, Danbury, Connecticut 06810. We are an equal opportunity employer/male and female.

 **General DataComm  
Industries, Inc.**

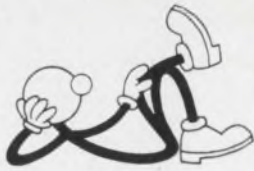

## EFFORTLESS . . .

If you're ready to move on with your career, it can be a lot easier than you expect.

We are the members of



who work extensively with electronics industry leaders. The companies we service have many openings and pay for us to search you out.

Send your resume to the office nearest you. Then sit back and relax while we do the work.

### RECRUITING SERVICES, INC.

2601 Bellevue At W.H. Taft  
Cincinnati, Ohio 45219  
(513) 861-3454

### RIKER PERSONNEL

834 Circle Tower  
Indianapolis, Indiana 46204  
(317) 632-5422

### BRENTWOOD PERSONNEL ASSOCIATES

Electronics Division  
1280 Route 46  
Parsippany, New Jersey 07054  
(201) 335-8700

### CAREER SPECIALISTS, INC.

4600 El Camino Real, Suite 206  
Los Altos, California 94022  
(415) 941-3200

### STAFF DYNAMICS, U.E.

26 Sixth Street  
Stamford, Connecticut 06905  
(203) 324-6191

### ANDERSON-TAYLOR

P.O. Box 21  
Exton, Pennsylvania 19341  
(215) 363-1600

190 associates internationally

Engineering

# NORTHROP DESIGN ENGINEERING

*great purposes...  
greater achievements*

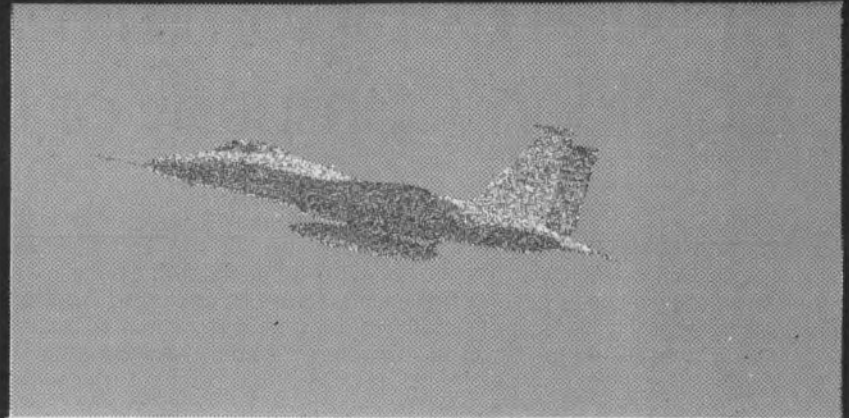

Establishing goals that challenge your ability. . . creates a sound beginning. Advancing beyond those objectives. . . instills pride.

At Northrop Defense Systems Division, a leader in advanced Electronic Countermeasure technology, we provide the guidance and professional freedom necessary for creative problem-solving and maintaining our leadership in the state-of-the-art.

If you are a Design Engineer with the following qualifications and possess a strong drive toward self-fulfillment, we invite you to consider an exciting career at Northrop.

- \*BSEE, familiar with design for AGE test equipment.
- \*Minimum of 5 years experience in Digital Design, using TTL-DTL, MOS and micro-processor in designing and testing computers.
- \*Design of Tuning Unit Analog and digital circuits. Familiarity with RF component interface circuits.
- \*Minimum 5 years experience in analog and/or digital design. Familiarity with microwave components preferred.
- \*PROJECT ENGINEER with analog/digital circuits and microwave components experience.

In addition to the opportunity to join one of the finest engineering teams in the nation, we offer an excellent salary/benefits program. Qualified individuals are invited to send brief letter or resume in confidence, to:

Director—Design Engineering  
Department EM  
**NORTHROP CORPORATION**  
Defense Systems Division  
600 Hicks Road, Rolling Meadows, Illinois 60008  
An equal opportunity employer m/f

# NORTHROP



## HOW TO PLACE YOUR AD

**CALL THE RECRUITMENT HOT LINE 201-843-0550  
OR  
USE OUR TELECOPIER EXT. 212**

# CSC

## ENGINEERS

**We're Seeking Engineering Talent,  
And We're Rewarding It As Well!**

Computer Sciences Corporation, Systems Division, is seeking qualified communications professionals. Individuals with a desire to learn more and to contribute more to their field. And for these people, CSC Systems Division is providing outstanding opportunities for continued professional accomplishment and for personal growth within our organization. We also are offering highly competitive incomes and more than generous benefits. Investigate immediately if you meet the requirements listed below.

**ENGINEERS** to analyze antenna system performance and power budgets and analyze and interpret antenna patterns. Qualifications include BSEE, 4-8 years experience in VLF to HF antenna systems, preferably submarine antennas — buoyant cables, mast mounted, towed buoys.

**ENGINEERS** to provide technical, engineering and management support to Navy SSN communications program. Qualifications include BSEE or Naval Sciences, experience in submarine communications and/or command systems.

**ENGINEERS** to manage Coordination Drawing program to support Navy Special Communications project, design system interface, prepare coordination drawings. Qualifications include BSEE, 1-4 years coordination drawings, mechanical or engineering drafting experience.

**ENGINEERS** to provide engineering and management support to Customer's VERDIN and Cesium Beam Frequency Standard Programs. Qualifications include BS, 2-5 years background in engineering, configuration management or logistics.

Please send resume to:

**William E. Penn**  
Professional Staffing Representative

We aggressively support  
equal opportunity and  
affirmative action.

**COMPUTER  
SCIENCES  
CORPORATION**

Systems Division  
6565 Arlington Boulevard  
Falls Church, VA 22046

Major Offices and Facilities  
throughout the World

### Schlumberger

## MICROWAVE DESIGN ENGINEER

Industry leader has an immediate need for experienced engineer with working knowledge of microwave systems. The position involves the conception and design of sophisticated high temperature instrumentation to be used in our worldwide logging operations.

Advanced degree required — MS or Ph.D in electronics or Physics. Experience in analog and digital circuits, electromagnetic theory, and communications is desired. Applications involve development of systems for measuring propagation characteristics in earth formations at high temperatures.

Outstanding facilities provided, high-caliber supporting personnel, exceptional benefits and working conditions. Permanent positions — no term contracts.

Send resume to:

**T. E. Holmes**

*We Are An Equal Opportunity Employer M F*

## Schlumberger Well Services

P.O. Box 2175 Houston, Texas 77001

*We Are an Equal Opportunity Employer M F*

## ELECTRONIC SALES

Because of new product lines and expansion of sales, marketing positions available for persons with successful background in sales of sophisticated electronic products or systems. Prefer electronics-oriented degree but will consider persons with comprehensive electronics sales background who have non-technical degree or at least 2 years college. Would consider persons who have been in middle management positions with large police department or highway patrol and have technical and sales aptitude or experience. Experience in dealing with government agencies and law enforcement personnel highly desirable. Draw, commission, bonus, car, expenses. Moderate to heavy travel. Positions available in Southeast Central, West Central U.S. and East and West Coasts. Resumes, with earnings history and requirements, may be sent confidentially to:

**50 Essex Street, Rochelle Park,  
Box #9 RLC  
New Jersey 07662**

## SALES ENGINEER

We are a medium size Electronic Manufacturer with a challenging opportunity for an aggressive Degreed Sales Engineer who has 2 to 3 years experience in sales preferably in selling Machine Control Equipment.

This position involves sales to machine builders nationwide and some travel is required. Salary commensurate with experience.

Please submit complete resume to.

**J. R. Mueller**  
Stewart-Warner Electronics  
1300 N. Kostner  
Chicago, Ill. 60651

*an equal opportunity employer m/f*

## 7 OPENINGS

PICK YOUR STATE AND POSITION. Critical needs exist in FL, GA, AL, MS, LA, TX, NC, SC, KY, & TN. We have 192 affiliates in the U.S. to help. Confidential and no fees.

**LANDRUM PERSONNEL ASSOCIATES**  
P.O. Box 1373, Pensacola, FL 32596, 904/434-2321

**Help your  
Heart...  
Help your  
Heart Fund**

American Heart Association



## IC Test Engineer S. Florida



Racal-Milgo, Inc., a worldwide designer and manufacturer of data communication equipment, is looking for an IC test engineer with programming experience on the Fairchild "Sentry" system, the Tektronix System or the Macrodata System.

Qualified individual must have a strong background in State of the Art semiconductor technology. Experience in device design or component evaluation of LSI technologies helpful. BSEE or MSEE desired.

The successful applicant must be able to communicate and interface well with others in order to effectively administer program development and characterization testing on a "Sentry VII" system. Position includes both technical and supervisory responsibilities.

We offer excellent salary and a complete benefits package. If you are looking for a challenging, rewarding career in the communications industry and can meet these requirements, we welcome your reply. Send your resume in complete confidence to Laura Jack, Employment Manager, or call collect (305) 591-5214.

## Racal-Milgo —the new name for ICC

8600 N.W. 41st St., Miami, FL 33166 (305) 592-8600

Equal Opportunity Employer



## CONSOLE COMMUNICATIONS SALES

Due to market potential and rapidly increasing sales in Communications Division of diversified electronics manufacturer (music amplification/P.A. systems, law enforcement radar, communications products), a new position exists for person with some or all of the following qualifications: electronics-related or technical degree; comprehensive knowledge of (FM 2-way) land mobile communications and/or telephone switching systems; familiarity with D.P. language and logic; demonstrated success in sales of electronics products and systems; experience in dealing with law enforcement and government agencies. Moderate to heavy travel. Salary, draw, commission, bonus, car, expenses. Position will be on East Coast. Relocation may or may not be necessary, depending on location of person hired. Please send resume, including earnings history and expectation in confidence to:



Kustom  
Electronics  
Inc.

Mr. Bruce Keeton  
Personnel Director  
1010 W. Chestnut  
Chanute, KS 66720

"World Leader In Traffic Safety Radar"  
An Equal Opportunity Affirmative Action Employer

### YOU REACH ENGINEERS WITH TITLES LIKE THESE:

- Chief Engineer • Development Engineer • Design Engineer • Project Engineer
- Electronic Engineer • Engineer-Supervisor • Section Leader
- Staff Engineer • Systems Engineer • Test Engineer • Standards Engineer
- Master Engineer

## DIVISION SALES MANAGER

### Sale of Solid State Power Conversion Systems

We are an international electronic firm on the move ... stocks traded on the NYSE. We need a pace-setter Sales Manager looking for an opportunity to organize and develop an ongoing dynamic multi-million dollar division into a \$50 million operation. This individual will possess personal initiative, drive, organizational and sales ability.

The individual we seek will be technically educated with a degree and a minimum of 5 years progressive experience in budgeting, product planning and development, and marketing. This person will have supervisory experience and may presently be employed in a sales management capacity of a \$100 million corporation. A primary requirement will be the capacity to develop strategy and sustain diverse marketing activities in both commercial and defense markets. Approximately 30% air travel required.

We offer challenge, a chance to pull out the stops and show what you can do. And, of course, our salary is commensurate with experience, and complemented by a salary incentive program. You will love our location near a large metropolitan city in the Southwest. For the right person we have a lot to offer.

If you are ready for a move up, send your resume with salary history in strict confidence to:

**50 Essex Street, Rochelle Park,  
Box #9 RLR  
New Jersey 07662**

### SPECIALTY FLUX SALES

Aggressive reps needed to sell expanding high profit line of fast-moving specialty soldering and brazing fluxes. Full technical and laboratory back-up provided. For full information call or write:

#### Superior Flux

95 Alpha Park Cleveland, Ohio 44143  
(216) 461-3315

## KEEP

## Electronic Design's GOLD BOOK HANDY



**When  
You Call**

## CLASSIFIED

### PRINTED CIRCUIT BOARD GRAPHICS

Precision artwork films produced from your schematic and layout requirements

- Guaranteed Accuracy
- Fast Service
- Full Documentation

#### RODRIGUEZ APPLIED SYSTEMS

1312 Pacific Coast Highway  
Hermosa Beach, CA 90278  
(213) 372-8103

### ISOLATED-PAD-DRILL-MILL

or - Professional Breadboards add to/modify existing etched boards. Complete set of (3) tools with replaceable No. 60 Carbide Drill IP6003C \$30.00 A.F. Stahler Co P.O. 354 Cupertino CA 95014 (408) 252-4219

### ETCHING MACHINE WANTED

for printed circuits, 1 chamber, min. sheet size 12 in. x 16 in.

American I.D., 145 58th St., Brooklyn, N.Y. (212) 492-3400

# Advertiser's index

Advertiser	page	Advertiser	page	Advertiser	page
A P Circuit.....	194	*Fairchild Semiconductor, A Division of Fairchild Camera and Instrument Corporation.....	106,107	PPG Industries, Inc.....	99
A P Products Incorporated.....	196	Ferranti Electric, Inc.....	178	Panasonic Electronic Components.....	Cov III
AMP, Incorporated.....	16,17	Figaro Engineering, Inc.....	209	Panduit Corporation.....	195
AMP, Incorporated, Capatron Division.....	16,17	Fluke Mfg. Co., Inc., John.....	39	Potter & Brumfield, Division of AMF, Incorporated.....	52,53
Abbott Transistor Laboratories, Inc.....	123	GTE Sylvania Connector Products Operation.....	33	Power Conversion, Inc.....	182
Advanced Micro Devices.....	4,5	GenRad.....	209,210	Power/Mate Corp.....	210
Airpax Electronics, Cambridge Division.....	129	General Magnetics Inc.....	222	Practical Automation Inc.....	168
Airpax Electronics, Controls Division.....	193	General Scanning, Inc.....	140	Precision Filter Inc.....	153
Allen Bradley, Electronics Division.....	162H	Gould Inc., Advance Division.....	136	Precision Monolithics, Incorporated.....	19
Allen Avionics, Inc.....	211	Gould Inc., Instrument Systems Division.....	18,185	Q Matic.....	211
Allied Chemical, Metglas Products.....	177	Gralex Industries, Division of General Microwave Corp.....	206	RCA Electro Optics.....	115
American Microsystems, Inc.....	32	Guardian Electric Manufacturing Company.....	162F	RCA Solid State Division.....	Cov IV*
Amperite Co., Inc.....	208	Gulton Industries, Inc., Measurement & Control System Division.....	167	Radiation Devices Co. Inc.....	169
Amplifier Research Corporation.....	146	Hansen Manufacturing Co., Inc.....	207	Racal Dana.....	56,57
Analog Devices, Inc.....	66,67	Hayden Book Company, Inc.....	158,178*	Republic Electronics Corp.....	205
Anzac Electronics.....	192	Hayden Publishing Company, Inc The Gold Book.....	171	Reticon Corp.....	163
Arnold Magnetics Corp.....	7	Hecon Corporation.....	199	Rogan Corporation.....	148
Aromat.....	138	Heinemann Electric Company.....	142,143	Rogers Corporation.....	208
B & K Precision-Dynascan Corp.....	83	Heyman Manufacturing Company.....	184	SMK Electronics Corporation of America.....	167
BEI Electronics, Inc.....	167	Honeywell Test Instruments Division.....	79	Scientific Atlanta Inc./Optima Div.....	156
Bendix Corporation, The, Electrical Components Division.....	73	Hudson Tool & Die.....	145	Seaelectro Corporation.....	200
Bivar, Inc.....	169	Hughes Aircraft Company, Microelec- tronic Products Division.....	114	Servo-Tek Products Company.....	187
Bodine Electric Company.....	195	IEE.....	144	*Sfernice.....	174
Bourns, Inc., Trimpot Products Division.....	Cov II	ITT North-Microsystems Division.....	159	Simpson Electric Company.....	27
Buckeye Stamping Company, Inc., The.....	187	Industrial Devices.....	210	Slaughter Company.....	202
*Burr-Brown Research Corporation.....	166	Industrial Timer, A Unit of Esterline Corporation.....	195	Souriau Inc.....	208
Burroughs Corporation.....	105	Intech, Incorporated.....	157	Spectra-Strip Corp.....	88,89
CTS Corporation.....	175	Intel Corporation.....	8,9	Sprague Electric Company.....	58
CTS Knights, Inc.....	206	Intel Special Products.....	118,119	Standard Grigsby, Inc.....	150
Capitol Machine & Switch Co., Inc., The.....	202	Intelligent Systems, Inc.....	206	Systron-Donner.....	188
Cartron Division of Illinois Tool.....	162G	International Microsystems.....	173	T-Bar, Incorporated.....	192
Centralab, The Electronics Division of Globe-Union, Inc.....	87	Intersil Inc.....	20,21	TRW Cinch Connectors, an Electronic Components Division of TRW, Inc.....	210
Cincinnati Electro Systems.....	211	Itoh Electronics, Inc., C.....	199	TRW/IRC.....	210
Citizen America Corporation.....	205	Iwata Electric Co., Ltd.....	210	Taylor Industries, Inc.....	206
Clarostat.....	210	Johanson Manufacturing Corp.....	54	Technical System Consultant's.....	210
CODI Corporation.....	170	KSW Electronics Corp.....	194	Tecnetics, Inc.....	176
Computer Conversions Corp.....	208	Krohn-Hite Corporation.....	43	Tektronix IDP.....	131
Computer Labs, Inc.....	201	Kroy Industries Inc.....	182	Tektronix, Inc.....	61
Comstron/ADRET.....	162B	LFE Corporation.....	190	Teledyne Crystalonics.....	210
Control & Information Systems.....	198	LH Research, Inc.....	141	Texas Instruments, Incorporated Components Group.....	160,161
Coto Coil Company, Inc.....	194	L X D Inc.....	98	Thomas Electric.....	180
Custom Electronics, Inc.....	186	Licon, Division of Illinois Tool Works, Inc.....	162C	United Systems Corporation, a Subsidiary of Monsanto.....	200
Daini Seikoshi Co., Ltd.....	208	Littelfuse, Subsidiary of Tracor.....	162D	Vectron Laboratories Inc.....	200
D.A.T.A. Books.....	203	3M Company.....	15,205	Vero Electronics, Inc.....	166
Data Display Products.....	37	MP Odell Company.....	195	Vishay Resistive Systems Group.....	10
Data General Corporation.....	41	Magnetic Shield Division, Perfection Mica Company.....	207	Visual Communications.....	55
Data I/O Corporation.....	28,29	McLean Engineering Laboratories.....	205	Wavetek Indiana Incorporated.....	135
Data Precision Corporation.....	23	Memorex.....	22	Wavetek San Diego, Inc.....	1
Datel Systems, Inc.....	147,149,151	Mepco/Electra, Inc.....	34	Windjammer Cruises.....	128
DayLight Display Corp.....	208	Methode Electronics, Inc.....	208	Woodtron LTD.....	211
Deltrol Controls.....	162E	Methode Manufacturing Co.....	209	Zero Corporation.....	162
Deniston, Inc.....	202	Microswitch, A Division of Honeywell.....	165		
Dialight, A North American Philips Company.....	64	Midtex Inc.....	204		
Digital Laboratories.....	211	Miller Co., Inc., W. A.....	211		
Dormeyer Industries, Inc.....	162A	Miller-Stephenson Chemical Co., The.....	191		
Douglas Electronics, Inc.....	204	Mini-Circuits Laboratory, A Division of Scientific Components Corp.....	2		
EECO.....	189	Motorola Components Products Dept.....	152		
EH International.....	30	Motorola Semiconductor Products, Inc.....	11,12,13,24,25,26,62,63		
EMM Electronic Memories, Commer- cial Memory Products.....	14	Newport Laboratories, Inc.....	179		
E-T-A Products Co. of America.....	208	Nichicon America Corporation.....	154,155		
Eagle Magnetics, Inc.....	211	Nicolet Instrument Corp.....	133		
Edmund Scientific Company.....	202	Norplex Division.....	137		
Efratom California, Inc.....	209	Non-Linear Systems, Inc.....	198		
Electro Design, Inc.....	209	North American Philips Controls Corp.....	164		
Electro Space Fabricators, Inc.....	209				
Electronic Applications Co.....	184				
Electronic Design.....	31,45,46,47,48,183,197,208				
Electronic Measurements, Inc.....	6				
Electronic Navigation Industries.....	181				
Essex Group.....	178				
Exact Electronics, Inc.....	196				

## RECRUITMENT

Anheuser Busch.....	213
Computer Science.....	219
General Data Comm Industries.....	217
Hughes.....	214
Martin Marietta.....	212
National Personnel.....	218
Northrop.....	218
Qyx.....	215
Racal Milgo.....	220
Rockwell.....	216
Shulmberger.....	219
Tektronix.....	213
Varo.....	212
Wellex.....	215
Westinghouse.....	213

\*Advertisers in International Edition

# SOLID STATE 3 WIRE SYNCHRO TO LINEAR D.C. CONVERTER



## RESPONSE CURVE

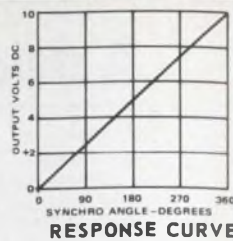
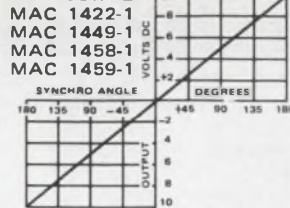

## FEATURES:

- Develops a DC output voltage linearly proportional to a synchro angle over a  $\pm 180^\circ$  range.
- Completely solid state with all of the inherent advantages over a mechanical system such as:
  - High reliability (since there are no moving parts)
  - Light weight—6 ozs.
  - Small size
  - All units hermetically sealed

- Wide temperature range operation
- Output short circuit protected
- Three wire inputs isolated from ground
- Package size may be altered at no extra cost
- Units can be altered to accept different line to line voltages or different operating frequencies at no extra cost
- Not affected by reference voltage or power supply variations.

UNIT	MAC 1422-1	MAC 1449-1	MAC 1458-1	MAC 1459-1	MAC 1460-1	MAC 1461-1
TRANSFER EQUATION	$\pm IV/18^\circ$	$\pm IV/18^\circ$	$\pm IV/18^\circ$	$\pm IV/18^\circ$	$+IV/36^\circ$	$+IV/36^\circ$
ACCURACY (+25°C)	½%	½%	½%	½%	½%	½%
ACCURACY (-25°C+85°C)	1%	1%	1%	1%	1%	1%
L - L SYNCHRO INPUT (VRMS)	11.8	90	11.8	90	11.8	90
FREQUENCY (Hz)	400	400	60	60	400	400
FULL SCALE OUTPUT	$\pm 10V$	$\pm 10V$	$\pm 10V$	$\pm 10V$	$+10V$	$+10V$
OUTPUT IMPEDANCE	$<1\Omega$	$<1\Omega$	$<1\Omega$	$<1\Omega$	$<1\Omega$	$<1\Omega$
L - L INPUT IMPEDANCE	$>10K$	$>30K$	$>2K$	$>10K$	$>10K$	$>30K$
REFERENCE VOLTAGE (VRMS)	26	115	26	115	26	115
OPERATING TEMP. °C	-25 - +85	-25 - +85	-25 - +85	-25 - +85	-25 - +85	-25 - +85
D.C. SUPPLY	$\pm 15V$	$\pm 15V$	$\pm 15V$	$\pm 15V$	$\pm 15V$	$\pm 15V$
D.C. SUPPLY CURRENT	$\pm 75MA$	$\pm 75MA$	$\pm 75MA$	$\pm 75MA$	$\pm 75MA$	$\pm 75MA$
BANDWIDTH	10Hz	10Hz	OPT.	OPT.	10Hz	10Hz
WEIGHT	6 oz.	6 oz.	6 oz.	8 oz.	6 oz.	6 oz.
SIZE	3.6x2.5x0.6	3.6x2.5x0.6	3.6x3.0x0.6	3.6x3.0x1.0	3.6x2.5x0.6	3.6x2.5x0.6

## A.C. LINE REGULATION

A new method has been developed which allows us to provide a low distortion highly regulated AC waveform without using tuned circuits or solid state active filters of any kind.

The result is a frequency independent AC output regulated to 0.1% for line and load with greater than 20% line variations over a wide temperature range.

## FEATURES:

- 0.1% total line and load regulation
- Independent of  $\pm 20\%$  frequency fluctuation
- 1 watt output
- Extremely small size
- Isolation between input and output can be provided

Specifications: Model MLR 1476-1  
AC Line Voltage:  $26V \pm 20\%$  @  
400Hz  $\pm 20\%$

Output:  $26V \pm 1\%$  for set point

Load: 0 to 40ma

Total Regulation: +0.1%

Distortion: 0.5% maximum rms

Temperature Range:  $-55^\circ C$  to  
 $+125^\circ C$

Size: 2.0" x 1.8" x 0.5"

Other units are available at different power and voltage levels as well as wider temperature ranges. Information will be furnished upon request.

## High Precision Analog Multipliers

PRODUCT ACCURACY (MCM 1519-1)  $\pm 1\%$  OF ALL THEORETICAL OUTPUT VALUES OVER FULL MILITARY TEMPERATURE RANGE OF  $-55^\circ C$  TO  $+125^\circ C$ . ZERO POINT ERROR FOR ANY INPUT COMBINATION IS  $\pm 2MV RMS$



### Features:

- No external trims required
- Distortion free AC output over entire dynamic range
- Linearity, product accuracy and zero point virtually unaffected by temperature

- All units are hermetically sealed and are not affected by external fields
- High analog product accuracy and wave quality allows dual multiplier assemblies to be matched with 1% of point over the specified temperature range
- Full four quadrant operation
- Package size, power supply requirements and other specs. may be altered to your exact requirements at no extra cost.

### Specifications:

- Transfer equation:  $E_o = XY/10$
- X & Y input signal ranges: 0 to  $\pm 10V$  PK
- Maximum zero point error (X=0; Y=0 or X= $\pm 10$ ; Y=0 or X=0; Y= $\pm 10$ ): 2MV RMS
- Input impedance: Both inputs 20K min.
- Full scale output:  $\pm 10V$  peak
- Minimum load resistance for full scale output: 2K $\Omega$
- Output impedance: 1 $\Omega$
- Short circuit duration: 5 sec.
- Frequency response characteristics (both inputs) 1% amplitude error: DC to 1200 Hz (min.) 0.5 DB Amplitude error: DC to 3500 Hz min. 3 DB point: Approx. 10K hz Roll off rate: 18 DB/octave
- Noise Level: 5MV PK-PK @ 100K Hz approx.
- Operating temp. range: See chart
- Storage temperature range:  $-55^\circ C$  to  $+125^\circ C$
- DC Power:  $\pm 15V \pm 1\%$  @ 30MA
- Dimensions: 2" x 1.5" x .6"

Type No.	Product Accuracy	Operating Temperature Range
MCM 1519-1	$\pm 0.5\%$	$-55^\circ C$ - $+125^\circ C$
MCM 1519-2	$\pm 0.5\%$	$-25^\circ C$ - $+85^\circ C$
MCM 1519-3	$\pm 0.5\%$	$0^\circ C$ - $+70^\circ C$
MCM 1520-1	$\pm 1.0\%$	$-55^\circ C$ - $+125^\circ C$
MCM 1520-2	$\pm 1.0\%$	$-25^\circ C$ - $+85^\circ C$
MCM 1520-3	$\pm 1.0\%$	$0^\circ C$ - $+70^\circ C$

There is No Substitute for Reliability



# GENERAL MAGNETICS • INC

211 Grove St., Bloomfield, New Jersey 07003 - Tel. (201) 743-2700

Circle 118 on reader service card

# Panasonic resistors- for everything from rock 'n roll to numerical control



It goes without saying, what you need in a resistor depends upon your application and your design criteria. Which means your resistor needs are rarely cut and dried. The product you want today probably won't fit your requirements next week.

That's why we'd like to tell you about the Panasonic line. Take another look at the headline of this ad. We mean it! Whether your application is in Consumer Products or Professional Equipment; EDP or Communications; Instrumentation, Control Equipment or even Automotive—chances are there's a Panasonic resistor to meet your needs. And at prices you'll find hard to ignore.

Our product line includes molded, conformal coated, DIP and SIP packages. All meet the same rigid quality standards Panasonic products are noted for. And they can be ordered from our headquarters in Secaucus, N.J. or a Panasonic distributor near you.

For samples, prices and technical information, call or write: Panasonic Electronic Components, One Panasonic Way, Secaucus, N.J. 07094, (201) 348-7266.

	Power Rating	Resistance Range	Tol.
Carbon Film	1/8, 1/4, 1/2W	4.7Ω-5.6MΩ	2%, 5%
Carbon Composition	1/8, 1/4, 1/2W	2.2Ω-22MΩ	5%, 10%
Metal Oxide	1/2, 1, 2, 3W	.20Ω-100KΩ	2%, 5%
Metal Film	1/4, 1/2W	10Ω-2MΩ	0.5%, 1%
DIP/SIP Networks	Contact Local Sales Office		

**Panasonic**<sup>®</sup>  
just slightly ahead of our time

# RCA first in CMOS.

## The go-everywhere $\mu$ P now has a do-everything design aid.

Now you can quickly and economically prove out the RCA 1800...our cost-effective, environmentally rugged, CMOS microprocessor.

Our new COSMAC Micromonitor CDP18S030 is a complete portable  $\mu$ P system diagnostic tool. The best tool, in fact, to perform breadboard debugging and factory checkouts and field tests without additional diagnostic equipment. The Micromonitor can take instructions electronically, supply hardcopy or CRT display through your terminal, and

become more powerful via our COSMAC Development system with floppy disk.

**Prototype debugging.** Simply plug the CPU of your system under test into the Micromonitor. You now have control of both hardware interfaces and program execution. You can plug memory into the Micromonitor to emulate ROM. Using the keyboard and display, you can start/stop, examine any portion of the system, and make changes.

**Unique automated testing.** The Micromonitor can be used with any of its configurations to provide the factory test system you require.

**Field service.** Its self-contained package is designed to be carried easily to any place RCA 1800 microprocessor systems are in operation.

**Operation software.** An optional Micromonitor Operating System (MOPS) CDP18S831 gives you an extended set of commands. MOPS, on the COSMAC Development System with floppy disk option, helps the Micromonitor do everything from simple terminal-Micromonitor dialog to fully automated system testing.

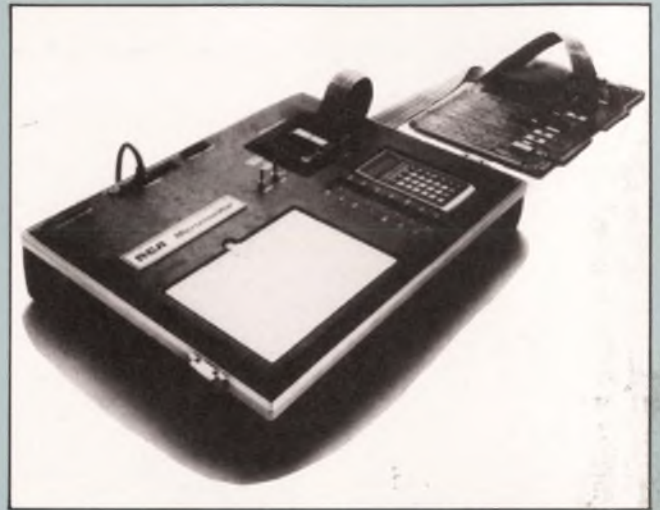

RCA Solid State, Box 3200  
Somerville, NJ 08876

Tell me more about why the Micromonitor is one more reason to go RCA 1800. My microprocessor application is:

Name \_\_\_\_\_

Title \_\_\_\_\_

Company \_\_\_\_\_

Address \_\_\_\_\_

CIRCLE NUMBER 232

**RCA 1800. Our systems are go.**

**RCA**