

Electronic Design® 8

VOL. 26 NO.

FOR ENGINEERS AND ENGINEERING MANAGERS — WORLDWIDE

APRIL 12, 1978

Data converters and μ Ps nest as ICs reach amazing densities. We're not home yet, but getting there as more and more functions appear on one chip. Although

monolithic converters are inching up, modular and hybrid a/d's and d/a's still hold top performance honors. Nestle up to the inside stories, beginning on page 38.



A New Dawn In Trimmer/Resistor Technology...

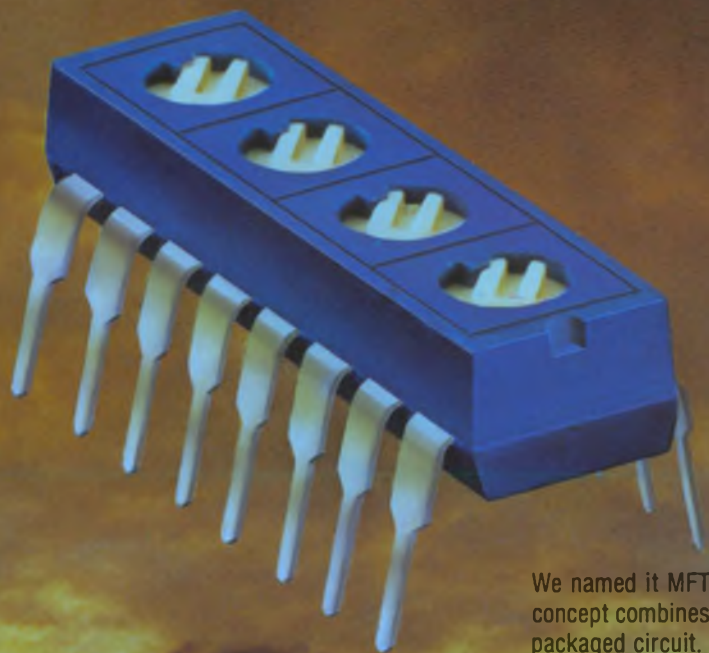

**We've put it
all together in
one space/cost
saving package.**

We named it MFT™ . . . our multi function trimmer. This revolutionary concept combines cermet trimmers and fixed resistors into a single pre-packaged circuit. A consolidation of functions has been designed into a new product line of cost-effective DIP components.

All trimmer applications require a fixed resistor to either divide a voltage or limit a current. The nine MFT trimmer models will functionally satisfy almost any trimmer application.

SAVES SPACE — MFT trimmers drastically reduce PC board space required for the peripheral components of a linear IC.



SAVES TIME — MFT trimmers reduce the time and cost of designing circuits. It also saves production time as MFT trimmers are compatible with DIP automatic insertion equipment. And, there are less components to purchase and handle.

SAVES MONEY — MFT trimmers lower total "on-board" component costs. In addition, MFT trimmer DIPs are compatible with automatic test equipment, reducing inspection costs.

INCREASES PERFORMANCE — Temperature tracking is better than discrete components . . . 50 ppm/°C. Trimmers/Resistors are manufactured simultaneously on a common substrate. MFT trimmers are more reliable as a result of pre-tested circuitry and reduction of connections.

The sealed multi function trimmers are available in nine configurations of the multiple trimmer and network combinations. Call or write today for your MFT trimmer catalog.

TRIMPOT PRODUCTS DIVISION, BOURNS, INC., 1200 Columbia Avenue, Riverside, CA 92507. Phone: 714 781-5204. TWX: 910 332-1252.



BOURNS®

For Immediate Application — Circle 130 For Future Application — Circle 230

When you put a Wavetek Model 172A into your system, you're ready to handle almost anything. It's an oscillator, DC reference, waveform generator, synthesizer and pulse generator all in one. It covers the frequency range of .0001Hz to 13MHz, with 5½ digits of resolution and .0005% accuracy. Naturally you get all types of waveforms (with synthesizer purity if you need it), along

with FM, pulses, ramps, and DC or AC references.

But Model 172A is not only a versatile stimulus, it's a stimulating conversationalist. It talks to your system via the GPIB bus, and has a microprocessor front end to format and execute commands. It can even store 100 programs internally. There is also a 40 character alphanumeric display for local interactive programming

and visual status checks.

Now that you've seen our stimulus, how about giving us your response? Just circle the reader service number for details, or contact us direct. Wavetek San Diego, 9045 Balboa Avenue, P.O. Box 651, San Diego, Ca 92112. Tel: (714) 279-2200 TWX (910) 335-2007

WAVETEK®

CIRCLE NUMBER 2

This may be all the stimulation your automatic test system needs.

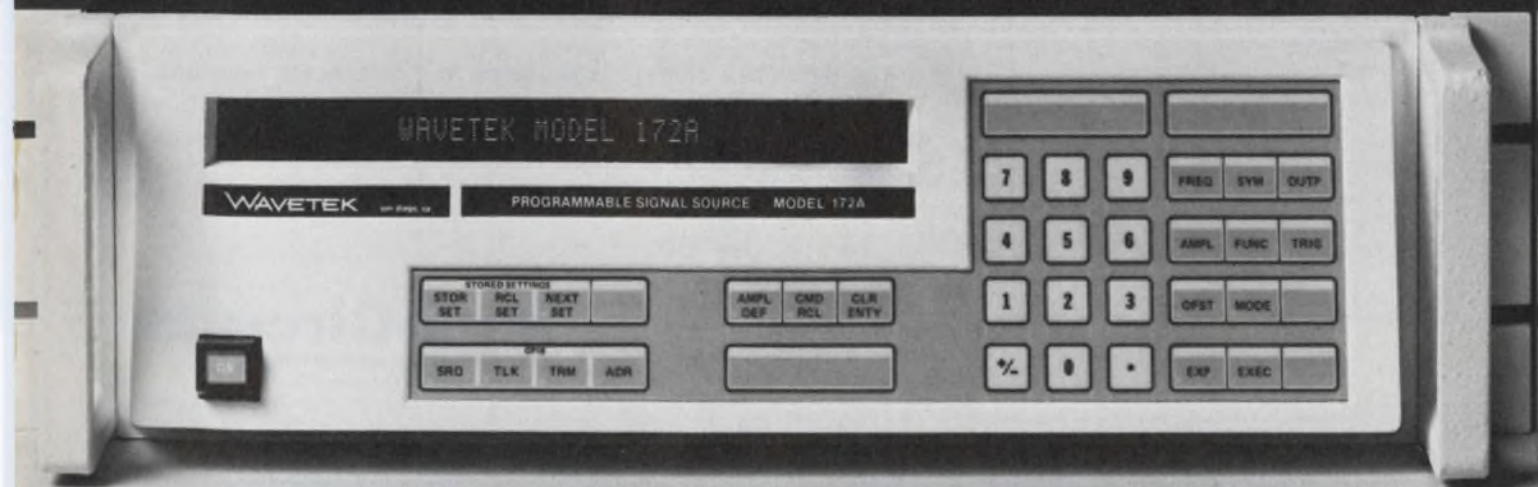

SUPER-MIXER

10-3000 MHz
6.5 dB conversion loss

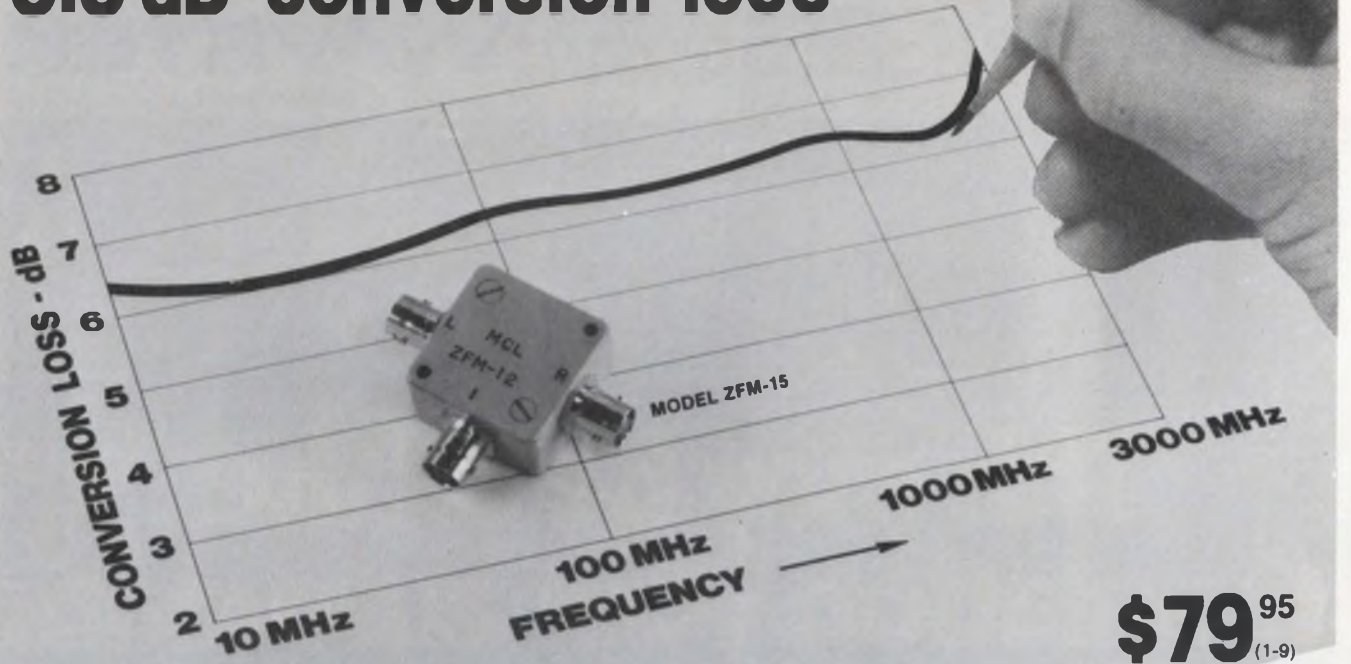

\$79⁹⁵
(1-9)

Mini-Circuits offers you less conversion loss... why settle for more!

Specifications — Model ZFM - 15

Frequency Range, MHz			
LO	10-3000	RF	10-3000 IF 10-800
LO Power +10 dBm			
Conversion loss, dB	Typ.	Max.	
20-1500 MHz	6.3	7.5	
10-3000 MHz	6.5	8.5	
Isolation, dB (10-3000 MHz)			
	Typ.	Min.	
LO-RF	30	20	
LO-IF	30	20	
Signal 1dB Compression level +5 dBm			
Impedance all ports	50 ohms		
VSWR (At ports)	Typ.	Max.	
LO	1.6	2.1	
RF	1.4	2.1	
IF	1.3	1.8	
Connectors, BNC STD, TNC on request			
Type N and SMA \$5 additional			
Mounting:			
Thru-hole, Threaded insert, Flange			
Size: 1 1/4" x 1 1/4" sq x 3/4" high			

Now for the first time . . .

Mini-Circuits offers the only Double-Balanced Mixers in the world that span the 10-3000 MHz range with only 6.5 dB conversion loss and 1.4 (typ.) VSWR throughout the entire band for only \$79.95 (1-9).

Specify the ZFM-15 for such applications as wideband ECM receivers where wide dynamic range is essential; the 1 dB compression point for the ZFM-15 is +5 dBm. The price/performance of the ZFM-15 even makes it ideal for narrowband applications including TACAN and S-Band telemetry.

The miniature ZFM-15 is available in 4 connector versions and 3 mounting configurations. These super mixers are in production now to meet our standard off-the-shelf one week delivery schedule.

2625 East 14th Street Brooklyn, New York 11235 (212) 769-0200
Domestic and International Telex 125460 International Telex 620156

World's largest manufacturer of Double-Balanced Mixers
Mini-Circuits
MINI-CIRCUITS LABORATORY
A Division of Scientific Components Corp

International Representatives: **AFRICA:** Alitra (PTY) Ltd. P.O. Box 9813, Johannesburg 2000, S. Africa **AUSTRALIA:** General Electronic Services, 99 Alexander Street, New South Wales, Australia 2065 **ENGLAND:** Dale Electronics, Dale House, Wharf Road, Frimley Green, Camberley Surrey **EASTERN CANADA:** B.D. Hummel, 2224 Maynard Avenue, Utica, NY 13502 (315) 736-7821 **FRANCE:** S.C.I.E. - D.I.M.E.S. 31 Rue George - Sand 91120 Palaiseau, France **GERMANY, AUSTRIA, SWITZERLAND, DENMARK:** Industrial Electronics GMBH 6000 Frankfurt/Main Klüberstrasse 14 West Germany **INDIA:** Gaekwar Enterprise, Kama Mahal, M.L. Dananukar Marg, Bombay 400 026, India **ISRAEL:** Vectronics Ltd. 69 Gordon Street, Tel-Aviv, Israel **NETHERLANDS, BELGIUM, LUXEMBOURG:** Coimex, Veldweg 11, Hattem, Holland

NORWAY: Datamatik AS, Ostensjoveien 62 Oslo 6, Norway **SINGAPORE & MALAYSIA:** Electronics Trading Co. (PTE) Ltd. 87 Bukit Timah Road, Singapore 9 Malay Peninsula **SWEDEN:** Iniegerad Elektronik AB Box 43 S-18251 Djursholm, Sweden

US Distributors: **NORTHERN CALIFORNIA:** PENN-STOCK Co., Foothill Office Center, 105 Fremont Avenue, Los Altos, CA 94022 (415) 948-6533 **SOUTHERN CALIFORNIA, ARIZONA:** Crown Electronics, 11440 Collins Street, No. Hollywood, CA 91601 (213) 877-3550 **NEW YORK:** MICROWAVE DISTRIBUTORS COMPANY, 61 Mall Drive, Commack, N.Y. 11725 516 543-4771

CIRCLE NUMBER 3

30/Orig.

ELECTRONIC DESIGN 8, April 12, 1978

NEWS

- 35 **News Scope**
- 38 **Converters are finally beginning to blast off**, and microprocessor compatibility is the fuel—An Electronic Design special report.
- 52 **Hanging transistors**, slim silicon make very fast monolithic converter.
- 55 **Washington Report**

TECHNOLOGY

- 66 **Video analog-to-digital conversion** calls for virtuoso performances. And the plot really thickens when you have to produce high resolution.
- 74 **Emulate your MOS microprocessor** with bipolar bit slices and don't worry about performance limits. You can boost capabilities.
- 84 **Plan a programmable pulse generator** around ECL ICs for rapid response. Control leading and trailing edges individually.
- 90 **Thermistors make good thermometers**—if you know how to linearize the operation of these semiconductor elements.
- 94 **Simplify air-gap calculating** with a Hanna curve. A single plot for a magnetic material serves all core shapes and sizes.
- 100 **Product serviceability**: You can design for it. Among the choices are built-in self-test and a serviceability review.
- 106 **L.J. Sevin of Mostek** speaks on bypassing dead ends.
- 110 **Ideas for Design**:
Dual-voltage regulated 5-A supply has adjustable outputs that track.
Constant-frequency pulse-width modulator built with one IC.
Convert any random number generator to a Gaussian distribution.
- 122 **International Technology**
- 124 **Annual Index**

PRODUCTS

- 139 **Modules & Subassemblies**: One DIP a/d or d/a converter fits microprocessors like a glove.
- 140 **Modules & Subassemblies**: 12-bit data-acquisition system interfaces directly with μ Ps.
- 160 **ICs & Semiconductors**: CCD analog multiplexers draw 0.1 mW but handle 32 inputs.
- 150 Micro/Mini Computing
- 154 Instrumentation
- 166 Components
- 170 Data Processing
- 174 Packaging & Materials
- 178 Power Sources

DEPARTMENTS

- 61 **Editorial**: Enthusiasm
- 7 Across the Desk
- 180 Application Notes
- 180 New Literature
- 182 Vendors Report
- 187 Employment Opportunities
- 194 Advertiser's Index
- 194 Information Retrieval Card

Cover: Photo by Art Director, Bill Kelly. Data converters courtesy of Analog Devices and Datel. Dolls courtesy of Marni Runyon.

Intel announces 32K and 64K for EPROM and micro



Check Pin 18 on our new 2332. It's the key to compatibility with high performance microcomputers and EPROMs.

Now's the time to get samples or place your order for the 2332 or 2364. They're our new 32K and 64K ROMs that will change the way you design your system. Here's how.

Microcomputer system components—EPROMs, ROMs and microprocessors—need to be designed as an integral unit, not piecemeal. That's the only way to provide maximum design flexibility and ensure a longer life cycle for your system. We've looked ahead at your future design requirements to provide you with components today that will enable you to take advantage of tomorrow's advances. The result is a family of compatible 5V EPROMs and ROMs for microcomputer systems.

Intel's new 2332 and 2364 are the latest members of that family. They provide system compatibility in three important ways.

First, these new ROMs have a guaranteed access time of 300 ns—fast enough to take full advantage of new, advanced microprocessors. To achieve 300 ns speed with low power dissipation, our parts are Edge-Enabled. That's where Pin 18 comes in. It provides the Chip Enable function necessary for the internal clock circuitry.

64K ROMs designed computer compatibility.

Second, the 2332 and 2364 are compatible with our 2716 industry-standard 16K EPROM and will be compatible with our 32K EPROM when it is introduced. Again, Pin 18 is the key. Note that Pin 18 performs the same power control function on all devices. So you can prototype with EPROMs and go directly to high density ROMs for production.

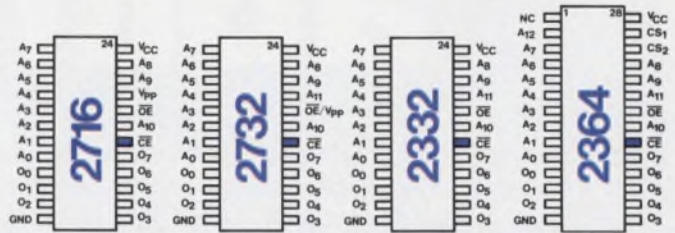

	16K EPROM	32K ROM/EPROM	64K ROM
Organization	2K x 8	4K x 8	8K x 8
Active Icc (max)	100 mA	40 mA	40 mA
Standby Icc (max)	25 mA	15 mA	15 mA
Access Time (max)	350-450 ns	300 ns	300 ns

Engineering the 2332 and 2364 for microcomputer system compatibility led us to the third important advance—the end of bus contention problems. In new multiplexed microprocessor systems, such as the MCS-85 and MCS-86, the Output Enable (Pin 20) needs to be independent of the Chip Enable (Pin 18) which is the power control and selection function. So the 2332 and 2364 have an Output Enable (\overline{OE}) for independent control of the data bus, with no possibility of multiple device selection. And input latches on all Edge-Enabled devices allow direct interface with new multiplexed microprocessors.

Low power is essential to meet today's design requirements. We've achieved low power in our 32K and 64K ROMs that can't be matched by fully static parts. Active current of the 2332 and 2364 is 40 mA (maximum). And Intel's Edge-Enabled devices have the added benefit of using Pin 18 for the power control function. So standby current is automatically reduced to 15 mA (maximum).

To get complete details on this important and complex subject, send for our 2332/2364 applications note AP-30, "Applications of Intel's 5V EPROM and ROM family for microcomputer systems." It provides board layout recommendations, system design applications, timing diagrams, function explanations and discusses PL/M modular software compatibility. Write: Intel Corporation, Literature Dept., 3065 Bowers Avenue, Santa Clara, CA 95051. Or for samples of these new parts, contact your local Intel representative.



intel® delivers.

Visit us at the Hanover Fair '78
April 19 through 27, 1978. Cebit-West,
Hall 18. Booth 1503

CIRCLE NUMBER 4

Europe: Intel International Corporation S.A., Rue du Moulin a Papier, 51-Boite 1, B-1160, Brussels, Belgium. Telex 24814.
Japan: Intel Japan Corporation K.K., Flower Hill-Shinmachi East Building 1-23-9, Shinmachi, Setagaya-ku, Tokyo 154. Telex 781-28426.

dependability

Our customers just plug in our power supplies and forget about them. Fortunately, these same customers don't forget about us. Which helps to explain why we are now the world's largest manufacturer of SCR supplies.

In a word: dependability. In another word: reliability.



One- and three-phase rack-mounted power supplies from 500 to 10,000 watts. Call TOLL FREE 800-631-4298 for complete information and prices, or write for our catalog.



ELECTRONIC MEASUREMENTS INC.

405 Essex Road, Neptune, N.J. 07753
Phone: (New Jersey) 201-922-9300. TOLL FREE 800-631-4298
Specialists in Power Conversion Equipment

CIRCLE NUMBER 5

Publisher

William Maass

Editors

Editorial Offices
50 Essex St.
Rochelle Park, NJ 07662
(201) 843-0550
TWX: 710-990-5071
(HAYDENPUB ROPK)
Cable: Haydenpubs Rochellepark

Editor-in-Chief George Rostky

Managing Editors:

Ralph Dobriner
Michael Elphick

Senior Associate Editor

Stanley Runyon

Associate Editors:

Sid Adlerstein
Nicholas Bodley
Dave Bursky
Morris Grossman
Gene Heftman
Andy Santoni
Max Schindler

Contributing Editors:

Peter N. Budzilovich, Jules H. Gilder,
Sidney Moskowitz, Nathan Sussman

Editorial Field Offices

East

Jim McDermott, Eastern Editor
P.O. Box 272
Easthampton, MA 01027
(413) 527-3632

West

Dick Hackmeister, Western Editor
8939 S. Sepulveda Blvd., Suite 414
Los Angeles, CA 90045
(213) 641-6544
TWX-1-910-328-7240

Dave Barnes, Western Editor
465 S. Mathilda, Suite 302
Sunnyvale, CA 94086
(408) 736-6667

Editorial Production

Marjorie A. Duffy, Production Editor
James Keane, Copy Editor

Art

Art Director, William Kelly
Richard Luce, Anthony J. Fischetto

Business Manager

Thomas E. Vachon

Production

Manager, Dollie S. Viebig
Nancy Hurey

Circulation

Director, Barbara Freundlich
Senior Assistant, Gail Stone

Information Retrieval

Paula Greenleaf

Advertising Promotion

Director, William Hussey
Assistant, Judith Nappo

Reprints

Maxine Sassano

Across the desk

Not NASA

In reference to "Solar-Cell Technology Advances—But Slowly" (ED No. 26, Dec. 20, 1977, p. 24): Please be informed that the Nebraska 25-kW solar photovoltaic power system you mentioned was built by MIT/Lincoln Laboratory for ERDA (now the Department of Energy), and not by NASA.

M. D. Pope

Energy Systems Engineering
Massachusetts Institute of Technology
Lincoln Laboratory
Lexington, MA 02173

An audio op amp, please

This is an appeal to the electronics industry via ELECTRONIC DESIGN to give us an operational amplifier especially designed for audio preamplifier applications.

IC op amps in general tend to have transient problems as a byproduct of excessive open-loop gain and the need for lag compensation within the operating band. A review of well-known IC op amps typically reveals open-loop gain values so large that roll-off compensation, usually spanning the entire audio band, is needed for stability. In effect, feedback is applied around an amplifier-integrator combination.

A high-quality audio-system gain block most often has a 10-to-30 voltage gain (about 20 to 30 dB, as frequently stated). Starting with a well-designed amplifier, 20 to 30-dB feedback is usually all that is needed to achieve the low distortion and high stability desired. For the values of closed-loop gain and feedback mentioned, an open-loop gain of only 1000 (60 dB) would be sufficient—a far cry from the 90 to 120 dB typical of existing ICs. With a gain of 1000, and frequency-response break points not unrealistically above the audio band, feedback without in-band

compensation could be used. If compensation above the audio band is needed for stability, a lead network in the feedback leg would be preferable.

The other characteristics and features deemed desirable in an operational amplifier would still apply. In addition, the new IC should be capable of delivering 15 to 20 V peak-to-peak into 600 Ω for line driving.

J. L. Markwalter, PE

363 River Rd.
Arnold, MD 21012

Misplaced Caption Dept.



At a florin per statement, you call that software good value?

Sorry. That's Rembrandt Van Rijn's "Pastor Johannes Elison," which hangs in the Museum of Fine Arts in Boston.

Watch how you use 'di/dt'

The Focus on power transistors and thyristors (ED No. 23, Nov. 8, 1977, p.

(continued on page 8)

Electronic Design welcomes the opinions of its readers on the issues raised in the magazine's editorial columns. Address letters to Managing Editor, Electronic Design, 50 Essex St., Rochelle Park, NJ 07662. Try to keep letters under 200 words. Letters must be signed. Names will be withheld upon request.

JANCO ROTARY SWITCHES

offer **SIMPLE**
solutions to complex
switching problems!



**P-C
Rotary
Switches**

"THE MIGHTY MINIATURE"

Optimum simplicity! Features the sophisticated circuitry of a coded switch plus all the advantages of a sealed rotary... and it's only .6" in diameter and .5" deep (from mounting face to the base of the pin terminals). Mounting is simpler! Wiring is simpler! Available in 8, 10, 12 positions. 1" diameter is available in up to 24 positions.

**PUSH-BUTTON
Rotary Switches**



Unique in design by virtue of their simplicity, these Janco rotary switches also function accurately and quickly in the most adverse environmental conditions. Can be "ganged" together for high density packaging. Available in bi-directional and uni-directional in 8, 10, 12, 16 positions with codes galore! And Janco switches are QPL, too!



Rotary Selector Switches

Standard rotary selector switches, power, miniature, micro-miniature, solenoid operated, keylock, momentary, etc. ... Janco has the rotary switch for your application. Proof is in the usage! Almost every military and commercial craft that flies has been using Janco rotary switches for over 30 years!

Janco
CORPORATION

3111 Winona Ave., Burbank, CA. 91504
Phone 213-845-7473 • TWX 910-498-2701

CIRCLE NUMBER 6

Across the desk

(continued from page 7)

52) needs some clarification. A statement about thyristors on p. 59 reads: "Also, the rate of rise of the input-gate trigger current (di/dt) must be limited to prevent damage to the thyristors."

The gate terminal doesn't usually have a maximum di/dt rating. The designation " di/dt " generally refers to the rate of rise of an SCR's anode current, and using the term to refer to its gate could be confusing.

Although the gate doesn't have a di/dt rating, it is usually necessary to specify a gate current's minimum rate of rise (as well as peak gate current) at which the anode-current di/dt is guaranteed. Operating at a lower rate of rise of gate current can cause even the specified anode current di/dt to damage the thyristor.

Consequently, if the quoted sentence had used the words "carefully controlled" instead of "limited," and had not included " di/dt ," the statement would have been more accurate.

D. Haslam

Mullard Hazel Grove
Bramhall Moor Lane Hazel Grove
Stockport Cheshire SK7 5BJ England

We slipped a few digits

In the Intel product story that appeared on p. 117 of the February 15, 1978 issue, the first three digits of the Intel telephone number are incorrect. The correct telephone number is (408) 987-8080.

Figure this one out

The following is a puzzle. We are generally familiar with what happens when a charged capacitor is switched in parallel with an equal uncharged capacitor. Of course energy is lost, and the final charge of the two parallel capacitors is the same at half the voltage:

Suppose, by adding an *ideal* inductor and diode to the capacitor-charge-transfer system, we attempt to eliminate any energy loss. What is the end result after the system has settled (after switch closure)?

Here's the answer: Capacitor C_1 is discharged to zero volts, and C_2 is

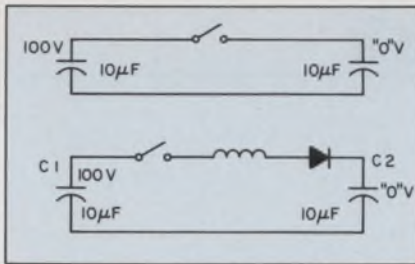

charged to the full 100 V. This can be deduced from energy considerations and symmetry, and without any significant math. If the energy loss is zero, no charge-conserving end result can be imagined other than the one I have stated.

Peter Lefferts

National Semiconductor
Semiconductor Div.
2900 Semiconductor Dr.
Santa Clara, CA 95051

Nichrome is still the way to go for PROMs

In "Improved Processing Will Boost High-Performance Memories, μ Ps" (ED No. 1, Jan. 4, 1978, p. 44), you make the following statement on p. 46:

"To attain the speed improvements demanded by the systems under design, PROM manufacturers are heading in the direction of titanium-tungsten fuses instead of nichrome. Not only does the titanium-tungsten combination jack up speed, but it also permits a lower programming voltage, which lessens the voltage strain on the PROM."

Here are the facts:

Circuit design will dictate access time. Choice of material for the fusible link employed in PROMs cannot affect performance of identical circuits if electrical characteristics of fuse elements are similar. In today's practice the resistance of comparable-geometry nichrome and titanium-tungsten fusible links is similar (same order of magnitude) and thus cannot strongly influence over-all circuit performance.

As for "lower programming voltage," nichrome for fusible links provides all the desired characteristics to program easily and with ample energy available to do it reliably. Calculations have shown that fusing energy for nichrome fusible links is comparatively low, i.e., 1μ J, and requires voltage and current conditions well attainable by the Harris PROM design, which

permits less than $10\text{-}\mu$ s fusing times per link.

Nichrome remains a proven reliable and reproducible material with which to continue manufacturing present and advanced state-of-the-art PROMs. Titanium-tungsten offers no performance advantages and has potential reliability risks such as an intermittent bit failure mode.

C.J. VanLeeuwen
Manager, Reliability

Harris Semiconductor Products Div.
P.O. Box 883
Melbourne, FL 32901

New Books

Analysis and Design of Analog Integrated Circuits—P.R. Gray and R.G. Meyer, John Wiley & Sons, One Wiley Drive, Somerset, NJ 08873, 683 p. \$22.50.

Circle No. 551

DBUG: An 8080 Interpretive Debugger—C.A. Titus and J.A. Titus, E & L Instruments, Inc., 61 First St., Derby, CT 06418, 91 p. \$5.00.

Circle No. 552

Professional Electrical/Electronic Engineer's License Study Guide—E.J. Ross, Tab Books, Blue Ridge Summit, PA 17214, 476 p.

Circle No. 553

Electronic Devices and Circuit Theory—R. Boylestad and L. Nashelsky, Prentice-Hall, Englewood Cliffs, NJ 07632, 701 p. \$17.95

Circle No. 554

Electronic Processes in Unipolar Solid-State Devices—D. Dascalu, ISBS, Inc., P.O. Box 555, Forest Grove, OR 97116, 624 p. \$45.50

Circle No. 555

Digital Modulation Techniques in an Interference Environment—K. Feher, Don White Consultants, 656 Quince Orchard Rd., Suite 410, Gaithersburg, MD 20760, 188 p. \$25.00.

Circle No. 556

Integrated Circuits: A User's Handbook—M.M. Cirovic, Prentice-Hall, Inc., Englewood Cliffs, NJ 07632, 304 p. \$18.95.

Circle No. 557

An Introduction to Microcomputers, Vol II—Some Real Products (June 1977 Revision)—A. Osborne, Adam Os-

(continued on page 19)

hp MEASUREMENT COMPUTATION **news**

product advances from Hewlett-Packard

APRIL, 1978

New printer/plotter combines fast text printing and high-quality true-vector graphics

HP-IB

Whether your application calls for high-quality graphics, or fast text printing, or a combination of both for extensive plot annotation, HP's 7245A Plotter/Printer is an excellent solution for your needs. With a printing speed of 38 characters per second (cps) and plotting speeds equal to or greater than that of dedicated vector plotters, the HP desktop plotter/printer is an outstanding general-purpose device for your HP-IB controller. Some areas of application are engineering design, production testing, data acquisition, process monitoring, analytical plotting, long-term business forecasting, and project management.

The microprocessor-based 7245A uses a bidirectional paper drive to advance a 61-metre (200-foot) roll of thermosensitive paper for unattended long-axis plotting. A sprocket paper drive and a patented microstep motor drive give the 7245A excellent line quality and repeatability of 0.25 millimetres (0.010 inches) maximum from any point on the chart.

A state-of-the-art, thin-film, thermal printhead makes possible the combination of true-vector graphics and fast printing. It has 12 resistors to print 7×9 dot-matrix



If your application calls for both plotting and/or printing, unattended plotting, or long-axis plots, the new 7245A is an HP-IB printer/plotter you will want to know more about.

characters in four orthogonal directions. This allows 88 columns to be printed across the 216-millimetre-wide (8.5 inch) paper. A larger 14×9 dot-matrix font is used to print titles at 19 cps in a 44-column format.

Programming is easy thanks to 46 built-in programmable instructions for features such as unit scaling, graph rotation, point digitizing, character size, slant, and direction, and selecting any of seven dashed line fonts and five drawn

and eight matrix character sets, six of which are European.

Standard printer escape code sequences for the 7245A enable you to set, execute, and clear tabs, form-feed forward or reverse, change character size, underline, select any of eight dot-matrix character sets, and select the "display functions" mode for printing all 128 ASCII characters, including the control code characters.

For details, check B on the HP Reply Card.

IN THIS ISSUE

New computing component for OEM's • μ P enhanced microwave counter • DS/1000: the latest link

Solutions books provide added usefulness to your HP-19C/29C

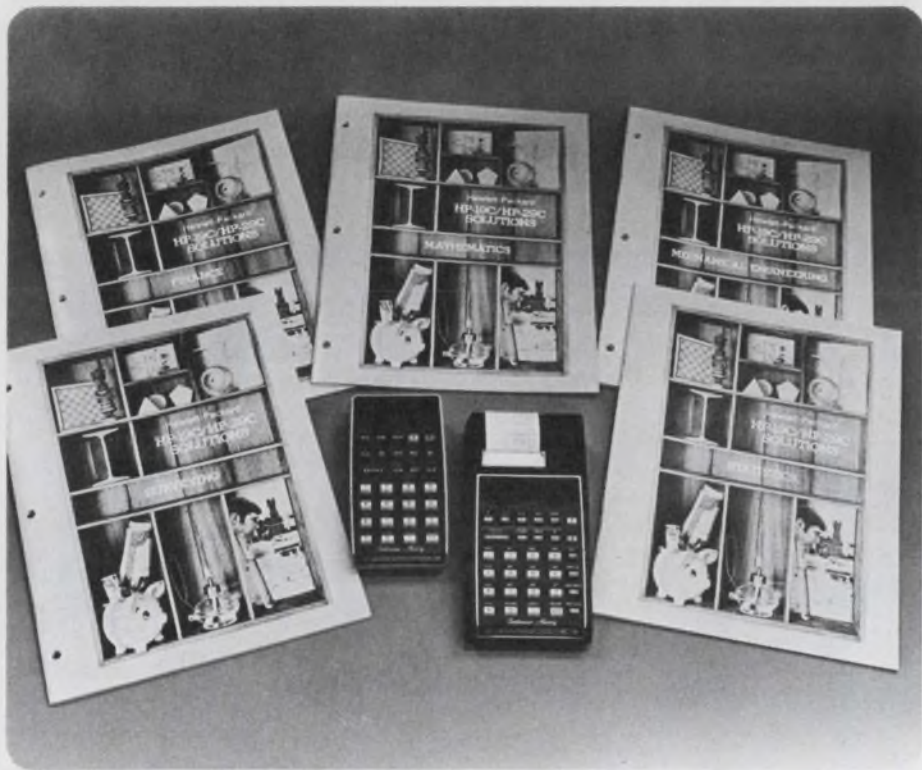

Hewlett-Packard recently introduced ten new solutions books, designed to provide owners of HP-19C and HP-29C programmable calculators with solutions to a number of general applications. Each of the HP-19C/29C Solutions Books gives the user up to 12 programs, all selected for maximum interest and usefulness.

Every Solutions Book contains a summary of each program, a listing of program steps, and an explanation of how the results are displayed on the calculator. Detailed program information allows even an operator with minimal experience to program the calculator correctly. With the continuous memory capability and the 98 program-step capacity of the HP-19C/29C, the user need only key in the program initially.

As a part of the more general applications, the new *Student Engineering Solutions Book* is written to appeal to many

students in different engineering fields who frequently perform the same type of calculations and can use the same routines. The other HP-19C/29C Solutions Books are:

1. Surveying
2. Mathematics
3. Statistics
4. Finance
5. Electrical Engineering
6. Navigation
7. Mechanical Engineering
8. Civil Engineering
9. Games

Each of these new Solutions Books provides HP-19C or HP-29C owners with added dimensions to the already extensive library of HP program solutions.

Check A on the HP Reply Card if you'd like more information.

New μ P-controlled pulser features HP-IB programmability and unmatched accuracy

Combining microprocessor control with highly accurate pulse circuitry, HP's 8160A Programmable Pulse Generator offers important new pulse capabilities for bench and automatic testing applications. Microprocessor control, for example, lets you simply and directly enter desired pulse parameters via the instrument's keyboard. LED's display all pulse parameters with 3-digit resolution.

Accuracies are 2% in repetition rate and output levels, 1% in delay and width, and 3% in transition time. Thanks to these, you can now rapidly set-up an accurate pulse, and you don't need a measuring instrument to tweak-in each pulse parameter.

For automatic testing applications, all pulse parameters and operating modes are programmable via the Hewlett-Packard Interface Bus. Simple, straightforward command sequences made possible by the microprocessor make remote control as easy as manual operation. Faster program generation and reduced software costs are direct benefits.

Five nanosecond variable transition times and 20 V output amplitudes complement the 8160A's fast 50 MHz repetition rate. When dual outputs are required, option 020 adds a full second channel to the 8160A. Independent control of delay, width, transition times, and output levels on the second channel lets you easily simulate clock and data waveforms, two phase clocks, and balanced signals.

The 8160A includes still more, like burst and learned modes, digital storage of 10 complete parameter sets, microprocessor detection of set-up errors, and internal batteries that preserve all stored data even when power is switched off.

To obtain full information, check C on the HP Reply Card.

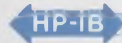

DS 1000: The latest distributed processing link

HP is not new to computer networking. We have been delivering reliable networks for the last five years. Now with the introduction of DS/1000, we have a truly generalized nodal network which supports a variety of configurations.

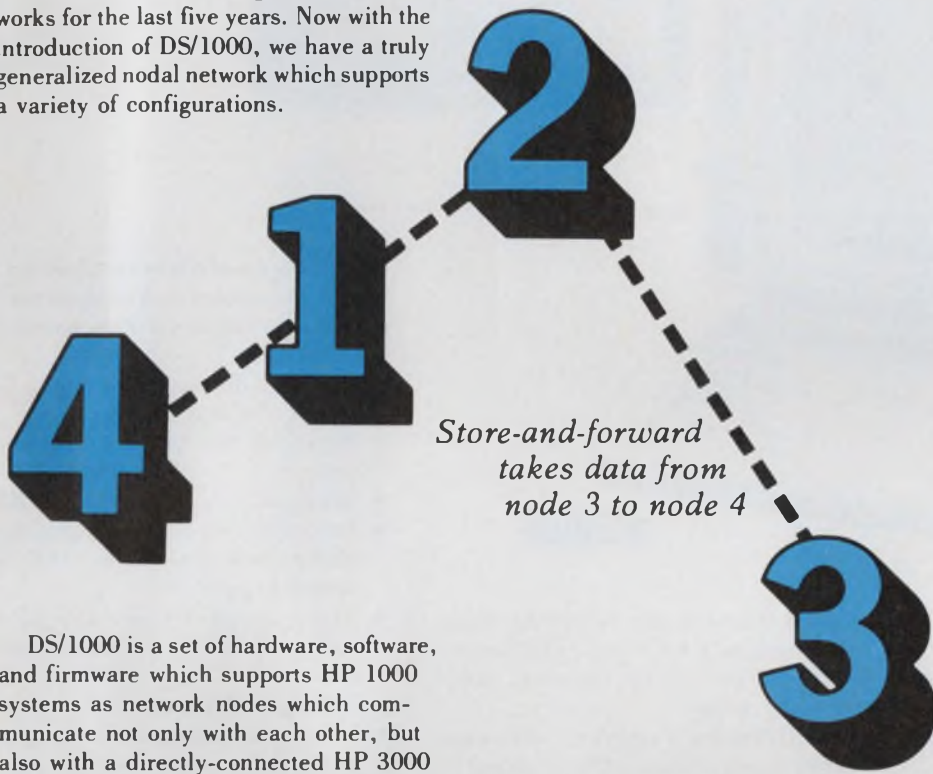

The application programmer need only identify the node where the printer is located, and DS/1000 forwards the information from node-to-node until it reaches that address.

Microcoded Driver

DS/1000 takes advantage of the microcode-ability of the HP 1000 in its Communications Access Method driver. CAM allows simultaneous requests on multiple communications lines between HP 1000's to be serviced concurrently. For example, a DS/1000 node can handle four concurrently active 9600 baud lines, or two active hardwired lines with a combined effective throughput of up to 20K-bytes/second.

Tri-Directional Error Check

To ensure data transmission integrity, DS/1000 has powerful microcoded error checking. Data blocks, when received,

0	0	0	0	0	0	0	0	0	0	0	0	0	1	1	0
0	1	0	0	0	1	1	0	1	0	0	1	0	0	0	1
0	0	0	0	0	0	0	0	0	0	0	0	0	0	0	1
0	0	0	0	0	0	0	0	0	0	0	0	0	1	0	1
0	0	0	0	0	0	0	0	0	0	0	0	0	0	1	1
0	1	0	0	0	1	1	0	0	1	0	0	1	1	0	0
0	1	0	0	1	1	1	0	0	1	0	0	0	0	0	1
0	1	0	0	1	1	0	1	1	0	0	0	1	0	1	0
0	0	0	0	0	0	0	0	0	0	0	0	0	0	0	1
0	0	1	1	1	1	1	1	0	0	0	1	0	1	1	0
0	1	0	1	0	0	1	0	0	1	0	1	0	1	0	0
0	0	0	0	0	0	0	0	0	0	0	0	0	0	0	1

are checked simultaneously for vertical, longitudinal, and diagonal parity.

Obtain full details by checking D on the HP Reply Card.

DS/1000 is a set of hardware, software, and firmware which supports HP 1000 systems as network nodes which communicate not only with each other, but also with a directly-connected HP 3000 Series II computer. And, there is no significant increase in complexity for the applications programmer. All network information flow is handled by DS/1000.

With a powerful remote command processing capability, DS/1000 users at terminals on one HP 1000 node can access any other HP 1000 in the network, be it local or remote.

These users can easily utilize files, programs, and peripherals on other nodes, even when they are unattended. Individual HP 1000 nodes can be connected in any manner that suits the material flow of a plant or geography of a region—a star arrangement surrounding a central node, a ring, a string, or any combination of these. Nodes are connected with either a single four-wire cable or by full-duplex modems. DS/1000 is particularly well-suited for instrumentation, computation, and operations management tasks in functional areas such as manufacturing, R&D, quality control, and distribution.

Moreover, DS/1000 to DS/3000 communication facilitates the integration of these tasks with commercial data processing available on the HP 3000 Series II, such as production scheduling, order processing, and accounting.

Store-and-forward

Nodal addressing combined with a store and forward technique, enables users to access any DS/1000 node from any other node, and allows them to transport programs freely within the network.

A user at a node in New York, for example, can write to a line printer at a node in Boston. If the user later transports the program from New York to a node in Atlanta, the same line printer in Boston would be accessed without change to the user's program.

Speed soft-copy graphics with new graphics translator

The speed of soft-copy graphics lets you see your system's output quickly and allows correction of such items as improper scale factors or undesired system parameters prior to making permanent records.

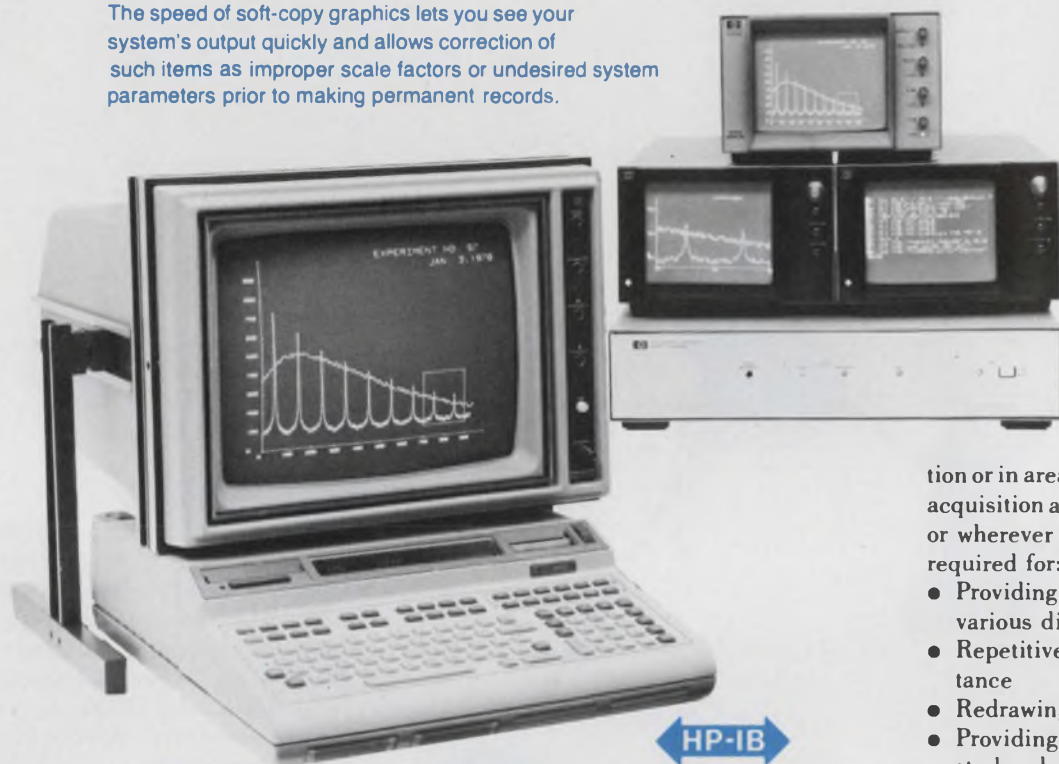

Hewlett-Packard's new 1350A Graphics Translator brings the speed of soft-copy graphics to HP-IB instrumentation systems. The graphics translator converts outputs from digital systems to analog outputs to drive high-resolution CRT displays.

With the 1350A and one or more of HP's electrostatic CRT displays, you can display your system's output in a fraction of the time required by hard-copy devices,

evaluate the result, and modify the output before making a hard copy. That means faster analysis, quicker decisions, and less paper usage.

The 1350A has a significant advantage in system applications with its ability to drive at least ten high-resolutions electrostatic displays and provide four different presentations on multiple displays simultaneously. The graphics translator is also excellent for analytical instrumenta-

tion or in areas of engineering design, data acquisition and network analysis systems, or wherever high-resolution graphics are required for:

- Providing different information on various displays
- Repetitive flashing vectors of importance
- Redrawing presentations in <400 ms
- Providing high-resolution graphic strokes between 1000 by 1000 addressable points
- An easy graphics solution for HP-IB or optional RS-232C instrumentation systems
- Writing 2048 vectors and/or characters
- Selecting a display size and brightness to meet your requirements.

To learn more about how the 1350A Graphics Translator can bring soft-copy speed to your HP-IB system, check E on the HP Reply Card.

Guide to electronic counters

Selection of the electronic counter best suited to your needs is made easy by a new, four-color guide. It summarizes specifications of the 15 counters in our line—your broadest choice from any manufacturer. Included are the new 5342A Microwave Counter (see page 8 of this issue) and the 5370A Universal Time Interval Counter, offering 20 picosecond resolution.

For your complimentary copy of this guide, check F on the HP Reply Card.



Latest developments in logic analysis

The February 1978 issue of the HP Journal devotes its entire 32-pages to the topic of logic analysis. Several articles examine the latest developments in logic analyzers while another presents an overview of the ongoing revolution in digital testing.

For a complimentary copy of the February 1978, HP Journal, Check G on the HP Reply Card.

A new computing data acquisition component for OEM's

If you are an OEM and interested in low-cost computing components for your measuring instruments for scientific research, clinical analysis, or industrial applications, you should know about the HP 97S I/O Calculator. A fully programmable printing calculator, with BCD interfacing, the HP 97S just may be the solution to the problem of how to automate your products at an affordable price.

Based on the HP-97 Programmable Printing Calculator, the HP 97S incorporates BCD interfacing so that data can be efficiently gathered from a wide range of instruments including: electronic balances, photometers, densitometers, thermal conductivity measurement devices, strain gauge systems, calorimeters, devices for measuring ion activity, titrators, pH meters, coordinate measurement equipment, physical measuring equipment, or any BCD output device.

Your customers will appreciate the HP 97S with your product, not only for its low cost, but also for its many computational features. The HP 97S features include:

- 244 steps of program memory, a magnetic card reader for storing programs and data,

- three levels of subroutines,
- labelling,
- indirect and relative addressing,
- RPN logic,
- built-in printer, and
- a large, bright display, tilted for easy reading.

Programming power and simple interfacing also make your job easier. Getting the 97S up and running with your instruments will require two simple steps—interfacing and programming. To get you started, HP provides detailed documentation. The installation and operation manual includes detailed technical specifications and clear instructions for simple interfacing, as well as helpful diagnostics and service information.

The programming guide gives step-by-step explanations for programming and the Standard Application Pak includes 15 pre-recorded programs and 24 blank cards.

For more details on how you can add intelligence and hard-copy output to your products, check H on the HP Reply Card.



Whether you are an OEM manufacturer of electronic balances, photometers, calorimeters, pH meters—or any BCD output device—this calculator can make your instrument "smart" at a price you can afford.

New, compact power supply features triple outputs



Convenient power for circuit breadboards is yours with this new three-in-one lab bench power supply.

This low-cost, compact, three-in-one power supply is a handy addition to the lab bench where single or multiple voltages are needed for designing and testing breadboards and prototypes. The HP 6235A Triple Output DC Power Supply delivers three adjustable DC output voltages: 0 to 6 V at 1 A, 0 to +18 V at 0.2 A, and 0 to -18 V at 0.2 A. A single 0 to 36 volt output at 0.2 A can also be obtained by connecting across the -18 V and +18 V terminals. The +6 V and +18 V outputs can be adjusted independently. The -18 V output is adjusted with a tracking ratio control, after which it will proportionately follow the +18 V output as the +18 V control is adjusted. The +18 V and -18 V tracking outputs are especially useful for powering operational amplifiers and other circuits requiring symmetrical operating voltages.

The supply is a constant voltage/current limit type, with each voltage continuously adjustable over its range, while the maximum current available is automatically limited to prevent overloading. You can quickly select and monitor voltage or current for each output with the pushbutton meter switches.

Weighing only 2.3 kilograms, (5 lbs.), the new 6235A is small enough to pick up with one hand. It can be powered from 115 V or 230 V, 47-63 Hz AC input.

Check I on the HP Reply Card for more information about this triple output power supply for your lab bench.

New note describes 100 dB microwave measurements

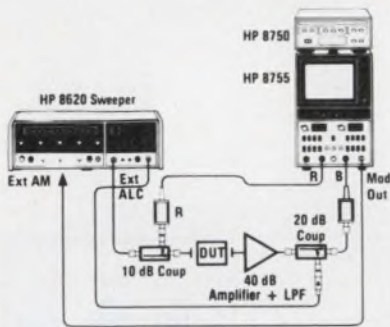

Microwave swept measurement setup uses RF amplifier within leveling loop to achieve >100 dB dynamic range.

“100 dB Dynamic Range Measurements Using the HP 8755 Frequency Response Test Set”, a new HP application note (AN 155-2), will be of interest to people making RF and microwave swept measurements. Expanded dynamic range is achieved by using the associated sweep oscillator’s leveling/modulation element as an “automatic RF substitution” device by configuring it within the system’s power leveling loop. The note discusses the factors that determine and limit measurement dynamic range. Equipment cited in the note covers from 10 MHz to 18 GHz.

For your complimentary copy of AN 155-2, check J on the HP Reply Card.

Application Note describes 1 MHz to 18,000 MHz synthesized source

The third application note from the Microwave Synthesizer Series, AN 218-3, is now available.

It describes how the HP 8672A and HP 8660A/C Synthesized Signal Generators can be combined with programmable signal switching to yield a signal generator with one output connector covering from 1 MHz to 18,000 MHz. In addition, the frequency resolution of the 8672A generator is improved from its usual 1, 2, and 3 kHz, to 1, 2, and 3 Hz. Such a programmable source is excellent for automatic test systems.

Some sample desk-top computer software sub-routines are given to aid the user in programming the system.

For your complimentary copy, check K on the HP Reply Card.

Troubleshoot three-state data buses conveniently, quickly, economically

Troubleshooting three-state data buses in digital circuitry, computers, and data communications systems can be challenging under the best of circumstances, but imagine yourself in this situation: a stuck data bus line with RAM’s micro-processor and I/O devices attached to it, all of which appear the same electrical potential. Since the board is too expensive to toss away and you don’t have the hours of time needed to use analog troubleshooting techniques, consider the HP IC troubleshooters.

The IC troubleshooters allow you to isolate quickly and conveniently the bus problem outlined here by giving you a combination of three tools you need to determine if the bus line is shorted, open, or has a bad driver. The troubleshooters you need first are the handheld HP 545A Probe and the 546A Pulser. Just pulse and probe the stuck line to see if its logic state can be taken to a HIGH. If not, then there is a short to ground on the line. To find it, keep pulsing the bus line while you use our 547A Current Tracer to follow current pulses directly to the shorted bus element.

Detecting stuck bus lines often requires a combination of voltage and current information. The HP IC troubleshooters provide stimulus and response capability in both the voltage and current domains for more complete, economical digital troubleshooting.

For more information, check L on the HP Reply Card.



HP’s 545A Probe, 546A Pulser and 547A Current Tracer help pinpoint logic faults on three-state buses.

Speed transceiver, audio or broadcast testing with HP’s new distortion measurement set



In addition to the time-saving convenience of auto set level and auto null, a built-in tracking oscillator for audio measurements gives you a low-distortion source for testing high quality audio equipment and allows you to tune one instrument instead of two.

Whether you’re testing transceivers, professional audio equipment or broadcast performance, the HP 339A Distortion Measurement Set can help you make quick and accurate measurements.

Automatic frequency nulling and auto set level of the 339A speed your total harmonic distortion measurements (THD), while true-rms detection provides accurate measurements to as low as 0.0018% (-95 dB) from 10 Hz to 110 kHz. Just select the frequency of the built-in -95 dB low distortion oscillator and the 339A’s front panel “turn signal” indicators show you how to make the proper range settings.

In transceiver testing, automatic setting of the 100% reference level over a 10 dB input range means fewer critical adjustments, saving you a considerable amount of test time. True-rms detection lets you accurately determine thermal noise and harmonic components in making SINAD measurements.

Broadcast compliance testing is easy with the 339A’s built-in AM detector, 30 kHz low-pass filter, switchable VU meter ballistics, and a +2 to -12 dBm (600 Ω) meter scale. You can quickly isolate the causes of out-of-limit readings and reduce set-up time when checking equipment for compliance with government regulations.

Contact your local HP field engineer for further details or check M on the HP Reply Card.

Low R_S beam lead PIN diode switches in less than 2 ns

The HPND-4050 offers 1.3 Ω typical (1.7 max) series resistance at only 10 mA for high frequency performance in shunt. This low resistance reduces power requirements and makes it suitable as a shunt switching element in stripline and microstrip circuits. The low current requirements are of interest to designers for portable, airborne or shipboard applications including switching, attenuating, phase shifting and modulating at microwave frequencies. Reverse recovery time of two nanoseconds meets or exceeds requirements for fast switching in high frequency modulator and attenuator component applications in ECM systems. The capacitance of the HPND-4050 is 0.15 pF maximum and breakdown voltage is 30V minimum. Nitride passivation of the HPND-4050 provides immunity from environmental contaminants.



The HP mesa process with glass backfilling is responsible for the performance of this beam lead PIN. The mesa construction constrains the minority carriers, thereby enhancing switching speed.

For details, check N on the HP Reply Card.

HP introduces its largest 7-segment red LED display

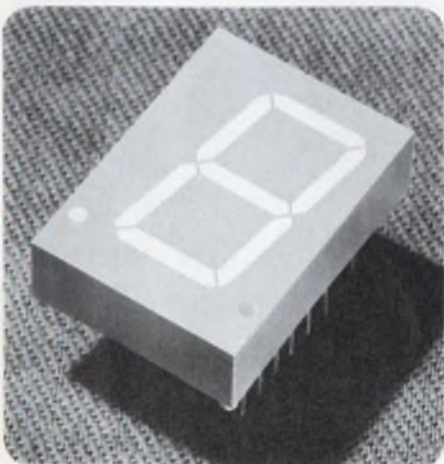

The new HDSP-3400 Series red LED numeric display is the largest in Hewlett-Packard's seven-segment product line, which ranges in size from 2.59 millimetre (.10 inch) to the new 20.32 millimetre (0.8 inch) display.

Readable in bright light at distances of up to 10 metres (33 feet), the HDSP-3400 is designed for use in electronic instruments, point-of-sale terminals, television sets, weighing scales, digital clocks, and a number of other applications requiring low power consumption in a large, easy-to-read display.

The gallium arsenide phosphide displays are in a standard 15.24 millimetre

(0.6 inch) dual-inline-package that permits mounting on PC boards or in standard IC sockets for easy use.

Models in the new series are: HDSP-3400, common anode left hand decimal; 3401, common anode right hand decimal; 3403, common cathode right hand decimal; 3405, common cathode left hand decimal; 3406, universal overflow (± 1) right hand decimal.

The HDSP-3400 Series displays are available from stock of Hewlett-Packard's franchised distributors.

For greater details about this new product, check O on the HP Reply Card.

Microprocessor enhances capability and lowers cost of a new microwave counter

On the basis of its cost reduction alone, a full capability, automatic, 10 Hz to 18 GHz microwave frequency counter priced 20% less than any other in its performance class would be interesting news to people doing microwave work. But add to this lower price the other features of HP's 5342A and you have what is perhaps the best value and most significant development in microwave counters for many years. With these features your bench, systems or field measurement tasks can now be performed faster, more conveniently and more economically over a wide range of input parameters:

- Measure input signal level at the same time you measure frequency without switching input connectors (option 002); 10 MHz to 18 GHz frequency coverage with ± 1.5 dB accuracy.
- >50 MHz FM tolerance lets you measure heavily loaded communications carriers on-line with active traffic.
- Microprocessor supervised measurements and front panel keyboard make set-up faster, more convenient, more error-free...lets you enter frequency/amplitude offsets, to be added to or subtracted from the measured results.
- Automatic amplitude discrimination measures only the highest signal in the input spectrum.
- Hewlett-Packard Interface Bus (option

011) provides systems control for all measurement capabilities and access to measured results.

- Optional, built-in digital-to-analog converter (option H01), allows high accuracy plots of frequency or amplitude changes, via strip chart recorder.
- Compact half-rack module size makes the 5342A convenient for field use.

This blend of high performance, unmatched versatility and low price was achieved by a new harmonic heterodyne converter technique with microprocessor based calculations and control. This reduces the need for expensive components to a single hybrid, thus lowering the cost significantly. The 5342A shines in other specifications too. Sensitivity is -25 dBm, 500 MHz to 12.4 GHz and -20 dBm...to 18 GHz. Time base crystal aging rate is $<1 \times 10^{-7}$ /month ($<5 \times 10^{-10}$ /day in option 001). Dynamic range is 30 dB, 500 MHz to 12.4 GHz, and 25 dB to 18 GHz (42 dB and 35 dB, respectively, if you order amplitude measurement option 002 or extended dynamic range option 003.)

For more information, check P on the HP Reply Card.

HP-IB



The new 5342A's great FM tolerance allows heavily loaded communications carrier frequencies to be measured on-line and with active traffic. This plus optional amplitude measurement gives you two of the most often needed communications measurements in a single, compact package. HP-IB option offers full systems capability too.

East-4 Choke Cherry Road, Rockville, MD 20850.
Ph. (301) 948-6370.
South-P.O. Box 10505, Atlanta, GA 30348.
Ph. (404) 434-4000.
Midwest-5201 Tollview Dr., Rolling Meadows, IL 60008.
Ph. (312) 255-9800.
West-3939 Lankershim Blvd, North Hollywood, CA 91604. Ph. (213) 877-1282.
Europe-Central Mailing Depot., P.O. Box 529, Amstelveen-1134, Netherlands, Ph. (020) 47 20 21
Japan-Yokogawa-Hewlett-Packard Ltd., Ohashi Bldg., 1-59-1 Yoyogi, Shibuya-ku, Tokyo 151. Ph. 03-370-2281/92.

HEWLETT  PACKARD

MEASUREMENT **news**
COMPUTATION
product advances from Hewlett-Packard

March/April 1978

New product information from

HEWLETT-PACKARD

Editor: Bojana Fazarinc-Bitencourt

Editorial Offices:

1507 Page Mill Road
Palo Alto, California, 94304 U.S.A.

Across the desk

(continued from page 8)

borne and Associates, Inc., P.O. Box 2036, Berkeley, CA 94702, 868 p. \$15.00.
Circle No. 558

Microprocessors in Instruments and Control—R.J. Bibbero, John Wiley & Sons, Inc., One Wiley Drive, Somerset, NJ 08873, 301 p. \$15.75
Circle No. 559

Getting Involved With Your Own Computer, A Guide for Beginners—L. Solomon and S. Veit, Ridley Enslow Publishers, 60 Crescent Place, Box 301, Short Hills, NJ 07078, 216 p. \$5.95.
Circle No. 560

The Design of Operational Amplifier Circuits, with Experiments—H.M. Berlin, E & L Instruments, Inc., 61 First St., Derby, CT 06418, 277 p. \$9.00.
Circle No. 561

Technical Report Standards, How to Prepare and Write Effective Technical Reports—L.R. Harvill and T.L. Kraft, Banner Books International, 7435 University Ave., LaMesa, CA 92041, 56 p. \$3.95.
Circle No. 562

Using Digital and Analog Integrated Circuits—L.W. Shacklette & H.A. Ashworth, Prentice-Hall, Inc. Englewood Cliffs, NJ 07632, 303 p. \$10.95
Circle No. 563

Handbook of Interactive Computer Terminals—D.E. Sharp, Prentice-Hall, Inc. Englewood Cliffs, NJ 07632, 266 p. \$17.95
Circle No. 564

Microprocessors, from Chips to Systems—R. Zaks, Sybex, Inc., 2161 Shattuck Ave., Berkeley, CA 94704, 416 p. \$9.95.
Circle No. 565

Nonlinear Systems Analysis—M. Vidyasagar, Prentice-Hall, Inc., Englewood Cliffs, NJ 07632, 302 p. \$21.95.
Circle No. 566

Experiments in Digital and Analog Electronics—H.W. Malmstadt, C.G. Enke and S.R. Crouch, E & L Instruments, Inc., 61 First St., Derby, CT 06418, 400 p. \$17.00.
Circle No. 567

The Architecture of Concurrent Programs—P.B. Hansen, Prentice-Hall, Englewood Cliffs, NJ 07632, 317 p. \$16.95.
Circle No. 568

Our newest air variable capacitor's biggest feature:



It's small size.

As you can plainly see, our new air variable capacitor is nearly as small as many sub-miniature ceramic trimmers. It also features the same mounting configuration which means you can use it in many of the same applications

But small size isn't the only reason for buying our new Micro T™ capacitor. Because it's air variable, it offers you

great stability. Q is typically 1000 at 100 MHz. TC is ± 45 PPM/°C. And it's available in maximum capacities of 3, 6.5, 12.7, and 19.0 pF in either vertical or horizontal tuning PC and stripline mounting versions. What's more, it gives you all this for a very small price.

E. F. Johnson Company/Dept. E.D., Waseca, MN 56093

Please send me technical information on sub-miniature air variable capacitors.

Please send me samples. You can call me at _____

Name _____

Firm _____

Address _____

City _____ State _____

Zip _____

For fast service, contact your local Johnson Distributor.



JOHNSON

CIRCLE NUMBER 7



**“There is
than an**

**“At Intersil, we think CMOS analog
switching technology is one such idea.”**



Intersil 1967-

LEADERSHIP IN ANALOG SWITCHING.

Intersil has offered a number of “firsts” in analog switching:

- First, with virtual ground switches
- First, with ultra low power CMOS monolithic analog gate technology
- First, with monolithic CMOS latch proof technology
- First, with Varafet technology

Today we offer over 150 analog switching devices...tomorrow, we'll be introducing new devices that reduce component count, reduce overall system cost and increase reliability. We think cost effective solutions to your design problems are an idea whose time has come.

VIRTUAL GROUND SWITCHES.

The IH5009 series of analog switches was designed to fill the need as an easy-to-use, inexpensive switch for virtual ground switching into

operational amplifiers. This family is primarily intended for constant impedance switching multiplexing and interfaces with 5V or 15V logic. Switching accuracy is increased through a built in compensating FET for use in the gain feedback loop of the op amp.

ULTRA LOW POWER CMOS GATES.

The IH5040 family of monolithic analog gates was designed using an improved, high voltage CMOS technology. The advantages are T²L, DTL, CMOS and DMOS compatibility...combined with ultra low power operation. The technology provides input overvoltage capability to $\pm 25V$. Diode protected inputs eliminate the need for special handling techniques associated with other CMOS analog gates. Destructive latchup has been totally eliminated. And, there is no need for external logic to prevent channel-to channel shorting. Power requirements of the IH5040 family of CMOS gates, up to 30 times lower than previously available state-of-art devices, open up new low power applications in

nothing more powerful idea whose time has come."

Victor Hugo, 1802-1885

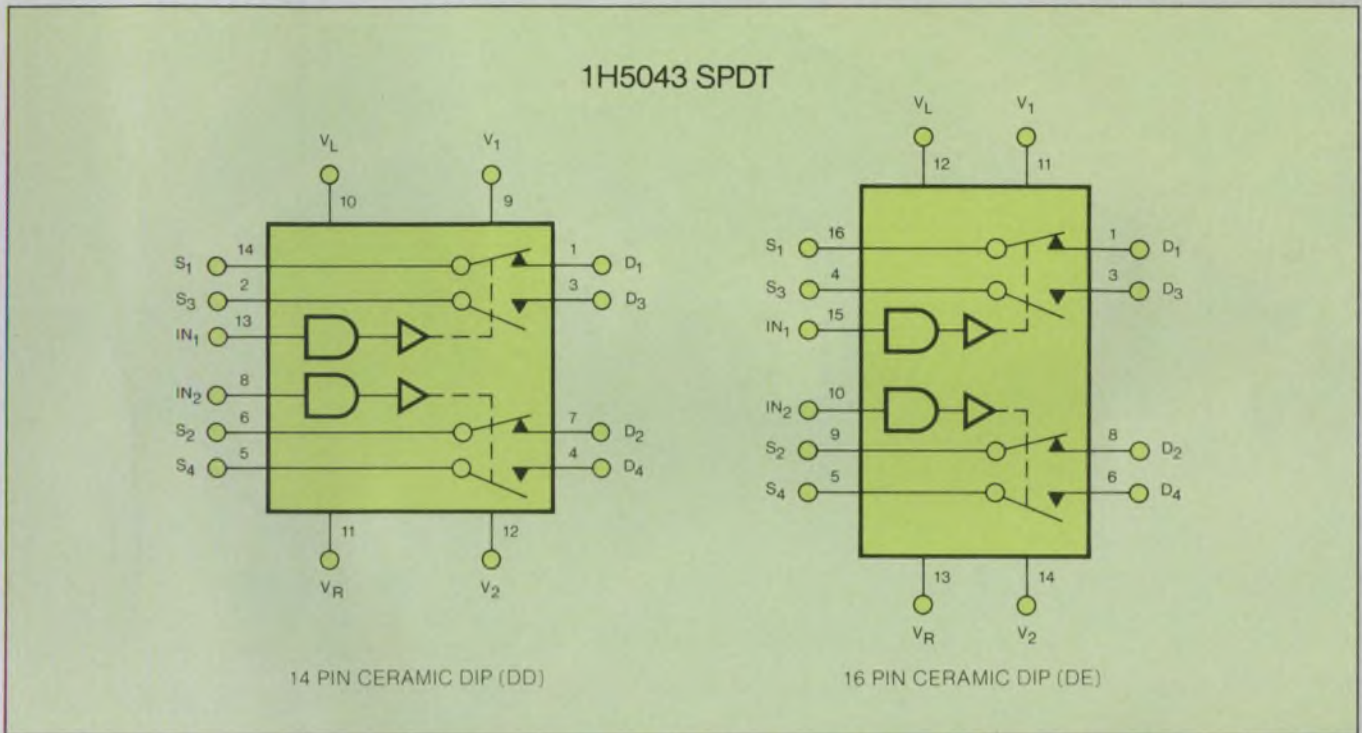

portable and battery operated equipment.

HIGH PERFORMANCE VARAFET CMOS GATES.

Intersil was first with a family of low power, high level Analog Gates: The IH181 Series. The Family incorporates two of our leading technologies: CMOS and VARAFET.

The result is a series of latch proof CMOS gates which draw extremely low quiescent current from power supplies...reducing system power dissipation from milliwatts to nanowatts with no sacrifice in switch performance. The IH181 family is pin for pin compatible with the DG181 family.

LOW COST VARAFET SWITCHES.

The IT401 Quad J-FET Switch with varactor diodes integrated into the gates of the FETS provides high speed, easy to use switches while eliminating the need for external capacitors, diodes and resistors. That means high performance analog switches at lowest possible cost.

INTERSIL SALES OFFICES:

CALIFORNIA: Santa Clara (408) 984-2170, Carson (213) 532-3544 • COLORADO: Denver (303) 750-7004 • FLORIDA: Fort Lauderdale (305) 772-4122 • ILLINOIS: Hinsdale (312) 986-5303 • MASSACHUSETTS: Lexington (617) 861-6220 • MINNESOTA: Minneapolis (612) 925-1844 • NEW JERSEY: Englewood Cliffs (201) 567-5585 • OHIO: Dayton (513) 866-7328 • TEXAS: Dallas (214) 387-0539 • CANADA: Brampton, Ontario (416) 457-1014

INTERSIL

Analog Products — Hybrids/Gates
10710 North Tantau Ave., Cupertino, CA 95014
Tel: (408) 996-5000 TWX: 910-338-0171
(800) 538-7930 (outside California)

Gentlemen, Send me your literature on:

_____ IT401 _____ IH5040
_____ IH181 _____ IH5009

_____ Send me Intersil's New 20x24 Victor Hugo poster.

Name _____

Company _____

Address _____

City _____ State _____ Mailing Code _____

Country _____

CIRCLE NUMBER 8

ED041278

odds-on choice

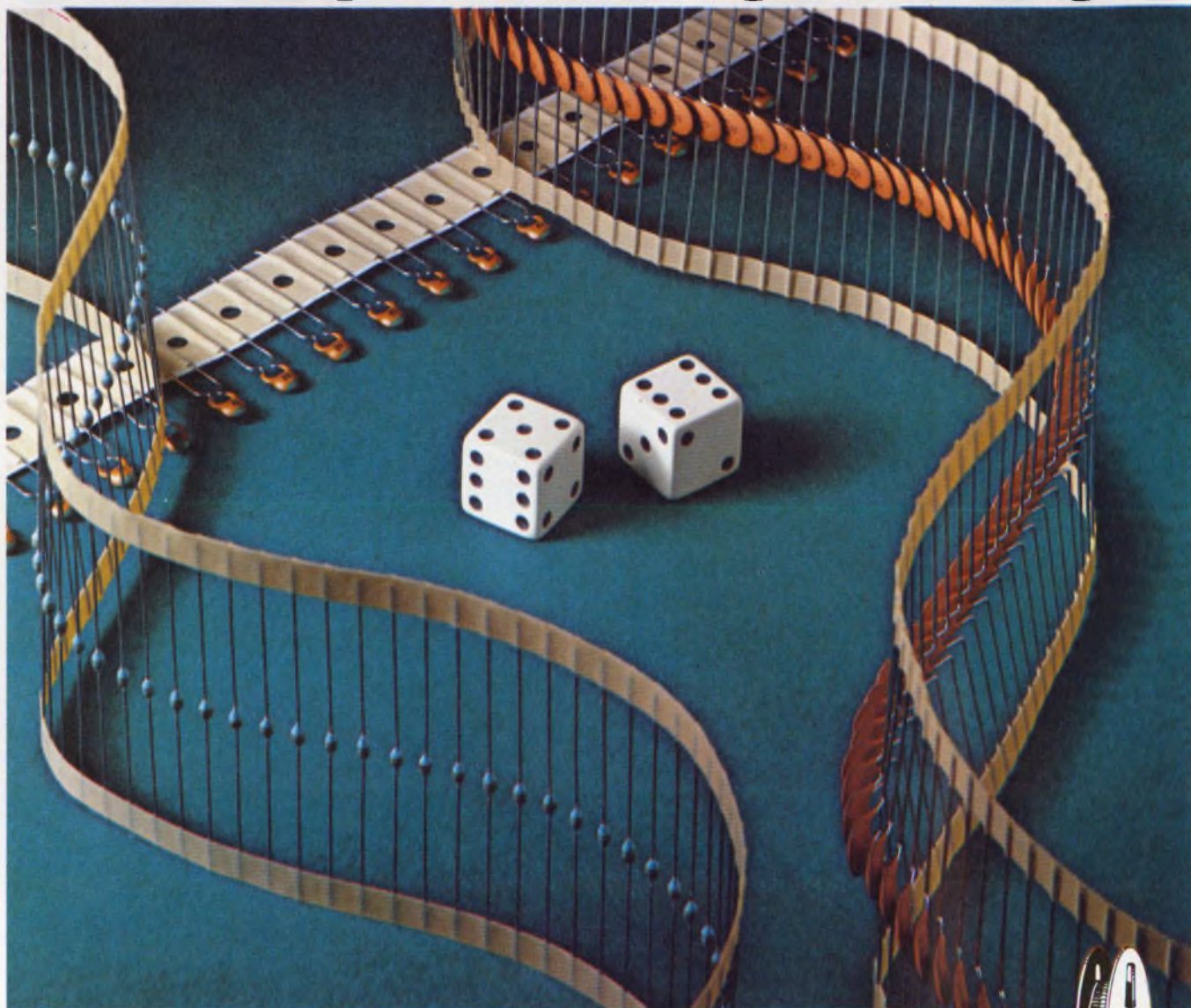

in automatic insertion of ceramic disc and monolithic capacitors

If you're into automatic component insertion, Murata can offer both monolithic and disc ceramic capacitors to meet the specifications of virtually every type of automated insertion equipment including Universal, USM, Panasert[®] and Avisert[®]. What's more, we supply more taped and reeled, and taped and ammo-packed capacitors than any other capacitor manufacturer in the world. That's experience you can count on. To make a good thing even better, odds are our standard capacitor line includes exactly the TC, voltage rating, size and temperature range your application requires.

Make Murata your odds-on choice in capacitors for automatic insertion. Write for our complete catalog to: Murata Corporation of America, 1148 Franklin Road, S.E., Marietta, Georgia 30067. Phone 404-952-9777.

first in ceramics

muRata

CORPORATION
OF AMERICA

WELCOME TO SYN CITY

the one location that
has it all in frequency
synthesizers.

Syn City.



Comstron/Adret offers the largest selection of high quality, value oriented synthesizers and signal generators in the world . . . enough to be a city in itself.

Fully programmable from 0.01 Hz to 1.28 GHz for bench, lab and systems . . . IEEE 488 Bus Option.

You'll find standard models with the exact functions you want . . . models that outperform competitive units at substantial savings.

So, the next time you need a syn, any syn, make your destination Syn City.

Comstron/Adret, The Metropolis of Synthesizers.

- **Model 6300**—Generator synthesizer, 300 Hz - 110 MHz
- **Model 6315**—Generator synthesizer, 400 kHz - 600 MHz
- **Model 6316**—Generator synthesizer, 400 kHz - 1.28 GHz
- **Series 3300/3310**—Generator synthesizer/Frequency synthesizer, 300 Hz - 60 MHz
- **Model 1013**—Frequency synthesizer, 0.1 Hz - 13 MHz in 5 ranges
- **Model 1010**—Spin-wheel tuned frequency synthesizer, 1.0 Hz - 10 MHz in 2 ranges
- **Model 3100**—Generator synthesizer with wired option, 0.01 Hz - 200 kHz
- **Model 2400**—Level generator/Frequency synthesizer, 300 Hz - 14 MHz
- **Model 2430**—Level generator/Frequency synthesizer, 300 Hz - 18.6 MHz for Telecommunications applications
- **Model 5104**—Compact OEM synthesizer for Phase-Locked Sources, 90 to 120 MHz
- **Model 2230**—Generator synthesizer, 10 Hz - 1 MHz for Telecommunications applications

Call, write or circle the reader service number for our full-line Synthesizer Catalog.

The name to remember in synthesizers.

comstron/adret

200 East Sunrise Highway, Freeport, New York 11520 • (516) 546-9700 TWX 510-225-3699



MICRO

Introducing a microprocessor that thinks it's a minicomputer.

Introducing 9440 μ FLAME™ — the world's first 16-bit bipolar microprocessor that executes a minicomputer instruction set with minicomputer performance.

The 9440 μ FLAME microprocessor is a complete minicomputer CPU on one chip, packaged in a 40-pin DIP.

Major applications for the new device include OEM data processing in a variety of computing control and instrumentation environments; telecommunications PBX and PABX switching installations; and distributed intelligence, distributed multi-processing and

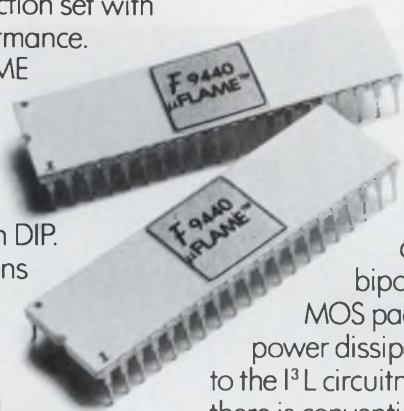

Hot new technology.

The new microprocessor is based on an advanced form of I^2L technology known as I^3L ™ (Fairchild's Isoplanar Integrated Injection Logic). It provides the combined advantages of bipolar high speed and MOS packing density and power dissipation. In addition to the I^3L circuitry on the 9440 chip, there is conventional TTL circuitry which allows TTL interface with other logic, PROMs and RAMs.

Build your own.

Fairchild is offering an introduc-

The software will include a floppy disc operating system, disc operating system and a FORTRAN compiler. New LSI circuits will include a 16K TTL dynamic RAM; a memory control with control, refresh and DMA capabilities; an I/O control, and a hardware multiply and divide capability.

We put the whole 9440 story in a brochure for you. Just write us and we'll send you a copy. For kits and data sheets, contact your Fairchild representative or sales office. Or order direct from Fairchild Camera and Instrument Corporation, MICROFLAME Mail Stop 22-240, 464 Ellis Street, Mountain View, California 94042. Tel: (415) 962-4626. TWX: 910-379-6435.

FLAME™

MICROPROCESSOR

front-end (terminal) processing.

Where there's flame there's fire.

Fairchild is also introducing its FIRE™ (Fairchild Integrated Real Time Executive) software. FIRE I is an initial software package for the 9440 that includes the required development aids: diagnostics, a bootstrap and binary loader, and an interactive entry and debugging program.

In addition, the μ FLAME microprocessor can execute the Data General NOVA 1200 instruction set. FIRE software such as text editor, symbolic debugger and business BASIC are also available now.

tory low-cost kit to familiarize you with the outstanding advantages of the 9440 μ FLAME microprocessor. It consists of the 9440, sixteen 4,096-bit TTL dynamic memories, the SSI/MSI components required for memory control, plus FIRE I software manuals and instructions. You get the entire kit for only \$750. It will enable you to construct an exercise at the board level in your own format.

Only the beginning.

More sophisticated FIRE software, board level hardware and LSI support circuits will become available throughout the year.

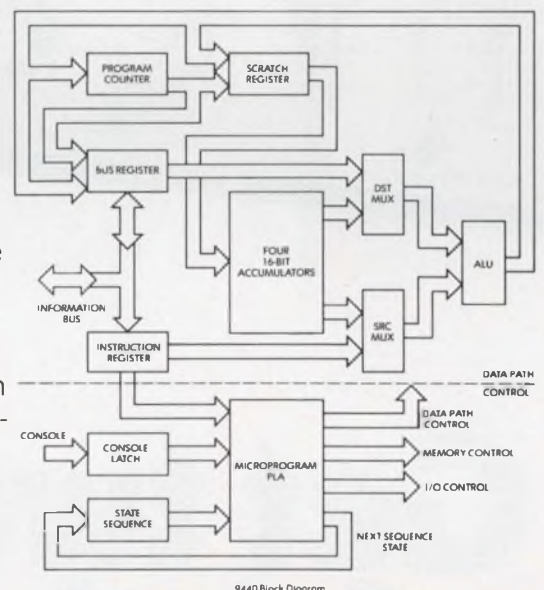

FAIRCHILD

**Call us on it.
(415) 962-4626**

CIRCLE NUMBER 11

If you know signal generators, you know they're typically high-dollar items. You can pay \$6,000 or more for a phase-locked unit, and a programmable with all the goodies can go for \$10K and up. But our Model 3001 is the exception.

First of all, the 3001's base price is just \$2,980. That buys you full frequency programmability, 0.001% accuracy, 1 to 520 MHz frequency range, stability of 0.2 ppm per hour, built-in AM-FM capability, and a front

panel that was actually designed for the user.

Now let's talk options. One lets you lock the 3001 to either an external frequency standard via rear panel BNC input or an internal reference frequency standard with 5×10^{-9} per day stability. And there are others like reverse power protection and auxiliary RF output. But even if you took all these options, you couldn't spend more than \$3,880. Simple arithmetic says

that it's still a lot cheaper to buy two loaded Wavetek 3001s than one Brand X.

At any rate, ask for a Model 3001 demonstration. If the economy alone isn't enough to get you, the performance will. WAVETEK INDIANA, PO. Box 190, Beech Grove, Indiana 46107, Telephone (317) 783-3221, TWX 810-341-3226.

WAVETEK®

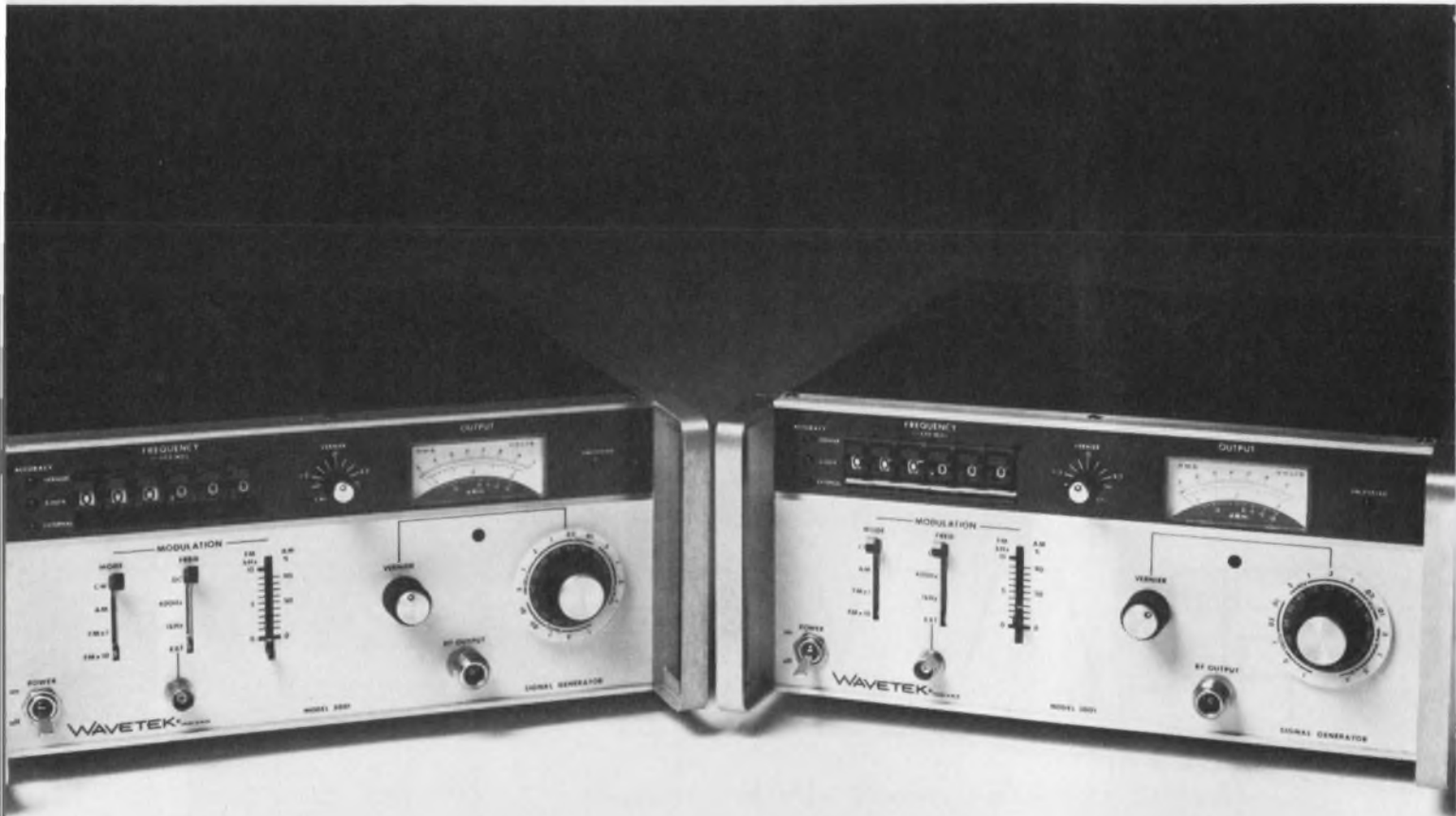

Get two Waveteks for the price of one Brand X.

Portable Weather Station

Rain or shine, arctic or desert,
-20°C to +70°C



Geophysical Monitor

Event-triggered recording to save tape,
batteries and for fast computer data-spotting



Traffic or Noise Level Logger

Accepts analog or digital
(event counter) inputs



Oceanographer's Probe

No outside power needed,
runs on internal batteries

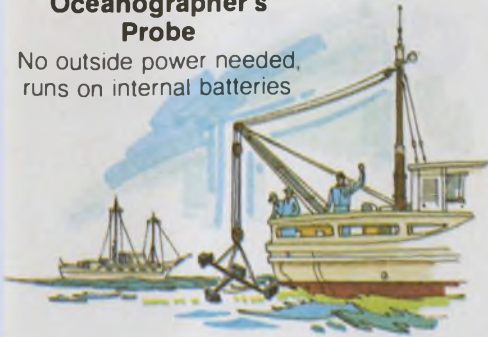

Log your Analog Data on Digital Tape Cassettes . . .



Pollution and Environmental Logger

Crystal CMOS clock
can command different
scan periods

Biomedical Data Recorder

Optional 5 mV
differential amplifier
for low level detectors



DATEL'S DL-2 DATA LOGGER

An Important New Tool- Choose Datel's DL-2 Cassette Data Logger for unattended standby recording of multi-channel, slowly-varying analog samples. The DL-2 samples up to 64 high level or low level analog channels, digitizes them to 12-bit binary coding and records them on a cassette at 5 samples per second. Also recorded are a one year calendar clock with one second resolution produced by an internal CMOS crystal oscillator. And external digital samples (up to 36 bits) may be recorded at any time. Analog scans are started automatically from a preset front panel scan timer with intervals from one second up to 30 hours.

The all-CMOS electronics of the DL-2 and stepper-motor transport consume only one watt while recording and microwatts while powered-down between scans. A set of batteries in the front cover will power the DL-2 for a year or longer, recording up to 120,000 samples

Or external +12VDC or AC power may be used.

The DL-2 features a high-quality instrumentation amplifier (down to $\pm 5\text{mV}$ full scale input) and weather-proof housing and connectors suitable for -10°C to $+60^\circ\text{C}$ environments. (-40°C optional)

A companion DL-2R Cassette Reader offers a convenient playback front end to a minicomputer, microprocessor, TTY, CRT terminal or modem telephone coupler.



1020 Turnpike Street, Canton, MA 02021
TEL: (617) 828-8000 TWX: 710-348-0135

At Power/Mate, fast delivery of open frame power supplies is an open-and-shut case.

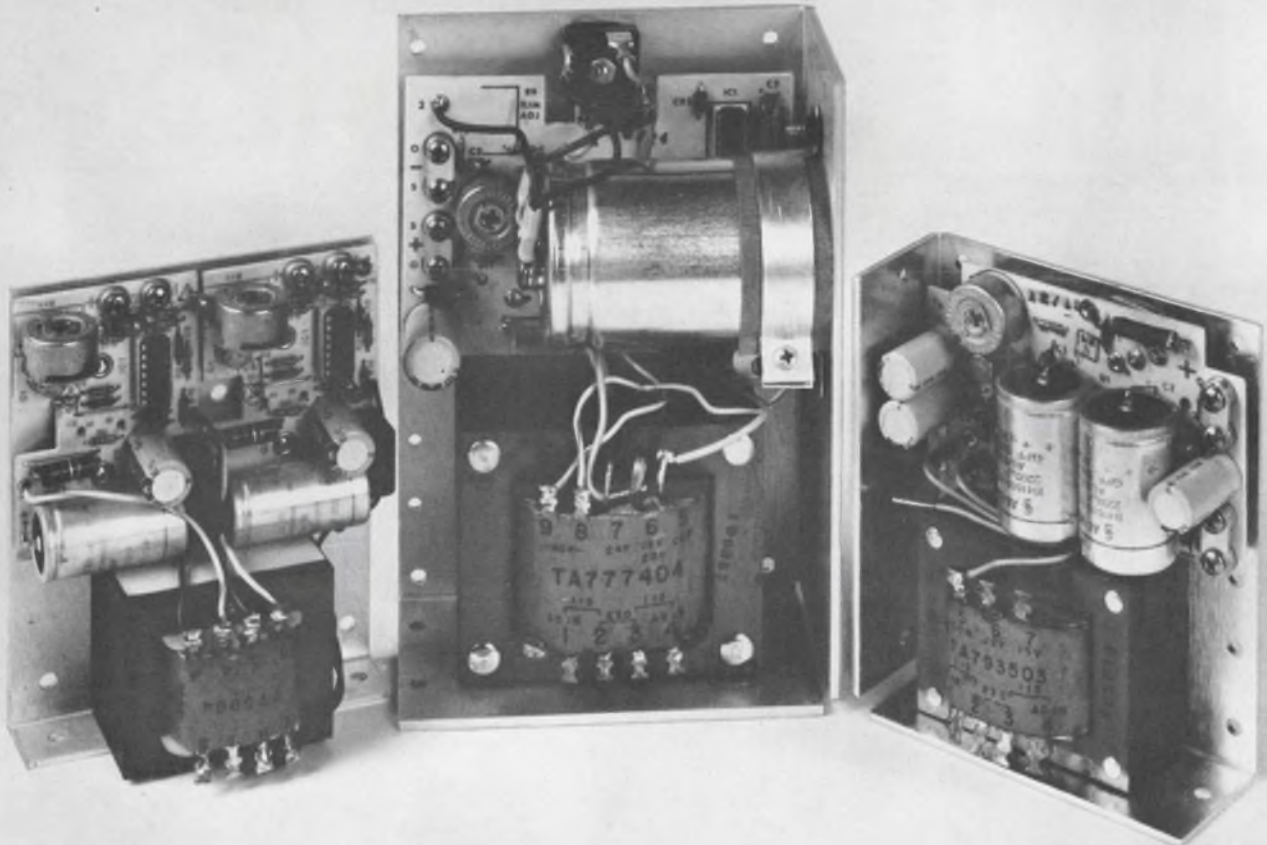

Power/Mate can deliver open frame supplies faster than anyone else in the business.

And that's a fact!

Our Econo/Mate II series is available in single, dual and triple output models with all the built-in reliability you've come to expect from Power/Mate.

But for all its quality features, a Power/Mate open frame supply is still, most of all, economical.

We wouldn't call it Econo/Mate if it wasn't.

Our Econo/Mates are stocked in-depth, along with our switching-regulated, miniature, modular, sub-modular and lab supplies.

All ready for immediate delivery from our East or West Coast plants.

And Power/Mate stands behind each and every power supply we make.

We've been doing it for fifteen years.

So if you're looking for a power supply today, from a company who will still be here tomorrow, look no further.

Call Power/Mate.



POWER/MATE CORP.

514 S. River St./Hackensack, New Jersey 07601/(201) 343-6294/TWX (710) 990-5023
17942 Skypark Circle/Irvine, California 92714/(714) 957-1606/TWX (910) 595-1766

The world's largest supplier of quality power supplies.

The Portable Data Logger

10 Analog Channels • Thermal Printer • 4-1/2 Digit DPM • 99 Min/Sec Timer

Datel has it, Model PDL-10—the portable approach to measuring, scanning and logging analog signals. Its small size allows it to be positioned near sensors and test apparatus. That means less cabling, lower noise, and lower cost. And the convenience of operating your data logger right next to laboratory equipment. Weighing only 12 lbs. (5,5 Kg), the PDL-10 is easily carried to different measurement sites.

But Datel hasn't sacrificed performance for portability. Ten input channels are provided, along with a 4-1/2 digit panel meter, a 7-column thermal printer for instant hard copy printout, scan electronics, and a 99 Min/Sec Scan Interval clock. Other features include multirange capability for each channel (± 200 mV, ± 2 V, ± 20 V), relay-switched differential inputs, and for further flexibility, individual SKIP controls for each channel.

Thus, the user may monitor any desired number or combination of channels.

The high performance and versatility of the PDL-10, together with its small size and weight, make it ideal for bench-top operation in laboratory and industrial applications where slowly varying signals from bridge transducers such as thermocouples, strain gages, and pressure sensors are to be monitored and recorded. In addition, the excellent common-mode rejection of the PDL-10 provides high noise immunity in industrial applications.

Input connections are made through convenient screw terminals on the rear panel. Operation requires no special training or knowledge and will usually be mastered within a matter of minutes.

Send today for the free 12-page brochure detailing PDL-10's capabilities.



D **DATEL**
SYSTEMS, INC.

CIRCLE NUMBER 15

Meet our better half's family.

Our better half from TI. It's the edgeboard connector half of a PC board/edgeboard connector system. And definitely today's best value.

Its glass-filled thermo-plastic polyester contact housing meets U.L. Flammability Classification 94V-0 to make our better half better.

Its functional and dimensional interchangeability with common one-piece edgeboard connectors gives you price and delivery advantages and makes our better half better.

Its construction, designed to meet or exceed demanding military performance specifications (MIL-C-21097), makes our better half better.

Its minimum 50 micro-inches wrought gold inlay (75μ " for solder tail terminations) provides greater reliability at contact mating surfaces to make our better half better.

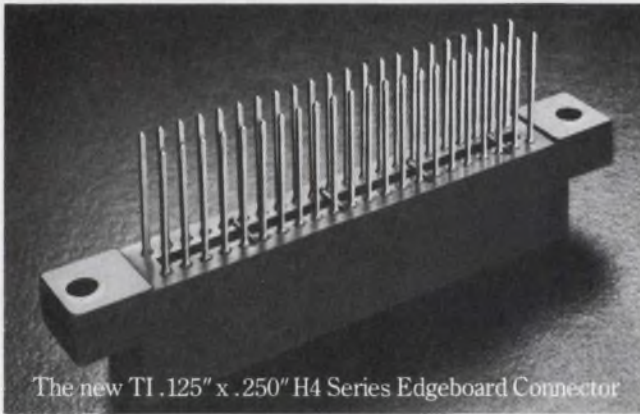

The new TI .125" x .250" H4 Series Edgeboard Connector

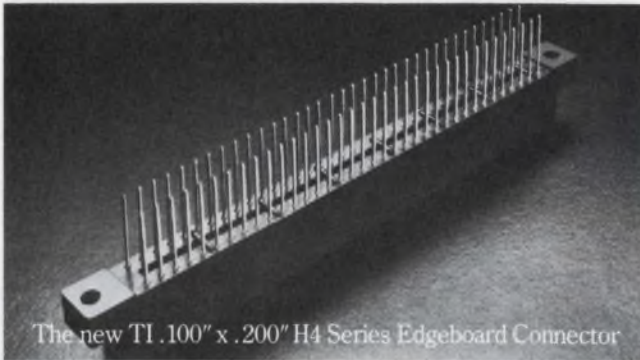

The new TI .100" x .200" H4 Series Edgeboard Connector

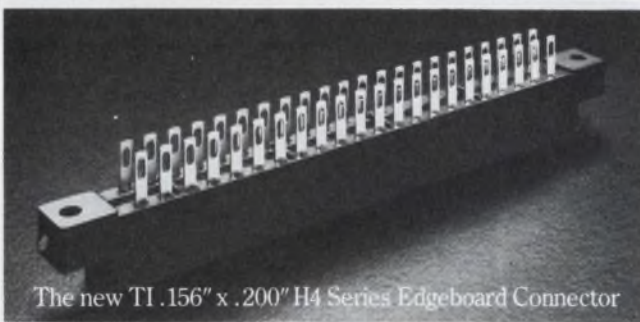

The new TI .156" x .200" H4 Series Edgeboard Connector

Its off-the-shelf availability through our extensive nationwide distribution network makes our better half better.

Its bifurcated contacts provide greater connection reliability to make our better half better.

Its between-position polarizing key system allows more efficient use of the connector to make our better half better.

Its practical design coupled with our low, low prices (as exemplified by our low cost IC's) make our better half better.

Its alternative termination styles (.100" & .125" style in solder tail and wire wrap; .156" style in solder tail and pierced solder), and mounting ear configurations give more application flexibility to make our better half better.

Texas Instruments Incorporated
Mail Station 2-16, Attleboro, MA 02703
I'd like to meet T.I.'s better half.
Please send information on your Better Half's Family
of new H4 Series Edgeboard Connectors.

- For an immediate application.
 Please contact me directly. For reference.

Name _____

Title _____

Company _____

Area Code _____ Phone _____ Ext. _____

Address _____ Mail Station _____

City _____ State _____ Zip _____

ED



TEXAS INSTRUMENTS

INCORPORATED

CIRCLE NUMBER 16

The 8080 A/D & D/A Advantage

super-software supplied • fast, on-card DMA logic • 80 (to 256) channel expansion from just 2 cards

Datel's SineTrac 800 has it. SineTrac 800 slide-in A/D and D/A cards provide a complete analog "front-end" inside your Intel MDS-800 or SBC-80/10/20 microcomputers.

SineTrac 800 is ideal for industrial data logging, process loops, and high speed data acquisition systems.

The A/D card contains 32 single-ended or 16 differential channels with 12-bit resolution. An A/D Expander card offers 48 additional channels. Thus, two cards give 80 single-ended or 64 differential channels! Card addressing allows expansion to 256 channels. Throughput is 20 microseconds with rates up to 36,000 samples/second in DMA mode.

SineTrac D/A cards contain either 8 channels or 4 channels.

More SineTrac system advantages include on-card start and final address register/counters to save time and CPU housekeeping, and an adjustable IC scan clock with interrupt-flagged scan markers for event-triggered or internal scan starts.

The paper tape diagnostic test programs, supplied, allow channel calibration and a multi-scan accuracy test with decimal printout. The programs diagnose error conditions, give a descriptive TTY printout between selected channels, and continuously loop for scope or logic analyzer troubleshooting.

A/D or D/A cards are \$650* (singles). Write today for complete details.

*U.S.A. domestic prices only

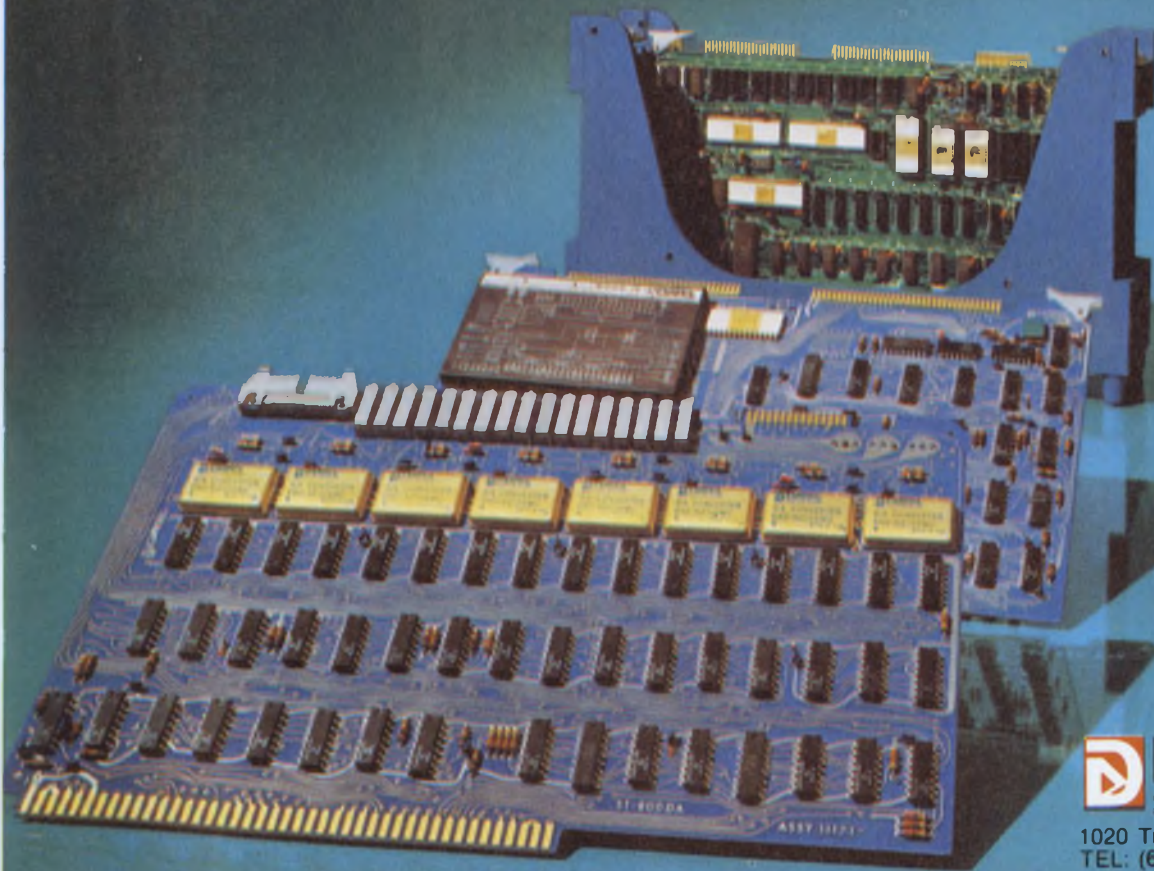

DATEL
SYSTEMS, INC.

1020 Turnpike Street, Canton, MA 02021
TEL: (617) 828-8000 TWX: 710-348-0135

**DATA PRECISION
MULTIMETERS...**

**WHEN YOU WANT
THE BEST ON
THE BENCH.**



Data Precision's leadership in digital instrumentation is based on high-value product planning, years-ahead engineering, and painstaking quality control. As a result, nearly 100,000 Data Precision instruments are now providing dependable service, at sustained accuracy, all over the world.

In addition to the following bench instruments, Data Precision manufactures a complete line of portable and system multimeters and portable and bench counters.



MODEL 1350
Full Function 0.1% Accuracy 3½ Digit DMM With Extra Fault Protection \$169.00

This new DMM features both Hi/Lo excitation on its resistance measurement mode, 5 ranges each of DC and AC voltage and current measurement, and excellent protection from damage, both physical and electrical. The 1350 comes complete with test leads and complete documentation.



MODEL 1750
Extra Function 3½ Digit Bench/Portable DMM Includes Current to 10 Amperes, dBm, Hi/Lo Ohms, True RMS and Field Installable Battery/BCD Output \$279.00

Designed for flexible, high precision applications our new Model 1750 offers 36 ranges and 6 functions. In addition to all standard measurements it measures -60 to +20 dBm, current to 10 amps and reads all AC directly in True RMS. Both optional rechargeable battery pack and isolated BCD output are field installable.



MODEL 3400
Lab/Systems 4½ Digit Autoranging Multimeter \$795.00

The Model 3400 is the world's most accurate systems/lab full function 4½ digit multimeter. It is a fully programmable systems multimeter as well as a highly versatile stand alone autoranging instrument with 2 and 4 wire resistance, remote triggering and AC/DC, DC/DC voltage ratio measurement in addition to DC and AC voltage ranges. Also available with IEEE STD 488 interface (Model 3410).

MODEL 3400R
With True RMS \$895.00

The same specifications and features as Model 3400 but with True RMS AC volts. Model 3400R is also available with IEEE STD 488 interface.



MODEL 3500
Autoranging Lab/Systems 5½ Digit DMM With 1µ Volt/1 Milliohm Sensitivity DC and AC \$995.00

The Model 3500 offers autoranging, remote ranging and trigger, 2 and 4 wire resistance measurement, DC and AC voltages plus DC/DC and AC/DC ratio measurement, BCD output with a basic DC accuracy of ±.007%.

For complete information or a demonstration, contact your local Data Precision representative or Data Precision Corporation, Audubon Road, Wakefield, MA 01880, USA, (617) 246-1600. TELEX (0650) 949341.

Prices U.S.A.

 **DATA PRECISION®**
...years ahead

Visit us during ELECTRO '78 in Boston at Booths #2224-26-28.

FOR DEMONSTRATION CIRCLE NUMBER 18

FOR INFORMATION ONLY CIRCLE NUMBER 19



Hybrid Systems: Recognized For Experience

The right kind of experience. In the toughest jobs. In the most demanding environments. For more than a decade, Hybrid Systems has been building products that stand up to every challenge. Data converters. Thin film resistors. Hybrid IC's.

We're proud of our record as a world leader in thin film technology, and we fight hard to protect it. Our expertise in hybrid integrated circuit converters, for example, is backed by the design and manufacture of hundreds of different modules incorporating proprietary thin film nichrome ladder networks for superior tracking and matching.

Our manufacturing techniques are MIL-certified. Hybrid Systems' products all meet MIL-M-38510C Class B standards by 100% screening per method 5004.3 of MIL-STD-883A. Class A processing can be provided. And you can call on our decade of front-line experi-

ence to rigorously control every step of the manufacturing process and to work closely with your engineers in system design and in the field.

Not all our products are for defense. But we design our commercial and industrial products the same way as the military ones. Send for our latest catalog. It presents 12 new series of hybrid IC data converters—a dozen more ways in which you can benefit from our experience.



When the chips are down...

Hybrid Systems

CORPORATION

Crosby Drive, Bedford, MA 01730
Phone (617) 275-1570
(TWX 710-326-7584 HYBRIDSYS BFRD)

In Europe: Hybrid Systems GmbH, 61 Darmstadt, Luisenplatz 4, Germany
Tel: 6151-291595 (TELEX 419390 HYSY D)

In The United Kingdom: Hybrid (Component) Systems U.K. Ltd
12A Park Street, Camberley, Surrey
Tel: (0276) 28128 (TELEX 858720 HYBRID G)

A/D & D/A Converters • Thin Film Resistors • Hybrid Integrated Circuits

CIRCLE NUMBER 20

Binary-coded magnetron shifts frequency in ns

A binary-coded, electronically-tuned pulse magnetron now in the feasibility stage shifts its frequency extremely fast—in nanoseconds—according to a digital control signal. Not only does it provide direct digital control of frequency, but the magnetron will be simpler and cost less than the oscillator-amplifier chains now used for rapid frequency shifts at high power.

So fast is the tuning that "during the pulse, [the magnetron] can sweep through a whole bunch of digitally processed frequencies," according to Dr. Chester G. Lob, technical director of Varian Associates (Beverly, MA) where the magnetron is being developed. Such frequency agility is welcome in sophisticated radars. With it, they are able to cope with ECM better. Pulse-compression radars in particular will put this swift tuning to good use. In such a radar, a high-peak-power pulse is "simulated" by transmitting a long, moderate-peak-power pulse that changes frequency in a well-defined pattern. A filter in the receiver, matched to this pattern, converts the received pulse into one that is much narrower, and also has much higher peak amplitude. Range resolution is as good as the narrow pulse would give.

Up to now, electronic tuning hasn't been very successful in high-powered pulse magnetrons. Indeed, mechanically-tuned magnetrons, around for decades, are still being developed. However, Varian is developing two electronic schemes, and the binary-coding idea is an extension of them. In the Varian magnetron, each bit of the binary-coded frequency-command signal has its own auxiliary cavity. These cavities are coupled to the main anode's resonator structure; each cavity shifts the magnetron's frequency by a different, binary-weighted amount. Inside each cavity, an rf switch, operated by the digital signal, opens or shorts an appropriate point in the cavity to change the susceptance that is reflected back to the main resonator. Thus,

the magnetron's frequency is shifted.

Switching is done by p-i-n diodes or by multipactor (from "multiple impacting") discharge. The latter is a secondary-emission effect that occurs in an rf field above a certain power level; electrons accelerated by the rf field hit a secondary-emitting surface and knock loose more electrons. The process continues until a space charge develops, and the rf field is absorbed and converted to heat.

A commercially-available digitally-tuned magnetron is still several years away, according to Dr. Lob.

Powerful lasers may make good power transmitters

Transmitting power through space by high-energy laser beams may become a reality. Experiments using a "thermo-electronic laser-energy converter" have, for the first time, demonstrated the feasibility of converting a laser output directly into dc power.

The Telec, developed at the NASA Lewis Research Center in Cleveland, is basically a vacuum tube with a filament, or thermionic emitter, and an electron-collecting electrode. Most important, a low-pressure gas in the tube provides a plasma-arc discharge. Adding laser energy to the plasma produces the converter output.

The Telec feasibility model is a small device using a low-power laser, according to Don Alger, Telec project manager at NASA Lewis. The Telec cell produces an open-circuit voltage of 2.5 V and a short-circuit current of about 0.7 A. Work is now proceeding on a larger Telec converter, to be tested in June, that will accept the input of a 10-kW laser beam. An output greater than 2 kW is expected from this converter says Alger, although the theoretical efficiency of the system is 50%.

The present Telec system is a version of a device proposed several years ago. In the early version a plasma is created within the tube by a surrounding rf field. This field increases the energy of the electrons from the thermionic emitter, which are captured by a collector electrode surrounding the plasma to produce the dc output.

In the new system, an arc between electrodes initiates the plasma discharge, and the laser beam is focused onto the tube to maintain the discharge. At the same time it adds energy that appears as the dc output.

Theoretical studies by Ned Rasar of Rasar Associates, Sunnyvale, CA, who first proposed the present Telec system to NASA in 1973, suggest that the system can be scaled up to produce as much as 10 MW.

Molded printed-circuit holds chips flexibly

Mounting contact pads and wiring on a resilient rubber backing forms a flexible assembly that can hold leadless hybrids and chip carriers as well as more common circuit components.

The stiffness of the silicone rubber substrate can be varied from place to place in the assembly. The most sponge-like areas can cushion the non-conducting parts of components mounted on the substrate, or act as hinges, or provide pressure where external connections interface with the assembly. More rigid sites can act as IC-chip bonding, discrete component soldering or mechanical-attachment points.

Elastomer and conductive paths can be molded with raised areas for high-pressure electrical contacts that seal

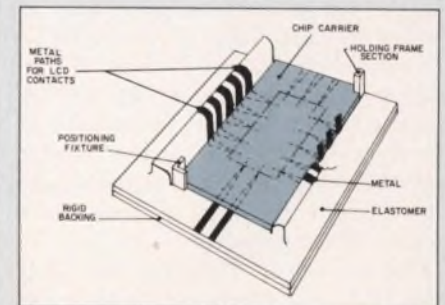

A molded elastomer holds an IC that is packaged in a chip carrier. A liquid-crystal display can be mounted on top to connect with metal conducting paths.

against atmospheric contaminants. Components and mounting hardware can be accommodated in depressed areas.

Metal paths, generally nickel, can pass from flexible to rigid areas and between raised and depressed areas without breaks. The metal can be plated with another metal, such as gold, and assemblies have been made with nickel and gold plating over copper. Moreover, parts of the metal paths can be coated to insulate and protect from mechanical abrasion.

The rubber-backed unit can include a rigid backing not only to give it more mechanical strength but also to simplify mounting in a final assembly.

The most common application will probably be chip-carrier sockets, says Len Buchoff, technical director at Hulltronics Inc. (Hatboro, PA), where the technique is being developed. An integrated circuit housed in a leadless chip-carrier package can be plugged into a metal-on-elastomer socket that is either an integral part of a larger metal-on-elastomer assembly or mounted on a conventional PC board.

Another possibility, says Buchoff, is to reflow-solder an unpackaged chip into a well in a metal-on-elastomer assembly, then seal the chip with an epoxy or silicone fill. This technique may prove valuable where thinness is desirable, as in digital watches.

Three-point probe tracks faulty ICs on PC boards

The latest instrument for tracking faults on PC boards down to the errant component uses an injected ac signal and a three-point probe to determine which lead connected to a signal bus is keeping the bus stuck high or low.

Called the Electronic Knife, the probe has a red light that turns on when all three leads at the probe tip are connected to one IC lead. A low-level ac signal, injected through the outside contacts, superimposes an ac current on the dc current flowing through the lead. An ac signal is used to eliminate the effects of thermals and other offset voltages.

Developed by Teradyne Inc. (Boston, MA), the Electronic Knife is used with the firm's L135 LSI board-test system. The L135 determines the impedance in each direction along the IC lead, and flags the device with the lowest impedance to the node. Generally, it's this device that controls the bus

and keeps it stuck at the wrong state.

Fault tracking with the Electronic Knife follows a standard guided-probe procedure for tracking down faulty nodes. Once a PC board has failed a test, the test system directs an operator to probe various points on the board until the node causing all subsequent nodes to fail has been located. Unfortunately, more information is usually needed to proceed with a repair.

To repair a failed board, the faulty component has to be located. With the Electronic Knife, the L135 system directs the operator to probe the pins of each device connected to the faulty node until the faulty component is isolated.

Other approaches to the same problem include the GenRad Inc. Bug Hound Model 2220 (see ED No. 19, Sept. 13, 1977, p. 21). The Bug Hound senses the magnitude and phase of magnetic fields around printed wires to determine where a fault current is flowing. Available as part of a GenRad test system or as a separate benchtop instrument, the Bug Hound goes for under \$800.

A magnitude-sensing current tracer that performs the same function is available from Hewlett-Packard's Santa Clara Division. The Model 547A current tracer is available only as a hand-held, independent instrument, while the Teradyne probe can only be purchased as part of the L135.

μ C phone will dial, compute, tell time

Soon your telephone may remember your favorite phone numbers and dial them for you, tell you the time of day and the length of your call—and double as a scientific calculator whether you're on the phone or off. The key is a standard microcomputer.

Prototype electronic phones with the advanced features have been built by General Instrument Microelectronics (Hicksville, NY) to demonstrate the capabilities of the company's standard PIC1650 microcomputer, preprogrammed for use inside the telephone instrument. For the telephone application, modular firmware was included in the on-chip ROM in the basic NMOS 8-bit μ C.

The masked 512 \times 12-bit ROM firmware lets an OEM designer implement any or all of the following functions: storage of up to thirty-two 12-digit phone numbers, an up-to-12 digit

display, either a scientific or a four-function calculator, and a time-of-day clock with or without the elapsed-time feature. Various numbers of additional standard chips are needed for these implementations.

General Instrument's specialized μ C chip, now in development and scheduled for spring sample production, uses its microprocessor to time the generation of dial pulses. Future versions will permit the 1650 to be interfaced to a tone-dialer chip.

While the first version will also use volatile RAM memory to store phone numbers, later versions will offer non-volatile EAROM (electrically alterable read-only memory) so that stored numbers will be retained should telephone-system power fail.

Automatic Nav receiver frees pilot's fingers

Using a computer-controlled aircraft navigation receiver, a pilot doesn't have to seek reliable VHF-omnirange (VOR) station signals by hand anymore. Not only does the receiver do the selecting automatically, it even displays a selected number of station bearings repeatedly as the plane flies along. These data are fed into the computer to give the pilot a continuous "fix" on his position.

The new VHF scanning receiver/computer system, developed by Ohio University in Athens for NASA, uses an rf front end with digital control of its frequency synthesizer to scan a 200-channel range between 108 and 118 MHz. The rf front end's tuning control is TTL-compatible, and in the original NASA version uses a Hewlett-Packard HP-9825 desktop calculator to simulate a navigation computer. Flight tests for NASA in the San Francisco Bay area have demonstrated system feasibility.

But now a lower-cost general aviation model is being developed by Dr. Robert Lilley, assistant director of avionics engineering at the university. For this version, a MOS Technology 6502 microcomputer is being integrated as the 8-bit computer control. To avoid the time delay in the slewing of the AGC-voltage level of one station to that of another whose signal is much stronger, the AGC function has been removed from the receiver and put under computer control. The computer remembers the AGC level associated with the different stations and correlates the voltages with each useful station frequency.



BENDIX BRISTLE BRUSH BUNCH.

Opens new horizons for PCB design.

70%-90% Reduction in Mating and Unmating Forces

- simpler board support systems
- fewer damaged boards

Extended Circuit Count Potential

- up to 400 Bristle Brush contacts per connector

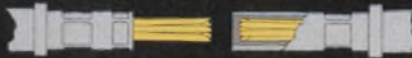

Extensive Product Line

- mother board, daughter board, input/output, PC receptacle body styles
- 2-, 3-, and 4-row configurations
- 90° and straight PC, solderless wrap, crimp removable, willowy tail terminations

For complete information, contact The Bendix Corporation, Electrical Components Division, Sidney, New York 13838.

Bendix

Converters are finally blasting off, and μ P compatibility is the fuel

After years of sluggish growth, data converters are on the verge of becoming a bright new star in the semiconductor galaxy—and perhaps even eclipsing the widespread aura of microprocessors. The signs are encouraging:

- Converters in monolithic IC form are cutting into the territory dominated by discrete-component (modular) and hybrid types. At the same time, hybrids are moving into high performance, the domain of discrete designs.

- Data-acquisition and other converter-intensive subsystems are benefiting from two developments: More functions are being squeezed under one roof in both monolithic and hybrid circuits, and interest is perking up in dedicated analog-I/O PC boards.

- Microprocessor compatibility has become a must for data-conversion products, whatever the packaging.

- Nonlinear and specialized converters—voltage-to-frequency, logarithmic, companding, codecs and the like—are getting more action.

This rapid converter progress on several fronts is bringing higher resolution, faster speeds, a dramatic tumbling in prices, radical size reductions, and better linearity and tempcos with fewer adjustments (not necessarily all together). But with change comes new controversies, and more questions than answers.

What, exactly, is μ P compatibility? Which reference is best—external, buried zener or band gap? Which form of trimming yields the most stable results, especially in the long run? Should a converter be placed on one or a few chips for best performance and cost? How should functions be partitioned among the various elements in a converter-microprocessor system?

Finally, which IC technology—

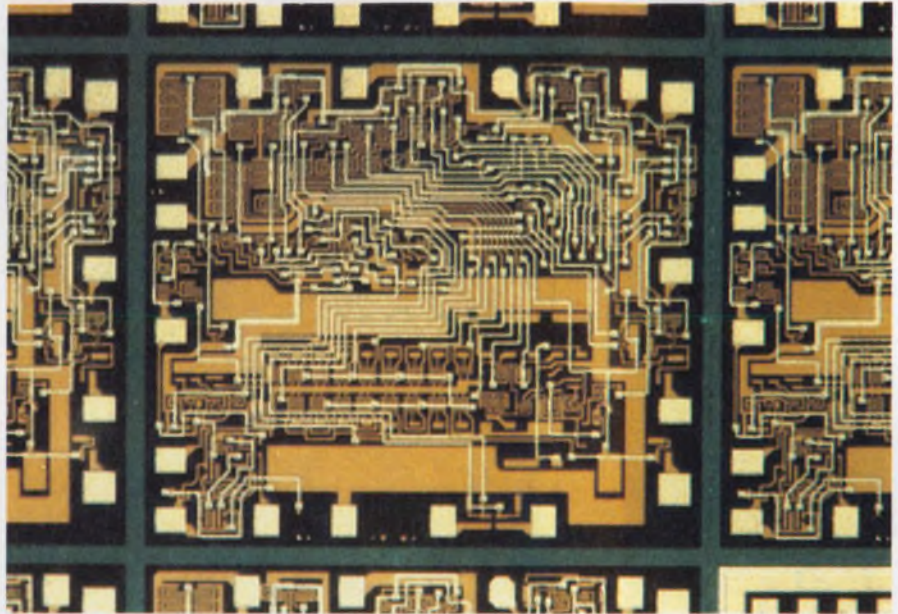

Digitizing video signals is the target of many new high-speed converters, both in monolithic and hybrid form. Motorola's MC10318—an 8-bit unit with a 10-ns settling time—demonstrates the progress in ICs.

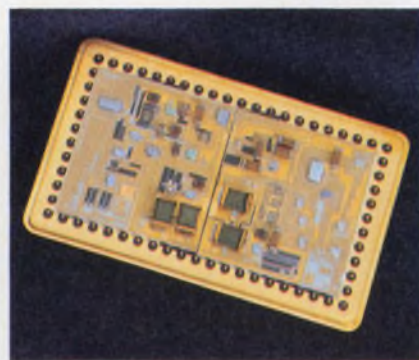

The first hybrid data-acquisition system, the Datal HDAS-16MC, packs 16 channels of 12-bit conversion in a miniature, 62-pin package. And it sells for only \$295.

bipolar, CMOS, I²L or a combination—will produce the performance needed to capture the lion's share of the converter market?

At the moment, there aren't any clearcut answers. At the same time, pressure is mounting for second-sourc-

ing and standardizing—at least in interfacing. And new μ Ps on the horizon will clutter the situation even more. One thing is clear, however. The future for high-volume, low-cost converters belongs to ICs.

Territorial bites

Monolithic data converters, in various forms, have been nibbling away for 10 years at territory traditionally held by packaged discrete modules and hybrid circuits. ICs have already captured most low-performance 6 and 8-bit applications, and now threaten to do the same to 10-bit designs. With the expected groundswell in converter- μ P systems, IC manufacturers are gearing up to turn their nibble into what they hope will be sizable bites.

Improved IC processing, advanced LSI techniques and new circuit designs are teaming up to produce much better a/d and d/a converters. And now

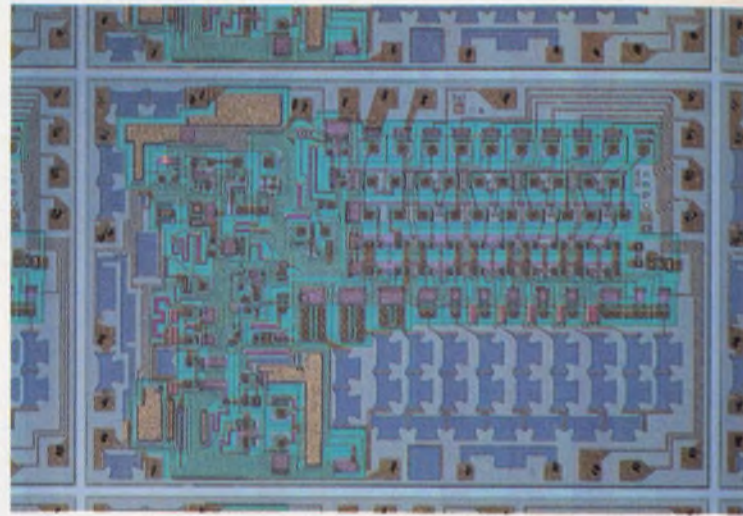
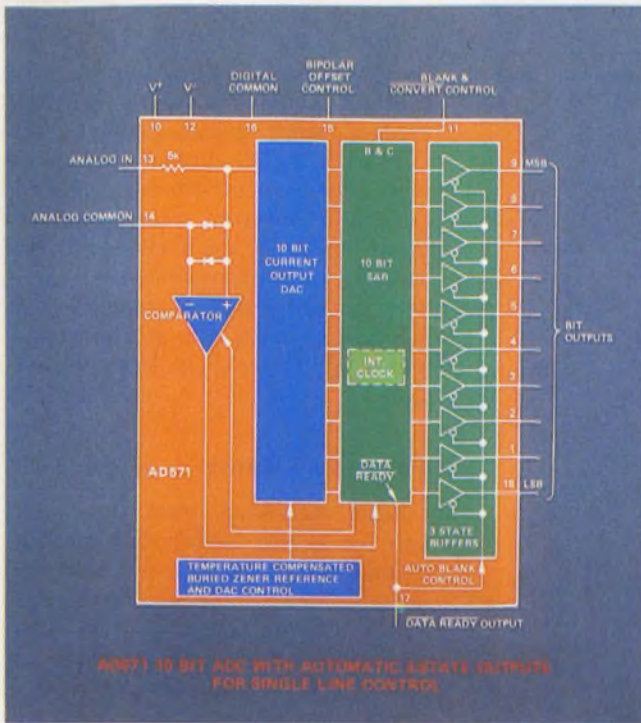

Monolithic-converter circuits have progressed to where an entire 10-bit, successive-approximation a/d can be made in one piece of silicon (left). Not only that, but the digital outputs are bus-compatible for μ P interfacing. Another converter (above), a bipolar 10-bit d/a sells for \$10 and contains a buried zener (Analog Devices).

monolithics are moving into the 12-bit range in resolution, into the sub-microsecond range in speed and into eye-opening price categories—under \$15 for 12-bit d/a's and below \$2 for 8-bit units. A/d-converter prices are dropping, too, even as their performance climbs.

Absolutely startling is the growing complexity of individual chips. Voltage references and output amplifiers—rare items on many converter chips—are moving on-board with increasing frequency. Input registers, three-state logic, handshaking control and other interfacing circuits are appearing in practically all new designs. And most amazing, entire data-acquisition systems have been packed onto one chip.

In recent months, a flurry of new monolithic devices has been unwrapped by more than a dozen vendors:

- Fast bus-oriented multiplying d/a converters that are compatible with TTL, MOS or CMOS, and have a guaranteed "negative" data-hold time (Advanced Micro Devices, see ED No. 7, March 29, 1978, p. 114).

- A 10-bit successive-approximation a/d converter that is built with a combination of I²L and bipolar processing and includes a buried zener, clock, control logic and three-state outputs for μ P interfacing (Analog Devices). Another Analog product, a 12-bit multiplying CMOS d/a with true 12-bit linearity, sells for only \$12.00.

- 10-bit successive-approximation and tracking a/d converters using dif-

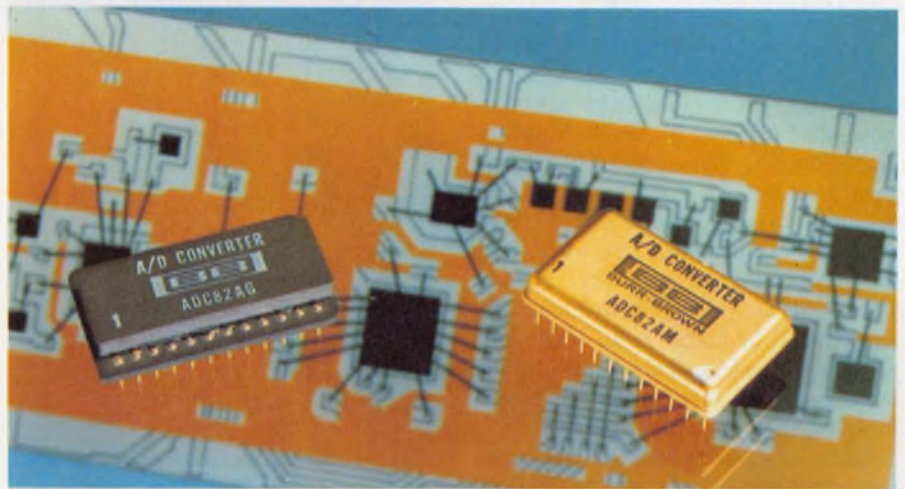

Hybrid converters are entering performance areas previously dominated by discrete designs. Burr-Brown's ADC82 is laser-trimmed to reduce adjustments.

fused resistors that require no trimming (Ferranti Ltd. of Great Britain).

- A 12-bit d/a that settles to within $\pm 1/2$ LSB in a maximum 400 ns (Harris Semiconductor).

- An integrating two-chip a/d with up to 16 bits of resolution and compatibility with both UARTs and μ Ps (Intersil).

- An 8-bit, 10-ns d/a intended for high-speed video applications (Motorola).

- A single-chip data-acquisition system with a 16-channel multiplexer and an 8-bit, three-state-output a/d converter (National Semiconductor).

- 10-bit d/a converters that include both reference and output op amp, yet

settle in 1.5 μ s and consume only 350 mW over the full military temperature range (Precision Monolithics, which introduced the first complete monolithic d/a converter eight years ago and the first companding d/a last year).

- A processor-compatible d/a with voltage reference, buffer amplifier and an 8-bit input latch (Signetics).

- A two chip, 4-1/2-digit a/d for digital-volt and digital-panel meter applications, built with combined PMOS and bipolar processing (Siliconix).

- An 8-bit parallel a/d converter that packs in 256 comparators and converts at a sizzling 50-ns rate (TRW LSI Products, See ED No. 7, March 29, 1978, p. 116).

These are but a sprinkling. Moreover, the converter metamorphosis is far from over, according to papers presented at the International Solid State Circuits Conference held recently in San Francisco. One chip announced at that meeting: a CMOS 12-bit, 8-channel data-acquisition system with triple-state buffers, read/write interface and address-decoding logic—all powered by a 5-V supply. Developed by Tokyo Shibaura Electric Co., that chip, among others, is like a bell tolling for the days left to the converter as an individual component.

But though subsystem and system-like converter designs in both IC and hybrid form are clearly the wave of the future, the configuration isn't quite so clear. But before that issue is settled, there is a broader question to be answered: What constitutes true processor compatibility?

Converters bubble over

The microprocessor explosion, which has caused the converter cauldron to really start bubbling, has also rejuvenated interest in analog interfacing. Physical parameters like temperature, pressure and velocity are usually measured as analog signals, which eventually must be converted to the digital form needed by the μ P. Thus, a/d converters are figuring more and more in data acquisition and process-control systems, and, in fact, are expected to surpass d/a converters in sales soon.

Right now, there are few converter vendors who don't claim to be the first with "true" μ P compatibility. Most of the action here is in 8-bit converters intended to mate with μ Ps of the same resolution. But the 10 and 12-bit IC sectors are revving up. Analog Devices is still the sales leader, but is being challenged by AMD, Fairchild, Harris, National, PMI, Texas Instruments and others. Motorola, probably the 8-bit leader, is seeing more competition too.

The requirements for compatibility depend on who's talking. Some feel that a converter should be dedicated to one μ P. Others see "wide-range" converters as the way to go. In general, memory mapping and accumulator I/O are the two basic ways to hook up to a μ P.

Under these two "umbrellas," a bunch of features is being offered as "proof" of compatibility. Among them: latched or byte-oriented, three-state outputs and double-buffered or latched



First of its kind: This single-chip data-acquisition system includes an 8-bit a/d with Tri-state outputs, a 16-channel multiplexer and logic control to interface μ Ps (National).

inputs for isolation from a data bus; and more recently, chip-select inputs to position a converter within a memory map, and read/write and addressing or encoding circuitry.

By consensus, memory mapping seems to be the best converter- μ P match. The converter ideally looks like any other memory location to the μ P, and the full flexibility and power of the μ P's memory-reference instructions are available. Special I/O instructions to transfer data between converter- μ P registers aren't necessary.

But how the data are transferred and how the various logic and analog ele-

ments are partitioned within the system aren't too clear. Lyle Pittroff, product marketing manager for hybrid microcircuits at Beckman Instruments, the company which introduced the hybrid converter, poses the following question: "Do you have the address decoding in the d/a-converter package, or do you use another standard chip to decode and route logic in a memory-mapped interface? The answer isn't clear."

Memorable future

Roger van Aken, marketing manager for Analog Devices in Limerick, Ireland, takes a tantalizing peek at the future: "Ideally, a converter should look exactly like memory—100% like memory, not 80 to 90%, as when the converter says 'wait, I'm not ready,' or 'start me,' and so on. We think we have the solution to get that 100% level."

Three-state is not the best way, van Aken goes on, and will probably be superseded. "Once the interface problem is solved, it can be extended to other products—data-acquisition systems, for instance. Thus, at least as far as new technology goes, the engineering challenge is in the system, not the individual converter."

The linearity problem has been solved, according to van Aken. "Precision isn't a problem anymore. So specs will be de-emphasized, at least initially, and acquisition power and ease of use will take the center ring."

Others have different viewpoints, of course. Both Motorola and Ferranti see the price erosion of a/d's leading to separate converters on each channel and thereby increasing accuracy and speed in multichannel uses. And at an ISSCC panel discussion Robert Pease, staff scientist at National Semiconductor, wondered how "LSI, a merged concept, is going to work with the real world of spread-out sensors?"

Others at the conference offered answers. "For systems less than 10 bits, the converter will be integrated on the same chip as the μ P," predicts Barrie Gilbert, a scientist at Tektronix. "Greater than 10 bits, the devices will be separated."

But Professor Hugo De Man of the Catholic University of Belgium would like to "put the a/d right on the chip with the sensor."

Analog Devices' Paul Brokaw, director of product planning, points to the

DDC crunches the best features into Synchro Converters.

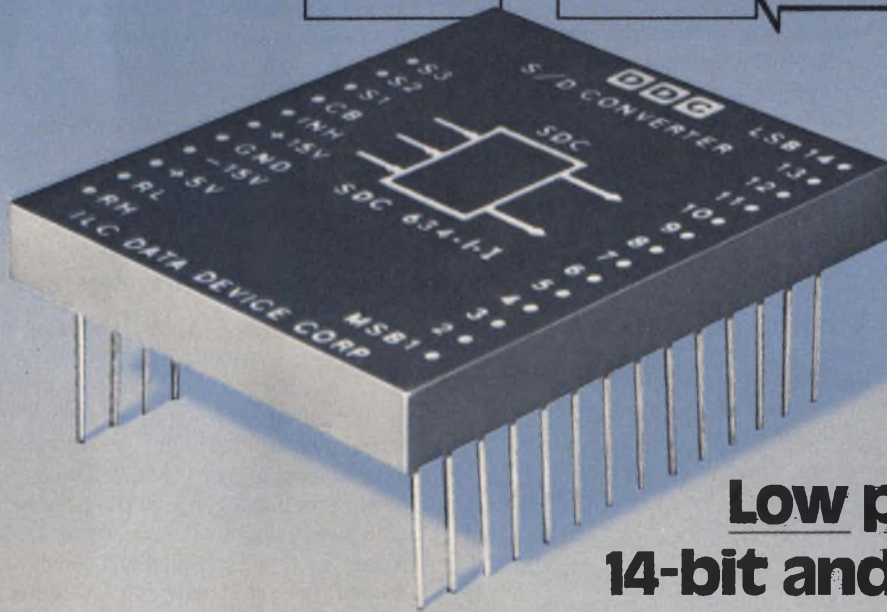
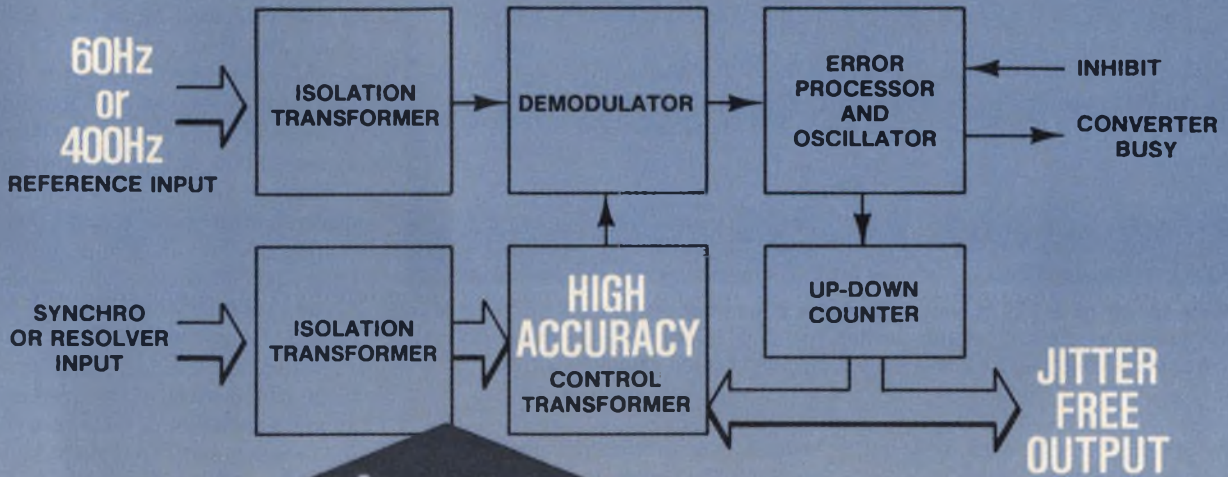

Low profile, low cost 14-bit and 12-bit modules.

What makes DDC's new S/D tracking converters unique is a combination of performance characteristics not presently available from anyone else. For example, an exclusive CT algorithm provides inherently higher accuracy with jitter-free output. Signal and reference inputs are fully isolated by internal 60Hz or 400Hz transformers. All semiconductor components are hermetically sealed.

The new low-profile 14-bit SDC-634 Series features two accuracy options: Either ± 4 minutes ± 0.9 LSB, or ± 2.6 minutes. The 12-bit SDC-632 Series offers an accuracy of ± 8.5 minutes. All standard synchro and resolver inputs are available and output is TTL and CMOS compatible. These converters meet or exceed MIL-STD 202E. Call or write today for complete data including price. You may also want a copy of DDC's new Product Selection Guide which features the broadest line of Synchro Data Conversion Products available.



ILC DATA DEVICE CORPORATION

A Wholly Owned Subsidiary of ILC Industries, Inc.

Airport International Plaza, Bohemia, New York 11716

516-567-5600, TWX 510-228-7324

ILC Dover—Sole designer and manufacturer of Apollo and Shuttle space suits

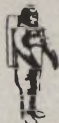

Leader In Synchro Conversion • Hi-Speed, Hi-Accuracy D/A & A/D Conversion • Military Data Conversion Systems

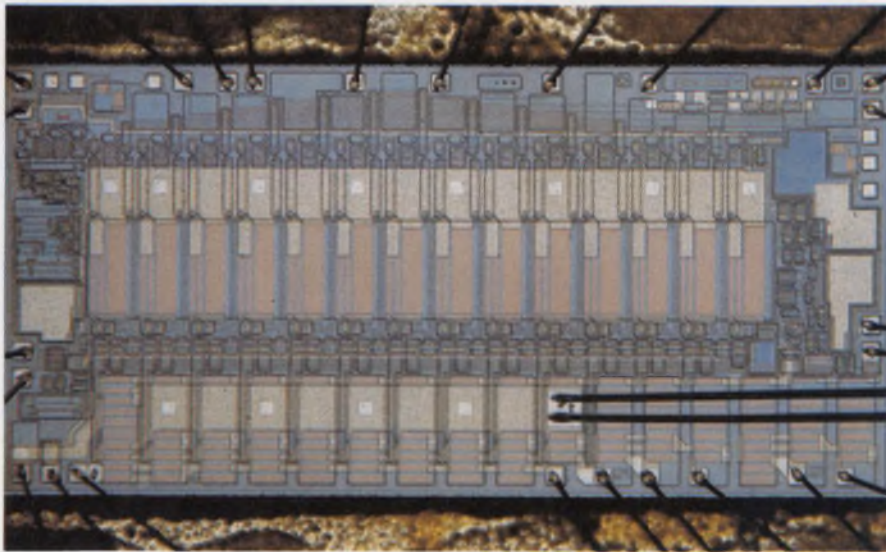

Ultrahigh speed in a 12-bit monolithic d/a converter is offered by the Harris Semiconductor HI-562. The unit settles to $\pm 1/2$ LSB in a maximum 400 ns, and it boasts a high accuracy— ± 1.5 LSB worst-case absolute error.

growing use of a/d converters for isolation, and to the rising interest in voltage-to-frequency converters. "Watch for v/f-to-digital converters," Brokaw warns. And others agree.

Remote conversion helps

Why? For one thing, remote conversion is growing, according to Automated Industrial Measurements, which offers transducer digitizers and systems for thermocouples and

bridges. For such conversion, v/f converters offer several advantages over the conventional, parallel-output a/d: serial output, higher resolution, lower cost. And newer IC and modular designs are bringing improvements in linearity, full-scale output frequency and tempcos.

A sprinkling of new products demonstrates how far v/f's have come: V/f's from Dynamic Measurements have six decades of dynamic range and 0.01% linearity. A new chip from Raytheon

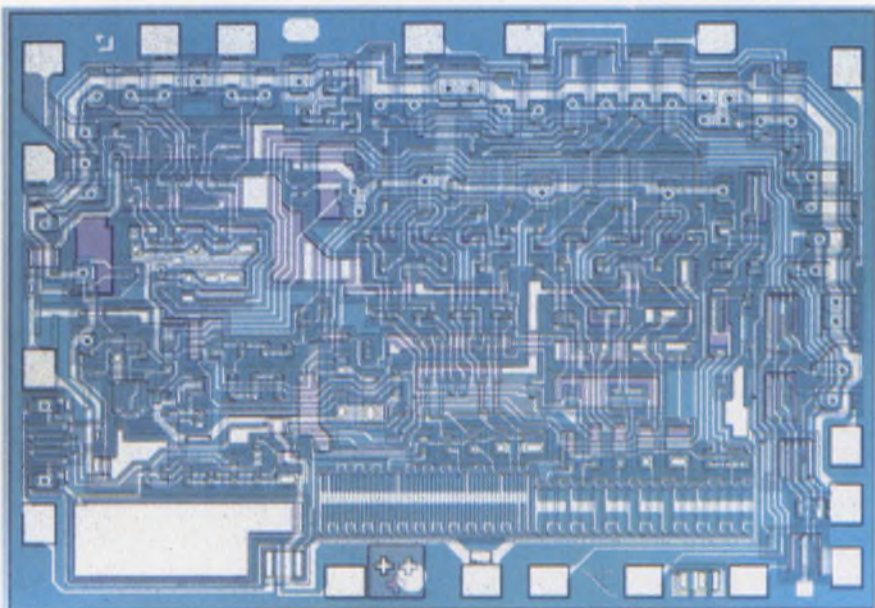

Companding d/a converters, from Advanced Micro Devices, offer nonlinear transfer functions and so achieve wide dynamic range. The Am6070, for example, covers 72 dB, equivalent to that of a 12-bit conventional d/a.

Semiconductor, introduced at the ISSCC, keeps linearity to 0.025% at 100 kHz, with a buried zener reference. And a coming device from a well-known semi house guarantees a 50-ppm tempco over the entire -55 to 125 -C range.

Others active in IC v/f's include Analog Devices, Burr-Brown, Intech/Function Modules, National Semi, and Teledyne Semi. From these come converters built with bipolar, thin-film-on-bipolar, and combined bipolar and CMOS. But as yet, no v/f has appeared that claims μ P compatibility.

Many of the design decisions being made today revolve around the partitioning of the analog and digital portions of μ P-compatible converters. "True compatibility," says Donald Comer, design engineering manager at Precision Monolithics, is wiring directly to a bus, with no IC interface. But all μ Ps are different. So some provision for programming flexibility is needed if one part is to fit all μ Ps."

The problem with the converter as a piece of memory is getting the analog and digital to work together, Comer notes. "Analog processes optimize different parameters than do digital."

Interface leans on system

AMD's Russell Aptel, manager of LIC systems and applications, believes that "in linear, the system definition is becoming more important. This translates to flexibility to interface with several μ Ps or UARTs. Thus, you need more intelligence in the peripheral (converter), for example, to generate binary or two's complement codes under software control or pin strapping."

To Intersil's Skip Osgood, marketing manager for data-acquisition products, it's not the converter, but the application that determines the interface, "and by whether the data are transmitted in serial or parallel format and by the assistance option provided by the selected μ P and converter."

What it all boils down to, according to Osgood, is that "the μ P-UART interface will play the most important role in future converter designs."

Besides the demand for a better interface, which Harris Semiconductor interprets as "three-state outputs and digital control of word length, unipolar/bipolar operation and auto scaling functions," microprocessors bring not only the benefits of self-calibration

30 MHz



THE NEW
FUNCTION
GENERATOR
THAT OFFERS
MORE!

KH KROHN-HITE
CORPORATION

Avon Industrial Park, Avon, Mass. 02322 • (617) 580-1660

Krohn-Hite's new Model 2000 function generator supplies sine, square and triangle waveforms from .003 Hz to 30 MHz. This powerful generator delivers 30 volts p-p, and over 1/2 watt of output power. It features a calibrated attenuator, external frequency control 1000:1, symmetry control, calibrated CV output and much more for only \$895.00.

For fast action call The Wavemakers at (617)-580-1660 or any local office listed below.

SALES OFFICES: ALA., Huntsville (205) 534-9771. ARIZ., Scottsdale (602) 994-5461. CAL., San Jose (408) 292-3220, Inglewood (213) 674-6850; COL., Denver (303) 773-1218; CONN., Canton Center (203) 525-7647; FLA., Orlando (305) 894-4401; GA., Atlanta (404) 455-1206; HAWAII, Honolulu (808) 941-1574; ILL., Arlington Hts. (312) 394-3380; IN., Fort Wayne (219) 485-0845; KS., Lenexa (913) 888-0215; LA., Lafayette (318) 984-3516; MD., Towson (301) 321-1411; MASS., Wakefield (617) 245-5940; MICH., Southfield (313) 569-4497; MINN., St. Paul (612) 645-5816; MO., St. Louis (314) 731-5400; N.M., Albuquerque (505) 255-2330; N.J., Cherry Hill (609) 482-0059; N.Y., Elmont (516) 488-2100, Rochester (716) 328-2230, Syracuse (315) 437-6666, Vestal (607) 785-9947; N.C., Burlington (919) 227-3639; OHIO, Chesterland (216) 729-2222, Dayton (513) 434-8993; OKLA., Tulsa (918) 299-2636; ORE., Portland (503) 297-2248; TEX., Dallas (214) 661-0400, Houston (713) 688-1431; UTAH, Sandy (801) 942-2081; VA., Falls Church (703) 573-8787; WA., Bellevue (206) 454-3400; CANADA, Montreal, Quebec (514) 341-7630, Ottawa, Ontario (613) 235-5121, Toronto, Ontario (416) 445-9900, Vancouver, British Columbia (604) 253-5555, Halifax, Nova Scotia (902) 454-8321, St. John's, Newfoundland (709) 726-2422.

CIRCLE NUMBER 22

but also the pressure to drop the cost of a/d conversion into line with the low cost of digital processing.

Converting with software

But microprocessor compatibility can mean something entirely different—such as the opportunity to “drastically alter the traditional a/d-converter concept in high-accuracy applications,” according to FX Systems of Kingston, NY, a specialist in conversion instrumentation.

What FX is getting at is the elimination of the conventional a/d as a piece of hardware. “Manufacturers of component a/d converters have gone to great lengths to incorporate automatic-zero correction in hardware and have vastly improved gain accuracy, stability and linearity with laser trimming and the like,” says Ronald Straw, an FX engineering manager.

“For most applications, like DPMs and portable equipment, their efforts have been successful in terms of cost and performance.”

However, Straw cautions, these hardware approaches are inherently limited in speed and accuracy. On the other hand, “the μ P allows us to go back to square one. Automatic μ P operations go on in the background while the device continues normally in the foreground. The result is a system that extracts 16-bit data at 12-bit speeds with 18-bit accuracy or better.”

The resulting hardware portion of the converter becomes extremely

simple to manufacture, according to Straw, since the strict requirements of temperature and gain stability, accuracy and linearity no longer exist. The only requirements are that the linearity maintain a “pattern,” and that the other parameters not change more rapidly than the background correction functions can follow.

Soon, most high-accuracy test equipment will apply these techniques, Straw believes. And vendors of component a/d converters will be pressured to use the techniques in devices intended for μ P interfaces.

Straw does concede that transferring converter functions to software will cause immense standardization problems. He also feels that whoever solves the problem rationally will probably create a *de facto* standard.

Software conversion isn't new, of course. It's been used in one form or another for years. For instance, Norman Wheelock, IC product marketing manager for Siliconix, will be glad to show how to get 5-1/2-digit a/d performance without using a 5-1/2-digit chip (which doesn't exist at the moment): “Let the μ P do some conversion during ‘loaf’ periods.”

In fact, with software and some peripheral circuitry, a microprocessor can perform successive-approximation quite readily, points out Richard Gerdes, president of Optical Electronics in Tucson. The drawback is the memory space that must be used and the slow speed. Higher speed requires a converter to talk and work with the μ P.

And Rochester Instrument Systems (Rochester, NY), which sells an auxiliary instrumentation line called UNIMOD, offers a μ P-based unit that does conversions under PROM control. Standardization is provided for by the company's “universal module” approach.

Therefore, “compatibility,” whatever it means, cuts across all packaging styles, all IC-process methods and almost all circuit arrangements—from integrating to successive approximation to quantizing, or parallel, converters. And not to be outdone, vendors of hybrid-circuit converters are bringing forth their own compatible designs, among other innovations.

Temporary is a long time

For a technology that was supposed to be “interim” 10 years ago, hybrid circuits are awfully healthy. As a matter of fact, they're growing. The reasons are clear. As ICs move up in performance and complexity, hybrids stay one step ahead by using these very encroachers to escalate even more in functions and performance. And the ability to tweak component values lets hybrids tackle very difficult problems.

Consequently, as one-chip ICs huff and puff to get beyond 10 bits, hybrids have already mastered at least 16 and are moving on. As ICs push to boost speed, hybrids are shoving—hard enough to threaten the modular speed leaders. And as ICs strain to squeeze more on one chip or to stretch chip size, hybrids are smoothly dropping several ICs into one DIP-like package.

But it's also clear that where an IC can give equivalent performance, it will win over a hybrid because it costs less.

Still, hybrid progress has been remarkable. Datel Systems' 12-bit, 16-channel data-acquisition system is one of the most complex production hybrids yet developed. In one 62-pin package, it contains a multiplexer, an instrumentation amplifier, a sample-and-hold, a 12-bit a/d converter, a reference circuit and address and control logic.

Yet the Datel is already being overshadowed. Burr-Brown has just unwrapped an 80-pin DAS with the same number of bits and channels plus the ability to interface with the 8080A, 8048, Z80 and SC/MP microprocessors—with no additional components (see p. 140).

Two spanking-new converters, from Micro Networks (see p.139), are aimed

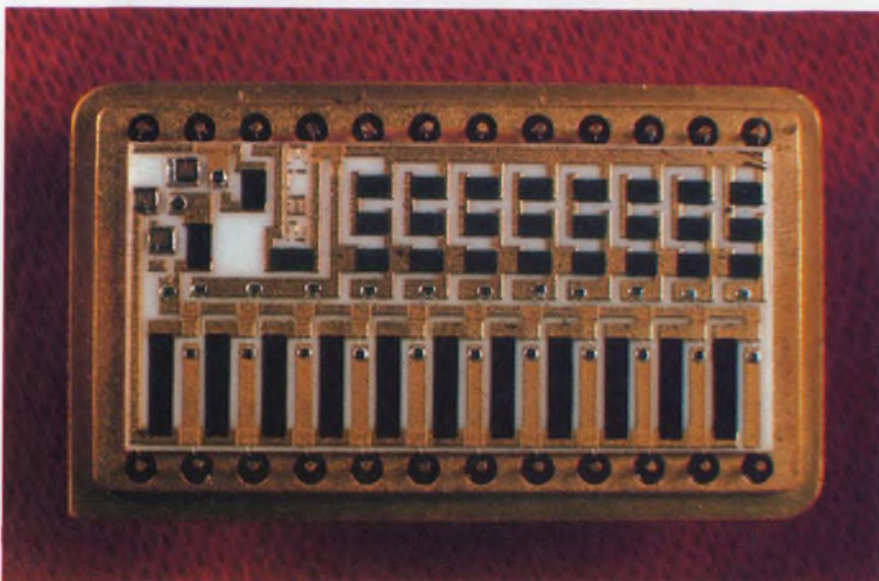

With hybrid-circuit construction moving in on the top-speed areas usually occupied by modular designs, some module makers have begun to offer both types. The HDS-1025 10-bit, 25-ns d/a from Computer Labs is an example.

5 DAY DELIVERY

Microcomputer Analog I/O Systems
with extensive software diagnostics

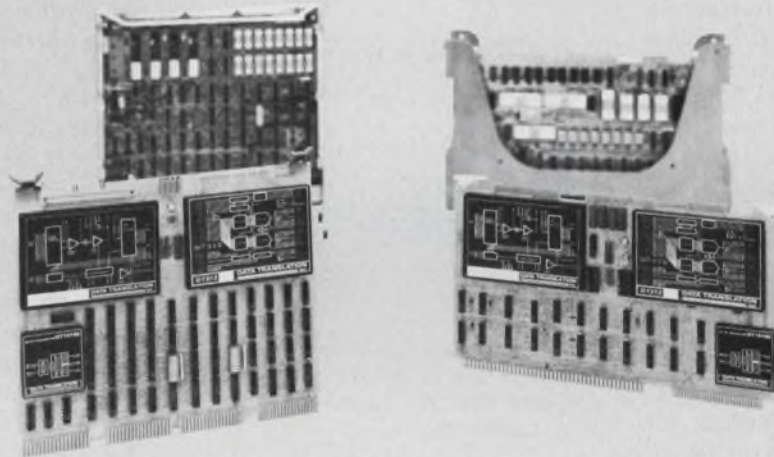

For:

INTEL SBC-80 Series (8080A)

ZILOG MCB Series (Z-80)

DEC LSI-11 & LSI-11/2

Computer Automation LSI 2,3 & 4 Series

National Semi IMP/PACE & BLC-80 Series

PLUS the widest selection of Data Acquisition Modules
anywhere. Concentrate on the Software and other key
system Requirements... and let us take care of Your
Analog Problems.

SEND for Full Technical Data or Call us.

GSA Contract No. GS-00S-64219

DATA TRANSLATION

INC

4 Strathmore Rd., Natick MA 01760

(617) 655-5300 Telex 94-8474

INTERNATIONAL SALES OFFICES: ARGENTINA, Buenos Aires, 89 4594; AUSTRALIA, N.S.W. (02) 747 2731; BELGIUM, Brussels 02 352135; ENGLAND, Cheshire (061) 236 2321; FINLAND, Helsinki, 90 357457; FRANCE, Buc 956 31 30; GERMANY, Puchheim (089) 80 60 61 62; INDIA, Bombay 298686; ISRAEL, Ramat Hasharon; ITALY, Milano 34 93 041; JAPAN, Tokyo (03) 355 1111; NETHERLANDS, Rijswijk 70 996360; NEW ZEALAND, 814 9385; NORWAY, Oslo 0269 44 90; PORTUGAL, Lisboa 4 53 13; SPAIN, Barcelona (93) 301 78 51; SWEDEN, Vallingby 08 38 00 65; SWITZERLAND, Zurich 01 54 70 60.

CIRCLE NUMBER 23

at 8-bit μ P-based systems, but claim universal compatibility. The converters, an a/d and a d/a, include chip-select and read-write logic, and appear to a processor as two successive memory locations.

Meanwhile, with the onslaught of both ICs and hybrids, what of the modular converter? Some industry observers give it little chance. But others, like Joe Santen, manager of data-conversion products for Burr-Brown, and Bob Diamond, president of Dynamic Measurements, disagree.

"Problems like the high-power dissipation associated with very-fast-converter designs and the need for long-term stability will always gain acceptance for discrete products," Santen states. "However, to be successful," he adds, "a modular (or hybrid) converter must fill a very precise need."

Diamond concurs: "To keep the technological leadership," he observes, "modules will be designed for specific systems. They will use monolithics as building blocks and incorporate more functions—sample-and-hold, arithmetic processing, and analog functions.

D.W. Loyer, product manager for Intech/Function Modules, chimes in: "Although it sounds like the tolling of the bell for modulars, one must consider the ever-changing demands of the converter market. Resolution will go no farther than about 18 bits, except for logarithmic units, which will extend to 22 bits. But the main criterion will be speed. Modular converters will continue to dominate the high-speed areas—like video."

Phoenix Data, for one, has set out to prove Loyer right with a 15-bit a/d converter that converts in 5.5 μ s at 0.002% linearity and 0.004% accuracy; a 16-bit a/d that draws only 500 mW; and an ultrafast d/a that changes seven bits at 60 MHz. An impending d/a converter is expected to handle 12 bits at 30 MHz—the best yet.

One class of modular converter, the synchro-to-digital (s/d), has had to put up with encroachment by hybrid circuits, but now operates in too small a market to interest IC makers in developing a monolithic s/d. Even so, s/d's are making progress. Packages are shrinking toward the 0.4-in., low-profile height demanded for reduced PC-card spacing. As a result, volume and weight are being cut.

According to North Atlantic Industries, a major s/d supplier, performance has leveled off at about ± 4 arc minutes and will remain there for

most applications. Although prices have eroded steadily over the past few years, North Atlantic sees an end at least to price cuts traceable to competitive pressures.

Other trends, in the view of Control Sciences Incorporated, include industry acceptance of the tracking s/d for single-channel operation; the incorporation of 60-Hz transformers within the module (a 0.8-in. package); and the use of a variety of logic—TTL, CMOS, LSTTL.

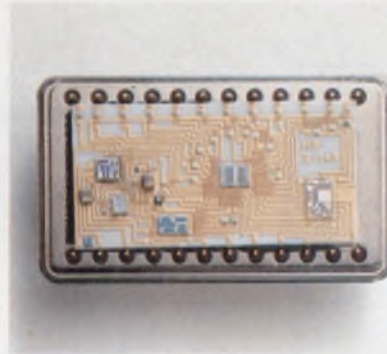

Multiplying d/a converters are arriving more often these days. The Hybrid Systems DAC391 handles 12 bits in two quadrants.

Whereas CSI points to hybrids vs modules as the major technical issue in s/d's, the major technical issue now, claims North Atlantic, is how to reduce cost. (An s/d can run into hundreds of dollars.)

Another voice, another opinion

A third contender in s/d's, Natel Engineering, offers a third opinion—the main issue is finding the best way to incorporate or interface with the μ P. Hybrids, Natel says, are allowing more functions in a single module. One example is Natel's two-speed, 20-bit s/d packed into a single module.

One way to fight is to switch. And that's just what Computer Labs, a respected module maker, has done with its 10-bit, 25-ns hybrid d/a converter and some other related products. Others—like Datel and Tektronix—have come up with new modular constructions, Datel with its ADC-TV8B, a "hybrid" module that converts to 8 bits at a blazing 20-MHz rate; and Tektronix with its 8-bit ADC 820, which runs neck and neck with the Datel.

The Datel converter places both hybrid and monolithic devices on a single PC board, while the Tek unit—

also a board—performs all the quantizing and coding with three LSI chips. These converters may redefine what is meant by "modular."

Printed-circuit boards have become the medium for an entirely new class of products—analogue I/O boards dedicated to a specific microcomputer. Offered by both converter and computer houses, the boards perform a variety of signal processing on both the input and output sides of a μ C, and on many channels simultaneously. Together with ICs, hybrids and modules, the boards offer still another choice in μ P-compatible applications. (For a complete discussion of analogue I/O boards, see ED No. 19, Sept. 13, 1977, p. 26 and ED No. 1, Jan. 4, 1978, p. 50.)

With IC converters of every shape and size getting chosen by more and more designers, attention must finally be paid to several pertinent questions. The main one is: Which IC process—if any—is likely to dominate and so find its way into most future products? But that isn't the only concern. Which trimming method and which reference are likely to give the best temperature performance and long-term stability? For that matter, does the increasing density of ICs help performance and stability or threaten them? A related question: Are two chips better—and more cost-effective—than one?

Right now, no one has all the answers. The various semiconductor houses have made their choices and are standing by them. Some are betting on CMOS as the winning converter technology. Others are staying with bipolar or mixed bipolar with I^2L or with FETs. A few who can afford to do so are hedging their bets and working with several processes. Still others think the best way to optimize performance is to separate the analog portion of the converter—the biggest problem area—from the digital portion.

Every process has its advantages and disadvantages, of course, in terms of noise margins, stability, power consumption, supply levels, speed, area required on chip and other parameters. Because no one process can provide everything, semiconductor designers have brilliantly combined processes to give the best of each in some areas—but not all, and compromises are still necessary.

However, the search continues to find the best ways to produce good switches, comparators and references—three keys to converter performance.

In the ensuing debates, voices seem

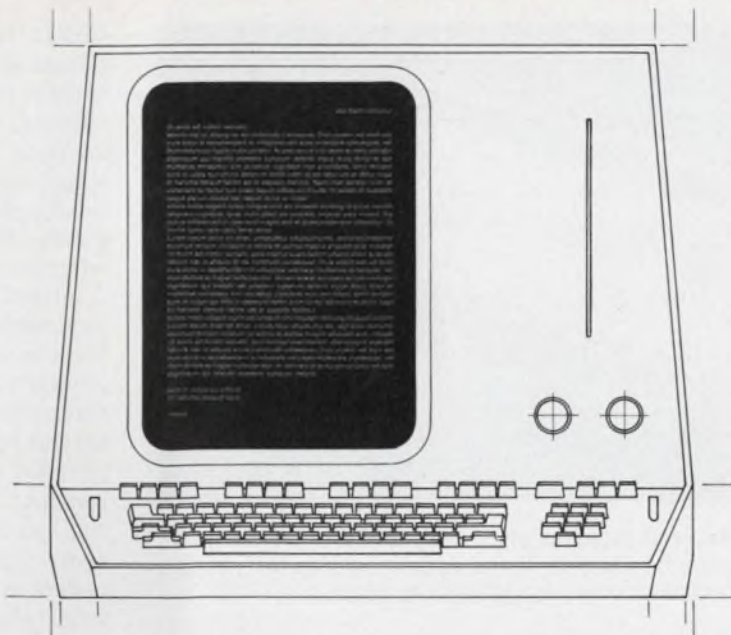

Display Technology just took a giant step forward.

With the M4408 by Motorola. Like some of our others, it's a 15" raster scan CRT display module, but that's where the similarities end. The M4408 was specifically developed for systems that demand displays of up to 6,300 upper and lower case, clearly readable characters.

With its unique horizontal or vertical mounting capability, the M4408 can display a full typewritten page (96 characters x 66 lines) or a wide page printer format (132 characters x 48 lines...or 43 if you prefer). And those are only two examples. The M4408 is the optimum display for any high performance, high density character application.

The cost? Not much more than conventional 15" 80 x 24 type displays — considerably less when you consider cost per character. And the M4408 doesn't require high speed, expensive logic either.

When you compare features, we think you'll agree that the Motorola M4408 is the price performance winner.



MOTOROLA INC.
Data Products

455 East North Ave., Carol Stream, IL 60187 (312) 690-1400 TWX: 910-252-4404

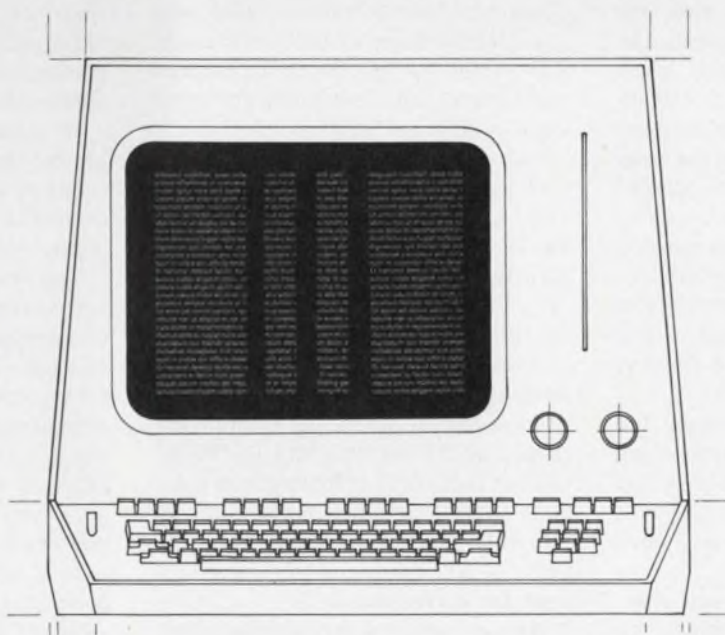

CIRCLE NUMBER 24

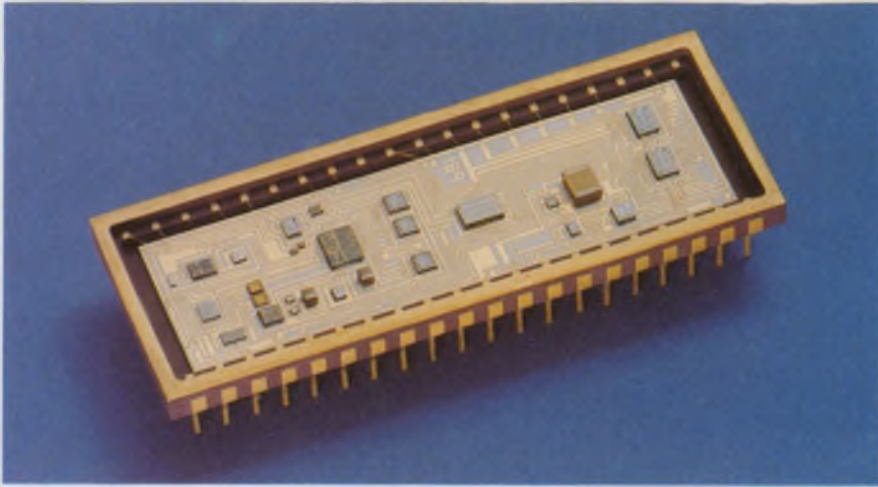

How to interface with a μ P is a hot topic for discussion today. Micro Networks offers its solution with a 12-bit a/d converter that supplies circuitry for memory mapping: chip select, address decoding and read/write logic.

to become loudest on the subject of trimming. At present, three methods—laser-trim, zener zapping and blown-link—are used to trim a converter for desired resolution, linearity, tempco, full-scale calibration, offset and other parameters.

Which trimming works best?

Proponents lining up behind each method are quick to point out virtues or limitations, depending on which side they're on. But a few are candid enough to admit that at least the long-term reliability of all three methods is still a wait-and-see situation. Generally, converters below 8 bits don't require any trimming, so the arguments center around the medium and high-performance areas.

Laser trimming, the most widespread trimming and the most expensive in terms of equipment, can handle wide trim ranges, and many parameters and provide high resolution. It's the only continuous method. However, detractors question the long-term effects: Where does the ash go? How is the glass-passivation material affected? Does the laser set up thermal stresses that result in later drift?

A related question is where to trim to avoid stress—at the wafer-probe stage or after assembly, when the cost of trimming climbs steeply?

Harris Semiconductor states the case for laser burn: All indications are that fully-passivated, laser-trimmed nichrome is more than adequate for 12 bits and holds promise for even higher resolution.

Zener zapping, a step-by-step process, sidesteps the laser "problem" by

shorting out on-chip zeners where necessary to correct individual bits. Among its other advantages: the short can be tried before actual metalization; in addition, trimming is easy to do at wafer sort, so the vendor can offer both packaged, trimmed chips or chips that can be trimmed by the user in his own hybrid circuit. (However, Analog Devices, for one, performs laser trim at the wafer stage.)

Disadvantages of zener zapping include the extra room taken up on the chip—up to 50% of the area—and the discrete nature of the process, which limits the number of possible trims and the achievable resolution. But proponents say that that thin-film resistors also take space, and that a tighter original design makes up for the limited resolution capabilities.

The third approach, aluminum links blown by a laser to trim bits, may have the disadvantages of both rival methods, with few of the benefits. But supporters say, "no problems when done well."

One way to get around the trimming problem is to not trim at all. Ferranti Ltd. has been able to do so by diffusing matched resistors into a tracking 10-bit a/d converter. And AMD is working on a trimless 12-bit bipolar d/a with no thin-film resistors.

Analog Devices' Brokaw, however, notes that full-scale adjust will still be needed, depending on the absolute accuracy of the system. And Tektronix' Gilbert feels that trimming won't decline but will actually increase in use: "Circuits must work right the first time, in real time, and there won't be time for corrections."

At any rate, industry debates don't

stop at trimming vs not trimming. As references begin to come on-board, and as MOS reference devices continue to improve, yet another question takes the floor: Which reference technology is best: standard zener, buried zener or band gap? The responses are crucial—a converter can be no better than its reference voltage.

Intersil philosophically compares good references to good wines: Nobody is quite sure how to make them, but generally the older the technology, the better the results. So, says Intersil, it's hard to beat the old temperature-compensated zener, with current flow adjusted to the optimum for each diode. And according to Intersil's Osgood, many high-resolution (16-bit) converters are ratiometric, so good, long-term references aren't needed.

Paul Brokaw summarizes the differences between buried zeners and band-gap references. "The buried is quieter, offers less circuit complexity in I²L and conventional bipolar. The band gap is more flexible and is aimed at lower voltages (5-V supply). Which one you use depends on the circuit."

PMI's Comer observes that "the band gap needs more room on the chip, and with customers asking for more functions, the buried zener takes less room." And "although the band gap has a theoretical stability edge, it doesn't work in practice," Comer adds. "Off-board is still the method if you need the best drift."

Russ Aptel, recalling that 13 bits give 100-ppm resolution, prompts users to ask themselves, how good a reference they really need. Dr. Samuel Wilensky, vice president of engineering for Hybrid Systems, states flatly that "very stable references capable of maintaining 100 ppm over a full temperature range are not commercially obtainable at this time."

Of course, there are ways to get around that limitation—like the fairly common practice of heating a chip to control the temperature. But, as Aptel points out, a heater needs power.

One way to get around some converter performance restrictions is to develop specialized units aimed at just one job—like the so-called nonlinear converters. Logarithmic converters, codecs (coders/decoders) and companding d/a converters offer such advantages as wide dynamic range without an inordinate or even unobtainable number of bits.

As a result, the equivalent of 20-bit performance is available, if needed. Or—on the less exotic side—the equivalent

Heinemann introduces a new product...

Help.



800-257-9590*

Now we've made it easier than ever to solve your circuit protection and control problems: a call to 800-257-9590 puts you instantly in touch with a Heinemann technical-service engineer who can help you apply circuit protectors and solid-state relays in innovative, cost-saving ways.

For example, you might ask our technical engineer to help reduce costs with close-tolerance overload protection. It will help cut down component oversizing — a costly proposition you can do without.

Or do you have a piece of equipment that must be shut down if a limit is exceeded (pressure too high, tank over-filled, etc.)? Our technical engineer can explain how a circuit breaker can be the most cost-effective limit control to shut down the equipment — and provide overcurrent protection to boot.

A Heinemann hydraulic-magnetic circuit breaker or solid-state relay may very well be the inexpensive solution to your control or protection problem. All you have to do is keep our number handy:

800-257-9590

It's like having your own personal design expert at your fingertips!

Help with:

Circuit protection

We have everything you need to protect your circuits... from breakers with 10,000A interrupting capacity to an inexpensive alternative to the bothersome cylindrical fuse. And we'll be glad to help you with information about time delays, ratings, and even UL and NEC requirements.

Equipment protection

We've helped many engineers protect their equipment inexpensively from out-of-limit conditions like high temperature, high pressure, low flow rate, etc. Just give us a call and learn what we can do for you.

Control

Applying solid-state relays is tricky. We'll tell you how to watch out for high dv/dt , transients, and inadvertent turn-on. And we'll explain how our solid-state relays' special features help protect your equipment from failures.

"Special" products

Did you ever spend too much time trying to get a component or rating that no one seemed to make? Just give us a call. Many "specials" are standard at Heinemann. And with our Jet Start fast delivery, you might have that "special" sooner than you think.



HEINEMANN

Trenton, New Jersey 08650

We keep you out of trouble.

*Mon.-Fri. 8:30AM-4:30PM Eastern Time



variable capacitors

... made by Johanson, of course! Quality without compromise is our target in the design and manufacture of capacitors in sizes, mounting configurations and capacitance values to meet every application. Perhaps that's why—for nearly three decades—superior variable capacitors have been synonymous with the name Johanson, where standards of excellence always come first.

Electronic accuracy through mechanical precision.

MANUFACTURING CORPORATION
Rockaway Valley Road
Boonton, N.J. 07005
(201) 334-2676, TWX 710-987-8367

lent of a 12-bit range at an 8-bit price. Consequently, although telephone systems formed the initial market for many of these devices, they aren't the only beneficiaries now—industrial control, audio, and servo systems, to name a few, are staking claims.

All in all, the furious pace of converter development and the quantity and variety of products already available must make one wonder what can happen next. The answer: Plenty! Within the next two or three years:

- Monolithic converters will approach the lofty 100-MHz range, as work pushes into the next frontier of quantizing, or parallel techniques.

- Converters will be built with on-chip UARTs or other peripheral chips and possibly even with user-accessible memory for even more flexibility.

- Integrating 4-1/2-digit a/d's will appear on one chip, possibly with the ability to drive LEDs or LCDs directly.

- An "economy" line of converters will sell for \$1 or less in large quantities, just like op amps.

- "Smart converters," designed for automobiles and other consumer goods, will make their debut.

What will emerge five years from now is anybody's guess. But with complexity now doubling every few years, it's not hard to envision entire data-acquisition systems integrated with μ Ps, or transducers delivering signals that require no data conversion. Or how about a breakthrough in what now appears to be an almost unsolvable problem—how to standardize interface specifications, terminology and converter testing methods. ■■

Need more information?

For further information on data converters readers may consult the manufacturers listed here by circling the appropriate numbers on the reader service card. More vendors and information may be found in Electronic Design's GOLD BOOK.

Advanced Micro Devices, 901 Thompson Pl., Sunnyvale, CA 94086 (408) 732-2400.

Circle No. 480

Analog Devices Inc., P.O. Box 280, Norwood, MA 02062 (617) 329-4700

Circle No. 481

Analogic Corp., 1 Audubon Rd., Wakefield, MA 01880 (617) 246-0300

Circle No. 482

Automated Industrial Measurements, P.O. Box 125, Wayland, MA 01778 (617) 653-8602

Circle No. 483

Avco Corp., Electronics Div., 4807 Bradford Dr., Huntsville, AL 35805 (205) 837-6500

Circle No. 484

Beckman Instruments Inc., 2500 Harbor Blvd., Fullerton, CA 92634 (714) 871-4848

Circle No. 485

Burr-Brown Research Corp., 6730 S. Tucson Blvd., Tucson, AZ 85734 (602) 294-1431

Circle No. 486

Computer Laboratories Inc., 505 Edwardia Dr., Greensboro, NC 27409 (919) 292-6427

Circle No. 487

Control Sciences Inc., 8399 Topanga Canyon Blvd., Suite 303, Canoga Park, CA 91304 (213) 887-7344

Circle No. 488

Data Technology Corp., 2700 S. Fairview Rd., Santa Ana, CA 92704 (714) 546-7160

Circle No. 489

Datel Systems Inc., 1020 Turnpike St., Canton, MA 02021 (617) 828-8000

Circle No. 490

Dynamic Measurements, 6 Lowell Ave., Winchester, MA 01890 (617) 729-7870

Circle No. 491

FX Systems Corp., 77 Cornell St., Kingston, NY 12401 (914) 338-0515

Circle No. 492

Fairchild Semiconductor, 464 Ellis St., Mountain View, CA 94042 (415) 962-5011

Circle No. 493

Ferranti Electric Inc., E. Bethpage Rd., Plainview, NY 11803 (516) 293-8383

Circle No. 494

Harris Semiconductor, P.O. Box 883, Melbourne, FL 32901 (305) 724-7407

Circle No. 495

Hybrid Systems Corp., Crosby Dr., Bedford Research Park, Bedford, MA 01730 (617) 275-1570

Circle No. 496

ILC Data Device Corp., 105 Wilbur Pl., Bohemia, NY 11716 (516) 567-5600.

Circle No. 497

Intech/Function Modules, 282 Brokaw Rd., Santa Clara, CA 95050 (408) 244-0500

Circle No. 498

Intersil Inc., 10710 N. Tantau Ave., Santa Clara, CA 95014 (408) 996-5000

Circle No. 499

Micro Networks Corp., 324 Clark St., Worcester, MA 01606 (617) 852-5400.

Circle No. 500

Micro Power Systems, 3100 Alfred St., Santa Clara, CA 95050 (408) 247-5350

Circle No. 501

Motorola Semiconductor Prod. Inc., P.O. Box 20912, Phoenix, AZ 85036 (602) 244-6900

Circle No. 502

Natel Engineering Co. Inc., 8954 Mason Ave., Canoga Park, CA 91306 (213) 882-9620.

Circle No. 503

National Semiconductor Corp., 2900 Semiconductor Dr., Santa Clara, CA 95051 (408) 732-5000

Circle No. 504

North Atlantic Industries, 200 Terminal Dr., Plainview, NY 11742 (516) 681-8600

Circle No. 505

Optical Electronics Inc., Box 11140, Tucson, AZ 85734 (602) 624-8358

Circle No. 506

Phoenix Data Inc., 3384 W. Osborn Rd., Phoenix, AZ 85017 (602) 278-8528

Circle No. 507

Precision Monolithics, 1500 Space Park Dr., Santa Clara, CA 95050 (408) 246-9222

Circle No. 508

RCA Solid State Div., Somerville, NJ 08876 (201) 685-6000

Circle No. 509

Raytheon Co., Semiconductor Div., 350 Ellis St., Mountain View, CA 94042 (415) 968-9211

Circle No. 510

Rochester Instrument System Inc., 255 N. Union St., Rochester, NY 14605 (716) 325-5120

Circle No. 511

Signetics, 811 E. Arques Ave., Sunnyvale, CA 94086 (408) 739-7700

Circle No. 512

Siliconix Inc., 2201 Laurelwood Rd., Santa Clara, CA 95054 (408) 246-8000

Circle No. 513

TRW LSI Products, One Space Park, Redondo Beach, CA 90278 (213) 535-1831

Circle No. 514

Teledyne Philbrick, Allied Dr., Rte. 128, Dedham, MA 02026 (617) 329-1600

Circle No. 515

Teledyne Semiconductor, 1300 Terra Bella Ave., Mountain View, CA 94043 (415) 968-9241

Circle No. 516

Telesis Laboratory, 41 1/2 S. Paint St., Chillicothe, OH 45601 (614) 773-1414

Circle No. 517

Texas Instruments Inc., P.O. Box 5012, Mail Station 84, Dallas, TX 75222 (214) 238-2011

Circle No. 518

Tokyo Shibaura Electric Co. Ltd., Kawasaki, Japan

Circle No. 519

Zeltex Inc., 940 Detroit Ave., Concord, CA 94518 (415) 686-6660

Circle No. 520

What's TRW up to now?

Optimizing metal film.



TRW thin film resistors optimize parameters like real estate, accuracy, speed, reliability, and resistance range.

In discrete devices, sets, or networks.

For instance, our ultra-precision MAR series does all of the above with absolute TC's and tolerances to ± 5 ppm/ $^{\circ}$ C, $\pm 0.1\%$. Our smallest discrete uses $< .016$ in² of PCB space. Complex sets and networks include 16 Bit Binary Ladders, input

attenuators and others up to 28 pins.

In straightforward precision, we have a range of standards in R2R Ladder, MIL-R-83401 flat pack, and RNC resistors with a verified MTBF of 280×10^6 unit hours.

Contact TRW/IRC Resistors, 4222 South Staples, Corpus Christi, Texas 78411. (512) 854-4872, Dept. M. For standards in all types of resistors, call your local TRW distributor.

TRW IRC RESISTORS

ANOTHER PRODUCT OF A COMPANY CALLED TRW

Hanging transistors, slim silicon make very fast monolithic converter

Picture a couple of monolithic transistors and a pair of thin-film resistors hanging in space within a block of silicon. They are supported only by the leads connecting the resistors, bases, emitters and collectors to the individual pads on the block. That seemingly precarious arrangement forms the basis for a monolithic, thermal true-rms converter that could very well revolutionize wideband ac-signal measurements.

Developed by John Fluke Manufacturing Co., from a concept originated by Burr-Brown, the converter has elements carved out of a single block of silicon with a proprietary controlled-etching process that Fluke, understandably, is keeping under wraps. But before the etching process, Fluke grinds the 30-mil-thick wafer—containing about 1000 transistor pairs—to a razor-thin thickness of just 3 mils. The etching-out yields thermally isolated transistors, and the grinding produces low thermal mass for super-fast response. After separation, the complete chips are bonded into TO-5 cans, then tested.



Two transistors can hang in space thanks to a controlled etching process. The IC is only 3 mils thick.

The Fluke converter doesn't cost as much as existing thermal designs, according to Elvet Moore, Manager of Fluke Labs in Seattle. But not only that, its frequency response is roughly 10 times better—at least 1.5 GHz.

Each chip consists of a matched bipolar pair—physically separated in space—and matched 100- Ω resistors, also separated, with one resistor evaporated next to the base junction of one transistor die (see photo). With the elements connected as in the figure, the ac input signal is converted to its

equivalent heating power in the left 100- Ω resistor. The subsequent heating of the associated base-emitter junction produces a signal change at the transistor collector.

Since the thermally isolated second transistor sees no heat, a differential signal appears at the input of the external op amp. The output of the op amp drives the second resistor, heating it. The base-emitter of the second transistor now proceeds to drift, and produces a signal at the second input of the differential op amp. When the heat produced by the second resistor balances that of the first, the circuit stabilizes. The dc output of the op amp is then proportional to the rms value of the input signal.

Vibration and shock are no problem, states Moore, because of the device's low mass. In fact, the device meets military vibration specs. The converter is further evaluated for seven or eight days with an overvoltage that heats the die to 300 C, followed by a two-week burn-in at 125 C.

Only the lead inductance limits the response, says Moore, since the input impedance is basically resistive. The crest factor is at least 20 and may be double that, again thanks to the resistive input.

The chip can comfortably handle at least a 100:1 dynamic range, with sensitivity and accuracy depending on the input-signal level, the working range and other factors.

Present full-scale output is 1 V dc; a 0.1% input change produces a 3.4-mV base-emitter variation. However, by carefully matching circuit elements, or by evacuating the TO-5 can, sensitivity can be increased tenfold. Dynamic range can also be boosted by preceding the converter with an amplifier and voltage divider. The bandwidth is then limited by the amplifier-divider.

One Fluke product—a true-rms DVM—has already benefited from the improved converter (see ED 7, March 29, 1977, p. 97), and more products are coming. ■■

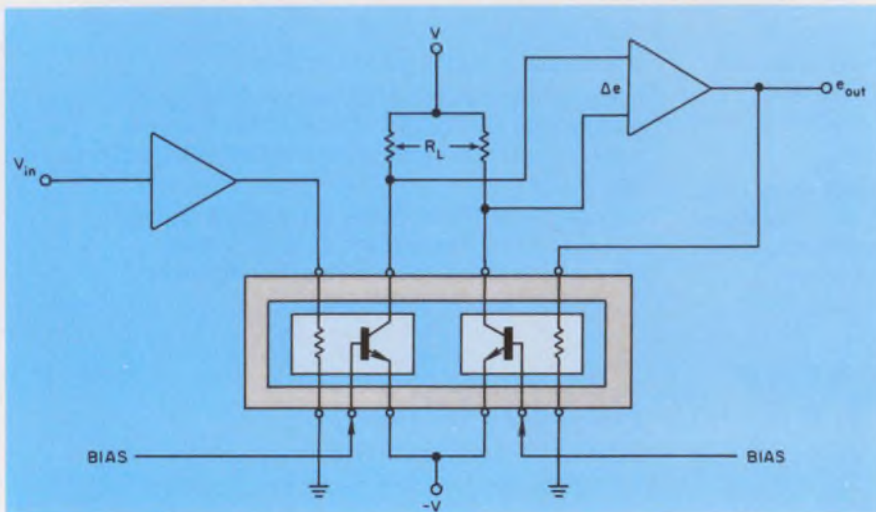

How the monolithic chip works in a closed-loop, ultrawideband rms-to-dc converter is shown in this simplified circuit.

New: The First Monolithic D/A Converter System.

No one else can give you an 8-bit DAC with all peripheral functions on-chip. It's truly microprocessor-compatible and costs \$6.95!

Single-chip D/A converter circuits have been around a long time. But so have the design problems that go along with them when interfacing with microprocessors—selection of op amps, voltage reference, latches and the various other active components you've had to add to use them.

Now, for the first time, you can simplify your system design by using the Signetics 5018 Monolithic D/A Converter System. It combines, on a single chip, the converter circuit and all the required peripheral functions—a voltage reference, input latches, and an output amplifier. It costs, in quantities of 100 and up, only \$6.95. That's one reason why it saves you money.

Reduce Parts Count and Assembly Costs.

The 5018 is a system simplifier and cost reducer. You can forget about the costs associated with all those extra parts. Material control is simpler. Incoming test and inspection costs go down. Component handling and assembly expenses can be reduced as much as 75 percent.

SIGNETICS D/A CONVERTERS

5018—Monolithic D/A Converter System
 5007/5008—8-Bit, High Speed, Multiplying DAC ($\pm 0.19\%$)
 5009—8-Bit, High Speed, Multiplying DAC ($\pm 0.1\%$)
 MC 1408—8-Bit, Multiplying D/A Converter

Ideal Architecture for Computer-Based Systems.

The 5018 has built-in latches and extremely low input loading (1/100 TTL load per line). These features make it a good choice for multiple-peripheral, bus-oriented microprocessor or computer-based systems. The low input loading lets you drive many converters from a single bus.

The latches then permit the bus to service several peripherals at its maximum throughput rate.

Temperature stability is an added plus. The reference voltage can be adjusted for correct full-scale value with minimal temperature effects.

Temperature-related inaccuracies are also minimized because the precision, low-temperature coefficient resistors are on the chip.

Other Signetics DACs.

The 5018 is our newest D/A conversion product. The coupon below will help you learn more about it. If you'd like other data sheets on our other D/A converters listed below, be sure to check the appropriate boxes or call your nearest Signetics distributor.

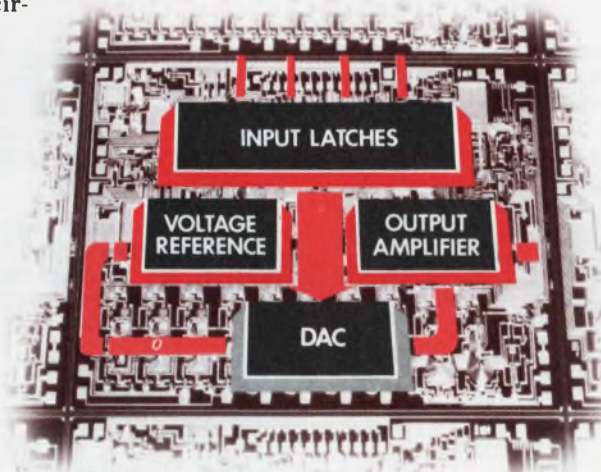

signetics

a subsidiary of U.S. Philips Corporation

Signetics Corporation
 811 East Arques Avenue
 Sunnyvale, California 94086
 Telephone 408/739-7700

To: Signetics Information Services, 811 E. Arques Ave.
 P.O. Box 9052, MS 27, Sunnyvale, CA 94086

Please send me information on the 5018 DAC System

I'm also interested in these other D/A conversion products:

5007/5008 5009 MC1408

I have an urgent requirement. Please have a D/A conversion specialist phone me at once: () _____ X _____

Name _____ Title _____

Company _____ Division _____

Address _____ MS _____

City _____ State _____ ZIP _____

ED412

CIRCLE NUMBER 28

Designing in opto?

Call us for your broadest choice of high-technology optoelectronic components — off the shelf!

Spectronics optoelectronic components are designed to meet growing needs in such areas as industrial controls, copiers, card readers, computers, telecommunications, solid state relays, motion sensors, line drivers, switching supplies and object sensors. Even if your application is different, it's likely we've got a component to do your job.

Infrared Emitters and Detectors

Spectronics IR emitters and detectors are available either as stand-alone components or in pre-aligned optical switch (interrupter module) configurations. They interface directly with digital logic circuits.

Here's How They Work

Spectronics high-efficiency infrared light emitting diodes and light sensitive phototransistors are specially matched for peak efficiency. Design our components into your circuits just like diodes and transistors.

What's your application? Do you need to sense falling quarters or moving parts? Or perhaps the leading edge of paper or the speed of a shaft? Spectronics infrared LEDs and phototransistors will do these jobs for you . . . and a lot more. In pulsed applications, the emitter and detector can be placed a dozen feet apart. Or we've got standard modules with gaps from .1 to .375 inches.

Need to detect a moving train of objects or count passing water drops? Or sense a credit card or other document? Then consider our reflective object sensors. We can supply the discrete components or make custom arrays for just about any application.

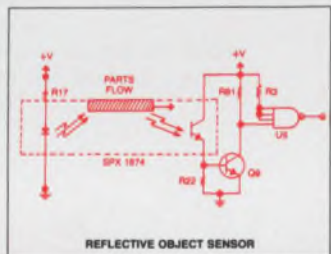
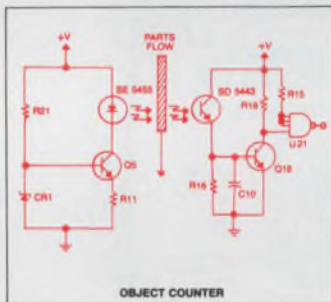

Designing a Microprocessor Interface?

You can isolate your μP from power line and switching transients with our optocouplers. Our patented epoxy inner mold assures reliable isolation from surges to 5000 VDC. Drive currents can be as low as 1 mA.

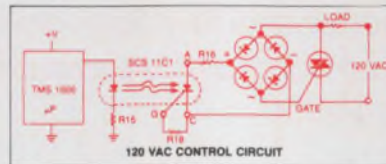

Gating an SCR or TRIAC?

Level shifting from control circuits to power line levels is readily accomplished. Our SCR coupler can gate a 40 amp TRIAC. The complete Spectronics line also includes standard transistor and darlington outputs.

1 MBit/SEC.

Distributed power supplies are no problem with Spectronics couplers rated for data transmission rates of 1 MBit/sec. Our couplers can help you eliminate ground loops in data terminals, computer peripherals and instrumentation systems.

High-Technology Leader

Last year, Spectronics devoted over \$1 million to optoelectronic research and development. That's one of the reasons you'll be hearing more about us. And we want to hear from you. Call us now for assistance with your non-standard design problem, or write for our free opto catalog. Spectronics Commercial Components Division, 830 East Arapaho Road, Richardson, Texas 75081, telephone (214) 234-4271.

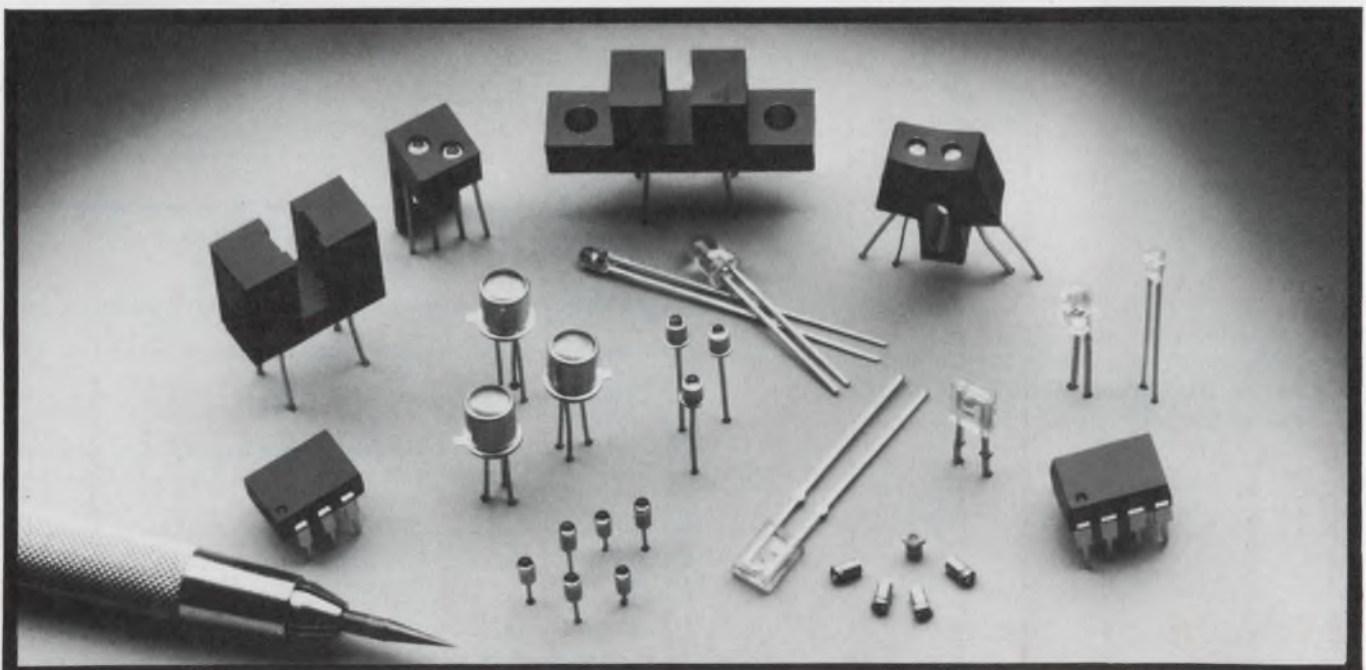

Experiments picked for U.S.-European spacecraft

The National Aeronautics and Space Administration and the European Space agency have jointly chosen 30 scientific experiments to be flown in a pair of satellites that will study the polar regions of the sun.

The experiments are intended to investigate solar wind, cosmic rays and the sun's corona (the outermost solar atmosphere). They are being supplied by scientists from 65 universities and research centers in Belgium, Canada, Denmark, France, West Germany, Great Britain, Greece, Italy, Japan, the Netherlands, Norway, Switzerland and the United States.

The satellites won't be launched until 1983—and won't reach the sun until February 1987—but the space agencies decided that the experiments should be selected now to give the scientists enough time to get them ready.

The program, one of the few new spacecraft projects for which funds were requested in President Carter's fiscal 1979 budget (see Washington Report, ED No. 4, Feb. 15, 1978, p. 39), is known either as the "solar polar" or as the "out-of-the-ecliptic" project. The two spacecraft would be launched from NASA's Space Shuttle using the Inertial Upper Stage (IUS) solid rocket to boost them out of earth orbit and on their way toward the sun.

The 350-kg satellites will be launched toward Jupiter and will use that giant planet's massive gravity to pull them out of the ecliptic plane (the imaginary flat plane at which most of the planets circle the sun) and back toward the sun. Each spacecraft will pass within 450,000 kilometers of Jupiter, one over the north pole and one over the south pole, and then swing past the sun at a distance of 250-million kilometers, again one over each pole. They will then become comets with an anticipated life of more than 2000 years.

Liquid crystal material helps test ICs

Liquid-crystal material is being used at the Air Force's Rome (NY) Air Development Center to detect both glass-pinhole and metalization-open defects in integrated circuits.

The new approach offers advantages over the three conventional testing methods, according to the principal researcher, Carmine Salvo, of the Center's Reliability Branch. Optical microscopes lack the resolution to find small faults. Electrical testing often causes further damage when the mechanical probes touch the circuit's surface. And scanning electron microscopes can only examine circuits for a short time because a prolonged electron-beam scan may alter the circuit's operation.

The new technique consists of placing a drop of liquid-crystal material, which has the consistency of 30-weight motor oil, on the surface of the IC and covering it with a glass plate coated with a thin conductive layer. This combination of glass plate, liquid crystal and circuit forms a transparent cell that can be viewed through an optical microscope.

To locate a pinhole fault, power is applied across the cell. Where current flows through a pinhole, the liquid crystal swirls. Pinpointing the unintended flow of electrical current locates the fault.

To find a metalization-open defect, power is applied to the IC itself. The resulting visual display appears to have a break in it at the defect site.

Once either type of defect is located, a scanning electron microscope can be used for closer inspection at high magnification.

\$2.3-billion Canadian aircraft project up for grabs

Four American aircraft manufacturers and one European consortium are vying for a \$2.3-billion project to replace Canada's fighter aircraft. The project, which involves a great deal of avionics and ground-support equipment, would give the Canadian armed forces modern equipment to help their participation in the North American Air Defense Command (Norad) air defense of this continent and for tactical support of NATO forces in Europe. The new aircraft will replace Canada's CF-101 and CF-104 jets, which are approaching retirement age.

The American competitors and their proposed aircraft are Grumman Aerospace Corp., Bethpage, NY (F-14); General Dynamics Corp., Fort Worth, TX (F-16); McDonnell Douglas Corp., St. Louis (F-15 and F-18) and Northrop Corp., Hawthorne, CA (the F-18L export version of the F-18). The European entry is the British-Italian-German consortium known as Panavia, which is proposing its multirole combat aircraft (MRCA). But more than one aircraft may have to be selected if the Canadians decide a single version cannot meet both the Norad and NATO requirements.

Flight simulators may help test more pilots

The Federal Aviation Administration is relaxing its stand against the use of flight simulators for checking out air-taxi pilots and may even accept simulator time in lieu of actual flight time. Not only will this reduce the costs of pilot certification, it will save fuel as well.

Pilots of corporate jets are permitted to substitute simulator time for the real thing. But the FAA won't let air-taxi operators do it unless the simulator industry comes up with a set of hardware and software standards to ensure that the simulators will be realistic enough. The agency has begun holding preliminary talks with manufacturers, and no deadline has been set for the standards.

Currently, simulators can be used only for ground training, not as substitutes for the flight checks required for periodic certification. But if simulator standards are approved by the FAA, local general-aviation district offices that certify pilots will be permitted to accept the use of simulators.

Capital Capsules: **The United States and Soviet Union expect to begin full-power operation around the middle of this year of the first high-magnetic-field, magneto-hydrionic, electric-power generator.** The system has been in limited operation since last December using a 40-ton superconducting magnet built by the Argonne National Laboratory. The magnet has been connected to the U-25 MHD pilot plant at the Institute of High Temperatures near Moscow . . . Fairchild Industries (Germantown, MD), prime contractor on the A-10 close-support jet, has begun **flight-testing the use of flares and chaff to confuse enemy radars.** The dispensers are located in the wing tips and the aft end of the landing-gear pods.



TM 500 Hits the Road.

If you're on the move making on-site field tests or measurements, a TEKTRONIX TM 500 Test and Measurement system is a great way to go.

With a TM 515 Traveler Mainframe, you can leave behind all the problems of crating up your instrumentation for travel . . . without saying good-bye to laboratory accuracy and convenience.



Up to five TM 500 plug-ins pack neatly in the handsome, but rugged, carry-on TM 515 Traveler Mainframe. Instruments and all weigh about 30 lbs. and slip under the seat of most commercial aircraft.

And, with nearly 40 ready-to-go TM 500 plug-in instruments to choose from, you can handle just about any test or measurement application anywhere, on a moment's notice. The TM 500 family includes DMMs, Counters,

FOR TECHNICAL DATA CIRCLE NUMBER 30

Generators, Amplifiers, Power Supplies, Oscilloscopes, Logic Analyzers and Word Recognizers designed to meet a variety of performance capabilities.

Each plug-in can operate independently or in combination through the built-in electrical interfacing of the mainframe's "mother board."

For example, an interfaced digital field service system might include a dual channel oscilloscope, a digital delay, a counter and a multimeter to give you a universal



Oscilloscope Calibration Travel Lab



RF Sweeper Travel Lab



Audio Travel Lab

counter, full function DMM capabilities plus trigger level readouts at the touch of a button, or even the ability to display and count signals simultaneously through a single probe.

And it's just as easy to configure a travel lab for an oscilloscope calibration, audio and RF sweeper applications, logic analysis or control system maintenance, etc. TM 500 is designed for configurability.

So, the next time a call comes in from across town, or across the country, be prepared to hit the road with the compact performance and go-anywhere convenience of a TM 515 Travel Lab.

For on-the-road engineering, TM 500 is just the ticket.

TM 500 Designed for Configurability

Call the Tektronix Field Office near you or write for our free TM 500 concepts brochure to get other ideas on how an economical TM 500 test and measurement system can give you unmatched value for your instrument dollar. Write: Tektronix, Inc., P.O. Box 500, Beaverton, Oregon 97077, (503) 644-0161, Ext. 5283. In Europe: Tektronix Limited, P.O. Box 36, St. Peter Port, Guernsey, Channel Islands.

Tektronix
COMMITTED TO EXCELLENCE

FOR DEMONSTRATIONS CIRCLE NUMBER 47

Fluke Counters.



What's in a name?

CIRCLE 139 FOR 1900 SERIES LITERATURE
58

CIRCLE 140 FOR 1953A LITERATURE ONLY
ELECTRONIC DESIGN 8, April 12, 1978

A glance at our counter guide shows how broad a selection you have when you choose the Fluke name.

Pick resolution from six to nine digits, and top-end frequencies from 80-1250 MHz. Notice that all Fluke counters are multi-function, from the frequency/period/totalize capability of the 1900A to the six-function 1953A Universal Counter-Timer. All models have input signal conditioning for reliable readings in the presence of noise, distortion, and ringing, and most have attenuators for increased dynamic range. So for R&D, GENERAL BENCH or PRODUCTION LINE applications, buy exactly what you need over an affordable, performance-effective price range.

For FIELD MAINTENANCE AND SERVICE, most of the line is available with an optional rechargeable battery pack installed inside the compact, portable case. Let autoranging keep the display full at all times for "hands-off" convenience, and rely upon autoreset to eliminate erroneous

RFI-shielded, and TCXO timebases are available for the kind of high accuracy you might need over environmental extremes. And if you choose the 1920A, you can get a resolution multiplier for high-resolution audio measurements.

If you have an ADVANCED BENCH or SYSTEMS application, the 1953A was designed for you. With fully programmable ranges and functions (including trigger level), the 1953A is available with



Fluke 1953A: a name and number to remember for perfection in programmable counter-timers.

IEEE-488 or BCD parallel options, at a price more than \$1,000 less than the competition's similarly-equipped models.

CALL (800) 426-0361, TOLL FREE and let us show you how the Fluke name is as meaningful

Counter Selection Guide	1900A	1910A	1911A	1912A	1920A	1925A	1952B	1953A
Number of Digits	6	7	7	7	9	9	7/8	9
Frequency (MHz) <i>Basic Unit Options</i>	80	125	250	520	520 1250	125 520	80	125 1250
Period	•	•	•	•		•	•	•
Totalize	•	•	•	•		•	•	•
Time Interval							•	•
Ratio		•*	•*	•*	•*	•*	•	•
A gtd by B							•	•
Sensitivity (mV)	25	15	15	15	15	15	50	30
Trigger Level Control		•	•	•		•	•	•
External Timebase Input		•	•	•	•	•	•	•
Battery Option	•	•	•	•	•			
TCXO Option		•	•	•	•	•	•	•
Ovenized Timebase Option						•		•
DOU Option	•	•	•	•	•	Std		•
Autoreset	•	•	•	•	•	•		
Autorange	•	•	•	•		•		
U.S. Price Basic Model (No Options)	\$345	\$395	\$495	\$620	\$995	\$750	\$795	\$995

partial-readings. In the Fluke tradition, they'll take a real field beating, too.

COMMUNICATIONS people find the 1911A through 1925A attractive for VHF/UHF measurements. They're so sensitive that a simple optional whip on the 50-Ohm fuse-protected input makes transmitter checks quick and easy. With automatic clean dropout, you'll always be right because the reading goes to zero with a fading signal. They're

in counters as it has been for other fine test and measurement instrumentation for the last 30 years. It's your assurance you've bought the best, backed by more than 32 service centers in 18 countries, worldwide.

John Fluke Mfg. Co., Inc., P.O. Box 43210, Mountlake Terrace, WA 98043. In Europe, contact Fluke (Nederland) B.V., P.O. Box 5053, Tilburg, The Netherlands. Tel. (013) 673973. Telex: 52237.

*Using external timebase input

Command Performance: Demand Fluke Counters.



2102-8007

CIRCLE 46 FOR DEMONSTRATION

Dialight is your second source to C&K for miniature rockers and toggles...



Come to the people who've always been specialists in having more good ways to solve problems: Dialight. What we've done in indicator lights, illuminated switches, readouts and LEDs, we're doing now in miniature rockers and toggles.

This new Dialight family of switches, which comes in a full range of sizes is, we're proud to point out, all-American made.

When you consider all the configurations of styles, sizes, life and safety ratings, colors and mountings, you'll find there are literally hundreds of thousands of design combinations. Such a number of possibilities

can in itself be a problem, except that the new Dialight catalog is specifically designed to prevent confusion and help you quickly and easily find the most advantageous combination of features for your applications.

If you'd like to see what Dialight quality rockers and toggles can do for the looks, durability and economics of your products, contact us today for the Dialight "Meets Your Need" Book. Your free copy will include a list of stocking distributors in the U.S. and Canada.

DIALIGHT

A North American Philips Company

American made by DIALIGHT in Brooklyn, N.Y.

Dialight meets your needs.

Dialight, 203 Harrison Place, Brooklyn, N.Y. 11237 (212) 497-7600

CIRCLE NUMBER 32

Enthusiasm

Nobody can beat Charlie for enthusiasm. Whenever we get together, we wash down a meal, and he tells me about the sensational products his company has developed and will soon develop. And production? Nobody beats Charlie's company on production. In fact, he's already produced a million pieces of one difficult part, and delivered two million to the auto companies alone.

You can't listen to Charlie without being caught up in his excitement and without believing all his reasons for competitive products being inferior. He has lots of reasons.

First, of course, his company has the best engineers because company spirit is terrific. In fact, engineers from other companies always want to join his company while nobody ever leaves. Well, almost nobody. The ones who leave aren't much good anyway.

More important is the fact that his company has a real dedication to its specialty, while industry's large companies don't have that commitment. After all, they're involved in many other product areas. Charlie forgets that most of those big companies are at least ten times as large as his company and they have specialized groups dedicated to his specialty. What about excellent products from *small* competitors? That's easy. Charlie ignores all small companies except his own.

So when he wages verbal battle, it's on selected ground, with selected weapons, against selected foes. Within those limits, Charlie tells the truth. Well, mostly. He does suffer a small blind spot for dramatic products that come from others.

Well, if you know where Charlie's coming from, you can learn a lot about what his company's doing, what his competitors are doing and what's going on in his field. You must understand, of course, that it's not rare for company executives to try to impress people—and to be enthusiastic.

Much of Charlie's enthusiasm is well spent. His company has been growing handsomely. And most of his products—even some "breakthrough" products—have been selling well, even working well, in the field.

I'm very fond of Charlie so I often fear that someday his enthusiasm will race too far beyond reality. If he lets that happen, will he be able to catch up?



A handwritten signature in cursive script that reads "George Rostky".

GEORGE ROSTKY
Editor-in-Chief

Meet DIN, IEC and VG standards

Eurocard

Quality connectors from a big connector user

As a big connector user, Philips have long recognised the need for International, interconnection standards. But as a user, we also recognise that there's more to a connector than the

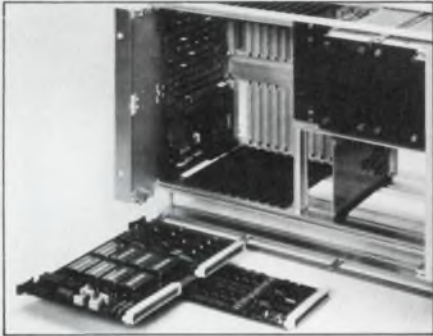

dimensions and format of the Eurocard system.

In connectors there's a vital parameter called quality. So don't look just to DIN and IEC, look also for a supplier who can meet the critical, German Military (VG) standards. Because even if you don't need these high-quality standards, it's important to know that your connectors were made to the same quality levels, on the same equipment, by the same people. People like Philips.

A comprehensive range

As illustrated in the table above, Eurocard connectors are available in two series for 2 A and 5.5 A applications and in 2-row, 3-row and 4-row configurations. The series are designated F068-I and F068-II respectively

F068-I 2,54 mm 2 A at 20°C IEC 130-14 / DIN 41612 / VG 95324

	2-row body				3-row body								
	male		female		male		female		male		female		
number of contacts	1 x 32	2 x 32	1 x 32	2 x 32	2 x 16	2 x 32	3 x 32	2 x 16	2 x 32	3 x 32	2 x 16	2 x 32	3 x 32
pitch (mm)	2.54	2.54	2.54	2.54	5.08	2.54	2.54	5.08	2.54	2.54	5.08	2.54	2.54
row spacing (mm)	-	2.54	-	2.54	5.08	5.08	2.54	5.08	5.08	2.54	5.08	5.08	2.54
straight wire-wrap pins													
90° dip-solder pins													
straight dip-solder pins													
solder tags													
90° wire-wrap pins													

★ available with protruding ground contacts
 ▲ available to German MIL Spec VG 95324

and are available with a wide range of accessories.

Contacts and terminations

The main specification points are given in the table below. In addition it should be noted that F068-I male connectors with dip-solder pins and all male F068-II connectors can be supplied with protruding earth contacts. Use of these contacts ensures that electrostatic effects do not damage sensitive components, such as some IC types, when the connector halves are separated.

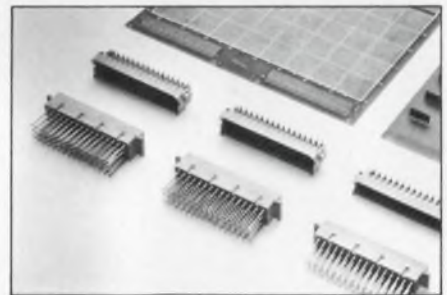

Above, male F068-II connectors on single- and double-format Eurocards for mating with female connectors with wire-wrap pins.

Below, male F068-I connectors mate with female connectors having either wire-wrap or dip-solder pins.



	F068-I		F068-II	
	male	female	male	female
material for metal parts	brass	phos. bronze	brass	phos. bronze
contact finish (gold on nickel)				
IEC and DIN:	nickel	2 µm	2 µm	3 µm
	gold	1.3 µm	1.3 µm	1 µm
VG 95324:	nickel	2 µm	2 µm	-
	gold	2.5 µm	3 µm	-
termination finish	gold flash on 1 µm nickel		6 µm tinned	
reinforced contacts	-	no	-	yes
non-reinforced contacts	-	yes	-	yes
removable contacts	no	no	yes	no
mechanical endurance	400 insertions: IEC 512-5 500 insertions: VG 95324		400 insertions: IEC 512-5	



Electronic Components and Materials

Connectors

**Developed and
made in Europe**

F068-II 5,08 mm 5,5 A at 20°C IEC 130-1 / DIN 41612						
3-row body				4-row body		
	male		female		male	female
number of contacts	2 x 16	3 x 16	2 x 16	3 x 16	4 x 16	4 x 16
pitch (mm)	5,08	5,08	5,08	5,08	5,08	5,08
row spacing (mm)	5,08	5,08	5,08	5,08	5,08	5,08
straight wire-wrap pins						
90° dip-solder pins						
straight dip-solder pins						

all connectors use even numbered pins only.
all male connectors available with protruding ground contacts.
all female connectors available with reinforced contacts

the male connectors will only mate with females having the same code. A set of coding parts is available for this purpose.



Testing sometimes requires that temporary connections be made to the wire-wrap pins of rack-mounted female F068-I connectors. As shown below, a set of parts is available for this purpose.

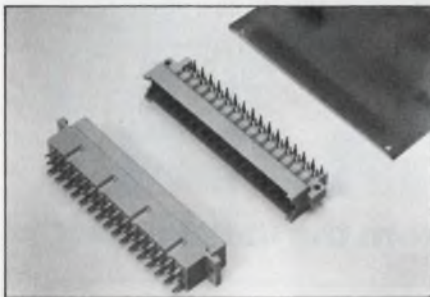

Above, male F068-II connector on single-format Eurocard for mating with female connector having dip-solder pins.

Below, male F068-I connector with right-angled wire-wrap pins to obviate the use of intermediate pins.

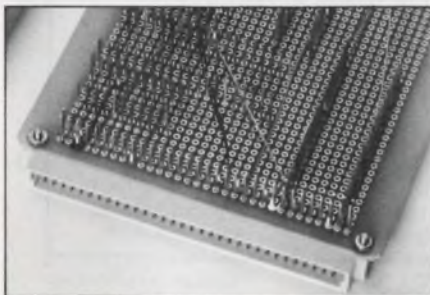

All female F068-II connectors are supplied with contacts reinforced by metal springs. This ensures reliable operation under severe conditions such as vibration.

Accessories

A comprehensive range of accessories is available including cable hoods for use with both male and female F068-I connectors. The hoods are manufactured in two parts and are provided with a cable clamp and three cable entry positions, which allow cable feedthrough.

Three basic connections can be made: cable to panel-mounted male connector; cable to cable and cable to board-edge male connector. The illustration above shows a cable to rack-mounted female connector via an extender board. The F068-I connectors can also be coded so that

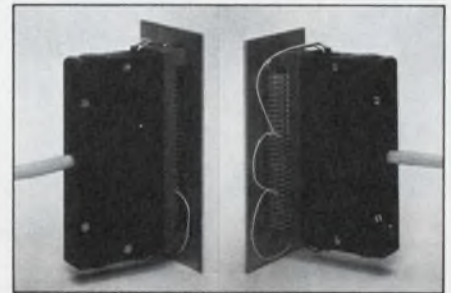

A useful accessory for the F068-II series is the simple tool that allows the pins to be removed from the male connector. This can be used, for example, to relocate a protruding earth contact.

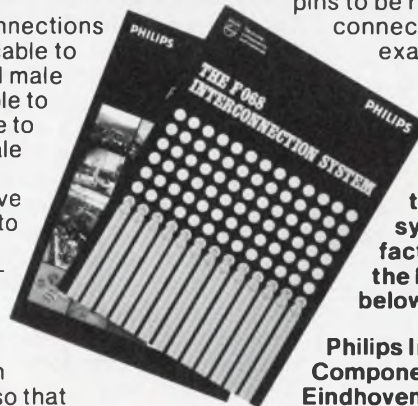

For a detailed brochure on the F068 interconnection system and our manufacturing facilities please use the Reader Service Number below.

Philips Industries, Electronic Components and Materials Division, Eindhoven, The Netherlands.

PHILIPS

CIRCLE NUMBER 33

Motorola introduces low-power CMOS single-chip microcomputers.

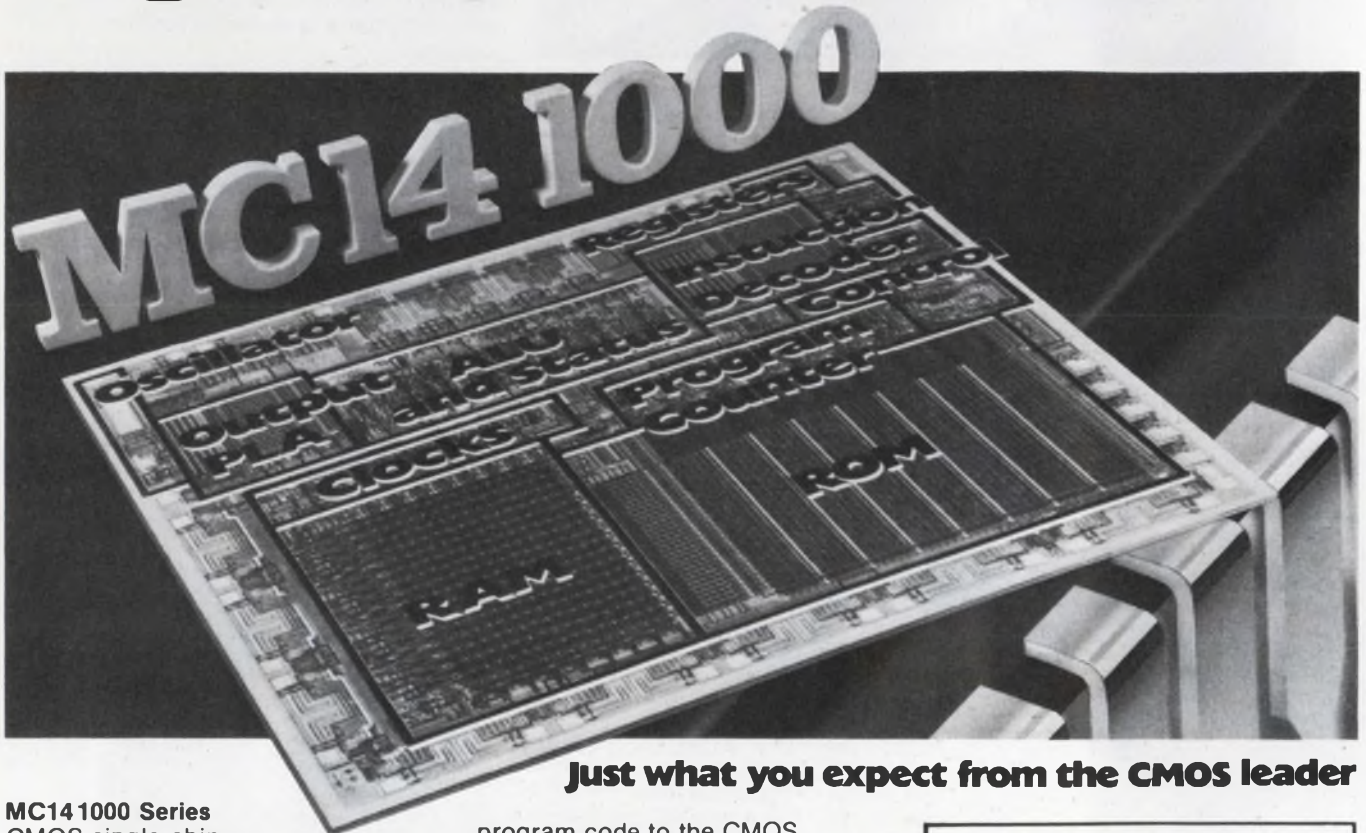

Just what you expect from the CMOS leader

MC141000 Series

CMOS single-chip microcomputers. The MC141000 . . . 28-pin package. The MC141200 . . . 40-pin package • 8,192 bits of ROM • 256 bits of static RAM • 3–6 V battery operation • 5 V TTL and CMOS compatible • Fully static • 20 mA output drive

Compatibility. These CMOS microcomputers are both *program* and *pinout* compatible with the PMOS TMS1000, but because they are CMOS, they provide high noise immunity and low power operation. The series also plays easily with over 140 standard Motorola CMOS parts, as well as TTL. Now those low-power battery operated and battery back-up systems are practical.

Powerful support. MC141000 Series support is headed by the EXORciser™-based MC141000-1200 Development System for hardware and software simulation of the user system. It lets you emulate, edit, and debug your design, and allows conversion of a PMOS TMS1000

program code to the CMOS MC141000 object code.

Applications galore. Appliance Controllers • Portable Toys • Data Terminals • Distributed Computing Systems • Radio/Communications Controllers • Remote Sensing Systems • Cash Registers • Security Systems • Telecommunications Systems • Smart Instrumentation • Automobiles • Power/Energy Controllers • Environmental Controllers

Doing it your way. Every MC141000 or 1200 is essentially your own design, so that's the way we handle it. We'll take your source program or source code, or we'll start from scratch and do the entire "turnkey" job with complete application and program effort.

For assistance, contact your Motorola sales office or authorized distributor without delay, or write Motorola Semiconductor Products Inc., P.O. Box 20912, Phoenix, AZ 85036 for a data sheet.

More Support

- MC141099—An MC141000 with off-board ROM and PLA for real-time system development. 48-pin package. Available, April.
- MCM145101—256 × 4 CMOS static RAM. Memory expander.
- MC14053B and MC14551B—CMOS MUXs for input expanders. (MC14551B available, May)
- MC14443 and MC14447—Microprocessor compatible A/D Converters.
- MC14469—Addressable Asynchronous Transmitter-Receiver for serial communications.
- MC141000 Series Programmer's Reference Manual. Available, April.

*Trademark of Motorola Inc.



MOTOROLA
Semiconductor Group



The Sinclair PDM35. A personal digital multimeter at only \$49.95

A digital multimeter used to mean an expensive, bulky piece of equipment.

The Sinclair PDM35 changes that. It's got all the functions and features you want in a digital multimeter, yet they're neatly packaged in a rugged but light pocket-size case, ready to go anywhere.

The Sinclair PDM35 gives you all the benefits of an ordinary digital multimeter – quick clear readings, high accuracy and resolution, high input impedance. Yet at \$49.95 it costs less than you'd expect to pay for an analog meter!

The Sinclair PDM35 is tailor made for anyone who needs to make rapid measurements. Development engineers, field service engineers, lab technicians, and computer specialists will find it ideal.

With its rugged construction and battery operation, the PDM35 is perfectly suited for hand work in the field, while its angled display and

optional AC power facility make it just as useful on the bench.

Features of the PDM35

- 3½ digit resolution.
- Sharp, bright, easily read LED display, reading up to ± 1.999 .
- Automatic polarity selection.
- Resolution of 1 mV and 0.1 nA.
- Direct reading of semiconductor forward voltages at 5 different currents.
- Resistance measurement up to 20 M Ω .
- 1% of reading accuracy.

Operation from replaceable battery or AC adapter.
Industry standard 10 M Ω input impedance.

Technical Specification

DC Volts (4 ranges)

Range: 1 mV to 1000 V.

Accuracy of reading: 1.0% \pm 1 count.

Note: 10 M Ω input impedance.

AC Volts (40 Hz-5 kHz)

Range: 1 V to 500 V. Accuracy of reading: 1.0% \pm 2 counts.

DC Current (6 ranges)

Range: 1 nA to 200 mA.

Accuracy of reading: 1.0% \pm 1 count.

Note: Max. resolution 0.1 nA.

Resistance (5 ranges)

Range: 1 Ω to 20 M Ω .

Accuracy of reading: 1.5% \pm 1 count.

Note: Also provides 5 junction-test ranges.

Dimensions: 6 in x 3 in x 1½ in.

Weight: 6½ oz.

Power supply: 9 V battery or Sinclair AC adapter.

Sockets: Standard 4 mm for resilient plugs.

Supplied with: Leads, test prods, operating instructions, carrying wallet.

Options: AC adapter for 117 V 60 Hz power. De Luxe padded carrying wallet. 30kV high-voltage probe.

The Sinclair credentials

Sinclair have pioneered a whole range of electronic world-firsts – from programmable pocket calculators to miniature TVs – holding a world-lead in innovative electronics. The PDM35 embodies six years' experience in digital multimeter design, in which time Sinclair have become one of the world's largest producers.

Find out more!

You can see the PDM35 at any of the Sinclair distributors listed on this page. Or, if you'd like full details of operation and performance, and a complete distributor list, just send the coupon below. We'll send you all the facts by return.

The Sinclair PDM35 will make your life a lot easier – send the coupon today!

Send to: Sinclair Radionics Inc, Galleria, 115 East 57th Street, New York, N.Y. 10022, U.S.A.
Please send me full illustrated details of the Sinclair PDM35 personal digital multimeter, without obligation.

Name.....

Position.....

Company.....

Address.....



sinclair
ED World leaders in fingertip electronics

Sinclair Radionics Inc, Galleria, 115 East 57th Street, New York, N.Y. 10022, U.S.A.

See the PDM 35 at: Carter McCormick & Peirce Inc., Farmington, Mich. 313-477-7700; Crane & Egert Corp., Elmont, N.Y. 516-488-2100; Dyte Central, Arlington Heights, Ill. 312-394-3380; F. L. W. Inc., Costa Mesa, California. 714-751-7512; International Standard Components, Mountain View, CA 415-964-4171; Ossmann Instruments Inc., Syracuse, N.Y. 315-437-6666; Par Associates, Denver, Colorado. 303-355-2363; Scientific Associates, Washington D.C. 703-573-8787; Southern Peripherals & Instruments Inc., Atlanta, Georgia. 404-455-3518. Available in Canada from Gladstone Electronics, Toronto, Ont. 416-787-1448.

Video analog-to-digital conversion

calls for virtuoso performances. And the plot really thickens when you have to produce high resolution.

Accurately digitizing analog signals containing high frequencies, demands ultrahigh-speed, or video, a/d converters. Such a converter is essential to diverse uses like radar-signature or transient analysis, high-speed digital-data transmission, video densitometry, and digital television. In television alone, a speedy converter can help enhance images, correct time-base errors, convert standards, synchronize or store frames, reduce noise, and record TV.

Most video a/d converters work in the 1-to-20 MHz range. But at these speeds, resolution can be a problem. Fortunately, 8 bits and fewer most often suffice in ultrafast a/d applications.

Higher resolutions are hard (and expensive) to come by, particularly at 10 to 20 MHz. In this ultrahigh-speed range, 4 bits is about the practical limit for a single-stage converter. However, you can cascade a/d stages for more than 4 bits.

Below 5 MHz, you can retain the "one bit at a time" concept of the familiar successive-approximation converter, while reducing the time delays inherent in converting each bit. The "propagation" (or variable-reference-cascade) converter of Fig. 1 does just this.

Comparators star in propagation a/d's

The critical parts of the circuit are the comparators, which must be very fast, and the switches, which must be not only very fast but also capable of withstanding the reference voltage. A propagation a/d converter uses one comparator per bit. Furthermore, each bit is converted in sequence, beginning with the most significant. With a -5 V reference, the circuit of Fig. 1 handles inputs from 0 to +10 V.

Comparator A₁ makes its decision at a +5 V input: when the analog-input voltage exceeds +5 V, the output is true. The threshold of comparator A₂ is set for an input of either +2.5 or +7.5 V, depending on the output of comparator A₁. If the analog input voltage exceeds +7.5 V, comparator A₂ also goes true. If, however, the analog input voltage is between +5 and +7.5 V, the output becomes ZERO; an input

Table 1. Comparator thresholds for a 4-bit propagation-type a/d converter

Scale	Comparator Number			
	1	2	3	4
FS-1 LSB			+8.750	+9.375
3/4 FS		+7.500		+8.125
			+6.250	+6.875
1/2 FS	+5.000			+5.625
			+3.750	+4.375
1/4 FS		+2.500		+3.125
			+1.250	+1.875
1 LSB				+0.625

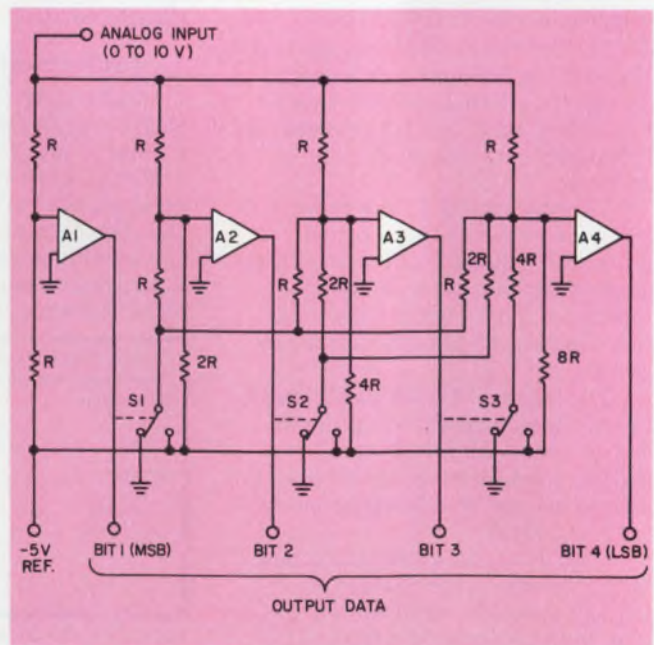

1. A propagation-type a/d converter uses one comparator per bit, with each bit converted in sequence. At best, this type of a/d runs at 5 MHz for up to four bits.

between +2.5 and +5 V produces a ONE. And for less than 2.5-V input, the output becomes ZERO.

As you can see, then, the output of comparator A_1 sets the threshold of comparator A_2 via electronic switch S_1 . S_1 switches one end of the resistive divider at comparator A_2 to ground when the output of comparator A_1 is ZERO, and to the -5 V reference when it is ONE. Therefore, the threshold of the second comparator is set for either of two analog-input-voltage levels: +2.5 or +7.5 V.

This process continues for comparators A_3 and A_4 . Each succeeding threshold is set by the result of all previous comparator decisions. Thus, comparator A_3 has four possible threshold levels, +1.25, +3.75, +6.25, or +8.75 V. Similarly, comparator A_4 has eight possible threshold levels (for a summary of each comparator's threshold levels, see Table 1).

Obviously, a propagation-type converter becomes more complex as its resolution increases beyond 4 bits. Higher resolution requires not only more resistors—to set the new threshold levels—but also higher-value resistors. The resistor values go up in a 1, 2, 4, 8,...binary sequence. So as the number of bits increases, the resistors soon take on values so large as to affect the conversion time for the less-significant bits. The fault lies with slow settling of the currents switched through the resistors. The time constants, caused by switch plus stray capacitances and the high-value resistors, cause the delays.

Still, you can achieve 50-ns per bit conversions with a propagation-type converter. After a new input is applied to the converter, the resulting digital output word propagates rapidly down the converter-output lines, as each comparator and switch change states. Instead of simply allowing the circuit to propagate naturally, you can also operate it in a clocked mode by using sampling (gated) comparators, rather than the usual ungated kind.

But 5-MHz and higher conversion rates, together with the complexity required for higher than 4-bit resolution, severely limit the video uses of propagation-type analog-to-digital converters.

Quantizer plays the lead

Fortunately, a much faster technique is available. Parallel conversion (also called flash, or simultaneous)

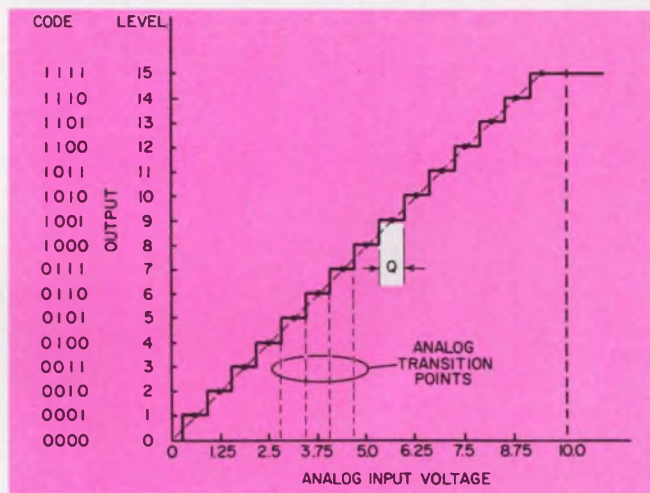

2. The quantizer transfer function for a 4-bit parallel-type converter shows how the analog input is broken into 16 different levels. Each word of digitally coded output signals represents a range, Q , of input voltage.

is more popular because it is faster than propagation. A parallel-type a/d converter is simply a quantizer circuit followed by a decoder circuit. As a matter of fact these two functions are fundamental to all a/d converters. The difference is that these functions are clearly separate in a parallel a/d.

The quantizer section of a parallel converter is defined by its transfer function, which is shown for a 4-bit quantizer, in Fig. 2. The quantizer breaks up the continuous-analog input (horizontal axis) into discrete-output levels (vertical axis).

In Fig. 2, the output is divided into 16 different states, or 2^n levels, where n is the number of bits. Along the horizontal axis of the transfer function are $2^n - 1$ or 15 analog-transition points which represent the voltage levels that define the edges between adjacent output states or codes.

There is no one-to-one correspondence between input and output for the quantizer, which assigns one output code word to a small range, or band, of analog-input values. The size of this band is the quantum, Q , and is equal to the full-scale-analog range divided by the number of output states:

$$Q = \frac{FSR}{2^n}$$

Table 2. Parallel 3-bit a/d coding

Scale (fraction of full scale)	7-Line equally weighted code with overrange	Binary code
+9/8	11111111	1000
	01111111	0111
+3/4	00111111	0110
	00011111	0101
+1/2	00001111	0100
	00000111	0011
+1/4	00000011	0010
	00000001	0001
0	00000000	0000

function becomes that of a complete a/d converter rather than just a quantizer alone.

The binary codes are assigned by a circuit that decodes the quantizer-output logic. Though you can select any code, the code shown, natural binary, is most used. Notice that the analog center of each code word—the exact analog value—is depicted by a dot on the transfer-function graph.

The transfer function in Fig. 2 depicts an ideal quantizer or a/d converter. A real device, of course, has errors in offset, scale-factor (gain) and linearity.

Fig. 3 shows a circuit implementation of a 3-bit parallel a/d converter. Usually, the quantizer portion of such a circuit consists of a bank of $2^n - 1$ high-speed comparators. But, in Fig. 3, 2^n or 8, comparators are used, because this circuit also provides an overrange output that can be used for expansion.

The bank of comparators has 2^n analog-transition points. These are directly set by biasing one side of the comparator inputs from a reference with a series string of equal-value resistors, R. The Q for this circuit depends on the value of R, the reference voltage, and the total resistance:

$$Q = (V_{REF}R)/R_{TOTAL}$$

The bottom and top resistors in the string have values of R/2, which correspond to the values of the first and last analog-transition points. These transitions are at Q/2 and FS -(Q/2), respectively.

Without the overrange output, the last analog transition point would be at FS -(3Q/2). The value of the top resistor would then be 3R/2.

Enter the decoder

The parallel converter's decoder section is a rather straightforward logic circuit. It translates the logic outputs from the comparators into the most commonly used code, natural binary.

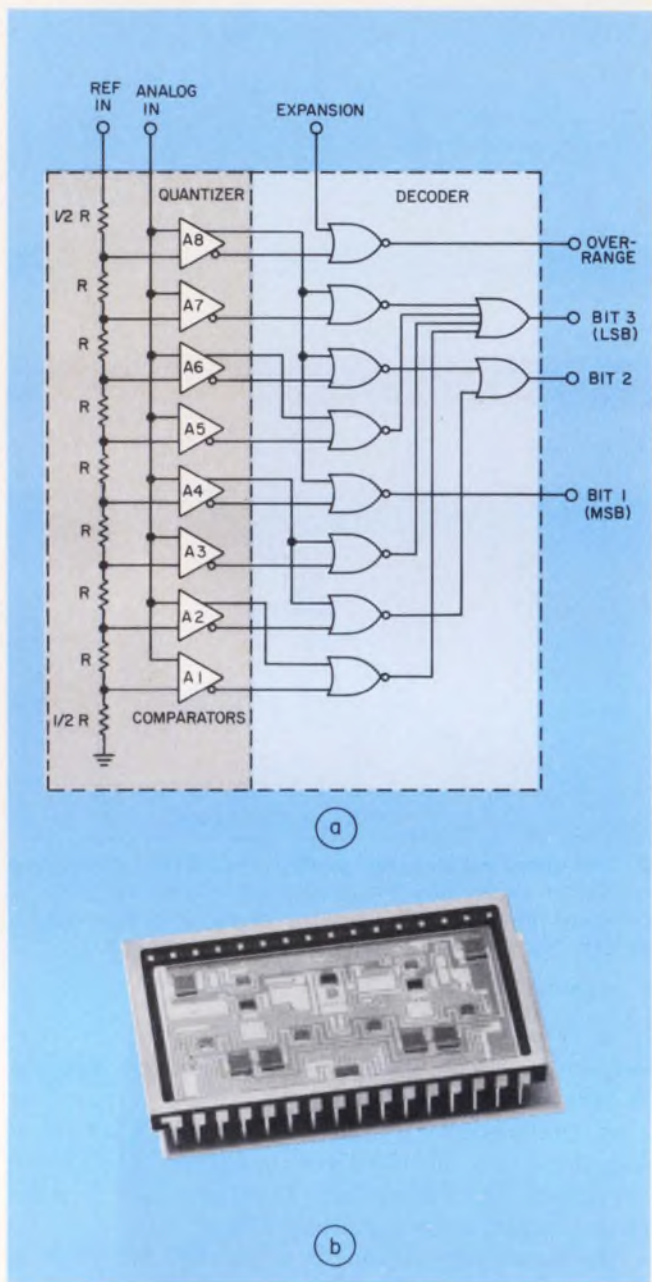

3. The circuit for a parallel 3-bit a/d converter (a) has just two basic sections: the quantizer and the decoder. The transition points in the quantizer are set by biasing each comparator, through a resistive divider and reference. The complete 3-bit analog-to-digital converter comes packaged as a thin-film hybrid (b).

In Fig. 2, where the full-scale-input range is 10 V,

$$\begin{aligned}
 Q &= \frac{10}{2^4} \\
 &= \frac{10}{16} \\
 &= 0.625 \text{ V.}
 \end{aligned}$$

Fig. 2 shows levels of 0 through 15 at the output. When binary-code words are assigned to these output states, as shown in the leftmost column, the transfer

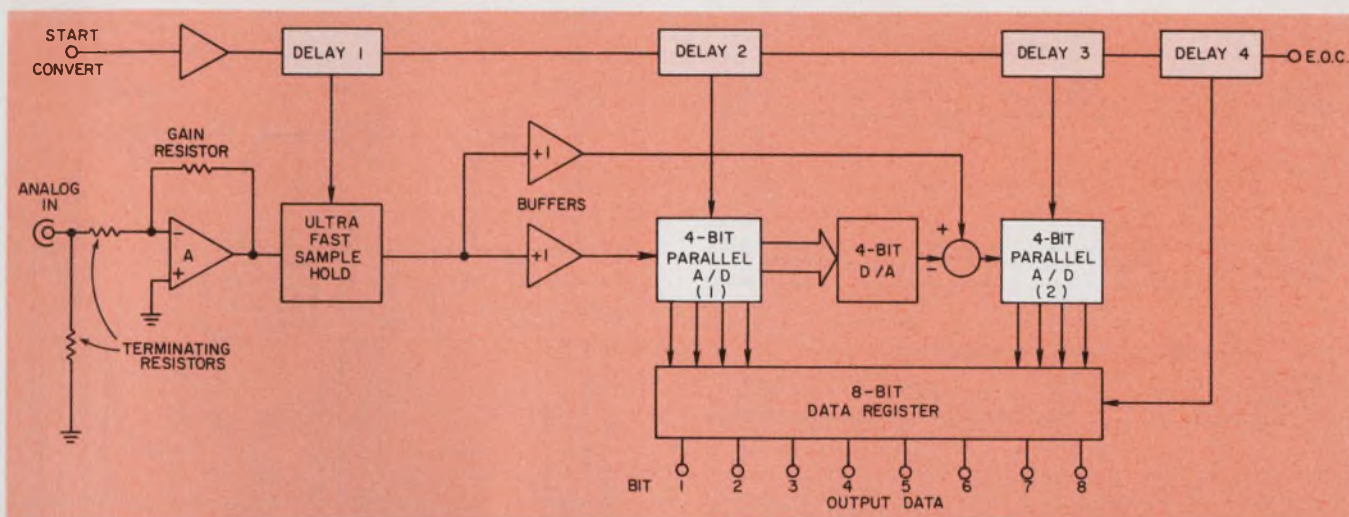

4. **Two-stage parallel a/d converters** can develop 8-bit resolutions at 20 MHz. Though conversion 1 begins at the

Start-Convert pulse and ends 65 nanoseconds later, subsequent conversions take only 50 nanoseconds.

Table 2 shows the coding for quantizer and decoder outputs. In this quantizer-output code, the seven comparator-output lines (eight, counting the over-range comparator) are equally weighted. This equally weighted code is simple and unambiguous, but inefficient—only one output line changes at a time from all-ZERO to all-ONE outputs. Except for not being cyclical, the quantizer code is like the Johnson code used in shift counters. Like the quantizer code, Johnson code proceeds from all-ZEROS to all-ONES, but then cycles back to all ZEROS.

In the decoder, simple NOR and OR gates perform the logic according to the following equations:

$$\begin{aligned} \text{Bit 1} &= A_4 \\ \text{Bit 2} &= A_6 + A_2 \cdot \bar{A}_4 \\ \text{Bit 3} &= A_7 + (A_5 \cdot \bar{A}_6) + (A_3 \cdot \bar{A}_4) + (A_1 \cdot \bar{A}_2), \end{aligned}$$

where the A_n 's are the numbered-comparator outputs in Fig. 3, Bit 1 is the MSB and Bit 3 is the LSB. The AND function in the equations is replaced by a NOR in the actual circuit. The OR function can be implemented by tying together the appropriate outputs of wire-ORed ECL logic.

With ultrafast analog comparators, parallel conversion offers the ultimate conversion speed. Since the comparators all change state simultaneously, the quantizer output is available after just one propagation time. Of course, the decoder adds more delay, but high-speed Schottky-TTL or ECL circuits can minimize the decoding time.

In 3-bit form with an additional comparator, for overrange, the parallel converter in Fig. 3 can be expanded for higher resolution. You can connect two converters, combine into one flash converter to get often-needed 4-bit resolution. Likewise you can connect four such circuits for 5-bit resolution—and so forth. In this way, these circuits can be used as "building blocks" for ultrafast a/d converters. Conversion rates of 50 MHz, for 3, 4, or 5-bit a/d's, are

possible using the commercial hybrid version of these expandable parallel converters.

Comparator plays a complex role

The most critical component in a parallel a/d converter—as in a propagation converter—is the comparator. It not only determines the speed of the converter but also the accuracy. Ultrafast sampling comparators like the 685, 686 and the dual 687 are excellent for this function.

A sampling comparator has two Latch-Enable inputs that switch it into either a Compare or Latched mode. In the latter, the comparator's digital output is locked until the next comparison is made.

Whether or not you use a sampling comparator, you must consider the propagation delay for small overdrive. This is important because the analog full-scale-signal range is generally small for ultrafast a/d converters—commonly between 1 and 4 V. The comparator must change state rapidly for a Q/2 analog-input change. For a 4-bit converter with a 1-V input range, this represents an overdrive of 31 mV; for an 8-bit converter with the same input range, the overdrive is just 2 mV.

The analog-input characteristics of a comparator are important because they affect conversion accuracy. Input-offset voltage and input-bias current are usually the most significant of these parameters. The offset voltage directly affects the accuracy of the quantizer's analog-transition points; the input-bias current also affects the accuracy through the effective input resistance of the comparator.

Since an ultrafast comparator generally has bias currents as high as 10 μ A, its inputs must look into low resistances. Fortunately, for small-signal ranges like 1 to 4 V, each resistance in the series network can be kept low. In an actual 3-bit parallel hybrid

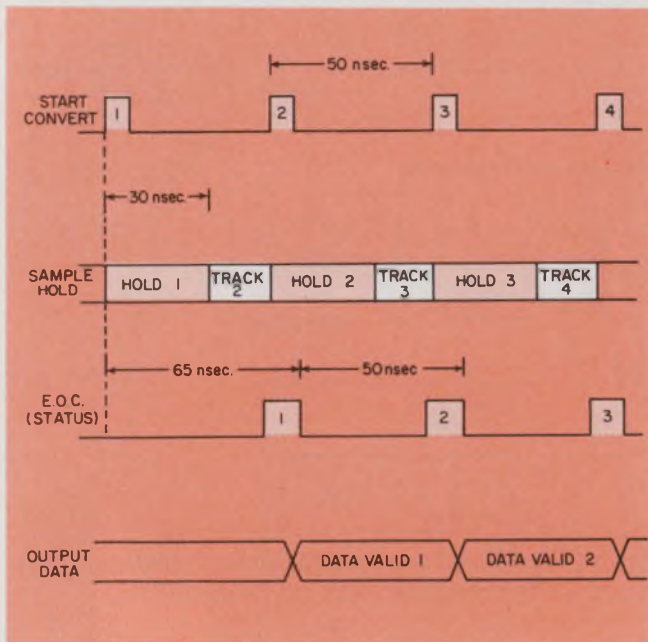

5. **Timing for the 8-bit two-stage a/d converter** allows for two modes in the sample-and-hold circuit—Hold and Track. These occur between successive Start-Converts. The second and succeeding conversions take 50 ns.

converter, laser-trimmed, thin-film-resistor networks make the transition points stable and accurate.

One comparator parameter that greatly affects the speed is input capacitance. For example, the analog-input line to a 4-bit a/d with overrange feeds 15 parallel-comparator inputs. It must be driven from a low-impedance source to retain high speed. Therefore, either a high-speed input-buffer amplifier or a sample-and-hold circuit drives the input.

Parallel a/d conversion suffers from one significant drawback; more resolution than four bits requires many comparators. The number (N_c) increases exponentially with n , the number of bits:

$$N_c = 2^n - 1$$

An 8-bit converter, for example, requires 255 comparators. That many comparators vastly complicates bias-current and input-capacitance problems—to say nothing of the high power dissipation they produce. Another problem, of course, is how to position so many comparators while minimizing lead lengths.

Coming onstage—the two-stage a/d

As a result, the practical limit of parallel a/d converters is usually 4 bits. Higher-resolution designs use a two-stage parallel technique that is really a combination of the parallel and propagation techniques. It cascades two 4-bit conversions.

This two-stage method is illustrated in Fig. 4, which shows the block diagram of a complete 8-bit, 20-MHz converter, including buffer amplifiers and a sample-and-hold. Starting at the input, amplifier A termi-

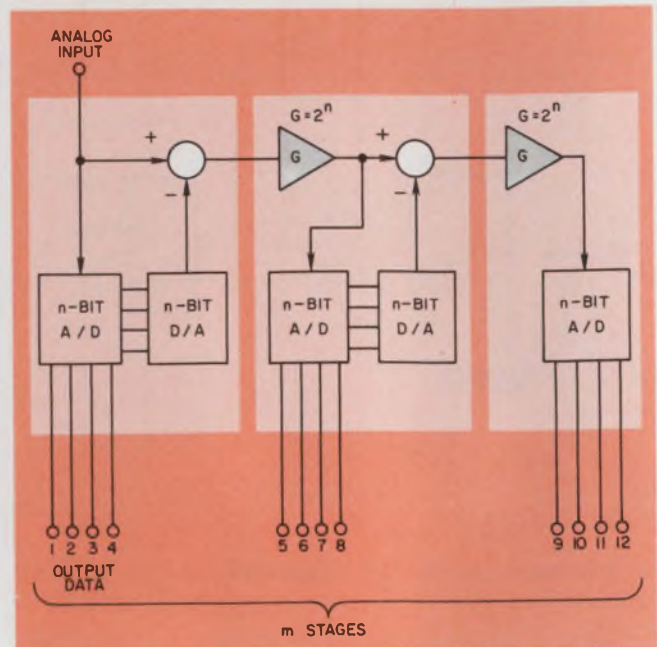

6. **A generalized n-bit, m-stage a/d converter** develops an output with $n \times m$ bits of resolution. In each stage, except the first, the analog result of the subtraction is amplified by a circuit whose gain is 2^n .

nates the analog input with the proper impedance and scales the signal for the sample-and-hold circuit. During its conversion to digital form, the ultrafast sample-and-hold acquires and holds the analog-input.

The sample-and-hold output goes into two unity-gain buffer amplifiers, one of which buffers the input to parallel 4-bit a/d converter 1. This a/d converts the input level, then stores the digital result in half of the output-data register. In addition, 15 undecoded comparator-output lines drive a 15-line, equally-weighted digital-to-analog converter. This d/a, in turn, generates an analog voltage that is subtracted from the other buffered-input signal.

The subtraction result, a residual signal, goes to the input of the second parallel 4-bit a/d, the output of which goes to the other half of the output-data register. The input signal is therefore sampled and converted to digital form in two 4-bit steps.

Four digital delays time the converter as shown in Fig. 5. A pulse at the Start-Convert input begins the timing sequence. The Start-Convert pulse puts the sample-and-hold into the Hold mode for 30 ns. During this time, the first 4-bit conversion is made and the second 4-bit converter quantizes the residual signal. While the second a/d conversion is decoded and transferred to the data register, the sample-and-hold goes into the Track mode to acquire the next value.

When the conversion is done and the 8-bit word is ready in the output register, the delay circuit generates an End of Conversion (or Status) pulse. In the timing diagram, numbers 1, 2, 3 and 4 indicate the relationship of the signals for the first, second, third

Slower a/d converters are alive and well

The two most popular techniques for a/d conversion are dual-slope (a) and successive-approximation (b). Together these methods probably account for over 98% of all analog-to-digital converters in use.

Dual-slope conversion, an indirect method, converts the analog-input voltage into a time period. Then a digital clock and counter measure the interval. For only serial-output data, a simple gate replaces the counter. The method is simple, accurate, and inexpensive, but suffers one major drawback: Conversion is usually slow—often taking milliseconds.

Successive approximation a/d converters, on the other hand, can be much faster. They can convert to 12 bits in 2 to 50 μ s and to 8 bits in 400 ns to 20 μ s. Also, every conversion is completed in a fixed number (n) of clock periods, where n is the resolution in bits.

Successive-approximation, a direct method, puts a d/a converter inside a feedback loop containing both analog and digital elements. The successive-approximation register controls the d/a converter, and the comparator and clock, in turn, control the register.

A conversion consists of turning on, in sequence, each bit of the d/a converter, starting with the most significant. During each clock period, the analog input and the d/a output are compared. The comparison determines whether to leave each bit on or turn it off.

So, after n clock periods, each bit has been turned on, a comparison has been made, each bit's logic state has been decided and the conversion is complete. Clock periods usually last from just fractions of a micro-

second to several μ s. Each clock period must allow time for comparator switching, changing successive-approximation-register states and d/a converter switching plus settling. Settling time for the d/a converter takes a large part of the clock period because the output must settle to within half the least-significant bit before the comparison starts.

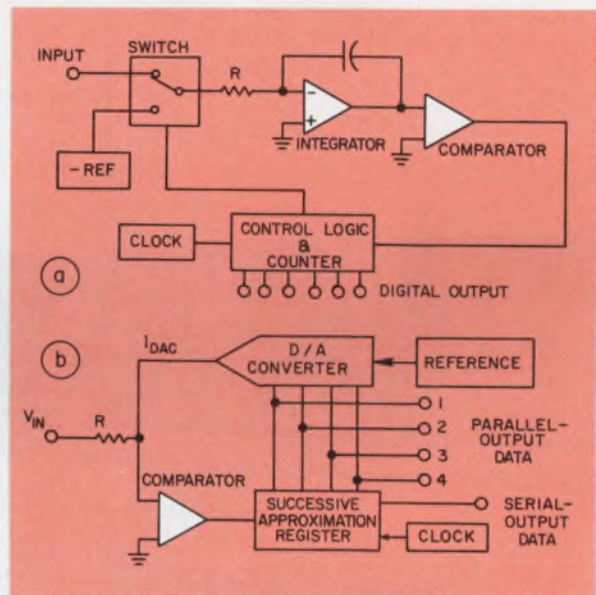

and fourth conversions. The delay from the leading edge of the Start-Convert pulse to the falling edge of the Status pulse is 65 ns—the delay for the first conversion. After the first conversion, new output data arrive every 50 ns—a rate of 20 MHz.

A two-stage parallel a/d converter is practically the only device used for ultrafast conversion at 8-bit resolution. Moreover, just about all new 8-bit converters have built-in sample-and-holds to shorten the effective aperture time of the conversion from the 50 ns of the converter in Fig. 4, to a fraction of an ns.

While the 8-bit a/d in Fig. 4 is functionally simple, it's actually difficult to develop. In fact, it usually takes longer to develop than today's other types of a/d's. More engineering time can go into just determining circuit and ground-plane layout than into any other part of the development.

Behind the scenes—a hybrid

At least one commercial 8-bit converter uses thin-film hybrid components as building blocks, which organize the critical-circuit functions into miniature packages. For example, each 4-bit a/d shown in Fig. 4 can be implemented with two hybrid 3-bit expand-

able decoded a/d's. Also, the 15-line d/a converter, the sample-and-hold and the input-buffer amplifier can be readily hybridized. The remaining noncritical circuit elements can be made from standard monolithic devices and passive components.

The hybrid circuits' stable thin-film resistors can be laser-trimmed for optimum linearity. The entire circuit of Fig. 4 fits on a single circuit card, so laying out critical components is less formidable.

Propagation and parallel two-stage are specific examples of a more general conversion method by which m stages of n bits each, make an a/d converter with $m \times n$ bits of resolution (see Fig. 6). In each case, the residual analog signal from the subtraction is boosted for the next stage by an amplifier with gain of 2^n . This technique can produce a 12-bit a/d converter using three parallel 4-bit a/d stages. ■■

Bibliography

Schmid, H., *Electronic Analog/Digital Conversions*, Van Nostrand Reinhold Co., New York, 1970.

Acknowledgement

The author wishes to acknowledge the contribution of James B. Knitter to this article in the form of helpful technical discussions with the author.

Intel's 8080A gets JAN approval.

Can't we list
all 26 of Intel's
military parts?

No room.

Intel introduces the first JAN-qualified microprocessor, the 8080A. It's available now, and listed in QPL-38510 as M38510/42001BQB.

Now you can build your military projects with the most popular microprocessor ever, and avoid special approval procedures and reliability documentation.

In addition to our JAN-qualified 8080A, Intel's military ic-38510 pro-

gram includes 26 LSI components manufactured in full compliance with the testing and screening requirements of MIL-M-38510D and MIL-STD-883B. For details on the JAN8080A, and our other military products, write Intel Corp., Military Program Manager, 3065 Bowers Avenue, Santa Clara, CA 95051.

intel delivers.

CIRCLE NUMBER 36

**What's the next
big step up
in transient
protection from GE?**

**600 joules.
25,000
peak amperes.**

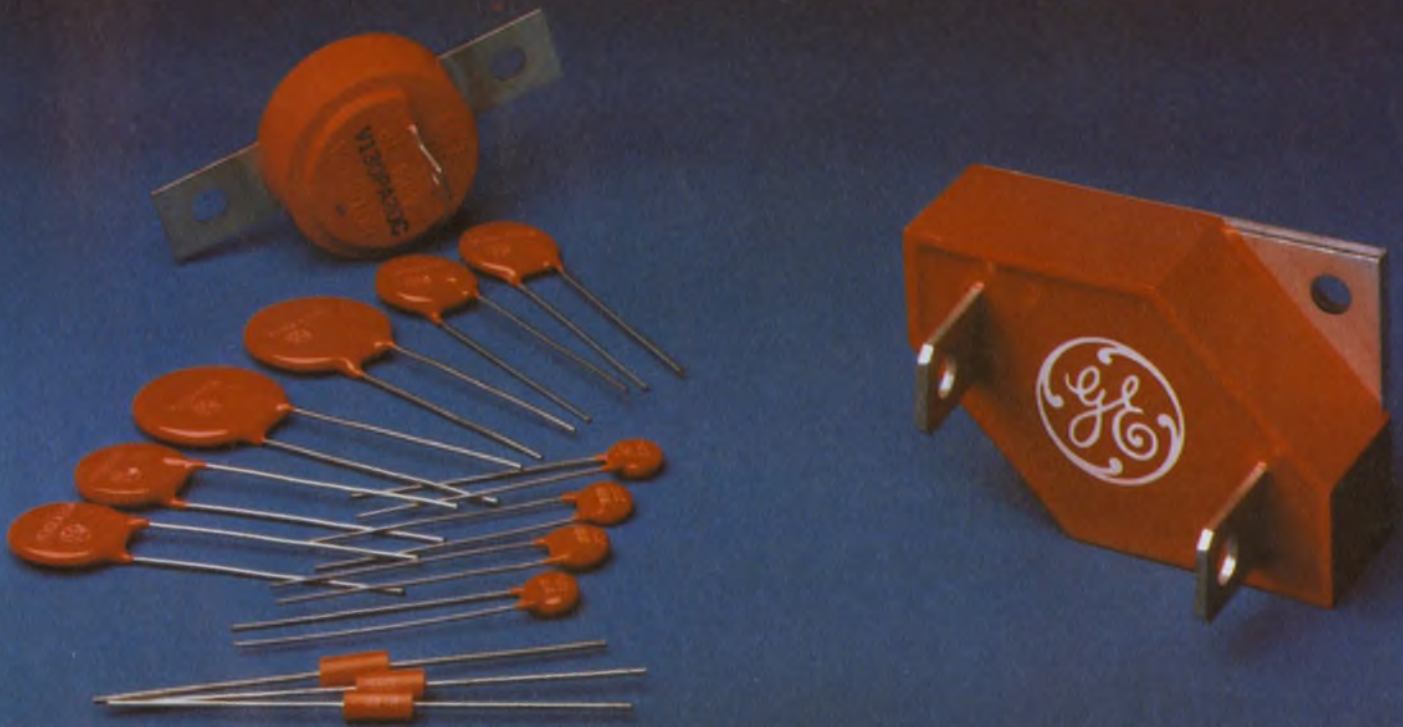

General Electric's new High Energy GE-MOV[®] varistor. It suppresses 600 joule transients up to 25,000 peak amperes. That's a big step up from the previously offered range of 150 joules, 4,000 amperes.

The new "HE" series GE-MOV varistor is available now. And it's more economical than other existing high energy transient suppression devices. Suggested prices start at \$22.50 in lots of 50.

In 1972, GE introduced the ac line voltage GE-MOV varistor, which immediately became a standard by which other transient protection technologies were measured. A year later, we developed the Power MOV varistor, meeting the need for a more ruggedly packaged, high current/energy capability device for light industrial applications. But we didn't stop there. We introduced the ZA and MA series to protect lower voltage electronic circuitry and provide packages compatible with high volume, automatic insertion techniques.

And now there's the new High Energy GE-MOV varistor.

Technological leadership. Experience. Innovation. These are what you've come to expect from GE. The more important transient protection is to you, the more you need GE-MOV varistors.

For further information, call your local authorized GE semiconductor distributor, or write General Electric Co., Electronics Park 7-49, Syracuse, N.Y. 13221.

In Europe, contact Electronics Trading Company, County Louth, Dundalk, Ireland.

222 08

[®] Registered trademark of General Electric Co

**There's more
to GE semiconductors
than meets the eye**

GENERAL  ELECTRIC

Emulate your MOS microprocessor with bipolar bit slices and don't worry about performance limits. You can boost capabilities yet maintain software compatibility.

Although MOS microprocessors such as the 8080A and 6800 offer quite a bit of performance in their small packages, at times they aren't fast enough or they don't have the exact instructions you need. You can get around either problem by emulating such processors with bit-slices.

Since slices operate at bipolar speeds, you can reduce execution speeds by two to nine times. And, since the slices are microprogrammable, you can write your own instruction set or duplicate a microprocessor's instruction set—or both.

In a design cycle, most processor features are examined, and the software is developed simultaneously with the hardware. If, at that time, you find that the processor is too slow, you either find another—and start development all over again—or build a higher performance version of the μ P. Since a large chunk of capital has already been invested to develop the software, the only real alternative is to build a software-compatible emulation.

Let's examine the design and construction of an emulation board for the popular 8080A μ P. Not only does the emulator offer a two to ninefold reduction of instruction-execution time, it includes multiply and divide instructions as well (Table 1).

So, you've decided to emulate

To build an emulator, though, you'll have to duplicate a lot more than just the 8080A processor chip. A minimal 8080A processor system typically consists of eight circuits, as shown in Fig. 1.

Either 2 or 4-bit slices can be used to build the emulator; for an example let's use the N3002 2-bit slice and other components from the 3000 family. (For more about the 3000 family of bit slices, see *Microprocessor Basics Part 12*, *Electronic Design*, March 29, 1977, p. 86 to 95.)

To build your processor emulator, you have to select the proper hardware, and develop the microprogram. Hardware emulation will consist of cascaded N3002 slices for the CPU, some 82S115s for the microprogram control store, an N3001 for the microprogram

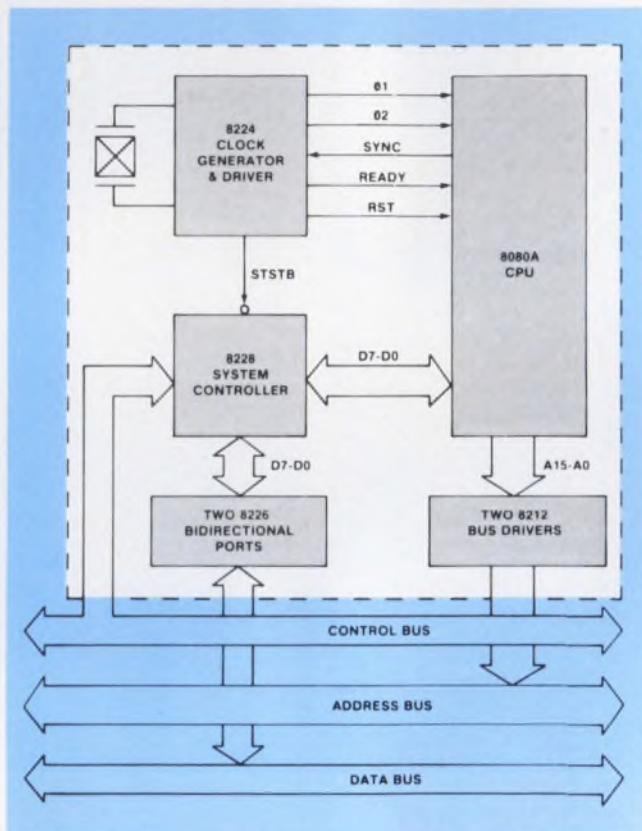

1. When building an emulator for the 8080A, you must emulate more than just the processor to take advantage of the capabilities of the bit slices.

sequence controller and some general logic circuits.

The microprogram is a series of microinstructions (the basic bit-slice instructions) that define how the bit slice will perform. In a bit-slice system, all major subsections are directly or indirectly controlled by a microinstruction. Each 8080A instruction, then, is a macroinstruction, consisting of a sequence of microinstructions.

All microinstructions are held in the microprogram control store, which is usually a ROM or PROM. However, if your system has a writable control store, part of the storage area is RAM.

Instructions in the control store are accessed by the microprogram sequence controller, which in turn

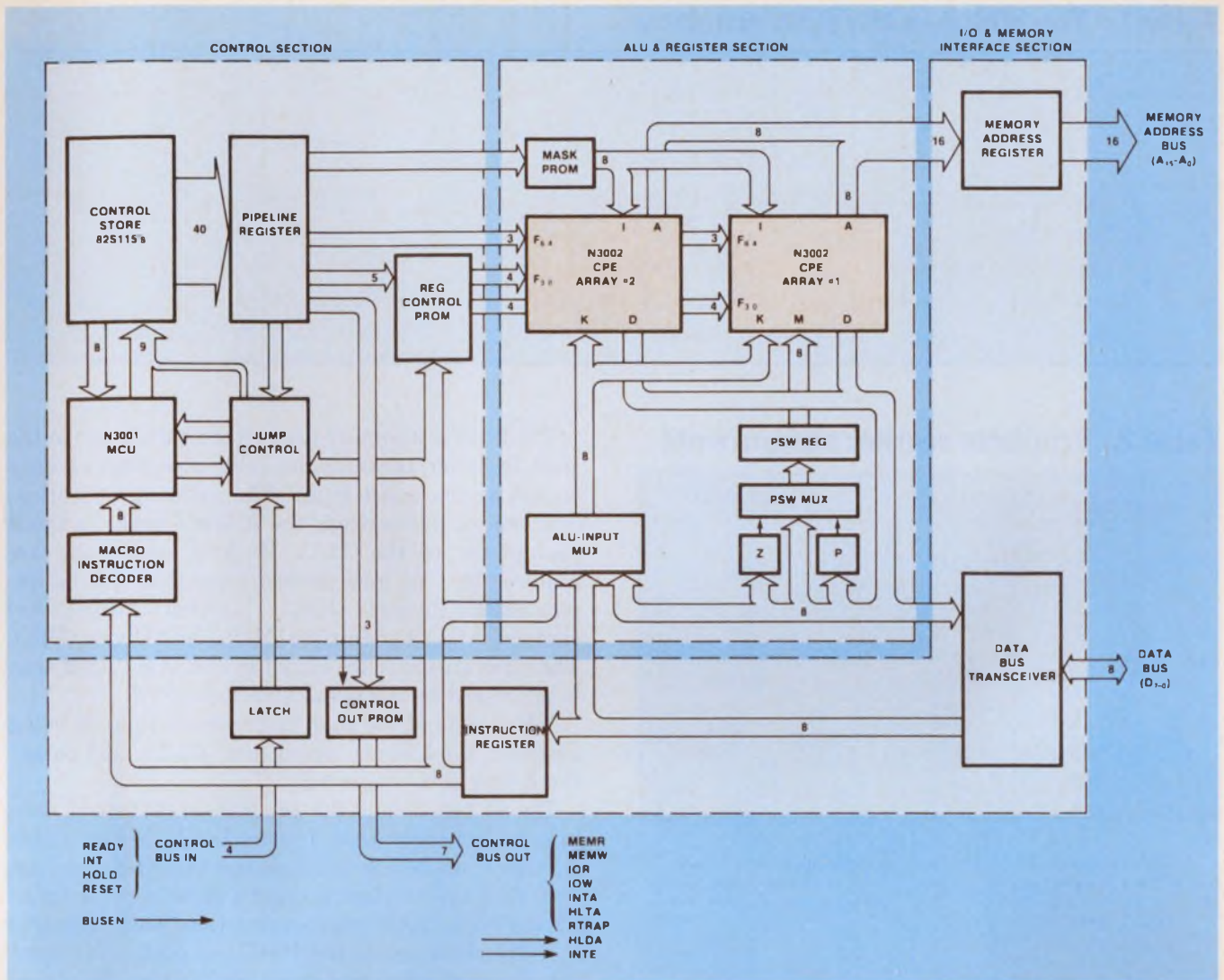

2. The architecture of the 8080A emulator uses two processor arrays and a 48-bit control word to duplicate

both the functions of the CPU and the basic control circuits surrounding the processor.

generates the addresses to the control store under the direction of the decode logic and CPU. The decode logic decipheres the macroinstruction fed in from the main memory on the external data bus and generates an address or command for the sequence controller.

To perform all the control operations that emulate the 8080A, a word width of 48 bits has been selected for the control store memory. A word that wide can provide commands for duplicating the 8080A's control-bus signals, doing the internal control of the slices, and modifying the address generated by the N3001 sequencer.

The emulator (Fig. 2) can be broken into three functional sections: control, register and arithmetic-array, and I/O and memory interface.

Replace the 8080A with two arrays

The core of the 8080A emulator—the ALU and register section—contains two 8-bit arrays, each built

from four N3002 slices. Control lines of slices are paralleled in each array so that each group of four slices acts as a single processor. Array 1 is used to duplicate the 8080A ALU and register array, as defined by Table 2. Array 2 is functionally equivalent to Array 1, but may operate independently or be combined with Array 1 for 16-bit operations (macro address and stack-pointer calculations).

Each 8-bit ALU array has a carry lookahead generator that can provide a carry output from the ALU. For 16-bit operation, the two carry outputs are fed into a third generator to produce a carry-out of the 16-bit ALU. To simplify 16-bit operations, the carry-out of the low-order array must become the carry-in bit of the high-order array. This is accomplished by a multiplexing scheme that also controls the carry lookahead generators. The entire operation is controlled by a microinstruction using the control signals CS2, CS1, CS0, and DBY.

Several buses are formed by the signal lines that

Table 1. The 8080A vs the 8080 emulator

	8080 Emulator	8080A System
Versatility	Microcode expandable	Fixed instruction set
Instruction set	78 instructions plus multiply & divide	78 instructions
Speed	0.3 to 2.25 μ s/inst.	2 to 9 μ s/inst.
Power supplies	5 V	+5 V/-5 V/+12 V
Power consumption	Typically 21 W	Typically 4.6 W
Form factor	SBC 80/10 or 20	SBC 80/10 or 20
Clock	Single phase	Two phase nonoverlapping

Table 2. Emulator register assignments

N3002 REGISTER	ARRAY 2	ARRAY 1
R0	B	C
R1	D	E
R2	H	L
R3	SPh	SPI
R4	PCh	PCI
R5	Not Used	Not Used
R6	Not Used	Not Used
R7	Not Used	Not Used
R8	Not Used	Not Used
R9	Working Storage	Working Storage
T	A	A
AC	Working Accumulator	Working Accumulator

NOTE

- A Accumulator
- B, C, D, E, H, L Working Registers
- SPI Low-order stack pointer address
- SPh High-order stack pointer address
- PCI Low-order program counter address
- PCh High-order program counter address

go to each N3002 array. For each array there is a Data Out (DO) bus, an Address (A) bus, a Data Input (K) bus, a Mask (I) bus, a Program Status Word (M) bus and a Function bus. The DO bus is 8 bits wide with three-state outputs from each array and gets fed to two places—the main output data bus and back to the ALU-input multiplexer. The two DO buses are wire-ORed and controlled directly by microcode. The selected data bus drives the multiplexer and the output transceiver.

A-bus outputs from each array are combined to form a 16-bit address that emulates the 8080A's address bus. The combined 16-bit output is latched into the external memory-address register, which in turn drives three 8T97 bus drivers that send the address off to external main memory.

Forming the main input data path to the arrays, K-bus inputs allow data to be moved into a register inside the slices without passing through the accumulator or the T register. This is an unconventional role for the K bus, which is usually used to mask values loaded into the ALU. Using the K bus like this is essential when the contents of both the accumulator and the T register must be saved. The K bus is fed by the ALU-input multiplexer, which, as you now know is microinstruction controlled.

The I bus is normally used as the data input to the slice. However, the bus's flexibility also makes it easy to use as the mask input. The masking operation, ANDing, occurs between the K and I buses in the B multiplexer of the ALU. Masking operations are required by four macroinstructions that will be implemented—Restart (RST), Decimal Adjust Accumulator (DAA), Multiply (MUL), and Divide (DIV). The mask patterns are stored in a 32 x 8 PROM that is addressed by a microinstruction word.

When none of the four macroinstructions is being executed, the I bus is forced to all-ONES, and passes the K-bus data unaltered.

The M bus brings the program-status-word data into the low-order array (Array 1). The M-bus inputs on Array 2 are not used and are tied to the I-bus inputs. This PSW information is made available to the array for the PUSH PSW macroinstruction, which requires that the slices access the PSW and push its current value onto the external stack, defined by the stack-pointer register. Definitions for the PSW bits are listed in Table 3.

The Function bus is simply a 7-bit control bus that defines what operation each slice will perform. The bus is divided into two subgroups—the F group, which determines the ALU function to be performed; and the R group, which defines the registers used in the operation defined by the microcode.

Don't forget the control buses

One other section of the 8080A system remains to be emulated—the input and output control buses. To duplicate the input control lines, you need a latch to hold the control signals and then feed them into the jump-control circuit that tells the microsequencer which microprogram word to access. For the memory and I/O control output lines, part of the microprogram control word and a bit from the jump control circuit can be used to address a PROM. Inside the PROM are the 16 possible combinations of control signals for the bus. These signals are defined in Table 4.

Except for the IORI and MEMRI signals, all PROM outputs are presented directly to the external bus. Before the IORI and MEMRI signals can be fed out, they must be strobed into separate flip-flops to change

Table 3. PSW bit definitions

BIT	MNEMONIC	NAME
D ₀	CY	Carry
D ₁	1	Logic one
D ₂	PRTY	Parity (Even)
D ₃	0	Logic zero
D ₄	HC	Half carry (for BCD operations)
D ₅	0	Logic zero
D ₆	ZERO	Result equals zero
D ₇	SIGN	MSB

Table 4. I/O control-signal assignments

B ₇	B ₆	B ₅	B ₄	B ₃	B ₂	B ₁	B ₀
Most-Significant Bit (not used)	RTRAP	HLTA	INTA	IOW	IORI	MEMW	MEMR
							Least-Significant Bit

Table 5. Macro pipeline update sequence

	MACRO INSTRUCTION CYCLE		
	(X)	(X+1)	(X+2)
Instruction being executed	N-1	N	N+1
eMAR	N	N+1	N+2
iMAR	N+1	N+2	N+3
PC (R4)	N+2	N+3	N+4

the signals into \overline{IOR} and \overline{MEMR} , respectively.

Control for all the sections of the 8080A emulator is provided by the microprogram held in the control store. Built from six 512 × 8-bit bipolar PROMs, the control store holds up to 512 48-bit-wide microinstructions. However, only 345 microinstructions are needed to duplicate the 8080A instruction set and include the multiply and divide commands. This leaves the unused locations available for future expansion.

Each 8080A command accepted by the emulator's instruction register provides the first microinstruction address of each set of microinstructions that will perform the macroinstruction desired. The op code held by the latch is decoded by a mapping PROM that sends a starting address to the sequencer.

To speed up the instruction fetch and execution cycle, the pipeline register used in the emulator's control store holds a microinstruction so that the present instruction can be executed as the next sequential instruction is fetched. Otherwise, the next command could not be fetched until the current command is executed—which means, in many cases, a delay of 50 to 150 ns per instruction.

Actually, there are two pipelined sections in the emulator—the microinstruction fetch and execute loop and the macroinstruction fetch and execute loop.

The macroinstruction loop ensures that the next three consecutive instructions are available locally in the CPU. This pipelined architecture greatly enhances machine performance when consecutive operations are performed, and does not detract from machine operation if nonconsecutive instructions must be performed.

The macroinstruction pipeline consists of four dedicated registers:

- PC: a 16-bit program counter residing in slice register R₄.
- iMAR: a 16-bit internal memory address register.
- eMAR: a 16-bit external memory address register.
- IR: an 8-bit instruction register.

The first three are used to maintain addresses that eventually will be used to access the external main memory via the emulator's memory-address bus. The fourth register stores the op codes and data returned from memory via the data bus. Each of the first three registers gets updated at the end of every macroinstruction cycle, as illustrated by the sequence shown in Table 5.

Once a starting address has been determined and loaded into the N3001, all subsequent microinstruction addresses for a macroinstruction are generated by the sequencer, or altered by the current microinstruction. All microinstructions held in the control store have the same general 48-bit format as defined in Fig. 3. Each word is divided into many smaller sections called fields, whose width can be as small as a single bit. Each field defines a hardware control operation for the emulator.

With all hardware defined and the format for the microinstruction selected, your next task is to write the microinstructions that emulate the macroinstructions of the microprocessor.

Develop the microinstruction routines

To describe the development of all the 8080A macroinstructions in microinstruction form would require a book in itself. For a comparison of all the 8080A instructions and their emulator equivalents, check Table 6. However, to see how every macroinstruction can be emulated, examine in detail how the 8080A's MOV A,H (move the contents of register H into the accumulator) instruction is duplicated.

For the emulator to execute the MOV A,H instruction, the op code for the MOV command must first be fetched from the main computer memory. Then the contents of register 2 of Array 2 must be moved to the T register of both Arrays 1 and 2 (A←H). A simplified flow chart of the entire microroutine is shown in Fig. 4.

The basic program for the emulation system consists of a master microinstruction program, then one subroutine for each 8080A instruction—approximately 80—including the multiply and divide commands. Every microinstruction subroutine that executes a macroinstruction returns to the first microinstruction of the program loop, which is a fetch instruction to

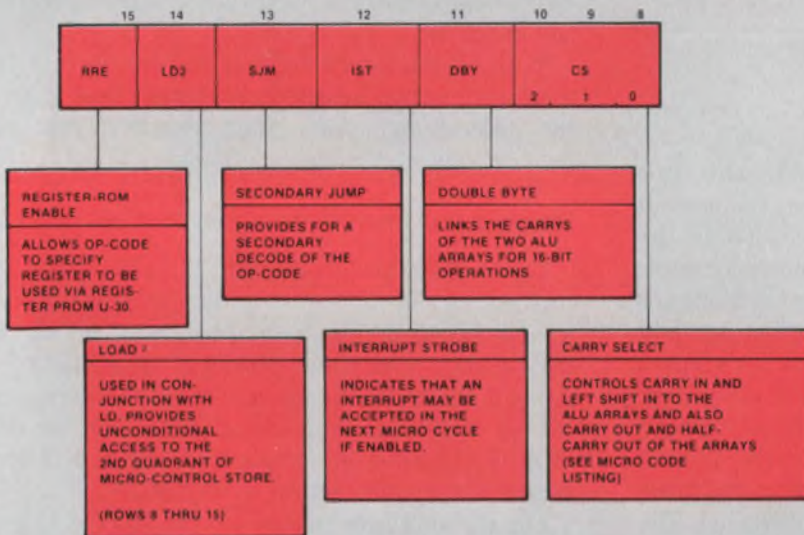
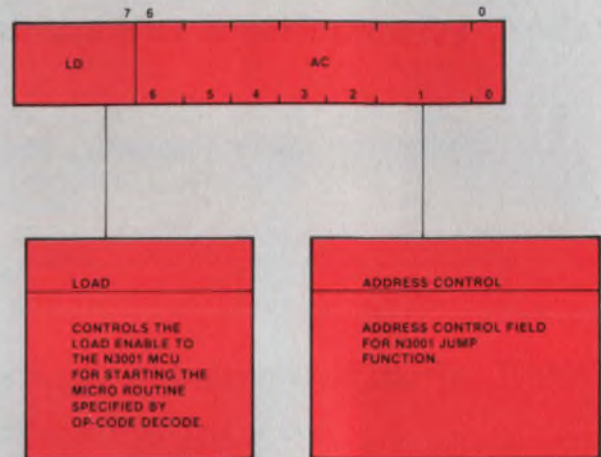
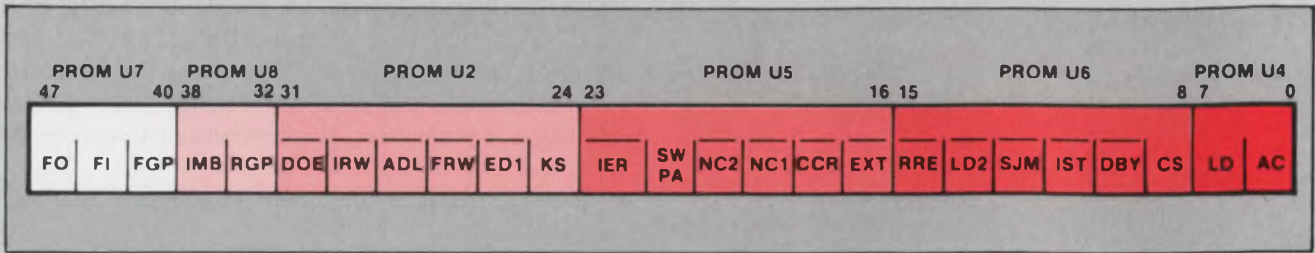

3. A 48-bit microinstruction word broken down into many smaller control fields lets you control all the hardware to emulate the 8080A. Because the slices are micro-programmable, new instructions can be added simply by developing new sequences of microinstructions that will perform macro operations.

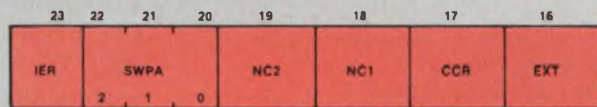

STATUS WORD - PROM ADDRESS

CONTROLS OUTPUT OF STATUSES:

RTRAP
HLTA
INTA
IOW
IOR
MEMW
MEMR

NO-CLOCK FOR ARRAY 1

DISABLES CLOCK FOR ARRAY 1 SO NO OPERATION WILL BE PERFORMED

EXTERNAL TEST

INITIATES A WAIT LOOP BASED ON THE READY SIGNAL:

READY LOW - ODD ADDRESS
READY HIGH - EVEN ADDRESS

INTERRUPT ENABLE REGISTER

CONTROLS THE LOADING OF FO INTO THE INTE F/F TO ENABLE OR DISABLE INTERRUPTS

NO-CLOCK FOR ARRAY 2

DISABLES CLOCK FOR ARRAY 2 SO NO OPERATION WILL BE PERFORMED

CONDITIONAL CLOCK READY

CONDITIONS THE CLOCKING OF BOTH ARRAYS ON THE PRESENCE OF THE READY SIGNAL.

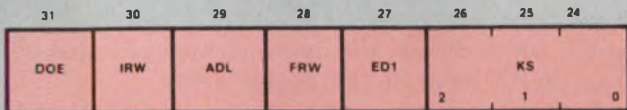

INSTRUCTION REGISTER WRITE

LOADS DATA COMING IN ON THE DATA BUS INTO THE INSTRUCTION REGISTER.

FLAG REGISTER WRITE

LOADS THE PARITY, ZERO AND SIGN FLAGS INTO THE PSW.

K-BUS SELECT

CONTROLS ALU INPUT

K1 - ALL 1's
K0 - ALL 0's
KM - MEMORY
KNM - COMPLEMENT MEMORY
KIR - INSTRUCTION REGISTER
KNIR - COMPLEMENT INSTRUCTION REGISTER
KD - ALU DATA OUT
KND - COMPLEMENT ALU DATA

DATA OUT ENABLE

ENABLES ALU DATA ONTO THE DATA BUS FOR WRITING TO MEMORY OR I/O.

ADDRESS LOAD

LOADS EXTERNAL MEMORY ADDRESS REGISTER TO ACCESS MEMORY OR I/O.

ENABLE DATA 1

ENABLES ARRAY 1 DATA ONTO DO BUS, OTHERWISE ARRAY 2 DATA.

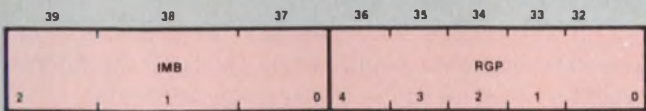

I-MASK BUS

THIS FIELD, ALONG WITH CARRY AND HALF-CARRY, SELECTS ONE OF THE 32 POSSIBLE MASKS TO BE SENT TO THE ALU FROM THE MASK PROM.

REGISTER GROUP

SELECTS THE REGISTERS TO BE USED IN ALU OPERATIONS. THIS FIELD IS AN ADDRESS TO REGISTER SELECT PROM U17 WHICH DETERMINES THE 4-BIT REGISTER CONTROL FIELD FOR EACH ALU ARRAY. (SELECTS REGISTER R3 FOR BOTH ARRAYS IF THE RRE SIGNAL IS ACTIVATED)

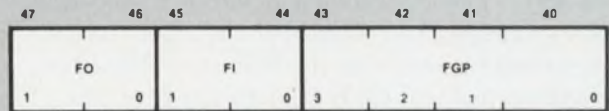

FLAG OUTPUT CONTROL

FF0: FO - ZERO
FF1: FO - ONE
FFZ: FO - Z FLAG
FFC: FO - C FLAG

FUNCTION GROUP

PROVIDES TWO 3-BIT FUNCTION CONTROLS, ONE FOR ARRAY 1 AND ONE FOR ARRAY 2.

FLAG INPUT CONTROL

HLB: (NO CHANGE)
STC: C FLAG - FI
STZ: Z FLAG - FI
STB: C & Z FLAGS - FI

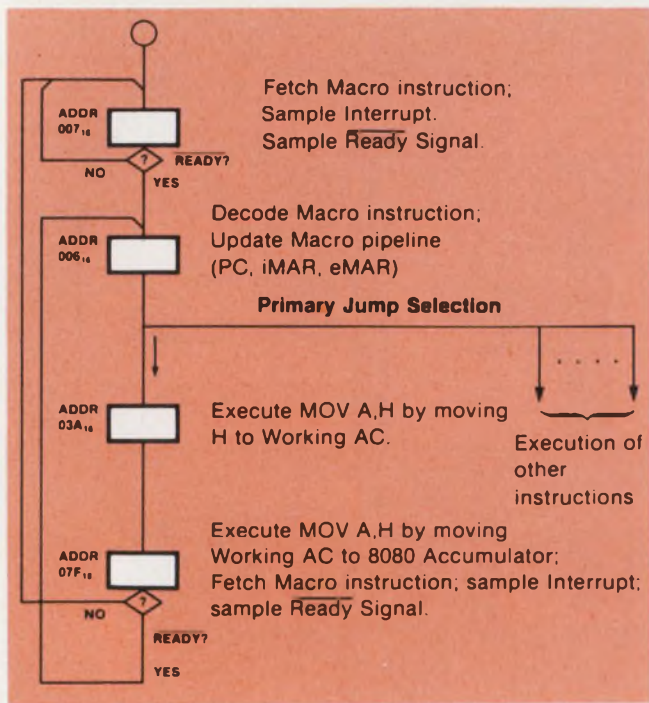

4. To duplicate the MOV A,H instruction of the 8080A, check this flow chart, which shows all the operations that must be performed under software control.

pull the macroinstruction from the main memory. The microinstruction subroutine also samples the $\overline{\text{READY}}$ line.

The first instruction causes the program to loop in a wait state until the $\overline{\text{READY}}$ line goes low. Once the line goes low, the emulator's program decodes the macroinstruction, updates the macro pipeline, and starts executing the microcode for the macroinstruction. To execute the MOV A,H instruction, data held in the H register (R_2 of Array 2) must be transferred, through a series of steps, to the accumulator (T register) in Array 1.

To provide a starting point for the microcode listing (Fig. 5), use address 007_H as the idle address to which every microroutine will return. And until the $\overline{\text{READY}}$ line goes low (indicating valid data on the data bus), the emulator tries to execute the microinstruction at location 007_H . The instruction at 007_H is a loop that repeatedly latches the contents of the data bus into the instruction register with the $\overline{\text{TRW}}$ control-field bit.

The address control (AC) field in the first line of

microcode specifies a jump to the current row (row 0, column 6). And as long as the $\overline{\text{READY}}$ line is false, the microinstruction will loop to itself i.e., address 007_H . While the wait loop is executing, the $\overline{\text{EXT}}$ field enables the $\overline{\text{READY}}$ line to control MA_0 , and $\overline{\text{IST}}$ enables the interrupt logic.

When the $\overline{\text{READY}}$ line becomes true, the microprogram goes on to 006_H , which is then used to maintain the microaddress pipeline and translate the op code into a beginning address for the MOV micro-routine.

If you assume the MOV A,H instruction has been fetched by the emulator from the main memory (location N), the macro's pipeline status has a definite state (Fig. 6a), which must now be updated (Fig. 6b). The PC register is updated by performing a double-byte increment. To perform the two necessary functions, the following control fields must be used:

- DBY, which places the two slice arrays into the 16-bit operand mode.
- FF1, which forces a ONE to be output on the N3001 $\overline{\text{FO}}$ pin.
- AN, which directs the uncomplemented value of $\overline{\text{FO}}$ to the $\overline{\text{CI}}$ input of the double array.
- R44, which selects register R_4 of both Array 1 and Array 2.
- K1, which forces the negative-true K bus of the slices to all-ONES.
- LM1, which forces the ALU function to be performed by the double-byte array.

The four other mnemonic microcode assignments, ADL, SJM, LD and JPX, are used for general house-keeping: ADL loads the external memory address register to access the memory, SJM provides for a secondary decode of the op code, LD controls the load enable to the microprogram control unit for starting the microroutine specified by the op code decode, and JPX is a 3001 command to jump and test the PX bus and load the PR latch of the N3001.

Once an entire line of microcode is executed, the microaddress changes to $03A_H$, which begins the actual execution of the MOV A,H instruction. The code at address $03A$ performs two major jobs:

1. It moves the contents of R_2 to the working accumulator of the slices.
2. It determines the secondary jump destination. The first operation requires five fields of the microprogram word to move the register contents:

ADDR	FO	FI	FGP	IMB	RGP	DDE	IRW	ADL	FRW	ED1	KS	IER	SWPA	NC2	NC1	CCR	EXT	RRE	LD2	SJM	IST	DBY	CS	LD	AC	COMMENTS	
(007H) :			NOP		RFF		IRW				K1						EXT				IST				JCR(006H) :	FETCH	
(006H) : FF1			LMI		R44			ADL			K1									SJM		DBY	AN	LD	JPX	JPX	FETCH
(03AH) : FF1			ILR		R33						K1							RRE						NAN	LD		
(07FH) : FF1			LDI		REE		IRW				KD							EXT			IST		AN		JZRO8:MOV A. (B,D,M)		

5. Developing the microcode for the emulation system can be quite complex with each microword containing 48

bits. However, not all fields are used by each microword, which simplifies development somewhat.

Table 6. 8080A vs emulator cycle times

Instruction	8080		8080 A		Factor of speed increase
	Emulator Cycles	Time μ S	Cycles	Time μ S	
MOV r1,r2*	3	0.45	5	2.5-	5.6 (times)
MOV M,r	8	1.20	7	3.5	2.9
MOV r,M	6	0.90	7	3.5	3.9
HLT	4	0.60	7	3.5	5.8
MVI r	4	0.60	7	3.5	5.8
MVI M	7	1.05	10	5.0	4.8
INR	3	0.45	5	2.5	5.6
DCR r	4	0.60	5	2.5	4.2
INR M, DCR M	9	1.35	10	5.0	3.7
Arithmetic reg	4	0.60	4	2.0	3.3
Arithmetic mem	7	1.05	7	3.5	3.3
Arithmetic immed.	4	0.60	7	3.5	5.8
RLC	4	0.60	4	2.0	3.3
RRC	3	0.45	4	2.0	4.4
RAL	3	0.45	4	2.0	4.4
RAR	3	0.45	4	2.0	4.4
JMP	6	0.90	10	5.0	5.6
<u>JMP</u>	4	0.60	10	5.0	8.3
CALL	13	1.95	17	8.5	4.4
<u>CALL</u>	4	0.60	11	5.5	9.2
RET	8	1.20	10	5.0	4.2
<u>RET</u>	2	0.30	5	2.5	8.3
RST	13	1.95	11	5.5	2.8
IN	8	1.20	10	5.0	4.2
OUT	8	1.20	10	5.0	4.2
MUL	26	3.90	—	—	—
DIV	31-53	4.65-7.95	—	—	—
LXI	7	1.05	10	5.0	4.8
PUSH	11	1.65	11	5.5	3.3
PUSH PSW	11	1.65	11	5.5	3.3
POP	9	1.35	10	5.0	4.1
POP PSW	8	1.20	10	5.0	4.2
STA	9	1.35	13	6.5	4.8
LDA	8	1.20	13	6.5	5.4
XCHG	7	1.05	4	2.0	1.9
XTHL	15	2.25	18	9.0	4.0
SPHL	3	0.45	5	2.5	5.6
PCHL	6	0.90	5	2.5	2.8
DAD	4	0.60	10	5.0	8.3
STAX	8	1.20	7	3.5	2.9
LDAX	5	0.75	7	3.5	4.7
INX	2	0.30	5	2.5	8.3
DCX	3	0.45	5	2.5	5.6
CMA	2	0.30	4	2.0	6.7
STC	3	0.45	4	2.0	4.4
CMC	4	0.60	4	2.0	3.3
DAA	8	1.20	4	2.0	1.7
SHLD	11	1.65	16	8.0	4.8
LHLD	12	1.80	16	8.0	4.4
EI	2	0.30	4	2.0	6.7
DI	2	0.30	4	2.0	6.7
NOP	2	0.30	4	2.0	6.7

*MOV A.A; MOV B.B, etc., are treated as NOPs.

NOTE: The above stated instruction execution times assume an 8080 emulator microinstruction cycle time of 150 ns and an 8080A clock cycle time of 500 ns.

LOCATION	CONTENTS	LOCATION	CONTENTS
PC (R4)	= N+2	PC (R4)	= N+3
3002 MAR	= N+1	3002 MAR	= N+2
Ext MAR	= N	Ext MAR	= N+1

(a)

(b)

6. Updating the status of the macro-pipeline registers (a) is done once the macroinstruction gets decoded. The updated status (b) is held in the same registers.

- FF1, to force a ONE on the N3001's \overline{FO} pin.
- NAN, to complement \overline{FO} and deliver it as \overline{CI} to both slice arrays.
- K1, to force the K bus to all-ONES.
- R33, to select register 3 for each array.
- ILR, to instruct the slice to move R_3 to the working accumulator.

Additional fields finish the job

Two other control fields are used in the microword to perform the second task. The RRE field bit enables the op-code-register control PROM, and the LD field enables the microprogram control unit for a new address loaded in from the PROM. The microprogram next accesses address $\emptyset 7F_H$ in the control store.

The secondary jump executed in the microword at address $\emptyset 3A$ brings the microprogram to the instruction at address $\emptyset 7F$. This instruction also performs two tasks:

1. It completes the register move from the working accumulator to the accumulator (registers AC to A).
2. It returns the microprogram to $\emptyset 06_H$ if \overline{READY} is low, or else to $\emptyset 07_H$.

The register transfer is completed with microinstruction fields FF1, AN, \overline{REE} , KD, \overline{EDI} and LDI. Fields FF1 and AN are as defined before; REE selects the T register of both arrays; KD selects the Data Out bus of both arrays as the input to the K bus; and \overline{EDI} , by default, selects Array 2 as the source of the Data Out bus. LDI completes the functional execution of MOV A, H by transferring the contents of AC to A.

To complete the last half of the microinstruction, memory request is active; \overline{EXT} selects the \overline{READYQ} as the Source for MA_0 ; \overline{IRW} latches the external data bus into the instruction register; and \overline{IST} enables the interrupt acknowledge logic.

These are normal housekeeping operations, performed at the end of every macroinstruction routine. If the main memory is not busy, i.e., \overline{READY} is active, the next microinstruction executed will be at location $\emptyset 06_H$. However, if the main memory is busy, then the control will return to location $\emptyset 07_H$, where it will wait until the main memory responds with the next macroinstruction. ■■

Note

Details for the construction of a full board containing the emulator are available by circling the reader service number below. Full schematics, board layout and microprograms are included.

Circle No. 319

OUR OS4000 TAKES OVER WHERE TUBE STORAGE LEAVES OFF.

The Gould OS4000 digital memory oscilloscope extends your capabilities beyond the limits of conventional storage tube technology.

With the OS4000, stored transients do not deteriorate and are clearly displayed as will indefinitely — as long as you choose to keep the data. Stored trigger points allow you to display pretrigger signals as well as the signal itself. You see what actually caused the signal.

Digital storage also offers you four useful options: 1) Fully automatic operation, 2) analog and digital output for hardcopy, 3) higher resolution through expansion of stored traces, 4) the ability to generate complex wave forms.

The OS4000 can enhance the effectiveness of traditional dual trace displays by simultaneously displaying real time and stored traces without the amplitude restrictions of a split beam storage tube. Both signals have optimum brightness to help you draw the critical inferences from close comparisons. At low

frequencies there is no irritating flicker or C.R.T. glow.

Rated at 10 MHz for conventional operation the OS4000 utilizes an 8 bit x 1024 word RAM, with a sampling frequency of 1.8 MHz. Normal/refreshed/roll modes are standard.

With a multitude of new applications in general electronics, medical electronics, research laboratories and transducer related measurement situations, Gould's OS4000 simply out-classes every tube storage scope on the market. But even though the OS4000 represents a step forward in storage scope technology, it is both easy to use and extremely affordable.

For more information contact Gould Inc., Instruments Division, 3631 Perkins Ave., Cleveland, OH 44114. In Europe contact Gould Advance LTD., Roebuck Rd., Hainault, Essex, CB10 1EJ, England.

For brochure call toll free (800) 325-6400. Ext. 77. In Missouri: (800) 324-6600.



Example of expanded output (1:2)

 **GOULD**

Choke!

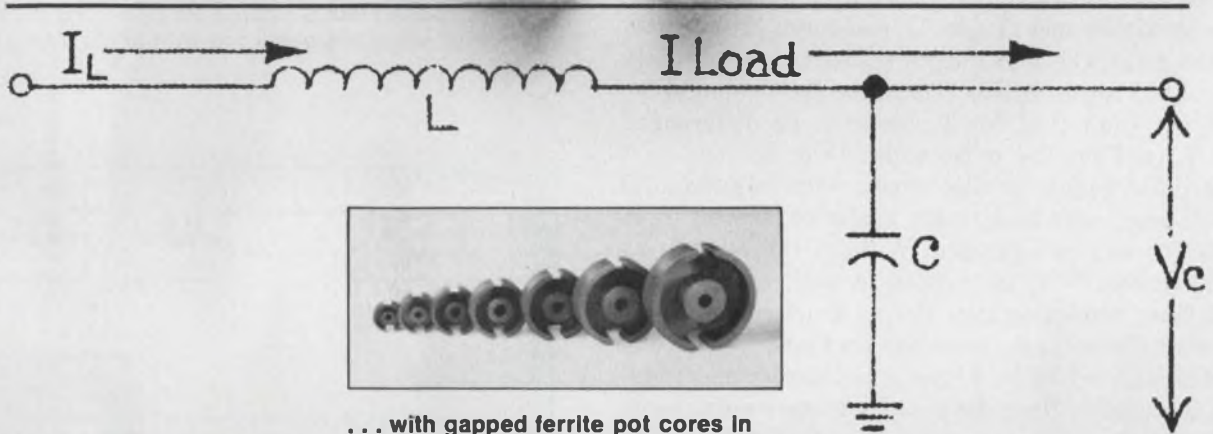

... with gapped ferrite pot cores in 3C8 material from The Cube

We'd like to announce the end of 'by guess and by gosh' in designing output filter chokes. Ferroxcube now offers a complete line of gapped pot cores, in 3C8 material, with standardized gap length and standardized A_L values.

The gap lengths have been optimized to prevent saturation of the core due to high DC fields, while simultaneously providing maximum impedance to the AC ripple current.

Gapped pot cores, bobbins and hardware are available in 14, 18, 22, 26, 30, 36 and 42 mm sizes. For complete specifications, call on The Cube.

Call
on the
cube



FERROXCUBE Division of Amperex Electronic Corporation,
Saugerties, New York 12477 (914) 246-2811
A North American Philips Company



Plan a programmable pulse generator

around ECL ICs for rapid response. Control leading and trailing edges individually. Get high resolution, too.

Fast, programmable pulse generators capable of parallel operation aren't exactly off-the-shelf items. But you can design one with standard ECL ICs, and get super performance: 1 to 3-ns response time, ± 20 -ps resolution and ± 40 -ps linearity. And since you can trigger several generators at once, you can generate complex waveforms, too.

Seventeen-bit binary numbers define the leading (T_L) and trailing (T_T) edges of the output pulse in terms of delay times (see Table 1) measured from time T_0 —the point where an output transition occurs with all data bits set to ZERO. The value for T_T should be set larger than that for T_L because the difference, $T_T - T_L$, defines the pulse width (Fig. 1).

The pulse generator also works with less than 17 bits—if, say, only 16 bits are available, the bit 0 or bit 16 line can be left open. Without the bit 0 line, the maximum delay is snipped in half; without the bit-16 line, resolution gets cut as much.

Transitions occur between the standard ECL levels of -0.85 and -1.75 V. Either a positive or negative pulse is available from the complementary outputs of a 1670 flip-flop. Use the negative output if you wish to OR a number of pulse generators together to produce a complex pulse chain.

The basic generator has two identical delay circuits, one for the leading edge and the other for the trailing edge (Fig. 2). A 100-MHz oscillator supplies identical clock signals to the leading and trailing increment generators.

Each time a pulse is required, an external start signal is clocked so that the leading edge occurs halfway between clock transitions. The signal is then sent to the leading and trailing increment generators. The propagation delay through the generators depends on binary bits 0 through 8 and can be varied, in 10-ns increments, from a minimum 33 ns to a maximum 5.153 μ s.

To produce delay variations smaller than 10 ns, the generator combines a ramp generator, d/a converter, and high-speed comparator. A complementary ECL transition at the inputs of the ramp generator produces a positive-going, linear ramp at the output. The

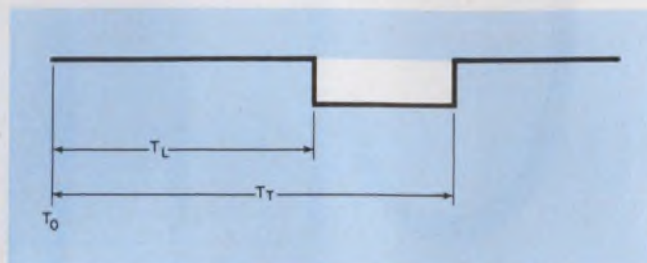

1. Output pulse width is established by setting the leading and trailing edges independently with 17-bit binary words.

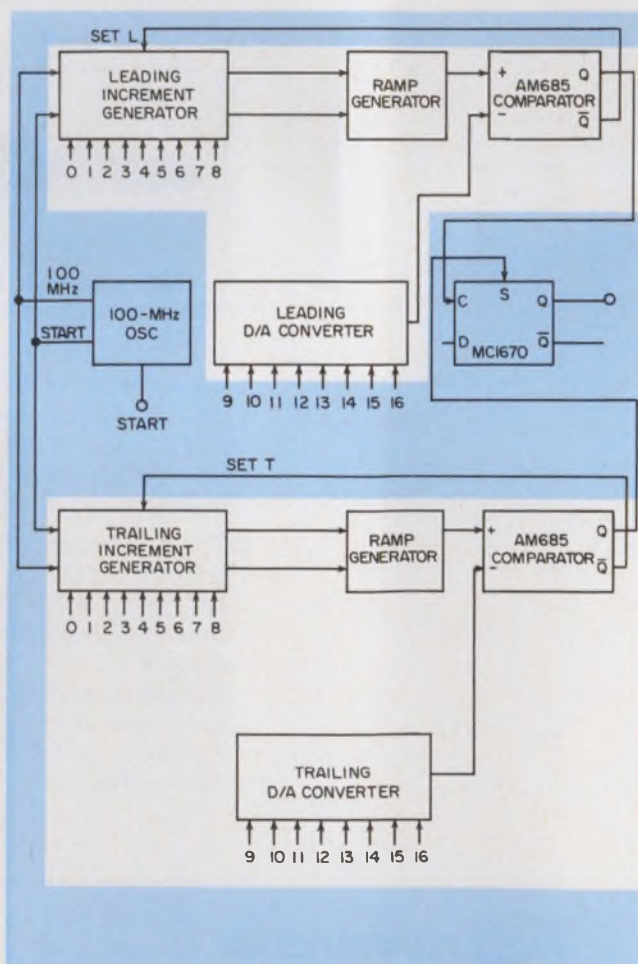

2. The generator design centers on two delay circuits, one for each transition edge. The d/a converter's output controls the propagation delay for small transition increments (lower 8 bits).

Harley Ristad, Staff Engineer, International Business Machines Corp., 5600 Cottle Rd., San Jose, CA 95193.

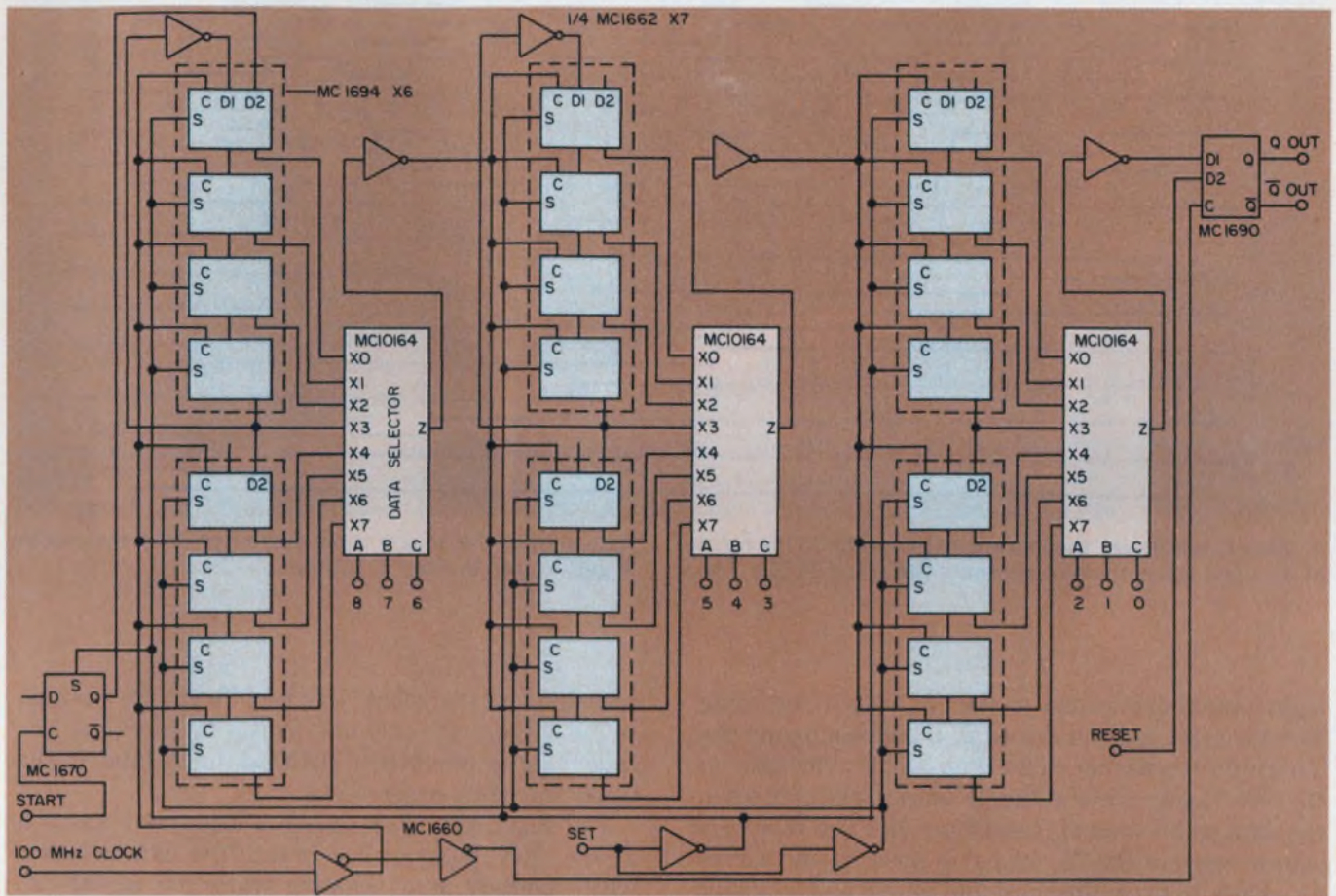

3. Three shift-register stages comprise the increment generator, which operates like a mechanical counter.

comparator fires when the ramp voltage equals the d/a output level.

D/a converter determines speed

The greater the d/a's output, the greater the propagation delay through the ramp generator, comparator, and 1670 flip-flop. The resulting delay can be varied, in 39-ps increments, from as few as 17 to as many as 26.961 ns. Note that the maximum repetition rate is limited by the 1- μ s response time of the d/a converter. If the data aren't changed, a pulse can be repeated every 200 ns.

A positive transition from the leading-edge comparator activates the clock input of the flip-flop. The ZERO at the data input, appearing at the 1670's output, starts the output pulse. An "up" level from the trailing comparator activates the flip-flop's "set" input, forces the output to an "up" level, and terminates the pulse.

Fourteen ICs comprise the increment generator (Fig. 3). A positive pulse on the set lines puts all shift-register stages, along with the 1670 "start" flip-flop,

in the ONE state. A positive-going transition on the "start" line activates the clock input of the 1670, which causes the ZERO on the data input to appear at both the "Q" output and at the "Data 2" input of the first stage of the first shift-register module. This initiates a series of events (Fig. 4):

Each positive transition of the 100-MHz clock causes the ZERO at the "Data 2" input to shift down one stage. When the ZERO reaches the fourth stage, it is inverted and fed back as a ONE to the "Data 1" input of the first stage. Because of the OR function, this ONE now proceeds down the stages of the shift register. As long as the "set" line remains a ZERO, ONES and ZEROS will be alternately shifted down the eight stages of the two shift-register modules. Consequently, a square wave is generated with one-eighth the 100-MHz clock frequency, or 12.5 MHz.

Data "ripple" down

The outputs of the first two shift-register modules become the inputs of the first eight-channel data selector (the 10164). The data present on one of the

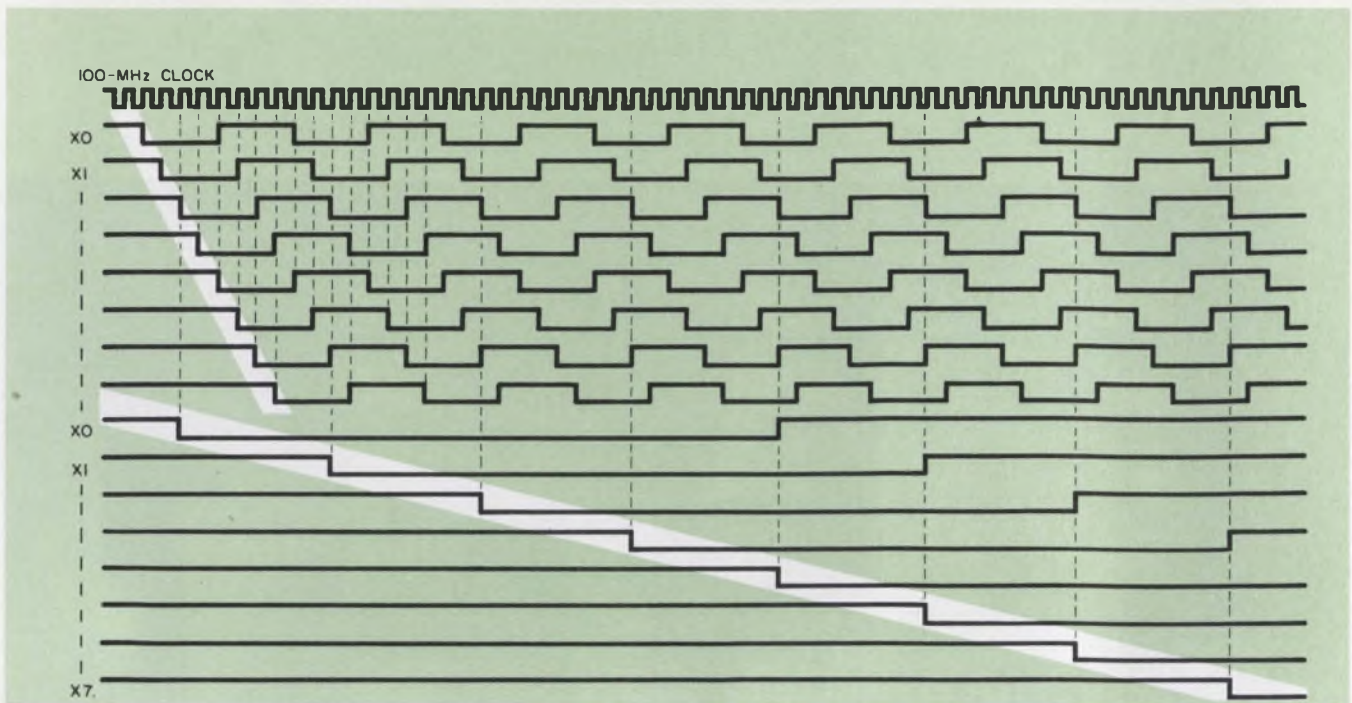

4. Data "shift down" the increment generator in the form of a square wave made of alternate ONES and ZEROS. The

frequency of the square wave decreases progressively as it gets closer to the "Z" output.

eight inputs are routed to the "Z" output according to a three-bit code on the A, B, C address inputs. As shown on the timing chart (Fig. 4), only the data on the "X2" input appear at the "Z" output, and only when the data on bit lines 6, 7, and 8 are 010. The 12.5-MHz square wave at the "Z" output is inverted and serves as a clock to drive the third and fourth shift-register modules.

Similarly, ONES and ZEROS alternately shift down the third and fourth shift registers, and generate a 1.56-MHz square wave. Which data-selector input accepts the square wave depends on data bits 3, 4 and 5. Again, the 1.56-MHz square wave at the "Z" output is inverted to drive the fifth and sixth shift-register modules.

The increment generator is made up of three nearly identical stages, with each generating the clock signal for the stage following. Since no stage follows the third, there is no need for the third to generate a square wave; thus, the fifth shift-register module does not have a "wrap around."

The 1690 output flip-flop has three functions:

- It relocks the signal with the 100-MHz clock so that the output transition occurs exactly at 10-ns increments. The various paths through the 10164 data selectors provide slightly different delays, so that the positive transition arriving at D_1 occurs at about 11-ns increments.

- Its "Data 2" input is available for a "reset" line.

- Its complementary outputs are available to drive the ramp generator.

Square waves aren't generated for the special case of data bits 0 through 8 being all ZEROS. A positive

transition on the "start" line rapidly ripples through to the output with only two pauses for clocking. The "start" signal produces a ZERO at the D_2 input of the upper left shift-register stage.

The next 10-ns clock causes a negative transition at the "X0" input of the first 10164 data selector, which appears as a negative transition at the "Z" output. The transition, inverted at the clock inputs of the second stage, becomes a negative transition at both the "X0" input and the "Z" output of the second 10164 data selector.

Similarly, transitions propagate through the third stage, and are then clocked through the 1690 flip-flop. Because of the flip-flop output transition, the ramp generator slews up until it fires the comparator. The "Q" output of the comparator feeds back as a "set" signal for the increment generator, which places all the shift-registers in the ONE state. (When the data are all ZEROS, the "set" signal is fed back so fast, there is no time for square waves to be generated.)

The increment generator works somewhat like a three-digit odometer, in which 10 rotations of a lower-order wheel actually rotate the next-order wheel once. In the increment generator, eight square-wave cycles of a lower-order stage force the next higher stage to generate one square-wave cycle.

The ramp generator has two ECL stages, a current source, and two clamping networks (Fig. 5). The five 51- Ω resistors (in series with the output line and the bases of the 2N4260 and 2N2857 ECL pairs) damp out spurious oscillations and can be ignored in the normal operation of the ramp generator. The two terminating 51- Ω resistors (between -2 V and the Q and \bar{Q} input

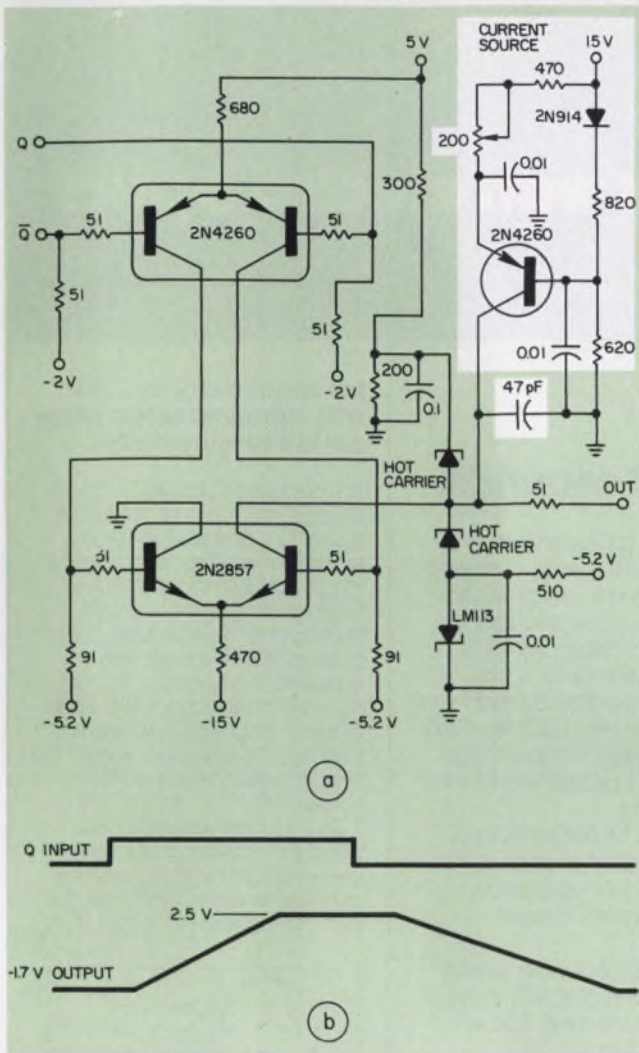

5. Constant-current charging of a capacitor forms the basis for the ramp generator (a). The ramp slews up until it is clamped by conduction of the hot-carrier diode (b).

lines) prevent step inputs from reflecting back into the input transmission lines.

In a quiescent state, the right side of each ECL pair conducts. Then, 9-mA passes from 5 V through the 680- Ω resistor, through the conducting right side of the 2N4260 pair, then out the collector and through the 91- Ω resistor to -5.2 V. The resulting voltage drop across the 91- Ω resistor raises the base potential of the right side of the 2N2857 to 0.8 V above -5.2 V.

Because the left side of the 2N4260 doesn't conduct, there is no current in the left 91- Ω resistor, and the base potential of the left side of the 2N2857 is -5.2 V. The potential difference between the bases causes the right side to conduct and the left side to cut off.

With the right-side 2N2857 conducting, 20 mA goes into the collector, out the emitter, and through the 470- Ω resistor to -15 V. Half the current comes from the collector of the 2N4260 current source (at the upper right of Fig. 5), and the remaining current comes from ground, up through the LM113 reference diode and the hot-carrier diode.

Table 1. Ideal values of T_L or T_T for selected binary inputs

Binary input	Delay (ps)
0000000000000000	00.0000
0000000000000001	39.0625
0000000000000010	78.1250
0000000000000011	117.1875
0000000001000000	2500.0000
0000000001111111	4960.9375
0000000011111111	9960.9375
0000000100000000	10000.0000
0000001111111100	39843.7500
0000010000000000	40000.0000
1111111111111100	5119843.7500

Table 2. Key performance specs

Resolution	± 20 ps
Linearity	± 40 ps
Tempco (to 40 C)	± 20 ps/ $^{\circ}$ C
Duty cycle	± 40 ps
Jitter	Increment portion = ± 40 ps Vernier portion = ± 40 ps
Power-supply sensitivity	± 40 ps for $\pm 10\%$ variation
Edge interaction (as two pulses approach)	± 40 ps
Total rms accuracy	± 108 ps

When a transition occurs at the inputs, the right-side transistors of each ECL pair turn off, and the left-side ones turn on. When the right side 2N2857 turns off, it "releases" the 10 mA from the collector of the 2N4260 current source, and the current charges the 47-pF capacitor—with a linear slope from the lower clamp potential of -1.7 V to the upper clamp potential of 2.5 V (remember, a linear voltage ramp is generated whenever a capacitor is charged by a constant current source.)

The "start" signal is clocked before going to the increment generators, which prevents erratic operation that may occur when the "start" signal falls very close to the clock transition. For this special case, one increment generator may clock immediately, while the other waits for the next clock. Performance specs of the generator are shown in Table 2.■

Opening new frontiers with electro optics

Just what the doctors ordered: RCA-developed PMTs that allow whole-body CT scanning in only 2 seconds.

Computerized tomographic (CT) X-ray scanners are creating a lot of excitement in medical circles. Unlike conventional X-rays, where a dense object can block out something important such as a tumor, a CT scan from hundreds of directions produces a highly revealing, complete cross-sectional view of the patient.

Vital links in this process are the hundreds of photomultiplier tubes which measure light scintillations caused by X-ray beams passing through the body and striking individual crystal detectors. RCA, of course, has a long background in the design and manufacture of PMTs. So we've been able to provide extremely reliable tubes with the performance required for critical measurements at ever-faster scanning speeds—

users report as fast as 2 seconds.

These PMTs feature a wide dynamic operating range due to a highly conductive cathode surface and low anode dark current characteristics. Cathode currents of several nanoamperes and anode dark current in the picoampere range are possible when using the PMTs at operating voltages around 600 volts, characteristic of most CT scanning systems.

Two sizes of RCA 10-stage head-on tubes are being used in scanners. The 4886 has a 3/4" diameter and the S83001E a 1/2" diameter bialkali photocathode.

They represent a clear case where RCA saw a need and applied years of PMT experience to meeting it. Now, what can we do for you?

For spectroscopists: PMT with improved responsivity out to 850 nanometers.

The popular RCA 4840 1-1/8" dia., 9-stage PMT has been improved again. Its high responsivity now extends over a broader spectral range—to 850 nm typical. And there are some other benefits from buying this RCA tube. The assurance that comes from domestic manufacture. Prompt delivery. Price—about \$55. And in-depth application support from people who really know how to help you get the most from a PMT.

So if you're involved in broadband spectroscopic analysis or low-level light detection systems—analyze the extra benefits you get from buying your PMTs from RCA.

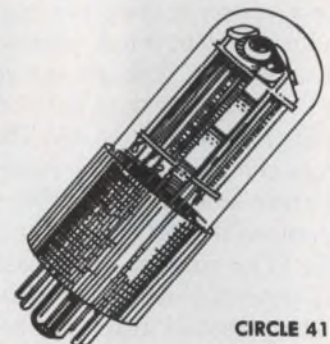
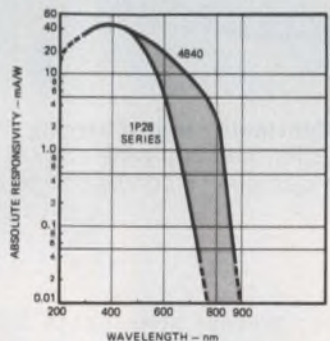
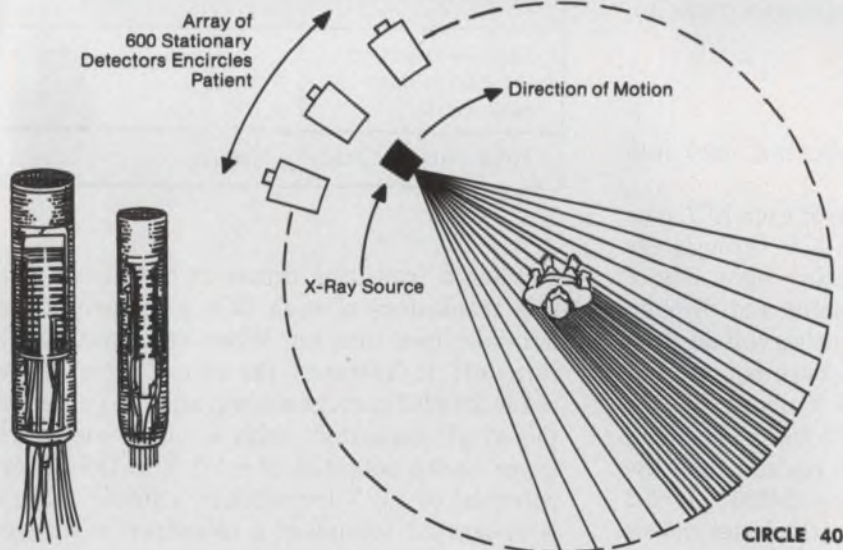

If electro optics can solve your problem, remember: EO and RCA are practically synonymous. No one offers a broader product spectrum. Or more success in meeting special needs. Call us for design help or product information. RCA Electro Optics, Lancaster, PA 17604. Phone 717-397-7661. Sunbury-on-Thames, Middlesex TW16 7HW, England; Ste.-Anne-de-Bellevue, Quebec, Canada; Sao Paulo, Brazil; Hong Kong.

RCA

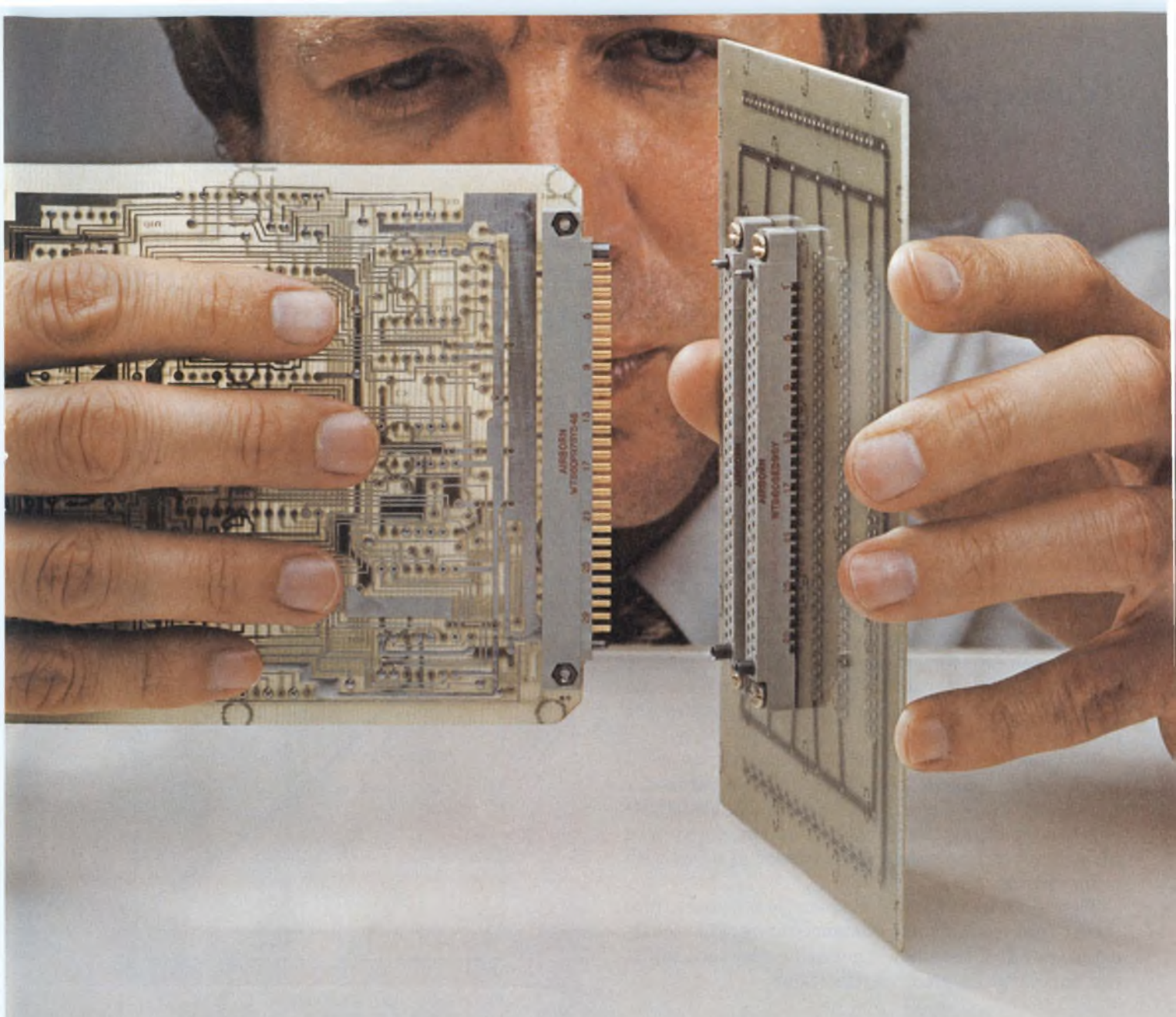

We don't build a connector for everybody.

We build everybody a connector.

More often than not, your problem can't be solved with a substandard connector. That's why our first concern is quality. You present us with a problem and we're flexible enough to give you back an approved connector that's designed or modified for your application.

We make connectors for PC card to chassis or mother board connections. We make connectors for PC board input-output, cable to panel and cable to chassis connections. We make connectors for inter-

equipment connections like cable to panel, cable to cable and drawer to cabinet. And we make every component that goes into them.

It simply comes down to this. You either use a connector that's been stamped out on an assembly line or a connector that's carefully and completely built specifically for your job.

That decision is easy. And that's why we're in the connector business.

If you want the best, call AirBorn.

AirBorn, Inc.

Thermistors make good thermometers—if you know how to linearize the operation of these semiconductor elements to make them fit your temperature range.

You can build a temperature-measuring circuit by putting a nonlinear thermistor into a simple voltage divider to linearize its operation. The output voltage of the divider, taken across its load resistor, becomes a linear function of temperature over a specific temperature range. As a result, you can use this characteristic to construct thermometers to cover any range of temperature you need.

But designing a thermistor circuit gives you only the temperature-sensing portion of your thermometer. For direct temperature readout, you'll have to connect the circuit to an analog or digital meter. And here, an op-amp summing amplifier provides the interface between thermistor and meter.

To determine the linear operating region of a particular thermistor, refer to a family of curves for that device. Manufacturers generate and publish these curves by plotting the transfer function of a voltage divider for various values of resistance in series with a thermistor.

To select a thermistor that spans your temperature range, first examine its resistance-temperature characteristic. You'll see how linearizing resistors adjust the curves to fit your specifications.

Linearize with a single resistor

The well-known nonlinear resistance characteristic of a typical thermistor is shown, referenced to 25 C, in the graph of Fig. 1. On the y-axis, the thermistor's temperature coefficient of resistance, $r(T)$, is given by

$$r(T) = R_T / R_0 \quad (1)$$

where R_T = thermistor's resistance at any temperature, T , and

R_0 = thermistor's resistance at 25 C.

If a thermistor is connected in series with a resistor to form the simple voltage divider of Fig. 2, the normalized output voltage, $E_T(T)/E_i$, is reasonably linear over a temperature range determined by the value of the resistor. For this circuit the transfer function, $F(T)$ is found by

$$F(T) = 1 / (1 + R_T / R_0) \quad (2)$$

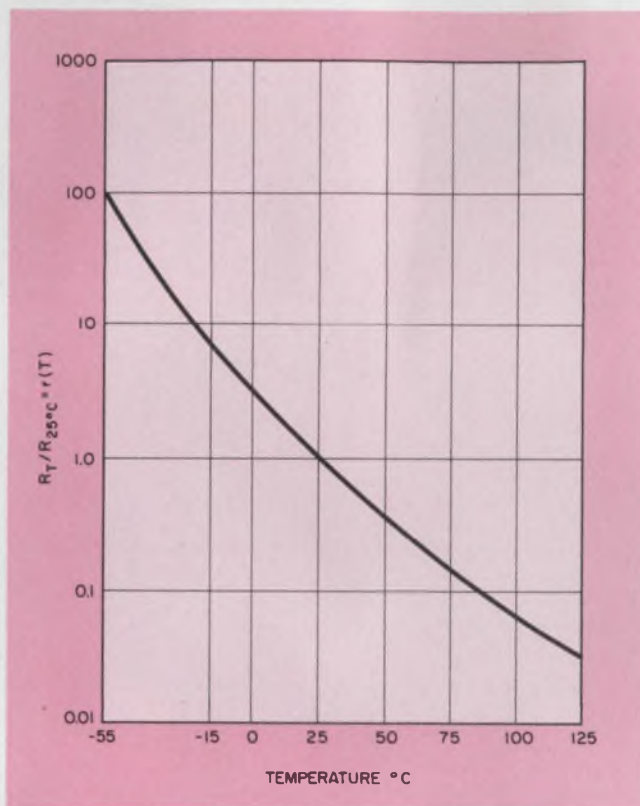

1. A thermistor's resistance varies nonlinearly with temperature as shown in this resistance-temperature curve, which is normalized at 25 C.

$$F(T) = [1 + (R_0 R_L) r(T)] \quad (3)$$

where $F(T)$ = linearized temperature function, and R_L = linearizing resistance.

A plot of Eq. 3 with respect to temperature is shown in Fig. 3 for various values of ratio R_0/R_L . You can use the curve to find the ratio that covers the temperature range of your thermometer. For example, a room-temperature thermometer should be optimized for linearity around 25 C and referring to Fig. 3, you can see that a resistance ratio, $R_0/R_L = 1.5$ would be a good choice for this thermistor. For a clinical thermometer, to be used at normal skin temperature of 37 C, the thermistor gives the most linear performance at a resistance ratio between 3.0 and 4.0.

Say you want to build a room-temperature thermometer calibrated directly in °F, and you select

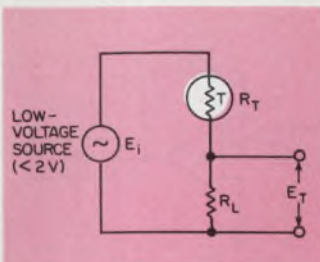

2. To linearize a thermistor's operation, simply connect it in series with a load resistor and make a voltage divider. The region of linear operation for the thermistor depends on the value of R_L .

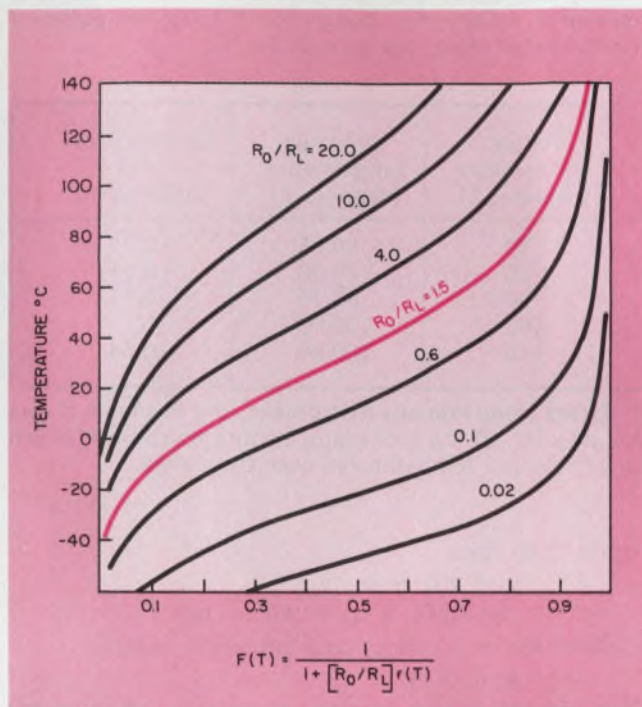

3. A thermistor will operate linearly over a number of temperature ranges, depending on the value of R_0/R_L . For a room-temperature thermometer, $R_0/R_L = 1.5$ gives the most linear performance.

a resistance ratio of 1.5. Using a thermistor such as a Victory Engineering UniChip, which has an R_0 of 10 k Ω , calculate the linearizing resistor's value from 10 k $\Omega/R_L = 1.5$. It is 6.67 k Ω . With both component values of the voltage divider established you must now design an interface circuit with both gain and zero-shift to match the thermistor to a meter.

Scaling for direct readout

In Fig. 3, the slope of the R_0/R_L line is equivalent to the gain of the interface circuit's summing amplifier. You can always find the slope directly from the graph, but for precise results you're better off calculating it from a manufacturer's table for a specific thermistor.

A table for the UniChip (Fig. 4) gives values of $F(T)$ over the room temperature range on the R_0/R_L line. From the table, divide changes in room temperature by the corresponding change in $F(T)$ for each interval. Now average the results. You'll find the slope to be 175.1, which is the gain of the interface circuit's

summing amplifier.

Because the R_0/R_L line is linear in the operating region, it can be defined by the general straight-line equation, $y = mx + b$. For Fig. 3, this equation is expressed as

$$T = m[F(T)] + T_0 \quad (4)$$

where T = temperature,

m = slope of the R_0/R_L line—175.1 in this case,

T_0 = value of T where the R_0/R_L line intercepts the T axis (y intercept).

In Eq. 4, the only unknown is T_0 , but its value can easily be calculated at several temperatures over your range. The table in Fig. 5 enables you to do just that, giving an average value of T_0 of 6.804 F. Now you're ready to put the terms in Eq. 4 to work by completing the interface design for your thermometer.

A complete thermometer

The whole ball of wax—thermistor circuit, interface and readout device—is shown in Fig. 6. The slope of the thermistor circuit, 175.1, equals the gain of the op amp, and is expressed as

$$R_2/R_1 = 175.1/E_i \quad (5)$$

From this equation you can calculate R_2/R_1 . And while Eq. 5 is theoretically a constant, make R_2 a variable resistor to provide a convenient means of calibration.

With a second voltage divider, composed of R_3 and R_4 , the T_0 intercept is provided for. Now you have to return to the general straight-line equation and re-

Temperature (T) [degrees F]	Temperature coefficient [r(T)]	Output function [F(T)]
60	1.531	0.30335
70	1.189	0.35926
80	0.9296	0.41764
90	0.7329	0.47634
100	0.5819	0.53395
110	0.4654	0.58889

4. You'll get better precision if you calculate the slope of the R_0/R_L line from a manufacturer's table like this one, instead of doing it graphically.

Temperature (T)	Intercept $T_0 = T - 175.1 F(T)$
60	6.884
70	7.094
80	6.871
90	6.593
100	6.505
110	6.886

5. To find the T_0 intercept, calculate it at several points over the temperature range, then take the average value of your results.

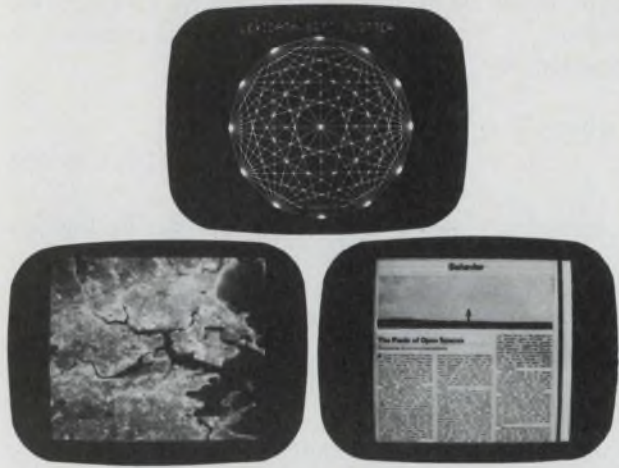

Raster scan high resolution refresh graphics

at a price you can't ignore

Now you can have a system
to meet your unique computer-graphics applications

System-sophistication made practical for the OEM and end-user

- Full refresh, flicker-free, raster scan display
 - up to 1280 x 1024 pixels in 16-levels of grayscale
 - display 1024 simultaneous colors from color look-up table
 - up to 16 bits of intensity or overlay data per pixel
- Interfaces for most minicomputers
- Gamma-corrected and composite video output
- High-speed, variable image processing
 - pixel update as fast as 45 nsec per pixel
 - random and sequential update
 - dynamic memory allocation
 - writable control store
- User can program the alphanumeric generator and define the cursor
- Nondestructive functions to highlight image displayed
 - vector and alphanumeric overlays on image
 - zoom with continuous 4-directional scrolling
- Command I/O and DMA to host computer
- Peripheral options

A versatile graphics-system to meet your widely diverse needs that you'll want to know more about. Just write Lexidata Corporation, 215 Middlesex Turnpike, Burlington, MA 01803 or faster yet, call us at 617 273-2700, and ask for Martin Duhms.



Best in graphics, year after year

215 Middlesex Turnpike, Burlington, MA 01803
617 273-2700 • TWX 710-332-1381

CIRCLE NUMBER 43

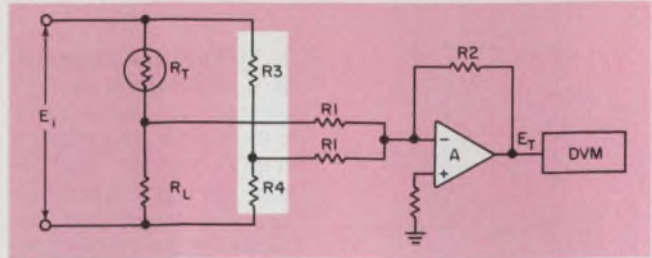

6. Connecting a thermistor to a readout device requires a scaling circuit composed of an op amp summing amplifier and the R_3R_4 voltage divider. With the proper resistance values, this design for a room-temperature thermometer reads out directly in $^{\circ}\text{F}$.

Actual temperature [degrees F]	Indicated temperature [degrees F]	Linearization error [degrees F]
70	69.25	-0.75
80	79.48	-0.52
90	89.75	-0.25
100	100.00	0
110	109.46	-0.54

7. Errors creep into any instrument, and this table shows you how far off the room-temperature thermometer will be at selected temperatures over the range.

write it so that

$$y = mx + b$$

$$= m(x + a) = mx + ma$$

where $ma = b$, the y-axis intercept, and
 $a = b/m$.

You can solve for b/m since the slope and intercept are both known: $b/m = 6.804/175.1$, or 0.0388. And this value, when inserted in a voltage divider equation for R_3 and R_4 gives

$$R_4/(R_3 + R_4) = 0.0388. \quad (6)$$

Solving for R_3/R_4 , you get 24.77. Now with Eqs. 5 and 6, you can determine the values of the four resistive components in the interface circuit. The thermometer is complete, but the one question yet to be answered is: How accurate will it be?

In the first place, you can calibrate this design for zero nonlinearity at any point of its span. If the thermometer is calibrated at 100 F, you can expect the nonlinearity errors to be close to the values shown in the table of Fig. 7.

A certain amount of error is introduced by the device you select. The highest quality thermistors, for critical applications, have manufacturing tolerances that are accurate to within ± 0.35 F. So consider this the smallest device error that you can get. Moreover, errors can be introduced by self-heating, but you can hold them to less than ± 0.2 C in still air by keeping power in the thermistor below 0.2 mW. To do this with a 10-k Ω device, current must be less than about 0.15 mA. Time lag can be a factor in some applications. But a low-mass thermistor such as a UniChip has a time constant of less than 4 seconds in still air and less than 0.5 seconds in a moving fluid.■

Finally - a cheap (or rather inexpensive) Video A/D Converter



Now you can afford to go digital

We've done today what everyone thought was years away. We've developed a Monolithic Video A/D Converter to sell for less than \$500—it works just great—and best of all, it's ready for delivery now.

TRW's new 8 bit TDC 1007J costs only \$485 (in 100's), features up to a 10 to 1 power reduction over existing converters, is less than $\frac{1}{3}$ the size, and converts with unmatched accuracy up to 30MHz (33 ns conversion time).

The TDC 1007J exceeds the standards that networks require for studio equipment, yet is economical enough for field and/or industrial use. If you have a product that is now using one of those expensive Video A/D Converters you can mount the TDC 1007J (and about \$30 worth of other components) on a card and start saving a bundle immediately. (Incidentally—we are making available, in small quantities, an evaluation board. It's a fully tested drop-in unit containing everything you need to go digital—just ask for TDC 1007 PCB.)

Let us show you how you can go digital...economically. Available from stock from Hamilton/Avnet or contact your local TRW Electronic Components field sales office or call Willard Bucklen at (213) 535-1831, or send coupon.

TRW LSI Products

An Electronic Components Division of TRW Inc.,
P.O. Box 1125
Redondo Beach, CA 90278

Please send data sheets on the new TDC 1007J Monolithic Video A/D Converter and the TDC 1007 PCB.

Name

Company

Div/Dept Mail Code

Address

City

State Zip

ED-4

TRW LSI PRODUCTS
... for Digital Signal Processing

Simplify air-gap calculating with a Hanna curve. You need only a single plot for a particular ferromagnetic material to serve all core shapes and sizes.

Establishing the proper air gap in a ferromagnetically cored coil can be a tedious trial-and-error process. But with a Hanna curve¹ for the core material, you can zero in on the correct gap in only one or two tries.

A ferromagnetically cored coil that carries dc current generally needs an air gap in the core's magnetic path to keep the core from saturating. In the magnetically saturated region, the coil's ac inductance drops rapidly as the dc current increases (Fig 1). Saturated, a coil's variable inductance can distort signals passing through the coil and generate unwanted harmonics and signal-mixing products—particularly undesirable in filter networks. Also, the lowered ac inductance can overload and even damage a driver circuit, when the coil is used to couple the driver to a load.

Too often, when designing an inductor that carries a dc bias, you don't have enough design data and must resort to trial-and-error testing. You first have to select a core size that can hold enough turns of wire of a diameter that can carry the dc safely and give you the required inductance.² Then you have to test the core with dc to determine if you still get the ac inductance you want without magnetically saturating the core. If the inductance is insufficient or the core saturates—or both—you need a larger core to hold more turns or to allow a larger gap to prevent saturation—or both. You may have to repeat this process several times until you get the right combination of gap and core size.

Many A_L - I_{dc} curves needed

Of course, if you could get a family of A_L - I_{dc} curves, as illustrated by Fig. 1, for each core shape (toroid, pot, E, etc.) and size you are working with, you could get a good design on almost the first trial. For a given core A_L factor (nanohenries/turn²) and dc bias, the curves give the required air gap.³ The ac inductance, L , of a coil wound on such a core is then determined by the relationship,

$$L = N^2 A_L \text{ (nanohenries),}$$

where N is the number of turns. But it's impractical for core makers to supply the large number of A_L -

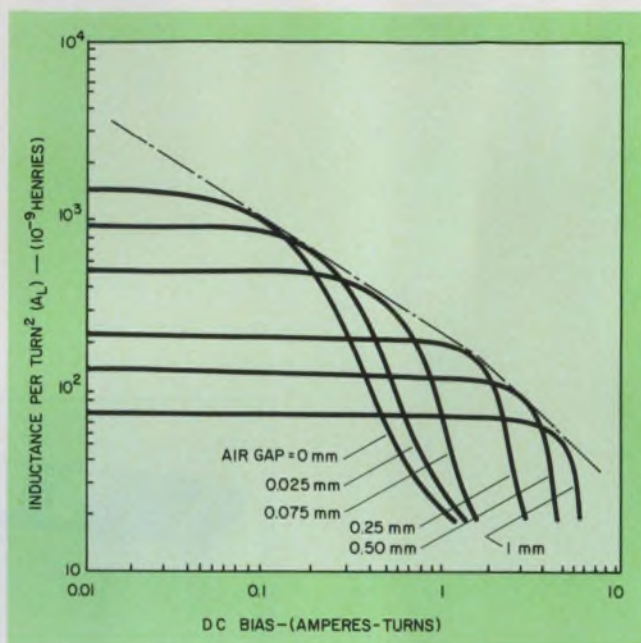

1. The inductance of a ferromagnetically cored coil remains fairly constant with increasing dc through its winding until the core starts to saturate magnetically. However, the larger the air gap in the core, the larger the range of dc the coil can handle before saturation.

I_{dc} curve families you would need. Instead, most manufacturers merely supply A_L , the inductance factor for a particular core at a specified flux density, and don't go into any details about the air gap.

To understand what an air gap does, first note the shape of the B-H curve of a core without an air gap (Fig. 2a). A small amount of dc easily raises such a core's flux density to near saturation. Thus, you can get only a small useful flux change, ΔB , which is limited between the core's maximum flux density, B_m , and the residual flux level, B_r . With an air gap, however, the B-H curve looks like Fig. 2b, where ΔB has a much wider range between B_r and B_m .

The flux density that results from dc is

$$B_{dc} = 0.4 \pi N I_{dc} / [d_g + (d_e / \mu_{dc})] \text{ (gauss),}$$

where d_g is the air-gap length, d_e is the effective magnetic length of the core⁴ in centimeters and μ_{dc} is the dc permeability of the core material.

For the ac flux density,

$$B_{ac} = E(10^8) / K f N A_e \text{ (gauss),}$$

Warren A. Martin, Chief Electronic Engineer, Fair-Rite Products Corp., Wallkill, NY 12589.

where E is ac voltage, f is the frequency in hertz and A_e is the effective cross-sectional area of the core in square centimeters. The constant K depends upon the ac voltage's wave shape: For a sine wave, where E is in rms volts, K is 4.44 (or $0.707 \times 2 \pi$); and for a square wave, E is in peak volts and K is 3.99 (or $0.636 \times 2 \pi$).

Clearly, if the sum of B_{dc} and B_{ac} shifts the core's flux above the maximum operating flux density of the material, B_m , the incremental (or effective) per-

Now, instead of a separate curve for each gap size, as in Fig. 1, you plot a single line equivalent to the line that is tangent to the family of curves in Fig. 1 to produce the Hanna curve. Hanna curves also can be determined experimentally.¹

The Hanna curve (Fig. 3) represents Fair-Rite's No. 77 ferrite material, which is typical of the ferrites used with air gaps. To select a core type, size and air gap for a given inductance and dc bias current, proceed as follows:

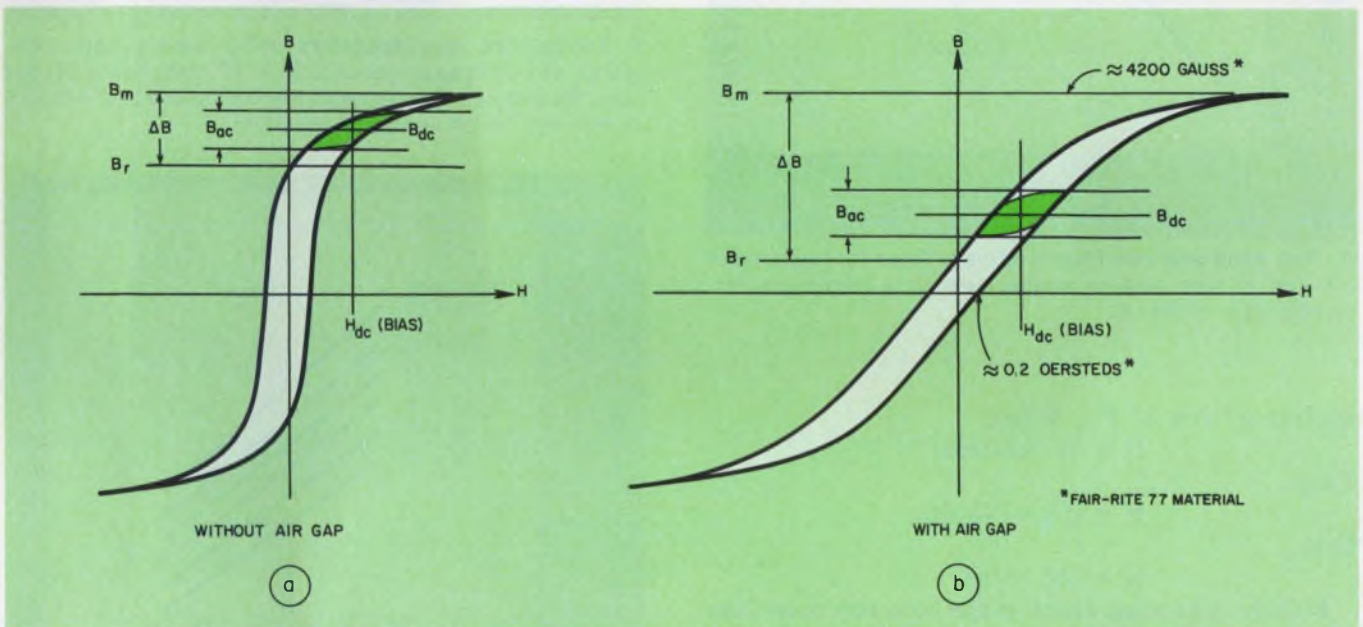

2. The B-H curve of a magnetic material without an air gap (a) has a small ΔB range. Insert an air gap (b), and

you lengthen the range of ΔB from the residual flux level, B_r , to saturation, B_m .

meability of the material for ac, μ_e , is reduced, which lowers A_L and the inductance, since:

$$A_L = 4 \pi \mu_e (10^{-9})/C_d.$$

In this equation, C_d is a dimensional core constant,⁴ equal to d_e/A_e , sometimes supplied by ferrite-core manufacturers. Naturally, B_{dc} is smaller when you have an air gap (Fig. 2b), and this is not as easily saturated as when there is no air gap (Fig. 2a). And even if μ_e also is lowered by the air gap, μ_e is still larger than if the core saturates.

Only one Hanna curve needed

But where you need many curve families of a plot like Fig. 1 to determine the proper air gap, just one Hanna curve can serve for all shapes and sizes of a particular core material. You get a Hanna curve by normalizing the horizontal and vertical scales of Fig. 1. To do that, plot LI_{dc}^2/V_e instead of A_L on the vertical scale, and the core's field strength, H , instead of the dc bias current on the horizontal scale. Core constant V_e is the effective volume of the core, inductance L is in henries and the field strength is

$$H = 0.4 \pi NI_{dc}/d_e \text{ (oersteds).}$$

1. Calculate LI_{dc}^2 . For example, given $L = 10$ mH and $I_{dc} = 1$ A,

$$LI_{dc}^2 = 10 \times 10^{-3}$$

2. Pick a core. For example, keep the LI^2/V_e ratio roughly between 10^{-4} and, say, 4×10^{-3} to keep the design within the central portion of the Hanna plot. Furthermore, since the Hanna curve consists of points partially into saturation, it's wise to select a larger core, if you have a choice so that you operate into the flat portion of A_L-I_{dc} curves (Fig. 1). In other words, choose a V_e so that the LI_{dc}^2/V_e ratio is towards the lower end of the Hanna curve.

Based on these considerations, let's try a 30×19 -mm pot core whose V_e is 6.34 cm³ (from a manufacturer's catalog, Fig. 4). Then,

$$LI_{dc}^2/V_e = 10 \times 10^{-3}/6.34 = 1.57 \times 10^{-3}.$$

3. Determine the air gap, Δd . Enter the Hanna curve (Fig. 2) with

$$LI_{dc}^2/V_e = 1.57 \times 10^{-3}$$

and determine $\Delta d/d_e = 0.03$.

Since the 30×19 pot core has an effective path length, d_e , of 4.58 cm (from the catalog), then the air gap is

$$\Delta d = 0.03 \times 4.58 = 1.38 \text{ mm.}$$

4. Determine the number of turns, N . From the

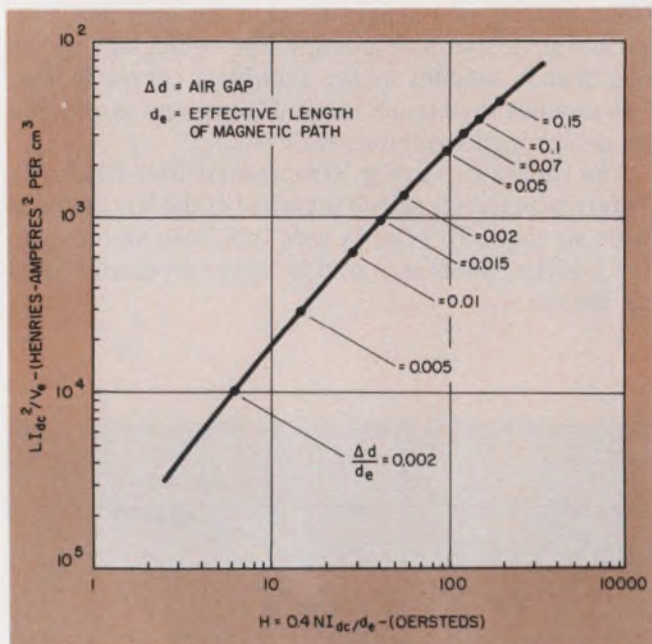

3. You need only one Hanna curve to solve for the correct air gap in any size or shape core of a particular ferromagnetic material.

horizontal axis of Fig. 2 find

$$H = 70 \text{ oersteds.}$$

Since

$$H = 0.4 \pi N I_{dc} / d_e,$$

then

$$N = 256 \text{ turns.}$$

Finally, you must check if the core you chose has a large enough window to hold comfortably the 256 turns of wire in a size large enough to carry the I_{dc} and any signal current without overheating and without an excess amount of resistance for your circuit. But these problems are dealt with in detail in the references.^{3,5} You may need another try with another core size to get exactly what you want; the wire may not fit or the core may be too large.

To help in a second try, or as a check on the calculations for your first try with the Hanna curve, some manufacturers also supply an A_L versus air-gap family of curves for particular types of cores. The Fig. 5 curves are for Fair-Rite-77 pot cores. To use such curves, solve for A_L as follows:

$$\begin{aligned} A_L &= L/N^2 \\ &= 10 \times 10^{-3} / (256)^2 \\ &= 152 \text{ nH/turn}^2. \end{aligned}$$

Note that the previously calculated $\Delta d = 1.38$ mm coincides on the curve with $A_L = 152$ for a 30×19 -mm pot core. This checks the calculations. But the next larger 36×22 -mm pot core with about 2.4 mm of air gap has the same A_L and would give the same inductance with 256 turns as the 30×19 core. In addition, you would be working lower on the B-H curve and less likely to saturate with the larger core.

You get the gap by grinding away a portion of a core's center post (Fig. 4) or, which is more common, by buying the core already gapped from the manufac-

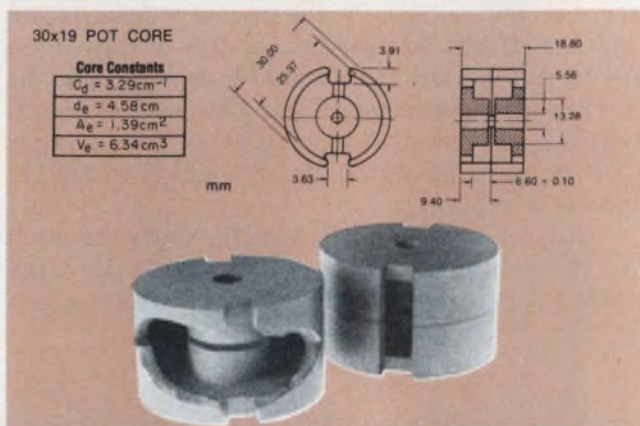

4. Ferrite-core manufacturers often supply core constants, as in this example of a 30×19 -mm (nominal) pot core. Note the air gap between the two halves of the core's center leg, which is rarely specified.

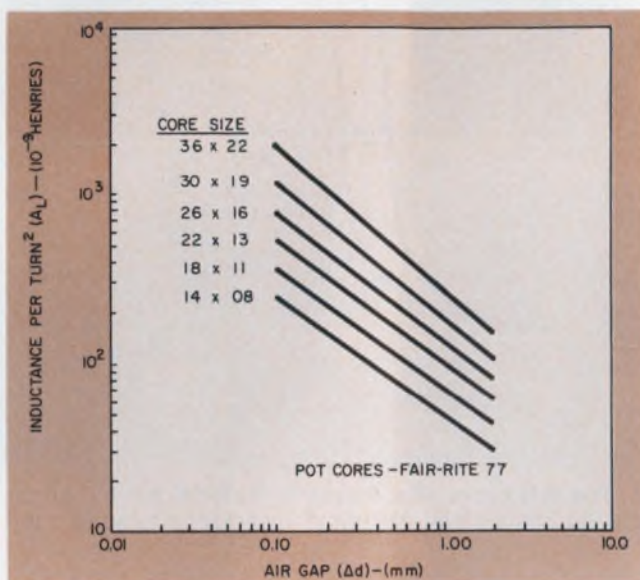

5. For a given A_L factor a larger core requires use of a larger air gap, which provides greater protection against core saturation. A family of such A_L -gap curves is a big help in making core selections.

turer. It is usually more economical to put the total gap in only one of the two core halves, rather than half the gap in each core section. Also, nonmagnetic shims can be used to obtain the air gap. This is usually done by placing the shim between the outside walls of the mating pot-core (or E-core) sections. This shim should then have a thickness only half that of the total gap required, because you get also an air gap equal to the shim thickness in the center post.■

References

1. Hanna, C. R., "Design of Reactances and Transformers which Carry Direct Current," *Journal of the AIEE*, February, 1927, pp. 5-8.
2. Manka, W. V., "Design Power Inductors Step by Step," *Electronic Design*, Dec. 20, 1977, pp. 148-154.
3. van der Poel, J. M., "Improve Inductor Design Accuracy," *Electronic Design*, Feb. 2, 1976, pp. 58-62.
4. Distefano, M. I., "Adjust Ferrite-core Constants," *Electronic Design*, Nov. 22, 1977, pp. 154-156.
5. Gross, T.B., "Multilayer Coil Design is Made Easy," *Electronic Design*, Mar. 15, 1978, pp. 102-106.

DP Dialogue

Notes and observations from IBM that may prove of interest to the engineering community



Here, telemetry devices transmit experimental data to a mobile laboratory. Similar advanced technology is reflected in Deere's worldwide data base of thousands of components, letting engineers utilize existing parts when developing new products.

At John Deere, No One Reinvents the Wheel

Engineers at John Deere don't spend time reinventing the wheel or designing new hydraulic pumps or valves when existing ones will do the job. At their fingertips are data on all Deere parts and

design parameters on commonly used parts and components. This multinational manufacturer of machines for farm and construction has created a multilingual data base called WISE—Worldwide

Information System for Engineering.

"If an engineer in, say, our Mannheim, Germany plant needs a hydraulic cylinder design," says Gordon Millar, vice president of engineering, "he can use an online terminal to call up complete descriptions of similar cylinders already in use in Deere worldwide. He will probably find a design he can use with little or no change.

In Four Languages

"Since WISE is literally a worldwide system, it cuts across barriers of language, distance and culture," adds G.T. Underwood, manager of Deere's corporate engineering standards department. "Our master list of terminology is already in four languages: English, French, German and Spanish and all dimensions are in metric and English. WISE has greatly enhanced our worldwide standardization efforts. Also our engineers around the world can readily access design specifications, application information, cost, vendor lists and the like."

"WISE was the first element of a corporate parts data base," says Larry Moore, administrator of engineering information in Deere's corporate engineering standards department. "Now it has links to other business systems in the company, supporting applications in such areas as service parts, warranty service, and parts catalog publications.

"Currently there are about 50 CRT (cathode ray tube) and 100 computer output microfiche display stations in 20 design centers in the U.S., Europe, Argentina, Australia and South Africa. CRT's access our IBM System/370 complex in Moline through the same telephone lines that carry our voice communication.

"The engineer can search the data base by attribute, such as the size or pressure rating of a hydraulic cylinder. In effect, he describes a desired part to the system and automatically receives back a listing of all Deere parts which fit the description.

"We're achieving better parts commonality, and better, faster communication among engineering and manufacturing groups all around the world, by means of the computer."

CADAM is Brought to Martin Marietta Engineers

Engineers are using a multiple-site version of the Computer-Graphics Augmented Design and Manufacturing (CADAM) system at Martin Marietta Aerospace. CADAM converts freehand sketches, made with a light pen directly on the screen of a CRT display, into fully detailed and dimensioned drawings.

At Martin's Orlando (Florida) Aerospace Division, which designs and builds sophisticated guided missile systems, the interactive portion of CADAM runs on a System/370 Model 138 in the division's main engineering facility. The data base of drawings, graphics standards, and design data is stored in a host computer operated by Martin Marietta Data Systems in a computer center five miles away.

"With this approach, we can bring CADAM to the engineer in his work environment, and at the same time give him access to a centralized data base," says Kermit E. Gay, director of the Orlando Aerospace Account for Martin Marietta Data Systems (also a subsidiary of Martin Marietta Corp.). "Despite the constant stream of revisions, CADAM assures us that all engineers working on related projects use the same version of



To calculate geometry and make engineering drawings of missiles, Martin Marietta uses CADAM, a program product available from IBM.

the design data. And everyone uses the same library of graphic standards for fittings, hardware and other repeatedly used graphic elements."

Adds Thomas Boulter, engineering task leader/CADAM for the Orlando Division: "Putting functions 'outboard' in a dedicated processor creates a simple, responsive local system for us. And CADAM is oriented toward me as an engineer; it does things the same way I do.

"Today, we are developing everything from early concept to production drawings on CADAM, and doing it four or five times faster than before."

Engineer Paul Arnold designs stabilized-platform gimbal systems and other precision electromechanical equipment at Orlando. "CADAM takes over much of the math required to lay out a mechanical system," he says. "We handle many cylindrical and conic surfaces, and the system takes care of all the geometric calculations—coordinate transformations and the like. We can observe gear engagement, gimbal articulation, and similar part compatibility on the terminal screen—blowing up the scale of miniature assemblies as large as necessary to see any interference. We can make parts move on the screen—'preprocessing' or rotating a gyroscope, for example, through its full range of travel."

"CADAM also helps us prepare design concepts for proposals," Boulter notes. "Working interactively at the terminal, an engineer can reach an optimum configuration quickly.

"CADAM is easy to learn," he adds. "I was teaching others to use it after only 30 hours of instruction myself."

Decision Tables Automate the Programming of Logic

	01	02	03	04	05
Red Signal	No	No	Yes	Yes	Yes
Right turn intended	—	—	No	No	Yes
Pedestrian present	No	Yes	Yes	No	No
Go	X				X
Stay		X	X	X	

This simple table makes the go, no-go decision for an automobile where right turns on red are legal. Each vertical column is a rule to be read from top to bottom. The conditions above the double line lead to the actions below it. DTABL routines would determine that one more rule is needed ("Yes, Yes, Yes, Stay") and that rules 03 and 04 can be condensed into one by the use of "don't care," indicated by a dash.

Decision tables are not as well known as they deserve to be. They are a powerful tool for coping with complex decision-making in such engineering applications as image analysis, flight simulator control systems, and utility station or other large plant control systems. A less obvious example is the design of an electronic circuit to find the simplest layout with the fewest crossovers.

On paper, decision tables are a clear, concise and self-documenting notation for program logic. With computer programs called decision table processors, such tables can be converted into

executable programs by the computer itself.

In the simple decision table above, each vertical column on the right is a rule. The number of possible rules rises rapidly, even for small problems: as 2^N with "N" the number of conditions. Electrical engineers will note a resemblance to the notation used in "truth tables" for switching logic.

IBM's APL Decision Table Processor (DTABL) accepts decision table input in a simple format. The processor checks it for validity and completeness, then determines the most efficient flow se-

quence through the logic. Finally, DTABL generates a program in a standard computer language such as APL, PL/1, COBOL or ALGOL. Or DTABL can express the program flow in a user-written "pseudocode" (e.g., "Close valve no. 37"), readily expandable into any desired programming language.

In a complex application, it is easy to overlook ambiguous, missing or redundant rules, especially when "don't care" states are introduced. The DTABL error-checking logic reports such errors before it compiles a program.

When a program must be executed many times, as in a real-time control system, its length becomes crucial. DTABL helps here with an optimization function which usually generates programs as short as, and sometimes shorter than, those produced by experienced programmers.

Although DTABL is implemented in the APL programming language, it can be used with no knowledge of APL. The engineer thinks in the logic of his application; he need learn only a few simple notation rules for filling in the decision-table form to obtain the power of DTABL.

Who's Zoo: A Social Register for Animals

One American zoo needed a Celebes ape not long ago. Another needed an echidna (or spiny anteater). A computer helped each identify a zoo with a surplus of the desired animal.

The American Association of Zoological Parks and Aquariums, in conjunction with Federal agencies and private foundations, sponsors a project that some day will store data on every animal in every zoo in most countries of the world. The association's International Species Inventory System (ISIS), headquartered at the Minnesota Zoological Garden, Apple Valley, has already placed in an IBM computer detailed information on 25,000 mammals and 10,000 birds located in zoos in the United States, Canada, and Europe. ISIS will someday also include data on reptiles, amphibians, and fish.

A Vital Task

Says Janice M. Olsen, systems manager of ISIS: "A vital task of modern zoos is to develop and maintain self-sustaining populations of captive wild species and—in certain cases—to provide the only reservoir of species on the verge of extinction. To do this, we must collect data and share it.

"ISIS tells us the captive numbers and reproductive rates of animals on the endangered species list, such as the Indian rhinoceros, Siberian tiger and orangutan. This information aids the development of breeding management programs for captive wild animals."

Finding Rare Mates

Another valuable service of ISIS—the acronym spells the name of the Egyptian goddess of motherhood and protection—is the finding of a mate for a rare species in a zoo that does not have one of each sex. The computer, which is an IBM System/370 Model 158 in the state data processing center in St. Paul, Min-



nesota, helps to match animals needing mates with available candidates, to the benefit of the rare species themselves and of zoos all around the world.

The International Species Inventory System (ISIS), a computer data base of animals in zoos, is helping endangered species like this Siberian tiger.

Data Management and Retrieval Aids for APL Users

These program products, implemented in the user-oriented APL programming language, are operated interactively, through a terminal.

1. **A Departmental Reporting System (ADRS)** allows the engineer to produce reports customized to his needs. It extracts the required information from an existing data base.

2. **APL Data Language** is a powerful data management facility: a dictionary-driven, data-independent, data storage and retrieval system.

Complements the extensive data manipulation capabilities of APL.

3. **APL Data Interface** is a general-purpose facility for inquiry into many types of data files. A simple and economical way to interactively access data to obtain immediate answers to unanticipated questions.

For more information on these and other IBM program products, contact your local IBM branch office or write to the Editor of DP Dialogue at the address on the right.

DP Engineering Dialogue is designed to provide you with useful information about data processing applications, concepts and techniques. For more information about IBM products or services, contact your local IBM branch office, or write Editor, DP Dialogue, IBM Data Processing Division, White Plains, N.Y. 10604.

Data Processing Division

Product serviceability: You may not be able to measure it, but you can design for it. Among the choices are built-in self-test and a serviceability review.

Ask any engineer what he means by a serviceable product, and he'll probably say it's one that can be repaired quickly and economically. Ask him how he quantifies or measures a product's serviceability, and he'll probably say: "You can't."

Frankly, serviceability—or how much of it you want

Kenneth Jessen, Service Engineering Manager, Hewlett-Packard, Loveland Instrument Division, P.O. Box 301, Loveland, CO 80537

—goes beyond good design. It depends greatly on who your customer is and what your customer expects. Those who repair products themselves may want enough serviceability to hold down turn-around time. Others may want rapid, on-site repairs by exchanging modules. Hence down time is the crucial parameter.

The number of ways to design for product serviceability is almost endless. Among the more important are physical design, labeling, fault indication, self-test, and serviceability review.

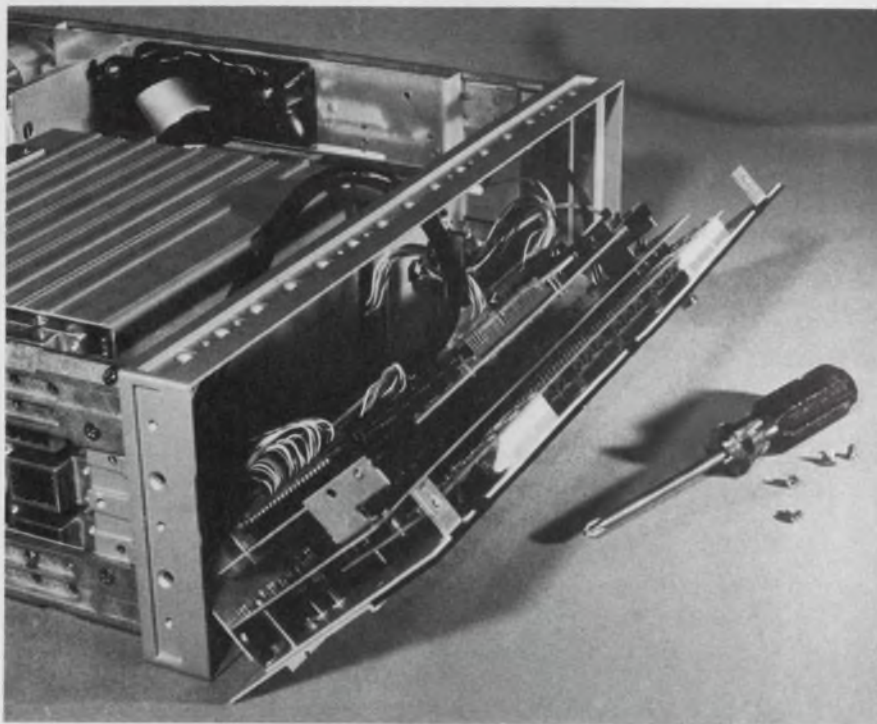

Obviously, a product's physical design greatly affects its serviceability. For example, a single large PC board containing most of a product's circuitry is generally less expensive than modules. To put each group of circuits on individual PC boards requires a motherboard to make all the necessary interconnections. You must add edge connections for each board as well.

Though more costly to produce, the modular concept is far more serviceable. You can isolate faults to a

board, and repair the circuit on that board or exchange it with a new board. Troubleshooting by board substitution from a kit is a good strategy for modularized products. Being able to replace a faulty component is usually less time-consuming on a small, easy-to-remove board than on a large one mounted in the product's frame. So before you take the usual approach of looking strictly at the manufacturing cost, consider the warranty dollars and the cost of ownership to the customer.

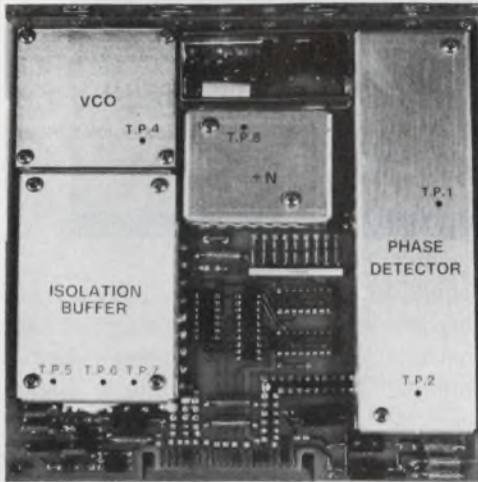

Labels are an easy and important way to boost serviceability. As many reference designators as possible should be imprinted on PC boards to save time locating parts. If the board is to be serviced from either side, obviously the reference designators should be placed on both sides. Along this same line, it is very

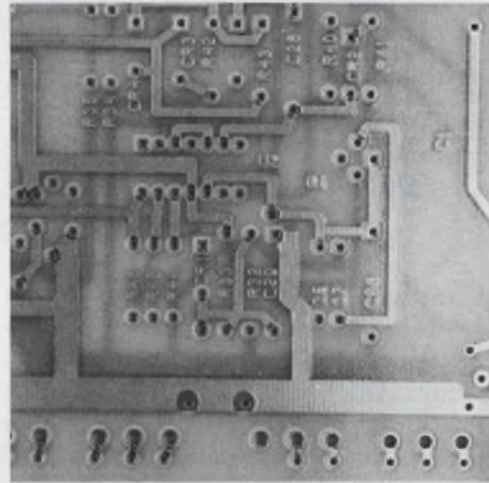

helpful to identify pin No. 1 on an IC, the negative side of a capacitor, which transistor pin is the emitter, and so on. One simple way to identify major nodes: Use a square pad instead of a circular one. On a 16-pin IC, that square pad stands out immediately and adds nothing to the cost of the product.



Tiny LED indicators cost just pennies, but will save many dollars in troubleshooting. They find use in an almost infinite variety of circuitry. For example, they can show whether a power supply is regulating (use a green LED) or in current limit (a red LED). In a

synthesizer, a LED can show quickly whether any of the phase-locked loops are unlocked. Or it can indicate when a circuit is sampling properly. The beauty of these little indicators is that simple visual inspection will spot the obvious failures.



Built-in self-test is an increasingly important serviceability design concept. A popular tendency (especially in microprocessor-controlled devices) is to use a keyboard to enter data or control functions. You'll find them in microwave ovens, TV sets, instruments and many other products. But from a service stand-

point, keys are a problem. They tend to wear out and become intermittent. Some sort of self-test is almost necessary to determine proper key actuation. One method: Include a test mode to display the code for each key as it is depressed. The test can be performed automatically upon turn-on or whenever desired.

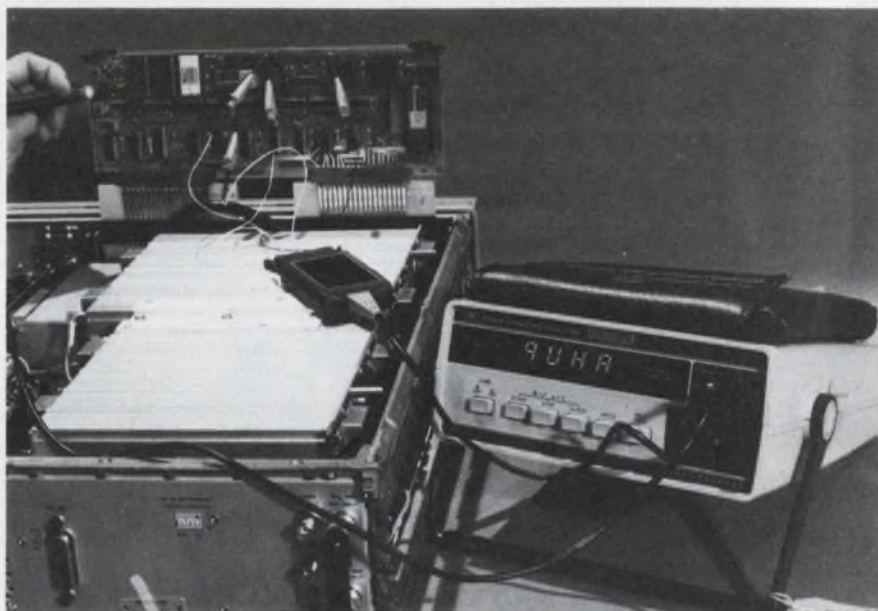

A new self-test concept, signature analysis, is especially good for microprocessor controlled circuits. Here, a stimulus designed into a product's firmware is transmitted by the microprocessor in such a way as to exercise each logic element. It can be proven that each node in a circuit reflects a unique data stream when so stimulated. The data stream can be compressed into a simple four-character signature, in hexadecimal code, by means of a shift register with feedback through an exclusive-OR gate. An instru-

ment, called a signature analyzer, displays the code.

The success of signature analysis depends greatly on how you use it to isolate failures. For example, a test routine may be required for each ROM, to enable it and then fully exercise all addresses. With a signature analyzer looking at the signatures on each data-bus line, the contents of the ROM can be fully and quickly tested. Adding such test routines is inexpensive—all it requires is that you reserve some space in one of the ROMs.



To reduce failure rate, provide a front-panel CRT on/off switch, possibly incorporated with the intensity control.

We will do this on one prototype, and then incorporate the feature in the first run.



The final firmware should prevent any combination of front-panel controls from hanging up the processor.

The structured programming now under way will prevent hang-ups.



Inspection holes in the shielding for power supply LEDs would provide a quick check without having to remove the shield.

Won't do. Holes can have unpredictable effects on air flow. Any service probably will require removing shield anyway.

Will do. Warning should also say not to unplug the power supply PC with power on.



The main shield should warn against plugging-in a board backwards or into the wrong socket while on extenders. Service can work with the lab on content.

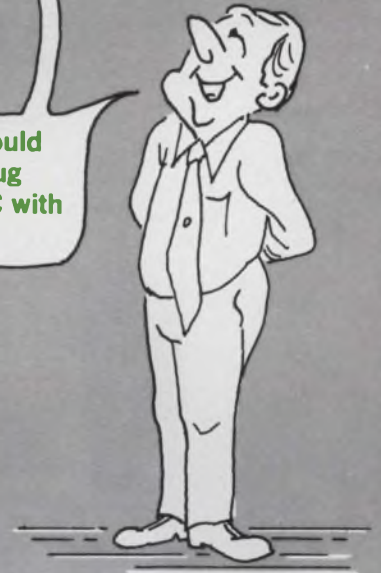

But how can you look into all serviceability possibilities when you're under pressure to stay on schedule, keep costs in line and get all your circuits operating according to specifications? Bearing this in mind, many companies employ service engineers who act as consultants. Ideally, the service engineer is armed with a wealth of practical experience—with a few good "war stories" thrown in for good measure.

One way a service engineer works is through serviceability reviews, which are really nothing more than brainstorming sessions. Attendees should be people familiar with the product—anyone from test technicians, technical writers, production engineers and possibly even wiring-and-assembly personnel.

Representatives from the design team often attend

the review and may even give a presentation on some of the designed-in service features. Led by the service engineer, the group conducts an orderly product review. The design team must be receptive to the spirit of the review and willing to act on realistic, constructive suggestions. The results of the review are sent to the design team in commentary form. The team adds its response, and the entire review is published in a comment-response format.

Some suggestions are accepted. Some aren't. But no attempt is made to enforce any element in the review since the objective of the process is mostly awareness of potential problems. The ultimate test of the process is whether warranty cost comes down and your customers are satisfied.■

Introducing the Motorola baud rate generator.

Twice the component in half the space.

Now you can get a dual-programmable baud rate generator with a self-contained quartz crystal in hybrid form. All wrapped in a .2" high DIP package which takes up just half the board space of conventional generators.

It's the Motorola K1135A. Our baud rate generator eliminates the need for separate crystals and chips. It cuts out starting problems. You don't have to cope with spurious oscillations that mean expensive "end of the line" rework. And the self-contained packaging

means easy control over inventory.

For price list, rep list and data sheet, call Barney Ill at (312) 451-1000. Or write Motorola, Component Products Department, 2553 N. Edgington, Franklin Park, Illinois 60131.



MOTOROLA INC.
Communications Group

CIRCLE NUMBER 48

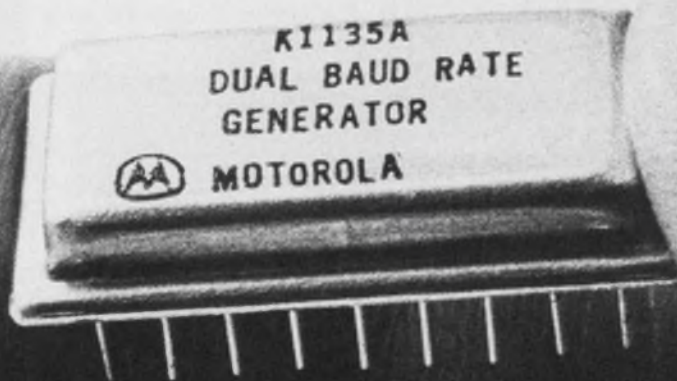

Want simpler backplane connections? Come to the source.

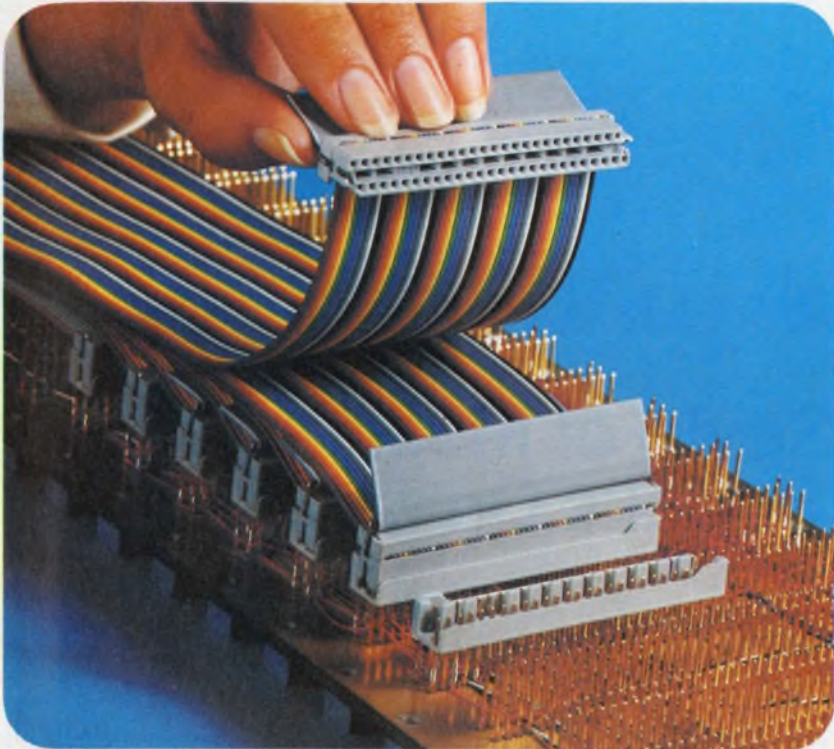

Now, a unique Scotchflex brand Socket Connector and Keying Header system lets you interface directly with backplane wire wrap pins and provides for easy, positive polarization and keying. The header design allows for thousands of unduplicated polarizing combinations without loss of backplane pins. The 50-position connector mates with .025" square pins on .100" x .200" grid spacing. Header allows space for and protects two layers of wrap below it. System also provides polarizing keys and strain relief handles.



Need some other ways to simplify wiring and increase circuit density? 3M's Scotchflex line offers you a broad choice of mass terminating socket connectors, plus wire wrap or solder tail headers to suit your specific design problem. Keying capability is also provided.

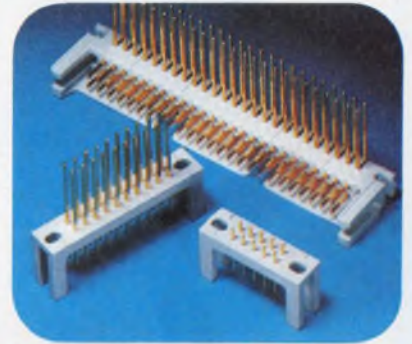

There are several more things you can get only from 3M. The broadest range of flat cables and complete system components. Best off-the-shelf availability. Proven performance. And the unmatched experience of the people who pioneered this reliable mass termination system.

"Scotchflex" is a registered trademark of 3M Co.

Scotchflex[®] systems from 3M. The source.



See our
catalog in EEM,
page 2256



L.J. Sevin of Mostek Speaks On

Bypassing Dead Ends

Your engineers, more than anybody else, can help you avoid dead ends that can block your company's growth. You must consciously and deliberately plan to avoid those traps just as you must plan and organize for growth. You need to develop a strategy.

The key element in organizing for growth lies in evaluating every new product in terms of its likely future. You can't merely judge a product by its own merits. You have to weigh it in terms of its likely offspring and in terms of the rest of your current product line. It must be consistent with the company's product strategy. It must fit the markets you're trying to serve with your other products.

This means you often have to shun those target-of-opportunity products—the ones that look appealing because you know you can make them easily and sell a large number for a limited period.

You must avoid the temptation to chase everything that looks as if it might turn a short term profit—even a handsome one. Your products must hang together. And every product should lead to follow-on products for the future.

To accomplish this you have to imbue your engi-

neers with the philosophy that they are not in business to make just any products. You have to convince them that it's not enough to develop a great product but, rather, that they must develop a great product that's part of the business they're in now—and the business they'll be in a few years from now.

You want designs that can lead to next-generation products—products that can grow. What this boils down to is simply keeping your eye on the target. That's real easy to do in hindsight.

I'll show you how easy it is to go after products that are wrong. Some years ago, as you may know, we developed an organ chip—a good one. It was highly profitable, so you might say that it was clearly a good product. But it was a dead end. It led nowhere. We had no future in the market for organ chips. We would have had a better payoff if we had invested our money and resources in something else, a memory chip for example, since serving the computer-memory market has always been one of our basic strengths.

We had a less happy experience when we got into the hand-held calculator business. For a while that looked like a stroke of genius. Then the market fell apart. We should have realized that we were really trying to get into consumer electronics, not just the hand-held calculator business and, as such, would have had to devote much more of our talent and

resources and approach it with much more dedication than we ultimately did. Fortunately, we got out with our skins intact.

That experience taught us that, even if you know that a business will be very profitable for a while, it can be unwise to go into it.

When you get into a project that's a dead end, you suddenly find yourself with engineers who must be transplanted into something else. They have to start all over again.

The engineers who worked on that "brilliant" dead-end product invested a good part of their personal careers in that program. They expended a great deal of ingenuity and talent in, say, the one-chip calculator. Then when the project died, they had to start learning new things. They may not be on the bottom of the

Who is L.J. Sevin?

He taught briefly after he got his MSEE in 1960 from Louisiana State University in Baton Rouge, his home town. Then he joined Texas Instruments in Dallas, where he worked at several assignments until he took one challenge that he failed. That challenge was the herald of the destiny of L.J. Sevin, a man whose friends and colleagues call him, simply, "L.J."

For a year and a half he wrestled with the problems of designing a sense amplifier for thin-film memories. His conclusion in 1965 that "It can't be done," drove him to start work in field-effect transistors, then MOS and bipolar memories. Four years later, 39-year-old Sevin started Mostek Corporation, which was dedicated, at first, to semiconductor memories.

Until recently, Sevin served as chairman, president and chief executive officer of Mostek, a company whose 1977 revenues exceeded \$85 million. Then in May 1977, the board elected Charles V. Prothro to the position of president and chief operating officer, allowing Sevin to reduce his workday to no more than about 25 hours.

Sevin does find time to spend at his weekend and summer home on a Texas lake about 100 miles from home. He occupies himself there in boating and fishing and other outdoor activities. Indoors, he's a devotee of music, mainly classical. He can listen to Bach or Telemann as well as Charles Ives, John Cage or Samuel Barber, but he can't take hard rock. Of Claude Debussy, his most recent discovery, he says, "How is it I missed this man all these years?"

Sevin and his wife, the former Jo Danna, have three daughters, Paula, Joanna and Christine, and a son, Gordon.

learning curve on something new, but they're not at the top either. We've thrown away part of the education that we put into them.

Of course, many product areas are closely allied. A calculator chip has a lot in common with a microprocessor chip, so the fellow who leaves calculator design and goes into microprocessor design is not really at the bottom of the learning curve. But he's not at the top, which is where he would have been if he had been working on microprocessors all along.

The engineers who started with our company designing memories are on top of the world. They're the best memory designers because they have behind them a long stretch of learning how to make memories. Accumulated experience is one of the greatest teachers. We gave them an opportunity because we gave them the task to develop a product line with a future.

Memory is just one example of a product with a future. The world is always going to need memories—bigger, cheaper and faster ones.

Now, how do we avoid falling into another business in which we don't belong? One way is to make certain that the right people are involved in any important product decision and that these people evaluate every proposal on the basis of how much future it might have—how much follow-on. If a product is just an end in itself, it won't pass our test. It must lead to future products or it's not for us.

We want the products with a future. But that's not an easy decision because when you invest in a long-term product, you can't be too sure about it.

You can be rather certain about the profitability of a short-term product. So carrying out the philosophy is easier said than done.

Many people say that engineers don't know anything about business. That's obviously nonsense. They have a lot of savvy about business. They have a lot of crazy ideas, too, but most of those crazy ideas come about because they don't have all the facts. So there's now lots more engineering content in the decisions we make and we're stronger for it.

Many people think engineers are rather conservative. If you combine that reluctance to change with our philosophy of challenging every new product proposal, you might ask, won't this almost guarantee that we'll miss many important business opportunities? It hasn't and it won't.

We've gotten into the memory-systems business even though, for many years, we thought we should stick to memory chips and stay away from systems. We went into that business—and the decision so far looks right—partly due to pressure from our engineers. Would we generate another business like that? I think so. ■■

Industry asked us for hundreds of variations of these switches. Evidently we're pushing the right buttons.

And we intend to keep pushing them.

So that every time one of your new ideas creates a design problem, MICRO SWITCH will be ready with the miniature manual switch that solves it.

At last count, we offered hundreds.

The Series 8 lineup of miniature manuals includes toggles, pushbuttons, paddles and lighted or unlighted rockers. They're UL listed at 6 amps, 125 VAC. And every one is available in a low energy version as well.

Choose terminal variations ranging from solder to quick-connect to PC board or wire wrap. There's also a choice of panel and bushing-sealed pushbuttons and toggles. And non-threaded bushings on PC mounted toggles. Even colored sleeves and integral colored tips for the toggles.

And of course, you'll find one feature you won't find anywhere else — the quality you've come to expect from MICRO SWITCH. Series 8 switches are inspected to a 1% Acceptable Quality Level (AQL).

That's quality you can put your finger on.

For your immediate product needs, see your nearest MICRO SWITCH Authorized Distributor. If you have other requirements, contact a MICRO SWITCH Branch Office or call 815/235-6600.

MICRO SWITCH

FREEMONT, ILLINOIS 61032
A DIVISION OF HONEYWELL

MICRO SWITCH products are available worldwide through Honeywell International.

CIRCLE NUMBER 50 FOR DATA



The Lear Siegler Ballistic Head™ for matrix printers.

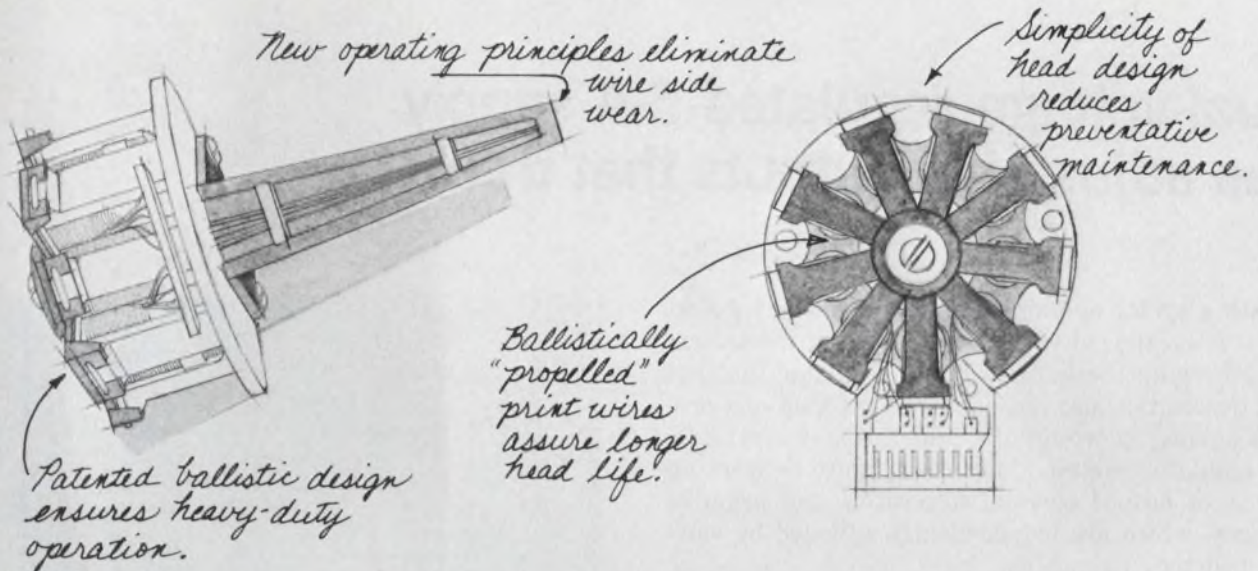

LEAR SIEGLER, INC.
ELECTRONIC INSTRUMENTATION DIVISION
DATA PRODUCTS

Lear Siegler, Inc./E.I.D., Data Products, 714 Brookhurst Street,
Anaheim, CA 92803, (800) 854-3805. In California (714) 774-1010.

CIRCLE NUMBER 51

WHO NEEDS A VIDEO OP AMP

**With 1 GHz Gain Bandwidth Product
and
70 Nanosecond Settling to 0.01%?**

Far more people than you would have imagined! People who require the performance of a true differential input op amp at frequencies from DC to beyond 100 MHz, with the ease of using a 741 at 100 kHz. Those who want a ± 5 volt output to reach an accuracy of 0.01% in 70 nanoseconds. Others who require this state-of-the-art performance from -55°C to $+125^{\circ}\text{C}$, and many more who require the high reliability provided by MIL STD 883 processing.

Your application may not need the full temperature range or the hermetically sealed DIP, but for many industrial applications these and other features of the new Video Op Amp offer you vital reliability.

All of this and more is available to you off-the-shelf with the 1435 – **The op amp that solves problems you didn't even try to solve before!**

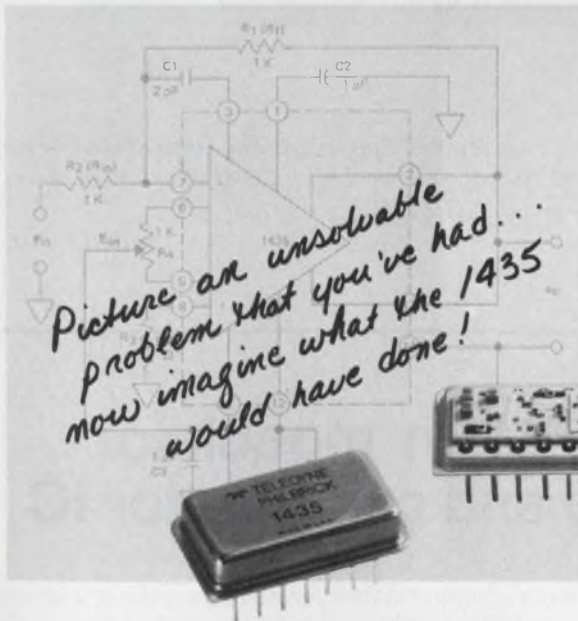

TELEDYNE PHILBRICK

Allied Drive at Route 128
Dedham, Massachusetts 02026
Tel: (617) 329-1600

TWX: (710) 348-6726
Telex: 92-4439
Cable: TELEPHIL

Ideas for design

Dual-voltage regulated 5-A supply has adjustable outputs that track

With a $\mu A741$ op amp connected as a comparator, and a few external components, you can transform two IC regulators into a voltage regulator that not only tracks, but also has safe-area limiting and protects against short-circuits and thermal overloads. The regulator combination in the figure delivers up to 5 A of output current at positive and negative voltages, which are independently adjusted by variable resistors R_1 and R_2 .

Using the component values shown, the positive regulator, a Fairchild $\mu A78HG$, provides outputs over 5 to 20 V. At the other end, the $\mu A79HG$ negative regulator can be adjusted from -2.2 to -24 V. For tracking, connect the Common terminals of the regulators to each other, and to the comparator's output.

Suppose the positive output voltage decreases because of a line or load variation, or a temperature condition. This reduced level is fed to the 741's inverting ($-$) input; as a result, voltage increases at its output. The increased voltage raises the potential at both regulators' Common terminals, which forces the negative regulator to reduce its output. In other words, a change in one output voltage produces a corresponding change in the other, and the outputs track each other.

Each regulator has its own internal reference, so there is no slaving. The outputs and degree of tracking are proportional to the ratio of $(R_1 + R_3)$ divided by $(R_2 + R_4)$.

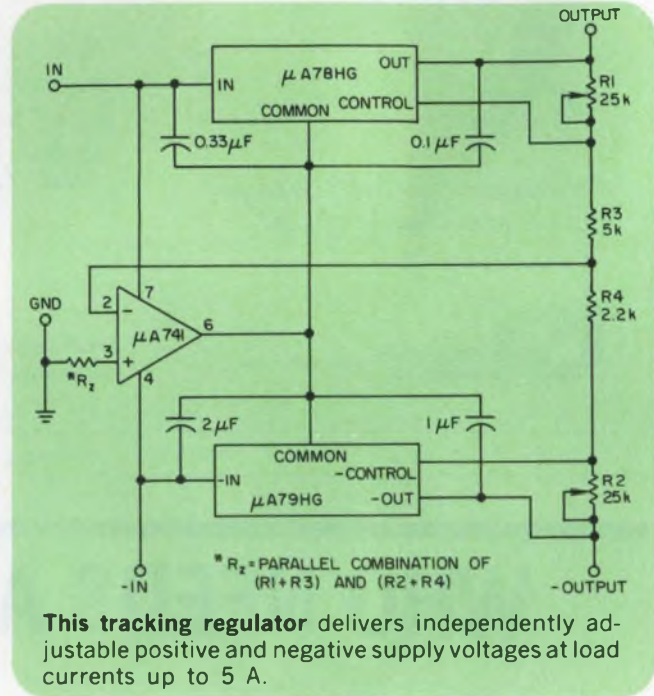

This tracking regulator delivers independently adjustable positive and negative supply voltages at load currents up to 5 A.

Lewis Hinkle, Specialist, The Ohio State University Behavioral Science Lab., 404-B West 17th Ave., Columbus, OH 43210.

CIRCLE NO. 311

Constant-frequency pulse-width modulator built with one-chip op-amp and comparator IC

The pulse-width modulator design in Fig. 1 requires both the linear characteristics of two op amps and the abrupt switching sensitivity of two dc comparators. However, a Motorola MC3405 IC can provide the four circuits in one package. Two op amps operate as a constant-frequency triangle/square-wave oscillator,

and two comparators operate as modulator and output shaper. Because the IC can operate on either a single or split supply voltage over a wide voltage range, the modulator can be constructed to interface with digital or analog circuits.

In Fig. 1, op amp A_1 and capacitor C form an

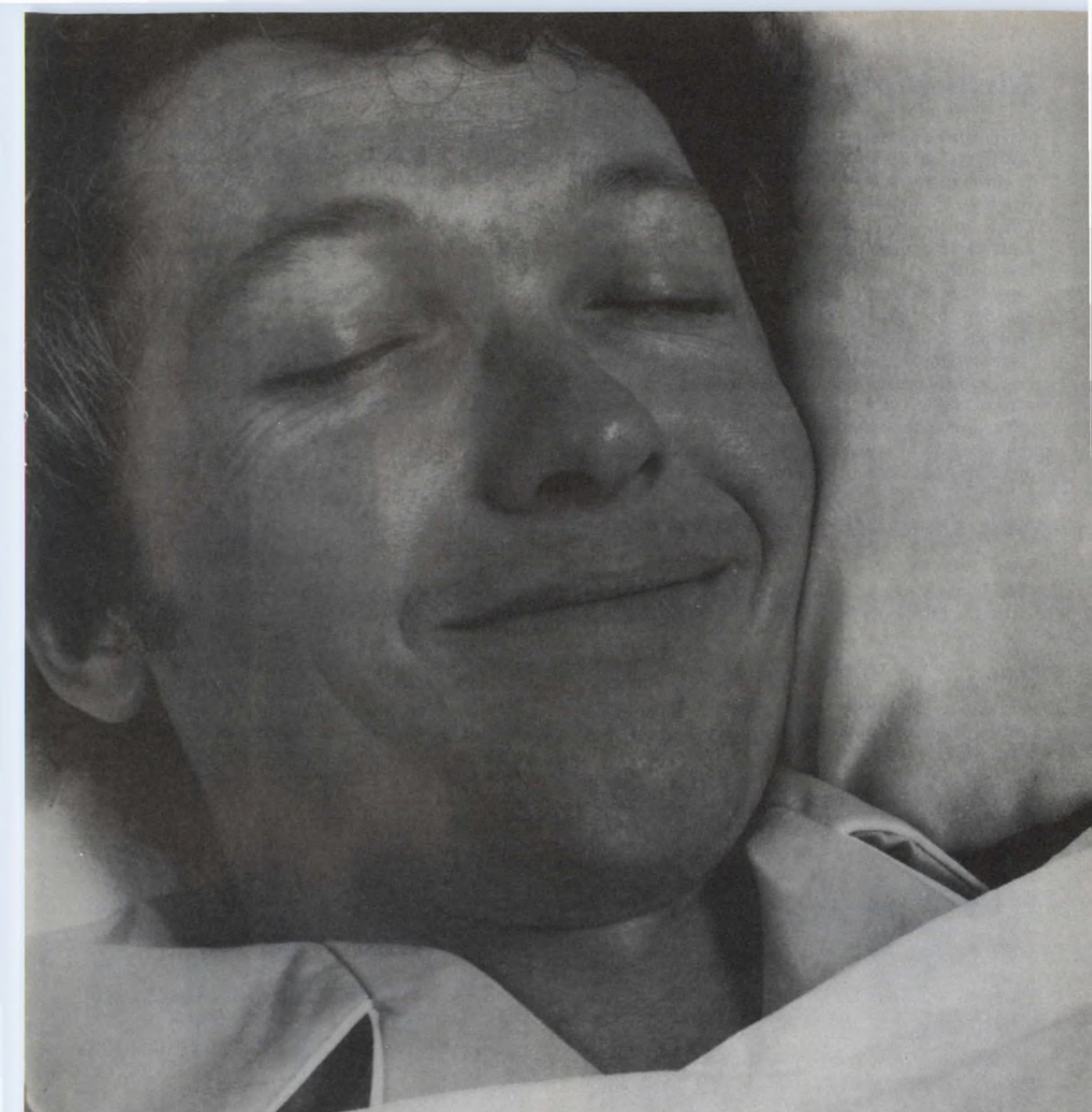

**I Dreamed...
I bought a 12 Bit Data Acquisition System for \$137.50***

That's no dream. You can slash costs today with a μ p-compatible, 16 channel, dual-in-line system. By combining our MN7130 multiplexed S/H amplifier and our popular ADC80 12 Bit A/D, you achieve a 30KHz thruput rate in only 2 DIP's! Wake up to Micro Networks, where designers' dreams are realized.

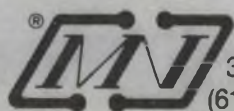

Micro Networks Corporation
324 Clark Street, Worcester, Massachusetts 01606
(617) 852-5400 • TWX: 710-340-0067
CIRCLE NUMBER 61

*100 quantities.

Ideas for design

integrator, whose output voltage is sensed by op amp A₂. If the output of A₂ is low, current flows out of C through resistor R_f until the integrator output reaches the upper switch point of A₂, causing it to switch to the high state. Current in R_f now reverses and flows into the capacitor until the integrator output reaches the low switch point, whereupon the process repeats. Since the voltage on pin 9 of the IC is held constant by the feedback around A₁, the current flowing in R_f is constant during each half-cycle, and the capacitor will charge and discharge at a uniform rate, which produces the linear triangle wave, V_i, shown in Fig. 2a.

The upper and lower switch points of A₂, and hence the upper and lower limits of the triangle wave, are given by the following equations:

$$V_{TH} = V_{EE} + 1/2 V_S \left(1 + \frac{R_2}{R_1} \right),$$

$$V_{TL} = V_{EE} + 1/2 V_S \left(1 - \frac{R_2}{R_1} \right),$$

where $V_S = V_{CC} - V_{EE}$.

Oscillator frequency, determined by triangle-wave switch points and the combination of feedback resistor magnitude and capacitor value, is given by:

$$f = \frac{R_1}{4 R_f C R_2}$$

The instantaneous voltage of the triangle wave is compared to an input control voltage by comparator A₃, whose relative point of output switching is thus a linear time function of control voltage. Comparator A₄ shapes the output square wave and, depending upon connections to pins 5 and 6, may or may not invert the signal.

The duty cycle of the output, V_o, is given by the following:

$$\text{duty cycle} = \frac{V_C - V_{TL}}{V_{TH} - V_{TL}} 100\%,$$

and the pulse width by the following:

$$\text{pulse width} = \left(\frac{V_C - V_{TL}}{V_{TH} - V_{TL}} \right) (1/f)$$

for $V_{TL} < V_C < V_{TH}$.

The circuit as shown can operate on a single supply from +5 to +36 V, or a split ± 2.5 to ± 18 V. At low frequencies, nonlinearity error for duty cycles approaching the 0 and 100% extremes is small. However, as the circuit approaches its upper-frequency limit, about 20 kHz, the circuit produces a slight rounding of the triangle wave with corresponding nonlinearity.

Tom Hopkins, *Industrial Systems Engineering, Motorola Semiconductor Products, Inc., 5005 E. McDowell Rd., Phoenix, AZ 85008.*

CIRCLE NO. 312

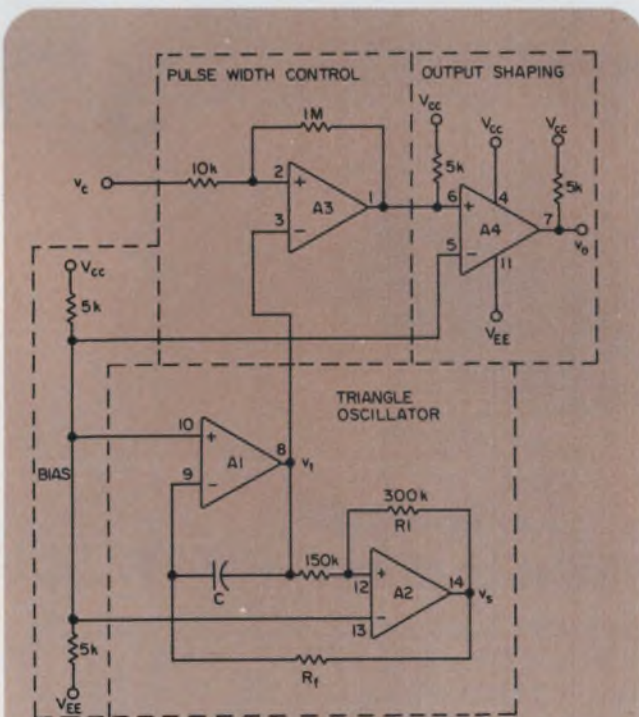

1. A single chip that contains two op amps and two comparators simplifies the construction of a constant-frequency pulse-width modulator. Op amps A₁ and A₂ operate as an oscillator, comparator A₃ modulates, and comparator A₄ shapes the output.

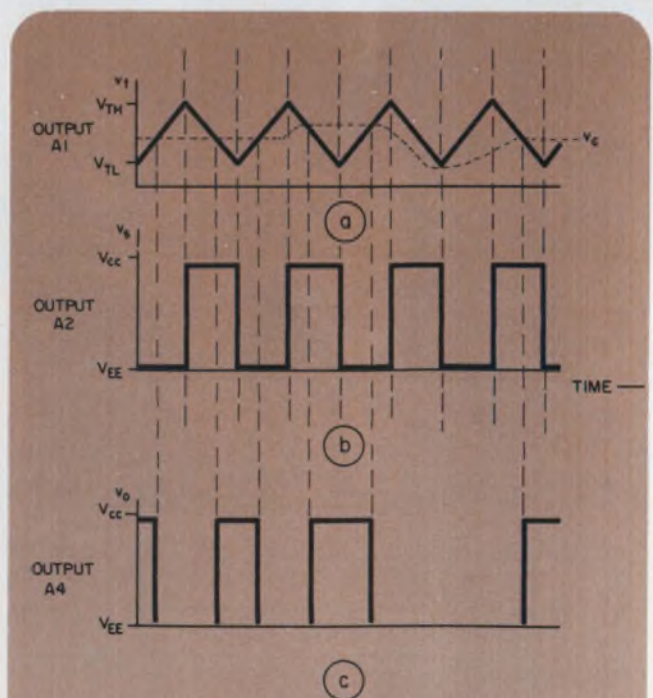

2. Triangle/square-wave oscillations (a and b) are applied to the modulator/shaper, which provides a pulse-width-modulated signal output (c).

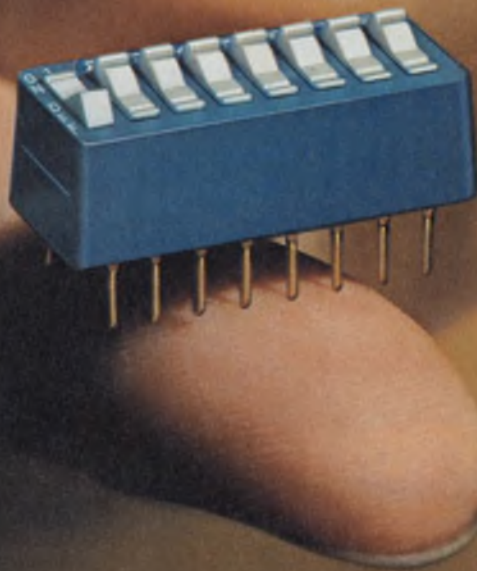

How an 80¢ AMP switch cut manufacturing time and costs. And created a new technology.

Many companies don't call AMP until they need electrical connectors or switches. But why wait till then? If you involve us early enough, we can help you save money. A lot of money.

Here's an example:

Programming printed circuit boards used to involve installing an intricate network of jumper wires and plugs.

Until a customer asked us to find a better way.

We invented the DIP switch, which made programming p-c boards as easy as pushing number-coded actuators.

As a result, our customer was

able to produce standardized boards that they could easily and quickly customize according to orders.

They saved hundreds of thousands of dollars in manufacturing and inventory costs. And a whole new technology was born.

Can we produce the same kind of savings for you?

If your company manufactures electrical/electronic products, the

AMP
INCORPORATED

AMP has a better way.

answer is probably yes. But it's important for you to call us in early.

That's when our experience in developing connectors, switches and application equipment for hundreds of industries worldwide can help you the most.

Early Involvement.

At AMP, we call this approach to solving our customers' problems "Early Involvement." It's our better way. And it's what makes an 80¢ DIP switch worth so much more than 80¢.

For a copy of our new DIP switch catalog, call Customer Service at (717) 564-0100.

Or write to AMP Incorporated, Harrisburg, PA 17105.

Barcelona • Brussels • Buenos Aires • Frankfurt • Harrisburg • Helsinki • 's-Hertogenbosch • London • Luzern • Mexico City • Montreal
Paris • Puerto Rico • Sao Paulo • Stockholm • Sydney • Turin • Toronto • Tokyo



FROM 20Hz TO 4,500 MHz

S-D has just the right counter for your communications and low frequency needs.

Communications Counters

Systron-Donner offers you a choice of no less than *four* communications counters from 100 MHz to 4,500 MHz. Small and lightweight, all of these counters feature the latest advances in high speed, precision frequency measurement.

- **Sensitivity:** 10mV RMS (Models 6241A, 6242A, 6243A). Model 6244A: 10mV RMS to 500 MHz, -13 dBm above 500 MHz.
- **Overload protection:** Withstands high input signal levels without damage.
- **Display:** 8 LED digits, 0.1 Hz resolution.
- **Tone measurement (opt.):** Example: measure 1020.01 Hz automatically in 1 sec.
- **Meet the whole family:** 100 MHz Model 6241A—\$595; 512 MHz Model 6242A—\$795; 1250 MHz Model 6243A—\$995; 4500 MHz Model 6244A—\$2150.

Low frequency counters, 10 and 80 MHz

Not all low cost counters are alike! S-D's are different because they can *accurately* measure most of the signals encountered in low frequency applications. Here's why:

- Three-position attenuator: x1, x10, x100. (avoids false counting)
- Offset control allows measurement of *non-sinusoidal* waveforms
- Four selectable gate times from 0.1 Hz to 100 Hz
- 25 mV RMS sensitivity
- Advanced input circuitry to assure error-free measurements.

Model 6202B (10 MHz), \$295. **Model 6203B** (80 MHz), \$325. (U.S. prices only).

For sales assistance, contact Scientific Devices or Systron-Donner at 10 Systron Drive, Concord, CA 94518. Phone (415) 676-5000.

SYSTRON  DONNER

Ideas for design

Any random number generator can have a Gaussian distribution

You can simulate electrical noise and many other random processes with a random-number generator programmed to provide a Gaussian probability distribution. Random-number programs available in many computer languages aren't necessarily Gaussian. But by using the Central-limit Theorem, you can

```

LIST
2 REM--- TO FIND PROBABILITY DENSITY OF AVERAGE OF 'A' SAMPLES
3 REM--- OF RND(0)--.5
10 DIM P(61)
20 FOR A=1 TO 10
90 REM---S= NO OF SAMPLES
100 LET S=100000.
150 REM---CLEAR ARRAY
160 FOR X=1 TO 61
170 LET P(X)=0
180 NEXT X
200 REM--- ESTIMATE RMS (R2)
210 LET R2=.28868/SQR(A)
220 REM--- NORMALISE DENSITY AXIS
230 LET Z=1000/S
290 LET R=0
300 REM---GET SAMPLES AND STACK IN P ARRAY
310 FOR I=1 TO S
340 REM--- GET AVERAGE VALUE
350 LET X=0
360 FOR K=1 TO A
370 LET X=X+RND(0)
380 NEXT K
400 LET X=X/A--.5
410 REM--- ACCUM X*2
420 LET R=R+X*2
450 REM--- NORMALISE X=0-31 IN ARRAY,X=R2*41
460 LET X=INT(10*X/R2+31.5)
470 IF X<1 OR X>61 THEN 500
480 LET P(X)=P(X)+Z
500 NEXT I
510 REM--- CALC. TRUE RMS
520 LET R=SQR(R/S)
700 GOSUB 3000
710 PRINT "PROBABILITY DENSITY OF AVERAGE OF 'A'VALUES OF RND(0)--.5"
715 PRINT "NORMALISED TO RMS ESTIMATE 'E'="R2
720 PRINT
730 PRINT "NUM. OF SAMPLES="S" TRUE RMS="R
735 PRINT
740 PRINT "X/E          P(X)E*E"
745 LET B=23
750 PRINT TAB(B)"0 ---- 10 ---- 20 ---- 30 ---- 40"
800 FOR X=5 TO 57
810 PRINT (X-31)*.1;TAB(12);P(X)
820 PRINT TAB(B)"1"
824 IF P(X)<.5 THEN 830
826 PRINT TAB(P(X)+B*.5)"*"
827 GOTO 840
830 PRINT
840 NEXT X
900 GOSUB 3000
1000 REM--- FIND ERROR FROM STANDARD GAUSSIAN CURVE
1005 PRINT "MEASURED- CALCULATED NORMAL DISTRIBUTION"
1006 PRINT
1010 PRINT " X/E (P(X)E-P(X)E)CALC ) * TRUE RMS"
1020 PRINT TAB(B-1)"-20 --- -10 ---- 0 ---- +10 --- +20"
1100 FOR X=5 TO 57
1105 REM---THEORETICAL PROBABILITY OF X
1110 LET F=100/(SQR(2*3.14159))*EXP(-.5*((X-31)*R2+.1)^2)/(R*2)
1115 LET F=P(X)/R2-F
1130 PRINT (X-31)*.1;TAB(12);F;
1140 PRINT TAB(B)"1"TAB(F+B*20.5)"*"
1200 NEXT X
1300 NEXT A
2000 STOP
3000 FOR I=1 TO 10
3010 PRINT
3020 NEXT I
3030 RETURN
9999 END

```

READY

1. With this program written in Basic language, a random-number generator is converted to provide a Gaussian probability distribution, and then plotted. Statements 350 to 400 of the program make the actual conversion.

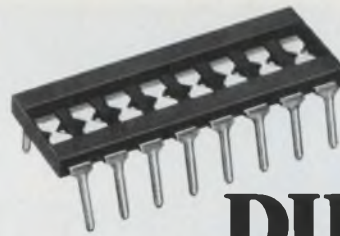

"AMP DIP shunts make manual programming easy at low cost."

You can program right on the board without special tooling. With the standard version, you just cut the conductive straps or leave them intact to achieve open or closed circuitry. With the more versatile insulation displacement package, you make connections by inserting #27 magnet wire in the displacement slots.

Either way, you achieve reliable programming easily and inexpensively. And if a change is necessary, both can be quickly altered or replaced.

Today AMP DIP shunts are used extensively in instrumentation, computers, industrial controls, almost anywhere simple programming is desired. And wherever you use them AMP technical support will be there, too. It's an integral part of the way we do business, and has been for over 35 years.

For more information on AMP DIP shunts, just call Customer Service at (717) 564-0100.

Or write AMP Incorporated, Harrisburg, PA 17105.

AMP is a trademark of AMP Incorporated.

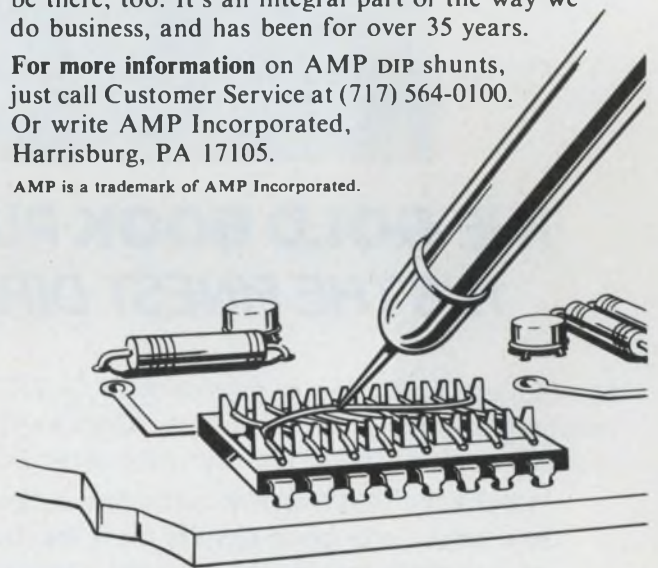

AMP has a better way in DIP switching.

AMP

INCORPORATED

CIRCLE NUMBER 54



THE GOLD BOOK PUTS IT ALL TOGETHER... IT'S THE FINEST DIRECTORY IN THE FIELD

Mr. Robert T. Dudley is president of ELECTROL, INC., York, Pennsylvania, manufacturer of adjustable speed drive controllers, "Command Lock" SCR controls and "Command-Tach" digital readout controls. His directory? *Electronic Design's* GOLD BOOK.

"I think the GOLD BOOK is the finest directory in the field. We use it constantly. We've had especially good results from the Trade Names section. The GOLD BOOK gives an excellent feel for the sources available for each particular product. It's a vast well of information for electronics engineers and designers. The GOLD BOOK does a better job of putting directory information together than anyone in the industry."

The GOLD BOOK is working for advertisers because it's working for 95,000 engineers, engineering managers and specifiers — like Mr. Dudley — throughout the U.S. and overseas. Is your company represented in its pages?

IF IT'S ELECTRONIC...IT'S IN THE GOLD BOOK!

Ideas for design

write a program that produces a Gaussian distribution.

According to the Central-limit Theorem, the sum of a large number of independent random variables about a mean value approaches a Gaussian distribution regardless of the distribution of the individual variables. Accordingly,

$$X = \frac{1}{A} \sum_{i=1}^{i=A} (R_i),$$

$$\bar{X} = \bar{R}$$

(continued on page 76)

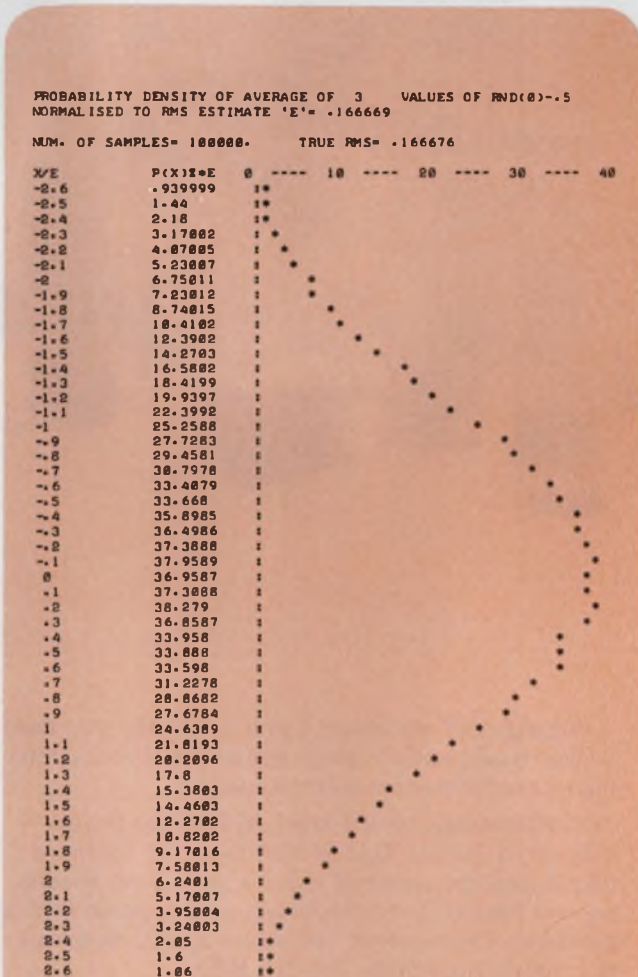

2. Application of the Central-limit theory to a random-number generator by the conversion program, results in a bell-shaped Gaussian curve. Three random numbers are summed (A = 3), averaged, and the result printed out. In all, 10⁵ random numbers are used to generate the curve.



"We save on both installation and maintenance with AMP LED switches."

You can't beat them for printed circuit board fault indication or field service. You get continual and immediate visible indication of switch and circuit operation. As a result, diagnosis is simpler and both servicing and downtime are reduced. Installation is easy, too, because of the compact package design.

You can count on excellent reliability with AMP LED DIP switches. They have a cycle life of at least 7,000 cycles per pole, the ability to withstand temperatures ranging from -73.3°C to 135°C, and the ruggedness to take vibration, shock, and environmental extremes. Standard or momentary actuators are available. They can be used in a broad range of applications including computers, instrumentation, controls, communications . . . in fact, anywhere operator feedback display is desired.



And don't forget AMP technical service. You get it whenever you need it, from product conception through application.

For more information on the full line, just call Customer Service at (717) 564-0100.

Or write
AMP Incorporated,
Harrisburg, PA 17105.

AMP is a trademark of AMP Incorporated

AMP has a better way in DIP switching.

AMP

INCORPORATED

CIRCLE NUMBER 54

**Need miniature audio transformers
in most popular configurations
in any of three sizes?**

TRW/UTC has a stock answer.

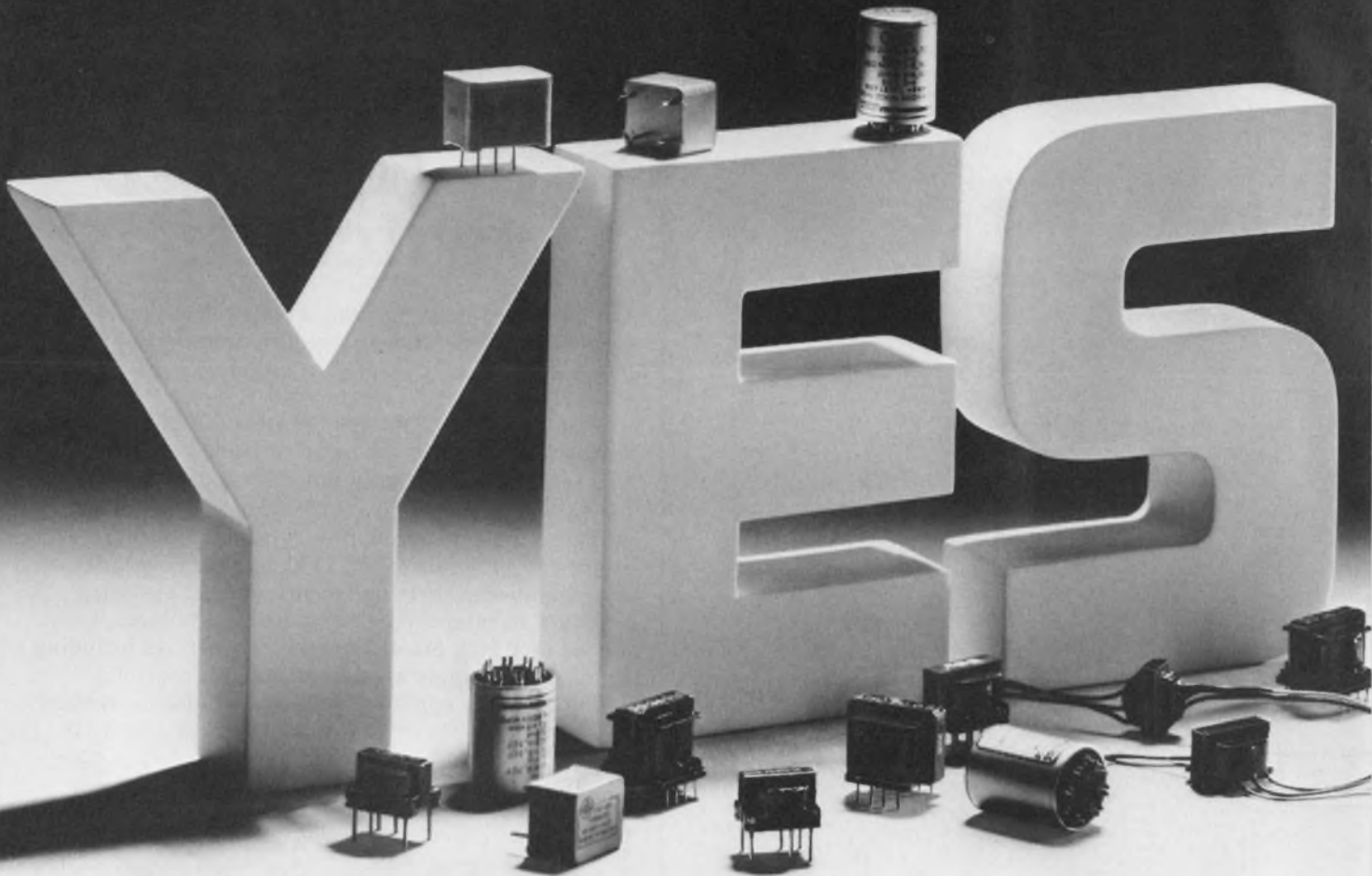

TRW/UTC has a line of miniature industrial audio or signal transformers that come in three wattage ratings. And, they're available in four different configurations.

To find the unit you need, check the table below.

	Ouncer	Subouncer	Sub-Subouncer
P.C. Board Mounting	PC-O Series	PC-SO Series	PC-SSO Series
Flexible Leads		SO Series	SSO Series
Molded		SO#P Series	SSO#P Series
Alarm Housing	O Series		

Because our miniatures come in 4 styles, you have a choice. Now you can design our unit into your circuit in the manner most convenient for you.

For immediate off-the-shelf delivery check your authorized TRW/UTC local distributor. Or for more information on standards that are something special, contact TRW/UTC Transformers, an Operation of TRW Electronic Components, 150 Varick Street, New York, N.Y. 10013. Area Code: 212-255-3500.

CIRCLE NUMBER 58

TRW UTC TRANSFORMERS

ANOTHER PRODUCT OF A COMPANY CALLED TRW

Ideas for design

(continued from page 117)

and

$$X_{\text{rms}} = \frac{R_{\text{rms}}}{\sqrt{A}}$$

where

- X = One value of generated Gaussian noise,
- R_i = One value of original noise,
- A = Number of summed R values,
- \bar{X} = Mean value of generated noise,
- \bar{R} = Mean value of original noise,
- X_{rms} = Rms value of generated noise about mean,
- R_{rms} = Rms value of original noise about mean.

The Basic program (Fig. 1) demonstrates the theorem, (statements 350 to 400). In the program, R = RND (Ø)-0.5 with the Mean = 0 and the values of A range from A = 1 to A = 10. A printout for a value

X/E	(P(X)-P(X))%CALC	TRUE RMS
-2.6	-.418645	1
-2.5	-.31323	1
-2.4	-5.98993E-02	1
-2.3	.336826	1
-2.2	.522037	1
-2.1	.831114	1
-2	1.35039	1
-1.9	.667849	1
-1.8	.84443	1
-1.7	1.00458	1
-1.6	1.29748	1
-1.5	1.31789	1
-1.4	1.60694	1
-1.3	1.2826	1
-1.2	.520714	1
-1.1	-.613853	1
-1	1.06173	1
-.9	1.12007	1
-.8	.489349	1
-.7	-.402626	1
-.6	8.63419E-02	1
-.5	-1.53752	1
-.4	-.927322	1
-.3	-1.63801	1
-.2	-1.714	1
-.1	-1.73479	1
0	-2.93401	1
.1	-2.38496	1
.2	-.823769	1
.3	-1.27872	1
.4	-2.86782	1
.5	-1.31746	1
.6	-.27539	1
.7	3.01743E-03	1
.8	-1.08578	1
.9	1.07008	1
1	.441803	1
1.1	3.39241E-02	1
1.2	.79068	1
1.3	.662674	1
1.4	.406969	1
1.5	1.50791	1
1.6	1.17747	1
1.7	1.41461	1
1.8	1.27446	1
1.9	1.01787	1
2	.840355	1
2.1	.77111	1
2.2	.48203	1
2.3	-.406831	1
2.4	-.189908	1
2.5	-1.153224	1
2.6	-.29864	1

3. The deviation of Fig. 2 from a calculated Normal (Gaussian) distribution shows only small errors. Summing more than three numbers gives only slightly better accuracy.

"It's a snap to switch AMP side-actuated types, even in a stack."

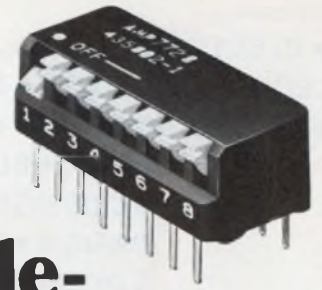

You can program a card without removing it from the cage with these right-angle DIP switches. They can be actuated easily from the edge of the board. And they can be commoned to provide multi-pole configurations.

They also have the inherent advantages of DIP switches such as: Very low profile for complete compatibility with other packaging components. Fully sealed base for protection and assurance of excellent electrical and mechanical performance. And more—including AMP technical aid. We're ready to work with you because we believe you're entitled to it. And the sooner the better. Because that's when we can help the most.

AMP right-angle DIP switches come in the industry's widest range of sizes. They are particularly applicable in computer and instrument card cages, avionics systems and communications equipment.

For more information on them, just call Customer Service at (717) 564-0100. Or write AMP Incorporated, Harrisburg, PA 17105.

AMP is a trademark of AMP Incorporated.

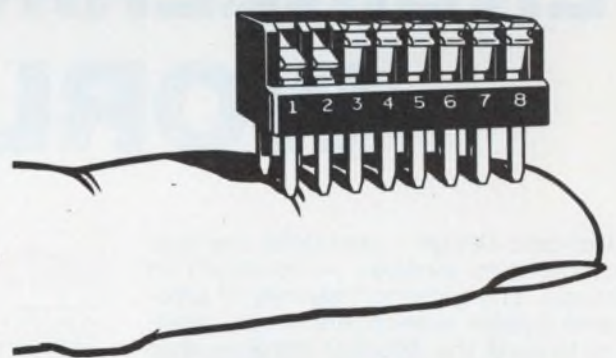

AMP has a better way in DIP switching.

AMP
INCORPORATED
CIRCLE NUMBER 54



FOR ENGINEERS & ENGINEERING MANAGERS WORLDWIDE

Electronic Design's popularity overseas continues to increase — especially in Europe. The growing fraternity of *Electronic Design* subscribers is now pushing toward the 100,000 mark — and more than 16,000 are located *outside* the U.S.A. In fact, we now have more OEM engineering managers and engineer subscribers in Europe than any



other U.S. journal. Engineers throughout the world look to the U.S. for leadership, and they turn to *Electronic Design* for the same reasons you do. If your company sells in Europe, or is thinking of starting up, pass the word to your marketing people. Maybe they aren't aware of our power, influence and authority among key specifiers overseas.

BEST READ ELECTRONICS PUBLICATION IN THE WORLD

Ideas for design

of A as low as $A = 3$ provides a very close approximation to the familiar bell-shaped Gaussian distribution with very little computation time (Fig. 2).

The program prints the following data:

(1) rms estimate (E) = $\frac{0.28868}{\sqrt{A}}$

(2) Number of samples of X taken (100,000)

(3) $X_{rms} = \text{True rms}$

(4) Normalized tabulation and plot of X/E versus the probability density [$P(X)$ in % * E]

(5) Measured minus calculated Normal distribution.

Fig. 3 is a plot of deviation of Fig. 2's generated distribution from the true Normal distribution, also calculated in the program. The value of A depends on the degree of accuracy required. But the larger A is, the closer the distribution is to Gaussian. The distribution of the input samples (R_i) will affect the value of A required to give an acceptable accuracy.

The Hewlett-Packard Basic random number generator (RND (\emptyset)) has an equal probability distribution between 0 and 1, which can be plotted by the program of Fig. 1, by setting A equal to 1.

Colin Gyles, Project Engineer, Canadian Marconi Co., Montreal, P.Q. Canada.

CIRCLE NO. 313

IFD Winner of December 6, 1977

K. C. Herrick, Chief Engineer, ESI Electronics Corp., 1258 Fitzgerald Ave., San Francisco, CA 94124. His idea "Electronic Car-alternator Regulator Built with Low-cost Discrete Components" has been voted the Most Valuable of Issue Award.

Vote for the Best Idea in this issue by circling the number for your selection on the Reader Service Card at the back of this issue.

SEND US YOUR IDEAS FOR DESIGN. You may win a grand total of \$1050 (cash)! Here's how. Submit your IFD describing a new and important circuit or design technique, the clever use of a new component or test equipment, packaging tips, cost-saving ideas to our Ideas for Design editor. Ideas can only be considered for publication if they are submitted exclusively to ELECTRONIC DESIGN. You will receive \$20 for each published idea, \$30 more if it is voted best of issue by our readers. The best-of-issue winners become eligible for the Idea of the Year award of \$1000.

ELECTRONIC DESIGN cannot assume responsibility for circuits shown nor represent freedom from patent infringement.

ELECTRONIC DESIGN 8, April 12, 1978

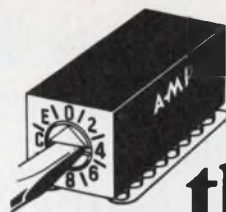

"You can actuate these AMP PCB switches 4 different ways!"

By screwdriver, lever, extended D shaft actuator or by adjusting plug. Whichever fits your application best.

Each of these economical, low profile PCB switches has 4 Form "C" switches operated by encoded cams. All the cams are bidirectional and have positive detent settings. And all the contacts are gold plated phosphor bronze.

Each switch is available in 2, 8, 10, and 16 position configurations. Plus special versions, made to your order. Input/Output pins are spaced on .100" X .300" centers.

Whichever version you choose, you can count on AMP technical service and support. And you can take advantage of it even while your product is still in the planning stages. We believe in that kind of early involvement. Because it means better results for you.

For more information on these preprogrammed PCB switches, call Customer Service at (717) 564-0100. Or write AMP Incorporated, Harrisburg, PA 17105.

AMP is a trademark of AMP Incorporated.

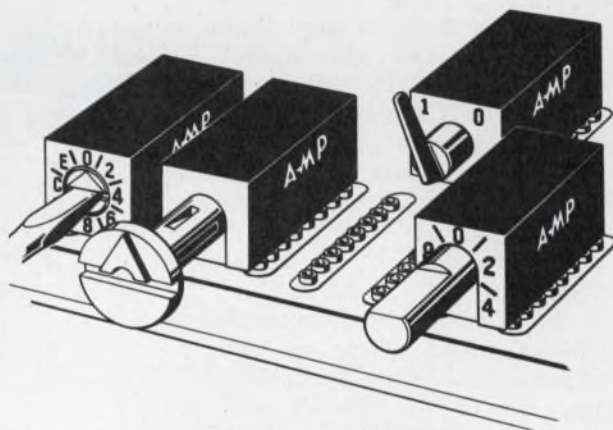

AMP has a better way in DIP switching.

AMP
INCORPORATED
CIRCLE NUMBER 54

LSI codec leads to single-line PCM

An LSI single-chip coder-decoder is inexpensive enough to allow pulse-code modulation of one telephone line at a time rather than in the groups of 24 to 30 currently handled.

The LSI codec, developed by the British Post Office at its Martlesham Heath Research Center, performs a/d conversion by first translating to a delta-sigma code, then translating to PCM at 8-k samples/s and 8 bits/sample. Not only is this intermediate modulation compatible with the standard 30-channel 2048-kbit/s data comm system, but the chip also eliminates precision analog components and promises low cost in large

quantities.

Conversion to delta-sigma code is done by sampling the analog signal at 2048 kHz and generating a 1-bit code for each sample. Logic then converts the signal to PCM. A complementary technique performs the reverse d/a conversion.

Prototype chips have been made at Martlesham and quantity orders have been placed with Ferranti and GIM.

The first application will be in the Post Office's own digital-switching PABX slated for the 1980s. One possibility, connecting individual customers to local exchanges, could lead to digital switching at the local level.

Four-scan system finds bottle contaminations

An automatic bottle inspector checks empty bottles on an assembly line for contamination with the help of four separate optical-detection channels. The Opti-Scan III by Barry-Wehmiller Ltd. of Bolton, England, has a high-speed, rotating-prism optical scanner that looks down bottle necks and inspects bottle bases as they pass over a light source.

The scanner image is projected onto photocells, whose signals are amplified and analyzed to detect dirty or contaminated bottles. These are automatically rejected from the line. The average rate of false rejects is low—less than two per 1000 inspected.

The system achieves its accuracy by scanning three overlapping sections—the central, intermediate and peripheral zones of the bottle base—to detect small particles or objects. A fourth test, over-all light transmission, indicates any gross contamination, such as paint covering the entire base.

The first scan is made before the bottle reaches the optical center of the machine so that central or concentric objects can be detected. Once the bottle is centered, second and third scans



occur, while the over-all light reading is taken simultaneously by separate photocells.

Automatic color-compensating circuits adjust the scan outputs for the color and density of each bottle.

Test results show that opaque objects 3 mm in diameter will be detected with better than 95% reliability, while objects 4.5 mm and larger will be found 99% of the time.

Engine particles gauged by laser system

A laser instrumentation system can gather information for the first time on the velocity and turbulence of fuel/air particles in a car-engine cylinder before combustion.

Designed at the Research Establishment in Harwell, England, the device is essentially a laser anemometer that looks into the cylinder via a small glass window. Interference fringes appear in the cylinder. Light scattered by the mixture particles, which range from 1 to 100 μm , is gathered by a photomultiplier tube and amplified for analysis. How the information gleaned related to the effectiveness of combustion is being studied.

Measurements aren't thrown off by dirt from the combustion process entering the path of the beam, because the laser system measures frequency and not amplitude. Work is now planned on a much more sensitive system that will be able to discriminate between individual chemical elements in the fuel/air mixture.

Navigators sink or sail with computer system

A computer-controlled simulator used for training ship navigators has recently gone into operation at a nautical training college in Kalmar, East Sweden.

Developed by Norcontrol of Norway, the new system permits an instructor to create any traffic situation up to four ships in any given area of water. The instructor can use the simulated movements of an additional 40 ships in order to create innumerable traffic situations.

With the computer technology incorporated in the simulator, and complete, standardized program can be built and used at several nautical training colleges. This paves the way for establishing a joint Nordic training system for navigators.

Norcontrol has also developed a method for the exact reproduction of charts on the simulator's radar screen.

abbott

POWER SUPPLIES

Come to the specialist.

We started out pretty small back in '61. But we were big on product quality and reliability. Had to be. Uncle Sam was our only customer. Over the years we stuck with our own technology. We grew. Became specialists. And we kept on improving our power supplies.

It all paid off. Just look at Abbott today.



Militarized Power Supplies — Our early bread-and-butter line has grown to over 1500 versions. Some we stock. Yet we're equipped to provide fast delivery on any number of high efficiency, hermetically sealed, single or dual output power supplies and switcher modules. That includes our popular 60 and 400Hz and DC versions with outputs from 3VDC to 740VDC, 1 to 250 Watts. And prices go as low as \$174 for 2-4 units.

For Catalog Circle Card Number 90



Industrial Power Supplies — Ours isn't a big line yet — only 279 models. But you won't find a better quality of OEM power modules anywhere. (It's just our hi-rel way of thinking.) We provide covered/open frame, AC to DC single, dual and triple output versions, with outputs of 5 to 36VDC, 0.5 to 320 Watts. Plus DC to AC converters with 50 to 60Hz outputs. Competitively priced? You bet. As low as \$35 for up to 24 units.

For Catalog Circle Card Number 91

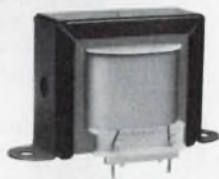

Transformers — For the do-it-yourself power supply designer who wants our kind of quality for his own military, industrial and pcb application. If you're one of them, we offer over 800 standard transformers, with instructions on how to specify for your custom units. Included are 60 and 400Hz, single phase input versions. Prices start as low as \$5.10 for up to 9 pieces.

For Catalog Circle Card Number 92

See Power Supply Section 4000, and Transformer Section 5600, Vol. 2, of your EEM catalog; or Power Supply Section 4500, and Transformer Section 0400, Vol. 2, of your GOLD BOOK for complete information on Abbott products.

abbott transistor

LABORATORIES, INCORPORATED

General Offices
5200 W. Jefferson Blvd., Los Angeles 90016
(213) 936-8185 Telex: 69-1398

Eastern Office
1224 Anderson Ave., Fort Lee, N.J. 07024
(201) 224-6900 Telex: 13-5332



Electronic Design 1977 Annual Index of Articles

Circuits & Circuit Theory

- Active low-pass filters. . .ART, ED 18, p. 144
- Active zener circuit provides clipping adjustable down to almost zero. . .IFD, ED 9, p. 118
- Analyze I²L accurately. . .ART, ED 13, p. 90
- Approximate the tangent function with a multifunction converter and op amp . . .IFD, ED 4, p. 136
- Bias-current cancellation easily implemented with matched op amps. . .IFD, ED 13, p. 108
- Build a high-frequency phase-locked loop with common IC components. . .IFD, ED 16, p. 108
- Build high-Q LC-tuned circuits. . .ART, ED 16, p. 90
- Circuit detects and remembers bipolar analog signals. . .IFD, ED 21, p. 208
- Circuit generates almost any sequence of fixed-width timing pulses. . .IFD, ED 23, p. 104
- Circuit provides a Gaussian response with a multifunction converter and op amp . . .IFD, ED 6, p. 104
- Circuit that latches/unlatches magnetic devices uses almost zero standby current. . .IFD, ED 6, p. 106
- Codec converts with ladder of Cs, not Rs . . .NEWS, ED 21, p. 19
- Complementary amplifier improved by double-ended symmetrical configuration. . .IFD, ED 10, p. 92
- Control the ac input to a power supply and reduce load and line effects by 40 dB . . .IFD, ED 11, p. 212
- Control 10 to 10,000 Hz digitally and get complementary output frequencies . . .IFD, ED 2, p. 90
- Convert unipolar CMOS signals into analog bipolar outputs. . .IFD, ED 22, p. 88
- Dc current-source design equations . . .ART, ED 22, p. 82
- Demand power supply draws low standby current. . .IFD, ED 19, p. 118
- Digitally programmable clock source built with a d/a and v/f converter. . .IFD, ED 12, p. 118
- Driving inductive loads. . .ART, ED 4, p. 86

Department Key

ART	Technical Article
IFD	Ideas for Design
NEWS	News
PF	Product Feature
SR	Special Report

- Equations to parallel transistors. . .ART, ED 4, p. 94
- Float your input amplifier. . .ART, ED 4, p. 100
- Flyback-inverter efficiency increases when the transformer is loaded properly . . .IFD, ED 22, p. 92
- FOCUS on multiple-output dc supplies . . .SR, ED 20, p. 58
- Generate nonlinear sweep functions across a capacitor with a feedback circuit. . .IFD, ED 8, p. 144
- Hybrid amplifiers deliver premium specs at low cost. . .PF, ED 12, p. 125
- Lock onto frequency. . .ART, ED 13, p. 84
- Low-cost integrator multiplies 555 timer's delay range 100 times. . .IFD, ED 9, p. 120
- Op amps jump ahead with less drift and more drive. . .PF, ED 11, p. 227
- Output from compression amplifier is constant over an input range of 50 dB. . .IFD, ED 3, p. 74
- PIN-diode attenuator. . .ART, ED 7, p. 100
- Precision peak-to-peak ac-dc converter built with single-supply op-amp circuit . . .IFD, ED 24, p. 159
- Programmable unijunction delay circuit features high noise immunity. . .IFD, ED 13, p. 106
- Pulse-width-modulated switcher. . .ART, ED 8, p. 110
- Restore dc to your filtered channel. . .ART, ED 11, p. 202
- Slew rate important for audio amps. . .ART, ED 11, p. 172

- Solid-state-relay applications. . .ART, ED 22, p. 68
- Speed up PLLs. . .ART, ED 24, p. 124
- Square-to-triangle-wave converter provides constant amplitude, rapid response. . .IFD, ED 24, p. 160
- Upper and lower thresholds can be set independently in latching-comparator circuit. . .IFD, ED 26, p. 176
- Variable-delay circuit built with multi-vibrators preserves pulse width of the input signal. . .IFD, ED 16, p. 110
- Voltage references determine accuracy . . .ART, ED 16, p. 84
- Wide-frequency-range clock source needs few discrete components. . .IFD, ED 9, p. 116
- 555-timer circuit generates ultra-low-frequency signals. . .IFD, ED 14, p. 90

Communications, Microwaves & Lasers

- Analog-to-digital switch is on in military, civilian communications. . .SR, ED 1, p. 54
- Business to test satellite communications . . .NEWS, ED 25, p. 21
- California may get its very own satellite . . .NEWS, ED 20, p. 24
- Class E can boost the efficiency. . .ART, ED 20, p. 96
- Consider pulse-width modulation for transmitting data by cable. . .IFD, ED 8, p. 146
- Constant-bandwidth PLL tone decoder accepts wide range of input voltages. . .IFD, ED 23, p. 106
- Data communications. . .SR, ED 18, p. 86
- Digital radio affected by lack of standards . . .NEWS, ED 3, p. 14
- Encoding/decoding circuit handles audio signals of up to 3.3 kHz. . .PF, ED 5, p. 83
- FCC to select a standard for stereo broadcasting on AM. . .NEWS, ED 11, p. 28
- Fiber-optic cables tough enough for heavy sea use. . .NEWS, ED 22, p. 19

Fiber-optic links go into telephone nets . . . NEWS, ED 11, p. 21

Fiber-optics systems are few, but watch out for the explosion. . . NEWS, ED 15, p. 26

High-energy electron beam powers 100-kW laser. . . NEWS, ED 8, p. 25

High-frequency synthesizer. . . ART, ED 4, p. 120

International standards set for fiber optics . . . NEWS, ED 3, p. 14

Jitter and drift cut in Trapatt oscillator . . . NEWS, ED 10, p. 22

Laser modulator requires less power . . . NEWS, ED 24, p. 22

Laser scanner finds textile flaws. . . NEWS, ED 17, p. 38

Laser system scribes—also cuts, drills and welds. . . PF, ED 10, p. 126

Linear/loop antenna may resolve Quad-vs-Yagi controversy. . . SR, ED 8, p. 64

Low-noise vhf synthesizer is small and inexpensive. . . PF, ED 6, p. 114

Matched filters boost receiver gain. . . ART, ED 11, p. 162

Million-hour life seen for GaAlAs lasers . . . NEWS, ED 16, p. 26

Modern media. . . SR, ED 18, p. 98

Nuclear pumping may put gas lasers in space. . . NEWS, ED 18, p. 20

Optical-fiber transmission links. . . ART, ED 23, p. 64

Perform calculations or tell time—on the phone. . . NEWS, ED 14, p. 22

Put the resolution where needed in a digitally controlled tuning system. . . IFD, ED 25, p. 98

Radio. . . SR, ED 18, p. 58

Radio receiver reaches 670 GHz with 'quasioptics' and new mixer mount . . . NEWS, ED 23, p. 26

Real-time digital audio processor picks out distorted conversations. . . NEWS, ED 17, p. 34

Recorded messages to be stored in bubble memory. . . NEWS, ED 5, p. 18

SSB and vhf-FM radiotelephones highlighted at National Boat Show. . . NEWS, ED 3, p. 22

Schottky diode mixer enables imaging system to operate at 90 GHz. . . NEWS, ED 2, p. 30

Small PBX system has 'large' capabilities . . . NEWS, ED 4, p. 21

Telephone. . . SR, ED 18, p. 43

Television. . . SR, ED 18, p. 70

Tiny companding a/d crams 72 dB of input into 8 bits. . . PF, ED 9, p. 128

UV excitation doubles efficiency of CO laser. . . NEWS, ED 25, p. 22

X-band radar receiver has everything but bulk. . . NEWS, ED 3, p. 13

Yak it up long-distance—but watch the charges. . . NEWS, ED 17, p. 19

60-MHz power oscillator generates a low-noise output. . . IFD, ED 10, p. 90

Components

Adjust ferrite-core constants. . . ART, ED 24, p. 154

Subject Listing

Circuits & Circuit Theory	Industrial Electronics
Communications, Microwaves & Lasers	Management
Components	Materials & Packaging
Computers & Data Processing	Medical Electronics
Consumer Electronics	Microprocessors
Displays & Electro-Optics	Military & Aerospace
General Industry	Semiconductors
	Test & Measuring

Avoid relay-specification pitfalls. . . ART, ED 6, p. 78

Bypass filters extend. . . ART, ED 15, p. 78

Consider polypropylene capacitors. . . ART, ED 20, p. 76

Design power inductors step by step . . . ART, ED 26, p. 148

FOCUS on miniature switches. . . SR, ED 6, p. 66

Graph provides easy solution for choosing a preferred-number sequence. . . IFD, ED 22, p. 90

Heat switches the PTC thermistor. . . ART, ED 23, p. 76

High-voltage resistor. . . ART, ED 20, p. 84

Metal-film 2% 1/4-W sized resistors cover 0 to 22 M Ω and handle 350 V to 1/2 W . . . PF, ED 14, p. 99

Optimize circuit overload protection . . . ART, ED 22, p. 76

PCB dielectric replaced by a safer fluid . . . NEWS, ED 5, p. 18

Revisiting the cross-field inductor. . . ART, ED 6, p. 82

SAW oscillator takes strain by working as a pressure sensor. . . NEWS, ED 25, p. 38

Selecting capacitors properly. . . ART, ED 13, p. 66

Simple solid-state relay circuit can be built with few components. . . IFD, ED 2, p. 96

Small low-cost solid-state relays handle the 5-to-40-A load range. . . PF, ED 11, p. 252

Thin-film SAW units are very temperature-stable. . . NEWS, ED 1, p. 27

Computers & Data Processing

A/d converter delivers 8-bit words at 20-MHz data rates. . . PF, ED 25, p. 105

Bell modems face redesign to meet FCC demands. . . NEWS, ED 24, p. 21

Bit-oriented protocols plus standard interfaces ease data communication . . . SR, ED 12, p. 36

Business computer has a small price tag . . . NEWS, ED 1, p. 28

Chips replace software in data-comm systems. . . NEWS, ED 9, p. 27

Charge-coupled approach leads to new LSI digital logic devices. . . NEWS, ED 3, p. 20

Chip power reduced by CAD programs . . . NEWS, ED 15, p. 22

Clipped pin protects software from prying eyes. . . NEWS, ED 20, p. 23

Combination circuit reduces part count with RAM and I/O on same chip. . . PF, ED 13, p. 134

Compute coupled-microstrip line. . . ART, ED 1, p. 116

Computer-aided design beats trial-and-error—just find the software. . . SR, ED 12, p. 44

Computer-graphic photo montage simplifies land-use projects. . . NEWS, ED 17, p. 32

Control up to four drives with processor-based system. . . PF, ED 25, p. 111

Cut your processor's computation time . . . ART, ED 17, p. 82

Digital process monitor uses PROM for scaling. . . PF, ED 24, p. 175

Digital tape recording is denser, but standardization isn't standard. . . NEWS, ED 21, p. 28

Direct addressing way up with 32-bit computer. . . NEWS, ED 24, p. 22

Distributed processing spreads computer intelligence around. . . NEWS, ED 19, p. 38

Double-buffer characteristic of a UART gives speed without overrun errors . . . IFD, ED 26, p. 178

Double memory catches hidden logic glitches. . . NEWS, ED 23, p. 21

Dynamic memories offer advantages . . . ART, ED 14, p. 66

Exchange data between digital systems . . . ART, ED 9, p. 96

Faster modems and terminals spur data communications at 1200 bps. . . NEWS, ED 20, p. 28

Firmware, software package shapes distributed systems network. . . PF, ED 23, p. 124

Floppy-disc drives come in compact packages. . . PF, ED 15, p. 115

FOCUS on cassette and cartridge recorders. . . SR, ED 12, p. 66

FOCUS on floppy-disc drives. . . SR, ED 21, p. 196

FOCUS on semiconductor RAMs. . . SR, ED 17, p. 56

Four-phase logic is practical. . . ART, ED 26, p. 160

ANNUAL INDEX

- High density tape head reads data at 240 Mbit/s. .NEWS, ED 17, p. 20
- Home computer spells out errors in plain English. .NEWS, ED 17, p. 20
- Industry's first 18-bit modular DAC fits in palm-sized case. .PF, ED 6, p. 113
- Intelligent memory holds the key to a limitless array of computers. .NEWS, ED 16, p. 30
- Interface circuit teams cassette recorder with a CRT to work as a TTY/paper-tape unit. .IFD, ED 12, p. 120
- Kenneth Iverson: From a symbolic notation to A Programming Language. .SR, ED 12, p. 52
- Jumbo serial memories now off the shelf. .NEWS, ED 8, p. 25
- Keyboard for 64-key ASCII code features very low power consumption. .IFD, ED 1, p. 132
- Largest bubble chip developed by Rockwell. .NEWS, ED 13, p. 18
- Logarithmic a/d delivers like a 23-bit unit. .NEWS, ED 22, p. 20
- Logic interfacing circuit translates many levels to TTL regardless of polarity. .IFD, ED 17, p. 106
- Long shift registers can be built with RAMs. .IFD, ED 1, p. 128
- Lowest-cost 16-bit mini leads computer-kit line. .NEWS, ED 14, p. 21
- Mini systems group upgraded by Honeywell. .NEWS, ED 3, p. 13
- Minicomputers are banding together to replace central processors. .SR, ED 1, p. 46
- Model RAMs automatically. .ART, ED 17, p. 72
- Modern data acquisition is complex. .ART, ED 22, p. 60
- Multichannel 12-bit DASs packed into tiny plug-ins. .PF, ED 22, p. 114
- Multilingual teleprinter types in either direction. .NEWS, ED 11, p. 40
- NDRO core memory protects data from noise. .NEWS, ED 4, p. 22
- Novel rotary printer prints 2200 characters/s. .NEWS, ED 7, p. 19
- Obtain a compressed counting range with a variable-modulus counter. .IFD, ED 14, p. 88
- Optical recorder employs new storage medium. .NEWS, ED 13, p. 18
- Optimize transducer/computer interfaces. .ART, ED 11, p. 178
- PROM programmer has slave unit capability. .PF, ED 19, p. 148
- PROM programmers have grown—some have both brains and 'personality'. .SR, ED 12, p. 58
- Peripheral distributes computer power with cable. .NEWS, ED 20, p. 23
- Power-off switch saves watts in new PROM. .NEWS, ED 13, p. 18
- Power switch ROMs and PROMs quickly. .ART, ED 9, p. 102
- Powerful calculators for the blind. .ART, ED 5, p. 54
- Predict a 4-k RAM's average I_{DD} . .ART, ED 17, p. 78
- Predict system dependability. .ART, ED 19, p. 100
- Printer-calculator combo plots graphs, writes words. .NEWS, ED 12, p. 21
- Programmable gate arrays add flexibility, cut complexity. .PF, ED 2, p. 101
- Programming controller for the 2708 EPROM copies data in-circuit. .IFD, ED 8, p. 148
- Provide a carriage-return delay for typewriter data terminals with hardware. .IFD, ED 20, p. 110
- Pulsing a PROM's supply voltage greatly reduces the energy used. .IFD, ED 16, p. 102
- Put all input a/d channels under DMA. .ART, ED 1, p. 100
- Real-time systems often use interrupts. .ART, ED 10, p. 80
- Recognize upper-case letters only with a simple two-gate circuit. .IFD, ED 15, p. 106
- Revised data-interface standards. .ART, ED 18, p. 138
- Rugged minicomputer is conduction-cooled. .NEWS, ED 12, p. 22
- Scientific calculators offer more computing power—and cost less. .NEWS, ED 5, p. 20
- Select a character/function decoder. .ART, ED 14, p. 80
- Shifting control to firmware speeds computer operations. .NEWS, ED 23, p. 28
- Simplify analog/computer interfacing. .ART, ED 17, p. 92
- Simulated operations help oil tanker officers. .NEWS, ED 6, p. 21
- Single-board minis deliver maxi performance at micro \$. .PF, ED 11, p. 234
- Snare those elusive aliasing errors. .ART, ED 11, p. 186
- Software distribution is a problem in personal computing—with solutions. .NEWS, ED 21, p. 34
- Speed up digital processors. .ART, ED 19, p. 78
- Standard to improve computer security. .NEWS, ED 2, p. 15
- Standardized interfaces isolate. .ART, ED 24, p. 114
- Standards for dynamic MOS RAMs. .ART, ED 17, p. 66
- Static or dynamic RAMs? Only the system can say for sure. .NEWS, ED 6, p. 51
- Superplotter draws dashed lines in four colors, doubles as printer with five type fonts. .PF, ED 7, p. 124
- Synchronous counter also shifts for serial/parallel conversions. .IFD, ED 19, p. 118
- TI data terminals contain bubble memory. .NEWS, ED 10, p. 22
- Talking and Braille calculators serve the blind—for a high price. .NEWS, ED 20, p. 32
- Tape transport is small, but its bit-storage capacity is big. .NEWS, ED 22, p. 28
- Thermal printer delivers full pages in less than 20 s. .PF, ED 22, p. 100
- Two-headed floppy accesses twice the data in half the time. .PF, ED 9, p. 146
- Two-speed s/d converter yields 20 bits from 1 box. .PF, ED 20, p. 115
- Versatile PROM programmer takes on all memories. .PF, ED 6, p. 120
- Voice recorder uses digital-data compression. .NEWS, ED 1, p. 27
- Wang small business computer line expanded. .NEWS, ED 7, p. 20
- 24-channel, 8-bit a/d comes in just two 32-pin DIPs. .PF, ED 7, p. 118
- 32 times the bit rate instead of 16 from a programmable baud generator. .IFD, ED 17, p. 104
- \$500 computer system talks over IEEE 488 bus. .NEWS, ED 11, p. 21

Consumer Electronics

- Audio compass tells you when you're out-of-line. .NEWS, ED 23, p. 22
- Be a gambler without losing—time, that is. .NEWS, ED 16, p. 25
- Bipolar processor in TV set leads to preprogrammed channel selection. .NEWS, ED 3, p. 24
- Calculators lose keys, batteries—and gain timer. .NEWS, ED 14, p. 21
- Chess and chance games win at electronics show. .NEWS, ED 4, p. 21
- Circular-polarized beams will clear up TV picture. .NEWS, ED 13, p. 17
- Digital-integrator for intrusion systems discriminates against false signals. .IFD, ED 5, p. 74
- Digital is still the way to go for consumer-electronics products. .SR, ED 1, p. 50
- Digital wristwatch contains a scientific calculator. .NEWS, ED 5, p. 17
- Display tells how far to drive—or walk. .NEWS, ED 15, p. 22
- Driving shocks electronically softened. .NEWS, ED 25, p. 22
- Electronic car-alternator regulator built with low-cost discrete components. .IFD, ED 25, p. 100
- Electronic dice game built with only analog circuits. .IFD, ED 15, p. 102
- Electronic regulator for car alternators switches on/off rapidly to maintain 14 V. .IFD, ED 15, p. 100
- Electronics in cars must be as reliable as in space. .NEWS, ED 25, p. 22
- Game timer generates coasting pulses positively clamped to prevent a glitch. .IFD, ED 25, p. 96
- HP wristwatch—first with timely calculations. .NEWS, ED 13, p. 17
- IR-activated headphone works without a cord. .NEWS, ED 3, p. 13
- Indoor FM antenna is tunable and 'electronically directable'. .NEWS, ED 23, p. 34
- LCD watches, calculators to run on 5-year cells. .SR, ED 18, p. 130
- Music played, recorded by electronic pianist. .NEWS, ED 15, p. 21
- Now you can watch two shows at once. .NEWS, ED 21, p. 20
- PLL IC for televisions eliminates H and V knobs. .NEWS, ED 23, p. 22
- Rf power alerts, control begins at home. .NEWS, ED 20, p. 23

Another Industry Breakthrough!



Introducing... The Harris HI-562 D/A Converter.

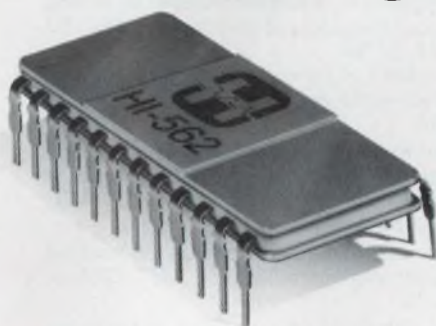

If you've been looking for the right D/A converter to match your brightest design ideas, you can stop looking... it's here... the new Harris HI-562.

The HI-562 is the first monolithic D/A to combine high speed performance and true 12-bit accuracy on the same chip—attained through the utilization of the most advanced laser resistor trimming techniques in the industry. Consider these features:

- Fast Settling: 200 ns to $\pm 1/2$ LSB
- Excellent Linearity: $\pm 1/4$ LSB
- Low Gain Drift: ± 2 ppm/ $^{\circ}$ C
- Fully monotonic over temperature

At only \$29 (100-up), the Harris HI-562 is the cost-effective answer to your most demanding data conversion

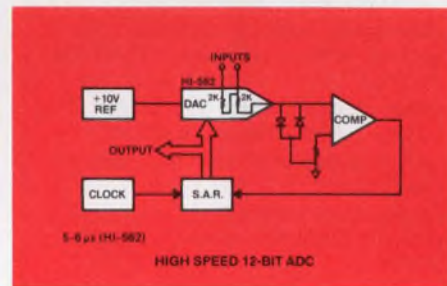
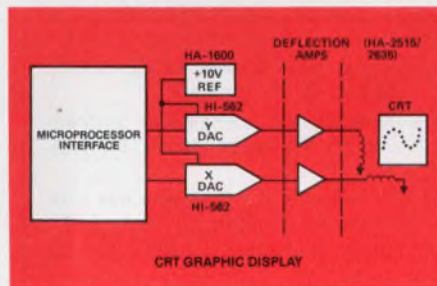

design problems. So if you are into A/D converters, CRT graphic displays, process control systems, precision instruments, data acquisition systems, communication terminals... to mention a few... the Harris HI-562 can provide you with the performance, economy, accuracy and design versatility you won't find in any other D/A converter.

Available in a 24-pin DIP, the 562 operates on +5V and -15V supply voltages and a +10V reference.

Check out this new dimension in data conversion. Contact your nearby Harris Semiconductor distributor for evaluation devices. For full details, call the Harris Hot Line, or write: Harris Semiconductor Products Division, P.O. Box 883, Melbourne, Florida 32901.

HARRIS HOT LINE!
1-800-528-6050, Ext. 455

Call toll-free for phone number of your nearby Harris sales office, authorized distributor or expedited literature service.

Harris Technology
...Your Competitive Edge



HARRIS
SEMICONDUCTOR
PRODUCTS DIVISION
A DIVISION OF HARRIS CORPORATION

ANNUAL INDEX

- Radar braking system, your car won't stop at every tree. . .NEWS, ED 23, p. 30
- 'Roots' of improving CBs can be traced to varied technologies. . .NEWS, ED 8, p. 32
- S/n up, phase distortion down in Hall playback. . .NEWS, ED 16, p. 25
- Schottky diodes rectify efficiently in a bicycle-lighting system. . .IFD, ED 14, p. 92
- Smoke detectors coming on strong—look for ICs. . .NEWS, ED 22, p. 24
- Speeders beware: The cops can fake you out. . .NEWS, ED 26, p. 19
- Stereo cartridge holds up to 1 Mbyte of data. . .NEWS, ED 10, p. 22
- Timer pulses coasting to a stop heighten electronic game realism. . .IFD, ED 5, p. 78
- Timing circuit burps battery to improve charging efficiency. . .IFD, ED 12, p. 116
- Ultrasonic system turns the lights on and off. . .NEWS, ED 2, p. 16
- Video games continue to sell big, but EMI/RFI proofing is a problem. . .NEWS, ED 9, p. 36
- Videocassette player handles 4-hour tapes. . .NEWS, ED 19, p. 22
- Warbling alarm generator with two op-amp oscillators. . .IFD, ED 7, p. 108
- Zinc-chlorine batteries being readied for cars. . .NEWS, ED 6, p. 22

Displays & Electro-Optics

- Add missing segments to 6 and 9 on standard seven-segment decoders. . .IFD, ED 19, p. 122
- Atomic structures are more precise in 3-D. . .NEWS, ED 3, p. 14
- Color monitors can be adjusted on sight. . .NEWS, ED 9, p. 28
- Convert seven-segment numerical code to decimal with simple gates. . .IFD, ED 4, p. 132
- Current limiters added to smallest LED lamps. . .NEWS, ED 16, p. 26
- Design your own data terminal. . .ART, ED 16, p. 56
- Diode-feedback comparator circuit regulates a LED's drive current. . .IFD, ED 6, p. 108
- Fiber-optic connector cuts interface losses. . .NEWS, ED 26, p. 20
- FOCUS on readouts. . .SR, ED 25, p. 56
- Graphics terminal plots, stretches, zooms & pans. . .PF, ED 14, p. 92
- Graphics unit drives four different X-Y displays. . .PF, ED 22, p. 99
- Implement a lab-scope data display with μ P software. . .IFD, ED 3, p. 68
- Interface slows visual-display data for driving data-recording peripherals. . .IFD, ED 19, p. 120
- Liquid-based solar cells: high efficiency, low cost. . .NEWS, ED 18, p. 20
- Liquid-crystal panels put car functions on display. . .NEWS, ED 9, p. 27
- Liquid crystals, lasers and μ P's reflected in tomorrow's displays. . .NEWS, ED 10, p. 42

- Low-cost electro-optical disc stores clear images. . .NEWS, ED 1, p. 28
- Narrow your choice of displays. . .ART, ED 25, p. 68
- Optical couplers isolate, control and monitor to allow 6-kV supply to float. . .IFD, ED 4, p. 134
- Ovshinsky strikes again: amorphous solar cells. . .NEWS, ED 16, p. 25
- Process makes optical strands long and strong. . .NEWS, ED 1, p. 27
- Solar-cell technology advances—but slowly. . .NEWS, ED 26, p. 24
- Solar energy may power rendezvous with comet. . .NEWS, ED 21, p. 20
- Sturdy electromagnetic element displays in color, saves power. . .NEWS, ED 25, p. 34
- TTL oscillator interfaces data for display by a television set. . .IFD, ED 5, p. 76
- Trace symbols on CRT screen without access to the Z axis. . .IFD, ED 4, p. 138
- Video terminal combines graphics, text processing. . .NEWS, ED 22, p. 20

General Industry

- As R&D spending goes, so goes our technology—down. . .NEWS, ED 24, p. 21
- Biggest windmill to generate 2.5 MW. . .NEWS, ED 16, p. 26
- Electric power may come from thermal noise. . .NEWS, ED 7, p. 20
- Engineers: prepare for a taxing time. . .NEWS, ED 6, p. 22
- From those who brought you Wescon—here's Midcon. . .NEWS, ED 9, p. 21
- Bill Hearn of Berkeley Laboratory wins annual 'Ideas for Design' award. . .IFD, ED 1, p. 130
- National group stumps for U.S. technology. . .NEWS, ED 22, p. 20
- New York's blackout: Too many questions, not enough answers. . .NEWS, ED 17, p. 28
- Technology: With society or against it? . . .NEWS, ED 25, p. 40
- Wage busting plagues engineers, but help may be on the way. . .NEWS, ED 4, p. 26
- Vladimir Zworykin the man who was sure TV would work. . .SR, ED 18, p. 112
- 1977 career and salary survey. . .SR, ED 16, p. 36

Industrial Electronics

- Alarm circuit guards a guarding-camera system. . .IFD, ED 9, p. 114
- Buffer circuit for line driver protects against shorts and ± 325 -V surges. . .IFD, ED 23, p. 102
- Build a versatile nonsequential controller that is faster than a microprocessor. . .IFD, ED 24, p. 164
- Computer locates objects on product line. . .NEWS, ED 23, p. 21
- Control the speed and phase of a dc motor by comparison against a control frequency. . .IFD, ED 17, p. 102
- DPM makers earn Underwriters' recognition. . .NEWS, ED 23, p. 21

- Drive servos with a switching amplifier. . .ART, ED 26, p. 142
- Expander matches ground-fault interrupt circuit to UL trip-time specifications. . .IFD, ED 3, p. 70
- Float charger independently recharges two lead-acid cells connected in series. . .IFD, ED 17, p. 108
- FOCUS on stepping motors. . .SR, ED 22, p. 48
- Iso/instrumentation amp even powers transducer. . .NEWS, ED 8, p. 26
- Keys to quality intercom design. . .ART, ED 11, p. 194
- Optocoupled line-receiver input discriminates against narrow noise pulses. . .IFD, ED 26, p. 174
- Phase-sequence detector built with a dual D-type flip-flop. . .IFD, ED 7, p. 106
- Process controls are evolving fast. . .ART, ED 24, p. 142
- Rf beam welds and cuts metals, ceramics and cements. . .NEWS, ED 8, p. 34
- Reduce ground-loop problems in safety-grounded instruments. . .IFD, ED 16, p. 106
- Remote-base biased SCR to make a simple HV logic translator. . .IFD, ED 11, p. 216
- Solid-state I/O relays control loads of up to 4 A. . .PF, ED 25, p. 120
- Storing energy for peak power is a job for 'super' batteries. . .NEWS, ED 6, p. 30
- Transformer completely isolates contact without a floating power source. . .IFD, ED 20, p. 106

Management

- Fred Bucy of TI speaks on managing innovation. . .ART, ED 19, p. 108
- Wilf Corrigan of Fairchild speaks on aiming your engineers at objectives. . .ART, ED 23, p. 94
- Carl Korn of Dynascan speaks on training real-world engineers. . .ART, ED 16, p. 94
- Stan Kukawka of Allen-Bradley speaks on getting the small-company spirit in a large engineering organization. . .ART, ED 8, p. 138
- Dick Lee of Siliconix speaks on making your engineers bigger. . .ART, ED 4, p. 126
- Dave Methvin of Computer Automation speaks on getting your engineers to do engineering. . .ART, ED 11, p. 206
- Mal Northrup of Rockwell speaks on building program managers. . .ART, ED 25, p. 90
- Eduard Pannenberg of Philips speaks on measuring engineers. . .ART, ED 15, p. 94
- Webb Scroggin of Dana Labs speaks on speeding from lab to marketplace. . .ART, ED 13, p. 96
- Jim Wolfe of Centralab speaks on decentralizing engineering. . .ART, ED 6, p. 98

Materials & Packaging

- Ceramics, ceramoplastics and glasses. . .ART, ED 8, p. 100

When RFI problems get sticky, try **stickn fingers**®

Attaches faster, shields better than anything else!

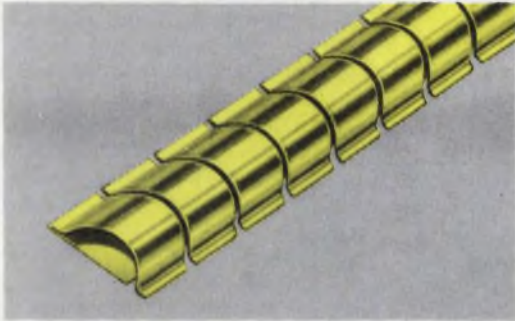

SERIES 97-500 The original Sticky Fingers with superior shielding effectiveness.

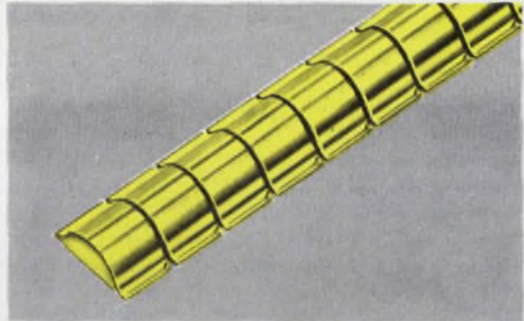

SERIES 97-520 A smaller size Sticky Fingers for high shielding effectiveness in less space.

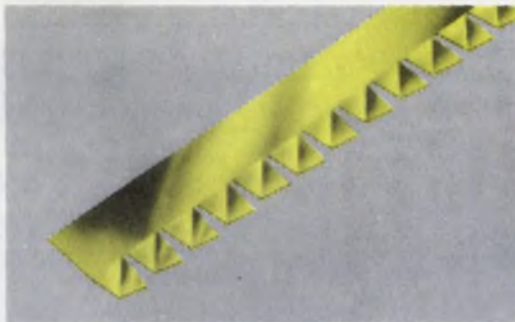

SERIES 97-555 New Single-Twist Series for use when space is at a premium. Measures a scant $\frac{3}{8}$ " wide.

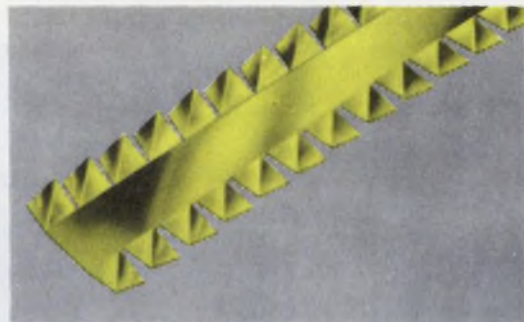

SERIES 97-560 New $\frac{1}{2}$ " wide Double-Twist Series, ideal for panel divider bar cabinets.

Now you can specify the exact type beryllium copper gasket that solves just about every RFI/EMI problem. Perfect for quick, simple installation; ideal for retro-fitting. Self-adhesive eliminates need for special tools or fasteners. Write for free samples and catalog.



INSTRUMENT SPECIALTIES COMPANY, Dept. ED-65

Little Falls, N.J. 07424

Phone—201-256-3500 • TWX—710-988-5732

ANNUAL INDEX

Current-carrying rods power backplane-less card assemblies. . .NEWS, ED 13, p. 30

Design EMI shielding more accurately . . .ART, ED 6, p. 88

Determine wire size with nomograms . . .ART, ED 20, p. 90

Don't let shield currents defeat the purpose of shielding. . .IFD, ED 1, p. 126

Electromagnetic-interference specs . . .ART, ED 25, p. 76

FOCUS on flat flexible cable. . .SR, ED 9, p. 60

FOCUS on multipin cable panel connectors. . .ART, ED 13, p. 54

Graphite to improve more connector contacts. . .NEWS, ED 11, p. 22

Grounding and shielding practices. . .ART, ED 1, p. 110

Heat pipe may replace heat sink in power semis. . .NEWS, ED 20, p. 24

IC packages are changing shape to handle growing LSI chips. . .NEWS, ED 26, p. 30

Inexpensive metal cabinets come in a variety of sizes. . .PF, ED 5, p. 88

Magnetic shielding strengthened 'softly' . . .NEWS, ED 8, p. 40

Piezoelectric ceramics. . .ART, ED 19, p. 92

Plastic insulation is safer than asbestos . . .NEWS, ED 21, p. 20

Plated-hole attachment method reduces shorts and leaks in ECL three-plane panels. . .PF, ED 13, p. 115

Shrinkable plastic tubes. . .ART, ED 26, p. 166

Wideband vertically mounted microstrip transformer uses little PC-board area . . .IFD, ED 20, p. 108

Wire-brush connector contacts mate easily, provide low contact ohms. . .PF, ED 7, p. 128

Medical Electronics

Brain cells monitored by tiny FM transmitter. . .NEWS, ED 26, p. 20

ITT head gets patent on wrist pulse monitor. . .NEWS, ED 2, p. 6

Microprocessors

Analog boards for microcomputers: You can't always get what you want. . .SR, ED 19, p. 26

Analog I/O cards for industry plug into Motorola 6800. . .PF, ED 19, p. 131

Best processor performance. . .ART, ED 12, p. 84

Binary-to-BCD conversion for μ Ps packs the units and tens into one byte. . .IFD, ED 21, p. 212

Break the 65-kbyte address barrier. . .ART, ED 23, p. 82

Build a μ P-based simulator and learn . . .ART, ED 12, p. 104

Chip can interface micro with bus—all by itself. . .NEWS, ED 21, p. 19

Choosing a μ P by its capabilities is a growing 'family affair'. . .NEW, ED 12, p. 26

Circuit allows program-halt and single-instruction mode on μ P. . .IFD, ED 2, p. 94

Computer uses micro, multiprogramming . . .NEWS, ED 9, p. 28

Control your analog variables digitally . . .ART, ED 5, p. 68

Cut a building's energy use, call on 'Judy' the μ P system. . .NEWS, ED 6, p. 26

Cut a/d conversion costs by using. . .ART, ED 9, p. 86

Design of a home security system. . .ART, ED 9, p. 70

Develop systems around the SC/MP. . .ART, ED 2, p. 62

Development aids speed SC/MP system prototyping. . .PF, ED 3, p. 35

Digitally programmed oscillator is suitable for μ P control. . .IFD, ED 13, p. 102

Elephant with μ P brain skates in Rose Parade. . .NEWS, ED 2, p. 15

Emulate a seven-segment decoder with a subroutine in a μ P control program . . .IFD, ED 18, p. 148

Exploit existing Nova software. . .ART, ED 19, p. 54

First development system for bit-slice μ Ps . . .NEWS, ED 14, p. 22

Getting the bugs out of your software . . .ART, ED 12, p. 96

Hardware memory, software give μ P systems macro performance. . .NEWS, ED 18, p. 26

Circuit Breakers

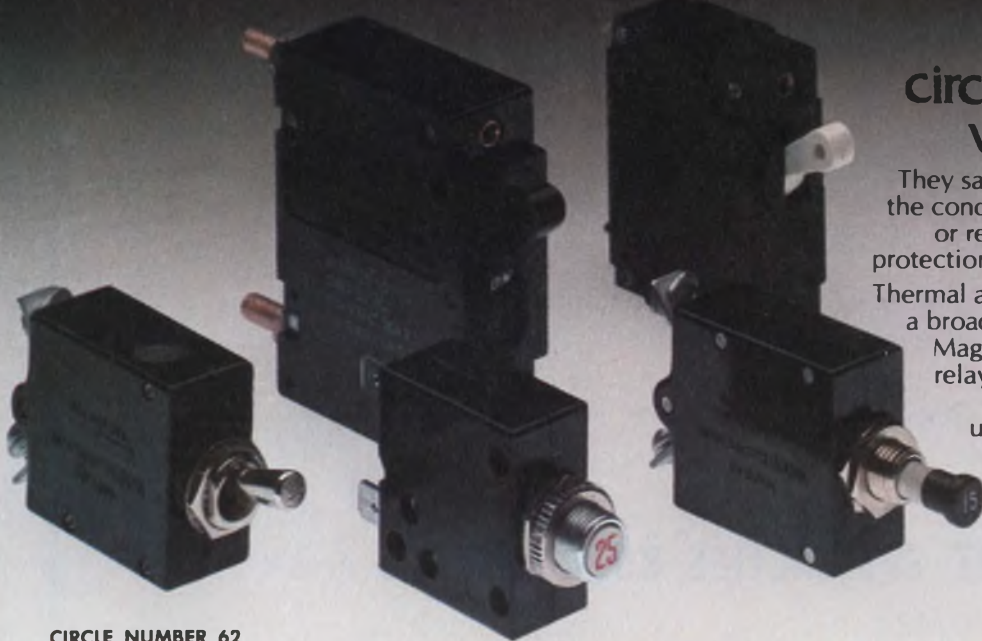

CIRCLE NUMBER 62

Potter & Brumfield
circuit breakers know
when to say no!

They say no to overcurrents and faults until the condition is corrected, even if the toggle or reset button is held in manually. Extra protection against mechanical or human error! Thermal and magnetic hydraulic models offer a broad range of current ratings and styles. Magnetic models feature series, shunt or relay trip; auxiliary switch; instantaneous or time delay trip, and multi-pole units with toggle or rocker operation.

P&B circuit breakers are not one-shot throwaway devices. Save! Say no to fuses and call or write Potter & Brumfield Division, AMF Incorporated, 200 Richland Creek Dr., Princeton, IN 47671. 812/386-1000.

Potter & Brumfield

High-performance processors. . .ART, ED 7, p. 86

Home computers: from a bag of parts to a system you simply plug in. . .NEWS, ED 19, p. 36

Intelligent teletypewriter. . .ART, ED 2, p. 74

Intel's advanced 80/20 has twice the memory. . .NEWS, ED 9, p. 28

Interfacing with μ Ps improved by LSI chips. . .SR, ED 18, p. 124

Keep your microcomputer alive. . .ART, ED 16, p. 80

Keyboard-to-microprocessor interfaces: Should you use an encoder or the μ P. . .NEWS, ED 8, p. 73

Locate interrupts for μ P peripherals quickly without the need for polling. . .IFD, ED 15, p. 104

Low-cost μ P selection. . .ART, ED 5, p. 60

MOS μ P or bipolar slice? It's more than a matter of speed. . .NEWS, ED 7, p. 63

Marry your μ P to monolithic a/ds. . .ART, ED 2, p. 82

Mate microprocessors with CRT displays. . .ART, ED 19, p. 68

Microcomputer with 8085 is the lowest priced, yet. . .NEWS, ED 12, p. 22

Microcomputer's I/O software. . .ART, ED 7, p. 76

Microprocessor-based video games. . .ART, ED 25, p. 84

Microprocessor data manual. . .SR, ED 21, p. 82

Microprocessor fundamentals. . .ART, ED 21, p. 74

Microprocessor selection guide. . .SR, ED 21, p. 55

Microprocessors communicate. . .ART, ED 23, p. 88

'Modularize' μ P chip functions and improve your testing results. . .NEWS, ED 1, p. 75

Multi- μ P systems combine the efficiency. . .ART, ED 16, p. 68

Multiprocessing can marry a radar. . .ART, ED 16, p. 74

Nonvideo games pit man vs microprocessor. . .NEWS, ED 10, p. 21

One-chip microcomputers arrive—and they're very capable. . .SR, ED 8, p. 56

One-chip or bit-slice—know their limits. . .SR, ED 18, p. 126

PC boards with μ Ps need faster testers. . .SR, ED 18, p. 122

Peripheral chips add functions—and problems—to μ P systems. . .NEWS, ED 10, p. 32

Powerful microprocessor performance. . .ART, ED 14, p. 54

Primer on bit-slice processors. . .ART, ED 3, p. 52

Program μ Ps with the new software design aids. . .NEWS, ED 2, p. 20

Programmable baud generator for an 8080 works off the system's clock. . .IFD, ED 16, p. 104

Second source coming for single-board μ C. . .NEWS, ED 8, p. 26

Simplify your next microcomputer. . .ART, ED 15, p. 64

Single-bit μ P avoids overkill. . .PF, ED 10, p. 106

Single-board control computer uses 8748/8048 microprocessor. . .PF, ED 10, p. 112

Software called the key to future μ P designs. . .NEWS, ED 15, p. 34

Software is a vital part of any computer. . .ART, ED 1, p. 90

Software modules are the building blocks. . .ART, ED 3, p. 62

Solve software problems step by step. . .ART, ED 2, p. 54

Soviet process control will go the μ P route. . .NEWS, ED 4, p. 21

Speedy arithmetic circuit unburdens busy microprocessor systems. . .PF, ED 4, p. 43

Take advantage of 8080 and 6800. . .ART, ED 8, p. 90

Time stretcher speeds memory access in Z80 μ P. . .IFD, ED 18, p. 150

Tracing signatures finds faults on μ P boards. . .NEWS, ED 7, p. 19

Users and manufacturers don't speak the same μ P language. . .NEWS, ED 7, p. 26

Watchdog circuit guards μ P systems against looping. . .IFD, ED 2, p. 90

μ P-based computer system sells for under \$1000. . .NEWS, ED 6, p. 36

μ P-controller pen gauges signatures. . .NEWS, ED 26, p. 20

μ P packs mini power but stays Z80-compatible. . .NEWS, ED 21, p. 20

4-bit slices. . .ART, ED 10, p. 62

...and other solutions to your tough design problems are found in P&B's growing product line.

AMF
Potter & Brumfield

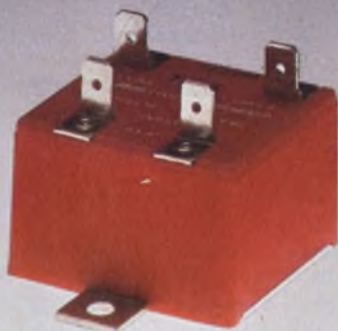

New low-cost ECT hybrid AC relay. Reed-triggered triac switches 2 to 32 amps. Now with AC or DC input. Life to 10 million operations. Has built-in snubber for loads of .40 P.F. or greater. UL-CSA rated.

CIRCLE NUMBER 151



New Sealed R50 PC board relays. Flow solderable and immersion cleanable! Low-profile 2 and 5 amp. models permit high density packaging. UL recognized. Many SPDT and DPDT models directly compatible with TTL, CMOS and HTL buffers. Terminal spacing for 0.1" grid.

CIRCLE NUMBER 152



CMOS controlled CG time delay. Standard delays range from 0.1-1 sec. to 10-100 min. Delays to one year or more available. Repeatability is typically .05% for DC units, 0.1% for AC, including the first cycle! DPDT contacts rated 10 amps at 120V AC. Delay on operate, interval on or delay on release models.

CIRCLE NUMBER 153



Long-life S11L DC solenoid. Shock-dampened operation extends life for tough vending machine, machine tool control and photocopy machine applications. Pull-on-operate 6, 12 and 24 volt continuous duty coils. Insulation: Class A 105°C.

CIRCLE NUMBER 154

ANNUAL INDEX

(continued from page 131)

- 4-bit μ P slices. . .ART, ED 10, p. 74
- 16-bit bipolar microcomputer family is 10 times faster than MOS-based systems . . .PF, ED 5, p. 41
- 16-bit bipolar μ P chip suits tough environment. . .NEWS, ED 4, p. 22
- 16-bit microprocessor can run the lights, too. . .NEWS, ED 9, p. 27
- 8048 is second-sourced. . .NEWS, ED 18, p. 20
- 8080As are not all alike; you should know the differences. . .NEWS, ED 2, p. 41

Military & Aerospace

- Antenna receives sub signals at 100-m depth. . .NEWS, ED 5, p. 18
- Assembly problems? A NASA team may help. . .NEWS, ED 10, p. 21
- Bubble memories are going military in air and space applications. . .NEWS, ED 13, p. 34
- ELF technology saved—Seafarer gets a year. . .NEWS, ED 18, p. 19
- Laser radar lets copters track tiny obstacles. . .NEWS, ED 12, p. 21
- Manpack satellite communications links soldiers with air, sea support. . .NEWS, ED 17, p. 36
- Photocell tells if army weapons are on-target. . .NEWS, ED 23, p. 21
- Pilots will know where lightning strikes . . .NEWS, ED 6, p. 22
- Put your product in space and see what happens. . .NEWS, ED 2, p. 15
- Shuttle tolerates glitch—computer gets 'voted out'. . .NEWS, ED 19, p. 22
- Space scope to seek X-ray sources . . .NEWS, ED 11, p. 38
- Standard Navy computer has low-power core memory. . .NEWS, ED 23, p. 27

Semiconductors

- BBD time delay sets record at 4096 stages . . .NEWS, ED 18, p. 20
- Break loose from fixed IC regulators . . .ART, ED 8, p. 118
- CCDs: the least power and the highest density. . .NEWS, ED 22, p. 19
- CMOS puts new a/d technique ahead of dual-slope method. . .NEWS, ED 8, p. 36
- Consider mask-programmable arrays . . .ART, ED 26, p. 156
- Current-mode logic is packed densely to raise speed and cut power drain . . .NEWS, ED 5, p. 32
- D/a offers tenfold speed boost over competition. . .PF, ED 9, p. 123
- Do-it-yourself with MOS and bipolar IC . . .NEWS, ED 5, p. 17
- Don't trade off analog-switch specs. . .ART, ED 15, p. 56
- Fabrication and circuit progress leads to better microwave devices. . .NEWS, ED 7, p. 38
- Fast fall-time power transistors handle large secondary breakdown energy . . .PF, ED 7, p. 115

- Faster, denser, cheaper: And what an assortment. . .SR, ED 8, p. 61
- Faster doping will increase semi yields and performance. . .NEWS, ED 13, p. 38
- First monolithic 12-bit DAC uses a new zener trim technique. . .NEWS, ED 4, p. 34
- FOCUS on linear-IC amplifiers. . .SR, ED 4, p. 72
- FOCUS on power transistors and thyristors. . .SR, ED 23, p. 52
- I^2L and CMOS battle for lead as IC-technology race heats up. . .NEWS, ED 7, p. 42
- I^2L performance will be improved several ways. . .NEWS, ED 25, p. 21
- Look out, power transistors: Here come the power FETS. . .NEWS, ED 22, p. 30
- MOS memory performance matches bipolar in medium-speed range. . .NEWS, ED 7, p. 30
- NMOS memories—they're faster and run cooler. . .NEWS, ED 6, p. 21
- Out in space or on the road, discrete devices are on the job. . .SR, ED 1, p. 38
- Plastic-cased PROM matches EPROM for less. . .NEWS, ED 17, p. 19
- Plastic VMOS FETs vie with power bipolars . . .NEWS, ED 19, p. 22
- Point-contact diode spans dc to infrared . . .NEWS, ED 11, p. 22
- Popular IC-timer in DIP is compatible with high-noise immunity logic. . .PF, ED 16, p. 114
- Power transistor process boosts performance. . .NEWS, ED 21, p. 38
- Regulator delivers 3 to 30 V and limits currents to 1.8 A. . .PF, ED 26, p. 192
- SCR-bridge currents can be complex . . .ART, ED 20, p. 70
- Spectrum analyzer on a chip? Analog CCD module comes close. . .NEWS, ED 21, p. 32
- TI's new op amps use much less power . . .NEWS, ED 14, p. 22
- Technologies needed to increase IC density. . .NEWS, ED 15, p. 21
- Temperature, not current switches p-n-p element. . .NEWS, ED 2, p. 32
- μ Cs on a chip and integrated d/a's about to usher in an IC harvest. . .SR, ED 1, p. 34
- Ultra-high-speed logic—more than just a promise in LSI. . .NEWS, ED 7, p. 34
- Watch that transistor phase lag. . .ART, ED 1, p. 122
- 16-k RAM makers play speed leapfrog . . .NEWS, ED 15, p. 21

Test & Measuring

- Automatic testing makes cents—but not all the time. . .NEWS, ED 25, p. 30
- Autorangeing comes to low-cost, vhf counter. . .PF, ED 13, p. 126
- Bit-slice development system looks like a compact instrument. . .PF, ED 26, p. 188
- Calibrator stores tolerance limits. . .PF, ED 19, p. 142

- Changing tests as you go improves ATE throughput. . .NEWS, ED 20, p. 24
- Component temperature measurements can improve your design. . .SR, ED 24, p. 86
- Crystal-controlled time-base generator measures frequency/time in low-cost scopes. . .IFD, ED 10, p. 88
- DVM chips include 7-segment decoder and LED drivers. . .PF, ED 9, p. 124
- Data logger changes role with drop-in card modules. . .PF, ED 2, p. 104
- Design an IEEE-488 bus. . .ART, ED 24, p. 104
- Digital-panel thermometer automatically scans inputs. . .PF, ED 18, p. 157
- Double-exposure technique lets you take good spectrum-analyzer photographs . . .IFD, ED 11, p. 218
- Excite your SAW device. . .ART, ED 8, p. 132
- FET bias curves. . .ART, ED 7, p. 98
- First dual-display counter. . .PF, ED 8, p. 186
- John Fluke of Fluke Mfg. speaks on the future of the voltmeter. . .SR, ED 24, p. 96
- FOCUS on electronic counters. . .SR, ED 11, p. 54
- FOCUS on logic and μ P analyzers. . .SR, ED 3, p. 40
- Four memory chips can be tested at once . . .NEWS, ED 12, p. 22
- Function generator breaks 50-MHz output barrier. . .PF, ED 10, p. 102
- IC tester handles 120-pin devices. . .NEWS, ED 24, p. 22
- Improve your digital recorder. . .ART, ED 24, p. 148
- Instrument safety standard may come true on the fourth try. . .NEWS, ED 9, p. 42
- Interface for IEEE-488 bus. . .NEWS, ED 8, p. 26
- Junction-to-case thermal resistance can be 'measured'. . .PF, ED 10, p. 104
- Logic analyzer traces nested loops to 7 levels with state sequences and 'menu' control. . .PF, ED 10, p. 99
- Logic analyzers aim to fill more needs . . .NEWS, ED 17, p. 19
- Logic monitors add data-stream comparison. . .NEWS, ED 25, p. 22
- Measure phase noise. . .ART, ED 4, p. 106
- Measure relay-operate and release times automatically on standard digitally timers. . .IFD, ED 11, p. 214
- Measure SAW-device characteristics . . .ART, ED 4, p. 112
- Microprocessor boards are here; now they have to be tested. . .SR, ED 8, p. 58
- Microprogram control on your analog tester. . .ART, ED 14, p. 74
- Module simplifies DPM recipe—you can choose the display. . .PF, ED 25, p. 106
- North Sea oil platform will monitor its own movements. . .NEWS, ED 11, p. 36
- Phase-sensing probe finds more shorts, opens. . .NEWS, ED 19, p. 21
- Printed-circuit dc performance. . .ART, ED 6, p. 94

Programmable source spans 1 mHz to 30 MHz. . .PF, ED 19, p. 145

Resolving DMM accuracy. . .ART, ED 5, p. 72

Scope measures its own rise time. . .ART, ED 24, p. 130

Sig gens, synthesizers—and a capable off-spring. . .SR, ED 24, p. 76

Signal source selection isn't easy. . .ART, ED 13, p. 76

Simple CMOS keyboard encoder circuit programs voltage source in 1-V steps . . .IFD, ED 7, p. 104

Simple circuit blanks the leading zeros for single-chip DVM/DPM a/d converters . . .IFD, ED 20, p. 106

'Smartly' dressed instruments will save you real money this year. . .SR, ED 1, p. 42

Solve phase-angle averaging riddles . . .ART, ED 15, p. 88

Spectrum analyzer boosts accuracy and resolution. . .PF, ED 18, p. 158

Stop counter errors. . .ART, ED 1, p. 104

Strongest magnetic field takes little power . . .NEWS, ED 8, p. 25

Temperature controller keeps components out of the ovens. . .PF, ED 26, p. 182

Test converters fast. . .ART, ED 24, p. 136

Test digital circuits in step-by-step or continuous modes driven by the tested system's clock. . .IFD, ED 21, p. 210

Test probe checks power or continuity without switching or probe adjustments. . .IFD, ED 3, p. 72

Tester 'learns' what it measures. . .NEWS, ED 23, p. 34

Testers can penetrate the surface of Mars . . .NEWS, ED 16, p. 26

Testing circuit cards can be a 'monstrous' job. . .SR, ED 24, p. 64

Testing 16-k dynamic RAMs. . .ART, ED 19, p. 86

Three-digit bipolar voltmeter built with v/f converter and BCD counters. . .IFD, ED 19, p. 116

Time-interval meter reads digitally to 99.9 ms on a DVM IC. . .IFD, ED 6, p. 108

UL 1244 will change instrument probe designs. . .NEWS, ED 13, p. 17

Ultrasonic transducer tests without contact. . .NEWS, ED 26, p. 19

Verify transistor ratings. . .ART, ED 8, p. 126

Voltage comparators provide null detection for bridge circuits. . .IFD, ED 18, p. 152

What's wrong with your instrument? It may tell you. . .SR, ED 24, p. 56

What's wrong with 488? Not much, but . . .SR, ED 24, p. 48

3-1/2-digit multimeter: the lowest-cost of the low. . .NEWS, ED 21, p. 19

7-1/2-digit DVM—another first. . .NEWS, ED 5, p. 18

60-GHz spectrum analyzer resolves down to 30 Hz. . .PF, ED 8, p. 183

250-MHz counter works from NiCd batteries. . .PF, ED 5, p. 86

New Multimeter — New Price 5½ Digit — AC, DC, Ω — the new CIMRON® DMM53 \$795.⁰⁰



Cimron, the 5 digit specialists since 1963, who brought you the first full-function 5½ digit DMM for less than \$1000.00, now bring you a 5½ digit, full function DMM for \$795.00, with specifications to 1 year, autozero, autorange, 5 ranges DC, 5 ranges AC, 6 ranges ohms, high input impedance to 20VDC and many other features.

5150 Convoy St.
San Diego, Calif. 92111
Phone (714) 279-8620
Telex 695047

California Instruments
A Norlin Technology Company

CIRCLE NUMBER 63

Four ways to build better Power Chokes... with ferrite cores from Fair-Rite

When designing switch mode power supplies, you can provide more stable inductance for the filters in the presence of DC load currents, by using these types of ferrite cores:

1.



Gapped pot cores for exceptional shielding qualities.

2.



Gapped E-cores, giving moderate shielding at lower cost.

3.



Round bobbins; priced lower yet; no shielding qualities, but highly stable.

4.

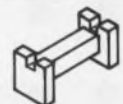

Square bobbins; most economical; without shielding properties, but least affected by DC.

Write for FREE application note on use of the Hanna curve to select the proper air gap for ferrite cores. All, and much more, from:



FAIR-RITE PRODUCTS CORP.

Wallkill, NY 12589 Phone 914-895-2055 TWX: 510-249-4819

FERRITE CORES FOR THE ELECTRONICS INDUSTRY

CIRCLE NUMBER 64

How 36 trigger points can simplify analysis of your microprocessor-based systems.

5ns Glitch Capture.

Latch mode for glitch detection, or sample mode, can be independently selected for channels 1-8 and 9-16. Wide bandwidth BNC input allows capture of pulses as narrow as 5ns.

Mixed Logic Thresholds.

Select one threshold voltage for channels 1-8, another for 9-16. Dial in ECL, TTL, MST, any of three user-preset values or continuously variable level.

Display Control. Select timing diagram, data domain logic state display or map mode dot pattern of system operation, using the accessory 116 Display Control. Memory feature permits comparison of current and stored system characteristics.

Precise Memory Control. Pretrigger recording enables you to split the 512-word memory to capture data on both sides of the trigger event. Or, with Delay Mode, start of recording can be delayed as long as 9999 clock intervals after the trigger.

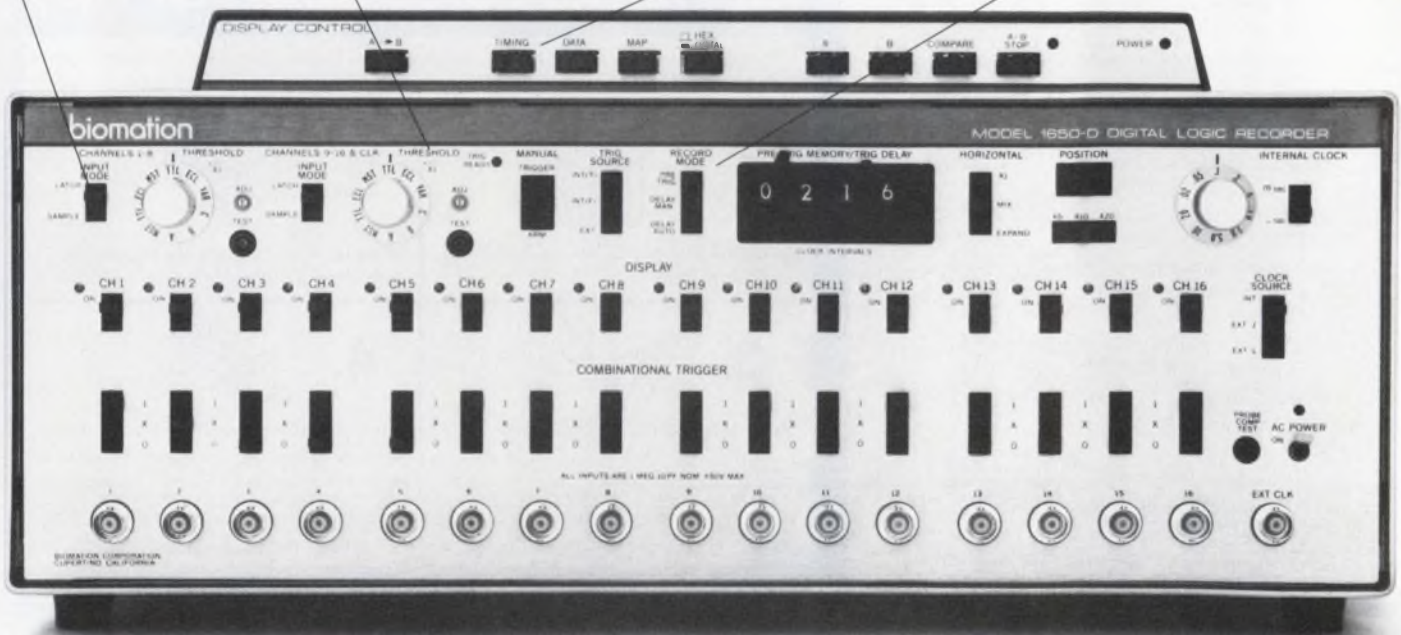

Designing a microprocessor-based system? There's no better way to get a precise, detailed look at both 8-bit and 16-bit microprocessor system operation than our 16-channel, 50 MHz logic analyzer.

Plug in two of our 10-TC active probe pods and the 1650-D's combinational trigger capability is expanded to trigger on words up to 36 bits long. That gives you the power to record

and analyze up to 16 digital signals triggering from up to 20 additional locations. Now, with the 1650-D, you can trigger on word lengths that you just couldn't detect before.

Versatility is the key to the 1650-D's popularity with designers working on microprocessor system development, instrumentation interfacing or analysis



Time Domain. Timing diagram lets you see the sequential and simultaneous relationship between digital signals, to simplify hardware troubleshooting.

of real-time digital circuits. With the 116 Display Control, the 1650-D gives you the capability to analyze both timing and logic state displays. That's the key to simplified hardware/ software debugging and integration. A Latch Mode on the input signal

enables the 1650-D to detect and record glitches or pulses as narrow as 5ns — vital information when troubleshooting the operation of digital circuits. Or, for data analysis, Sample Mode ignores synchronous glitches not coincident with the data clock.

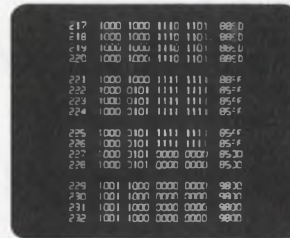

Data Domain. Display logic states (1's and 0's) with hex or octal translation. That's essential information for troubleshooting software and firmware.

There's not space here to give you all the details on how our 1650-D, with 10-TC probe pods and 36-bit trigger, can simplify your task. But we'll gladly send you detailed information on the 1650-D and our entire line of

logic analyzers, from the budget-priced 920-D to the ultra-fast, 200 MHz 8200. And, at your convenience, we'll arrange a demonstration of Biomation's logic analyzers in your lab, capturing and displaying the data you work with.

Write, call or use the reader service card. Biomation, 4600 Old Ironsides Drive, Santa Clara, CA 95050. (408) 988-6800. TWX: 910-338-0226.



Map Mode. Each digital word can be translated into a singularly positioned dot in this graphic representation of recorded data. Especially useful for spotting illogical or illegal memory addresses.

biomation

*“Neither a borrower
nor a lender be ...”*

If you don't have your own personal copy of **ELECTRONIC DESIGN's** new 1978-1979 **GOLD BOOK**, you should order one right now **FOR** yourself.



Just complete the order form below and mail it to us today. We'll gladly bill you later.

ELECTRONIC DESIGN / GOLD BOOK
Hayden Publishing Co. Inc.
P.O. Box 13803, Philadelphia, Pa. 19101

412 R

Send us _____ copies of the 1978-1979 GOLD BOOK at \$30 (U.S., Canada and Mexico) and \$40 (all other countries).

- Bill me.
 Bill my company. Company purchase order number _____

NAME _____ TITLE _____

COMPANY _____ DEPT. _____

COMPANY ADDRESS _____

CITY/PROVINCE _____

STATE/COUNTRY _____ ZIP/POSTAL CODE _____

Touch switches are



...and CENTRALAB has them NOW

When Centralab introduces touch switches you can be sure they're "In". Backed by 40 years of switch know-how, and after years of intensive research and testing, Centralab is now delivering, in batch-process volume, a complete touch switch system. We call it MONOPANEL.

MONOPANEL is a thin, light, flat, front panel subassembly containing micro-motion touch switches already mounted and interconnected . . . with LED's, nomenclature, graphics and colors to meet your functional and aesthetic requirements.

Batch-Processed For Economy With Quality

MONOPANELS are batch-processed as 11" X 17" master panels only .075" thick, each containing up to 700 switches. Every Monopanel is a complete, 100% pre-tested subassembly containing switches, front panel and graphics.

60,000,000 Cycles Without Failure!

The basic MONOPANEL switch has been operated for sixty million switching cycles without mechanical or electrical failure. And MONOPANEL has been tested and proven against 22 separate mechanical, electrical and environmental standards.

Custom Designed For Your Application

On each 11" X 17" panel you can custom-design individual boards to meet your front panel needs. The illustration

above shows just a few of the almost endless variations possible from each master panel.

Unlimited Graphics Available

The flat, smooth, front panel surface permits unlimited choice of graphics. Functions may be grouped by color, with 480 colors available. Thirty choices of type style and size. And whatever visual symbols meet your specific needs.

THIS IS MONOPANEL:

- A complete touch switch sub-assembly, ready to mount.
- All switches and graphics on a .075" thin panel.
- Flat, spill-proof surface wipes clean.
- Noiseless.
- 100% tested.
- Choice of terminations.
- Operating voltage: 50 V max.
- Operating current: 100 mA max.
- Contact resistance: 0.2 ohms typical.

Standard 12 and 16 position keyboards are available through Centralab Industrial Distributors. For more information on *custom* MONOPANELS,

(414) 228-2604, or send for this **FREE** brochure today.



CENTRALAB

Electronics Division

GLOBE-UNION INC.

5757 NORTH GREEN BAY AVENUE
MILWAUKEE, WISCONSIN 53201



Quality Products For Your Design: Ceramic Capacitors • EMI/RFI Filters • Thick Film Circuits • Rotary, Slide and Pushbutton Switches
• Touch Switches • Potentiometers and Trimmers.

CIRCLE NUMBER 67

Half-size Amber R Relays

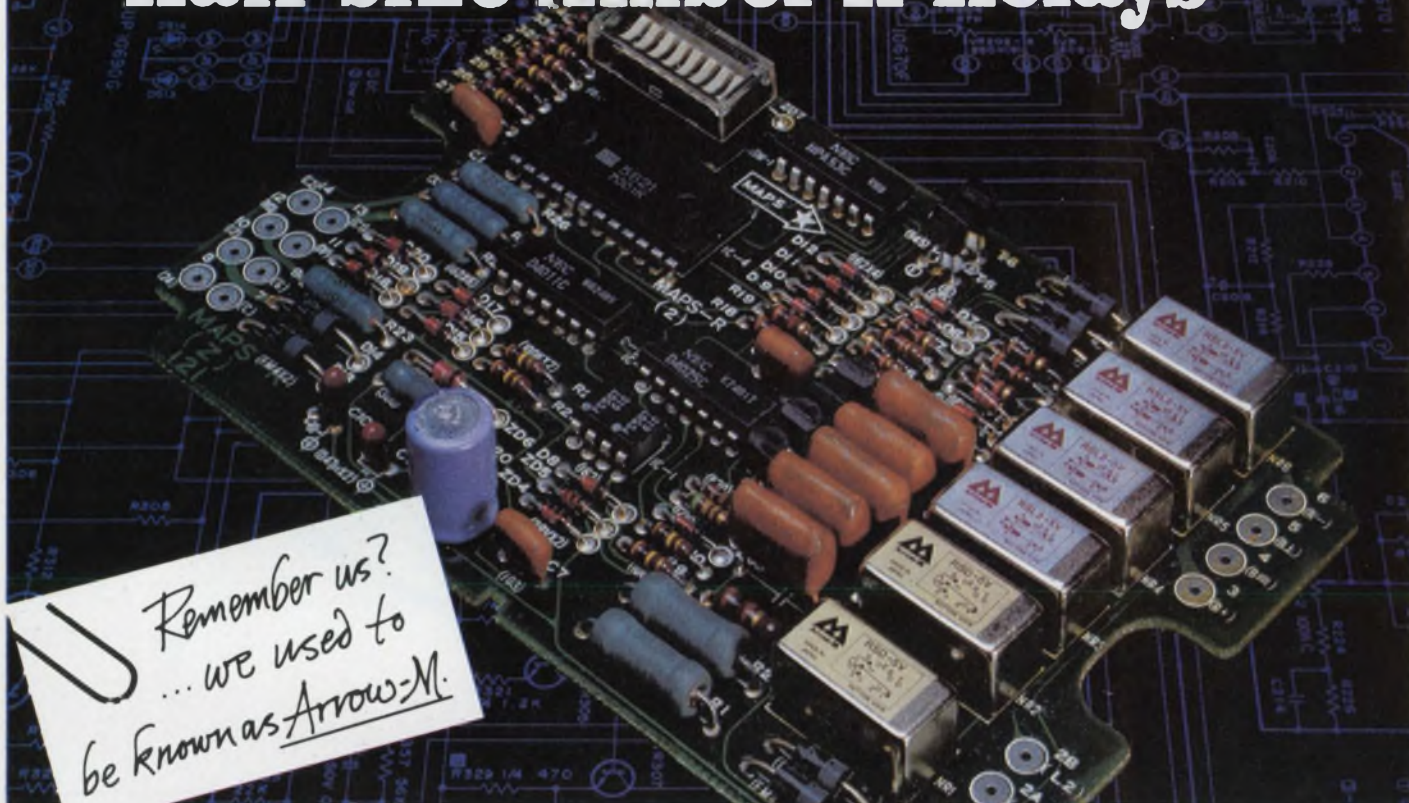

High capacity, high sensitivity units can be driven by TTL and DTL.

For example: The minimum operating power for a single side stable type is 80mw, for a latching type 40mw.

- Aromat R Relays are available in 1 Form C contacts which can carry a high current capacity of 1 Ampere 20 watts, and are capable of resisting welding at higher inrush currents. The dry circuit type, which can switch current as low-level as 100uA, is available in addition to the power type.
- In addition to the standard, there are 1 coil and 2 coil latching types, which are useful for logic circuit design as a memory component.
- Not only can they be automatically wave soldered on PC boards with a high density of electronic parts, but they are simple to clean with most degreasers and detergents without affecting maximum contact reliability.

Relays for Advanced Technology

More than 22 million R Relays in service around the world.



Aromat

Member of Matsushita Group

**Contact Your
Aromat Representative
or Distributor Today.**

Aromat Corporation:
250 Sheffield Street
Mountainside, NJ 07092
(201) 232-4260

Mid-Western Office:
311 Lively Blvd.
Suite 1
Elk Grove, IL 60007
(312) 593-8535

Western Office:
22010 S. Wilmington Ave.
Suites 300 & 301
Carson, Calif. 90745
(213) 775-3512

One-DIP a/d or d/a converter fits microprocessors like a glove

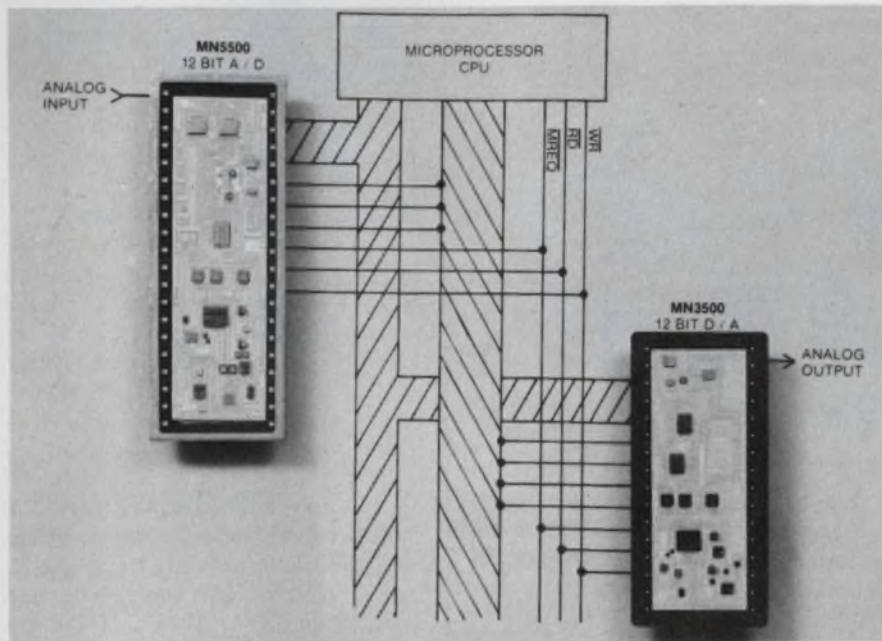

Micro Networks, 324 Clark St., Worcester, MA 01606. John Munn (617) 852-5400. See text.

Often, a microprocessor-based system needs either an analog voltage converted to 12 bits or 12-bit digital data converted to an analog voltage. Of course, the converters must interface with the processor and often even operate under its control. Two single-DIP 12-bit converters from Micro Networks fit the bill. The 32-pin MN-3500 d/a and the 40-pin MN-5500 a/d both deliver $\pm 1/2$ LSB linearity from 0 to 70 C and contain all the circuitry for control by, and interfacing with, most microprocessors and development systems.

The interface logic for these hybrid converters is truly universal—both devices mate directly with any 8-bit microprocessor. They connect right to the buses and control lines and contain all necessary chip-select, address-decode and read-write logic and buffering. The converters even have the acknowledge output that some processors and development systems require. In addition, both the a/d and the d/a boast

five user-selectable analog ranges, from ± 20 mV to ± 10 V.

Both converters can operate in either a memory-mapped mode or with I/O interfacing. In either case the converters appear to the processor as two successive memory or I/O locations.

They also feature both software and hardware interrupt capabilities. For interrupt-mode operation, the status of each converter is available as a control output and on the data bus.

The d/a converter has a 3- μ s settling time, while the a/d unit converts in 25 μ s max. When the a/d converter is used with only a single-channel input, nine processor-program steps must be added to the 25- μ s conversion time. In multiplexed operation, with, say Micro Network's MN 7130 multiplexer, the number of processor steps increases to 14 and, of course, the 40-kHz throughput rate goes down accordingly.

So, when you must add analog channels to your microprocessor system and don't want to spend the time to design the control logic and interfacing that other converters require—or if board

space is a consideration—you can simply add an MN-5500 a/d channel for \$155 (1 to 24), \$142 (25 to 99), or \$129 (100 up). Add-on, single-channel MN-3500 d/a's cost \$112, \$99 and \$90 in the same quantities. Delivery takes two to four weeks.

The Micro Networks converters are by no means the only a/d's or d/a's available. But they do offer the most complete self-contained microprocessor interfacing and control logic. Other compact hybrid or monolithic a/d's with 8-bit-bus interfacing capability and three-state outputs include the following: The 10-bit AD 7570 from Analog Devices, Norwood, MA; the MP20 and 21 from Burr-Brown Research, Tucson, AZ; and the ADC 816 and 817 from National Semiconductor, Santa Clara, CA. The MP 20/21 and ADC 816/817 are 8-bit devices that contain 16-channel multiplexers.

Other d/a converters suitable for microprocessor interfacing are the 12-bit 7545/6 from Beckman Instruments, Fullerton, CA; the 10-bit 7522 from Analog Devices; the MP 10 and 11 from Burr-Brown, and the 9-bit 6081 and the 8-bit 6080 from Advanced Micro Devices, Sunnyvale, CA.

Micro Networks **CIRCLE NO. 304**
Advanced Micro Devices

CIRCLE NO. 305
Analog Devices **CIRCLE NO. 306**
Beckman Instruments **CIRCLE NO. 307**
Burr-Brown Research **CIRCLE NO. 308**
National Semiconductor **CIRCLE NO. 309**

8-digit display module gives bold characters

OPCOA, 330 Talmadge Rd., Edison, NJ 08817. Bob Kokesh (201) 287-0355.

Type 600 display modules are red LED displays whose character height is 0.6-in. The display uses a common-cathode-multiplex configuration with low-power-consumption levels. Typical operating conditions are 20 mA pk for a luminous intensity of 250 mcd. Pk wavelength is 630 nm. The power dissipation at 25 C is 620 mW per digit.

CIRCLE NO. 323

12-bit data-acquisition system interfaces directly with μ Ps

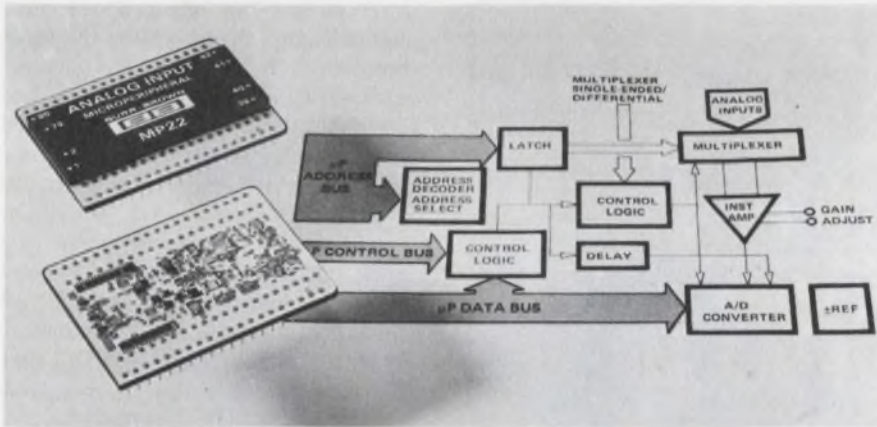

Burr-Brown Research Corp., Box 11400, Tucson, AZ 85734. Steve Harward (602) 294-1431. See text.

A compact, hybrid 12-bit-output data-acquisition system, the MP22, needs no extra logic to operate with several popular microprocessors—the 8080A, Z80, 8048 and SC/MP. Furthermore, only minimal external logic is needed for other μ Ps such as the 6800, the 650X series, the F8 and the 8085.

The MP22 is also compatible with the PDP-8, PDP-11, Nova and Eclipse minicomputers.

Sixteen single-ended or eight differential inputs are multiplexed, and an instrumentation amplifier permits the full-scale input to be as low as 5 mV. At unity gain, full-scale range is 0 to +5 V.

Programming is simple—just one or two instructions. An address decoder is included, and internal control logic generates signals needed for halt, interrupt, and DMA modes. Some μ Ps, like the 6800, need a bit of external logic such as a dual one-shot and a three-input gate.

A CMOS a/d converter in the MP22 provides 12-bit data, which are multiplexed onto an 8-bit data bus through three-state outputs. Throughput rate, typically 22-k channels/s, is limited by the microprocessor.

Bipolar inputs unfortunately require an external amplifier and some resistors, although Burr-Brown hopes to make these unnecessary in a few months.

System accuracy figured on a root-sum-square basis is $\pm 0.1\%$ of full-scale, at the minimum 40 μ s per channel, with ± 12 -V supplies. $\pm V_{cc}$ can be from ± 10 V to ± 18 V, while the logic supply is +5 V.

The MP22 comes in an 80-pin quad in-line package measuring 1.70×2.15 in. and operates between -25 and $+85$ C. Prices go from \$245 (1 to 9 qty.), \$225 (10 to 24), \$210 (25 to 99). Delivery is from stock for quantities up to 25.

Datel offers competing 12-bit systems: the HDAS-16, which has 16 single-ended inputs, and the HDAS-8, with eight differential inputs. Datel's systems have better analog specs, are faster, and—unlike the MP22—include a sample-and-hold. However, they need more logic for μ P interfacing. Cost is \$395 (1 to 9, -25 to $+85$ C.).

Micro Networks has a comparable, 0 to 70-C, two-package system consisting of the MN 7130 and the MN 5500. (For more on the MN 5500, turn to p. 139.)

Burr-Brown
 Datel
 Micro Networks

CIRCLE NO. 320
 CIRCLE NO. 321
 CIRCLE NO. 322

Fiber-optic detectors mate with TI line

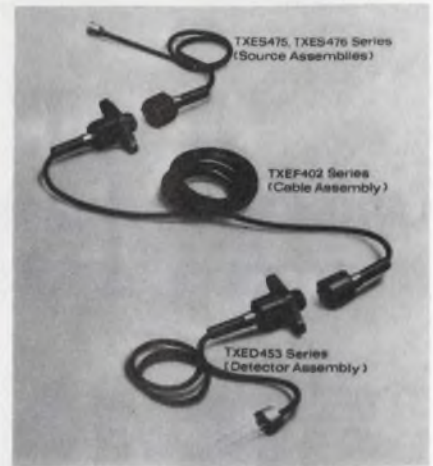

Texas Instruments, P.O. Box 5012, M/S 308 (Attn: TXED453, TXEF402), Dallas, TX 75222. Jim Walyus (214) 238-4422. See text; 4 to 6 wks.

A fiber optic silicon-detector-assembly series, the TXED453 and a cable-assembly series, the TXED402 are compatible with the TXES475/-TXES476 source assemblies previously announced by TI. TXED453 assemblies have a capacitance of 2 pF at V_R of 25 V and a dark current of 2 mA at V_R of 25 V. Each assembly consists of an optical detector, integral fiber-optic cable and a connector termination. Series TXEF402 has eight cable lengths from 1 to 50 m. Each cable has a max attenuation of 350 dB/km at 790 nm with a material aperture of 0.53. The detectors are priced from \$22 to \$28 and the cables are priced from \$19 to \$179 depending on length.

CIRCLE NO. 324

8-bit d/a converter interfaces μ Ps

Hybrid Systems, Crosby Dr., Bedford, MA 01730. Larry Lauenger (617) 275-1570. \$24; 2 to 4 wks.

The DAC336-8, an 8-bit d/a converter, interfaces with 2560 and 8080 microprocessors. The unit has an input storage register, output amplifier and a precision reference. All units are pretrimmed to $\pm 0.05\%$. Pin jumping allows a choice of four voltage outputs: 0 to -10 , 0 to $+10$, ± 5 and ± 10 V. Other features include 4- μ s settling time, $\pm 1/2$ LSB linearity and tempco of ± 50 ppm/ $^{\circ}$ C from 0 to 70 C. The device accepts TTL, DTL and 5-V CMOS logic levels and delivers a minimum of 5 mA at 10-V output.

CIRCLE NO. 325

Introducing Shugart's SA450 double-sided minifloppy.[®]

440 Kbytes on-line without a flip.

Why flip? Nobody delivers this much on-line data storage from a single minifloppy disk drive with total compatibility. Nobody but Shugart offers a complete family of minifloppy disk products. Now a single minidiskette™ can carry operating system software, application programs or about 220 pages of text. All available on-line. Reach 440 Kbytes (unformatted) with random access speed. Without flipping media.

Two heads are better than one. The proprietary Shugart head design allows you to read and write both sides of the minidiskette. So you can write and read larger data files without the delays and risks that come from additional diskette handling.

We promised. We delivered. The SA450 delivers true upward expansion based upon the industry standard 35 track format. This proven *Format With a Future* allows you to use single or double-sided minidiskettes without sacrificing the margin that you've come to expect with the minifloppy.

Proven technology—single or double density. The Shugart SA450 minifloppy disk drive has the same compact size and low weight as the original minifloppy—the Shugart SA400. And it's electrically, mechanically, and media compatible. Double density (MFM/M²FM) is standard, but you can also operate single density on one side or two.

There's more. The unique direct-drive spiral cam actuator.

Low heat dissipation, write protect, activity light, die cast base plate, and DC drive motor, too. But you get the idea. Nobody makes more minifloppy disk drives than Shugart. Over 25,000 have been installed since we introduced the little guy in September 1976. Nobody can claim more experience. So if you want 440 Kbytes of on-line storage, big drive data integrity, with proven reliability—and you're into word processing, intelligent terminals, small business systems or home computing—you'll love the SA450.

Why flip? You can have the real double-sided minifloppy from the people who started the minifloppy revolution. Shugart.

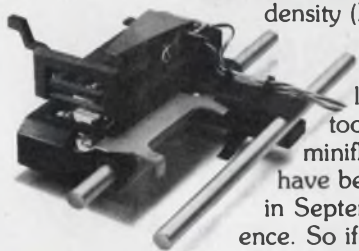

 Shugart Associates

415 Oakmead Parkway, Sunnyvale, California 94086
Telephone: (408) 733-0100
West Coast Sales/Service: Telephone: (408) 252-6860
East Coast Sales/Service: Telephone: (617) 890-0808
Europe Sales/Service: 3, Place Gustave Eiffel, Silic 311
94588 Rungis, France Telephone: (1) 686-00-85

[™]minidiskette trademark of Shugart Associates.



**The Leader
In Low Cost
Disk Storage.**

MODULES & SUBASSEMBLIES

LED unit displays 8 characters



Monsanto Electronics, 3400 Hillview Ave., Palo Alto, CA 94304. (415) 493-3300. \$39 (100 qty).

The MAN2815 display consists of eight 0.135-in. red alphanumeric characters. Each character is a 14-segment display. The unit consumes 0.5-mA forward current or 1 mW per segment. The average luminous intensity per segment is 100 μ cd (typical) and 60 μ cd (min) at a forward current of 2.5 mA. In addition, the intensity is controlled, segment to segment, and character to character to a ratio of 2 to 1. The units contain internal wiring for multiplexing. The end-to-end size is 1.39-in. character spacing is 0.175 in.

CIRCLE NO. 326

8-bit a/d converter operates to 20 MHz

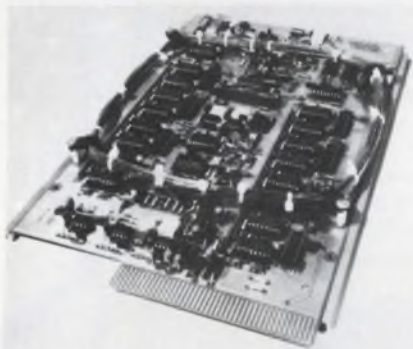

LeCroy Research Systems, 1806 Embarcadero Rd., Palo Alto, CA 94303. (415) 328-3750. \$1610; stock to 8 wks.

The Model AD208 a/d converter can give you 8-bit conversion as often as every 50 ns for analog input signals of up to 512 mA. 30-MHz bandwidth for full amplitude signals and ± 25 -ps aperture uncertainty allow accurate tracking of sine waves well above the Nyquist limit. In addition, a dc-offset adjustment allows conversion of both bipolar and unipolar signals. An input-switching relay disconnects the analog input and grounds the input to allow direct measurement of the pedestal and dc offset.

CIRCLE NO. 327

Audio attenuator takes BCD or TTL programming

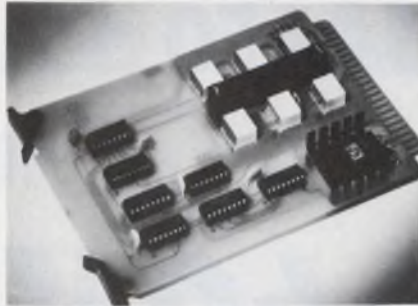

Syntest, 169 Millham St., Marlboro, MA 01752. (617) 481-7827. \$211; stock to 4 wks.

The Model SM-030 is a modular externally programmable audio attenuator. It can be programmed to provide up to 63-dB attenuation in 1-dB steps. Input programming may be either BCD or binary positive true TTL signals. On-board logic latching is also provided for interfacing to most computer output buses. Both input and output impedances are 600 Ω unbalanced. The max input power level is 250 mW. The module has an accuracy of ± 0.25 dB over its attenuation range from dc to 1 MHz. Temperature stability is ± 1 dB from 0 to 50 C.

CIRCLE NO. 328

Digital unit measures pressure directly



Doric Scientific, 3883 Ruffin Rd., San Diego, CA 92123. Jim Stein (800) 854-2708. \$895; 8 wks.

The Model 420P digital pressure indicator shows pressure readings directly on 0.6-in. LED displays with 0.2% accuracy. A pressure transducer is built into the indicator. The pressure line is connected to a fitting on the rear of the instrument. The display can be set to read in psi, kg/m², mm of Hg or other engineering units. The resolution is 0.01 psi on models reading to 100 psi and 0.1 on models reading to 1000 psi. A range of 0 to 5000 psi is also available with 1-psi resolution. The unit is in a case that fits in a 72 x 144-mm panel cutout.

CIRCLE NO. 329

SPRAGUE 'HALL EFFECT' SENSORS

are available for
immediate delivery
from these stocking
distributors:

AVNET ELECTRONICS

350 McCormick Ave.
Costa Mesa, Calif. 92626
TEL. 213/558-2011

ELMAR ELECTRONICS

2288 Charleston Rd.
Mountain View, Calif. 94041
TEL. 415/961-3611

NEWARK ELECTRONICS

500 N. Pulaski Rd.
Chicago, Ill. 60624
TEL. 312/638-4411

NEW YORKER ELECTRONICS

426 Fayette Ave.
Mamaroneck, N.Y. 10543
TEL. 914/698-7600

PIONEER/CLEVELAND

4800 E. 131st St.
Cleveland, Ohio 44105
TEL. 216/587-3600

STERLING ELECTRONICS

20 Summer St.
Watertown, Mass. 02172
TEL. 617/926-9720

WILSHIRE ELECTRONICS

1 Wilshire Road
Burlington, Mass. 01803
TEL. 617/272-8200

65-7118

There's a better way to measure or monitor mechanical motion—

magnetically-activated 'Hall effect' integrated circuits

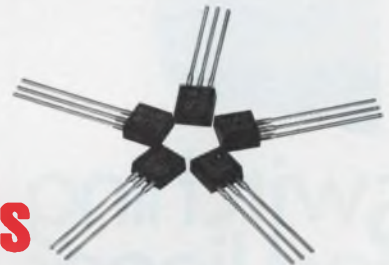

- Convert mechanical motion to electronic signals by sensing changing magnetic fields.
- Excellent for position sensing, thickness determination, weight measurement, speed control, pressure monitoring.
- Provide contactless switching—no contacts to wear, no contact welding.
- Highly reliable under adverse environmental conditions.
- None of the contamination problems suffered by mechanical or photo-electric switches.
- No moving parts to cause spurious signals often associated with conventional switches.
- Economical transistor-style package.
- Ideal interface between mechanical motion and electronic controls, counters, etc.

TYPE UGN-3020T DIGITAL SENSORS

TYPICAL APPLICATIONS

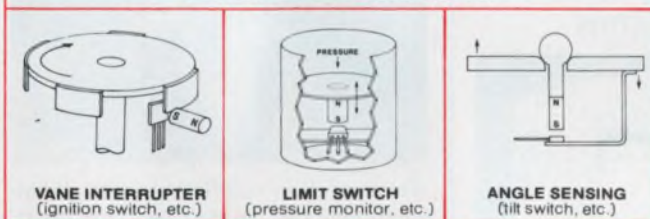

VANE INTERRUPTER
(ignition switch, etc.)

LIMIT SWITCH
(pressure monitor, etc.)

ANGLE SENSING
(tilt switch, etc.)

- Designed for use with readily-available samarium cobalt or sintered alnico VIII permanent magnets.
- Operate at any voltage from 4.5 to 24 VDC.
- Constant amplitude output, independent of frequency up to at least 100 kHz.
- Higher sensitivity, wider operating temperature range, smaller physical size, more economical than any other device of its type.

TYPE UGN-3501T LINEAR SENSORS

TYPICAL APPLICATIONS

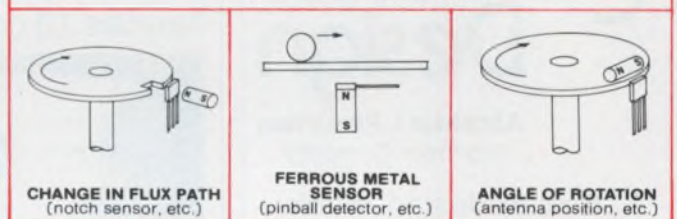

CHANGE IN FLUX PATH
(notch sensor, etc.)

**FERROUS METAL
SENSOR**
(pinball detector, etc.)

ANGLE OF ROTATION
(antenna position, etc.)

- Voltage output of these devices is proportional to magnetic field intensity.
- Will operate if slightest change in flux path is made.
- Operate at any voltage from 8 to 12 VDC.
- Hall cell and linear differential amplifier integrated in one monolithic device to simplify problems relating to handling of millivolt analog signals.
- Exceptional temperature stability.

Call your nearest Sprague stocking distributor (see opposite page) for price and delivery information. For easy-to-understand application engineering assistance, write or call John Haussler, Hall Cell IC Product Manager, Sprague Electric Co., 70 Pembroke Rd., Concord, N.H. 03301; telephone 603/224-1961. For complete technical data, write for Engineering Bulletins 27404.11 and 27500 to: Technical Literature Service, Sprague Electric Company, 347 Marshall Street, North Adams, Mass. 01247.

4SS-7131R2

SPRAGUE
THE MARK OF RELIABILITY

a
**General
Cable**
subsidiary

THE BROAD-LINE PRODUCER OF ELECTRONIC PARTS

CIRCLE NUMBER 70

Just
Published!

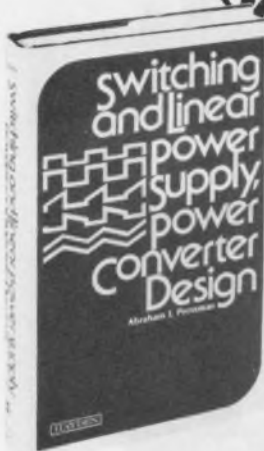

Switching and Linear power supply, power converter Design

Abraham I. Pressman
Raytheon Company

A "how-to-design" book
written from a power
supply designer's
point of view!

Covers all the circuits, systems,
magnetics, and thermal design
skills essential to modern power
supply design.

#5847-0, cloth, 384 pages, \$19.95

**ORDER YOUR 15-DAY
EXAMINATION COPY
NOW!** When billed,
remit or return book.

**HAYDEN BOOK
COMPANY INC.**
50 Essex Street,
Rochelle Park, N.J.
07662



MODULES & SUBASSEMBLIES

Synchro BCD converters are in single modules



Control Sciences, 8399 Topanga Canyon Blvd., Canoga Park, CA 91304. (213) 887-7344. \$400 to \$450; stock.

Two series of miniature, high performance, single-module synchro-to-BCD tracking converters accept three-wire synchro or four-wire resolver input data over a frequency range of 50 to 1200 Hz. The converters are self-contained and do not need any external transformers at the lower frequencies. Packaged in a 3.125 x 2.62 x 0.82-in. module, the units supply either unipolar or bipolar outputs. The four-decade-output Type 168C650 provides angular displacement data from 0 to 359.9° or ±179.9° with an accuracy of ±6 min ±0.9 LSB, while the 3-decade Type 168C750 outputs 0 to 359° or ±179°, accurate to ±30 min ±0.5 LSB.

CIRCLE NO. 330

Medium speed printer handles 18 columns



Keltron, 225 Crescent St., Waltham, MA 02154. Ted Chadurjian (617) 894-0525. See text; 4 to 6 wks.

The DM300 series are medium-speed, 3-line per s printers, capable of printing up to 18 columns. The print drums come with 13 positions per column and can print 40 different characters and numbers. Input is in serial form at TTL levels in BCD code. An internal shift register is provided and the input is stepped through the register on receipt of a clock or strobe signal. Pricing (100 qty) is \$325 for a cased model and \$275 for an OEM version. The size is 5.25 x 7.5 x 10 in.

CIRCLE NO. 331

Fiber-link aided by terminator tool

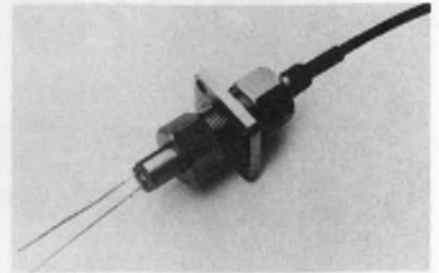

Ammark, P.O. Box 608, Litchfield, CT 06759. (800) 243-5252. See text.

The Fiber-Link 3100 range of high-precision transmitters-and-receive-module connectors are for use with the 1-mm diameter polymer fibers in the construction of short-haul data links. A coupling loss of 2 dB is achievable using the specially developed automatic-terminator tool. Using this device, low-loss terminations can be made by unskilled personnel in less than 15 s without any requirement for polishing. The parts for a basic 10-m link are priced at under \$60.

CIRCLE NO. 332

PCM filters are telephone quality

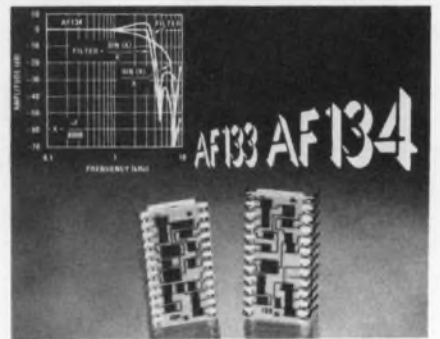

National Semiconductor, 2900 Semiconductor Dr., Santa Clara, CA 95051. Mike Turner (408) 737-5854. \$9.95 to \$12.50 (100 qty); stock.

AF130 pulse-code-modulation filters meet the two-wire and four-wire requirements for amplitude and phase delay plus the life expectancy and quality required for telephone-line transmission. The AF133 and AF134 are transmit and receive filters for 8-kHz sample-rate PCM systems. The AF133 has a bandpass ripple of ±0.125 dB from 300 to 3000 Hz, a max attenuation of 0.9 dB at 3400 Hz. At 4000 Hz min attenuation is -15 dB. Above 4600 Hz, min attenuation is -32 dB. The AF134 receive filter provides compensating "peaking" for the Sine x/x attenuation of zero-order-hold sampled-data recovery systems.

CIRCLE NO. 333

When your show must go on,

In an industry where aspiring new IC's emerge daily, it helps to know there's an old pro **D/A converter** you can count on to carry the show.

Our DAC-100, introduced in 1970 as the **AIM DAC**, is an established performer. Proven in a multitude of applications ranging from avionics to commercial monitoring equipment, it's available in over 50 varieties. There are 4 nonlinearity specs, 2 full scale output options, 4 T.C. choices. Temp ranges include $-55^{\circ}\text{C}/+125^{\circ}\text{C}$, $-25^{\circ}\text{C}/+85^{\circ}\text{C}$, and $0^{\circ}\text{C}/+70^{\circ}\text{C}$.

The DAC-100 cuts heat and cost dramatically without sacrificing speed or performance. Its fast settling time will give you more data per second. So our DAC-100 doesn't need to prove itself a star. It has already played the circuit.

Free App. Notes

We have a great bunch of Applications Notes supporting the Old Pro. We'll be glad to send them to you. Just write, phone or TWX us. The numbers are below.

call in our Old Pro.



Precision Monolithics, Incorporated
1500 Space Park Drive, Santa Clara, CA 95050
(408) 246-9222. TWX: 910-338-0528
Cable MONO.

CIRCLE NUMBER 72

MODULES & SUBASSEMBLIES

DPM changes ranges automatically



International Microtronics, 4016 E. Tennessee St., Tucson, AZ 85714. Otto Fest (602) 748-7900. \$124; stock to 4 wks.

When signals exceed the set range of the 300-Series DPM, it automatically shifts to the next-higher range. The DPM has four ranges: 200 mV, 2 V, 20 V and 200 V. Decimal points are positioned automatically and step-up or step-down response time is 360 ms.

CIRCLE NO. 334

High-output linear amp provides wide bandwidth

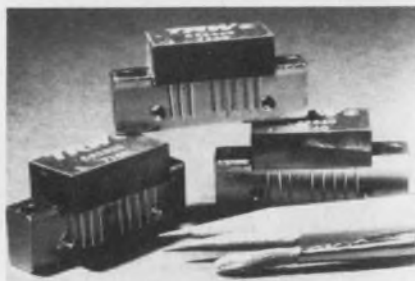

TRW RF Semiconductors, 3435 Wilshire Blvd., Los Angeles, CA 90010. Don Feeney (213) 679-4561. \$23.28; stock to 2 wks.

A linear hybrid amplifier, CA2820, combines wide bandwidth and high output power. The amplifier operates from 5 to 500 MHz with a flatness of ± 1.5 dB. Typical output pk envelope power is 400 mW. The device is internally matched for 50- Ω impedance and has a min third-order intercept of 35 dBm. Gain at 100 MHz is 30 dB. The CA2820 operates from a 24-V dc power supply. The input and output return loss ratio is held to 2:1 over the entire bandwidth.

CIRCLE NO. 335

SSB modulator has 1-octave bandwidth

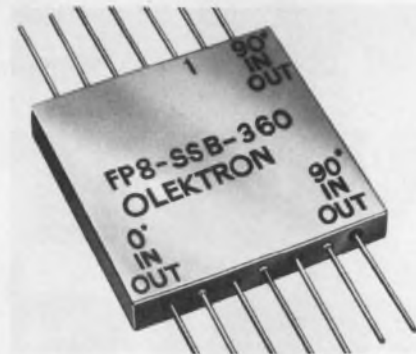

Olektron, 6 Chase Ave., Dudley, MA 01570. (617) 943-7440. \$115; 3 to 4 wks.

Model FP8-SSB-360 single-sideband modulator has an rf bandwidth of one octave centered on any selected center frequency from 10 to 500 MHz. The modulation bandwidth is dc to 500 MHz and conversion loss is less than 10 dB. Carrier suppression is 40 dB with a sideband level 30 dB below the desired output level and an rf level of up to 0 dBm. The modulator has two modulation-input ports that must be excited in phase quadrature for normal operation. The size is 0.81 \times 0.81 \times 0.145 in.

CIRCLE NO. 336

New Shapes For '78

We are proud to introduce our new collection of VEROBOXES[®] for 1978 — consisting of seven styles in over 20 convenient sizes. Pictured here is the sloping front ABS vacuum formed box, available in two sizes (one is even big enough for a full typewriter keyboard) and the hinged, one-piece, dust-free 'Flip Top' box molded from tough polypropylene. Additionally, we are offering a new box with a battery compartment which is accessible from the outside (for both 9V and 1.5V) molded from Hi-Impact polystyrene and a strong, lightweight aluminum enclosure with black matte panels and brushed aluminum covers in three sizes. Our new 1978 catalog supplement outlining all of the specifications of these and the other new VEROBOXES is available upon request. Let us give a 'Custom' look to your company's component package.



Vero Electronics, Inc.

171 Bridge Road, Hauppauge, N.Y. 11787
Tel.: (516) 234-0400 TWX: 510-227-8890

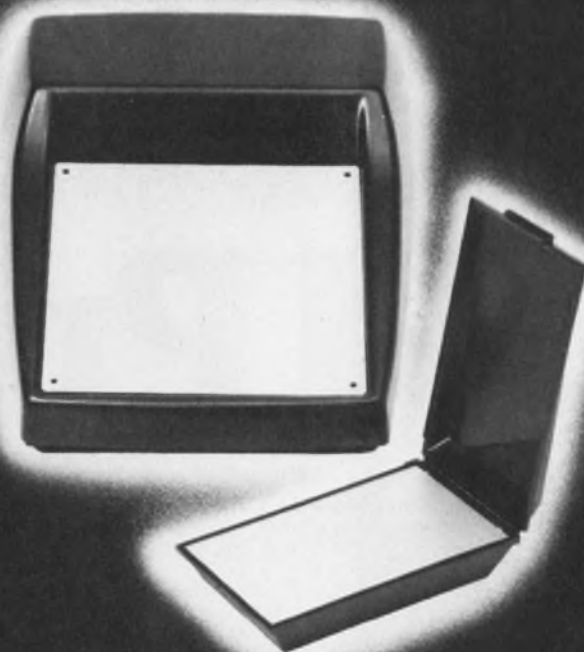

VERO LTD — SOUTHAMPTON, ENGLAND ■ VERO GMBH — BREMEN, W. GERMANY ■ VERO SA. — PARIS, FRANCE

CIRCLE NUMBER 133

IMAGINE YOUR PRODUCT AS A THERMOSET PLASTIC MOLDING



ROSITE® glass reinforced thermoset polyester moldings are produced by three different processes to provide the optimum levels of strength, accuracy and stability specified in the product design. In deciding whether to use the injection, compression or transfer process, factors such as material properties, required characteristics, design complexity, size, quantity and economics must be considered.

The most important benefit of the injection process is its efficiency for large quantities. Automation is inherent to the injection press, increasing productivity 25% to 30% over other processes, resulting in lower production costs.

Our compression process is primarily employed to obtain physical strengths comparable to metal fabrications. Because of the better orientation and greater amounts of glass fiber in the compounds we

can improve stress characteristics 25% to 400% over injection or transfer. With some special compounds, we can achieve superior strengths in excess of 100,000 psi, flexural and 40,000 psi, tensile. Compression molding is also chosen for larger sizes (up to 78" in length, 60" in diameter and 30" in depth), molded-in inserts and lower quantity economics.

Transfer molding is a major production process of ours to mold intricate configurations, control tighter tolerances (up to $\pm .0005$ in./in.) and minimize flash. Often, we can combine multiple components in one family mold. Complicated inserts can also be molded into parts, simplifying assembly operations.

Another and older process, cold molding utilizes less expensive materials in very fast molding cycles to form fairly complex

shapes for high temperature and arc quenching applications.

The net effect of using ROSITE moldings is a superior product design produced at a favorable cost with fewer production complications. A conversation with one of our sales engineers will give you a chance to examine the applicability of ROSITE moldings to your product design. Call us.

Rostone Corporation

2450 Sagamore Parkway South
Lafayette, Indiana 47902
317/474-2421

**CUSTOM ENGINEERED
PLASTIC MOLDINGS**

MOD-POT® offers still more. New switch. New conductive plastic element.

Allen-Bradley introduces a new rotary switch for the MOD-POT series. Designed for signal level circuits. Tested for current levels as low as 15 milliamps, with 5-volt open circuit. Plus new conductive plastic resistance elements with low turning torque for velvet-smooth rotation. And CRV of typically less than 0.2%. Linear and modified log tapers (CW and CCW) available from 100 ohms to 1 megohm. All feature smooth characteristics, particularly at resistance roll-on and roll-off positions. Come to the original source for MOD-POTS. We have what you need; our distributors have them when your need is now. Ask for Publication 5217.

Low detent torque
and low contact
resistance.

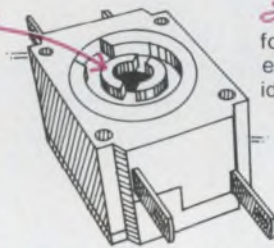

Smooth surface
for low turning torque,
excellent linearity and
ideal roll on/roll off.

*Variety of switch
options:* rotary
(CW or CCW actuation),
push-pull or momentary
push. Gang switching
capability.

*Vernier drives
and concentric shafts
also available.*

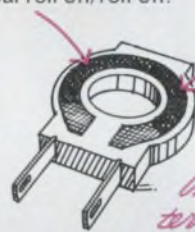

*Conductive plastic
resistance track
is embedded into
substrate.*

*Insert molded
terminals* Choice of
solder lug or PCB pins.

Quality in the best tradition.



ALLEN-BRADLEY
Milwaukee, Wisconsin 53204

CIRCLE NUMBER 123

EC165

C.P. CLARE'S μP KEYBOARD WITH REEDS. THE BEST OF THEM ALL.

Best μP.

Here's why. Its second-generation microprocessor has EPROM capability — real smarts. It gets us from your keyboard concept to a prototype design in record time. It enables completely customized software control of all key functions. You can program in automatic repeats, multiple program a single keyboard, program changes in the field. You can have 8-bit serial and/or parallel I/O. Three-key rollover is built in with N-key rollover possible. There are no compromises and the options are unlimited.

Best of both worlds.

Couple this μP with the unique low-profile reed switches we manufacture and you've got the best of two technologies — an unbeatable keyboard system. You know reed contacts are sealed against hostile environments. You know reeds are extremely dependable and stable. They'll switch faultlessly over 10^8 times. They are low in power consumption. And zero in power drain. Another key point: they've got the feel operators like, so speed and accuracy increase.

Best keytops.

C. P. Clare's keytops are non-glare, 2-shot molded. The legends sharp and clear for life. The colors lab-quality, 3-dimensionally controlled. Yes. 3-dimensionally controlled.

Best advice.

C. P. Clare's μP keyboard is the best of them all. But is it best for you? Call the C. P. Clare sales office nearest you and arrange to talk to a keyboard expert. He'll tell you honestly if it is, or if you'd be better off with another C. P. Clare keyboard design. Talk to him today. Or, if you prefer, write C. P. Clare and Company, 3101 W. Pratt Avenue, Chicago, IL 60645. Or call 312-262-7700.

We help you compete

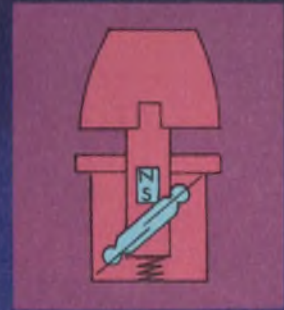

Height with keytop: $1\frac{1}{16}$ "



C. P. CLARE & COMPANY
GENERAL INSTRUMENT CORPORATION



The "INTELLIGENT" DVM's from Guildline

from \$

2995

G GUILDLINE

100.7065

MODELS 9575 / 9576

MEASUREMENT

dc voltage • ac voltage
resistance • 1pV sensitivity
auto and manual ranging
scale length 3½ digits to 6½ digits
hidden decades
396 readings/s at 3½ digits
51 readings/s at 5½ digits

PLUS

offset • multiplication • ratio
limits • percentage deviation
max, min, peak-to-peak
temperature • statistics
all under time control

with 4 systems } bcd
interfaces: } RS 232
 } IEEE/IEC

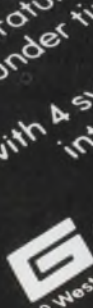

Guildline Instruments, Inc.
2 Westchester Plaza, Elmsford, NY 10523, (914) 592-9101

Available on GSA contract

Electro '78—Booths 2101,3

CIRCLE NUMBER 124

TELTONE INTRODUCES SOMETHING MORE FOR LESS.

We'd like you to meet our new M-907 Touch Tone* Decoder. It does everything a good DTMF decoder should do. And it does something other DTMF decoders don't do.

It counts rotary dial pulses.

But the M-907 does two jobs, so you get more for less.

You get a central office quality tone decoder *and* an accurate dial pulse counter in one low priced, ready to install package.

The heart of this new decoder-counter is a P-MOS L.S.I. chip that converts tones and pulses into three types of logic level outputs: Decimal, BCD, and 2 of 8. You also get dial tone rejection at no extra cost.

You may need only the chip to incorporate with your filter. We also offer the chip alone or with our

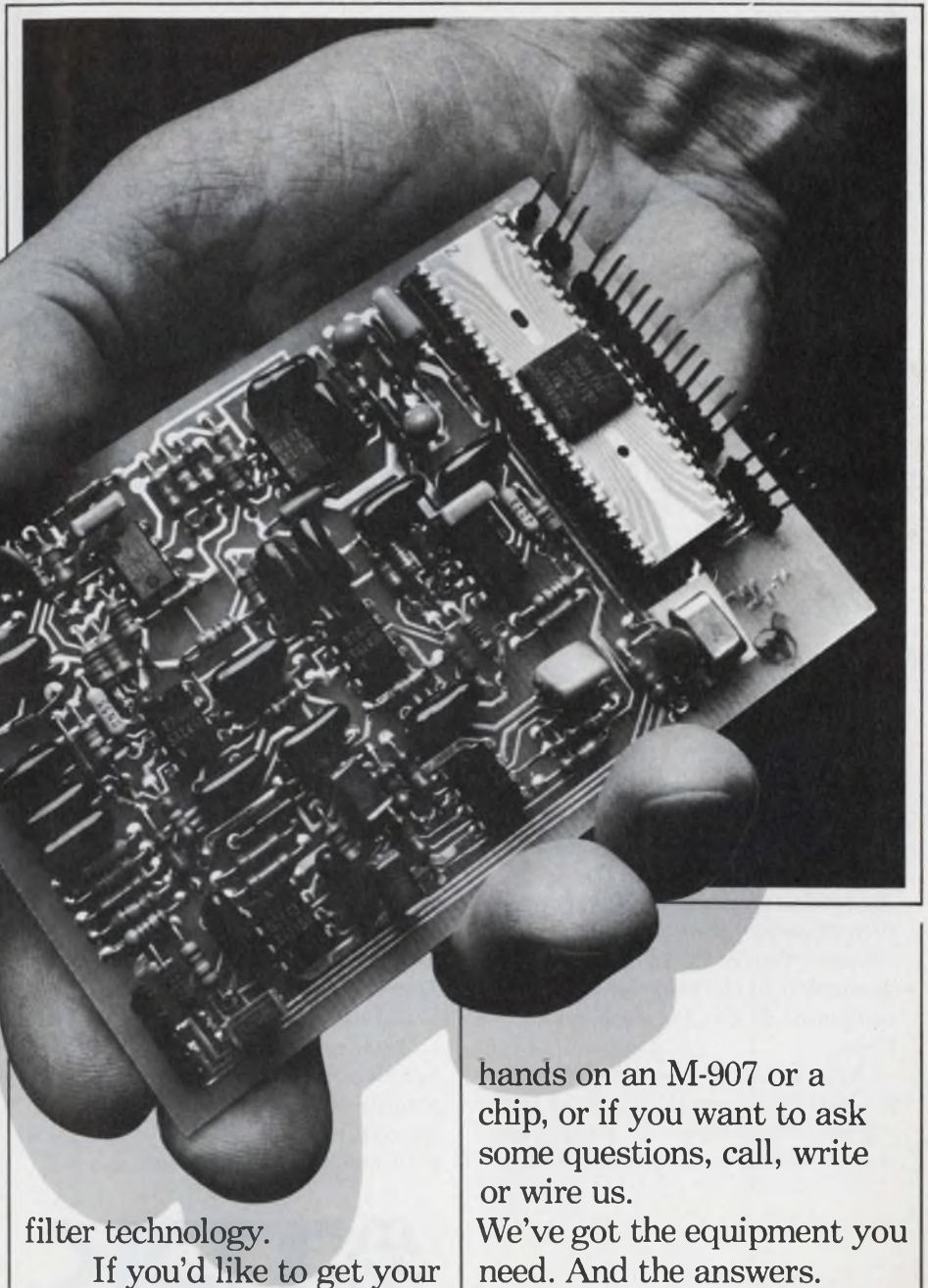

filter technology.

If you'd like to get your

hands on an M-907 or a chip, or if you want to ask some questions, call, write or wire us.

We've got the equipment you need. And the answers.

THE NEW M-907 TOUCH TONE DECODER

TELTONE®

Tel-Tone Corporation, 10801 120th N.E., Kirkland, Washington 98033/Phone (206) 827-9626/TWX (910) 449-2862
An equal opportunity employer. *Touch Tone is a registered service mark of A.T.&T.

CIRCLE NUMBER 125

PTC thermistors and piezoceramic materials. Two more of our many sound investments.



PTC thermistors and piezoceramic materials. Working their way to the top.

Our PTC thermistors are thermal resistors whose resistance increases when the temperature reaches a preset level. They do a solid job in current limiting, in constant temperature heaters and temperature detectors, etc.

Our piezoceramic materials are the workhorse of piezoceramic buzzers and ignition units for cigarette lighters. Designers of ultrasonic equipment find that the materials labor long and hard. They're on the job in TV remote control units, and ultrasonic transmission and reception equipment. Ultrasonic elements are picked for a wide variety of jobs, too.

For us, it all goes to show that our workmanship pays off.

Our heat-sensitive PTC thermistors and piezoceramic materials are destined to go places fast as their range of applications grows and grows. Actually, they're already on the move. Assemblers of electronic products and equipment all over the world go for them.

We're in our element when it comes to electronic materials. We've got quite a product repertoire. Like ferrite cores that are indispensable for circuits and

magnetic memories, ceramic capacitors, ferrite magnets for speakers and motors, absorbers that soak up electromagnetic waves, coils, transformers and filters. They bring in the orders because of their quality and overall performance.

We've also made quite a name for ourselves in cassette tapes. They're another offshoot of our magnetic material expertise and a popular choice with audiophiles in over 100 countries

throughout the world where good quality sound is in demand.

But to be frank, we have a 40-year head start in magnetic technology. Ever since 1935, our policy has been to create materials for tomorrow. And sell tomorrow's materials today. That's what we mean by sound investment. If you want to invest in your future with today's electronics materials, we'll be glad to hear from you.



TDK ELECTRONICS CO., LTD. 14-6 Uchikanda 2-chome, Chiyoda-ku, Tokyo 100, Japan Phone: Tokyo (03) 257-2525
TDK CORPORATION OF AMERICA 2041 Rosecrans Avenue, Suite 365, El Segundo, California 90245 U.S.A. Phone: (213) 644-8625 **CHICAGO BRANCH** 2906 West Peterson Avenue, Chicago, Illinois 60659 U.S.A. Phone: (312) 973-1222
NEW YORK BRANCH 755 Eastgate Blvd., Garden City, N.Y. 11530 U.S.A. Phone: (516) 248-5230
TDK ELECTRONICS CORP. (Handles recording tapes only) 755 Eastgate Blvd., Garden City, N.Y. 11530 U.S.A. Phone: (516) 746-0880
TDK DE MEXICO S.A. de C.V. (Handles ferrite magnets only) Carr. Juarez-Porvenir Parque Ind. A.J. Bermudez, Cd. Juarez, Chih. Mexico Phone: 3 88 27
MH&W INTERNATIONAL CORP. (Handles professional ferrites only) 14 Leighton Place, Mahwah, New Jersey 07430 U.S.A. Phone: (201) 891-8800 Telex: 134 484
MH&W INTERNATIONAL (CANADA) LTD. (Handles professional ferrites only) 6358 Viscount Road, Mississauga, Ontario, L4V 1H4 Phone: (416) 245-3606
MONTREAL 7575 Trans Canada Highway, Suite 305, St. Laurent, Quebec, H4T 1V6 Phone: (514) 331-2827

CIRCLE NUMBER 126

DESIGN BECKMAN CONVERTERS IN. DESIGN PROBLEMS OUT.

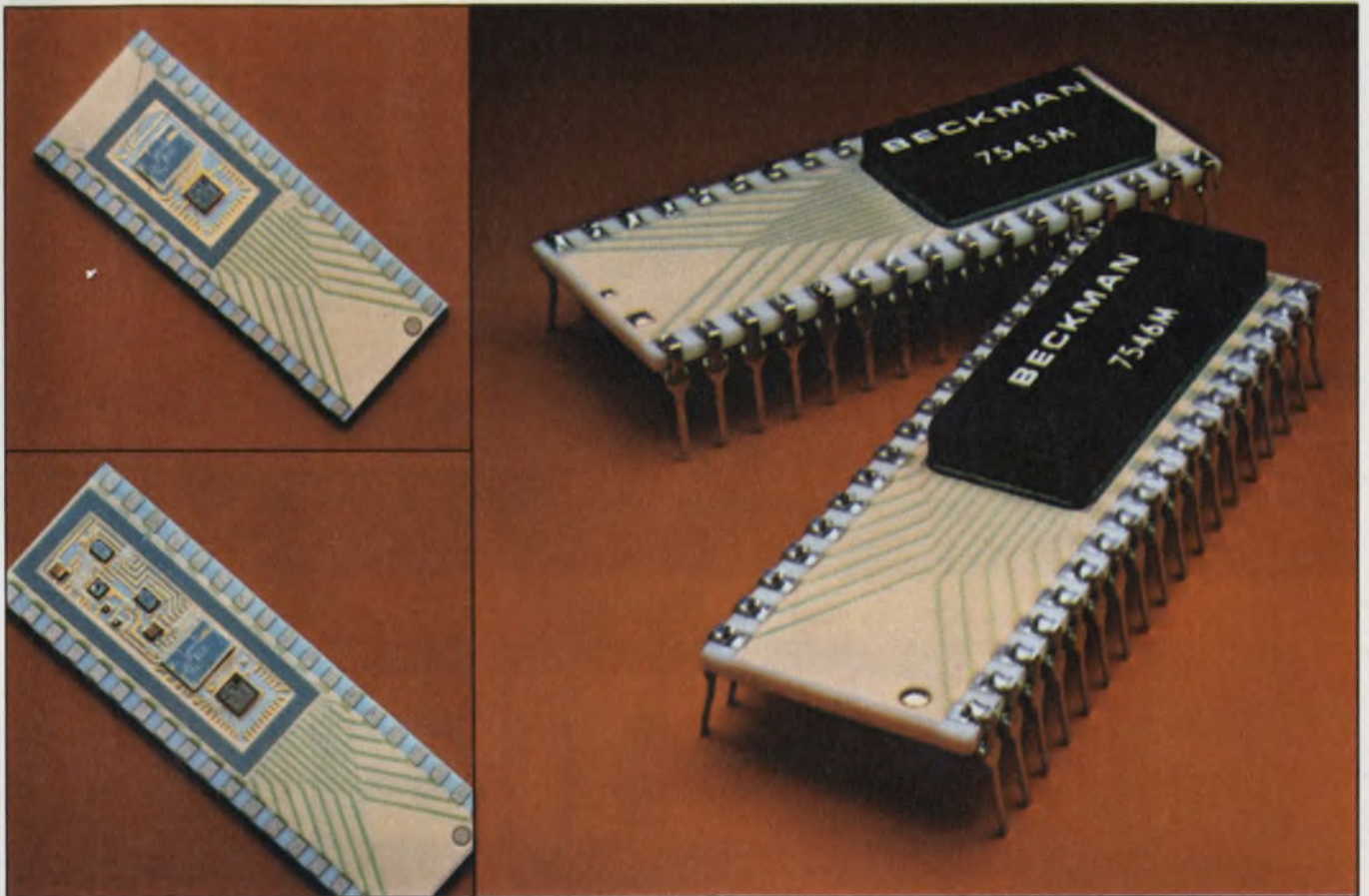

Our new line is 8-bit microprocessor compatible with true 12-bit performance. And that's not just another line.

Presenting our new CMOS 12-bit DACs and ADCs. They're the first to offer complete 8-bit microprocessor compatibility. Real 12-bit accuracy. And CMOS or TTL logic compatibility, all in a single competitively-priced package.

They're exceptionally accurate, so put them to your toughest test. We did. And that's why we can guarantee $\pm 0.012\%$ linearity over the full operating temperature range for each model in the 7545 or 7555 series. Gain and offset are also guaranteed over the full operating temperature range for the 7546 series. When you select 7546 DACs or 7556 ADCs with built-in reference and output buffers or comparators, gain and offset specifications are also guaranteed.

All series can operate in a serial or parallel mode. And they can be alternately switched from one mode to the other.

Both the DAC input registers and the ADC three-state output registers can accept either TTL logic levels using a +5 volt supply or CMOS logic levels using supply levels from +5 to +15 volts.

Simplify your 8-bit microprocessor interface. Put exceptional accuracy to work, and minimize your overall system error. Come to Beckman, the converter source. Call your local Beckman representative. To get his number, or immediate technical literature, call (714) 871-4848, ext. 1776. The price of designing accuracy in doesn't have to be out of hand.

BECKMAN®

CIRCLE NUMBER 127

8 Bit A to D/D to A Converter - the first priced at only \$4.50*

The Ferranti Model ZN425E—an 8 bit dual mode analog to digital/digital to analog converter features:

- Single chip monolithic construction
- Typical settling time 1.0 μ s for 1 L.S.B. step
- 8 bit binary counter, R-2R ladder network and switches
- On-chip precision voltage reference
- Self-contained, precision ramp generator
- TTL and CMOS compatible



better by design



FERRANTI
semiconductors

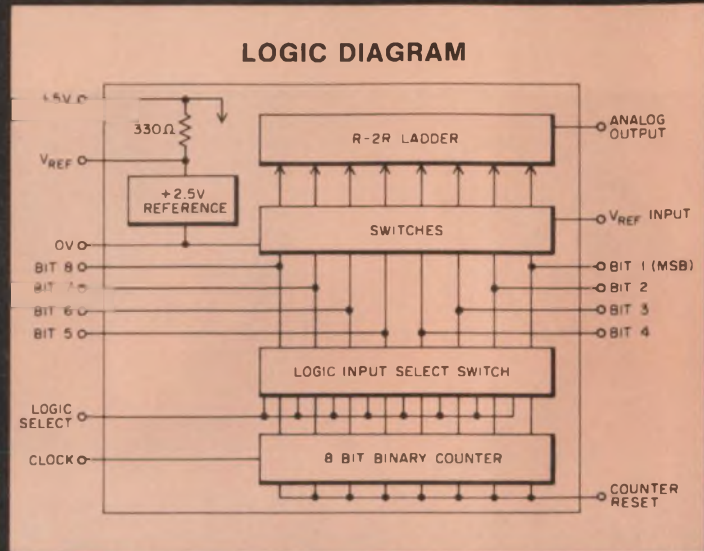

*1000 piece price

FOR COMPLETE SPECIFICATIONS, CONTACT: FERRANTI ELECTRIC, INC. / SEMICONDUCTOR PRODUCTS
EAST BETHPAGE ROAD, PLAINVIEW, NEW YORK 11803 PHONE: (516) 293-8383 / TWX: 510-224-6483

CIRCLE NUMBER 128

VARIETY

ESSEX/SUFLEX has a wide selection of Astratite[®] heat shrinkable tubing to insulate and protect circuits, wiring harnesses, fuses, diodes, capacitors, terminals and junctions.

Polyolefin very flexible, flexible or semi-rigid . . . lower cost Polyvinyl Chloride tubings (cross-linked and non cross-linked) standard wall or thin wall . . . greater or lesser than 2:1 recovery ratio. All from one source — Essex/Suflex. And most of these Astratite versions are UL listed.

Samples, property data and prices available from 29 Essex/IWI Warehouse/Sales Centers and many independent distributors — or contact: Essex Magnet Wire & Insulation Division, Essex/Suflex, Newmarket, N.H. 03857, Phone: 603/659-5555.

ESSEX
GROUP



Subsidiary of
UNITED
TECHNOLOGIES

CIRCLE NUMBER 129

Motorola pipes up with the very latest thing in BIFET technology.

Delivery.

The pipe is full and overflowing!

Supported by substantial inventory and a full production pipeline, Motorola now has major-source capability for supplying 12 variations of LF155/156/157 BIFET series *immediately*.

Because we intend to be your No. 1 BIFET supplier before others can say "where-did-they-come-from," we have ensured total warehouse availability of plastic and metal devices before turning on the valve. We're ready for those BIG orders that may choke our competitors' plumbing.

It looks like we'll be the only real supplier of 8-lead ceramics, too, while only one other source makes B-suffix types, two sources won't touch the '157 series and four manufacturers aren't supplying plastic. Motorola's got all three temperature versions, plus plastic DIP. And we'll have A-suffix versions soon.

We're out to flood the market with the best BIFETs the least money can buy! Contact your franchised Motorola distributor or Motorola Semiconductor Products Inc., P.O. Box 20912, Phoenix, Arizona 85036.



And you thought the Alaskan pipeline was full!

MOTOROLA

Semiconductor Group

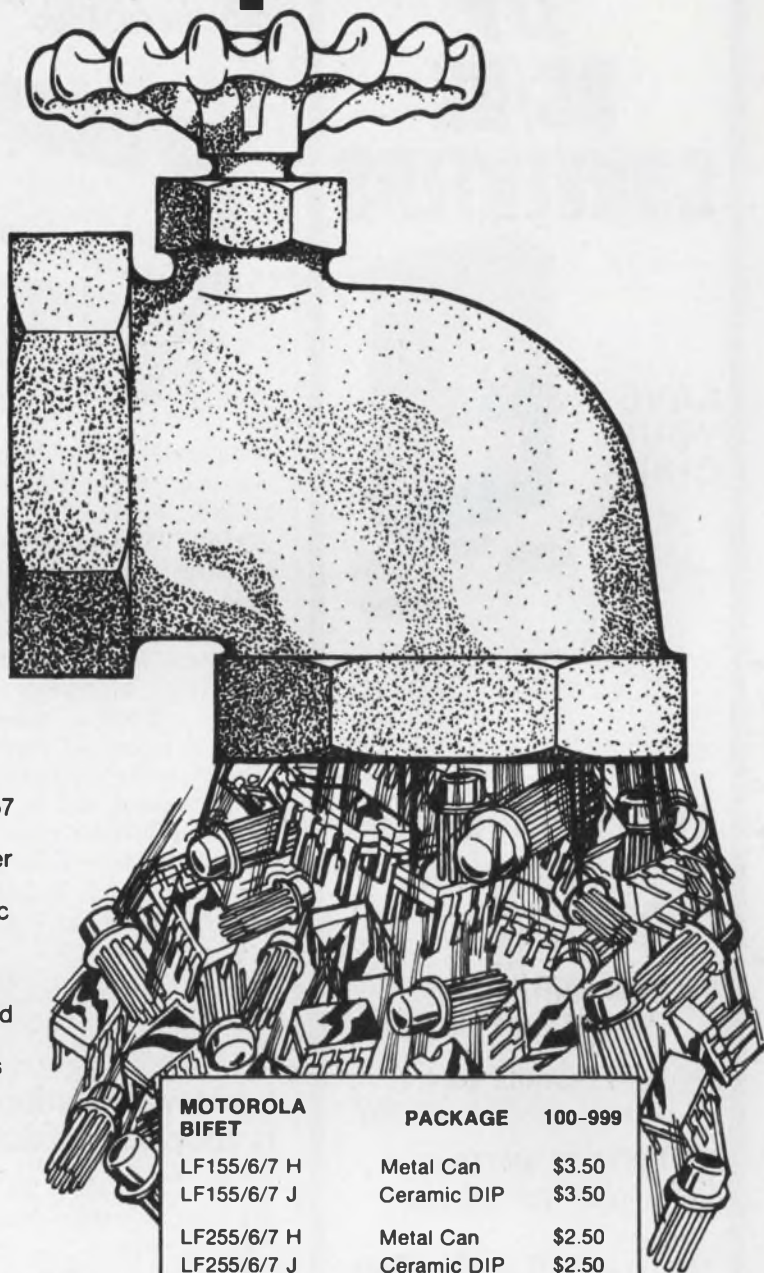

MOTOROLA BIFET	PACKAGE	100-999
LF155/6/7 H	Metal Can	\$3.50
LF155/6/7 J	Ceramic DIP	\$3.50
LF255/6/7 H	Metal Can	\$2.50
LF255/6/7 J	Ceramic DIP	\$2.50
LF255/6/7 N	Plastic DIP	\$1.85
LF355B/6B/7B H	Metal Can	\$1.45
LF355B/6B/7B J	Ceramic DIP	\$1.45
LF355B/6B/7B N	Plastic DIP	\$1.10
LF355/6/7 H	Metal Can	\$1.05
LF355/6/7 J	Ceramic DIP	\$1.05
LF355/6/7 N	Plastic DIP	\$.75

Metal Can



Plastic DIP



Ceramic DIP

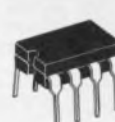

true μP DC/DC CONVERTERS

SAVE
YOUR
CHIPS...



...AND
YOUR
INPUT
SOURCE

The U, CU Series

- INPUT PROTECTION:
Over/Under Voltage
Shutdown-Standard
- CHIP PROTECTION:
Clamped Logic Outputs
- INPUT RANGE TO 4:1:
9-36V...18-72V...28-90V
- UP TO 25 WATTS OUT:
Singles-Triples-Quads

See Us in EEM and Gold Book

Get The Facts Fast. Circle the number for Free Catalog. We'll also include the new issue of our power supply journal,

WATTS UP



**SEMICONDUCTOR
CIRCUITS, INC.**

218 RIVER ST., HAVERHILL, MA 01830
Tel. (617) 373-9104, TWX. 710-347-0269

CIRCLE NUMBER 74

MODULES & SUBASSEMBLIES

High-speed a/d processes video



Datel Systems, 1020 Turnpike St., Canton, MA 02021. Eugene Zuch (617) 828-8000. \$1995.

ADC-TV8B is an 8-bit (48-dB) a/d converter with a conversion rate of 20 MHz. The converter is useful for video applications such as digital time-base correctors, frame synchronizers, special-effects processors and digital radar systems. Customer-supplied start-conversion pulses adjust throughput for any rate up to 20 MHz. Characteristics can be optimized at popular conversion rates of 14.3 MHz (17.72 MHz), four times the color sub-carrier frequency. A choice of analog input ranges include 0 to 1, 0 to 2, 0 to 5, ±1, ±2 or ±5 V.

CIRCLE NO. 337

Low-level isolation amp is chopper stabilized

Analogic, Audubon Rd., Wakefield, MA 01880. Bill Domenico (617) 246-0300. \$119.

A precision isolation amplifier is chopper stabilized and amplifies inputs ranging from 10 to 100 mV. The MP225A provides 160 dB of isolation and shielding between input and output and rejects common-mode voltages up to 1000-V pk. The linearity is within 0.015% of full scale (FS). Gains from 100 to 1000 are programmed by a single external resistor. Noise is less than 1 μV from dc to 5 Hz, common mode impedance is 1000 MΩ and output impedance is 0.1 Ω. Offset tempco is ±0.5 μV/°C and gain tempco is ±20 ppm FS/°C. The unit is packaged in a shielded module: 2 × 2.4 × 0.5 in.

CIRCLE NO. 338

Sealed module converts dc to synchro input

General Magnetics, 211 Grove St., Bloomfield, NJ 07003. (201) 743-2700. \$550; 6 wks.

The MAC 1562-1 dc-to-synchro converter is housed in a hermetically sealed container measuring 3.925 × 2.9 × 0.7 in. The module provides 0.5-VA full-power output at 400 Hz and requires ±15 V dc at 100 mA for full load with a 26-V, 400-Hz reference. The output is insensitive to 10% reference-voltage variations. Specs include an accuracy of 15 minutes of arc, full range dc inputs of ±10 V for a transfer function of ±18°/V and a tracking accuracy of 720°/s.

CIRCLE NO. 339

Minirecorder provides thermal-edge printing

MFE, Keewaydin Dr., Salem, NH 03079. Jim Muckenhoupt (603) 893-1921. \$525; 6 to 8 wks.

Alphanumeric thermal-edge printing is available on the M1-40 DCM miniature 40-mm dc recorder. The hardware fits into the direct-writing instrument. The edge printing provides simultaneous display of supplementary information in conjunction with the analog trace. The recorder uses inkless thermal writing and has 5, 10, 25 and 50 mm/s speeds. Operation is from 10 to 14 V dc with a 1-cm frequency response to 110 Hz. Amplifier sensitivity is 100 mV/cm with a 100-kΩ input impedance. The size is 3.8 × 2.5 × 5.8 in.

CIRCLE NO. 340

Modem filters handle 60 to 600-baud data

Frequency Devices, 25 Locust St., Haverhill, MA 01830. W. Morse (617) 374-0761. \$19.00 (100 qty); 2 to 4 wks.

A more than 100-member family of fixed-frequency active modem filters includes models for standard CCITT 60, 75, 110, 150, 300 and 600-baud applications. The 534 types are precisely defined bandpass filters whose center frequencies have an inverting mid-band gain of 0 ±0.5 dB. Relative to the midband gain, the filters attenuate the in-channel space and mark frequencies by no more than 1.5 dB, while attenuating space and mark frequencies of adjacent channels by 28 dB min.

CIRCLE NO. 341

Robert Bosch Mini-Giants™ in a nutshell



Actual Size

Smallest 30-amp, quarter-million-cycle relay for the price

Capacity. Plug-in Mini-Giants rated at 30 amps, with 60-amp peak. Standard PC board rated at 15 amps, with 30-amp version also available.

Size. PC relay is 0.56 cubic inch. Plug-in is 0.8 cubic inch. Both measurements less terminals.

Switching life. All Mini-Giants built for 250,000 cycles at full rated load (or 10 million at no load). This compares to 100,000 cycles in many comparable relays from other makers.

Versatility. Mini-Giants can be used in 6, 12 or 24 VDC applications: remote controls, alarms, car systems, agricultural and construction equipment, and much more.

Cost. Mini-Giants give you all these features combined at a surprisingly low price. Fill out this coupon and we will contact you to discuss your specific needs. Or call Dave Robson at (312) 865-5200 and ask about relays. Either way, do it now.

Name _____

Title _____

Company _____

Address _____

City, State, Zip _____

Phone _____

ROBERT BOSCH
CORPORATION

2800 S. 25th Ave., Broadview, IL 60153

Attn: O/ESL3-Relay Sales

© 1978 Robert Bosch Corporation

101



THERMALLY SENSITIVE THICK FILM RESISTOR PASTES

Screen Printed Resistors with NEGATIVE or POSITIVE TCR.

- Compensate for, or match, resistance-temperature traits of other circuit components.
- Sense critical threshold levels.
- Counteract gain changes from temperature variations in communication channel circuits.
- Trigger circuit or device functions.

RESISTIVITY:
100 to 1,000,000 ohms/square

TCR:

- **850-N Series** -1000 to -6000 ppm/°C.
- **850-P Series** +1000 to +3500 ppm/°C.

LINEAR TCR

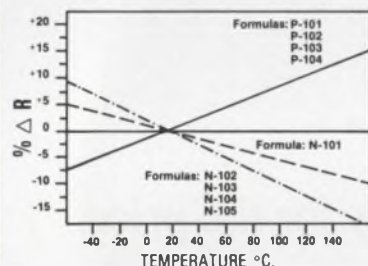

FEATURES:

- **TFS Fast Fire**—25 Minute Cycle.
- **Fires at 850°C**—compliments other 850°C resistor systems.
- **TFS Thin Resistor**—10 micron thick for fast trimming with laser or abrasive trimmers.
- **Sharp**—reproducible prints with **PARTILOK®** screening vehicle—never a need to jar roll or stir the paste.
- Tailored to Pd-Ag, Pt-Ag or gold bearing conductors.



for full information contact
THE PASTEMAKER

THICK FILM SYSTEMS, INC.

324 PALM AVE., SANTA BARBARA, CA 93101
TEL: (805) 963-7757

CIRCLE NUMBER 76

MICRO/MINI COMPUTING

Memory cassette has 50% greater capacity

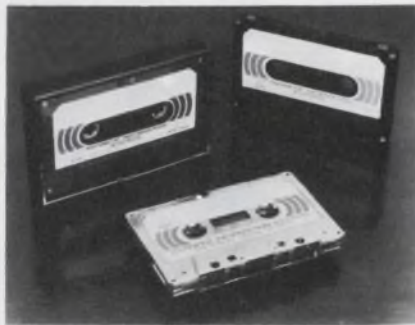

Magnetic Information Systems, 415 Howe Ave., Shelton, CT 06484. (203) 735-6477. From \$2.75 (unit qty); stock.

An extended memory cassette contains 450 ft of tape instead of the usual 300 ft and requires no changes to the cassette machine or system. A new thinner Mylar tape is used to produce the extended cassette. With a special carbon coating, recording accuracy is assured. After many tests including a life test of 10,000 passes, the tape proved to have the same tensile strength as standard tape.

CIRCLE NO. 342

Easy-to-use μ C teaches basic concepts



Energy Electronic Products, 6060 Manchester Ave., Los Angeles CA 90045. (213) 670-7880. \$229.

An easy-to-use microcomputer, the KX-33B, is intended to teach the basic concepts of computer technology, including the execution of functions by combining instructions with input signals. Basically a controller, the KX-33B is built around the Panasonic 4-bit MN1400 microprocessor. In addition to the ALU, the chip includes a 1024 \times 8 ROM for the system program and a 64 \times 4 RAM that stores keyboard data. Also included are an 8-bit latch, audio amplifier, multivibrator ICs and a speaker.

CIRCLE NO. 343

μ C mainframe includes control panel



Zeda Computer Systems, 666 N. 380 W., Provo, UT 84601. Aaron Davis (801) 377-4465. \$1600; stock.

Zeda-80 is a 4-MHz, Z80-based microcomputer mainframe with an intelligent control panel. The panel displays and alters the contents of registers or memory, reads input ports, writes to output ports and searches memory. The panel also sets multiple break points and bootstrap loads floppy-disc or cassette operating systems. Data entry and display is done in hexadecimal. Operation modes include run, slow execute, single instruction and trace.

CIRCLE NO. 344

Arithmetic processor mates with Z80

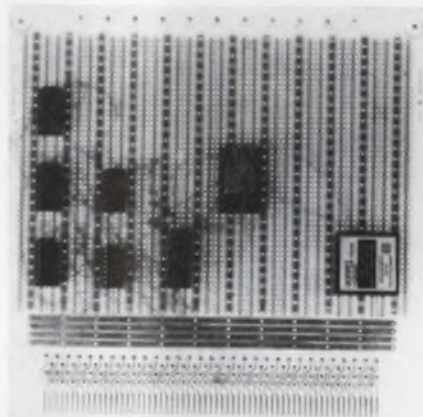

Signal Laboratories, 202 N. State College Blvd., Orange, CA 92668. Bill Chidester (714) 634-1533. \$749; stock.

Fully compatible with the Z80 MCB, this high-speed arithmetic processing unit board (HAPUB) provides the hardware necessary to accomplish arithmetic, trigonometric, inverse trigonometric, logarithmic, exponential and square-root functions. Also provided are fixed-point integer, single and double precision (16 or 32 bit) and floating-point, single precision (32 bit) operation with bidirectional conversion capability from one to the other. The HAPUB is compatible with the Zilog Z80 card cage and 8-bit bidirectional data bus, through which all data and command transfers occur.

CIRCLE NO. 345

Want high accuracy at low cost?

Try our 9400 V/F, F/V converter

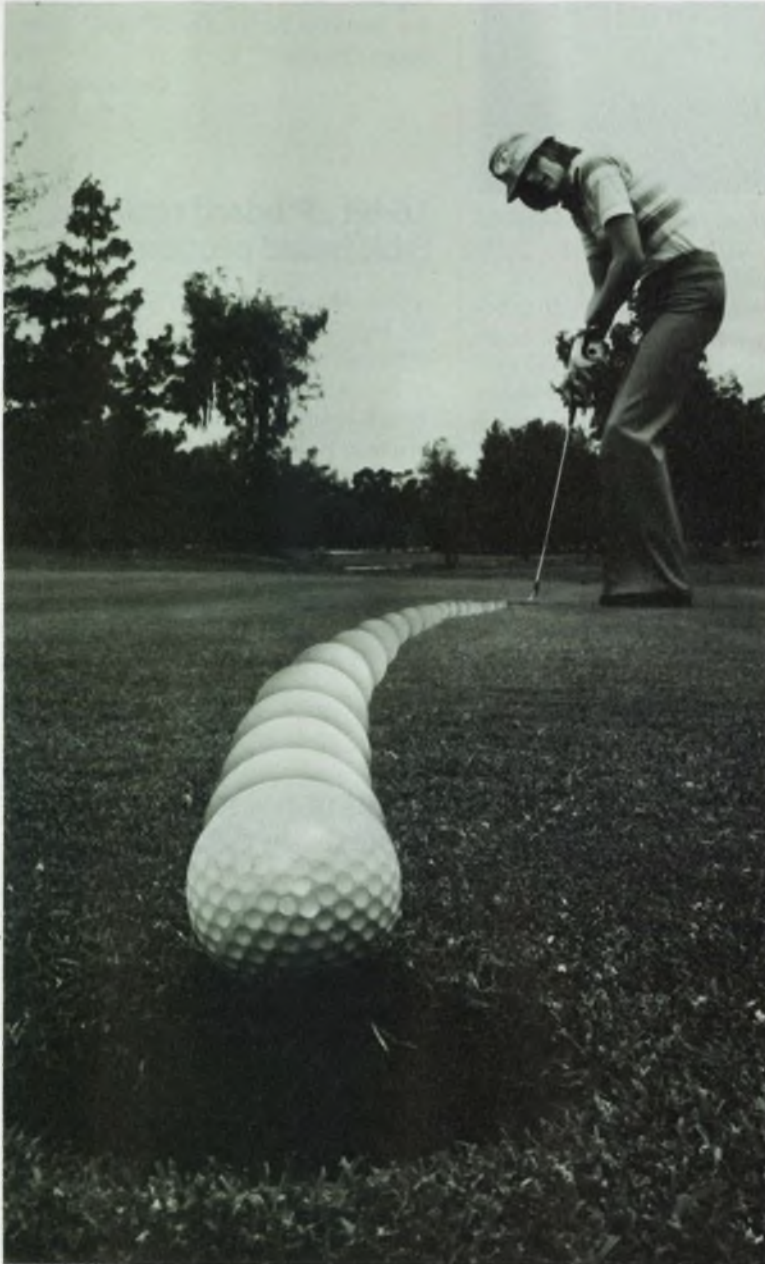

You may find another voltage-to-frequency converter as accurate as ours. You may even find another as inexpensive. But for accuracy at cost (price/performance), the Teledyne 9400 stands alone. Compare these qualifications:

Linearity: 0.01% to 10 KHz; 0.1% to 100 KHz.

Cost: Just \$3.70 each in 1K quantities.

Versatility:

Operates in either V/F or F/V mode.

Operates on either single or dual power supply.

Low power dissipation: 20mW.

Pulse and square wave outputs (V/F).

Op amp output (F/V).

Simplicity: Just add 2 capacitors and 3 resistors.

The Teledyne 9400 combines bipolar and CMOS technology on a single chip for maximum performance. Some popular applications include 13 bit A/D converters, 4-digit panel meters, μ P data acquisition, analog data transmission, weighing systems, temperature sensing and control, speed sensing and control, frequency meters.

If you'd like a data sheet and 8-page application note, please contact us at the address below, or call (415) 968-9241, X 241. Ask for Michael Paiva.



TELEDYNE SEMICONDUCTOR

1300 Terra Bella Avenue, Mountain View, California 94043 • (415) 968-9241

SALES OFFICES: DOMESTIC: Salem, N.H. (603) 893-9551; Stony Brook, N.Y. (516) 751-5640;

Des Plaines, IL (312) 299-6196; Los Angeles, CA (213) 826-6639; Mountain View, CA (415) 968-9241

INTERNATIONAL: Hounslow, Middlesex, England (44) 01-897-2503; Tiengen, West Germany 7741-5066;

Kowloon, Hong Kong 3-240122; Tokyo, Japan 03-403-8141

CIRCLE NUMBER 77

Hybricon delivers the practical solution to building wire wrapped μ P interface circuits.

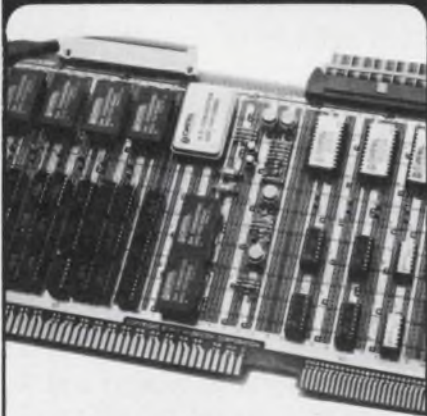

Until now design engineers had basically two choices when building wire wrapped microprocessor interface hardware —

*The cheap and dirty kluge board
or*

*The expensive and usually inflexible
socket pin board.*

HYBRICON has solved this dilemma with
THE MICRODESIGNER BOARDS

featuring —

- Bus compatibility with the Z80, 8010, 6800 and others
- Multiple uncommitted V_{CC} and gnds
- .3", .4", .6", and .9" spacing to accommodate all popular DIP packages
- Pins in the I/O, V_{CC} and gnd locations only for economy and flexibility
- Designer documentation aids
- A complete line of accessories

Call or write Dan Murphy,
Hybricon Corporation or your
nearest sales representative.

 **HYBRICON CORPORATION**

410 Great Road • Littleton, Massachusetts 01460
Telephone: (617) 486-3174

CIRCLE NUMBER 78

MICRO/MINI COMPUTING

Bank-switchable ROM plugs into LSI-11s

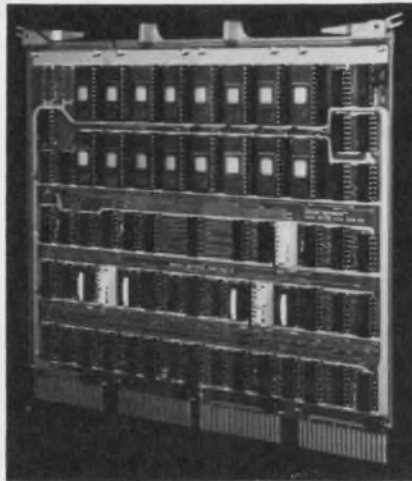

Digital Pathways, 4151 Middlefield Rd., Palo Alto, CA 94306. (415) 493-5544. \$695.

The bank-switchable ROM-016 functions within DEC LSI-11 based computers. On a single quad-board, the system accommodates up to 16,384 16-bit words that have been programmed into Intel 2716 EPROMs or 2316E ROMs. The memory is physically divided into four independent blocks, each containing 4 kwords. Each of these blocks can be enabled and assigned a portion of the available address space through either a set of manual switches or a device register. A computer with limited address space can make use of extensive libraries of routines far in excess of normal capacity by selectively enabling one or more blocks while disabling the remaining unused blocks.

CIRCLE NO. 346

5 Mbyte add-on memory cycles in just 450 ns

Mostek, 1215 W. Crosby Rd., Carrollton, TX 75006. Bill Smith (214) 242-0444. See text; 8 wks.

The MK 8600 memory chassis has a total capacity of 5 Mbytes. The general purpose 12.25-in. chassis, with power, uses the MK 8000 memory card that includes $16\text{ k} \times 18$ to $128\text{ k} \times 24$ words of storage. Access time is 250 ns with a cycle time of 450 ns. The configuration of the chassis allows for up to 16 MK 8000 boards, plus error correction coding, and there are four additional slots for I/O. The price varies with memory and interface requirements.

CIRCLE NO. 347

Disc controller mates with PDP-11s

Rianda Electronics, 2535 Via Palma, Anaheim, CA 92801. (714) 995-6552. \$3300; 4 wks.

A cartridge disc controller, Model 14XX, is compatible with DEC PDP-11 computers. Either complete subsystems, including a selected disc drive, or only the controller with cable can be supplied. When DEC software compatibility is not required, the controller will interface with up to four 10-Mbyte dual-disc drives. The Model 14XX is supplied with a system unit suitable for installation in the PDP-11 computer chassis.

CIRCLE NO. 348

16-bit μ P board replaces 8-bit based processors

Alpha Microsystems, 17875 Sky Park N., Irvine, CA 92714. John French (714) 957-1404. \$1495; stock to 2 wks.

The AM-100, an S-100 compatible, 16-bit microprocessor board set, replaces 8-bit based processors and offers multitasking, multi-user time-sharing in a disc operating system environment. Using Western Digital's WD-16 microprocessor, the device provides 16-bit flexibility and speed with 11-digit floating point arithmetic capability and an on-board real-time clock.

CIRCLE NO. 349

Floating-point board mates with SBC 80

North Star Computers, 2465 Fourth St., Berkeley, CA 94710. (415) 549-0858. \$299 (kit), \$399 (assembled).

A hardware floating-point board (FPB-B) compatible with the SBC 80 is for fast floating point processing. The FPB-B performs decimal add, subtract, multiply and divide up to 50 times faster than 8080 software. Number representation is BCD and the precision is software selectable up to 14 digits. To perform an operation, the 8080 or Z80 processor passes the arguments and specifies the operation and precision to the FPB-B which executes the operation and returns the result to the processor. Approximately 1 k of memory is saved over using software arithmetic.

CIRCLE NO. 350

There are still some customs in this country well worth observing.



Good things can still come to you in small packages . . . whether it's a clever and trusty little data go-between, or the company that makes it.

We're small enough to chat with, but we're also large enough to respond quickly. No matter if the job's small or large, we'll take the design burden off your shoulders. After all, who's going to pass up the chance to get the custom product they want in a smaller size, in half the time, for a lot less money.

Besides our bulging shelves filled with already proven standard items, we also have produced over 500 custom designs for industrial and military applications.

Drop us a line or call. We'd love to tell you all about our customs that are well worth observing.

intech/function modules, 282 Brokaw Road, Santa Clara, CA 95050. (408) 244-0500. TWX: 910-338-0254

intech
function modules

CIRCLE NUMBER 79

Zeltex

14 BIT

HIGH PERFORMANCE

A^{TO}D

CONVERTERS

ONLY \$199*



You could pay that or more for just 12 bits. But with the ZAD3014, you get 14-bits—a cost-effective solution for a wide range of high performance applications.

The ZAD3014 delivers 14-bit resolution at conversion times of less than 100 μ sec. With four input ranges (+10V, +5V, 0 to 10V and 0 to 5V) and three output codes (unipolar binary, offset binary and 2's complement) to give you all the flexibility you need in a space-saving 3.5 cu. in. case.

Thin film resistors with low temperature coefficients insure that no codes are missed over the 0 to 70°C operating range. External zero and full scale adjustments are provided.

Is that all there is? No. Zeltex quality and reliability are built-in. As always.

*(100 unit qty.)

The Conversion Product Specialists
940 Detroit Avenue, Concord,
California 94518.
(415) 686-6660/TWX 910-481-9477

CIRCLE NUMBER 80

INSTRUMENTATION

Function generator gives three waveforms



Continental Specialties, 70 Fulton Terrace, New Haven, CT 06509. (203) 624-3103. \$74.95.

The Design Mate-2 provides sine wave, triangle and square-wave outputs. The sine-wave output has 2% max total harmonic distortion over the entire frequency range of 1 Hz to 100 kHz. The triangle wave linearity is 1% and the square wave rise and fall times are 0.5 μ s (max) with a 600- Ω termination. The frequency dial is calibrated at 10 Hz, 100 Hz, 1 kHz and 10 kHz, providing accuracies to 5% of the dial setting. Output amplitude is variable from 0.1 to 10 V pk-pk into an open circuit.

CIRCLE NO. 356

System tests memories of various types



Macrodata, P.O. Box 1900, Woodland Hills, CA 91365. (213) 887-5550. \$55,900; 12 wks.

The MD-207 system dynamically tests memory boards and complete memory systems. The system can test semiconductor, core, plated wire and bubble memories. Hardware includes a programmable, split-cycle clock generator with up to 32 independently programmable edges to handle the timing requirements of synchronous and asynchronous semiconductor memories. The tester can address 24-bits and offers a 144-bit algorithmic data I/O and full computer control.

CIRCLE NO. 357

Digital testing scope combines 3 functions



Biomation, 4600 Old Ironsides Dr., Santa Clara, CA 50505. David Blecki (408) 988-6800. \$8950.

The DTO-1 digital testing oscilloscope combines the functions of a comparison tester and a time-domain logic analyzer to automate the testing of digital-circuit-based equipment. It also provides many of the features of a normal bench oscilloscope. These capabilities are obtained in one unit that has microprocessor intelligence, a single signal-input probe, a trigger probe, a CRT display and oscilloscope-type controls for use in either manual or automatic modes. The DTO-1 stores reference logic signals in its integral magnetic tape unit.

CIRCLE NO. 358

Digital meter reads true-rms I, V and W



Clarke-Hess, 156 Fifth Ave., New York, NY 10010. (212) 255-2940. \$985; 4 wks.

The Model 255 is a broadband digital readout, true-rms reading volt-ampere-wattmeter. The meter measures voltage, current and power in low-power-factor and/or distorted waveshape circuits from dc to 100 kHz. From 30 Hz to 100 kHz the accuracy is $\pm 0.4\%$ of full scale. Full-scale current ranges are 5, 50, 500 and 5000 mA and voltage ranges are 20, 200 and 1000 V. Power values range from 10 mW to 5 kW.

CIRCLE NO. 359

How to tell a Super-VOM from just the everyday garden-variety Brand X.

ONLY THE SUPER-VOM (Triplett's New 60) HAS ALL THESE FEATURES:

X'TRA RUGGED CONSTRUCTION
(For an accidental drop up to a five-foot height)

BUILT-IN "CONFIDENCE-TEST"
for periodic meter reassurance checks after overload/drops.

OVERLOAD PROTECTED
All ranges; 3-fuse arrangement including diodes and 2 Amp./1000 V protection fuse.)

ANGLE-RANGE SELECTOR SWITCH
(Most VOM's have 2 or more. Single switch minimizes range selection errors)

SAFETY DESIGNED FOR YOU
(Completely insulated; new Safety Leads; prevents explosive arcs from high energy circuits up to 20 KW)

48" SAFETY ENGINEERED TEST LEADS
(Especially designed recessed safety connectors and heavily insulated alligator clips)

ONLY 2 RECESSED INPUT JACKS
(Makes lead changes unnecessary—Some VOM's have as many as seven)

DETENTED HANDLE POSITION



\$102

Nobody else offers these features in a VOM at any price. So for only \$102, the Model 60 is the safest, most versatile, most honestly priced quality VOM you can buy. And, for just \$8 more, you can have the Model 60-A that has 1 1/2% DC accuracy, plus a mirrored scale.

That's the kind of Triplett one-upmanship appreciated the world over by value conscious users in industrial production and maintenance, TV - Radio - Hi-Fi shops, vocational training and hobbyists, airconditioning, appliance and automotive service, R & D, and application engineering . . . anyone who wants to be more productive with the latest in VOM technology. Model 60 Type 2 Approved by MESA, Approval 2G-2880.

Drop in on your nearest Triplett distributor or Mod Center and drop the new Model 60. Ask for a no-obligation demonstration of every feature. Compare it with any other VOM. You'll know why Triplett Models 60 and 60-A eliminate over 90% of the costly repairs from VOM misuses. Cultivate a profitable habit for selecting Triplett design-firsts.

TT **TRIPLETT**
BLUFFTON, OHIO 45817
CIRCLE NUMBER 81

Triplett. The easy readers



wire wrapping center



for quality electronic parts and tools.

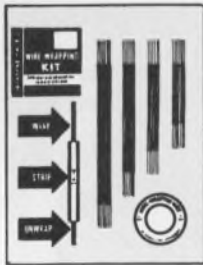

WIRE-WRAPPING KITS

Contains: Hobby Wrap Tool WSU-30, (50 ft.) Roll of wire Prestripped wire 1" to 4" lengths (50 wires per package) stripped 1" both ends.

Wire Wrapping Kit (Blue)	WK-2-B	\$12.95
Wire Wrapping Kit (Yellow)	WK-2-Y	\$12.95
Wire Wrapping Kit (White)	WK-2-W	\$12.95
Wire Wrapping Kit (Red)	WK-2-R	\$12.95

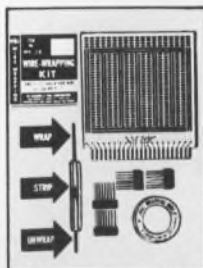

WIRE-WRAPPING KIT

Contains: Hobby Wrap Tool WSU-30, Roll of wire R-30B-0050, (2) 14 DIP's, (2) 16 DIP's and Hobby Board H-PCB-1.

Wire-Wrapping Kit	WK-3B (Blue)	\$16.95
-------------------	--------------	---------

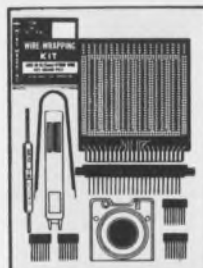

WIRE-WRAPPING KIT

Contains: Hobby Wrap Tool WSU-30 M, Wire Dispenser WD-30-B, (2) 14 DIP's, (2) 16 DIP's, Hobby Board H-PCB-1, DIP/IC Insertion Tool INS-1416 and DIP/IC Extractor Tool EX-1

Wire-Wrapping Kit	WK-4B (Blue)	\$25.99
-------------------	--------------	---------

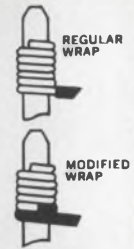

Wire-wrapping, stripping, unwrapping tool for AWG 30 on .025 (0.63mm) Square Post.

HOBBY WRAP TOOL

Regular Wrap	WSU-30	\$6.95
Modified Wrap	WSU-30M	\$7.95

NEW

HOBBY WRAP Model BW 630

Battery wire wrapping tool

COMPLETE WITH BIT AND SELECT



WIRE-WRAPPING TOOL

For .025" (0.63mm) sq. post "MODIFIED" wrap, positive indexing, anti-overwrapping device.

For AWG 30	BW-630	\$34.95*
For AWG 26-28	BW-2628	\$39.95*

Bit for AWG 30	BT-30	\$3.95
Bit for AWG 26-28	BT-2628	\$7.95

*USE "C" SIZE NI-CAD BATTERIES (NOT INCLUDED)



ROLLS OF WIRE

Wire for wire-wrapping AWG-30 (0.25mm) KYNAR® wire, 50 ft. roll, silver plated, solid conductor, easy stripping.

30 AWG Blue Wire 50ft. Roll	R 30B 0050	\$1.98
30 AWG Yellow Wire 50ft. Roll	R 30Y 0050	\$1.98
30 AWG White Wire 50ft. Roll	R 30W 0050	\$1.98
30 AWG Red Wire 50ft. Roll	R 30R 0050	\$1.98



WIRE DISPENSER

- With 50 ft. Roll of AWG 30 KYNAR® wire-wrapping wire.
- Cuts the wire to length.
- Strips 1" of insulation.
- Refillable (For refills, see above)

Blue Wire	WD-30-B	\$3.95
Yellow Wire	WD-30-Y	\$3.95
White Wire	WD-30-W	\$3.95
Red Wire	WD-30-R	\$3.95

PRE CUT PRE STRIPPED WIRE

Wire for wire-wrapping AWG-30 (0.25mm) KYNAR® wire, 50 wires per package stripped 1" both ends.



30 AWG Blue Wire 1" Long	30 B 50 010	\$1.99
30 AWG Yellow Wire 1" Long	30 Y 50 010	\$1.99
30 AWG White Wire 1" Long	30 W 50 010	\$1.99
30 AWG Red Wire 1" Long	30 R 50 010	\$1.99
30 AWG Blue Wire 2" Long	30 B 50 020	\$1.07
30 AWG Yellow Wire 2" Long	30 Y 50 020	\$1.07
30 AWG White Wire 2" Long	30 W 50 020	\$1.07
30 AWG Red Wire 2" Long	30 R 50 020	\$1.07
30 AWG Blue Wire 3" Long	30 B 50 030	\$1.16
30 AWG Yellow Wire 3" Long	30 Y 50 030	\$1.16
30 AWG White Wire 3" Long	30 W 50 030	\$1.16
30 AWG Red Wire 3" Long	30 R 50 030	\$1.16
30 AWG Blue Wire 4" Long	30 B 50 040	\$1.23
30 AWG Yellow Wire 4" Long	30 Y 50 040	\$1.23
30 AWG White Wire 4" Long	30 W 50 040	\$1.23
30 AWG Red Wire 4" Long	30 R 50 040	\$1.23
30 AWG Blue Wire 5" Long	30 B 50 050	\$1.30
30 AWG Yellow Wire 5" Long	30 Y 50 050	\$1.30
30 AWG White Wire 5" Long	30 W 50 050	\$1.30
30 AWG Red Wire 5" Long	30 R 50 050	\$1.30
30 AWG Blue Wire 6" Long	30 B 50 060	\$1.38
30 AWG Yellow Wire 6" Long	30 Y 50 060	\$1.38
30 AWG White Wire 6" Long	30 W 50 060	\$1.38
30 AWG Red Wire 6" Long	30 R 50 060	\$1.38

© KYNAR PENNVALT

MINIMUM ORDER \$25.00, SHIPPING CHARGE \$1.00, N.Y. CITY AND STATE RESIDENTS ADD TAX

OK MACHINE & TOOL CORPORATION
3455 Conner St. Bronx, N.Y. 10475 ■ (212) 994-6600 ■ Telex 125091



DIP/IC INSERTION TOOL WITH PIN STRAIGHTENER

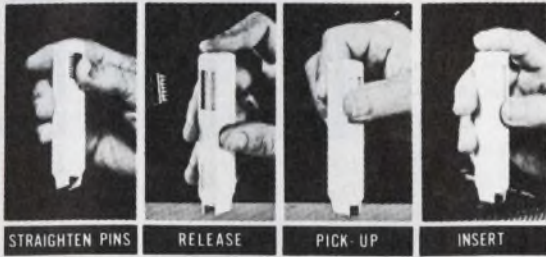

STRAIGHTEN PINS RELEASE PICK-UP INSERT

14-16 Pin Dip IC Inserter INS-1416 \$3.49

DIP/IC EXTRACTOR TOOL

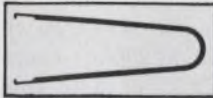

The EX-1 Extractor is ideally suited for hobbyist or lab engineer. Featuring one piece spring steel construction. It will extract all LSI, MSI and SSI devices of from 8 to 24 pins.

Extractor Tool EX-1 \$1.49

P.C. BOARD

The 4 x 4.5 x 1/16 inch board is made of glass coated EPOXY Laminate and features solder coated 1 oz. copper pads. The board has provision for a 22/44 two sided edge connector, with contacts on standard .156 spacing. Edge contacts are non-dedicated for maximum flexibility.



The board contains a matrix of .040 in diameter holes on 100 inch centers. The component side contains 76 two-hole pads that can accommodate any DIP size from 6-40 pins, as well as discrete components. Typical density is 18 of 14-Pin or 16-Pin DIPs. Components may be soldered directly to the board or intermediate sockets may be used for soldering or wire-wrapping.

Two independent bus systems are provided for voltage and ground on both sides of the board. In addition, the component side contains 14 individual busses running the full length of the board for complete wiring flexibility. These busses enable access from edge contacts to distant components. These busses can also serve to augment the voltage or ground busses, and may be cut to length for particular applications.

Hobby Board H-PCB-1 \$4.99

PC CARD GUIDES

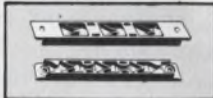

TR-1 consists of 2 guides precision molded with unique spring finger action that dampens shock and vibration, yet permits smooth insertion or extraction. Guides accommodate any card thickness from .040-100 inches.

QUANTITY - ONE PAIR (2 pcs.)

Card Guides TR-1 \$1.89

PC CARD GUIDES & BRACKETS



TRS-2 kit includes 2 TR-1 guides plus 2 mounting brackets. Support brackets feature unique stabilizing post that permits secure mounting with only 1 screw.

QUANTITY - ONE SET (4 pcs.)

Guides & Brackets TRS-2 \$3.79

PC EDGE CONNECTOR



44 Pin, dual read out, .156" (3.96 mm) Contact Spacing, .025" (0.63 mm) square wire-wrapping pins.

P.C. Edge Connector CON-1 \$3.49

P.C.B. TERMINAL STRIPS

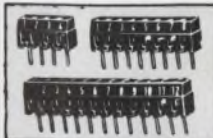

The TS strips provide positive screw activated clamping action, accommodate wire sizes 14-30 AWG (1, 8, 0, 25mm) Pins are solder plated copper, .042 inch (1mm) diameter, on .200 inch (5mm) centers.

4-Pole	TS- 4	\$1.39
8-Pole	TS- 8	\$1.89
12-Pole	TS-12	\$2.59

DIP SOCKET

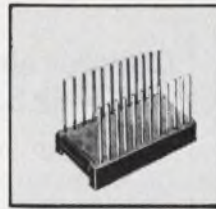

Dual-in-line package, 3 level wire-wrapping, phosphor bronze contact, gold plated pins .025 (0,63mm) sq., .100 (2,54mm) center spacing.

14 Pin Dip Socket	14 Dip	\$0.79
16 Pin Dip Socket	16 Dip	\$0.89

RIBBON CABLE ASSEMBLY SINGLE ENDED

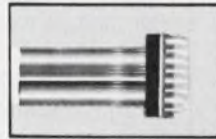

With 14 Pin Dip Plug 24" Long (609mm)	SE14-24	\$3.55
With 16 Pin Dip Plug 24" Long (609mm)	SE16-24	\$3.75

DIP PLUG WITH COVER FOR USE WITH RIBBON CABLE

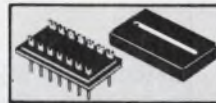

14 Pin Plug & Cover	14-PLG	\$1.45
16 Pin Plug & Cover	16-PLG	\$1.59

QUANTITY: 2 PLUGS, 2 COVERS

RIBBON CABLE ASSEMBLY DOUBLE ENDED

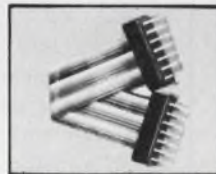

With 14 Pin Dip Plug - 2" Long	DE 14-2	\$3.75
With 14 Pin Dip Plug - 4" Long	DE 14-4	\$3.85
With 14 Pin Dip Plug - 8" Long	DE 14-8	\$3.95
With 16 Pin Dip Plug - 2" Long	DE 16-2	\$4.15
With 16 Pin Dip Plug - 4" Long	DE 16-4	\$4.25
With 16 Pin Dip Plug - 8" Long	DE 16-8	\$4.35

TERMINALS

- .025 (0,63mm) Square Post
- 3 Level Wire-Wrapping
- Gold Plated

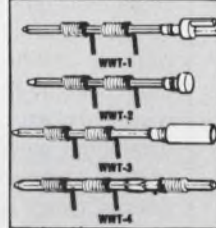

Slotted Terminal	WWT-1	\$2.98
Single Sided Terminal	WWT-2	\$2.98
IC Socket Terminal	WWT-3	\$3.98
Double Sided Terminal	WWT-4	\$1.98

25 PER PACKAGE

TERMINAL INSERTING TOOL

For inserting WWT-1, WWT-2, WWT-3, and WWT-4 Terminals into .040 (1,01mm) Dia. Holes.



INS-1 \$2.49

WIRE CUT AND STRIP TOOL



Easy to operate - place wires (up to 4) in stripping slot with ends extending beyond cutter blades - press tool and pull - wire is cut and stripped to proper "wire-wrapping" length. The hardened steel cutting blades and sturdy construction of the tool insure long life.

Strip length easily adjustable for your applications.

DESCRIPTION	MODEL NUMBER	ADJUSTABLE "SHINER" LENGTH OF STRIPPED WIRE INCHES TO INCHES	Price
24 ga. Wire Cut and Strip Tool	ST-100-24	1 3/4" — 1 1/2"	\$ 8.75
26 ga. Wire Cut and Strip Tool	ST-100-26	1 3/4" — 1 1/4"	\$ 8.75
26 ga. Wire Cut and Strip Tool	ST-100-26-075	7/8" — 1 1/8"	\$ 8.75
28 ga. Wire Cut and Strip Tool	ST-100-28	7/8" — 1 1/8"	\$11.50
30 ga. Wire Cut and Strip Tool	ST-100-30	7/8" — 1 1/8"	\$11.50

THE ABOVE LIST OF CUT AND STRIP TOOLS ARE NOT APPLICABLE FOR MYLENE OR TEFLON INSULATION

MINIMUM ORDER \$10.00, SHIPPING CHARGE \$1.00, N.Y. CITY AND STATE RESIDENTS ADD TAX

OK MACHINE & TOOL CORPORATION

3455 Conover St., Bronx, N.Y. 10476 ■ Tel: (212) 633-1111 ■ Telex: 125091

CIRCLE NUMBER 82

**WHEN
HALF THE
POWER**



**WILL
DO
THE
WHOLE
JOB!**

If your application requires only moderate power, ENI's new Model A150 will do the job. All it takes is a laboratory signal generator and you've got a perfect match for RFI/EMI testing, NMR/ENDOR, RF transmission, ultrasonics and more.

Capable of supplying more than 150 watts of RF power into any load impedance, the A150 covers the frequency range of .3 to 35 MHz.

We could mention unconditional stability, instantaneous failsafe provisions and absolute protection from overloads and transients, but that's what you expect from any ENI power amplifier, and the A150 is no exception!

For additional specifications, a demonstration, or a copy of our new, full-line catalog, contact ENI, 3000 Winton Road South, Rochester, New York 14623. Call 716-473-6900 or Telex 97-8283 ENI ROC.

ENI

The World's Leader in Power Amplifiers

CIRCLE NUMBER 83

INSTRUMENTATION

Counter aimed at 800-MHz band

Tektronix, P. O. Box 500, Beaverton, OR 97077. (503) 644-0161. \$1100; 9 wks.

The DC508 counter module measures in the newly opened 806 to 947-MHz two-way communication band. The module counts to 1 GHz with 20-mV rms sensitivity. Readout is on a 9-digit LED display. A 100× resolution multiplier is included for voltage measurements.

CIRCLE NO. 360

Measure signals with any waveform

Epoch Enterprise, P.O. Box 17582, Tucson, AZ 85731. Roger Southwick (602) 885-3819. \$2620; 4 to 6 wks.

You can measure peak, mean, mean square, true rms, cross mean square and cross rms with the versatile U-Functionmeter. The meter treats all signals as probabilistic functions and measures any statistically stationary signal, periodic or aperiodic, independent of waveform. An additional capability is the dual-channel feature that measures the cross product of the channels. This feature can be used to measure signal power since the product of voltage and current is power. The frequency range is 10 Hz to 2 MHz. Voltage range is from 1 mV to 300 V in 12 steps, and input impedance is 1 MΩ and 35 pF.

CIRCLE NO. 361

Slim DPM boasts low cost

Fairchild Instruments & Controls, 1725 Technology Dr., San Jose, CA 95110. John Hatch (415) 962-3617. \$33.00 (any qty).

The Model 30 low-cost, 3-1/2-digit flat-pack digital panel meter operates from a 5-V-dc input voltage with a typical power consumption of 0.75 W. With the display blanked, power consumption is reduced to 0.05 W. Full-scale range is ±1.999 V with a resolution of 0.0005%. External resistor-divider networks give higher ranges. Accuracy is 0.1% of reading, ±1 digit. The display height is 0.5 in.

CIRCLE NO. 362

4-1/2-digit DPM resolves 1 μV



United Systems, 918 Woodley Rd., Dayton, OH 45403. (513) 254-6259. \$275; stock.

A 4-1/2-digit, panel-mount instrument, the Model 2780A-00, measures dc voltage with 1-μV resolution in the 20-mV range. Another unit, Model 2780A-01, measures dc voltage with 10-μV resolution in the 200-mV range. The LED display is 0.6-in. high and auto zero eliminates internal instrument drift. A front-panel zero offset compensates for system-introduced zero error. Dimensions are 4.39 × 1.89 × 5.55 in.

CIRCLE NO. 363

DPM uses snap-on display filters

Data Tech, 2700 S. Fairview, Santa Ana, CA 92704. (714) 546-7160. \$39.00.

Model 73 3-1/2-digit digital panel meter features interchangeable filters for panel design flexibility. A 0.43-in. LED display provides a wide viewing angle on the translucent 3.49 × 2.09-in. snap-on red acrylic filter. Accuracy is ±0.05% of the reading ±1 count. Full scale is 200 mV. Front mountable, the meter requires 2.72 in. of depth, including the panel thickness.

CIRCLE NO. 364

HV power supply adjusts to 3 kV



Hamamatsu, 120 Wood Ave., Middlesex, NJ 08846. Ralph Eno (201) 469-6640. \$425.

The Model 215 high-voltage power supply features output voltage fully adjustable from 0 to ±3 kV dc with reversible polarity. The resolution of output voltage is 200 mV.

CIRCLE NO. 365

FREE CATALOGS on PM and SHUNT-WOUND adjustable speed drive systems



Catalog CDC-PM describes PM systems, 1/12-1/4 Hp. 20 pages, 57 drawings, photos and tables.



CDC-SH describes shunt-wound systems, 1/50-1/4 Hp. 16 pages, 51 photos, drawings and tables.

... from Bodine and Bodine Distributors

Designed and built by Bodine to give you *perfectly matched* speed/torque control characteristics—provide reliability and performance you might expect only from far more costly and complex systems.

**BODINE
ELECTRIC
COMPANY**

BODINE MOTORS
GEAR MOTORS
SPEED CONTROLS

Send for catalogs today.

Bodine Electric Company, 2500 W. Bradley Place, Chicago, IL 60618

CIRCLE NUMBER 84

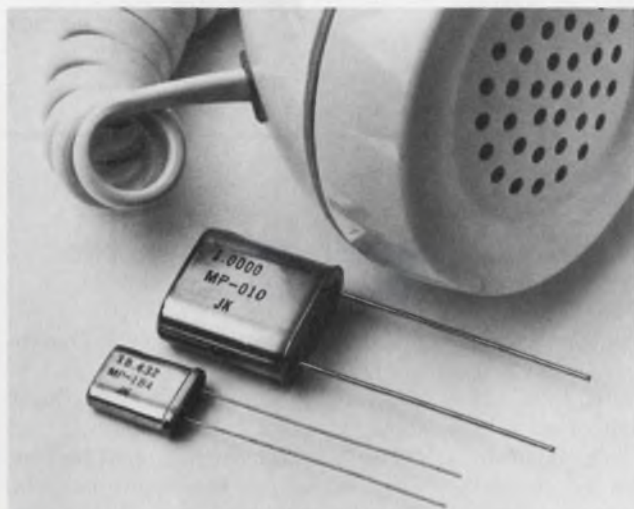

Now specify or order guaranteed on-frequency μ P crystals by phone.

Just tell us what microprocessor you are using (manufacturer and number) and the frequency you want. One of our 31 stock frequencies will fill your needs. It's that simple.

Because we work with microprocessor manufacturers, most crystals are ready for delivery, off-the-shelf. Prices range from \$2 to \$6 each (at 100 pieces per frequency).

Give us a call at (815) 786-8411, or call your CTS Distributor. (Specs in EEM.) CTS Knights, Inc., 400 Reimann Street, Sandwich, Illinois 60548.

CTS KNIGHTS, INC.



CIRCLE NUMBER 85

ELECTRONIC DESIGN 8, April 12, 1978

OVERVOLTAGE PROTECTION



\$2.95
(1000 pcs.)

Here's positive low cost protection for your IC's, transistors, microprocessors, Power Supplies, etc. And it's designed for P.C. board mounting too. The LVC-1 switches rapidly (us) to a short circuit whenever the voltage across it exceeds the trip threshold.

7 Steps to a dependable design

In just 15 minutes - using this ad, you can "design-in" proven protection and then go on to the tough jobs.

1) Select your protection "trip level" \pm 10% Nominal

P.S. Volt.	5V	6	8	9	12	15	18	24	28	30
Suggested Trip Volt.	6.2V	6.8	10	12	14	17	22	28	33	36

2) Check over the major specifications

- Temp. (operating) - 40°C to + 100°C
- Temp. coefficient (mv/°C) $t_c = 2.18 Et - 24$
- Peak Current 50A/8ms, 13A/800ms
- Circuit Loading 10ma

3) Power Supply Current (nominal) should be <3 Amps. No heat sink required if fuse or circuit breaker is employed.

4) Price-Delivery-Availability

1 pc	\$4.75 ea.	Stock
25	4.50	"
100	4.25	1 week
500	3.50	2 weeks
1000 pc	2.95	per schedule

5) Mount on P.C. Board

6) **SPECIAL OFFER**

CALL MIKE COYLE FOR NO CHARGE SAMPLE
(516) 586-5125 x402

7) Ordering Information LVC-1A-*

*Trip voltage selected in (1)

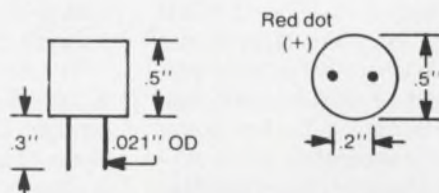

M1

MCG Electronics, Inc.
160-402 Brook Ave, Deer Park, N.Y.

CIRCLE NUMBER 86

159

CCD analog multiplexers draw 0.1 mW but handle 32 inputs

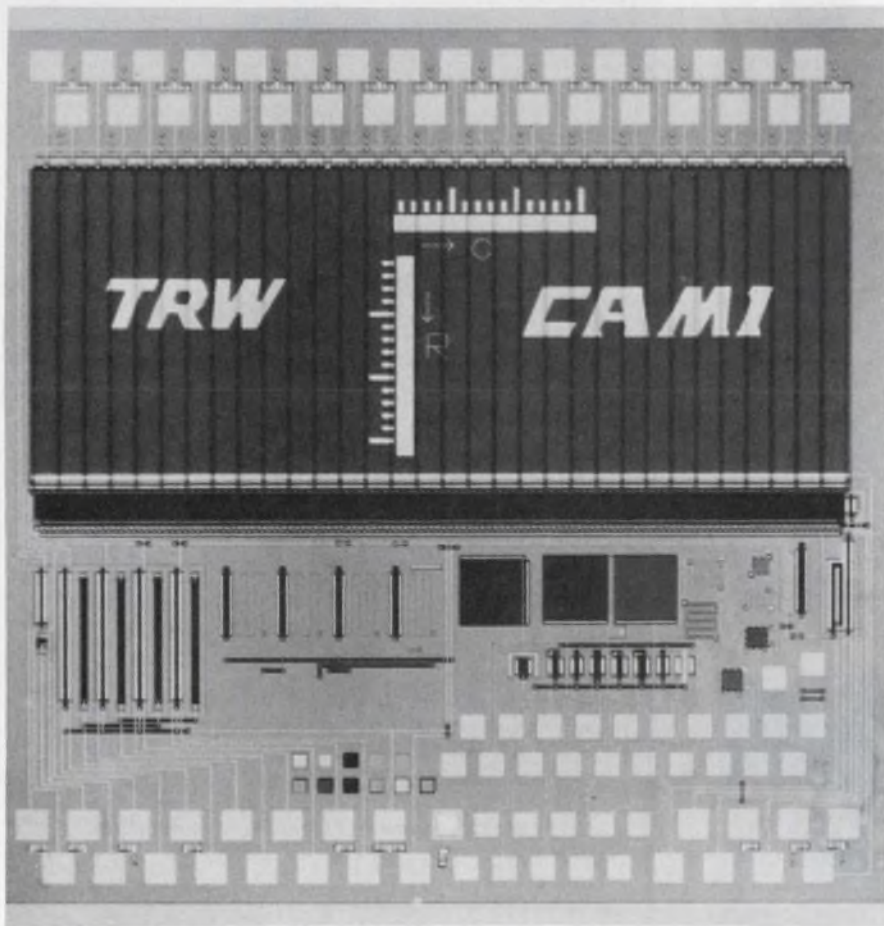

TRW Defense and Space Systems Group, One Space Park, Redondo Beach, CA 90278. Bill Huber (213) 536-4207. P&A: See text.

Built from charge-coupled devices to keep power dissipation and noise to a minimum, TRW's CAM is the only CCD-based analog multiplexer available commercially. This analog multiplexer handles 32 input channels—yet dissipates a mere 0.1 mW when operated on a 1% duty cycle. Since the CAM is intended to multiplex large arrays of photodiodes where 100 or more multiplexers might be used in a low temperature environment, its low power dissipation is essential to allow efficient cooling when the unit is mounted adjacent to the diode array.

Photodiodes are often cooled to 150 K to minimize thermal noise during operation. At 150 K, the CAM has a

thermal noise of just 20 μ V rms. Input voltages to the array can span a four decade range from 15 μ V to 150 mV.

The internal structure of the CAM is such that a voltage gain of up to 18 V/V can be obtained from input to output. Since the signals fed into the multiplexer have slowly varying amplitudes, the sample rate can range from 1 to 100 Hz. However, the CAM, which typically finds itself in multiple-unit systems, can be read out at rates exceeding 100 kHz.

The deviation of output signal linearity is kept to within 50-mV from a straight line fit over the full dynamic range of about 3 V. Input settling time is about 5 ms before data on the inputs are transferred to the serial output registers.

All internal timing is controlled via a MOS-level external four-phase clock.

However, on-chip enable circuitry isolates the multiplexer clock lines and output line for time-phase multiplexing of many CAM chips.

Available as a bare chip (150 \times 150 mils), a 64-lead plastic or ceramic DIP, or a flatpack, the TRW multiplexer requires eight voltage inputs of -1, -4, -6.3, -10, -15, -15, -20 and -24 V. All levels can be derived from one master supply by use of a resistive ladder and some filtering. The CAM uses a p-type surface channel CCD structure. Although there are no other CCD multiplexers available, there are several CMOS units that can perform a similar job, but at higher power and noise levels.

Modified versions of the CAM are also available for reasonable-quantity orders. Prices start at about \$150 each for small-quantity orders. Delivery is 30 days for small orders.

CIRCLE NO. 303

Quad register gives two sets of outputs

Advanced Micro Devices, 901 Thompson Pl., Sunnyvale, CA 94086. E. Sopkin (408) 732-2400. \$3.10 (molded); stock.

The Am25LS2519 is a quad register with two sets of three-state outputs. The chip consists of four D-type flip-flops with a buffered common clock enable. Information meeting the set-up and hold time requirements of the D inputs is transferred to the flip-flop outputs on the low-to-high transition of the clock. One set of outputs contains a polarity control so that the outputs can either be inverting or noninverting. Typical clock-to-output delay of the device is 20 ns. An active-low asynchronous clear is also included. Packaging is a 20-pin molded or ceramic DIP or flat-pack.

CIRCLE NO. 366

Join the IMC Book Club*

Free 72 page Vaneaxial Fan Catalog contains airmovers rated for highest efficiencies.



This catalog features IMC's Turbo-Slot fans which produce high pressure at low speed and Mixed Flow fans which combine the space-saving advantages of the axial type fan with the desirable performance characteristics of the centrifugal and standard vaneaxial fans. "Hi-Slip" models for high altitude applications are available as well as many custom models to fit your specific needs.

For immediate service please call Gene Egan, V.P. Sales 516/334-7070.

*Product Literature Broadside and request card will be sent to you along with this catalog.

SERVING INDUSTRY OVER 25 YEARS

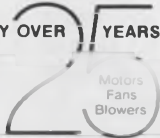

IMC MAGNETICS CORP.

EASTERN DIVISION
570 MAIN STREET, WESTBURY, NEW YORK 11590

CIRCLE NUMBER 87

The Common Denominator Of An Uncommon Company



... is quartz. Then NEL puts 24 years of design experience to work. In addition to our leading position in the low frequency field, we provide broad coverage of high frequency crystals as well as hybrid crystal oscillators. All units are hermetically sealed. We also offer assistance with microprocessor design problems. You'll find our delivery record and customer service are excellent.



For more information send for NEL's FREE design manual/catalog. Write to:



Northern Engineering Laboratories, INC.

357 BELOIT ST., BURLINGTON, WI 53105 (414) 763-3591

CIRCLE NUMBER 88

ELECTRONIC DESIGN 8, April 12, 1978

Design it for safety!

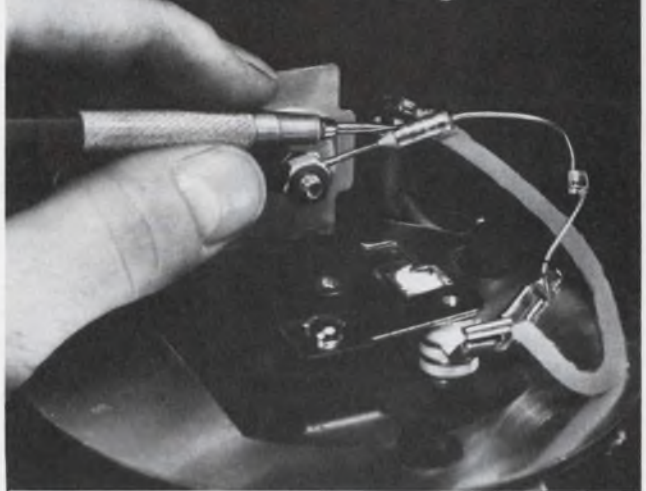

4000 Series MICROTEMP® thermal cutoff in electric fryer

Guard your products and profits with MICROTEMP® thermal cutoffs

Our 4000 Series MICROTEMP® thermal cutoff protects this fryer, those using it, and those who make and sell it. If the fryer overheats, for any reason, the alert MICROTEMP® opens the circuit to cut off power.

After cutoff, the fault must be corrected and the MICROTEMP® cutoff replaced before the fryer can be used again.

Quick-connect terminals make it easy to replace the cutoff in the field without soldering.

Millions of MICROTEMP® thermal cutoffs are now being used on hundreds of OEM electrical applications. We can provide the right thermal cutoff—temperature ratings from 136 to 468°F, assorted terminations,

mounting packages and insulation—to meet your design and production needs precisely and economically. Write or call us for specific data and test samples.



MICRO DEVICES



DIVISION OF EMERSON ELECTRIC CO.
1881 SOUTHTOWN BLVD.
DAYTON OH 45439 513-294-0581

EMERSON

See us at Booth D658 at the Design Show
CIRCLE NUMBER 89

4-bit μ C takes 50 instructions

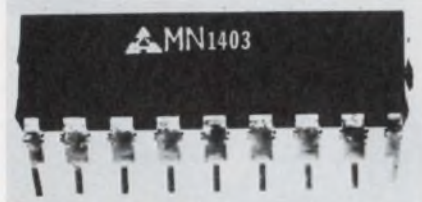

Panasonic, 1 Panasonic Way, Secaucus, NJ 07094. Bill Bottari (201) 348-7276.

A 50-instruction microcomputer is packaged in an 18-pin DIP. The MN1403 includes a two-level subroutine stack, one 4-bit parallel-input port, one input-sense line and four discrete output lines. The instruction cycle is 10 μ s. Also included are a clock generator, ALU, 512 words of ROM and 16 words of RAM with four directly addressable words.

CIRCLE NO. 367

Low-NF GHz transistors are in popular packages

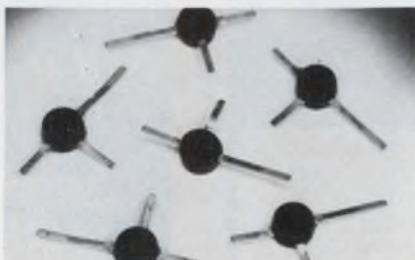

Siemens, 186 Wood Ave. S., Iselin, NJ 08830. (201) 494-1000. \$1.49/\$1.65 (1000 qty); stock.

Two GHz-range transistors are in popular configurations and have low-noise characteristics. Designated BFR90 and BFR91, the devices are available in standard "T" style plastic packages. They are also available in the TO-72 metal can, SOT-23 micro-miniature package and in a ceramic stripline package. The BFR90 has a gain bandwidth product of 4.5 GHz at 20 mA. Its noise figure is 2 dB at 800 MHz. The BFR91 has a product of 4.5 GHz at 25 mA and a 2.8-dB noise figure at 800 MHz.

CIRCLE NO. 368

Op amps include FET inputs on single chip

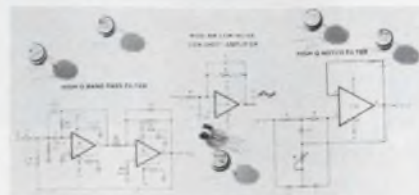

Signetics, 811 E. Arques Ave., Sunnyvale, CA 94086. Rick Eklund (408) 739-7700. \$2.67 (100 qty); stock.

Three series of operational amplifiers, LF155, 156 and 157, have matched input JFETs on the same monolithic chip. Common features are an input bias current of 30 pA, input offset current of 3 pA, input impedance of $10^{12} \Omega$, input offset voltage of 1 mV, voltage offset temperature drift of 3 μ V/ $^{\circ}$ C and input noise current of 0.01 pA/ $\sqrt{\text{Hz}}$. Specific features of the LF155s are 4- μ s settling time, 5 V/ μ s slew rate and 2.5-MHz bandwidth. The LF156 has 1.5- μ s settling time, 12 V/ μ s slew rate and 5-MHz bandwidth. LF157 features 1.5- μ s settling time, 50 V/ μ s slew rate and 20-MHz bandwidth.

CIRCLE NO. 369

TYPE 224M FABMIKA[®] CAPACITORS



THE ECONOMICAL HIGH-VOLTAGE MICA

- Film-wrapped reconstituted mica capacitors ideal for airborne electronics . . . also well-suited for ground equipment applications including radio transmitters, induction heating equipment, electrostatic precipitators.
- High dielectric strength, small size, high temperature performance, low temperature coefficient of capacitance.
- Capacitance values range from .0018 to 1.0 μ F in voltage ratings from 1500 to 7500 WVDC.

Write for Engineering Bulletin 1735 to Technical Literature Service, Sprague Electric Co. 347 Marshall St., North Adams, Mass. 01247.

THE BROAD-LINE PRODUCER OF ELECTRONIC PARTS



General Cable subsidiary

CIRCLE NUMBER 93

TYPE 715P FILMITE[®] 'L' CAPACITORS



LOW DISSIPATION FACTOR

- Polypropylene film dielectric . . . similar to polystyrene in high a-c current-carrying capability, but has added advantage of 105 $^{\circ}$ C operation.
- Conformally coated with flame retardant epoxy.
- Ideal in solid-state TV vertical circuits, r-f generators, pulse-forming networks, plus other applications where high a-c current flow is found.
- Capacitance change with temperature less than 3% over operating temperature range of -55 $^{\circ}$ C to +85 $^{\circ}$ C.
- Capacitance values from .001 to .47 μ F, voltage ratings from 400 to 1600 WVDC.

Write for Engineering Bulletin 2090 to Technical Literature Service, Sprague Electric Co. 347 Marshall St., North Adams, Mass. 01247.

THE BROAD-LINE PRODUCER OF ELECTRONIC PARTS



General Cable subsidiary

CIRCLE NUMBER 94

High-speed transistors switch 7.5 A

General Semiconductor Industries, P.O. Box 3078, Tempe, AZ 85281. Jim Williams (602) 968-3101. \$4.65 to \$5.65 (100 qty); stock.

The Models XGSQ7530, 7535 and 7540 have switching speeds of 1 μ s at 7.5 A. Collector saturation voltages are typically 0.3 V. The V_{CE0} is 300, 350 and 400 V for the respective models. The package is a TO-66 metal case.

CIRCLE NO. 370

Power Schottky diode handles 30 A

TRW Power Semiconductors, 14520 Aviation Blvd., Lawndale, CA 90260. John Power (213) 679-4561. \$5.25 (100 qty); 4 to 8 wks.

A Schottky diode, SD241, is rated at 45 V, 30 A and has high temperature capability that meets MIL-S-19500, MIL-I-45208 and MIL-Q-9858. The operating temperature range is -55 to 150 C.

CIRCLE NO. 371

Low-noise zeners conform to MIL spec



CODI, Pollitt Dr. S., Fair Lawn, NJ 07410. (201) 797-3900. \$2.80 (100 qty); stock.

A series of low-noise, low-leakage voltage regulator diodes, 1N5518B to 1N5528B is available as JAN and JANTX versions and conforms with the requirements of MIL-S-19500/437. The zener voltages range from 3.3 V to 8.2 V \pm 5%. All diodes in this series are supplied in a 400-mW hermetically sealed DO-7 glass package. Operating characteristics include: test currents, 1 to 20 mA; dynamic impedance, 18 to 40 Ω ; max noise 0.5 to 4 μ V/ $\sqrt{\text{Hz}}$; voltage regulation, 0.05 V at 0.01 mA to 0.9 V at 2 mA; max reverse current, 0.5 mA to 5 mA.

CIRCLE NO. 372

Controlled rectifiers turn off fast

RCA, Route 202, Somerville, NJ 08876. (201) 685-6423. \$1.03 up (1000 qty); stock.

Three series of fast turn-off silicon controlled rectifiers, S5800, S5801 and S5802 are for inverter/regulator applications. Turn-off time for an 8-A load is 6 μ s for the S5800, 10 μ s for the S5801 and 15 μ s for the S5802.

CIRCLE NO. 373

SCRs have dv/dt rating up to 500 V/ μ s

FMC, 800 Hoyt St., Broomfield, CO 80020. (303) 469-2161. \$31.10 (10 qty).

Series 035 and 039 inverter SCRs have dv/dt capability up to 500 V/ μ s. The Series 039 covers the 100 through 600-V range and the Series 035, the 700 through 1200-V range at 55 and 63 A rms. In addition to choice of dv/dt ratings, turn-off times of 10 or 20 μ s may be specified for the Series 039 and 30 or 40 μ s for the Series 035.

CIRCLE NO. 374

SERIES 207C300/207C400 MODULES

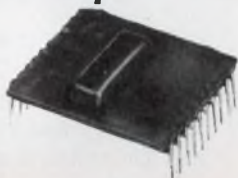

ACTIVE FILTERS FOR USE WITH MODEMS

- Designed for low speed modem applications.
- Provide all necessary filtering for originate only, answer only, or answer/originate operation.
- Series 207C300 transmit modules feature 6-pole filter to suppress output sidebands, reduce harmonic distortion.
- Series 207C400 receive modules include 10-pole filter to eliminate noise and local carrier signals.
- Absolute max. ratings include supply voltages of +18V (V_{cc}), -18V (V_{ee}), 5.5V (V_{dd}). Operating temp. range is 0° to +70°C. Storage temp. range is -40° to +125°C.

Write for Engineering Bulletin 22113 to Technical Literature Service, Sprague Electric Co. 347 Marshall St., North Adams, Mass. 01247.

THE BROAD-LINE PRODUCER OF ELECTRONIC PARTS

SPRAGUE
THE MARK OF RELIABILITY

General Cable subsidiary

CIRCLE NUMBER 95

ELECTRONIC DESIGN 8, April 12, 1978

TYPE 292P PACER® FILM CAPACITORS

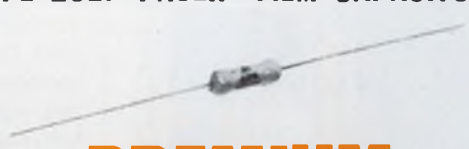

PREMIUM CAPACITORS FOR IMPROVED PERFORMANCE

- Epoxy-coated version of the proven sleeved-case PACER® polyester-film, end-cap construction capacitor.
- Flame-retardant coating provides improved humidity resistance, life, and insulation resistance.
- Metal end-caps are welded to foil electrodes, eliminating problems associated with soldered construction. End-caps also block entrance of moisture into ends of the film section and assure excellent lead concentricity.
- Voltage ratings of 80 and 200 WVDC at 85°C. Capacitance values from .001 to .27 μ F.

Write for Engineering Bulletin 2066.6 to Technical Literature Service, Sprague Electric Co. 347 Marshall St., North Adams, Mass. 01247.

THE BROAD-LINE PRODUCER OF ELECTRONIC PARTS

SPRAGUE
THE MARK OF RELIABILITY

General Cable subsidiary

CIRCLE NUMBER 96

163

Mini HV rectifiers have PRV up to 10 kV

Scientific Components, 350 Hurst St., Linden, NJ 07036. Joe LaBruna (201) 791-9500. \$0.90 (100 qty).

Units in the HP series of miniature high-voltage rectifiers provide peak inverse voltage of 6 to 10 kV at 250 or 300-mA rectified current when submerged in oil at 100 C. Current at 85 C air temperature is 150 mA. Specs include 2- μ A max dc reverse current at rated PIV, 8 to 12-V max forward voltage at rated current, one-cycle surge of 25 to 30 A for 8 ms and max operating and storage temperature from -55 to 125 C.

CIRCLE NO. 375

System interface chip has its own memory

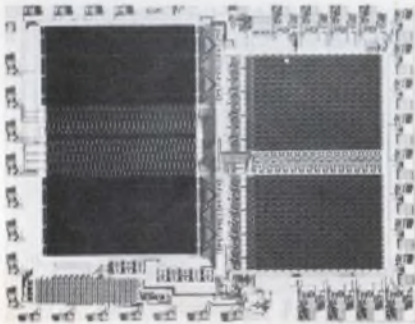

Signetics, P.O. Box 9052, Sunnyvale, CA 94086. Rick Eklund (408) 739-7700. \$17.00 (1000 qty); stock.

The 2656 system memory interface (SMI) is a single monolithic IC for microprocessor interfaces that contains its own memory, internal timing and I/O ports. The chip can be combined with microprocessors to form a powerful two-chip microcomputer that gives system flexibility and both memory and I/O expansion capabilities. The SMI is a mask-programmable circuit that has 2 k \times 8 ROM, 128 \times 8 static RAM, eight multipurpose I/O pins for external chip selects or I/O data-port bits, an 8-bit latch for output data and an internal clock generator programmed with crystal, R-C or external input. Packaging is in a 40-pin DIP.

CIRCLE NO. 376

DIP contains five independent transistors

Sprague Electric, 347 Marshall St., North Adams, MA 01247. (413) 664-4411.

The ULN-2083 and ULS-2083H are 16-lead DIP arrays that contain five independent npn transistors. The devices are available in the 0 to 85-C (ULN-2083A) and -55 to +125-C ranges (ULS-2083H). Each transistor is capable of 500-mW dissipation and the rating for the total package is 750 mW. The dc forward-current-transfer ratio is 40 (min) and collector-emitter breakdown voltage is 15 V (min).

CIRCLE NO. 377

Chip acts as 4-bit data-processor slice

Advanced Micro Devices, 901 Thompson Pl., Sunnyvale, CA 94086. E. Sopkin (408) 732-2400. \$29.95 (100 qty); stock.

The low-power Schottky circuit in the Am2903 is a 4-bit micro-programmable data-processor slice containing a multifunction ALU, a 2-port 16-word scratch-pad memory, an additional accumulator register and shifting and control logic. The chip provides multiply and divide operations as well as arithmetic shifts and all operations available on the 2901A slice. Its two data-input ports can operate between any two internal registers, any internal and external data bus or between two external data buses. The chip is in a 48-pin ceramic DIP.

CIRCLE NO. 378

4-bit-slice 2900 μ Ps are 30 to 50% faster

National Semiconductor, 2900 Semiconductor Dr., Santa Clara, CA 95051. Howard Raphael (408) 737-5956. 100 qty price: \$17.20 (2901A); stock.

A family of 2900-type 4-bit slices use a new bipolar LSI process and are 30 to 50% faster than similar designs. The IDM2900 family (16 in all) uses a process that combines low-power Schottky peripheral circuitry with high-speed three-state emitter-coupled logic circuitry for interface. With the IDM2901 4-bit-slice MPU, the basic microcycle time is in the 60 to 70-ns range. Execution time for a typical operation, such as an add and shift, is in the 60 to 120-ns range. Power consumption for the +5-V device is about 800 to 900 mW.

CIRCLE NO. 379

Dual rectifiers are on single chip

Texas Instruments, P.O. Box 5012, M/S 308 (Attn: TIR Rectifier), Dallas, TX 75222. Keith Renard (214) 238-3041. \$0.48 to \$0.72; stock.

The TIR101 and TIR102 series incorporate, on a single chip, two rectifiers in a common cathode configuration in a TO-220AB plastic package. Devices in the TIR201 and TIR202 series have common anodes. Used as a complementary pair of common cathode and common anode, the devices perform as a full-wave bridge rectifier. The average output current capability is 6 and 12 A with 50 and 40-A peak surge current characteristics, respectively.

CIRCLE NO. 380

Three-state counters handle BCD and binary

Advanced Micro Devices, 901 Thompson Pl., Sunnyvale, CA 94086. E. Sopkin (408) 732-2400. From \$2.90 (100 qty); stock.

The Am25LS2568 and Am25LS2569, programmable up/down BCD and binary counters, have three-state outputs and a choice of synchronous and asynchronous clear. Maximum clock-to-output delay is 27 ns. A ripple carry output allows cascaded operation by connecting to the CET of the succeeding device. The clock carry output provides glitch-free pulses for clock driving. The counters are in DIPs and flat packages.

CIRCLE NO. 381

8-channel drivers supply vacuum fluorescents

Sprague Electric, 347 Marshall St., North Adams, MA 01247. (413) 664-4441.

Type UDN-6118A and UDN-6128A 8-channel drivers interface low-level logic to drive vacuum fluorescent displays. Both devices drive the digits and/or segments of the displays and permit all eight outputs to be activated simultaneously. Pulldown resistors are included in each output and no external components are required for most uses. The UDN-6118A is compatible with TTL, Schottky TTL, DTL and 5-V CMOS. UDN-6128A is for use with MOS (PMOS or CMOS) logic operating from 6 to 15 V.

CIRCLE NO. 382

Three differential amps are housed in DIP

Sprague Electric, 347 Marshall St., North Adams, MA 01247. (413) 664-4411.

The ULN-2047A is a silicon npn multiple-transistor array of three independent differential amplifiers housed in a DIP. The power dissipation of any one transistor is 300 mW, while the total-package dissipation is 750 mW at 25 C. Collector-to-emitter breakdown voltage is 30 V (min) and the dc forward-current-transfer ratio is 75 (min) at 10 mA. Differential-input-offset voltage is 5 mV (max).

CIRCLE NO. 383

HV rectifiers have fast recovery

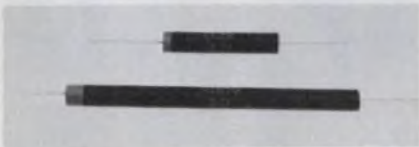

Scientific Components, 350 Hurst St., Linden, NJ 07036. Joe LaBruna (201) 791-9500. \$1.50 to \$15.00; stock to 2 wks.

The Cartrade series of high-voltage silicon cartridge rectifiers is rated up to 50 kV and has a recovery time of 300 ns. Peak inverse voltage is from 5 to 50 kV, with minimum avalanche voltage from 6 to 60 kV. Forward voltage drop ranges from 4.4 to 44 V at 200 mA dc, 25 C. Max forward current output is 150 to 200 mA at 25 C, and 75 to 100 mA at 100 C.

CIRCLE NO. 384

Constant-current diodes are approved by DESC

Teledyne Crystalonics, 147 Sherman St., Cambridge, MA 02140. Raymond Moore (617) 491-1670. Stock.

DESC approval has been received for an improved line of current-regulator diodes, JAN-TX 1N5293 to 1N5314, to MIL-S-19500/463A USAF. The diodes are now constructed with a "C"-bend chip contact instead of a spear. The diodes couple high-impedance circuits with current regulation and have constant current from 0.22 to 4.7 mA in 10% increments at voltages from 3 to 100 V. Units can be connected in parallel for higher current.

CIRCLE NO. 385

Tone dialer uses inexpensive crystal

Mostek, 1215 W. Crosby Rd., Carrollton, TX 75006. Joe Jarrett (214) 242-0444. \$4.95 (100 qty); stock.

The MK 5090 tone dialer uses an inexpensive TV color-burst crystal reference to provide eight different audio frequencies that are mixed to yield tones for dual-tone multifrequency

(DTMF) telephone dialing. The device was designed specifically for integrated tone dialer uses that require variable supply operation with loop compensated tone regulation single-contact-keyboard, chip disable input, and a mute output that is open circuit when no keyboard buttons are pushed and pulls to the V+ supply when a keyboard button is pushed.

CIRCLE NO. 386

MICROPROCESSOR CORE MEMORIES

FOR THE LSI-11, 8080, 6800, IMP-16P, S100

THE MM-1103 OFFERS 2 OR 4 TIMES THE MEMORY CAPACITY!
FOR THE SAME SIZE AND POWER AS THE DEC MMV-11A!

MM-1103
8K X 16

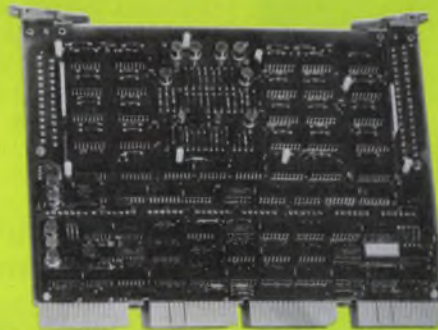

MM-1103/16
16K X 16

PLUGS DIRECTLY TO DEC LSI-11 AND PDP 11-03 COMPUTER



MM-6800 8K X 8

FOR MOTOROLA'S EXORCISER
AND MICRO MODULES

FEATURES:

- o NON-VOLATILE.
- o PIN-TO-PIN COMPATIBILITY.
- o POWER MONITORING FOR DATA PROTECTION.
- o DELIVERY FROM STOCK.
- o ONE YEAR WARRANTY ON PARTS AND LABOR.
- o ALL UNITS TEMPERATURE CYCLED AND BURNED IN.



MM-S100 8K X 8

FOR IMSAI 8080, ALTAIR,
AND SOL MICROCOMPUTER



MM-8080AL 8K X 8

FOR INTEL'S MDS 800
AND SBC 80/10 MICROCOMPUTER

Micro
Memory
Inc

9438 Irondale Ave.
Chatsworth, California 91311
Telephone: (213) 998-0070

CIRCLE NUMBER 97

Move Air... Not Components!

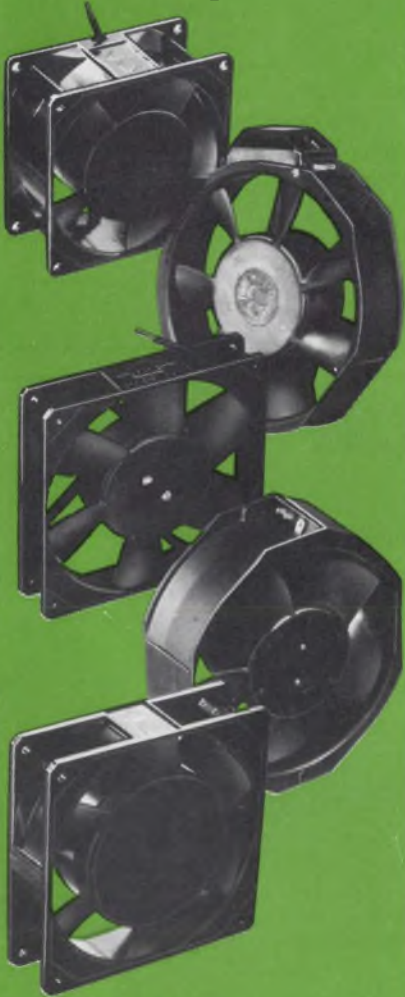

There's an Etri Fan

(just say ee-tree)

for virtually every application

Etri fans move more air... no matter how crowded it is behind the panel. You don't have to burn up hours juggling components and making trade-offs just to get the airflow you need. We're not a bit hard to fit into your panel. Sizes on our flat axials range from a skinny 1" profile on up... all on standard mounting centers. Air deliveries from 20 to over 2000 CFM will help you keep your cool.

Etri fans are plenty rugged, too. Vibration-resistant housing; precision-molded, reinforced impellers; lifetime bearings... that's just part of the story.

Want to see more?

Send for our free catalog!

Etri, Inc.

8002 S. Madison Street
Burr Ridge, IL 60521
(312) 325-9380

CIRCLE NUMBER 98

COMPONENTS

Non-PCB capacitors case-rupture protected



Cornell-Dubilier Electronics, 150 Avenue L, Newark, NJ 07101. Doug Graham (201) 589-7500.

UL-listed capacitors, types KK, KA, KT and KB, contain protective devices to prevent case rupture in the event of internal capacitor failure. The units are made with Dykanol XN impregnating fluid free of polychlorinated biphenyl. The capacitors meet industry standards of 99.5% minimum survival after 5000 h and 94% minimum survival after 60,000 h at rated voltages and temperatures.

CIRCLE NO. 387

SIP cermet trimmers inserted by machine



Bourns Inc., Trimpot Div., 1200 Columbia Ave., Riverside, CA 92507. (714) 781-5320. \$0.75 (1000 qty); 6 to 8 wks.

The Model 20 is a machine insertable SIP cermet trimmer for high-density PC board spacing. The multiturn trimmer has 0.1-in. pin spacing and sits 0.185-in. off the board. Resistance values are available in 18 steps from 10 Ω to 5 M Ω . Specs include mechanical adjustment of 15 turns, $\pm 0.05\%$ adjustability in voltage-divider mode and $\pm 0.1\%$ in rheostat mode, tempco of ± 100 ppm/ $^{\circ}\text{C}$ and power rating of 0.5 W at 70 C.

CIRCLE NO. 388

Pushbutton switches work at low levels

Series 11LL



Series 31LL

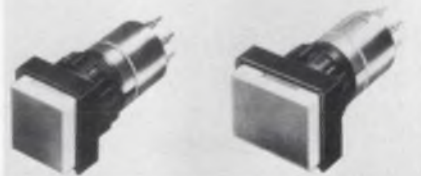

Unimax Switch, Ives Rd., Wallingford, CT 06492. (203) 269-8701. \$3.40/\$4.30 (unit qty); stock.

EAO Series 11LL and 31LL pushbutton switches are for low-level power use. The maximum contact rating is 100 mA at 60 V ac or dc and the contact resistance is less than 50 m Ω . The Series 11LL units come with round lens caps, and the 31LLs with either square or rectangular caps. A selection of cap colors is available. Contact configurations include 2-NO and 2-NC momentary, 1-NO and 1-NC momentary, make-before-break momentary, 2-NO alternate action, 2-NC alternate action and make-before-break alternate action.

CIRCLE NO. 389

Mini capacitors use DIP lead spacing

Seacor, 598 Broadway, Norwood, NJ 07648. (201) 768-6070. See text; stock to 4 wks.

SMMKO miniature capacitors have leads spaced 0.3 in. to accommodate standard DIPs. Capacitance ratings from 0.001 μF to 0.1 μF in 10% and 20% tolerances are available. Working voltages are 100 V dc and 63 V ac. Operating temperature is -40 to 100 C. Typical pricing is \$0.061 in 5000 quantity for a 0.01 μF , 20%, 100-V-dc unit.

CIRCLE NO. 390

ELECTRONIC DESIGN 8, April 12, 1978

Illuminated pushbuttons use split-screen display

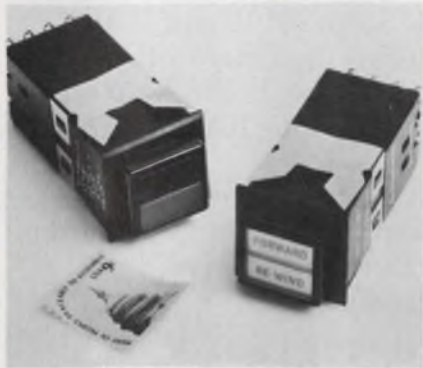

Dialight, 203 Harrison Pl., Brooklyn, NY 11237. (212) 497-7600. \$3.77 up (1000 qty); stock.

Illuminated pushbutton switches in the 330 and 331 series use two incandescent lamps and provide horizontally (330) or vertically (331) split displays. The lamps are T-1-3/4 and operate on 5 to 28 V. They can be energized together or by separate circuits. Models are available for panel or snap-in bezel mounting. Snap-action SPDT and DPDT switches are available with momentary or alternate-switching action.

CIRCLE NO. 391

Cermet-film resistors approved by MIL-R-39017C

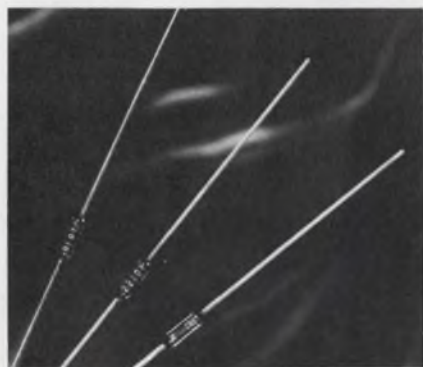

Allen-Bradley, 1201 S. Second St., Milwaukee, WI 53204. (414) 671-2000. See text.

Type CC cermet-film fixed resistors, Style RLR07, have been approved for spec MIL-R-39017C over the entire range from 10 to 22.1 M Ω . Type CC is offered in 1/8-W rating at 125 C and in 1/4 and 1/2-W ratings at 70 C; in MIL styles RN55C, RN55D and RLR07; in 2, 1 and 0.5% tolerances; and with tempcos of 100 ppm/ $^{\circ}$ C and 50 ppm/ $^{\circ}$ C. All styles are within the same 0.25 x 0.09-dia package. RLR07 pricing is \$0.22 in 1000 quantity for values of 1 M Ω or less and \$0.42 for values above 1 M Ω .

CIRCLE NO. 392

Thumbwheel switches use LED lighting



Digitran, 855 S. Arroyo Pkway., Pasadena, CA 91105. Bob Ryder (800) 528-6050. \$4.10; stock.

The 43000, 44000 and 45000 thumbwheel miniswitches have LED lighting and a snap-together assembly. The LED lights only the number on the dial instead of the entire face. The rear-mounted 43000 series is interchangeable with most 0.5-in. wide switches. The 44000, front-mounted, and the 45000, rear-mounted, are interchangeable with 0.315-in. switches. All three have 10 standard dial positions.

CIRCLE NO. 393

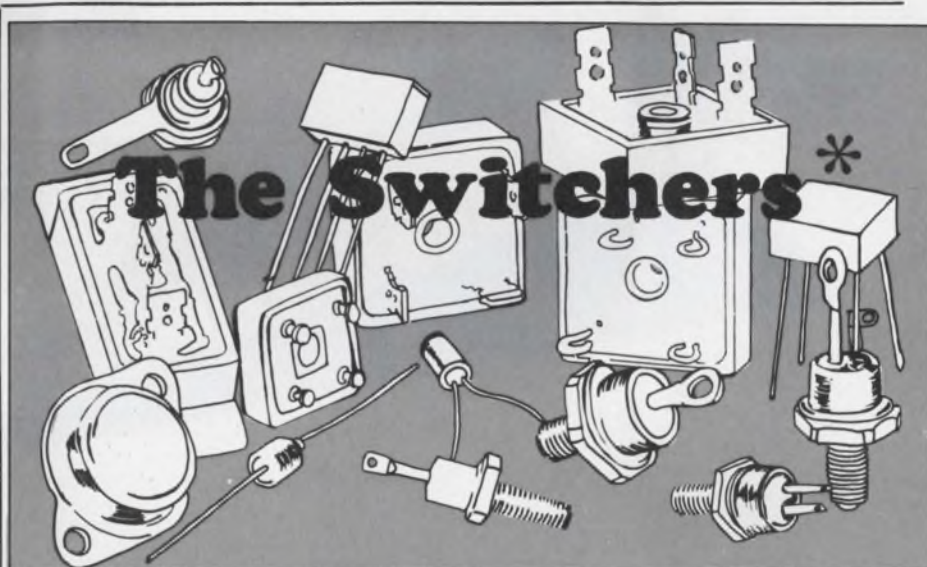

Complete switching rectifier source

Many of you know NAE as a source for military components; but did you know that we are also a source for a complete line of Switching Rectifiers from 1 amp. to 80 amps. including SUPERFAST and SCHOTTKY types.

NAE expertise allows us to supply both 200 NS and SUPERFAST (<50NS) in all packages shown above . . . SHOTTKYS can be supplied in DO-4,

DO-5, and TO-3 packages.

Whatever your requirements in switching devices . . . discreet or multi-chip configurations . . . it will pay you to check NAE . . . THE SOURCE for Switching Rectifiers.

Need instant information? Call Rick at (617) 598-4800. Complete specifications sheets and catalogs are yours for the asking.

Call or write today:

SEND FOR
FREE
CATALOG



nae INC.
SEMICONDUCTORS

Name _____

Title _____

Address _____

City _____ State _____ Zip _____

Tel. _____

My particular application is: _____

69 Bennett Street, Lynn, MA 01905
617/598-4800 • TWX: 710-334-0254

We've been in S3A, Aegis, Intelsat, the F-14, F-15 and Minuteman.

We're in LAMPS, Proteus, TDRSS, the Space Shuttle, IUS, the F-16 and F-18.

Why do Advanced Micro Devices military high-reliability devices go on so many business trips? Because they're made right. Because when we say MIL-STD-883 Class B, we mean it. And when we say Class A, we mean it, too.

That applies to every military hi-rel part we make: Logic, Interface, Bipolar LSI, MOS and Linear. Advanced Micro Devices is heavily committed

to JAN. We were the first manufacturer to gain Part I qualification to the low-power Schottky MSI JM38510/30106 and /30107 slash sheets. With Part II on many others. In addition, we plan to supply to the Am2901A (/44001) and 4K MOS static RAM (/23701-4) slash sheets.

Next time you've got a project in the works, be sure to ask about the military hi-rel's from Advanced Micro Devices.

We could go places together.

Advanced Micro Devices



Multiple technologies. One product: excellence.
901 Thompson Place, Sunnyvale, California 94086
Telephone (408) 732-2400

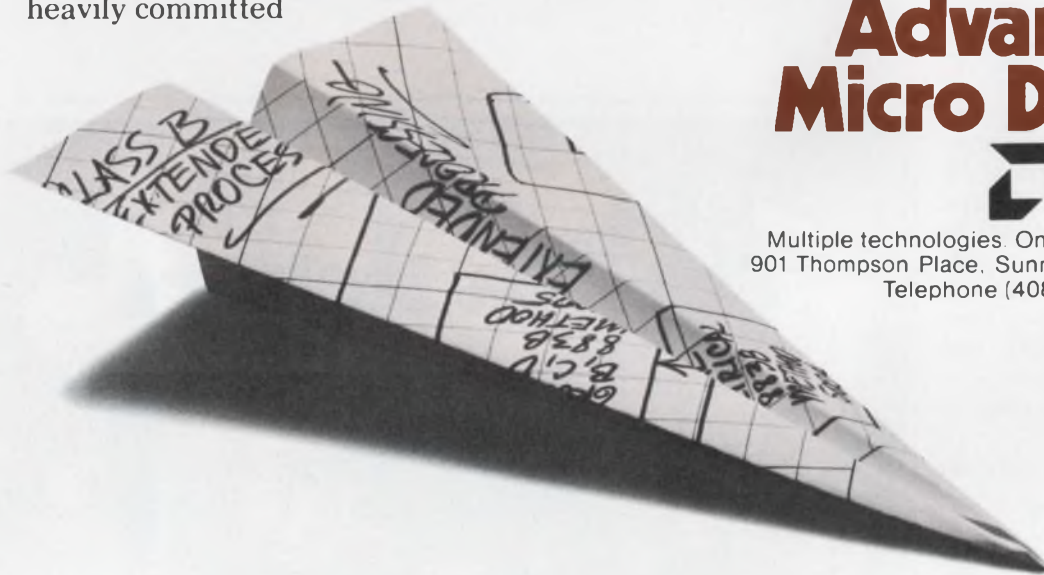

YOU WOULDN'T BELIEVE WHERE WE'VE BEEN.

Advanced Micro Devices, Inc. • France: Silic 314-Immeuble Essen, 20 Rue Saarinen, 94588 Rungis Cedex, France, Tel: (1) 686-91-86.
Germany: 8000 Munchen 2, Herzog-Heinrich-Strasse 3, West Germany, Tel: (089) 539588; United Kingdom: 16 Grosvenor Place, London,
SW1, England, Tel: (01) 235-6380; Belgium: 412, Avenue de Tervuren, B P 9, 1150 Brussels, Belgium, Tel: 32-2-771.99.93.

CIRCLE NUMBER 100

COMPONENTS

Ceramic chip capacitors operate to 4 kV

HIGH VOLTAGE

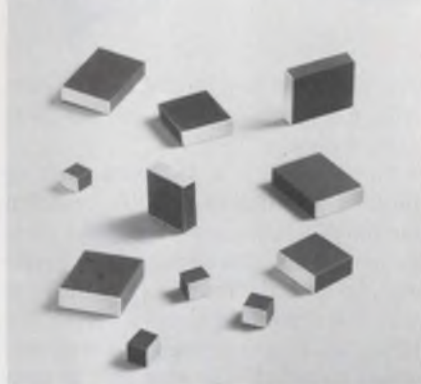

Johanson Dielectrics, P.O. Box 6456, Burbank, CA 91510. (213) 848-4465. \$0.40 to \$4.65 (1000 qty); stock to 8 wks.

Ceramic chip capacitors rated to 4 kV dc are available with NPO/COG or BX/X7R-dielectric characteristics. Units come in five standard sizes from 0.15 × 0.15 × 0.12 to 0.53 × 0.4 × 0.12 in. Capacitance values to 0.15 μF are available. Standard voltage ratings are 1, 2, 3 and 4 kV dc.

CIRCLE NO. 394

Solid-state DIP relays switch 1.5 A ac

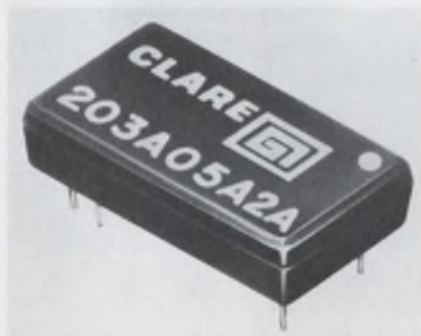

C.P. Clare, 3101 W. Pratt Ave., Chicago, IL 60645. (312) 262-7700. From \$7.20 (1000 qty).

Model 203 solid-state relays in a DIP have current ratings of 1.5 A in still air and 2 A in 100 ft/min moving air. The relays control ac loads with zero-cross (synchronous) switching and have inputs compatible with DTL or TTL logic levels. Isolation between the input and output is 2 kV rms. Two basic types are available: one switches load voltages to 240 V ac; the other switches 24 or 48 V ac.

CIRCLE NO. 395

Ultrasonic lines delay with glass elements

Corning Memory Products, Raleigh, NC 27604. (919) 876-1100. \$225; 4 wks.

Super Base delay lines, or memory units, rely on precisely ground and polished glass elements as the transmission medium. In each unit an input transducer converts the incoming signal from electrical to acoustical form. The relatively slow movement of the acoustical signals, which bounce off the glass surfaces, provides the desired delay. An output transducer reconverts the signal to electrical form. The delay lines have a bandwidth of 16 MHz and delay tolerances of ±10 ns.

CIRCLE NO. 396

Reed relays packaged three ways

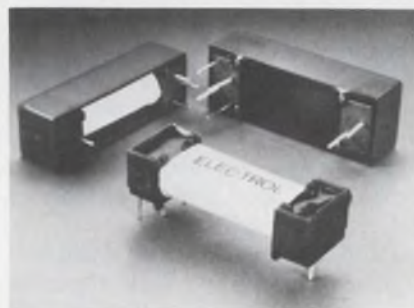

Elec-Trol, 26477 N. Golden Valley Rd., Saugus, CA 91350. (805) 252-8330. From \$1.61 (100 qty); 6 to 8 wks.

Tri-Packs reed relays are available in three package configurations: open, enclosed and fully sealed. The units are 1.25 × 0.35 in. and have a maximum contact rating of 10 W at 200 V and 0.75 A. The relays are available in 1A to 5A, 1B, 2B 1A1B and 2A2B contact forms and with both standard and sensitive coils for voltages from 6 to 48 V dc.

CIRCLE NO. 397

Piezo acoustic generator howls at 85 dB-level

Kyocera International, 8611 Balboa Ave., San Diego, CA 92123. (714) 279-8310.

A piezoelectric acoustic generator produces 85-dB sound when any voltage above 5 V dc at 0.7 to 20 mA is applied. With suitable electronics and mounting technique, the 85-dB sound is highly audible 10-ft away. Various frequencies are available in the full range of human hearing. Optimum frequencies of 1 to 6 kHz are standard for warning devices.

CIRCLE NO. 398

Wrap-and-fill caps are fully rated to 125 C

W-K Industries, 1960 Walker Ave., Monrovia, CA 91016. (213) 359-8281.

H-style wrap-and-fill capacitors have a metallized polycarbonate dielectric that allows an operating temperature range of -55 to 125 C, without derating. The capacitors use extended-foil construction, and tin-plated copper-clad steel-wire axial leads. Voltage ratings are available at 50, 100, 200, 400 and 600 V dc in a wide range of capacitance values.

CIRCLE NO. 399

Solid-state transducers measure pressure



Micro Switch, 11 W. Spring St., Freeport, IL 61032. (815) 235-6600. \$20.

Two types of piezoresistive strain-gauge pressure transducers, types 99PC and 121/122PC, accurately measure fluidic pressure and convert it into a highly linear electrical output. Pressure on a diaphragm surface of a 0.1-in.-square, silicon sensor chip causes a resistance change and ripple-free dc output. The fully amplified 6.5-V output of the 99PC transducer permits interfacing with microprocessors and other control systems. The span is from zero to 15 psi. The smaller 121/122PC transducer is not amplified and its typical output is 250 mV.

CIRCLE NO. 403

Liquid-crystal displays 8 dot-matrix digits

Crystaloid Electronics, P.O. Box 628, Hudson, OH 44236. (216) 688-2180. \$10 (1000 qty).

An 8-digit 5 × 7 dot-matrix liquid-crystal display has a 0.25-in. character height. The displays, 2.5-in. long by 0.8-in. high, can be stacked end to end or vertically to make larger displays.

CIRCLE NO. 404

MILITARY
APPLICATIONS

AD CONVERTERS

by

MSK

Accuracy

Speed

Size

Repairability

Military

Temp. Range
-55°C to +125°C



- 4 Bit/50 nSec; Low Cost
- Ideal for Radar Scan Converters
- Holds Absolute Accuracy Over Temperatures
- Tracks a 10 MHz Analog Input



- 9 Bit/200 nSec.
- < 2 Bit Drift Over Temperature
- Insensitive to Clock Frequency

For Further Information Call or Write
M.S. Kennedy Corp.
Pickard Drive, Syracuse, New York 13211
Tel. 315-455-7077

CIRCLE NUMBER 101

DATA PROCESSING

Modem handles 2400 bits/s



*Teledynamics, 525 Virginia Dr., Fort
Washington, PA 19034. (215) 643-3900.
\$765/\$805; 4 wks.*

The Model 7201C modem is Bell-201C compatible and has features similar to those of the Bell unit. The modem comes for private lines or for DDD networks. The dial-up version is for direct connection to the switched network, eliminating the need for a data-access arrangement. The 7201C has both self-test and loopback-test capabilities. Two front-panel switches select rest modes. Front-panel indicator lamps display control and data functions for system fault diagnosis.

CIRCLE NO. 405

Video monitor sports programmable control



*Digitech Data Industries, 66 Grove St.,
Ridgefield, CT 06877. (203) 438-3731.
\$2500; 8 to 10 wks.*

The Pacerscope is a programmable video monitor that provides a window to a data communication circuit from the RS232 interface. The user can view all data in real time, up to 9600 FDX, or selectively display only portions of diagnostic interest. Off-line, the unit displays thousands of characters to permit analysis of recorded data. The 1024-character window displays in alphanumeric, hexadecimal or binary form at the push of a button.

CIRCLE NO. 406

Modem direct-connects and auto-answers



*Prentice, 795 San Antonio Rd., Palo
Alto, CA 94303. (415) 494-7225. \$250 to
\$370; 6 wks.*

The P-113D is a two-wire, half or full-duplex, Bell-compatible modem for the automatic answering of a computer call-up. The modem is a direct-connect unit and interfaces to the two-wire dial network through a 97A or 97B jack; a data access arrangement (DAA) is not required. The unit can be connected in any of the three standard modes: programmable, fixed loss or permissive. Specs include a 0 to 300 bit/s serial binary asynchronous data format, -3 to -12 dBm transmit levels, -48 dBm receiver sensitivity and FSK modulation.

CIRCLE NO. 407

Adapter doubles speed of DECwriter-II



*Larks Electronics & Data, P.O. Box 22,
Skokie, IL 60077. Bob Sklar (312)
677-6080. \$95; 2 to 4 wks.*

The Accelewriter doubles the speed of any LA36 DECwriter to operate at 600 baud. The adapter converts the standard 110/150/300 baud unit to 110/300/600 baud. The device changes the internal timing of the printer and causes it to print at 60 char/s. Installation requires the removal of two ICs from the logic board of the printer and replacing them with IC sockets. The adapter is then installed in place of the two original ICs.

CIRCLE NO. 408

High-speed printer is mobile and heavy duty

Axiom, 5932 San Fernando Rd., Glendale, CA 91202. Simon Harrison (213) 245-9244. \$180 (100 qty).

The EX-201 is a high-speed, fixed-head electrosensitive printer for mobile printing and heavy-duty use. The printer operates from 12-V dc and uses a fixed-stylus print head. The print head is in light contact with a drive roller that moves paper under the head at up to 6 in/s. Alphanumeric printing speed is 800 char/s and characters may be formatted horizontally or vertically on the paper to give line or message printing. The size is 4.6 × 2.6 × 5.2 in.

CIRCLE NO. 409

I/O recorder stores analog data



Edco Scientific, P.O. Box 64, Sherborn, MA 01770. Bill Towne (617) 653-2992. \$4500.

Biotape Model 500-C is a computer I/O recorder that stores analog data, time signals and voice on magnetic-tape cassettes. A rear bus connector permits remote or computer control of all tape motion and status monitoring. Five FM data channels plus an independent direct record channel are provided in addition to a dedicated timing track that records an internally generated clock signal. A built-in event encoder is panel and/or remote operated.

CIRCLE NO. 410

Acoustic coupler and modem in one package

Anderson Jacobson, 521 Charcot Ave., San Jose, CA 95131. (408) 263-8520.

An acoustic coupler and a modem are combined in the AJ1245 for use in full-duplex asynchronous 103-mode operation at speeds up to 450 baud, or—with the flick of a switch—in half duplex 202S or 202C mode at speeds up to 1200 baud. The device is used as an acoustic coupler by inserting any standard handset into locking cups on the modem.

CIRCLE NO. 411

Switch selects any one of six CRT displays



International Data Sciences, 100 Nashua St., Providence, RI 02904. (401)

274-5100. \$175; ¼ wks.

The Model 8574-D CRT selector switches any two-wire input to any one of six 2-wire outputs so the user can manually select any one of six CRT displays. A 6-position rotary switch on the front panel switches the input from a rear-panel BNC connector to any one of six BNCs. The module is for desktop switching only, and no power is required. The size is 5.25 × 2 × 7.5 in.

CIRCLE NO. 412

NEW 8 & 10-Bit Hybrid D/A's settle in 25 NS:



The fastest hybrid micro-circuit D/A converters on the market. That's what the Computer Labs HDS-0820 and HDS-1025 are since they exhibit settling times as low as 25 ns. And even though their power dissipation of less than 3/4 watt is almost one-half that of competitive D/A's, a full 10 mA output current is maintained. So they can be used to drive transmission lines or other low-impedance loads, directly.

Active laser trimming has been used in the construction of the HDS Series to produce high accuracy and adjustment-free performance. Each is housed in a 24-pin DIP case and has an internal precision reference. They are ideally suited to operate with high-speed A/D converters, CRT displays, television picture reconstruction equipment, automatic test equipment, and much more. Call

or write now for more information on these outstanding hybrid converters.



COMPUTER LABS

TWX 510-922-7954

COMPUTER LABS, INCORPORATED

505 EDWARDIA DR. ● GREENSBORO, N. C. 27409 ● 919/292-6427

CIRCLE NUMBER 102

DATA PROCESSING

Line printer also does graphics



Malibu Design Group, 21110 Nordhoff St., Chatsworth, CA 91311. (213) 998-7694. \$2000.

The Model 160 line printer is a bidirectional 165 char/s dot-matrix machine with graphics capabilities—each of the nine printheads is under software control. The printer has logic-seeking, re-inking rollers and jumper-selectable primary voltage. Software supports the 96-character ASCII set, but the user may change the characters. The paper feed allows dots to be placed immediately adjacent, either horizontally or vertically, giving graphics at 3000 dot locations per square inch.

CIRCLE NO. 413

Wideband analog link uses guided lightwave



Radiation Devices, P.O. Box 8450, Baltimore, MD 21234. P.E. Rybak (301) 628-2240. \$725; stock to 4 wks.

Fibercom wideband analog fiber-optics links using single-fiber interconnection are capable of 10-Hz to 20-MHz operation from distances of several meters to more than 1 km. The links have a minimum signal-to-noise ratio of 50 dB at 1-V pk-pk input, flatness of ± 1 dB, linearity better than 1%, pulse overshoot less than 5%, tempo of $\pm 0.5\%/^{\circ}\text{C}$ and 50 or 75- Ω impedance. Transmitters and receivers are housed in RFI-tight enclosures 15.9 \times 5.1 \times 10.1 cm in size.

CIRCLE NO. 414

Disc drives provide parallel data transfer

Amplex, 401 Broadway, Redwood City, CA 94063. (415) 367-4151. From \$30,000.

Model PTD-9300 parallel-transfer disc drives provide an 8 or 9-bit parallel transfer capability and 300-Mbyte storage capacity for rapid processing of large amounts of data. Three configurations allow simultaneous data transfer from four, six or eight (nine) head configuration, respectively. The standard unit contains two groups of nine disc tracks per disc cylinder. The control unit can access the nine tracks of either group concurrently, and all tracks of a group can be written or read simultaneously.

CIRCLE NO. 415

Printer mixes graphics and ASCII alphanumeric

Axiom, 5932 San Fernando Rd., Glendale, CA 91202. Simon Harrison (213) 245-9244. \$795; 4 wks.

A compact micrographics printer, the EX-820, mixes high-resolution graphics and full ASCII alphanumeric from simple user software commands. The printer uses 5-in. wide electrosensitive paper, is packaged in a contoured molded case and is also available as a 5-1/4 in. high rack-mount. Software control provides flexibility in mixing alphanumeric ASCII fields and graphic fields on any line. The user can choose from four pre-programmed horizontal dot resolutions up to 128 dots/in. Once the fields have been defined, the EX-820 automatically formats graphic and alphanumeric printouts.

CIRCLE NO. 416

Printers form 3 columns with single hammer

Sheldon-Sodeco Printer, 4 Westchester Plaza, Elmsford, NY 10523. (914) 592-4400. \$105 (15 columns), \$130 (21 columns).

The PR series of 15 and 21-column printers operate at speeds up to 3 lines/s for numeric models and 1.5 lines/s for full alphanumeric by using a spanning hammer that forms characters for three columns with a single hammer. The printers do single or multiline ticket printing and have paper slewing speeds up to 10 lines/s. Drive motor power consumption is 3 W.

CIRCLE NO. 417

Portable data recorder stores 64×10^{10} bits

Sun Systems, P.O. Box 182, Sun Valley, ID 83353. Paul Bosted (208) 726-9336.

Adastor is a portable solid-state digital-data recorder that has a storage capacity of up to 64×10^{10} bits. Smaller than a shoe box, the unit presents a histogram analysis of stored data for CRT display or hard-copy. Powered by internal rechargeable batteries, the recorder operates continuously for 80 to 1800 hours. Memory circuits maintain data in standby for a minimum of 3 years. The size is 4.5 \times 9 \times 6 in.

CIRCLE NO. 418

Data logger takes thermistor probes



Instrulab, 1205 Lamar St., Dayton, OH 45404. Bruce Slemmer (513) 223-2241. \$2500; stock to 10 wks.

Expanded capabilities of the Model 2000 data logger include a plug-in range card that permits the device to measure temperature from any thermistor input. Standard cards are available for both YSI 400 and 700 series probes and cards can be supplied for other resistance/temperature curves. The logger has a display of 28,000 instead of the conventional 19,999 to allow temperature readings up to 280 degrees to be read with a resolution of 0.01%.

CIRCLE NO. 419

Back-up switch replaces faulty modem with spare

International Data Sciences, 100 Nashua St., Providence, RI 02904. (401) 274-5100. \$250; 4 wks.

The Model 8509-D spare-modem back-up switch transfers the combined RS-232 and telephone-line interface of a faulty on-line modem to a back-up system. The switch has a "chaining" feature that allows a single spare modem to replace any one of a group of on-line modems. Connections are pin-for-pin compatible with all modems and telephone-line interfaces and no power is required. The size is 6.875 \times 3.125 \times 7.75 in.

CIRCLE NO. 420

NEW!

From CAPITOL

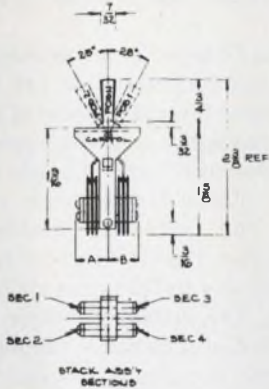

MODEL MLA LEVER SWITCH

A panel-mount switch with one-piece molded cam and handle. It extends only 1 5/8" behind panel. Extremely smooth operation with positive detent action.

COMPLETE SPECIFICATIONS IN NEW BROCHURE

CAPITOL

The Capitol Machine & Switch Co.
87 Newtown Road,
Danbury, CT 06810
203-744-3300

CIRCLE NUMBER 103

THE SUPERIOR PROM PROGRAMMER

PRICED AT \$1695
Personality
Modules \$330



IM 1000 PROGRAMMER UNIT INCLUDES:

- Capacity to program any PROM
- Microprocessor Controller
- Sixteen Key Data Entry Keyboard (0-9, A-F)
- Fourteen Digit Alph-numeric Display
- 32,000 Bits of Internal RAM Memory
- Selectable Baud Rates (110 to 9600)
- Parity Checking (Even, Odd, None)
- TTY Interface (20 MA. Loop)
- EIA RS 232C Interfaces (Two I/O Ports)

FOR FURTHER INFORMATION:

IM International Microsystems, Inc.
638 Lofstrand Lane
Rockville, Maryland. 20850
or call: (301) 340-7505

CIRCLE NUMBER 105

ELECTRONIC DESIGN 8, April 12, 1978

AMPERITE Thermostatic



DELAY RELAYS



Delays: 2 to 180 seconds*

LOW COST • LONG LIFE • MAXIMUM STABILITY

Hermetically sealed — not affected by altitude, moisture or climate changes . . . SPST only — normally open or closed . . . Compensated for ambient temperature changes from -55° to +80°C . . . Rugged, explosion-proof, long-lived . . . Standard radio octal and 9-pin miniatures.

*MINIATURES Delays: 2 to 120 seconds.

RELAY PRICES:

Standard or
Miniature—
Under

\$5.00 each

PROBLEM?

Send for
BULLETIN
No. TR-81

AMPERITE CURRENT REGULATORS

Automatically keeps current at a definite value. For AC or DC . . . Hermetically sealed, rugged vibration-resistant, compact, most inexpensive.

Price, under \$4.00 ea.

Write for Bulletins TR-81, LD-73 and AB-51

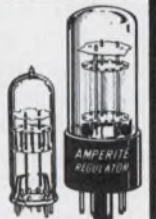

AMPERITE

600 PALISADE AVE.,
UNION CITY, N.J. 07087
Telephone: 201 UNion 4-9503

Canada: Atlas Electronics, Ltd., 50 Wingold Ave., Toronto M6B 1P7

CIRCLE NUMBER 104

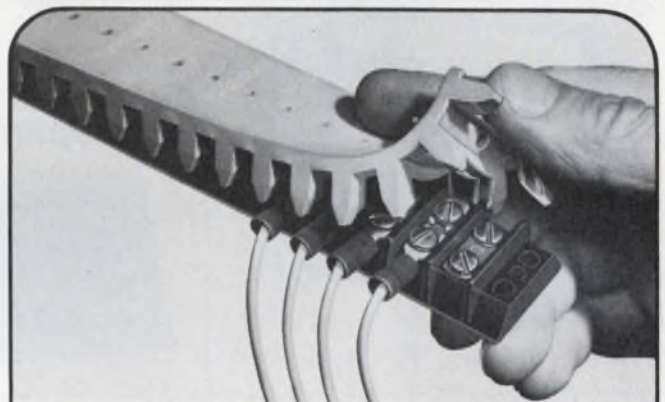

NEW SAFE-TI CAPS™

Protect your terminal board connections by covering them with Kulka's non-flammable, rubber Safe-Ti Caps™. These unique covers guard against spills, dirt and accidental short circuits from dropped tools. Available in all the popular sizes. Be sure to send for Kulka's free catalog.

Kulka

A NORTH AMERICAN
PHILIPS
COMPANY

520 S. Fulton Ave., Mt. Vernon, NY 10551 Tel: 914 664 4024

CIRCLE NUMBER 106

PACKAGING & MATERIALS

Wire-wrappable panels accept all IC sizes

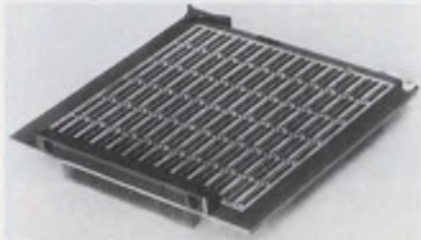

Excel Products, 401 Joyce Kilmer Ave., New Brunswick, NJ 08903. (201) 249-6600. From \$109.40; stock.

Pluggable IC wire-wrappable packaging panels, 6000 Series, accept all IC sizes from any manufacturer. Also, these high-density panels can accommodate pin or socket-style I/O connectors, and 60 or 72-pattern boards are standard. The panels measure 6.95 x 7.353 and 0.125 or 0.063-in. thick and are double sided with ground and power planes connected at each pattern.

CIRCLE NO. 421

Assemble fiber optics with designer's kit



AMP, Harrisburg, PA 17105. (717) 564-0100. \$165; stock.

A fiber-optics designer's kit includes an assortment of emitter and detector bushings, splice bushings, polishing bushings, several sizes of connector ferrules, a polishing plate, a hand tool for terminating cable and sample lengths of optical cable. The parts accommodate most common sizes and types of fiber-optic cables, emitters and detectors. An instruction booklet provides cross-referenced data concerning semiconductor emitters and detectors as well as fiber-optic cables. The kit contains enough components to house 25 emitters or detectors, make five free-hanging and five bulkhead-mounted splices and terminate 20 fiber-optic cables.

CIRCLE NO. 422

Wire terminator selects lengths by pushbutton



Ark-Les, 51 Water St., Watertown, MA 02172. Bob Olsen (617) 924-2330. See text.

A fully automatic cut, strip and terminating machine, the CS21, lets you choose wire lengths by pushbutton. Terminal selection and positioning is done with quick change, modular tooling. The machine produces an effective rate of 3400 double-ended terminations per hour on 7-in. lead wires. Wire length is adjustable from 3 to 999.9 in. and 12-to-22 gauge wire with insulation ranging from 0.075-in. diameter to a wall thickness of 5/64 in. can be used. The machine is priced according to the number of combinations of terminations desired.

CIRCLE NO. 423

Shielding film protects static-sensitive parts



3M, P.O. Box 33600, 3M Center, St. Paul, MN 55133.

A transparent shielding film protects PC boards and static-sensitive devices from static electricity. The film creates a Faraday cage around electronic devices and, because it is transparent, ensures that devices remain visible at all times. The film is three-layered and consists of a conductive metallic outer layer that provides the shielding, a polyester film that offers high tensile strength and tear resistance and a heat-sealable polyethylene layer that has antistatic properties to prevent charge generation inside the bag. The bags are available in sizes from 4 x 4 in. up to 15 x 18 in.

CIRCLE NO. 424

Cable connector gives tight seal



Cam-Lok, 10540 Chester Rd., Cincinnati, OH 45215. Jim Trester (513) 771-3171.

The Porta-Change is a multipin field-attachable connector that can be used outdoors or indoors because of an oiltight, watertight and dust-proof seal. The two-piece body is made of high-impact plastic for corrosion resistance. The internal molded synthetic-rubber insert insulates the electrical contacts and provides visible polarization. The mated connector is securely locked by a threaded coupling that prevents accidental disengagement. The connectors are rated at 20 A, 600 V and are for use on 2, 3 and 4-conductor cable of sizes from #18 through #12.

CIRCLE NO. 425

Data-bus cables mate computers to testers



Belden, 2000 S. Batavia Ave., Geneva, IL 60134. (312) 232-8900. See text; stock.

A line of data-bus cable assemblies for interfacing computers with programmable test and measurement devices meets the requirements of IEEE Standard 488. The cable's 24-conductors terminate in 24-contact male/female connectors. Eight conductors are for general interface management, six are for data byte transfer control, eight for conductors for data I/O and two single conductors serve as logic and earth grounds. The price for a 6-ft cable in quantities of 50 and up is \$36.

CIRCLE NO. 426

Mini-relay sockets meet Signal Corps specs

Eby, 4701 Germantown Ave., Philadelphia, PA 19144. (215) 842-3000.

A group of miniature relay sockets includes a 10-pin flange-mounted model, and two 8-pin models. The 10-pin socket, Type 9883-46-02, meets Signal Corps spec SM-D-415156. The 8-pin socket, Type 9883-15-02 meets spec SM-D-414117. For PC boards, use the Type 9883-14-11 socket that meets SM-C-374819. The contact tails on this socket are accurately controlled and tightly fit to PC-board holes without the need for clamping.

CIRCLE NO. 427

Coating removes glare from PC boards

SK Industries, 141 Laburnum Lane, Fountain Valley, CA 92708. (714) 963-2281.

Glare-eliminating coating, Dulta Kote-II, for PC boards and assemblies, improves labor efficiency and inspection time. A brush or spray coating changes to flat white on metal surfaces while remaining transparent on laminate areas. Black shadows and glaring highlights are eliminated providing sharp visual contrast. The coating converts to white within 15 s, tack free within 90 s. Hand soldering reconverts the coating to transparent or it removes with alcohols and chlorinated or fluorinated solvents.

CIRCLE NO. 428

Precision wave solderer sports reduced price

Manix, Box 496, Huntingdon Valley, PA 19006. (800) 523-1960. See text.

The WS-12 precision wave-soldering machine is available at the reduced price of \$5495. Standard equipment includes solid-state controls, a tubular porous-stone foam fluxer, two 1.5-kW radiant preheaters, two 2.2-kW immersion-type solder-pot heaters, a fully adjustable 12 x 1.25 x 0.5-in. solder wave, a remote-control timer and an automatic temperature stabilizer. The machine also has a fume-dispersal system, tempered safety-glass enclosure and an 18-in. pallet that adjusts to a full 12-in. width.

CIRCLE NO. 429

Capacitor clips made of nylon



Richco Plastic, 5825 N. Tripp Ave., Chicago, IL 60646. Linda Rooney (312)

539-4060. Samples.

Series SCH clips are all-nylon holders for capacitors. They screw mount at almost any angle. Capacitors are firmly held with a locking clamp that easily twist releases for reuse. The clips handle capacitors with 1-3/8 to 1-7/16-in. diameters. Two universal screw-type feet provide mounting and two support tabs provide stability. Once positioned, the clips stand 1/2 in. above the chassis surface.

CIRCLE NO. 430



Give your PDP-11 a Calendar.

When you equip your computer with a TCU-100, you'll automatically have the date and time available when you power up.

It's an easy way to keep track of downtime, too. Furthermore, you can use the unit like an alarm clock. Set it to interrupt at preset times—or at intervals as short as 1/2048 second.

TCUs are shipped preset to your local time, but can be set to any time you want by a simple software routine. The built-in battery back-up is good for months with out computer power.

For the LSI-11 user, we offer the TCU-50—the same reliable timekeeper without the interrupt capability. With either unit, time is cheap. The TCU-100 is just \$495. And the TCU-50 is only \$325.

Time is only one way we can help you upgrade your PDP-11 or LSI-11 system. We'd also like to tell you about the others.

So contact Digital Pathways if you're into -11's. We are too.



DIGITAL PATHWAYS INC.

4151 Middlefield Road • Palo Alto, California 94306 • Telephone (415) 493-5544
CIRCLE NUMBER 102

The Seastrom Touch



FREE 250 page illustrated catalog with 30,000 part numbers in stock for immediate delivery . . . all types of washers, shims, spacers, lugs, clips, clamps, plugs, insulators, military standards, etc.

NEW PRODUCT!

U-TYPE Sheet metal nuts now available. Send for your FREE U-Nut catalog.



SEASTROM

MANUFACTURING CO., INC.

701 Sonora Ave. • Glendale, Calif. 91201
(213) 245-9121 TWX 910-497-2271

CIRCLE NUMBER 109

PACKAGING & MATERIALS

Solder-stop keeps surfaces solder-free

London Chemical, 240 Foster Ave., Bensenville, IL 60106. Ken Anderson (312) 766-5902.

A removable solder-stop, WR, protects surfaces that must be kept free of solder during flow-soldering operations. The material prevents solder-take on contact surfaces, circuit-pad areas, pins, plated-through holes and lugs. The coating resists both water-soluble and resin solder fluxes and can be removed in water and water/Loncoterge cleaning systems.

CIRCLE NO. 431

Solderless breadboards for DIPs or wide LSIs

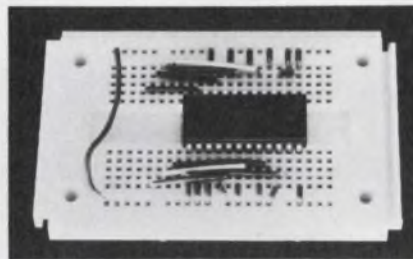

Continental Specialties, 70 Fulton Terrace, New Haven, CT 06509. (203) 624-3103. \$5.50/\$6.25.

Palm-sized solderless breadboards are 3.6-in. long. Type EXP350 has 0.3-in. center-to-center spacing to accept standard DIP packages. Another version, type EXP650, has 0.6-in. spacing for wide LSI DIPs.

CIRCLE NO. 432

Ceramic potting compound stands up at 3000 F

Aremco Products, P.O. Box 429, Ossining, NY 10562. Herb Schwartz (914) 762-0685. \$33 (1-lb kit); stock.

Ceramacast 528, a two-component ceramic, potting mixture capable of use to 3000 F, consists of a ceramic powder base and liquid activator. The compound is used at temperatures over 600 F, where silicone and epoxy compounds deteriorate. Set-up time is 6 to 8 min. with no shrinkage. After it sets, a low-temperature bake at 200 F completes the cure cycle.

CIRCLE NO. 433

High-density plugs are MIL qualified

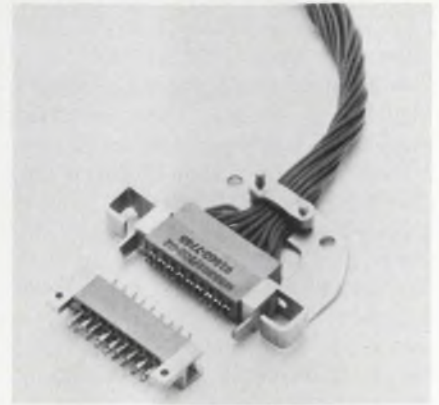

Elco, 2250 Park Pl., El Segundo, CA 90245. Karl Neumuller (814) 643-0700.

The Type 8221, 0.05-in. staggered mini-Varilok plugs and receptacles have been fully qualified to MIL-C-55302B, Amendment 2 for connectors, and for printed circuits, FSC 5935. Also, they are covered by MIL-C-55302/99-107 and they are to be included on the Qualified Products list. The units accommodate parallel or perpendicular PC-board mounting. They use crimp contacts, need a low insertion force and are useful for high-density applications. The contacts can be hand or machine crimped to solid or stranded AWG 22 to 30 wire. Current rating of the series is 5 A with 22 wire. Contact resistance is 6 mΩ max.

CIRCLE NO. 434

Cable-tie tool has tension gauge

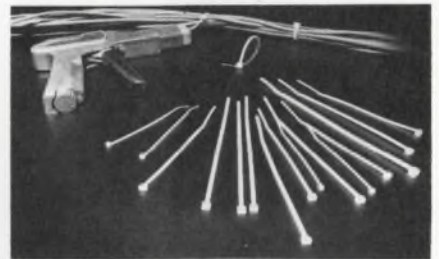

Waldon Electronics, 4301 W. 69 St., Chicago, IL 60629. (312) 585-1212.

Two lightweight hand-type tension control tools permit rapid fastening and flush cut-off of nylon cable ties. Models 65098 and 65099 weigh 1 lb each and have easy-to-read tension gauges that identify proper tension settings. The tension adjustment is easy to use and holds at each setting with a detent locking action. The tools can also be locked for quality control and production operations.

CIRCLE NO. 435

If you're looking for high capacitance

You'll be interested in AVX Ceraseal®. It's a unique ceramic-epoxy encased radial capacitor designed specifically to put the maximum amount of capacitance in the minimum size package.

To get capacitance of 1 mfd and above in a standard CKR06/CK06, .290 inch-square case size, most manufacturers use a smaller, thinner chip. The result is thinner dielectric layers with greater chances for failure. Instead, AVX uses a

thinner case, the Ceraseal ceramic-epoxy coating. It provides excellent physical protection for the chip. And it allows us to put more plate area and thicker dielectric layers into the standard CK06 package size.

AVX offers Ceraseal construction, in standard off-the-shelf products, up to the

MIL-designated CKR08 2.0 mfd capacitance rating, all available at

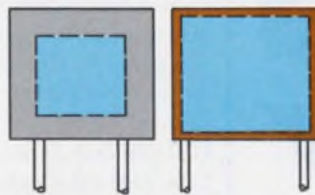

the highest military reliability levels. And we can build Ceraseal radials to even higher

reliability levels, tight tolerances, with capacitance values up to 50 mfd.

If you need high capacitance, with the reliability that only a ceramic multilayer can provide, contact your local AVX representative or distributor. He's the only one who can offer you Ceraseal components. And Ceraseal is the answer.

...look to AVX.

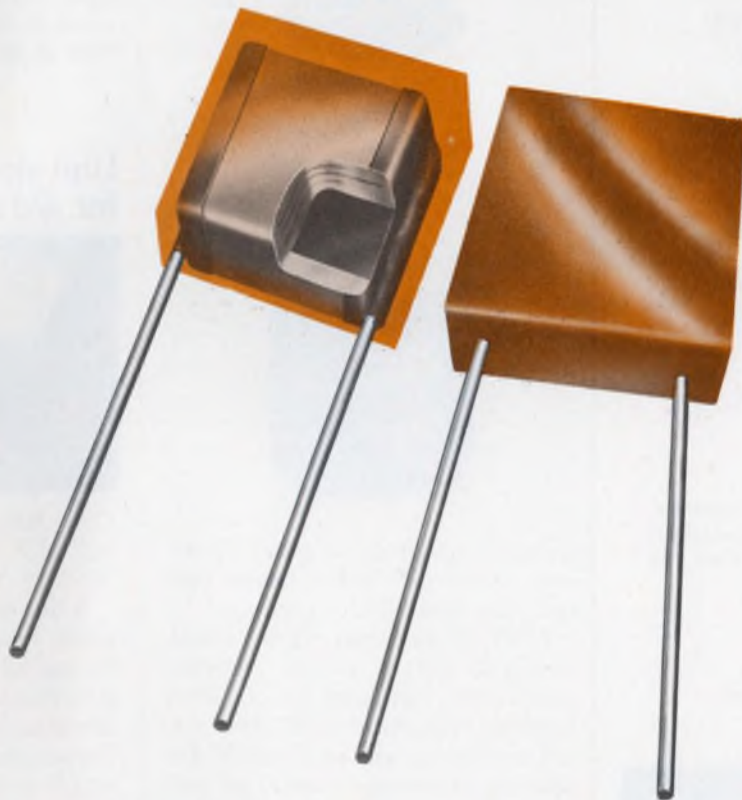

AVX CERAMICS

AVX Ceramics, P.O. Box 867, Myrtle Beach, SC 29577 (803) 448-3191
TWX: 810-661-2252; Olean, NY 14760 (716) 372-6611 TWX: 510-245-2815
AVX Limited, Aldershot, Hampshire, GU12 4RG England, Tel: Aldershot (0252) 312131 Telex: 858473

DELAY LINES



We offer the most complete line of delay lines in the industry.

- DIP DELAY LINES
- TAPPED DELAY LINES
- VARIABLE DELAY LINES
- TRIMMER DELAY LINES
- AUDIO DELAY LINES
- VIDEO DELAY LINES
- DIGITAL DELAY LINES

Items in stock shipped immediately. Check our stock supply for your urgent needs. We invite custom designs and militarized requirements.

We stand behind our products 100%

DATA DELAY DEVICES



253 CROOKS AVE., CLIFTON, N.J. 07011 Tel. (201) 772-1106
See us at DEEC, Anaheim, Ca., Booth #12

POWER SOURCES

Power supply has covered frame

Standard Power, 1400 S. Village Way, Santa Ana, CA 92705. (714) 558-8512. \$49 to \$345.

The CPS (covered power supplies) units have anodized aluminum covers that protect components and provide personnel safety. Technical features include terminal strip connection, voltage and current limit adjustment and 115/230-V-ac input at 47 to 440 Hz. Line and load regulations are $\pm 0.1\%$ with a 0.1% typical ripple. Response time is 50 μ s.

CIRCLE NO. 436

25-Ah lead-acid cell fits in a beer can



Gates Energy Products, 1050 S. Broadway, Denver, CO 80217. George Sahl (303) 744-4806. \$10.30 (1000 qty).

A 2-V, 25 Ah energy cell is a sealed, lead-acid, spirally wound, rechargeable battery that is the size of a 16-oz beer can. Features of the BC (beer can) cell are: charge and discharge in any position, at constant current or voltage, fast cycling or long-term float capability; no memory effects; and no damage to cell due to reversal. The nominal cell voltage is 2 V and the capacity rating is 26 Ah at 20-h rate or 20 Ah at 1-h rate.

CIRCLE NO. 437

Solid-state ac units are power expandable



Pacific Power Source, 5291 Systems Dr., Huntington Beach, CA 92649. (800) 854-2433.

The J series of linear ac-power sources feature a parallelable 1.3-kVA linear power amplifier that provides for a wide range of standard models, ranging from 2.5 to 70-kVA single-phase and up to 210-kVA three-phase. The sine-wave output is variable in frequency from 47 to 500 Hz. Output distortion is 0.75%, load regulation is 0.25% and line regulation is 0.1%. Three precision frequencies are provided as specified by the user at the time of ordering.

CIRCLE NO. 438

Unit yields all voltages for a/d converters



Calex Mfg., 3355 Vincent Rd., Pleasant Hill, CA 94523. R.C. Kreps (415) 932-3911. \$89/\$95; stock.

A line of encapsulated triple-output power supplies offer the advantage of having all the voltages required for powering a/d-converter modules in one miniature unit. The supplies are PC or chassis mountable and provide ± 15 or ± 12 V at 100 mA and 5 V at 500 mA. Specs include operating temperatures from -25 to $+71$ C and line voltages of 100, 115 or 220 V ac at 50 to 500 Hz. The modules are short-circuit protected by fold-back current limiting. The size is 1.25 \times 2.5 \times 3.5 in.

CIRCLE NO. 439

ELECTRONIC DESIGN 8, April 12, 1978

Relays for every reason

Series MK

- Open, closed and hermetically sealed.
- Five individual series.
- Low profile plug-ins.
- Choice of plug-in, .110 quick connect, .187 quick connect, PC board or solder connections.
- Contact arrangements up to 3 Form C.
- Contact ratings 5 or 10 amp at 120 VAC.
- Current sensitive to 240 volts.
- Factory stock or at your nearest Line Relay distributor.



For prices and a free catalog of over 200 different relays and accessories, write or call: Line Electric
U.S. Highway 287
Parsippany, NJ 07054
(201) 887-8200
Telex: 13-6494



LINE RELAYS
AN ESTERLINE COMPANY

CIRCLE NUMBER 112

ALCOKNOB

COLLET KNOBS AND ACCESSORIES

Function, styling and simplicity of assembly were our main criteria in the development of this new knob series. Featuring a unique mounting technique which allows firm attachment to a shaft without the use of set screws.

ALCO has become a leading source for knobs in the USA . . . We offer the widest variety including many premium anodized aluminum and phenolic knobs.

Our new Collet Series fills industry needs for knobs with outstanding features at prices you can afford.

Three basic families are offered in a variety of size and style. Usefulness is further enhanced by a full line of accessories including dials, nut covers and many more.

All Knobs in this series are illustrated in our new 32-page catalog and are available "off-the-shelf" in production quantities. Call Customer Service for more detailed information.



ALCO

ELECTRONIC PRODUCTS, INC.
1951 OSBORNE STREET, NORTH ANDOVER, MA 01854

Tel: (617) 685-4371

TWX: 710 342-0552

A SUBSIDIARY OF

AUGAT INC

CIRCLE NUMBER 113

Test With Confidence

HIGH SPEED CIRCUIT TESTER

for accuracy and integrity

Series

703



3000 tests per minute
Useful anywhere
A dielectric test
is not needed

SELF PROGRAMMING FOR TESTING UP TO 500 POINTS
MICRO-PROCESSOR CONTROLLED . . . GO/NO-GO OPERATION
DIGITAL READOUT OF FAULT AND LOCATION

MANUFACTURERS OF INSULATION TESTERS
CABLE & HARNESS TESTERS . . . MEGOHMMETERS
STROBOSCOPES . . . COIL & WINDING TESTERS
& BATTERY TESTERS

SLAUGHTER COMPANY

MOORE & HAILEY STS
Tele: 405-223-4773

ARDMORE, OKLAHOMA 73401
TWX: 910-830-6972

CIRCLE NUMBER 114

ELECTRONIC DESIGN 8, April 12, 1978

DIGITAL CLOCKS

23:59:59

Thousands of Configurations at
Off-the-Shelf Prices. Options Include:

- Time ranges from milliseconds to years
- Large character LED displays
- Buffered BCD outputs at TTL levels
- Standby Battery operation
- Video digital time displays
- ASCII output for RS232C ports
- Time Code Generators and Readers with IRIG, NASA, and level shift codes

Chrono-log Corporation, 2 West Park Road,
Havertown, Pa. 19083 Phone: (215) 853-1130



CHRONO-LOG
CORPORATION

CIRCLE NUMBER 115

Application notes

Microwave freq counters

Four principal down-conversion techniques for extending the frequency range of counters into the microwave region are discussed in a 13-page application note. Hewlett-Packard, Palo Alto, CA

CIRCLE NO. 440

Rectifier circuits

"Rectifier Circuits for Linear ICs" discusses techniques for designing rectifiers using the components available on semi-custom ICs. Design precautions are examined in detail and illustrative diode, peak detector and averaging-rectifier circuits are presented. Interdesign, Sunnyvale, CA

CIRCLE NO. 441

Gas-discharge tubes

Characteristics and performance data for gas-discharge tubes for the protection of personnel and electrical and electronic equipment against voltage transients are described in an eight-page brochure. Siemens, Iselin, NJ

CIRCLE NO. 442

Spectrum analyzers

How the testing and adjustment of phase-locked-loop demodulators can be greatly simplified by using a spectrum analyzer with built-in tracking generator and display memory is shown in a six-page brochure. Marconi Instruments, Northvale, NJ

CIRCLE NO. 443

Silicon power devices

"Free Floating Silicon—Solderless Construction of Large Diameter Silicon Power Devices" discusses thermal and electrical-conductivity problems encountered in the development of silicon power devices. It also describes various packaging and bonding techniques and compression-assembly approaches. FMC Corp., Broomfield, CO.

CIRCLE NO. 444

New literature



Digital logic, TTL IC

A 16-page catalog lists 80 TTL devices in 74, 74H, 82, 93 and 96 Series families, together with a direct cross-reference chart to major manufacturers numbers. The catalog contains logic block diagrams for each device type, plus tables of the basic specifications and parameters. Package availability and mechanical data are shown for 14, 16, and 24-pin plastic and ceramic DIPs. NEC America, Santa Clara, CA

CIRCLE NO. 445

Microcomputers

A 24-page brochure covers the micro-NOVA family of microcomputers. Data General, Westboro, MA

CIRCLE NO. 446

Semiconductor accessories

Technical-application notes on semiconductor accessories, engineering drawings, thermal-performance curves, photographs and isometric illustrations are included in a 68-page catalog. Thermalloy, Dallas, TX

CIRCLE NO. 447

Electromechanical equipment

Thousands of electromechanical equipment units and components are illustrated in a 116-page catalog. American Design Components, New York, NY

CIRCLE NO. 448

S/d converters

A two-speed, 20-bit synchro/digital converter packaged as a standard module is described in a two-page data sheet. The data sheet provides specifications and ordering information. Natel Engineering, Canoga Park, CA

CIRCLE NO. 449

Computers

Over 1500 computer-related products from over 170 different vendors are shown in an 84-page catalog. The catalog is priced at \$1. American Used Computer, Boston, MA

CIRCLE NO. 450

Digital panel printer

Electrical and physical characteristics, I/O connections, timing diagram, paper loading, applications and ordering information on a 7-column thermal printer, Model DPP-7, are contained in a 12-page catalog. Datel Systems, Canton, MA

CIRCLE NO. 451

LED scanner

A modular, self-contained LED scanner is the highlight of a six-page, full-color catalog that instructs users on how to create a self-contained photoelectric scanner that meets exact scanning needs. Banner Engineering, Minneapolis, MN

CIRCLE NO. 452

Temperature measurement

The 1978 Temperature Measurement Handbook and Catalog covers basic temperature-measurement data. The latest thermocouple-calibration tables (released by the National Bureau of Standards), RTD tables, response times for thermocouples, temperature vs millivolt conversion tables, material-selection guides and technical data on thermometry form an integral part of this edition. Omega Engineering, Stamford, CT

CIRCLE NO. 453

Liquid crystals

A four-page brochure describes liquid-crystal displays. Hughes Micro-electronic Products Div., Irvine, CA

CIRCLE NO. 454

LEDs

Featured in a 72-page catalog are digital, alphanumeric and integrated-logic LED displays, ranging in height from 0.27 up to 1.02 in. Detailed dimensional drawings and technical data accompany the more than 133 different model LEDs and accessories. IEE, Van Nuys, CA

CIRCLE NO. 455

Terminal boards

A terminal board, block and strip catalog shows 15 board types, in addition to describing hardware variations, board and insulator-strip markings, and prototype services. Kulka Electric, Mount Vernon, NY

CIRCLE NO. 456

Programmable timers

An eight-page brochure explains the operation of the UP-timer—the universal programming timer. Xanadu Controls, Springfield, NJ

CIRCLE NO. 457

Attenuators

Subminiature and miniature rotary-step; tandem-mounted rotary-step; bench-type rotary-step; fixed-value coaxial; programmable; and special and custom-designed attenuators are featured in a 16-page catalog. Telonic/Berkeley, Irvine, CA

CIRCLE NO. 458

Fiber-optic connectors

Descriptions of fiber-optic connectors and Gold Dot interconnection systems are provided in data sheets. Hughes Connecting Devices Div., Irvine, CA

CIRCLE NO. 459

Air movers

"MIL Grade Fans and Blowers" is 189 pages of data on air movers, including sections on general engineering information, fan laws, selecting and specifying air movers, and up-to-date product information. Rotron, Woodstock, NY

CIRCLE NO. 460

Thermistors

Resistance-temperature characteristics and applications of a high-speed thermistor are shown in a two-page data sheet. Victory Engineering, Springfield, NJ

CIRCLE NO. 461

Microwave components

An 80-page catalog contains specifications on precision microwave components. Electrical, mechanical and environmental specifications are presented as well as operation characteristics. RLC Electronics, Mount Kisco, NY

CIRCLE NO. 462

Flexible discs

Information on the recording performance and physical characteristics of flexible discs is provided in a four-page brochure. The brochure includes features, user notes and compatibility references. Information Terminals, Sunnyvale, CA

CIRCLE NO. 463

Q. What do power lines and medical instruments have in common?



A. NAPCC miniature digital Elapsed Time Indicators and a need to conserve space.

Our Series 49200 Elapsed Time Indicator is tiny. Just 37/64" sq x 1-1/4". It's the ideal way to monitor equipment usage time where space is limited and accuracy extremely important.

For instance, utilities use them to measure peak demand time. They're installed in crowded instrument boxes on central monitor poles. Lots of information in just .418 cu. in. of space. Less mass. More room for other instruments. In electronic medical instruments designed for home rental, the ETI's record usage time for billing purposes. Other applications include monitoring operating time for parts replacement, maintenance, testing, etc. 1W, 115V ac, 60 Hz. Surface or through-panel mount.

Send for information today!

NORTH AMERICAN PHILIPS CONTROLS CORP.

Cheshire, Conn. 06410 - (203) 272-0301

For Immediate Need Circle Number 131
For Information Circle Number 135

Buzzzzz.
(Write for new catalog.)



Solid state electronic MICRO-BUZZER from CITIZEN: High reliability, competitively priced with immediate delivery.

A complete range: SMB 1.5, 6, 12, 24, VDC
RMB 3, 6, 12, 24, VDC
IMB (Intermittent) 6, 12, VDC

CITIZEN

CITIZEN AMERICA CORPORATION
1710 - 22nd St.
Santa Monica,
CA 90404

Toll Free (800) 421-6516
In Calif. (213) 829-3541
TWX: (910) 343-6450

Name _____
Company _____
Address _____
City _____ State _____
Zip _____ Phone _____

CIRCLE NUMBER 136

Waters Conductive Plastic Elements Can Cure Your Servo Feedback Problems

When it comes to the application of conductive plastic potentiometers or elements in servo feedback systems for recorders, controllers, and actuators, Waters wrote the book.

Waters makes rotary servo potentiometers from 1/2" to 2" diameter, and custom elements from 1/2" to 40" in length. All Waters' CP units provide infinite resolution, multi-million cycle life, and low output smoothness (.03%). Linearities can be specified to 0.1% using Waters own automated linearization technology.

Bring your servo feedback requirements to Waters for the professional solution to your individual application.

Call Waters at 617-358-2777 or circle reader service card.

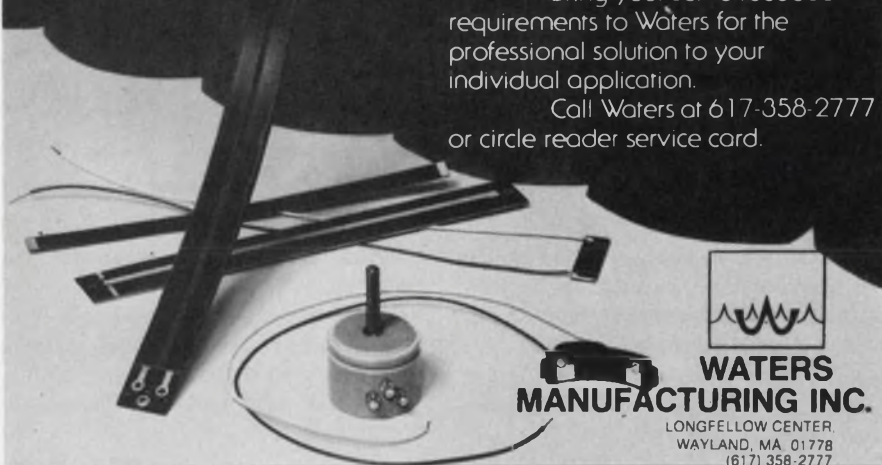

**WATERS
MANUFACTURING INC.**
LONGFELLOW CENTER
WAYLAND, MA 01778
(617) 358-2777

CIRCLE NUMBER 110

monolithics mix



Nuts to Noise! And Interference! And IM!

That's what monolithic filters are all about — selectivity. Our monolithic filters will crack your toughest requirement. And you won't have to shell out your whole parts budget. Over 60 stock models at 10.7 and 21.4 MHz save design time and production cost. Others from 5 to 180 MHz. Send for complete specs now.

The standard in monolithic crystal filters

NUTS TO NOISE!

Pti

Piezo Technology Inc.
2525 Shader Road, Orlando, FL 32804
(305) 298-2000

CIRCLE NUMBER 111

Vendors report

Annual and interim reports can provide much more than financial position information. They often include the first public disclosure of new products, new techniques and new directions of our vendors and customers. Further, they often contain superb analyses of segments of industry that a company serves.

Selected companies with recent reports are listed here with their main electronic products or services. For a copy, circle the indicated number.

Xonics. Medical diagnostics, commercial X-ray inspection systems, lasers, data systems.

CIRCLE NO. 464

Planning Research Corp. Professional services.

CIRCLE NO. 465

Scientific Atlanta. Communications, satellite communications, cable TV, instrumentation, telecommunications, antenna and microwave instrumentation, enclosures.

CIRCLE NO. 466

Harris Corp. Communication and information-handling systems and equipment, semiconductors.

CIRCLE NO. 467

Bio-Medicus. Nonpulsatile blood pump.

CIRCLE NO. 468

Valtec. Fiber-optics, electronics, optics.

CIRCLE NO. 469

Ampex. Audio/video products, magnetic tape, data/memory products.

CIRCLE NO. 470

Anderson Jacobson. Data communications equipment, computer terminals.

CIRCLE NO. 471

ARI Industries. Cable, nuclear instrumentation.

CIRCLE NO. 472

BASF Wyandotte. Chemical products.

CIRCLE NO. 473

Electronic Design

ELECTRONIC DESIGN's function is:

- To aid progress in the electronics manufacturing industry by promoting good design.
- To give the electronic design engineer concepts and ideas that make his job easier and more productive.
- To provide a central source of timely electronics information.
- To promote communication among members of the electronics engineering community.

Want a subscription? ELECTRONIC DESIGN is circulated free of charge to those individuals in the United States and Western Europe who function in design and development engineering in companies that incorporate electronics in their end product and government or military agencies involved in electronics activities. For a free subscription, use the application form bound in the magazine or write for an application form.

If you do not qualify, paid subscription rates are as follows: \$30.00 per year (26 issues) U.S./Canada/Mexico, \$40.00 per year (26 issues) all other countries. Single copies are \$2.50 U.S. and all other countries. The Gold Book (27th issue) may be purchased for \$30.00 U.S./Canada/Mexico, and \$40.00 all other countries.

If you change your address, send us an old mailing label and your new address; there is generally a postcard for this in the magazine. You will have to requalify to continue receiving ELECTRONIC DESIGN free.

The accuracy policy of ELECTRONIC DESIGN is:

- To make diligent efforts to ensure the accuracy of editorial matter.
- To publish prompt corrections whenever inaccuracies are brought to our attention. Corrections appear in "Across the Desk."
- To encourage our readers as responsible members of our business community to report to us misleading or fraudulent advertising.
- To refuse any advertisement deemed to be misleading or fraudulent.

Individual article reprints and microfilm copies of complete annual volumes are available. Reprints cost \$6.00 each, prepaid (\$.50 for each additional copy of the same article), no matter how long the article. Microfilmed volumes cost \$23 for 1976 (Vol. 24); \$30 for 1973-75 (Vols. 21-23), varied prices for 1952-72 (Vols. 1-20). Prices may change. For further details and to place orders, contact Customer Services Dept. University Microfilms, 300 N. Zeeb Rd., Ann Arbor, MI 48106. (313) 761-4700.

Want to contact us? If you have any comments or wish to submit a manuscript or article outline, address your correspondence to:

Editor
ELECTRONIC DESIGN
50 Essex St.
Rochelle Park, NJ 07662

Electronic Design

Advertising Sales Staff

Susan G. Apolant
Sales Coordinator

Rochelle Park, NJ 07662

Robert W. Gascoigne
Thomas P. Barth
Stan Tessler
Constance McKinley
50 Essex St.
(201) 843-0550
TWX: 710-990-5071
(HAYDENPUB ROPK)

Philadelphia

Thomas P. Barth
(201) 843-0550

Boston 02178

Gene Pritchard
P.O. Box 379
Belmont, MA 02178
(617) 489-2340

Chicago 60611

Thomas P. Kavooras
Berry Conner, Jr.
200 East Ontario
(312) 337-0588

Cleveland

Thomas P. Kavooras
(312) 337-0588

Los Angeles 90045

Stanley I. Ehrenclou
Burt Underwood
8939 Sepulveda Blvd.
(213) 641-6544

Texas

Burt Underwood
(213) 641-6544

San Francisco

Robert A. Lukas
465 S. Mathilda, Suite 302
Sunnyvale, CA 94086
(408) 736-6667

United Kingdom-Scandinavia

Constance McKinley
50 Essex St.
Rochelle Park, NJ 07662
Phone: (201) 843-0550

Europe

W. J. M. Sanders
S.I.P.A.S.
Raadhuisstraat 24 - P.O. Box 25
1484 EN Graft-de-Ryp, Holland
Tel: 02997-1303 and 3660
Telex: 13039 SIPAS NL
Telegrams: SIPAS-Amsterdam

G. Nebut

Promotion Presse Internationale
7 ter Cour des Petites Ecuries
75010 Paris, France
Telephone: 5231917, 1918, 1919

Dieter Wollenberg
Erikastrasse 8
D-8011 Baldham/Muenchen
Germany

Telephone: 0 8106/4541

Robert M. Saidel
Technimedia International
Via G. Fara, 30
20124 Milan, Italy
Tel: 65.72.765
Telex: 25897 Utiidioma

Tokyo

Haruki Hirayama
EMS, Inc.
5th Floor, Lila Bldg.,
4-9-8 Roppongi
Minato-ku, Tokyo, Japan
Phone: 402-4556
Cable: EMSINCPERIOD, Tokyo



CUSTOM PRECISION POTS TO SUPPORT YOUR SYSTEMS



Multi-Gang, Multi-Tap (Wirewound and conductive plastic)



Varifunction Unitized Clutch Module



Linear Motion-Translatory (Wirewound and conductive plastic)



Torquer Pot

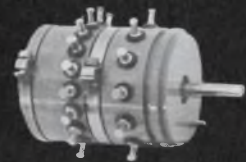

Single Turn Wirewound

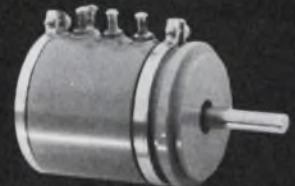

Multi-Turn Wirewound

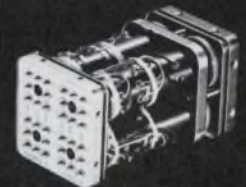

Multi-Function Modular or In-Line Packages
(Spring Return/Brakes/Clutches/
Pots/Commutators/Synchros)

Call or write for 52 page catalog.

Bowmar

BOWMAR/TIC, Inc.

850 Lawrence Drive
Newbury Park, Calif. 91320

(805) 498-2161 TWX 910-336-1265

CIRCLE NUMBER 117

quick ads

New and current products
for the electronic designer
presented by their manufacturers.

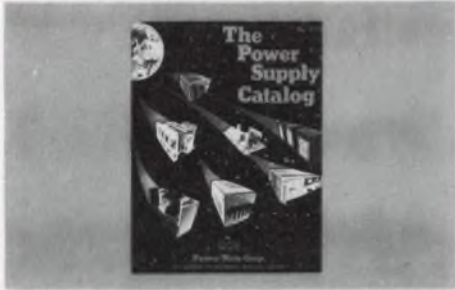

Free New catalog contains over 34,500 quality power supplies from the world's largest manufacturer, Power/Mate Corp. Power Supplies for every application including submodulars, open frame, variorated, encapsulated, laboratory & system. All units UL approved and meet most military and commercial specs for industrial and computer uses. Power/Mate Corp., 514 S. River St., Hackensack, NJ 07601 (201) 343-6294

POWER SUPPLIES

181



ATOMIC FREQUENCY STANDARD for communications/navigation systems & lab/field calibration. Model FRT outputs 10.5-1-0.1 MHz and 1 PPS optional. Long term stability 1×10^{-11} /month; short term is 1×10^{-11} for 1 sec, 1×10^{-12} /100 sec. avg. times. Low noise option available. Unit operates from -10°C to $+50^{\circ}\text{C}$ with relative frequency change of $< 1 \times 10^{-10}$. Internal battery provides 3 hours operation. EFRATOM CALIFORNIA, INC., 18851 Bardeen Ave., Irvine, CA 92715 (714) 752-2891

ATOMIC FREQUENCY STANDARD

184

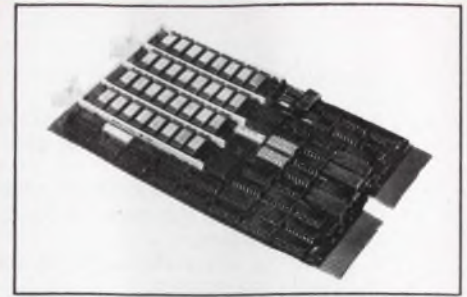

MINI/BUS[®] HELPS PACKAGE up to 32K words on a single high density add-in expansion memory. Low cost, low-inductance, high-capacitance bus bars can solve your printed circuit space problems and shorten assembly time while reducing and isolating noise. Call or write Rogers Corporation, Chandler, AZ 85224. Phone: (602) 963-4584. (EUROPE: Mektron NV, Gent, Belgium; JAPAN: Nippon Mektron, Tokyo.)

MINI/BUS

187

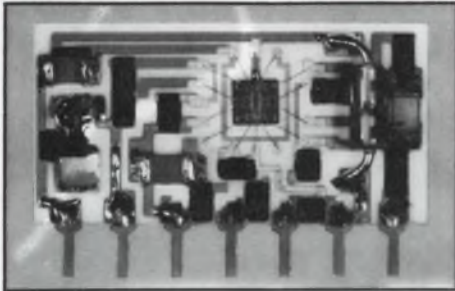

ULTRA SMALL ACTIVE BAND PASS FILTER fabricated using OP Amp incorporated Hybrids Circuit. Operating Voltage 1-2.5V/4-15V, Frequency Range 288.5-2800Hz, Q 180+20, 35+5 and etc. .788" x .138" x .433". By adding Feed Back Circuit of extra Diode and Capacitor, it does the job of small but reliable Oscillator. Active Filters can be tailor-made to customer's specifications. IWATA ELECTRIC CO., LTD. Mansei Bldg., 1-1-16 Sotokanda, Chiyoda-ku, Tokyo, Japan.

ACTIVE FILTER

182

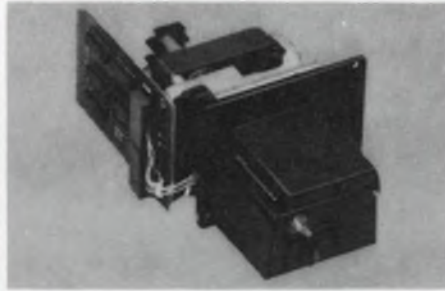

350 Char/Sec Low Cost Loader Solid state photoelectric components read all standard 5, 6, 7, or 8-level tapes. Smooth, quiet AC drive. Reliable high-speed paper tape data entry. Data amplifiers and "character ready" output available for CMOS or TTL interfaces. Standard interface or to your interface specifications. Fanfold boxes available. Addmaster Corporation, 416 Junipero Serra Drive, San Gabriel, CA 91776. Telephone: (213) 285-1121

PAPER TAPE LOADER

185

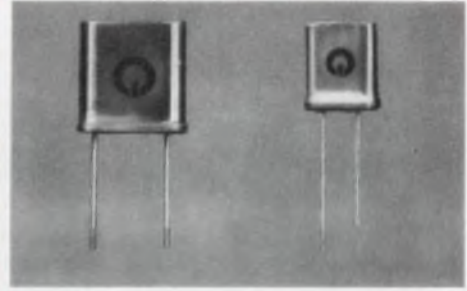

HIGH STABILITY LOW COST QUARTZ CRYSTAL for μ -processor and clock oscillator. Accuracy is $\pm 0.002\%$ at 25°C . Frequency change over -10 to $+55^{\circ}\text{C}$ is within ± 20 ppm. 1.000, 1.8432, 2.000, 2.097152, 2.4576, 3.2768, 4.0000, 5.0000, 5.0688, 5.1850, 5.7143, 6.5536, 10.0000, 18.0000, 18.4320, 20.0000, 22.1184 Immed. Divy. \$1.85 ea. 10 MHz up in HC-18/u; (Min. 100 pcs.) Q-MATIC CORP., 3194-D Airport Loop Dr., Costa Mesa, CA 92626, (714) 545-8233, Telex 678389

CRYSTAL

188

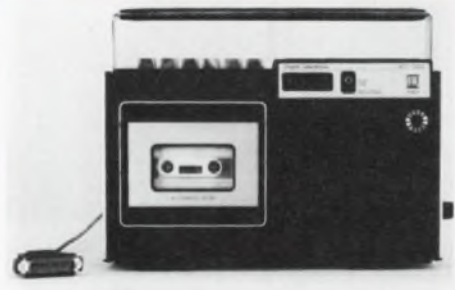

PROGRAM LOADER . . . uses computer's existing RS232 terminal port.

. . . A complete storage system . . . up to 109 8-bit characters/sec . . . any line speed 110 to 9600.

. . . Everything including RS232 plug and 48 inch cable in one ultra-compact rugged 5.5 lb. package . . . over 1.5 megabits/cassette.

. . . \$975.00 (USA-only) from DIGITAL LABORATORIES, 600 Pleasant St., Watertown, MA 02172 (617) 924-1680

PROGRAM RECORDER/LOADER

183



PROGRAMMING PROVERBS FOR FORTRAN PROGRAMMERS, H. F. Ledgard. These 26 unique "proverbs," or rules and guidelines, are specially designed to help FORTRAN programmers upgrade the quality of their work. Comes with many sample programs. #5820-9, 144 pages, \$6.95. Circle the Info Retrieval Number to order 15-day exam copy. When billed, remit or return book with no obligation. Hayden Book Co., 50 Essex Street, Rochelle Park, N.J. 07662.

PROGRAMMING PROVERBS

186

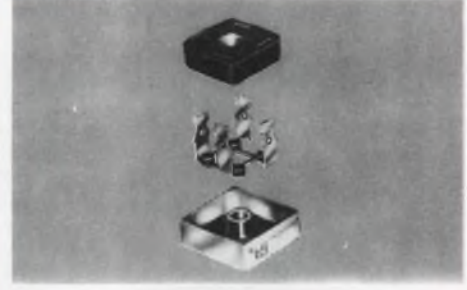

FREE SAMPLES OF 25 AMPERE BRIDGE RECTIFIERS. Electronic Devices, Inc., is offering free samples of a silicon bridge rectifier, to OEM's who outline their application, that is rated at 25 A., has 300 A surge; and PR Voltages from 50 to 1,000 V. These new Series PB Bridges are 1.125" square by .438" high; have 1,500 V RMS dielectric strength, U.L. Component Recognition, and 0.250 quick-connect terminals. From \$1.90 in thousand lot quantities. Electronic Devices, Inc., 21 Gray Oaks Ave., Yonkers, N.Y. 10710.

BRIDGE RECTIFIER

189



NEW DESKTOP TAPE READER—all you do is plug this Smart Box in. Up to 300 cps—RS232C, Current loop, parallel I/O—and quality built. State-of-the-art fiber optics, photo transistor read head, dual-sprocket drive. Outstanding for flexibility and simplicity. Low cost. Decitek, 250 Chandler Street, Worcester, MA 01602 (617) 798-8731.

NEW DESKTOP TAPE READER

190



Free 16-page 1978 Westinghouse Product Selector Guide contains descriptions, parameters, and part numbers for its entire line of high power rectifiers, thyristors (SCRs and RBDTs), transistors and assemblies. Over 30 new products are included in this guide. Send for your copy today. WESTINGHOUSE ELECTRIC CORPORATION, Semiconductor Division, Youngwood, PA 15697.

POWER SEMICONDUCTOR

193

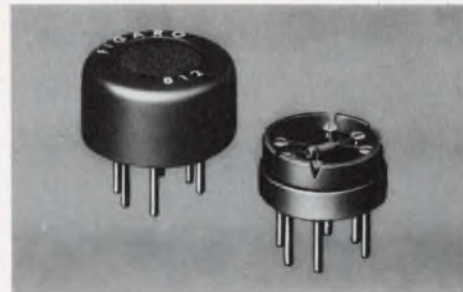

FIGARO GAS SENSOR TGS is a gas sensitive semiconductor. When combustible gas is absorbed on the sensor surface, a marked decrease of electrical resistance occurs. Major features of the sensor include high sensitivity, long term reliability and low cost. The applications are: GAS-LEAK ALARM, AUTOMATIC FAN CONTROL, FIRE ALARM, ALCOHOL DETECTOR, etc. Figaro Engineering Inc., North America Office-3303 Habor Boulevard, Suite D-8, Costa Mesa, Calif. 92626 Tel: (714) 751-4103 Telex: 678396

GAS SENSOR

196



HANDSOME, RUGGED ENCLOSURES Custom-crafted laminated Formica®-Mahogany-Formica® construction, internally reinforced corners, rich wood grain or solid color exteriors. Superb workmanship, competitive prices, any quantity. W. A. Miller Co., Inc., 307 Mingo Loop, Oquossoc, Maine 04964. Phone: 207/864-3344

ENCLOSURES

191

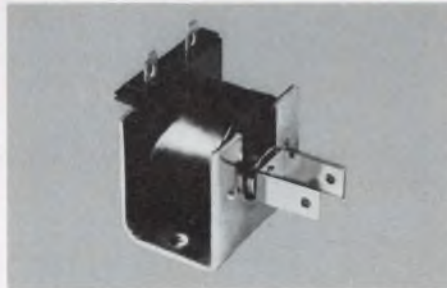

LOW COST DELTROL C-9 C-FRAME SOLENOID features molded-in terminals that end terminal breakage and molded coil that performs better under the harshest environmental conditions (looks better, too). 24, 120 and 240 VAC, continuous, intermittent and pulse duty cycles. AC power (seated) approx. 12VA continuous, 38VA intermittent and 125VA pulse. Free catalog from Deltrol Controls/Division of Deltrol Corp., 2745 South 19th Street, Milwaukee, WI 53215. Phone (414) 671-6800/Telex 2-6871.

C-FRAME SOLENOID

194

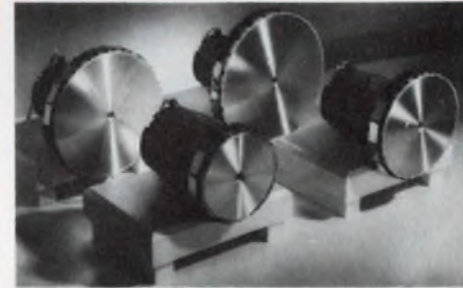

POLYSCAN ROTATING SCANNERS offer design engineers a ready-to-use component for laser beam and image scanning. PolyScan scanners, low in cost yet precise, are available as fixed line scanners or as raster scanners. They are used in surface inspection equipment, facsimile transceivers, bar code readers, measuring, control, displays, printers, surveillance and a dozen other applications. Scanco offers both fixed and user adjustable laboratory units. Contact SCANCO INC., 53 Water Street, S. Norwalk, CT 06854. Tel: (203) 853-9882.

LASER SCANNER

197



PROGRAMMABLE MOS/CCD DRIVER plug-in for Tektronix TM-500 series mainframes. Primarily a level shifter, the PI-451 converts a TTL input signal into a $\pm 25V$ output signal for driving MOS-type devices. Independ. output Hi/Lo levels man. adjustable or voltage prog. Digital programming option also available. Output transition times variable from $< 2.5ns/V$ to $> 2.5\mu s/V$. Max rep-rate $> 10MHz$ for 10V output and 40pf load. \$324. PULSE INSTRUMENTS CO., 1536 W. 25th St., San Pedro, Ca. 90732. (213) 541-3204

PROGRAM MOS/CCD DRIVER

192



STANDARD & CUSTOM DESIGNED HARDWARE. When you need dimensionally accurate, burr-free, chip-free electronic hardware . . . shipped on time . . . at competitive prices . . . order from R.A.F. You will always get high-quality, standard parts from stock. Custom designed parts from your blueprints manufactured and delivered promptly. Send for our 110 page, fully-illustrated catalog today. RAF Electronic Hardware, Inc., 260 Hathaway Drive, Stratford, CT 06497 (203) 377-6393, TWX 710-453-2073.

FREE 110-PAGE CATALOG

195



Free Catalog contains complete line of Power Supplies from Computer Products, Inc. Miniature encapsulated models from 3.6 to 28V, 25mA to 2A. DC/DC Converters, 5 to 12 Watt models, single and dual outputs. High-efficiency supplies, single and dual output, models to 100 Watts. Attractive OEM discounts. Computer Products, Inc. 1400 N. W. 70th Street, Fort Lauderdale, FL. 33309 305/974-5500

POWER SUPPLY CATALOG

198

quick ads

New and current products
for the electronic designer
presented by their manufacturers.

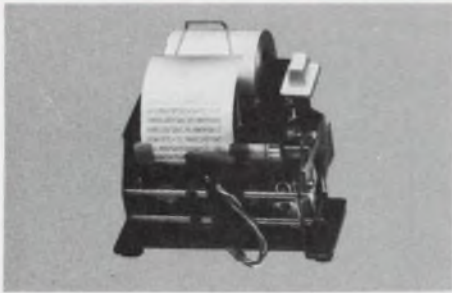

FAST, RELIABLE DISCHARGE PRINTER DC-1606B/DC-2106D prints 16 or 21 column alphanumeric in a 5 x 7 dot matrix format. Its MTBF is 3.0 million lines on a 2.25" paper costing less than a half a cent a foot. 3.8" H x 5.4" W x 5.5" D, it is as low as \$99 in 100 quantity. Interface electronics and power supply available. HYCOM, 16841 Armstrong Ave, Irvine, CA 92714 714/557-5252.

DISCHARGE PRINTER 199



BROAD RANGE GAUSSMETERS. Measure AC and DC magnetic fields. Read from milligauss to kilogauss to analyze magnetic circuits, measure residual fields, stray fields, absolute and differential fields. Models available: MG-2A analog display, 8 F.S. ranges from 10 G to 30 KG; MG-3A, analog display, 11 F.S. ranges from 1 G to 100 KG; MG-3D, digital display, 5 F.S. ranges from 10 G to 100 KG. Write Walker Scientific, Inc., Dept. QA/Rockdale Street, Worcester, MA 01606/(617) 852-3574.

BROAD RANGE GAUSSMETERS 202

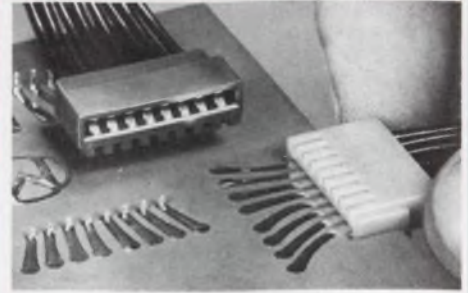

New Miniature Series 1500 Card Edge Connectors On .100" Centers For 1/16" PC Boards—Permit High-Density Wire-To-Board Interconnects plus in-the-field contact removal or replacement. Designed to mate with .062" thick single side PCB's. Permit independent wire harness assembly for 2/25 conductor cable. Methode 1400 Series crimp contacts used are rated at 3.5 amps. Contacts plated tin or gold. 94V-0 material housings. Methode Electronics, Inc., 1700 Hicks Rd., Rolling Meadows, IL 60008. (312) 393-3500.

MINIATURE CONNECTORS 205

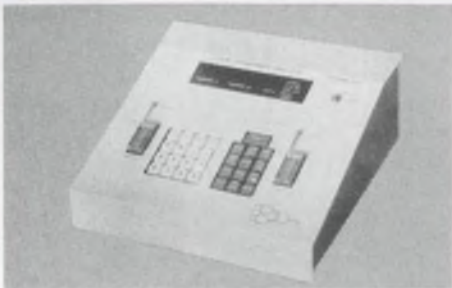

2704, 2708, 2716 USERS • Best PROM Programmer on the market at any price • PROSIM 1000 @ \$1295.00 complete with 2-yr warranty • Easy to operate • 12 function keys • ROM SIM • Universal interface capability • Full hexadecimal display • User program key • FREE Operations Manual on request • G E C O 145 Penn St., Millheim, PA 16854 814-349-5555

PROM PROGRAMMER 200



GAME PLAYING WITH COMPUTERS, Revised Second Edition, by Donald D. Spencer. This volume presents over 70 games, puzzles, and mathematical recreations for a digital computer. The reader will also find brand-new "how to" information for applying mathematical concepts to game playing with a computer. #5103-4, 320 pp., \$16.95. Circle the Info Retrieval Number to order your 15-day exam copy. When billed, remit or return book with no obligation. Hayden Book Co., 50 Essex St., Rochelle Park, N.J. 07662.

GAMES-PLAYING GUIDE 203

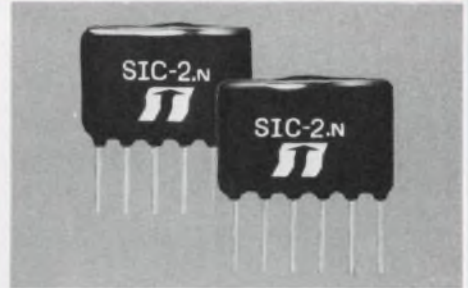

SEIKO's LOW FREQUENCY OSCILLATING CIRCUIT SIC-2. SIC-2 is a small, highly reliable oscillating circuit that allows you to construct a stable, compact oscillator by using it with a tuning fork. It features highly stable against temp. changes and aging and low-distortion sine wave output. Applicable for Standard oscillators, Selective calling systems, Remote control systems, Telemetering systems, Alarm systems. SEIKO INSTRUMENTS, INC., 2990 W. Lomita Blvd., Torrance, Ca. 90505 (213) 530-3400 Telex: 25-910-347-7307

L/F OSCILLATING CIRCUIT 206

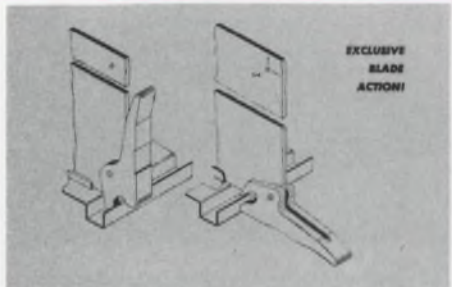

FREE SAMPLES of new, low-cost ElectroFlex injector/ejector for damage free insertion and extraction of P.C. boards. Unique design utilizes both surfaces of a single blade . . . eliminating need for very close tolerances. Full 5/8" travel in each direction assures straight-line card movement. Meets established industry standards for mounting. Molded in rugged UL-approved nylon for 1/16" through 1/8" boards. ELECTRO-SPACE FABRICATORS, Topton, Pa. 19562. (215) 682-7181

INJECTOR/EJECTOR 201



Overcurrent Protector, manual reset eliminates fuse replacement. Convenient panel mounting. 19 fractional ratings from 0.1 to 5 amp. Other models up to 400 amp. Trip-free and fool-proof, UL and CSA approved. High quality, low cost, \$1.61 ea. in 1000 lots. E-T-A Circuit Breakers, 7400 N. Croname Rd., Chicago, Ill. 60648. Tel: (312) 647-8303. Telex: 253780.

CIRCUIT BREAKER 204



New power supply catalog features reliable open frame DC supplies with excellent regulation and ripple, fold back current limiting, optional overvoltage protection, and full output to 71°C. Included in the catalog are electrical and mechanical specifications, photographs, outline drawings and a complete price list for one to a thousand pieces. Phone or send a purchase order for quick delivery from stock. ELECTROSTATICS, Inc., 7718 Clairemont Mesa Blvd., San Diego, CA 92111 714-279-1414

POWER SUPPLY CATALOG 207

Electronic Design

recruitment and classified ads

ELECTRONIC ENGINEERS

We have several client companies located in Danbury, Connecticut, seeking degreed electronic engineers in any one of the following fields: Microprocessor design in the telecommunications field; computer-controlled test equipment design; systems design for NDT; radar signal processing; power supply design (A/D and magnetic circuits); airborne radar systems design and display systems engineering.

The area provides fine recreational facilities (Lake Candlewood) and has good connections to the New York Metropolitan area. It is an ideal locale for family life.

Send your resume, or call Uni/Search, 203-792-8500. We are at 85 West Street, Danbury, Conn. 06810. George Field is handling these opportunities. Never a fee to the applicant.

ELECTRONIC TECHNICIAN (Communication Console)

Newly created position available with diversified electronics manufacturer for person with electronics school certificate or degree. Requires some experience with 2-way FM radio, police band, UHF/VHF communications equipment. Prefer field installation experience. Moderate travel. Excellent salary, benefits, and environment. Based in Kansas City area. Interview and moving expenses paid by Company.

Inquiries held in confidence. Please send detailed resume including job references, earnings history, and earning requirements to:



11700 W. 85th St.
Lenexa, KS 66216

An Equal Opportunity/Affirmative Action Employer

Sales

ELECTRONIC SALES ENGINEER

Due to expansion of sales and product lines, position available for person experienced in electronic communications equipment sales. Prefer electronic-related or technical degree. Will call on both established and new accounts, requiring moderate overnight travel. Draw, commission, bonus, company car and expenses. Salary potential limited only by individual performance. Earnings of employees in this position average app \$32,000. Positions available in San Francisco, Memphis, and Chicago.

Please send resume including earnings history, and expectations, in confidence, to:

HAYDEN PUBLISHING CO., INC.
BOX 8RR, 50 ESSEX ST.
ROCHELLE PARK, N.J. 07662

An Equal Opportunity/Affirmative Action Employer

ENGINEERS

The needs of our client firms, nationwide, for EE's, ME's, ChE's continues to expand and our recruitment program for 1978 is actively underway. Twenty years of successful engineering placement assures motivated, career conscious professionals a vehicle to realize the growth they desire. We provide personalized, confidential service and invite calls or letters of interest to be directed to: E. LUTTINGER

**W.J.W. Willard
Associates, Inc.**
One Lincoln Center, Syracuse, N.Y. 13202
(315) 422-5111

Fee Paid/EEO Employer M/F National Affiliates

KEEP

Electronic Design's
GOLD BOOK

**HANDY
When
You Call**

R&D DESIGN QC/AQ

Confidential screening against National openings
IF YOU ARE EVEN THINKING OF A CHANGE PLEASE CALL US

CALL TOLL FREE 24 HOURS

1-800-821-2270 X605
(in Mo. 1-800-892-7655)

A&D Circuit Des	\$27-27K
IC Design	\$16-25K
Microprocessor apps	\$19-29K
Diagnostic Pgmng	\$20-30K
ME-Electronic Pkngg	\$18-30K
Cmptr Image Gen	\$20-29K
FORTRAN	\$17-26K
Mini-computer Arch	\$20-30K
Med Electronics	\$18-27K
NDTF	\$16-28K
Comm Sys Des	\$18-28K

Ralph Stevenson, VP
JIM KING

438 Gulf Life Tower
Jacksonville, Florida 32207

LATE CLOSING DATES

Electronic Design is mailed every two weeks. Because of its timeliness, personnel recruitment advertising closes only two weeks before each issue's mailing date.

Issue Date	Recruitment	
	Closing Date	Mailing Date
Apr. 26	Mar. 31	Apr. 14
May 10	Apr. 14	Apr. 28
May 24	Apr. 28	May 12
June 7	May 12	May 26
June 21	May 26	June 9
July 5	June 9	June 23
July 19	June 23	July 7

Camera-ready film (right reading negatives, emulsion side down) or camera-ready mechanicals must be received by deadline. Or, if you wish us to set your ad (typesetting is free) simply pick up the phone and call our RECRUITMENT HOT LINE:
(201) 843-0550

PLACE YOUR AD AT ONLY

\$55

PER COLUMN INCH IN

SCIENTIFIC SYSTEMS ENGINEERS

McDonnell Douglas, St. Louis is seeking individuals with degree in Industrial Engineering or Computer Science and with experience in FORTRAN programming. Must have background in one or more of the following areas:

Geometric Modeling Computer Graphics
Simulation Models Data Base Systems
Distributed Processing

Explore the possibility of joining our team of skilled professionals in the expanding Computer Aided Manufacturing area developing advanced systems and technology by sending your resume to:

W. B. Kellenberger
Section Manager,
Professional Employment
Department EDN-78SE
P.O. Box 516
St. Louis, Missouri 63166

MCDONNELL DOUGLAS

CORPORATION

An Equal Opportunity Employer m/f

ENGINEERS

The Boeing Company in Seattle, Washington, has a variety of challenging career opportunities for experienced engineers on a wide-range of programs.

Enjoy the relaxed life-styles and unspoiled beauty of the Pacific Northwest in the "Nation's Most Liveable City." You won't find a better opportunity to combine career growth with a pleasing environment. We'd like to hear from you if you have a BS degree or higher in engineering or computer science and experience in any of the following areas:

- AUTOMATED TEST INSTRUMENTATION DEVELOPMENT
- COMPUTER AIDED DESIGN
- COMPUTERS AND DISPLAYS DESIGN
- DIGITAL CIRCUIT DESIGN
- ELECTRICAL/ELECTRONIC TEST
- ELECTRONIC MATERIALS AND PROCESSES
- ELECTRONIC PACKAGING DESIGN
- ELECTRONIC PARTS EVALUATION
- FLIGHT/MISSION/SYSTEMS TEST
- GUIDANCE AND CONTROL ANALYSIS
- NONDESTRUCTIVE EVALUATION
- OPERATIONAL SOFTWARE DEVELOPMENT
- SOFTWARE/COMPUTING SYSTEM DESIGN AND ANALYSIS
- SOFTWARE/COMPUTING SYSTEM TEST AND EVALUATION
- SOFTWARE QUALITY ASSURANCE
- TEST SYSTEMS SOFTWARE DEVELOPMENT
- TEST PROGRAM PLANNING
- SYSTEMS DESIGN ANALYSIS
- SYSTEMS REQUIREMENTS DEFINITION
- WIRING AND CONTROL DESIGN

Candidates must be U.S. citizens. Selected candidates will be offered an attractive salary, comprehensive fringe benefits package, and relocation allowances.

Send your resume to The Boeing Company, P.O. Box 3707-LML, Seattle, WA 98124.

An equal opportunity employer.

BOEING
Getting people together

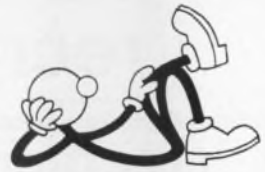

EFFORTLESS . . .

If you're ready to move on with your career, it can be a lot easier than you expect.

We are the members of



who work extensively with electronics industry leaders. The companies we service have many openings and pay for us to search you out.

Send your resume to the office nearest you. Then sit back and relax while we do the work.

BRENTWOOD PERSONNEL ASSOCIATES

Electronics Division
1280 Route 46
Parsippany, New Jersey 07054
(201) 335-8700

STAFF DYNAMICS, U.E.

26 Sixth Street
Stamford, Connecticut 06905
(203) 324-6191

ANDERSON-TAYLOR

P.O. Box 21
Exton, Pennsylvania 19341
(215) 363-1600

THE PERSONNEL CENTER

405 Loew Building
Syracuse, New York 13202
(315) 472-4551

RIKER PERSONNEL

834 Circle Tower
Indianapolis, Indiana 46204
(317) 632-5422

WESTERN PERSONNEL EMPLOYMENT

3800 North Central Ave., Suite 1007
Phoenix, Arizona 85012
(602) 279-5301

190 associates internationally

ENGINEERS

Design, Development, Testing

Due to the rapidly expanding use of electronic systems for convenience, entertainment and control devices, and the increasing sophistication of automotive electrical systems, Ford Motor Company has immediate opportunities offering excellent career development for graduate engineers.

Responsibilities will include areas of design, development release to production, and testing of components and systems in the areas indicated below. Positions offer excellent starting salaries and comprehensive employee benefits program. These positions are located in the Dearborn, Michigan area.

COMPONENT ENGINEERING SUPERVISOR

Qualified candidate will have a MSEE or Ph.D. with specialization in physical electronics plus four to seven years experience in circuit design and process technology for bipolar and MOS large scale integrated circuits.

COMPONENT ENGINEER

Experience in analog and digital circuit design, integrated circuit design and packaging or analytical laboratory techniques.

ELECTRONIC CIRCUIT DESIGNER

Experience with design rules and limitations, semiconductor wafer fabrication, knowledge and skill in the interface/circuit/process trade off of microelectronic design.

TEST ENGINEER

Experience in test procedures and test programs to determine functional and durability performance of sensor fuel control feedback system.

PRODUCT DESIGN ENGINEER

Qualified candidate will have design and development experience in one or more of the following:

- Digital and analog servo-control systems
- Small mechanisms, electro mechanical devices, hydraulic and pneumatic valves and actuators, and electronic packaging
- Digital hardware and software design
- Vehicle instrumentation, packaging of gages, clocks, warning lights, etc.
- Small motors for vehicle applications

For immediate and confidential attention, please send your resume to:



Electrical and Electronic Division

Product Engineering Office
P.O. Box 2053, Rm. B-094
EEE Building
Dearborn, Michigan 48121

An Equal Opportunity/Affirmative Action Employer M/F

ELECTRICAL DESIGN ENGINEER

We have a challenging position in the Controls Design field working with electronics, electrical, pneumatic, and micro-processor technologies. We design and manufacture control systems for the petrochemical pipeline transmissions industry, utility industries and turbo-machinery.

Prefer a candidate with a BSEE, 2 to 3 years experience or recent graduate. Company located in central Ohio is on an outstanding growth pattern offers stable position with excellent pay and complete benefit programs.

If you are qualified for a challenging position with a top quality organization send resume and salary history to:

Cooper Energy Services

Manager Salaried Personnel
North Sandusky Street
Mount Vernon, Ohio 43050

Equal Opportunity Employer M/F

PROJECT SUPERVISOR

Microprocessor Based to \$37,000

Will supervise engineers and programmers developing this State-of-the-Art electronic system. Key position with high visibility. Must have previous supervisory experience and a BS/MSEE. The essential technical skills are logic design, systems architecture and micro-processor applications.

We also seek design engineers for this project. Minimum one year experience. Salary to high \$20's.

For additional information contact Steve Ford or George Winton at (617) 426-4180. Please include salary history when submitting resume. Our client company assumes all fees.

ROGERS & SANDS

100 Federal Street
Boston, MA 02110

Member of
Mass. Professional Placement Consultants

N/C SYSTEMS ENGINEERS

McDonnell Douglas, St. Louis, has openings for individuals with BS or MSEE with experience in digital logic & computer programming to work in Computer Aided Manufacturing (CAM), particularly in area of real-time monitoring and control. Areas of responsibility will include advancing technology in area of N/C and other machine tool related applications. If you meet the above requirements, explore the possibility of joining our creative team by sending your resume to:

W. B. Kellenberger
Section Manager,
Professional Employment
Department EDN-78N
P.O. Box 516
St. Louis, Missouri 63166

MCDONNELL DOUGLAS



CORPORATION

An Equal Opportunity Employer m/f

ENGINEERS

Challenging Career
Opportunities
in An Aviation
Environment
\$21,883-\$28,444

- **AEROSPACE**—Survivability/
Vulnerability, Propulsion
- **ELECTRONICS**—EW, ASW, Navigation,
Computer/Software, Weapons Control,
Communications
- **GENERAL**—R&M, Specs and Stds.
- **MATERIALS**—Metals, Non-metals, NDTI

Interested, qualified candidates
send SF-171 (Application for Federal
Employment) to:

Civilian Personnel Division
Code AIR-9402
NAVAL AIR SYSTEMS COMMAND
Washington, D.C. 20361
Attn: Kelly D. Turbeville
An Equal Opportunity Employer

ELECTRONIC DESIGN

BRINGS YOU THE HIGHEST
NUMBER OF QUALIFIED EOEM
ENGINEERS AND ENGINEERING
MANAGERS ANYWHERE
... AT THE LOWEST COST
ANYWHERE!

SEMICONDUCTOR PROCESS ENGINEER

Must have thorough knowledge of
semiconductor process technology.
Silicon rectifier manufacturing
experience preferred. Excellent
opportunity for right person to take
charge of all process engineering.
Send resume including salary
history to: Mr. H. Kolokowsky, V.P.
Manufacturing

ELECTRONICS DEVICES, INC.
21 GRAY OAKS AVENUE
YONKERS, NEW YORK 10710
An Equal Opportunity Employer M/F

ENGINEERS- MANAGERS

\$18,000 to \$35,000
FREE PROFESSIONAL CONSULTING

Nationwide opportunities with client firms in:
**Telecommunications, RF/Microwave, Computer Software/Hardware,
Military & Commercial Communications Circuits/Systems Design.**

Is the flood of recruiting ads too much? Then leave the work to us—
at NO COST TO YOU!!
Call COLLECT Send your resume, and you will receive FREE
CONSULTING SERVICE including:

- Critique/modification, if necessary, of your resume.
- Control of who gets your resume.
- Detailed information on client firms.
- Economic advice on geographical areas.

OLIVER Associates

401 Broad Hollow Rd, Melville, NY 11746
(516) 249-0202

Engineer

ELECTRICAL ENGINEER (Console Communications)

Due to rapidly increasing sales in Communications Division of
diversified electronics manufacturer (music amplification, law
enforcement radar, console communications products), key
position available for B.S.E.E.-degreed person with experience in
land mobile 2-way radio (FM-police band) communications
systems and equipment. Duties include designing special
engineering features on consoles. Some travel. Based in Kansas
City. Interview and relocation expenses paid.

Please send resume, including earnings history and expectations,
in confidence, to:



**Kustom
Electronics
Inc.**

Mr. Bruce Keeton
Personnel Director
1010 W. Chestnut
Chanute, KS 66720

"World Leader in Traffic Safety Radar"
An Equal Opportunity Affirmative Action Employer

Recruitment Ads Pull

Come join me at Hughes and be part of the new world of electronics.

It's a good feeling to be in the vanguard of technology with employment stability through dynamic growth and diversification!

For Immediate Openings In:

Circuit Design Engineers

Experienced in RF, IF, Video, and A/D circuit design for use in Signal Processing in both airborne and space applications.

Digital Logic Design Engineers

Experienced in design and development of digital circuits using TTL, STTL, ECL and CMOS technologies.

Software Development Engineers

Experienced in the development of software for special purpose digital processors. Digital hardware background experience desired.

Product Design Engineers

Experienced in extremely high density physical and thermal designs for airborne and spaceborne signal processing.

Project Engineers

Experienced in the management of all aspects of a project including management of subcontracts and remote manufacturing facilities.

Digital Module Test Engineer

Experienced in developing software for automatically testing digital modules.

Digital Associate Engineer (Non MTS)

Having good rapport with digital logic design, logic schematics and the conversion of these to a computerized interconnect data base.

Call now—call collect: Richard Fachtmann, Assistant Manager, Signal Processing Laboratory, (213) 391-0711, Ext. 3904. Or send resume (referencing this ad) to: Professional Employment C, Aerospace Groups, 11940 W. Jefferson Blvd., Culver City, Ca 90230.

HUGHES

HUGHES AIRCRAFT COMPANY
AEROSPACE GROUPS

U S citizenship required Equal opportunity M/F/HC employer

Actual Hughes Scientific and Engineering Manpower Growth Curve
This chart indicates the Company's extraordinary record of growth with stability in the dynamic electronic technology industry

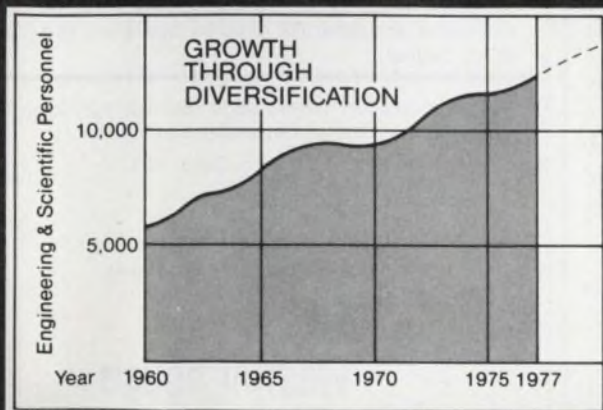

AMP INCORPORATED

Internationally known, ranking among the top 500 publicly held U.S. industries, and with major product lines in commercial fields, has opportunities for:

ENGINEERS

(ELECTRONIC PACKAGING)

To work with engineering team in the continued development of a premolded chip carrier and automatic assembly process which will produce finished electronic devices on strip. Should have knowledge of plastic materials, metals, stampings, plating, cleaning, testing, wirebonding. Experience in designing, building and operation of semiconductor packaging line helpful.



Please send resume in confidence to:
Thomas J. Sullivan
Area Personnel Manager

AMP

INCORPORATED

P.O. BOX 3608
Harrisburg, PA 17105

We Are An Equal Opportunity Employer M/F



Engineers

Our Hunt Valley complex, located in the northern suburb of Baltimore, has immediate openings in two engineering departments.

The Nuclear Instrumentation Control Department has requirements for engineers with experience in analog and digital circuit design. Responsibilities include the development and design of instrumentation and control equipment and systems for commercial and naval nuclear programs.

Requirements:

- BSEE with minimum of 5 years design experience.
- Ability to analyze designs and present results.
- Desire to apply innovative solutions to complex engineering problems.

The Integrated Logistics Support Engineering Department is involved in a variety of long-term automated test projects and has needs in the following areas:

Software

Applicants should have BSEE and major specialization in computers or with BS in Computer Science and a knowledge of digital and analog circuit design and at least 2 years experience in one or more of the following areas:

- Design and generation of analog/digital test application software
- Design and generation of ATE executive and support software.

Logistics and Maintenance

Applicants should have BSEE with advanced statistics and/or numerical analysis courses with a minimum of 2 years experience in one or more of the following: logistics models, simulation models, logistic support analysis, support equipment requirements, maintenance planning.

Digital Hardware Design

Responsibilities include systems specifications and design utilizing advanced microprocessors and microcomputers as applied to sophisticated electronic test problems. Minimum of 2 years experience and BSEE degree.

Electronic Design

Requires capability in solid state electronic design. Should have at least 2 years experience in analog and digital testing of military avionics sub-assemblies. BSEE required.

IF or RF Electronic Design

At least 2 years design experience involving very stable oscillators and other RF circuitry operating at X-band. BSEE degree.

For consideration, please send resume, stating present salary, and indicating department of interest, to:

R.A. Richmond, Dept. 401
Westinghouse
P.O. Box 1693
Baltimore, MD 21203

An Equal Opportunity Employer

Westinghouse

MARKETING MANAGERS ... PRODUCT MANAGERS ... SALES ENGINEERS ...

Who have had successful track records and are ready for greater challenges and rewards.

Advertising space sales and marketing counseling at Hayden Publishing can offer you those challenges and rewards. A career filled with challenges—a new and different one with each of hundreds of clients—one in which the personal and monetary rewards are high—it's not just a job—it demands a highly self-motivated individual with a strong desire for personal recognition who's willing to use every ounce of energy, experience and education—are you ready for this career?

If you are ready, Hayden Publishing's **Electronic Design**, **Computer Decisions** and **MicroWaves** are expanding and want the brightest and the best. Ideal candidates would have demonstrable sales and marketing successes and engineering and business management education.

Send resume with salary history and requirements to:

V. Daley, Hayden Publishing Company, Inc.,
50 Essex Street, Rochelle Park, NJ 07662.

Equal Opportunity Employer M/F

ENGINEERS

RCA Consumer Electronics

... is interviewing for Engineering positions requiring experience in one or more of the disciplines listed below. Successful candidates will work on TV and other products or related systems planned for the consumer market.

- TV SYSTEMS
- POWER & DEFLECTION
- SIGNAL PROCESSING
- TUNER DESIGN
- DIGITAL SYSTEMS
- MICROPROCESSOR APPLICATIONS
- IC — LINEAR AND DIGITAL (Consumer Products)
- AUTOMATIC TEST EQUIPMENT DEVELOPMENT
- AUTOMATION TECHNIQUES
- MECHANICAL DESIGN — Electronic Products
- MANUFACTURING SYSTEMS & PROCESSES

Openings are all degree levels. Competitive salaries and benefits.

Send resume to: Professional Employment, M.S. 6-207, RCA Corporation, 600 N. Sherman Drive, Indianapolis, IN 46201.

RCA

We are an equal opportunity employer F/M.

RF Engineers

Enter a challenging, creative, energetic small but expanding company. Massa Products Corporation is a rapidly expanding manufacturer of sophisticated commercial electronics equipment.

Our growth has created a need for a creative individual with a minimum of two years' experience in RF circuit design in the VHF and UHF frequency bands. Some knowledge of FCC regulations would be helpful.

Salary is commensurate with experience and qualifications. We offer an excellent benefits package, including profit-sharing. We firmly believe in promotions from within.

Please send resume in confidence, or call Dick Carpenter at 963-6363.



Massa Products Corporation
61 Teed Drive, Randolph, Mass.

An Equal Opportunity Employer

POWER SUPPLY AND FREQUENCY CHANGERS

Circuit Design Engineers Application Engineers

Key positions are now available in a multi-million dollar division of this expanding operation. Varo, Inc. is a progressive NYSE company and a leader in the electronics industry. The Power Systems Division specializes in the development of power supply systems for both military and commercial markets. Our needs are:

ELECTRONIC CIRCUIT DESIGN ENGINEERS — with a BSEE required and an MSEE preferred. Must have 8 to 10 years experience in HIGH VOLTAGE circuit design or LOGIC and POWER circuit design.

HIGH VOLTAGE experience will include the design of low voltage oscillators, voltage multiplying techniques and low current sensing circuits.

LOGIC AND POWER experience would include the utilization of SCRs and power circuit design and logic circuit design utilizing TTL, CMOS, and/or microprocessors.

APPLICATION ENGINEERS — for power convertors and frequency changers. The qualified individual will possess a BSEE with 5 years of progressive selling experience. Previous power systems design experience a plus. Must be able to develop marketing tactics, sales techniques, strategic plans, and product forecasts. Experience working with Department of Defense/Energy agencies a plus.

The company offers an excellent fringe benefit program. Salaries are commensurate with experience and are complemented by a salary incentive program. If you are ready for a real challenge, send your resume with salary history in strict confidence to:

Bob Williams

VARO, INC.

P.O. Box 401426, Garland, TX 75040

A progressive company with an active affirmative action program

Electronics

COMMUNICATION SALES ENGINEER (ELECTRONICS)

Due to rapidly increasing sales in Communications Division of diversified electronics manufacturer (music amplification, law enforcement radar, console communications products), an important position exists for person with electronic-related degree who has comprehensive knowledge of land mobile communications and/or telephone switching systems and equipment.

Requires some experience in sales and/or sales support function. Duties include customer interface, proposal preparation, and technical support. Potentially moderate travel. Position based in Kansas City area. Interview and relocation expenses paid.

Please send resume, including earnings history and expectation, in confidence, to:



Kustom
Electronics
Inc.

Bruce Keeton
Personnel Director
1010 W. Chestnut
Chanute, KS 66720

"World Leader In Traffic Safety Radar"

An Equal Opportunity/Affirmative Action Employer



**HOW TO PLACE YOUR AD
CALL THE RECRUITMENT
HOT LINE 201-843-0550**

Advertiser's index

Advertiser	page	Advertiser	page	Advertiser	page
AMP, Incorporated.....	113, 115, 117, 119, 121	Semiconductor Products Department.....	73	*Plessey Semiconductors.....	22, 23
AVX Ceramics Corporation.....	177	Gold Book, The.....	116, 136	Potter & Brumfield, Division of AMF, Incorporated.....	130, 131
Abbott Transistor Laboratories, Inc.....	123	Gould, Inc., Advanced Oscilloscope Div.....	82	Power/Mate Corp.....	28, 184
Addmaster Corporation.....	184	Guideline Instruments.....	146D	Precision Monolithics, Incorporated.....	145
Advanced Micro Devices.....	168			Pulse Instruments Co.....	185
AirBorn, Inc.....	89				
Alco Electronic Products, Inc.....	179	Harris Semiconductor, A Division of Harris Corporation.....	127	Q-Matic Corp.....	184
Allen-Bradley.....	146B	Hayden Book Company, Inc.....	144, 184, 186		
Amperite Co., Inc.....	173	Heinemann Electric Company.....	49	RAF Electronic Hardware, Inc.....	185
Aromat Corp.....	138	Hewlett-Packard.....	9-16, 17, 18	RCA Electro Optics.....	88
		Hybricon Corporation.....	152	RCA Solid State Division.....	Cover IV
Beckman.....	146G	Hybrid Systems Corporation.....	34	Rogers Corporation.....	184
Bendix Corporation, The, Electrical Components Division.....	37	Hycom.....	186	Rostone Corporation.....	146A
Biomation.....	134, 135				
Bodine Electric Company.....	159	IBM Data Processing.....	97, 98, 99	Scanco Inc.....	185
Bosch Corporation, Robert.....	149	ILC Data Devices, Inc.....	41	Seastrom Manufacturing Co., Inc.....	176
Bourns, Inc., Trimpot Products Division.....	Cover II	IMC Magnetics Corporation.....	161	Seiko Instruments, Inc.....	186
Bowmar Instrument Corporation.....	183	Instrument Specialties Company.....	129	Semiconductor Circuits, Inc.....	148
*Burr-Brown Research Corporation.....	146	Intech, Incorporated.....	153	*Sfernice.....	144
		Intel Corporation.....	4, 5, 72	Shugart Associates.....	141
CTS Corporation.....	159	International Microsystems, Inc.....	173	Signetics Corporation.....	53
California Instruments Company.....	133	Intersil.....	20, 21	Sinclair Radionics, Inc.....	65
Capitol Machine & Switch Co., Inc., The.....	173	Iwata Electric Co., Ltd.....	184	Slaughter Company.....	179
Centralab, The Electronics Division of Globe-Union, Inc.....	137			Spectronics, Incorporated.....	54
Chrono-Log Corp.....	179	Janco Corporation.....	7	Sprague Electric Company.....	142, 143, 162, 163
Citizen America Corporation.....	181	Johanson Manufacturing Corp.....	50	Systron-Donner.....	114
Clare, C. P., Company.....	146C	Johnson Company, E.F.....	19		
Computer Labs, Inc.....	171			TDK.....	146F
Computer Products, Inc.....	185	Kennedy Corporation, M. S.....	170	TRW/IRC Resistors.....	51
Comstron/Adret.....	23	Krohn-Hite Corporation.....	43	TRW/LSI Products.....	93
		Kulka Electric Corp.....	173	TRW/UTC Transformer, an Electronic Components Division of TRW, Inc.....	118
Data Delay Devices.....	178			Tektronix, Inc.....	57
Data Precision Corporation.....	32, 33	Lear Siegler, Inc., E.I.D. Data Products.....	109	Teledyne Philbrick.....	109
Data Translation Incorporated.....	45	Lexidata Corporation.....	92	Teledyne Semiconductor.....	151
Datel Systems, Inc.....	27, 29, 31	Line Electric, An Esterline Company.....	179	Tel-Tone Corporation.....	146E
Decitek, A Division of Jamesbury Corp.....	185			Texas Instruments, Incorporated.....	30
Deltrol Controls.....	185	3M Company.....	105	Thick Film Systems, Inc.....	150
Dialight, A North American Philips Company.....	60	MCG Electronics.....	159	Triplett Corporation.....	155
Digital Laboratories.....	184	Methode Electronics, Inc.....	186		
Digital Pathways, Inc.....	175	Micro Devices Corp.....	161	Vero Electronics, Inc.....	146
		Micro Memory Inc.....	165		
E-T-A Circuit Breakers.....	186	Micro Networks Corporation.....	111	Walker Scientific, Inc.....	186
Efratom California, Inc.....	184	Microswitch, A Division of Honeywell.....	108	Waters Manufacturing, Inc.....	182
Electro '78.....	82A-D	Miller Co., Inc., W. A.....	185	Wavetek Indiana Incorporated.....	26
Electro Space Fabricators, Inc.....	186	Mini-Circuits Laboratory, A Division of Scientific Components Corp.....	2	Wavetek San Diego, Inc.....	1
Electrostatics, Inc.....	186	Motorola Communications Group.....	104	Westinghouse Corporation.....	185
Electronic Design.....	120	Motorola Data Products.....	47		
Electronic Devices, Inc.....	184	Motorola Semiconductor Products, Inc.....	64, 147	Zeltex, Inc.....	154
Electronic Measurements, Inc.....	6	Murata.....	22		
Electronic Navigation Industries.....	158				
Essex Group.....	146H	NAE, Inc.....	167		
Etri, Inc.....	166	North American Philips Controls Corp.....	181		
		Northern Engineering Labs, Inc.....	161		
Fair-Rite Products Corp.....	133				
Fairchild Camera & Instrumentation Corp.....	24, 25	OK Machine & Tool Corporation.....	156, 157		
Fairchild Systems Technology, A Division of Fairchild Camera and Instrument Corporation.....	50A-B				
Ferranti Electric Inc.....	146H	Panasonic Electronic Components.....	Cover III		
Ferroxcube Corporation.....	83	Philips Electronic Components and Materials.....	62, 63		
Figaro Engineering, Inc.....	185	Piezo Technology, Inc.....	182		
Fluke Mfg. Co., Inc., John.....	58, 59				
GECO.....	186				
General Electric Company.....					

RECRUITMENT

AMP.....	192
Boeing.....	188
Ford.....	189
Hughes.....	191
Kustom Electronics.....	190, 193
McDonnell Douglas.....	187, 190
National Personnel.....	188
Naval Air Command.....	190
RCA.....	193
Varo.....	193
Westinghouse.....	192

*Advertisers in International Edition

Panasonic Nickel Cadmium Batteries.

When you've read one, you've read them all.

Count on Panasonic rechargeable Nickel Cadmium batteries to help your product perform to its full potential the first time the consumer flips the switch... and time after time thereafter.

This kind of reliability can only be assured through extensive testing. Panasonic batteries are 100% tested. We charge them, discharge them, run tests during discharge, and then recharge to at least 85% of capacity for shipping. That's why we can talk about the superb uniformity and close capacity/voltage characteristics exhibited by every Panasonic Nickel Cadmium battery. Because of their quality construction, they can last in storage for months without the need for recharge.

Standard Specifications

Model	Capacity 5 hr. (mAh)	Dimensions		Standard Charge		
		Diam. (in.)	Height (in.)	(mA)	(hrs.)	
NR-N	1.2	150	0.473	1.181	15	15
NR-AAA	1.2	180	0.414	1.752	18	15
NR-2/3AA	1.2	250	0.571	1.181	25	15
NR-AA	1.2	500	0.571	1.988	50	15
NR-1/2SC	1.2	600	0.906	1.044	60	15
NR-1/2C	1.2	800	1.024	1.221	80	15
NR-SC	1.2	1,200	0.906	1.693	120	15
NR-C	1.2	1,800	1.024	1.969	180	15
NR-D	1.2	4,000	1.299	2.402	400	15
NR-F	1.2	6,000	1.339	3.583	600	15

And all this Panasonic quality and reliability is available at prices that may pleasantly surprise you.

Our broad line of Nickel Cadmium batteries includes new super high capacity cells (such as 1.55 Ahr Sub-C), fast charge, and special standby batteries, available in popular configurations and voltage ratings.

For complete information, write or call for our catalog. In addition, you'll also find information on

Panasonic Gel Cell Lead Acid Batteries, Lithium and other primary batteries, and Solar Cells.

Panasonic Electronic Components, One Panasonic Way, Secaucus, N.J. 07094. Phone (201) 348-7277 or (201) 348-7278.

Panasonic
just slightly ahead of our time

CIRCLE NUMBER 119



RCA first in CMOS.

Ready with megarad CMOS to new MIL38510 specs.

RCA will take orders for 23 megarad-hard CMOS circuits to MIL-M-38510 Class S specifications. We're ready to deliver 10^6 radiation hardness because we've had so much experience in supplying CMOS hardened to 10^5 .

After shipping hundreds of thousands of parts to 10^5 Rads, megarad was a natural step up for us. Many of our Rad-Hard CMOS circuits are now in satellites. Voyagers 1 and 2, for example, which are well into space.

When you use RCA Rad-Hard CMOS, you can have added confidence because every single wafer processed for Rad-Hard is sample tested on one of our two in-house cobalt sources.

In addition to the 23 MIL types, we can produce any RCA COS/MOS logic circuits processed to megarad hardness.

Let us send you "Radiation Guidelines" plus two other papers on test results and recent advances in Rad-Hard CMOS. For immediate information, call (201) 685-6625.

Or write RCA Solid State headquarters in Somerville, NJ; Sunbury-on-Thames, Middlesex, England; Quickborn 2085, W. Germany; Ste. Anne-de-Bellevue, Quebec, Canada; Sao Paulo, Brazil; Tokyo, Japan.



0520	05204	05601	05301
05204	05102	05602	05504
05705	05603	05604	05502
05605	05003	05002	05001
05204	05603	05301	05501
05102	05704	05502	05502
05705	05604	05001	05002
05503	05003	05605	05101
05504	05204	05204	05702
05201	05102	05705	05703
05203	05705	05501	05601
05705	05001	05502	05602
05601	05705	05603	05603
05602	05102	05704	05704
05602	05705	05604	05604

When you say CMOS, say RCA first.