

Electronic Design 16

VOL. 25 NO.

FOR ENGINEERS AND ENGINEERING MANAGERS

AUG. 2, 1977

How do you weigh in against other engineers and engineering managers throughout the nation? The work you do, the money you make: Are they limited by

education, location, other factors? Your colleagues: Are they making more or less for the same work? How does the scale tilt for you? Measure yourself. Turn to p. 36.

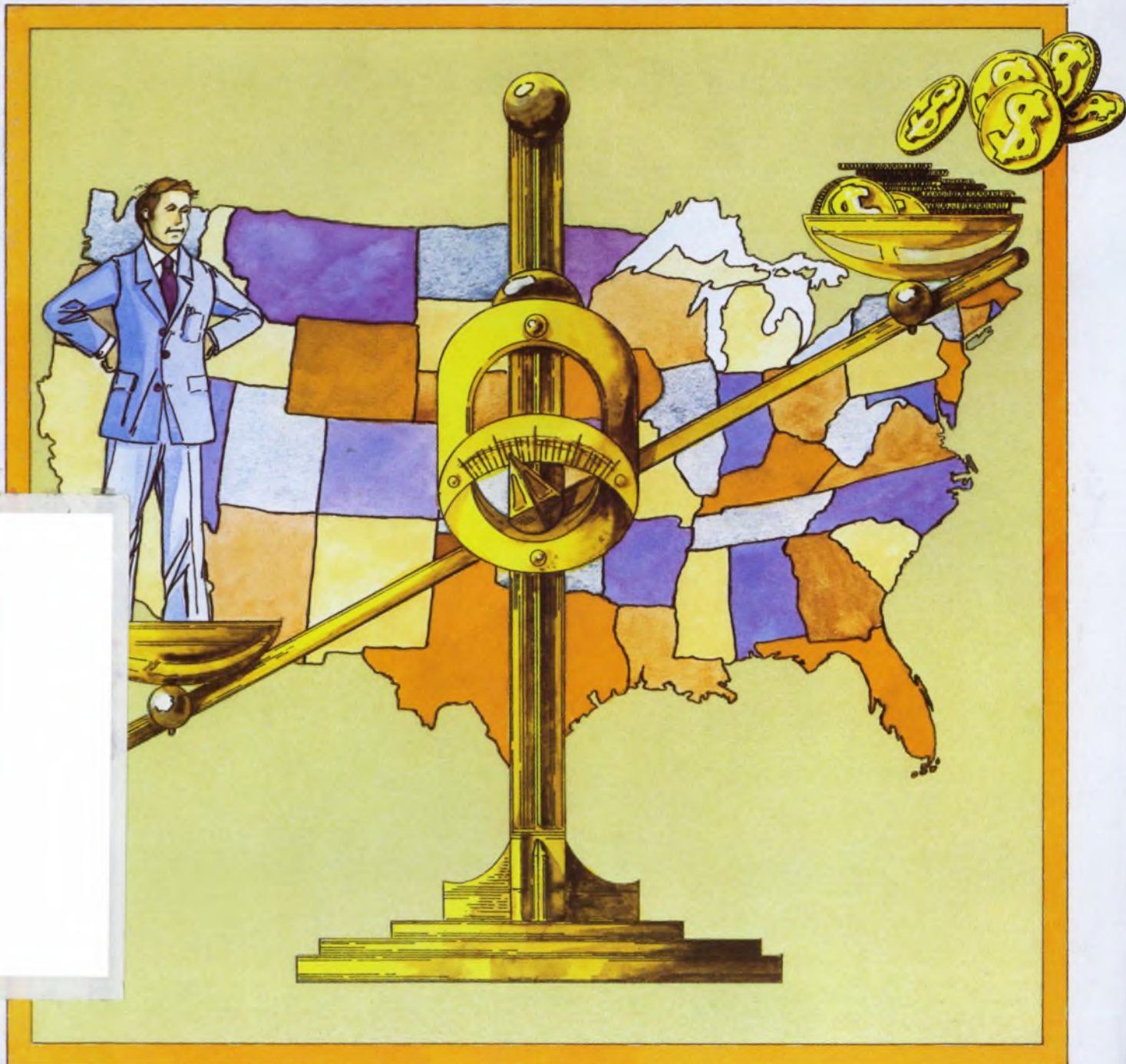

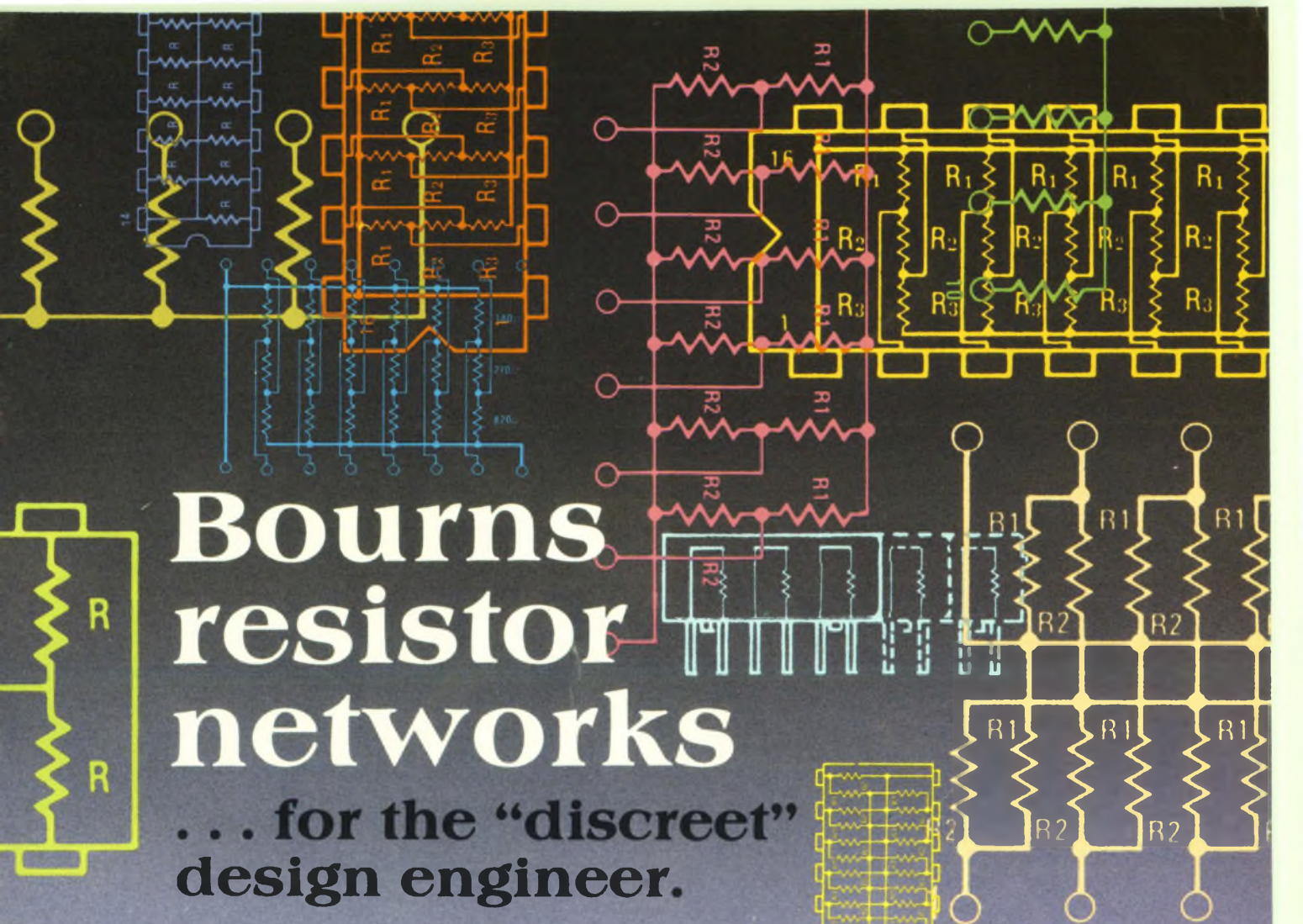

Bourns resistor networks

... for the "discreet"
design engineer.

Sure, you've already made a smart decision, choosing networks over discrete resistors. After all, the cost per resistor in a network package can be 40% less; they require only 10-15% of the P.C. board space needed by discretés; and component count is reduced as much as 95% with resistor networks.

But, when choosing a network supplier, you should also consider these points:

1. Bourns has the broadest network product line in the industry — over 1000 part numbers in all. And our standard DIP circuits range from simple pull-up configurations to Thevinin-equivalent ECL terminators and memory interface circuits.
2. Bourns Krimp-Joint™ offers both a mechanical and electrical bond that lap or butt joint construction doesn't provide. The lead is crimped onto the network element and a high-temp, reflow-resistant solder is used to prevent failure during wave soldering and in circuit thermal cycling and vibration.
3. Bourns was the first manufacturer to offer a complete line of off-the-shelf, super low profile SIPs with demonstrated automatic insertion capability.

These are the facts. So, now you can be even more "discreet". We're sure you'll specify Bourns Resistor Networks — direct or through your local distributor.

Send today for our new 1977 Resistor Networks Catalog.

TRIMPOT PRODUCTS DIVISION, BOURNS, INC., 1200 Columbia Avenue,
Riverside, CA 92507, Telephone 714 781-5415 — TWX 910 332-1252.

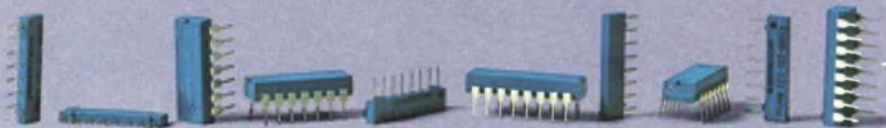

International Marketing Offices: European Headquarters — Switzerland 042/23 22 42 • Belgium 02/218 2005 • France 01/2039633 • Germany 0711/24 29 36 • Italy 02/32 56 88 • Netherlands 70/87 44 00 • United Kingdom 01/572 6531 • Norway 2/71 18 72 • Sweden 764/20 110 • Japan 075/921 9111 • Australia 02/55-0411 03/95-9566 • Israel 77 71 15/6/7

For Immediate Application — Circle 130
For Future Application — Circle 230

If you know signal generators, you know they're typically high-dollar items. You can pay \$6,000 or more for a phase-locked unit, and a programmable with all the goodies can go for \$10K and up. But our Model 3001 is the exception.

First of all, the 3001's base price is just \$2,750. That buys you full frequency programmability, 0.001% accuracy, 1 to 520 MHz frequency range, stability of 0.2 ppm per hour, built-in AM-FM capability, and a front

panel that was actually designed for the user.

Now let's talk options. One lets you lock the 3001 to either an external frequency standard via rear panel BNC input or an internal reference frequency standard with 5×10^{-9} per day stability. And there are others like reverse power protection and auxiliary RF output. But even if you took all these options, you couldn't spend more than \$3,650. Simple arithmetic says

that it's still a lot cheaper to buy two loaded Wavetek 3001s than one Brand X.

At any rate, ask for a Model 3001 demonstration. If the economy alone isn't enough to get you, the performance will. WAVETEK INDIANA, P.O. Box 190, Beech Grove, Indiana 46107, Telephone (317) 783-3221, TWX 810-341-3226.

WAVETEK®

CIRCLE NUMBER 2



Get two Waveteks for the price of one Brand X.

Introducing the SMALLEST

BROADBAND MIXERS

in the world - 40kHz - 2GHz



Act now to improve your system designs, increase your packaging density, and lower your costs... specify Mini-Circuits' new microminiature TFM series. These tiny units, the smallest off-the-shelf Double-Balanced Mixers available today, cover the 40 kHz - 2 GHz range and offer isolation greater than 45 dB and conversion loss of 6 dB. Each unit carries with it a 1-year guarantee by MCL. Upgrade your new system designs with the TFM, rapidly becoming the new industry standard for high performance at lowest cost.

Model No.	Frequency Range MHz		Line Octave From Band Edge	Conversion Loss, dB		Isolation, dB						Quantity	Price						
	LO	RF		Typ	Max	Lower Band Edge To one Decade Higher			Upper Band Edge To one Decade Lower										
	LO	RF		Typ	Max	LO-IF	LO-H	LO-IF	LO-H	LO-IF	LO-H								
TFM-2	1-1000	1-1000	DC-1000	6.0	7.5	7.0	8.5	50	45	40	40	35	25	20	25	20	0-49	\$11.95	
TFM-3	0.04-400	0.04-400	DC-400	5.3	7.0	6.0	8.0	60	55	40	50	35	30	35	25	25	5-49	\$19.95	
TFM-4	5-1250	5-1250	DC-1250	6.0	7.5	7.5	8.5	50	45	45	40	30	35	25	30	25	20	5-49	\$19.95
TFM-11	1-2000	1-2000	5-900	7.0	8.5	7.5	9.0	50	45	45	40	35	25	27	20	25	20	1-24	\$39.95
TFM-12	800-1250	800-1250	50-90	—	6.0	7.5	35	25	30	20	35	25	30	20	35	25	30	1-24	\$39.95

Signal: 1 dB compression level -1 dBm. Impedance, all ports 50 ohms. Total input power: 50 mW. Total input current: peak 40 mA. Operating and storage temperature: -55°C to +100°C. Pin temperature 510°F. (10 sec).

Simple mounting options offer optimum circuit layout.



Use the TFM series to solve your tight space problems. Take advantage of the mounting versatility—plug it upright on a PC board or mount it sideways as a flatpack.

WE'VE GROWN

Customer acceptance of our products has been so overwhelming, we've been forced to move to larger facilities — THANKS.

International Representatives: **AFRICA:** Afrita (PTY) Ltd, P.O. Box 9813 Johannesburg 2000 S. Africa. **AUSTRALIA:** General Electronic Services, 99 Alexander Street, New South Wales, Australia 2065. **ENGLAND:** Dale Electronics, Dale House, Wharf Road, Frimley Green, Camberley Surrey. **EASTERN CANADA:** B.D. Hummel, 2224 Maynard Avenue, Ulica, NY 13502 (315) 7367821. **FRANCE:** S.C.I.E. - D.I.M.E.S., 31 Rue George - Sand 91120 Palaiseau, France. **GERMANY, AUSTRIA, SWITZERLAND:** Industrial Electronics GMBH, 6000 Frankfurt/Main Klüberstrasse 14 West Germany. **INDIA:** Gaekwar Enterprise, Kama Mahal, M.L. Dananukar Marg, Bombay 400 026, India. **ISRAEL:** Vectronics Ltd., 69 Gordon Street, Tel-Aviv, Israel. **NETHERLANDS, BELGIUM, LUXEMBOURG:** Coimex, Veldweg 11, Hattem, Holland. **NORWAY:** Datamatik AS, Ostensjøveien 82, Oslo 6, Norway. **SINGAPORE & MALAYSIA:** Electronics Trading Co. (PTE) Ltd., 87 Bukit Timah Road, Singapore 9, Malay Peninsula. **SWEDEN:** Integerad Elektronik AB, Box 43, S-18251, Djursholm, Sweden.

U.S. Distributors: **NORTHERN CALIFORNIA:** Cain-White Co., Foothill Office Center, 105 Fremont Avenue, Los Altos, CA 94022 (415) 948-6533. **SOUTHERN CALIFORNIA, ARIZONA:** Crown Electronics, 11440 Gollins Street, No. Hollywood, CA 91601 (213) 877-3550.

World's largest manufacturer of Double-Balanced Mixers

Mini-Circuits

MINI-CIRCUITS LABORATORY A Division of Scientific Components Corp.

OUR NEW ADDRESS AND PHONE NO. IS:

2625 EAST 14th STREET
 BROOKLYN, NEW YORK 11235
 (212) 769-0200

DOMESTIC TLX 125460 • INTERNATIONAL TELEX 620156

NEWS

- 25 **News Scope**
- 30 **A method of connecting hundreds of microcomputers** into one huge memory has been proposed.
- 36 **1977 careers and salary survey**—A special report on the economic and career side of engineers and engineering management.
- 47 **Washington Report**

TECHNOLOGY

- 56 **Design your own data terminal.** Interface a dot-matrix printer to your processor and get printouts faster than with off-the-shelf units.
- 68 **Multi- μ P systems combine the efficiency** of dedicated microcomputers with the throughput of minis. And their modular structure makes expansion a snap.
- 74 **Multiprocessing can marry a radar** that detects only moving targets to a large air-traffic-control computer inexpensively—and with high reliability.
- 80 **Keep your microcomputer alive.** As power fails, switch essential 8080 data to all-CMOS standby memory and logic. They hardly drain the back-up battery.
- 84 **Voltage references determine accuracy,** ultimately, of many precision circuits. Several techniques are used to stabilize reference sources: Which is best?
- 90 **Build high-Q, LC-tuned circuits** for low frequencies. An op amp provides negative resistance and frequency-dependent capacitance to sharpen the response.
- 94 **Carl Korn of Dynascan** speaks on training real-world engineers.
- 102 **Ideas for Design:**
Pulsing a PROM's supply voltage greatly reduces the energy used.
Programmable baud generator for an 8080 works off the system's clock.
Reduce ground-loop problems in safety-grounded instruments.
Build a high-frequency phase-locked loop with common IC components.
Variable-delay circuit built with multivibrators preserves pulse width of the signal.

PRODUCTS

- 114 **ICs & Semiconductors:** Popular IC-timer in DIP is compatible with high-noise-immunity logic.
- | | | | |
|-----|-------------------------|-----|-----------------------|
| 120 | Micro/Mini Computing | 134 | Packaging & Materials |
| 128 | Data Processing | 135 | Instrumentation |
| 130 | Modules & Subassemblies | 136 | Power Sources |
| 132 | Components | 136 | Microwaves & Lasers |

DEPARTMENTS

- 53 **Editorial:** Unlucky in love
- | | | | |
|-----|-------------------|-----|----------------------------|
| 7 | Across the Desk | 142 | Vendors Report |
| 138 | Application Notes | 152 | Advertisers' Index |
| 139 | New Literature | 154 | Product Index |
| 142 | Bulletin Board | 154 | Information Retrieval Card |

Cover: Cover illustration by James Jany

ELECTRONIC DESIGN is published biweekly except 3 issues in July by Hayden Publishing Company, Inc., 50 Essex St., Rochelle Park, NJ 07662. James S. Mulholland Jr., President. Printed at Brown Printing Co., Waseca, MN. Controlled circulation postage paid at Waseca, MN and New York, NY, postage pending Rochelle Park, NJ. Copyright© 1977. Hayden Publishing Company, Inc. All rights reserved. POSTMASTER: Please send form 3579 to ELECTRONIC DESIGN, P.O. Box 13803, Philadelphia, PA 19101.

Get a Computer-6-PAC

The Complete Microcomputer, \$495.

There is no faster way to learn programming 8080A based systems than the ia7301 Computer-in-a-Book™. In one, rugged binder you get a fully operational microcomputer and a comprehensive programming course that work together to make you an expert microcomputer programmer. Almost anyone with an engineering background can follow the "learn-by-doing" text, application by application. Programming exercises include programming switching, timing and counting functions, writing programmable controllers, setting up data search and file maintenance routines, and multibyte arithmetic programs. Then, you'll expand and apply your newly acquired knowledge by programming a digital clock, computerize your check-book, and write a few games of skill like PONG™ and Mastermind™.

The ia7301 computer system comes to you entirely assembled and tested. All you need is a dual voltage power supply (+5V, +12V). As an option, lasis offers a compact supply that fits in a briefcase.

The ia7301 microcomputer features 1K RAM, 1K PROM (containing the monitor program), sockets for an additional 1K PROM, 2 I/O ports, a neat cassette tape interface, a set of eight 7-segment LED digital displays and a handy 24 pad keyboard. Which is to say, the Computer-in-a-Book has the best combination of features and capability at a very affordable price.

And since this system has a special monitor program which allows you to look into all operating parts of the microcomputer, you'll never get bogged down in loading or debugging programs. The monitor can be used anytime through versatile mode keys to display and change data and instructions in memory or in all the 8080A registers. Likewise, programs can either be executed or stepped through, instruction by instruction, so that you can learn your way around the inner workings of the system. Complete is the best word for the Computer-in-a-Book.

The Computer-in-a-Book will also support a large, expensive microcomputer development system. The portable binder containing the ia7301 computer, programming pad and Hex conversion card offers a powerful tool to write and pretest program segments which can then be assembled in the development system. This is very efficient since it allows many engineers to program and debug in rapid succession.

Then, as your company brings microcomputer based products to market, the Computer-in-a-Book becomes an excellent training system and trouble-shooting tool for field service technicians. The on-board cassette interface can play a major role in helping management communicate program changes and new test procedures to field personnel for hardly the cost of commercial cassette tapes.

Computer-in-a-Book is a trademark of lasis, Inc.
PONG is a trademark of Atari, Inc.
Mastermind is a trademark of Invicta Plastics (U.S.A.) Ltd.

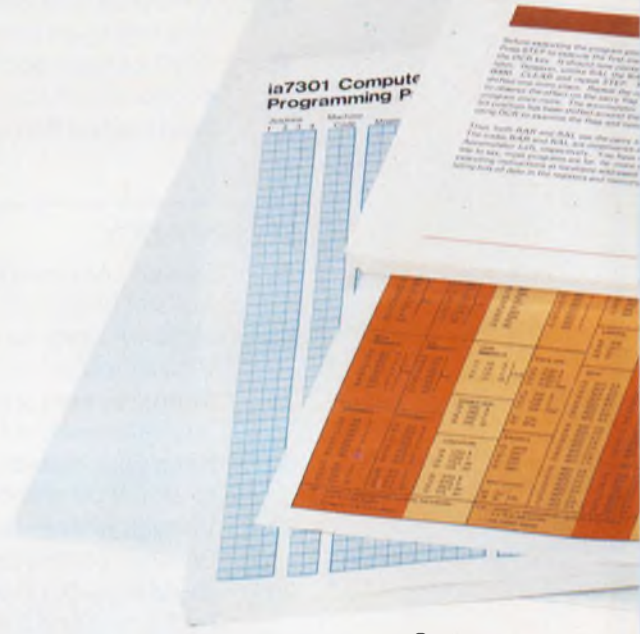

The ia7600 Series Expansion Cube.

As you might expect, lasis has combined a powerful hardware simulator and development system into one low cost package. The 7600 Series Expansion Cube has 12K RAM (expandable in 8K and 16K increments), 8K EROM, a CRT and keyboard interface, and much more.

The 7600 Series Cube can be used both as a Computer-in-a-Book add-on and as an inexpensive development system. It will simulate ROMs, program and test EROMs, and even electrically check out your prototype boards. We didn't make a cheaper development system, we just solved the microcomputer design cycle differently and better. The ia7600 will be available in late July. Watch for it.

The 6-PAC (Personal Application Cassettes), \$72.

Here is the first sampler of the lasis growing family of preprogrammed cassette tapes. It's our way of getting you into advanced, practical applications using your Computer-in-a-Book quickly and easily; no need to learn a specialized computer language. Use these six canned tapes containing over twelve interesting and varied programs as a springboard into your own applications. We give you the head



in-a-Book and a to go.



**Save \$24
and get
a free bonus**

If you order the Computer-in-a-Book and the 6-PAC before October 1, 1977, Lasis will discount the \$72 price of the 6-PAC to \$48. That is a \$24 cash savings. As an extra, Lasis will also give you a \$7.95 Microcomputer Applications Handbook as a Free Bonus. It contains over 140 pages of text, diagrams, and charts of

start. You see, we believe computers should work for you doing the things you expect them to do from day one. Look at what we put in this first sampler 6-PAC.

Tape	Side A	Side B
1	A Flexible Micro-Assembler program	Other Programming Aids
2	Floating Point Arithmetic	Other Math Functions
3	Challenging Games	More Games of Skill
4	Checkbook Balancing	Home Budget System
5	Programmable Controller	Digital Stop Watch
6	Educational Programs	Metric System Quizzes

By design each of the programs can be used right off the tapes through your home cassette recorder and the Computer-in-a-Book. Or if you wish, you can change or expand many of the programs to fit your specific application. It's up to you.

We will be announcing a continuing stream of new 6-PACs with such programs as a laboratory data analysis package, more process controller programs, inventory control systems, and much more. Now, you have a 6-PAC to go with the Computer-in-a-Book.

The Prices

The Computer-in-a-Book which contains an operational 8080A System, 250 page programming course, machine code pad, 26 page system service manual, and Hex conversion card are all contained in a sturdy 3-ring binder and offered for only \$495.

The complete set of 6 canned tapes in this first sampler 6-PAC is offered at \$72. It also includes the works on support documentation.

All Lasis products are warranted 90 days. Please allow 30 days for delivery.

microcomputer information. But you must place your order before October 1, 1977 to get in on this \$24 savings and free bonus.

OFFER GOOD ONLY TO OCTOBER 1, 1977

Please rush me _____ Computer-in-a-Book(s) at \$495 each and _____ 6-PACs at \$48 each, a \$24 savings.

I also need _____ PS-1 Power Supplies for the Computer-in-a-Book at \$62.50.

I want the Microcomputer Applications Handbook as a Free Bonus.

Here is my check for \$_____ (Calif. residents add 6 1/2% State Tax.)

Put this order on my Credit Card:

BankAmericard No. _____

Master Charge No. _____

For M.C. the 4 digits above my name are _____

My Signature _____

My card expiration date _____

Please print clearly

Name _____

Firm _____

Address _____

City/State/Zip _____



Lasis Inc., 815 W. Maude Ave., Suite 40,
Sunnyvale, CA 94086 (408) 732-5700

Still chained to wire?



Break the wire habit with Repco's modular RF links and discover new design freedom.

Repco's modular RF links are used in hundreds of applications including remote and supervisory control, voice communications, alarm and reporting systems... all become more versatile and effective through the use of Repco's rugged, reliable RF transmitters and receivers.

Repco's RF links are packed with performance features: *multiple transmission modes designed to carry tone, voice or low-speed digital data; a wide VHF/UHF frequency range; all units meet FCC and DOC requirements.*

Best of all, Repco's RF links are *economical*. They beat hard wire system costs over the long haul, thus affording you maximum performance at minimum expense. Now is the time for you to link up... with Repco's versatile RF links! Write or call today for free specs brochure, application booklet and special evaluation offer.



TX

Repco Inc.

A subsidiary of Scope, Inc.
1940 Lockwood Way
Orlando, FL 32804
(305) 843-8498



RX

World's leading manufacturer of modular communication products.

Sr. Vice President, Publisher

Peter Coley

Editors

Editorial Offices

50 Essex St.

Rochelle Park, NJ 07662

(201) 843-0550

TWX: 710-990-5071

(HAYDENPUB ROPK)

Cable: Haydenpubs Rochellepark

Editor-in-Chief George Rostky

Managing Editors:

Ralph Dobriner

Michael Elphick

Senior Associate Editor

Stanley Runyon

Associate Editors:

Sid Adlerstein

Dave Bursky

Morris Grossman

Gene Heftman

Andy Santoni

Max Schindler

Contributing Editors:

Peter N. Budzilovich, Jules H. Gilder,

John Kessler, Nathan Sussman

Editorial Field Offices

East

Jim McDermott, Eastern Editor

P.O. Box 272

Easthampton, MA 01027

(413) 527-3632

West

Dick Hackmeister, Western Editor

8939 S. Sepulveda Blvd., Suite 414

Los Angeles, CA 90045

(213) 641-6544

TWX: 1-910-328-7240

Dave Barnes, Western Editor

465 S. Mathilda, Suite 302

Sunnyvale, CA 94086

(408) 736-6667

Editorial Production

Marjorie A. Duffy, Production Editor

James Keane, Copy Editor

Art

Art Director, William Kelly

Richard Luce, Anthony J. Fischetto

Production

Manager, Dollie S. Viebig

Helen De Polo, Nancy Hurey

Circulation

Director, Barbara Freundlich

Information Retrieval

Paula Greenleaf

Advertising Promotion

Susan G. Apolant

Reprints

Maxine Correal

Pre-trigger info spots analyzer errors

Stanley Runyon's "Focus on Logic Analyzers" (ED No. 3, Feb. 1, 1977, p. 40) was one of the most comprehensive and best written logic-analyzer articles I have ever read. The article was a clear exposition of every factor of consequence involved in assaying the true cost and the true worth of an analyzer. This sort of article is a valuable service to manufacturer and customer alike.

As an advocate of both the dual-threshold and glitch-capture feature for analyzers, I wish to add that the combination of dual thresholds and glitch capture can record such anomalies as ringing, glitches, and improper level *before the trigger on all channels* while recording a transient event. On the other hand, using the trigger output of the analyzer to trigger an oscilloscope allows waveform anomalies to be detected only after the trigger and only on one channel per occurrence. When the trigger event indicates a system failure (such as a detected parity error or an interrupt on an unassigned channel), then pre-trigger information is infinitely more valuable than post-trigger information.

Carver Hill

E-H Research Laboratories, Inc.
515 11th St.
Box 1289
Oakland, CA 94604

Segments make weighty words

I read with interest the seemingly exhaustive treatment of seven-segment conversion by Mr. Kostanty in his Idea for Design, "Convert Seven-segment Numerical Code," (ED No. 4, Feb. 15, 1977, p. 137).

From the article's table, only five

segments—a, b, e, f, and g—are needed to identify a digit, a minus or a blank—12 items in all. However, the five segments, weighted as binary words, yield decimal equivalents as follows:

zero	— 30	six	— 23 (or 7)
one	— 8	seven	— 24
two	— 29	eight	— 31
three	— 25	nine	— 27
four	— 11	minus	— 1
five	— 19	blank	— 0

Clearly, such binary words also can be used to identify the seven-segment-coded digits.

Mark Gardner
President

Portatron
P.O. Box 2015
Station A.
Champaign, IL 61820

Misplaced Caption Dept.



3.2.4.1: Progress reviews shall be held at regular intervals.

Sorry. That's Antonio and Piero Pollaiuolo's "The Martyrdom of Saint Sebastian," which hangs in the National Gallery in London.

(continued on page 8)

Electronic Design welcomes the opinions of its readers on the issues raised in the magazine's editorial columns. Address letters to Managing Editor, Electronic Design, 50 Essex St., Rochelle Park, NJ 07662. Try to keep letters under 200 words. Letters must be signed. Names will be withheld upon request.

Is he really thinking?



Yes. And you would be, too, if you'd just found out that DATUM's tape system was thousands cheaper and months sooner!

DATUM guaranteed-performance tape or disk controllers and systems are available off-the-shelf for almost all minicomputers in use today.

Only DATUM has designed, built and installed over 7000 controllers and systems for so many different minicomputers to interface with so many different peripheral devices!

Check these features!

Triple-density NRZI formatting. Dual-density PE/NRZI formatting. 200 ips for all existing interfaces. Single-source responsibility for all major tape-drives.

Don't just get in some long line! Write today for specifications and prices.

Datum also manufactures cassette and rotating memories, data acquisition systems and timing instrumentation.

Peripheral Products Division
1363 S. State College Blvd., Anaheim, CA 92806 • 714/533-6333 EUROPE: Datum House, Cranford Lane, Harlington, Middlesex, UK • 01-897-0456

datum inc

Across the desk

(continued from page 7)

What we don't know can be a problem

I have observed several problems with TTL ICs within my company. Frankly, I had not thought of outside communication until I read the short note from Richard F. Binder about flip-flop input synchronization in "Across the Desk" (ED No. 4, Feb. 15, 1977, p. 8). Therefore, I pose some questions to your readers.

Problems we experienced with the 74LS160 series counters appear to be known only to subscribers to the Government Industry Data Exchange Program. First, has there been any honest and open acknowledgment or warning about the defective design of one manufacturer's parts? If they were automobiles, they would have been recalled with a public announcement!

Second, is there anyone with a good body of knowledge on the reaction of R-S flip-flops to pulses that are just below the required time and amplitude thresholds required for a true change of state? Someone should do a thorough article on the subject in a widely circulated journal such as ELECTRONIC DESIGN.

R. Schuchman
Design Specialist

Stromberg DatagraphiX Inc.
P.O. Box 82449
San Diego, CA 92138

Put metric conversion on future dashboards

Regarding "Liquid-Crystal Panels Put Car Functions on Display" (ED No. 9, April 26, 1977, p. 27): I suggest that auto manufacturers consider metric speed-conversion capability in future auto-panel systems. This includes a three-digit speed display (instead of the two-digit displays described) to accommodate 100 kilometers per hour (62 MPH).

Also, it might be attractive to the public if a dashboard switch were included to allow conversion between kilometers per hour vs miles per hour during the imminent period of transition to the metric system. Regardless of when road signs are changed to metric speed limits (or how quickly), I believe that most U.S. drivers will continue to think in terms of miles and miles per hour for a few years, even

after they buy their next new car.

As part of our sacrificial future of energy conservation, it would be nice to have a dashboard indicator that tells us our fuel-consumption rate since the last fill-up. This would serve as a constant reminder to conserve energy and help notify the auto owner when maintenance or a tune-up is needed to reduce fuel consumption. This should not cost much to add to the new digital-speed and fuel-level indication system described in your article.

Tom Shamburger
Sr. Mfg. Research Engineer
Lockheed Missiles & Space Co., Inc.
Industrial Engineering & Facilities
Sunnyvale, CA 94088

Focus on our company



Thank you for your informative article, "Focus on Logic and Microprocessor Analyzers," by Stanley Runyon (ED No. 3, Feb. 1, 1977, p. 40). We appreciate your mention of our 80-M logic analyzer, but unfortunately our company name, Digital Broadcast Systems, did not appear under the picture of our instrument.

Donald Hawkins
Digital Broadcast Systems, Inc.
4306 Governors Dr.
Huntsville, AL 35805

Ed. Note: The editor who confused Digital Broadcast Systems—the real manufacturer of the 80-M analyzer—with Digital Laboratories, a competitor, has been sent to broadcasting school to learn the business.

Loved the beefcake, but watch that chain

If you do not get a lot of letters from disgusted male engineers concerning the use of beefcake (masculine version of cheesecake) in the advertising of ECD Corp. (ED No. 11, May 24, 1977, p. 189), it will serve to prove that we aren't as rotten sports as females are.

I would not advise wearing the meter on a chain as shown, however, since the

chest hairs will occasionally catch in the chain, causing a type of pain no female could ever know. There are certain similarities, however, which is why one seldom finds topless accordion players of either sex.

James Rieger
Engineer

205 South Silver Ridge Dr.
Ridgecrest, CA 93555

First steps are the last

On p. 95 of Lance A. Leventhal's Microprocessor Basics: Part 13 (ED No. 8, April 12, 1977, p. 90), two discrepancies exist in the 8080 and 6800 programs for finding the maximum of an array of unsigned 8-bit numbers. The first jump instruction in the 8080 program and the first branch instruction in the 6800 program are incorrect. As written, the programs will both drop to DONE on the first pass. A Branch If Equal instruction should be used instead.

This was a very fine article, incidentally, and I hope you keep publishing articles aimed at the newcomers to the micro field.

Ralph Rocuzzo
R&D Engineer

Merrick Scale Mfg. Co.
180-192 Autumn St.
Passaic, NJ 07055

Mr. Leventhal replies

Ralph Rocuzzo is absolutely right about the errors. In fact, exactly the same error occurs in the multiword maximum programs on pp. 95 and 96. I can only apologize to the readers and editors of ELECTRONIC DESIGN for these inadvertent mistakes, which escaped several rounds of proofreading.

I should also note a slight error on p. 97—the result of some 8080 instructions getting into a 6800 program and somehow never getting corrected (my fault entirely). Anyway, the last program for the 6800 on p. 97 should read:

```
DSTRT LDAA #MESS CTR = LENGTH OF MESSAGE
      STAA CTR
      LDX #MESS PTR, DPTR = START OF MESSAGE
DRUN STX PTR SAVE STARTING POINTER
      LDAB #NDSPLY DCTR = NUMBER OF DISPLAYS
DSPLY LDAA X GET A CHARACTER FROM ARRAY
      JRS SEND SEND CHARACTER TO DISPLAYS
      INX DPTR = DPTR + 1
      DECB DCTR = DCTR - 1
      BNE DSPLY SEND NDSPLY CHARACTERS
      LDX PTR
      INX UPDATE PTR TO START AT NEXT CHARACTER
      DEC CTR COUNT DOWN NUMBER OF DISPLAY RUNS
      BNE DRUN
      WAI
```

hp MEASUREMENT COMPUTATION **news**

product advances from Hewlett-Packard

AUGUST 1977

100 MHz scope with unprecedented time-interval measuring accuracy

Here's a brand new concept in oscilloscopes. By incorporating a crystal controlled, time interval averaging counter with a 5-digit LED display into a 100 MHz delta time oscilloscope, the new HP 1743A offers major improvements in ease-of-use and accuracy. Nanosecond time intervals can easily be measured to 100 ps resolution, longer time intervals to 0.002 percent accuracy.

Additional features include:

1. Measurements of delta-time can now be made from the pulse that triggers the sweep, thus improving measurements of low rep rate or infrequently occurring pulses.
2. In the triggered delta-time mode, the 1743A automatically displays the time interval of interest without any "fine-tuning" by the operator.
3. With crystal timing you can use the sweep vernier to calibrate the CRT divisions for various measurements without uncalibrating the LED time readout.
4. Phase measurements on dual clocks or skew measurements between data channels are easily made between both channels. Three channel measurements can be made between the two vertical channels and on external trigger by using the third channel trigger view.

And there's much more. Check B on the HP Reply Card.



New dual-channel oscilloscope with third-channel trigger view and delta-time measurements also incorporates a 5-digit automatic time-interval averaging counter. Measurements are now 200 times more accurate than those using previous delta-time techniques.

New 2–18 GHz microwave pulser has 10 ns rise time

Modern high resolution radars and other microwave systems require fast risetime pulses for testing purposes. The HP 11720A Pulse Modulator provides pulses from 2-18 GHz with an 80 dB on-off ratio using a newly-designed PIN diode switch arrangement.



Now, signal generators can be upgraded to pulse modulation capability from 2 to 18 GHz with new fast pulse modulator.

An ideal input signal is the HP 8672A microwave synthesized signal generator or 8620C/86290A microwave sweep generator, both of which cover 2-18 GHz. Of course, any current microwave generator or source in use can be upgraded to provide high performance pulses by use of the 11720A Modulator. Sources with up to 100 mW output can be switched.

Rise/fall times are <math><10\text{ nS}</math> and internal delay is <math><70\text{ nS}</math>. Minimum pulse widths of <math><50\text{ nS}</math> are possible. This in-line switch has less than 10 dB insertion loss at 18 GHz (6 dB to 13 GHz). Input video is TTL compatible with >3V (on) and <math><0.5\text{V}</math> (off), with a complement function provided.

For more details, check A on the HP Reply Card.

Complex signal analysis made very easy

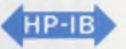

HP's 5420A digital signal analyzer is the "smartest" commercially available instrument for low frequency signal analysis. Here it analyzes the read/write head positioning servo of a disc memory.

Once restricted to specialists, the time and frequency domain analysis of complex signals by Fourier transform and related techniques can now be done with far less understanding of the theory involved, and in a fraction of the time previously required.

Applications include characterizing the open loop gain of an operating control system, measuring close-in phase noise, and the study of vibration and noise in mechanical structures.

HP's 5420A new dual-channel analyzer offers capabilities not found even in instruments costing up to twice as much.

Dynamic range exceeds 75 dB and frequency resolution to 0.004 Hz can be achieved anywhere in the 25 kHz range. Measurements include: linear spectrum, auto and cross power spectrum and spectral density, transfer function, coherence, time average, auto and cross correlation, impulse response and amplitude histogram.

The 5420A is the easiest to use digital signal analyzer with a continuous, fully annotated, calibrated display. Dual x and y axis cursors provide data readout and measurement control. A CRT-displayed "menu" guides you through instrument set up, and the built-in digital tape cartridge can store up to 50 instrument set ups and 120 measurement results for later use.

Check G on the HP Reply Card.

New developments enhance RF network analysis

The HP 8505A RF Network Analyzer (0.5-1300 MHz) acquires significant new capabilities by virtue of two new developments:

1. The new HP 8501A Storage-Normalizer accessory brings digital storage of displays, normalization of system characteristics, CRT labeling plus measurement enhancement through signal averaging and resolution magnification.
2. Ability to phase-lock the 8505A to general-purpose reference sources such as the HP 8640 and 8660 signal generators. Phase-locking permits full characterization of narrowband devices such as crystal filters with reso-

lution and stability as high as 1 Hz.

The new 8501A Storage-Normalizer brings flicker-free displays which can be annotated with scale factors and frequency data. Signal averaging improves resolution in narrowband group delay measurements and where signal levels are low. The magnification feature permits resolution to be increased up to 10 times.

Using the HP Interface Bus and an HP computing controller, powerful graphics capability is available. Add test limit lines, or display and annotate program listings and instructions.

For additional technical information, check K on the HP Reply Card.

New storage-normalizer brings additional capabilities to HP 8505A network analyzer:

Storage and Averaging (photo A)—two traces, with and without averaging, are stored, to demonstrate improvement that averaging brings to group delay measurements of narrowband devices. **Normalization and Labelling** (photo B)—test device's response deviation from standard is displayed directly along with overall response of standard.

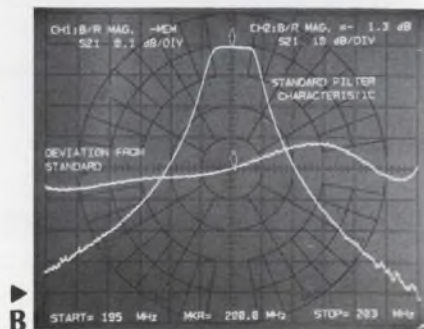
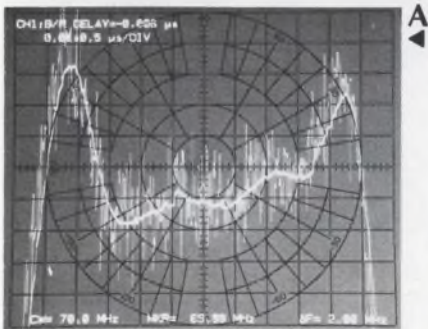

New microwave power measurement Application Note

One of the classic application notes from Hewlett-Packard was AN 64, *Microwave Power Measurement*. Now, a completely rewritten note AN-64-1 *Fundamentals of RF & Microwave Power Measurements* is available to bring all of the pertinent power measuring principles up-to-date.

AN 64-1 explores in detail three of the most popular power sensing techniques, thermocouple elements, thermistors, and diodes including a comparison of the advantages and disadvantages of the three methods. A comprehensive error analysis section follows with particular emphasis on mismatch considerations. Included also are some pulse power measurement considerations.

For your free copy, check N on the HP Reply Card.

How to configure your own automatic network analyzer

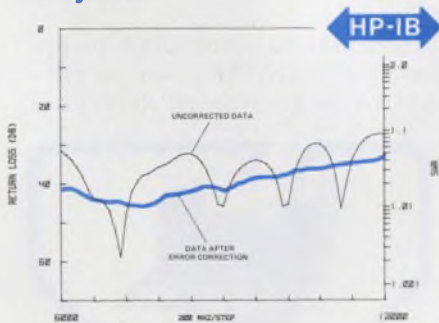

An economical method for semi-automatic, *error-corrected* microwave network measurements is described in Application Note 221. The HP-IB system uses the HP 8410 network analyzer and HP 9825A desktop computer, with 110 MHz to 18 GHz range.

Sources of error and the essentials of error correction are described. A sample 9825A program for calibration and measurement is listed along with annotations and flow charts. Results that demonstrated significant improvements in accuracy are presented.

If your work involves microwave measurements, be sure to send for your free copy. Check O on the HP Reply Card.

Continuous memory retains your programs and saves your data—even when you turn it off

Continuous memory makes it possible to add functions to those already preprogrammed into the HP-25C, ready at the touch of a key.



The continuous memory capability of the HP-25C scientific programmable pocket calculator can provide tremendous values in time-savings and convenience to any scientist, engineer or student who uses a few long programs repeatedly. The 25-C not only retains the last program you used, it also retains all data in the registers. And now, with a reduction in the price, you can save money too.

Continuous memory in the 25-C is the only feature not found in the popular HP-25. Otherwise, both calculators offer the same powerful capabilities.

- 49-step program memory plus 8 addressable registers
- BackSTep and SingleSTep keys let you review the entire memory one step at a time, in either direction

- Conditional branching allows you to test relationships between values
- Pause feature allows you to momentarily interrupt program execution and display the results of the X register for evaluation or recording
- Trig and log functions plus rectangular/polar conversions
- Statistical capabilities: summations, mean and standard deviations
- Three display modes: decimal, scientific or engineering notation
- All memories available for register arithmetic.

Either calculator is a good choice for your professional needs.

For more information, check C on the HP Reply Card.

Build your own automated system around an HP computing controller



Shown above is an HP computing controller in a microwave test laboratory. The test limits can be set from the keyboard of the controller; the controller tests all parameters and makes NO-GO decisions. Data can be stored for later evaluation and analysis of quality control information.

A fast and inexpensive way to add data acquisition and analysis capability to your instruments is with HP computing controllers—the HP 9825A and 9815A. Each compact controller is a complete, one-package system with integrated keyboard, display, strip printer, easy-to-use language and tape storage. Interfacing the controller to your instrument is simple. Plug in the appropriate interface card, write a simple application program and your system is on its way up. Off-the-shelf interface cards and built-in software allow you to interface to BCD, 8 or 16 bit parallel, bit-serial and HP-IB (Hewlett-Packard Interface Bus)-compatible instruments.

HP 9825A controller

The HP 9825A computing controller provides minicomputer-like speed and capability. It features buffered I/O and live keyboard. A built-in 250k-byte tape cartridge with a 3k-byte-per-second transfer rate and 90-inch-per-second search rate allows quick storage and retrieval of data. Using the HP-IB, the 9825A can control as many

as 14 instruments and peripherals with each HP-IB Interface card. Up to three cards may be connected. The programming language (HPL), designed for scientists and engineers, is easy-to-learn and, in combination with the keyboard's eight editing keys, is easy-to-use.

HP 9815A controller

The HP 9815A computing controller with its 96k-byte tape cartridge can be anything from a simple data logger to a controller of a small automatic instrumentation system. Its 16-character alphanumeric thermal printer can be programmed to instruct the operator and provide labeled hard-copy results. Programming, for interfacing as well as data analysis, is fast and easy, using RPN. The AUTOSTART feature allows your program to begin executing automatically when the power is turned on.

For your copy of a brochure illustrating automatic test systems with integral desktop controllers, check M on the HP Reply Card.

Cut development costs when upgrading to a new desktop computer

For desktop calculator owners whose applications have outgrown their earlier HP 9800 series calculators, a simple way to move up to a more powerful data handling system is now offered.

The HP 98032A Interface Card allows accurate and swift transfer of data from the 9810A, 9820A, 9821A or 9830A/B to the newer 9825A and 9831A computing controllers. The same interface card also permits the direct transfer of data and programs used with the 9830A/B into the larger memory of an HP 9831A computing controller.

To perform the transfer, simply plug the interface card into your old calculator and connect the other end of the card to your new 9825A or the 9831A. In a fraction of the time it would take to manually re-enter the data or program, the interface card smoothly transfers it — unattended. In case an error is encountered in the transfer, an error message will be automatically recorded and prompt the user for a later correction.

For additional information on upgrading to an HP 9825A or an HP 9831A, check L on the HP Reply Card.

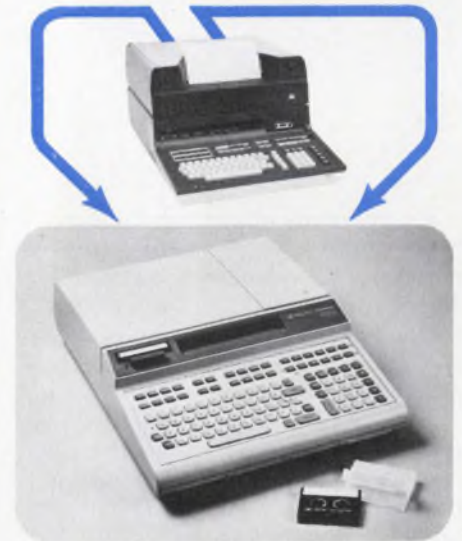

If your applications require larger storage and faster processing speeds than your earlier model desktop calculator can offer, consider upgrading to or adding a powerful new HP desktop computing controller. A new interface card will now enable you to transfer your data and/or programs simply, quickly, economically.

Distributed System/3000 brings remote computers within your reach

For the first time, it is now possible to interconnect Hewlett-Packard 3000 Series II Computer systems in distributed processing networks. DS/3000 consists of new software developed as an extension of Multi-Programming Executive II, the computer's basic operating system. MPE provides for multiple interactive and concurrent batch operations. It also brings an accounting structure and file security that provide protection against unauthorized use of local or remote HP 3000 systems and their data.

When existing 3000 Series II computers are networked with DS/3000, the user's investment in application software is protected. That software will require no change because the MPE operating system was designed to accommodate such future developments as networking.

DS/3000 cuts the cost and slashes the time and effort needed to get a useful distributed data-processing system up and running. You can sit down at a terminal and use the programs, files and data resident in any interconnected HP 3000. You don't need a special program to do it, either. Simply identify the computer you want to talk to and you're on-line.

With the same ease, you can shift programs and files from one HP 3000 to another. All that is needed to interact with a remote system is to add the word REMOTE to some commands. Remote files are as easily accessible as those stored locally. Only seven simple new commands need to be added to the HP 3000 repertoire to accomplish program-to-program communication among systems. Remote peripheral devices are also at your command. Operation at this high level without a massive investment in special programming is a breakthrough in distributed processing.

DS/3000's architecture is layered

DS/3000 has been implemented with a 'layered' architecture, so that user-created software will not become obsolete because of technological advances that may occur in communications.

Each layer to a large extent functions independently. In the future, network enhancements to DS/3000 could be

accomplished by providing a new software/hardware update to just one layer. This change would not affect either the structure or the usage of DS/3000 user commands and procedures.

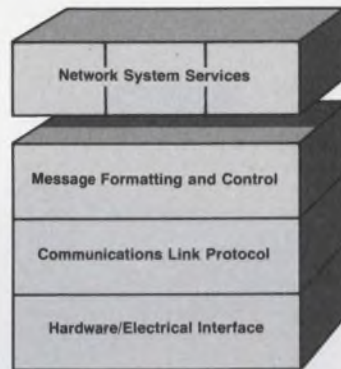

The layers. The first layer, the electrical interface to external modems, meets EIA RS 232C and CCITT standards. Systems can be linked over common carrier facilities at speeds up to 9600 bits per second or over hardwired lines at speeds up to 2.5 million bits per second.

The next layer is concerned with link protocol in a point-to-point configuration. It currently multileaves data bidirectionally over half or full duplex common carrier facilities, using IBM-

compatible Binary Synchronous Communication (BSC) protocol.

The third layer automatically handles conventions of message formatting and manages the flow of messages between systems.

The top (fourth) layer is the most exciting for it represents the set of full, high-level system services available to the user on DS/3000. These include sharing of resources, remote command processing, remote file access and program-to-program communication.

The HP 3000 Series II Computer

The all-round performance of the HP 3000 makes it an ideal departmental computer for solving a wide range of problems such as order processing, inventory control, cost accounting and materials requirement planning.

With its versatile executive software, the HP 3000 offers speed and power. The built-in flexibility of the HP 3000 will allow you to take advantage of technological developments in distributed data processing.

For more information, check D on the HP Reply Card.

Instantaneous information sharing between HP 3000 computers is now practical and economical. New software puts data and processing power of remote computers at your command—at your terminal. Just add the word "REMOTE" to the appropriate commands.



Microprocessor in new LCR automates a wide range of measurements



While the microprocessor in the new HP 4262A LCR meter automates and simplifies component measuring and testing, the arrangement of the instrument front panel keyboard switches assures maximum operating convenience and error-free operation.

This new Hewlett-Packard 4262A Digital LCR Meter is a 3-1/2 digit microprocessor-based instrument that meets today's requirements for measuring capacitance, resistance and inductance of components in the laboratory, on the production line and in quality assurance inspection.

Because the 4262A is microprocessor-based, it features automatic operation and internal self-test capability to insure the instrument is functioning properly. For example, the operator simply selects the function and loss parameters, one of three test frequencies and inserts the device to be measured. The LCR Meter does the rest—automatically selecting the proper range and equivalent circuit mode. Deviation measurements are also provided for very useful comparisons when measuring the range of small trimmer or variable capacitors. Capacitance can be measured from

0.01 picofarads to 19.99 millifarads, inductance from 0.01 microhenries to 1999 henries and resistance from 1 milliohm to 19.99 megaohms. D and Q (loss) are also measured; D is measured from 0.001 to 19.9 and Q from 0.05 to 1000.

In addition to automatic measurement and wide range, the 4262A basic accuracy is 0.2 percent of reading. Measurement frequencies of 120 Hz, 1 kHz and 10 kHz are available. An HP-IB option allows the system-oriented user to easily interface the 4262A with a calculation controller or computer for increased speed, programmed measurements, automatic decision making and permanent hard copy records.

For more information, check F on the HP Reply Card.

A/D converter puts your analog voltages onto the HP Interface Bus

With the 59313A Analog to Digital Converter you can convert up to 4 channels of dc voltage sources to digital form for use in measurement or test systems structured around the Hewlett-Packard Interface Bus (HP-IB). A particularly useful application is in adapting, to systems use, instruments whose outputs are dc voltages.

The 59313A was designed specifically for systems use. It can perform 200 conversions per second on a single input channel or 50 per second on each of four channels. Selectable rates are 5, 10, 20, 50, 100 or 200 samples per second and are accurate to $\pm 0.05\%$. Resolution is 0.05% (10 bits plus sign), and the dual slope A to D converter has a linearity better than 1/2 least significant bit (LSB) and 4.75 ms conversion time.

The four jumper-selected voltage ranges can be screw-driver adjusted to values of ± 1.0 to ± 1.3 , ± 2.5 to ± 3.5 , ± 5.0 to ± 7.0 , and ± 7.0 to ± 10.3 volts, so as to maintain maximum resolution with a variety of voltage sources. The input can take 30 volts rms without damage, and input impedance exceeds 1 megohm.

The binary output code is readily converted to decimal form, or other codes, with a computing controller on an HP-IB system.

For more information, check H on the HP Reply Card.



The HP 9825A computing controller programs the HP 59313A for versatile, four-channel A to D conversion on an HP-IB system.

Easier-to-read characters with new 16-segment display

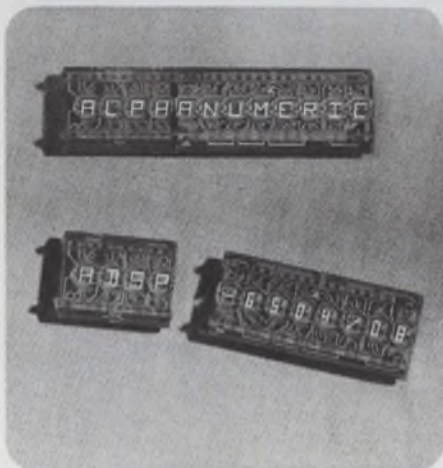

HP now offers a 16-segment font in a new display for applications requiring lower power usage with ease of readability.

The first 16-segment solid state LED alphanumeric displays from Hewlett-Packard are now available. They are designed for use in computer peripheral products, automotive instrument panels, calculators plus instruments and systems requiring low power con-

sumption in an easy-to-read display.

Magnification of the LED by an integral lens enhances the character intensity while keeping the power use at a minimum, and results in a character size of 3.8 mm. In addition to the 16 segments, the display has a centered decimal point and colon. Drawing as little as 1.0 to 1.5 mA average current per segment, they are easily read at a distance of more than six feet.

The new HDSP-6504 and HDSP-6508 four- and eight-character offer complete 64-character ASCII set capability. Both dual-in-line packages can be stacked end-to-end for applications requiring additional characters.

More rugged than standard PC board/lens type display packages, the new HP devices are well suited for demanding in-field applications such as in computer-based mobile units.

For more information, check I on the HP Reply Card.

New low R_s beam lead PIN switches in just 2 ns



A new mesa process with glass backfilling is responsible for the performance of this new beam lead PIN. The mesa construction constrains the minority carriers thereby enhancing switching speed.

Representing a major improvement in beam lead PIN technology, the Hewlett-Packard HPND-4050 offers 1.3 ohms typical (1.7 max) series resistance at only 10 mA current. This low

resistance reduces power requirements and makes it ideal as a shunt switching element in stripline and microstrip circuits. The low current requirements make it suitable for use in portable, airborne or shipboard applications.

Reverse recovery time is typically 2 ns, which meets or exceeds switching time requirements for fast switches for high frequency modulator and attenuator component applications in EW systems. Capacitance of the HPND-4050 is 0.15 pF maximum and breakdown voltage is 30V minimum.

For more details, check E on the HP Reply Card.

HP offers wide choice of quality optoelectronic components



This new *Optoelectronics Designer's Catalog* contains detailed, up-to-date information on our complete optoelectronic product line. It is divided into five major product sections: solid state lamps, solid state displays, optocouplers, emitters, and PIN photodiodes.

Included in the 200 pages are product photographs, specifications, operating characteristics, and performance graphs.

For your copy, check Q on the HP Reply Card.

New Schottky Technical Note

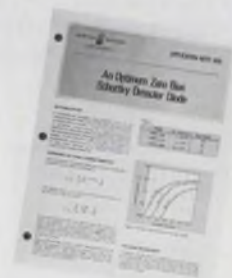

Application Note 969 addresses the theory behind a new line of Schottky detector diodes. Conventional Schottky detector diodes require a small amount of dc bias for low level detection to take place. Even though only a few microamperes are required, this is often difficult to supply. These new Schottky diodes (HSCH-3171 series) eliminate this need for dc bias and are more efficient as detectors compared with conventional Schottky detector diodes.

For your free copy of this application note, check P on the HP Reply Card.

New 50 MHz serial data generator produces 2048 bit data streams plus PRBS

Now the HP 8018A provides the answer to all your requirements for serial digital stimulus. The 8018A includes two data channels, each with 1,024 bits of digital memory. Both word length and the number of words may be selected to exactly match your application. Serializing the channels, you can generate data streams up to 2,048 bits in length, sufficient for even the most complex data requirements.

Pseudorandom pattern generation is also included. With preset sequences from 511 to over 1 million bits long, you can easily produce worst case testing patterns or simulate actual traffic in a data network. An innovative new technique even lets you interleave PRBS and programmed data words in a single stream, perfect for simulating preamble—data message—postamble patterns.

The 8018A's high performance output amplifier delivers clean 5 ns pulses with amplitudes up to 15V. A switchable 50-ohm source minimizes reflections under various load conditions, helping you maintain pulse integrity right up to your circuit or system under test. A full complement of cycle modes

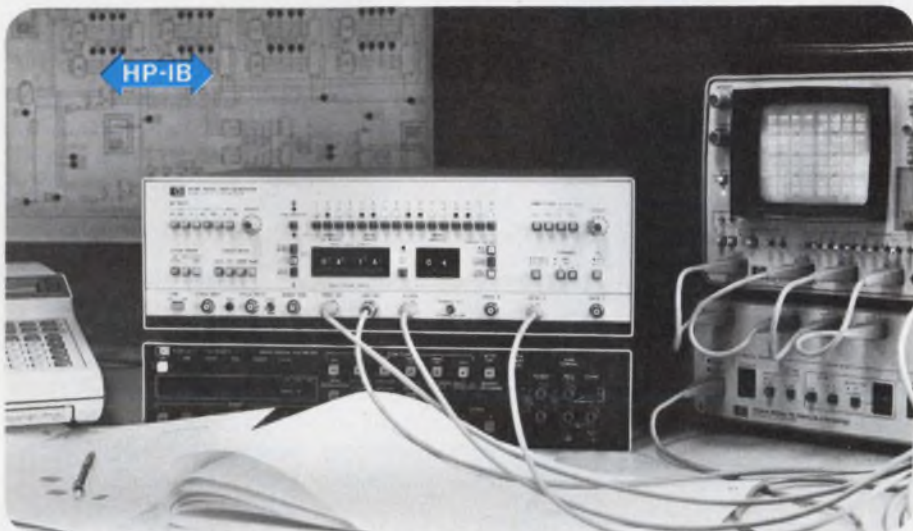

Suitable for bench and systems applications, the 8018A data generator is shown above. The logic analyzer displays the data pattern that has been generated for testing a serial digital interface. Both the data generator and the voltmeter are under programmed control using an HP desktop computer.

and trigger outputs simplifies synchronization with other instruments. An optional HP-IB programming interface enables you to rapidly load all 2,048 memory bits or integrate the 8018A's capabilities into automatic test systems.

This unmatched feature set has been

designed to shorten and simplify troubleshooting tasks wherever a source of serial data is required.

To find out more about this powerful new digital performer, check J on the HP Reply Card.

East-4 Choke Cherry Road, Rockville, MD 20850,
Ph. (301) 948-6370.

South-P.O. Box 10505, Atlanta, GA 30348,
Ph. (404) 434-4000.

Midwest-5201 Tollview Dr., Rolling Meadows, IL 60008,
Ph. (312) 255-9800.

West-3939 Lankershim Blvd., North Hollywood, CA
91604, Ph. (213) 877-1282.

Europe-7, rue du Bois-du-lan, P.O. Box, CH-1217, Meyrin-2,
Geneva, Switzerland, Ph. (022) 41 54 00.

Japan-Yokogawa-Hewlett-Packard Ltd., Ohashi
Bldg., 1-59-1 Yoyogi, Shibuya-ku,
Tokyo 151, Ph. 03-370-2281/92.

HEWLETT  **PACKARD**

MEASUREMENT **news**
COMPUTATION
product advances from Hewlett-Packard

July/August 1977

New product information from

HEWLETT-PACKARD

Editor: Iona M. Smith

Editorial Offices:

1507 Page Mill Road
Palo Alto, California, 94304 U.S.A.

Across the desk

(continued from page 8)

Blame the moon

The moon must have been full when type was set for the product story, appearing on p. 160 of our June 21, 1977, issue, on Teledyne Philbrick's 1435—not 1453. It's a 1000-MHz op amp that settles to 1% in a mere 10 ns. What's more, Teledyne Philbrick is on Allied—not Alled—Drive.

CIRCLE NO. 319

New Books

Analysis and Design of Sequential Digital Systems—L.F. Lind, J.C.C. Nelson, Halstead Press, 605 Third Ave., New York, NY 10016, 146 pgs. \$17.00

CIRCLE NO. 461

Digital Computer Circuits and Concepts—B. Deem, K. Muchow, A. Zepa, Prentice-Hall, Inc., Englewood Cliffs, NJ 07632, 487 pgs. \$15.95

CIRCLE NO. 462

Microcomputer Handbook—C.J. Sippl, Petrocelli/Charter, 641 Lexington Ave., New York, NY 10022, 480 pgs. \$19.95

CIRCLE NO. 463

Optimum Systems Control—A.P. Sage, C.C. White, Prentice-Hall, Inc., Englewood Cliffs, NJ 07632, 413 pgs. \$22.50

CIRCLE NO. 464

Microprocessors: Fundamentals & Applications—W.C. Lin, IEEE Press, Distributed by John Wiley & Sons, Inc., 605 Third Ave., New York, NY 10016, 335 pgs. \$9.95

CIRCLE NO. 465

Shock & Vibration Handbook—C.M. Harris and C.E. Crede, McGraw-Hill Book Co., 1221 Avenue of the Americas, New York, NY 10020, 1322 pgs. \$47.50

CIRCLE NO. 466

Handbook of Oscilloscope Waveform Analysis and Applications—M. Ritter-Sanders Jr., Reston Publishing Co., Inc., P.O. Box 547, Reston, VA 22090, 200 pgs. \$15.95

CIRCLE NO. 467

Electronic Designer's Handbook, second edition—L.J. Giacoletto, McGraw-Hill Book Co., 1221 Avenue of the Americas, New York, NY 10020, 2344 pgs. \$47.50

CIRCLE NO. 468

Airborne Delivers Tomorrow.

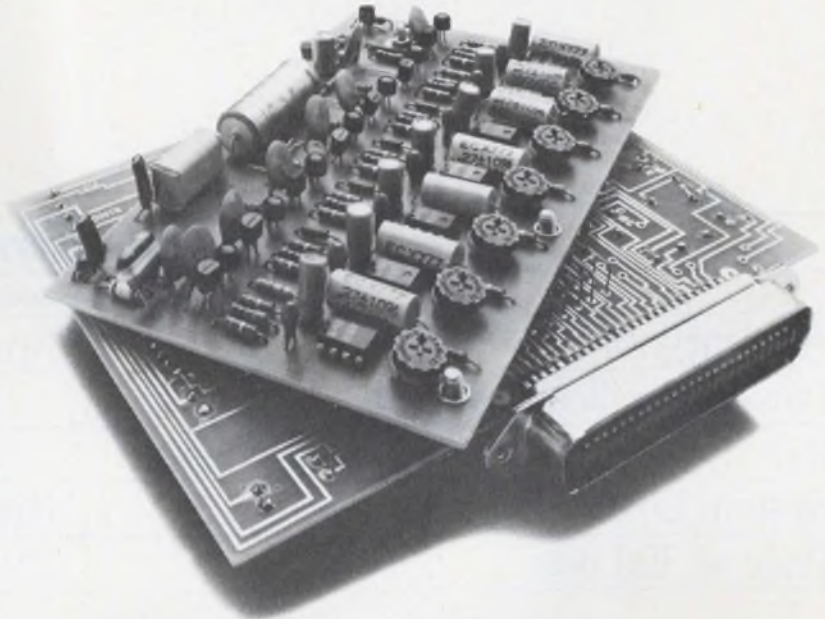

Everyday.

When you need to rush any size critical electronic components, computer parts, programs, documents or equipment from your city to virtually any U.S. destination, get it Airborne.

We deliver tomorrow all over the country, door-to-door, 10,000 times a day.

If your smaller items fit within one of our 13" x 18" Express Pack containers, we'll provide it without adding a penny to our competitive rates. Our "soft pack" is a waterproof, tearproof and sealable envelope which accommodates things like printed

matter, catalogues, and blueprints. Our "hard pack" is a rigid box with a convenient handle which provides excellent protection for delicate chips or electronic modules.

Regardless of size or weight, Airborne picks up your shipment when you want it picked up and delivers it on time. Door-to-door.

Call Airborne today.

We deliver tomorrow. Everyday.

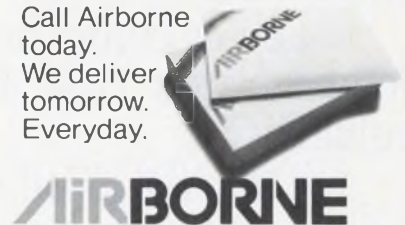

CIRCLE NUMBER 7

If this ad doesn't don't know what

A/D Converters

	Motorola's MC14433	National's ADD3501 (MM74C935-1)
Accuracy: 0° to +70°C	No spec	± 1 count max
Power Supplies Required	2	1 (+5V)
External Active Components Required	4	2
System Cost	Higher	Lower
Price @ 100 pcs.	\$9.97	\$9.95

National introduces its answer to the Motorola MC14433. The ADD3501 3½-digit A/D converter...manufactured using National's standard MM74C Series CMOS process.

As you can see from the chart, it offers more performance and requires fewer external components than Motorola.

Fewer components means lower system cost and greater reliability.

The ADD3501 uses pulse width modulation as a conversion technique, rather than

dual slope. Which means inherently better temperature and long term stability.

And our out-of-range indication is "OFL," not just a blink.

The ADD3501 is available now from National distributors. Pick up a few samples and give us a look-see.

One-stop shopping for digital panel meter and digital multi-meter components.

Another nice thing.

You can fill your whole shopping list from National.

convert you, we will.

The LM336 Reference, plus the other external components you might need for your panel meters and digital

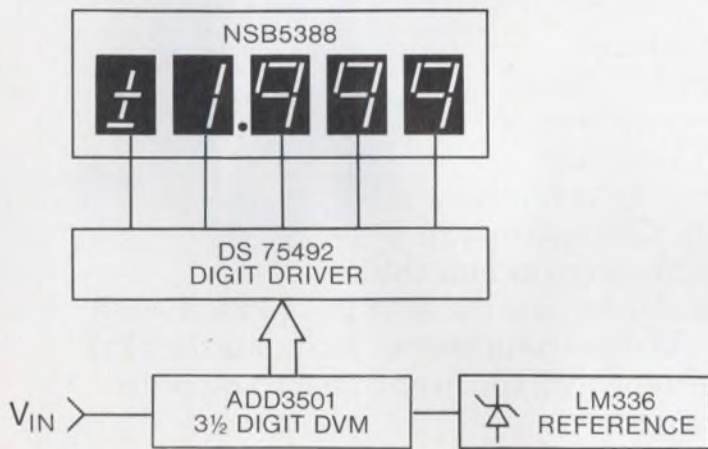

DVM BLOCK DIAGRAM

multimeters: Regulators, Digit Drivers...NSB & NSN Series Seven Segment displays...and Resistor Arrays.

Other ways to convert you.

The ADD3700. A 3³/₄ digit device instead of 3¹/₂. With twice the resolution of the ADD3501, and twice the

accuracy (0.025%).

And the bipolar ADD2500. A complete converter on a chip, including the reference. All it needs are a few passive external elements and a display, \$7.95.

The new monolithic A/D Converters from National. Hello more reliability. Hello less cost. Goodbye Motorola.

National Semiconductor Corporation
2900 Semiconductor Drive
Santa Clara, CA 95051

Gentlemen:

Please try converting me. Send technical literature on your new converters and associated digital panel meter components.

Name _____ Title _____

Company _____

Address _____

City _____ State _____ Zip _____

ED8/2

 **National Semiconductor**

Intel delivers a unique the 8085. It's like the

Introducing the 8085, a unique new microcomputer that is part of a new Intel[®] microcomputer system—the MCS-85.[™]

The 8085 is both software and bus compatible with the 8080. So you can take

full advantage of the wealth of software, peripherals and development tools that

have helped make the 8080 the industry standard.

Yet the 8085 is 50% faster than the 8080. So your 8085-based products will enjoy a new level of performance at even lower cost.

All components in the MCS-85 system have higher level integration, making it possible to replace a 10-chip 8080 system with three MCS-85 chips. Components of the MCS-85 system include the 8085 CPU, the 8155 256-byte RAM with I/O and timer, and the 8755 16K EPROM with I/O and interchangeable 8355 ROM with I/O. All these components, including the 8755 EPROM, operate from a single +5V TTL supply enabling you to go from prototype to production without board or power supply changes.

It all adds up to faster, easier, more economical—and better—system design.

The 8085 is more than a faster, more efficient microcomputer. It's the newest example of Intel's total system commitment. Here's what that means for existing 8080 users and new microcomputer users.

Because the 8085 is fully compatible with 8080 software and 8200 series peripheral components, it protects your investment in existing designs and allows you to implement new designs without starting the development cycle all over again.

And now you can design your 8085 and 8080 systems around four new advanced peripheral controllers: the 8271 Floppy Disc Controller, the 8273 Synchronous Data Link Controller, the 8275 CRT Controller and the 8279 Keyboard/Display Interface. Like the other 8200 series peripherals, these new devices are fully programmable, single chip solutions to system interface requirements.



new microcomputer, 8080. Only better.

Intel's total system commitment means that the MCS-85 is being introduced as a fully supported, complete system. All the support that has helped 8080 users get



to market sooner now gives 8085 users a head start too.

To speed programming we provide PL/M, the high level programming language for microcomputers that can cut months off software development. The Intellec® microcomputer development system, with ICE-85™ in-circuit emulation and symbolic debugging, helps reduce system integration and debug time. Then there's application assistance worldwide. Training classes and seminars to help you get the most from the MCS-85 system. And a comprehensive development software library at your disposal.

Total system commitment. It protects your investment. And gives you the jump in a competitive world. Because MCS-85 is a complete and fully supported system, comparing Intel with any other microcomputer supplier becomes an apples to oranges comparison.

The fastest way to get started is to order MCS-85 products from your local Intel distributor. Almac/Stroum, Component Specialties, Cramer, Elmar, Hamilton/Avnet, Harvey Electronics, Industrial Components, Liberty, Pioneer, Sheridan, L.A. Varah, or Zentronics.

Or, for our detailed MCS-85 brochure, use the reader service card or write us directly. Intel Corporation, 3065 Bowers Avenue, Santa Clara, California 95051.

intel® delivers.

AUGAT MAKES IT EASY TO BUY THE BEST.



One of the biggest reasons Augat sockets outsell all others is that we make Augat sockets the easiest to buy. Augat offers IC sockets for off-the-shelf delivery from hundreds of worldwide distributor locations. So you have it easy when you buy the best. And here are some of the best you can buy.

Our Series 300 low-profile sockets excel over competitive types with their superior beryllium copper side-wipe contacts that handle all com-



300 Series low-profile

ponent lead sizes with better retention and longer contact life. They are available in all sizes from 8 to 40 contacts.

Our 300 Series wire wrap sockets are the best buy in the industry today. Their special pin taper locks them in place without bonding or soldering, and

they're very attractively priced.



300 Series wire wrap

Our 500 Series sockets are the industry's "premium grade", the ones to use when high reliability and exceptional performance (at a reasonable price) are a must. They come in 12 sizes between 8 and 40 contacts.

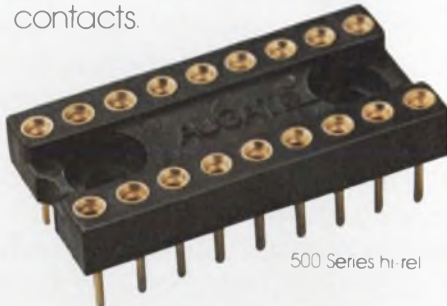

500 Series hi-rel

Our 700 Series lead socket carrier is a new concept of growing popularity. The metal carrier holds the individual contacts in place through assembly and soldering, and is then removed. Advantages: improved airflow and complete topside accessibility for inspection and solder rework. Available in 14 sizes.

Beyond that, of course, is our

broad selection of standard profile and test sockets, LED sockets, and numerous accessories.

So the next sockets you buy, make them Augat. They're not only the best you can get, but getting them is a breeze... just about anywhere. Write us for a condensed socket selection guide with prices and a list of our distributors.

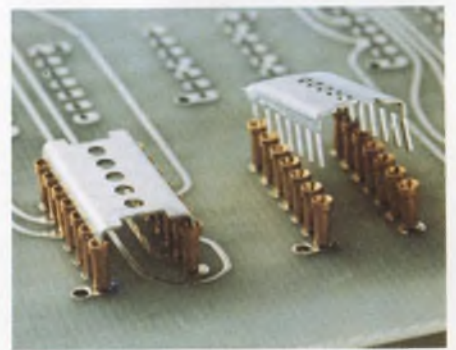

700 Series lead socket carrier

Augat, Inc., 33 Perry Avenue, P.O. Box 779, Attleboro, Mass. 02703. Tel. (617) 222-2202

AUGAT[®]

Augat interconnection products, Isofonics microcircuit packaging, and Alco subminiature switches.

Be a gambler without losing—time, that is

An on-the wrist gambling casino is the latest feature to be packaged into an LCD digital watch. Based on a random-number generator in the watch circuitry, three games are available simply by pressing a Game and a Display switch: Jack Pot, Dice, and Roulette.

Jack Pot displays three random numbers, from 1 through 6, to simulate the three spinning wheels of a slot machine. Dice displays two random numbers from 1 to 6 to imitate the roll of a pair of dice. Roulette winds up with a number from 1 to 36, as in the spinning of a roulette wheel. The watch is appropriately named the Monte Carlo. Gaming, timing and other functions are controlled by four switches on the watch by Unitrex in New York City. One switch, the normal time display, is also used in playing the games. A second is the Game switch, which selects the three games but also returns the watch to the normal hours and minutes time mode. A Light switch turns on back illumination for night viewing, while a Set switch is used to set the time.

All three games use the same pseudo-random generator, observes Dwain Holst, president of Datatime, Sunnyvale, CA, designer and supplier of the watch IC chips. In the Game modes, the normal timing logic is locked out and the random numbers are displayed.

To play Jack Pot when the watch is displaying the time, the game switch is pressed once. To start the three Jack Pot numbers "rolling," the Display switch is pressed. As long as the display switch is held in, the three numbers continue to change rapidly.

Because of the flow response of the LCD, the individual numbers cannot be detected. Once the Display switch is released, the rate at which the random numbers are sent to the display begins to slow down—just like slot machine wheels. Finally, the right hand digit appears motionless, then the middle

digit and finally the left-hand digit.

If all three digits are the same, the Jack Pot is hit and four Js flash in the display. Pressing the Game switch twice selects Dice, while three times gives roulette. As with Jack Pot, the Display button is operated to set the Dice and Roulette numbers in motion and to stop them.

Pressing the Game switch a fourth time returns the watch to timekeeping. Pressing the Display button then shows the day and date. Pressing Display twice more within two seconds shows minutes and seconds. A final push on Display, brings back the hours and minutes digit to view.

S/n up, phase distortion down in Hall playback

An 8-track record-playback head for magnetic tape recorders is the first Hall-effect consumer application. Incorporating thin-film Hall elements in the playback structure, the Hitachi head has lower cross talk, higher signal-to-noise ratio and substantially lower phase distortion than those of conventional magnetic coil playback devices.

Key to Hitachi's design is a 2- μm , thin-film, indium-antimonide Hall element with a highly efficient magnetic structure. Microzone-melting the Hall element on a ferrite substrate reduces noise to present low levels. On this basic element, a ferrite pole piece is fastened and ground to form a playback head with a 3- μm gap.

Signal-to-noise ratio of Hitachi's playback unit is 3 to 5 dB better than competitive conventional units, says Gentaro Miyazaki, director of Hitachi's Consumer Products Research Center in Lyndhurst, NJ. Cross talk is below -50 dB at 80 Hz. And phase distortion is so low that rectangular or square waves can be reproduced with excellent fidelity—a major requirement for hi-fi buffs.

In addition, the time lag between recorded and monitored voice or music is less than that for conventional heads. The physical distance between the recording head gap to the reproducing head gap has been reduced. The conventional distance is 3.2 mm. For the Hitachi device, it is 2.4 mm.

The first Hall-effect playback heads produced a few years ago not only had poor s/n ratios and frequency response, but were costly to boot—\$500 to \$600. Hitachi's method of fabrication produces low device cost—on the order of 9 dollars in large quantities, according to Miyazaki. The device is being mass-produced in Japan.

Ovshinsky strikes again: amorphous solar cells

Even as the scientific community's attitude toward Stanford Ovshinsky's development of noncrystalline, amorphous semiconductors has begun to turn from skepticism to acceptance, the inventor has come up with a new application for the devices: solar cells that are claimed to be two orders of magnitude less expensive than conventional silicon cells.

Such devices can be made to produce electricity at a cost of 0.2 cents/kWh, compared with 25 cents/kWh for crystalline-silicon solar cells, according to Ovshinsky's firm, Energy Conversion Devices Inc. of Troy, MI. To be competitive with conventional sources, the company says, the cost must be 3 cents/kWh.

Amorphous semiconductors can cost less than crystalline devices because their materials can be mixed by a simple process and can contain fairly high amounts of modifiers—20% or more. On the other hand, silicon crystals must be extremely pure, and the small amounts of modifiers used in the doping process can be difficult to control.

To make amorphous-semiconductor solar cells, the basic material is chemically modified to increase its conductivity. Low conductivity, among other factors, had made amorphous materials unsuitable for converting sunlight to electricity.

Ovshinsky's work with amorphous materials, which began in 1958, has long been regarded with suspicion, in part because the materials' responses could not be explained simply. But in recent years, potential applications have begun to emerge.

Burroughs Corp. has been working on amorphous memory devices. Energy Conversion Devices has also developed an amorphous-material microfiche system that may soon be marketed in the United States by Minnesota Mining and Manufacturing.

Biggest windmill to generate 2.5 MW

The largest windmill in history—a 2.5 MW system with blades spanning a circle 300 feet in diameter—will be built over the next two years in a test program conducted by the Energy Research and Development Administration. Although experimental, the wind turbine—the name for modern electrical generating windmills—will be located at a utility-company site and will supply electricity to a local electrical system for public use.

The program will investigate the economics and operating characteristics of large wind turbines when coupled with conventional power plants, according to an ERDA spokesman. Special emphasis will be on developing a wind turbine capable—if produced in quantities of up to 100 units—of providing electricity at a cost approaching that of conventional power plants.

ERDA and the National Aeronautics and Space Administration, which will manage the program, are negotiating a \$10-million contract with Boeing Co. of Seattle to design, build and install wind turbines at sites with a mean wind speed of 14 mph. Such sites are relatively common throughout the United States.

The largest currently operating wind turbine is the 100 kW, 125-ft diameter system built for ERDA by NASA-Lewis Research Center at its Plum Brook test area near Sandusky, OH.

Million-hour life seen for GaAlAs lasers

Solid-state gallium aluminum arsenide lasers with average projected lifetimes of one-million hours—or 100 years—have been reported by Bell Laboratories.

These long-lived room-temperature lasers are essential for future optical communications systems.

"Aging tests have shown that these lasers now last so long, that it's hard to determine their expected lifetime in a system application," according to Barney DeLoach, head of the light-

wave-sources department.

"However, by operating groups of lasers at temperatures considerably higher than room temperature—90 C (194 F), 70 C (158 F), and 50 C (122 F)—we were able to cause them to fail in measurable times. Even so, some tests exceeded two years."

By extrapolating these high-temperature results to lower temperatures, says DeLoach, Bell Labs was able to project room-temperature (22 C or 72 F) lifetimes of about a million hours.

Actual equipment-frame temperatures in operating lightwave systems exceed 22 C. Initially, thermoelectric cooling devices will be used to maintain near-room-temperature conditions for the lasers.

Current limiters added to smallest LED lamps

On-chip current-limiting resistors have been added to red LED lamps that can be mounted on 0.1-in. centers—25% less spacing than in other available lamps with built-in resistors. The current limiters eliminate the need for an external resistor and make for a more compact and simpler design in such applications as digital status indicators, cameras, and portable equipment.

Because the LEDs from Hewlett-Packard Co., Palo Alto, CA, also contain reverse-protection diodes, the lamps can operate from 5-V sources without additional biasing components.

The Model HLMP-6600 requires a nominal forward current of 10 mA and typically emits 2.4 mcd of axial luminous intensity. The HLMP-6620 typically draws 5 mA and delivers 0.6 mcd. Both lamps go for \$.75 in quantities up to 99 and \$.53 in quantities over 1000.

CIRCLE NO. 318

Testers can penetrate the surface of Mars

An instrument package that can be dropped from a satellite orbiting Mars can penetrate the surface of the planet and perform experiments as deep as 45 feet. Preliminary development and testing of the penetrators has been completed at Sandia Laboratories in Albuquerque, NM.

Funded by NASA's Ames Research Center at Moffett Field, CA, the penetrators may become part of a geology mission to Mars in 1984. Tests of the

packages were performed in earth materials, loam and sand-covered lava, resembling the surface materials expected on Mars. The tests were conducted at McCook, NE, and Amboy Crater, CA.

In the proposed Mars system, the penetrators will be ejected from a spacecraft near the high point of an elliptical orbit, where orbital speed is lowest. The penetrators will decelerate through the Martian atmosphere, with a final descent by parachute, and strike the surface at roughly 500 ft/s.

A detachable afterbody containing an antenna, transmitter, and command receiver will be sheared off at impact and remain on the surface. At the other end of a 45-ft multilead umbilical cable, the main body of the vehicle will dig in anywhere from 40 in. to 45 ft, depending on the nature of the surface.

Instruments within the hollow projectile—about 3½ in. in diameter and 4 ft long—will record scientific data to be stored in an on-board memory and telemetered back to Earth via the orbiting spacecraft. The experimental package is expected to last at least 400 days.

Data-gathering begins on impact, with an on-board accelerometer generating a signal that will provide a vertical profile of the penetrability of the layers it passes through. This will also give an indication of the physical geology of the impact site. Other experiments have not yet been selected by NASA scientists, but may include thermal, seismic, and geochemical measurements to provide information on the structure, composition, and state of the Martian interior. Tests for detecting water and the past or present occurrence of life may also be included.

Several experiments could be conducted by opening a door in the side of the penetrator to expose a sample of the surrounding strata to analytical instruments. Power for the instruments and for data storage would come from two radioisotope thermoelectric generators located near the front of the penetrator. The RTGs would also recharge high-capacity batteries that provide power for data transmission.

Sandia has been conducting high-speed earth penetration studies for about 20 years as part of its nuclear weapons programs for the Energy Research and Development Administration. The Mars penetrator design is similar to a sea-ice measuring system developed by Sandia for the Coast Guard.

CIRCLE NUMBER 10 ►

"BLUE MAX" DID IT!

Do you need a capacitor that provides miniature size, maximum CV ratings, consistent quality at a competitive price?

Datapoint Corporation of San Antonio, Texas, manufacturers of advanced business processors did, and they chose the KEMET "Blue Max" dipped monolithic ceramic capacitor. This durable and reliable workhorse helps provide the quality consistent in all Datapoint processors.

Available in three dielectrics — COG Ultra-Stable, X7R Stable, and Z5U General Purpose — in six case sizes. Choose from more than 350 CV ratings, in capacitance values from 2.2 pF to 4.7 uF in 50, 100 and 200 voltage ranges.

Want to know more? Write us: Components Department, Union Carbide Corporation, P.O. Box 5928, Greenville, SC 29606; phone: (803) 963-6300; TWX: 810-287-2536; Telex: 57-0496.

Or see your local KEMET Capacitors Distributor.



Datapoint 5500 Advanced Business Processor

KEMET OFFERS YOU MORE.

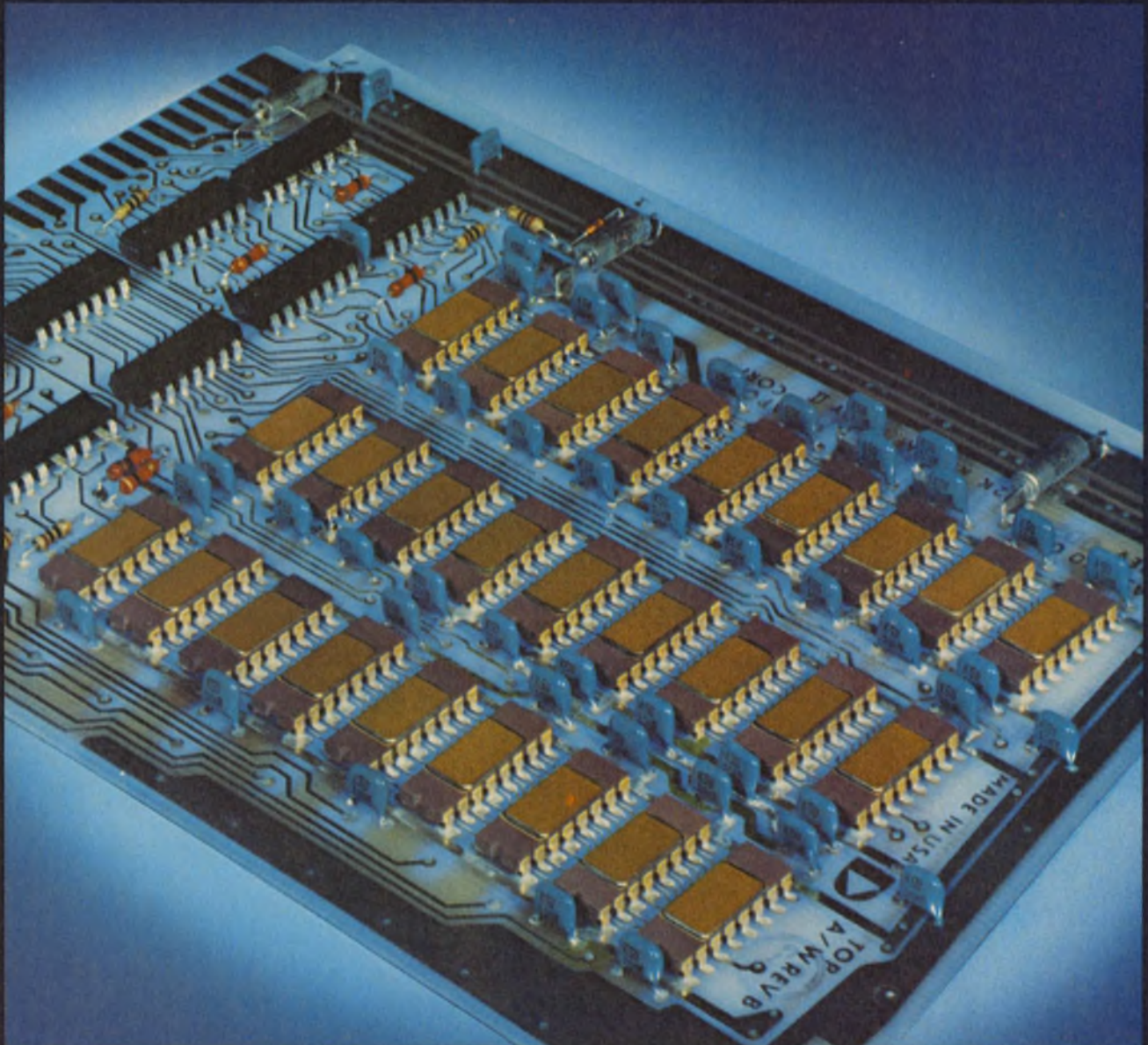

UNION CARBIDE COMPONENTS DEPARTMENT

KEMET and Blue Max are trademarks of Union Carbide Corporation.

In Europe: Union Carbide Europe, S.A. - 9, Rue Pedro Meylan, Geneva 12, Switzerland. Phone: 022 47 4411. Telex: 545 22553.

**PMI's
COMDAC™ companding
D/A converter. When
you think about what
it can do, nothing
seems very far-fetched.**

Not long ago, we ran a little contest in one of the electronics magazines. We asked engineers to come up with the most creative ideas they could think of to put PMI's unique COMDAC—the first and only companding D/A converter—to work. We got lots of responses with exciting ideas. But the interesting part is that no less than **five** engineers said they'd had terrific ideas—but they couldn't submit them because their corporate attorneys were starting patent searches.

That's the kind of brainstorming that COMDAC has generated since we first introduced it.

The reason is simple: nature is nonlinear. People, plants, animals, water, wind—we don't live in a straight-line world. We live in a world of curves, slopes, and human response systems (ears, eyes, touch) that do not follow straight-line paths. In trying to reduce these things to digital data, or to imitate them, we've always fallen short.

Until COMDAC.

With the help of COMDAC you can linearize analog signals. COMDAC can supply the shades of grey, the sweeping curves, the "vive la différence!" of the natural world. COMDAC uses logarithmically companded digital techniques for D/A conversion; with just eight bits, it provides the dynamic range of a 12-bit DAC—72dB or 4096:1. With that range, it can produce a convincing facsimile of the human voice, for example. Your watch radio can awaken you gently, with soothing, motherly tones, or shake you out of bed with a drill sergeant's scream—whichever is called for in your case.

It's six-forty — rise and shine. Squash at eight. Board meeting at ten.



Consider these applications—some of which are already a reality:

- Digitized audio—music, sound effects, voice (μP controlled)
- XYZ positioning (automated drill presses, for example)
- Motor controls
- Echo/reverb devices (for electronic guitars, electronic organs, synthesizers)
- Voltage-controlled oscillators and filters
- Servo motor controls

- Altimeters
- Waveform generation (with PROM)
- VU meters (for better response)
- Voice recognition (imagine a typewriter you could dictate letters to!)
- Tone generators
- Voice encryption
- Voice warning systems (they're already using them in aircraft)
- LOG sweep generators
- Data acquisition
- Recording studios
- Verbal response systems (like, your car could give you the word when it's overheating)

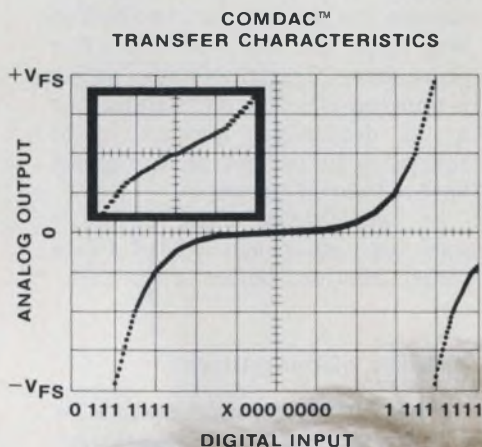

Keep in mind that COMDAC is not just a concept. It's a working reality. In the last two years, we've delivered half a million and cut the price in **half**. And since the 8-bit COMDAC can do many things a

12-bit DAC can do, think of what you will save by using a low-cost 8-bit system to do the job of the expensive 12-bit approach.

With a little bit of thought, a creative engineer—that's you—can come up with some really dazzling ideas. The surface has just been scratched. If you'd like a copy of all our contest entries, circle the bingo number below. We'll send technical literature that will help you with your application. Want a sample COMDAC? Send us a request on your letterhead.

Precision Monolithics, Incorporated
1500 Space Park Drive, Santa Clara, CA 95050 (408) 246-9222.
TWX: 910-338-0528 Cable MONO



CIRCLE NUMBER 11



Intelligent memory holds the key to a limitless array of computers

A scheme to connect hundreds of microcomputers into a potentially endless array of distributed intelligence has been developed by a research team at Carnegie-Mellon University in Pittsburgh. The processors would be connected into a common, intelligent memory that can accommodate 2^{28} words of storage, or well over 250-million words.

"Cost is the crux of the problem in expanding a distributed processing system," notes researcher John Ousterhout, speaking at the National Computer Conference in Dallas. "In most cases, cost increases nonlinearly with size; it is proportional to the number of processors times the number of memory boxes. Extending a system from 16 processors and 16 memory boxes to 32 and 32 will square the cost, not double it." So the idea was to find a computer structure that can accommodate a very large number of processors—hundreds of them—and very large amounts of memory without reaching a point of cost-saturation.

Too much waste

Currently, distributed microcomputer systems are structured so that each processor has uniform access to all parts of memory—an extravagant use of hardware since most programs don't require vast amounts of storage at all times. According to the Carnegie-Mellon approach, the interconnection between processors and memory is distributed, packet-switching techniques are used to shuffle data around and each processor has quick access to its own local memory. A "unit of memory" is associated with a "unit of processing" and the boundaries are highly flexible. Each processor has access to all the other processors' memories and vice versa.

Dick Hackmeister
Western Editor

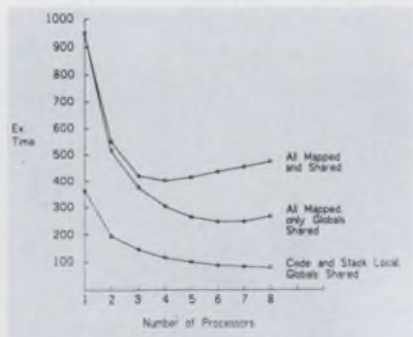
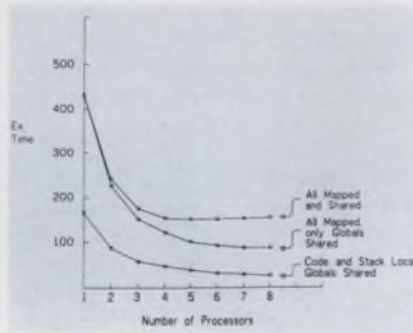

Two different programs have been debugged and run on the Carnegie-Mellon distributed-processing system; one solves partial differential equations (PDE) and the other is a sort routine (Quick Sort). These graphs show the decrease in execution time for an increasing number of processors sharing the job. The degree of task-sharing is optimized when the program code and subroutine stack reside in local memory and all the working computers have access to common global commands (macroinstructions).

Local memory-access time is about $3 \mu\text{s}$ and the remotest data can be accessed in about $25 \mu\text{s}$. When any processor needs data from afar, it is accessed by the intelligent memory and delivered in packets—so data are never "deadlocked." This problem occurs when each data stream needs the bus to travel in the opposite direction at the same time and they impede each other.

Routing data in packets of 16-bit

words side-steps deadlocking much like railroad trains passing each other on sidings. One packet is held in a buffer, away from the bus while the other passes freely. Then the shunted packet is returned to the bus and continues on to its destination, perhaps to be shunted again or have another packet buffered out of its way.

By "leapfrogging" data, the bus is used just long enough to send a data packet from one buffer to the next.

Clusters of computers

When the data packet reaches its destination, it is latched into a buffer, which is also the input port to a cluster of as many as 14 processors.

Each of the processors in a cluster has its own local memory. Processors and memory are connected through a switch, which is controlled by the buffer—an intelligent port. The switch can be set to connect the processor to either the input port/buffer memory or the processor's own local memory.

The switch, buffer, port and intercluster bus are all invisible to the local processor.

The key to the Carnegie-Mellon system's extensibility, says Ousterhout, is its modularity, which allows hundreds of processors to be added to the system cheaply.

Even though each processor has only a single, 16-bit address bus, it has access to virtually 2^{28} memory locations. What's more, as a result of clever indexing and mapping, no bus in the system has more than 16 lines.

The local switches, detecting an address generated by the local processor, connect it to either the local memory or the input port (from the intercluster bus), depending on the four most-significant bits.

Those four bits serve as a page number; the remaining 12 bits are the

(continued on page 32)

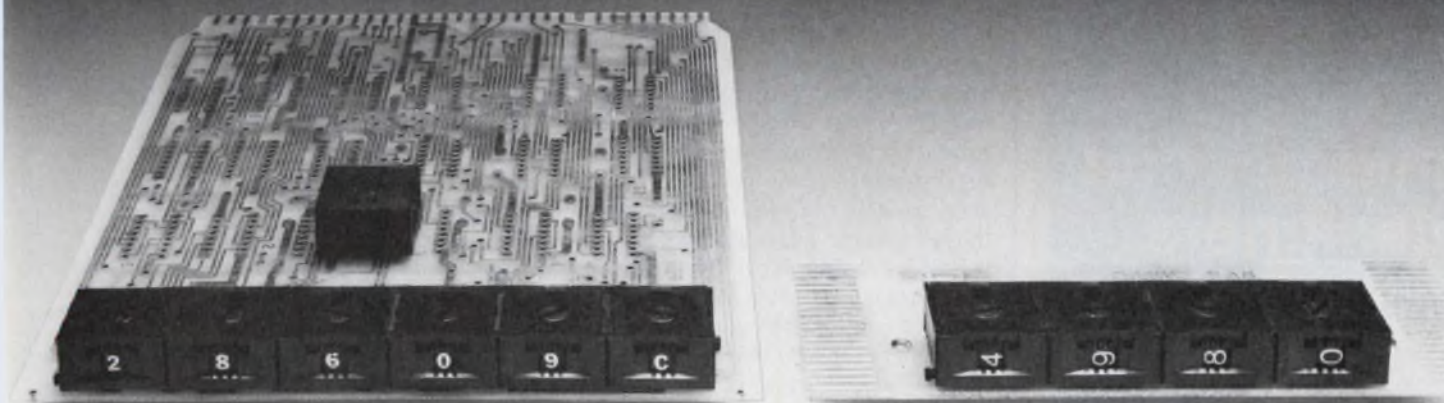

SNAPPY LITTLE NUMBERS

Save time and money with SAE Strip-Pak™ rotary PCB switches. These snappy little numbers come in a wide range of output codes, and are the most reliable PC board rotary switches you can buy.

The unique modular design of Strip-Pak switches lets you snap them together in strings. You can even mix output codes within the same gang. And Strip-Pak switches can be placed individually, too, either horizontally or vertically, any place on a board.

Additional versatility is provided by a choice of three operating methods: by thumb pressure, with a screwdriver, or with an optional snap-in knob.

SAE Strip-Pak switches are every bit as tough as they are versatile. We use a beryllium copper detent spring instead of plastic teeth or gears, for an operating lifetime of 500,000 detents. And that's a snappy *big* number.

More reliability comes from total in-house manufacture. SAE makes every part, inspects every part, and controls every detail of assembly.

We use tighter tolerances and we demand more precise registration of code discs and contacts. Every switch is a work of art.

Preformed, heat-treated terminals are made from 30 percent thicker stock, and the glass filled polyester housing resists both moisture and solvents. The terminals are completely sealed so you can wavesolder without flux wicking.

SAE makes a complete selection of switches, including large thumbwheels, programmable Bit™ switches and Strip-Pak switches. Write or call us and ask for a catalog.

We're Stanford Applied Engineering,
340 Martin Avenue, Santa Clara, California
95050. 408/243-9200.

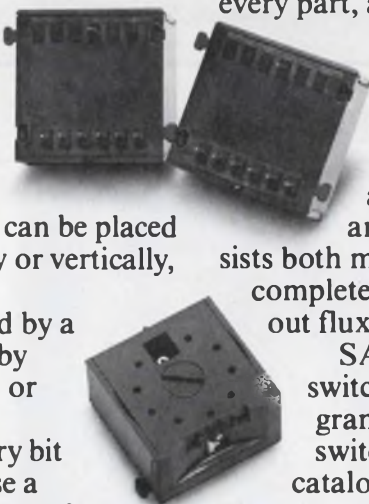

The OEM Connection

CIRCLE NUMBER 12

giga-trim capacitors for microcircuit designers

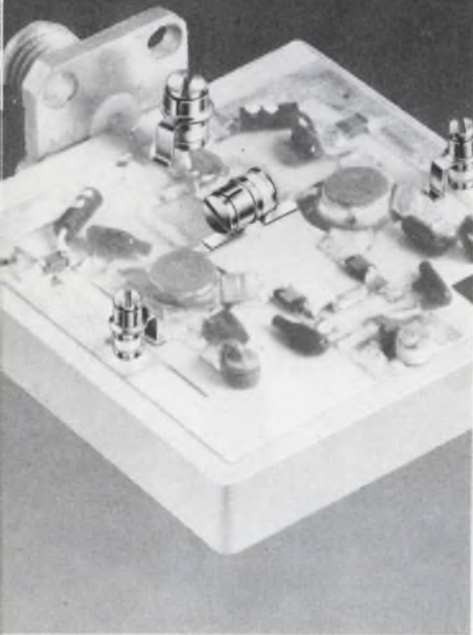

Giga-Trim® (gigahertz-trimmers) are tiny variable capacitors which provide a beautifully straight forward technique to fine tune RF hybrid circuits and MIC's into proper behavior. They replace time consuming cut-and-try adjustment techniques and trimming by interchange of fixed capacitors.

Applications include impedance matching of GHz transistor circuits, series or shunt "gap-trimming" of microstrips, external tweaking of cavities, and fine tuning of crystal oscillators.

Johanson

MANUFACTURING CORPORATION

BOONTON, NEW JERSEY 07005

201 / 334-2676

(continued from page 30)

offset. If the address calls for the processor's local page, the switch connects the processor directly to its local memory. If not, it may get connected to *another* local processor's memory, to the intercluster bus port's buffer, or even back to its own local memory, though this last alternative is unlikely.

Besides being a buffer, the intercluster bus port is a mapping processor that controls the relationship between the generated address-page number and the rest of the system.

Four bits per page

The four-bit page numbers define one of 16 words in a look-up table residing in the local switch. The higher-level mapping processor/buffer memory/input port defines those relationships, and loads the co-relating addresses that are in the look-up table. For this reason, the mapping processor can detect an overabundance of remote memory references. And, though not yet programmed to do so, the mapping processor can relocate that remote data into the processors' local memory. All this is invisible to the user.

In short, the local processor generates a memory address of 16 bits. The switch interprets the top four bits as an indirect address. The indirect address is defined as another location somewhere within the realm of 2^{28} locations. (The limit of 2^{28} is arbitrary

and can be increased with very little effort.)

Beyond flexibility of addressing and memory sharing, all processors can communicate directly with all other processors through a memory-location "window"—any two processors address the same location and communicate bidirectionally through it. This is similar to a DMA (direct memory-access) operation.

All processors can interrupt each other, diagnose each other, single-step each other, and more. And they all run asynchronously.

The Carnegie-Mellon project is currently in "Phase 2," an evaluation phase. To date, 10 processors in three clusters have been implemented and two applications programs have been debugged. One is a quick sort routine, the other solves partial differential equations.

Experiments that partition programs into different parts of memory while monitoring the execution time as a function of the number of computers actually working have lived up to the team's expectations. "Phase 3" of the project will expand the number of processors in the system to several hundred. It will take several years, though, to accomplish, says Ousterhout.

The Carnegie-Mellon work was funded by the National Science Foundation, the Advanced Research Projects Agency and the Air Force. Digital Equipment Corp. supplied the hardware. ■■

A signature verifier



A ballpoint pen and writing tablet incorporating piezoelectric transducers converts handwriting movements into electrical impulses.

Developed at Sandia Laboratories, Albuquerque, NM, the pen and tablet instrument can be incorporated into signature verification systems to help control access to areas where personnel have to identify themselves.

The pen produces electrical signals that reflect the unique horizontal and vertical motions occurring as a signature is written. The tablet produces signals from handwriting pressures.

SE6150: More than an oscillograph.



An Innovation.

The innovation is built-in signal conditioning. And it pays off in time and convenience.

With EMI's new SE6150 ultra-violet oscillograph, you can move from one test to a completely different test without changing or adjusting the set up. Six channels are pre-conditioned to record up to 2 KHz fsd from high or low impedance voltage sources ranging from 500 mV to 500 V. Six additional channels provide direct galvanometer entry for high output

type transducers. Connection can be made instantly via any or all of these versatile inputs.

The SE6150 also offers an easy-to-read display, trouble-free ultra-violet recording and a price that's hundreds of dollars below less capable instruments.

Best of all, it's from EMI, a world leader in quality instruments. A name that means innovation. EMI Technology Inc., Instrumentation Division, 55 Kenosia Avenue, Danbury, CT 06810. Phone: (203) 744-3500, TWX: 710-456-3068.



EMI Technology Inc., Instrumentation Division
A member of the EMI Group. International leaders in music, electronics and leisure.



UBIQUITOUS

The Ballantine 3028A; at home in Bryce Cañon, on shipboard, or in your maintenance shop and laboratory. In one fine instrument Ballantine has combined features otherwise found only in a number of lesser multimeters. It is another new Ballantine with full performance and top quality.

- DISPLAY:** 3-1/2 large LED
- FUNCTIONS:** AC, DC Volts
AC, DC Amps
 Ω low power
 Ω high power
Display Test
Battery Check
- RANGES:** 32
- ACCURACY:** To $\pm 0.05\%$ ± 1 digit
- FREQUENCY:** 15 Hz to 110 kHz
rms responding
- MODEL 3028A: \$279**

- Fully EMI shielded
- No fuses; circuit breaker protected
- AC RMS response for accuracy with distorted inputs
- One year calibration interval
- Safety compliant
- Uses only standard parts
- Optional:* battery pack, analog meter, 20 amp range, 40 kV dc and 700 MHz detector probes, full complement of accessories

Ballantine



Introducing the hungry ECLIPSE.

Data General's new ECLIPSE S/130 computer has a bigger appetite for work than any other mid-range mini. And enough speed and versatility to wolf down any kind of data you have to dish out.

The hungry ECLIPSE computer is built around the same powerful architecture as our super high-speed ECLIPSE S/230. Added to that is a host of special features that make the hungry ECLIPSE unique. Like our fast micro-coded floating point and efficient character string instruction sets. And our second-generation WCS general-purpose user microprogramming ability that results in unmatched throughput in demanding applications. To top it off it also includes AOS, our amazing new heuristic multi-programming advanced operating system, and of course the full range of Data General's economi-

cal big-computer peripherals, software and worldwide support.

Now, you don't have to skimp along with an undernourished mini that's too limited for your work. Or splurge on one that's too fat just to get the performance you need. Just order an ECLIPSE S/130 computer. It will make your work load a lot leaner. Want more food for thought? Send for our brochure.

- Send your S/130 brochure.
 Send your S/130 brochure and have your sales representative call.

Mail to: Data General, Westboro, MA 01581

Name _____

Title _____

Company _____

Address _____ Tel. _____

City _____ State _____ Zip _____

ECLIPSE is a registered trademark of Data General Corporation.
 © Data General Corporation, 1977

ED 8/2

 **Data General**
 It's smart business.

CIRCLE NUMBER 16

Data General, Westboro, MA 01581, (617) 366-8911. Data General (Canada) Ltd., Ontario.
 Data General Europe, 15 Rue Le Sueur, Paris 75116, France. Data General Australia, Melbourne (03) 82-1361.

1977 Career and Salary Survey

Like almost everyone else, U.S. design engineers make more money than they did five years ago. But many think they should be making even more. According to an ELECTRONIC DESIGN career and salary survey conducted five years ago (ED No. 9, April 27, 1972, p. 42), nearly 60% of the respondents made \$15,000 or more. According to a survey conducted in June of this year, nearly 60% make at least \$20,000. But close to 40% make no more than \$24,999. Another 30% make \$25,000 and more.

Half the respondents to the 1977 survey consider themselves underpaid.

According to this survey:

- Almost half (44%) are project engineers, senior engineers and group leaders; one-third are technical-staff members, scientists, physicists or engineers.

- Nearly one of every four works on computers and data-processing equipment; one of every five works on communications, navigation or guidance equipment. Slightly fewer work on aircraft, aerospace, ground-support or oceanographic equipment.

- Virtually half have no more than a bachelor's degree, while another 30% have Master's degrees. About 4% have PhDs. (Five years ago, 33% had Master's degrees, and 5% had PhDs.)

- Close to 60% of the respondents are between 25 and 39, and 27% between 40 and 49. (One out of five is at least 30 and at most 34.)

- Just about everybody has been unemployed (99%) during his engineering career, but the overwhelming majority (88%) have been out of engineering work less than 1% of their professional time.

- Seven out of 10 work from 36 to 45 hours a week, but fully 19% work as many as 49 hours a week.

- Very few (3%) have suffered from wage busting—salary cuts due to contract bidding.

- Almost half participate in civic activities.

The paychecks may be healthier, but over half the respondents in two higher-priced groups consider themselves underpaid. Almost 65% of the chief/principal engineers and division heads think so. So do 55% of the section or department heads.

In addition, the largest salary bloc to complain of being underpaid makes \$20,000 to \$24,999 (Table 1). One out of four chief/principal engineers and division heads can be found there—as well as 43% of the project engineers, senior engineers and group leaders.

From the mountains. . .

A majority of those respondents living in New England (63%) believe they deserve more in their paychecks. An even greater majority in the Mountain region (70%) do *not* consider themselves deprived. The Middle Atlantic and Midwest respondents considering themselves underpaid fall slightly below 50% and likeminded respondents from the South, Southwest and West Coast land slightly above.

By education, the best paid are PhDs, the tiniest population. And 77% of them don't feel underpaid. They stand the best chance of making at

least \$35,000. In addition, engineers with Master's degrees have been able to jump slightly ahead of those with bachelor's degrees. While 61% of the latter make \$15,000 to \$24,999, 64% of the former make \$20,000 to \$29,999. Interestingly, 42% of those with no degree—and according to the responses, there are many more of them than PhDs—make \$20,000 to \$24,999.

Respondents working on industrial controls and medical equipment make the lowest salaries, with half the former and 60% of the latter making less than \$20,000. It was even worse five years ago. Then, only one of every four in medical equipment was making at least \$15,000. Now, nine of every 10 makes that much. But no one gets as high as \$25,000.

In 1972, half those in industrial controls made at least \$15,000, but only 18% made at least \$20,000. In 1977, 43% make over \$20,000.

The largest percentage of respondents, by product category, to make over \$30,000 works in consumer electronics (Table 1). Five years ago, only 15% made over \$25,000. Now 47% make over \$25,000.

Engineers in the consumer industry are better educated than they were five years ago. At that time, none of the respondents had a Master's degree. Five years later, half the respondents in consumer electronics have one (Table 3).

How long one has been working affects how much he makes—but subtly. Almost as high a proportion of respondents with five to nine years' experience makes between \$20,000 and \$24,999 as the percentage of those with 10 to 14 years under their belts. And both percentages are high, according to Table 1. But after that, the former group falters, while the latter group gives respondents with 15 to 19 years behind them a run for the money at the \$25,000-to-\$29,999 level. The 15-to-19-year veterans, in turn, almost match the proportion of respondents with up to 24 years' experience making between \$30,000 and \$35,000. As Table

Something about the survey

In May, 1977, a career and salary questionnaire was sent to 1000 engineers and managers randomly selected from ELECTRONIC DESIGN's domestic circulation. As of July, this circulation comprises 88% of ED's total circulation.

The response was both quick and overwhelming. Two days after the questionnaires were mailed, eight surveys came back, filled out. By the cut-off date, 406 questionnaires had been filled out and returned.

Special thanks go to Elaine Acquire, without whose typing and mailing help there would have been no survey.

James Keane
Associate Editor

(continued on page 38)

NOW! SINGLE IN-LINE RESISTOR NETWORKS WITH IMPROVED PERFORMANCE

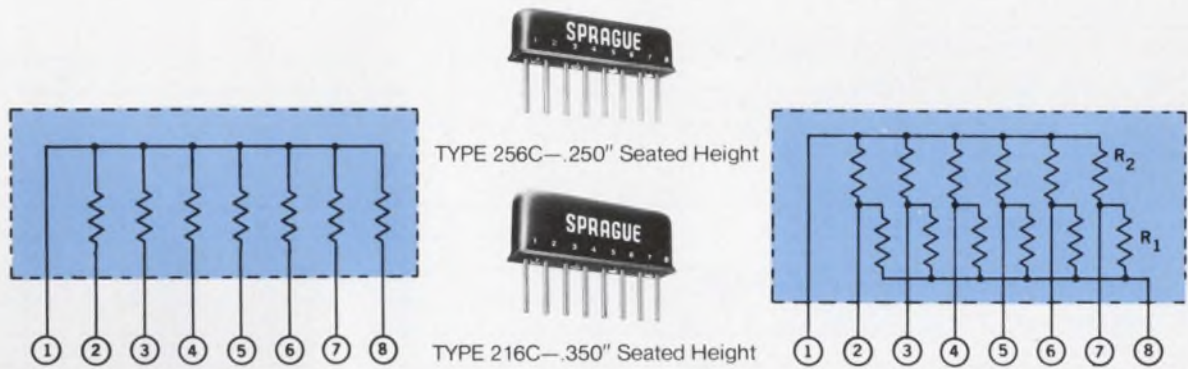

BOARDABLE AND AFFORDABLE

Low Cost and High Density Configuration

are only two of the features of Sprague Type 216C and 256C Metanet® Resistor Networks. Now, you can also enjoy the benefits of improved power dissipation, better temperature coefficient of resistance, and closer standard resistance tolerance.

Save Board Space. Single in-line design permits vertical installation, which allows more units to be seated in less space. This mounting style also results in improved high-frequency performance and significant in-place cost reduction. (Metanet Resistor Networks are also available in 14 and 16 pin DIP packages.)

Better TCR. Typical temperature coefficient of resistance is within ± 200 ppm/°C, cutting previous allowable limit almost in half.

Up-graded Power Dissipation. Individual terminating, pull-up/pull-down, and interface networks are capable of dissipating 250 mW per resistor at 70°C, an increase of 100% over previous designs.

Closer Resistance Tolerance. Standard resistance tolerance for each resistor is $\pm 2\%$, with other tolerances between $\pm 1\%$ and $\pm 5\%$ available on special order. (Resistor-Capacitor networks are also available. Standard Monolythic® capacitor tolerance is $\pm 20\%$ and resistor tolerance is $\pm 2\%$. Tighter tolerances are available on special order.)

Proven Product Line. Sprague has more than fifteen years of experience in the development and manufacture of precision thick-film resistor networks, which include individual terminating, pull-up/pull-down, interface, and dual terminating designs.

For complete technical data, write for Engineering Bulletin 7041B to:
Technical Literature Service, Sprague Electric Co.,
347 Marshall Street, North Adams, Mass. 01247.

THE BROAD-LINE PRODUCER OF ELECTRONIC PARTS

CIRCLE NUMBER 17



Table 1. Salary Profile (All the number responses denote %)

	Under \$10,000	\$10,000- \$12,499	\$12,500- \$14,999	\$15,000- \$19,999	\$20,000- \$24,999	\$25,000- \$29,999	\$30,000- \$34,999	\$35,000 and over
Titles & (% of total response)								
President or Vice President (1)	—	—	—	—	33	33	33	—
Technical or research director (1)	—	—	—	—	—	67	—	33
Chief engineer, principal engineer or division head (6)	—	—	9	9	26	26	17	13
Section head or department head (15)	—	—	2	16	31	27	19	5
Project engineer, senior engineer or group leader (44)	1	1	2	22	43	20	7	4
Member of technical staff, scientist, physicist or engineer(33)	1	4	9	41	30	9	5	1
Products & (% of total response)								
Computers & data-processing equipment (24)	1	1	4	27	40	20	5	2
Instrumentation (13)	—	4	10	22	31	23	10	—
Communications, navigation or guidance equipment (20)	—	1	4	27	33	17	14	4
Consumer electronics (4)	—	7	—	—	46	13	27	7
Industrial controls (10)	—	—	10	43	17	17	10	3
Components, subassemblies, hardware or materials (7)	—	4	—	18	48	15	4	11
Aircraft, aerospace, ground support or oceanographic equipment (19)	1	—	4	23	39	19	9	5
Medical equipment (3)	—	10	—	60	30	—	—	—
Company location & (% of total response)								
New England (14)	—	2	7	19	40	21	9	2
Mid Atlantic (24)	—	2	3	18	31	23	16	7
Midwest (17)	1	3	6	33	37	13	6	1
South (6)	4	—	8	20	40	12	8	8
Southwest (9)	—	3	—	32	46	8	8	3
Mountain (3)	—	—	20	50	10	20	—	—
West Coast (27)	—	1	4	32	34	22	6	1
Highest level of education & (% of total response)								
No degree (9)	—	6	3	33	42	11	5	—
Associate degree (10)	—	2	15	37	29	10	7	—
Bachelor's degree (47)	1	1	7	30	31	19	7	4
Master's degree (30)	—	1	—	18	41	23	14	3
PhD (4)	—	—	—	6	44	19	12	19
Electronic work experience & (% total response)								
4 years and under (15)	3	5	24	45	19	2	2	—
5-9 years (24)	—	2	2	46	41	9	—	—
10-14 years (16)	—	—	—	25	44	20	8	3
15-19 years (19)	—	3	4	13	35	30	11	4
20-24 years (10)	—	—	—	15	36	28	13	8
25-29 years (11)	—	—	—	3	37	28	23	9
30 years and over (5)	—	—	—	14	27	18	32	9
Ages & (% of total response)								
Under 25 (3)	14	7	29	50	—	—	—	—
25-29 (16)	—	2	16	51	28	3	—	—
30-34 (20)	—	3	1	36	44	11	5	—
35-39 (19)	—	3	4	25	40	18	5	5
40-44 (16)	—	—	2	6	37	37	14	4
45-49 (11)	—	—	—	12	34	36	14	4
50-54 (7)	—	—	—	14	43	22	14	7
55-59 (5)	—	—	—	15	25	20	30	10
60-64 (2)	—	—	—	—	33	—	50	17
65 & over (1)	—	—	—	50	—	—	50	—
Feel underpaid? & (% of total response)								
Yes (50)	1	2	5	32	37	15	5	3
No (50)	—	1	5	20	35	22	13	4

(continued on page 40)

CIRCLE NUMBER 19 ►

Just as you can count on water to freeze at 32° F,



you can count on Synchron motors.

When you buy a motor for installation in your product, the last thing you want is a troublemaker. You want to install it and forget it.

Despite many similarities, all synchronous motors aren't the same. Not by a long shot. No matter what anyone may claim.

You can't judge performance and dependability by data sheets alone. Or by price. Or delivery. Or the flip of a coin. The big difference often is the brand name. And what's behind it. The integrity of the company that makes the motor. The expertise



of the designer and the people who put it together and test it.

We make Synchron motors as if our name were on your product. Total quality, total dependability. Designed right and built right, to do the job right. That's the only way we do business.

Call or write for our specification sheets and the name and location of our representative in your area.

Choose from five principal styles of Synchron motors—60 or 50 Hz—from one revolution per week to 900 rpm—from 8 thru 98 oz-in torque at 1 rpm—from hundreds of different outputs.



HANSEN MANUFACTURING CO., INC.

Princeton, Indiana 47670

a subsidiary of IMC MAGNETICS CORP.

We make every Synchron motor as if our name were on your product

(continued from page 38)

1 further illustrates, the race doesn't stop there.

Salary may be a thorn in many sides, but it doesn't seem to sour many outlooks on the profession itself. Even though half consider themselves underpaid, the majority are satisfied that they chose to be an engineer. Only 22% express dissatisfaction. The most dissatisfied are the project/senior engineers or group leaders—and only one of four feels that way.

Not only that, but an even greater majority—almost nine of every 10—indicate they like their job duties in general.

How one feels about his job isn't always affected by how many hours he works per week. While 28% of the respondents who indicated they like their duties work 36 to 40 hours a week, 39% of the respondents feeling the same way work as much as 45 hours a week. Then the good feeling starts to wear off. Only 21% of the enthusiastic respondents work up to 49 hours a week, while as low as 9% work at least 50 hours a week.

What's more, with half the respondents complaining of lack of money, only one out of 10 moonlights. (Five years ago, one out of five indicated they were moonlighting.) In addition, 30% of the respondents indicate that their spouses work.

Ironically, the salary range in the most satisfied area—the Mountain region—runs far behind that in all the other regions. As Table 1 further illustrates, the biggest chance of making at least \$30,000 seems to be in the Middle Atlantic region, while the best chance of making close to \$25,000 is in the Southwest.

Where is everybody?

Salary aside, an engineer's geographic location can certainly help or hurt his career. For example, if he works on computers and data-processing equipment, his best bet for work is the West Coast, which contains over one-third of that industry (see Table 2). His next bet is the Middle Atlantic—only a continent away.

As Table 2 also illustrates, the Middle Atlantic region is slightly better than the West Coast for communications, navigation or guidance equipment. New England is where a

(continued on page 42)

Table 2. Products by location (top); Location by products (bottom)¹

Note: All the number responses denote %

Products worked on	Location						
	New England	Middle Atlantic	Midwest	South	South-west	Mountain	West Coast
Computers & data-processing equipment	13	20	19	6	7	1	34
	25	21	27	24	19	10	30
Instrumentation	23	17	11	6	10	4	29
	23	10	9	12	14	20	14
Communications, navigation or guidance equipment	13	30	17	6	8	1	25
	19	25	19	20	16	10	18
Consumer electronics	27	13	21	13	13	—	13
	7	2	4	8	5	—	2
Industrial controls	12	20	46	7	3	5	7
	9	8	27	12	3	20	3
Components, subassemblies, hardware or materials	11	29	15	4	15	4	22
	6	8	6	4	11	10	5
Aircraft, aerospace, ground support or oceanographic equipment	6	30	6	6	10	3	39
	9	24	7	20	21	20	27
Medical equipment	10	20	10	—	40	10	10
	2	2	1	—	11	10	1

¹The top numbers are the % reported of the products worked on in a certain geographic region, while the bottom numbers are the % reported of a certain geographic region devoted to each product category.

Table 3. Education (All the number responses denote %)

	No degree	Associate degree	Bachelor's	Master's	PhD
Titles					
President or Vice President	—	—	33	67	—
Technical or research director	—	—	100	—	—
Chief engineer, principal engineer or division head	4	4	57	22	13
Section head or department head	15	15	35	35	—
Project engineer, senior engineer or group leader	9	9	44	33	5
Member of technical staff, scientist, physicist or engineer	8	12	52	24	4
Products worked on					
Computers and data-processing equipment	9	13	42	32	4
Instrumentation	6	17	46	27	4
Communications, navigation or guidance equipment	14	6	44	32	4
Consumer electronics	—	14	29	50	7
Industrial controls	15	12	54	17	2
Components, subassemblies, hardware or materials	15	7	52	15	11
Aircraft, aerospace, ground support or oceanographic equipment	4	8	52	34	2
Medical equipment	—	—	70	20	10
Locations					
New England	10	11	43	34	2
Middle Atlantic	6	8	43	37	6
Midwest	11	11	50	23	5
South	—	4	56	32	8
Southwest	5	14	49	24	8
Mountain	30	—	50	20	—
West Coast	11	12	46	29	2

What's TRW up to now?

Metal film with muscle.

Our Metal Glaze™ resistors are rated 2 to 4 times mil spec power, yet retain precision resistor characteristics.

Now, with both strength and precision, you can take advantage of these thick film resistors and standardize on one size. Or benefit from an improved safety factor. For example, our 1/8W 1% device will handle 1/2W @ 70°C, or up to 40W pulse.

What's more, we've added a new 2W standard.

It takes 50% of the board space of the old 2W, yet is rated 3W @ 25°C. We're also in the process of substantially increasing resistance well into the megohms.

TRW metal films with muscle are available from 1/8W to 5W, 200V to 15KV, with 1, 2 and 5% tolerance. For standards in all types of resistors, contact your local TRW distributor. Or TRW/IRC Resistors, 401 N. Broad St., Philadelphia, Pa. 19108. (215) 922-8900, Dept. G.

TRW IRC RESISTORS

ANOTHER PRODUCT OF A COMPANY CALLED TRW

™ Metal Glaze is the TRW trademark for its thick metal film resistors.

CIRCLE NUMBER 20

Table 4. Work Week (All the number responses denote %)

	Hours per Week							
	Less than 20	20—30	31—34	35	36—40	41—45	46—49	50 and over
Titles								
President or Vice President	—	33	—	—	—	—	33	33
Technical or research director	—	—	—	—	—	33	—	67
Chief engineer, principal engineer or division head	—	—	—	—	26	22	30	22
Section head or department head	2	3	—	—	16	26	40	13
Project engineer, senior engineer, or group leader	1	1	1	1	29	45	16	6
Member of technical staff, scientist, physicist, or engineer	1	2	1	1	40	38	11	6
Products worked on								
Computer and data-processing equipment	—	1	—	1	24	45	14	15
Instrumentation	—	—	—	—	27	42	25	6
Communications, navigation or guidance equipment	1	—	—	1	35	38	17	8
Consumer electronics	7	13	—	—	33	14	33	—
Industrial controls	—	—	—	—	32	29	32	7
Components, subassemblies, hardware or materials	—	4	—	—	30	44	15	7
Aircraft, aerospace, ground support or oceanographic equipment	1	3	1	—	39	35	15	6
Medical equipment	—	—	10	10	20	40	10	10
Underpaid ?								
Yes	1	1	1	—	30	36	20	11
No	1	2	1	2	31	39	18	6

good part of consumer electronics can be found, while the Midwest, with 48%, is clearly the place to be for industrial controls. (Five years ago, only 27% of the industry was located there.)

Almost 30% of those working in components, subassemblies, hardware or materials are situated in the Middle Atlantic region. Close to 30% of those in instrumentation work on the West Coast. The biggest chunk of the medical equipment industry lies in the Southwest. Almost 40% of those working on aircraft, aerospace, ground-support or oceanographic equipment reside on the West Coast.

No matter what degrees have or haven't been attained or how many hours are logged, all the respondents keep themselves up-to-date with various educational tools. They were asked to rate several ways to keep up to date.

The highest point gatherer is trade magazines, with 17% of the total score. Not too far behind is manufacturers' literature, with 15%. Books take third with 14%, while manufacturers' sales or applications engineers, at 12%, nudge past trade shows and college courses at 11%. Correspondence courses bring up the distant rear at 8%.

On the move. . .

One trait many respondents share is mobility. Half the respondents reveal

Table 5. Relocation (All the number responses denote %)

To	From							
	Same region	New England	Middle Atlantic	Midwest	South	Southwest	Mountain	West Coast
New England	61	—	39	0	0	0	0	0
Middle Atlantic	41	19	—	19	13	0	2	6
Midwest	69	5	12	—	7	5	2	0
South	50	18	13	13	—	6	0	0
Southwest	26	5	21	26	5	—	0	17
Mountain	29	0	29	0	14	14	—	14
West Coast	60	10	6	8	2	7	7	—

that they relocated to work for their present companies. Money seemed a factor at the high end of the salary scale. Seven out of 10 respondents making between \$30,000 and \$34,000 relocated. Indeed, eight of 10 making \$35,000 and beyond had to "move" into their current jobs.

One of the least affected groups makes between \$25,000 and \$29,999. "Only" 38% had moved. But just about half those making slightly less—\$20,000 to \$24,999—relocated to their present jobs.

The two least affected groups are at the bottom of the salary scale—"only" 29% of those earning between \$10,000

and \$12,499 and 32% of those getting \$12,500 to \$14,999 made a move.

In relocating, job level plays an uncertain role, at best. While two-thirds of the technical or research directors moved to their present jobs, not nearly as great a proportion of chief/principal engineers or division heads had to pack their bags (35%). Over 40% of the section/department heads pulled up stakes, while for the rest of the respondents, it was virtually 50-50.

Interestingly, the groups most likely

(continued on page 44)

Safety. Long life. Reliability. Pour it on.



Now there's an all-purpose encapsulant that gives you silicone performance at the price of organics. Dow Corning Sylgard[®] 170 A&B silicone elastomer. A two-part liquid encapsulant that cures at room temperature or can be heat accelerated to increase production rates.

Sylgard 170 carries the UL 94VO rating, the very highest rating for flame retardancy for this type of product.

Sylgard 170 offers excellent temperature stability. It is

reversion resistant at high temperatures. And that means greater reliability and longer product life under the most severe environmental conditions.

Sylgard 170 has great dielectric properties, too. So it's perfect for general potting and encapsulating jobs like modules, relays, power supplies, amplifiers, ferrite cores and connectors. At a price that'll let you keep a margin of profit in your product as you build in an extra margin of safety.

So add it up. Safety and reliability throughout the temperature range. Longer product life. Reasonable price. Sylgard 170 silicone elastomer. Pour it on.

Call your Dow Corning representative or write Dow Corning Corporation, Department A7-511, Midland, Michigan 48640.

DOW CORNING

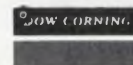

(continued from page 42)

to relocate, in terms of experience, are at opposite ends of the spectrum. Nearly 60% of those with at most four years' experience have relocated to take their present job. But almost 70% of those who have been working at least 30 years have relocated to get where they are now.

For that matter, over half the respondents with 25 to 29 years on the job have made a move. The least likely to go are the respondents who have rung up 10 to 24 years as engineers. And even their percentages are in the low-to-mid-40s.

The industry with the most movers is components, subassemblies, hardware or materials—over 60%. The second most affected product group is computers and data-processing equipment—55%. The least affected industry is industrial controls—39%.

. . .but not far

Where did everybody go? The answer, basically, is "Not too far." Impressive majorities in New England, the Midwest and the West Coast moved, but stayed in those regions. The Middle Atlantic and Southern regions as well were the scenes of considerable movement within their boundaries (Table 5).

When the respondents did decide to break regional ties, they pretty much went no farther than a neighboring region. Or regions.

For example, if the relocaters in New England didn't come from somewhere else in the region to begin with, they came from the Middle Atlantic. Those leaving New England stayed primarily on the East Coast.

Very few relocating Southerners made it all the way to the West Coast. They stopped at the Mountain region on one side or the Midwest and Middle Atlantic regions to the north.

Respondents departing the Midwest took advantage of their central location to push out primarily into the adjacent Middle Atlantic and Southern regions and then as far as the Southwest.

In keeping with the over-all pattern, mobile respondents from the West Coast basically didn't get past the Southwest and Mountain regions.

Very few made the long haul from coast to coast.

Almost half of those who have relocated participate in civic activities.

1. What national issues especially concern you?

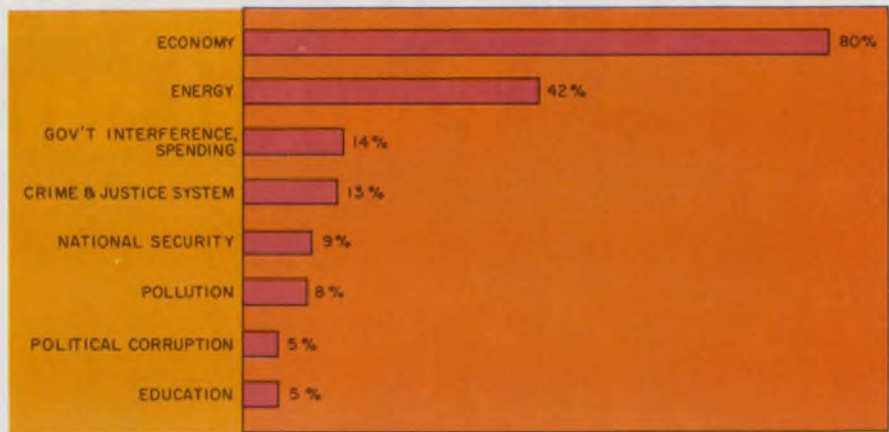

2. Which leisure activities do you enjoy?

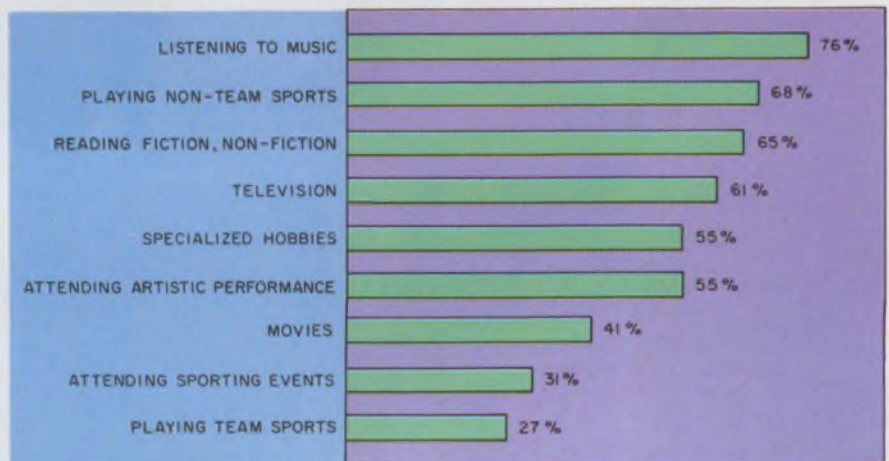

Indeed, over 47% of all respondents are active in community affairs. Approximately seven of every 10 who are civic-minded are between the ages of 30 and 49.

About 36% of the civic-minded work as many as 45 hours a week. About 30% work 36 to 40 hours a week.

Above and beyond community interests, the respondents concern themselves with national issues—but only a few really grab their attention. When asked to name the national issues (not necessarily one) that especially concerned them, eight of every 10 picked the economy (see Fig. 1). But "economy" is an umbrella term that covers several worries. To many, economy means inflation, to others it means taxes. To a small group, it means unemployment.

Of course, other national issues got attention. Energy—how to get it, how to save it—is on 41% of the respondents' minds. Big Government interference and spending are a distant

third. Crime and the justice system concern a smaller group, as do national security, pollution, declining morality and political corruption. But such controversial topics as equal rights and abortion are of little concern to most of the respondents.

One question that provoked a fragmentary response was "Whom do you trust?" The biggest fragment, 21%, didn't respond. Another 7% said they trust no one.

No single answer was dominant. Only 13% indicated they trust themselves, while 26% revealed that they trust their wives and families. Even here, one respondent qualified his answer: "My wife and one of my two children." God received 16%, and 4% stipulated "everyone until proven otherwise." Some 3% made a point of announcing they do *not* trust politicians.

One respondent unequivocally stated he trusts "me, ELECTRONIC DESIGN and God (in that order)." ■

We're making the semiconductor memory your systems need. MCM4027

Give credit where credit is due. The originators of the industry standard 16-pin 4K RAM did an outstanding job. Now, Motorola's own design has produced a "perfect match" second source, an undetectable plug-in replacement for the MK4027.

Big deal? You bet. Compare ours and theirs. Your system won't be able to tell the difference, but you will, and that's the way you want it. You'll know the MCM4027 because it's the one with superior reliability, lower prices, and fast, volume delivery.

MCM4027 reliability- proven.

The MCM4027 is fabricated with our highly reliable N-channel silicon gate technology. You expect it to be good, but the proof is in results. Of all the suppliers attempting to qualify their 4027s at a major computer manufacturer, only two have succeeded. Only Motorola's MCM4027 qualified on the first try, with no failures in one million device hours.

MCM4027 delivery- off-the-shelf.

No one can deliver 4027 4Ks from the factory or authorized distributors faster than Motorola, and we'll match our continuing MCM4027 production and delivery against any in the business.



MCM4027 prices- the lowest.

Read as many price lists as you can find. Motorola has the lowest prices on 4027 4K RAMs. You'll find the same kind of pricing in production quantities.

	Access time-max.	Price, 100-up
MCM4027C2*	150 ns	\$8.20
MCM4027C3*	200 ns	\$6.90
MCM4027C4*	250 ns	\$6.60

*Ceramic device prices are equally attractive

Profile of an industry standard.

The MCM4027 is designed to provide high performance at low cost in main-frame memories, buffer memories, and peripheral storage. Three versions provide a choice of speeds from 150 ns to 250 ns. Power dissipation is very low, just 27 mW (max) in standby, and 470 mW (typ) while active. It's in the standard 16-pin packages, plastic and ceramic, with power supply pins on the corners to assist in optimizing system layout. All inputs are TTL compatible and the output is 3-state TTL compatible. It's also compatible with other popular 4K RAMs like the 2104, 4096 types, and the MCM6604. Latches for Address, Chip Select, and Data In are all on the chip.

Design in the 4027, then specify MCM4027 for the best in delivery and reliability at the industry's lowest prices.

Announcing another
industry standard.
The MCM4096 is available
from Motorola August 1.



MOTOROLA Semiconductors
The mind to imagine... the skill to do.

SIGNALS FROM OUTER SPACE MAY HELP US RECONSTRUCT THE PAST.



The experiment sounds deceptively simple. Scientists on different continents will record the precise instant that certain radio signals from beyond our galaxy reach their observatories. Comparison of these signals may then show that the continental plates are moving at a measurable rate, direct proof of the theory of continental drift.

This finding would be a major milestone in the reconstruction of our earth's history. But everything depends on the accuracy of the experiment. And that's one reason that Honeywell Model Ninety-Six tape

systems have been chosen to do the recording.

In addition to consistent, gentle tape handling, the Ninety-Six offers 28 data channels, a choice of tape widths and recording formats, and unique wideband ferrite heads. You may find that this is just the type of performance you need to solve your down-to-earth recording problems. For complete details on our Model Ninety-Six, or other Honeywell instrumentation recording systems, write or call: Ed Haines, Honeywell Test Instruments Division, Box 5227, Denver, CO 80217. (303) 771-4700.

WE'LL SHOW YOU A BETTER WAY.

Honeywell

CIRCLE NUMBER 23

Washington report

B-1 demise benefits cruise missiles

President Carter's decision to cancel the B-1 bomber will accelerate development of cruise missiles to be carried on existing B-52 bombers—and later on a new family of cruise missile-carrying aircraft based on current wide-bodied jets such as the Boeing 747.

One of the first steps in the quickened cruise-missile program will be to increase the commonality between the guidance systems of the Air Force's Air Launched Cruise Missile (ALCM) and the Navy's Tomahawk cruise missile, according to Navy Capt. Walter Locke, manager of the Pentagon's Joint Cruise Missile Project Office. Greater commonality is needed, according to Locke, because the next ALCM flight tests aren't scheduled until early 1979 while the Navy has about 20 flights scheduled for its Tomahawk over the next two years. Although each missile has the same guidance system, McDonnell Douglas's terrain-contour-matching (Tercom) system, the two services had been drifting apart on guidance requirements. Commonality, estimated as high as 30%, had dipped to 10% when the Air Force and Navy began engineering development of their missiles in January. Locke now puts it at about 50% and says it can go higher.

Common guidance will enable the Air Force to capitalize on the extensive flight testing of the Navy's Tomahawk—19 successes in 22 attempts. The results can be applied to the ALCM, which is not as far along in development. It has only been flown six times, and two of the flights crashed.

Although McDonnell Douglas makes the same guidance system for both missiles, the Navy permits the company to do all the systems integration before turning the system over to Tomahawk's prime contractor, General Dynamics. On the other hand, ALCM prime contractor Boeing receives all the subsystems separately and does the systems integration job on the vehicle, including the preparation of the guidance algorithms.

As part of the commonality requirement, both cruise missiles will carry the Litton P-1000 series inertial platform (also used on the F-15, F-5E and F-18 fighters) and the Litton LC 4516 navigation computer modified (modified from the computer on the F-5E). An improved Litton navigation computer, the 4516C, will go on the later models of the cruise missiles.

Before the President announced his decision, both cruise missiles were supposed to have achieved an initial operational capability by June, 1980. But now IOC will be pushed forward to improve strategic defenses, says Defense Secretary Harold Brown.

Each B-52 will be able to carry up to 20 cruise missiles—12 mounted on the wings and eight on an internal rack. With 250 B-52s, that adds up to 5000 cruise missiles that could be ordered. Defense officials estimate privately each missile will cost \$1-million (with inflation).

The B-1 program would have cost \$24.8-billion if the President had ordered construction of all 244 aircraft requested by the Air Force. Now, only four developmental aircraft will be built, and total spending will be slightly more than \$4-billion. The first three are currently in flight test and the fourth, designed to test the defensive electronic countermeasures (ECM), is due to begin flying in early 1979.

Another victim of the B-1 decision was a new version of the Short Range Attack Missile, the SRAM-B, which was to have been carried on the new bomber. The

B-52s are currently equipped with SRAM-A air-to-ground missiles. Boeing is the prime contractor for both versions.

Navy examining new sighting system on F-14

A gyro-stabilized closed-circuit television system being tested on the Navy's F-14 fighter is expected to increase the range at which pilots can identify enemy aircraft. Using their eyes, they currently have to get to within three miles to positively identify Soviet MIG fighters.

But the television sight unit developed by Northrop is supposed to be good to at least 10 miles. If an enemy fighter can be identified outside 10 miles, the F-14 can fire a Sidewinder or Phoenix missile before it gets within range of the enemy aircraft's missiles.

TVSU is slaved to the F-14's radar and AWG-9 Phoenix missile's fire control system. The "gimballed" telescope-TV system has two fields of view. Images are displayed in both the front and rear cockpit while TVSU maintains an optical lock-on and track of the target through ground clutter, evasive maneuvers and electronic countermeasures. All four TVSUs being tested at Nellis Air Force Base, NV, have operated without failure.

New attack system's future up to Congress

A team of electronics companies headed by Lockheed Missiles & Space Co. has been selected by the Air Force to develop a new system for locating and attacking enemy air defenses. But the program's future hinges on Congress appropriating \$30-million for development.

Known as the Precision Location Strike System (PLSS), the program includes IBM on weapons guidance, E-Systems on airborne sensors and aircraft installation, and Rockwell International's Collins Government Telecommunications Div. on ground communications. Lockheed also is negotiating with Harris Corp., Control Data Corp., Sperry Univac and Motorola to be subcontractors.

The development phase is expected to take four and a half years with the last year devoted to testing prototype hardware. The total contract is estimated to be worth \$120-million. A team headed by Boeing was the losing bidder.

Airborne radios to use MNOS circuits

Magnavox is using MNOS memories developed by the Air Force Avionics Laboratory and based on earlier commercial development at NCR Corp. to provide channel selection in the ARC-164 airborne radio.

The circuits, which store 16-bit channel frequency codes in each of 20 present channels, are more reliable and less expensive than the core memories used in previous airborne radios, according to the Air Force. The MNOS circuits can be expanded to 32 channels. The Air Force is also looking at applications in satellites requiring long lifetime in orbit.

Capital Capsules: Two spacecraft to orbit Mars and drop roving vehicles on the planet's surface comprise a major new program planned by NASA for next year's budget. Launch is planned for 1984 from the Space Shuttle and cost is expected to be in the billion-dollar class....Control Data has delivered the first two models of its **AYK-14 standard airborne Navy computer** to McDonnell Douglas for installation in the F-18 fighter. The computers are designated the XN-2A configuration and include dual 32-k core memory modules....One of the electronics research tasks proposed by the Defense Advanced Research Projects Agency (DARPA) is to **improve III-V materials for higher-power solid state sources.**

Coming through...

with a vital part in product design

It's what's up front that counts. That's why it pays off to involve Belden in the early stages of a project.

We know the codes, specs and electrical/environmental parameters your faced with. We've come through with answers to some extraordinary new applications.

As much as any component, wire, cable and cord, can make a critical difference in your product's performance. And your costs. By drawing on thousands of high-quality standards—and a wealth of custom engineering knowhow—we can tailor an answer to fit your needs. Exactly.

We can even help you cope with the economics of wire processing, assembly and installation. Our problem solving experience ranges from innovative

packaging to total manufacturing analysis.

Whether you need cord sets, special harnesses, shielded cable construction, flat cable—or help putting it all together, involve a Belden Wire Specialist. He'll come through with everything we've got. For answers right now, phone:

317-966-6661 Electronic Division or mark 400 on reader service card.

312-986-1600 Electrical Division or mark 401 on reader service card.

312-887-1800 Transportation Division or mark 402 on reader service card.

Or write Belden Corporation, 2000 S. Batavia Ave., Geneva, IL 60134

BELDEN



Coming through...
with new ideas for moving electrical energy

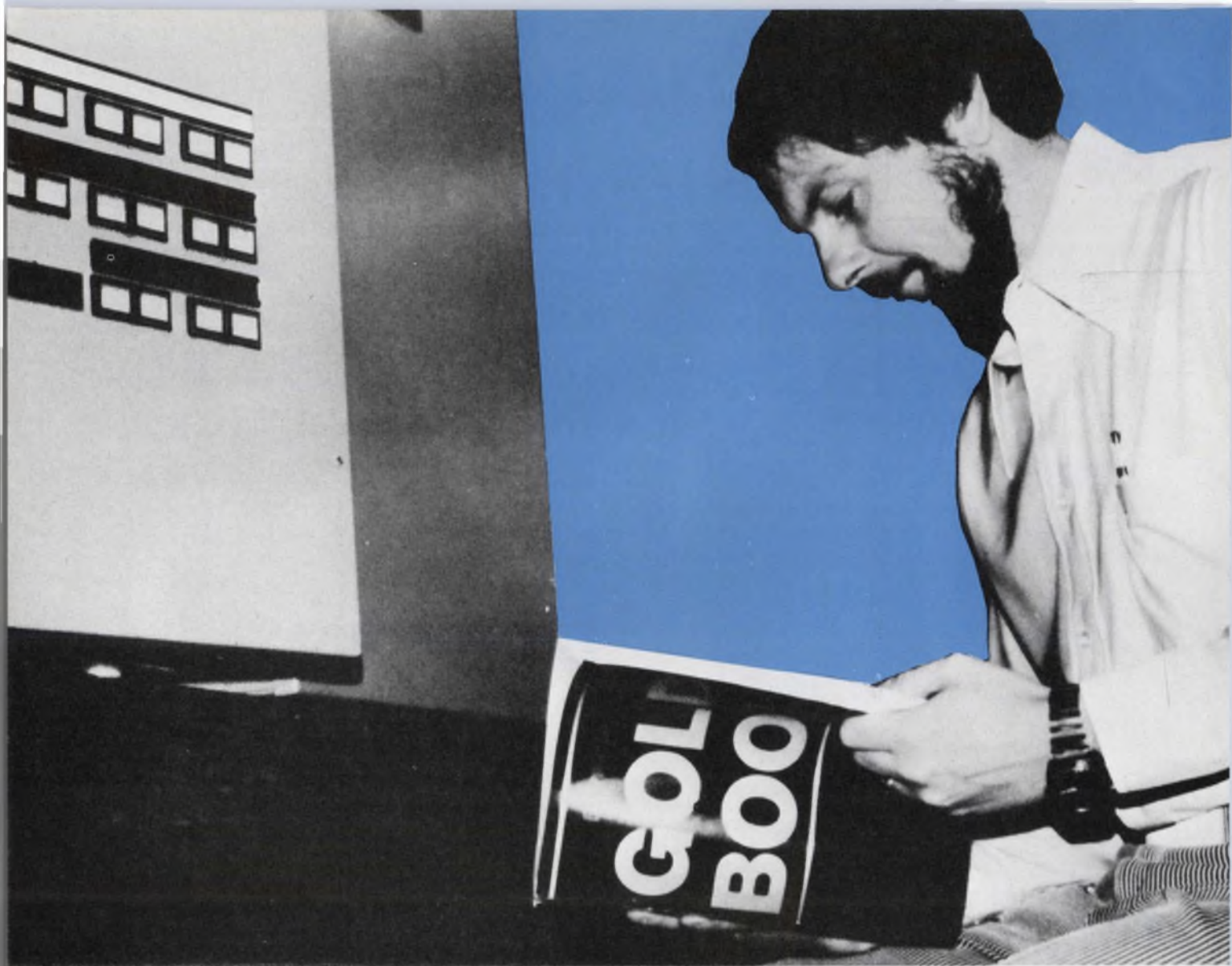

“THE GOLD BOOK HAS HELPED ME LOCATE SOME OF THE UNUSUAL PRODUCTS THAT ARE HARD TO FIND IN OTHER BOOKS”

Gary McIntyre is Test Supervisor for Moore Systems, Sunnyvale, California. Moore produces communications alarm controls, data loggers, computer monitoring systems and digital telemetering systems. McIntyre supervises final unit and systems testing, also in-house computer systems check out.

His directory? *Electronic Design's* GOLD BOOK.

“I refer to the GOLD BOOK two or three times a week. It allows for quick reference for many electronic products. By using the GOLD BOOK I can readily see what and where things are available for purchase. It's extremely useful, superior in all aspects.”

Moore Systems purchases equipment worth several thousand dollars per two-month period through the GOLD BOOK. The GOLD BOOK is working for advertisers because it's working for users — like Mr. McIntyre — throughout the U.S. and overseas.

IF IT'S ELECTRONIC...IT'S IN THE GOLD BOOK

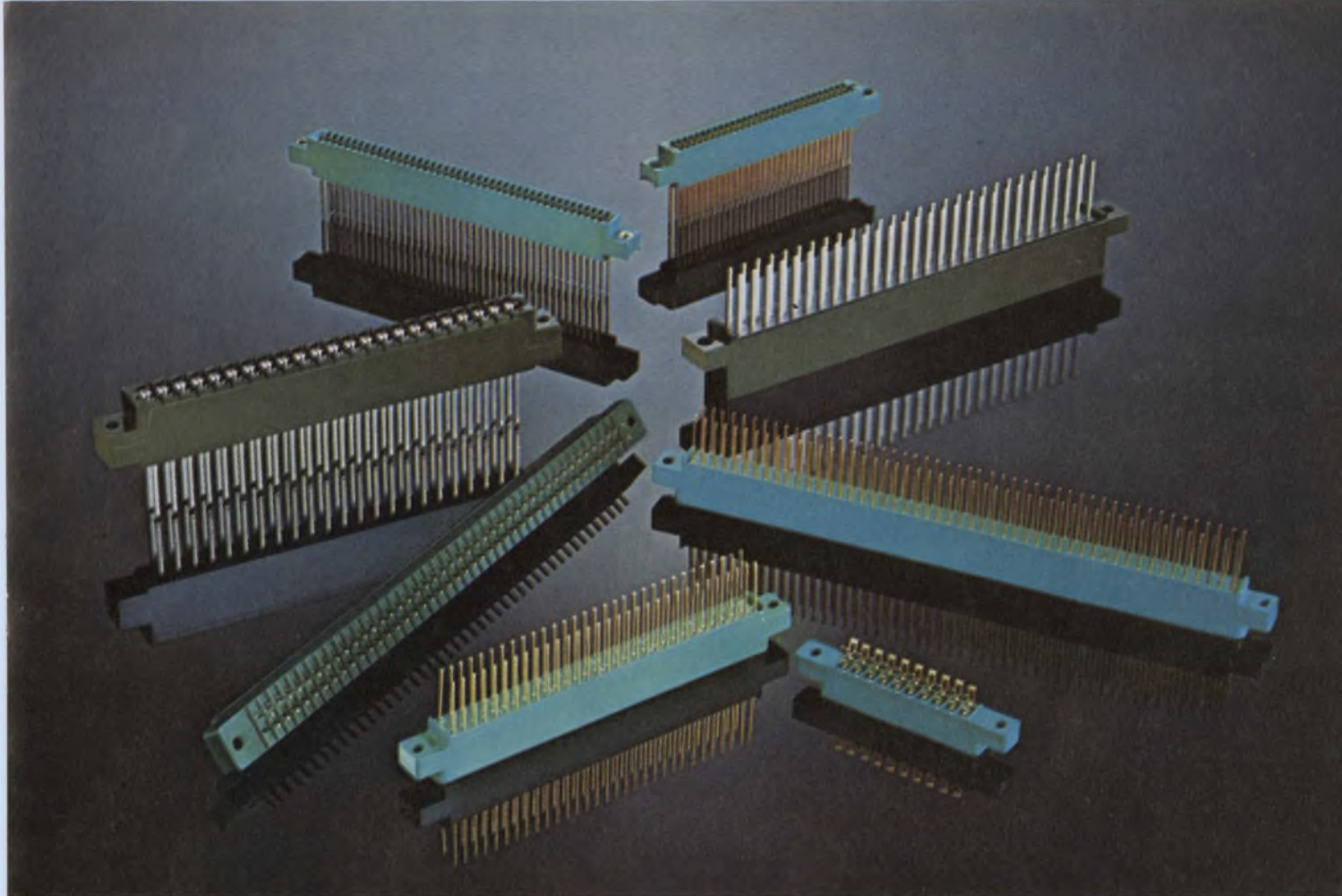

PC Connectors give our family the edge. We can give you the edge with fast delivery and wide variety in off-the-shelf PC connectors.

In .100, .125, .156 and .200 inch spacing you can take your choice for motherboard or automatic wiring applications.

You can also pick the contact you want —gold-dot or gold-plated. These include bifurcated bellows, cantilever beam and bifurcated cantilever beam designs.

Connector housings are available in glass-reinforced phenolic, diallyl phthalate and glass-reinforced polyester thermoplastic. A variety of mounting configurations are also readily available.

All have been designed to meet the applicable performance requirements of MIL-C-21097, and they're all available now.

So be sure to have a shipping date in mind when you contact GTE Sylvania, CPO, Box 29, Titusville, Pa. 16354 Phone 814-589-7071.

Remember, good connections run in our family.

GTE SYLVANIA



DISPLAY THE 267th BIT and be sure it's not the 268th or 269th...

Finding the 267th bit takes quite a while, and then you're not sure you have the right one. The solution is programmed digital delay. On the Philips PM 3261, you can program the delayed timebase to start on the nth bit. By means of an internal variable-speed clock, the events counter can be preset from 1 to 99,999 events, with complete trigger level setting control.

Another addition to the Philips family of HF portable oscilloscopes, the 120 MHz PM 3261 adds easily programmable digital delay to the already completely separate delayed timebase control section found on its predecessors.



Utilize our toll-free HOT LINE number 800 631-7172
New Jersey residents call (201) 529-3800 collect.

*U.S. domestic price only



Special TTL triggering selection allows the PM 3261 to react just as logic does - a TTL level window prevents false triggering on rising or falling edges.

The PM 3261 list price is only \$ 2595.00*

For further information contact, Philips Test & Measuring Instruments, Inc.

In the United States:
85 McKee Drive
Mahwah, New Jersey 07430
(201) 529-3800

In Canada:
6 Leswyn Road
Toronto, Ontario Canada M6A 1K2
(416) 769-7188



FOR RENT... the most advanced new products from Intel's Intellec[®] Microcomputer Development System family, including the exciting new 888...

You can take delivery now at low monthly rental rates on these ready-to-use products from 10 fully-stocked U.S. and Canadian instant inventory centers.

The Intellec System 888 is the new development package which provides all the resources necessary to develop microcomputer system software in assembly language or in Intel's high level programming language, PL/M-80. Included in the system are the MDS-800 with 64k bytes of RAM and resident PL/M-80 high-level language compiler, the new MDS-DDS 1-million byte capacity Dual Drive Double Density Diskette Operating System, and the MDS-CRT. It's available now.

The Intellec MDS-800 supports the development and implementation of Intel 8080, 8085, 8748, 8048, 8035 and Series 3000 microcomputers. It includes an 8080A CPU, a universal bus with multiprocessor and DMA capability, an 8-level maskable priority interrupt structure, a real-time clock, 256-byte bootstrap loader, 2k bytes of ROM memory, 16k bytes of RAM, and interfaces for a teletypewriter, CRT, high-speed paper tape reader, high-speed tape punch, line printer and Universal PROM programmer. Standard software includes a ROM-resident system monitor, a RAM-resident 8080/8085 assembler and a text editor. It's available now.

The Intellec MDS-016 is a 16k RAM option, consisting of a model 2107 N-Channel dynamic RAM. It's available now.

The Intellec MDS-PTR is a High-Speed Paper Tape Reader peripheral, including a cable assembly and featuring a transfer rate of 200 cps. It's available now.

The Intellec MDS-PRN is a High-Speed Printer peripheral. The 5x7 matrix line buffered printer operates at a maximum of 165 cps. Line width is switch-selectable from 80 columns at 10 characters/inch to 132 columns at 16.5 characters/inch. The printer produces an original plus four copies and includes a tabletop cabinet, power supply, interface cable, operator lights, automatic on-off motor control and a 2-channel VFU control. It's available now.

The Intellec MDS-DDS is a Dual Drive Double Density Diskette Operating System for MDS-800 direct access bulk storage. It includes an intelligent controller and two Diskette Drive Units (each with 500,000 byte capacity), a cabinet, power supplies, cable assemblies and two ISIS-II system software Diskettes. ISIS-II includes a Relocating Macro-Assembler, Linker, Object Locator, Text Editor and Library Manager. The DDS is expandable to 2-million bytes. It's available now.

The Intellec MDS-CRT is a Keyboard Display Unit providing total user communication with all Intellec Diskette software and peripherals. The keyboard is detachable, and the RS232C-compatible CRT provides asynchronous data transfer rates of up to 9600 baud and features cursor positioning and cursor homing capability. It's available now.

The Intellec MDS-80-ICE is the famous In-Circuit Emulator which allows the design, development and debugging of a product in its own real-time operating environment. The ICE module consists of an 8080 CPU In-Circuit Emulator and includes a cable assembly and interactive software. It's available now.

The Intellec UPP-101 is a Universal PROM Programmer, including a cabinet, software, power supplies, cable and one 16/24-pin zero insertion force PROM programming socket pair. At least one "personality card" is required. It's available now.

The Intellec UPP-816 is a Personality Card for the 2716 2k x 8 EPROM, which features a 450 nanosecond access. It's available now.

The Intellec UPP-848 is a Personality Card for the new 8748 single-chip LSI microcomputer. The card includes an adaptor socket. It's available now.

The Intellec UPP-855 is a Personality Card for the new 8755 PROM (a pin-for-pin equivalent of the 8355 ROM) which contains 2k bytes of program memory, an address latch and two 8-bit general purpose I/O ports (one of which may be used to address external memory). It's available now.

The Intellec MDS-PLM is a Resident Compiler for Intel's High Level Programming Language, PL/M. It translates a source program written in PL/M into machine code for the 8080A and 8085 microcomputers. An MDS-DDS and 64k bytes of RAM are required. It's available now.

The Intellec MDS-D48 is a Support Package for assembling 8748, 8048 and 8035 single chip microcomputer programs on the MDS-800. It's available now.

The Intellec PROMPT-48™ is a Personal Programming Tool for the 8748 and 8048. It runs programs in real-time, with multiple breakpoints, or with single-stepping. PROMPT-48 includes both 8748 and 8035 CPUs, an EPROM Programmer, an integral keyboard, displays and system monitor in ROM. The system provides 64 bytes of RAM register memory, 1k bytes of EPROM program memory, 256 bytes of RAM data memory and 1k bytes of RAM program memory. System I/O, bus and memory can be expanded or directly interfaced to a user prototype. It can be used as a stand-alone system, or it can work with any terminal. It may be connected to the MDS-800 for direct program downloading and includes I/O ports, a bus cable and comprehensive documentation. It's available now.

The Intellec PROMPT-SER is a serial cable for connecting PROMPT-48 to a TTY or CRT. It's available now.

The Intellec PROMPT-SPP is a Specialized EPROM Programmer Kit which allows PROMPT-48 to be connected to the MDS-800 as a specialized EPROM programmer peripheral or debugging station. It's available now.

You can rent any of these products—from stock, immediately —by contacting

Rental Electronics, Inc.

Another of the **AMERICAL** companies

Anaheim, Calif. (714) 879-0561
Mountain View, Calif. (415) 968-8845
Northridge, Calif. (213) 993-RENT (7368)
Fort Lauderdale, Fla. (305) 771-3500

Des Plaines, Ill. (312) 827-6670
Burlington, Mass. (617) 273-2770
Gaithersburg, Md. (301) 948-0620
Dallas, Texas (214) 661-8082
Oakland, N.J. (201) 337-3757
Rexdale, Ontario, Canada (416) 667-7513

CIRCLE NUMBER 123



From REI...off-the-shelf,
throughout North America.

Allen-Bradley Variable Resistors:

We have what you need.

**Our distributors have
them when your
need is now.**



ALLEN-BRADLEY VARIABLE RESISTORS



Type J: 1 $\frac{1}{32}$ " diameter. Hot-molded carbon composition. 50 ohms to 5.0 megs. 2.25W at 70°C. 100M cycle rotational life. Single, dual, triple sections. SPST switch optional. Many other options. Publication 5200. **500 piece price \$1.27 (single).**



Type EJ: 1 $\frac{1}{32}$ " diameter. Hot-molded carbon composition. 50 ohms to 5.0 megs. 2.25W at 70°C. 1 MILLION cycle rotational life. Single and dual sections. Slip clutch optional. Many other options. Publication 5230. **500 piece price \$1.50 (single).**



Series 70: $\frac{3}{8}$ " square MOD POT[®] Hot-molded composition, cermet, conductive plastic. 50 ohms to 10.0 megs. 100M cycle rotational life. Single, dual, triple sections. Switches optional. Many other options. Publication 5217. **500 piece price \$1.19 (single).**



Series 72: Case, bushing and shaft are non-metallic (for double insulation). Otherwise, same as Series 70. Singles and duals only. Publication 5217. **500 piece price \$0.90 (single).**



Series 73: A lower priced version of Series 70. Singles and duals only. Publication 5217. **500 piece price \$1.04 (single).**



Type G: $\frac{1}{2}$ " diameter. Hot-molded composition. 100 ohms to 5.0 megs. 0.5W at 70°C. 50M cycle rotational life. SPST switch optional. Many other options. Publication 5201. **500 piece price \$1.72.**



Type GD: Dual section version of Type G. Well suited for attenuator applications. Publications 5213 and 5221. **500 piece price \$3.67.**



Type W: A lower priced version of Type G. Publication 5212. **500 piece price \$1.19.**



Type WR: Radial lead version of Type W. SPST switch optional. Publication 5220. **500 piece price \$1.30.**



Type SP: $\frac{3}{8}$ " diameter. Cermet element. 50 ohms to 1.0 megs. 1.0W at 70°C. 25M cycle rotational life. Publication 5216. **500 piece price \$2.00.**



Type M: 10.0 MM (.394") cube. Conductive plastic element. 100 ohms to 1.0 megs. 25M cycle rotational life. Single and dual sections. Switches optional. Other options. Case, bushing and shaft are non-metallic. Publication 5239. **500 piece price \$2.12 (single).**

Quality in the best tradition.



ALLEN-BRADLEY

Milwaukee, Wisconsin 53204

CIRCLE NUMBER 124

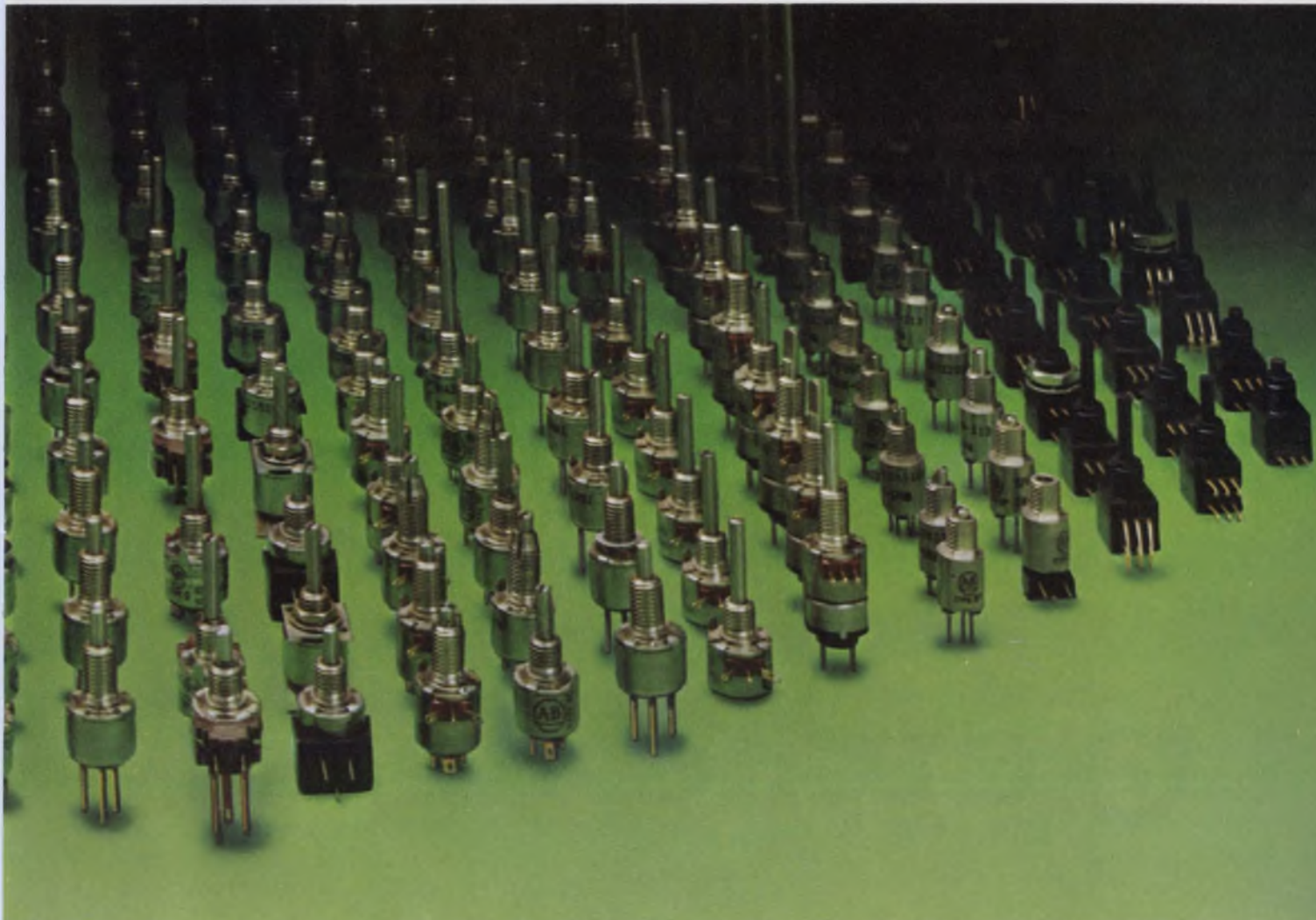

The answer is 1300

Now, what was the question?

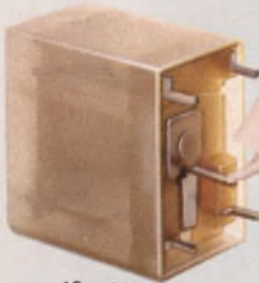

10 amps
SPST-NO or NC, SPDT

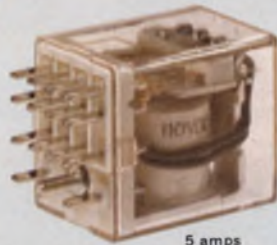

5 amps
4PDT



13 amps
DPDT



5 to 50 amps
SPST, SPDT, DPDT

Where can you get a miniature enclosed relay to handle anything from less than 5 amps to 50 or more?

The answer is one of Guardian's series 1300 relays . . . small in size . . . low in cost . . . high in quality . . . long on the features you want most.

All are engineered to give you maximum control capacity in minimum size . . . to give you an expected mechanical life measured in the tens of millions of operations. All together they give you the most complete line of miniature enclosed relays to meet your most exacting specifications in your most demanding applications.

The Guardian 1300 line doesn't stop with just relays: It includes mounting sockets and hardware that let the relay fit your application, not vice versa. Plus, side mounting/permanent stud hardware that allows you to mount these relays in any position.



Send for the 48-page book that tells it all. Yours free for the asking from your Guardian Angel.

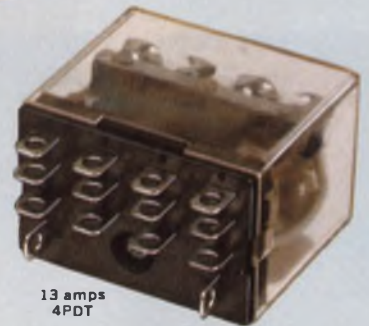

13 amps
4PDT



5 amps
DPDT

 All are recognized under the component program of Underwriters Laboratories, Inc.



GUARDIAN®

GUARDIAN ELECTRIC MANUFACTURING CO. • 1572 W. Carroll Ave. • Chicago, IL 60607 • 312/243-1100



See, we sell all the parts together. Or all the parts apart.

If you are looking for complete telephones to use as part of a system, or if you need telephone parts to build into your product, GTE Automatic Electric is the logical source.

Why? Because we are the largest U.S. manufacturer of telephones and telephone subassemblies outside the Bell System.

So, if you are an OEM and you have quantity requirements for telephones or telephone components, we'll usually have what you are looking for. Telephones in a large variety of styles and colors. And components ranging from handsets and hookswitches to housings and hardware. If it goes into a telephone system, we probably make it.

Use the coupon for a complete catalog. Or, if you are in a real hurry, call John Ashby at (312) 562-7100, Ext. 250.

When it comes to quality components, call THE SOURCE: GTE AUTOMATIC ELECTRIC.

Please send your catalog of communications components.

Please send more information and prices on _____ of _____.
(Quantity) (Product)

Name _____

Title _____ Phone _____

Company _____

Address _____

City _____ State _____ Zip _____

Mail to: Mr. J. D. Ashby, B-4,
GTE Automatic Electric, Northlake, Ill. 60164

GTE AUTOMATIC ELECTRIC

You Don't Have To Beg, Borrow Or Buy...

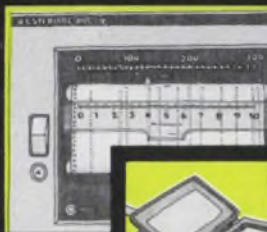
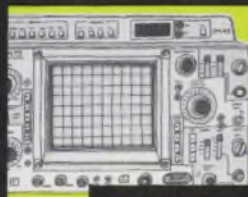
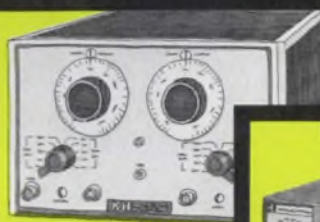
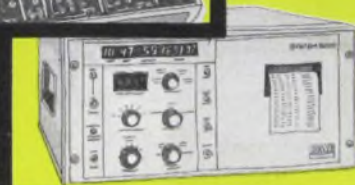
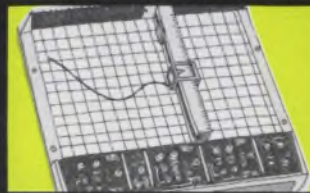

Rent'em From GE

Short or long-term instrument rentals give you flexibility and economy.

GE has over 9,000 instruments available for immediate shipment: □ Tek Scopes □ Biddle Megger Insulation Testers □ H-P Signal Generators □ Honeywell Oscillographs □ Complete Data Systems □ Esterline Angus Recorders □ GE Chart Recorders □ Modems □ Communication Terminals ... all calibrated to the manufacturer's specs.

We have over 100 Sales/Service Centers,

and one of them is near you. In addition to maintaining our Rental Inventory, they can also repair and calibrate your own equipment.

Don't borrow someone else's GE Rental Catalog. **Call collect (518) 372-9900** or your nearest Sales/Service Center.

**Quick-rental[®]
instruments**

ALA. BIRMINGHAM (205) 925-3101 • ARIZ. PHOENIX (602) 278-8515 or 8516, TUCSON (602) 294-3139 • CAL. LOS ANGELES (213) 642-5350, SAN FRANCISCO (415) 436-9260 • COL. DENVER (303) 371-1260 • CONN. SOUTHINGTON (203) 621-4059 • FLA. JACKSONVILLE (904) 751-0610 • GA. ATLANTA (404) 457-5563 • ILL. CHICAGO (219) 933-4500 • IND. INDIANAPOLIS (317) 639-1565 • KY. LOUISVILLE (502) 452-3311 • LA. NEW ORLEANS (504) 367-6528 • MD. BALTIMORE (301) 332-4700 • MASS. BOSTON (617) 396-9600 Ext. 160, SPRINGFIELD (413) 781-1111 • MICH. DETROIT (313) 285-6700 Ext. 208 • MINN. MINNEAPOLIS (612) 522-4396 • MO. KANSAS CITY (816) 231-4377, ST. LOUIS (314) 965-7115 • N.J. CLIFTON (201) 471-6556 • N.Y. BUFFALO (716) 876-1200, SCHENECTADY (518) 385-2195 • N.Y.C. CLIFTON, N.J. (201) 471-6556 • N.C. CHARLOTTE (704) 525-0311 • OH. CINCINNATI (513) 874-8512, CLEVELAND (216) 523-6382, TOLEDO (419) 691-3501 • OR. PORTLAND (503) 221-5101 • PA. PHILADELPHIA (609) 424-4450, PITTSBURGH (412) 462-7400 • TEX. DALLAS (214) 357-7341, HOUSTON (713) 672-3570 • VA. RICHMOND (804) 232-6733 • WASH. SEATTLE (206) 854-0211 • W.V. CHARLESTON (304) 345-0920 • WISC. MILWAUKEE (414) 744-0110 • PUERTO RICO PONCE (809) 843-4225

GENERAL  ELECTRIC

CIRCLE NUMBER 127

14 new line circuits from the leader. Texas Instruments.

To the most comprehensive line of interface circuits come 14 new line drivers, receivers and transceivers offering the same performance, reliability and economy that have made Texas Instruments the world leader in line circuits with a total of 43 products. And they're available now, from your local TI distributor.

Line receivers for IBM 360/370 I/O applications.

The SN75125 and SN75127 are monolithic seven-channel line receivers in a 16-pin package that meet the IBM 360/370 I/O specification. Special low-power design and Schottky-clamped transistors allow for low supply-current requirements while maintaining fast switching speeds and high-current TTL outputs. Both operate from a single 5V power supply. The SN75127 has standard V_{CC} positioning.

The SN75128 and SN75129 are eight-channel line receivers with many of the features of the 125 and 127 plus common strobes for each group of four receivers. The SN75128 has an active-high strobe while the SN75129 has an active-low strobe.

RS-422 dual differential drivers.

The SN55/75158 and SN75159 are dual differential line drivers designed to meet EIA Standard RS-422. They require only a single 5V power supply and offer balanced-line

operations, TTL and DTL input compatibility, short-circuit protection and high output impedance in the power-off condition. Typical propagation delay times are 16 ns. Input clamp diodes provide transient voltage protection.

The SN75159 offers all of the features of the SN75158 driver plus 3-state outputs for bus-organized systems.

Dual line receivers.

To the SN55/75140 Series are added the 141, 142 and 143 dual single-ended line receivers with TTL-compatible strobes and outputs. Each features single 5V supply requirements, ± 100 mV sensitivity, reference voltage adjustable from 1.5 to 3.5V for maximum noise immunity, and a high input impedance for data-bus applications.

Like the existing SN55/75140, the new 141 offers a common reference pin and common strobe but adds an input-protected diode for the power-off mode. The 142 and 143 line receivers have individual reference pins, individual strobes and an internal 2.5V reference available. The 143 receiver has a diode-protected input stage.

General-purpose line drivers with 3-state outputs.

The DS78/8831 and DS78/8832 can be used as either single-ended or dual differential drivers. They operate on a single 5V power supply and are ideal for party-line applications. All offer very low output impedance with high drive capability, also 40-mA sink and source capability. Typical propagation delay times

are 15 ns. The drivers are differentiated by the output clamp diode to V_{CC} on DS78/8831.

Single-ended transceiver.

The SN75136, a functional pin-for-pin replacement for the Signetics N8T26, is a quad transceiver using Schottky-clamped transistors and a single 5V power supply. Both the driver and transceiver have 3-state outputs for data-bus operations. PNP inputs minimize input loading (200 μ A max.).

Differential transceivers.

The SN75118 and SN75119 are single differential transceivers similar to TI's SN75116 and SN75117 with the added feature of 3-state receiver outputs. Both devices operate from a single 5V power supply.

Free Data Book.

Mail the coupon below for a free copy of the new 206 page Line Driver and Line Receiver Data Book. You'll find complete specifications on all of these new products plus selection guides, future products, ordering and applications information for the complete line of TI drivers, receivers and transceivers. Included are the popular SN75107, 108, 109, 110 and 112 dual line drivers, the SN75121 and 123 dual line drivers and the SN75122 and 124 triple line receivers. You'll also find the SN75150 dual line driver and the SN75154 quad receivers along with the SN75188 quad line driver and SN75189 and 189A quad line receivers. All of these and other widely used line circuits are yours for the asking.



FREE!

Line Driver and Line Receiver Data Book

Selection guides • Interchangeability guides • Thermal information • Ordering instructions and mechanical data • Individual data sheets • Typical applications • Selection guide for other interface circuits • Future products.



Texas Instruments Incorporated
Inquiry Answering Service
P. O. Box 5012, M/S 308
Dallas, Texas 75222

Please send me a free copy of the Line Driver and Line Receiver Data Book.

Name _____ Title _____

Company _____

Address _____

City _____ State _____ Zip _____

Check here for other interface circuits data books.

- Memory Interface Data Book
- Peripheral Driver Data Book
- Display Driver Data Book

ED

TEXAS INSTRUMENTS
INCORPORATED
CIRCLE NUMBER 26

A sleeper.

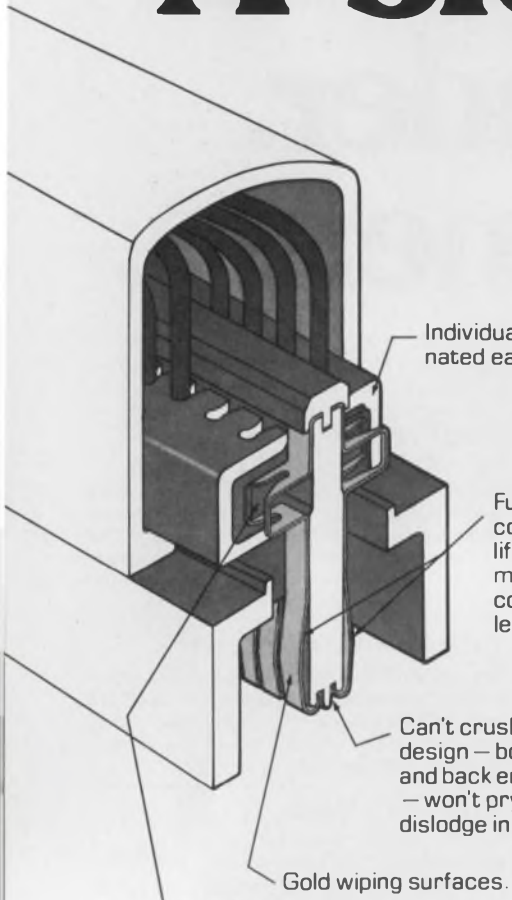

Contact area on each wire is larger than a cross section of the wire itself (.012 sq. in. on 24 awg). 4 contact areas on each wire (not just 2); strain relief on each wire.

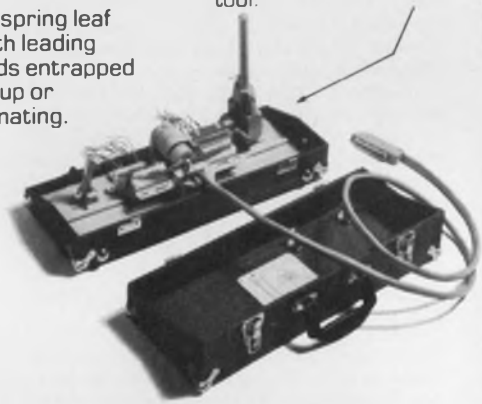

Intermateable with other industry standard 50 pin ribbon contact connectors.

Looks as good as it works. Clean design. High impact plastic, in cable-matching light olive gray.

The plain truth is, there just isn't another 50 contact solderless connector you can buy that's this good.

Take a look at the details of the Vitel-F. Compare it with whatever you're now using.

Costs? We'll bet it's no more than you're now paying — probably less; this is a competitive business, you know.

But, frankly, the field termination tool that completes our system, The Pushover, is such a dramatic improvement over the others, that it tends to steal the show.

It shouldn't, of course. The connector is what you and your customers have to live with...and we'd like to show you how easy that can be.

Call or write us for details.

 **Viking**
CONNECTORS

Viking Industries, Inc./21001 Nordhoff Street/Chatsworth, CA 91311 U.S.A./ (213) 341-4330

Unlucky in love

Jack was in love again. He had met this beautiful lady who radiated excitement, enchantment and warmth. She had everything he wanted and she apparently wanted him; she repeatedly invited him to call.

And call he did. Often. But each time he telephoned, she was unavailable—always with profound regrets and a perfect reason. She had to entertain her folks who had unexpectedly arrived from out of town. Or she had suddenly developed a terrible cold. Or her boss, without warning, had demanded that she work incredibly long hours, and she was dreadfully tired. But still eager.

In time Jack quit calling. This was a love that the fates were against. Conspiring with the fates was the fact that the lady had another love, and she found time-sharing difficult.

In a sense Jack had another love, too. If ever a man could feel something like love for a supplier, Jack could. For a new vendor had everything an engineer could pray for. Or so the salesman assured him. This vendor had the industry's broadest line, the best state of the art in product sophistication, the highest reliability, the lowest prices and the quickest delivery. Who wouldn't love a vendor like that?

So Jack started placing orders. But things didn't work out quite right. Though the vendor had the broadest line, he seemed never to have just the part that Jack needed. He had 0.02- μ F capacitors, but not 0.01 μ F. He had polystyrenes, but not Mylars. The high failure rates Jack encountered were peculiar to that line alone. And the prices—they were much better on the parts Jack didn't need. Delivery, too, was better on the other lines.

In time, Jack quit placing orders with this vendor. It seems that the vendor had another love—an older and larger customer whose requirements always took priority.

Jack wasn't always lucky in love.



GEORGE ROSTKY
Editor-in-Chief

AMP research discovered Bonded Lubrication 5 years ago.

It's now today's better way to extend contact life without compromising performance.



Through the electron microscope, the dramatic improvement AMP Bonded Lubrication makes in contact life and performance is clearly evident.

With the popular DUALATCH connectors, Bonded Lubrication has reduced plating thickness requirements and more than doubled the previously accepted cycle life of 10,000 insertions and withdrawals.

For example, look at the effect on the connector contact shown. Not only is wear to the plated surface greatly reduced by the permanent lubrication but it

Dramatic difference in wear between contacts utilizing the unique AMP Bonded Lubrication Process and ordinary contacts is shown by these scanning electron microscope images.



significantly lowers the insertion forces when mating high-pin count connectors. Now Bonded Lubrication can be applied to a variety of contact geometries without compromising electrical performance.

Or consider what AMP lubrication leadership has done for contacts used in our tin-plated products like surface mount ZIF connector and Bifurcated Leaf types. Their lubricated contact surfaces are protected from the detrimental effects of oxidation and fretting corrosion. Indeed, there are now applications where high performance tin-plating, with the correct contact design and Bonded Lubrication, can be used in place of noble metals.

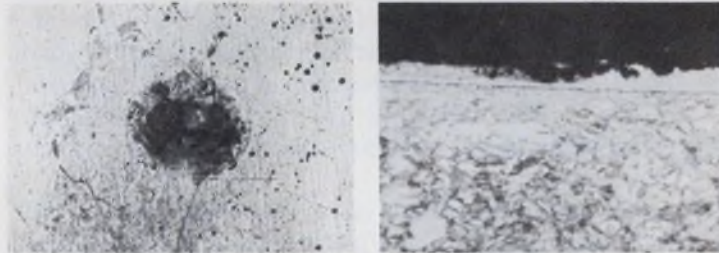

AMP's Materials Research Laboratory pictures of surface oxidation and fretting corrosion on non-lubricated contacts.

AMP lubricated contacts are today's answer to extended contact life and performance, and together we can search out better ways to assist your designs.

For more information on the products mentioned, circle the reader service number. For more technical information on lubrication just call Customer Service at (717) 564-0100, extension 8400. Or write on your Company letterhead to AMP Incorporated, Harrisburg, PA 17105.

AMP has a better way.

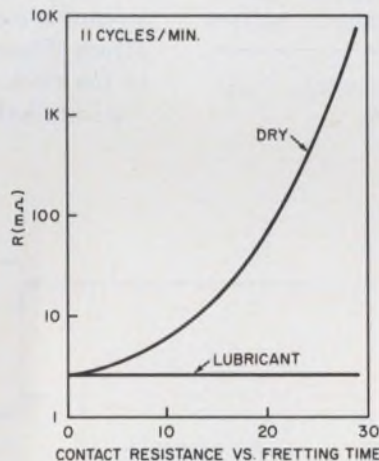
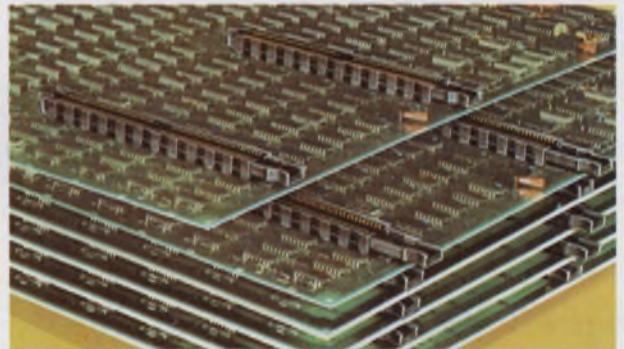
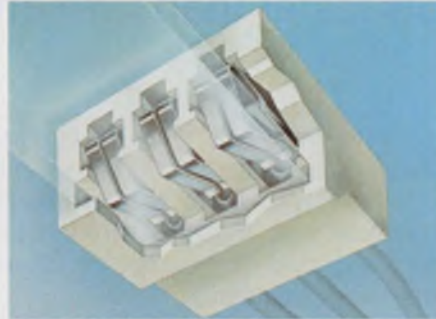

Flat, stable resistance of contacts with AMP lubrication compared to dry contacts.

**SEE US AT
INELTEC, BASEL**

AMP
INCORPORATED

Design your own data terminal.

Interface a dot-matrix printer to your processor and get printouts faster than with off-the-shelf units.

General-purpose data terminals work into most computers. But if you design a data terminal around a dot-matrix printer, you can tailor the terminal's interface to the system and improve throughput. Where data terminals double as message switchers efficiency can improve dramatically.

Begin your data-terminal design by selecting a printout device—for example, Victor Comptometer's IMP 130 dot-matrix print mechanism. Generating a printed line takes 800 ms, and a line feed 200 ms when not preceded by data. The print head, containing seven print solenoids, uses an optical gate to generate a print strobe signal from a slotted metal comb. The line feed also uses an optical gate, but this one operates from a disc containing an index slot.

Store and read with separate clocks

To mate efficiently with the printer, let a system clock store the data in intermediate output buffers

Robert J. Stetson, Engineer, Storage Technology Corp., 222 S. Riverside Plaza, Chicago, IL 60606.

at the system's data rate. Then, with an output clock, shift out the data at 9600 baud. Pause for 800 ms after each line feed containing data, and for 200 ms after each line feed that isn't preceded by data. For example, when a message is followed by four line feeds (to place the message above the tear line on the platen), insert a 200-ms pause between each line feed.

Going from the output to the input side of the terminal's interface, the most popular input data format is serial 6-bit American Standard Code for Information Interchange (ASCII) code. The logic for mating an IMP 130 printer mechanism to serial 6-bit ASCII-coded data is summarized in the block diagram of Fig. 1. The following are the major functional components of the terminal's processing and control logic:

- A serial-to-parallel (s/p) converter, clock and error logic (Fig. 2). The s/p converts serial input data to a parallel-bit format. In addition, the input data stream is monitored for parity, framing and overrun errors. These data input operations are synchronized to the clock.

- Data buffers and a function decoder (Fig. 3). The

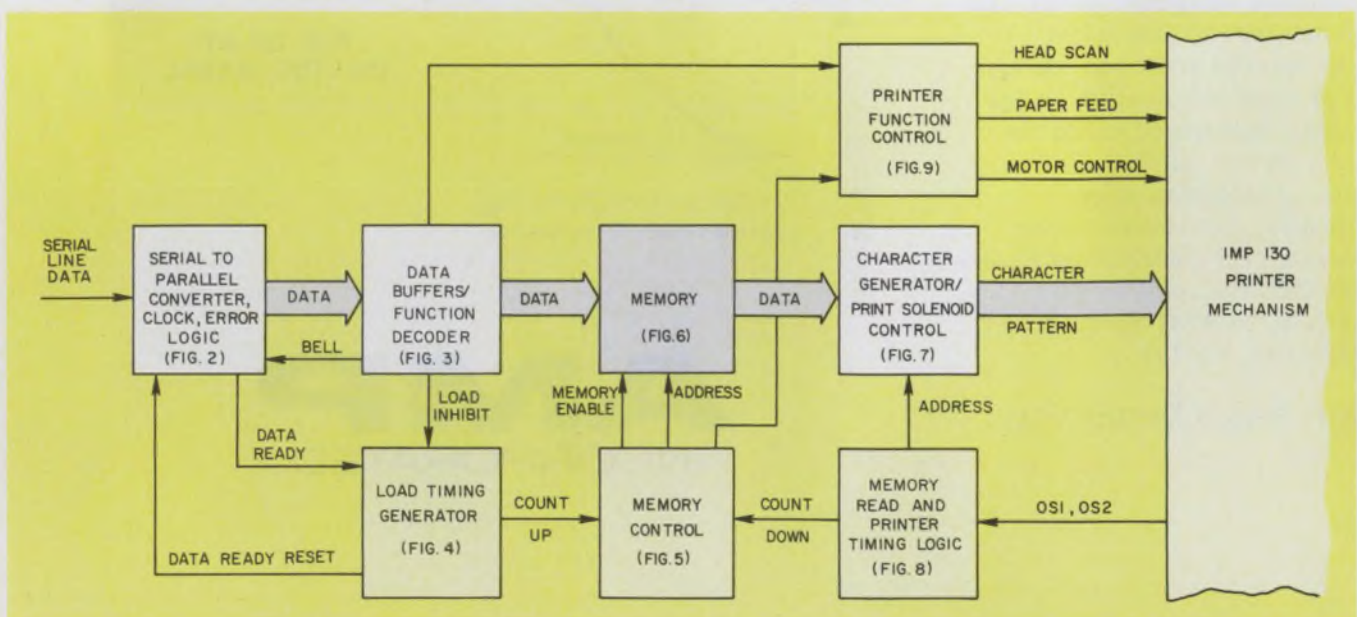

1. **Memory matches input to output data rates.** Serial-input data are converted to parallel, then buffered, de-

coded and read into memory—all at the system's clock rate. Stored data generate printer-control signals.

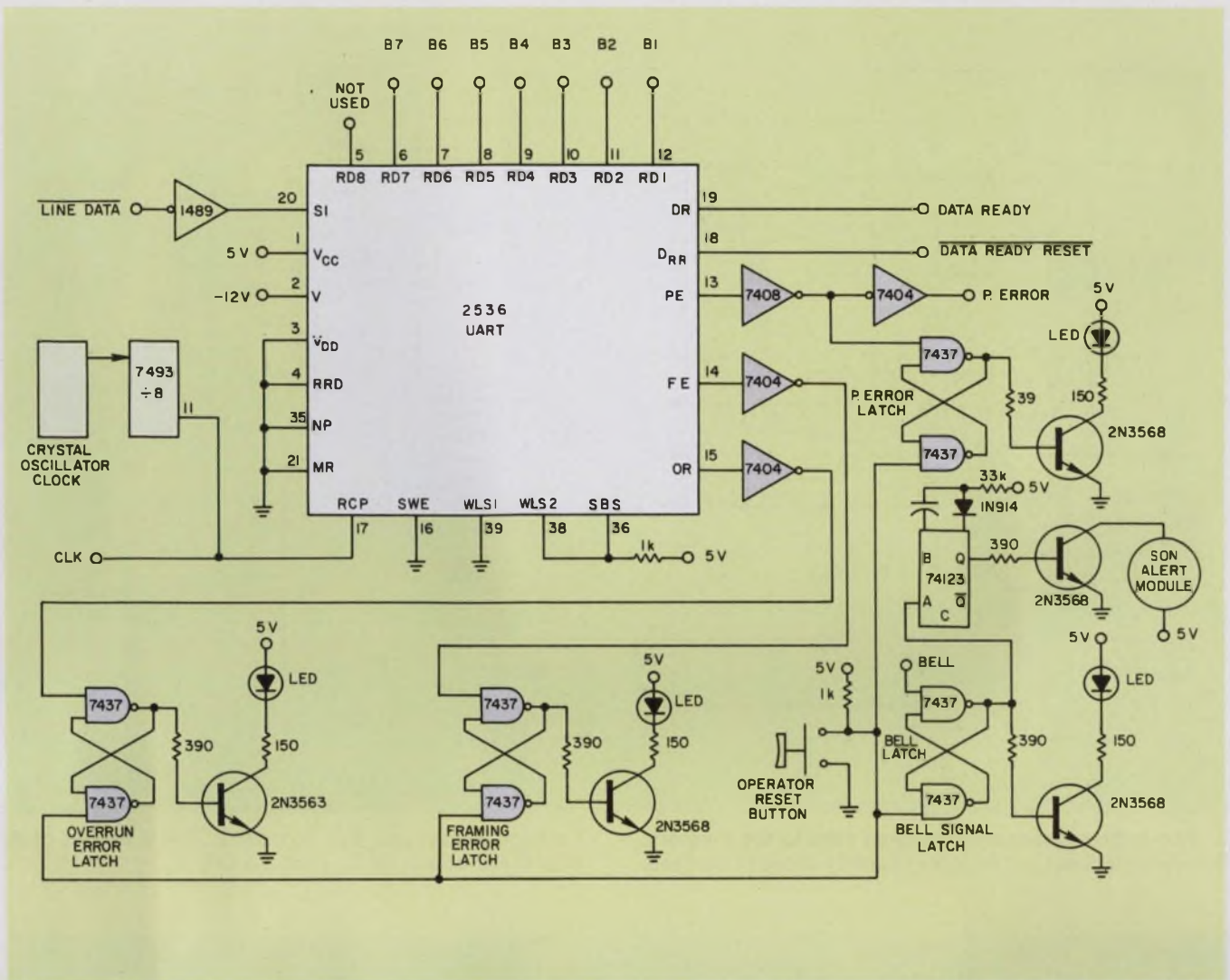

2. The UART converts serial input to parallel, at up to 16 times the baud rate, under control of the system clock.

Flags indicate parity, framing and overrun errors. Data Ready indicates that outputs are stable.

data buffers present parity-checked data to the memory, while the function decoder channels the decoded printer functions to dedicated lines.

- A load-timing generator (Fig. 4). Actuated by the Data Ready signal, this generator develops signals to load a line of characters into memory.

- Memory-control logic (Fig. 5). This logic generates the addresses for loading and unloading memory. The memory is loaded by the Count Up signal from the load-timing generator, the Count Down signal from the memory-read. Printer-timing logic unloads the stored characters to the printer.

- A memory (Fig. 6), which consists of six chips, each capable of storing 16 four-bit words. Pairs of chips are accessed together—one chip stores four bits and the other stores two bits—for a total of six bits per word.

- A character generator and print-solenoid controls (Fig. 7). This circuitry converts the 6-bit ASCII characters from the memory into the appropriate sequence of print-head control signals. The print head forms a character in reverse, that is, the head moves from

right to left across the platen.

- Memory-read and printer-timing logic shown in Fig. 8. This logic generates the address sequence for the character generator.

- Printer-function control (Fig. 9). This consists of the gating and timing circuits that control the printer's motor, paper feed and head scanning.

Choose circuits for performance and cost

For stability at low cost, use a crystal clock. Make the oscillator's frequency the baud rate times 128, because crystals in the 1-MHz range are inexpensive. Then, for the final clock frequency, divide by eight with a 7493 counter. The result is a clock frequency, 16 times the baud rate, required by the universal asynchronous receiver/transmitter (UART).

The UART (Fig. 2) performs serial-to-parallel conversion both reliably and inexpensively. What's more, you get error flags—use them to monitor incoming data. Note the 1489 line receiver at the UART's input. It converts EIA standard data voltages

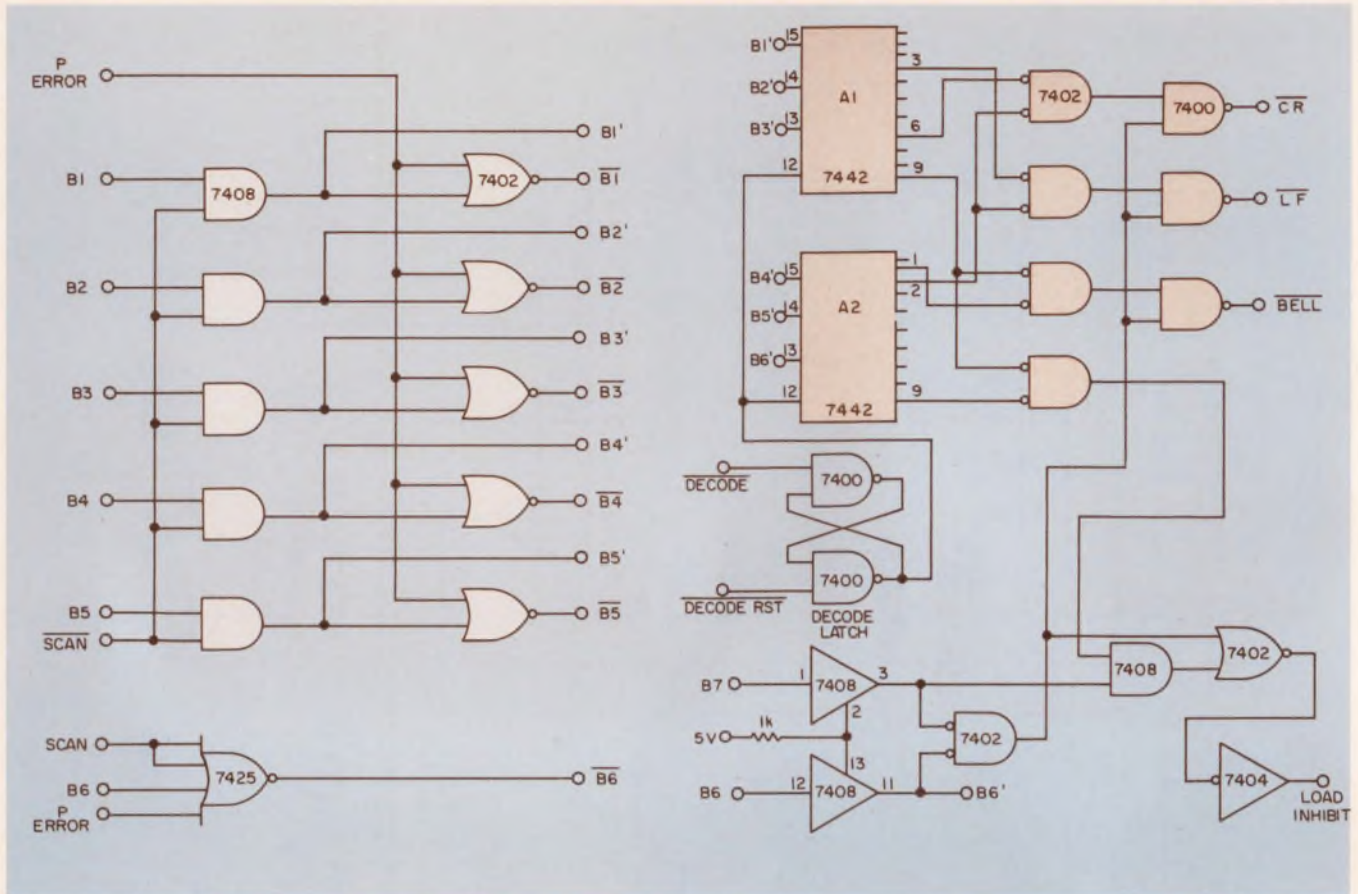

3. The buffers gate parity-checked data to the memory. Binary-to-decimal converters efficiently decode Line Feed,

Carriage Return and Bell functions. The 6 output of A₁ plus the 2 output of A₂ produce CR.

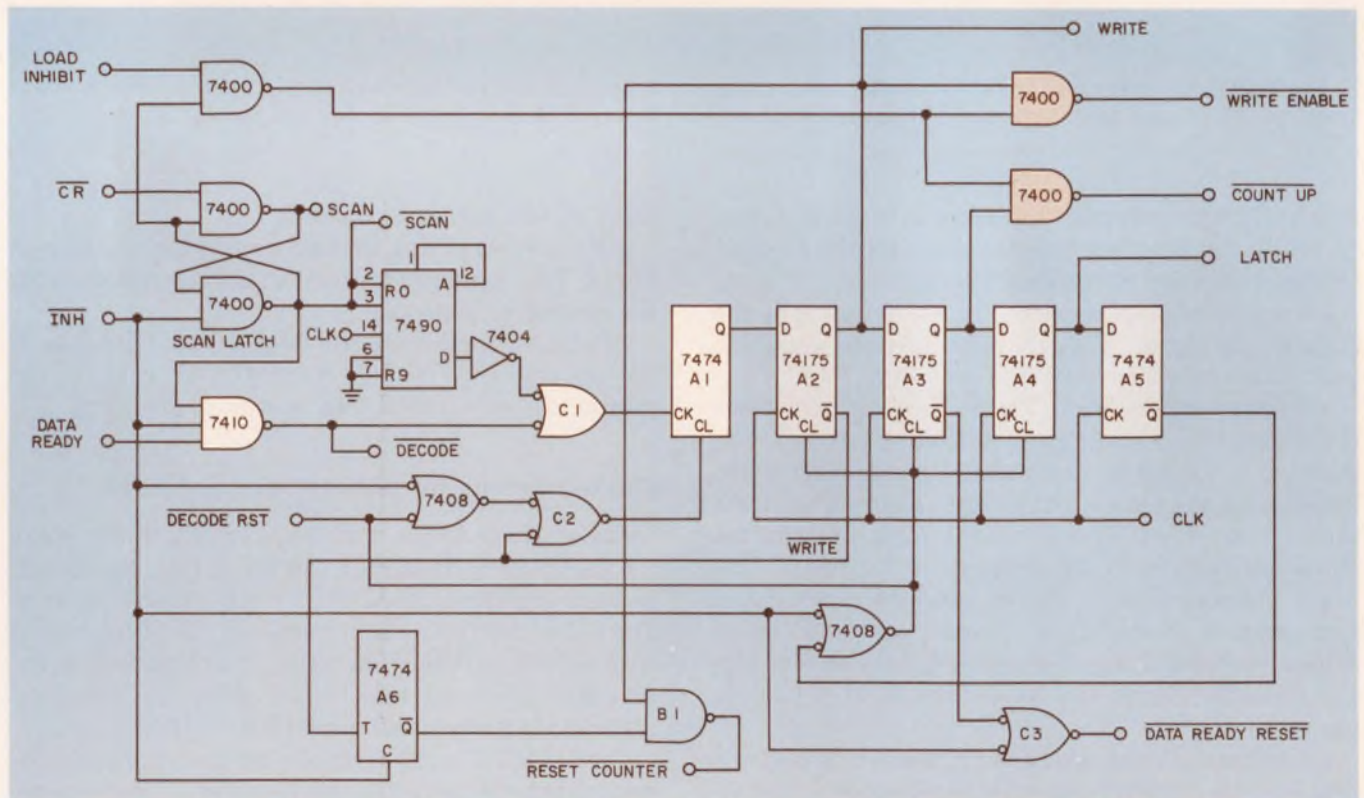

4. Load-timing logic develops the Write Enable, which loads a line of characters into the memory. When the UART signals that data are ready, A₂ through A₅ connected as

a shift register, generate the Count Up signal in synchronism with the system clock. The Write, Write Enable and Latch signals are produced similarly.

memory equals 34. Then Inhibit resets the scan latch and other associated circuits in Fig. 4.

Three memory areas store a line of print

The memory-address counter generates 16 addresses from either the Count Up or Count Down signal. Decoders, shown in Fig. 5, steer the first, second and third group of characters to the memory areas enabled by ME₁, ME₂ and ME₃, respectively. The memory is loaded, a byte at a time, until it is full (34 bytes).

Once a full line of characters is stored, the head scans. Since the memory-address counter then decrements, stored data are accessed in reverse (right to left) of the order in which the line of characters was loaded. This reverse addressing is controlled by Count Down (Fig. 5).

The memory's contents are printed on the platen from right to left, with left-margin justification. The head-scanner comb (OS₁) has an excess of slots, which cause the address counter to count down past zero to address 255, which then generates End Line. End Line, ORed into the paper-feed circuit, provides the paper feed each time the head scans.

The memory is shown in Fig. 6. Binary inputs 1, 2, 4 and 8 provide addressing for 16 memory locations common to all chips. The six memory chips are enabled two at a time. Memory addresses 00 through 15 are each scanned twice on the first two cycles (ME₁, ME₂). Only addresses 00 and 01 are scanned on the third cycle (ME₃).

Three of the six chips store bits 1, 2, 3 and 4 while the other three chips store bits 5 and 6. Although you can receive 8-bit ASCII incoming data, the memory stores only 6-bit ASCII. When working with 8-bit

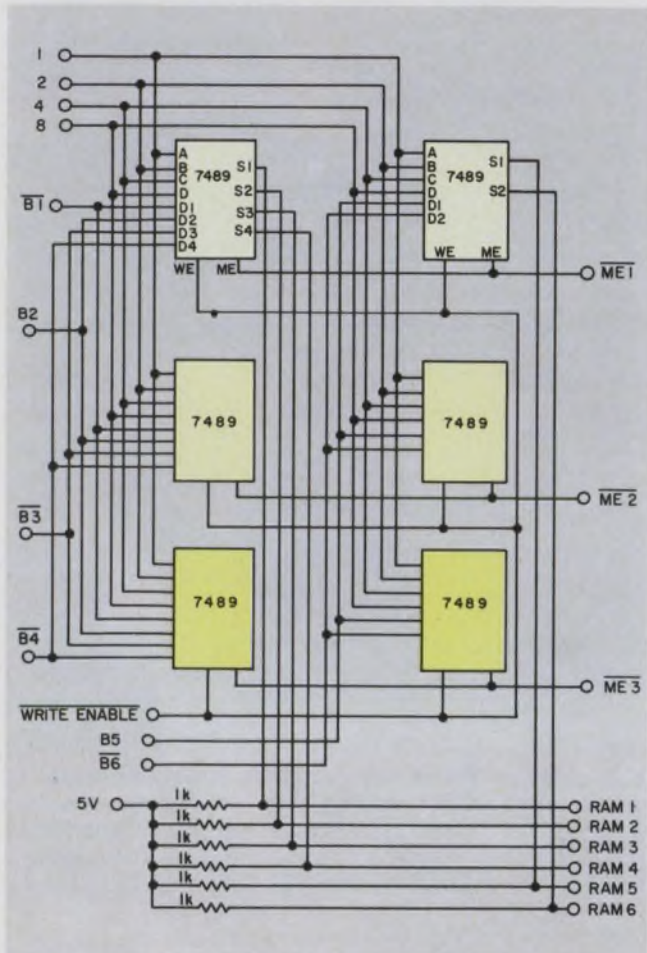

6. The memory contains six chips—each capable of storing 16 four-bit words. Chips are accessed two at a time by the ME₁, ME₂, or ME₃ signals, with one chip storing four bits and the other, two bits. The Write Enable signal determines whether the memory is activated for storage or readout. Four-bit binary signals from the memory-address counter locate each data byte.

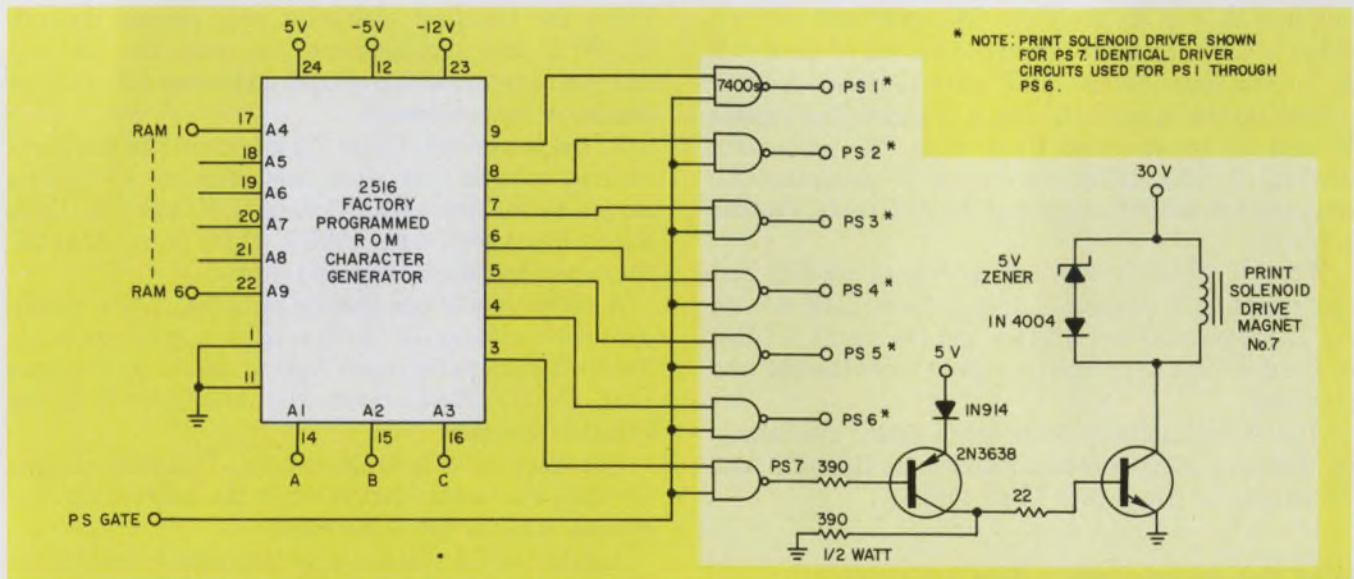

7. The character generator is a preprogrammed ROM that sequences character-pattern signals for the print heads. Its inputs are parallel 6-bit-ASCII-coded characters from

the memory and the sequenced A, B and C address signals from the printer-timing logic. The PS Gate strobes each ROM output into its solenoid driver.

character printers, only the character generator need be modified. Both the existing memory and UART can handle 8-bit characters.

Select a well-ventilated location for the 7489 memory chips—they run hot. Try to place temperature-sensitive components away from these chips in your mechanical layout of the system.

One chip generates the characters

Availability and economy make using the 2516 character-generator ROM a smart move for the designer. The preprogrammed chip gives you a character that is 7 dots high by 5 dots wide, with a gap width between characters of one dot location.

Address inputs A, B and C count down from 05 to 00 for each character presented at the input. This counting sequence causes the print head to form the character in reverse, with the head moving from right to left (the A, B and C addressing is binary).

Do not use the outputs of the character generator to drive the print solenoids. The print solenoids should not be activated for more than 420 or less than 390 μ s. When the solenoids are operated for too long, the pins on the scan head snag the ribbon and damage the head. Solenoids active for less than the proper time

produce light and uneven printing.

To ensure the correct pulse width for the solenoids, use the PS Gate to time the driver's output. The PS-Gate signal is generated by a phototransistor and a LED with a slotted-comb interrupter (Fig. 9). The comb remains fixed as the head passes from one end of its travel to the other.

The output of the operational amplifier in Fig. 9 is a sine wave that is clipped by the diode to ground and squared by a 74123 Schmidt trigger. The resulting clean square wave triggers the timer (Fig. 8) that generates the PS Gate. Use low-tempco precision resistors and capacitors for the PS-gate circuit.

The circuits work—if you're careful

As illustrated in Fig. 7, the print signals are gated to the drivers through 7400s. There may be a temptation here to use 7437s, with a fan-out of 30. But due to the driver-input configuration used, this isn't necessary. The sink-current capabilities of the 7400 are quite adequate.

The solenoid drivers in Fig. 7 have a superior record. The 2N5192 transistor is rated at about 7 A at 30 V and the solenoid coils draw a mere 2 A.

Keep the 30-V circuits isolated as best you can from all sensitive circuitry. Noise is always a problem when you switch high currents. Use filters around the preamps to the drivers and a separate ground return for the +30 V. The amount of bypass-filtering required depends on your layout.

The character generator is addressed by the counter in Fig. 8, which stays reset until the memory is fully loaded. A bypass capacitor on the output of B₁ eliminates ringing.

The printer-function control consists of timers and drivers (see Fig. 9). Every cycle of the timing generator produces a Write signal that starts the motor timer. Once started, the motor operates for one second.

Don't lose Line Feeds

Because Write is not generated by a function, you can lose some Line Feed signals, when the motor stops at the end of a message. To avoid losing these, let Line Feed also activate the motor.

Connect End Line to the paper-feed timer to provide a Line Feed after a printed line. When preceded by data, the Line Feed is lost because Data Ready Reset is driven low by the first space inserted in memory after a CR.

When the address counter reaches 34 and Load is high, set the head-scan latch and enable the character generator's address counter in Fig. 8. Also, prevent additional loading of the memory as well as decoding of control characters by driving Inhibit low.

When its latch is active, the head drives across the platen. At the conclusion of the scan, End Line resets the latch. But what if the latch isn't reset? As a backup,

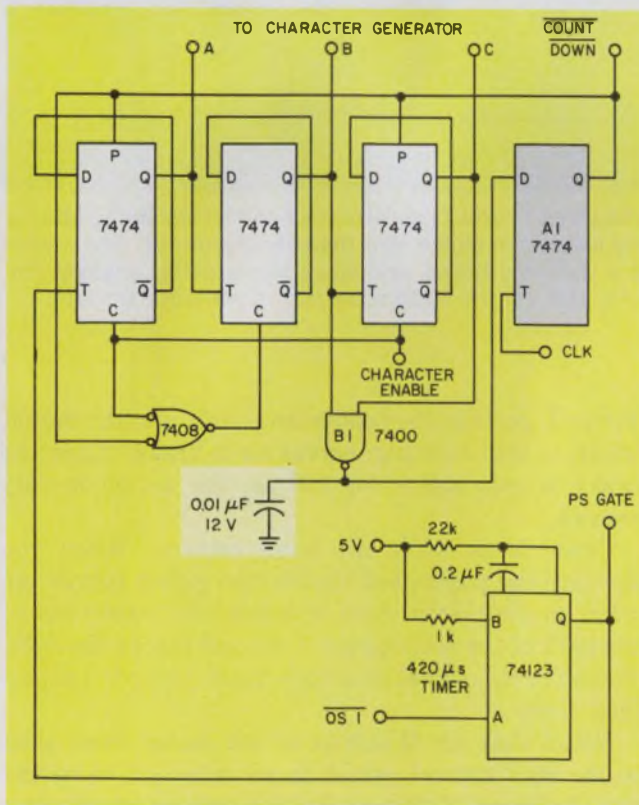

8. Character Enable toggles the 3-bit counter to generate the A, B and C address signals that sequence the character generator. Flip-flop A₁ produces the Count Down signal that decrements the memory address counter. The damping capacitor at B₁'s output squelches ringing.

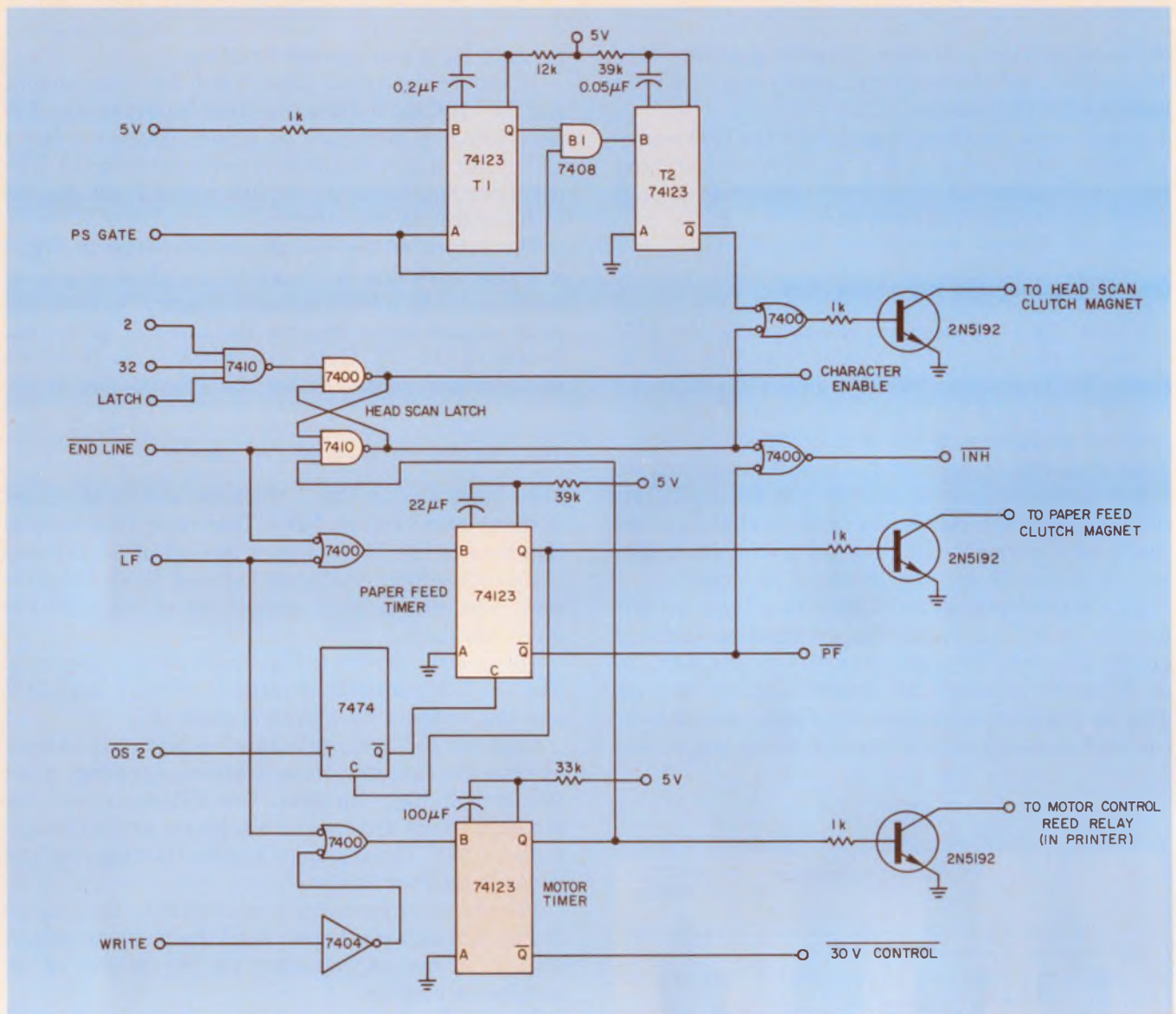

9. Function-control timers clock the printer. Paper feeds while the printer head returns. Once started, the motor operates for one second. When shortened time between PS Gate signals indicates that the head is moving too fast,

one-shots T_1 and T_2 control the head's velocity by pulling the head-scan clutch into the running motor. The motor is a dynamic brake, and since the braking engages for only 100 μ s, the head-scan action remains smooth.

the motor timer times out and releases the clutch by resetting the latch.

When the clutch releases, the head begins its return travel powered by a spring. To prevent the head from slamming against the right-side stop you must control the head's velocity. Tie the PS gate to the A input of timer T_1 and to one input of B_1 and the result is a simple velocity control.

Two timers control head speed

Each time a PS-gate signal is received, T_1 fires on the negative transition (trailing edge) of the signal and enables B_1 . If T_1 times out before the next PS gate, T_2 is not triggered. However, if the head is moving too fast, the next PS gate comes sooner, so the signal will be gated through, because T_1 is still enabled.

Timer T_2 pulls in the head-scan clutch, and the motor, which is still running, serves as a brake. Since the brake is only active for 100 μ s, the action is very smooth.

Paper feeds while the head returns. When you activate the paper-feed clutch, the paper moves upward on the platen. Also, the disk slot moves out of the path of the optical gate (OS_2) and blocks the light. When the OS_2 signal goes high again, clear the paper-feed timer.

Notice that the Q output of the motor timer goes to the 30-V control, which is an interlock to reduce the likelihood of damage to the printer mechanism or print solenoids, should the logic fail.

Use a 1488 line driver at the output of the system to convert the logic levels directly to line voltages consistent with EIA RS-232C data specifications. ■

MOTOROLA OMNIBUS



Rollin' along the routes to right design

Superpower* Schottkys unprecedented performance at high temps.

Motorola's new state-of-the-art MBR7545 power Schottky rectifier is rated for 150 A peak, 50% duty cycle square wave output, 20 kHz 150° junction (90°C case), AT RATED REVERSE VOLTAGE!

The 20 to 40 V MBR7520 series of Schottky barrier devices employs epitaxial construction with oxide passivation, and has AVALANCHE characteristics for transient immunity! Lower leakage current allows no derating for reverse power.

Motorola offers the broadest line from 0.5 A to 75 A and at highest V_R —45 V—for larger ranges of input V from off-line supplies. Extremely low V_F , as much as 0.1 V less, can save you up to 20% in power at 100 A over other types. Super-high case and junction temperature capabilities (175°C peak) afford smaller heat sinks, higher reliability... up to twice the amount of heat dissipation than also-rans.

Even dv/dt is upped... 1,000 V/ μ s for the '7545. And θ_{JC} . It's just 0.8°C/W instead of the usual 1.0 for more reliability and efficiency.

And that's what Schottkys are all about—efficiency in high-frequency switching. The new MBR7520—7545 units will be the new standards in those designs. Price for the prime MBR7545 is \$7.95, 100-up.

Send for data sheets and spec-by-spec, side-by-side comparison of this new standard with the SD51. A real eye-opener.

Also available are new 35 A DO-4s and 60 A DO-5s with similar capabilities. □ A

M.O.D. Adventures in processing with MECL 10800 LSI

Nowhere is the number-crunching power and flexibility of microprogramming more aptly demonstrated than in this high-speed, bipolar LSI processor.

Called M.O.D. for Microprogrammed On-Line Demonstrator, it's an 8-bit arithmetic processor built from the MECL 10800 family.

Slave to an M6800 MOS EXORciser* system, the M.O.D. has a 1K x 32-bit writable control store, extensive micro-instruction set (including BCD), and 17 working registers. Operating with a 10-MHz clock rate, a single precision binary floating point multiply requires 37.6 μ s. The M6800 system allows a user to read, load and dump WCS as well as run microprograms.

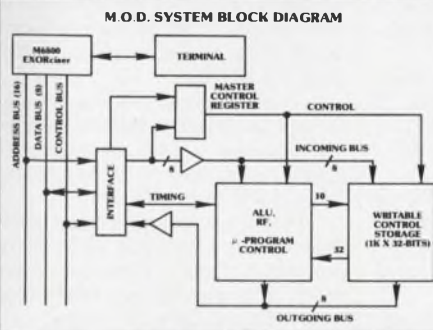

There's a new handbook describing the M.O.D. in detail and it's available only through your local Motorola Field Applications Engineer. It shows processor structure, gives microprogramming techniques and examples as well as lots of other nitty-gritty. Just call him on the phone and fork over \$1.50.

*Trademark of Motorola Inc.

Motorola Announces NE592/SE592 Diff Amp

Here's a linear gem for magnetic memories, communications, display and video recorder systems: the NE/SE592—a monolithic, two-stage, differential output, 90-MHz, wideband video amplifier.

It has fixed gains of 100 and 400 without external components and adjustable gains from 400 to 0 with one external resistor. The input stage has been designed so the circuit can function as a high-pass, low-pass or band-pass filter with the addition of a few external reactive elements between the gain select terminals.

Available in plastic and ceramic DIPs or metal can versions and in two temperature ranges (0° to 70°C and -55° to 125°C) it's particularly useful in magnetic tape or disk file systems using phase or NRZ coding and in high-speed thin-film or plated wire memories.

Prices are good, \$1.10 to \$2.95, 100-up, delivery's excellent. □ B

Let's talk about digitizing voice with I²L Interface ICs

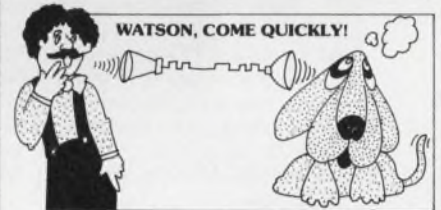

How'd you like an interface IC that multiplexes many voice channels on a single pair of wires, switches telephone PBX and scrambles for secure communications?

Try a continuously variable slope delta modulator, or CVSD. It's a simple alternative to more complex conversion schemes in systems requiring digital communication of analog signals.

S/N ratios of the recovered signal do not vary with distance when using digital transmission; and multiplexing, switching and repeating hardware is more economical and easier to design. The CVSD A-to-D is well-suited to digital communications and is an economical, efficient means of digitizing inputs for digital transmission.

The MC3417L military version and MC3418L telephone-quality CVSDs are firsts. They'll soon see use in telephone, PBX, military and commercial security, because they provide a breakthrough into practical, mass-producible telephone codes.

Features include one-chip encode and decode functions with digital input for selection... compatible I²L-linear bipolar technology... CMOS-compatible digital output... input threshold selectable. The '3417 has a 3-bit algorithm for 16 kHz and below clock rates and the '3418 4-bits for 32 kHz and higher.

The loop offset and current matching of the '3418 have been laser-trimmed to allow outstanding idle channel performance in commercial telephony.

'3417, 100-up, \$6.95; '3418, \$7.95.

Send for an applications-oriented data sheet and complete technical article. □ C

The lowest-cost 4027

challenges the 4K RAM field

Of all the 4K dynamic RAMs that have achieved popularity, our 4027 is the industry standard. And priced better than 40% below competitive types at current prices. The challenge for 4K memory leadership is on.

Motorola's highly reliable N-channel silicon gate technology results in a 4096 x 1 organized RAM designed for high-performance, lowest-cost applications in mainframe memories, buffer memories, and peripheral storage. It's a second source for the MK4027.

Three speeds are presently offered, each in plastic and hermetic 16-pin dual in-line packages. The first has a maximum access time of 150 ns, and the second and third are 200 ns and 250 ns versions. The first has maximum Read and Write cycle times of 320 ns, and the others are 375 ns. The low-power dissipation is 27 mW max, standby, and 470 mW typical, active.

Each of the 64-row addresses is refreshed every 2.0 ms in this one-cell design. All inputs are TTL-compatible, and the output is three-state TTL-compatible. Power supply pins are at the corners of the standard 16-pin packages for optimized board layout. Our 100-up prices for the fast, faster, and fastest MCM4027Ps are \$6.60, \$6.90, and \$8.20. □ D



MCM6670

newest ROM character generator

The MCM6670 is mask-programmable, a horizontal scan (row select) character generator with 128 characters in a 5 x 7 matrix. It complements our broad line of 128c x 7 x 9 and 128c x 9 x 7 character generator ROMs.

A static 8K ROM in an 18-pin package, with diagonal corner supply pins, it operates at a max access time of 500 ns from a single +5 V power supply. It's TTL-compatible.

You specify the content of the 6670 by programming a single photomask. Photomask encoding is computer-aided for quick, economical, and efficient implementation of the bit pattern.

In operating the 6670, a seven-bit address code selects one of the available characters, and a three-bit row select chooses the correct row to appear at the outputs. The rows can be sequentially selected to provide a seven-word sequence of five parallel bits per word for each selected character.

In plastic, the MCM6670 is \$8.15, 250-up (minimum quantity), after a one-time mask charge. □ E

MPS6172
complements
MPS5172



for 11.5¢

The lowest-priced industry-standard plastic transistor now has a PNP complement . . . and it's equally low-cost!

The MPS6172 is a true, spec-for-spec matchup with the '5172 . . . hFE range of 100 to 500 at 10 mils . . . 0.25 volts V_{CE} (sat) max . . . one-piece, injection-molded Unibloc* package . . . etc.

Use it for general-purpose, low-level amplifier applications where you don't want to spend much more than a thin dime or so, 100-up. For either one. □ F

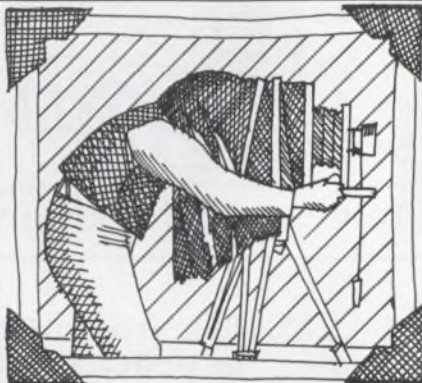

Get a better picture

with 1,400 V Horizontal Darlington

Wide-screen advantages are here with the 8A MJ10011—brilliantly conceived to combine output transistor with damper diode, provide an order of magnitude increase in gain and equal the performance of discretes, such as the BU208, in all critical parameters such as t_f , SOA, V_{CE} (sat) and thermal stability.

It does all that plus furnishing better-than-discrete cost effectiveness.

This new unit allows options never before available. The transistor has nominal hFE of 40 at 5 A compared to 3 for the discrete BU208. This allows sat V typically less than 2 V at 4 A with only 200 mA of base drive whereas a discrete needs 2 A drive for comparable sat V. This modest demand greatly simplifies drive circuitry and is well within IC technology needed to produce an integrated driver plus oscillator which would direct-drive the MJ10011.

The integrated diode section functions as well as existing discrete damper diodes and provides a path for the yoke current during negative swing of the scan cycle with about 1.2 V drop at 4 A.

And an ac coupling capacitor from the driver to the Darlington input offers built-in protection from excessive current flow which otherwise destroys the output if the horizontal oscillator locks up.

Thermal stability is ensured through proprietary glass passivation and specially-constructed TO-3 packaging providing high voltage and low thermal resistance capabilities. Large glass insulators around B-E pins maximize creepage paths and resist arcing. Header thickness is optimized for typically 0.6°C/W θ_{JC} without sacrificing strength.

100-up is just \$3.50. □ G

M10800 IS MECL LSI!



Recently introduced is one of the best-conceived, high-performance bipolar processor functions available today . . . the MC10803 memory interface. It's the communication or interface link between main system processor and main memory or peripheral section.

It controls bidirectional flow of data to and from the main processor and, in parallel with data transfer, it generates or formats memory addresses. The latter is accomplished with an on-chip ALU. By placing an ALU at the processor, peripheral port memory addressing can be done in parallel with the main ALU complex operations.

Introductory price for the '10803 is \$40 in quantities of 100. Of course, it's in the new 48-lead quad in-line QUIL* package.

ALU to you

If you haven't heard of the MC10800M 4-bit ALU, listen up.

Fully characterized over the MIL range of -55° ambient to 150°C T_J , you can use it in applications from space satellites to the Alaskan oil field. Or, if you're not into stuff that heavy, use the standard MC10800 ALU characterized from -30° to +85°C ambient just like the standard MECL 10K series logic family.

Whichever you do, you've got the MECL heritage behind you, developed over years to its present level of LSI sophistication and performance. Speed—performance—system density. MECL LSI.

And militarily speaking

. . . we're the only ones with JAN MECL! The six units found on MIL-M-38510/60 are now available from Motorola . . . the first and only source to be drafted!

JM38510/06001BEB	10501 Quad NOR Gate
JM38510/06002BEB	10502 Quad NOR Gate
JM38510/06003BEB	10505 Triple OR/NOR
JM38510/06004BEB	10506 Triple NOR Gate
JM38510/06005BEB	10507 Triple EXOR/EXNOR
JM38510/06006BEB	10509 Dual OR/NOR

MECL Memory magic . . .

Memories complete MECL's magnificent story. There's a new 256 x 1-bit memory with a max access time of 15 ns available in sample quantities—the MCM10152 RAM. Pinouts and function are the same as the popular MCM10144. And the MCM10139 is a new 32 x 8 programmable ROM. It too is accessed in 15 ns and is sample-available.

Others in the MECL memory production bag are:

MCM10143	8 x 2 Multiport Register	10 ns
MCM10144	256 x 1 RAM	26 ns
MCM10145	16 x 4 Register File	15 ns
MCM10146	1024 x 1 RAM	29 ns
MCM10147	128 x 1 RAM	12 ns
MCM10149	256 x 4 PROM	25 ns

Do it with MECL. It's quicker! □ H

Standard add-in, add-on and microcomputer memory systems expand the capability of popular mini's and micro's

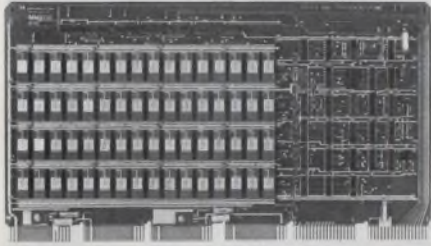

Board and cabinet level memory systems are relatively new in the product mix of the Motorola Semiconductor Group but Motorola's memory system people are old hands in the field. It's not so surprising then, that in a short time our line of add-in, add-on, and microcomputer memory systems has grown to nine standard board-level systems, a selection of chassis, and a creative custom capability.

MMS80810—Here's a high density 32K x 8 or 16K x 8 memory that's designed for 8080A systems, so it's SBC80/10-compatible. It's fast, with a max access time of 450 ns. A refresh cycle is generated by on-board logic, asynchronous to the MPU, and it has on-board address select jumpers for locating 32K words in a 64K word memory map in independent 8K segments. Even the SBC80/10's originators don't have this one.

MMS1110—This one's a 16K x 16 LSI-11† compatible memory that mounts directly into the H9270 backplane slot. All timing, control and bus interface logic are included. It's compatible with the DEC Q Bus†. It's fast, low power, and at \$790 in the 25 quantity, low cost. An 8K x 16 version is \$420 and a 12K x 16 board is \$650 in the same 25 lots.

MMS1116—A high speed, fully expandable 16K x 16 PDP-11 add-in memory. The MMS1116 mounts directly into the MF11 backplane used with PDP-11/05, 11/10, 11/35, 11/40, and 11/45. Complete hardware and software compatibility. With DEC's memory management, this system can provide up to 124K words of main memory. Maximum access time is 400 ns. At \$1,100 in quantities of 25, it's very economical, too.

MMS1118—Another PDP-11 add-in memory, this one 16K x 18. It's designed for the PDP-11/04 and PDP-11/34, and plugs into the modified UNIBUS†. The MMS1118 is fast, with a max access time of 550 ns, compact, and low cost, with a 25 quantity \$890 price tag. It has short circuit memory protection, too.

MMS3400—The 3400 is a 64K x 9 or 32K x 18 building block memory for large systems. It combines high-speed access time of 450 ns max, low P_D of only 30.6 W continuous DMA operation and modular expandability—configuration for up to 256K words per system is practical. Asynchronous or Handshake refresh modes are options and either word or byte mode may be selected with use of an on-board jumper. The 3400 also provides short circuit memory protection.

M6800-based systems benefit, too

MMS68100—This 16K x 8 memory was designed to provide a fast, low-cost, high-density board to simplify the design of M6800-based systems. "Hidden Refresh" relieves the MPU from time wasting refresh cycles. Refresh is transparent to the system. Address select jumpers on the card permit user defined addressing. Cost of the 16K x 8 system is only \$465 in quantities of 25, and there's an 8K x 8 version for just \$285.

MMS68102—Non-volatility is the key to this 16K x 8 EXORciser* compatible memory. Battery backup circuitry consumes only 0.3 W @ +12 V in the backup mode. A multi-layer card makes the MMS68102 very compact. Access time is only 350 ns. Prices are surprisingly low; \$735 for the 16K x 8 and \$465 for the 8K x 8, in quantities of 25.

MMS68103—Here is a 16K x 8 memory with edge connector pin assignments just like both EXORciser and Micromodules. On-board refresh makes the system look static and improves throughput by reducing MPU overhead. It, too is fast, yet inexpensive.

MMS68104—Call this one the kit companion. It's an ultra low cost, \$395 each, 16K x 8 memory design to provide the maximum amount of memory at the least expensive price for hobbyists and users of the MEK6800DII kit. □ †

†Trademark of DEC

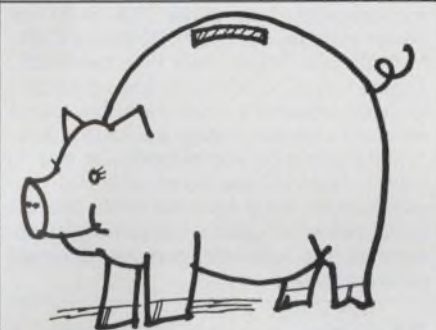

30A, 500 V Switchmode* Darlingtons

Save Blood, Sweat, Tears & \$\$

How about saving at least 25% in bucks and an infinite amount of wear and tear on yourself in switching regulator design? The fastest, highest-current, highest-voltage power switching transistor around can do it for you!

The MJ10015-16 SuperPower* Darlingtons are designed for high-voltage, high-speed power switching in inductive circuits where fall time is critical . . . regulators, inverters, solenoid/relay drivers and motor controls.

Where they really shine is in large switching regulators by eliminating, or drastically reducing, paralleling. With these, the paralleling and matching is already done—all you do is plug 'em in and watch 'em go: 180 ns typical fall time . . . 1 μs inductive storage time . . . 25 min gain at 20 A . . . 450 and 500 V BVCEO! □ †

*Trademark of Motorola Inc.



Lock in your frequencies with these PLL frequency synthesizers

Motorola has taken the industry standard phase-locked loop frequency synthesizers and made them for operation over a wider voltage range and to higher temperatures. They are the MC145104, 06, 07, 09, and MC145112.

The MC145106 is the full pinout star performer in this family of monolithic CMOS devices designed for applications in equipment such as CB and FM transceivers. The other units are all limited pinout versions. The operating temperature range is -40° to +85°C, the full standard industrial range. A single supply in the +4.5 to +12 V range is all that's required.

The device includes an oscillator/amplifier, a 2¹⁰ or 2¹¹ divider chain for the oscillator signal, a programmable divider chain up to 2⁹ for the input signal, and a phase detector. The phase detector controls a voltage-controlled oscillator.

Our replacement chart works this way:

MC145104 for SM104, MM55104, MM55114
MC145106 for MM55105, MM55116
MC145107 for SM5107
MC145109 for SM5109
MC145112 for SM5106

□ K

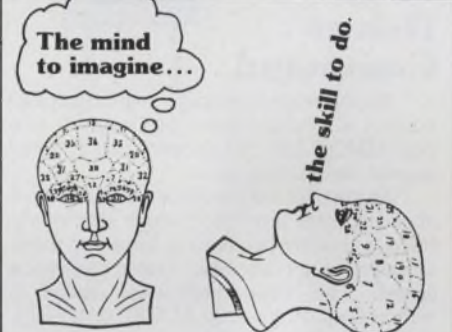

—in every mainstream technology.

Technology in ECL. Technology in TTL. Technology in MOS.

That's what we've got, and in every processor, logic and memory category.

We've been around a long time in ECL and MOS logic, we've innovated with 6800 and 10800 processors and we've intro'd some great RAMs, ROMs and PROMs.

Last, but not least: 54/74LS . . . we've turned raw silicon into fine-tuned LS TTL product in just 2 months. The circle (or square matrix) is now complete. Motorola is a leader in every mainstream technology.

Put it all together with our overwhelming discrete capability and our leadership in linear interface and you've got what Motorola is all about—the most complete semiconductor technology from here to there. And no other can make that claim.

LINEAR INTERFACE AND DISCRETES

	ECL	TTL	MOS
MPU	10800	2900	6800
LOGIC	10K	LS	CMOS
MEMORY	1K RAMs PROMs	4K, 8K PROMs 1K RAMs	4K Static RAMs 4K, 16K Dynamic EARAMs - ROMs

8K EPROMS

— 450 ns or 300 ns



'77's new 8K EPROMs provide two different speeds: 450 ns for the MCM68708/MCM2708 and a faster 300 ns for the MCM68A708/MCM27A08. All are pin-compatible with our MCM65308 and MCM68308 mask-programmable 8K ROMs, and upward compatible with the 16K MCM65317 and MCM68316E mask-programmable ROMs, for low cost and high volume applications. The 68708 and 68A708 are bus compatible with the M6800 micro-processor family.

They are organized as 1024 bytes of 8 bits and use three power supplies. These highly reliable 8K EPROMs are available now in 24-pin ceramic packages specified for a 0° to +70°C temperature range. The 450 ns 68708 and 2708 are \$32.00, 100-up; \$37.50, 100-up, for the 300 ns parts. □ L

Alterable Automotive Speed Controller Resumes Speed

On Simple Driver Command

Sophisticated vehicular highway speed control is now as simple as designing in a new CMOS LSI component with a speed sensor and throttle servo.

Motorola's MC14460 is an automotive speed control processor which continually trims a throttle positioning servo for maintenance of an alterable stored reference speed. The stored reference speed is trimmed up or down by ACCEL or DECEL commands from the driver.

A brake input interrupts the processor's control, but a simple RESUME command from the driver returns the vehicle to the most recent stored speed.

The MC14460 has both master oscillator and pulse oscillator on the chip, and all inputs are diode protected. It features internal redundant brake and minimum speed checks, and uses low frequency speed sensors. No throttle position feedback is required.

TYPICAL AUTOMOTIVE CRUISE CONTROL APPLICATION

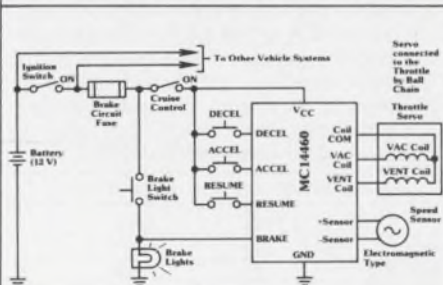

□ M

Peace & quiet return to amplifier designs



with 0.5 dB NF 2N6428-29A TO-92

If you're familiar with audio devices, you know you can't get much below 1 dB NF at about 100 μ A without creating an uproar in design compromise.

Wideband RF Amps

Offer Ultra-Linearity & Response Flatness



A series of 4 wideband RF modules covering 1 to 250 MHz and 10 to 400 MHz ranges provides state-of-the-art linearity.

Designed for radio and cable communication systems plus RF instrumentation and operating from either 13.6- or 24-volt power supplies, the MHW590-93 amps offer ± 1.0 dB gain flatness over their bandwidth. Typical G_{PF} is 36 dB and the units are spec'd for high-performance systems with a source and load impedance range from 50 to 100 Ω .

Performance and reliability is due to hybrid, high-rel type construction of gold metallization on alumina substrate, fluxless solder reflow process for component attachment to the substrate, and laser-trimmed resistors. □ o

Master Semi Selection

with a Master Semi Selector Guide



Here's the new-edition cornerstone of our exclusive Update System . . . 250 pages of up-to-date perspective on all available Motorola components—from Micro-Ts to memories.

It lists, in alpha-numeric sequence, every standard product in the vast Motorola inventory and divides this total offering into a variety of major product categories, with sufficient technical info to permit an intelligent, first-order evaluation. Preferred devices are highlighted.

Master your semi selections now . . . find out the most suitable device for your specific application.

Check the proper box on the coupon. . . then check your local OEM sales rep or distributor for the very best of semiconductors. Motorola's. □ P

Well, we've got the new '6428 series and it offers 0.5 dB typ at 100 μ A and 5 V. It's quietly taking over the low-level, low-noise amplifier world.

A major technological breakthrough made it possible. Without shooting off our mouth on too many secrets, we use virtually defect-free material—no voids or displaced lattice. Then we employ nitride-passivated die with improved designs. Then we use epoxy-packaging with greater moisture resistance which also affords long-term reliability.

And we'll sell it to you for just 40¢-55¢, 100-up.

They've just been JEDEC-registered and are available in any quantity from the Quiet Zone of your Motorola distributor or sales office. Ahhhhh . . . □ N

Beep Beep

for HV Ignition Darlington



Make way for MJ10012 400 V silicon power . . . it's designed specifically for the high-voltage, high-current, harsh environmental needs of automotive applications.

With a rated operating temperature range from -65°C to +200°C, the 10 A metal TO-3 extends by 50°C the limits of previous high-SOA Darlington for demanding auto markets. Nobody else can touch that. It's also useful in switching regulators and motor control.

Nobody else can touch the SOA either—3.5 A at 50 V; or the power dissipation—100 W; or the h_{FE} —300 at 3 A. Even PD is double the competition—100 W at 100°C.

Or the price—just \$2.75, 100-999. That's just HALF what others ask. Oh, there is a similarly-priced unit . . . in plastic. But with only HALF our specs. □ q

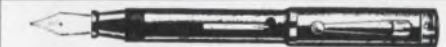

TTL RAM has the speed you need to write/read.



Bipolar, has intro'd another fast-access RAM with all the features you need for high-performance applications. You can get to it in 30 ns, typical.

The MCM93415 and MCM93425 are 1024-bit read/write RAMs organized 1024 words by 1 bit.

They're made with full decoding on-chip, separate data input and data output lines and an active filter chip select. Both are fully compatible with standard DTL and TTL logic families and the '425 has a three-state output to drive bus-oriented systems and/or highly capacitive loads. The '415 is open-collector.

Both provide non-inverting data output, 15 ns typical chip select, 500 mW typical PD and replacement of F-troop's 93415 and 93425.

You'll want 'em for buffer control storage, high-performance main memory, bipolar bit slice and high-speed microprogram control memory storage applications.

Just \$9.75 for the plastic DIP and \$11.00 for the ceramic, 100-up. Send for the data sheet. □ R



Keeping Time

LED or LCD

Whichever way the digital timepiece market eventually goes, Motorola has the standard CMOS circuits and custom capability to match.

The better established LED timepieces are ideally served by the fully integrated 6-function, 4-digit MC14470 circuit. It's fabricated with our low threshold metal-gate technology and designed to interface easily with LED alphanumeric displays of 9-segment first and second digits. Display segment and digit drivers are on-chip. Other chip features include a four-year calendar, interdigit blanking and switch-contact debouncing. Functions include hours with minutes and seconds, day-date and month-date.



LCD displays have been steadily claiming greater support in the marketplace, and Motorola has kept pace with the trend with a raft of new offerings. Of these the MC14482 is the most versatile. It's a fully integrated 6-function, 4-digit circuit with 5-function options. Because the versatility of the circuit allows operation with four different function options, it can be a real inventory reducer. The different display formats are 6-function, Slant-R, 6-function Bar-a, 5-function standard U.S., and 5-function European.

Other LCD timepiece circuits available include the MC14480, a 5-function, 4-digit circuit that replaces the S1424A, TP0232/0233, MM58118/58120, and the MM58117/58119. Our MC14479 is a mirror image of the MC14480. The standard 6-function, 4-digit circuits are rounded off with the MC14481, which interfaces with a 3-1/2- or 4-digit display with an additional segment above and one below the colon.

Motorola's keeping time with the way the world keeps time. □ s



Challenge of the month!

— Our TO-220 vs Anybody's.

We tested. We compared. We documented. We published.

We know, for instance, we had no failures at all after 750,000 device-cycles of 1 minute on/1 minute off at $\Delta T_J = 75^\circ C$. Try that with others.

We know we had less than 1% failure after 8-1/2 million device-cycles at $\Delta T_J = 100^\circ C$. The best of our "competitors" had twice that many failures.

We know Motorola TO-220s have orders of magnitude less failures than others in temp cycling, pressure cooker, high-temp reverse bias and thermal shock. Because we tested and compared.

Our new TO-220s have the nitty-gritty. 2-1/2 times stronger, lead-free, die-attach solder. Cross-hatched die bond areas that control solder thickness and minimize bond degradation. Moisture barrier moats around bond area. Ultrasonic wire bonding. Glass passivation. Heavier, rugged, flat copper leads. Industry-proven mold compound. In-process QA controls at all critical points. Etc., etc., etc.

Motorola TO-220 is designed better than anyone else's to last longer.

Prices are lower, too. Series-by-series and quantity-by-quantity. And even though we 100% test all spec'd electrical parameters INCLUDING SOA, they're still lower than others. (continued)

We've even got Switchmode* units ready to take over your high-voltage needs from 350 to 400 V. Included are all the specs you need to design and characterize high-frequency, 100°C inductive applications.

2N-, TIP- and MJE-types are available now from distributor or factory from 1 A to 15 A, EpiBase* and diffused mesa with more types arriving constantly. A special brochure can be had including rel-report, data sheets, selector guide and . . . the lowest prices around. □ T *Trademark of Motorola Inc.

TO-3, TO-66 DEflation and the prices come tumblin' down

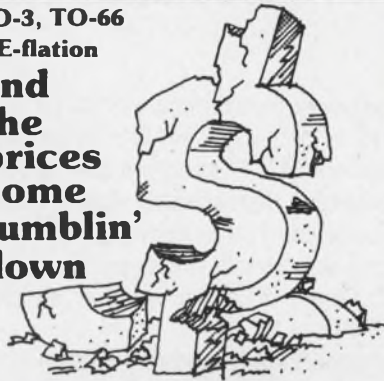

An average 12-1/2% price cut on seven commodity power transistors now brings Motorola prices about 10% lower than others!

We've cut the 2N3055 and its PNP complement MJ2955 6¢ apiece . . . the 2N6569 and its complement 2N6594 6¢ apiece and the 2N3054 driver and its complement 2N3740 7¢ apiece.

And you'll notice we price NPNs and PNP's equally. We're the first and only source to give you this advantage!

Close on the heels of this cost-saving are decreases in 40 other TO-66 prices—at an average of 45%!

75 additional TO-3 standards have been cut an average of 35%, too. You can now get all the quality, reliability and delivery you want in a TO-66 and TO-3 at the lowest prices in town:

Part	Description	100-Up	
		Old	New
2N3738	225 V/2 A Power Switch	\$1.25	\$1.14
2N3441	160 V/3 A Amplifier	2.50	0.75
2N5430	100 V/7 A Amplifier	6.65	2.10
2N5052	200 V/2 A Power Switch	3.35	2.50
2N3442	140 V/10 A Gen'l Purpose	1.75	1.10
2N6228	140 V/6 A Gen'l Purpose	4.28	1.10
2N6338	100 V/25 A Switch	7.15	3.75

Move up to Motorola quality—and low price!

All Aboard! Motorola Omnibus • Rollin' along the routes to right design.



(Coupon Missing?) Send inquiries to: Department LDC, Motorola Semiconductor Products Inc., P.O. Box 20912 Phoenix, AZ 85036

- A MBR7520-45
- B NE5292/SE592
- C MC3471/73418L
- D MCM802P
- E MCM8570
- F MFS6172
- G M110011
- H MCI1883
- I MCI1884
- J JAN MECL
- K MCM10143
- L MCM10144
- M MCM10145
- N MCM10146
- O MMS8819
- P MMS110
- Q MMS1116
- R MMS1128
- S MMS2800
- T MMS28100
- U MMS28103
- V MMS28104
- W MCM145104-112
- X MCM145104-118
- Y MMS28106
- Z MMS28108
- AA MMS28109
- AB MMS28110
- AC MMS28111
- AD MMS28112
- AE MMS28113
- AF MMS28114
- AG MMS28115
- AH MMS28116
- AI MMS28117
- AJ MMS28118
- AK MMS28119
- AL MMS28120
- AM MMS28121
- AN MMS28122
- AO MMS28123
- AP MMS28124
- AQ MMS28125
- AR MMS28126
- AS MMS28127
- AT MMS28128
- AU MMS28129
- AV MMS28130
- AW MMS28131
- AX MMS28132
- AY MMS28133
- AZ MMS28134
- BA MMS28135
- BB MMS28136
- BC MMS28137
- BD MMS28138
- BE MMS28139
- BF MMS28140
- BG MMS28141
- BH MMS28142
- BI MMS28143
- BJ MMS28144
- BK MMS28145
- BL MMS28146
- BM MMS28147
- BN MMS28148
- BO MMS28149
- BP MMS28150
- BQ MMS28151
- BR MMS28152
- BS MMS28153
- BT MMS28154
- BU MMS28155
- BV MMS28156
- BW MMS28157
- BX MMS28158
- BY MMS28159
- BZ MMS28160
- CA MMS28161
- CB MMS28162
- CC MMS28163
- CD MMS28164
- CE MMS28165
- CF MMS28166
- CG MMS28167
- CH MMS28168
- CI MMS28169
- CJ MMS28170
- CK MMS28171
- CL MMS28172
- CM MMS28173
- CN MMS28174
- CO MMS28175
- CP MMS28176
- CQ MMS28177
- CR MMS28178
- CS MMS28179
- CT MMS28180
- CU MMS28181
- CV MMS28182

For complete product itineraries, fill in and send to: Motorola Semiconductor Products Inc., P.O. Box 20912, Phoenix, Arizona 85036

Please have salesman call () _____

Name _____ Title _____

Company _____ Address _____

City _____ State _____ Zip _____

Multi- μ P systems combine the efficiency of dedicated microcomputers with the throughput of minis. And their modular structure makes expansion a snap.

The trend away from the powerful CPU, and toward multiple μ Ps is not only a matter of economics. Multi-microprocessor (MMP) systems also offer the advantages of graceful degradation and a flexibility that greatly simplifies system growth. Modular expansion permits gradual growth increments, and there is less software interaction than with a single, high-performance CPU.

Because processing modules (PMs) execute tasks simultaneously, processing bottlenecks are minimized; and because each PM can be designed for its specific job, throughput is high. The detailed configuration of a multi- μ P system depends on its specific tasks. Such factors as the number of users, devices to be controlled, input types, processing load, and real-time response must be analyzed before you design the PMs and the system that holds them together.

Nevertheless, many multi- μ P systems share enough requirements to make the design of a general-purpose system practical. Such a system can provide office-building security, collect data and control terminals or parking lots. You can also use it to sense and control remote, and quite diversified equipment.

If used for security, a terminal-control unit (TCU) of the system (Fig. 1) can read a uniquely encoded card that permits the user entry into a secured area (building, factory, garage, hotel room, or parking lot). The TCU can check authorization, note the time, monitor traffic, and, if there is an entrance fee, keep financial records. The system's data base is centrally located and may be interrogated by many TCUs, which may be placed simultaneously on one full-duplexed communications line (Fig. 2).

Central-site functions include communication control, file management, hard-copy output or interactive CRT use. Sensors at remote sites may perform such environmental measurements as air quality and smoke density. Or they may monitor energy load, burglar alarms or highway traffic, and transmit results to the central site for processing and storage.

Which μ P is best?

Before you can begin designing a multi- μ P system in detail, check the available μ Ps, and study their

Ted Burton, President, SECOM, P.O. Box 2074, Culver City, CA 90230.

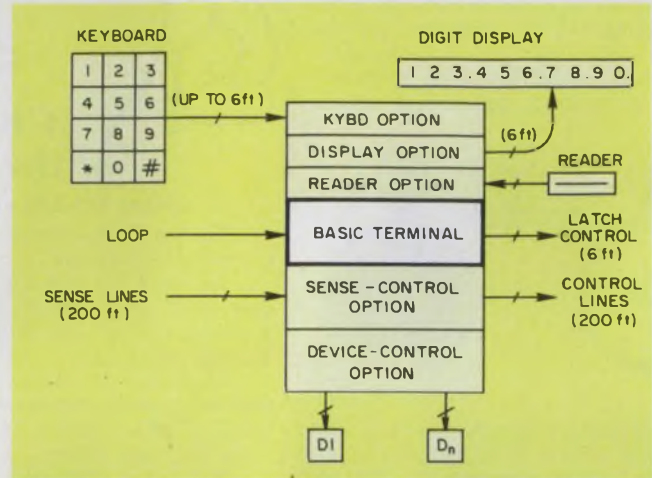

1. A terminal control unit can serve many functions. In this case, the card reader monitors access to a secured area by scanning an ID card.

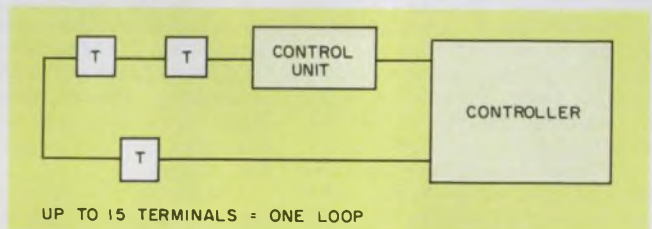

2. The communications loop control unit can handle up to 15 terminals per loop.

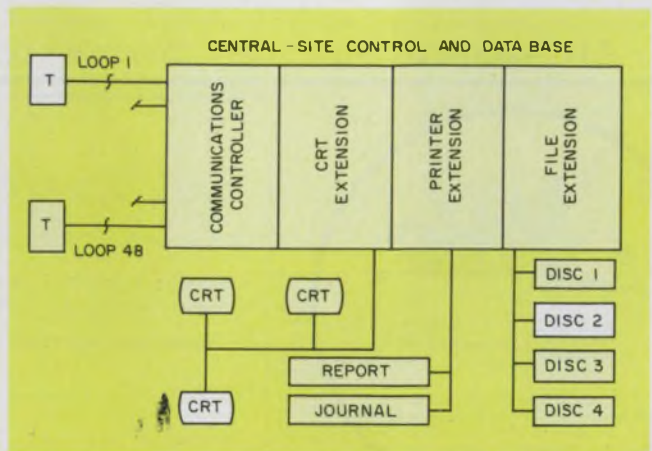

3. The complete system consists of a central-site unit and peripherals. With 48 communications controllers, this system accommodates 720 terminals.

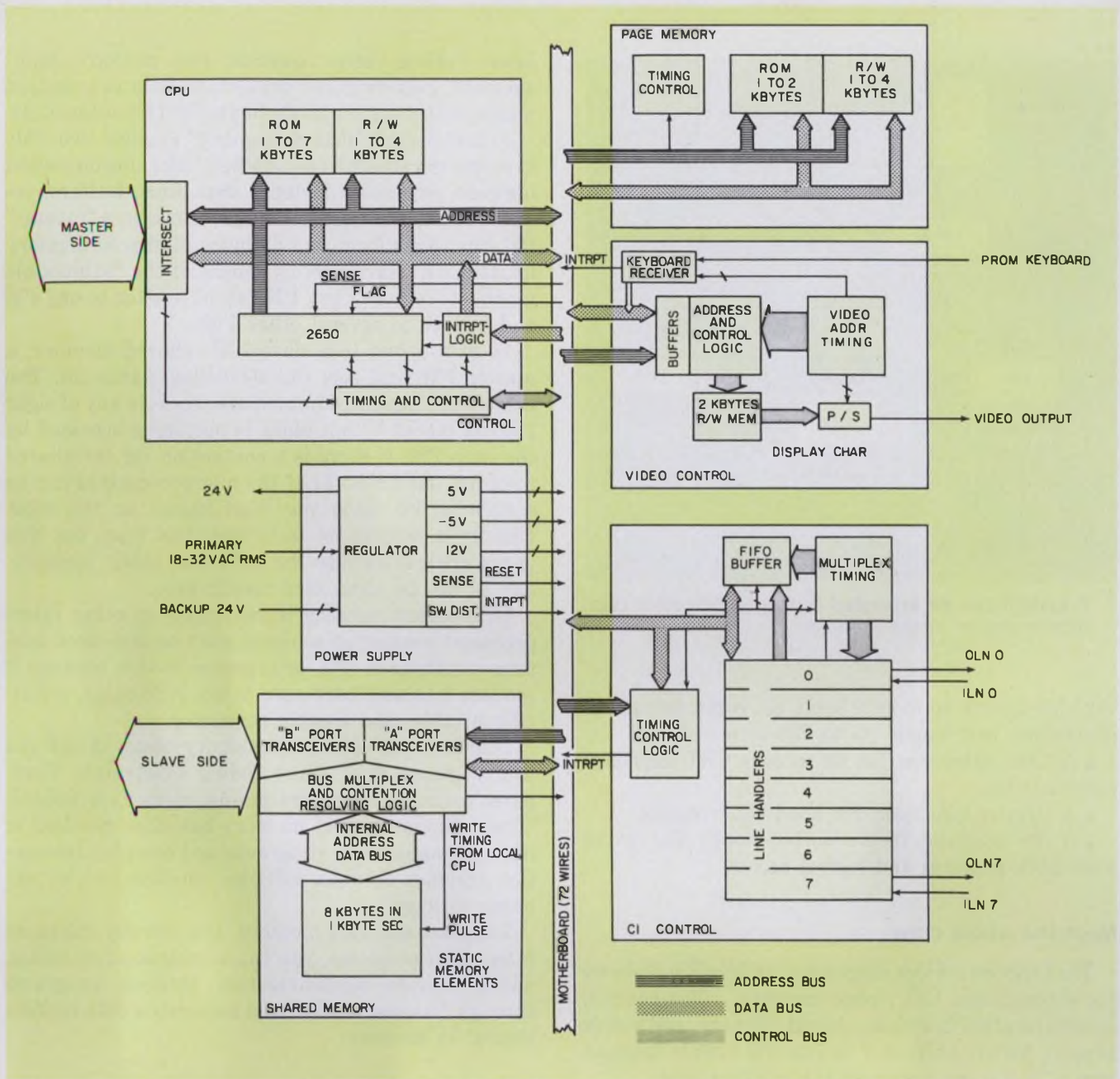

4. Processing modules consist of six submodules. Each is built on a PC board measuring 7 × 7 in.

impact on system engineering, software design, and system cost. The Signetics 2650, for instance, offers a good mix of instruction-set power, hardware-interfacing simplicity and cost for the system shown in Fig. 2.

The 2650's wide variety of addressing modes, particularly indirect and indexed addressing, coupled with a minicomputerlike instruction set and an impressive register complement make programming extremely efficient. As shown by benchmark programs written for different μ Ps, this efficiency reduces memory needs.

The 2650's interrupt structure permits multiple vectored interrupts to service routines located any-

where in addressable memory, and you can exploit this feature when servicing interrupts from the communications interface, CRTs, or floppy disc.

A single 5-V supply, single-phase TTL clock and static operation are all advantages: The 2650 can be suspended indefinitely while resolving access contention, and can easily be single-stepped during system debugging.

Each PM in the system consists of a 2650 microprocessor, up to 32 kbytes of local memory, 8 kbytes of shared memory, and generally one or two I/O controllers. The interfaces (Fig. 3) include:

- A communications controller handling up to eight full-duplex lines with up to 15 terminals per line, at

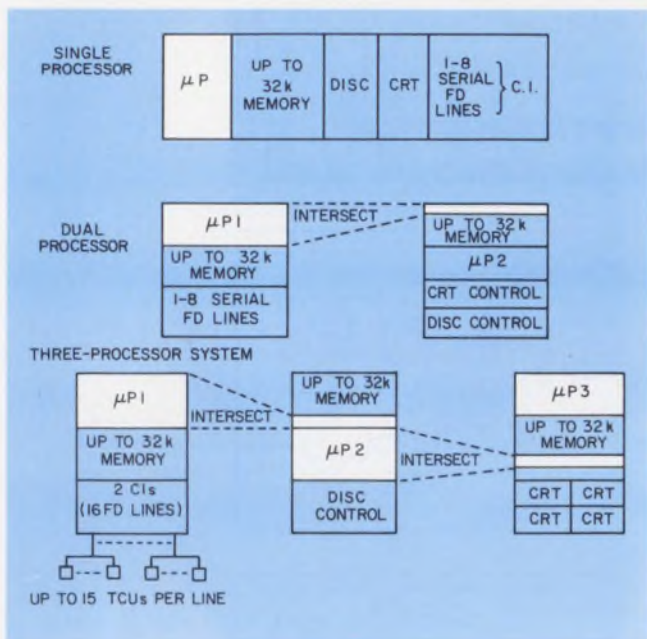

5. A system can be expanded from one processor (top) in increments of single modules.

variable speeds up to 2400 baud. Six communications controllers can handle up to 720 terminals.

- A CRT extension for up to four CRT/keyboard combinations.
- A printer extension for hard copy reports.
- A file extension for up to four floppy-disc drives with both physical and logical access.

Meet the whole crew

The functional block diagram of a PM in Fig. 4 shows six submodules: CPU, page memory, video control, communication interface, shared memory, and power supply. All are built on 7 × 7-in. PC boards inserted into a 72-pin connector on the motherboard.

A CPU submodule contains the 2650 microprocessor, up to 7 kbytes of PROM memory for program storage, up to 4 kbytes of RAM for data storage and programs loaded from a floppy disc, timing and control for system synchronization, interrupt logic for interprocess communication, and an "intersect" feature for the shared-memory interface. The "page memory" provides additional program and data storage: up to 7 kbytes of ROM and 4 kbytes of RAM, in 1-k increments.

A video control unit (VCU) is the brain of a custom terminal consisting of a keyboard and a 20-line CRT with 64 characters per line. The VCU provides the system with a man-to-machine interface by enabling an operator to interrogate the central data base. The operator may search for a name in a file, call up a blueprint or examine a report.

Through the μ P-resident program, the communication interface (CI) controls up to eight full-duplex

lines. Polling, error control, line protocol management, buffering and converting data to standard message formats are implemented in this submodule.

A dual-ported "shared memory" enables two PMs to communicate with one another. Information passed between processors includes data files, buffers, request blocks and queues. The processor in a "master" PM can access from 1 to 8 kbytes of shared memory located in a "slave" PM by means of the "submodule intersect" feature. Any PM can be master to one PM and a slave to several other PMs.

To gain access to a slave PM's shared memory, a master PM first sets the 2650 Flag status bit. The master PM is granted immediate access to any of eight 1-kbyte blocks if that block is not being accessed by the local PM. If there is a contention for the shared memory, one (or both) of the microprocessors can be suspended by using the Wait signal on the 2650. Usually, a suspension lasts less than 5 μ s, but this is not critical because the 2650 uses static memory, and so can be suspended indefinitely.

Dual-ported memory is preferable to other inter-processor connection schemes such as dedicated bus, time multiplexed bus, or crossbar switch because it reduces intersect hardware to six MSI chips, a flat-ribbon cable, and a cable connector.

Dramatically decreased memory costs have freed the programmer of many coding constraints. Compared to the cost of programming, memory is, indeed, "free." The low cost of memory has often resulted in huge, unmanageable programs and complex interaction schemes between software modules, which are prone to bugs.

To isolate software modules, and thereby minimize interaction problems, you can use structured tables, which provide communication between programs through "request blocks" and associated data buffers located in memory.

Software is king

In this multi- μ P configuration, the operating system is a floating real-time executive (REX) that resides in a 1-k PROM in each PM. The subroutines of the interrupt-driven REX are specifically designed to run in a real-time multimicroprocessor system, and it has three important features:

1. All application requirements for I/O are made through the REX in software rather than hardware. So the multi- μ P system's physical resources can be changed without affecting application software.
2. Floppy-disc memory is supported by the REX through an overlay control system that permits the system's features to be extended and facilitates off-line processing.
3. The REX's modular design permits such features as utility routines, diagnostics and simulation, debug or report-writing capability to be added easily.

The REX program is divided into two logical sec-

Message flow within a two-processor system

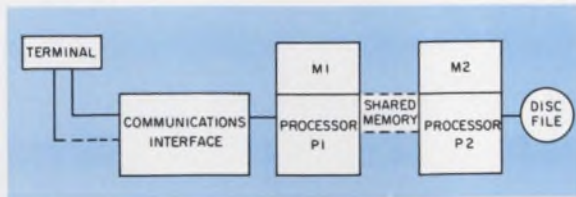

1. Terminal has keyed message into buffer and "message complete" button is pressed.
2. Terminal sets traffic flag, ready to deliver message to communications line when polled.
3. Terminal service routines of P₁ polls terminal.
4. P₁ receives message from the communications interface through terminal service routines. Message is formatted to standard.
5. Upon detection of "end of message," the message is queued by REX to the proper base-level process for service.
6. Application program (base level) formulates the proper response to the terminal, and queues the response.
7. Application program formulates I/O request block and queues it to "log-in."

8. When base-level program is done, control returns to REX. Base level is now free to process additional messages.

9. While base level was completing steps 7 and 8, the return response to the terminal was in process at the interrupt level. Upon completion, the base-level routine is notified.

10. Intersect-software in REX passes log-in message to P₂.

11. P₂ intersect software in REX routes message to appropriate application.

12. LOG routine composes disc I/O request block, and queues request to disc.

13. Disc processes request and routes completion signal to base-level LOG routine.

14. LOG routine completes transfer to disc.

In this example the message paths are direct. In a more complex operation the message paths needn't be sequential. As more processors or functions are added to the system, the number of routing paths increases, but does not become more complex for any given processor in the system. Therefore, each processing module may be viewed as a distinct building block, and modular development of the system is practical.

tions, the unprotected "base level" section where interrupts are enabled, and the "interrupt level" section, where they are disabled. Applications programs typically execute in base level on a first-in, first-out basis. I/O handling routines and certain operating-system tasks execute at interrupt level. A base-level applications program that is executing at the time of an interrupt is saved until the operating level is changed back to base level and execution resumes.

For base-level task control, the operating system uses a 4-byte prefix to message buffers or control tables. The prefix is organized as follows:

THREAD	+0	Link Address, high-order byte
	+1	Link Address, low-order byte
TADD	+2	Task Address, high-order byte
	+3	Task Address, low-order byte

The first two bytes (THREAD) are used to link the packet to the base level task queue. When the 4-byte prefix reaches the head of the queue, control passes to the program whose start address is in the TADD field.

How PMs can pass the buck

Tasks are passed from one program to another in the form of software tables called "I/O request blocks." If the program resides in a different PM from the one that's executing it, I/O request blocks and

associated data are passed through restricted data buffers in shared memory.

Each 2650 μ P can service up to eight interrupts, with another eight available as options. They act as follows:

- System reset: a jump to the initialization routine.
- Real-time clock: When any of the decrement counters has reached zero, a jump is made to its associated program.
- CRT interrupt: The CRT keyboard is checked for "character present" and, if true, the character is queued to the routine specified in the device control block of the CRT for base-level processing.
- CI half-full interrupt: Normal processing of the CI buffer includes message routing and polling.
- Fault time: Should a module fail, system clean-up routines are called.

Except for system reset and fault time, all interrupt routines must save and restore the base-level program they interrupt. All interrupt routines must use the interrupt-level entries to subroutines of the REX.

If you design a multi- μ P system properly, expansion becomes easy. Upgrading from a two-processor system to a three-processor system may become necessary because of increased CRT activity, a larger traffic load between the communications system and the disc, or the need to accommodate high-level languages. Representative configurations for system expansion are shown in Fig. 5. ■■

**With an in-house MOS
capability of your own,
why would you
call in outside help for
an important custom
design program?**

Ask Burroughs.

Burroughs Corporation needed 5 custom circuits, designed to work near the upper edge of MOS technology, for delivery in 6 months. To handle their peak design load, they called on AMI.

We translated Burroughs' logic into MOS circuit designs, cutting several months off the normal time cycle with our exclusive Symbolic Layout of

Integrated Circuits (SLIC).

We delivered. And the Burroughs B 80 computer was unveiled on schedule.

For other MOS companies, this would be a remarkable story. For us, it's pretty standard. Since 1966, we've been solving custom MOS problems effectively, confidentially and economically for many of the world's

largest companies.

The experience they value so highly is available to you. For information, write to AMI Marketing, 3800 Homestead Road, Santa Clara CA 95051.

Or contact your local AMI sales office. We'll deliver like nobody else can.

AMI[®]
AMERICAN MICROSYSTEMS, INC.

Multiprocessing can marry a radar that detects only moving targets to a large air-traffic-control computer inexpensively—and with high reliability.

Microprocessors can often simplify knotty interface problems—such as marrying an advanced radar system to a large air-traffic-control (ATC) computer. Thanks to the flexibility of μ P-based logic (see box), three microcomputer boards can do the job much more economically than a minicomputer: The parts cost for all three boards is \$1500, and a system of this complexity can be developed by a couple of engineers in a few months. What's more, the microprocessors' ability to test themselves, as well as the whole interface, strengthens system integrity.

The moving-target-detector (MTD) radar maintains surveillance of several hundred moving targets, in the presence of clutter like terrain and weather echoes, generating massive data. But the ATC computer requires a special input data format, and an interface is needed.

The interface (Fig. 1) has to accept 50,000 bit/s of "threshold-crossing" data, translate them into standard FAA target report messages, and transmit those messages over two (redundant) communication lines to the ATC computer center. Five basic functions must be performed by the microprocessor-based interface system:

1. Receive individual range-gate threshold-crossing data.
2. Make individual crossings coalesce into potential targets.
3. Apply acceptance criteria to extent of range and azimuth.
4. Format target report and radar-status messages.
5. Buffer messages and transmit them over redundant communication lines.

Microprocessors share the load

In addition to inputting range-gate threshold-crossing data and outputting target-report messages, the microprocessor must combine individual threshold crossings into a single target report. And these target reports must also be checked to establish that the data are credible. Since a timing analysis of these functions

Dr. Thomas Gabriele, Supervisor, Computer-Aided Design, Bendix Communications Div., Baltimore, MD 21204

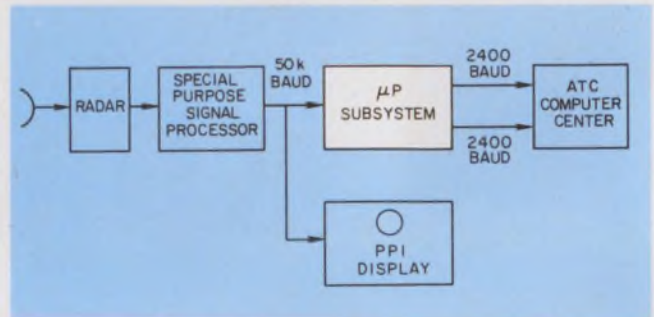

1. A moving-target detecting radar uses signal processing to extract the target data from the clutter. Microprocessors interface the MTD system with the large air-traffic-control computer.

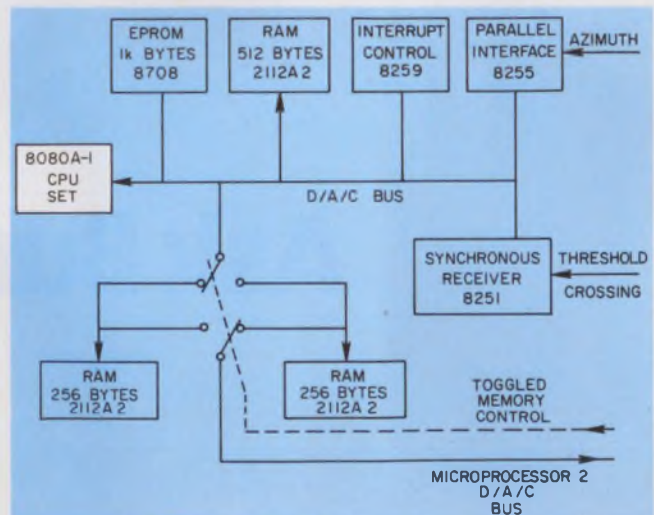

2. One of the three μ Ps used, μ P₁, processes incoming target information and stores it in a "toggle" memory.

indicated that a single microprocessor cannot accomplish everything in the allotted 25-ms interval, the tasks are divided among three microprocessors. One microprocessor (μ P₁) accepts the input data, performs some preliminary processing and stores the data in microprocessor memory.

Another microprocessor (μ P₂) performs the bulk of the actual data processing and only outputs range and azimuth data of acceptable quality, which are then

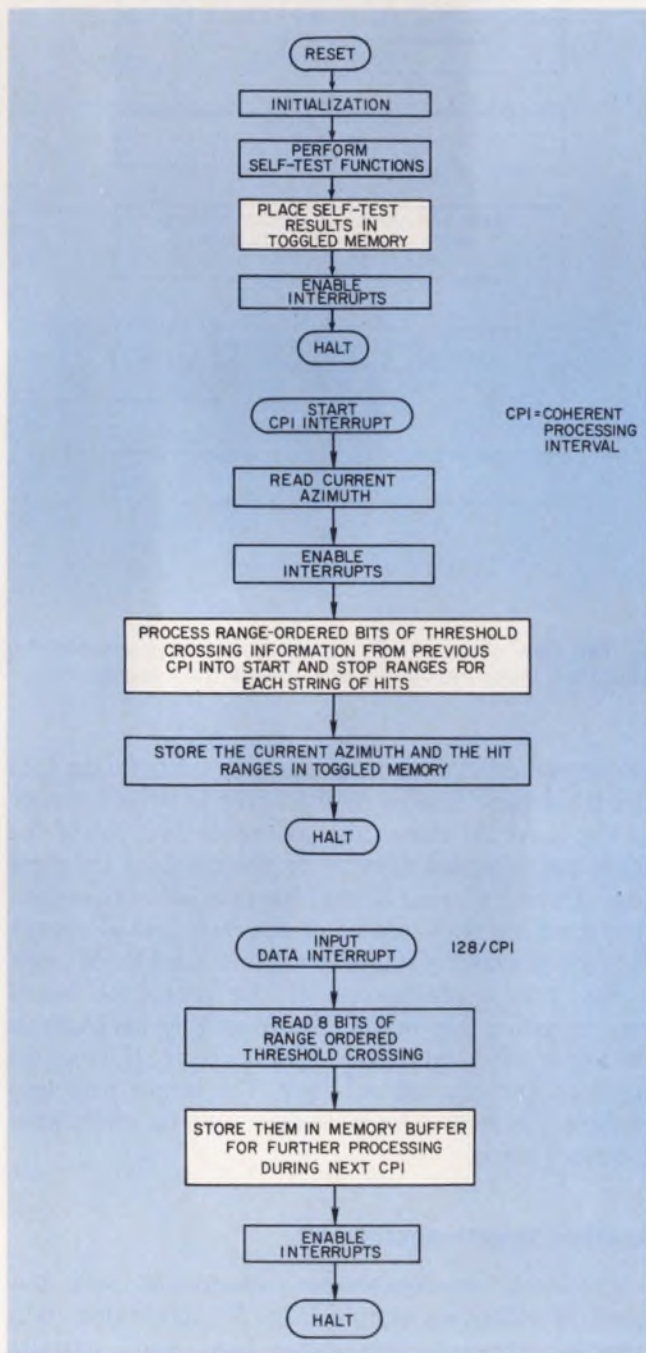

3. During alternate coherent processing intervals (CPI) μP_1 processes and stores target data.

Multiprocessing: wave of the future

Microprocessors are adding a new dimension to data processing. You can now break down a system's overall requirements into specific tasks, and assign a separate microprocessor to each of them. Such distributed systems offer many advantages.

For instance, you can employ multiple microprocessors within a single system and by providing surplus processing capacity you can boost system reliability. In the event of failure of a particular processing element, you divert processing tasks from that element to the others in the network. Such dynamic reallocation provides a much higher level of virtual redundancy than the mere number of processors indicates.

A multimicroprocessor system design can also be used simply to reduce over-all system cost, if you dedicate separate microprocessors to different major system functions. A design based on several microprocessors may be more cost effective by a factor of 10 than a single conventional minicomputer.

In addition, the system's idle time can be used by the microprocessor to test itself—often by adding only a few instructions to the program. For example, reading fixed values from memory, performing simple computations with those values, and comparing results with other fixed values in memory, tests memory addressing, CPU-instruction execution, and control-bus operation. With some additional hardware, the microprocessor can even perform built-in test functions of other subsystems.

Because microprocessor chip sets can easily multiplex a variety of data over a single serial communication line, they reduce the amount of wiring required in a large system. One day microprocessors may significantly reduce the cost of large avionic systems by multiplexing signals onto single transmission lines.

reported to the ATC center.

A third microprocessor (μP_3) is responsible for handling the dual (redundant) communication lines. It formats all output messages and gives the ATC computer the operational status of the remote radar.

Of course, using these three microprocessors in this way cannot reduce the total processing time of the

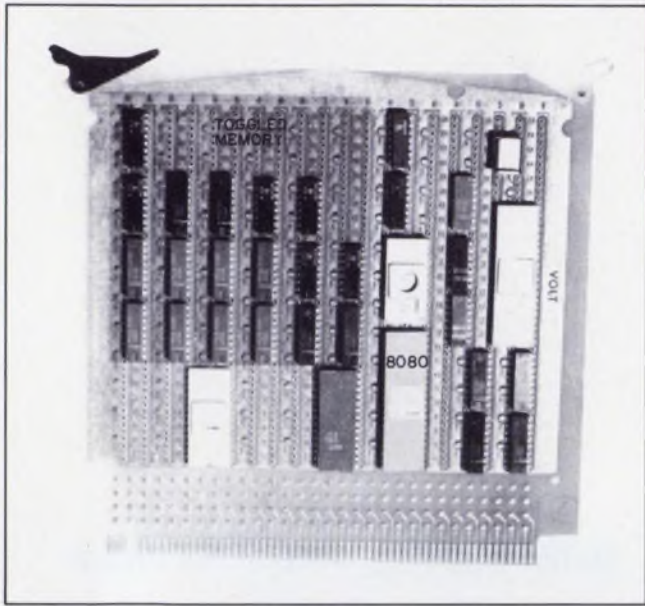

4. The three microcomputers each take up a PC board. The toggle memory resides at the top left of the μP_1 board. The rest is occupied by the 8080 and its support chips.

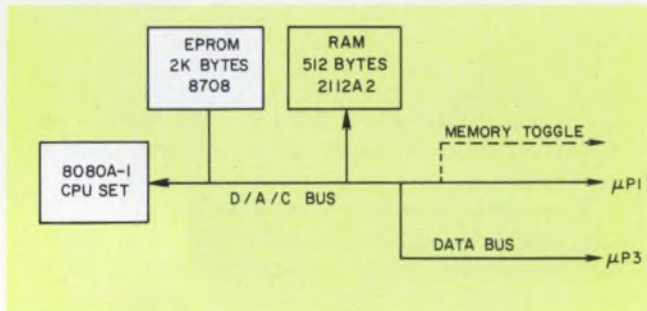

5. Most of the signal processing is handled by μP_2 , which gets data from toggle memory, and passes results to μP_3 .

data. But μP_1 can start working on the next data batch while the other two are still busy with the previous one.

Using several microprocessors also makes it possible to tailor the architecture of each μP 's subsystem to the particular tasks that are assigned to it. Fig. 2 outlines the functional organization of μP_1 . It receives threshold crossings through a serial interface, while azimuth data are inputted over a 12-bit parallel interface.

Enter the toggled memory

Processing time is divided into "coherent processing intervals" (CPI). As the flow chart for μP_1 (Fig. 3) shows, the threshold crossing and azimuth data are converted into range limits, which have to be passed to μP_2 . The resulting heavy information flow between the two microprocessors must be handled without disrupting the actual processing tasks.

The problem can be solved by a "toggled" memory.

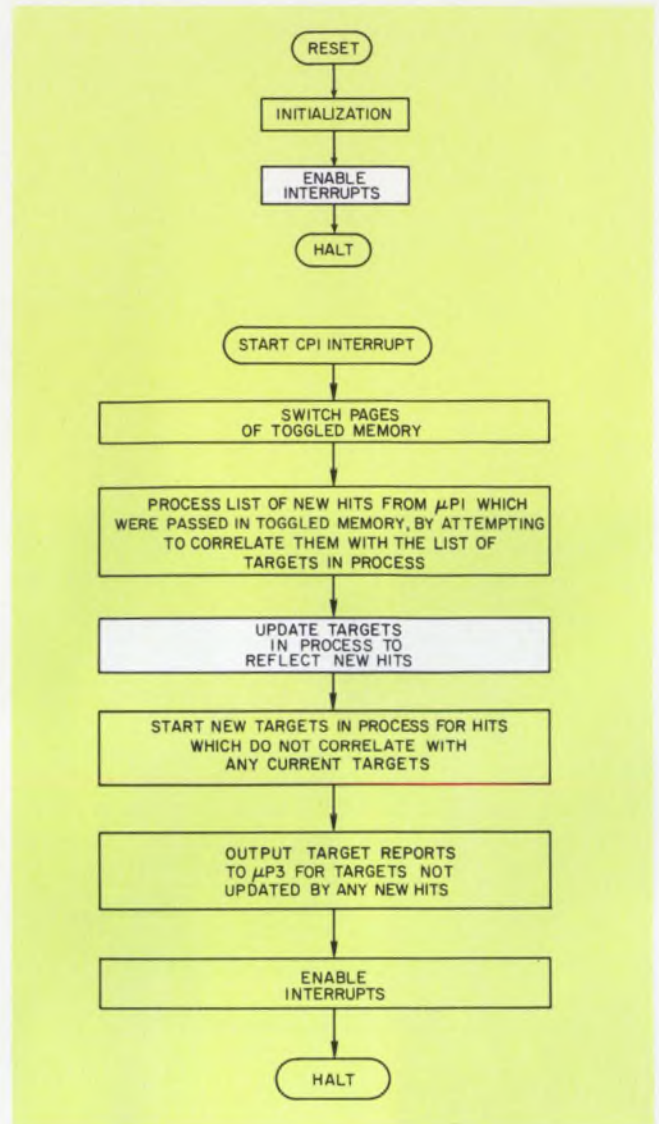

6. The flow chart of μP_2 shows how the processor determines from individual hits where the targets are.

During all odd 25-ms intervals, μP_1 writes data into the RAM page located in the lower left-hand corner of Fig. 2. At the same time, μP_2 reads data out of the RAM page located directly to the right of the first page. During all even 25-ms intervals, μP_1 writes data into the RAM page located on the right and μP_2 reads the data previously stored in the left-hand RAM page.

Fig. 4 is a photograph of the prototype board implementing this design. The 18 smaller packages in the upper left-hand corner of the board are the toggled memory and bus control logic. The larger packages contain the 8080 microprocessor and its associated interface chips.

Another target—another hit

The second microprocessor's functional block diagram is relatively simple (Fig. 5). It obtains data directly through its data bus and outputs range/azimuth pairs of reported targets to μP_3 . But as the flow chart (Fig. 6) shows, μP_2 also identifies

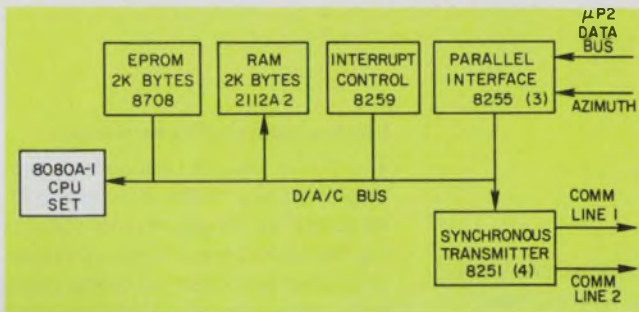

7. Communications with the ATC system are handled by μP_3 , which uses two redundant data lines, but switches to a single line if one becomes defective.

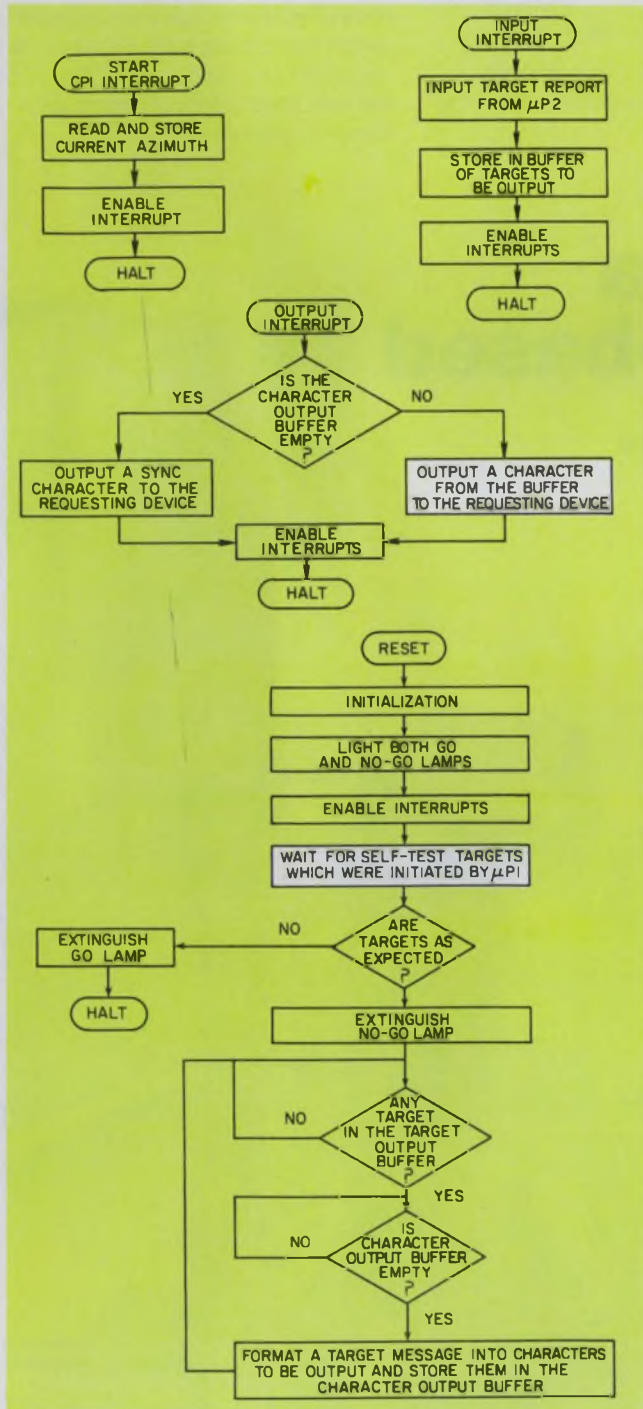

8. The normal operation of μP_3 is traced in these flow charts. The bottom one includes the self-test feature.

new targets. It does so by comparing the "hit list" of μP_1 with previously identified targets. The updated target data are now ready for transmission to μP_3 .

The third microprocessor, μP_3 , is in charge of this transmission (Fig. 7). It has a rather large 2-kbyte RAM to store as many as 200 target reports until they can be sequenced onto the two output lines. The μP controls two 8251 serial-communications interface chips for each communications line. Each of the 8251s can handle up to 8 bits.

But the message words to the ATC computer must be 13 bits long. So, in response to interrupts, μP_3 outputs eight bits on one communications chip, and five bits on the other. The clocks to these chips, and the data from them, are hardware-steered so that the 13 bits appear consecutively on the communications line (Fig. 8). To improve system reliability, the two lines share the message load except when μP_3 discovers that one of the lines is out of order. In this event, all messages go over the good line.

Get a free bonus

As a result of using microprocessors for the radar interface, an extra feature is available—a self-test capability that guarantees over-all system integrity. Whenever the system is turned on, the microprocessors test themselves automatically. The operator can also initiate a test at any time. Instead of listening to the radar, μP_1 accesses "canned" data stored in its ROM memory, and treats them as if they came from the radar. After performing its preliminary processing, μP_1 passes the results on to μP_2 , which processes the test data as it would any other data.

The test data are designed to produce four acceptable targets. Accordingly, μP_3 , which is aware of the test, doesn't compose output messages for the first four target reports it receives from μP_2 . Instead, it goes to its read-only memory and retrieves copies of the four correct target reports. It compares these with what it receives from μP_2 . If they agree, it turns on a Go light. If they do not correspond, it turns on a No-go light. In this manner the operator knows positively whether the system is performing all functions properly.

Each of the microprocessors and their associated circuitry are assembled on 6 × 6 in. standard logic prototype boards. They consume a total of 18.5 W and are easily integrated with the rest of the radar's signal processing hardware. The need to handle 32 separate targets at the same azimuth simultaneously dictates the use of 3-MHz 8080s, rather than the conventional 2-MHz versions. The parallel interface between μP_2 and μP_3 , the toggled memory, and the aforementioned output-communication line interface are unique to this 8080 application. ■■

Acknowledgment

The radar interface was constructed by the Bendix Communications Division, under internal funding, in cooperation with the FAA.

You've designed, debugged, and loaded your system software. Now you need several powerful capabilities to ensure trouble-free execution on the prototype: the ability to look at data in different ways . . . to compare known good data with new data quickly and easily . . . to analyze both system and peripheral-interface timing.

The TEKTRONIX 7D01F Logic Analyzer offers you all those capabilities in a single instrument.

Look at data in different ways.

The 7D01F lets you choose from five display modes: maps; state tables in hexadecimal, binary, or octal code; or timing diagrams. How often have you encountered a problem you knew you could spot just by scanning overall program flow? How often have you wished you could compare state tables in the hexadecimal code you work with as well as the binary code your microprocessor knows? How often have you wanted to switch from a state table display to its corresponding timing diagram? The 7D01F can help at each step of this troubleshooting procedure.

Troubleshooting a microprocessor-based system is easier...

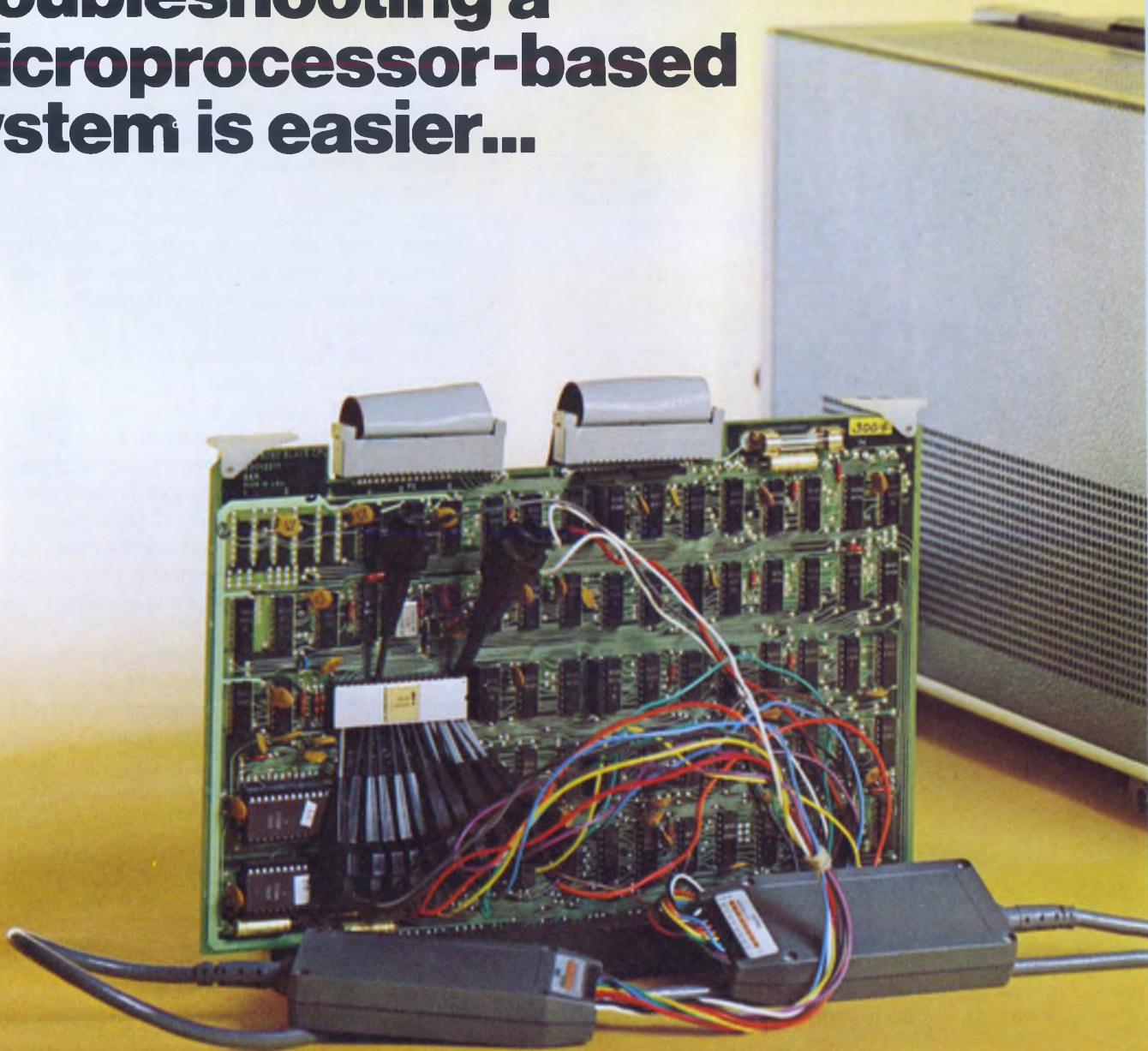

Compare known good data with new data.

The 7D01F features two comparison modes which facilitate in-depth software/hardware debugging. The EXCLUSIVE-OR and RESET-IF modes speed up what would otherwise be a very tedious process: checking the program flow chart against what falls out when the program is run.

For an EXCLUSIVE-OR comparison, simply verify known good data, store it in reference memory; acquire new data, and select a table comparison mode. The reference table and the compared table (which may be in hex, octal, or binary) will be displayed side by side, and the differences between the two will be highlighted for ready identification.

Use RESET-IF to track down an intermittent fault. In this mode the 7D01F can automatically acquire and compare up to 4096 bits of new data to 4096 bits of reference data. Data is continually reacquired until a mismatch occurs. If there is a mismatch, the instrument holds the display, highlights the differences, and displays the number of resets that occurred. This frees the operator from continually monitoring for wandering programs, intermittent loops, or ragged-edge timing problems.

Analyze system and interface timing.

The 7D01F offers synchronous data acquisition at speeds up to 50 MHz. But it is sometimes necessary to view microprocessor operation with increased timing resolution, as well as to locate timing discrepancies in the system's interface with the outside world. You may, for example, need to asynchronously examine data coming into the I/O port before you can determine whether incorrect information is coming from the I/O port itself or the hardware on the other side. The 7D01F offers asynchronous data acquisition at sample intervals of up to 100 MHz.

...with the Tektronix 7D01F Logic Analyzer.

All these unique features are available only in the TEKTRONIX Logic Analyzer. To find out more about how the 7D01F can simplify your work with microprocessor-based systems, just call your local Tektronix Field Engineer. He'll demonstrate the 7D01F in your application, and acquaint you with its many other features, including 16-channel word recognition, 1M Ω /5 pf logic probes, 16-channel data acquisition, 4k formattable memory, and 7000-Series mainframe compatibility.

You should also send for our newest application note, describing in detail how a 7D01F can be used with microprocessor-based systems. Write Tektronix, Inc., P.O. Box 500, Beaverton, Oregon 97077. In Europe, write Tektronix Limited, P.O. Box 36, St. Peter Port, Guernsey, Channel Islands.

Tektronix[®]
COMMITTED TO EXCELLENCE

For technical data circle 101
For demonstration circle 102



Keep your microcomputer alive.

As power fails, switch essential 8080 data to all-CMOS stand-by memory and logic. They hardly drain the back-up battery.

Preserve microcomputer-system data—during shut-downs or input-power failures—by using a battery-powered CMOS RAM to store the contents of essential registers and selected memory locations. When used with simple CMOS logic, a CMOS RAM like RCA's 1824CD draws so little current that a relatively small and inexpensive battery can sustain most systems for weeks.

At the expense of only 500 μA , the 1824CD RAM lets you store 32 eight-bit words. Using CMOS throughout, the interface logic and RAM can operate for a month from a single small NiCd battery like GE's five-volt 04B111AGT1. Just one day of line-powered operation will give the battery enough charge to operate for a week.

It's polite to interrupt

The key to the power-transfer system is the Interrupt feature of an 8080 microprocessor. The battery-powered CMOS logic generates a Power-down Interrupt signal to the 8080 when line voltage drops below the critical level of 90 V ac and remains below 100 V ac for a predetermined interval. This PDI signal leads the 8080 system into a nonactive state.

To prevent false writing into the RAM during power transients, a latch circuit makes the RAM inaccessible until normal input power is restored. During the shut-down procedure, the 8080 sets a CMOS latch in the interface logic. The μP pulses this latch via one of its output ports.

The logic is vigilant

To prevent the PDI from causing data to be written partially, the processor executes a Disable-Interrupt instruction before loading data into the battery-powered RAM. When writing is complete, an Enable-Interrupt instruction makes the 8080 system responsive to the Power-down Interrupt signal. The power-down condition must be detected early enough so that the system's power supply can maintain operation

during the transition to battery power.

To ensure early power-down detection, logic monitors the voltage across the storage capacitor (V_{cap}) inside the power supply. As a result, the Interrupt is generated a few tenths of a second before power drains from the system's supply.

In addition to generating PDI, the battery-powered CMOS logic monitors the power status. When power is down, the status can be either

- Intentional power-down, caused by switching the system power off, or
- Nonintentional power-down, caused by a PDI while the power switch is off.

These two power-activity states are presented as input bits to the 8080, which checks them when the system is powering-up. If the previous powering-down was intentional, nothing more happens. If not, however, the system informs the operator that a power failure has occurred.

Everything stays orderly

During system operation, a brief power failure sends the system through an orderly shut-down and start-up sequence. The system alerts the operator to what otherwise would seem erratic behavior.

While powering-up, the system can also check the contents of preselected RAM addresses that are loaded with known words. If these tested words prove out, the system commences its operational program. If the test data aren't correct, the system indicates to the operator that memory wasn't retained correctly during the power-on/off cycling.

The system's line-operated 12-V supply charges the battery, and series resistor R_5 limits the charging current to the recommended 45 mA¹ (one-tenth the battery capacity) for the 0.45 A-h battery. From the schematic, in which an asterisk marks each battery-operated element, you can see that the logic draws so little current that it has practically no effect on the charging.

When power fails, the storage capacitor discharges almost linearly through the regulator—so long as V_{cap} remains more positive than the sum of the regulator voltage and the load voltage.² Potentiometer R_2 develops the PDI signal when V_{cap} drops below +6 V (and the ac input goes below 90 V rms). At this

Larry Bruni, Senior Associate Engineer, Kimball Systems, 151 Cortlandt St., Belleville, NJ 07109

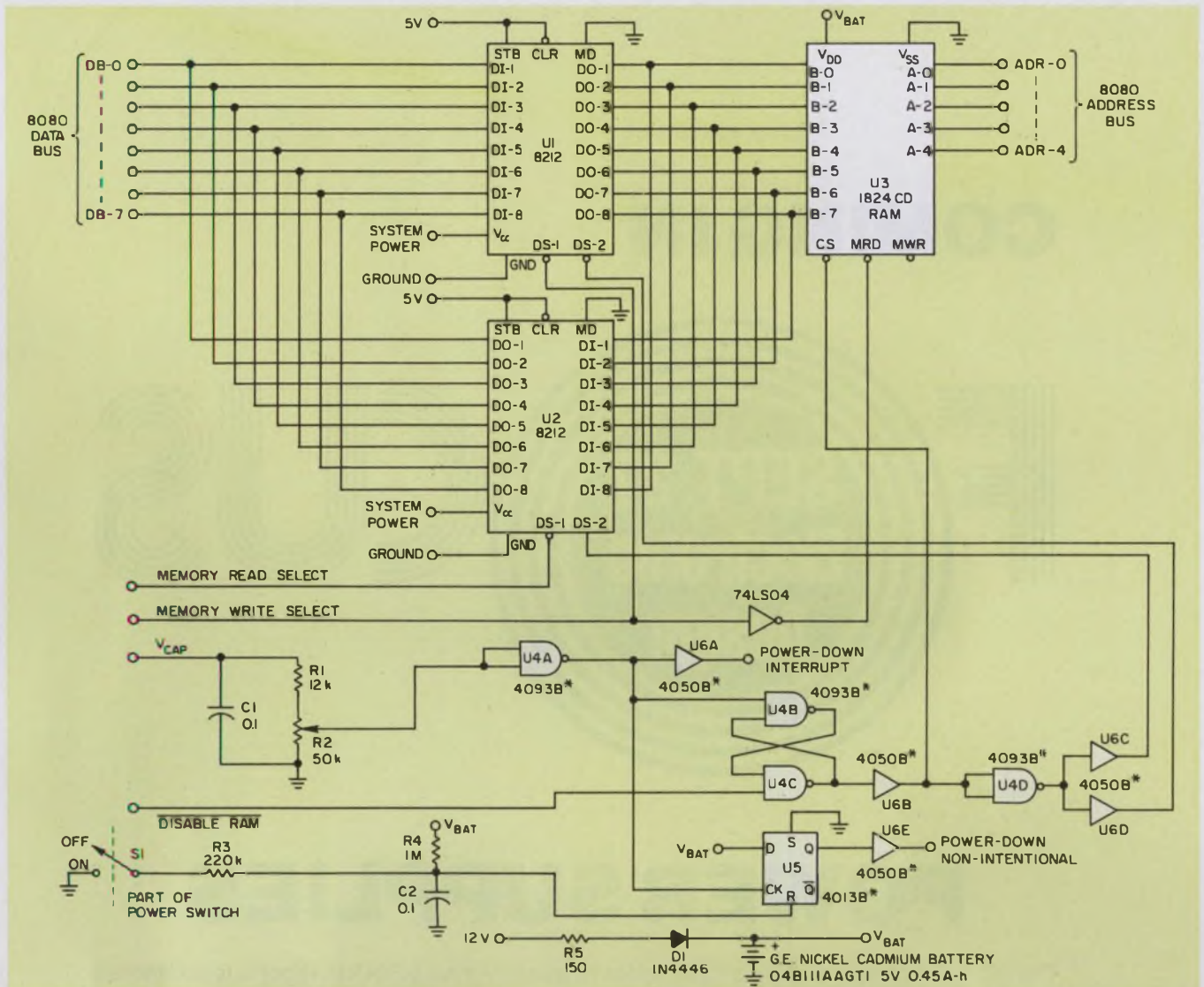

The CMOS RAM, U₃, stores 32 eight-bit words. This backup memory stores the contents of critical registers or totals from daily operations in the event of line-power

failure or during intentional shut-down. The all-CMOS logic draws so little current that the small battery can support the system for a month.

level, the capacitor still has enough power to operate the system for at least 0.1 s.

Interrupt waits for power to return

PDI stays active until V_{cap} rises to +7 V (and the ac input goes above 100 V rms). So, the system has an added advantage: The ac-line voltage is monitored at power turn-on. In systems with motors, this sensing can prevent burn-out due to low voltage. The CMOS Schmitt-trigger circuit, U_{4a}, monitors V_{cap} .

In response to PDI, the microprocessor generates the Disable RAM signal, which toggles the latch consisting of gates U_{4b} and U_{4c}. The latch, in turn, isolates the RAM from the system. This same latch also deactivates the 8212 buffers, U₁ and U₂, which normally operate between the data bus and the RAM. Once set, only power restoration can reset the latch—it drives the PDI signal low.

Flip-flop U₅ indicates whether or not a power-down was intentional. For nonintentional power-down, the leading edge of the PDI signal sets U₅. If the power switch is on, U₅ remains set after the leading edge passes. When power is restored, the μP examines the state of U₅ and sees that the power removal was nonintentional—a failure.

The only way to reset U₅ is to turn the power switch off. So, once the operator knows that power has failed, he turns the system off. Then, when power is restored, he simply restarts the system.

The combination of R₃, R₄ and C₂ filters the power-switch line from noise. ■■

References

1. *Nickel-Cadmium Battery Application Engineering Handbook*, Second Edition, General Electric, Gainesville, FL, pp. 5-1, 5-2.
2. Watson, C. A., Jr., "Power Supply's VC Product Sets Interrupt Capability," *Electronics*, Oct. 14, 1976, pp. 117-118.

COMING IN



POWER SUPPLIES

The 8th in *Electronic Design's* 1977 series of award-winning FOCUS reports is scheduled for the September 27 issue. The Topic: Multiple-output DC Power Supplies.

There is growing interest in power supplies that deliver more than one voltage. These units have all the problems of ordinary power supplies, plus special ones of their own. The report will help engineer-readers avoid pitfalls in specification, application and use. It will look at questions like:

- *Why should you select one supplier over another?*
- *What special features do companies offer in their products?*
- *How do they obtain these features?*
- *What specs are deceptive, ambiguous or omitted?*
- *Where is confusion most apt to occur?*
- *How do you select a power supply most appropriate to your needs?*

As usual, the FOCUS will dig beneath the surface to tell it like it is.

Don't miss this report, it's one you will want to read and keep.

FOCUS ON MULTIPLE-OUTPUT DC POWER SUPPLIES

**ANOTHER REASON ELECTRONIC DESIGN IS THE BEST
READ ELECTRONICS PUBLICATION IN THE WORLD.**

A "Special" reminder.

We don't stock this one.

We put it together to demonstrate Cutler-Hammer's unique capability to produce custom—and even proprietary—switch "specials" to satisfy virtually any end-product requirement.

We offer "specials". . . toggle, rocker, paddle, rotary, slide, key, lever-lock or pushbutton. Both illuminated and non-illuminated.

. . . ac or ac/dc. For one-hole, flush, sub-panel, snap-in or nest mounting. In all sizes. With special circuits that can be ampere or horsepower rated . . . or both.

. . . with screw, spade, pc, solder lug, wire wrap, wire lead and integrated wire terminations.

For "special" assistance on commercial, industrial and MIL-Spec applications, call your Cutler-Hammer sales office or distributor.

And for the many "non-specials" we *do* stock—write Milwaukee for your copy of our new 144-page catalog.

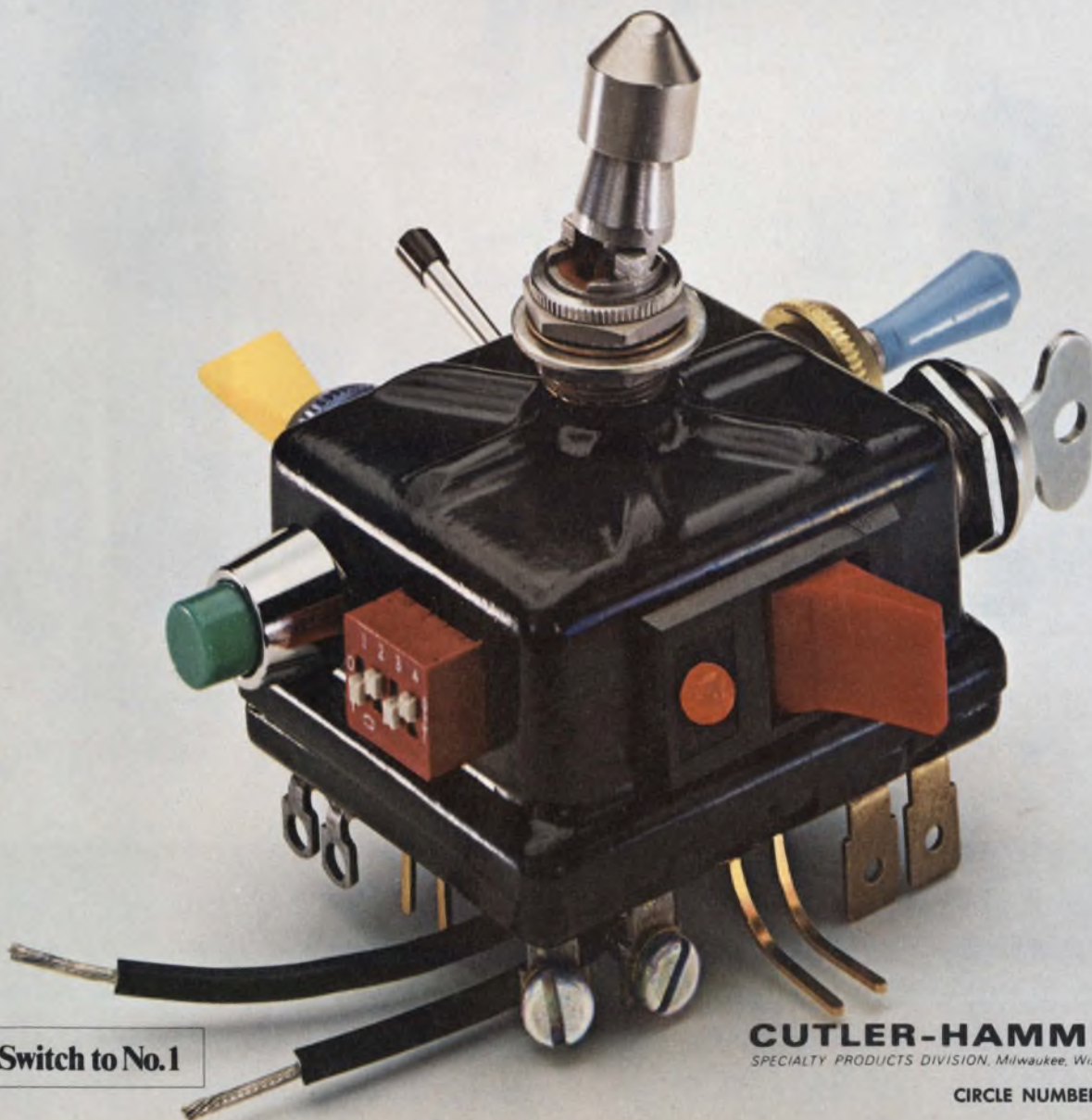

 Switch to No.1

CUTLER-HAMMER
SPECIALTY PRODUCTS DIVISION, Milwaukee, Wis. 53201



CIRCLE NUMBER 131



Digital introduces DECstation. A big computer system that's small enough for anyone.

Digital put an amazing LSI version of the PDP-8 inside a DECscope, added some ingenious interconnecting devices and created something new. The DECstation. A complete computer system big enough to do all kinds of work and small, simple and inexpensive enough to do it for almost anyone.

DECstation. A complete computer system in disguise. It looks like a terminal, but look again. The DECstation has a powerful general purpose computer, a video terminal, a dual diskette drive, and its own special operating system. What's more, you can hook up two different printers and a second dual diskette drive. Then put the whole thing in a mini-desk, and when you're done you'll have the smallest big computer you've ever seen.

The Video Data Processor. It's the big reason the DECstation's so small. The VT78 Video Data Processor is a computer wrapped in a terminal. Inside the familiar DECscope you'll find an LSI version of the PDP-8 with 16K words (32K characters) of MOS memory and built-in interfaces. Two serial asynchronous ports feature speeds from 50 baud to 19.2 kilo-

baud. A disk port interfaces with up to 4 diskette drives. A parallel I/O port for printers and custom interfacing provides data transfer rates up to 180 kilobits/sec. All standard.

You can go from carton to computer in less than an hour. If you can push a button, you can run a DECstation. Because one button is all it takes to start things up. The bootstrap and self-test routines are built in.

Put it together, plug it in, and immediately you can begin to run anything from the PDP-8 software library. Which means you start with one of the most comprehensive sets of software tools available in a small system. Including two proven operating systems: OS/78 for stand alone applications and RTS/8 for real-time. OS/78, an extension of

OS/8, supports a number of languages, including FORTRAN IV and BASIC. So all you have to do is load the operating system and start programming your application.

Whatever that application, if you're looking for a sophisticated little system, at the right price, and a remarkable OEM tool, consider DECstation. \$7995 each. \$5436 OEM quantity 50.

For our free brochure, write Digital Equipment Corporation, Parker Street, Maynard, MA 01754. European headquarters: 81 route de l'Aire, 1211 Geneva 26. Tel: 42 79 50. In Canada: Digital Equipment of Canada, Ltd.

digital

PDP-8 Marketing Communications
Digital Equipment Corporation, Parker Street, PK3-1, M34
Maynard, MA 01754.

Send me the free DECstation brochure. (please print)

Name _____

Company _____

Address _____

City _____ State _____ Zip _____

Phone _____ OEM _____ End-user _____

Application _____

_____ Please send additional information about the PDP-8 family.

AN IMPORTANT ANNOUNCEMENT FOR USERS OF RESISTORS:

A NEW CONCEPT... including new lower prices... and stock delivery to boot.

Current design practice has been to overspecify resistors to allow for expected tolerance degradation in service.

Now, Vishay offers a new approach, with lower prices and short deliveries to bring Vishay S102 resistors within reach of designers whose end tolerance is $\pm 1\%$.

In the past, you had to compromise, buying some other resistor that had to start with $\pm 0.05\%$ tolerance to assure you $\pm 1\%$ at end of life.

You needn't overspecify any longer. Now, for just \$1.90, you can buy a standard $\pm 0.5\%$ Vishay S102 resistor with the stability your designs demand, assuring a far better $\pm 1\%$ end-of-life tolerance maintainability than is available anywhere else. And, in the bargain, you get improved system performance, reliability, and quality with the resistor you really want. It's a step-up which is now well worth taking. Specify your resistance values from the Mil-R-55182 standard value table, and get delivery from stock—ten days maximum.

How come we can drop our price so drastically?

Our production has always been

geared to turning out **special** orders to any crazy resistance value you might come up with. But now our computer tells us that most of you specify standard values from the E192 list of Table 4 on Mil-R-55182, and that our unique ability to create any resistance value to 7-digit accuracy is utilized by only a small percentage of our customers.

So what could be more natural than for us to build an inventory of our renowned S102 resistors in all the standard $\pm 0.5\%$ resistance values of Mil-R-55182, and to pass our production savings on to you?

Our new \$1.90 price in 100-piece quantities (even lower in larger quantities) covers all the standard resistance values from 10 ohms to 49.9k. From 50.5k to 100k, the price is only pennies higher. So buy $\pm 0.5\%$ Vishay resistors by this plan, and save all the headaches you may now be having with the temperature, frequency, stability, and noise characteristics of your present $\pm 0.05\%$ resistors.

Of course, if you really need that special resistance value, or a tolerance down to $\pm 0.001\%$, remember we're still Vishay, the only resistor

manufacturer that can give you all six of the top performance specs.

Purchased tolerance vs. design tolerance.

Our new booklet on design tolerance clearly explains the differences between purchased tolerance and the actual performance of resistors after even a few hours' service. It may be an eye-opener for you. Ask for a copy.

Meanwhile, for full information on our new price plan and stocking facilities, call us collect at (215) 644-1300.

Vishay Resistive Systems Group, 63 Lincoln Highway, Malvern, PA 19355.



Only Vishay resistors give you all six top performance specs.

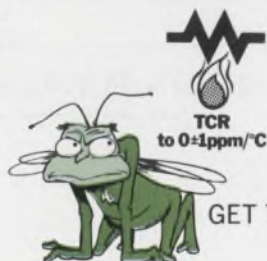

TCR
to 0-1ppm/°C

TOLERANCE
to .001%

As low as 1-ns
RISE TIME—
NO INDUCTANCE

TRACKING
to 1/2 ppm/°C

STABILITY
to 5 ppm/yr

NO NOISE

GET THAT BUG OUT OF YOUR EQUIPMENT.



BENDIX BRISTLE BRUSH BUNCH.

Opens new horizons for PCB design.

70%-90% Reduction In Mating and Unmating Forces

- simpler board support systems
- fewer damaged boards

Extended Circuit Count Potential

- up to 400 Bristle Brush contacts per connector



Extensive Product Line

- mother board, daughter board, input/output, PC receptacle body styles
- 2-, 3-, and 4-row configurations
- 90° and straight PC, solderless wrap, crimp removable, willowy tail terminations

For complete information, contact The Bendix Corporation, Electrical Components Division, Sidney, New York 13838.

Bendix



How do you squeeze
7000 feet of reliability
into a fighting
package?

Ask Hughes.



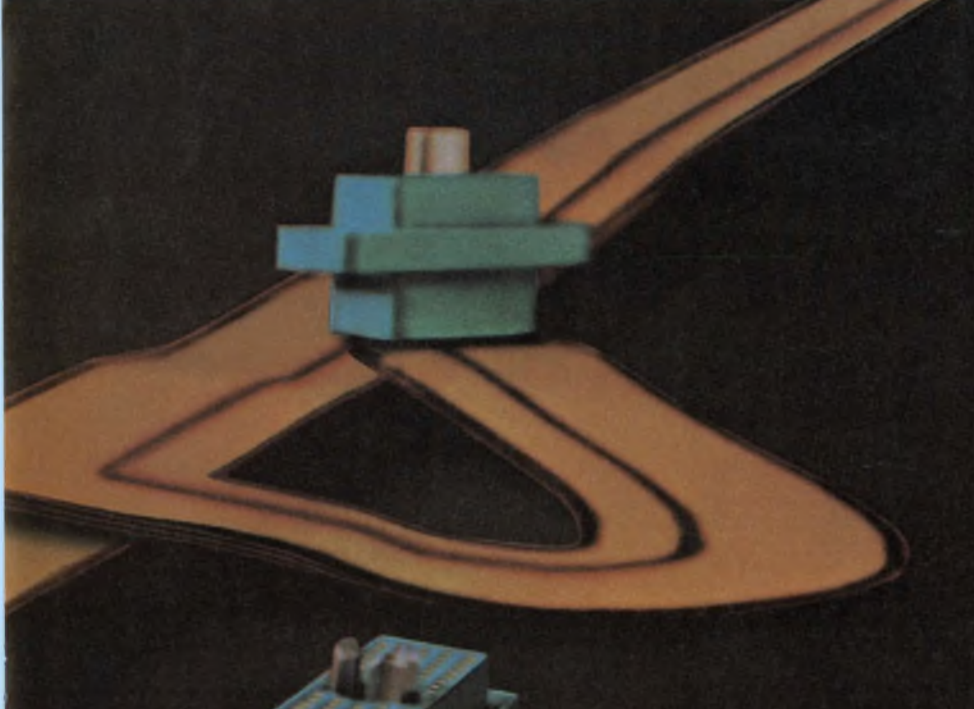

Total interconnection technology.

When it's a complex fighting machine like the Navy's A-6E and its TRAM target sensing system's highly sophisticated avionics, you connect with Hughes capability. Hughes, because of our deep involvement in high-technology military and aerospace programs: Phoenix, Maverick, Lance, Minuteman, AWACS, F-14, F-15, Space Shuttle, Viking, Sonobuoy, F-4, A-7, Condor, Standard Missile, F-8, Trident, Hobo, Sprint, and many more.

With all that experience, we've developed not only the hardware and the circuitry, but also the concepts and design capability to solve the toughest interconnection problem. And the techniques to make it work. Aside from our design-to-system advanced packaging, we also offer umbilical and special connectors and off-the-shelf connectors.

Umbilical and other special connectors. Our umbilical on the new laser-guided Maverick is typical of our specials; we also have connectors on many of the country's airborne missiles where sure-fire operation is critical to national defense. Meeting your requirements is the challenge to us. We give priority to your special-connector problems. Solutions are just part of what we offer.

Off-the-shelf connectors. The new C-21 (MIL-C-85028) is another typical example of Hughes hi-rel technology. For high-altitude applications the C-21 has individual seals for up to 250 psi on the contacts, preventing altitude breathing and consequent contamination. It's a Hughes exclusive.

Our standard line also features subminiature rectangulars, standard size, subminiature circulars, and miniature rectangulars—better because they're super hi-density connectors. Our exclusive PolarHex™



Center Jackscrew coupling device makes it all possible. Another Hughes first is our HAC PAK™ connector (MIL-C-28804), the simplest way to connect round to flat cables.

Ask Hughes. Squeezing reliability into any sophisticated machine is no problem for you. Just ask Hughes Connecting Devices, 17150 Von Karman Avenue, Irvine, CA 92714, or call (714) 549-5701.



HUGHES

HUGHES AIRCRAFT COMPANY
CONNECTING DEVICES

Total interconnection technology: the hardware, the circuitry, and the concepts.

IT'S A TOUGH WORLD OUT THERE.

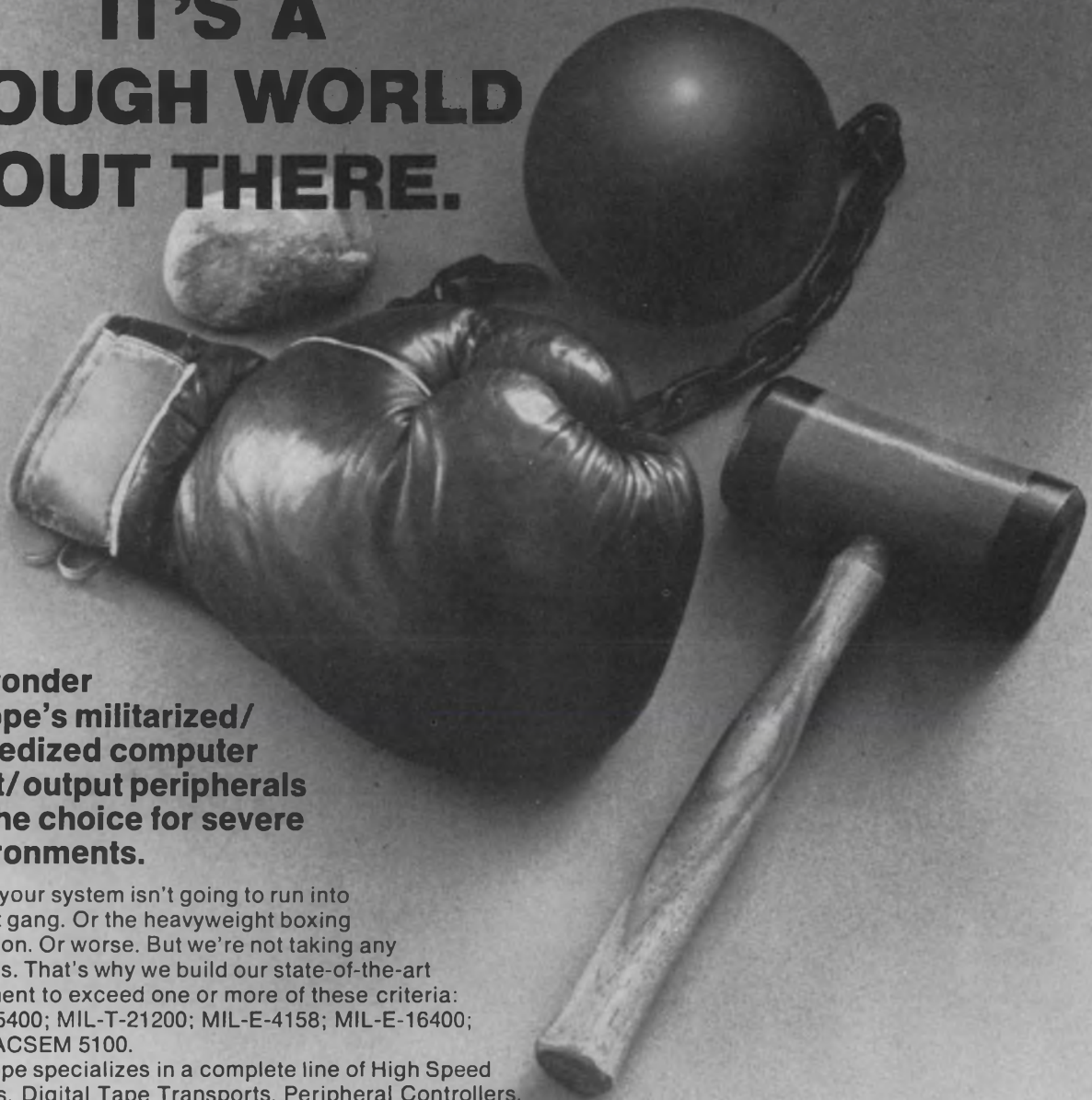

**No wonder
Miltope's militarized/
ruggedized computer
input/output peripherals
are the choice for severe
environments.**

Maybe your system isn't going to run into a street gang. Or the heavyweight boxing champion. Or worse. But we're not taking any chances. That's why we build our state-of-the-art equipment to exceed one or more of these criteria: MIL-E-5400; MIL-T-21200; MIL-E-4158; MIL-E-16400; and NACSEM 5100.

Miltope specializes in a complete line of High Speed Printers, Digital Tape Transports, Peripheral Controllers, Floppy Disc Drives, Tape Cartridge Recorders and Keyboard Printer I/O display terminals.

All designed to assure you of exceptional reliability for just about any tactical or ruggedized application your system encounters. So, if you're interested in computer input/output peripherals that are tough enough to take anywhere, call Miltope.

MILTOPE MAKES IT EASIER.

MILTOPE

CORPORATION

NINE FAIRCHILD AVENUE • PLAINVIEW, N.Y. 11803 TEL: 516-938-9500 TWX: 510-221-1803

TAPE TRANSPORTS

- IBM Compatible, 7 or 9 track • 800 and/or 1600 BPI Format • Speeds to 125 IPS
- Withstand High Altitudes



HIGH SPEED PRINTERS

- 33, 80, 132 column formats • Up to 400 lines per minute • Built-in test equipment • 4 copies • Serial keyboard option



TAPE CONTROLLERS

- Compatible with PDP-11, Honeywell 316/516, MIL-STD-1397, NOVA Series
- Built-in test capability
- Error Correction

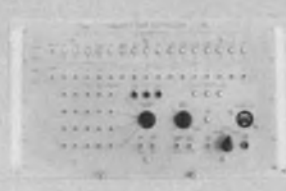

FLEXIBLE DISK DRIVES

- Over 6 million bits of on line storage • 77 Data track, 6400 bits per inch • Random Access • 500 KC Data transfer rate



CIRCLE NUMBER 135

Meet our better half.

The New TI .156" x .200" H4 Series Edgeboard Connector.

Our better half from T.I. It's the edge-board connector half of a PC board/edgeboard connector system. And definitely today's best value.

Its minimum 75 microinches wrought-gold inlay provides greater reliability at contact mating surfaces to make our better half better.

Its bifurcated contacts provide greater connection reliability to make our better half better.

Its between-position polarizing key system allows more efficient use of the connector to make our better half better.

Its off-the-shelf availability through our extensive nationwide distribution network makes our better half better.

Its construction, designed to meet or exceed demanding military performance specifications (MIL-C-21097), makes our better half better.

Its functional and dimensional interchangeability with common one-piece edgeboard connectors gives you price and delivery advantages and makes our better half better.

Its termination and mounting flexibility, including both solder tail and solder eye terminations, as well as flush or earless mounting, make our better half better.

Its glass-filled thermoplastic polyester contact housing meets U.L. Flammability Classification 94V-0 to make our better half better.

Its practical design coupled with our low, low prices (as exemplified by our low cost IC's) make our better half better.

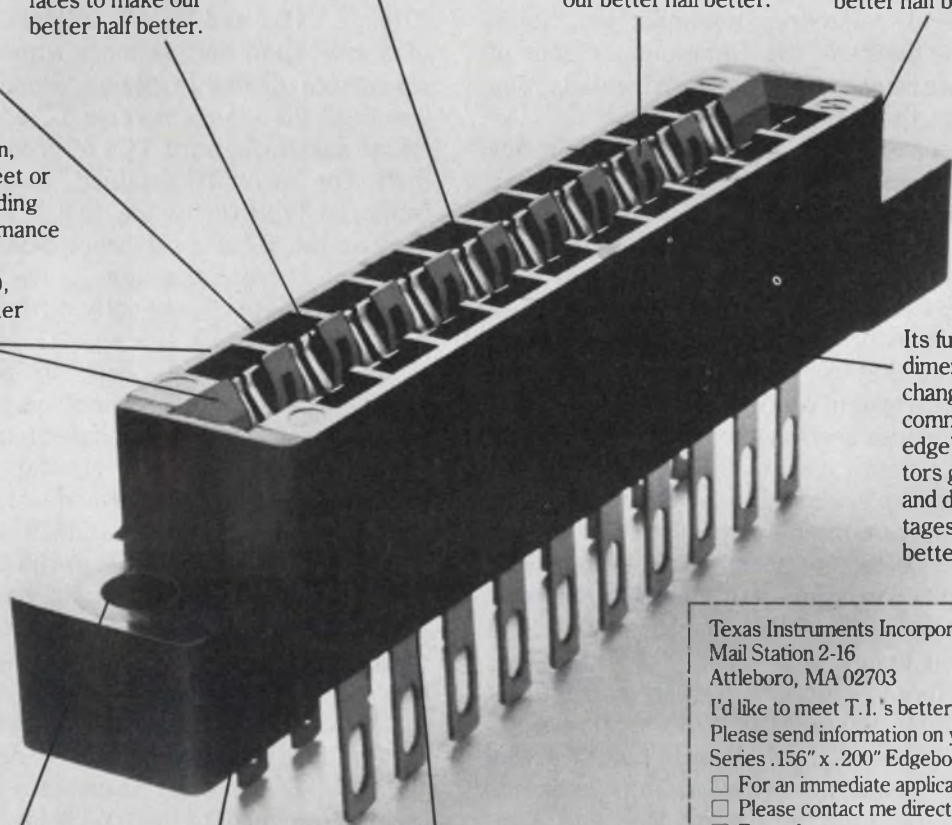

Texas Instruments Incorporated
Mail Station 2-16
Attleboro, MA 02703



I'd like to meet T.I.'s better half.
Please send information on your new H4 Series .156" x .200" Edgeboard Connector.

- For an immediate application.
- Please contact me directly.
- For reference.

Name _____

Title _____

Company _____

Area Code _____ Phone _____ Ext. _____

Address _____ Mail Station _____

City _____ State _____ Zip _____

ED

TEXAS INSTRUMENTS
INCORPORATED

Voltage references determine accuracy, ultimately, of many precision circuits. Several techniques are used to stabilize reference sources: Which is best?

The performance of d/a and a/d converters, digital voltmeters, regulated power supplies and many other circuits ultimately relies on the accuracy of their voltage (or current) references. It's important, therefore, that you understand the numerous methods of deriving accurate references and the performance you can expect from them.

Simple reference circuits can be built from a few discrete components, or precision IC references can be purchased (see table). For high performance—temperature coefficients of 10 ppm/°C or less and comparable long-term drifts—hybrid-packaged IC references approach the best attainable within the state of the art. Monolithic circuits provide a little less performance, but they cost less, too.

No matter which type of reference you use, you must make sure it provides accuracy and stability greater than those of the circuit it controls. Since a 12-bit a/d converter, for example, should resolve 0.025% of full scale, a major portion of this capability will be lost if the reference doesn't perform much better. And when temperature variations are included, the temperature coefficient (TC) of the reference can be the largest source of error.

Therefore, reference-regulation errors as small as 0.001 to 0.01% (10 to 100 ppm), TCs of 1 to 20 ppm/°C and long-term drifts of 10 to 20 ppm/month aren't unusual. And often such specifications must be maintained with several milliamperes of load and wide input-voltage and temperature variations.

Several varieties of reference diodes are listed in the comparison table—from the simplest (class A) to the more sophisticated devices, such as the LM329 and LM399 series (class B and C).

Stabilized diodes make simple references

The simplest reference source uses a temperature-compensated diode.¹ It consists of only one series resistor between a voltage-supply line and the reference diode (Fig. 1). The output voltage is taken across

the diode. Best results are attained when load-current variations are minimum.²

Two series of simple reference diodes—types 1N821 through 1N829 and 1N4611/4611C—are combinations of a zener and one or more conventional forward-conducting diodes in series. Such an arrangement "cancels" the zener's reverse TC against the conventional diodes' forward TCs to produce a low over-all drift. The lowest TC attained, about 5 ppm/°C maximum, is typified by the 1N829 and 1N4611C. But because the TC of a reference diode depends heavily upon the current through it, the current must be closely regulated—especially with the 1N821 series; somewhat less with the 1N4611 series.

Represented schematically by the familiar zener symbol, these diode references are packaged in standard outlines with the specs listed (class A) in the table.

For a lower dynamic impedance than a simple compensated zener can provide—typically less than 1 Ω —you can use the LM329 temperature-compensated reference (class B in the table). It comes in four grades—10, 20, 50 and 100 ppm/°C—which are suffixed A, B, C and D, respectively. While less dependent on current than the class A diode—in the class B, the TC is poorer. Nevertheless, the zener diode in the LM329 is a so-called subsurface type, with greater long-term stability than the surface zeners of the class A devices. Packaged in a TO-92 outline, the schematic symbol of the LM329 is still that of a zener, although the integrated circuit in the package has many parts besides the subsurface zener.

Because of its very low dynamic impedance, the LM329 in Fig. 1a minimizes error from input-voltage variations, load variations and series-resistor drift. The major error results from the LM329's TC.

Fig. 1a tabulates the major worst-case errors for a 15 ± 1 -V supply and a 0.5-mA $\pm 25\%$ load. The TC error causes about 90% of the total error. The resulting over-all error of about 0.1% restricts this circuit to use for converters of eight bits or fewer.

For both low impedance and low TC, active temperature-stabilized reference diodes such as the LM399A, LM399 and LM3999 (class C) are recommended. These class-C diodes are similar to the LM329, but incorporate heaters that keep the internal

Walter G. Jung, Consultant, Pleasantville Laboratories, Forest Hill, MD 21050.

Comparison of reference sources

Device	Manufacturer	Class*	Output voltage	Load current	Output impedance	Temp. coeff.	Input voltage	Long-term stability
1N821-829 series 1N4611-4611C series	Many Sources	A	6.2 ± 5% V	7.5 ± 0.01 mA	15 Ω	5ppm/°C (max) (1N829A)	↑ determined by user	—
		A	6.6 ± 5%	2.0 ± 0.2	75	5 (1N4611C)		—
LM329 (suffixes A, B, C, D)	National Semiconductor	B	6.9 ± 5%	1	0.8	0, 20, 50, 100	↓	20ppm/1000hr (typical)
LM399A		C	6.95 ± 5%	1	0.6	1		20
LM399		C	6.95 ± 5%	1	0.5	2		20
LM3990		C	6.95 ± 5%	1	0.5	5		20
AD580M	Analog Devices	D	2.50 ± 1%	10	1 (max)	10	4.5 to 30 V	10
MC1403A	Motorola	D	2.50 ± 1%	10	0.91 (max)	25	4.5 to 40	
REF-01E	Precision Monolithics	D	10.00 ± 0.3%	10	0.8	8.5	12 to 40	—
REF-02E		D	5.00 ± 0.3%	10	0.8	8.5	7 to 40	—
LH0070-2 LH0071-2	National Semiconductor	E	10.00 ± 0.01%	5	0.2	4 **	13 to 33	500 (max)***
		E	10.24 ± 0.01%	5	0.2	4	13 to 33	500 (max)
AD2700L,U	Analog Devices	E	+10.00 ± 0.025%	10	0.05 (max)	3	+13 to +18	100/1000 hr (max)
AD2701L,U		E	-10.00 ± 0.025%	10	0.05 (max)	3	-13 to -18	
AD2702L,U		E	±10.00 ± 0.025%	5	0.05 (max)	3	±13 to ±18	

* A = Temperature-compensated reference diode.
 B = Active temperature-compensated reference diode (IC).
 C = Type B, with thermally stabilized substrate.
 D = Three-terminal monolithic IC.
 E = Hybrid IC, actively trimmed to high accuracy.
 ** Approximated for comparison. Actual spec is 0.04% @ -25 to 85 C.
 *** Over life of unit, period unspecified.

Diagram (a): LM329B with TO-92 diode, RI = 47k, V_{REF} = 6.9V, I_L = 0.5mA.

Diagram (b): LM3999 with TO-46 diode, RI = 4.7k, V_{REF} = 6.95V, I_L = 0.5mA.

Diagram (c): 399A with RI = 5.36k 1% 100ppm, V_{REF} = 6.95V, I_L = 0.5mA.

Typical performance

Temp. range (25 to 70 C):	20 ppm/°C (max) @ 45 C	900 ppm
TC:	425 μV/V	62 ppm
Input regulation:	0.0035 (ΔI _L ≤ 25%)	35 ppm
Load regulation:	20 ppm	20 ppm
Long term stability:		1017 ppm
		or about 0.1% suitable for 8 bits
TC:	5 ppm/°C (max) @ 45 C	225 ppm
Input regulation:	4.7 μV/V	70 ppm
Load regulation:	0.0037% (I _L ≤ 25%)	37 ppm
Long term stability:	20 ppm	20 ppm
		352 ppm
		or about 0.035% suitable for 9 bits
TC:	1 ppm/°C (max) 45 C	45 ppm
Input regulation:	280 μV/V × 0.15 V	6 ppm
Load regulation:	0.00087% (I _L ≤ 25%)	26 ppm
Long term stability:	20 ppm	20 ppm
		97 ppm
		or about 0.0097% suitable for 11 bits

1. A temperature-compensated zener (a) is a simple low-cost reference source. Improved performance and lower impedance can be obtained with a built-in heater that

maintains the unit at 85 C (b). The heater is electrically isolated from the diode in some thermally regulated references (c), which allows greater flexibility.

substrate at 85 C. This achieves a 1 to 5-ppm/°C TC combined with about 0.5-Ω impedance.

The LM3999, like the LM329, is contained in a TO-92 package. Its heater has one lead in common with its diode, and the heater operates on 9 to 36 V, consuming about 360 mW in 25 C of still air. The heater's initial surge current is typically 140 mA, and warm-up time is 5 s.

To electrically isolate the heater from the diode, the LM399 and LM399A are packaged in insulated TO-46 housings with four leads. For both units, the heater typically consumes 255 mW at 25 C, and takes 3 s to warm up.

Calculations for the LM3999 show better precision than with the LM329 (Fig. 1b)—an over-all error of 352 ppm, or 0.035% vs 0.1%. This precision is suitable for converter resolutions of 9 bits. The circuit in Fig. 1c, however, is optimized to perform even better with the LM399A and its TC of 1 ppm/°C. To take advantage of this low TC, the supply voltage must be restricted to ±1% variations and a stable 100-ppm resistor must be specified for R₁. A worst-case error analysis of the circuit results in an over-all error of less than 100 ppm (0.01%), which is suitable for 11-bit accuracy.

Not included in those error analyses are the initial voltage tolerances of the diodes and all possible load effects. In practice, the initial tolerances can be trimmed with divider resistors, but then the divider errors have to be included in the over-all error budget.

Current references can easily be constructed by feeding load resistor R_L (in Figs. 1a, 1b or 1c) into an op-amp summing point instead of to ground. However, the TC of R_L would then become part of the error budget. Many popular IC converters, such as the 1408 or DAC-08, operate with such current references.

Bootstrapping the diodes lends flexibility

While the unbuffered diode-reference circuits in Figs. 1a, b and c suffice for many applications, often voltage adjustability is needed and current levels of several milliamperes must be supplied—usually beyond the capabilities of the unbuffered circuits. Buffered circuits, like those in Fig. 2, are popular because of their simplicity and good performance.

Because the op-amp buffer operates with a single supply voltage, the output has the same polarity as the supply, and start-up is positive. When the reference diode breaks down, the negative-feedback loop sets the output voltage at

$$V_0 = V_{ref} \cdot \frac{R_2 + R_3}{R_2} \quad (1).$$

To build a negative-output reference circuit, reverse the diode, ground pin 7 of the op amp and apply the unregulated negative supply voltage to pin 4. If used,

R₅ is returned to pin 4.

From Eq. 1, resistors R₂ and R₃ determine V₀. Resistor R₁ determines the current in the reference diode, D₁, which remains constant because V₀ and V_{ref} are constant. The diode should have the desired TC, while R₂ and R₃ should have low tracking TCs. For minimum bias-current errors, R₄ should be equal to the value of R₂ and R₃ in parallel. The op-amp drift should be about 5 μV/°C, computed at 1 ppm/°C for a 6-V reference diode.

Resistor R₁, whose selection is governed by the reference diode, yields nominal currents of 1, 2 and 7.5 mA for the LM329, 1N4611 and 1N829 diodes, respectively. For 7.5 mA use, additional current is supplied by R₅ to ease the burden on the op amp. For best results, R₁ can be trimmed to set the over-all TC of the circuit nominally to zero at 25 C.

However, to attain maximum TCs less than 10 ppm/°C over a wide temperature range, the total circuit must be considered as a single thermal system, both mechanically and electrically. This approach accounts for the superior performance of hybrid and monolithic IC references.

Hybrids for high performance

Hybrid and monolithic references are usually trimmed with a laser under operating conditions to adjust the output voltage and minimize the TC. Hybrid

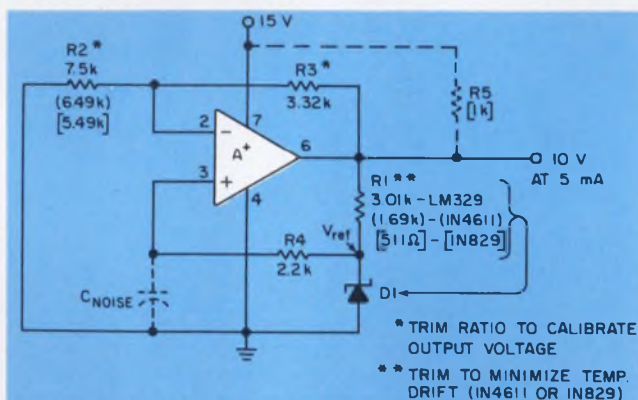

Suitable component combinations

Over-all TC	D ₁	A ₁	R ₂ /R ₃	R ₁
<50 ppm	329B	741	10 ppm/°C tracking	100 ppm
<25 ppm	1N4611B or 1N827	301A	5 ppm/°C tracking	↑
10-15 ppm	1N4611B or 1N827	AD741L, OP-02E	2 ppm/°C tracking	optimize (see text)
≈ 5 ppm	1N4611C or 1N829	*	1 ppm/°C tracking	↓

2. An op-amp booster can be used to obtain voltages different from the reference diode and to handle larger current loads than a simple zener diode.

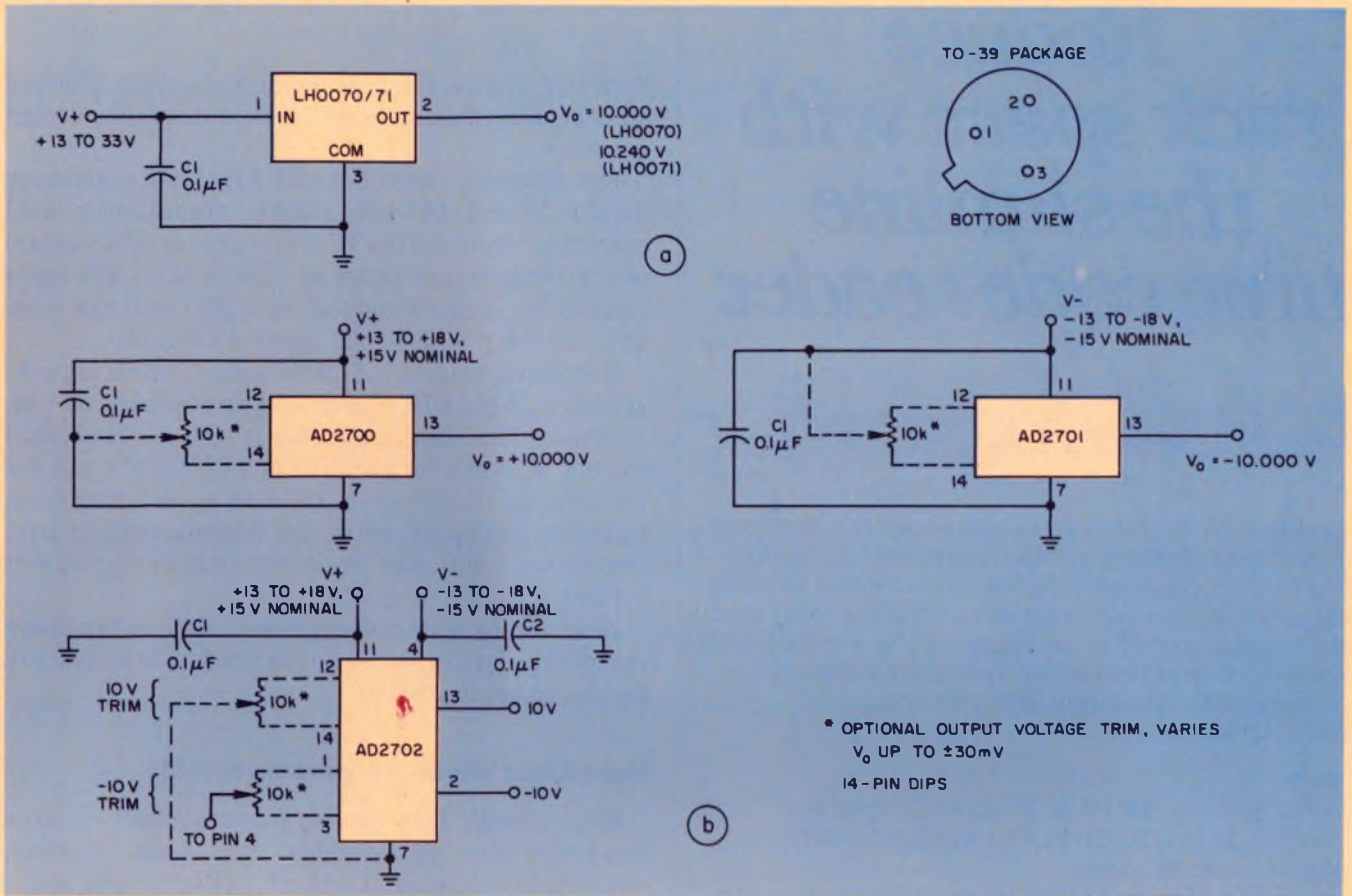

3. Voltage references in hybrid packages provide the highest "as-delivered" accuracy. They are trimmed for

precise output voltages (a), and some versions allow further external trimming as well (b).

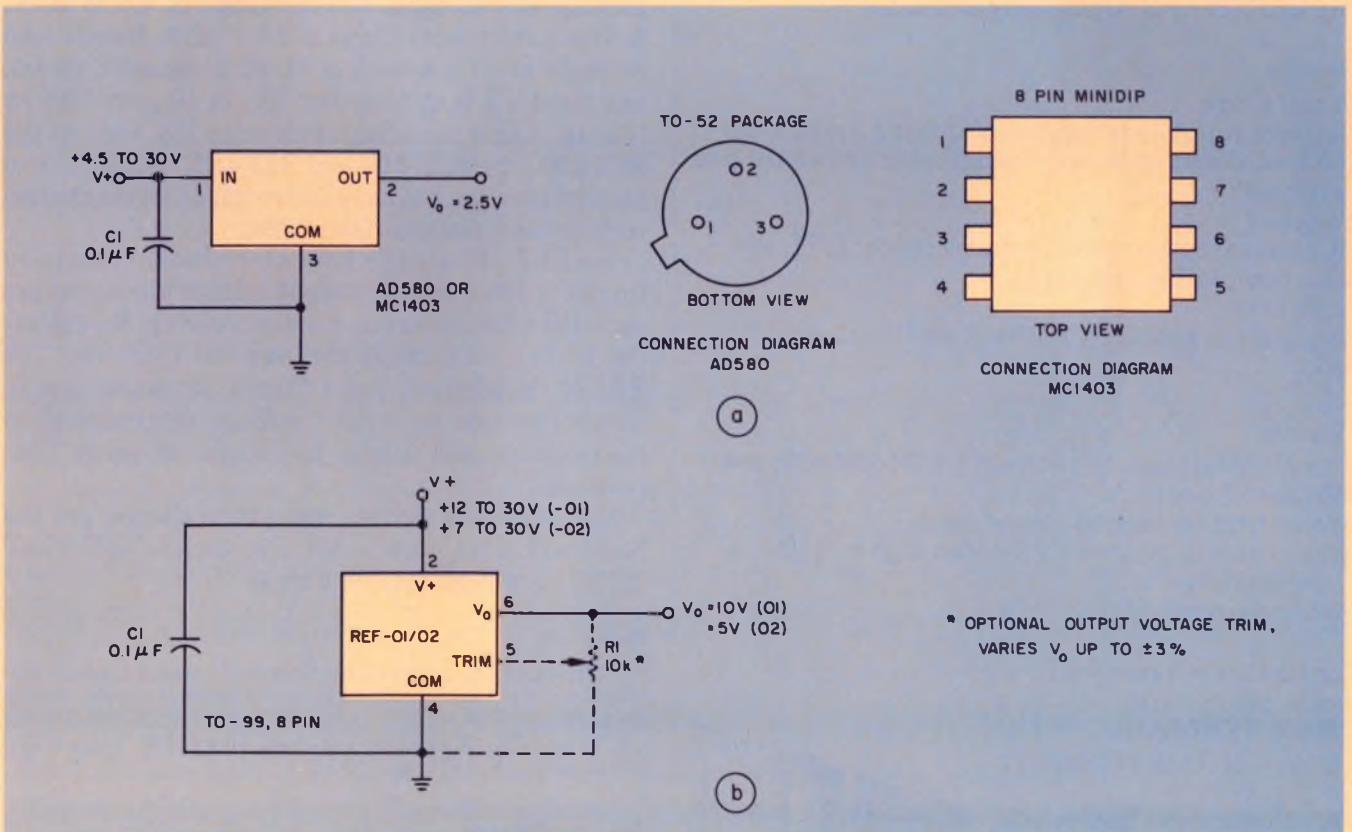

4. Monolithic voltage-reference ICs can be cheaper than hybrid circuits, but some performance is sacrificed. As

with hybrids, both fixed (a) and externally trimmable versions (b) are available in various voltage ratings.

Reduce rack space with the slimline time code reader.



The Model 8395 reads serial time code outputs from time code generators or tape reproducers, displays time in days (optional), hours, minutes and seconds, and optionally provides serial and parallel outputs to other equipment. The unit may also be ordered with forward/reverse reading option, error by-pass, multiple-code input, and input filtering. Specifications follow.

Inputs

Code Options: IRIG A, B, E, or G (specify)

NASA 36 Bit, XR3/2137 (switch selected)

Impedance: 4K ohms

Level: 50 mVpp to 10 Vpp (wider range optionally available)

Frequency: 100 Hz to 250 KHz

Modulation Ratio: 2:1 to 6:1

Input Filtering: Optionally available

Outputs

Serial Code

Buffered input code capable of driving a minimum of 200 feet of unterminated coaxial cable or twisted pair (optional).

Parallel

BCD days, hours, minutes and seconds, DTL and TTL compatible (optional).

Isolation

All outputs separately buffered and short-circuit proof.

Physical

The physical characteristics of the Model 8395 are:

Weight: 8 pounds

Mounting: Standard 19 inch rack

Size: 19 inches wide x 1.72 inches high x 13.25 inches deep

Temperature: 0°C to -60°C

For further information, please call or write
TRAK SYSTEMS,
Division of Trak Microwave Corporation,
4722 Eisenhower Boulevard,
Tampa, Florida 33614,
Phone (813) 884-1411,
TLX 52-827.



CIRCLE NUMBER 36

devices, however, can provide the highest as-delivered accuracy, and they demand a minimum of user design attention.

For example, LH0070-2 and LH0071-2 references deliver 10 and 10.24 V $\pm 0.01\%$, respectively; load current is 5 mA; and the TC is specified as 0.04% (max) over a temperature range of -25 to 85 C. The units can handle input voltages of 13 to 33 V and the long-term stability spec is 500 ppm/yr (Fig. 3a).

Another hybrid, the AD2700 series, which is packaged in a 14-pin DIP, delivers output voltages of +10, -10 and ± 10 V. Initial accuracy is 10 V $\pm 0.025\%$; load current is 10 mA for the 2700 and 2701 and 5 mA for the 2702; input voltage is 13 to 18 V; and long-term stability, 100 ppm/1000 h. An optional output trim can be used with the devices to adjust the output voltage ± 30 mV (Fig. 3b).

However, hybrids are expensive, and less expensive monolithic devices, while not as precise, are adequate for many applications.

Monolithics almost as good as hybrids

Even though they can be manufactured in large quantities for considerably less than hybrids, monolithic reference ICs don't perform that much poorer. In monolithics, initial tight calibration and some maximum specs might be poorer. For example, the three-terminal AD580M contained in a TO-52 package can accept a voltage range of 4.5 to 30 V, deliver a reference voltage of 2.5 V $\pm 1\%$, handle load currents to 10 mA with a TC of 10 ppm/°C (max), and provide a long-term stability of 10 ppm/1000 hr (Fig. 4a). Other monolithic reference ICs, such as the MC1403A, the REF-01E and REF-02E are also three-terminal devices, but have somewhat different characteristics and features (see table).

The REF-01E and 02E have a terminal for trimming (pin 5). If left open, the output voltage tolerances are as in the table; however, a potentiometer, R_1 , can set the output $\pm 3\%$ about the nominal (Fig. 4b). The REF-02, in addition, has a "Temp" terminal (pin 3), which provides an output voltage proportional to temperature, and allows the device to sense temperature.

New reference devices, not yet available, are the National LM336, a 2.5-V unit, and the Analog Devices' AD581, a programmable unit. ■■

References

1. "Temperature Compensated Voltage Reference Diodes," Application Notes - 2, *Zener Diode Product Catalog*, Siemens, Scottsdale, AZ, pp. 7-14.
2. Jung, W.G., *IC Op Amp Cookbook*, Howard W. Sams & Co., Indianapolis, IN, 1974, pp. 139-143.

Acknowledgement

This article is adapted from the author's forthcoming book "IC Converter Cookbook," to be published by Howard W. Sams & Co., Indianapolis, IN.

AT UNDER \$2000, THE MODEL 40 OEM PRINTER NOT ONLY COSTS LESS TO BUY—IT ALSO COSTS LESS TO OWN.

It costs less to buy because for less than \$2000 you get a 300 lpm printer that's completely operational. All you furnish are 115 VAC and the serial signal source.

Once on-line, our model 40 OEM printer costs less to own. Not only is it highly reliable, it requires little maintenance.

Even when maintenance is needed, the MTTR averages only $\frac{3}{4}$ hour, thanks to built-in diagnostics that help pinpoint trouble quickly. And with only seven modular mechanical assemblies and one CMOS logic card, repairs are simple.

This modularity and diagnostic capability also cut the cost of training service personnel.

To reduce your logistics problems and spare parts inventory, there's an 80% parts commonality between all model 40 printers. Plus Teletype offers an exchange repair service that can save you up to 50%.

For more information about our model 40 OEM printers, send in the coupon. Or call 312/982-2000.

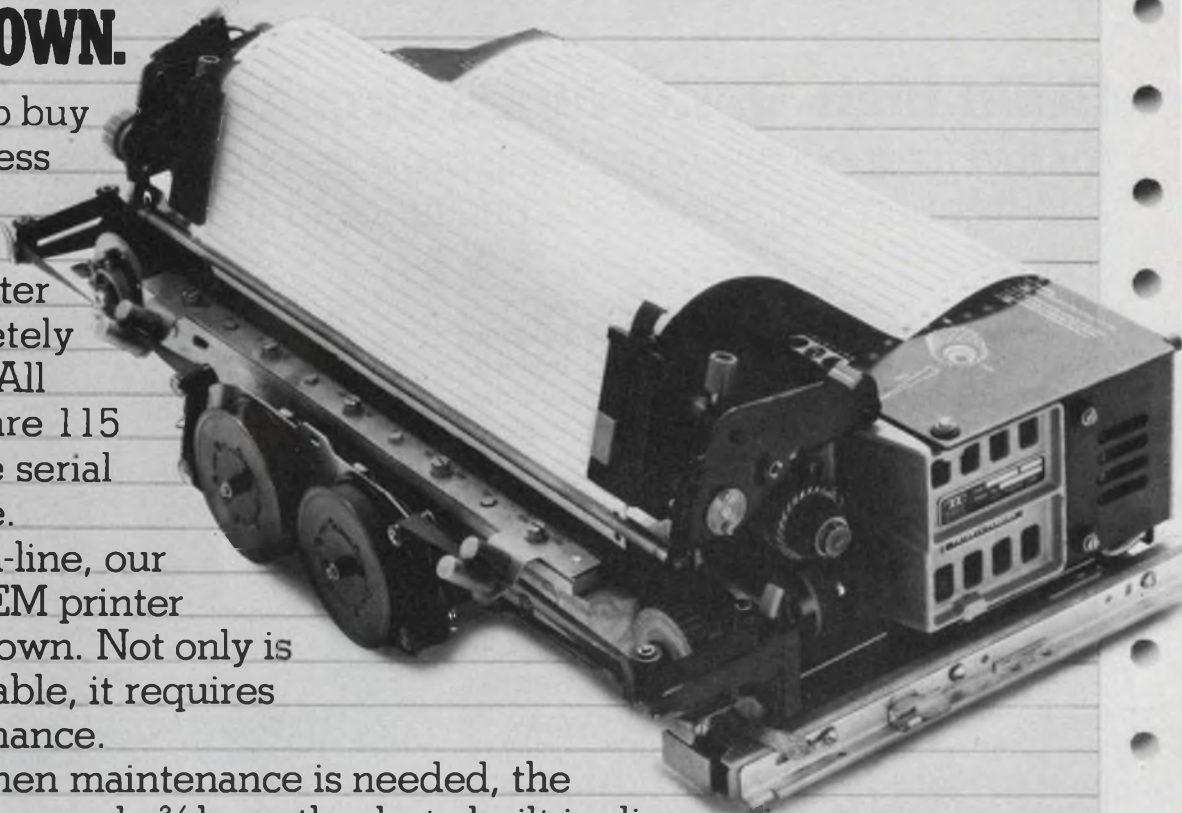

**THE TELETYPE® MODEL 40 OEM PRINTER.
NOTHING EVEN COMES CLOSE.**



Teletype Corporation
Dept. 89-0
5555 Touhy Ave.
Skokie, IL 60076

Please send me additional information about the model 40 OEM printers.

Name _____

Title _____

Company _____

Address _____ Phone _____

City _____ State _____ Zip _____

Teletype is a trademark and service mark registered in the United States Patent and Trademark Office.

Build high-Q, LC-tuned circuits

for low frequencies. An op amp provides negative resistance and frequency-dependent capacitance to sharpen the response.

The trouble with trying to design high-Q, LC-tuned circuits for frequencies below 100 Hz is that even with the best magnetic materials, you cannot make inductors and transformers with high Q. But by combining conventional inductors and transformers with an operational amplifier you can obtain a sharply tuned active LC circuit. The op amp improves selectivity in two ways: Negative resistance cancels core losses, and frequency-dependent capacitance resonates with the inductors to produce steep skirts in the response.

Although replacing LC networks with active circuits is commonplace for small-signal, low-frequency filtering, the technique has not previously been extended to applications that require you to detect feeble low-frequency signals while retaining the common-mode isolation of coupling transformers. Though the circuits described are designed for ground-fault-current-interrupter (GFCI) applications, you can extend their use to such applications as current probes and instrumentation for bioelectric measurements.

How the circuits work

Obviously, if inefficient inductors are connected to negative resistances that supply the coil and core losses, they will exhibit high Q. Then if such inductors, along with their negative-resistance sources, are connected in series or in parallel to a capacitor, you should be able to build resonant circuits. In reality, however, the attainable Q will be limited by variations in inductor losses with temperature and signal level. And, of course, if too much negative resistance is supplied, the circuit will become unstable.

The frequency selectivity of LC circuits can be augmented even further by making the capacitor frequency-dependent. If the capacitance increases with increasing frequency, the skirts of the response curve on both sides of resonance will be steeper than the usual 12-dB/octave that characterizes individual LC sections of conventional design.

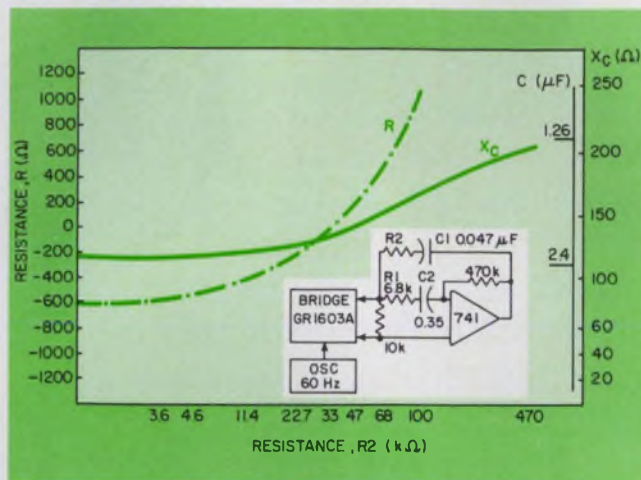

1. Large reactance changes can be obtained with an op-amp circuit that has a handful of extra components in its feedback loop (a). As R_2 increases, the capacitive reactance increases and the resistance goes positive.

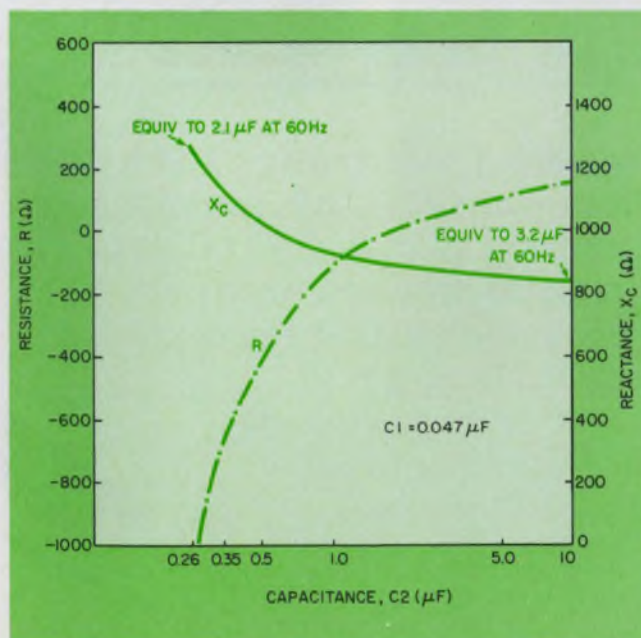

2. Large changes in generated capacitance for the circuit of Fig. 1 occur as the reactance of C_2 shifts. The curves shown are for 60-Hz operation.

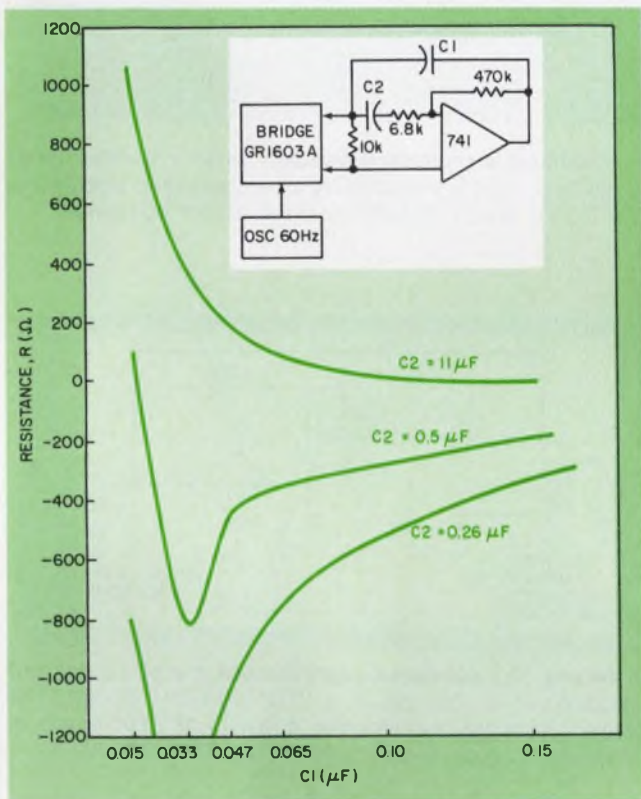

3. Rapid shifts in resistance, as seen by the impedance bridge, occur when C_1 and C_2 change.

Fig. 1 depicts an active circuit developed for a 60-Hz GFCI. The leads from the bridge are usually connected to an inductor or transformer winding, which is to be resonated. As resistor R_2 is varied, this circuit generates a capacitive reactance ranging from 2100 to 1100 Ω , which corresponds to 1.24 to 2.4 μF . An interesting advantage of this circuit is that it generates large capacitances—a real economic plus in low-frequency LC networks.

For smaller values of R_2 , the circuit also supplies negative resistance. (Note that the circuit presents a positive resistance of 10 k Ω when $R_2 = \infty$).

Things really begin to happen when C_2 changes (Fig. 2). The generated capacitance increases with a drop in the reactance of C_2 —caused either by an increase

in C_2 or the signal frequency. The effect of C_2 on the resistance is even more pronounced. To achieve stability at low frequency under a variety of conditions, you often need to supplement the inductor losses with a fixed resistor (10 k Ω , in this example). Without the decreasing susceptance of C_1 , however, the negative resistance would tend to “run away” with decreasing frequency in spite of the damping resistor.

The somewhat complicated interdependence of C_1 and C_2 upon the generated resistance is shown in Fig. 3. Again you can see that resistance becomes a positive 10 k Ω when either C_1 or the frequency becomes zero.

Active circuit outperforms passive

Compare the performances of a miniature ferrite-core transformer in passive and active tuned circuits (Figs. 4a and 4b, respectively). To ensure stable operation with the transformer over a wide range of temperature and signal amplitudes, the active circuit is damped with the 3.3-k Ω resistor. The circuit generates 0.57 μF by multiplying the 0.059 μF of C_1 almost tenfold. The transformer sees the same capacitance in both the active and the passive circuit.

The difference in the secondary voltage, E_s , is due to absorption of the transformer losses by the negative resistance. While the op-amp provides additional gain, this is a side benefit compared to the large bandwidth reduction—from 44 Hz to 3 Hz.

The use of an LM3900 Norton quad in the circuit of Fig. 5 not only permits you to work with a single-ended power supply but also leaves three amplifiers for other purposes. The transformer design is non-critical and inexpensive. It has a 2100-turn secondary of 42-gauge wire on a silicon-steel EI-187 core.

In a passive configuration, this transformer resonates with a low-loss, 3- μF capacitor, and the circuit has a 6-dB passband of 36 to 127 Hz. However, using the circuit of Fig. 5, the new passband turns out to be 54 to 67 Hz. Paradoxically, since one stable 3- μF capacitor is more expensive than all of the components in Fig. 5, the improvement in signal-to-noise ratio is accompanied by a cost reduction.

Note that, though it's usual to ground pin 7 of the LM3900, you can actually ground either V+ or V-.

ECL* Packaging Panels

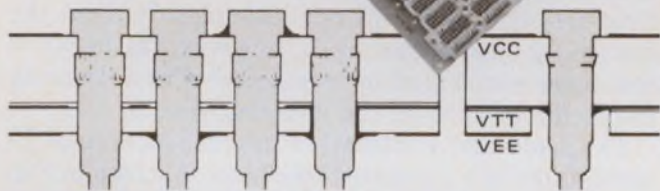
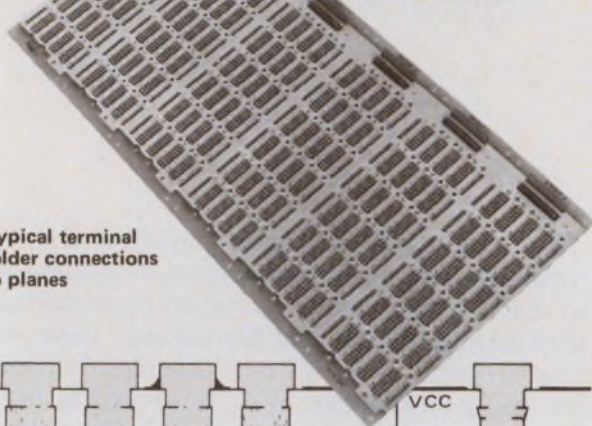

EMC's co-axial plated-thru and non-plated-thru hole design. Competitor's solder joint-in-the-hole. Potential flux contamination.

*Eliminate Contaminated Layers

Packaging panels for ECL do work!

Typical of EMC . . . a clever, unique solution to an annoying problem. Soldering terminals to the top (VCC) and bottom (VEE) voltage planes is easy, but reaching the middle (VTT plane) requires an enlarged hole through the bottom plane. Result? The inconvenience of working in a confined recessed hole, contamination caused by flux entrapment, and the difficulty of inspection.

EMC solves the problem by selective plating thru of the holes needed to reach the middle plane, so that the soldering job is on the surface . . . simple, clean, easy to check. And it's ideal for installing decoupling capacitors, too. EMC's design also provides maximum metal plane coverage, and of course, uses the patented Nurl-loc terminal. Interested? Contact Electronic Molding Corp., 96 Mill Street, Woonsocket, R. I. 02895. (401) 769-3800.

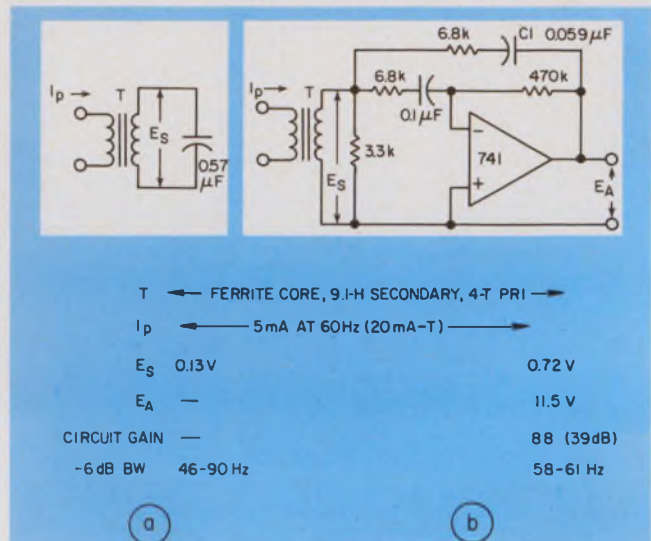
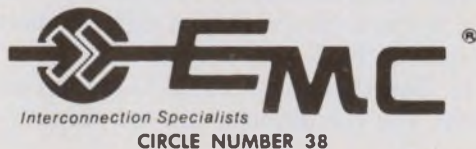

4. Passband is reduced drastically when a conventional tuned circuit (a) is replaced by an active tuned circuit (b). The 3.3-kΩ shunt resistor ensures stable operation.

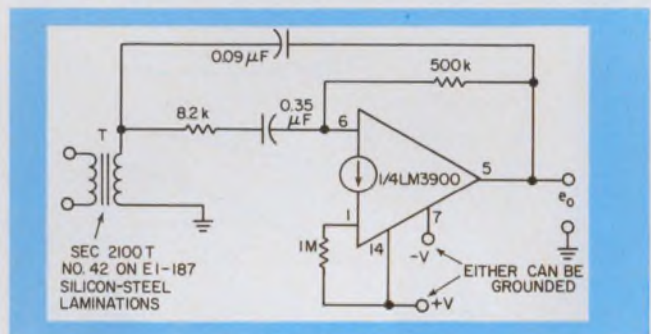

5. Nearly 10:1 passband improvement in a 60-Hz current transformer is obtained in a GFCI with this circuit. The secondary of the transformer consists of 2100 turns of 42-gauge wire on EI-187 silicon-steel laminations.

In the circuit's GFCI application, grounding V+ will avoid false triggering of an SCR during a start-up transient. With V+ grounded, the op amp cannot go positive when the power-supply voltage is applied.

Although determining component values for the circuits described will require some trial and error, the following procedure will make it easier:

1. Calculate the capacitance needed for the desired resonant frequency. The circuit will generate a capacitance of C_1 multiplied by the closed loop gain—which you can assume to be 10.
2. Start with $C_2 = 5C_1$, $R_1 = XC_2$, $R_2 = 0$.
3. If your circuit oscillates, add a shunt resistor and/or increase R_2 .
4. To increase the effects of frequency change, reduce R_1 and/or C_2 .
5. Check circuit stability over the required temperature and signal-level range. ■■

WANTED

3MHz to 2350MHz



The **VS90 SWEEP GENERATOR**

DESCRIPTION

- Wide Frequency Range-3MHz to 2350MHz**
- High Output Level-0.7v RMS into 50 ohm**
- Wide Sweep Width-100kHz to 1100 MHz**
- High Stability-Less than 20kHz residual fm**
- Flat Output-Leveling Int Ext. 0.5dB**

Price **\$2695⁰⁰** **Delivery Stock**

Texscan

Texscan Corporation 2446 North Shadeland Ave. • Indianapolis, In. 46219 (317)357-8781



Carl Korn Of Dynascan Speaks On

Training Real-World Engineers

Engineers are supposed to be objective, realistic, practical, down-to-earth people. They are supposed to design real products for real markets. And they are supposed to design them for manufacture on real production lines with real components obtainable from real vendors.

And frequently they do.

But very often, engineers—especially younger, unscarred engineers—fall into traps. It's one of the roles of engineering management to help these engineers avoid these pitfalls, as they can be terribly costly.

The first thing you have to fight is the idea that you can get something for nothing—or almost nothing. The something-for-nothing syndrome hits many engineers.

A fellow reads about a new component and he charges in with: "Wow, they've just introduced this brand new device and we can now add this function and it will cost us almost nothing."

Whenever I hear that, I shudder. It's happened to me often enough so that I know that when an engineer tells me we can get something for nothing, or almost nothing, we have to be careful.

When we go along with one of these brand new components, we often find that our testing cost shoots

up. Or the number of rejects we encounter during incoming inspection soars. Or reliability drops. It's quite possible that the incremental cost of the part itself may be negligible, but the total cost of putting in the function may not be adequately considered.

New devices must be greeted with great caution. I recall a new semiconductor many years ago. We bought thousands. In the first five lots of production parts, each time the manufacturer produced them they came out different. The manufacturer, in fact, gave each lot a different part number.

Because we were in a hurry to use this exciting new part, we had to re-design our unit each time to make the new part fit because the vendor couldn't make the new one like the old one. Mind you, these were not hand-produced models; we had thousands of production parts.

Now this raises another problem, one of the most important problems we face—relationships with suppliers.

We don't make basic components. We make equipment using components provided by other people. So we write specifications around their components. But we frequently have a hard time getting suppliers to produce to their own standards.

Sometimes we have to reject 25% of the parts in a lot. This tends to drive our prices up and to drive us in the direction of hopping from supplier to supplier. That's not desirable. I think they have a better system in the Far East, where an equipment manufacturer gets in bed with his component supplier. So the supplier tries his darnedest to take care of his customer. That practice is less prevalent here. There is too much concern with squeezing the last tenth of a cent out of the cost of a component.

To save money the engineer may decide that he can make a design that will do very nicely using parts with the specifications shown on the manufacturer's data sheets. But he had better find out if the manufacturer's parts are like his data sheets.

If you're designing something that's not achievable in production because of component limitations, then you're kidding yourself. You have to make sure that you're buying real parts that you can actually get instead of parts that look great on a data sheet.

Even worse than buying from a data sheet is buying from samples you get from a salesman. A salesman brings in a few parts and they test out beautifully. Unfortunately, they may represent the best that a production line has ever produced.

Let's talk for a moment about this business of component specifications. Say you need a part with 1% tolerance. You would expect a bell-curve distribution of parts around that tolerance. You'd expect a lot less at the limits than at the center. But when you actually make tests and take a distribution curve, you find that there's a hole in the middle. You are getting only the limits. Someone else paid a premium for the stuff in the middle.

Unfortunately your design may have been based on the bell curve. If everything you receive is at the limits then your design is wrong. So it may be necessary to specify the distribution of the new parts you require.

But new parts are not the only problem. You can run into snags with old components, too. You decide that you can add this new function and all you'll have to do is add a potentiometer to the front panel. But that added pot may change the size of the front panel and change the size of the entire instrument, requiring a major redesign.

That's an easy trap to fall into because, at first, all you see is the cost of a front-panel pot. And that's not much. So it's necessary to teach your engineers to live in a world with real components.

It's also necessary to teach your engineers that their lab is not necessarily the real world.

When an engineer designs a product, he must remember that production units won't be tested in the lab under the conditions in which he tested his prototype. They will be tested on a production line by people who don't have his skills. These people may not be using—and may not need—the test equipment

he used in the lab. There are many sophisticated tests that the engineer may need that don't have to be made on the production line.

The production line, in fact, should be a major concern for the engineer. Usually he tends to overlook how things will go together mechanically. He may not realize that a new part, even one that might be slightly more costly, might save money in the long run because it might make it easier to manufacture the entire equipment.

At this stage the engineer has already laid out his PC boards and he's reluctant to make a change. He feels that the cost of a change is very high. He may lock himself in because he doesn't want to change his boards. And he may be right.

So it's important, as soon as your engineers start laying things out, that they be involved with the people from production. At this stage they should be deciding how the product will be manufactured and how it will be tested. You don't want a situation where certain parts can't be tested because you can't get at them. The link between design engineering and production engineering should be made at the earliest possible stage.

But something else should be done even earlier. You have to decide what the product is going to be. That's not as trivial as it seems.

You have to be wary of the temptation to redesign your equipment for broader or different markets. I can show you an example in some of the CB test equipment we recently introduced. We could have done all sorts of things to make the equipment useful for the two-way radio business or for a broad range of lab applications in addition to CB testing. But by focusing on the requirements of CB testing, we were able to cut the cost of the equipment substantially, and thus expand its market, though we did not expand its capabilities.

We want our engineers to design for a market we've defined. We want to avoid the trap of: "Gee, if I add these two functions I'll expand my possible market another 5%." The engineers have to learn that we may not be able to sell that additional market because we don't have the right kind of sales organization. Or maybe the rest of the equipment won't adequately meet the needs of the additional market.

Deciding what the product should be can be one of the most challenging problems of all. You have to decide, not only what market you will serve, but how. This means that you have to decide, among other things, what goes on the front panel and what goes inside. You have to determine which features can be automatic, and therefore kept behind the panel, and which features should be brought out for user convenience or even for cosmetic reasons.

Here you have to resist the temptation to do everything in the most sophisticated way. It may not be desirable to make everything automatic, for exam-

Who is Carl Korn?



It began with the TV-repair and installation business that he started from his apartment in 1947. That was three years after he got his BEE from City College of New York, and just a year after he left the Navy and married Frances Ban, whose brother, Phil, was to become his business partner.

As his TV business began to mushroom, Carl Korn knew it would be extremely useful to be able to test vacuum tubes quickly and accurately in people's homes. So he started Dynascan to produce tube testers. These quickly became popular with the entire TV-service industry. That was when his own TV business was six years old and he was 32.

The next important product of what was to become B & K (for Ban and Korn) Precision, the electronic test-equipment group of Dynascan Corp., was an on-site CRT tester. By 1976, B & K accounted for about 17% of the \$100-million revenue of Dynascan, with the remainder in CB radios and radio remote-control systems. While Dynascan is still moving rapidly, so is Carl Korn, a man with boundless energy.

Though he seems to work 25 hours a day as president of Dynascan, he finds time to play a respectable game of golf (his handicap is about 15) and a mean game of tennis.

The Korn family has three children—Cheri Meisels, 26, Peter, 22 and Rhonda, 20.

ple. Sometimes you want lots of controls on the front panel because it conveys an impression that a piece of equipment is extremely powerful.

Now how do you go about teaching the younger engineer about the real world? You can't just stand there and lecture. Yet you want to teach him things you've learned from years and years of scars. How can you get that talent into a young engineer without having to wait all those years?

You have to structure your organization so that the key people who supervise the younger engineers fully understand that part of their function is education. One of the project leader's defined roles should be to teach the younger engineers things they haven't learned in school. And there's a lot.

One of the problems with school is the fact that many of the people teaching there never worked in industry. They so enjoyed the academic atmosphere that they went right from school to school—starting as student and finishing as teacher. Too often these people have zero conception of what the real industrial world is like. As students they were the cream of the crop. They did so well that the professors offered them assistant professorships.

But it's not easy to get senior people to educate the younger ones because you have an unusual situation. The old-timer doesn't know a lot of the things the newcomer has just learned in school. The older fellow, who has been working in industry for many years, may not be so well educated in the latest digital techniques, for example. So when the kid out of school comes around just brimming with information on digital design, the older engineer tends to be overawed.

He's reluctant to teach the new fellow. He feels he should be learning rather than teaching. He may feel that what he can impart is too trivial. An that's a danger.

It's particularly bad because the newer engineer may be unfamiliar with old technology that can sometimes provide a better solution than newer technology. I'll show you an example.

Some years ago we were designing a CRT tester that called for driving the CRT with high-voltage pulses having brief current peaks. The vacuum tube (remember the vacuum tube?) offered the best solution at that time, as the tube is very forgiving. It could take brief peak currents that would destroy many semiconductors.

But our young engineer didn't even know what a tube was. He had never used one, had never seen one. The old-timer was able to provide an old solution that turned out to be best.

With all these warnings, you can run into a problem created by the warnings themselves. You don't want to stifle creativity. You want to be innovative and you want to be a leader. So you want your people to think way out. This means they have to make mistakes. The only way to avoid mistakes is to avoid doing anything. And you want your people to do things.

If a guy has no failures, he is not trying enough. So you have to let him know he's expected to make mistakes. You must be prepared to accept some failures. This means you must welcome new ideas. But you must be careful with them, too, as they can often prove costly.

Getting your engineers to design *in* the real world, for the real world isn't easy. But it's of paramount importance. ■■

Datel's Low Power, Digital Cassette Transport

MODEL ICT-WZ



- Simple, reliable capstan stepping motor drive
- Ultra-low power (700 milliwatts while writing, microwatts in stand-by)
- CMOS electronics are ideal for +12VDC battery-powered portable instruments.
- Optional battery-power 16-channel A/D Converter Input
- Very high data capacity: 1.8 megabits, 220K bytes or 120,000 A/D samples

COVERED BY GSA CONTRACT

You'll find complete specifications on this product and more than 300 data conversion circuits and systems in Gold Book.

Just check Gold Book's Volume 3. That's Datel's complete Engineering Product Handbook, in its own separate volume. More than 290 pages of D/A & A/D Converters, Multiplexers, Sample-Holds, Op Amps, Power Supplies, Digital Panel Meters, and Printers, Digital Panel Instruments, Data Loggers, Digital Cassette Recorders, and Data Acquisition Systems. Each fully detailed on individual data sheets.

And it's available to you in Gold Book.

 **DATEL**
SYSTEMS, INC.
1020 Turnpike St., Canton, MA 02021
Phone: (617) 828-8000



See Electronic Design's
1977-78 "GOLD BOOK" — Vol. 3 page 281

• Santa Ana, CA (714) 835-2751, (L.A. Exchange) (213) 933-7256 • Sunnyvale, CA (408) 733-2424 • Gaithersburg, MD (301) 840-9490

**Monolithic Capacitors have been
our business for nearly three decades.**

(We build them better.)

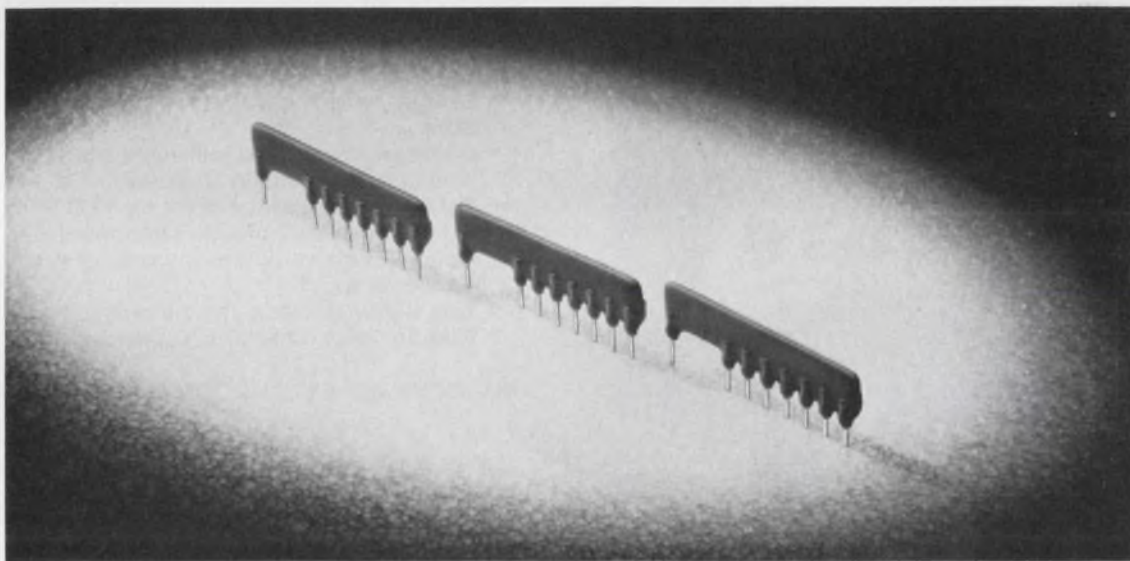

We build SIP Capacitor Networks to your specifications

Our single in-line package (SIP) capacitor network has 10 leads — nine capacitor sections and one ground.

But you can re-design it to your needs — we're very flexible.

In fact, we'll supply it with fewer leads . . . with NPO, X7R and BX dielectrics . . . with combinations of capacitance values . . . all in the same package.

What will it do? Reduce your assembly

costs (compared with individual leaded components) and provide higher reliability, especially for high-volume production.

As important, it's backed by the monolithic capacitor technology that has given us a high-quality reputation for nearly three decades.

If you're interested in a SIP network, send us your drawing or your requirements. We'll design it for you.



Vitramon®

Vitramon North America
Division of Vitramon, Incorporated
Box 544, Bridgeport, Conn. 06601
Tel: (203) 268-6261

Subsidiaries: Vitramon Limited (London) • Vitramon GmbH (Stuttgart) • Vitramon France S.A.R.L. (Paris) • Vitramon Pty. Limited (Sydney) • Vitramon Japan Limited (Tokyo)

Datel's New Low Priced Digital Panel Meter

MODEL DM-3100

FEATURES

- ▶ Miniature case with 0.5" LED display
- ▶ Bipolar, differential ± 2 VFS input
- ▶ 3½ Digit resolution with Autozeroing
- ▶ LCD display available at additional cost
- ▶ Additional ranges — customer programmable
- ▶ 4½ digit resolution also available—\$59 (100's)
- ▶ Additional current and ohmmeter capability — customer programmable

\$29*

\$35 (1-99) \$29 (100-499)



You'll find complete specifications on this product and more than 300 data conversion circuits and systems in Gold Book.

Just check Gold Book's Volume 3. That's Datel's complete Engineering Product Handbook, in its own separate volume. More than 290 pages of D/A & A/D Converters, Multiplexers, Sample-Holds, Op Amps, Power Supplies, Digital Panel Meters, and Printers, Digital Panel Instruments, Data Loggers, Digital Cassette Recorders, and Data Acquisition Systems. Each fully detailed on individual data sheets.

And it's available to you in Gold Book.

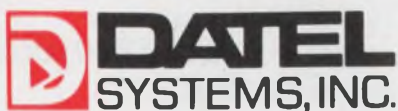

1020 Turnpike St., Canton, MA 02021
Phone: (617) 828-8000



See Electronic Design's 1977-78
"GOLD BOOK"—Vol. 3, page 226

Santa Ana, CA (714) 835-2751. (L.A. Exchange) (213) 933-7256 • Sunnyvale, CA (408) 733-2424 • Gaithersburg, MD (301) 840-9490
OVERSEAS: DATEL (UK) LTD—TEL: ANDOVER (0264) 51055 • DATEL SYSTEMS SARL 603-06-74 • DATELEK SYSTEMS GmbH (089) 78-40-45

CIRCLE NUMBER 42



HAYDEN

in personal computing books!

See for yourself the reasons why:

1. MICROPROCESSORS: New Directions for Designers by Edward A. Torrero, #5777-6, paper, 1975, 144 pp., 8½ x 11, illus., \$10.95.

2. GAME PLAYING WITH COMPUTERS Rev. 2nd Ed., by Donald D. Spencer, #5103-4, cloth, 1976, 320 pp., 6 x 9, illus. \$16.95.

3. FUNDAMENTALS AND APPLICATIONS OF DIGITAL LOGIC CIRCUITS by Sol Libes, #5505-6, paper, (\$6.95), #5506-4, cloth, (\$9.95), 1975, 192 pp., 6 x 9, illus.

4. COMPUTERS IN ACTION: How Computers Work by Donald D. Spencer, #5861-6, paper, 1974, 160 pp., 6 x 9, illus., \$5.50.

5. COMPUTERS IN SOCIETY: The Wheres, Whys and Hows of Computer Use by Donald D. Spencer, #5915-9, paper, (\$5.50), #5916-7, cloth, (\$7.50), 1974, 208 pp., 6 x 9, illus.

6. PROGRAMMING PROVERBS by Henry F. Ledgard, #5522-6, paper, 1975, 144 pp., 6 x 9, illus, \$6.50.

7. PROGRAMMING PROVERBS FOR FORTRAN PROGRAMMERS by Henry F. Ledgard, #5820-9, paper, 1975, 144 pp., 6 x 9, illus., \$6.50.

8. COBOL WITH STYLE: Programming Proverbs by Louis J. Chmura, Jr., and Henry F. Ledgard, #5781-4, paper, 1976, 144 pp., 6 x 9, illus. \$5.45.

9. MINICOMPUTERS: Structure and Programming, by T.G. Lewis and J.W. Doerr, #5642-7, cloth, 1976, 288 pp., 6 x 9, illus., \$12.95.

10. PATTERN RECOGNITION by M. Bongard, #9165, cloth, 1970, 256 pp., 6 x 9 illus., \$14.90.

11. DIGITAL SIGNAL ANALYSIS by Samuel D. Stearns, #5828-4, cloth, 1975, 288 pp., 6 x 9, illus., \$19.95.

12. BASIC BASIC: An Introduction to Computer Programming in BASIC LANGUAGE by James S. Coan, #5872-1, paper, (\$7.95), #5873-X, cloth, (\$9.95), 1970, 256 pp., 6 x 9, illus.

13. ADVANCED BASIC: Applications and Problems, by James S. Coan, #5856-X, cloth, (\$8.95), #5855-1, paper, (\$6.95), 1976, 192 pp., 6 x 9, illus.

14. FORTRAN FUNDAMENTALS: A Short Course by Jack Steingraber, #5860-8, paper, 1975, 96 pp., 6 x 9, illus., \$4.95.

15. DIGITAL TROUBLESHOOTING: Practical Digital Theory and Troubleshooting Tips by Richard E. Gasperini, #5708-3, paper, 1976, 180 pp., 8½ x 11, illus., \$9.95.

16. DIGITAL EXPERIMENTS by Richard E. Gasperini, #5713-X, paper, 1976, 192 pp., 8½ x 11, illus., \$8.95.

Write for 15-day examination copies of any of these books!

At the end of 15 days, please remit payment plus postage and handling, or return the books and owe nothing. Prices subject to change without notice. If payment

accompanies order, we pay postage and handling. Outside USA, cash must accompany order — include \$2.00 per book for shipping and handling.



Hayden Book Company, Inc.

50 Essex Street, Rochelle Park, New Jersey 07662

phone: (201) 843-0550



Datel's Hybrid A/D's-D/A's New Low Prices, Stock Delivery

MODELS ADC-HX, ADC-HZ, DAC-HZ

ADC-HZ12BGC

12 Bits Resolution
8 μ sec. Conv. Time
20 ppm/ $^{\circ}$ C Gain Tempco
32 Pin Glass DIP

\$119* (1-24)
\$77.50* (100's)

ADC-HX12BGC

12 Bits Resolution
20 μ sec. Conv. Time
20 ppm/ $^{\circ}$ C Gain Tempco
32 Pin Glass DIP

\$82.50* (1-24)
\$45.00* (100's)

DAC-HZ12BGC

12 Bits Resolution
3 μ sec. Setting Time
20 ppm/ $^{\circ}$ C Gain Tempco
24 Pin Glass DIP

\$39.00* (1-24)
\$25.00* (100's)

COVERED BY GSA CONTRACT

You'll find complete specifications on this product and more than 300 data conversion circuits and systems in Gold Book.

Just check Gold Book's Volume 3. That's Datel's complete Engineering Product Handbook, in its own separate volume. More than 290 pages of D/A & A/D Converters, Multiplexers, Sample-Holds, Op Amps, Power Supplies, Digital Panel Meters, and Printers, Digital Panel Instruments, Data Loggers, Digital Cassette Recorders, and Data Acquisition Systems. Each fully detailed on individual data sheets.

And it's available to you in Gold Book.

*U.S.A. Domestic Price Only



1020 Turnpike St., Canton, MA 02021
Phone: (617) 828-8000



See Electronic Design's
1977-78 "GOLD BOOK" Vol. 3 page 38

• Santa Ana, CA (714) 835-2751, (L.A. Exchange) (213) 933-7256 • Sunnyvale, CA (408) 733-2424 • Gaithersburg, MD (301) 840-9490

Pulsing a PROM's supply voltage greatly reduces the energy used

You can save energy by switching a PROM on only when needed. This mode is especially important in battery-operated equipment where bipolar PROMs have been avoided, because they consume a great deal of power.

A typical case is decoding a pocket-calculator's seven-segment output to BCD with a PROM. The supply current to the PROM is considerably higher than that drawn by a MOS calculator, but fortunately the PROM is needed only when a digit appears at the calculator's output.

In the figure, segment outputs SA through SG are ORed together into signal SS, which is a pulse train with a 1:1 mark/space ratio and period of 350 μ s. Transients at the leading edges of SS are "cleaned" by half a 74C221 dual one-shot, which then triggers the other half to provide negative-going pulses at its

$2\bar{Q}$ output. When $2\bar{Q}$ is HIGH, series-pass transistor Q_2 of the 723 voltage regulator is turned off via transistor Q_1 . Note that Q_2 is off most of the time.

When Q_2 is on, the output voltage, V_{cc} , rises to a predetermined value of 5 V after a delay, t_d , of about 1.5 μ s, and allows PROM operation for time t_p , which is also very short. The average power consumption of the decoding circuitry is, therefore, mainly in the 3 mA current drain of the voltage regulator. Since PROM operation draws 35 mA, pulsing saves more than 90% over continuous operation.

Peter A. Ernst, Institut für Regelungstechnik Universität Erlangen-Nürnberg, Cauerstrasse 7, 8520 Erlangen, Germany

CIRCLE NO. 311

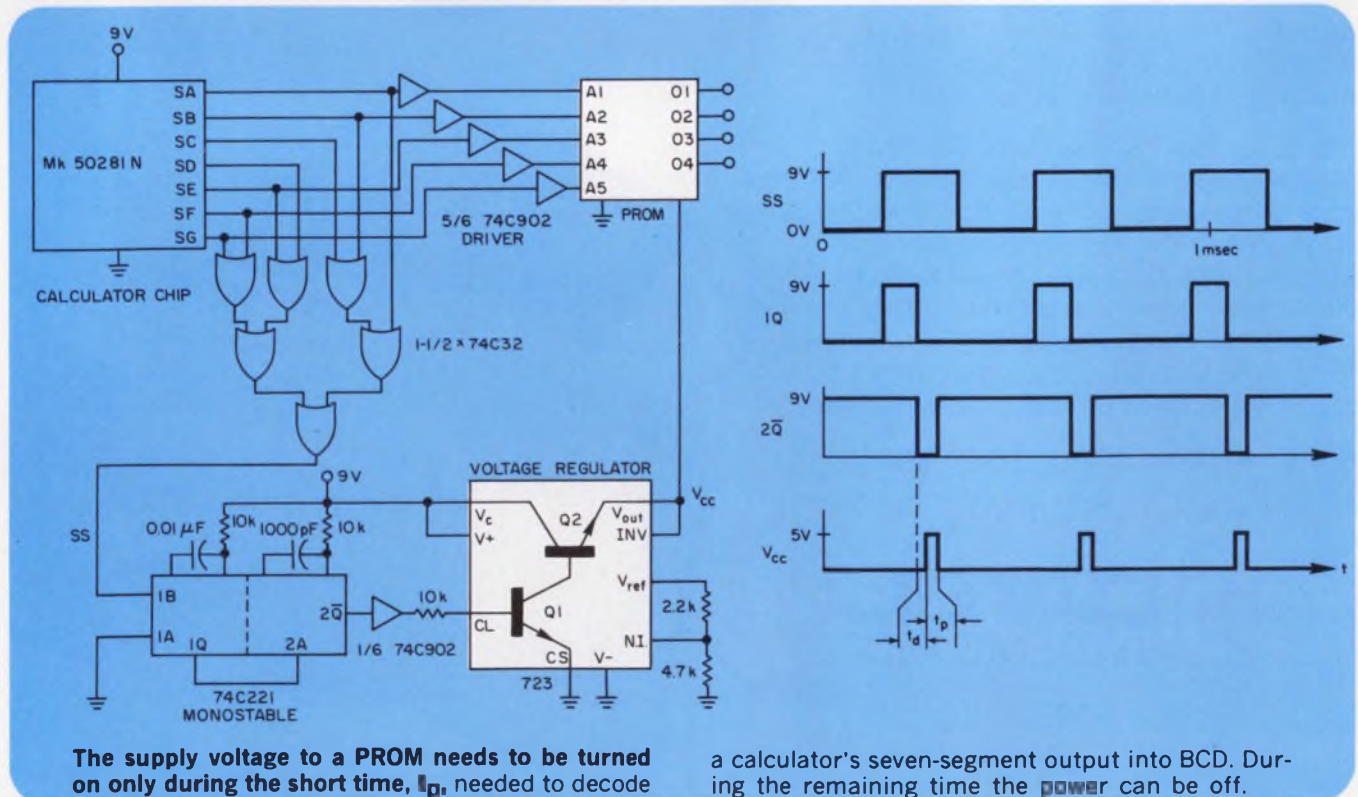

The supply voltage to a PROM needs to be turned on only during the short time, t_p , needed to decode

a calculator's seven-segment output into BCD. During the remaining time the power can be off.

Amphenol® UHF connectors point the way. With more ways to get quality terminations.



Just what you'd expect from the standard of the industry. Whatever your assembly-line method, there's an Amphenol UHF connector that fits right in. And Amphenol hand-crimp tools and crimping machines mean more efficient small- or large-volume assemblies.

Choose any of these different Amphenol assembly types (left to right above):

83-1SP all-solder. Still the most popular way to terminate the standard RG-8, RG-58, and RG-59 cables with confidence.

83-DCP all-crimp Series. Amphenol hex crimps make strong, simple terminations. Teamed up with our crimping machines, they give you the fastest, most economical way to terminate RG-8, RG-58, and RG-59 co-phase harnesses with Amphenol quality.

83-SP Series solder-contact/crimp-braid. Fast, reliable. Once again, the Amphenol hex-crimped braid is quicker than soldering.

83-58FCP* no-solder, no-crimp. Reduces your labor and assembly costs. Assembles with just an ordinary pair of pliers and a knife—simply package it unassembled for customer assembly. Saves you money and permits the customer to trim and customize his coax installation.

For fast solutions to your connector problems: Contact your local Amphenol sales office or Amphenol distributor. For more data call: (203) 743-9272 or write to: Amphenol North America Division, Bunker Ramo Corporation, RF Operations, Dept. C87A 33 East Franklin Street, Danbury, Connecticut 06810.



Twin-Hex Hand-Crimp Tool.



Pneumatic Crimp Machine.

The right idea
at the
right time.

AMPHENOL

CIRCLE NUMBER 45

Programmable baud generator for an 8080 works off the system's clock

Just three synchronous, presettable 4-bit binary counters and a NAND gate are needed to build a programmable baud-rate generator. The generator can give you virtually any baud rate, plus it uses the clock in your system, instead of a special crystal needed by off-the-shelf baud generators. Of course, the accuracy of the baud rate depends on the accuracy of the system clock.

The circuit in Fig. 1 uses the $\phi 2$ clock of an 8080-microprocessor system, which has a frequency of 2

MHz. A look-ahead-carry cascades the three counters, IC₁, IC₂, and IC₃. The 2's complement of the number, by which the master clock needs to be divided, is set up on the switches. With these set-up data, the ripple-carry overflow from the last counter stage, IC₃, presets the counters.

With an input clock period of 500 ns, the output, Q_D, of IC₁ produces a pulse width of 4 μ s, which enables the input, T, of IC₂. This pulse width assures an output clock of 4 μ s, which meets the minimum worst-case

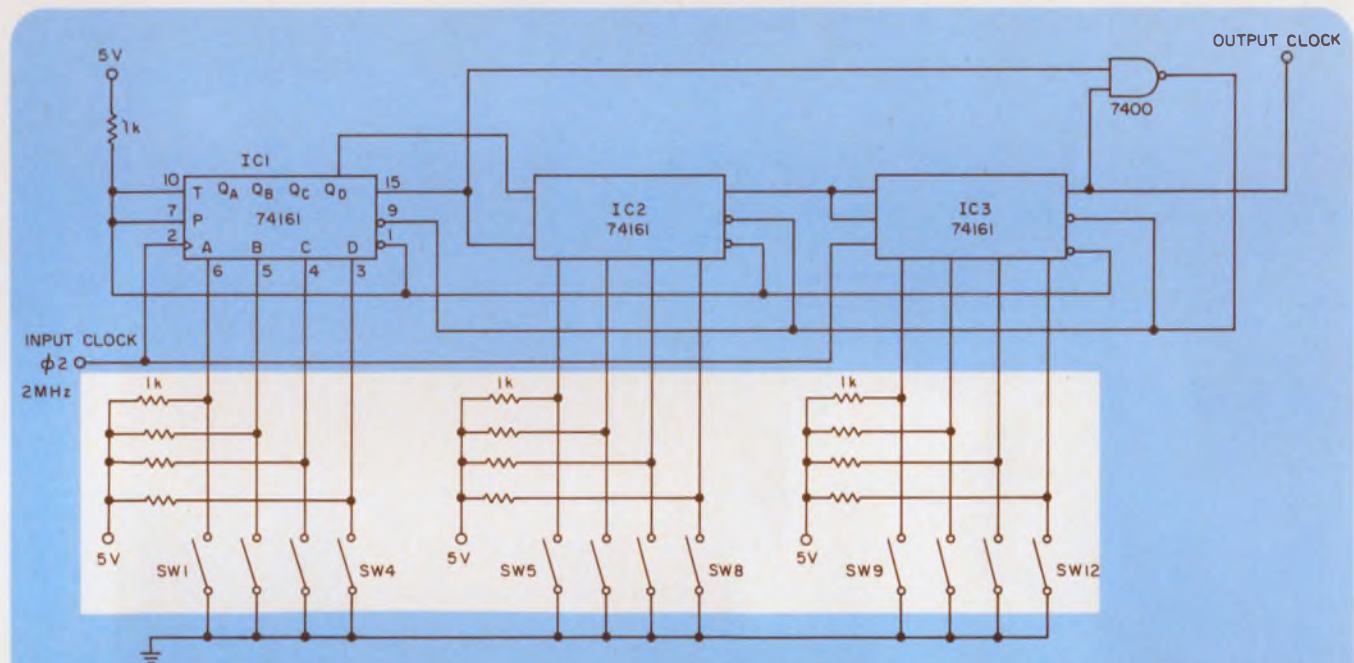

Baud rate	UART frequency 16X baud rate	Divisor	Switch settings											
			SW 12	11	10	9	8	7	6	5	4	3	2	1
50 b/s	0.800 kHz	2500	0	1	1	0	0	0	1	1	1	1	0	0
75	1.2	1667	1	0	0	1	0	1	1	1	1	1	0	1
110	1.760	1136	1	0	1	1	1	0	0	1	0	0	0	0
134.5	2.152	929	1	1	0	0	0	1	1	0	0	1	1	1
150	2.4	833	1	1	0	0	1	0	1	1	1	1	1	1
300	4.8	417	1	1	1	0	0	1	0	1	1	1	1	1
1200	19.2	104	1	1	1	1	1	0	0	1	0	0	0	0
1800	28.8	69	1	1	0	0	1	1	0	0	1	0	1	0

1. A programmable baud-rate generator driven by an 8080 μ P's clock can be programmed by setting

switches SW₁ through SW₁₂. The switch combinations in the table provide eight selections.

Elmwood makes Sense

Why overspecify? Choose the fast-response snap-acting Elmwood thermostat model that just fits your needs. Choose the levels of tolerance and differential that are right for your product, without wasted details or dollars.

For worldwide sales many Elmwood models meet CSA and European requirements (and DIN norms), as well as U.L. Ratings are to 15 amps, for exposures -65°F to 550°F (-54°C to 288°C), and each unit is factory pre-set, tested and tamperproof. Doesn't Elmwood make Sense? Ask for prototypes.



Elmwood Sensors, Inc. 1655 Elmwood Avenue, Cranston, R. I. 02907
PH 401/781-6500. Twx 710-381-6413.

European Div., Elmwood Sensors, Ltd.,
North Shields, Tyne and Wear, NE29 8SA
England Ph (089) 45-82821. Telex: 53284



Elmwood Sensors
Precision Controls



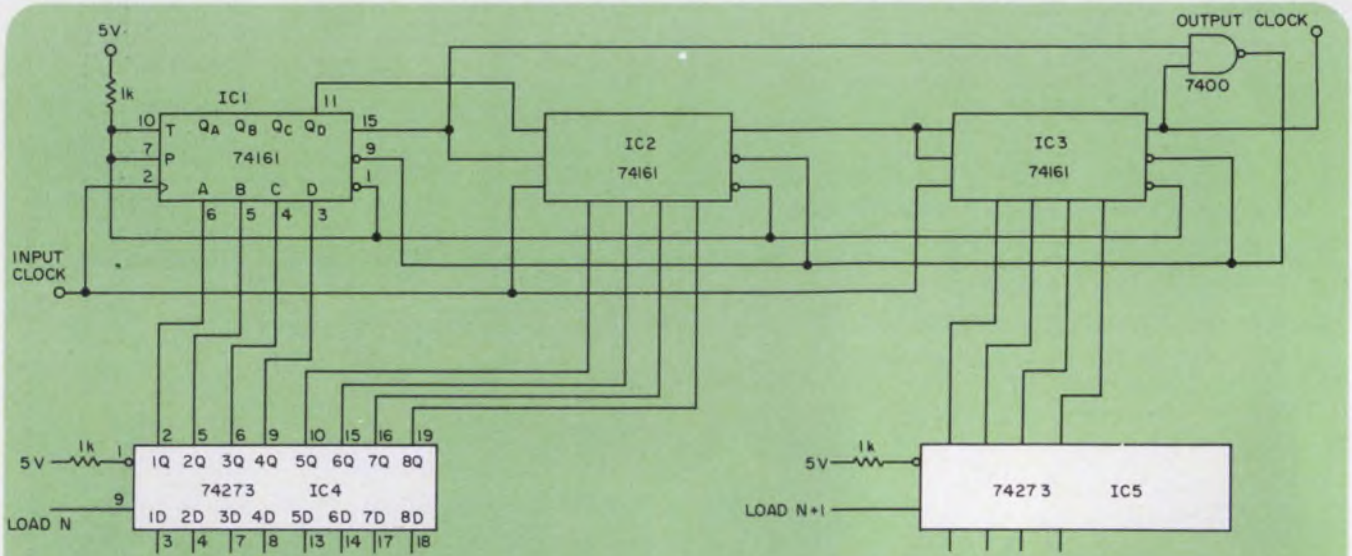

2. Software can set the baud-rate if the programming switches are replaced with two registers, IC₄ and IC₅.

pulse-width requirement of 2.5 μ s, needed for most UARTs. The table summarizes switch settings for baud rates of 50 through 1800.

Two registers, IC₄ and IC₅, in Fig. 2 allow software selection of the baud rate.

Naresh K. Batra, PE, Electronic Engineer, A. B. Dick Co., Information Products Div., 2200 Arthur Ave., Elk Grove Village, IL 60007.

CIRCLE NO. 312

Reduce ground-loop problems in safety-grounded instruments

Do current loops in your instrument's power-plug safety connection cause noisy or erroneous measurements? Consider the following solution before reaching for that three-prong to two-prong line-cord adapter.

The addition of a single high-current rectifier bridge allows the instrument's common to float at least ± 1 V away from the power-line safety ground to accommodate the few hundred millivolts of typical ground difference (see figure). But under fault conditions, the diodes fully conduct with a shock-free ± 2 V maximum drop, which preserves the protective function of the power ground.

The bridge must be able to carry the maximum fault current. However, since reverse voltage on each diode is less than 1 V, the bridge's voltage rating is unimportant.

Durward Priebe, Principal Engineer, R&D Laboratory, Hewlett-Packard, 5301 Stevens Creek Blvd., Santa Clara, CA 95050.

CIRCLE NO. 313

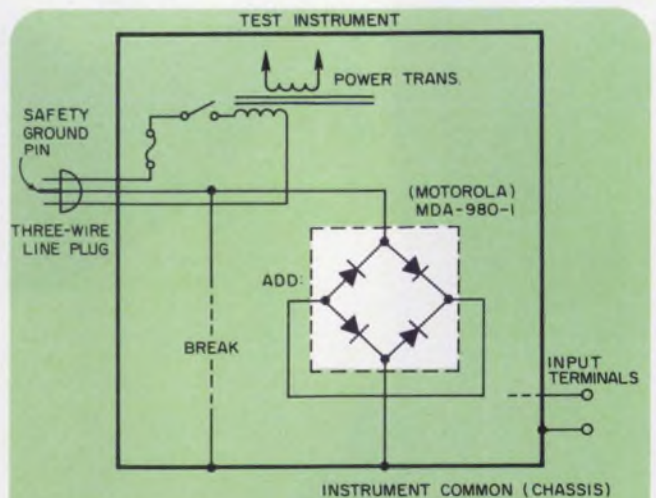

A bridge rectifier between an instrument's safety-ground pin and the chassis' common ground preserves the safety feature of the ground and also reduces ground-loop problems.

A good idea. Now it's practical...

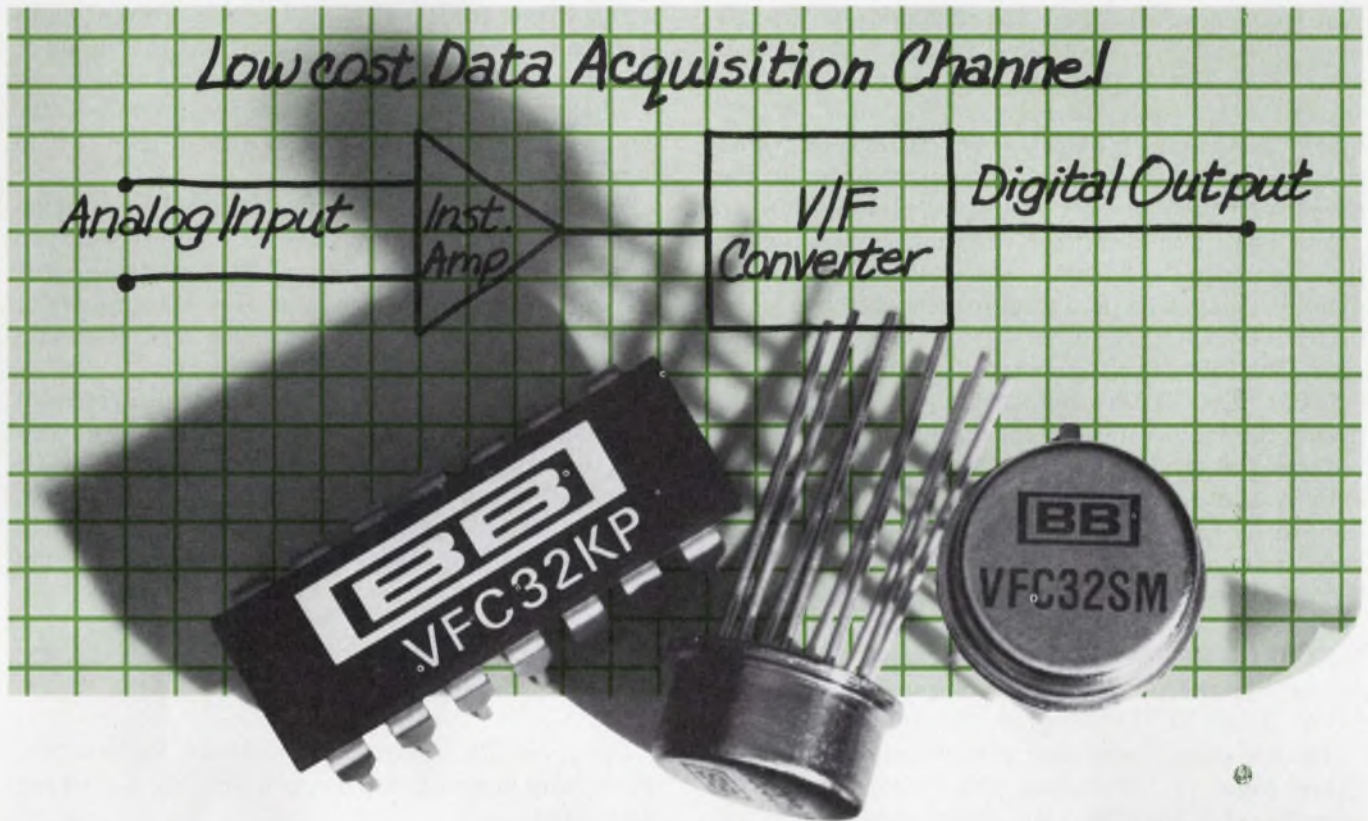

Burr-Brown's new VFC32 monolithic V/F converter provides $\pm 0.01\%$ (12-bit) linearity, a 6-decade dynamic range, yet costs only \$6.10 in 100's.

Now that precision performance and wide dynamic range are available in a low-cost monolithic V/F converter, you should take another look at this low-cost method of digitizing analog signals. The VFC32, with 12-bit linearity to 10 kHz, offers a sevenfold improvement over units you may have considered. And its top frequency of 0.5 MHz (with 8-bit

linearity) is five times higher than competitive units, allowing faster conversion times.

You can also use the VFC32 as an F/V converter. And you'll need no external active components. Use it in tachometer applications, or combine two VFC32s and make an analog-digital-analog data link that has high noise immunity.

Three versions are available, covering the temperature ranges of 0 to $+70^{\circ}\text{C}$ (epoxy DIP package), -25 to $+85^{\circ}\text{C}$ and -55 to $+125^{\circ}\text{C}$ (hermetically sealed TO-100 packages).

For complete details, contact Burr-Brown, International Airport Industrial Park, Tucson, Arizona 85734. Phone (602) 294-1431.

BURR-BROWN

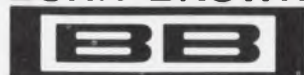

**Still at the top
except in price**

Build a high-frequency phase-locked loop with common IC components

In high-speed Schottky logic systems, the clock frequencies are usually well beyond 10 MHz. But ordinary IC phase-locked-loop chips can't perform at such frequencies. However, you can build—with readily available ICs—a Schottky-TTL compatible phase-locked-loop (PLL) that requires no special supply voltage levels—only the regular TTL +5 V. What's more, the circuit produces very little jitter, and remains near its nominal frequency even in the absence of the reference frequency (see figure).

The PLL, a conventional second-order configuration, includes both input and feedback-frequency dividers that feed a digital phase detector.¹ The detector's output, after filtering, is an error signal that controls a 54S124 voltage-controlled crystal oscillator (VCXO). The VCXO's output frequency "seeks" to match the input-reference frequency, which thereby reduces the error signal to a minimum.

Both the reference and VCXO frequencies are divided by four with two 54S112 flip-flops to bring them within the phase-detector's operating range. Therefore, with a 20-MHz input reference and VCXO output, the phase-comparator inputs operate at 5 MHz. If the VCXO's output is less than the reference frequency, the phase-detector output (pin 13) goes LOW; if the VCXO is higher, pin 2 goes LOW.

The low-pass filter circuit suppresses noise and the sharp edges of the output pulses from the phase detector. In addition, the filter determines the dynamic performance of the loop—a second-order loop

with a damping factor of 0.8 and a natural frequency of 4.5 krad/s.

The RC-filters at the input of the LM108 op amp, with a corner frequency of 82.3 krad/s, prevent high-frequency components from overdriving the inputs of the op amp. The LM108 operates with a single +5-V supply, draws low input-bias current, so the filter exhibits little drift, and provides high dc gain to help with initial acquisition.

The 54S124 VCXO is a dual-unit Schottky voltage-controlled oscillator, designed to be used with an external capacitor (pins 12 and 13) to establish the center frequency of the oscillator. However, the device becomes an excellent VCXO when a crystal is substituted for the capacitor.

The crystal should be cut to obtain a series-resonant frequency slightly above the desired center frequency—in this case, 20.03 MHz. Such a crystal allows VCXO frequency variation between 19.965 and 20.035 MHz, with a 0-to-4-V change on the input control (pin 1). For the best results, the 54S124 range-control bias (pin 14) is set near 3 V.

References

1. Gardner, F. M., *Phaselock Techniques*, Wiley, New York, NY, 1967.

James E. Buchanan, Westinghouse Electric Co., Friendship International Airport, Box 746, Baltimore, MD 21203.

CIRCLE NO. 314

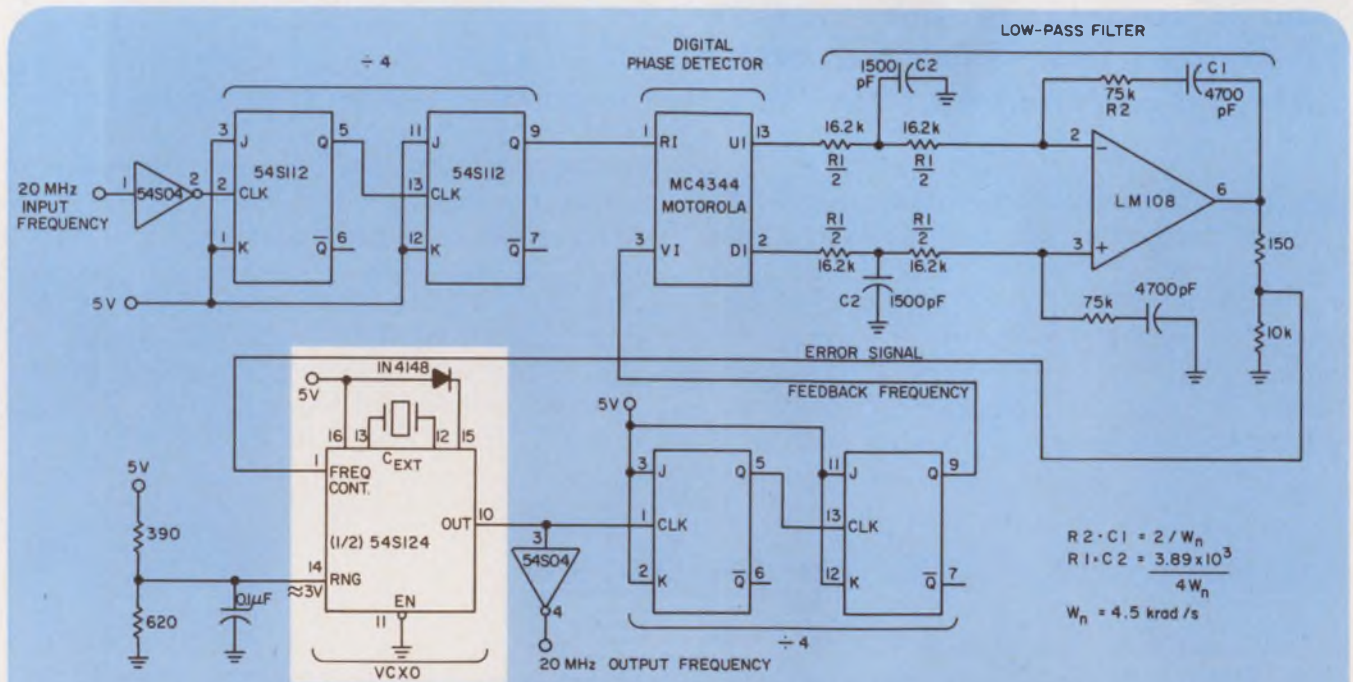

This crystal-stabilized phase-locked loop for Schottky frequencies can be constructed with readily

available IC components. Frequencies well above 10 MHz are easily handled by the circuit.



**So you're trying to develop a
new non-impact printing
system.**

So look into 3M's new thermal papers and technical support.

If you work on, think about, or dream of non-impact printers, talk to us. Tell us what you're up to. Let us do our homework, see how we can match our thermal paper and your project, and help you make dreams come true.

Because if you have the project, 3M has the paper. The widest line of 3M Brand heat print papers in the business—including standard-weight, card-weight, and label stock papers with outstanding stability, copyability, and

permanence of image. Plus transparency stock. And we can cut any sheet or roll to your exact sizes and specifications.

Even better, our Technical Support Staff loves to help people dream up non-impact printer solutions on 3M Brand heat print paper.

Mail the coupon and find out. And we'll bring you a "Creativity is Dreaming Organized" wastebasket, absolutely free!



To: Bob Spreng
Imaging Systems and Products
3M Company—Dept. DLR-87
St. Paul, MN 55101

I want to hear more about your 3M Brand heat print papers and 3M Technical Support. And please bring me a "Creativity" wastebasket for the dreams that don't quite make it.



NAME _____
TITLE _____ PHONE _____
COMPANY _____
ADDRESS _____
CITY _____ STATE _____ ZIP _____

CIRCLE NUMBER 48

Ideas for design

Variable-delay circuit built with multivibrators preserves pulse width of the input signal

A TTL variable-delay circuit that preserves the input pulse width may be constructed with two DM9602 multivibrators (see figure). The circuit provides time delays ranging from 100 ns to several hundred microseconds. The input-pulse period, however, must be equal to or larger than the desired time delay.

Multivibrator IC_1 triggers on the leading edge of the input pulse, and IC_3 on the trailing edge. If the time

constant R_4C_2 is much larger than $(R_1 + R_2)C_1$, and $(R_1 + R_2)C_1$ is equal to $(R_5 + R_6)C_3$, the output will be a delayed replica of the input pulse.

For the values shown in the figure, the time delay, determined by IC_1 , may be varied from 100 ns to 1 μ s.

John Keller, Advanced Development, Texas Instruments, Dallas, TX 75022.

CIRCLE NO. 315

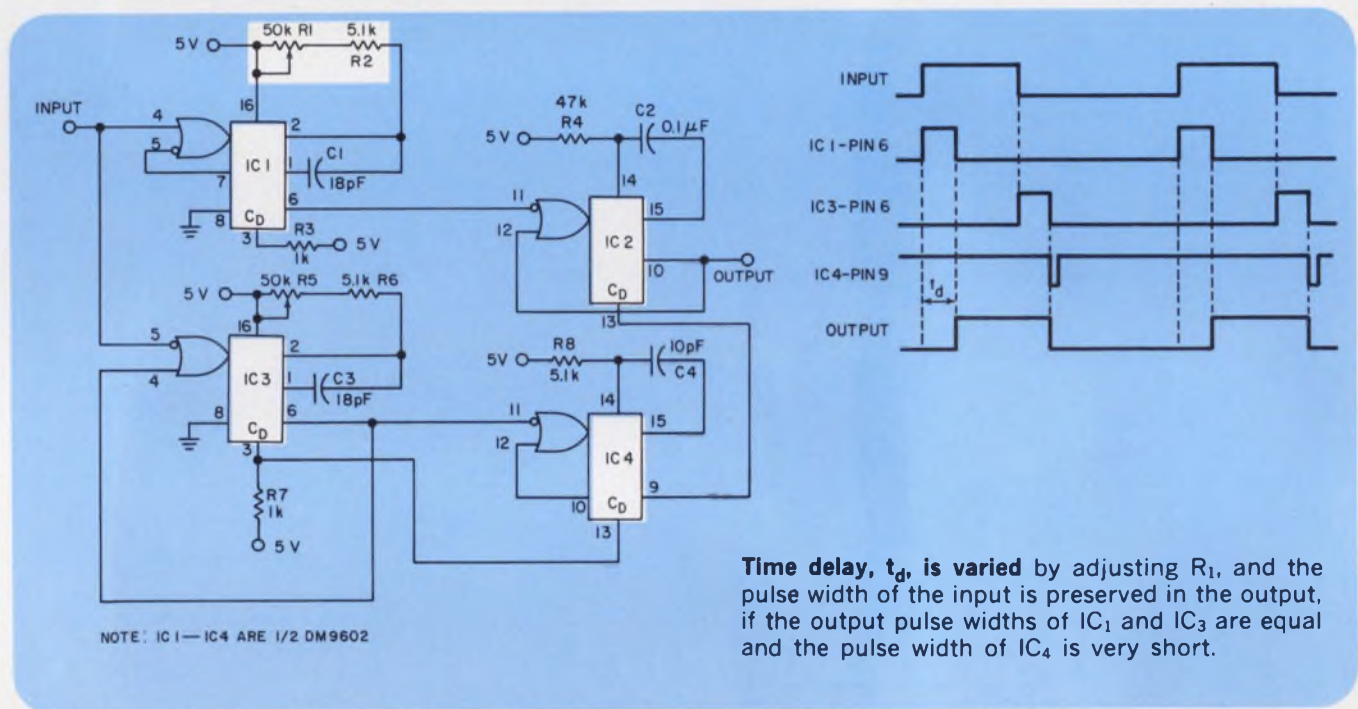

Time delay, t_d , is varied by adjusting R_1 , and the pulse width of the input is preserved in the output, if the output pulse widths of IC_1 and IC_3 are equal and the pulse width of IC_4 is very short.

IFD Winner of March 29, 1977

Gerald Buurma, National Semiconductor, 2900 Semiconductor Dr., Santa Clara, CA 95051. His idea "Simple CMOS Keyboard Encoder Circuit Programs Voltage Source In 1-V Steps" has been voted the Most Valuable of Issue Award.

Vote for the Best Idea in this issue by circling the number for your selection on the Reader Service Card at the back of this issue.

SEND US YOUR IDEAS FOR DESIGN. You may win a grand total of \$1050 (cash)! Here's how. Submit your IFD describing a new or important circuit or design technique, the clever use of a new component or test equipment, packaging tips, cost-saving ideas to our Ideas for Design editor. Ideas can only be considered for publication if they are submitted exclusively to ELECTRONIC DESIGN. You will receive \$20 for each published idea, \$30 more if it is voted best of issue by our readers. The best-of-issue winners become eligible for the Idea of the Year award of \$1000.

New from Centralab...

IMPS PUSHBUTTON SWITCHES

A new miniature modular building block system that offers microprocessor control designers more of what they need.

To meet the special digital and analog needs of today's μ P-based controls, Centralab offers design engineers a whole new system of modular pushbutton switch building blocks. We call it IMPS — Integrated Modular Panel System. IMPS saves PC board and panel area and simplifies front panel design, cuts assembly costs, reduces back-panel space requirements, and meets the digital-analog needs of μ P-based controls. Check these space saving, cost-cutting features.

Simplify front panel interface.

All IMPS switches regardless of function, are uniform in size, simplifying design and selection of front panel hardware. They have high volumetric efficiency, occupying .505" x .388" PC board area and require only .608" of space between PC board and front panel.



Cut assembly costs.

IMPS switches may be mounted on the front panel, and are designed for automatic wave soldering installation and PC board cleaning. Insert molded terminals prevent flux and solder wicking and contact contamination. Integral PC board stand-offs provide for efficient board cleaning.

Meet analog and digital needs.

IMPS switches are available with momentary, push-push and interlocking actions, with a long-life contact system that switches both digital and analog signals. To accommodate critical signal requirements, housings are high-insulation molded plastic with UL 94V-0 rating.

Available options.

Optional installations include ganged assemblies, front-panel mounting and wire-wrapping.



All IMPS pushbutton switches are built to Centralab's highest quality standards (see specifications at right). They're priced as low as 41 cents in 1,000 quantity. For full technical details, samples and quotation, call (515) 955-3770, or write to the address below.

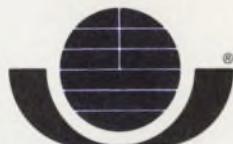

CENTRALAB

Electronics Division
GLOBE-UNION INC.
P.O. BOX 858
FORT DODGE, IOWA 50501

CIRCLE NUMBER 49

Built To Centralab Quality Specs.

IMPS Pushbutton Switches combine compact size, low cost and highest quality throughout.

- Silver or gold inlay wiping contacts for long-life and low-contact resistance.
- Less than 2 milliseconds contact bounce.
- SPST, SPDT, DPST, and DPDT switch contacts.
- Printed circuit, DIL socket or wire-wrap terminations available.
- 2.5 to 3.5 oz. actuation force (momentary).
- Choice of button interface — square or blade shaft (shown) — permits use of a variety of Centralab and industry standard buttons and keycaps.
- 10, 15, 20 or 25mm center-to-center spacing.

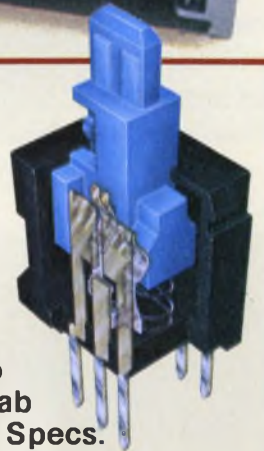

WE KNOW A LOT ABOUT A LITTLE.

550 Mu powder cores, for instance.

Our 550 Mu powder cores bridge the gap between 300 Mu cores and nickel laminations. Compared to 300 Mu cores, they pack 1.8 times more inductance into the same space. These toroids offer you less d.c. copper resistance, minimum distributed capacity, greater temperature stability than laminations and economies in assembly.

Samples are available upon request. 550 Mu is just one of 10 permeabilities, starting at 14 Mu, which will meet all your filter needs. Write Magnetics, Components Division, Butler PA 16001.



Available in 12 sizes from .250" to 1.50" OD.

Very special specialists in powder cores.



CIRCLE NUMBER 141

WE KNOW A LOT ABOUT A LITTLE.

High-perm ferrite cores, for instance.

Magnetics' ferrite cores offer you greater resistivity than metal alloys. Their high-permeability and high-flux levels provide high inductance in a small space. Our type W 10,000 perm material has an extremely high Curie temperature (140°C). In transformer applications ferrite cores make an excellent substitute for laminated cores, reducing cost and simplifying packaging. For more information on our 14 different ferrite materials, write Magnetics, Components Division, Butler PA 16001.

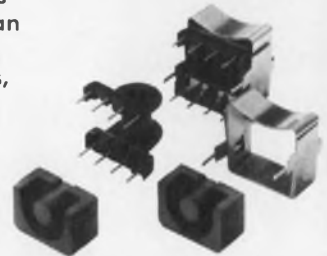

Available in EP, RM and toroid geometry shapes.

Very special specialists in ferrites.



CIRCLE NUMBER 142



There's a Hoffman enclosure for almost every electronic application you can think of.

Case in point: our consoles. They're designed to rigidly controlled parameters, so they can meet your exacting specifications. They answer your requirements for electronic enclosure applications in dust-filled industrial environments, including process-control computers.

They're components of a 1700-product Hoffman line, including free-standing enclosures, consoles, instrument boxes, and new electronic rack enclosures, in an extensive array of materials and sizes.

There is a Hoffman enclosure for almost every electronic application you can think of. All you need to do is think of us. Check with your local Hoffman distributor, or write directly for detailed specifications. Then see how well Hoffman quality will perform for you.

For complete data write:
HOFFMAN ENGINEERING COMPANY
Division of Federal Cartridge Corporation
DEPT. ED652, ANOKA MN 55303

Hoffman
ELECTRICAL ENCLOSURES

CIRCLE NUMBER 50

Pure logic and hard facts

1. In high-frequency power switching, heat is a prime factor in Darlington failure.
2. Turn-off time is the dominant cause of destructive temperature rise.
3. The faster the turn-off, the cooler the Darlington, the greater the reliability.

Take a look at competitive Darlings in an actual 20 KHz bridge converter circuit:

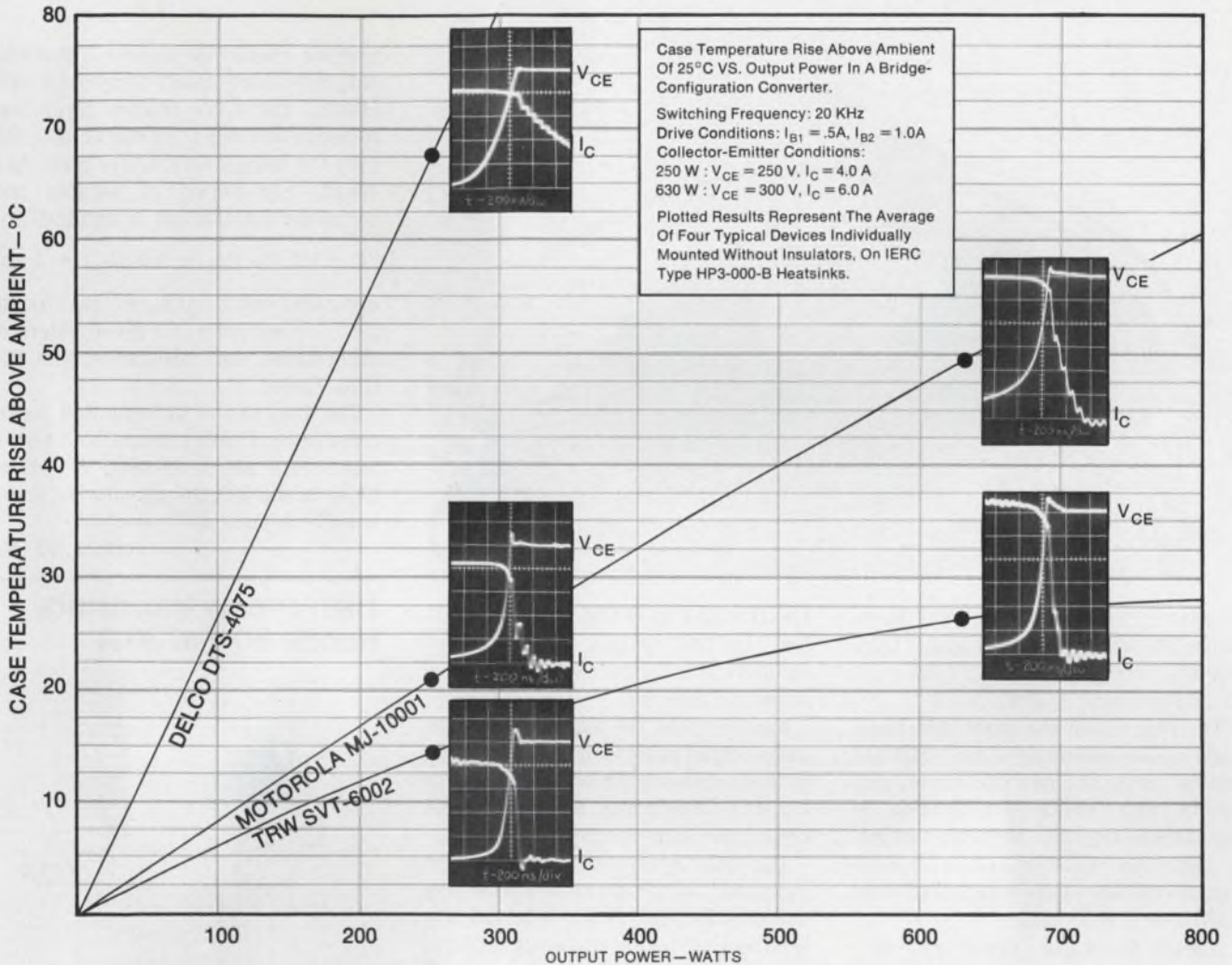

TRW operates at the lowest temperatures for the greatest reliability in high-frequency Darlington off-line switching regulators

And when you're working with high-power, fast-switching Darlings that's no small thing. When you need reliability at high frequencies, the best combination of switchoff and energy capability add up to greater efficiency and longer life. And what circuit are you about to design that doesn't deserve the best? Particularly when TRW Darlings are not only competitively priced, but are also immediately available in any quantity.

To get all the facts on TRW's high-frequency Darlington, use coupon or phone John Power at (213)679-4561.

TRW Power Semiconductors
 An Electronic Components Division of TRW, Inc.
 14520 Aviation Boulevard, Lawndale, California 90260

Please send me data sheets on TRW's Darlington transistors.

Please send me samples for _____ voltage and _____ current.

Name _____

Company Name _____

Position _____

Address _____

City _____ State _____ Zip _____

ED

TRW POWER SEMICONDUCTORS

ANOTHER PRODUCT OF A COMPANY CALLED TRW

CIRCLE NUMBER 51

Popular IC-timer in DIP is compatible with high-noise immunity logic

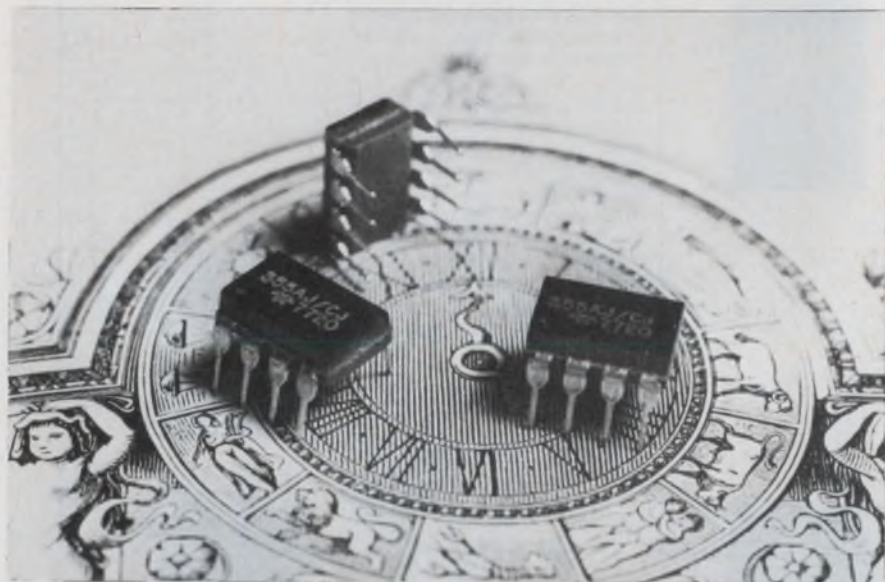

Teledyne Semiconductor, 1300 Terra Bella, Mountain View, CA 94040. (415) 968-9241. 100 qty price: \$1.10 (plastic), \$1.43 (ceramic); 2 wks.

The ubiquitous 555 timer now has a high-noise-immunity-logic (HiNIL) sibling rival. The new 355 timer, pin-for-pin and function-for-function, is the same as the 555—but with decidedly improved behavior and more compatible voltage specs when used with HiNIL or CMOS logic.

Industrial-control designers, who have tried using the 555 with HiNIL or CMOS-logic systems, have experienced a raft of problems.

Every time a 555's totem-pole output switches, the power supply can virtually short out. This problem is well known to computer logic designers, but often comes as a surprise to industrial-control engineers. The well-regulated and highly filtered 5-V supplies used for TTL usually can suppress with barely a quiver surges generated by a 555. But a HiNIL power supply usually ends up with a 300-mA, 200-ns spike on the supply line, when the 555's output goes HIGH.

HiNIL and CMOS logic aren't supposed to need tight regulation and heavy filtering. Consequently, when

HiNIL and CMOS flip-flops and counters in the system "mysteriously" change state, they are wrongly blamed as being unstable.

Furthermore, the trailing edge of the same output pulse from the 555 can put a 50-mA spike on the power-supply line—not as upsetting as the 300-mA surge, but still formidable.

The 355, specifically designed for industrial applications—with supply voltages ranging from 11 to 16 V—produces switching-transient spikes of only about 1 mA. Also, its reset threshold has been increased to be compatible with HiNIL. Like the trigger levels, this is proportional to the supply voltage. At 40% of the supply voltage, the reset voltage is between 4.4 and 6.4 V—to guarantee high noise immunity and still produce positive reset.

Of course, some compromises in performance are necessary. The 355 operates only at levels above 10 V; therefore, allowed current loads are reduced—100 mA source or sink current compared to 200 mA for the 555. And the 355 can't be used with TTL.

To eliminate the potentially heavy spikes of the 555, the 355's output stage is slowed. But in industrial work this

slowing should go almost unnoticed. And to be more closely compatible with HiNIL, the 355's trigger levels are raised to 45% of V_{CC} instead of 33%; this puts the trigger level above reset. As a result, the period of astable performance for the 355 is changed to

$$T = 0.5 C_T (R_A + 1.8 R_B) + 1 \mu s,$$

compared to $0.7 C_T (R_A + 2 R_B)$ for the 555. Consequently, for given values of capacitance and resistance, the 355 runs faster.

The $1 \mu s$ in the 355 equation represents internal delay, which isn't significant until about 20 kHz. A similar delay in the 555, though shorter, is not usually a published number.

CIRCLE NO. 301

High energy transistors handle 80 V at 30 A

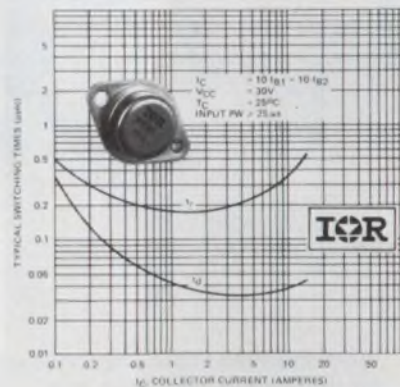

International Rectifier, 233 Kansas St., El Segundo, CA 90245. (213) 678-6281. From \$1.95 (100 qty); stock.

The 2N5879-82 series of complementary npn and pnp high-energy power transistors can handle 30 A of peak collector current. Transistors have V_{CE} or V_{CB} ratings of up to 80 V. The 2N5879 and 80 are pnp units and 2N5881 and 82 are npn. Units in the series all offer maximum dissipation ratings of 160 W and dc current gains of up to 35 at 4 V and 2 A. Switching rise time is $0.7 \mu s$, storage time is $1 \mu s$ and fall time is $0.8 \mu s$. TO-3 case.

CIRCLE NO. 302

Arrow-M R Relays

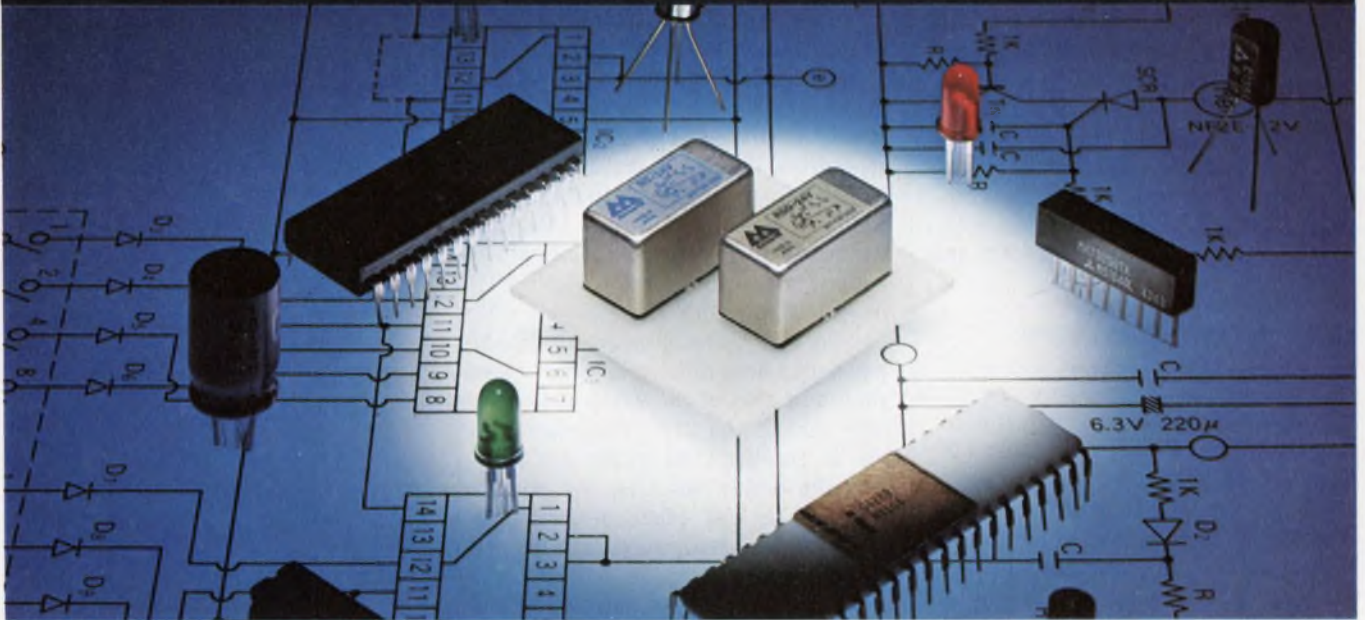

The many advantages and unique capabilities of Arrow-M's R Relays are far too extensive to be covered here. Therefore, we'd like to whet your creative appetite with a few outstanding facts:

1. Arrow-M R Relays are available in 1 Form C contacts which can carry a high current capacity of 1 Ampere 20 watts, and are capable of resisting welding at higher inrush currents. The dry circuit type which can switch current as low-level as 100uA is available in addition to the power type.

2. *High Speed:* Arrow-M R Relays can be operated at 500 cycles/sec.

The tiny power memory reed



3. Greater reliability and lower cost, due to simultaneous automatic fabrication of coil bobbin, contact and terminal.

4. In addition to the standard there are 1 coil and 2 coil latching types, which are useful for logic circuit design as a memory component.

5. Not only can they be automatically wave soldered on PC boards with a high density of electronic parts, but they are simple to clean with most degreasers and detergents without affecting maximum contact reliability.

6. *High Sensitivity:* Minimum operating power:
Single Side Stable 80 mw/Bistable 40 mw

7. *Longer Life:* Mechanical: More than 10^9 operations.
Electrical: More than 10^6 operations.
(1A 20vdc, 0.3A 110vac)

Hungry for more information?
For exact specifications
on all of our relays,
write or call your
nearest Arrow-M office.

Arrow-M Corporation
250 Sheffield Street
Mountainside, NJ 07092
(201) 232-4260

Mid-Western Office:
600 E. Higgins Rd.
Elk Grove Village, Ill. 60007
(312) 593-8535

Western Office:
22010 So. Wilmington Ave.
Suites 300 & 301
Carson, Calif. 90745
(213) 775-3512

Relays for Advanced Technology



Arrow-M

Member of Matsushita Group

CIRCLE NUMBER 52

Opto-isolator couples HNIL with TTL

Hamamatsu, 120 Wood Ave., Middlesex, NJ 08846. Ralph Eno (201) 469-6640. \$1.44 (1000 qty); 30 days.

Capable of coupling HNIL with TTL logic, the P1063 opto-isolator offers a rise time of 2 μ s. The device employs a GaAs LED and a silicon phototransistor. Isolation between input and output is 1500 V ac. DIP housing.

CIRCLE NO. 303

Line drivers/receivers work at 10 Mbaud

Advanced Micro Devices, 901 Thompson Pl., Sunnyvale, CA 94086. E. Sopkin (408) 732-2400. See text.

Models Am26LS31, Am26LS32, and Am26LS33 form a set of quad line drivers and receivers designed for driving long lines at rates in excess of 10 Mbaud. The Am26LS31 is a quad differential line driver having a propagation delay of 12 ns and capable of driving a 50- Ω terminated line. The Am26LS32 is a quad line receiver having an input sensitivity of ± 200 mV over an input range of ± 7 V. The Am26LS33 is a similar quad receiver for high-noise environments and features an input sensitivity of ± 500 mV over a ± 15 V common-mode range. The devices are available in 16-pin molded and ceramic-hermetic DIP and flat packages. Prices start at \$2 for the molded package in quantities of 100.

CIRCLE NO. 304

CMOS decoder demuxes 4-digit BCD for LCDs

Siliconix, 2201 Laurelwood Rd., Santa Clara, CA 95054. Jim Graham (408) 246-8006. \$6.49 (100 qty); stock.

Containing all the circuitry needed to decode up to four digits of multiplexed BCD information, the DF411 can also create the ac signals required to drive four LCD display digits. The DF411 is made from CMOS and its output signals are 50% duty cycle square waves and thus contain no dc component which could degrade display lifetimes. Only one external component, a small oscillator capacitor, is required for the DF411 to operate. Power consumption is 1.5 mW with outputs loaded. 40-pin DIP, 0 to 70 C.

CIRCLE NO. 305

NMOS 1-k static RAMs access at bipolar speeds

American Microsystems, 3800 Homestead Rd., Santa Clara, CA 95051. Ray Creech (408) 246-0330. See text.

With a minimum access time of just 45 ns, the 4015-3, a 1-k static NMOS RAM, competes with most bipolar memories. The RAM, organized as 1 k \times 1, is pin compatible with competing units such as the 2115 from Intel and the 93415 from Fairchild. Only a 5-V supply is required for the 16-pin DIP device. Made with the company's V-groove NMOS technology, the RAM has a chip area of only 4400 mil²—less than half that of the 93415 and about 60% that of the 2115. And, since the die is smaller, the yields are theoretically higher and thus the price is lower than the other devices—just \$6.20 for the plastic version in 100 qty lots. Stock.

CIRCLE NO. 306

Uhf power transistors deliver up to 10 W

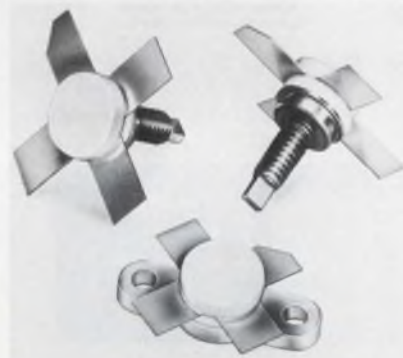

Amperex Electronic, Hicksville, NY 11802. Marty Burden (516) 931-6200. From \$5.25 (unit qty); stock.

Uhf power transistors, the BLW79, 80 and 81, have power gains of 10, 9 and 7 dB with power outputs of 2, 4 and 10 W, respectively. All three transistors use gold metallization and gold wire bonding. Diffused emitter ballasting enables the transistors to withstand VSWRs of 50:1 with high line voltage and a 20% overdrive at a heat-sink temperature of 70 C. All units are characterized for 380 to 512-MHz operation at a collector voltage of 12.5 V. They are available in either the .380SOE flange or stud package.

CIRCLE NO. 307

"WE'VE GOT THE SYSTEM!"

IT'S IN STOCK AT YOUR LOCAL BUD DISTRIBUTOR.

- ALABAMA**
Birmingham
James W. Clary Co.
205-322-2486
- ARIZONA**
Phoenix
Dalis Electronic Supply
602-254-8471
- ARKANSAS**
Little Rock
Carlton Bates Co.
501-562-9100
- CALIFORNIA**
Chatsworth
Wastates Electronics Corp.
213-341-4411
Los Angeles
RPS Electronics, Inc.
213-748-1271
Mountainview
Elmar Electronics, Inc.
415-961-3611
Riverside
Electronic Supply
714-787-9220
- COLORADO**
Denver
Electronic Parts Co.
303-744-1992
Newark Electronics
303-757-3351
- FLORIDA**
Orlando
Hammond Electronics, Inc.
305-849-6060
- GEORGIA**
Atlanta
Lykes Electronics
404-449-9400
- ILLINOIS**
Chicago
Newark Electronics
312-638-4411
Palatine
Ohm Electronics
312-359-5500
Peoria
Klaus Radio, Inc.
309-691-4840
- INDIANA**
Indianapolis
Graham Electronics Supply, Inc.
317-634-8202
Ra-Dis Co., Inc.
317-637-5571
- KANSAS**
Wichita
Radio Supply Co., Inc.
316-267-5213
- LOUISIANA**
Lafayette
Ralphs of Lafayette, Inc.
318-234-4507
- MARYLAND**
Gaithersburg
Pioneer/Washington Electronics, Inc.
301-948-0710
Rockville
Capitol Radio Wholesalers, Inc.
301-881-2270
- MASSACHUSETTS**
Dedham
Gerber Electronics, Inc.
617-329-2400
West Newton
A. W. Mayer Co.
617-965-1111
- MICHIGAN**
Ann Arbor
Wedemeyer Electronic Supply
313-665-8611
Livonia
Pioneer/Michigan
313-525-1800
RS Electronics
313-525-1155
- MINNESOTA**
St. Paul
Gopher Electronics Co.
612-645-0241
- MISSOURI**
Kansas City
Walters Radio Supply, Inc.
816-531-7015
- NEW MEXICO**
Albuquerque
Walker Radio Co.
505-247-2288
- NEW YORK**
Binghamton
Harvey Electronics of Binghamton
607-748-8211
E. Farmingdale
Harrison Electronics
516-293-7990
Lynbrook, L.I.
Peerless Radio Corp.
516-593-2121
- NORTH CAROLINA**
Winston-Salem
Kirkman Electronics, Inc.
919-722-9131
- OHIO**
Cleveland
Pioneer/Cleveland
216-587-3600
Radio & Electronic Parts Corp.
216-248-8900
Cincinnati
Hughes-Peters, Inc.
513-351-2000
Columbus
Hughes-Peters, Inc.
614-294-5351
Dayton
Pioneer/Dayton
513-236-9900
- OKLAHOMA**
Tulsa
Oil Capitol Electronics Corp.
918-622-8520
- PENNSYLVANIA**
Allentown
A. A. Peters, Inc.
215-434-5237
Montgomeryville
Pyttronic Industries, Inc.
215-242-6700
Philadelphia
Almo Electronics Corp.
215-698-4000
Pittsburgh
CAM/RPC Electronics
412-782-3770
Pioneer/Pittsburgh
412-782-2300
- SOUTH CAROLINA**
Columbia
Dixie Radio Supply Co., Inc.
803-779-5332
- TENNESSEE**
Memphis
Bluff City Electronics
901-523-9500
Nashville
Electra Distributing Co.
615-329-3971
- TEXAS**
Dallas
Wholesale Electronic Supply
214-824-3001
Ft. Worth
Swieco, Inc.
817-335-6521
Garland
Newark Electronics
214-271-2511
Houston
Harrison Equipment Co.
713-552-4700
San Antonio
Sherman Electronics Supply, Inc.
512-224-1001
- UTAH**
Salt Lake City
Standard Supply Co., Inc.
801-486-3371
- VIRGINIA**
Charlottesville
Virginia Radio Supply Co., Inc.
804-296-4184
- WASHINGTON**
Seattle
Aimac/Stroum Electronics, Inc.
206-763-2300

**"BET YOU CAN'T
BEAT THE
SYSTEM!"**

AND HERE ARE FOUR REASONS WHY:

Bud's Modular Electronic Packaging System gives you options. Options to use circuit boards; to use full-enclosed modules, to use all of one, or a combination of both to develop an electronic package for a variety of applications. Equally important, the Bud System gives you the flexibility to alter your original circuit board/module arrangement for subsequent applications. The options are yours.



1 Movable Snap-in Guides. One reason for the System's flexibility are full-length, impact-resistant guides. You can move them, snap them in and out -- adjust them to a basic pitch of 0.2" to accommodate circuit boards and modules -- without dismantling the System's outer frame. The System will house up to 42 circuit boards; however, even when densely packed, maximum ventilation is assured.

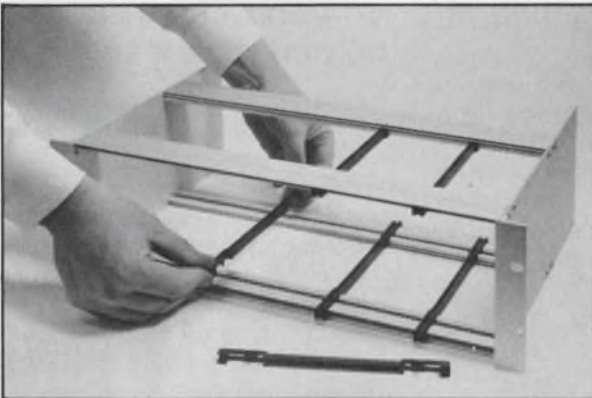

2 Perfect Alignment Between Connector and Circuit Board. The System's distortion-free guides offer packaging flexibility, and also provide the means for positive alignment. All edge connectors, plus panel-type connectors mounted to socket-mounting panels are securely attached at the rear of the guides. Insert circuit boards into the System and they slip directly into the edge connectors. Slide in larger modules and they make perfect contact with the panel-type connectors.

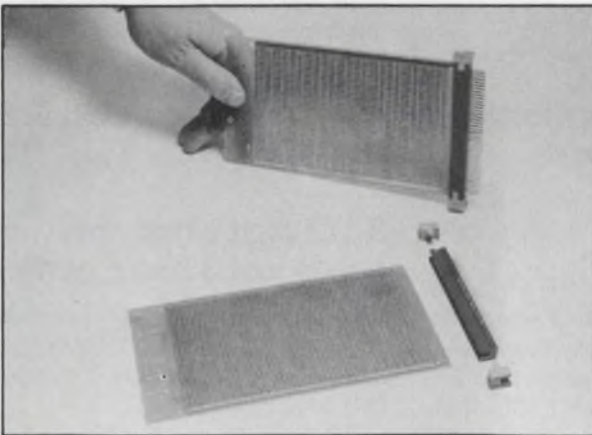
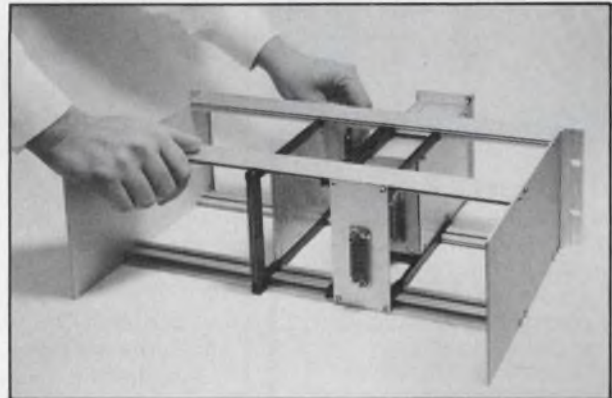

3 Board Profiling is Eliminated. A uniquely designed end foot, easily attached at the end of each guide, not only "leads" circuit boards into edge connectors, but also positions edge connectors so they will accept the full height of the boards. This eliminates board profiling and, in turn, results in maximum contact. Keep in mind the Bud System is designed to utilize a wide universe of circuit boards and edge connectors to give you maximum flexibility.

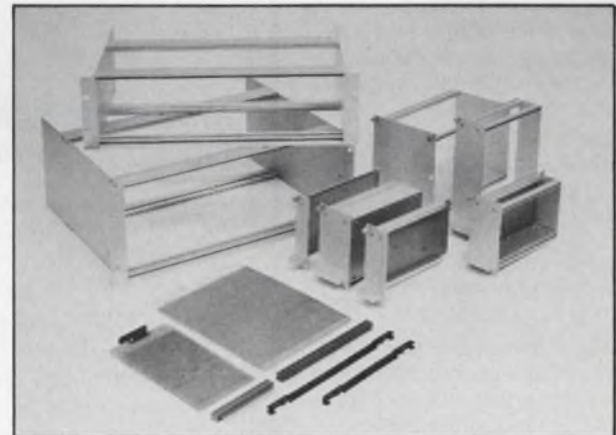

4 A Choice of Components. Regardless of what type electronic package is required for your present or future applications, Bud has the components to develop that package: eight sub-racks (outer frames), 20 sub-units (enclosed modules), six printed board units, eight circuit boards, plus single and double row edge connectors. All are fabricated to exacting tolerances. All are easily assembled. All are in stock -- immediately available.

Your Bud distributor will give you complete data on the Modular Electronic Packaging System. Better yet, he has a demonstration unit. See it. Work with it -- the packaging system that gives you options.

BUD

BUD INDUSTRIES, INC.
4605 East 355th Street
Willoughby, Ohio 44094

RF Power Amplifiers?

One unit may be all you'll ever need.



If you have the ENI Model 440LA ultra-wideband solid state power amplifier, all you need is a laboratory signal generator and you've got the ultimate in linear power for such applications as RFI/EMI testing, NMR/ENDOR, RF transmission, ultrasonics and more.

Capable of supplying more than 40 watts of RF power into any load impedance, the 440LA covers the frequency range of 150 kHz to 300 MHz.

We could mention unconditional stability, instantaneous failsafe provisions and absolute protection from overloads and transients, but that's what you expect from any ENI power amplifier, and the 440LA is no exception!

Our catalog contains complete specifications on the 440LA as well as the entire line of ENI amplifiers, and is available without obligation, of course.

For further information or a demonstration, contact ENI, 3000 Winton Road South, Rochester, New York 14623. Call 716-473-6900, or Telex 97-8283 ENI ROC.

ENI

The World's Leader
in Power Amplifiers

CIRCLE NUMBER 54

ICs & SEMICONDUCTORS

Uncommitted NMOS array yields up to 262 gates

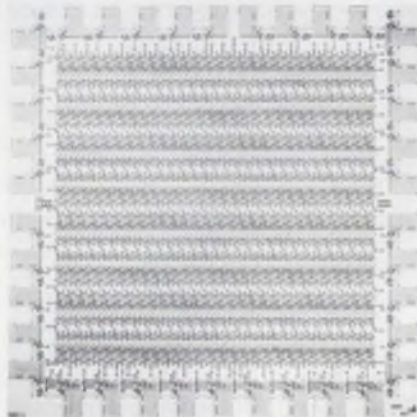

Interdesign, 1255 Reamwood Ave., Sunnyvale, CA 94086. Robert Townley (408) 734-8666. P & A: See text.

An NMOS uncommitted cell array, dubbed the digital Monochip, contains the equivalent of 262 gates on a 138 x 138-mil chip. The digital Monochip allows any electronic engineer, regardless of specification, to design a custom IC in a few days. Each cell can be connected into NAND or NOR logic and the levels are directly TTL and CMOS compatible. The tooling charge for either the digital or any of the linear Monochips is a constant \$2800, and the first 50 prototypes take four weeks.

CIRCLE NO. 308

MOS static RAMs match bipolar counterparts

Intel, 3065 Bowers Ave., Santa Clara, CA 95051. William Regitz (408) 246-7501. See text.

The 2115A/2125A and 2115AL/2125AL are 1024-bit static MOS RAMs. They are 30% cheaper and consume 20 to 50% less power than the 93415 and 93425 bipolar RAMs they replace. All four units have an access time of 45 ns max. The supply current for the "A" versions is 125 mA and for the "AL" versions is only 75 mA. Also available are low-power "-2" versions of the above models, with a maximum access of 70 ns. All units come in a 16-pin DIP and operate on a single 5-V supply at TTL levels. Prices (100 qty) are as follows: 2115AL/2125AL, \$7.40; 2115A/2125A, \$6.90; 2115AL-2/-2125AL-2, \$6.90; 2115A-2/2125A-2, \$6.15. Stock.

CIRCLE NO. 309

Multiprotocol USRT works at 2 Mbaud

Standard Microsystems, 35G Marcus Blvd., Hauppauge, NY 11787. (516) 273-3100. \$61.40 (500-999 qty).

The COM 5025 is a programmable multiprotocol controller that operates at speeds up to 2 Mbaud. A general-purpose universal synchronous receiver/transmitter, the 5025, can implement all major protocols including the bit-oriented SDLC, HDLC and ADCCP as well as the byte-oriented BISYNC and DDCMP. The unit is processor (8 or 16-bit) and TTL compatible. Data lengths from one to eight bits are individually selectable for both receiver and transmitter.

CIRCLE NO. 310

V/f/v converter needs only one power supply

Intech, 282 Brokaw Rd., Santa Clara, CA 95050. (408) 244-0500. \$12 (unit qty); stock.

Using only one +5 to +18-V supply, the Model A-8404 voltage-to-frequency converter provides linear conversion of 0 to +10-V analog signals to a digital pulse train whose repetition rate is proportional to the analog signal. The unit can also perform frequency-to-voltage conversion. Specifications include operating range to 1 MHz and linearity at 1 MHz of $\pm 0.4\%$, max. Output is DTL/TTL and CMOS compatible. 14-pin DIP.

CIRCLE NO. 320

3-1/2-digit clock chip needs just 3 more parts

General Instrument, Microelectronics Div., 600 W. John St., Hicksville, NY 11802. Sonny Sellars (516) 733-3120. \$6 (100 qty); stock.

The CK3500, an I²L 12-hour digital clock circuit, requires only a 3-1/2-digit display, an inexpensive 3.58-MHz crystal and a small trimming capacitor. Able to be driven directly from a car battery and operate over a wide voltage range the circuit has both a normal and a standby operating mode. In the standby mode, the current drain is typically 4 mA. When on, each segment output can sink 20 mA. Housed in a 40-pin DIP, the CK3500 operates over -20 to +70 C.

CIRCLE NO. 321

A/d converter chip runs on 25 mW

Siliconix Inc., 2201 Laurewood Rd., Santa Clara, CA 95054. Jim Graham (408) 246-8006. \$9.10 (100 qty); stock.

Using only 25 mW of power, the LD131 a/d converter offers a 3-1/3 digit (1500 count) system on a single CMOS chip. This TTL-compatible device has on-chip scaling resistors and clock. Nonlinearity is less than 0.1% of the analog input. Typical tempco is 15 ppm/°C. The unit has automatic zero and polarity. Temperature range is 0 to +70 C. 18-pin plastic DIP.

CIRCLE NO. 322

Bus transceivers sink up to 48 mA

Advanced Micro Devices Inc., 901 Thompson Pl., Sunnyvale, CA 94086. E. Sopkin (408) 732-2400. From \$5.50 (100 qty).

The Am2915A, Am2916A and Am2917A are bus transceivers built with Schottky technology. They sink 48 mA at 0.5 V at each terminal. Bus-to-receiver speed is 18 ns and clock-to-bus-delay is 21 ns. A three-state output with a 4-bit latch and a 4-bit register on the inputs are standard. Specifically, the Am2915A is a quad two-input device with three-state outputs on both driver and receiver; the Am2916A is a quad two-input device with three-state driver outputs and a 4-bit parity checker/generator; the Am2917A is a quad device with three-state driver and receiver outputs and a parity checker/generator. The Am2915A and Am2916A come in 24-pin DIPs; the Am2917A comes in a 20-pin DIP.

CIRCLE NO. 323

Power Schottky provides low V_f at high current

TRW Power Semiconductors, 14520 Aviation Blvd., Lawndale, CA 90260. John Power (213) 679-4561. \$6.75 (100 -999); stock.

By eliminating stored charge, the SD-51 power Schottky diode allows a forward voltage of only 0.6 V at a forward current of 60 A. The DO-5 housed device features a maximum forward current of 120 A at a 50% duty cycle with reverse leakage current of 200 mA. The dc blocking voltage is 45 V dc. The junction operating range is -55 to +150 C.

CIRCLE NO. 324

GE miniature lamps offer you gigantic design advantages.

With 11 new wedge base GE lamps, you have more choices than ever.



Enjoy new design freedom with this expanded line of GE all-glass wedge base lamps. And keep enjoying the inherent benefits of the line: savings in weight, space, time and costs. GE now offers more than 30 wedge base lamps in three sizes: miniature lamps T-3/4 (10 mm diam.) and T-5 (15 mm diam.); subminiature lamp T-1/4 (6 mm diam.). Voltages range from 2.5 V to 28 V. Candlepower from 0.03 to 21 cd.

Use GE wedge base lamps with confidence for indicator, marker and general illumination applications, especially where space is at a premium. You may enjoy lower systems cost than with metal-based lamps and LED's. They're easy to insert and remove; have no soldered connections to corrode or break; and the filament is always oriented the same in relation to the base.

To start saving with GE wedge base lamps now, send for the latest bulletin on GE's expanded line. Order #3-5259R2. It's free.



For whiter, brighter light use GE halogen-cycle lamps.

GE halogen-cycle lamps offer you very high light output from a very small package. They can provide better light efficiency because the bulb doesn't blacken and because of accurate filament placement. Many have uniform bulb tops (no tip).

You get a whiter light than from comparable incandescent lamps because of higher color temperature operation. And they maintain their high initial output level for virtually the life of the lamp.

Because of their lower electrical power requirements, you also save on operating costs vs. comparable incandescent lamps. Some halogen lamps have long design life for low maintenance costs, too.

You can use GE halogen-cycle lamps with confidence when your design needs call for a lot of light in restricted space. For greatly expanded information on GE halogen-cycle lamps, send for your free copy of the new GE bulletin #3-5257-R.

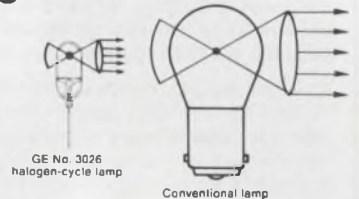

GE No. 3026 halogen-cycle lamp

Conventional lamp



How to order lamp samples and important new free catalogs.

For catalogs and information on how to get lamp samples, call your local GE Miniature Lamp Products Representative or write: General Electric, Miniature Lamp Products Department #3382, Nela Park, Cleveland, Ohio 44112.

GENERAL  ELECTRIC

CIRCLE NUMBER 55

BUILDING YOUR OWN POWER SUPPLY?

Think Twice!



Think "DESIGN-AS-YOU- ORDER"

Think of the expense and time involved in designing and building your own power supply, and how those resources can be applied to designing and building other components.

Now think about the exclusive Arnold Magnetics "Design-As-You-Order" system. You simply order your **custom** power supply from proven "off-the-shelf" sub-modules... no engineering charges, no lost design time. Just fill in our "easy-to-use" specification form, we'll do the rest. Your miniaturized, high efficiency power supply arrives encapsulated and pre-tested.

See if these parameters meet your needs:

- Inputs: Single or dual; 60Hz, 400Hz, 12VDC, 28VDC, 48VDC and 115VDC.
- Regulated Outputs: single or isolated multiple; 5 to 300VDC.
- Line and load regulation to 0.1%.
- Power: 3—160 watts (up to 3.9 watts/in³).
- Other catalog power supplies with outputs to 5000VDC and power to 200 watts.
- Capability to design and build to your special needs.

Send for a free "Design-As-You-Order"
Power Supply Kit today!



ARNOLD MAGNETICS CORPORATION

11520 W. Jefferson Blvd.
Culver City, Ca. 90230 • (213) 870-7014

CIRCLE NUMBER 56

MICRO/MINI COMPUTING

Cartridge drives pack 11.5 Mbytes onto tape



Data Electronics, 370 N. Halstead St., Pasadena, CA 91107. S. Thompson (213) 351-8991. \$1150 (100 qty); stock.

Complete with read/write electronics, the CMTD-3400S2 cartridge drive fits in just a 4.25 × 6.9 × 5.7-in. space. The drive can handle a 300 ft. 3-M cartridge and pack up to 11.5 Mbytes onto the tape. Data transfer rates of 192 kbits/s are possible. Optional cards for the drive include an interface card and an encoder card.

CIRCLE NO. 325

Prototyping kit eases 8085 system development

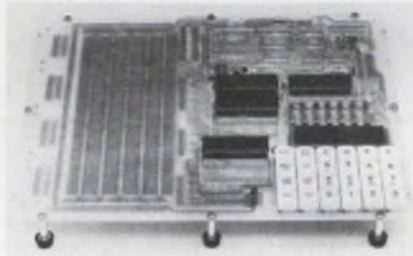

Intel, 3065 Bowers Ave., Santa Clara, CA 95051. Rob Walker (408) 246-7501. \$250; stock.

A system design kit for the 8085 microprocessor, the SDK-85, contains the CPU, memory and I/O. The kit includes system monitor software in ROM, an interactive keyboard-display and a comprehensive design library. With the monitor, programs can be entered in hex, executed, single-stepped and debugged. The monitor also supports serial data communications via a teletypewriter interface. Spaces are available on the board for components to build a buffered bus expansion interface and a separate breadboard area. Components included are an 8085 CPU with a typical instruction cycle of 1.3 μs; an 8155 RAM, I/O and timer; an 8355 ROM and I/O; an 8279 keyboard/display interface; and an 8205 decoder. The entire system operates from a 5-V supply.

CIRCLE NO. 326

Mini performance boosted with cache bus



General Automation, 1055 S. East St., Anaheim, CA 92803. (714) 778-4800. P & A: See text.

The GA-16/550 multiprocessor computer combines two high performance processors with dual cache bus and half a megabyte of error correcting memory. Costing less than \$50,000, the system provides the designer with high throughput, increased system integrity and the redundancy needed for today's critical networking applications. The dual cache bus structure connects up to eight very high performance processors to a large shared memory facility. A single cache bus can transfer data between as many as four processors and four memory banks at rates of up to 8 Mbytes/s. A parity-per-byte system protects the integrity of all data transfers. The GA-16/550 is a microprogrammed computer with a 240-ns microcycle time and a repertoire of 145 basic instructions.

CIRCLE NO. 327

Program converts 8080 assembly to Z80 code

MicroTec, P.O. Box 60337, Sunnyvale, CA 94088. Paul Greenfield (408) 259-8372. \$300; stock.

An 8080 to Z80 conversion program, written in standard ANSI Fortran, converts standard Intel assembly language statements to the equivalent Z80 statements. All required mnemonics, reserved names, and syntax conversions are performed. Other features include detection and flagging of certain errors present in the 8080 input statements; control of the formatting of the fields in the Z80 output statements; and output listing control statements.

CIRCLE NO. 328

Programmable servo runs under μ P control

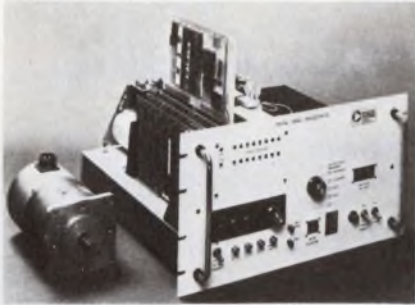

Torque Systems, P.O. Box 588, 225 Crescent Street, Waltham, MA 02154. Dick Matz (617) 891-0230. Typical system prices range from \$1000 to \$5000; stock to 6 wks.

The DS2200, a programmable digital servo control card, uses an F-8 μ P to control velocity, acceleration and position. A phase lock speed control regulates the constant velocity of the motor. Inputs to the system consist of parallel 8-bit data, a 3-bit address and three 8-bit words for position, another 8-bit word for velocity and one more for acceleration. The output is a serial pulse train at 10 kHz, maximum. Power requirements for the card are ± 15 V at 150 mA and 5 V at 1 A. Positioning accuracy is ± 1 bit.

CIRCLE NO. 329

8080-based computer has room for floppy disc



Vector Graphic, 790 Hampshire Rd. A-B, Westlake Village, CA 91361. Carol Ely (805) 497-0733. From \$369; stock.

The Vector 1+, an 8080-based micro-computer, can include a Shugart mini-floppy or equivalent in the same case. The designer cabinet contains an 18-slot, fully shielded S-100 motherboard, six connectors, and a power supply capable of delivering 18 A at 8 V and 2.5 A at ± 16 V. The 8080-based CPU board can be optionally ordered with eight-level vectored interrupts and a real time clock. A unique PROM/RAM board with 1 k of RAM and room for 2 k of PROM with a 512 byte resident monitor programmed on two 1702A PROMs is also available.

CIRCLE NO. 330

Micro disc drive drops access time by 80%

Micro Peripherals, 2900 Cordura Lane, Los Angeles, CA 90049. Keith Ullal (213) 472-6067. \$224 (100 qty); 10 wks.

The Series B51, a micro floppy disc drive, uses a unique band-drive that allows the head to be moved at a fast rate—claimed to be almost five times faster than its nearest competition.

Access time for 15 tracks is 75 ms. Data are transferred at 125 kbps in FM encoding and 250 kbps for double density. Standard capacity is 109.4 kbytes on 35 tracks, or 124.7 kbytes for a 40-track double density drive with single side recording. The drives use MFM, M²FM and GCR encoding techniques and 5.25-in. diskettes. Dimensions are 3.25 \times 5.55 \times 8 in. and weight is 3 lb.

CIRCLE NO. 331

No. 2
IN A SERIES
LOW NOISE TRANSISTOR
MICROWAVE TRANSISTOR
UPDATES FROM AVANTEK

G_{NF} : 9.5 dB

NF_{opt} : 3.0 dB

I_c : 5 mA

Frequency: 4.0 GHz

Avantek AT-4690

Guaranteed Specifications

Type	NF_{opt} dB (max)	G_{NF} dB (typ)	I_c mA	G_{max} dB (min)	I_c mA	f_{test} GHz	f_T GHz (typ)
AT-4690	3.0	9.5	5	12	15	4.0	8.5

Excellent Noise Figure, Gain and Dynamic Range

The designer need only look to the typical performance curves of Avantek's AT-4690 to determine its exciting potential. High gain and low noise figure, even at current levels up to 20 mA! Now you can design amplifiers with fewer stages and get more usable power.

The Avantek 70 mil stripline package is as dependable as the 4690 it contains. All Avantek transistors feature superior gold metallization and hermetic sealing to ensure consistent, reliable performance.

Availability? Of course! Remember Avantek is only a phone call away. Orders placed by noon will normally ship the same day.



Fast Delivery

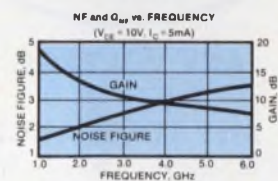
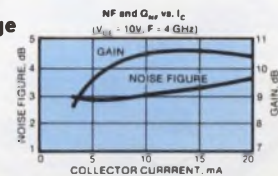

Contact: Avantek Transistor Applications Engineering
(408) 249-0700

3175 Bowers Ave., Santa Clara, CA 95051 TWX 910-339-9274 Telex: 346 377

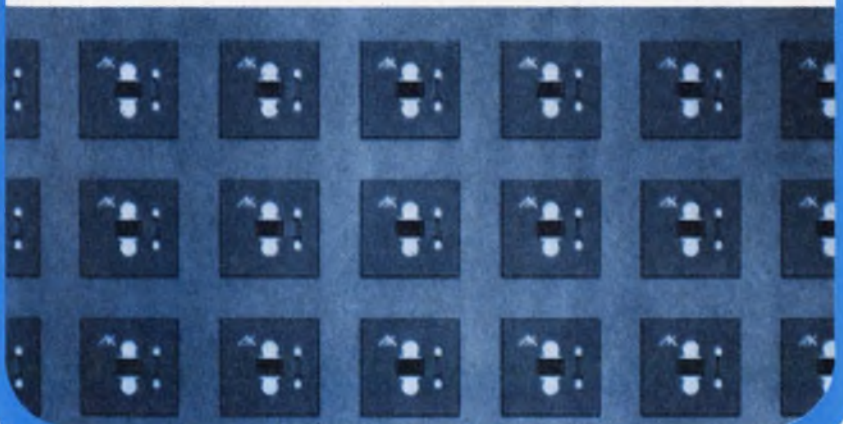

CIRCLE NUMBER 57

ALONE AGAIN

in low cost 1-watt
Zener Diodes

SCHAUER

"Z" SERIES ZENERS

DO-41 epoxy
molded case

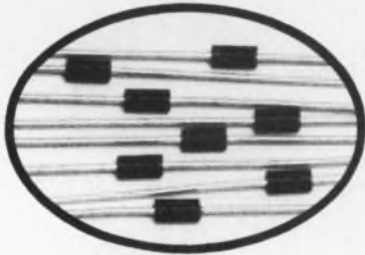

ANY VOLTAGE
2.6 to 34.0

ANY TOLERANCE
1% 2% 5% 10%
At Any Test Current

**Compare These Prices
On 1% Tolerance Diodes**

Quantity	Price each
1-99	91¢
100-499	83¢
500-999	77¢
1000 up	73¢

**LARGE STOCK
GOOD DELIVERIES**

Send for complete rating data
and other tolerance prices.

Semiconductor Division

SCHAUER

MANUFACTURING CORP.

4511 Alpine Ave., Cincinnati, OH 45242
Telephone 513-791-3030 Telex 21-4576

CIRCLE NUMBER 58

MICRO/MINI COMPUTING

Interface card gives SC/MPs three 8-bit ports

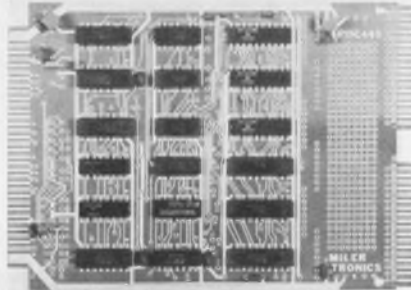

MilerTronics, 303 Airport Rd., Greenville, SC 29607. Michael Webb (803) 242-9232. \$195 (unit qty); 4 wks.

The PDC-440 is a 24-bit I/O card, bus and card-size compatible with the National ISP family of cards. It contains three 8-bit latched I/O ports, asynchronous data transfer input and output handshake controls and interrupt controlled data transfer capability. The card address is programmable, permitting multiple PDC-440 cards per system. A breadboard section is included for user supplied interfaces, and two 36 pin I/O connectors with user-definable pinouts are on the board.

CIRCLE NO. 332

Static memory card holds up to 32 kbytes

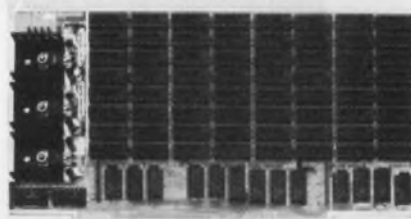

Artex Electronics, 605 Old Country Rd., San Carlos, CA 94070. Robert Jones (415) 592-2740. See text: stock.

A 32 kbyte static memory board, the 32K-100, is compatible with the S-100 microcomputer bus and speed-compatible with Z80-based systems. The basic board with all support circuits, power regulator, 8 k of RAM and assembly manual costs \$290. Additional 8 k chunks of RAM cost \$255, and a full 32 k memory board costs \$1055. The 32K-100 requires 8 V at 3 A, maximum, and has an access time of 250 ns. The board has buffering on all address and data lines, permits battery back-up and contains a bank select provision.

CIRCLE NO. 333

PROM board holds up to 16 2708 PROMs

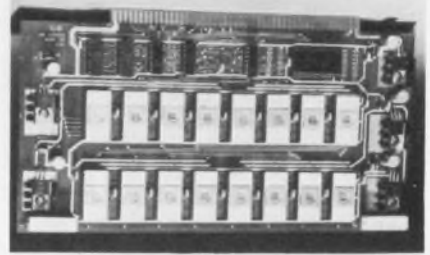

IBEX, 1010 Morse Ave., Suite 5, Sunnyvale, CA 94086. (408) 739-3770. \$85 (unit qty); stock.

Designed to plug into 8080-based Altair-compatible buses, a 16-k PROM board can hold up to 16 2708 PROMs. Unused 4-k sections can be disabled to allow RAM to exist within the board's address space. The board also has provisions for a wait state to allow it to operate with the faster Z80 μ Ps. Available as a kit, sockets are included for all ICs.

CIRCLE NO. 334

Microcomputer boards intended for OEM use

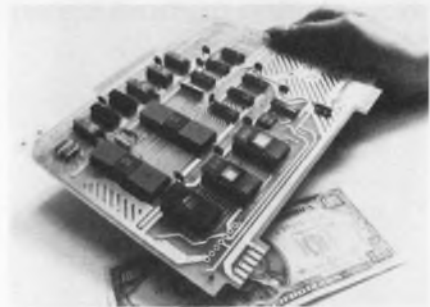

Intel, 3065 Bowers Ave., Santa Clara, CA 95051. Rob Walker (408) 246-7501. P&A: See text.

With a cost of \$99 in OEM quantities, the SBC 80/04 single board computer is claimed to be the lowest-cost computer ever offered. The SBC 80/04 operates from a +5-V supply, is based on the 8085, and includes provision for an on-board 5-V regulator. Also available are a directly compatible, more powerful version priced at under \$200 in OEM volumes, the SBC 80/05—and a prototyping package for both computers—the SBC 80P05, which costs \$895. The SBC 80/04 has a typical instruction execution time of 2 μ s. The board comes fully assembled and tested and measures 6.75 \times 7.85 in.

CIRCLE NO. 335

Paper-tape reader accepts tape at 150 cps

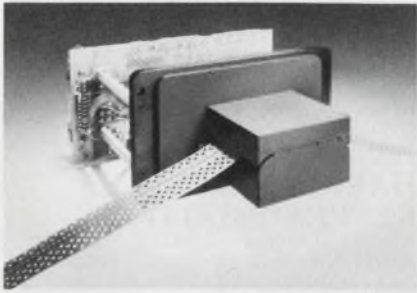

EECO, 1441 E. Chestnut Ave., Santa Ana, CA 92701. Bob Crum (714) 835-6000. \$290 (1 to 4 qty); stock.

The 2001-2 paper tape reader can handle punched tape at 150 cps. TTL compatible, the unit reads any commercially available punched tape. The read head opens wide for easy loading. Constructed of a high wear-resistant material, the read head will not build up static electricity which can cause data errors. The reader measures 3.16 × 6.44 × 3.88 in. (80.3 × 163.6 × 98.6 mm) and the read head extends 2.1 in. (53.3 mm) in front of the panel.

CIRCLE NO. 336

8080-based micro has octal front panel



Parasitic Engineering, P.O. Box 6314, Albany, CA 94706. Howard Fullmer (415) 547-6612. P & A: See text.

The Equinox 100, an under-\$700 8080-based microcomputer kit, features a 12-pad keyboard and numeric 7-segment LED display. Addresses and data on the S-100 bus computer are displayed in octal on the LEDs. The front-panel keyboard and display lets the operator monitor or alter any register, register pair, memory location or I/O device in the system. Equinox 100 can single-step through programs, step slowly at a programmable rate from 1 to 64-k steps per minute, or Halt at predetermined points without "going to sleep." Inside the microcomputer is a 20-slot busboard which is fully shielded by interlaced ground lines and has active termination on every bus line.

CIRCLE NO. 337

MEET OUR family of high VOLTAGE TEST PROBES

In 1967 we introduced the first high voltage test probe with a built-in meter. It became so popular that we have been adding new models ever since. Now there are five different versions to satisfy the demands of radio, television, appliance, audio, and electrical repair men in a wide variety of high voltage testing applications.

The five models are briefly described below. Our general catalog contains complete applications information, illustrations, specifications, and prices. Write for your free copy.

MODEL 4242—42,000 volts DC.
Negative ground.

MODEL 3157—15,000 volts DC.
Negative ground.

MODEL 4312—15,000 volts DC.
Positive ground.

MODEL 3163—6,000 volts DC.
Negative ground.

MODEL 3200—10,000 volts AC.

AVAILABLE THROUGH YOUR
FAVORITE ELECTRONIC PARTS DISTRIBUTOR

ITT POMONA ELECTRONICS

1500 East Ninth St., Pomona, Calif. 91766
Telephone (714) 623-3463, TWX: 910-581-3822



CIRCLE NUMBER 59

MICRO/MINI COMPUTING

Militarized computer has 19.56-in. ATR case

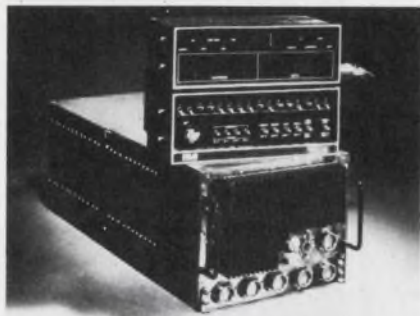

Rolm Corp., 4900 Old Ironsides Dr., Santa Clara, CA 95050. Rich Conley (408) 988-2900. From \$12,750; 30 days.

The 1602A militarized computer packs a CPU, up to 64 k 16-bit words of core memory, seven I/O interfaces, power supply and control-panel interface into a 19.56-in. ATR chassis. Requiring just one-third of the space of the previous model, the 1602A uses a redesigned, microprogrammed CPU. The same 1602 instruction set is retained and the CPU operates at a 20 MHz rate, executing a 52-bit micro-instruction in 150 to 250 ns. There is also room for an optional floating-point instruction set and the built-in test (BITE) self-diagnostic capability. Owners of 1602 systems can use the control panel with the 1602A.

CIRCLE NO. 338

Floppy discs fit in IBM or non-IBM drives

Electronic Memories & Magnetics, Media Prod. Div., 1020 Timothy Dr., San Jose, CA 95133. (408) 298-7090. From \$5 (unit qty.); stock.

A line of flexible disc media has been added to the company's Caelus line of disc products. Designated the CM-F11, CM-F21, and CM-F31, the discs use a special intermix lubrication to make the surfaces smooth. All envelopes are provided with special tabs for color coding and extra filing labels. The Model CM-F11 is totally compatible and interchangeable with the standard IBM 3740 or 3540 data entry systems. For Shugart-type systems requiring 32 sector holes and one index hole around the inside diameter, EMM's CM-F21 can be used. CM-F31 flexible discs are designed for Memorex 651 or equivalent disc drive systems requiring 32 sector holes and one index hole around the outside diameter.

CIRCLE NO. 339

Debug software handles 8080 assembly language

Computer Mart of New Jersey, 501 Route 27, Iselin, NJ 08830. (201) 283-0600. \$30 (paper tape), \$35 (diskette); stock.

The Dynamic Debugging System (DDS) is a debugging facility for 8080 assembly language programs. DDS can run a program one instruction at a time, automatically maintaining on a CRT a display of all registers, the following instructions, and portions of memory. The system can also operate in a breakpoint mode in which the program runs at full speed until it reaches one of several selected instructions. The automatic program monitoring provides an alternative to breakpoints. Rather than running the program with breakpoints, DDS can run the program until a prespecified condition occurs or DDS detects an error by itself.

CIRCLE NO. 340

Desktop microcomputer comes ready to run



Digital Electronics, 415 Paterson St., Oakland, CA 94601. Robert Christensen (415) 532-2920. From \$2200; 30 days.

The DE68DT microcomputer contains a full alphanumeric keyboard, 20-column alphanumeric display, 40-column impact printer, single or dual minicassette tape drives, a miniature floppy disc, RS232-C ports and a nine slot card cage. Based on the 6800 CPU, the computer even has the power supplies built into the desktop case. RAM can be expanded to 65 kbytes, and 16 kbyte EPROM cards are available. Software includes assembler, Basic and Fortran IV, as well as a 6 kbyte ROM/PROM operating system called DEbug. Two versions of the DE68DT are available. The standard DE68DT is a desktop unit, 22.25 x 17.5 x 7.5 in., which weighs less than 30 lb. The DE68C is a compact unit without integral miniature floppy disc, but otherwise similar to the DT.

CIRCLE NO. 341

HARRIS OEM

SALES OFFICES:

CALIFORNIA: Long Beach (213)426-7687; Palo Alto (415)964-6443
FLORIDA: Fort Lauderdale (305)971-3200; Melbourne (305)724-7430
ILLINOIS: Hinsdale (312)325-4242
MASSACHUSETTS: Wellesley Hills (617)237-5430
MINNESOTA: Minneapolis (612)835-2505
NEW YORK: Melville, L.I. (516)249-4500
OHIO: Dayton (513)226-0636
PENNSYLVANIA: Wayne (215)687-6680
TEXAS: Richardson (214)231-9031

HARRIS SALES

REPRESENTATIVES:

ALABAMA: Huntsville (205)533-3620
ARIZONA: Phoenix (602)971-6250
CALIFORNIA: Goleta (805)964-8751; Palo Alto (415)961-8121; San Diego (714)565-9444
COLORADO: Denver (303)759-0809
CONNECTICUT: East Norwalk (203)838-1493
FLORIDA: Boca Raton (305)395-6108; Oviedo (305)365-3283; Tampa (813)933-1759
ILLINOIS: Elk Grove Village (312)640-1850
INDIANA: Indianapolis (317)849-6454
IOWA: Cedar Rapids (319)377-8275
KENTUCKY: Louisville (502)451-9818
MARYLAND: Lanham (301)459-1556
MASSACHUSETTS: Burlington (617)273-1313
MICHIGAN: Farmington (313)476-2446
MINNESOTA: St. Paul (612)646-7217
MISSOURI: Hazelwood (314)731-5799; Independence (816)737-1100
NEW JERSEY: Keasbey (516)549-8400
NEW MEXICO: Albuquerque (505)265-5655
NEW YORK: Albany (518)489-7408 or 4777; Melville, L.I. (516)549-8400
NORTH CAROLINA: Winston-Salem (919)722-5151
OHIO: Cleveland (216)831-8292; Dayton (513)890-2150; Worthington (614)888-0483
OREGON: Beaverton (503)643-1644
PENNSYLVANIA: Allison Park (412)487-4300; King of Prussia (215)265-0634
SOUTH CAROLINA: Greenville (803)268-1125
TEXAS: Dallas (214)691-4592; Houston (713)780-9710
VIRGINIA: Charlottesville (804)973-6672
WASHINGTON: Bellevue (206)454-0300
CANADA: Mississauga (Toronto) (416)676-1042; Montreal (514)626-6723; Ottawa (613)729-1831

HARRIS NATIONAL

DISTRIBUTORS:

Hamilton/Avnet; The Harvey Group, Inc.; Kent Electronics; Schweber Electronics; R. V. Weatherford Company; Western Microtechnology
CANADA: Prelco Electronics Ltd.

HARRIS COMMITMENT:



NOW UNDER CONSTRUCTION... the most advanced fully automated CMOS production facility in the industry. A \$7.5 million commitment by Harris to meeting industry demands.

Designs like these come to life with the new HARRIS HA-4900 quad comparator

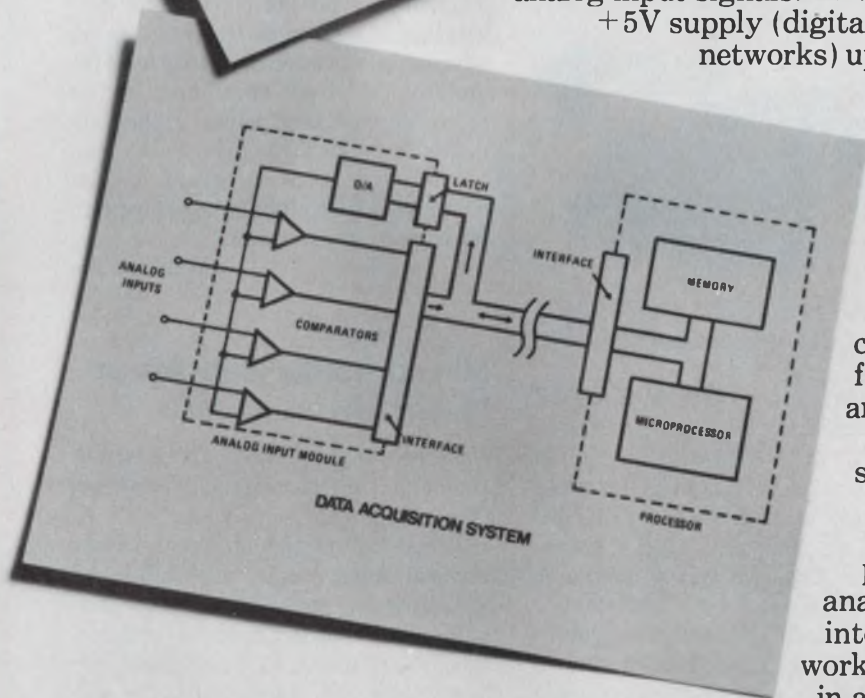
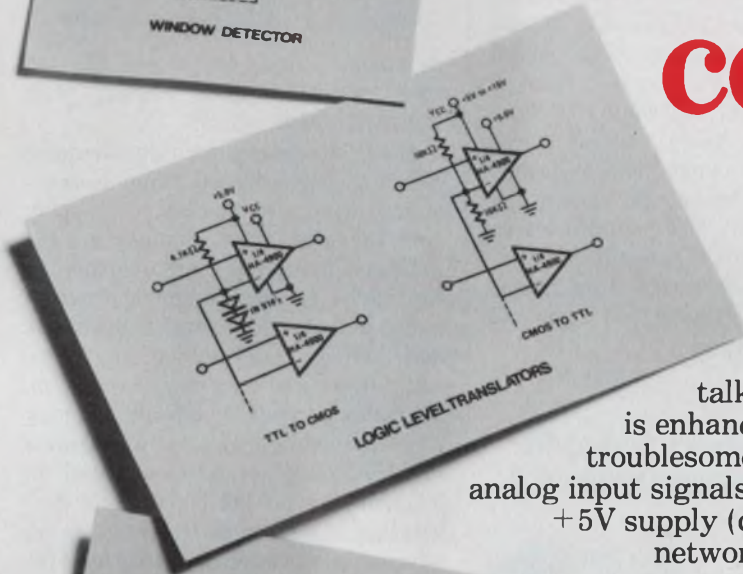
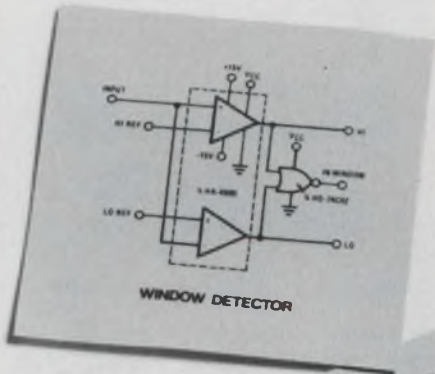

It's got everything...to add new life to your designs. *Speed.* Response time of 130 ns (with 5mV overdrive) makes the 4900 the fastest general purpose quad comparator available. *Accuracy.* It offers low offset voltage (2.0 mV), low offset current (10 nA) and virtually no channel-to-channel cross-talk for accurate signal level detection. Accuracy is enhanced by an output stage design that eliminates troublesome ground coupling between digital output and analog input signals. *Versatility.* Operates from either a single +5V supply (digital systems) or from dual supplies (analog networks) up to $\pm 15V$. Its output stage can be made compatible with virtually any logic family without the need for external components. *Economy.* Four comparators per package save both money and space. 100-up prices are only \$4.95 for the commercial unit (HA-4905), \$11.95 for the military version (HA-4900). The features combine to make the HA-4900/4905 ideal for precision, high-speed signal detection and processing in data acquisition

systems, test equipment, and micro-processor/analog signal interface networks. Available in a 16-pin dual-in-

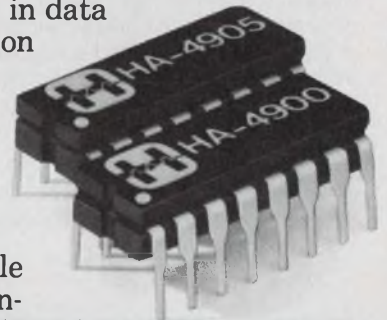

line ceramic package with $-55^{\circ}C$ to $+125^{\circ}C$ (4900) and $0^{\circ}C$ to $+75^{\circ}C$ (4905) temperature ranges.

Get the facts. Call your nearby Harris Semiconductor authorized distributor or sales location for complete specifications, or write Harris Semiconductor, P.O. Box 883, Melbourne, FL 32901.



HARRIS
SEMICONDUCTOR
A DIVISION OF HARRIS CORPORATION

KEEP THE HORSE BEFORE THE CART!

You've probably known design engineers who are half-way through a project before they realize the power supply that could have come from a standard line must all of a sudden be a customized design. And you also know what that means in the way of extra costs. It's the old cart before the horse theory.

Call us when you are in the embryonic stages of your design and we'll work with you in your primary important stages. And not only will you like the fact that our standard lines will both fit your supply and keep you in budget. . . you'll like the idea of our already field-tested dependability.

Our power supplies are available for OEM computer, point of sale, EDP, bank telling and telecommunications use:

- Switching regulator and linear designs • 11 models — single/multi-output • Voltage ranges, from 2 to 30V • 50 current levels from .01 to 225 amps • Overcurrent/overvoltage protection • Filtering to meet world-wide EMI requirements • Designed and built to UL, CSA and European safety requirements.

Dependability. That's a word we define as quality and reliability. It's also what design engineers define as our reputation!

NCR

NCR POWER SYSTEMS DIVISION

formerly Scott Electronics
584 S. Lake Emma Road, P.O. Box 898
Lake Mary, Florida 32746

Telephone (305) 323-9250

CIRCLE NUMBER 61

MICRO/MINI COMPUTING

Simulator program traces μ P operations

Peters Associates, P. O. Box 61622, Sunnyvale, CA 94088. (408) 245-1519. \$500; stock.

Trace-80, a relocatable tracing simulator for use on all 8080-based systems, can operate with only 4 kwords of memory. Major features of the interactive debugging aid include selection of registers for printing, display of or writing to user requested areas of memory, and the capability of running the user program at full speed until a breakpoint returns control to Trace-80. In an alternate mode, a circular queue stores machine status for the last 100 instructions or branch commands. A breakpoint causes display of this list. Trace-80 also warns of probable errors in the user program. The program has a relocating loader, relocatable object tape, test cases and full documentation.

CIRCLE NO. 342

CMOS memory board for SBC 80 systems holds 4 k

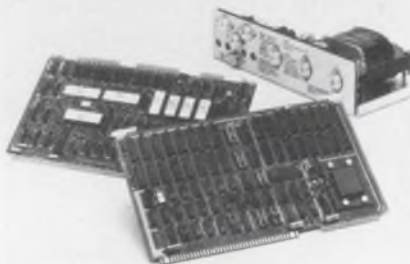

Intel, 3065 Bowers Ave., Santa Clara, CA 95051. Rob Walker (408) 246-7501. \$795 (unit qty); 4 wks.

The SBC 094, a 4096 byte CMOS RAM and battery backup board, can be shared by up to 16 master SBC 80/20 boards. Or, the board can be dedicated to a single master, such as the SBC 80/10. The SBC 094 CMOS memory gives any SBC 80 central processor ample time to transfer critical data to the CMOS RAM and execute an orderly shutdown procedure. Data can be retained for at least four days, using power from an on-board battery. The battery recharges automatically when system power is restored. The SBC 094 CMOS memory board uses jumpers to allow addressing to begin on any 4 k memory boundary. Maximum cycle times are 730 ns for read and 800 ns for write.

CIRCLE NO. 343

Programmable calculator displays and/or prints



Burroughs Corp., Burroughs Pl., Detroit, MI 48232. Bob Farkas (313) 972-7267. \$2195; stock.

The C 7400 programmable calculator offers a choice of operating modes—either print and display, or display only. Included in the calculator are 104 independent storage memories and the capability to handle 1000 program steps, including two-level subroutines and indirect addressing. Programs, subroutines and data can be stored on magnetic cards for automatic entry into the calculator. Up to 16 programs and 16 subroutines can be accessed via labeled keys on the calculator's conversational keyboard. Decisions on sequence and selection of control keys for program input are eliminated by use of an "execute key" which is the only method by which a keyboard entry can be transferred into a program. Results are printed with alphabetic description for easier interpretation.

CIRCLE NO. 344

Minicomputer handles up to 128 kbytes of core

General Automation, 1055 S. East St., Anaheim, CA 92803. David Armstrong (714) 778-4800.

The 16/340 minicomputer combines integral input-output capability and 128 kbyte core memory capacity. Built with a microprogrammable architecture, the computer is an extended version of the 330 system with the 450ns 330 CPU. The GA-16/340 offers byte and bit addressing, in 11 direct, indirect, program and base relative, and literal modes; word, byte, and bit manipulation; 16 general-purpose registers; foreground-background processing; hardware multiply-divide and much more.

CIRCLE NO. 345

Programmable calculators come with software

Texas Instruments, P.O. Box 5012, Dallas, TX 75222. (214) 238-2011. From \$79.95; stock.

The Programmable 58 and Programmable 59 calculators use plug-in, interchangeable software modules containing up to 5000 program steps each. Also available is the Programmable 57 calculator which has eight addressable multi-use memories and can store up to a 150 keystroke program. Both the 58 and 59 permit users to vary the allocation of storage capability between program steps and memory registers. The 58 offers up to 480 steps or up to 60 registers. The TI 59 offers up to 960 steps or up to 100 memories. All three programmables come with instruction books and with the 58 and 59 a Master-Library solid-state software module that contains 25 prewritten programs in mathematics, statistics, finance and other application areas is included. Optional libraries are also available, including applied statistics, real estate/investment, surveying, aviation and marine navigation.

CIRCLE NO. 346

Impact printer mates with M6800 systems



Motorola Semiconductor, P. O. Box 20924, Phoenix, AZ 85002. (602) 244-6900. \$1725 (60 Hz); stock.

Compatible with M6800 development systems, the EXORprint impact printer delivers up to 65 lines per minute. EXORprint produces lines of up to 80, 5 x 7 dot-matrix characters at 110/s, max. The impact head prints on 8.5-in.-wide roll paper using a conventional teletypewriter ribbon. Optoelectric sensing is used to accurately position each dot and to permit characters to be printed on the fly. A peripheral interface module connects the printer to the system bus. Functionally, EXORprint appears as a parallel interface Centronics 306 type printer. Versions of the printer operate from 110 V ac, 60 Hz or 230 V ac, 50 Hz.

CIRCLE NO. 347

Introducing Cobaloy P-212. A completely new development in EMI/RFI shielding.

Cobaloy P-212 is an environmentally stable magnetic and conductive coating, with a "Q" number of 7 compared to 25 for silver.

The lower the "Q" number, the better the shielding. "Q" number is the calculation for loss of electromagnetic energy. You can prove Cobaloy P-212's effectiveness on your own Q-meter. Check its stability and see if it isn't everything we say it is.

Cobaloy P-212 is the answer to many of the forthcoming microwave exposure restrictions.

Cobaloy P-212 is an outstandingly conductive acrylic paint system which will adhere to glass, plastic, metal and many other commercial substrates. With the expected tightening of regulations in EMI/RFI shielding, it is an excellent solution.

Cobaloy P-212's cost? About 10% of the cost of silver paint.

TYPICAL PROPERTIES

Surface Resistivity @ 0.002" Thick	0.9 ohms/sq.
Coverage 0.001" Thick Dry Film	250 sq. ft./gal.
Density (wet)	11.37 lbs./gal.
Color	Gray
Type Binder	Acrylic
Solvent	Butyl Acetate
Application	Brush, spray or dip

To order call Wes Tyler at (817) 640-8888. Or write The Cobaloy Company, Dept. D, 626 Great Southwest Parkway, Arlington, Texas 76011.

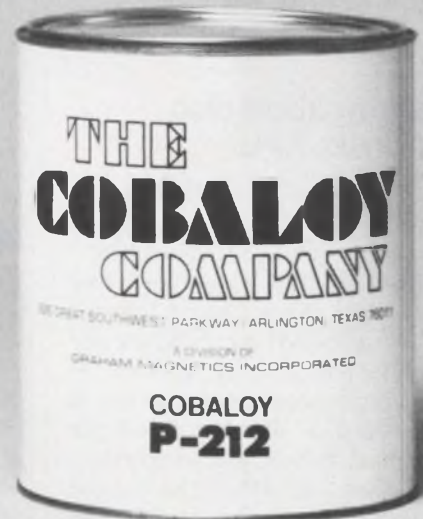

A product from the development laboratories of

THE COBALOY COMPANY
Arlington, Texas

DATA PROCESSING

Interface board drives 3 serial devices

Incosan, Inc., 160 Woodport Rd., Sparta, NJ 07871. (201) 729-3197. \$695 (unit qty); stock.

A single serial interface board drives three serial devices from a single omnibus slot in any DEC PDP8/A or PDP8/E computer. The board is particularly suited to a VT50 or VT52 TTY-replacement CRT, but accommodates any standard 20 mA unit. Selectable for each device are speed (75 to 9600 baud), IOT code, word length, parity and stop bit. The board may be operated without software modification.

CIRCLE NO. 348

Flexible-disc system is unusually flexible

Tri-Data Corp., 800 Maude Ave., Mountain View, CA 94043. Melinda Magnett (415) 969-3700. \$1995.

The FlexiFile 11 μ P-controlled flexible disc system provides low-cost storage for data processing and data communications. It enables the user to write, edit, store and retrieve information on flexible discs without tying up communications lines and CPU time. Front panel switches permit selection of the operating mode, and manual access to 32 tracks. Software-controlled lights indicate current mode status. Storage capacity is 98,304 bytes per disc with a transfer rate of up to 5120 bytes/s. The unit weighs 20 lb and measures 17 x 8.6 x 8 in.

CIRCLE NO. 349

IBM-compatible disc talks Basic, APL

Sykes Datatronics, Inc., 375 Orchard St., Rochester, NY 14606. Albert J. Montevicchio (716) 458-8000. \$3000.

Comm-Storr/5100 is a floppy-disc system, which plugs directly into the IBM 5100 serial I/O port without any changes in hardware or software. It features high-speed random access to any file on disc, directory-based file management system, and compatibility with Basic and APL. Files created under Basic can be read under APL and vice versa. The system comes with a tape cartridge containing 10 Basic key files and 14 APL functions. A dual drive is also available (\$4000).

CIRCLE NO. 350

Piggyback feeder serves 'daisy' printer

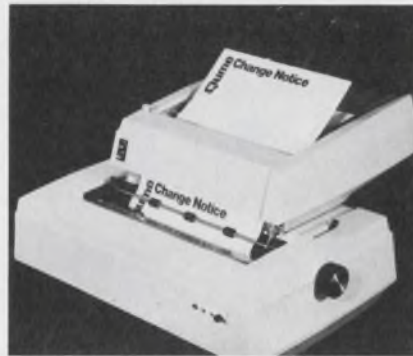

Qume Corp., 2323 Industrial Parkway West, Hayward, CA 94545. (415) 783-6100. From \$1390 (unit qty); 12 wks.

SpeedFeed is an add-on device that automatically inserts fresh paper into a printer and removes typed output under control of the customer's system. Designed to operate with any model of Qume's Q Series, Sprint 1 or Sprint Micro 3 Series of daisywheel printers, SpeedFeed accommodates a variety of paper types, weights, and sizes. Mounted atop a printer, SpeedFeed inserts paper directly into the printer's platen, then stores completed work in a hopper that holds up to 180 sheets in sizes up to 12 x 14 in.

CIRCLE NO. 356

There's no 'phantom' on this monitor

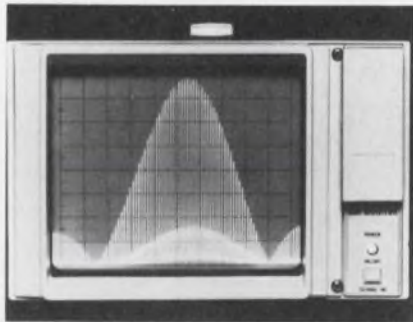

Tektronix, Inc., P. O. Box 500, Beaverton, OR 97077. Bob Down (503) 644-0161. \$1250 (unit qty); 12 wks.

In the Model 608 display monitor, a special CRT design suppresses the "phantom" spot which causes washout of contrast in gray-scale images. Other features of the 608 that contribute to crisper displays are 35-ns z-axis rise time, 22.5-kV accelerating potential, and a spot size of 0.012 in. Display area is 12 x 15 cm. Bandwidth is 5 MHz in x-y and 10 MHz for the z-axis.

CIRCLE NO. 357

Is it a terminal? Or is it a mini?



Lear Siegler Inc., 714 N. Brookhurst St., Anaheim, CA 92803. (714) 754-1193. From \$7000.

The VDP 1000 Video Display Processor defies classification. With a 16-bit computer, 16 kwords of high-speed memory (expandable to 32 k), and a virtual-memory operating system and dual floppy-disc backup storage built in, the VDP 1000 is more than a smart terminal. The 16 kword memory capacity is divided into 8 kwords of read-only memory for the terminal-handling program and 3 kwords for refresh and scrolling, leaving 5 kwords to user discretion.

CIRCLE NO. 358

Plotter routine generates halftones



Versatech, 2805 Bowers Ave., Santa Clara, CA 95051. Carl Larson (408) 988-2800. \$1000; 16 wks.

Full gray-scale halftones are produced on any Versatec electrostatic plotter with the Fortran package "Versaplot gray scale," which maintains high contrast and sharp detail with more than 32 levels of gray. Blacks are 100% black, whites are 100% white. Versaplot can also modify digital images—a tiny picture can be enlarged to fill the entire width of the plotter, multiple images are possible, or single images can be stepped and repeated.

CIRCLE NO. 359

All new TD Series power supplies

Reliable enough for microprocessors.
Economical enough for general purpose use.

- 45 different models; 5 to 250 volts.
- Single, dual, and triple outputs.
- 115 or 230 VAC input; 50 or 60 Hz.
- Regulation: 0.05% line; 0.1% load.
- Remote voltage sensing (most models).
- Automatic foldback current limiting.



Write or call for facts and specs.

TELE-DYNAMICS

DIVISION OF **AMBAC**

525 Virginia Drive, Fort Washington, Pa. 19034 • 215-643-3900

A STEP AHEAD IN QUALITY
CIRCLE NUMBER 63

The M-600 amp works harder at 2.5 ohms

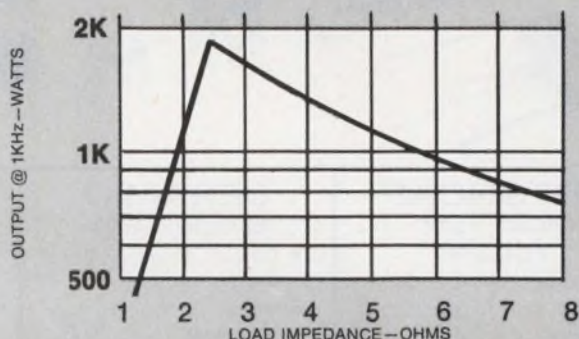

So each watt costs less

You get more watts per dollar from the Crown M-600 power amp if your circuit design lets it look at a 2.5Ω load.

The M-600 provides power from DC to 20KHz with complete protection against shorts, open circuits, mismatch, RF burnout and thermal overload. The M-600 will even drive a purely reactive load without overheating. Designed for continuous operation at full rated power, at any rated frequency.

One M-600 will cost you \$1,795. A copy of the spec sheet is free. Write today.

We'd also like to hear from you if you have any special amplification problems in the DC-20KHz range. We've already solved some tough, unique problems. We'd like to consider yours.

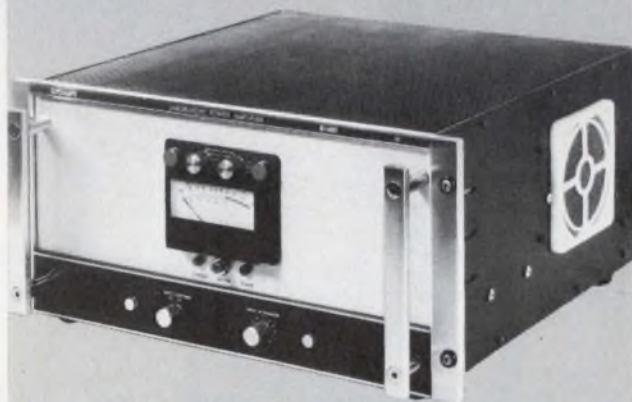

CROWN INDUSTRIAL

1718 W. Mishawaka Road, Elkhart, Indiana 46514
219 / 294-5571

CIRCLE NUMBER 65

NEW FROM BEI
Exclusive Manufacturers
of the **BALDWIN** Encoder



LED

LIGHT SOURCE
INCREMENTAL
ENCODERS

5VL70 SERIES

- 5VDC Input Voltage
- 60-4096 Counts per turn
- TTL Integral Electronics
- Solid State Light Source
- 100 KHz Frequency Response



BEI Electronics Inc.

CONTROLS AND INSTRUMENT DIVISION
1101 McALMONT ST. LITTLE ROCK, ARK 72203
TELEPHONE 501-372-7351 TWX: 910-722-7384

CIRCLE NUMBER 64

SPRAGUE
GOODMAN

TRIMMER CAPACITORS

Our only business!



PISTONCAP® Multi-Turn Tubular

- Low-Loss, Glass or Quartz
- High Stability/High Reliability
- Simple, Long-Life Adjust Mechanism
- Professional/Military Applications, MIL Approved

CERAMIC Single-Turn

- Compact, Conserves Board Space
- Variety of Mounting Configurations
- Low Cost for Commercial/Industrial Applications

FILMTRIM* Single-Turn Film

- PTFE, Polypropylene, Polycarbonate
 - Most Stable Trimmer for Size
 - Very Wide Capacitance Ranges
 - Low Cost for Commercial/Industrial Applications
- *Trade Mark

Tired of broken delivery promises and poor quality? Deal with the trimmer capacitor specialist, for quality products delivered on schedule! Call on us for custom designs too, we deliver!

TRIMMER CAPACITORS — OUR ONLY BUSINESS!

Sprague-Goodman Electronics, Inc.

(An Affiliate of the Sprague Electric Company)

134 FULTON AVE., GARDEN CITY PARK, N.Y. 11040 • 516-746-1385 • TLX: 14-4533

CIRCLE NUMBER 66

MODULES & SUBASSEMBLIES

Isolate high voltages in instrument systems



Intronics, 57 Chapel St., Newton, MA 02158. Richard Beede (617) 332-7350. \$48 (100 qty); stock to 2 wks.

Common-mode voltages as high as 5 kV, ac peak or dc continuous, can be isolated from the output by the IA276 amplifier module. In cardiac monitoring applications, low-level signals can be separated from body noise by 80 dB and from 60-Hz noise by 126 dB. The unit will reject input source imbalances of up to 5 k Ω and has a small-signal bandwidth of 1 kHz. A double-shielded floating output can minimize ac and dc ground loops, maximizing signal-to-noise ratio.

CIRCLE NO. 360

CRITICAL CRYSTALS

come from M-tron

M-Tron specializes in providing quality crystals and design assistance with maximum economy. Complete facilities for production of AT Cut crystals for commercial and military applications from 800 KHz to 200 MHz. Computer-aided design program speeds sample delivery for all types of precision, industrial and commercial applications.

Phone 800-843-6842 or write

M-tron INDUSTRIES, INC.

Box 630, Yankton, South Dakota 57078 A Div. of Lynch Corp

CIRCLE NUMBER 67

Registers mate data bus to 12-bit d/a

Datel Systems, 1020 Turnpike St., Canton, MA 02021. E. Zuch (617) 828-8000. From \$99 (1-24 qty); stock to 4 wks.

A 12-bit storage register, internal to the DAC-HK12B series of d/a converters, eases interfacing to either minis or microcomputers. A Load input tells the 24-pin hybrid converter to either store or transfer the input data. In addition to the input registers the units contain a precision zener-reference, a reference control, three quad current switches and a fast output amplifier. The converter's 2 ppm/ $^{\circ}$ C differential-linearity tempco gives you monotonicity over the operating temperature range. Additional features include: output-settling time of 3 μ s to 1/2 LSB for a 10-V change; max linearity and differential-nonlinearity errors of $\pm 1/2$ LSB; and max gain tempco of ± 20 ppm/ $^{\circ}$ C. Four models are differentiated by case type and operating-temperature range. Straight-binary and offset-binary coding are standard; BCD and two's complement coding are options.

CIRCLE NO. 361

Board adds controlled-gain channels to μ C

Signal Laboratories, 202 N. State College Blvd., Orange, CA 92668. D. Flagg (714) 634-1533. \$395; stock.

The programmable gain amplifier card is a Zilog Z80- μ C compatible accessory that offers two channels of computer-controlled amplification, each with both filtered and unfiltered outputs. Under control of the Z80, the gain of each channel can vary from unity (0 dB) through 54 dB (70 dB optional) in 2-dB increments with gain accuracy of 0.1% (0.01% optional). The Z80 can select any one of eight predetermined bandwidths for each channel's filtered output. Unfiltered outputs are 3-dB down at 50 kHz.

CIRCLE NO. 362

Tiny rf unit switches and modulates pulses

Summit Engineering, 2311 S. Seventh Ave., P. O. Box 1906, Bozeman, MT 59715. (406) 587-0636. \$60 (unit qty); stock to 30 days.

An spst current-controlled attenuator can switch and modulate pulses in a 50- Ω system, up to 500 MHz. Typ midrange specifications include insertion loss of 2.5 dB, on/off ratio of 40 dB and switching-signal isolation of 25 dB. TO-5.

CIRCLE NO. 363

MUXed 12-bit a/d mates via three-state logic

Zeltex, 940 Detroit Ave., Concord, CA 94518. R. Terry (415) 686-6660. \$225 (unit qty); stock to 30 days.

Bus interfacing is simple with the ZMP2000. Its 12-bit output, derived from one of the 16 multiplexed analog inputs, is presented via three-state logic. The module contains an s/h amp, 16 channels of FET-MUX switches, a 12-bit a/d converter plus all timing and control logic. Features of this data-acquisition system include: monotonicity from 0 to 70 C, max conversion time of 20 μ s, throughput rates up to 33,000 ch/s and differential linearity of ± 1 LSB with no missing codes. Standard inputs and outputs interface with CMOS, TTL logic is optional. 72-pin case, 3 x 4.6 x 0.375 in.

CIRCLE NO. 364

Cabinets for Electronic Systems CX-9 Series



Standard cabinets for monitors, keyboards, and electronic systems. Steel and aluminum construction. Use cabinets individually or interlock to form complete systems.

Call or write for complete catalog.

blc BACKER-LORING CORPORATION
65 WALNUT STREET, PEABODY, MASS. 01960 • 617-531-3600

CIRCLE NUMBER 68

Rustrak miniature multichannel recorders

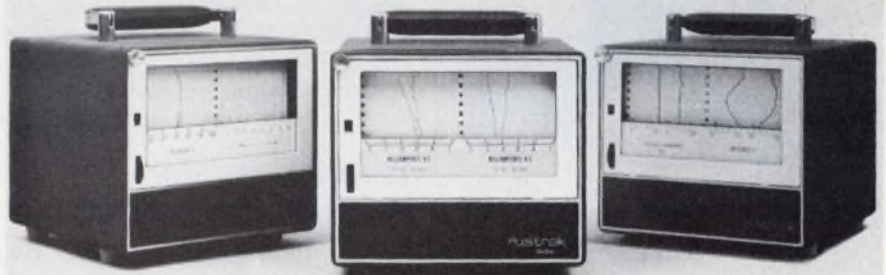

Record Volts, Amps, Pressure, Temperature, Events, More.

Or any combinations of these and many other parameters. You can record from two up to eight channels of analog data, or up to four channels of analog and eight channels of event information. A wide variety of useful options and accessories

are available as well.

Attention OEM's. Custom mounting arrangements, colors, nameplates, chart paper and scales available.

New 32 Page Catalog. Provides details on DC, AC, Temperature, Servo, Multichannel, Event and a variety of special recorder types.

gulton

Measurement & Control Systems Division
Gulton Industries Inc., East Greenwich, Rhode Island 02818
401-884-6800 • TWX 710-387-1500

CIRCLE NUMBER 69

Compact inductors feature low losses



TRW Inc., 401 N. Broad St., Philadelphia, PA 19108. (215) 922-8900.

A small-sized family of power-switching inductors, the SR series, features low temperature rise and low-loss characteristics. The units have an inductance range of 8 to 10,000 μ H. Losses in the 3-to-100-kHz frequency range are low. Compact and easy to install, the devices have pin terminals for PC-board mounting. Many are available with double windings, which allow series, parallel, center-tapped or transformer connections.

CIRCLE NO. 365

Dual in-line switches rock or slide

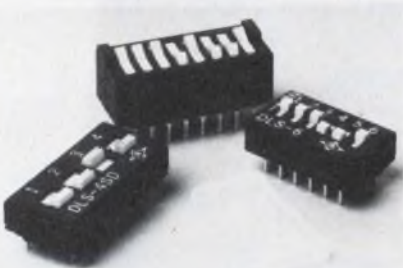

Alco Electronic Products, 1551 Osgood St., North Andover, MA 01845. (617) 685-4371. \$2.70: DSS-8 station (100 qty); 3 to 4 wks.

Two families of DIL switches offer designers a choice of rocker or slide actuation with between four and 10 stations. The DSS series has SPST rocker action and the DLS series SPST, a slide-actuated mechanism. Protective covers with built-in actuator locking features are available. The DLS family also includes SPDT models. All models have gold-plated contacts for dependable low-energy service over long periods of time. All terminals are sealed.

CIRCLE NO. 366

LEDs viewable over 180° with high brightness

Data Display Products, 303 N. Oak St., Inglewood, CA 90301. (213) 677-6166. \$0.56 (1000-4999); stock to 6 wks.

Ledy Bug LEDs can be viewed with considerable brightness over more than 180 degrees of viewing angle. They are available in red, amber and green. Conventional LEDs maintain full brightness only over narrow angles—typically 30°—with clear encapsulation. The Ledy Bug achieves its wide-angle with a flat-topped cylindrical Lexan fresnel lens. And this cylindrical lens is more attractive than the standard round lens that comes with most LEDs. A flat area on the base of the lens denotes the cathode pin.

CIRCLE NO. 367

Tilt switch packaged in welded-steel case

Fifth Dimension Inc., 7070 Alexander Rd., Princeton, NJ 08540. (609) 452-1200. Under \$1 (5000 qty); stock to 4 wks.

The TS7 precision tilt switch is normally open and operates when the switch is tilted 15 \pm 5 degrees in any direction from vertical. Other nominal angles of operation are available. The switch opens its contacts at 10 \pm 5 degrees from vertical. Hysteresis is less than 5 degrees. Not a glass capsule, but a rugged welded-steel package, the danger of broken capsules or mercury leakage is virtually eliminated. The mercury contacts of the unit are rated 1 A at 12 V dc or 0.5 A at 115 V ac. Contact resistance is under 1 Ω .

CIRCLE NO. 368

Trimmer resistors MIL-R-39035 qualified

Bourns, Inc., 1200 Columbia Ave., Riverside, CA 92507. (714) 781-5050. Stock.

Trimmers of the RJR28 and RJR32 style are claimed by Bourns to be the first qualified under the reliability requirements of MIL-R-39035. The RJR28 unit features a 1/2-in.-long rectangular package, giving it a volume 1/10 of the smallest trimmer in its style now available. Key specifications include a 10-turn mechanism, resistance range of 10 Ω to 2 M Ω and a power rating of 0.6 W at 25 C, derated to 0 at 150 C. The RJR32 trimmer is T0-116 DIP sized for automatic insertion on PC boards, and it has 20-turn adjustability.

CIRCLE NO. 369

Capacitive keyboard life is 3 \times 10⁸ operations



Cherry Electrical Products Corp., 3600 Sunset Ave., Waukegan, IL 60085. (312) 689-7702.

Cherry solid-state capacitive keyboards feature low-profile capacitive keys with no mechanical contacts. Virtually any customer requirement can be custom built. Life is estimated in excess of 300,000,000 operations, and the price will be competitive with mechanical contact units. The integrated keyboard encoder requires only a 5-V-dc supply. Up to 10 bits for 110 keys and four modes per key can be encoded. Codes are designed-in with a low-cost mask option and any code can be selected. Scan time is extremely adjustable from 10 to 80 μ s per key. A noise-immunity circuit distinguishes "good" keys from noise. Also featured is a key-recognition circuit to eliminate key teasing. Burst-rate speed capability is 1000 characters per second.

CIRCLE NO. 370

53-key ASCII keyboard available in kit form



George Risk Industries, GRI Plaza, Kimball, NE 69145. (308) 235-4645. \$59.95: kit, \$71.25: assembled (unit qty); stock.

The KBM series Model 753 key-switches and glass-epoxy PC-board circuit allow user selection of data and strobe polarity, parity sense, upper-case alpha-lock and access to three user-definable keys for custom keycode or function key assignment. The switchboard is available either in kit or assembled form and comes with full documentation. Estimated construction time is 2 h. A custom plastic enclosure, Model 701, precut for the 753 keyboard is also available.

CIRCLE NO. 371

Bodine has doubled its AC horsepower



AVAILABLE FROM STOCK

And our new 48-frame TEFC parallel shaft and right angle gearmotor designs are shorter, too. Proven gearheads with ratios from 5:1 through 60:1. Speeds from 340 through 28 Rpm. And torques through 330 Lb-in. Available in all popular AC windings and voltages. In a wide range of mounting configurations. You can get continuous duty ratings through 1/3 Hp—with gearhead or without. But get all the facts. Write for Catalog S.

ADE (After Delivery Economies) make Bodine a better fhp buy



Bodine Electric Company, 2500 W. Bradley Place, Chicago, IL 60618.

CIRCLE NUMBER 70

NEW!



A mighty big catalog about some mighty small switches.

This 44 page catalog consolidates the complete line of C&K small switches into a single, fact-filled, easy-to-read volume. It includes everything you need to know about toggles, rocker and lever handles, printed circuit mountings, snap-acting pushbuttons, 6 AMP alternate action and momentary pushbuttons, subminiature and microminiature pushbuttons, illuminated rockers, miniature power, slide, and thumbwheel switches—plus how-to-order information and a complete list of worldwide C&K distributors. Ask for your free copy and we'll show you a million and one ways to turn on the juice.

C&K Components, Inc., 103 Morse Street, Watertown, MA 02172
TEL: (617) 926-0800 TWX: 710 327-0460 TELEX: 92 2546

Free Engineering Samples on Request.

CIRCLE NUMBER 72

Special Relays — QUICKLY

Customer Designs Own Relay

One of our customers needed a relay to switch an Amp at 50 volts, inductive. Together we filled out an EAC application questionnaire. The result? A satisfied customer, and the specs below.

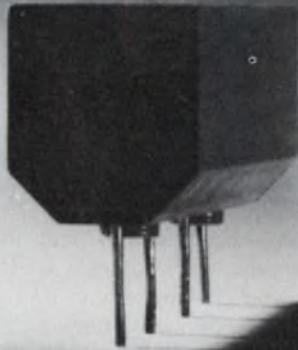

1 Amp switching current, 4 Amp surge current.
5, 6, 12, 24, or 48 volt DC coil voltage
switches inductive loads with little or no arc suppression to 50 V DC or AC
Size is 0.4 x 0.4 x 1.0 inch

You can design your relay too — just call, write, or twx us for your copy of the EAC application questionnaire.



EAC Electronic Applications Company

4918 Santa Anita Avenue, El Monte, CA 91734
213 / 442-3212 Twx 910 / 587-3351

CIRCLE NUMBER 71

ELECTRONIC DESIGN 16, August 2, 1977

NEW MULTI PUSH-BUTTON SWITCH LINE FROM SMK

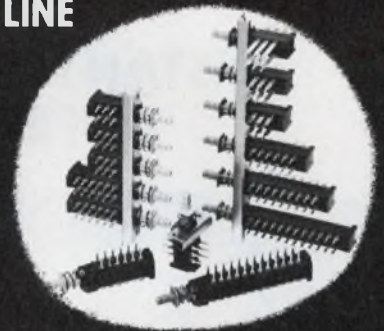

The JP-7000 Series Multi Push-Button Switches include interlocking, self-locking, momentary or reset type switches that are available with either 15 or 20MM spacing in DPDT, 4PDT, 6PDT, and 8PDT configurations. The switches are rated at 300mA @ 30V DC and operate from -10°C to +70°C with a mechanical life expectancy of 30,000 cycles. Up to a maximum of 6 switch stations can be interlocked if desired, and up to 12 switches can be mounted on the same frame. Representatives throughout the U.S. Call, write or wire:



SMK Electronics Corporation of America

118 East Savarona Way Carson, California 90746
Tel: (213) 770-8915

CIRCLE NUMBER 73

THE UN-QUARTZ RESONATOR

RMC CERAMIC RESONATOR

WHY pay for quartz, if quartz accuracy is not required in your digital clock generator—**USE RMC CERAMIC RESONATORS.**

ONLY 55¢ in 100 quantities for any oscillator frequency between 195 KHz and 600 KHz, ± 1 KHz. Less in larger quantities. Temperature stability: $< \pm 0.2\%$ (-20°C to $+65^{\circ}\text{C}$).

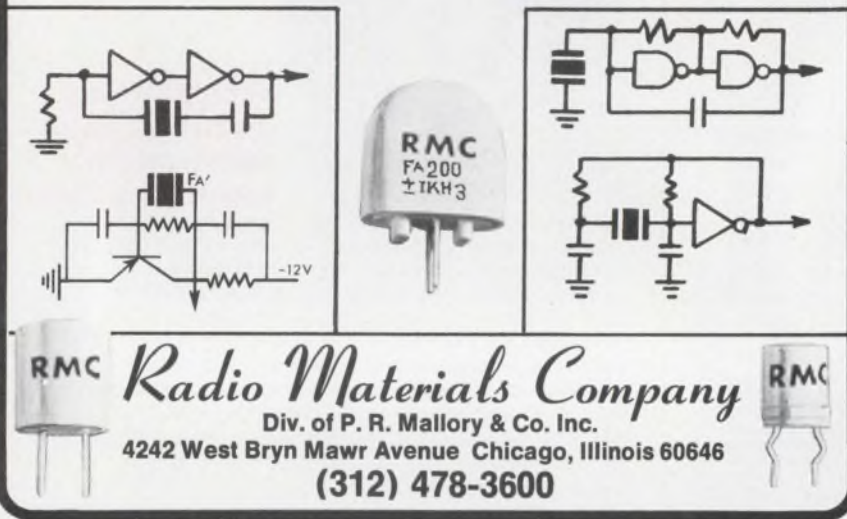

The advertisement features several circuit diagrams and a photograph of the RMC ceramic resonator component. On the left, there are two diagrams: the top one shows a simple oscillator circuit with a feedback loop, and the bottom one shows a more complex circuit with a -12V supply. In the center is a photograph of a cylindrical ceramic resonator with the text 'RMC FA200 ±1KHz' printed on it. On the right, there are two more circuit diagrams, one showing a square wave generator and another showing a different oscillator configuration. At the bottom, the RMC logo is flanked by the company name 'Radio Materials Company' and its address and phone number.

Radio Materials Company
Div. of P. R. Mallory & Co. Inc.
4242 West Bryn Mawr Avenue Chicago, Illinois 60646
(312) 478-3600

CIRCLE NUMBER 74

NEW! INSTANT FREQUENCY DIFFERENCE!



Tracor Model 527A measures frequency difference instantly, precisely. For precisely \$3,150. Front-panel meter reads directly to parts per 10^{11} . Allows adjustment of two oscillators to the same frequency, adjustment to a specific offset, determination of offset—all instantly. Plus both short-term and long-term stability analysis. Internal oscilloscope extends precision to 1×10^{-12} . Reference and signal frequencies need not be the same. Write or call for full technical and application information.

Tracor Industrial Instruments

6500 Tracor Lane • Austin, Texas 78721 • AC 512/926-2800

CIRCLE NUMBER 75

PACKAGING & MATERIALS

Flexible clip holds wires securely

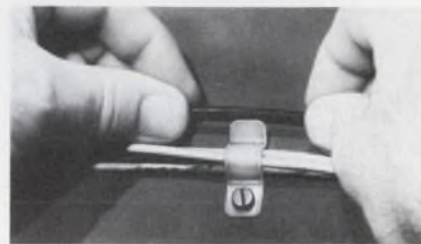

Weckesser Co., Inc., 4444 W. Irving Park Rd., Chicago, IL 60641. David Haines (312) 282-8626. \$20.53/100 (50,000 qty); stock.

The nylon Flex-Clip is specifically designed for convenience in the initial assembly of wires. Wires can be easily slipped in and out of a specially designed lip. Nevertheless, the clip's contour design and the spring-back flexibility of nylon holds bundles of wires securely.

CIRCLE NO. 372

Quad in-line socket accepts LSI packages

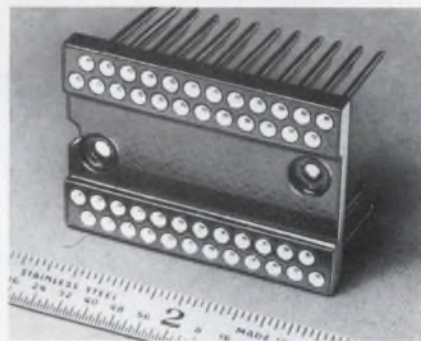

Garry Mfg. Co., 1010 Jersey Ave., New Brunswick, NJ 08902. Harry A. Koppel (201) 545-2424. \$1 to \$2.50; stock.

A 48-position QUILL (Quad-in-line) socket for packaging LSI and MSI headers accepts the Motorola QUILL M10800 and Texas Instruments SN-74581 series of bipolar devices. The headers are low-profile—made of thermoplastic Valox 420 SEO, UL 94VO listed—and use four-leaf beryllium-copper sockets for high retention. Closed-entry design prevents damage from misalignment of the IC chip-lead frame. Terminal sleeves are brass and available with either gold-over-nickel or electrotin-over-copper plate. They are supplied with dip-solder terminals, P/N 860-48-CC-D, and 0.025-in.² solderless wire wrap terminals, P/N 860-48-AA-D.

CIRCLE NO. 373

INSTRUMENTATION

Clamp-on meter reads digitally



Amprobe Instrument, 630 Merrick Rd., Lynbrook, NY 11563. (516) 593-5600. \$149.85, effective Aug. 1, 1977.

Model ACD-1 clamp-on volt/amp/ohmmeter, with digital readout, eliminates the possibility of reading incorrectly. The 3-digit readout is 0.43-in. high. Values under 100 are shown to the nearest tenth. The jaws of the new instrument take a conductor as large as 2 in. in diameter. Ranging is automatic.

CIRCLE NO. 374

15-MHz scope offers triggering features

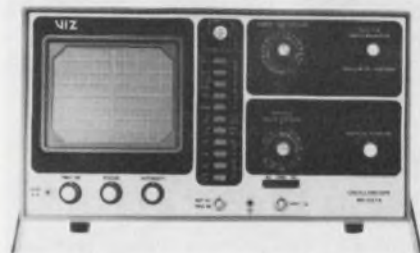

VIZ Test Instruments Group, 335 E. Price St., Philadelphia, PA 19144. (215) 844-2626. \$479 (dealer optional).

The WO-527A 5-in. triggered scope offers a vertical-amplifier frequency response to 15 MHz. The bandwidth of the horizontal amplifier covers dc to 1 MHz. Front-panel pushbutton switches control the display-mode and sweep-function selection. The trigger-level adjustment system uses LEDs to indicate trigger polarity at a glance. Sensitivity is 10 mV/cm.

CIRCLE NO. 375

μ P controls modes in frequency synthesizer



Hewlett-Packard, 1501 Page Mill Rd., Palo Alto, CA 94304. (415) 493-1501. \$7000; 90 days.

Model 3335A μ P based, 200-Hz to 80-MHz frequency synthesizer provides a resolution of 0.001 Hz and amplitude flatness of 0.15 dB over its entire range. For automated instrumentation systems, the 3335A includes the HP-IB (IEEE-488) interface bus as a standard feature. Among the benefits provided by the μ P is control of the automatic, manual and single-sweep modes. At turn-on, the μ P sets the instrument to 1 MHz at minimum output. Up to 10 instrument settings can be stored in 10 memory registers for later recall.

CIRCLE NO. 376

Here are the latest additions to the Par.Metal line of modern electronic housings!



new... sectional wall cabinets

WC SERIES

Made of 3 sections —

- Wall mounted rear unit — 4" deep
- Center body section — 12" deep
- Front door — 2" deep

new... low silhouette console cabinets

MODEL FS-21

Designed for any control requirement

- Provides unobstructed views
- Modular units for grouping
- 21" wide x 44" high x 24" deep

new... mod-cab welded desk cabinets

DC SERIES

- Panel heights from 3½" to 21"
- Two panel widths 9½" and 19"
- Three depths — 12", 18" and 22"
- Choice of 10 colors with walnut or black vinyl aluminum trim

SEND FOR COMPLETE LITERATURE OF PAR-METAL'S PACKAGING SYSTEMS

Par.Metal PRODUCTS, INC.

1260 Atlantic Ave., Brooklyn, N.Y. 11216 (212) 772-5800



CIRCLE NUMBER 76

POWER SOURCES

Unregulated dc supply powers microprocessors

Standard Power, Inc., 1400 S. Village Way, Santa Ana, CA 92705. Carroll Goldsworth (714) 558-8512. \$27.50; stock.

Microprocessors and peripherals with on-board voltage regulators can use the compact SMP 30B supply. Three output voltages (+9 V dc at 1 A and ± 18 V at 0.5 A) are provided, with either 115-V or 230-V, 50 or 60-Hz, input. The unit is one of a series of 13 SMP models that provide three or four output voltages with power handling capabilities from 30 to 100 W. The unit measures $3\frac{1}{2}$ (W) \times $3\frac{1}{2}$ (H) \times $4\frac{1}{4}$ (L) in. and weighs 2.1 lb.

CIRCLE NO. 377

Battery power systems handle critical loads



Stored Energy Systems, 2271 Mora Dr., Mountain View, CA 94040. Herb Kaewert (415) 961-7500. From \$600 (unit qty).

Power sources for loads that cannot be interrupted are provided by the BPS line. The units contain a battery, control system and a battery charger. Available in capacities from 20 to 1700 A-h, the units can contain one of five different battery types: high performance nickel cadmium, high capacity nickel cadmium, lead-planté, lead-antimony or lead calcium. The battery and charger sections are isolated by acid-alkali resistant steel housings.

CIRCLE NO. 378

MICROWAVES & LASERS

Continuous mixer covers 0.2 to 22 GHz

Vari L Co., Inc., 3883 Monaco Parkway, Denver, CO 80207. (303) 321-1511. \$650 (1-9 qty); 8 wks.

The DBM-1800 is a doubly balanced mixer with a continuous frequency response from 200 MHz to 22 GHz, and i-f response from 5 MHz to 7 GHz. Typical performance specs include: conversion loss, 8.0 dB; isolation, 25 dB; VSWR, $\leq 3:1$. The mixer package measures $2.3 \times 1.3 \times 0.85$ in. Hermetically sealed version is available.

CIRCLE NO. 379

Compact coax attenuators give 70 dB in 10-dB steps



Hewlett-Packard, 1501 Page Mill Rd., Palo Alto, CA 94304. (415) 493-1501. \$690 and \$1050; 4-6 wks.

Models 33321D (manual) and 33321K (programmable) coaxial step attenuators offer a range of 70 dB in 10-dB steps and mode-free operation to 26.5 GHz. Both models fit a $6.6 \times 2.1 \times 1.7$ -in. envelope. Repeatability is typically 0.05 dB after 1 million steps. Typical accuracy is 7% of dB reading at 26.5 GHz, where SWR < 2.2 .

CIRCLE NO. 380

Superfast attenuator clips 10 dB in 1 μ s

Avantek Inc., 3175 Bowers Ave., Santa Clara, CA 95051. Bob Goff (408) 249-0700. \$60 (1-5); 30 days.

Hermetically sealed in a TO-8 package, the UTF-025 voltage-controlled attenuator typically zips from 0 to 25 dB in 2.5 μ s. It is designed to work with 5-to-2500-MHz amplifier modules, and works over -54 to 100 C without degradation. Flat attenuation, high voltage-vs-attenuation linearity, improved intermodulation and a positive control voltage also contribute to the UTF-025's remarkable performance.

CIRCLE NO. 381

GaAs power FET handles 1 W at 8 GHz

Microwave Semiconductor Corp., 100 School House Rd., Somerset, NJ 08873. Richard Moffett (201) 469-3311. \$575 (100 qty); 1 wk.

The 88004 GaAs FET has a bandwidth of 2 to 10 GHz and a power capability of 1 W at 8 GHz. Designed for oscillators and linear power amplifiers, these flip-chip bonded devices have half the thermal resistance and common-source inductance of their predecessors. Three other GaAs FET models in the 88000 series offer various combinations of power, gain, and thermal resistance.

CIRCLE NO. 382

Tiny VCO reaches 3 GHz

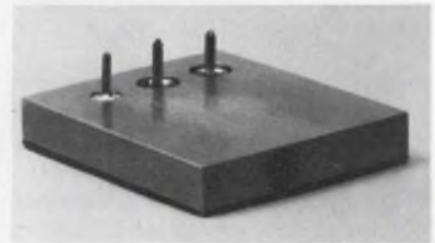

Applied Research, Inc., 76 S. Bayles Ave., Port Washington, NY 11050. Aldo Scandurra (516) 883-5700. \$150 (50 qty); 4-6 wks.

The matchbook-size VCOs, series OSC, are designed for PC board insertion. Standard octave ranges start at 100 to 200 MHz, and go to 700 to 1500 MHz, 1.5 to 2 GHz, and experimental units reaching 3 GHz are also available. Power output is greater than 0 dBm, and linearity is $\pm 1\%$.

CIRCLE NO. 383

Canned amplifier boasts 13 dB at 2 GHz

Watkins-Johnson Co., 3333 Hillview Ave., Palo Alto, CA 94303. (413) 493-4141. \$140; stock.

A low-noise, 10 to 2000-MHz amplifier in a TO-8 can, the WJ-A31, offers a typical noise figure of 3.7 dB with a gain of typically 13 dB. The A31 provides -2 -dBm output power capability at the 1-dB compression point. Cascaded with other TO-8 amplifiers, an over-all typical performance of 3.9-dB noise figure, 42-dB gain, and $+15$ -dBm power output over the full 10 to 2000-MHz range is possible.

CIRCLE NO. 384

now there is one... in signal processing

IF and Microwave Components From One Source.

Where others cut-off at 1 GHz, and still others begin at 1 GHz, Merrimac does it all from DC-18 GHz with lumped elements, stripline or ferrites. For years Merrimac has been a leader in IF while quietly manufacturing components for microwave systems. Now, we have two complete Signal Processing lines with IF, RF, microwave components and subsystems where we can meet your particular needs from over 700 standard off-the-shelf devices.

SPORTS ILLUSTRATIONS SUITABLE FOR FRAMING.



Football, Basketball, Soccer and Hockey.
Two Color reproductions FREE on request.

Circle the Reader Service Number 237

SINGLE AND DOUBLE BALANCED MICROWAVE STRIPLINE MIXERS



1.7-18 GHz

Check our minimum performance characteristics and see for yourself why Merrimac has the winning combination for you...

SINGLE BALANCED MICROWAVE STRIPLINE MIXERS

MODEL BMM-01-	RF & LO FREQ. (GHz)	IF BW (MHz)	ISOLAT'N dB (MIN)	NOISE FIG. dB (MAX)	CONV. LOSS dB (MAX)
2 95 G	1.7-4.2	DC-400	6	8.0	6.5
3 G	2.0-4.0	DC-400	8	7.5	6.5
3 90 G	2.6-5.2	DC-400	7	7.5	6.5
6 G	4.0-8.0	DC-400	6	8.0	7.0
10 G	8.0-12.4	DC-1000	6	8.5	7.5
15 G	12.4-18	DC-1500	6	9.0	8.0

DOUBLE BALANCED MICROWAVE STRIPLINE MIXERS

MODEL DBM-01-	RF & LO FREQ. (GHz)	IF BW (MHz)	ISOLAT'N dB (MIN)	NOISE FIG. dB (MAX)	CONV. LOSS dB (MAX)
2 95 G	1.7-4.2	DC-400	20	8.5	7.5
3 G	2.0-4.0	DC-400	20	8.0	7.0
3 90 G	2.6-5.2	DC-400	20	8.5	7.5
6 G	4.0-8.0	DC-400	20	9.0	8.0
8 G	6.0-12.4	DC-400	16	9.5	8.5
10 G	8.0-12.4	DC-700	18	9.0	8.0
15 G	12.4-18	DC-1000	15	10.0	9.0

send for our
**NEW '77 MICROWAVE
CATALOG.**

Circle the Reader Service Number 238

DOUBLE BALANCED MIXERS



DC to 1 GHz — in TO-5, Flat Pack or Relay Header

Check our minimum performance characteristics and see for yourself why Merrimac has the winning combination for you...

DC-500 MHz MODELS				
PACKAGE	MODEL NO'S	PRICE	CONVERSION LOSS	ISOLATION (DB-MIN)
RELAY HEADER	117A	\$ 8.45	5.5 dB Typ. 8.0 dB Max	L-R 40-30 L-X 35-20
FLAT PACK	DMF-2A-250	\$28.00	7.0 dB Typ. 8.0 dB Max	L-R 40-35 L-X 30-20
TO-5 (0.3" HIGH)	M-109	\$25.00	6.0 dB Typ. 8.5 dB Max	L-R 40-25 L-X 30-18
DC-1000 MHz MODELS				
RELAY HEADER	M-119	\$15.00	7.0 dB Typ. 8.0 dB Max	L-R 30-20 L-X 25-15
FLAT PACK	DMF-2A-505	\$28.00	7.5 dB Typ. 8.0 dB Max	L-R 35-25 L-X 30-20
TO-5 (0.3" HIGH)	M-122	\$38.00	6.5 dB Typ. 9.5 dB Max	L-R 40-25 L-X 30-20

LO POWER (ALL MODELS) +7 DBM NOMINAL

Send for complete data on the above Mixers and we will also include free MTBF data and information on our complete line of DC-3GHz "Connectorized" Single and Double Balanced Mixers.

send for our
**NEW '77 CATALOG
OF IF SIGNAL PROCESSING
COMPONENTS**

Circle the Reader Service Number 239

now there is one...in signal processing

Export Representatives Dage Corp.
Stamford, Connecticut 06902
(203) 324-3123 Tlx 710-474-2490 Telex: 96-5928

Merrimac
INDUSTRIES, INCORPORATED
POST OFFICE BOX 986, 41 FAIRFIELD PL., W. CALDWELL, N.J. 07006
• 201 575-1300 • TWX 710-734-4314

Bright n' Beautiful!

MIN-Lites

LED INDICATORS



Minelco's bright new 1550 Series LED indicators are made to be seen. High intensity LEDs, set into a beautifully finished and plated threaded mount to enhance your finest up-front panels. Low voltage, fully IC compatible, with fast switching time, and an exceptionally long life expectancy. **Write or call for prototypes and Bulletin C-21.** Minelco — A Talley Industries Company, 135 South Main St., Thomaston, Conn. 06787. Phone (203) 283-8261.

...from **Minelco**

CIRCLE NUMBER 77



Application notes

Detector diodes

Using a zero-bias Schottky detector diode is the subject of a four-page application note. Hewlett-Packard, Palo Alto, CA

CIRCLE NO. 385

Software programs

"Software Programs" describes the company's repertoire of software programs to support the Z80-microcomputer family. Also available are brochures describing the Z80-MCS-microcomputer system, the Z80 and Z80A CPUs and Z80A-microcomputer-board series. Zilog, Cupertino, CA

CIRCLE NO. 386

4-k RAMs

Selecting worst-case test procedures for 4-k RAM devices is described in an application note. Macrodata, Woodland Hills, CA

CIRCLE NO. 387

Alphanumeric display

"Applying the DL-1416 alphanumeric display" covers: device electrical description and operation; considerations for general-circuit designs; multidigit display systems; and interfacing to the 6800, Z80, and 8080 microprocessors. Litronix, Cupertino, CA

CIRCLE NO. 388

μ C system design

Three publications describe major trends in microcomputer-system design—the use of high-density dynamic RAMs, single-chip μ Cs and μ C-based OEM computers. Intel, Santa Clara, CA

CIRCLE NO. 389

Microwave components

Check full of performance graphs, specifications and photos, a 68-page "Microwave Component Applications" guide is a helpful aid when designing with modular amplifiers. Also available is an eight-page booklet, "A 1 GHz Prescaler Using GPD Series Thin-film Amplifier Modules." AvanteK, Santa Clara, CA

CIRCLE NO. 390

MICROPROCESSOR POWER SUPPLIES

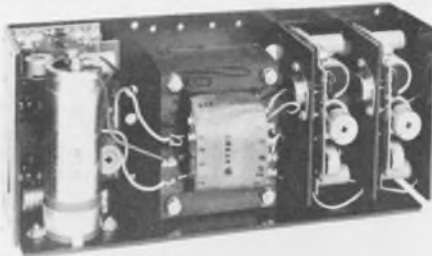

Featuring . . . High Reliability and Low Cost

Now Power/Mate introduces a series of triple output, open frame power supplies designed specifically for microprocessor users.

Based on a rugged, field proven design, the ETR series of microprocessor power supplies features Dual AC Input, remote sensing, adjustable current limiting and plug-in IC regulation throughout the line.

Built to the same rigid quality standards that have made Power/Mate the industry leader, they offer a very impressive 100,000 hour MTBF.

Best of all, the ETR series is economical and in stock. Call or write for our free brochure.



POWER/MATE CORP.

World's largest manufacturer of quality power supplies.

514 South River Street/Hackensack, N.J. 07601/Phone (201) 343-6294 TWX 710-990-5023

CIRCLE NUMBER 78

New literature

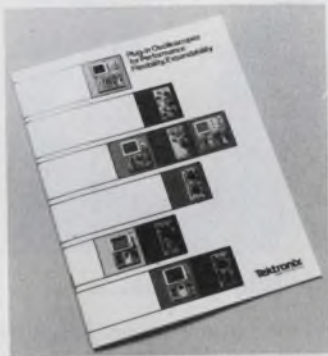

Plug-in oscilloscopes

A booklet offers help in selecting both plug-in modules and mainframes for the 7000-Series and 5000-series oscilloscopes. The selection procedure is designed to best match an oscilloscope to your present needs while providing expansion capability to meet future needs. Tektronix, Beaverton, OR

CIRCLE NO. 391

Electrical components

Photographs, engineering drawings, and specifications of switches, relays and solenoids are found in a 52-page catalog. Oak Industries, Crystal Lake, IL

CIRCLE NO. 392

Digital indicators

Complete specifications, option descriptions, and prices of the Trendicator digital indicators are contained in an eight-page brochure. Doric Scientific, San Diego, CA

CIRCLE NO. 393

Desktop computing system

A desktop computing system, featuring the data-retrieval power of a mainframe, is the subject of a six-page brochure. Wang Laboratories, Lowell, MA

CIRCLE NO. 394

Connectors

Specifications on series 1000, 2000 and 3000 miniature connectors are provided in a 16-page catalog. Methode Electronics, Rolling Meadows, IL

CIRCLE NO. 395

ELECTRONIC DESIGN 16, August 2, 1977

BUCKEYE flex-i-pak™ INSTRUMENT CASES

This is "THE" PACKAGE for prototype or production!

Design your case interior with standard accessories. 5 Heights—3 Depths.

Write Today for free catalog



the BUCKEYE stamping co.

555 Marion Rd., Columbus, Ohio 43207 Ph 614-445-8433

CIRCLE NUMBER 79

98% EFFICIENT AC LINE REGULATORS

TOPAZ AC Line Regulators solve brownout problems once and for all. Whether your application is a large computer system or a small instrument, TOPAZ regulators are the best solution.

Here's why:

- **98% EFFICIENCY** reduces heat losses and feeder costs.
- **FAST RESPONSE** (less than one cycle) prevents problems caused by short term voltage changes.
- **NO DISTORTION** is added to the output wave form.
- **SMALL SIZE AND WEIGHT** ease handling and reduce space requirements.
- **SILENT OPERATION** permits use in office areas without the annoying noise common to constant voltage transformers.
- **OUTPUT VOLTAGE** is unaffected by input frequency variations.



600 VA to 100 kVA
Priced from \$360.

All this plus TOPAZ noise suppression and quality at prices lower than you'd pay for regulators without these features. Put an end to brownout problems. Send for our brochure or give us a call today.

TOPAZ SOLUTIONS TO POWER PROBLEMS
ELECTRONICS

3855 Ruffin Road, San Diego, California 92123—(714) 279-0831—TWX (910) 335-1526

CIRCLE NUMBER 80



electrocube capacitors

MYLAR*



for MINI, MINI APPLICATIONS



Having problems squeezing standard size capacitors into your miniaturized system? Our Series 230 metallized Mylar* miniature capacitors could be the answer — many of these units are nearly 40% smaller than conventional models. You'll find them in 6 case styles, rated to 50 mfd and to 600 VDC, and available in both reel and unreel packaging. For your "mini" applications, contact Electrocube, 1710 So. Del Mar Ave., San Gabriel, CA 91776; Tel.: (213) 573-3300.

*TM DuPont

CIRCLE NUMBER 81

TRIO LABS' MAXI-POWER® 682



A 750 watt (5VDC at 150a) Switching Power Supply that has so many features it surpasses comparison.

- Input 208VAC nominal (115VAC-Model 683).
- Low Line -30% (146VAC).
- High Line +10% (229VAC).
- Ride through 35ms @ nominal.
- Efficiency up to 85%.
- Output 2-48VDC standard.
- Power Out up to 800w (750w @ 5VDC out).
- Output voltage adjust.
- Overcurrent protection foldback (standard) or constant current.
- Overvoltage protection crowbar SCR.
- Self Cooling
- Parallellable.
- U.L. recognized (approved).
- 5x8x11"
- Up to 2 watts/in³.
- As low as 63¢/watt.

TRIO LABS

The Switcher Source®

80 Dupont St.
Plainview NY
(516) 681-0400

CIRCLE NUMBER 82

"If you're really minding your own business, you're giving more to higher education."

John T. Connor
Chairman and Chief Executive Officer
Allied Chemical Corporation



Make America smarter. Give to the college of your choice.



Council for Financial Aid to Education, Inc.
680 Fifth Avenue, New York, N.Y. 10019

A Public Service of This Magazine & The Advertising Council.

NEW LITERATURE



Solid-state keyboards

Included in a six-page brochure are several full-scale photographs showing a solid-state capacitive keyboard in full view and low profile. Features and engineering drawings of an encoder are included. Cherry Electrical Products, Waukegan, IL

CIRCLE NO. 396

Displays

Bright low-voltage displays for calculators, DMMs, test equipment, car dashboards, clocks, radios, and POS terminals are shown in a guide. NEC America, Santa Clara, CA

CIRCLE NO. 397

5-1/2-digit DMM

Specifications of the DMM 52 5-1/2 digit, laboratory/systems type, digital multimeter are given in a four-page brochure. Aiken Industries, San Diego, CA

CIRCLE NO. 398

Precision pots, dials

Single and multiturn, laboratory and rectilinear-precision and non-precision potentiometers are covered in a 68-page catalog. Turns-counting dials are included. To simplify searching, two tables of contents organize products—one by key parameters and one by model numbers. Beckman Instruments, Helipot Div., Fullerton, CA

CIRCLE NO. 399

Thermal cutoffs

Specifications for thermal cutoffs, multiprotectors and pressure switches are given in a 16-page brochure. Micro Devices Div., Emerson Electric, Dayton, OH

CIRCLE NO. 403

Panels and accessories

Packaging panels and accessories, DIP and transistor sockets, test jacks, and feedthrough terminals are covered in this 52-page catalog. Photos, schematics, and complete specs are included. Electronic Molding Corp., Woonsocket, RI

CIRCLE NO. 404

Batch control systems

Listing over 40 industrial process applications, a 12-page bulletin describes different levels of batch control and the related instrumentation used. Programs for single-loop, multiple-loop, and multi-unit systems are included. The Foxboro Co., Foxboro, MA

CIRCLE NO. 405

CMOS ICs

A catalog gives characteristics of CMOS integrated circuits for clock and timing applications. Circuits included in the catalog are frequency dividers, decoders, and ripple counters, as well as a combination inverter-ripple counter-control logic device. Sprague Electric, North Adams, MA

CIRCLE NO. 406

Test instruments

Test instruments including oscilloscopes, frequency counters, digital and analog multimeters, audio and rf signal generators, semiconductor testers, power supplies, and CB and TV test instruments are featured in a 44-page catalog. B&K Precision, Chicago, IL

CIRCLE NO. 407

Microwave equipment

An 88-page coaxial and waveguide catalog gives product information and specifications on more than 350 microwave components used in measurement. Hewlett-Packard, Palo Alto, CA

CIRCLE NO. 408

Multicounters

The 1910A and 1911A automatic multicounters are highlighted in a four-page brochure. Specifications, ordering information and prices are included. John Fluke Mfg. Co., Mountlake Terrace, WA

CIRCLE NO. 409

Linear ICs

A 992-page technical manual describes more than 275 linear ICs and modules. Fully illustrated. GTE Sylvia, Stamford, CT

CIRCLE NO. 410

Motor-speed controls

Prices, photos and schematics are given in a motor-speed controls catalog. Electrol, York, PA

CIRCLE NO. 411

Memories

The 928-page 1977 data catalog presents an update of Intel's products and services. Sections of the catalog cover memory components, memory systems, microcomputer components and systems, OEM computer systems, MDS, software, user's software library, training courses and literature. The catalog costs \$2.50 each. Intel, Literature Dept., 3065 Bowers Ave., Santa Clara, CA 95051

INQUIRE DIRECT

STOP

WAITING ON OUTPUT FROM YOUR MINI

You Are Wasting More In Dollars For Human Resources Than This LINE PRINTER Costs

2400 LPM - 80 COL.
MODEL 8210 - \$3450*

1400 LPM - 132 COL.
MODEL 8230 - \$3785*

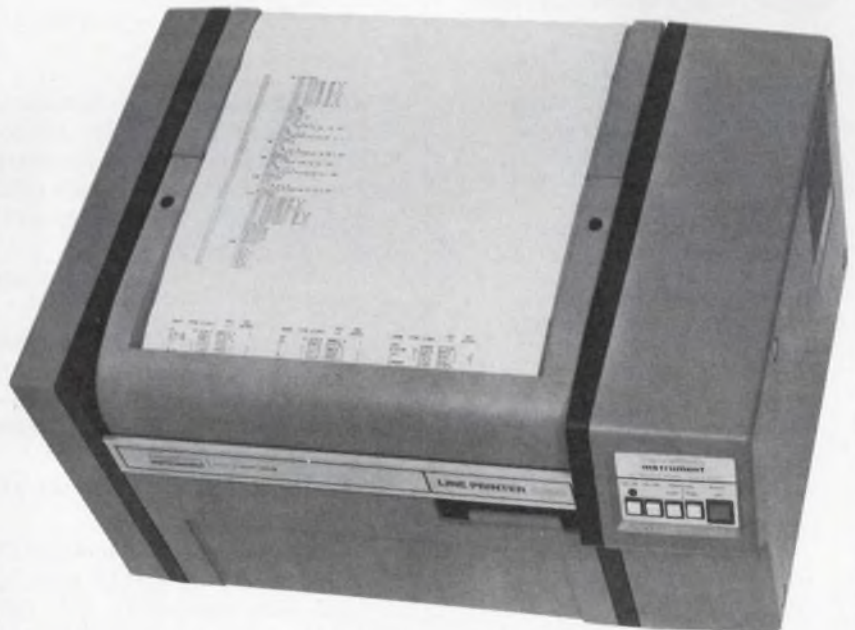

FOR ORDERING INFORMATION CALL OR WRITE:

**houston
instrument**

DIVISION OF BAUSCH & LOMB

ONE HOUSTON SQUARE (at 8500 Cameron Road) AUSTIN, TEXAS 78753
(512) 837-2820 TWX 910-874-2022 cable HOINCO

TELECOPIER EUROPEAN OFFICE Ruchesterlaan 6 8240 Gistel Belgium
Phone 056/237448 Telex Bausch 18398

"the recorder company"

* Domestic USA Prices, Qty 1, End User

CIRCLE NUMBER 83

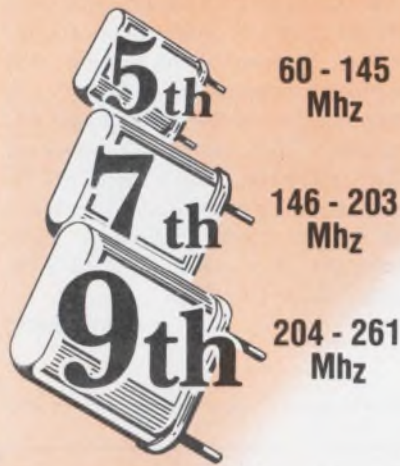

new broad spectrum

overtone crystals
for

oem's

New "Broad Spectrum" crystals by United States Crystal deliver a higher frequency range with reduced power requirements. They mean extra useful life for your products equipped with current power cell . . . or the ability to utilize smaller, less powerful batteries. For test sample crystal and quotations, send us your specifications along with quantity needed.

call **1-800-433-7140** Toll Free
8:00 a.m.-4:30 p.m. Central Time



UNITED STATES CRYSTAL

3605 McCart • Fort Worth, Texas 76110
TWX 910-893-4084 • Phone 817/921-3014

CIRCLE NUMBER 84

Bulletin board

National Semiconductor's muPro-80 development system now costs \$3950 as part of National's 8080A design package.

CIRCLE NO. 412

Solitron Devices' Semiconductor Div. has introduced two **nnp, high-voltage, planar, power transistors**—the 2N 6306 and 6308—that have recently received JAN, JAN-TX and JAN-TXV approval.

CIRCLE NO. 413

Texas Instruments' new regulating pulse-width modulator, the SG3524, is functionally equivalent to the Silicon General part with the same designation.

CIRCLE NO. 414

The Integrated Circuit Div. of Motorola has introduced its **1.5 and 2-MHz versions of the M6800 microcomputer components.** The new parts, in addition to the 50 to 100% improvement of throughput potential, have a power dissipation that is about 20% less than their M6800 predecessors.

CIRCLE NO. 415

Ryan-McFarland has introduced ROM versions of its 8080 MICRO BASIC runtime system. The firmware, delivered as a set of four 2308 (1024 × 8) parts, is priced at \$120 per set in single unit quantities.

CIRCLE NO. 416

Honeywell has reduced purchase prices 35% on memories above 512 kwords for its **large-scale Series 60—Level 66 and 68—and Series 6000 computer systems.**

CIRCLE NO. 417

Intersil has entered the **bipolar FET op amp** market by second sourcing National Semiconductor's LF 155/156A/155A and LF 355/356A/355A linear circuits.

CIRCLE NO. 418

Mostek has licensed Motorola as second source for the **MK 3870 single-chip microcomputer.**

CIRCLE NO. 419

Vendors report

Annual and interim reports can provide much more than financial position information. They often include the first public disclosure of new products, new techniques and new directions of our vendors and customers. Further, they often contain superb analyses of segments of industry that a company serves.

Selected companies with recent reports are listed here with their main electronic products or services. For a copy, circle the indicated number.

Belden. Wire, cable and cord.

CIRCLE NO. 420

Decision Data Computer Corp. Computer peripherals.

CIRCLE NO. 421

Thomas & Betts. Electrical/electronic connectors, terminals, fittings and accessories and related application tooling.

CIRCLE NO. 422

Bunker Ramo. Development, manufacture and leasing of electrical and electronic components.

CIRCLE NO. 423

General Automation. Computers and software.

CIRCLE NO. 424

Sierracin. Transparency products; heating and sensing devices; precision servo motors, and components.

CIRCLE NO. 425

Oak Industries. Components, controls, materials and communications.

CIRCLE NO. 426

Ball Corp. Glass containers and computer products.

CIRCLE NO. 427

AMP. Connection, switching and programming devices and application tools and machines.

CIRCLE NO. 428

Cutler-Hammer. Electrical/electronic equipment and aerospace systems and subsystems.

CIRCLE NO. 429

Join the IMC Book Club*



Free 92 page Catalog features specialty propeller and tubeaxial fans.

This catalog shows more than 100 standard designs, including 60 HZ, 400 HZ, multi HZ and DC versions plus a description of IMC's IMCool™ and Boxer® models. Information regarding the full line of accessories to fit the Boxer® fan is included.

For immediate service please call Gene Egan, V.P. Sales 516/334-7070.

*Product Literature Broadside and request card will be sent to you along with this catalog.

SERVING INDUSTRY OVER 25 YEARS

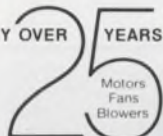

IMC MAGNETICS CORP.

EASTERN DIVISION

570 MAIN STREET, WESTBURY, NEW YORK 11590

CIRCLE NUMBER 85

You've been looking for a more reliable solid-state relay.

Just look at this one.

A unique combination of dv/dt snubber, fusible-link protection in the trigger circuit, plus an oversized triac—all combine to protect against catastrophic system failure should the triac fail to turn on.

Either zero-voltage or non-zero-voltage switching, both types rated for maximum ac load currents of 5A or 10A. Any control voltage from 3 to 32V dc; all models compatible with TTL, DTL, CMOS logic. Solder-pin, quick-on, or screw terminals.

Call (609-882-4800) or write for further information. Heinemann Electric Company, Brunswick Pike, Trenton, NJ 08602.

HEINEMANN

We keep you out of trouble.

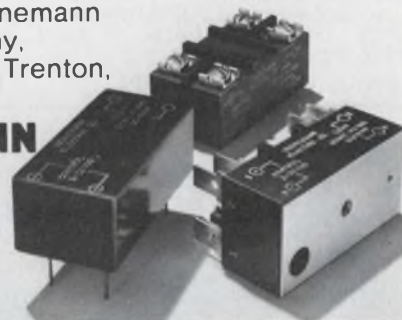

Heinemann 6961

CIRCLE NUMBER 87

WHO MAKES WHAT & WHERE TO FIND IT

Volume 1 of **Electronic Design's GOLD BOOK** tells all. And, when you look up an item in its **PRODUCT DIRECTORY** you'll find each manufacturer listed **COMPLETE WITH STREET ADDRESS, CITY, STATE, ZIP AND PHONE.** Save time. There's no need to refer elsewhere to find missing information.

IT'S ALL THERE
in
Electronic Design GOLD BOOK

Buzzzzz. (Write for new catalog.)



Solid state electronic MICRO-BUZZER from **CITIZEN**: High reliability, competitively priced with immediate delivery.

A complete range: **SMB** 1.5, 6, 12, 24, VDC
RMB 3, 6, 12, 24, VDC
IMB (Intermittent) 6, 12, VDC

CITIZEN

CITIZEN AMERICA CORPORATION
1710 - 22nd St.
Santa Monica,
CA 90404

Toll Free (800) 421-6516
In Calif. (213) 829-3541
TWX: (910) 343-6450

Name _____
Company _____
Address _____
City _____ State _____
Zip _____ Phone _____

CIRCLE NUMBER 88



CERAMIC CHIP CAPACITORS. SPLIT-CHIP, is a new concept in ceramic chip capacitor technology. These new units have two broad electrodes on one face and eliminate conventional wrap-around end terminations. This new concept provides lower cost and easier assembly. SPLIT-CHIPS are available in five standard sizes from .040" x .030" to .130" x .090" and .015" thick and in all popular dielectrics and capacitance ranges. JOHANSON DIELECTRICS, INC., Box 6456, Burbank, Ca. 91510 213-848-4465

CERAMIC CHIP CAPACITORS

181



ABSOLUTE ENCODER— ± 1 Part in 3600 System Accuracy, Electro-Magnetic Transducer + LED Display + BCD, Binary, and DC Output—Infinitely Adjustable Scale Factor (0 to 9999)—Hi Noise Immunity—Zero Offset—Single and Multi-Channel Units From \$375/Axis (1 pc.) Other CCC products are Synchro to Digital, Synchro to Linear DC, Digital or DC to Synchro Converters, and Solid State C.T.'s or CDX's. Send for Free Catalog & Application Notes. Computer Conversions Corp., East Northport, N.Y. 11731 (516) 261-3300.

ENCODER

184



LOW COST QUARTZ CRYSTALS Use Statek 10 to 300 kHz quartz crystals in TO-5s . . . they eliminate count down for oscillators, filters, tone generators, timers . . . They're rugged, accurate & resistant to high vibration and shock. Prices low as \$1.70 ea. in 1000 qty. Send your written application & we'll send you a sample. Call or write for literature. Details in Gold Book and EEM * STATEK CORP. * 512 N. Main, Orange, Ca. 92668 * (714) 639-7810 * Telex 67-8394

QUARTZ CRYSTALS

187



UNIVERSAL JUNCTION UNIT . . . for three devices, RS232C or current loop.

. . . Six switches provide all 63 interconnects that are possible between three I-O devices. LED's indicate data flow. . . .

. . . Designed to provide circuit compatibility and easy data routing between different manufacturer's devices. . . .

. . . \$350 (1-4) from DIGITAL LABORATORIES, 600 Pleasant St., Watertown, MA 02172 (617) 924-1680

3 PORT RS232 & 20 MA LOOP

182



INTEGRITY AND RECOVERY IN COMPUTER SYSTEMS, by T. K. Gibbons. Here is a step-by-step guidebook that places at your fingertips all the techniques and strategies you need for locating and correcting errors and failures and for re-establishing complete system integrity and reliability as quickly as possible. #5454-8, 144 pp., \$9.95. Circle the Info Retrieval Number to order your 15-day exam copy. When billed, remit or return book with no obligation. Hayden Book Co., 50 Essex St., Rochelle Park, N.J. 07662.

INTEGRITY & RECOVERY

185



SPECTRA-STRIP'S NEW PLANAR PRODUCT CATALOG & DESIGN GUIDE. AT LAST a complete catalog and design guide for planar connectors, ribbon and flat cables, flex circuits and planar interconnects. 86 pages on new products, connector applications, custom product designs, ultra flexible and high temperature cables, IDC connector designs and low cost interconnects. For your FREE copy write: Spectra-Strip Marketing Services, P.O. Box 415, Garden Grove, CA 92642

PLANAR CATALOG

188

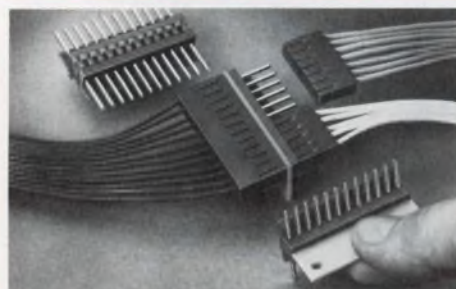

NEW "DOUBLE-HEADER" MINIATURE CONNECTOR ANSWER TO MYRIAD OF CONNECTION PROBLEMS. Have dual set of pins that interface with DIFFERENT SIZE crimp contact receptacles. In-line or right angle configurations with screw, rivet or snap-in PC board bulkhead mounts available. Permits identification of each pin with permanent legend on connector. Great for flying interconnects. METHODE ELECTRONICS, INC. 1700 Hicks Road, Dept. PR., Rolling Meadows, Illinois 60008. (312) 392-3500.

DOUBLE-HEADER CONNECTORS

183



NEW PRODUCT - UNIVERSAL 6 DIGIT COUNTER-TIMER-CLOCK. IT counts up, down, stores, presets, compares, resets, sets off alarms, measures speed, time, length, volume, levels, frequency, rpm and DOES NOTHING if you tell him so, all with one SINGLE I.C. It is available through our WORLDWIDE DISTRIBUTION NETWORK after it has been BURNED-IN for 150 HOURS and passed ALL the TESTS. PRICED at \$99 unit quantity. IMC, 4016 E. Tennessee St., Tucson, AZ 85714 (602) 748-7900

COUNTER-TIMER-CLOCK

186

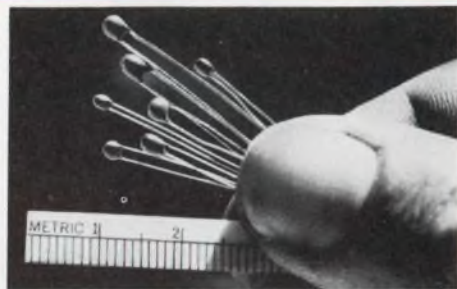

THERMISTORS with leads and coating are highly reliable low cost components in small dimensions more compatible with modern circuit design. R @ 25°C 100 Ω to 1 meg Ω $\pm 10\%$ to $\pm 1\%$. CURVE MATCHED INTERCHANGEABLES to $\pm .25^\circ\text{C}$. POINT MATCHED INTERCHANGEABLES to $\pm .2^\circ\text{C}$. Call or write for HP97 or TI SR52 THERMISTOR LINEARIZATION PROGRAM. WESTERN THERMISTOR CORPORATION, 403 Via El Centro, Ocean-side, CA 92054 (714) 433-4484.

THERMISTOR

189

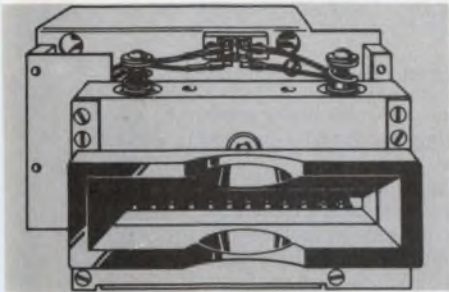

NEW COST-SAVING AMP "144" READS CARDS AND BADGES. The AMP 144 Combination Badge/Tabulating Card Reader saves space, complexity, terminal costs. Accepts punched-paper 80-column cards or plastic badges. Fully automatic read cycle. Reads numeric or alpha-numeric data up to 12 characters. Compact, rugged. Call (717) 367-1105, or write AMP Incorporated, Capatron Division, Elizabethtown, PA 17022. AMP is a trademark of AMP Incorporated.

COMBINATION CARD READER 190



DC CURRENT SENSORS. These solid-state devices have been specified for major U.S. satellite, missile, and aircraft projects, including GPS-NAVSTAR, SEASAT-A, F-16, AGENA, APOLLO, and SATURN IVB. They provide accurate, non-interrupted measurement of direct current with complete circuit integrity. ADC Products, 4900 W. 78th, Minneapolis, MN 55435. (612) 835-6800.

CURRENT SENSORS 193

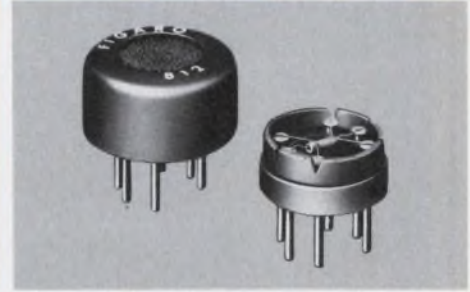

FIGARO GAS SENSOR TGS is a gas sensitive semiconductor. When combustible gas is absorbed on the sensor surface, a marked decrease of electrical resistance occurs. Major features of the sensor include high sensitivity, long term reliability and low cost. The applications are: GAS-LEAK ALARM, AUTOMATIC FAN CONTROL, FIRE ALARM, ALCOHOL DETECTOR, etc. Figaro Engineering Inc., North America Office-3303 Harbor Boulevard, Suite D-8, Costa Mesa, Calif. 92626 Tel: (714) 751-4103 Telex: 678396

GAS SENSOR 196



400 IDEAS FOR DESIGN, Volume 3, ed. by Morris Grossman. Brainstorm with the experts! Volume 3 of 400 IDEAS FOR DESIGN contains the best selections from *Electronic Design* that were published between 1971 and 1974. You'll find a wide range of ideas from very complicated to simple, but unique, approaches. #5111-5, 348 pp., \$13.95. Circle the Info Retrieval Number to order your 15-day exam copy. When billed, remit or return book with no obligation. Hayden Book Co., 50 Essex St., Rochelle Park, N.J. 07662.

IDEAS FOR DESIGN 191



The Sulzer Model 1115 5 MHz Crystal Oscillator was specifically designed for undersea applications where high stability and minimal power drain are of prime importance. Hermetically sealed in a precisely machined cylinder, its small size and light weight also make it ideal for portable applications. Power drain is 150 Milliwatts at 25°C and 300 Milliwatts at -5°C. AUSTRON, Inc., 1915 Kramer Lane, Austin, Texas 78758 (512) 836-3523

CRYSTAL OSCILLATOR 194



QUIK/STRIP BY ROGERS. Fast, low-cost system for connecting in-line pins on DIP socket boards and connector arrays. Shock and vibration resistant. 18 gauge current capacity. Can be used on pin densities as high as .100" x .100" and be stacked two or more high. Write or call for details. Rogers Corporation, Chandler, AZ 85224. Phone: (602) 963-4584. (EUROPE: Mektron NV, Gent, Belgium; JAPAN: Nippon Mektron, Tokyo.)

QUIK/STRIP 197



LEMO CONNECTORS are perfect for front panel applications. Superb design and craftsmanship complement any front panel design. The Quick Lock mechanism allows easy connection & disconnection. Panel space is saved because finger clearance is required on only two sides. The all metal shell is rugged and an effective strain relief grips the cable securely. Coax & multipin types from 2-18 pins are available from stock. Lemo U.S.A. Inc., 2015 2nd St., Berkeley, Ca 94710. Tel: 415/48-1966, Tx 335-393.

CONNECTORS 192



Free New '77 catalog contains over 34,500 quality power supplies from the world's largest manufacturer, Power/Mate Corp. Power Supplies for every application including submodulars, open frame, variorated, encapsulated, laboratory & system. All units UL approved and meet most military and commercial specs for industrial and computer uses. Power/Mate Corp., 514 S. River St., Hackensack, NJ 07601 (201) 343-6294

POWER SUPPLIES 195



Overcurrent Protector, manual reset eliminates fuse replacement. Convenient panel mounting. 19 fractional ratings from 0.1 to 5 amp. Other models up to 400 amp. Trip-free and fool-proof, UL and CSA approved. High quality, low cost \$1.39 ea. in 1000 lots. E-T-A Products Co. of America, 7400 N. Croname Rd., Chicago, Ill. 60648. Tel: (312) 647-8303. Telex: 253780.

CIRCUIT BREAKER 198

Electronic Design

ELECTRONIC DESIGN's function is:

- To aid progress in the electronics manufacturing industry by promoting good design.
- To give the electronic design engineer concepts and ideas that make his job easier and more productive.
- To provide a central source of timely electronics information.
- To promote communication among members of the electronics engineering community.

Want a subscription? ELECTRONIC DESIGN is circulated free of charge to those individuals in the United States and Western Europe who function in design and development engineering in companies that incorporate electronics in their end product and government or military agencies involved in electronics activities. For a free subscription, use the application form bound in the magazine or write for an application form.

If you do not qualify, paid subscription rates are as follows: \$30.00 per year (26 issues) U.S./Canada/Mexico, \$40.00 per year (26 issues) all other countries. Single copies are \$2.50 U.S. and all other countries. The Gold Book (27th issue) may be purchased for \$30.00 U.S./Canada/Mexico, and \$40.00 all other countries.

If you change your address, send us an old mailing label and your new address; there is generally a postcard for this in the magazine. You will have to requalify to continue receiving ELECTRONIC DESIGN free.

The accuracy policy of ELECTRONIC DESIGN is:

- To make diligent efforts to ensure the accuracy of editorial matter.
- To publish prompt corrections whenever inaccuracies are brought to our attention. Corrections appear in "Across the Desk."
- To encourage our readers as responsible members of our business community to report to us misleading or fraudulent advertising.
- To refuse any advertisement deemed to be misleading or fraudulent.

Individual article reprints and microfilm copies of complete annual volumes are available. Reprints cost \$6.00 each, prepaid (\$5.00 for each additional copy of the same article), no matter how long the article. Microfilmed volumes cost \$23 for 1976 (Vol. 24); \$30 for 1973-75 (Vols. 21-23), varied prices for 1952-72 (Vols. 1-20). Prices may change. For further details and to place orders, contact Customer Services Dept. University Microfilms, 300 N. Zeeb Rd., Ann Arbor, MI 48106. (313) 761-4700.

Want to contact us? If you have any comments or wish to submit a manuscript or article outline, address your correspondence to:

Editor
ELECTRONIC DESIGN
50 Essex St.
Rochelle Park, NJ 07662

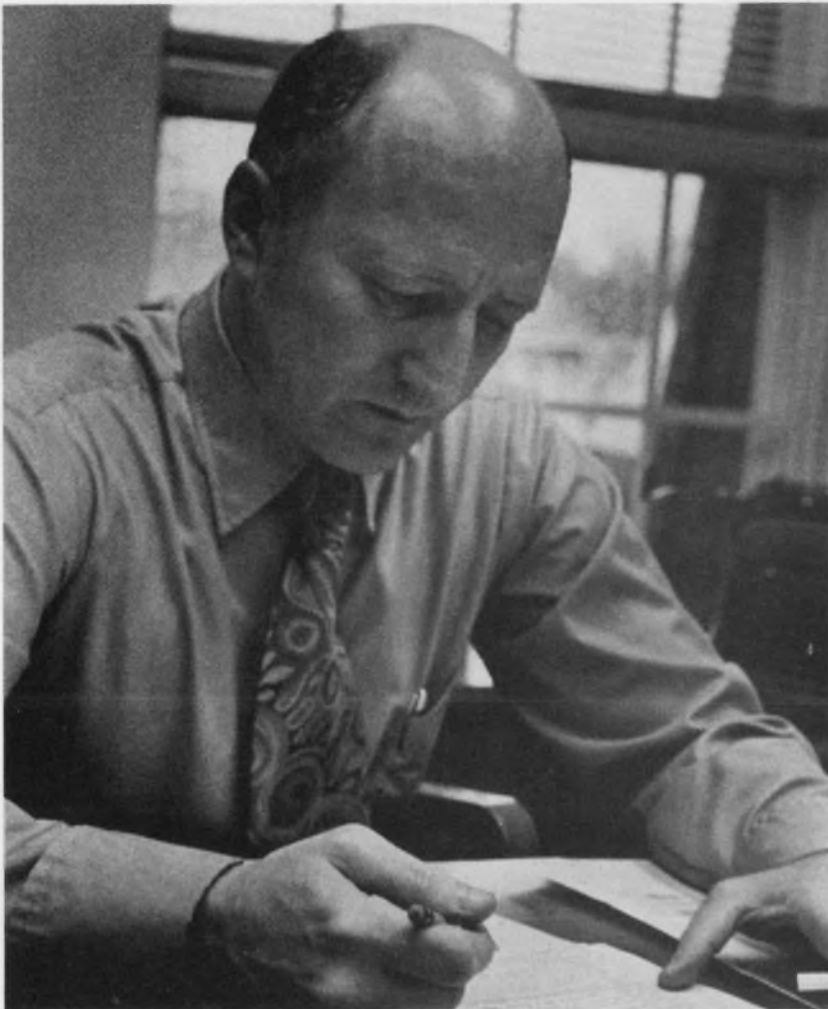

George Rostky, Editor-in-Chief, Electronic Design

Electronic Design WANTS YOU

If you have solved a tricky or unusual design problem ... if you have experience in a special area that will aid the design process ... if you have simplified a circuit or developed a practical design aid *why not share it with your fellow engineer-readers of Electronic Design?*

Each man has his own motivation for writing an article. Here are just a few:

- To help other engineers do their jobs better.
- To raise your professional status and speed your advancement.
- To help build your company's image.
- To increase your own knowledge.

To encourage authors to submit material to us, and to make it easier, we've prepared a special AUTHOR'S GUIDE that's yours for the asking. Contents include:

- Why write?
- Tips on writing.
- Why write for *Electronic Design*?
- Tips on getting it done.
- Which articles will *Electronic Design* accept?
- 7 Tests you can apply to your article.
- How long should it be?
- What happens to your article?
- What form should it take?
- Where to send it.
- Tips on structure.

Why not get started today? Payment can range as high as \$200 for an article contributed in a single issue.



FOR FREE
Electronic Design
AUTHOR'S GUIDE
CIRCLE NUMBER 300

GOOD BOOKS ARE HARD TO FIND.



WHY HIDE YOURS?

We are always looking for well-written manuscripts, or book proposals, for works on topics of interest to professional engineers that will advance their understanding of the state of their art.

What have you been working on?

What can we do for each other?

Let me know.

S. WILLIAM COOK
EDITORIAL DIRECTOR



Hayden Book Co., Inc.
50 ESSEX STREET
ROCHELLE PARK, N.J. 07662

Electronic Design

Advertising Sales Staff

Tom W. Carr, Sales Director
Robert M. Lepore,
Sales Coordinator

Rochelle Park, NJ 07662

Robert W. Gascoigne
Thomas P. Barth
Stan Tessler
50 Essex St.
(201) 843-0550
TWX: 710-990-5071
(HAYDENPUB ROPK)

Philadelphia

Thomas P. Barth
(201) 843-0550

Boston 02178

Gene Pritchard
P.O. Box 379
Belmont, MA 02178
(617) 489-2340

Chicago 60611

Thomas P. Kavooras
Berry Conner, Jr.
200 East Ontario
(312) 337-0588

Cleveland

Thomas P. Kavooras
(312) 337-0588

Los Angeles 90045

Stanley I. Ehrenclou
Burt Underwood
8939 Sepulveda Blvd.
(213) 641-6544

Texas

Burt Underwood
(213) 641-6544

San Francisco

Robert A. Lukas
3579 Cambridge Lane
Mountain View, CA 94040
(415) 965-2636

England

Constance McKinley
50 Essex St.
Rochelle Park, N.J. 07662
Phone: (201) 843-0550

Europe

Sanders, W. J. M.
Raadhuisstraat 24
Graft-De Ryp, Holland
Phone: 02997-1303
Telegrams: Euradteam-Amsterdam
Telex: 13039-SIPAS

G. Nebut
Promotion Presse Internationale
7 ter Cour des Petites Ecuries
75010 Paris, France
Telephone: 5231917, 1918, 1919

Dieter Wollenberg
Erikastrasse 8
D-8011 Baldham/Muenchen
Germany
Telephone: 0 8106/4541

Tokyo

Haruki Hirayama
EMS, Inc.
5th Floor, Lila Bldg.,
4-9-8 Roppongi
Minato-ku, Tokyo, Japan
Phone: 402-4556
Cable: EMSINCPERIOD, Tokyo



Save on Calculators

Hewlett-Packard

Model	Your Cost	Model	Your Cost
HP 10 Handheld AC/DC print. (new)	\$139.50	HP 55 Pro/powerful/was \$335.	\$139.00
HP 15C Print: HP29 Handheld	Call Us	HP 67 224 programmable steps	360.00
HP 21 Sci slide rule	63.50	HP 60 R.E./Banking	235.00
HP 22 Bus/Real Estate	99.00	HP 91 Print: HP45 space great	279.00
HP 25 Scientific	99.00	HP 92 New Bond Trader (print)	515.00
HP 25C Sci/retains memory	128.00	HP 97 Print: 224 Prog Step	600.00
HP 27 Comb/bus/stat/sci	139.00	Libraries for HP67 & 97	Each 29.75
HP 29C New/Comb/HP27 & HP25C	159.00	All HP accessories available at discount	

We are an HP franchised dealer. We will beat any deal. Each HP comes with charger, case, manuals, etc. 1 year warranty. Immediate delivery on all models.

Texas Instruments

Model	Your Cost	Model	Your Cost
TI 57 150 program steps	\$ 64.95	TI 5040 print./diag/lymem	\$ 99.95
TI 58 480 prog. steps/60 memories	104.95	TI 5050M AC/DC mem./chgr	82.95
TI 59 960 prog. steps/100 memories	229.95	Software for TI 59 and 58	each 29.00
SR 40 Scientific mc. charger	25.00	TI 5100 Desktop memory	43.95
SR 51-2 Sci. slide rule	49.95	Little Professor, educational	12.95
TI 30SP Scientific	18.00	Data Man - Big Professor, educ	21.95
TI 1580 Replays calc., great	25.95	Money Manager R.E./finance	18.95
TI 1750 10-in. wallet type 7M hr LCD	19.95	Bus. Analyst: R.E./finance	28.95
TI 2550-3 Business/memory	26.00	Data Crip 1000/rs/pencil thin	28.95
Libraries for SR 52	from 26.95	MBA Financial	67.95
TI 5015 printer/grand total	64.95		

Specials

Model	Your Cost	Model	Your Cost
Norelco 88	\$255.00	Pharicoder Dictators by "Olympus"	\$179.95 up
Norelco 95	149.00	Olympus Cassette Transcriber com	
Norelco 97	309.00	portable w/Sony M 101/Lanier MC60	319.95
Norelco 98	419.00	Casio Alarm/Calc. Clock CG1	44.95
Norelco 185	107.00	Texas Instruments Digital Watches from	9.95
Norelco 186	265.00	Hy Gain 40 Channel CB No. 2701	79.95
Norelco Cassette (30 min.)	2.95	Hy Gain 40 chan. pro. rem. No. 2716	249.95
Craig 2625 Elec. Notebook	149.00	Hy Gain 40 chan. Hide & Speak	
Craig 2705A Dictating/Trans.	189.00	remote No. 2769	199.95
Canon Electronic Printer	89.50	Hy Gain No. 2705 SS band 120 channel	349.95
Sharp Printer EL 1056	89.95	Bally "Fireball" pin ball machine	699.50
3M Dry Copier Model 051	139.00	Bally "Arcade" Prog. TV games	299.50
Sony M 101C Dictating Unit	154.00	Code-A Phone rem. cont. No. 1400A	259.95

Also SCM-Olivetti-Rock well-Victor-APP. Lloyd's Unites-Amans. Litton-Commodore Sharp-Canon-Craig-Panasonic-Sony-Sanyo-All kinds of digital watches and more.

Prices FOB L.A. Goods subject to availability. Ask for our famous catalog. We will beat any deal if the competition has the goods on hand. Add \$3 for shipping hand-held calculators. CA residents add 6% sales tax.

OLYMPIC SALES COMPANY INC.

216 South Oxford Ave. P.O. Box 74545
Los Angeles, CA 90004 • (213) 381-3911 • Telex 67-3477

CIRCLE NUMBER 89

KEEP Electronic Design's GOLD BOOK HANDY



When You Call

Save time when you contact suppliers. Check their catalog pages first in *Electronic Design's* GOLD BOOK. Maybe the information you need is right at your fingertips.

Electronic Design

recruitment and classified ads

PLACE YOUR AD AT ONLY \$45 PER COLUMN INCH IN

Electronic Design

— GET A REPEAT AD FREE!

With our 2 for 1 plan, your net cost in *Electronic Design* is only \$22.50 per column inch, lowest among all the national newspapers and electronics media. You get a total of 165,402 exposures to OEM engineers and engineering managers (not counting 10,600 more among general or corporate managers) at only 27¢ per thousand! You can't beat the price. You can't beat the coverage and you can't beat the quality.

YOU REACH ENGINEERS WITH TITLES LIKE THESE:

• Chief Engineer • Development Engineer • Design Engineer • Project Engineer • Electronic Engineer • Engineer-Supervisor • Section Leader • Staff Engineer • Systems Engineer • Test Engineer • Standards Engineer • Master Engineer

Electronic Design RECRUITMENT ADVERTISING RATES

15% commission to recognized agencies supplying offset film negatives. 2% 10 days, net 30 days. Four column makeup. Column width 1-3/4" x 10"

SPACE	DIMENSIONS		COST
	Wide	Deep	
One column inch	1-3/4" x 1"		\$45
2 col. in.	1-3/4" x 2"		\$90
1/16 page (1/4 col.)	1-3/4" x 2-1/2"		\$112.50
1/8 page (1/2 col.)	1-3/4" x 5"		\$225
1/4 page (1 col.)	1-3/4" x 10" Vert.		\$450
	3-1/2" x 5" Hor.		
1/2 page (2 cols.)	3-1/2" x 10" Vert.		\$900
	7" x 5" Hor.		
3/4 page (3 cols.)	5-1/4" x 10"		\$1350.
1 page	7" x 10"		\$1800.

NOTE: EACH RECRUITMENT AD YOU PLACE WILL BE REPEATED FREE OF CHARGE!

LATE CLOSING DATES

Electronic Design is mailed every two weeks. Because of its timeliness, personnel recruitment advertising closes only two weeks before each issue's mailing date.

1977 Mailing Date	Recruitment Closing Date	Issue Date on Cover
July 15	July 1	Aug. 2
July 29	July 15	Aug. 16
Aug. 12	July 29	Sept. 1
Aug. 26	Aug. 12	Sept. 13
Sept. 9	Aug. 26	Sept. 27
Sept. 23	Sept. 9	Oct. 11
Oct. 7	Sept. 23	Oct. 25
Oct. 21	Oct. 7	Nov. 8
Nov. 4	Oct. 21	Nov. 22
Nov. 18	Nov. 4	Dec. 6
Dec. 2	Nov. 18	Dec. 20



HOW TO PLACE YOUR AD CALL THE RECRUITMENT HOT LINE 201-843-0550

Camera-ready film (right reading negatives, emulsion side down) or camera-ready mechanicals must be received by deadline. Or, if you wish us to set your ad (typesetting is free) simply pick up the phone and call our RECRUITMENT HOT LINE — (201) 843-0550. Ask for:

Constance McKinley
RECRUITMENT ADVERTISING MANAGER
ELECTRONIC DESIGN

50 Essex Street, Rochelle Park, New Jersey 07662

ENGINEERS STABILITY GROWTH CHALLENGE

Our forte is the knowledge of nationally recognized Electronic firms which can offer the professional

Stability...Growth...Challenge

Our clients serve both the commercial and defense industries and have immediate openings for management oriented engineers.

Circuit Design Signal Processing
System Design Communications
Systems Analysis EW/ASW Systems
Computer Architect CS-Radar Nav
Microprocessors Process Controls
Manufacturing Operations Research

For immediate and confidential consideration please submit resume and salary history and geographic preference to R.A. Cooke, President.

Representing an Equal
Opportunity Employer M/F

Alden Associates Inc
414 Hungerford Dr.
Rockville,
Maryland 20850

ELECTRONIC ENGINEERS

Sals., open. Varied current openings particularly in Aerospace, Sonar & Reliability Engineering fields. BSEE & U.S. citizenship req'd. (firm). Replies kept confidential. EOE Fee Pd. Agcy. To save time, pls. send res. 1st. D. Jones Tech. Prof. Empl., Est. 1967 3111 St. Paul St. Balto. Md. 21218. 301-243-1545.

ENGINEER

BSEE, ME or Tech Degree for Richmond, Va. based company. Extensive travel. Sales experience preferred. New graduates considered. Salary plus commission. Send full resume to Post Office Box 27306 Richmond, Virginia 23261. Attention: Bonnie Henry.

Engineer

Software Engineer

Continuing growth of north suburban Chicago manufacturer of electronic based telecommunications terminals has several challenging opportunities available for Engineering Programmers. Individuals selected will assume responsibility for software development of micro-processor based telecommunications equipment.

This position requires a minimum of 2 years experience in assembly level design and implementation of mini/micro computer equipment.

Individuals willing to respond to challenge and contribute to a rapidly expanding development manufacturing effort should send resume of work experience and salary history to:

Personnel Department

EXTEL CORP.

310 Anthony Trail
Northbrook, Illinois 60062

an equal opportunity employer m/f

UNADVERTISED OPENINGS \$16-33K

• Hd. Software Des. • Radar
• Pwr. Supply Des. • Electro. Optics
• Test. Equip. Eng. • Microwave Comm.
• Mfg. Equip. & QC. • Marketing

Let our professional engineers assist you in advancing your career, or improving your choice of location. Due to our success, many NATIONWIDE companies have retained us to fill their confidential, unadvertised openings. Discretion assured. Contact Technical Dir.

Corporate Advisors 
12955 Biscayne Blvd., Miami, 33181
Professional Placement
(305) 891-4801

FIELD ENGINEER

Sal. \$12-30K depending on exp. 360/370 or other CPU training. Peripheral exp. acceptable. Nationwide & international.

FIELD SERVICE GROUP

2715 Via Montecito, San Clemente, CA
92672 Steve Andersen 714/498-0600.
All Fees Paid by Client Companies.



ENGINEERS

Needed for FEE PAID positions THROUGHOUT THE U.S. Over 1,000 client companies. Send resume and salary history or request confidential application today.

ATOMIC PERSONNEL, INC.

Suite D-2 1518 Walnut St. Phila. Pa. 19102

Empl. Agcy. All Technical Fields

Est. 1959

Recruitment Ads Pull

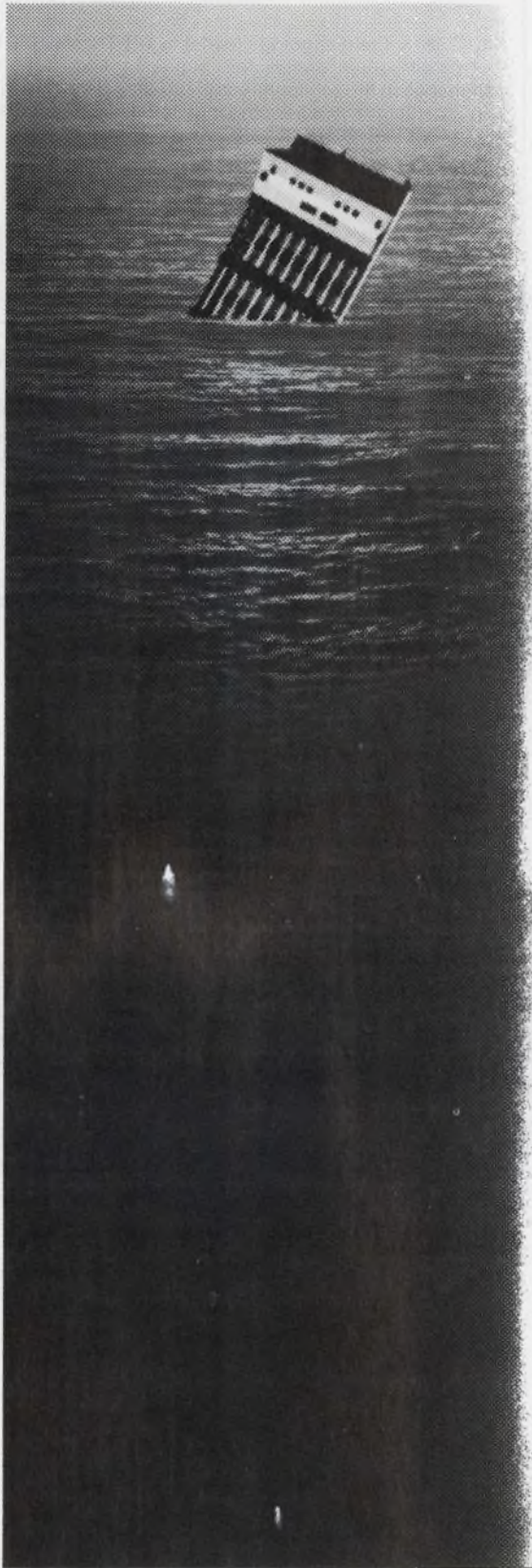

The Tip of an Iceberg

There's much more to GTE Automatic Electric Laboratories' involvement in the digital hardware and software evolution in Telecommunications.

The #3EAX computer-controlled switching system, a portion of which is portraying our iceberg tip, features a digital PCM network and stored program control. It is one of a family of advanced systems spearheading our digital evolution in telecommunications. Our primary assignment is to research and develop the communications systems of the future. Sophisticated systems employing state-of-the-art techniques in digital hardware, and the development of complex software architecture, support systems and programming.

GTE Automatic Electric is a major member of the GTE Family whose research and development expenditures ranked among the top 50 Research and Development spenders in U.S. industry in 1976.

We are embarking on a major expansion of our technical and laboratory staffs.

We're talking with skilled professionals... not only those with telecommunications experience, but individuals with experience in virtually every segment of the computer, and computer related hardware/software industry, including marketing and manufacturing support. If you have hardware/software skills in any of these areas, talk with us about a growth future in a massive growth field: Application Software, Digital switching systems, logic design, diagnostics, Software/Hardware interface and testing, data base systems, real-time systems design, CAD/CAM, mainframe design, micro/mini systems and design, and related areas.

For more information about your growth future in Telecommunications, talk with one of our representatives TODAY. Call Toll-Free: (800) 323-1966 or if in Illinois or surrounding areas call Toll-Free (800) 942-0491.

**GTE AUTOMATIC
ELECTRIC**

400 N. Wolf Road
Northlake, Illinois 60164

Equal Opportunity Employer M/F

Join a Leader

Electrical Engineers & Electronic Engineers

If you're the best, why not join the best?

OCLI, a leader in the design of optical thin film coating, is looking for BSEE or MSEE candidates for a variety of project tasks in our Corporate Equipment Engineering Group.

If you have a strong design background in electronic control systems and instrumentation and/or experience with design and troubleshooting of electrical power supplies, we'd like to talk with you.

Please forward your resume to the attention of P. Lang, Optical Coating Laboratory, Inc., P.O. Box 1599, Santa Rosa, CA 95402, or call collect: (707) 545-6440. We are an equal opportunity employer m/f.

Optical Coating

Laboratory, Inc.

LOCAL INTERVIEWS IN 1977

Microprocessor Hardware & Software Engineers
Computer Design Engineers & Programmers
Radar & Communication Engineers
Electro-Optics & Laser Systems Engineers
Automatic Test Equipment Engineers

Regional Consultants, Inc. is a nationwide technical search firm representing a broad base of clients serving the Electronics field.

We will be conducting interviews in all areas of the country where there are concentrations of technical talent. Our clients are willing to come to you. To meet with them and us, send your resume, including present salary and geographic preferences. If you don't have a prepared resume, drop us a brief hand-written outline of your background.

Search Director

REGIONAL CONSULTANTS, INC.

213 W. 9th Street, Cincinnati, Ohio 45202
(513) 579-1513

Our Clients are Equal Opportunity Employers



ENGINEERS TECHNICIANS

SILICONIX, the technology leader in JFETS, MOSFETS, VMOS, has career opportunities for engineers and technicians with experience in the semiconductor industry. If you are interested in joining a company where the individual is still important, take a look at SILICONIX.

WE HAVE IMMEDIATE OPENINGS FOR:

Device Engineers
Assembly Process Engineers
Sales Engineers
Reliability Engineers
Design Drafting Engineers

Engineering Aides
Electronic Techs (Maintenance)
Line Maintenance Techs
Calibration/Maintenance Techs

Siliconix offers excellent compensation plus a liberal benefit package including dental insurance, profit sharing, tuition assistance and a stock purchase plan.

For consideration, send your resume to Technical Employment, 2201 Laurelwood Road, Santa Clara, CA 95054. An Affirmative Action Employer.

Siliconix

SYSTEMS ARCHITECTS

Systems Architects needed for architectural planning and systems design of the next generation "General Merchandise" Real Time Multi Level Point-of-Sale systems. Responsibilities will include definition of systems requirements, formulation of architectural concepts and performance criteria, development of system specifications, and analysis of cost performance tradeoff.

These positions require a BS/MSEE, Computer Science or Software Engineering degree with 3-10 years experience in hardware/software design and development. Experience in system simulation, knowledge of communications protocols and operations evaluation techniques would be helpful. Candidates should be knowledgeable in operating systems, microprocessors, semiconductors, memories and peripheral devices.

This is a highly visible work environment and the work position is needed to respond to the exploding P.O.S. market and the growth of NCR's retail Terminal Systems Division in Cambridge, Ohio.

We invite your consideration at your earliest convenience:

Robert W. Donovan
Terminal Systems Division — Cambridge
NCR Corporation
Cambridge, Ohio 43725

Phone: 614/439-0291

NCR

An Equal Opportunity Employer

ENGINEERS & EDP

MEET 26 EMPLOYERS

Interviewing Soon in
MAJOR MARKETING AREAS

**MANY REQUIREMENTS FOR
AFFIRMATIVE ACTION APPLICANTS
INCLUDING PROFESSIONAL WOMEN**

At an Opportunity Center, you have a unique opportunity to meet representatives of top firms in private interviewing sessions all in a single day or evening. When you apply, your resume minus your name and present employer, is reviewed by representatives of Opportunity Center sponsoring firms. You are notified as to which firms would like to meet you. Your identity is revealed only after you have expressed interest in this corporation. Private interviews are scheduled at your convenience.

COMPANIES WHO HAVE ATTENDED

Allen Bradley
Ashland Oil
Automatic Sprinkler
American Air Filter
Bendix
Borg Warner
Burroughs
Carborundum
Combustion Engineering
Commonwealth Associates
Computer Science
Digital Equipment
Dravo
Emerson
Fairchild
General Electric
Gilbert Associates
Gould, Inc.
Goodyear
G.T.E.
Harris Electric
Honeywell
I.T.T.
Jos. Schlitz
Koppers Company
Litton
Martin Marietta
3M
McDonnell Douglas
Monsanto
Miles Laboratories
NCR
Owens Illinois
Picker X-Ray
Simmonds Precision
Singer
Stone and Webster
Sundstrand
Teledyne
Texas Instruments
TRW
Union Carbide
Westinghouse
Xerox

NO FEES OR CHARGES TO APPLICANTS
SEND RESUME TO:

OPPORTUNITY CENTER

Akron Savings Bld., Suite 1113
7 W. Bowery St., Akron, Ohio 44308

CHALLENGING GROWTH OPPORTUNITIES

\$15,000-\$30,000

We are the Midwest's exclusive recruiter for electronic project and design engineers. Through our "third-party approach" we offer you the opportunity to explore the best career growth positions in the ELECTRONIC INDUSTRY. Fees and relocation expenses paid. Mail your resume in confidence to LEN TERESINSKI, our Electronic Specialist, or call (414) 437-4353 daily, at home (414) 494-4674.

GREEN BAY MANAGEMENT RECRUITERS

115 S. Jefferson St., Suite 302
Green Bay, Wisconsin 54301

Licensed Employment Agent

ENGINEERS

We are currently searching for Engineers with 1-10 years of Design/Analysis and/or Integration/Test experience in AVIONICS, MICROWAVE, DIGITAL PROCESS CONTROL, MESSAGE SWITCHING, SATELLITE SIGNAL PROCESSING, TELEPHONE TRANSMISSION or MICROPROCESSOR/COMPUTER SYSTEMS. BS Degree & US Citizenship Required. Salaries \$14,000 to \$35,000. CALL COLLECT (301) 474-6266 or Submit Resume to:

TECH-ED SERVICES

10011 Rhode Island Avenue
College Park, Maryland 20740

A 100% Employer Fee Paid Agency Representing
Companies throughout the United States.

Systems Engineers

Since 1969, we've been providing Confidential and Industry-Knowledgeable placement for Hardware/Systems Design professionals.

Listed below are Current and Immediate requirements of Local and National client companies. These openings represent a cross-section of commercial electronics firms. If you have been thinking of investigating new opportunities, we urge you to contact Robert Norton for individual discussions of particular opportunities in your career field, or to submit confidential resume with salary information for review. All interviews are by appointment. Client companies assume all fees. Professional resume preparation and career path counseling are provided free of charge. For those who find it inconvenient to call during working hours, our office will be open until 7:30 p.m.

Computer Architects — BS/MSEE and some experience in the Definition and Development of Micro-Minicomputer Systems. Will be a principal participant in the development of a new family of computer systems. **Salary to \$35,000**

Microprocessor Design Engineers — BS/MSEE with some familiarity with Micro-processor utilization for Distributed Systems. Knowledge of any of the following would be highly regarded: 8080, 6800, LSI-11, F-8, 2901. **Salary to \$30,000**

Circuit Design Engineers — BSEE and at least 2 years of experience Developing Circuit Use Rules, Clock Distribution Systems and Power Distribution Systems as related to ECL utilized in small and medium systems. **Salary to \$25,000**

Peripheral Interface Design Engineers — BS/MSEE and experience in the Design of Interface Controllers between Magnetic Peripheral devices and Computer I/O Bus. **Salary to \$24,000**

CPU Design Engineers — BSEE/BSCS and experience in the Design of Digital Computers or Microprocessor Systems. Requires an understanding of Software, i.e., ASSEMBLY, FORTRAN or PL-1. **Salary to \$25,000**

Digital Logic and Circuit Design Engineers — BSEE and some experience in Logic and Circuit Design including a familiarity with TTL, CMOS, etc. **Salary to \$24,000**

Process Control Engineers — Degree in Engineering with background in Computer Sciences. 3-5 years of experience in the Application of Process Control Computers within the Petrochemical, Chemical, Pulp and Paper or Textile Industries. **Salary to \$16,000**

A/D-D/A Converter Engineers — 3-5 years of experience in Analog and Digital design utilizing discrete components, Hybrid Thick and Thin Film Processes and Monolithic IC's. **Salary to \$24,000**

Circuit Designers — BS/MSEE and some Hands/On Design experience employing ECL, SCHOTTKY, etc. **Salary to \$20,000**

nk Norton, Kleven and Co., Inc.
INDUSTRIAL RELATIONS MANAGEMENT CONSULTANTS

Three Fletcher Avenue, Lexington, Massachusetts 02173
Telephone (617) 861-1020

Member Massachusetts Professional Placement Consultants
Representing Equal Opportunity Employers M/F

The New 1977-1978 **GOLD BOOK** Has Just Been Published



And Completely Outdates Last Year's Edition

If you are currently a subscriber on **ELECTRONIC DESIGN's** qualified circulation file, you need do nothing. You will receive your new **GOLD BOOK** automatically. If you wish additional copies for other members of your company, you may order them now using the convenient coupon form below.

If you are not currently an **ELECTRONIC DESIGN** subscriber on our controlled circulation list, you may order your own multi-section set of the new **GOLD BOOK** by completing the form below. Shipment will be made promptly on receipt of your payment or company purchase order.

HERE IS WHAT YOU AND YOUR COMPANY WILL FIND IN THE UPDATED 1977-78

GOLD BOOK

- **Three sections** containing 2,496 pages of information to quickly locate products used by the electronics industry.
- **A Product Directory** with 5,434 product categories.
- **A Trade Name Directory** of 9,814 listings.
- **A Manufacturers' Directory** listing 8,057 companies in the electronics industry.
- **Two Distributors' Directories** with 2,050 distributors listed.
- **A Giant Compendium of Manufacturers' Data Pages** with specifications.

MAIL TODAY WITH PURCHASE ORDER

Electronic Design's GOLD BOOK 449R
Hayden Publishing Co., Inc.
P.O. Box 13803, Philadelphia, Pa. 19101 U.S.A.

Here is our purchase order for _____ sets of the 1977-1978 GOLD BOOK at \$30.00 per set—for U.S., Canada and Mexico. (All other countries: \$40.00 per set)

Check enclosed for \$ _____, Bill us.

Name (Print) _____

Title _____

Company _____

Address _____

City/Province _____

State/Country _____

Zip or Postal Code No. _____

QUANTITIES ARE LIMITED. PLACE ORDER TODAY!

Product index

Information Retrieval Service. New Products, Evaluation Samples (ES), Design Aids (DA), Application Notes (AN), and New Literature (NL) in this issue are listed here with page and Reader Service numbers. Reader requests will be promptly processed by computer and mailed to the manufacturer within three days.

Category	Page	RSN	Category	Page	RSN	Category	Page	RSN
Components			transistors, high-energy	114	302	Packaging & Materials		
buzzers	143	88	transistors, uhf	116	307	cabinets	131	68
capacitor networks	98	41	vlf/v converter	118	320	cases, instrument	139	79
capacitors	27	10	zeners	122	58	clips, wire	134	372
capacitors	32	13				connectors	52	27
capacitors, trimmer	130	66	Instrumentation			connectors	83	35
components, comm	50G	126	clamp-on meter	135	374	connectors (NL)	139	395
contacts	55	28	DMM (NL)	140	398	connectors, PC	50A	121
cores, ferrite	112	142	instrument rentals	50H	127	encapsulant	43	21
cores, powder	112	141	meter frequency	134	75	enclosures	112	50
crystals	130	67	multicounters (NL)	141	409	enclosures	117	53
crystals	142	84	oscilloscope	33	14	fans	143	85
gearmotors	133	70	oscilloscope	135	375	housings, electronic	135	76
indicators, LED	138	77	oscilloscopes, portable	50B	122	panels and		
inductors	132	365	recorders, multichannel	131	69	accessories (NL)	141	404
keyboard	132	371	rental instruments	50C	123	panels, packaging	92	38
keyboard, capacitive	132	370	sweep generator	93	39	shipping service	19	7
LEDs, wide-angle	132	367	synthesizer	135	376	sockets	24	9
lamps, miniature	119	55	test probes	123	59	sockets, quad in-line	134	373
motors	39	19				terminations	103	45
relays	50F	125	Micro/Mini Computing			wire, cable, cord	49	400
relays	115	52	amplifier	136	384	Power Sources		
relays	133	71	attenuator, variable	136	381	battery system	136	378
resistor networks	II	130	board, CMOS-memory	126	343	line regulators	139	80
resistor networks	III	231	board, PROM	122	334	power supply	120	56
resistor networks	51	26	boards, microcomputer	122	335	power supply, unreg	136	377
resistors, trimmer	132	369	calculator, prog.	126	344	power supplies	126	61
resistors, variable	50E	124	calculators	147	89	power supplies	129	63
switch, PB	31	12	calculators, prog.	127	346	power supplies, μ P	138	78
switch, tilt	132	368	card, interface	122	332	power supply	140	82
switches	133	72	components, microwave	136	380			
switches, DIL	132	366	components, microwave	136	382			
switches, PB	111	49	components, μ W and i-f	137	238			
switches, PB	133	73	computer, complete	124	341			
			computer, desktop (NL)	139	394			
Data Processing			computer, 16-bit	124	338	new literature		
disc-drive	128	350	computer, 8080-based	123	337	batch control systems	141	405
flexible-disc	128	349	debugger, software	124	340	CMOS ICs	141	406
line printer	141	83	discs, floppy	124	339	computer, desktop	139	394
monitor display	128	357	drive, cartridge	120	325	connectors	139	395
plotter software	128	359	drive, microfloppy	121	331	controls, motor	141	411
printer feeder	128	356	interface, serial	128	348	digital indicators	139	393
printer, OEM	89	37	kit, prototyping	120	326	displays	140	397
tape controllers	7	6	memory, static	122	333	DMM, 5-1/2-digit	140	398
thermal paper	109	48	microcomputer, 8080	121	330	electrical components	139	392
time-code reader	88	36	minicomputer	126	345	keyboards	140	396
video processor	128	358	mixer	136	379	linear ICs	141	410
			multiprocessor	120	327	microwave equipment	141	408
ICs & Semiconductors			oscillator	136	383	multicounters	141	409
array, uncommitted	118	308	printer	127	347	panels and accessories	141	404
clock, digital	118	321	program, conversion	120	328	plug-in oscilloscopes	139	391
CMOS (NL)	141	406	program, simulator	126	342	precision pots, dials	140	399
controller	116	310	reader, paper-tape	123	336	test instruments	141	407
converter, a/d	119	322	servo, programmable	121	329	thermal cutoffs	140	403
Darlington	113	51						
decoder, 4-digit	116	305	Modules & Subassemblies					
drivers/receivers	116	304	amp, programmable	131	362			
linear ICs	141	410	amplifier, isolation	130	360	application notes		
memories	116	306	converter, d/a	130	361	alphanumeric display	138	388
memories	118	309	DAU	131	364	detector diodes	138	385
opto-isolator	116	303	encoders	129	64	microwave components	138	390
power Schottky	119	324	links, rf	6	5	RAMs, 4-k	138	387
quad comparator	125	60	power amplifier	129	65	software programs	138	386
timer, IC	114	301	power amplifiers	118	54	μ C-system design	138	389
transceivers	119	323	switch, rf	131	363			
transistors	121	57						

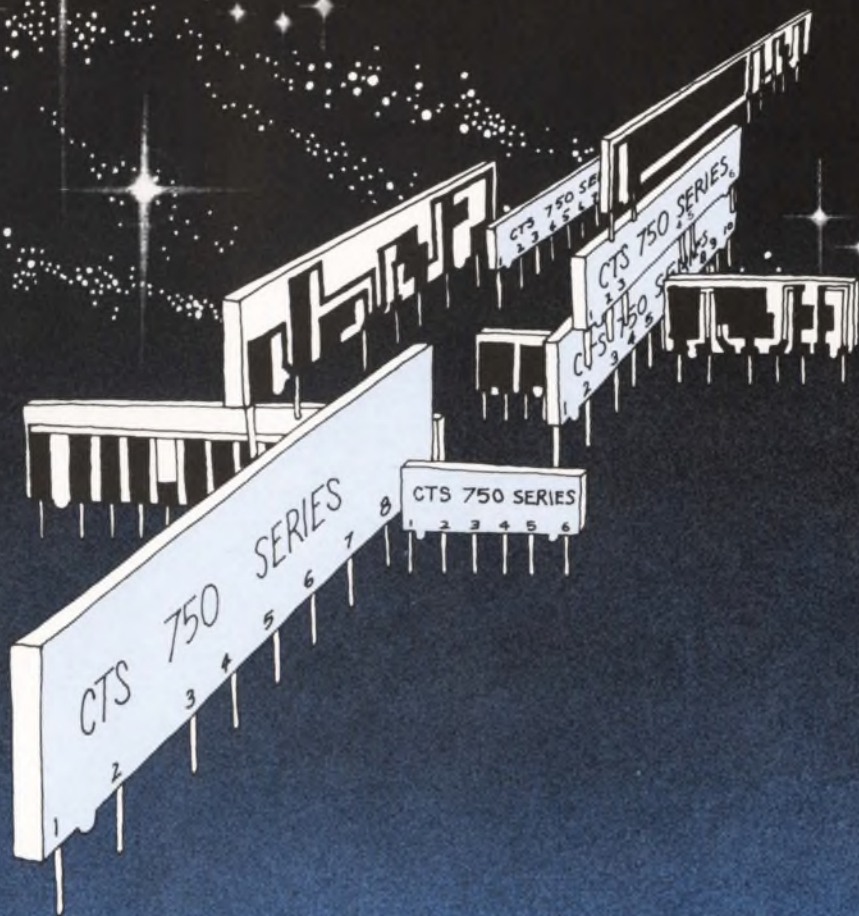

CTS conquers space.

And has for *well over a decade* with space saving Series 750 SIP cermet resistor networks. And with space a very important commodity in modern systems, you'll want to make CTS a very special source for your network needs.

You conserve valuable PCB space, enjoy greater system reliability, use fewer components, install easier—automatically, cut handling costs and derive faster inspection. CTS experience, technology and production capacity insure the highest quality, fastest delivery available.

Where one of our more than 130 *standard* off-the-shelf SIP's won't meet your circuit require-

ments, we'll custom design the resistor network you need in either conventional or low profile package configurations.

Be assured of ultra-high stability and reliability. Over 900 million hours of test data prove CTS reliability with an established failure rate of only 0.00051% per 1000 hours @ 95% confidence level—considerably superior to military failure level S of established reliability specs.

For your copy of our reliability report or complete resistor network data, write: **CTS OF BERNE, INC.**, 406 Parr Road, Berne, Indiana 46711. Phone (219) 589-3111.

CTS CORPORATION

Elkhart, Indiana

A world leader in cermet variable resistor technology.



Cash in on the CMOS advantage ...

New I/O devices make RCA 1800 μ P even more flexible.

Here is further proof of how flexible and cost-effective the CMOS RCA 1800 is compared to other microprocessor systems. Easily, and with minimum parts count, you get maximum flexibility—through these versatile, low-cost I/O devices. And CMOS itself helps reduce costs. Thanks to a single, non-critical voltage supply. Low power. High speed and noise immunity. And full military temperature range.

1 Two-mode UART

Unique among industry standard UARTs, the CDP1854 operates in two modes and is pin-out selectable by a single mode control. In Mode 0 it works as an industry standard 1602 UART. Mode 1 makes it compatible with the RCA 1802 and other 8-bit CPUs. And either mode gives high speed—up to 400K baud.

2 Address latch/decoders

These two devices, the CDP1858 and CDP1859, make it easy to expand the RCA 1800 memory. They interface directly with the CDP1802 memory address bus and serve as memory system decoders for large RAM systems. The CDP1858 is designed for use with CDP1821 type memories and the CDP1859 for use with CDP1822 type memories.

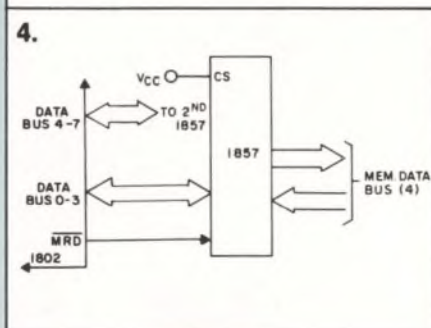
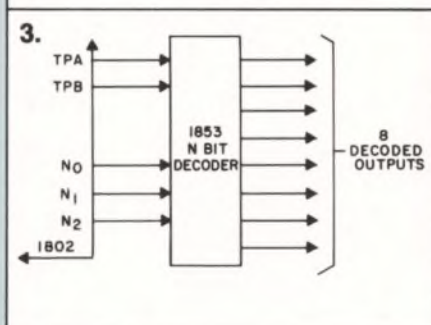
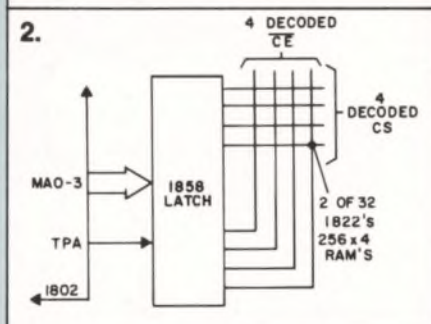
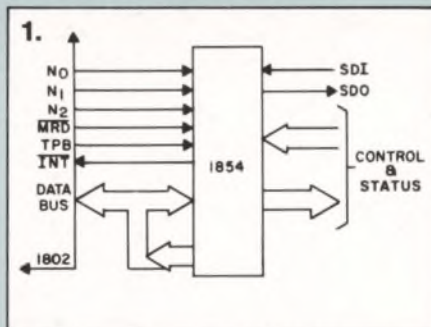

3 N-bit decoder

If you need a high-speed, low-power 3-to-8-line decoder circuit with the added feature of optional strobed outputs for spike free decoding, we've got that too. The CDP1853 has buffered inputs and outputs. It is fully compatible with the CDP1802 and is used in I/O decoding applications.

4 Bus buffer separators

For easy connection of standard memory and I/O devices to the CDP1802 microprocessor data bus, use the CDP1856 and CDP1857 non-inverting bus buffer separators. The CDP1856 is designed for data bus to memory interfacing and the CDP1857 for data bus to I/O interfacing.

For more information, contact your RCA Solid State distributor. Or RCA.

Write: RCA Solid State.
Box 3200, Somerville, NJ 08876;
Sunbury-on-Thames, Middlesex
TW16 7HW, England; Quickborn
2085, W. Germany; Ste.-Anne-
de-Bellevue, Quebec, Canada;
Fuji Bldg., Tokyo, Japan.

Easy I/O.
Part of the
CMOS advantage.

RCA