

Electronic Design 10

VOL. 25 NO.

FOR ENGINEERS AND ENGINEERING MANAGERS

MAY 10, 1977

The most extensive triggering yet in a microprocessor analyzer lets you dig into as many as seven nested subroutines. Use one bit, or as many as 32, to define

the trigger. Trace into a loop from up to seven locations. Read an on-screen 'menu' to choose formats or capture criteria. Select display modes, too. On page 99.



Look inside our new Precision Pot...



ONE-PIECE CONTACT

MOLDED-IN
TERMINALS

SILVER
DEPOSITION

For reliability, performance and savings.

Since our new potentiometer looks like others on the outside, here's the inside story... that's where Bourns makes the difference:

The total construction of this new 1% linearity, conductive plastic, single-turn pot is ingeniously simple. Our one-piece precious metal contact delivers tens-of-thousands more trouble-free revolutions than the typical failure-prone two-piece type. Then, our exclusive silver deposition between the molded-in terminals and the element guarantees a connection that won't migrate or weaken during installation and operation. And, proven techniques like low temperature firing and thermal swaging replace unreliable solder, conductive epoxy and silver cement throughout the potentiometer. No one matches our performance, and our price is just as eye opening — less than \$6.00 in production quantities.

With fewer parts, unique packaging and solid connections, the result is obvious — the most reliable precision potentiometer you can specify for the price.

The $\frac{7}{8}$ " diameter model is available in either bushing (Model 6637) or servo mount (Model 6537) styles. The larger $1\frac{1}{4}$ " diameter bushing mount (Model 6657) also offers a full line of non-linear functions... all with the same outstanding design and price advantages.

Take a look inside any other precision pot and you'll see why Bourns makes the difference.

Send for our new catalog today for complete details.

TRIMPOT PRODUCTS DIVISION, BOURNS, INC., 1200 Columbia Avenue, Riverside, California 92507,
Telephone (714) 781-5200 — TWX 910 332-1252.



International Marketing Offices: European Headquarters — Switzerland 042/23 22 42 • Belgium 02/218 2005 • France 01/2039633 • Germany 0711/24 29 36 • Italy 02/32 56 88 • Netherlands 70/87 44 00 • United Kingdom 01/572 6531 • Norway 2/71 18 72 • Sweden 764/20 110 • Japan 075/921 9111 • Australia 02/55-0411 03/95-9566 • Israel 77 71 15/6/7

CIRCLE NUMBER 252

The sweep signal generator world has a new leader to look up to. Model 2002 sweeps from 1 to 2500 MHz in four bands. Or it can sweep the entire range using the band stacking option. It has more flexibility than any broadband sweeper

we've made, along with +13 dBm output, ± 0.5 dB flatness, 0.005% marker accuracy, and $\pm 1\%$ display linearity. Look at the Model 2002 from any angle and you'll become a follower. Send us \$2700 and you'll become an

owner. Circle our reader service number for details. WAVETEK Indiana Incorporated, P.O. Box 190, Beech Grove, Indiana 46107. Telephone (317) 783-3221. TWX 810-341-3226.

WAVETEK
CIRCLE NUMBER 2

The new 2002 will sweep you off your feet.



RF TRANSFORMERS

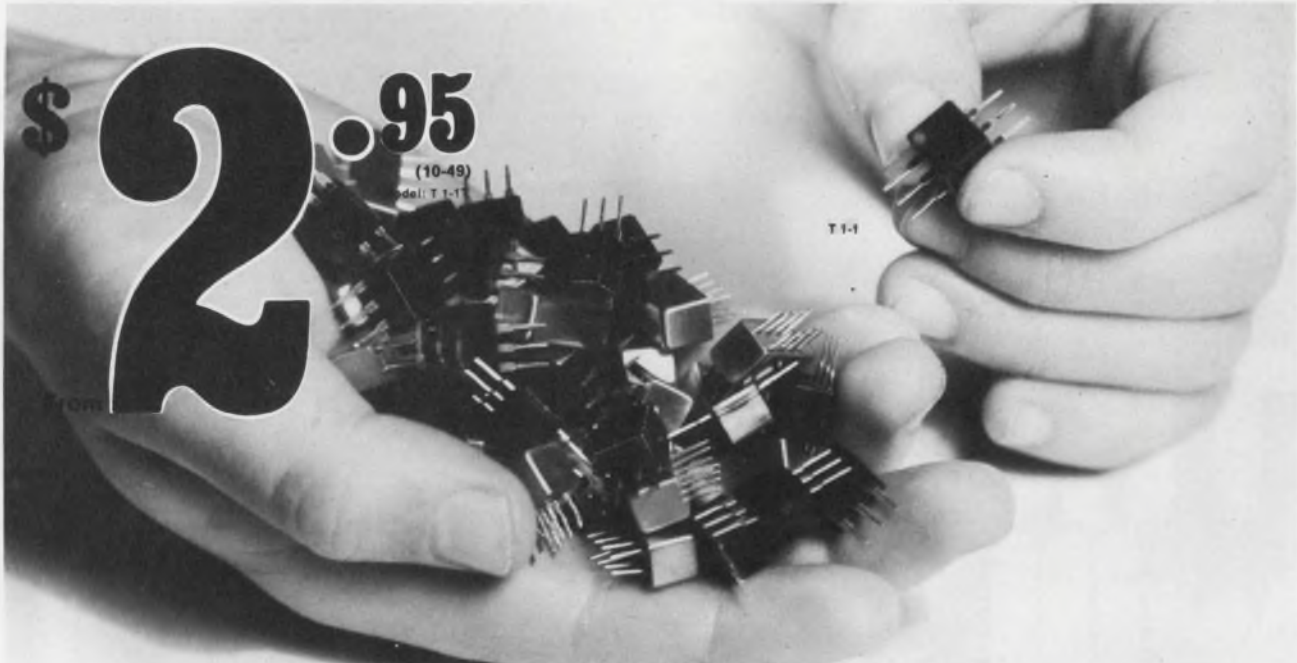

Have it your way! 36 models to choose from, 10KHz-800MHz

It costs less to buy Mini-Circuits wideband RF transformers. The T-series (plastic case) and TMO series (hermetically sealed metal case) RF transformers

operate with impedance levels from 12.5 ohms to 800 ohms and have low insertion loss, 0.5 dB typ. High reliability is associated with every transformer. Every

production run is 100% tested, and every unit must pass our rigid inspection and high quality standards. Of course, our one-year guarantee applies to these units.

DC ISOLATED PRIMARY & SECONDARY						
Model	TMO 1-1	TMO 1.5-1	TMO 2.5-6	TMO 4-6	TMO 9-1	TMO 16-1
Metal Case	T 1-1	T 1.5-1	T 2.5-6	T 4-6	T 9-1	T 16-1
Plastic Case	T 1-1	T 1.5-1	T 2.5-6	T 4-6	T 9-1	T 16-1
Freq. Range, MHz	15-400	1-300	.01-100	.02-200	15-200	3-120
Impedance Ratio	1	1.5	2.5	4	9	16
Max. Insertion Loss	MHz	MHz	MHz	MHz	MHz	MHz
3 dB	15-400	1-300	.01-100	.02-200	15-200	3-120
2 dB	35-200	2-150	.02-50	.05-150	3-150	7-80
1 dB	2-50	.5-80	.05-20	1-100	2-40	5-20
Price, Model TMO	\$4.95	\$6.25	\$5.95	\$5.95	\$5.45	\$5.95
(10-49) Model T	\$2.95	\$3.95	\$3.95	\$3.95	\$3.45	\$3.95

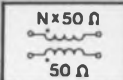

UNBALANCED PRIMARY & SECONDARY					
Model	TMO 2-1	TMO 3-1	TMO 4-2	TMO 8-1	TMO 14-1
Metal Case	T 2-1	T 3-1	T 4-2	T 8-1	T 14-1
Plastic Case	T 2-1	T 3-1	T 4-2	T 8-1	T 14-1
Freq. Range, MHz	0.15-600	5-800	5-600	15-250	2-150
Impedance Ratio	2	3	4	8	14
Max. Insertion Loss	MHz	MHz	MHz	MHz	MHz
3 dB	0.15-600	5-800	2-600	15-250	2-150
2 dB	0.2-400	2-400	5-500	25-200	5-100
1 dB	0.5-200		2-250	2-100	2-50
Price, Model TMO	\$5.45	\$6.25	\$5.45	\$5.45	\$6.25
(10-49) Model T	\$3.45	\$4.25	\$3.45	\$3.45	\$4.25

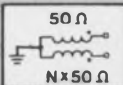

DC ISOLATED PRIMARY & SECONDARY CENTER-TAP SECONDARY								
Model	TMO 1-1T	TMO 2-1T	TMO 2.5-6T	TMO 3-1T	TMO 4-1	TMO 8-1T	TMO 13-1T	
Metal Case	T 1-1T	T 2-1T	T 2.5-6T	T 3-1T	T 4-1	T 8-1T	T 13-1T	
Plastic Case	T 1-1T	T 2-1T	T 2.5-6T	T 3-1T	T 4-1	T 8-1T	T 13-1T	
Freq. Range, MHz	05-200	07-200	.01-100	05-250	2-350	3-300	3-120	
Impedance Ratio	1	2	2.5	3	4	5	13	
Max. Insertion Loss	MHz	MHz	MHz	MHz	MHz	MHz	MHz	
3 dB	05-200	07-200	01-100	05-250	2-350	3-300	3-120	
2 dB	08-150	1-100	02-50	1-200	35-300	6-200	7-80	
1 dB	2-80	5-50	05-20	5-70	2-100	5-100	5-20	
Maximum Amplitude Unbalance MHz								
.1 dB	5-80	1-50	1-20	1-70	5-100	10-100	5-20	
.5 dB	05-200	07-200	01-100	05-250	2-350	3-300	3-120	
Maximum Phase Unbalance Degrees MHz								
1°	5-80	1-50	1-20	1-70	5-100	10-100	5-20	
5°	05-200	07-200	01-100	05-250	2-350	3-300	3-120	
Price (10-49)								
Model TMO	\$5.95	\$6.25	\$6.25	\$5.95	\$4.95	\$6.25	\$6.25	
Model T	\$3.95	\$4.25	\$4.25	\$3.95	\$2.95	\$4.25	\$4.25	

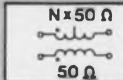

Primary Impedance: 50 ohms	TMO-series	T-series
Total Input Power: 1/2 watt	25 cu. inches	02 cu. inches
	07 ounces	01 ounces

Designers Kit Available

(TK-1) — 2 transformers of each type T1-1, T2-1, T4-1, T9-1, T16-1
\$32.00

(TK-2) — 2 transformers of each type TMO1-1, TMO2-1, TMO4-1, TMO9-1, TMO16-1
\$49.50

International Representatives: **AUSTRALIA:** General Electronic Services, 99 Alexander Street, New South Wales, Australia 2065. **ENGLAND:** Dale Electronics, Dale House, Wharf Road, Firmley Green, Camberley, Surrey. **FRANCE:** S. C. I. E. D. I. M. E. S. 31 Rue George Sand 91120 Palaiseau, France. **GERMANY, AUSTRIA, SWITZERLAND:** Industrial Electronics GMBH, Klüberstrasse 14, 6000 Frankfurt/Main, Germany. **ISRAEL:** Vectronics Ltd, 69 Gordon Street, Tel-Aviv, Israel. **JAPAN:** Denso Kaisha Ltd, Eguchi Building 8-1-1 Chome Hamamatsucho, Minato-ku, Tokyo. **EASTERN CANADA:** B. D. Hummel, 2224 Maynard Avenue, Ulica, NY 13502 (315) 736 7821. **NETHERLANDS, BELGIUM, LUXEMBOURG:** Comex, Veldweg 11, Hattem, Holland. **NORWAY:** Datamatik AS, Ostensjøveien 62, Oslo 6, Norway.

U.S. Distributors: **NORTHERN CALIFORNIA:** Cain-White & Co., Foothill Office Center, 105 Fremont Avenue, Los Altos, CA 94022 (415) 948-6533. **SOUTHERN CALIFORNIA, ARIZONA:** Crown Electronic, 11440 Collins Street, No. Hollywood, CA 91601 (213) 877-3550.

World's largest manufacturer of Double-Balanced Mixers

Mini-Circuits

Mini-Circuits Laboratory — A Division Scientific Components Corp.
837-843 Ullica Avenue, Brooklyn, NY 11203
(212) 342-2500 Int'l Telex 620156 Domestic Telex 125460

22 Rev. orig

NEWS

- 21 **News Scope**
- 32 **Peripheral chips are adding functions** and problems to microprocessor designs.
- 42 **Liquid crystals, laser systems and microprocessors** are reflected in tomorrow's displays.
- 53 **Washington Report**

TECHNOLOGY

- 62 **Use 4-bit slices** to design powerful microprogrammed processors. The 2900 family of circuits lets you build machines with cycle times of 110 ns.
- 74 **Wring out 4-bit μ P slices** with algorithmic pattern generation. You will be able to pinpoint faults in both hardware and software.
- 80 **Real-time systems often use interrupts** to service I/O devices in order of importance. Blocks of data can be moved quickly by direct memory access.
- 88 **Ideas for Design:**
Crystal-controlled time base measures frequency/time in low-cost scopes. A 60-MHz power oscillator generates a low-noise output. Complementary amplifier improved by double-ended symmetrical configuration.
- 94 **International Technology**

PRODUCTS

- 99 **Instrumentation:** Logic analyzer traces nested loops to 7 levels.
- 102 **Instrumentation:** Function generator breaks 50-MHz output barrier.
- 104 **Instrumentation:** Junction-to-case thermal resistance can be 'measured.'
- 106 **ICs & Semiconductors:** Single-bit μ P avoids overkill.
- 112 **Micro/Mini Computing:** Single board control computer uses 8748/8048 μ P.
- 126 **Microwaves & Lasers:** Fast laser system scribes—also cuts, drills and welds.
- 110 Power Sources 128 Components
- 118 Modules & Subassemblies 132 Data Processing
- 122 Packaging & Materials

DEPARTMENTS

- 59 **Editorial:** Learning sensitivity
- 7 Across the Desk 142 Advertisers' Index
- 133 Application Notes 144 Product Index
- 134 New Literature 144 Information Retrieval Card
- 136 Bulletin Board

Cover: Photo by William S. Porter, courtesy of Hewlett-Packard.

ELECTRONIC DESIGN is published biweekly except 3 issues in July by Hayden Publishing Company, Inc., 50 Essex St., Rochelle Park, NJ 07662. James S. Mulholland Jr., President. Printed at Brown Printing Co., Waseca, MN. Controlled circulation postage paid at Waseca, MN and New York, NY, postage pending Rochelle Park, NJ, Atlanta, GA. Copyright© 1977. Hayden Publishing Company, Inc. All rights reserved. POSTMASTER: Please send form 3579 to ELECTRONIC DESIGN, P.O. Box 13803, Philadelphia, PA 19101.

The 2900 Family: Two years later.

1975. Advanced Micro Devices introduces the world's best 4-bit microprocessor slice, the Am2901, along with a few support circuits.

1977. It's a whole new family. Now there's an Am2901A just like the Am2901, only better. Now there are 18 support circuits, two or three second sources and all the software you'd ever want. The 2900 family has become the family of the future. Here's why:

The first family.

The Am2900 family is the first group of products designed specifically for microprogrammed machines. Microprogramming is rapidly becoming the most popular way to design medium- and high-performance systems, to reduce development time, make changes easily, and conveniently add new features.

Less weight, less size.

With the Am2900 family, it's not uncommon for entire boards to be eliminated. You'll shrink system size and weight, increase

overall reliability and reduce manufacturing costs.

Time goes by, price goes down.

In July 1975, we told you we'd reduce the cost of the Am2901 by 30% per year. We've done it twice. Once in April 1976 and once in March 1977. The Am2900 family gets less and less expensive all the time.

We're so popular, we're the industry standard.

The Am2900 family is the most widely used Bipolar LSI family in:

- **Minicomputers:** For emulators, high-performance CPU's and add-ons by eight out of the top ten U.S. manufacturers.
- **High-performance controllers:** For discs, tapes, floppy discs and universal controllers.
- **Communications:** For PBX systems, central exchanges, multiplexers and modems.
- **Military:** For radar processors, display systems and the Navy's new standard avionic computer, the AN/AYK-14.

The Family:

CPU Slice (ALU and general registers)	Am2901A, 2902, 2903*, 2904*
Microprogram Control Units	Am2909, 2910*, 2911
Branch and Instruction Control for Microprogram Sequencers	Am29803, 29811
LSI Bus Interface Devices	Am2905, 2906, 2907, 2915A, 2916A, 2917A
Priority Interrupt Control	Am2913, 2914
Main Program Control	Am2930* 2931*, 2932*
New More Powerful MSI functions	Am2918, 2919, 2920, 2921, 2922

*In Development

Plus:

Schottky and low-power Schottky MSI, MOS static and dynamic RAM's and all the devices you need to build your high-performance microcomputer.

We don't sell and run.

Advanced Micro Devices offers learning aids to help speed up designs and keep your engineers up-to-date on the very latest microprogramming techniques. Learning aids and application materials like these perennial favorites:

- A 16-Bit Microprogrammed Computer
- The Am2900K1 Learning and Evaluation Kit
- The Microprogramming Handbook

- A High Performance Microprogrammed Disc Controller

In development:

- Vertically Microprogrammed State Machines
- An emulation of the Am9080A/8224/8228 using the Am2900 family

And two terrific design aids:

AMDASM

Our powerful, easy-to-use microprogram assembler offering software support through the worldwide INFONET time-sharing division of Computer Science Corporation. (It supports user-defined mnemonics for producing microinstructions up to 128 bits wide, and includes formatting and default features as well as tape generation for PROM programmers. If you've got the other guy's MDS system, ask for AMDASM/80. It comes on a floppy disk and runs under their operating system.)

AMDS

Beginning this fall, we'll be offering hardware support with the Advanced Microprogram Development System. (It's the first prototyping system especially designed for microprogramming systems.) It'll help speed up construction of prototype systems and generation and de-bug of microcode. Resident AMDASM, of course!

The Am2900 family.

It's today's product family for tomorrow's high-performance machines. Am2900. Remember that number. You're going to be hearing it a lot.

Advanced Micro Devices

Bipolar LSI. N-channel, silicon gate MOS. Low-power Schottky. Multiple technologies. One product: excellence.



from *Electronic Measurements* . . .

SCR 1~~Ø~~ & 3~~Ø~~ DC Power Supplies

We are pleased to report that we now produce the industry's largest selection of SCR phase-controlled power supplies.

How did we do it?

Slowly.

We didn't acquire the largest selection without selling a lot of power supplies along the way. Our way, for 35 years, has been giving the user what he wants; and in a watts/dollar ratio that gives him no choice but E/M.



Type	SINGLE PHASE				THREE PHASE			
Watts	500	800	1600	2400	2500	5000	10 KW	To 60 KW
Volts	0 to 7.5 V up to 600 V DC							
Amperes	0 to 0.75 A up to 3000 A DC							
Height (in.)	3.50	3.50	5.25	7.00	7.00	8.75	12.25	To 4'
Price (\$)	450	575	800	1000	1200	1500	2300	To
	to	to	to	to	to	to	to	
	500	650	895	1100	1600	2300	2900	9500

Over 100 standard models. Thousands of optional combinations.

To order, or for any technical information, call:
TOLL FREE (800) 631-4298



ELECTRONIC MEASUREMENTS INC.

405 Essex Road, Neptune, N.J. 07753

Phone (New Jersey) 201-922-9300 (Toll free) 800-631-4298

Specialists in Power Conversion Equipment

Sr. Vice President, Publisher

Peter Coley

Editors

Editorial Offices

50 Essex St.

Rochelle Park, NJ 07662

(201) 843-0550

TWX: 710-990-5071

(HAYDENPUB ROPK)

Cable: Haydenpubs Rochellepark

Editor-in-Chief George Rostky

Managing Editors:

Ralph Dobriner

Michael Elphick

Senior Associate Editor

Stanley Runyon

Associate Editors:

Sid Adlerstein

Dave Bursky

Morris Grossman

John F. Mason

Andy Santoni

Max Schindler

Contributing Editors:

Peter N. Budzilovich, Jules H. Gilder,

John Kessler, Alberto Socolovsky,

Nathan Sussman

Editorial Field Offices

East

Jim McDermott, Eastern Editor

P.O. Box 272

Easthampton, MA 01027

(413) 527-3632

West

Dick Hackmeister, Western Editor

8939 S. Sepulveda Blvd., Suite 414

Los Angeles, CA 90045

(213) 641-6544

TWX: 1-910-328-7240

Dave Barnes

844 Duncardine Way

Sunnyvale, CA 94087

(408) 736-6667

Editorial Production

Marjorie A. Duffy, Production Editor

James Keane, Copy Editor

Art

Art Director, William Kelly

Richard Luce, Anthony J. Fischetto

Production

Manager, Dollie S. Viebig

Helen De Polo, Nancy Hurey

Circulation

Director, Barbara Freundlich

Information Retrieval

Paula Greenleaf

Advertising Promotion

Susan G. Apolant

Reprints

Maxine Correal

Varactors do cost, but are indispensable

The statement, "In TV it's PLL vs varactor tuning" (ED No. 1, Jan. 4, 1977, p. 50), is very misleading. The technical truth is that in order to achieve digital (or analog) PLL in TV, varactor tuning is *indispensable*. The old-fashioned mechanical TV tuners do not lend themselves to PLL.

Another error is to believe that the varactor-tuning systems are "less expensive." They are more expensive than mechanical tuners for three reasons:

1. Varactors have a poor "Q" particularly in the uhf range, and these deficiencies have to be compensated by extra circuitry.

2. Varactor tuners require peripheral circuitry that is *not* cheap, such as stabilized tuning voltage supplies up to 30 V at temperatures from 0 C to +75 C.

3. The customer controls of varactor tuners can be costly, depending on the degree of sophistication, and are often very delicate (such as control potentiometers and switches that wear out easily).

P. H. Anrooy

QUASAR Electronics Corp.
Electronic Tuning Systems
9401 W. Grand Ave.
Franklin Park, IL 60131

Think positive

I adamantly object to the continually negative attitude in *every* editorial I have ever seen issued by ELECTRONIC DESIGN. How about some positive mental material leaking into your writings? All your theoretical companies slip into degradation (George saw it com-

ing!) when, in fact, thousands of successful companies do exist. Why not depict the rise and growth of these *factual* companies?

Hugh T. Vidovic/MSEE

General Diesel & Equipment, Inc.
3603 E. Beltline
Hibbing, MN 55746

Misplaced Caption Dept.



Harder Jack, the spec says
2500 g.

Sorry. That's Francisco de Goya y Lucinantes' "The Forge," which hangs in the Frick Collection in New York City.

Memory cycle time upped thousandfold

The item, "NDRO Core Memory Protects Data from Noise," in News Scope, Feb. 15, 1977, said that the read or write-cycle time of the memory was 1 ms. The actual cycle time is one microsecond.

Is he really thinking?



Yes. And you would be, too, if you'd just found out that DATUM's tape system was thousands cheaper and months sooner!

DATUM guaranteed-performance tape or disk controllers and systems are available off-the-shelf for almost all minicomputers in use today.

Only DATUM has designed, built and installed over 7000 controllers and systems for so many different minicomputers to interface with so many different peripheral devices!

Check these features!

Triple-density NRZI formatting. Dual-density PE/NRZI formatting. 200 ips for all existing interfaces. Single-source responsibility for all major tape-drives.

Don't just get in some long line! Write today for specifications and prices.

Datum also manufactures cassette and rotating memories, data acquisition systems and timing instrumentation.

Peripheral Products Division
1363 S. State College Blvd., Anaheim, CA
92806 • 714/533-6333 EUROPE: Datum
House, Cranford Lane, Harlington, Middlesex,
UK • 01-897-0456

datum inc

CIRCLE NUMBER 5

Electronic Design welcomes the opinions of its readers on the issues raised in the magazine's editorial columns. Address letters to Managing Editor, Electronic Design, 50 Essex St., Rochelle Park, NJ 07662. Try to keep letters under 200 words. Letters must be signed. Names will be withheld upon request.

LEDs, make

For most displays, they're up to 8 ways better.

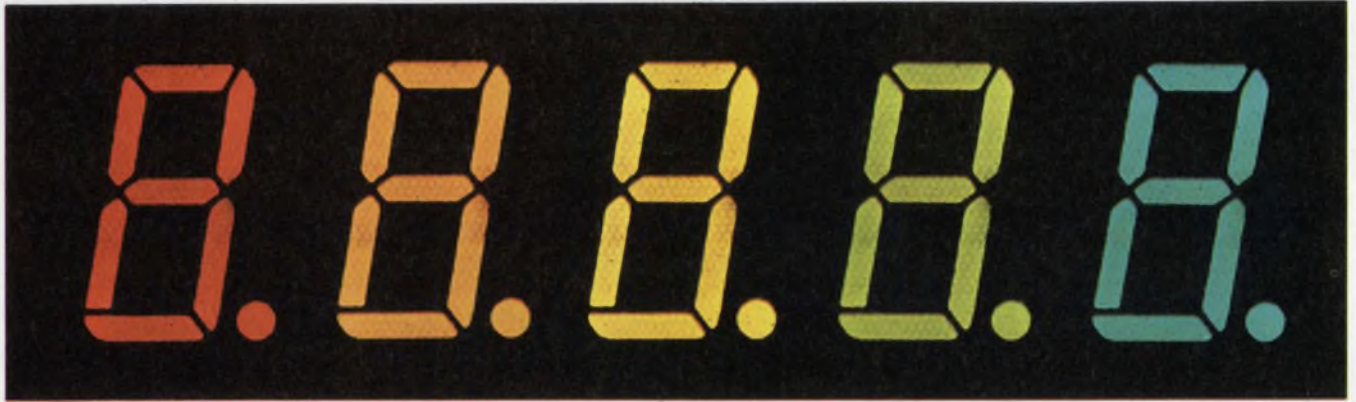

You've seen their bright, large, eye-pleasing characters in inexpensive calculators. They're called, technically, "Vacuum Fluorescent Indicator Panels" or, for short, FIPs. Actually, FIPs are modern developments of very old technology, that of the vacuum tube. In fact, they're triodes, complete with plate (anode), cathode, and grid, but with the addition of a phosphor on the segmented plate so the characters will glow. Brightly.



THE CHART TELLS THE STORY. Even though NEC is among the world's largest producers of both LEDs and gas discharge (plasma) displays, we see FIPs rapidly taking over for most applications—such as calculators, data & POS terminals, clocks, radios, car dashboards, microwave oven controls, instruments, CB, TV, etc. For obvious reasons, that are summarized in the chart at far right.



Typical Red LED

AND THERE ARE OTHER GOOD REASONS, SUCH AS RELIABILITY & LONG LIFE. The tremendous variety of uses that FIPs can be put to calls for very high acceptance standards. NEC has developed what may be the most rigorous QA and QC in the world. In a recent, routine test cycle, a total of 1085 FIPs of various models were put through a total of 15 grueling tests...with a single failure. The tests, and their standards, are described in the new FIP Selector Guide, available by mailing the coupon in this ad.

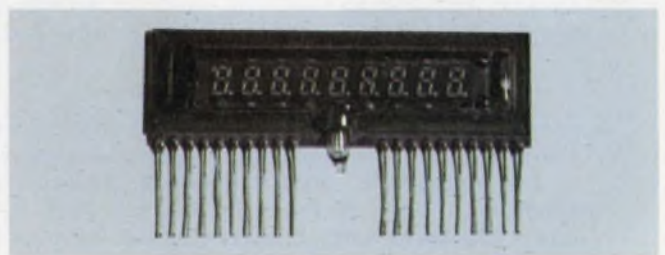

way for FIPs.*

ONE GLANCE TELLS THE COST/PERFORMANCE STORY. The larger the character size, the better the direct savings. That doesn't take into account the additional indirect savings from such things as simpler circuitry, fewer failures, and easier assembly. Check this graph, to get the idea.

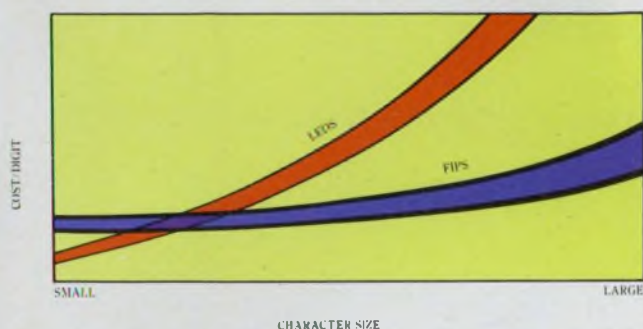

THE STORY ON BRIGHTNESS AND LIGHT BANDWIDTH. FIPs' phosphors are selected to be extremely efficient converters of electrical energy to light energy, minimizing power input. In addition, the light is spectrum-wide, from red to violet, and can thus be filtered to provide any single hue desired. The light predominates in the blue-green area, which overlaps the standard curve of human eye response (see graph), so the viewer perceives the maximum of brightness for the minimum of power input. And—the gentle, soothing blue-green glow is considered to be much less fatiguing to the eye than red and orange colors.

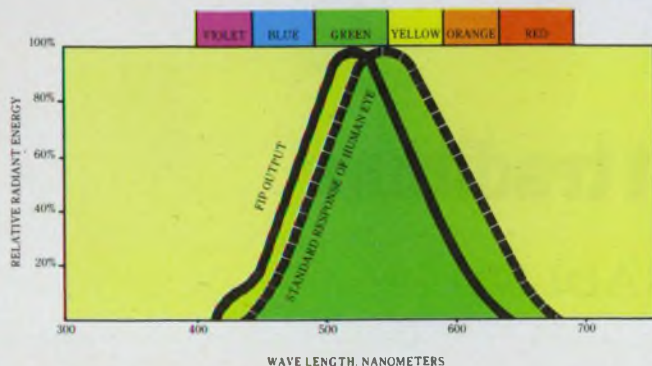

LED/GAS DISCHARGE/FIP COMPARISON CHART

	LED	GAS DISCHARGE	FIP
VOLTAGE	-1.7-5V	-150-200V	-10-40V
POWER/CHARACTER	high	low	low
CURRENT	high	low	low
MOS IC DIRECT DRIVE	no	no	yes
THIN & FLAT	yes	yes	yes
VIEWING ANGLE	wide	wide	wide
BRIGHTNESS	moderate	moderate	high
MOUNTING EASE	good	good	good
COST/PERFORMANCE	fair	good	excellent
READABILITY	fair	fair	outstanding
COLOR CHOICE	limited, fixed	red, limited	many—filterable

33 TYPES AVAILABLE IN HIGH VOLUME — HOW TO SELECT YOURS? Easy. Send for our just-off-the-press FIP SELECTOR GUIDE. It tells everything you need to know to select exactly the FIP for your application. Then, mail the postpaid return card bound into the guide, and we'll send you the data sheets you require, with the comprehensive specifications. Make sense? Then we hope to hear from you soon. Mail coupon, or telephone us at (408) 738-2180, Telex 34-7475.

NEC

NEC America, Inc.

CLIP THIS TO LETTERHEAD FOR FAST RESPONSE.

NEC America, Inc., Electron Devices Div.
3070 Lawrence Expressway
Santa Clara, CA 95051

Send me that 8-page FIP Selector guide.
My application is (or will be) _____.

Call me for immediate requirement at
(____) _____, extension _____.

NAME

TITLE

MAIL STOP

COMPANY

STREET

CITY

STATE

ZIP

*Registration Pending

A resistor for all reasons

Here's a way to cut the daylight out of your fixed resistor inventory. Standardize on our Type CC cermet. It's sized like a ¼-watt but you get performance that ranges from ½-watt at 125°C to ½-watt at 70°C (250 volt max.) Tolerance is 1% over the complete resistance range of 10 ohms to 22.1 megs or 0.5% from 10 ohms to 499K. TCR is as low as ± 50 ppm/°C. The one resistor for all reasons: industrial. RN55C, RN55D and RLR07 needs to 1% and 2% tolerance. We have what you need; our distributors have it when your need is now. Ask for Publication EC33.

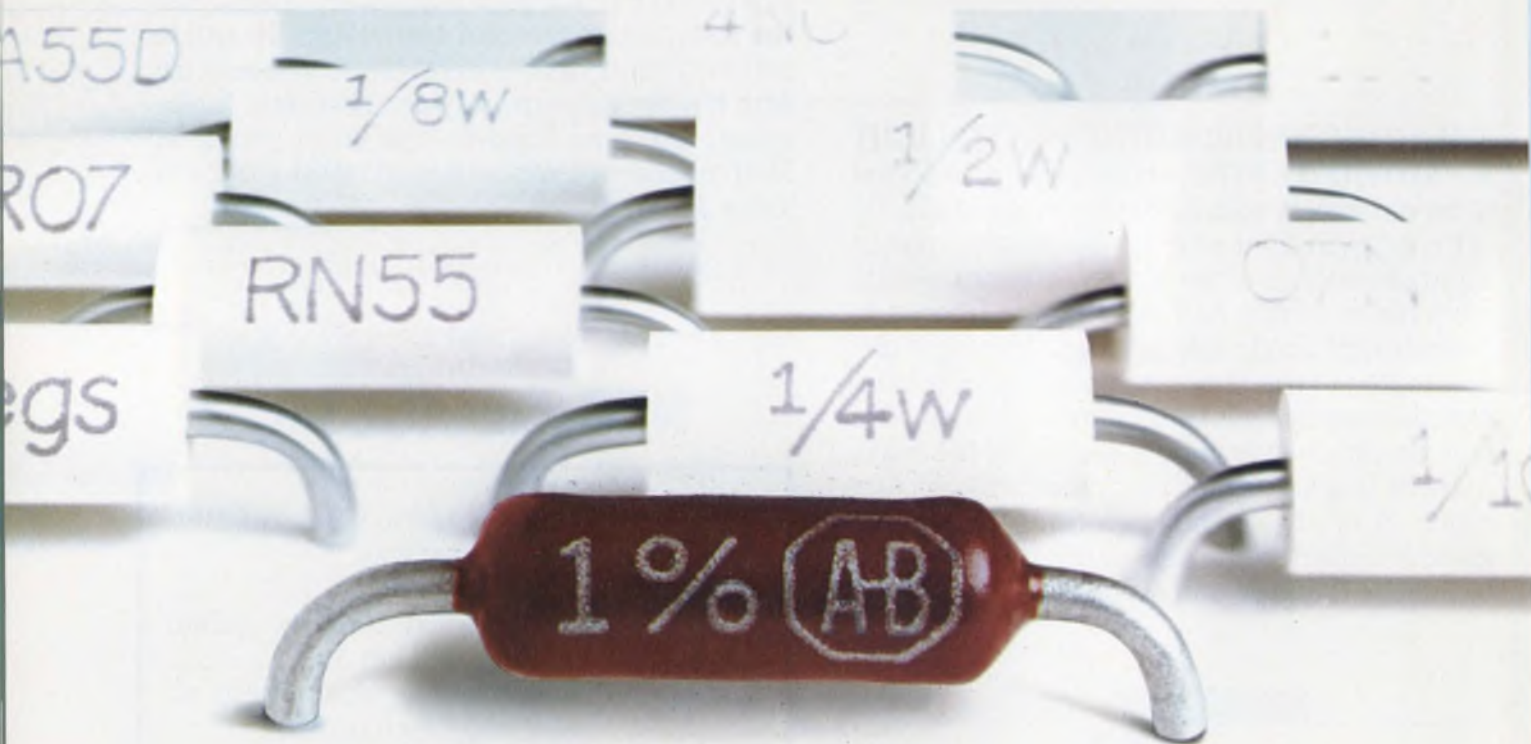
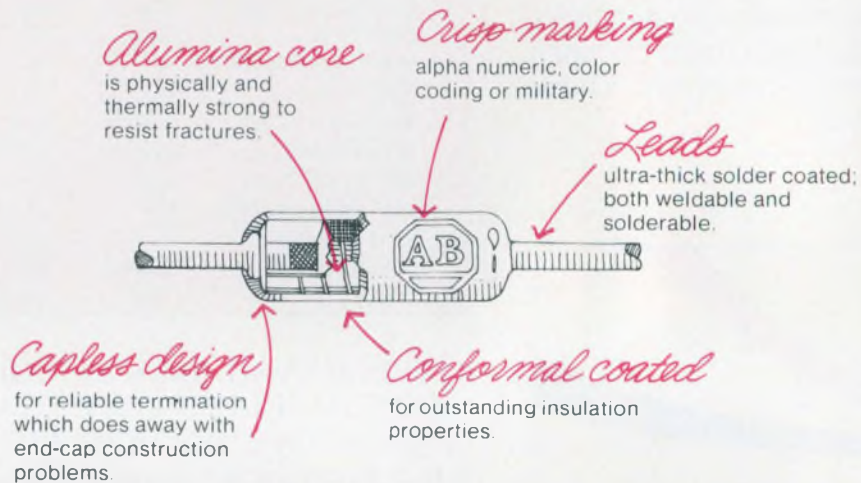

Quality in the best tradition.



ALLEN-BRADLEY
Milwaukee, Wisconsin 53204

EC129

CIRCLE NUMBER 7

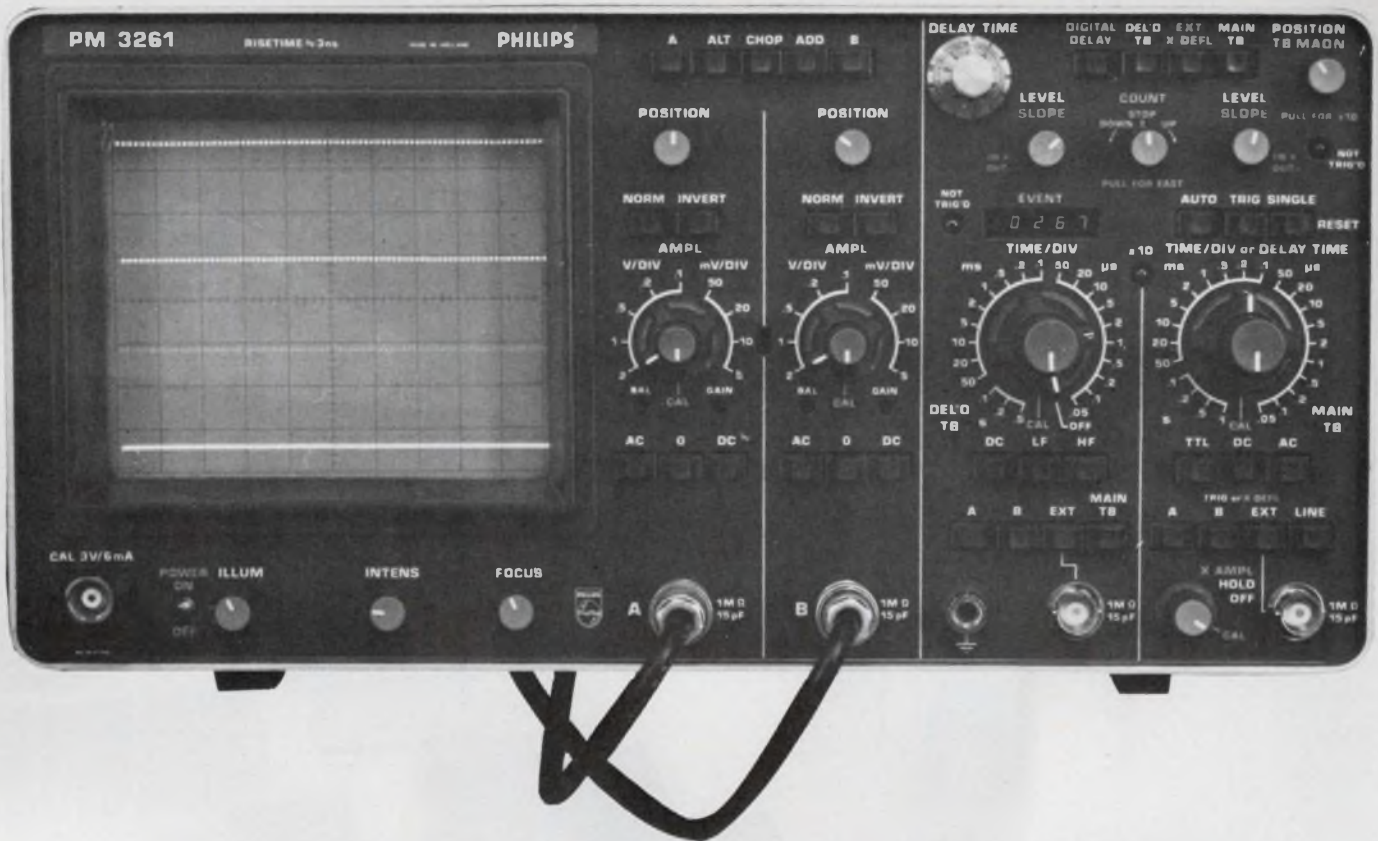

DISPLAY THE 267th BIT and be sure it's not the 268th or 269th...

Finding the 267th bit takes quite a while, and then you're not sure you have the right one. The solution is programmed digital delay. On the Philips PM 3261, you can program the delayed timebase to start on the nth bit. By means of an internal variable-speed clock, the events counter can be preset from 1 to 99,999 events, with complete trigger level setting control.

Another addition to the Philips family of HF portable oscilloscopes, the 120 MHz PM 3261 adds easily programmable digital delay to the already completely separate delayed timebase control section found on its predecessors.



Utilize our toll-free HOT LINE number 800 631-7172
New Jersey residents call (201) 529-3800 collect.
*U.S. domestic price only



Special TTL triggering selection allows the PM 3261 to react just as logic does - a TTL level window prevents false triggering on rising or falling edges.

The PM 3261 list price is only \$ 2595.00*

For further information contact, Philips Test & Measuring Instruments, Inc.

In the United States:
85 McKee Drive
Mahwah, New Jersey 07430
(201) 529-3800

In Canada:
6 Leslyn Road
Toronto, Ontario Canada M6A 1K2
(416) 789-7188



PHILIPS

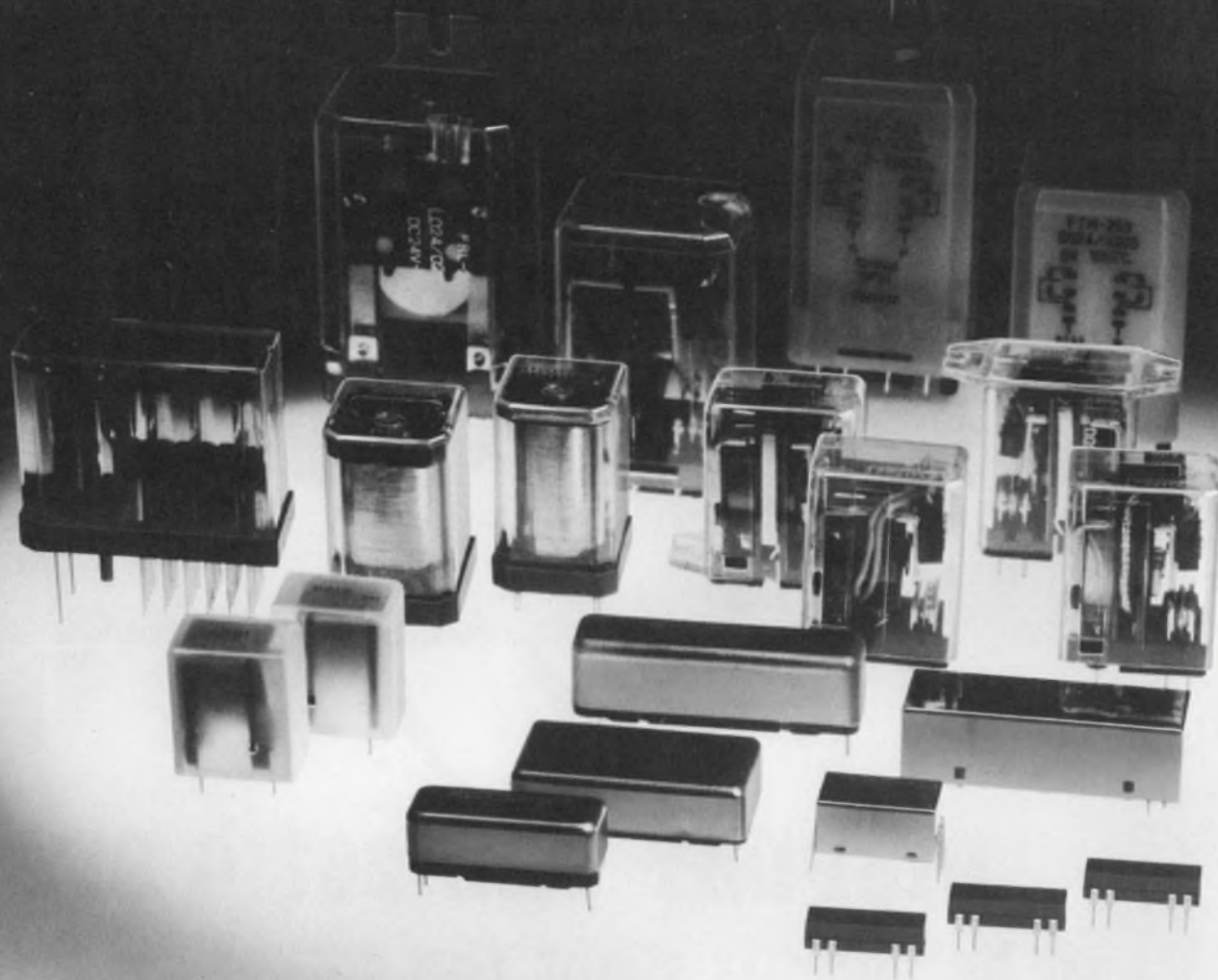

Make the switch to Fujitsu high

When it's time to put solid "switching power" into your equipment, it pays to select relays with proven performance and top quality. And that's just what you get when you specify Fujitsu relays. The wide-coverage Fujitsu relay lineup is here now ready to fill your total relay needs, from space-saving flat package units to powerful 10-amp general purpose models. Each and every Fujitsu relay is built to the quality standards that are synonymous with the name Fujitsu, and all feature proven performance that guarantees thousands of hours of failure-free operation. Here are just some of the features in store for you when you choose the name Fujitsu for your demanding relay needs.

Fujitsu flat package relays

The Fujitsu lineup of flat package relays offers exceptional coverage and the advantages of flux-contamination-immunity. Within the lineup are our FRL 410-series low-profile and our BR-series miniature GP models. The former are available in both DPDT and 4PDT contact arrangements and coil voltage ratings to 48V DC enabling the widest selection to meet demanding applications including those for communications. And our BR-series models offer you similar wide choice including 0.5A ultra-miniature models that enable exceptional component densities for solid savings in both equipment size and cost.

CIRCLE NUMBER 111

Fujitsu general-purpose relays

With a wide model choice, including units capable of handling loads to 10 amps, the Fujitsu general-purpose relay lineup is a winner. Most models are available in both DC- and AC-rated coils, and with a solid selection of mounting configurations. You also get solid load handling and a choice of contact material to meet your exact operation requirements. Contact arrangements available are from SPDT to 6PDT, depending on models, with 12PDT or 18PST available on special order with our 491-series miniature models. Yes, whether compact or high load, the Fujitsu GP relay lineup is solid to meet your total switching needs. And for special applications, Fujitsu relays with fixed, knob-adjustable, or driver adjustable time delay are also available.

CIRCLE NUMBER 112

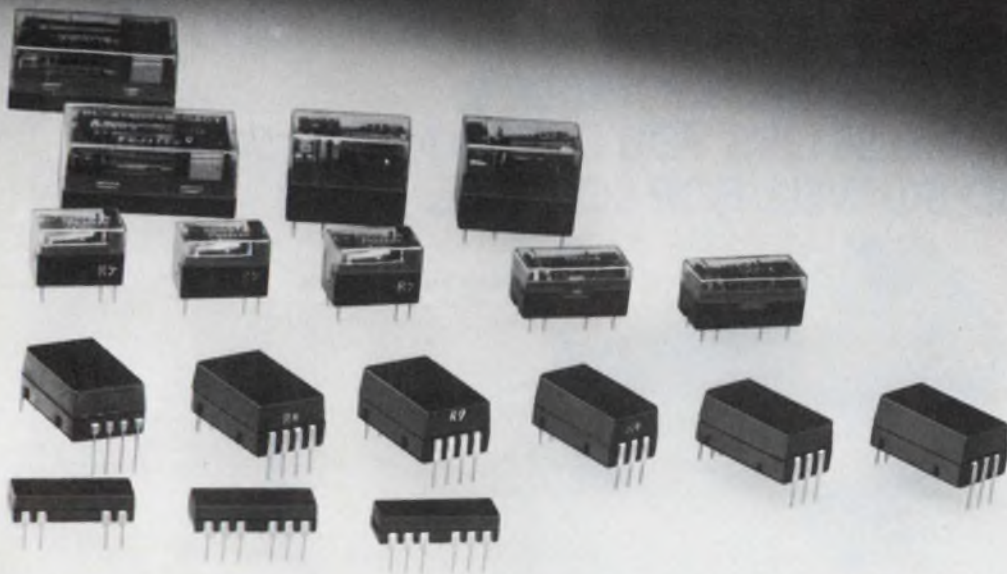

quality relays

Fujitsu reed relays

Featuring Fujitsu-built reed switches of exceptional quality, the Fujitsu reed relay lineup is the unbeatable choice for today's high-speed, low current switching applications. As standard features, you get low contact resistance, compact size, a wide choice of contact arrangements and coil ratings, the availability of shielding and other features, and models including a built-in latching function via the Fujitsu MEMOREED® switch. You even have a choice of mounting grid patterns when you pick the FRL 640-series, low-profile reed switches. Full-featured and available in a wide range of models, Fujitsu reed relays are the solid choice for today's demanding data processing and control applications.

CIRCLE NUMBER 113

Fujitsu mercury wetted-contact relays

Built to provide exceptional reliability for a variety of equipment applications, Fujitsu mercury wetted-contact relays are top performers. Among the advantages of our mercury wetted-contact models are freedom from contact bounce, low and stable contact resistance, wide load-handling capabilities (from micro-ampere levels to a full 2 amps), low unit profile, and the capability for being driven by ICs. In our five-model lineup, you can choose coil ratings to 24V DC, with all models guaranteeing at least 10×10^9 operations.

CIRCLE NUMBER 114



The Fujitsu relay lineup. It's full coverage and high quality for unbeatable performance, and at prices that will make you wonder why you didn't think Fujitsu before. So, join the growing number of makers who specify Fujitsu quality products. Call or write now for additional information. You'll be glad you did.

FUJITSU LIMITED
Communications and Electronics

FUJITSU AMERICA INC./Los Angeles Office: 1251 West Redondo Beach Blvd., Suite 304, Gardena, Calif. 90247, U.S.A. phone:213-538-3397 twx:910 346 6724 **Chicago Office:** P.O. Box 694, Lake Forest, IL. 60045, U.S.A. phone:312-295-2610 twx:910 651 2259
FUJITSU LIMITED/Components Group (Head Office): Syuwa Onarimon Bldg., 1-1, Shinbashi 6-chome, Minato-ku, Tokyo 105, Japan phone:03-437-2111 cable:FUJITSULIMITED TOKYO telex:2424511 FT SIN J **London Office:** Norman House, 105/109 Strand, London W.C. 2, England phone:240-0461/0462 telex:51 22305

Nothing—not even a scope or a voltmeter or even another logic tester. Because CSC's Logic Monitor™ 2 is the most convenient, efficient way ever developed to monitor circuit activity in digital IC's: it provides instant and continuous display of static and dynamic states of DIP IC's up to 16 pins.

Its built-in power supply, high input impedance and selectable logic thresholds provide the most accurate monitoring of counters, shift registers, gating networks, etc., on big, bright LED's. And because there is no loading of the circuit under test, logic level shifts, false triggering and power sup-

ply loading (that can occur with some equipment) are problems of the past.

LM-2 is a second-generation IC test instrument consisting of two units—a connector/display and a switchable precision voltage reference power supply. In operation, the threshold switch on the power supply is set to the proper logic family (RTL, DTL, TTL, HTL or CMOS). A clip lead is connected to the ground (plus VCC lead, in the case of CMOS), and the connector/display unit simply clipped over the IC under test. That's it.

Each of the 16 pins on the connector/display unit automatically

connects to the corresponding IC pin without any possibility of shorting, and feeds one input of a voltage comparator circuit. The other input is fed from a precision selectable voltage source. When the voltage on a particular pin is more positive than the reference (logic "1"), the corresponding LED lights—at any pulse frequency from DC to 30KHz (50% duty cycle).

If you're looking for an easy way to monitor digital circuits, LM-2 with its 16 channels of automatically-in-sync information and fast, instinctive operation, can't be beat. You won't find anything like it, anywhere near the price.

CSC'S LOGIC MONITOR 2. AT \$124.95, NOTHING ELSE LETS YOU DO SO MUCH SO FAST AND SO WELL FOR SO LITTLE.

Fully isolated power supply module—Constant, bright LED readings without drawing power from circuits under test

Sturdy, high impact construction throughout—At CSC, part of making a good thing means making it to last

Clip module slips easily over IC—Now, checking static and dynamic states of dual in-line IC's of up to 16 pins is literally a snap

Selectable threshold level—Matches characteristics of logic family under test—RTL, DTL, TTL, HTL or CMOS

Non-corrosive nickel-silver contacts—For maximum reliability and minimum contact resistance

Precision plastic guides and flexible web*—For short-free positive contact with IC under test

Big, bright 16-LED display—More information and no more eyestrain—get a picture of everything that's happening *simultaneously*

High input impedance—100K impedance for minimum circuit loading

CONTINENTAL SPECIALTIES CORPORATION

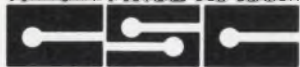

EASY DOES IT

For more information, see your distributor or write for our catalog and distributor list.
44 Kendall St., Box 1942 New Haven, CT 06509 • 203-624-3103 TWX: 710-465-1227 West Coast office:
Box 7809, San Francisco, CA 94119 • 415-421-8872 TWX: 910-372-7992

CIRCLE NUMBER 11

*U.S. PAT. NO. 3,914,007 © 1976 Continental Specialties Corp

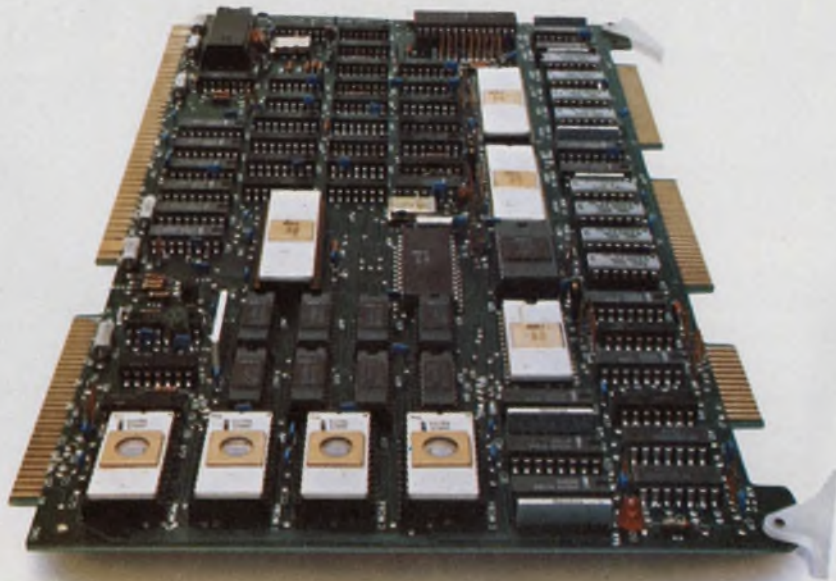

Intel delivers real time microcomputer multiprocessing. The new SBC 80/20 Single Board Computer.

SBC 80/20 delivers system throughput and design flexibility previously unobtainable on a Single Board Computer. Like our low cost industry standard SBC 80/10, the SBC 80/20 has everything you need—CPU, EPROM, RAM and programmable parallel and serial I/O—all on a single 6.75" x 12.0" board. And because the SBC 80/20 also has dual bus architecture, multiprocessor bus control, programmable eight level vectored interrupt and programmable timers, it is your best choice for real time multiprocessing and other high performance applications.

SBC 80/20 increases system throughput and improves system reliability by allowing tasks to be segmented in a true parallel processing

configuration. Operate up to sixteen SBC 80/20 systems simultaneously without tying up the system bus when using on-board memory and I/O. And when access is required to resources sharing the system bus, on-board multiprocessing logic provides the necessary bus priority control.

SBC 80/20 has eight levels of programmable vectored priority interrupt making it possible to immediately respond to critical I/O requirements. Priority assignments and priority algorithms are under program control and can be dynamically reconfigured as system requirements change.

SBC 80/20 has two programmable timers that increase throughput by relieving the CPU of timing and event counting operations. Each timer may

be programmed by system software to operate as a real time clock, interval timer, or event counter.

To protect data integrity, the SBC 80/20 includes an auxiliary memory power bus and all the logic necessary for implementation of a battery back-up system.

Ask for our new 24-page brochure describing the entire family of Intel® SBC 80 Single Board Computers, System 80 packaged systems and expansion boards. For your copy or for a demonstration contact your local Intel representative, use the reader service card or write: Intel Corporation, 3065 Bowers Avenue, Santa Clara, California, 95051.

intel delivers.

When a masterpiece is shown, the reasons it is one, often times aren't apparent.

ROSITE® moldings are presently being used by thousands of engineers in many innovative and masterful designs. Inside this XEROX 3100 copier there are 12 different ROSITE glass polyester moldings. They replace die-cast aluminum and other metal fabrications effecting economy and weight reduction helping make the 3100 copier a better product.

Each ROSITE molding was selected for a combination of reasons: dimensional accuracy (tolerances to $\pm .0005$ per inch) to eliminate machining—dimensional stability (creep resistance) at elevated temperatures and wear resistance through millions of cycles to assure long life—plus electrical insulation properties and a UL flammability rating of 94V-0.

Perhaps we can help you realize some of your ideas, too.

This concept of replacing metal with ROSITE works in many areas.



Rostone Corporation

2729 South Concord Road • Lafayette, Indiana 47902 • 317/474-2421

CUSTOM ENGINEERED PLASTIC MOLDINGS

XEROX® and 3100® are trademarks of Xerox Corporation.

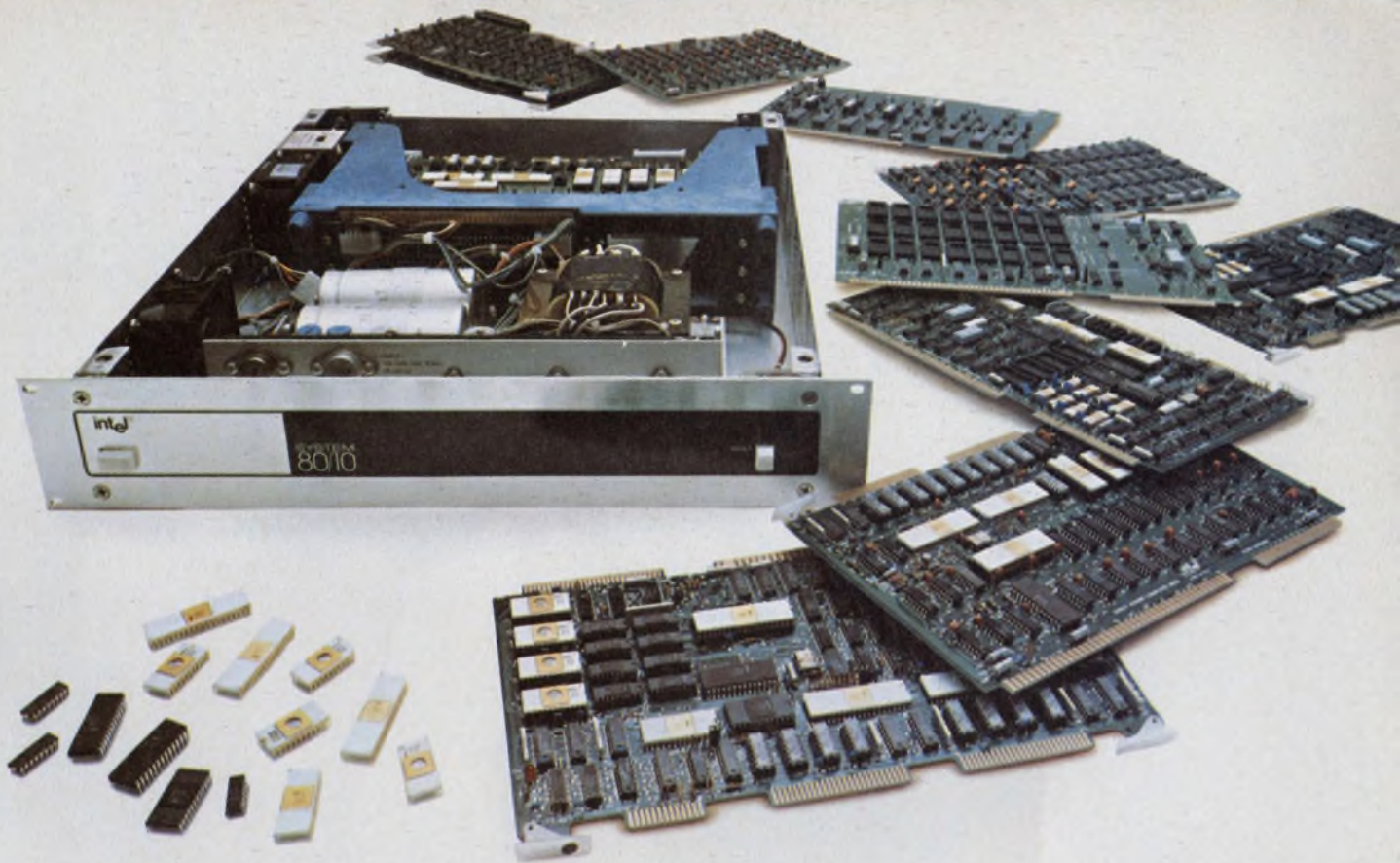

Intel delivers microcomputer systems that take the risk out of becoming successful.

Intel takes the risk out of becoming successful by providing economic, flexible and reliable microcomputer hardware and software solutions for your moderate and high volume requirements.

For most moderate volume microcomputer applications, it makes economic sense to buy an assembled and tested microcomputer system. That's why we offer two Single Board Computers (SBC 80/10, SBC 80/20) and two packaged systems (System 80/10, System 80/20). When you decide it's more economical to do the job "in-house," we'll make arrangements for you to use our bill of material, fab and assembly drawings, and artwork. And since we manufacture *all* the essential components—CPU, EPROMs, ROMs, RAMs, programmable I/O, and other LSI devices in volume, you can order the components from us and continue to take advantage of quantity discounts. *No penalty for success.*

Intel® microcomputer systems are flexible and easily configured to your specific needs. Expanding your system or reconfiguring the I/O is easy. All Intel microcomputer systems are supported by a complete line of I/O and memory expansion boards, diskette and DMA controllers, power supplies, card cages, and accessories. And since I/O, communications, timer and interrupt control functions are programmable, you can reconfigure the system to match your application by altering a few bytes of memory instead of redesigning system hardware.

And Intel delivers more than microcomputer systems that give you the cost/performance advantage. In addition we provide Intellec® Microcomputer Development System support to get you to market sooner. Intellec resident PL/M, the high level microcomputer language, can cut man months off your software development schedule. Intellec ISIS-II Diskette Operating Software, with

linkage and relocation capabilities, will save more programming time. Develop programs in small manageable modules—then link them together or link them with general purpose subroutines from a software library. Reduce system integration and checkout time with the Intellec resident ICE-80™ In-Circuit Emulator. Develop, symbolically debug and execute high level and assembly language programs directly on your System 80 or SBC 80 based prototype.

From hardware and software development all the way through production, Intel gives you the competitive advantage. For a copy of our new 24-page brochure or a demonstration contact your local Intel representative, use the reader service card, or write: Intel Corporation, 3065 Bowers Avenue, Santa Clara, California 95051.

intel delivers.



How to turn a computer into a disk jockey. The μ PD372 Floppy Disk Controller.

Now you can turn almost any micro or minicomputer into a genuine floppy disk jockey with the help of just one small chip.

Our μ PD372 Floppy Disk Controller. Or if your computer prefers playing tapes, we also have the μ PD371 Tape Cassette Controller.

Either one can take the place of from 50 to 60 TTL packages to save you space as well as money. The 372 is

completely compatible with IBM, Minifloppy,^{IBM} and other formats and controls up to 4 floppy disk drives. The 371 controls up to 2 tape cassette drives. They come with complete documentation and—best of all—they're available now.

The μ PD372 and 371 are just part of our complete family of micro-processor products including 8080As, dynamic and static RAMs, ROMs,

Electrically Erasable PROMs, and 8212, 8214, 8216, 8224, 8228/38, 8251, 8255 and other support chips. All backed by full documentation, applications support, and software.

The μ PD372. The μ PD371.

And the hits just keep on comin'.

NEC Microcomputers, Inc.
Five Militia Drive, Lexington, MA.
02173. 617-862-6410

TM Shugart Associates

NEC microcomputers, inc.

REPS: East - C&D Sales 301-296-4306, Contact Sales 617-273-1520, Harry Nash Assoc. 215-657-2213, Tech-Mark 607-748-7473, 716-223-1252, 315-652-6229, Trionic Assoc. 516-466-2300; South-Perrott Assoc. 305-792-2211, 813-585-3327, 305-275-1132, Wolfs Sales Serv. Co. 919-781-0164; Midwest - Electronic Innovators 612-884-7471, W. Pat Fralia Co. 817-640-9101, 817-649-8981, 713-772-1572, K-MAR Eng. & Sales 816-763-5385, R.C. Nordstrom & Co. 313-559-7373, 616-429-8560, Technology Sales 312-438-3300; West - Mike Duffy Assoc. 303-934-7392, Electronic Component Marketing 714-524-9899, 213-649-5374, Spedden Assoc. 714-295-6122, Summit Sales 602-994-4587, Trident Assoc. 408-734-5900, Tri Tronix 206-232-4993, 505-265-8409; Canada - R.F.Q. Ltd. 416-626-1445, 514-626-8324.

DISTRIBUTORS: Century Electronics (Albuquerque, Salt Lake City, Wheatridge CO), Diplomat (Chicopee Falls MA, Clearwater FL, Elk Grove Village IL, Farmington MI, Minneapolis, Mt. Laurel NJ, Salt Lake City, St. Louis, Sunnyvale, Totowa NJ, Woodbury NY), Future Electronics (Montreal, Ottawa, Rexdale, Canada), Harvey Electronics (Fairfield NJ, Lexington MA, Norwalk CT, Woodbury NY), Intermark Electronics (San Diego, Santa Ana, Sunnyvale), Lionex (Burlington MA), G.S. Marshall (Sunnyvale), Mirco Electronics (Phoenix), Resco (Raleigh), R-M Electronic (Kentwood MI, Madison Hgts MI), Semicomp (Newport Beach CA), Semiconductor Specialists (Burlington MA, Chicago, Dallas, Dayton, Farmington MI, Hazelwood MO, Indianapolis, Kansas City, Milwaukee, Minneapolis, Pittsburgh, St. Louis; Malton Canada), Sterling Electronics (Albuquerque, Dallas, Houston, New Orleans, Phoenix, San Diego, Seattle, Sun Valley CA, Watertown MA), Technico (Columbia MD, Roanoke VA), Zeus Components (Elmsford NY).

NEW BURROUGHS' 480-CHARACTER GAS PLASMA DISPLAY:

It's a space saver!
It's a weight saver!
It's a cost saver!

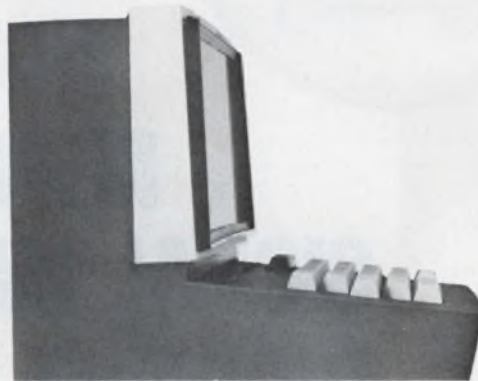

Burroughs low-cost 40, 240 and 480 character SELF-SCAN® II panel displays can help you reduce the size and weight of your data terminals by more than 50%. You'll reduce costs as well. And, at the same time, obtain excellent display readability under all operating conditions — indoors or out, day or night. Characters are uniformly bright, free of jitter and flicker with no fuzziness, distortion or loss of linearity at the display's edges. Character-to-background contrast is better than ever. And, the SELF-SCAN II panel's 40-character



line is compatible with popular software.

Other significant advantages include direct digital address, easy interface to microprocessors, thin cross-section and rugged construction for long service life under all operating conditions.

Give your data terminals a bright new outlook; call or write for complete information.

Burroughs Corporation,
 Electronic Components Division, P.O.
 Box 1226, Plainfield, New Jersey 07061.
 Telephone (201) 757-5000. SELF-SCAN® displays are available nationwide through our distributors, Hamilton/Avnet and Cramer Electronics.

You can see the difference

Burroughs





GET FETs

FOR

RF,

AUDIO,

VIDEO,

MIXERS,

SIGNAL SWITCHING,

CURRENT SOURCES,

HIGH VOLTAGE



Dial (415) 968-9241 for samples or design help

It's that simple. Just ask for Walter Wong. He'll be glad to help you decide which of our broad FET line will meet your need and how to use it best. Or drop him a line on your company letterhead. He'll send your sample by return mail.

FETs for all applications. Whatever you're designing—if it's a function FETs can handle—you can be sure we'll have a FET with the precise characteristics to meet your need. You can be sure, too, that the performance of production orders will be consistent with the samples you test.

Profit by our experience. We've been making

FETs longer than anyone else. We have a longer reliability history (ask about our involvement in Hi Rel programs, for instance). We lead the industry in high voltage FETs; in monolithic duals for matched performance. And we're price-competitive across the board.

Ask for applications help. If you'd like design assistance in the best use of FETs for your specific application, just ask. If your need is more general, our FET Application Data Book is just off the press. It, too, is yours for the asking. So dial our number today and ask.

 **TELEDYNE SEMICONDUCTOR**

1300 Terra Bella Avenue, Mountain View, California 94043 Tel: (415) 968-9241 TWX: 910-379-6494 Telex: 34-8416

SALES OFFICES:

DOMESTIC: Salem, N.H. (603) 893-9551; Stony Brook, N.Y. (516) 751-5640; Des Plaines, IL (312) 299-6196;

Los Angeles, CA (213) 826-6639; Mountain View, CA (415) 968-9241 • INTERNATIONAL: Hounslow,

Middlesex, England (44) 01-897-2503; Tlengen, West Germany 7741-5066; Kowloon, Hong Kong 3-240122;

Tokyo, Japan 03-405-5738

Nonvideo games pit man vs microprocessor

The widespread attention lavished on electronic video games has overshadowed another fast-growing sector—nonvideo, microprocessor-based games.

For example, the \$200 Chess Challenger by Fidelity Electronics, Ltd., Chicago, is a "board game." A player tries to beat a Nippon Electric 8080A μ P programmed to respond to the standard moves and rules of chess. The initial version, introduced at the Winter Consumer Electronics Show in January, is programmed so that an average player can beat it as often as 70% of the time. But the next version, to be available in June, will be able to pit its wits against better players with a smarter ROM programmed to be more competitive.

Meanwhile, Bally Manufacturing, Chicago, has produced the first μ P-based home version of its arcade pinball games. The \$800 Fireball is controlled by an F-8 microcomputer that includes the CPU and 11 peripheral chips. Up to four persons can play together, and scoring appears on LED readouts.

Should the Fireball malfunction, the user can check all the moving parts and bulbs by actuating a built-in diagnostic program with a switch. The program checks only as far as the computer-board level. At this point, the owner can remove the IC board and send it to a service center for repair. The arcade version has an extended diagnostic program that permits a serviceman to check all the way down to components on the board.

Fireball sales have encouraged Bally to ready two more consumer pinball games for introduction next month—Captain Fantastic and Evel Knievel.

Interactive games needn't be elaborate or expensive. Two battery-operated, hand-held games—Auto Race (\$25) and Football (\$30) by Mattel, Inc., Hawthorne, CA—contain small, dedicated microprocessors and special LED displays (see photo).

To win the auto race, a player must



Two electronic games from Mattel are Auto Race (left) and Football.

beat two other "cars"—actually small moving bars of red light. He steers his car to avoid collisions and races the other cars against a built-in digital timer. A four-speed gear shift is provided along with a loudspeaker and racing sounds.

To score in the football game, a user/challenger must run through μ P-controlled opponents (represented by bars of LED light) by keying in his own through-the-line or end runs. A digital LED scoreboard gives the down, yards to go, and the position of the ball on the field.

Calculator games are also making their presence felt in the marketplace. The first to be designed with six games programmed into it is the Mathemagician by APF Electronics, New York City. For games like Lunar Lander, Baseball, Goey Gumdrop and Arithmetic, overlays are placed over LED readouts.

For the Lunar Lander game, for example, an overlay is used that indicates the speed of the rocket ship's landing, its altitude, and the quantity of fuel used. The object of the game is to touch down without crashing, which is indicated by a "Contact" LED. Less perfect landings are signaled by other LEDs: "Repairable," "Crash," and "Stranded."

The growing popularity of "man-against-machine" games has led Hew-

lett-Packard to program a \$35 magnetic card of popular games. Many of the games in Pac I are large-computer games submitted by HP-65 and 67 programmable-calculator owners to the HP Users' Program Library.

The programs of submitted games have been refined to provide the highest programming efficiency, says Ken Newcomer, HP program applications engineer at Corvallis, OR. The games in Pac I may be played by one, two or more participants. Six of the games—Sub Hunt, Artillery, Super Bagel, NIM_n, Golf and Hexapawn—have variable difficulty. Two games—Dice and Slot Machine—rely totally on chance for the outcome. The other games are 21, Tic-Tac-Toe, Wari, Racetrack, Teaser and The Dealer.

Assembly problems? A NASA team may help

Electronics manufacturers with assembly problems can contact a NASA-sponsored team of experts for custom-tailored help. On request, the team will visit a plant, examine difficulties, and try to plug in solutions that NASA, or one of its contractors, has already developed for an aerospace program.

"We want to hit assembly operations more than device-production lines," says John D. Meyer, director of the manufacturing-applications teams. "We might be interested in companies building instrumentation devices for process control and other industrial applications."

A contract, set up for one year with options to extend, will be carried out by the Illinois Institute of Technology Research Institute (IITRI), Chicago, under the direction of NASA's Marshall Space Flight Center, Huntsville, AL.

A good example of NASA's technological wealth is conformal coatings for PC boards that create an environmental seal. Conformal coating materials developed by the NASA flight center have thermal expansion characteristics that match the devices they're used on.

IITRI plans to work through industry associations whenever possible. The Electronic Industries Association, for example, has just started a new manufacturing committee headed by Dale Hartman, director of manufacturing technology at Hughes Aircraft. Meyer's group plans to give one of its first presentations at the committee's

meeting in May. "We hope to visit 40 companies the first year," Meyer says, adding, "We already have requests from 20."

Companies interested in IITRI's personalized counseling can contact John D. Meyer at IITRI, 10 West 35th St., Chicago, IL 60616. Telephone: (312) 567-4609.

Jitter and drift cut in Trapatt oscillator

Using light from a laser diode to control a Trapatt oscillator not only reduces jitter up to 60% but also gets rid of more than 85% of the frequency drift associated with conventional Trapatt circuits.

A Trapatt (trapped-plasma, avalanche-triggered transit) diode is mounted at the end of a slug-tuned coaxial cavity so that its active region can be illuminated with a gallium-arsenide laser diode. The circuit was developed by Richard A. Kiehl and Errol P. EerNisse of Sandia Laboratories' Solid State Device Physics Division in Albuquerque, NM.

Trapatt devices are simpler and less expensive than multicomponent, chain-amplifier transmitters used in such high-frequency applications as pulsed radars. However, their use has been greatly limited by jitter in the leading edge of the rf pulse, sensitivity of jitter to circuit tuning, bias, and temperature, and frequency drift, due to heating, during each pulse. In conventional Trapatt devices, start-up jitter—the interval between bias application and oscillator start-up—can vary from 50 to over 100 ns.

The optically controlled Trapatt diode cuts jitter to 20 to 40 ns and makes jitter far less sensitive to circuit tuning, bias and temperature than conventional Trapatts. In addition, frequency drift, which averages about 1.4 %/ μ s in unilluminated diodes, drops to 0.2 %/ μ s in the optically controlled device. In fact, adds Sandia, by steadily increasing the intensity of illumination during the bias pulse, frequency drift can be virtually eliminated.

Trapatt oscillators incorporate semiconducting diodes mounted in a coaxial resonating cavity. When biasing current is applied to the diode, high-frequency waves are reflected back and forth within the cavity, and some of the energy escapes as rf output.

In the optically controlled oscillator,

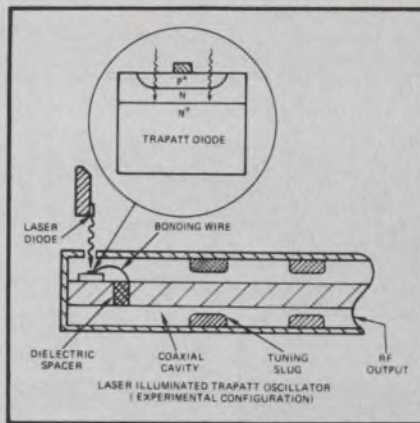

photons from the laser pulse create electron-hole pairs by penetrating about 20 microns into the Trapatt's active region. These carriers aid in avalanche multiplication, which in turn aids in triggering the rf output.

Short laser pulses produce sharp frequency-change spikes on the rf output signal form timing marks that are easily detected when the signal is reflected back to the receiver. These signals may be of value in extremely precise phase-tracking radars, radar altimeters, proximity fuses, perimeter surveillance devices, and high data-bit-rate phase coding for transponders. As a result, says Sandia, systems with peak pulse outputs of several hundred watts at frequencies from 500 MHz to 10 GHz should soon be possible.

Stereo cartridge holds up to 1 Mbyte of data

The familiar 8-track stereo cartridge has been adapted to store digital data instead of music. Like a floppy-disc drive or a cassette-tape drive, the 8-track digital-tape cartridge can record data on removable media and reproduce it reliably. But in addition, the cartridge can also hold a full Mbyte of data—much more than standard floppy discs and cassettes—and reportedly puts more data storage on line per dollar.

The cartridge is called a "floppy tape" by its developer, Intelligent Systems Corp. of Norcross, GA, because its bit-serial data format is a simpler version of the floppy-disc format. A photo-sensed foil segment at the splice in the tape loop replaces the index hole used on floppy discs. The gaps, track-and-sector addresses, 128-byte data blocks, and check sums are like those of soft-sectored floppy discs.

With the same construction and tape path as the standard audio cartridge, the digital-data cartridge can store an endless loop of recirculating tape on a single hub. Tape slips out of the center of this reel to go to the heads, then wraps back on to the outside of the reel. The eight data tracks are accessed by a four-head assembly. Track switching takes only 1 μ s if head motion is not needed—10 ms if the head assembly must move. The synchronous motor drive with read/write electronics, control electronics and a 4800/9600-baud RS232 asynchronous interface costs \$100 in large-quantity orders, according to C.A. Muench, ISC marketing vice president.

Cartridges loaded with a specially lubricated 3M digital tape cost about \$4 in quantities of 25 and up.

Circle No. 318

TI data terminals contain bubble memory

The first commercially available magnetic bubble memory was announced a couple of months ago—the TBM 0103 by Texas Instruments. Now two data terminals, incorporating the memory, have been announced by TI.

While a cassette system can take up to several minutes, both terminals can access any indexed records in memory in less than 15 ms. What's more, if the data location in either the 763's or the 765's memory is not indexed, their character-string search speed is 1000 characters per second—about four times faster than a cassette search. And the terminals' record-access time is more than 10 times faster than a floppy disc's, although their total data-transfer rates are lower.

Both members of the "Silent 700" series, the portable (17 lb) Model 765 and the larger table-top Model 763 come with 20,000 bytes of bubble-memory storage, expandable to 80,000 bytes in 20,000-byte increments. Each terminal is a fully capable 30-cps unit with a full ASCII keyboard, a built-in numeric cluster, a virtually silent thermal printer and an acoustic coupler. The portable 765 is equipped with a carrying case, as well as such traditional ASR functions as playback and record control with USAC USASCII commands, without additional cost.

Both terminals will be demonstrated at the National Computer Conference in Dallas, June 13 to 16.

Circle No. 319

NATIONAL ANTHEM



A Review of New Products and Literature from

National Semiconductor

LM140/340: Better Specs At The Same Price

Our LM140 series of three-terminal voltage regulators now offers a combination of features that gives you a higher-performance part, but with no increase in its price.

For example, our LM140 boasts superb low-frequency ripple rejection under load—to 80 dB, typ., depending on the output voltage level; excellent high-current load regulation at high input voltages—0.60%/V; line regulation, 0.06%/V; output current capability in excess of 1 A (with an adequate heat sink for the TO-3 package); and very low thermal feedback effects. Of course, internal thermal overload protection, internal short-circuit current limiting, and output transistor safe area protection are also included.

Now look at our brand new LM340. We're the first manufacturer to offer this commercial part with line and load regulations identical to the MIL version, yet priced the same as competing, less-tightly-spec'd devices.

And we've made both the LM140 and the LM340 very easy to use—they need very few external components, and are available in a wide range of fixed outputs between 5 V and 24 V. Ask too, about our LM140A and LM340A; these feature tighter output voltage tolerances and even better line/load regulation than the LM140/340. 

Protected CD4000's

Not all CD4020/40/60 CMOS counters have Schmitt triggers on the clock inputs. Ours do. And these Schmitts eliminate the problems commonly encountered on clock inputs in the competition's devices.

The CD4020B and CD4060B are 14-stage ripple-carry binary counters; the CD4040B is a 12-stage version. All advance one count on the negative transition of each clock pulse, reset to the zero state with a logical '1' at the Reset input (independent of the clock), operate between 3 V and 15 V, run at 8 MHz (at $V_{DD} = 10$ V), and are low-power-TTL compatible (fan-out of 2 driving 74L, of 1 driving 74LS). 

Support Circuits, Faster 8080A's Added

Less than one year ago we entered the 8080A marketplace with our INS8080A—a pin-for-pin, function-for-function replacement for you-know-who's MPU. But that was only the start. Since then we've added two more versions of that microprocessor, as well as a complete family of support circuits.

The new versions of our original 2- μ s cycle time INS8080A are the INS8080A-1, which has a 1.3- μ s cycle time, and the INS8080A-2, with a 1.5- μ s cycle time.

In addition to the faster 8080A's, we now offer ten types of interface circuits to support 8080A system design.

- DP8212 is an 8-bit μ o port that you can use to implement all major peripheral and MPU μ o system functions.
- INS8255 is a programmable peripheral μ o interface that features direct bit set/reset capability.
- DP8301 is a microprocessor interface latch element (MILE) with on-chip status flags for 'handshake' control and interrupt generation. It drives TTL, NMOS, PMOS, and CMOS circuitry.
- DP8224 is a crystal-controlled clock generator and driver, which also provides a status strobe and oscillator outputs for external circuits.
- DP8228/8238 are system controller and bus driver circuits that generate all needed read/write control signals, provide drive and isolation for the 8080A's bidirectional data bus, and a user-selected single-level interrupt vector.
- DP8304 is an 8-bit bidirectional bus transceiver with high active outputs to both ports, a Tri-State[®] chip enable control, and transmit/receive control.
- INS8251 is a universal communications interface (USART) for data com-

munication in 8080A and other bus-structured systems. (Available in April.)

- DP8216/8226 are μ o buffer drivers (4-bit parallel transceivers) suited to both 8080A and general MPU applications. (Available in April.) 



Video Modulator for Display, Game Systems

Our LM1889 lets you display video information—from VTR's, games, test equipment, etc.—on any standard black-and-white or color television receiver, and also lets you encode composite video. In addition, the LM1889 together with our MM57100 and MM53104 form a complete video game system.

Consisting of sound and chroma sub-carrier oscillators, quadrature chroma

modulators, rf oscillators and modulators for any two low-band vhf tv channels, the LM1889 interfaces audio, color difference, and luminance signals to a tv receiver's antenna terminals.

The LM1889 features dc channel switching, a wide range of operating voltages, excellent oscillator stabilities, low intermodulation, and a 5-V_{pk-pk} chroma reference signal. 

Not Just Another Pretty Shift Register



We've added two National-proprietary circuits to our line of digital products—the DM86LS52 and DM86LS62 shift registers. But if you're thinking, "Ho hum, just another shift register," you're wrong. For in each 18-pin package there are two registers—an 8-bit serial type in parallel with an 8-bit i/o type.

Such a device is called an 8-bit dual-rank shift register. And what that means is that each package gives you a bidirectional circuit designed to interface parallel and serial bus lines. Thus, you can transfer 8-bits-wide parallel data to a serial line, and vice versa.

The DM86LS52 lets you synchronously clear the registers, while the DM86LS62 lets you simultaneously transfer data between the serial and parallel registers.

To duplicate such functions with standard components would require about 13 packages; a single DM86LS52 or 62 does it all, and at about half the cost.

Specifics of these new bus-oriented registers include edge triggering on the positive transitions of the clock; pnp transistor inputs; input disable dominant over output disable; Tri-State® buffered, 8-bit common i/o pins; n-bit cascadability; 36-MHz (typ.) shift frequency; and 305 mW (typ.) power dissipation. 

Second-Source 8-Bit D/A Converters

Our LMDAC08 and LM1508/LM1408 monolithic D/A converters are direct replacements for the DAC-08 and MC1508/MC1408, respectively, and carry very low prices in 100-up quantities.

These current-output D/A's feature high-speed operation (typical settling times to within $\pm 1/2$ LSB are 100 ns for the LMDAC08 and 150 ns for the LM1508/LM1408); full-scale current matching to ± 1 LSB; and typical full-scale drifts of ± 10 ppm/°C (LMDAC08) and ± 20 ppm/°C (LM1508/LM1408). Excellent reference-to-full-scale current matching eliminates current trims.

Both the LMDAC08 and LM1508/LM1408 interface directly with DTL, TTL, CMOS, etc., logic levels. They operate between ± 4.5 V and ± 18 V, and dissipate only 33 mW, typical, at ± 5 V. 

8-Bit-Wide Tri-Safe™ PROMs Increase Memory Density



The DM74S470 (open collector) and DM74S471 (Tri-State®) PROMs are Schottky-clamped, 2048-bit memories organized 256 x 8. The DM74S472 (Tri-State) and DM74S473 (open collector) PROMs are also Schottky clamped, but are 4096-bit parts organized 512 x 8.

Although the word width is 8 bits—which, by the way, is ideal for MPU applications—these memories are housed in 20-pin DIPs only 0.3-inch wide. And this means that you get the increased memory density of 0.6-inch-wide designs, but at the better packing density of older, 4-bit-word designs in 0.3-inch-wide packages.

The combination of National's Tri-Safe™ programming and advanced, low-voltage titanium-tungsten fusing assures you of extremely high programming yields and the most reliable long-term stability you can buy.

The DM74S470/471 feature address access times of 60 ns (max.), while the DM74S472/473 have address access times of 65 ns (max.). The enable access time for all these parts is 30 ns, maximum. 

BI-FET™, Integrating A/D Analog Building Block

BI-FET technology — an IC process pioneered and introduced by National Semiconductor more than a year ago (see *National Anthem*, January 1976)—combines JFET and bipolar transistors on the same chip. For our LF13300, BI-FET technology provides a unity-gain, high-input-impedance (>1000 MΩ) buffer, a comparator and integrator, and nine rugged JFET analog switches.

As a result, the LF13300's accuracy is sufficient for use in DPMs of up to 4½ digits, or in data acquisition systems of up to 14 bits plus sign. The LF13300 is in fact ideal for use with our ADB4500P BCD digital and ADB1200P 12-bit binary building blocks. (You're more familiar with these ADB parts per their older numbers—MM5330 and MM5863, respectively.)

In general, the LF13300 eliminates many discrete components and reduces system complexity. In particular, the LF13300 features automatic offset correction, an analog input range of ±11 V with ±15-V supplies, a supply range of ±5 V to ±18 V, and TTL- and CMOS-compatible logic.



APPLICATIONS CORNER

How to Build a Digital Thermometer

Analog electronic thermometers have been available for some time, but they are generally difficult to read and, besides, are relatively fragile. Digital thermometers, on the other hand, are both easy to read and rugged.

The digital thermometer described here uses a ADD2500 2½-digit DPM chip for A/D conversion and display decoding. The LM134 programmable current source operates here as the temperature sensor, and the LM555 timer as a dc/dc converter. The DS8866 and the pnp transistors drive the NSB3882 display.

The LM134 makes an excellent temperature sensor: it has a constant temperature coefficient of +0.30%/°C (0.167%/°F); and its noise immunity and current programmability make it

ideal for remote sensing use. Output-current flow through a sense resistor scales the LM134's output voltage—in this case, to 10 mV/°F, which is one count of the DPM or 1°F displayed.

Besides a +5 V input, the ADD2500 draws 18 mA from a negative supply. This comes from the dc/dc converter (at -15 V) as a regulated current via the 2N5457 FET, the LED, and the 2N3904. The negative supply of the ADD2500 is internally Zener regulated; it, together with the two diodes and the resistor string between ground and I_{EE}, establish a low-drift offset voltage for the LM134's sense resistor.

The finished thermometer requires only a single, unregulated +12 V supply, and operates from -29°C to +60°C (-20°F to +140°F).

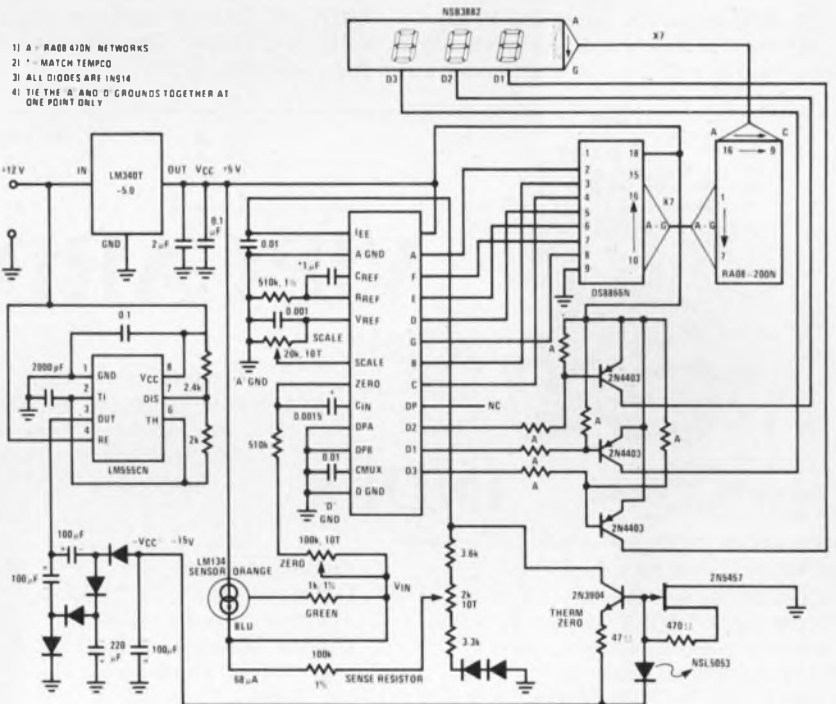

What You See Is What You Get: Chart Describes Pressure Transducers

Our new *Transducer Features Chart* shows you, at a glance, what's available in our line of IC pressure transducers.

The chart lists basic product type numbers on a vertical axis, and package options, etc., on a horizontal axis. At the projected intersection of the basic part number and the number of the option, the chart shows you the complete model number of the combina-

tion you've selected. Conversely, the absence of a number indicates that the combination you've selected is not a standard part.

So if you're working with pressure transducers, the *Transducer Features Chart* is a handy short-form guide to National's pressure transducer products. Just ask for a copy, and it's yours.

SC/MP Applications Handbook

Simple to use . . . cost effective . . . applications oriented. These terms are all descriptive of SC/MP—National's very popular single-chip 8-bit microprocessor. In support of such descriptors, National now offers the *SC/MP Microprocessor Applications Handbook*, which, in its 145 pages with 68 illustrations, defines SC/MP's internal architecture, pin-outs, and interfacing techniques—from an applications point of view.

The text also addresses the concepts, principles, hook-up details, and general implementation procedures that relate to the many applications for which SC/MP is so well suited.

The information is organized in capsule form so that the reader can use it to expand, modify, or customize a

given application. Those applications within the text are organized by class—A/D and D/A systems, keyboard/display systems, multiprocessor systems, and so on.

A great amount of general design data are also included, and the material covers the instruction set, addressing modes, I/O capabilities, interrupt structures, and other applications-related features.

The *SC/MP Microprocessor Applications Handbook* costs \$5.00 per copy. Send your check or money order—no cash, please—to Marketing Services M/S 520, National Semiconductor Corp., 2900 Semiconductor Drive, Santa Clara, CA 95051. (California residents add 6% sales tax, please; San Francisco Bay Area residents, 6.5%.)

MOS/LSI Databook

Our newest catalog is also a first edition. We've finally put together a definitive compendium of information describing our extensive line of MOS/LSI products.

This 1977 *MOS/LSI Databook*, describes our circuits for clocks, counters/timers, electronic organs, TV, A/D converters, CB radios, watches, calculators, control-oriented processors, keyboard encoders, and interface drivers, and also gives complete information about our LED displays, clock modules, and custom MOS/LSI capabilities.

It's all here—720 pages of data sheets, application notes, package drawings, definitions—and it's worth its price.

The *MOS/LSI Databook* costs \$4.00 per copy. Send your check or money order—no cash, please—to Marketing Services M/S 520, National Semiconductor Corp., 2900 Semiconductor Drive, Santa Clara, CA 95051. (California residents add 6% sales tax, please; San Francisco Bay Area residents add 6.5%.)

LED Catalog

Our new *LED Short Form Catalog* details our line of LED lamps and numeric displays.

The page headings of the ten-page catalog describe its content: Special Feature Lamps (constant current, side view, and high-lens types); Panel Indicators (red, green, and yellow); General Purpose Lamps; Numeric Displays; and Watch Display Die. For each lamp grouping the catalog shows appropriate application areas, lamp features, and the technical specifications for each lamp.

There's also a LED lamp locator that charts lens type versus lamp size, which lets you quickly locate the part number of the lamp suited to your specific needs; mounting clip information for panels and PC boards; and two pages of drawings of various mounting techniques, which name the sources of connectors and other mounting hardware. The catalog closes with a listing of National's LED segment and digit drivers, which shows, for each driver, its input compatibility, V_{out} , I_{out} , input code, and so on.

Our *LED Short Form Catalog* is free for the asking. Simply check the box on this issue's VIP card.

ED 5-10



VIP CARD

Complete card and mail to
NATIONAL SEMICONDUCTOR
 Attn: Marketing Services
 2900 Semiconductor Drive
 Santa Clara, CA 95051

INDEX

Please send me the information that I have checked:

<input type="checkbox"/> LM140/140A/340/340A Regs., Pg. A, Col. 1	<input type="checkbox"/> LMDAC08, Pg. B, Col. 2
<input type="checkbox"/> CD4020B/40B/60B Counters, Pg. A, Col. 1	<input type="checkbox"/> LF13300 A/D Block, Pg. C, Col. 1
<input type="checkbox"/> INS8080A-1/-2 MPUs/Support, Pg. A, Col. 2	<input type="checkbox"/> ADD2500 DPM, Pg. C, Col. 2
<input type="checkbox"/> LM1889 Video Mod., Pg. A, Col. 2	<input type="checkbox"/> LM134 Current Source, Pg. C, Col. 2
<input type="checkbox"/> DM86LS52/62 Registers, Pg. B, Col. 1	<input type="checkbox"/> Press. Transd. Chart, Pg. C, Col. 2
<input type="checkbox"/> DM74S470/471/472/473 PROMs, Pg. B, Col. 3	<input type="checkbox"/> LED Catalog, Pg. D, Col. 3

Please send me the literature that I have checked:

<input type="checkbox"/> AN-168 MM5856 Universal Timer Applications	<input type="checkbox"/> AN-172 Pulsed Power Supply Operation of Selected MM2102 Static RAM
<input type="checkbox"/> AN-171 PROM Power-Down Circuits	<input type="checkbox"/> AN-178 Applications for an Adjustable IC Power Regulator

Your End Product or Application: _____

Have Salesman Call YES NO

Please print clearly; this information will be used for our mailing list.

NAME _____ TITLE _____

COMPANY _____

ADDRESS _____

CITY _____ STATE _____ ZIP _____

The Simpson DIGITAL MULTIMETER FAMILY KEEPS GROWING!



**Here's our latest addition
For \$130:**

New Compact Portable Model 461
Complete with nickel-cadmium batteries, AC charger/adaptor, test leads and instruction manual

- 8 FULL HOURS continuous battery operation . . . a full day's work without interruption
- $\pm 0.5\%$ DC V accuracy ($\pm 0.25\%$ typical)
- Large bright 0.3" LED display
- Automatic zero and polarity
- 100 μ V, 0.1 Ω , 100 nA sensitivity
- 26 pushbutton selected ranges
- High energy fuse safely contained in case
- Folding bench stand
- Only 2 x 5.6 x 4.6"; 1½ lb.

ALL SIMPSON DMM'S HAVE

- Reliable overload-protected LSI circuitry
- Easy-to-read 3½ digit red LED displays with automatic polarity
- Performance proven with a 200-hour burn-in, backed up by a one-year guarantee
- Complete line of accessories is available

For \$210:

Popular Priced Model 464A

- 0.1% DC V accuracy
- 28 pushbutton ranges including 10A AC/DC
- Bright 0.43" LEDs, automatic zero
- High-impact case with tilt-view adjustable handle
- For AC line operation. Optional AC/rechargeable version available for \$247



For \$285:

Deluxe 460-3A

- 0.1% DC V accuracy, custom MOS/LSI circuitry
- 32 ranges including low power resistance ranges and 10A AC/DC current
- Bright 0.43" LEDs, automatic ZERO
- Calibrated auxiliary analog meter
- For AC line operation. Optional AC/rechargeable version available for \$322



For \$295:

Autorangeing Model 465A

- Automatically selects and displays the proper measuring range
- High 0.1% DC V accuracy, custom MOS/LSI circuitry, 0.43" LEDs
- Measures DC voltage to 1000 V, AC voltage to 600 V, resistance to 20 megohms, low power ohms ranges AC/DC current to 10A
- AC line operation. Optional AC/rechargeable version available for \$332



For \$257:

Digital VOM — the 360-2

- AC line and rechargeable operation standard
- 0.25% DC V accuracy exclusive MOS/LSI circuitry, automatic zero
- 29 ranges including low power resistance
- Calibrated zero center analog meter
- Recorder output



CHOOSE THE ONE THAT'S BEST FOR YOU
AT YOUR LOCAL ELECTRONICS DISTRIBUTOR

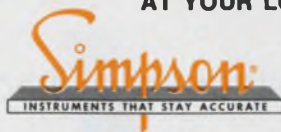

SIMPSON ELECTRIC COMPANY

853 Dundee Avenue, Elgin, Illinois 60120
(312) 697-2260 • Cable SIMELCO • Telex 72-2416

KATY INDUSTRIES



INDUSTRIAL
EQUIPMENT
GROUP

CIRCLE NUMBER 17

THE SPECTRUM ANALYSIS SPECTRUM

The HP 140 family covers it. Precisely. Conveniently. Completely. From 20 Hz to 40 GHz.

Select normal or variable persistence display or choose economy or high-resolution IF module. Then pick or change your frequency range by simply plugging in the appropriate tuning module.

20 Hz to 300 kHz

The 8556A tuner covers 20 Hz to 300 kHz and comes with a built-in tracking generator. It's calibrated for measurements in both 50 and 600 ohm systems, with accuracies better than ± 1 dB.



1 kHz to 110 MHz

The 8553B takes you from 1 kHz to 110 MHz with -140 dBm sensitivity. Signals can be measured with $\pm 1\frac{1}{4}$ dB accuracy. Choose the companion tracking generator/counter for wide dynamic range swept frequency measurements and precise frequency counting.



100 kHz to 1250 MHz

Use the 8554B tuning section to cover the 100 kHz to 1250 MHz range. Measure with $\pm 1\frac{3}{4}$ dB accuracy. Its companion tracking generator (500 kHz to 1300 MHz) also works with the 8555A tuning section.



10 MHz to 40 GHz

For 10 MHz to 40 GHz, choose the 8555A. Its internal mixer covers to 18 GHz, accessory mixer for 18-40 GHz. Maximum resolution is 100 Hz. Measure with $\pm 1\frac{3}{4}$ dB accuracy to 6 GHz, $\pm 2\frac{3}{4}$ dB to 18 GHz. For wide scans free from unwanted response between 10 MHz and 18 GHz, add the automatic preselector.



No matter what range you're working in, you need reliable unambiguous answers. HP's spectrum analyzers give you accurate measurements over wide, distortion-free dynamic ranges, time after time. Easy operation too, with front panel markings that really help reduce the possibility of operator error.

But there's much more. Call your nearby HP field engineer or write for the full story on HP's spectrum analyzer spectrum.

HEWLETT  PACKARD

Sales and service from 172 offices in 65 countries.
1501 Page Mill Road, Palo Alto, California 94304

CIRCLE NUMBER 18

Power supplies.

The HE200 Series Power Supplies offer the design engineer a low-cost, highly efficient alternative to the size, weight and heat generation problems normally associated with series-pass regulated supplies. Using state-of-the-art switching techniques and CMOS logic, the HE200 Series Supplies achieve 75% efficiency at full load.

All models in the HE200 Series have the "footprint" and mounting dimensions of the Lambda package size "B" supplies...a feature that allows the engineer to experiment with high-efficiency techniques in existing designs. In new designs, the engineer can take advantage of

the small size (1.2 watts per cubic inch) and light weight (1/2 ounce per watt) of the HE200 Series Supplies.

The highly reliable HE200 Series Supplies are all short-circuit proof, over-voltage protected, available in 115 and 230 VAC input models, and backed by a full two-year warranty.

Finally, the HE200 Series offers the design engineer considerable savings: 5 volts, 10 amps for \$195; 5 volts, 20 amps for \$295; and ± 15 volts, 1.5 amps for \$195 in single quantities.

 **Computer Products, inc.**

Distributors: Los Angeles 213-877-5518/
Dallas: 214-341-8311 • Houston: 713-780-2220

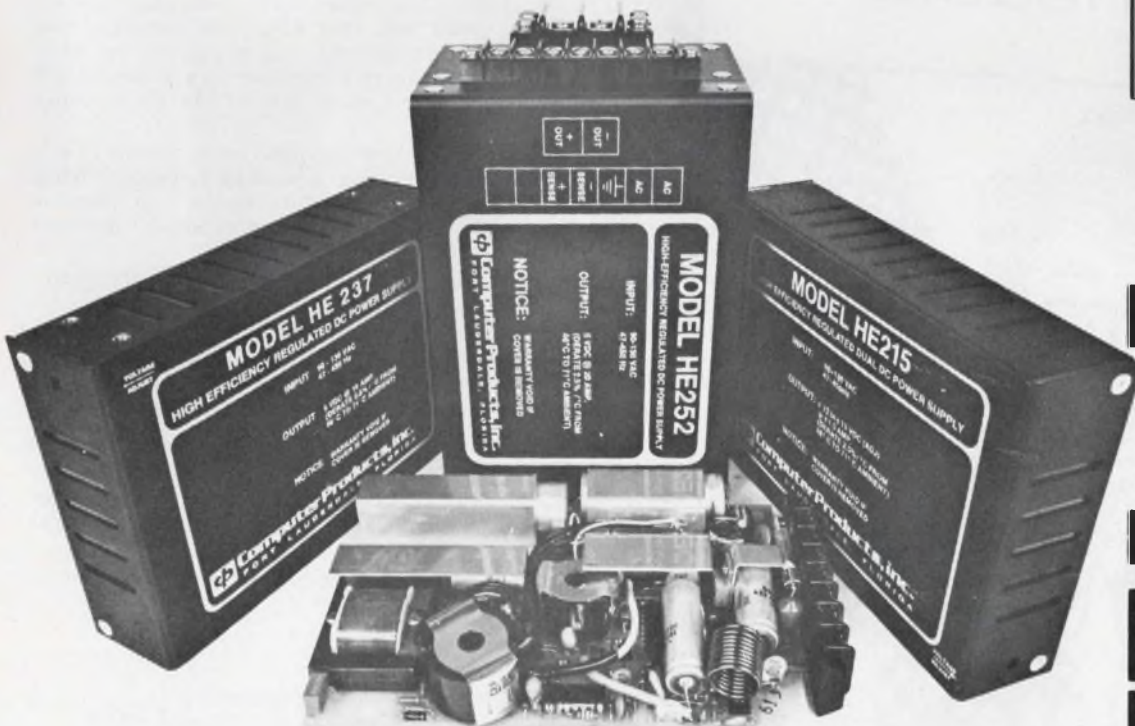

1400 N.W. 70th Street, Fort Lauderdale, Florida 33309 (305) 974-5500, TWX (510) 956-9895

CIRCLE NUMBER 19

High-Efficiency

Our REF-02's a TWOFER.



Free!

**TEMP
TRANSDUCER**

with the purchase
of each
PMI REF-02
5V reference.

FREE

5 VOLT REFERENCE
with purchase of
each PMI REF-02
temperature transducer.

At \$1.95 (100's), our new 5 Volt reference circuit, REF-02, is a good buy. But when you consider that we've wired up an unused pin to give you—at no additional cost—a temperature transducer, it's a steal. And it is very accurate, from super low (-150°C) to super high ($+170^{\circ}\text{C}$)!

Let your imagination explore the idea for a minute. Let's say your system design requires a **voltage reference**. What could you do with a free temperature sensor? monitor cabinet temperature thermal drift correction prevent thermal runaway.

The feedback signal for a temperature control loop is right here, at the REF-02.

And if you've designed in a **temperature sensor** and could use a good voltage reference (ours is very reliable—referenced to the bandgap energy of silicon) the REF-02 offers a way to simplify your design. One part doing the work of several invariably translates into savings. **Two-fer-the-price-of-one.**

WANT CHIPS?

Send a P.O. We're glad to sell REF-02 Chips. And you'll find them easy to calibrate in your hybrid. How about knowing the ambient temperature inside your package!

For data sheet, App. Note, or name of your nearest PMI distributor, write, phone or TWX us. Ask about the Twofer.



Precision Monolithics, Incorporated
1500 Space Park Drive, Santa Clara, CA 95050
(408) 246-9222. TWX: 910-338-0528
Cable MONO.

CIRCLE NUMBER 20

POWER SUPPLIES

for Logic
for Op Amps
for Microprocessors



Single, dual, and triple output supplies having output ratings from 1 to 28 volts; from 30 ma to 60 amps. A choice of performance levels, with regulation ranging from $\pm 0.005\%$ to $\pm 0.5\%$. Many provide dual and triple isolated outputs, matched or dissimilar, in both standard and user-selectable combinations. Others have balanced, tracking outputs.

The variety of shape factors and the mounting versatility of these supplies provide easy answers to mechanical layout problems. Miniaturized models are available for either PCB mounting or, with screw terminals, for chassis mounting. Narrow profile units fit into thin

spaces. Metered benchtop supplies are handy sources of power for experimental circuitry. Plug-in modules mount in seconds.

Ask for a copy of our full color, 28-page brochure. It contains complete specifications, outline drawings, prices, and — just as important — it also details our guarantee to ship within 3 days after receiving your order.

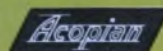

Corp., Easton, Pa. 18042 • Tel: (215) 258-5441

CIRCLE NUMBER 21

Peripheral chips add functions —and problems—to μ P systems

Peripheral chips are becoming more and more important to microprocessor systems because they provide the interface circuitry and hardware to perform functions the μ P can't handle, extending the capabilities of the CPUs themselves. In fact, over the next few years, the peripheral chips' share of the market for microprocessor-system components will grow as the CPU and memory shares decline (see graph). But as the influence and complexity of peripheral chips grow, so do the problems of testing and deciding when—and when not—to use the devices.

Running benchmarks

For one thing, it is becoming increasingly difficult to employ standardized benchmark tests to select a microprocessor. Rather than consider a CPU's features alone, many engineers are concerned with specific tasks and how easy or difficult it is to apply the microprocessor and its peripheral chips. So the peripheral chips available with one CPU may make that CPU seem more desirable than a superior CPU without the peripherals. "You can't just run a microprocessor through its paces and say it's the best," says Dan Abenaim, engineering manager of GenRad Inc.'s Electronic Instrument Division in Concord, MA.

Peripheral chips are also making it much more difficult to test microprocessor-based printed-circuit boards, says GenRad engineer Mark S. Mayes. "Peripheral chips can be more complex than processors, and there are often more of them on a board." While an 8080A CPU chip has fewer than 5000 transistor equivalents, a floppy-disc controller or a synchronous-data-link controller has the equivalent of over 22,000 transistors on a chip, says David

House, marketing manager at Intel's Microcomputer Division in Santa Clara, CA. In addition, a CRT controller contains about 15,000 transistors per chip, and even a relatively simple keyboard/display controller has about 6000, says House.

Searching for sources

Moreover, a CRT controller may represent 25 to 30 SSI and MSI chips, according to Art Gruszynski, product manager at National Semiconductor in Santa Clara, CA, which leads to another problem—alternate sources.

"We're talking about large-scale systems on a chip," says Gruszynski. "The more you do that, the more the buyer becomes dependent on the supplier." As a result, buyers are unwilling to commit to designs that use peripheral chips available from only one source.

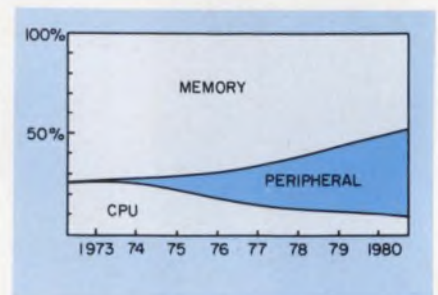

Microprocessor peripheral chips are getting so important, they will account for more than 40% of the dollar volume in μ P-system sales by 1980.

"There's still a considerable resistance in peoples' minds to buying a sole-source product," says David F. Millet, microprocessor product manager at NEC Microcomputers Inc., Lexington, MA. While NEC is the only source for some of its peripheral chips, the firm is negotiating for alternates.

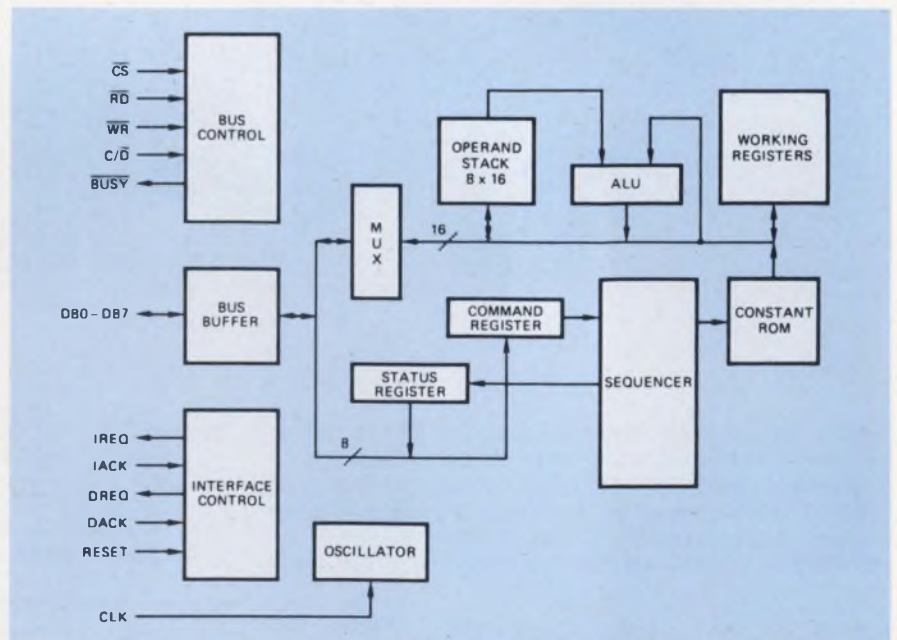

Plugging in a peripheral chip can add calculatorlike functions to a microprocessor-based system. This AMD circuit calculates trigonometric and logarithmic functions without tying up a lot of CPU time.

Andy Santoni
Associate Editor



UNIVERSAL'S NEWEST MODEM

For two-wire, full-duplex operation at 1200 BPS, Universal Data Systems proudly announces the Model 12-12, the newest addition to the UDS family of data modems. The unit operates synchronously or asynchronously over unconditioned dial-up or private telephone lines.

Terminal interface discipline with the 12-12 is identical to that commonly used for 103/113 modems. Using experience-proved phase shift modulation techniques, the UDS-12-12 transmits at 1200 BPS or any integral sub-multiple rate, without restrapping or adjustments.

The 12-12 is insensitive to word length, and it includes integral provision for automatic remote and local loopback testing. Delivery: 45 days ARO. For technical details contact UDS today.

\$600 Single Unit Price.



universal data systems

member of
IDCMA

4900 Bradford Drive • Huntsville, Alabama 35805 • Telephone (205) 837-8100 • TWX 810-726-2100

Created by Hall & McKenzie Advertising, Winter Park, Florida

And Texas Instruments is negotiating for alternate sources for its 9900-series devices.

Trading software for hardware

But sometimes peripheral chips aren't needed at all. "A microprocessor can do any job without sophisticated I/O chips, if it has enough time," says W.J. Dennehy, microprocessor-product marketing manager at RCA Solid State Division in Somerville, NJ. Peripheral chips are needed only when the CPU isn't fast enough to perform a specific task, or when there isn't enough time in the microprocessor's program to perform the function in software, says Dennehy. On the other hand, when high speed is demanded, or when the CPU has too many other tasks to perform, a universal asynchronous receiver/transmitter (UART) should be used, not software, according to Dennehy. In other cases, code conversion and formatting can be written into software. Storing a UART program in ROM costs about 32 cents—a good deal less than the cost of an additional chip, according to NEC's Millet.

If a minicomputer's CPU devotes just half its time to assigned tasks, that's too much, Dennehy says. Because the computer is employed in general-purpose systems, other, often unforeseen demands must be satisfied in the time remaining. But since, by and large, microprocessor CPUs aren't used in general-purpose applications, over 90% of the CPU's time can be dedicated to specific tasks, says Dennehy. Since operations can be handled in software, additional chips are unnecessary.

"If you're going to build a lot of something, you want to get your chip count down to nothing," Dennehy adds. That requires putting as much into software as possible.

Signetics' Weissberger agrees that some functions could be done in software, but complex tasks like synchronous data link control demand too much of a microprocessor's time and are best left to external hardware. "It takes a lot of overhead, and even the fastest bit-slice microprocessors can't do it," he says.

"The tendency is to use more and more the intelligence you're building into the system," says National's Gruszynski, so anything that can be off-loaded from the CPU should be performed elsewhere. For example, the

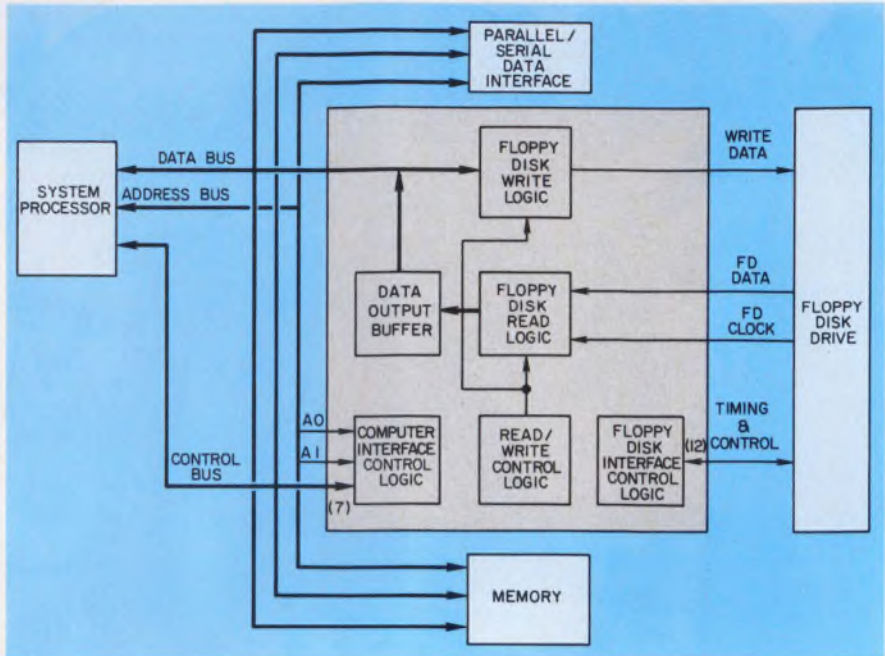

Peripheral chips tie peripherals to microprocessor systems, too. This National/Western Digital circuit interfaces a floppy-disc drive to a multiplexed three-state data bus.

microprocessor can scan a keyboard, but such a burden is better left to special-purpose peripheral chips.

Adding functions

Indeed, peripheral chips are often called upon to extend the capabilities of the CPU itself. For example, the Am9511 arithmetic processor unit from Advanced Micro Devices Inc. of Sunnyvale, CA, adds a number of calculatorlike mathematical functions to processor-oriented systems, which reduces the software necessary to perform these functions.

Besides the four basic arithmetic functions—add, subtract, multiply, and divide—the 9511 can perform trigonometric and inverse trigonometric calculations, square roots, logarithms and exponentiation and can store such constants as pi and e. Its operating mode can be either fixed point, with single or double precision (16 or 32 bits), or floating point, with single, 32-bit precision.

Like other peripheral chips, CPU extensions take some of the burden that system software would otherwise have to handle. And by quickly performing functions in hardware, they increase time in the CPU for other functions.

Without external arithmetic processors, even relatively simple operations like multiplication would be time-

consuming for most microprocessors, which perform multiplications by adding and shifting data. Some microprocessors, like Texas Instruments' TMS 9900, have built-in facilities for single-instruction multiplication, but must handle more complex calculations in software.

On the other hand, the 9511 takes data from the microprocessor, performs a function, and returns the result over an 8-bit bidirectional data bus. The device can be connected to the system through a conventional programmed I/O port, or through a faster direct-memory-access (DMA) controller.

Gaining access

The DMA controller is itself a useful peripheral device. By transferring data between memory and outside devices without passing the information through the CPU, a DMA controller, like Mostek's MK3854 for the F8, can take over some of the CPU's tasks, again leaving the microprocessor available for other operations.

In the IM6102 from Intersil Inc., Cupertino, CA, a DMA controller is incorporated with memory extension and interval-timer circuitry. A silicon-gate CMOS device that interfaces with the IM6100 microprocessor through the data bus and handshake lines, the IM6102 operates from dc to 8 MHz and



MULTI-TERM: HAPPY ENDING

Putting together a system that uses flat flexible cable? Watch out for these five key factors.

1. Cable Contacts

Insulation displacement requires a sharp edge. Any roughness or irregularity can nick the conductor and weaken it. Only SAE uses precision coining to produce a perfect contact surface.

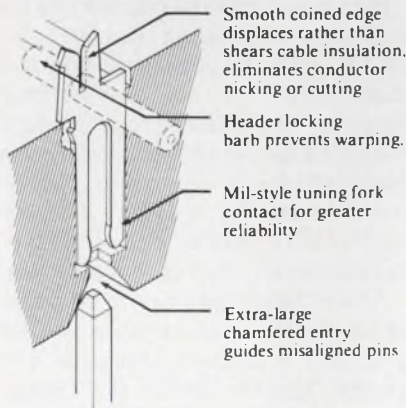

2. Mating Contacts

A lot of systems use a beam-type contact. SAE uses a military-type tuning fork configuration. It grabs the pin and produces maximum electrical reliability.

3. Header Security

Only MULTI-TERM™ contacts have locking barbs that bite into the header at every conductor position. Built-in pre-retention keeps header, contact and conductor securely mated. Vibration resistance is superior, and headers won't warp or bow.

4. Cable Quality

The best termination system in the world can't overcome irregular cable. Specify SAE ribbon cable as part of your system and you'll get more than just economy. You'll get dimensional stability.

5. Production Tooling

MULTI-TERM tooling speeds

production. Alignment is automatic, cuts and terminations are square, and the final result is as pleasing to the eye as it is effective and reliable.

SAE manufactures all the parts. PC connectors, header connectors, I/O headers, 14 and 16 pin DIP connectors and socket connectors. Tooling. Fixtures. Cable. You can buy any component you need.

Better yet, call SAE during your design phase. Let our engineers help work out a complete MULTI-TERM System for your flat cable runs. Your project, and your cable, will have a happy ending.



The OEM Connection

Stanford Applied Engineering, 340 Martin Avenue, Santa Clara, CA 95050. (408) 243-9200. TWX 910-338-0132

requires a single, 4 to 11-V supply.

The IM6102's real-time clock circuitry can be used to accurately measure and count intervals or events, as required by data acquisition and data processing systems. Similar functions can be added to 6800-based systems with the MC6840 programmable timer from Motorola Semiconductors, Austin, TX.

The 6840 has three 16-bit binary counters, three corresponding control registers and a status register. The counters are under software control and may be used to generate system interrupts as well as output waveforms.

For 9900-based systems, Texas Instruments offers the TMS 9901 programmable systems interface, which includes a real-time clock, interrupt-control circuitry, and I/O ports. An n-channel, silicon-gate device, the 9901 operates from a single, 5-V supply and has TTL-compatible inputs and outputs.

The 9901's clock consists of a 14-bit counter that functions as an interval timer by decrementing to zero, issuing an interrupt, and restarting at the programmed start value. The clock can also function as an event timer since, whenever the device is switched to the clock mode, the current value of the clock is stored in a register.

Six dedicated and nine programmable interrupt inputs are sampled and gated with their respective mask bits. If an interrupt input is active and enabled by its mask bit, the signal is passed to a priority encoder, which converts the highest priority signal to a 4-bit binary code. The code and the interrupt request are fed to the CPU at the proper clock time.

Communicating with peripherals

Besides extending CPU functions, microprocessor peripheral chips can interface the processor with external circuits and devices. These interface chips are either communications-oriented devices or circuits to interface microprocessors to such peripherals as floppy-disc drives and cassette recorders.

An example of the latter type is the FD1771 floppy disc formatter/controller from Western Digital Corp., Newport Beach, CA. An alternate source for the device is National Semiconductor Corp., Santa Clara, CA. As a formatter, the 1771 divides a disc according to IBM 3740 standards, with sector lengths of 128, 256, 512, or 1024 bytes. Discs can also be divided into non-IBM sector lengths from 16 bytes to 4 kbytes in 16-byte increments.

As a controller, the 1771 seeks any

track, restores to track zero, steps ± 1 track, reads and writes single or multiple sectors, and reads the identification field. The chip is programmed by the system's software, which—along with data, status, and control information—is transferred over a three-state bidirectional bus.

A similar floppy-disc controller, the μ PD373, is available from NEC Microcomputers Inc., Lexington, MA, along with the μ PD371 tape-cassette controller, which contains the circuitry needed to read data from, write data into, and control the motion of a digital cassette recorder. The μ PD371 also converts data from 8-bit parallel to phase-encoded format, and vice-versa, as well as generates and detects cyclic-redundancy check (CRC) codes.

Chips by type, too

Some peripheral chips complement particular microprocessor types. Intel offers a line of devices for its microprocessors, Motorola for its 6800, Zilog for the Z-80, Fairchild for the F-8, and Mostek for its versions of the Z-80 and F-8. Other chips can be used with any microprocessor, or at least with any that has an 8-bit bidirectional data bus. And some more general-purpose products, like analog-to-digital and digital-to-analog converters, can be considered microprocessor peripheral chips when they are applied in μ P-based systems.

Many of the latest converters are designed with microprocessor-based systems in mind, among other systems, says Ivar Wold, director of systems development at Analog Devices, Norwood, MA. The converters' digital-data terminals have three-state, byte-addressable configurations to minimize interface circuitry by permitting direct connection to the bidirectional data bus of the microprocessor.

Even where multiple converters are necessary, interfacing can be simplified with a peripheral-interface adapter (PIA) like the MC6820 from Motorola, says Dave Kress, product-marketing specialist at Analog Devices Semiconductor in Wilmington, MA. As shown in the figure, eight d/a converters can be interfaced to a 6800-type microprocessor through a single PIA.

Where digital data are to be transmitted to other devices, such as CRT terminals, a common approach is to process signals from the microprocessor through a UART. Asynchronous systems are simpler than synchronous systems, especially when a UART is employed. "A UART saves

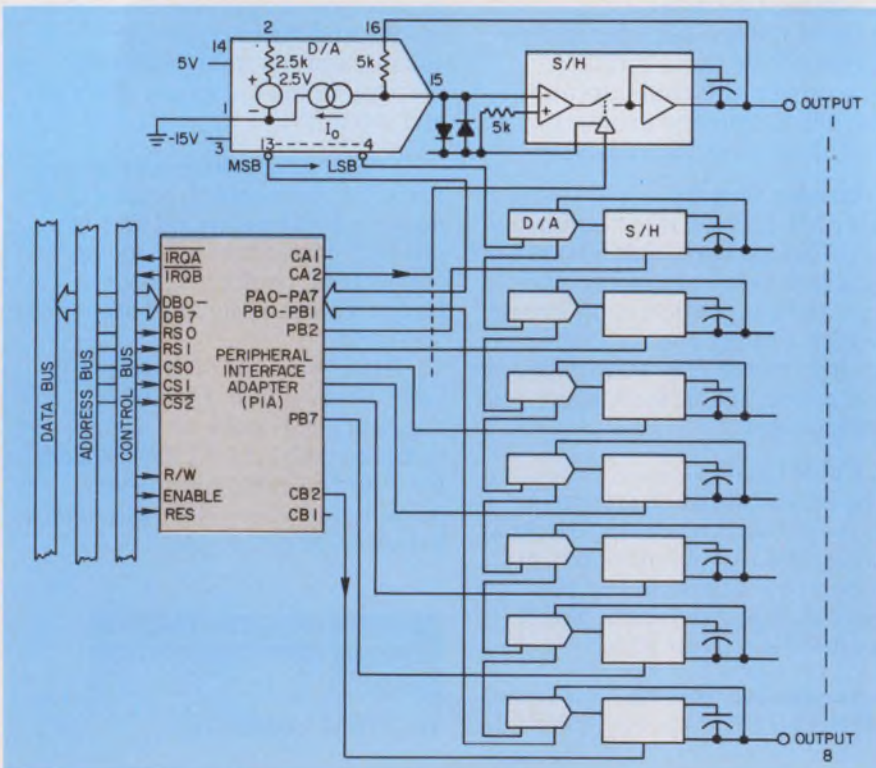

Talking to the analog world is simplified by feeding μ P digits through a peripheral interface adapter to as many as eight digital-to-analog converters.

COMPATIBILITY!

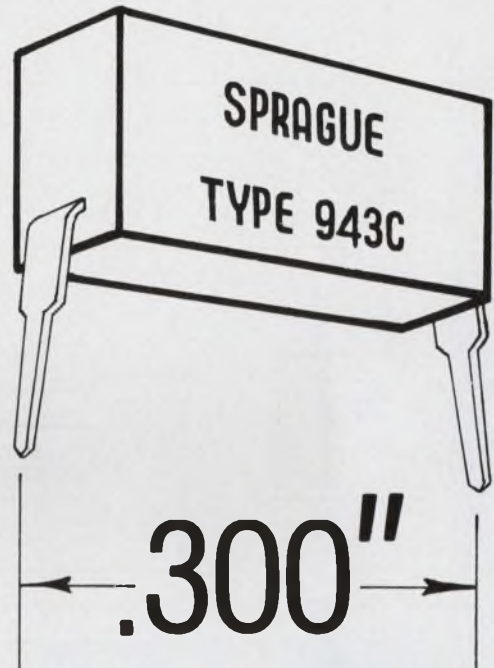
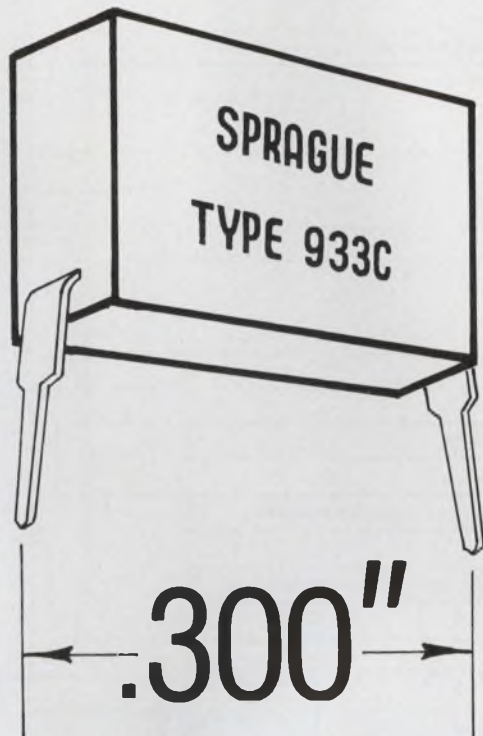

YOU CAN GET THESE MONOLYTHIC® CERAMIC CAPACITORS FROM SPRAGUE TODAY. . . AND IN VOLUME! WE HAVE BEEN MAKING 2-PIN DIP-STYLE* CAPACITORS FOR MORE THAN FIVE YEARS. WE HAVE THE PRODUCTION CAPABILITY AND THE PRODUCTION EXPERIENCE TO FURNISH YOU WITH THE CAPACITORS YOU NEED NOW . . . WHEN YOU WANT THEM!

Type 933C DIP Extended Range

Multi-layer construction. Moisture-proof molded case. Formulations available to meet temperature characteristics COG (NP0), X7R (semi-stable), and Z5U (general-purpose). Capacitance values to $.1\mu\text{F}$ at 100 V, to $.22\mu\text{F}$ at 50 V, to $.47\mu\text{F}$ at 25 V. Series 930C also includes 4, 8, 14, and 16 pin multiple-section dual in-line capacitors.

Type 943C DIP Low Profile

Identical in construction and electrical performance to Type 933C except for lower height, providing even greater compatibility with standard DIP integrated circuits. Capacitance range: 47pF to $.056\mu\text{F}$ at 100 V, to $.15\mu\text{F}$ at 50 V, to $.33\mu\text{F}$ at 25 V. Series 940C also includes 4-terminal ultra-low-inductance capacitors as well as 4, 8, 14, and 16 pin multiple-section dual in-line capacitors.

For more information on these and other Monolithic® Ceramic Capacitors, write for Engineering Bulletin 6242B to: Technical Literature Service, Sprague Electric Company, 347 Marshall Street, North Adams, Mass. 01247.

***Sprague puts more component families into dual in-line packages than any other manufacturer.**

CIRCLE NUMBER 24



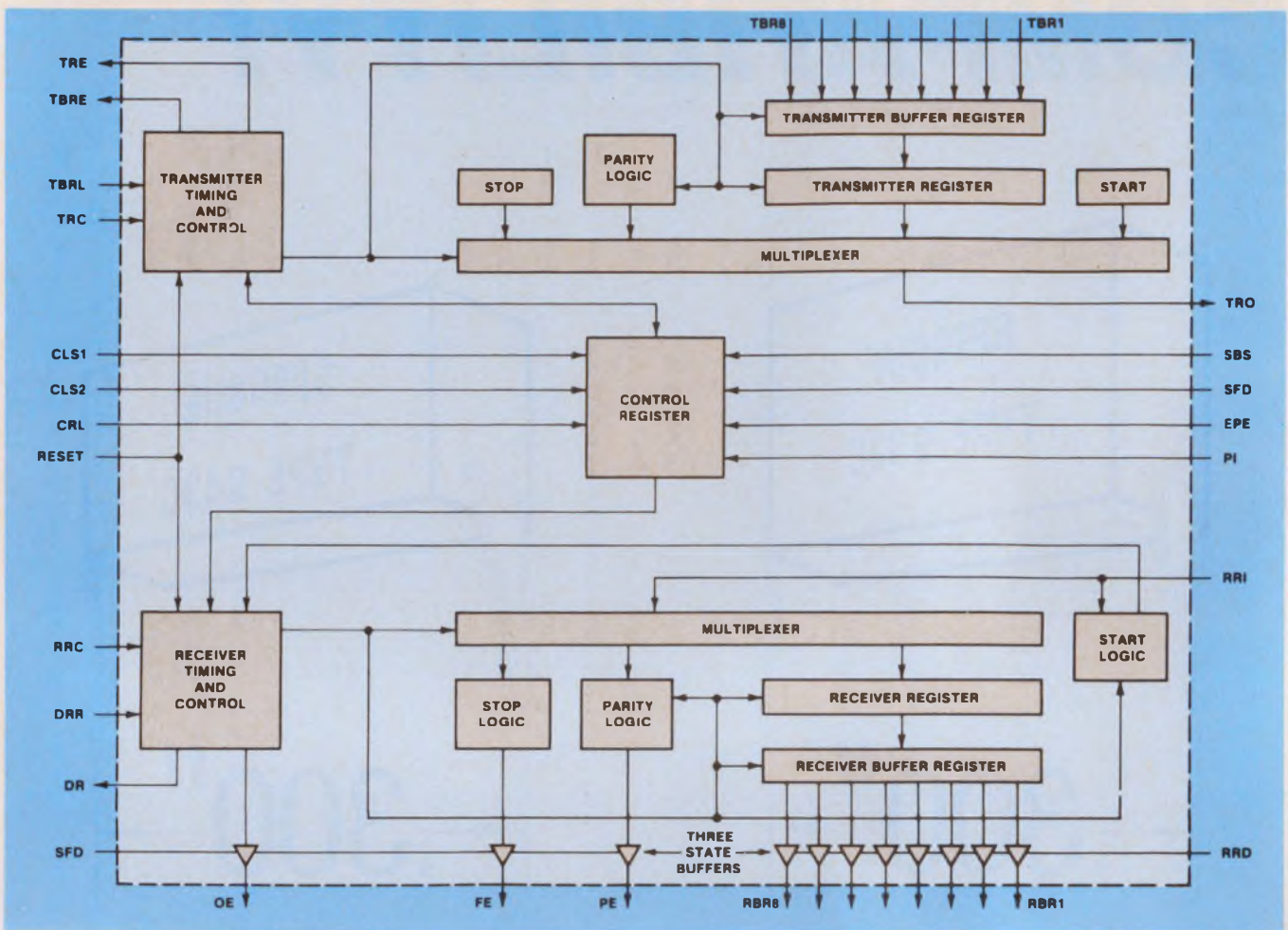

When digital data are transferred from one system to another, as from a CRT terminal to a microcomputer, the number of lines needed can be cut by employing an

asynchronous receiver/transmitter such as the HD-6402/HD-6403 from Harris Semiconductor, shown here, to convert from parallel to serial and back.

logic cost," explains Ed Zander, product manager for the Micro Nova line at Data General Corp., Southboro, MA.

Pin-compatible synchronous and asynchronous control devices represent Texas Instruments' approach to receiver/transmitters. Instead of using a serial interface with the processor, the TMS 9902 asynchronous and TMS 9903 synchronous controllers interface directly to 8-bit buses and operate from single, 5-V supplies. Because the 9902 is housed in an 18-pin package and the 9903 in a 20-pin package, a board design that leaves space for 20 pins can accept either device. So by simply changing one IC and the program, a designer can change from synchronous to asynchronous links. This can be less expensive than incorporating a universal synchronous/asynchronous receiver transmitter, with its 40-pin package, into a system, says Tom Miller, TMS 9900 program manager at TI in Houston, TX.

Even the latest microprocessors, like Intel's single-chip 8085, have per-

ipheral chips available. For CPU functional expansion, Intel offers timer, direct memory access, and interrupt controller chips. There are general-purpose I/O devices, universal synchronous/asynchronous receiver/transmitters (USART), and memory interfaces.

Aiming at common needs

In addition, Intel has just begun production of peripheral chips that perform "the four functions we found most prevalent," says Intel's House. The 827X peripheral series includes the 8271 floppy-disc controller, the 8273 synchronous data link controller, the 8275 CRT controller, and the 8279 keyboard and display controller.

The 8271 can control two single-sided for one double-sided drive in an IBM 3740 soft-sectored format. If the sectors are assumed to have no faults, the 8271 can drive four units. Programmable functions include record length, step rate, settle time, head-load time,

and head-unload index count.

The 8275 CRT controller has screen and character formats that can be programmed by feeding data into the device's registers. The registers appear to the microprocessor as if they were memory locations. In addition, the controller can detect light-pen outputs for changing data on the CRT screen.

Among the peripheral chips available for the Z-80 microprocessor, from Zilog and Mostek, are the Z80-PIO parallel I/O controller and Z80-CTC counter-timer. The interrupt control logic for these devices is included on the chip, so a separate interrupt controller chip is not always necessary when they are employed.

The latest Z-80 peripheral chips include a serial I/O controller and a direct memory access circuit. The DMA chip controls data transfers between two ports, which may be either system memory or peripheral I/O devices. The circuit can also search a block of data for a particular byte, with or without a simultaneous transfer. ■■

DP Dialogue

Notes and observations from IBM that may prove of interest to the engineering community.

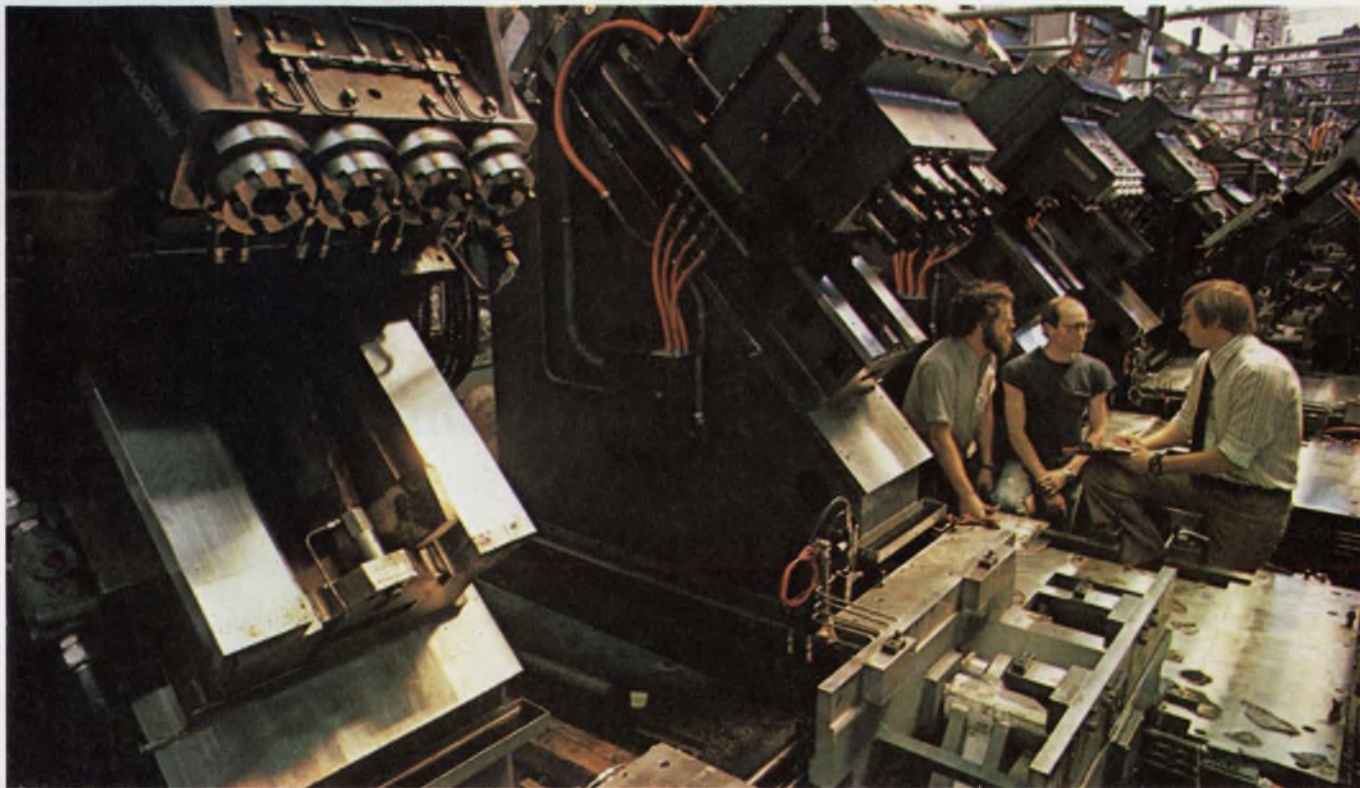

Work stations of an Ingersoll transfer machine. The transfer slides are at the bottom of the picture. Visible here is part of one section of a large machine which will make transmission cases.

Simulation Makes Giant Transfer Machines More Efficient

Computer simulation is helping huge transfer machines achieve as much as 15 percent higher productivity.

Robert Callahan, president of Ingersoll Manufacturing Consultants, attributes recent gains to an IBM computer program called General Purpose Simulation System V (GPSS V). It can be used in modeling a broad range of business activities, including manufacturing, physical distribution and transportation.

Callahan's group is a subsidiary of Ingersoll Milling Machine Company, Rockford, Ill., and is separate from that company's machine tool business. It helps manufacturing clients around the world to increase their return on investment and reduce costs.

Transfer machines finish rough cast-

ings into complex pieces such as engine blocks. They are named for the transfer mechanisms which automatically move the workpieces through successive 'stations' where cutting is done.

"If a line were built as a single straight-through train of work stations," Callahan says, "every stoppage would quickly bring the entire machine to a halt. So we lay it out in several sections, each supplied from a 'bank' of workpieces which can be drawn upon when upstream sections are stopped. How close a line comes to its production potential is determined by such factors as the number of sections and the size and placement of the banks.

"It is vital," he adds, "to design the section split and the banks correctly be-

fore the line is built. But there is no straightforward analytical way to calculate performance in advance. Simulation by computer is the ideal tool for this kind of problem; with a GPSS model of the entire line, we can test proposed layouts quickly and easily."

Callahan's group runs its simulations on an IBM System/370 Model 145 operated by the parent company.

"In designing a line," he adds, "we manipulate the computer model to work our way toward the best configuration. We try different layouts, section splits, banking arrangements and tool placements. GPSS lets us model the characteristics of each tool in detail; the resulting model behaves remarkably like the real transfer line."

Computing Power for Engineers

Design engineers can now access the computer directly through terminals in their offices to test tentative structural configurations, run simulations and develop improved designs. A growing number of companies are raising engineering productivity with IBM interactive computing facilities.

A user at a terminal can activate a previously prepared program stored in the computer. Or he can create a problem-solving routine to meet the need of the moment, using one of the simple-to-learn but powerful programming languages.

Facilities exist for presenting a computation as a curve, bar chart, histogram or frequency distribution on the screen of an IBM 3277 Display Station. In lengthy computations, intermediate results can be displayed, allowing the user

to watch the trend and terminate an unpromising trial.

Often, the user of the computer finds that a calculated result suggests further trials with new parameter values, approaching an optimum solution iteratively. With interactive computing, the user can obtain multiple job "turn-arounds" in a short time, rather than one or two a day.

Programs can be written for one-time use or to be kept in direct-access storage and invoked whenever needed. Such programs can be as large as a complex system simulation or as small as the evaluation of a simple expression. The computing power is always on tap, whenever it can be useful.

Facilities available from IBM bring interactive computing capability to any System/370 installation.



Simple instructions can specify graphic display (above, bar chart) of interactive computing results.

Computer Cuts Water Use More Than 30% for Farmers

Irrigation is vital to crop production in the Great Plains. The more water applied, the greater the production—up to a point. After that, water and energy are wasted and nutrients are leached out of the soil. Intuitive methods of scheduling irrigation usually lead to over-watering—or, in some cases, underwatering.

"With the help of a computer, a growing number of farmers in this area are achieving water and energy savings of 30 to 40 percent," says Paul Fischbach, extension irrigationist at the University of Nebraska.

These farmers are using one of more than 100 programs available in AGNET (Agricultural Computer Network), a re-

mote-access computer service developed at the university.

They obtain assistance through terminals in many locations throughout the state. When a farmer enters the word 'Irrigate' an IBM computer in Lincoln responds by requesting current information on his field. He enters daily temperatures, rainfall, amount of irrigation applied and soil moisture readings since the previous update.

When the farmer has keyed in all the requested weekly data, the computer uses up-to-date weather statistics for the region and the stored characteristics of the farmer's field to determine a suggested irrigation schedule.

At the university's Institute of Agriculture and Natural Resources, James G. Kendrick, professor of agriculture economics and Thomas L. Thompson, professor of agricultural engineering, lead the continuing development of the online AGNET system, implemented on an IBM System/370 Model 158 at the Nebraska State Department of Administrative Services.

Another AGNET program helps livestock growers calculate optimum feed mixes or formulas. For maximum growth rate, the nutrition requirements are different for various species and change as the animal grows. For example, AGNET identifies 13 different nutritional balances for beef cattle.

To develop a minimum-cost mix of cattle feed that meets nutritional and palatability requirements, the computer asks what ingredients are to be considered, and at what prices. The farmer enters his own prices or uses those in the AGNET data base.

He can ask the computer "what if" questions, test his decisions against hypothetical price and cost fluctuations, and calculate the total costs of crop production under different management techniques. A financial program analyzes investment in capital equipment, using any desired cost and performance assumptions. Other programs recommend pest control schedules, make fertilizer recommendations based on soil analyses and simulate the growth of livestock.

"The computer," Kendrick notes, "is becoming an important tool for improving the economics of farming in this area."



Nebraska farmer Kenneth Bruns takes a reading of soil moisture, one of the variables considered by AGNET in the calculation of an optimum irrigation schedule.

Designing Supersonic Aircraft with a Light Pen

The complex shape of a supersonic aircraft fuselage appears in crisp white lines on a CRT screen. The design engineer seated at the terminal presses a few keys and the image of the craft's landing gear unfolds into the extended position.

But the engineer observes some interference between the landing gear and the fuselage. Swiftly he touches keys and moves a light pen across the surface of the screen. As he works, the shape of the fuselage alters slightly, and when the landing gear descends again it is clear of all obstructions.

The scene is McDonnell Aircraft Company, where the engineer and his colleagues design high-performance aircraft. He is seated at one of 30 IBM 2250 Graphic Display Terminals in the St. Louis headquarters of the McDonnell Douglas Corp. subsidiary, using a graphics processing computer program called Computer Aided Design and Drafting (CADD, pronounced "caddy"). Created by McDonnell, CADD runs on two IBM System/370 Model 168 computers.

"We can sometimes identify engineering productivity gains of ten to one or more," says Stanley LaFavor, director of computer-aided technology. "In one instance, our engineers solved in two days a problem in landing gear placement which we couldn't have solved manually in six months.

IBM Interactive Languages for Engineers

Three IBM programming languages are designed specifically for problem-solving by engineers and other non-data processing professionals:

1. **VS APL** A broadly applicable interactive language, simple to learn, yet uniquely powerful for scientific and mathematical problems.

2. **VS BASIC** Powerful for a wide range of problem-solving, and flexible without sacrificing simplicity.

3. **VSPC FORTRAN** Permits problem-solver to create and invoke FORTRAN programs directly. The user enters data and receives results at the terminal.

For more information on these languages, write to the address on the right.

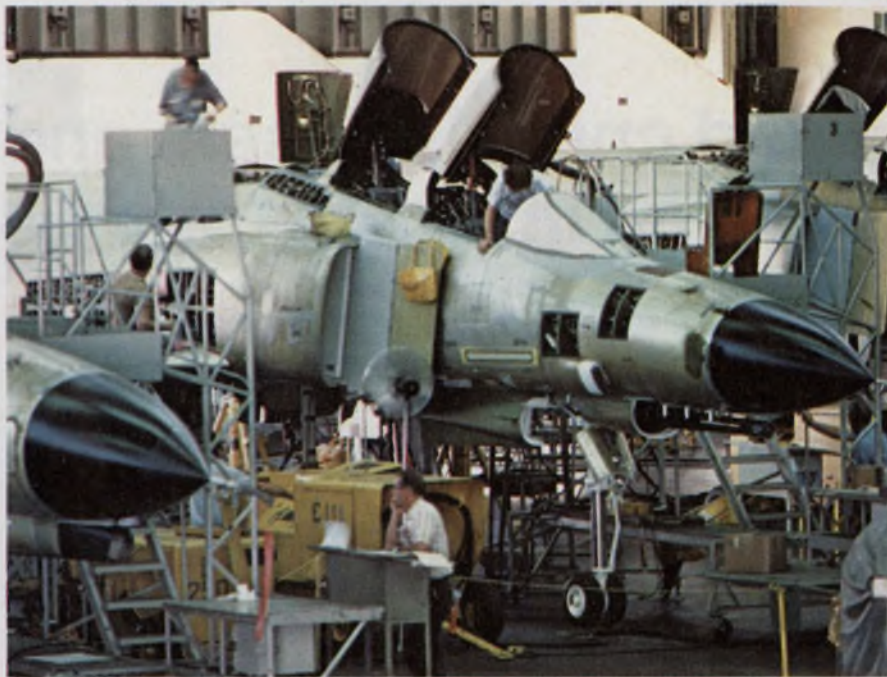

McDonnell Douglas engineers design structural components of these high-performance aircraft, working interactively with the computer at graphic terminals.

"Overall, we see an average engineering productivity gain of six to one," LaFavor adds, "and we are accomplishing many engineering tasks with CADD today that couldn't be done any other way. Formerly, with these difficult design problems, we had to take the first solution that would work; now we can find the best one."

A remarkably sophisticated graphics processor, CADD permits the engineer to display sight lines (indicating, for example, the unobstructed view from the pilot's seat), or to display any desired cross section of any geometric shape he has defined to the computer. Not only landing gear but any articulated part—hinged doors in compound-curved surfaces or an in-flight missile launching system—can be displayed and its motion in space delineated and checked for interference.

CADD displays three-dimensional shapes in trimetric projection, a type of perspective frequently used in drafting. The system can rotate a projection around any selected axis, move it in any direction or change its scale. The user defines a geometry and commands system functions by means of the light pen, the keyboard of the 2250, and a set of pushbuttons which control powerful graphics functions in the CADD program.

CADD permits structural components of the aircraft to be designed in detail at the terminal. To configure a fuselage bulkhead, for example, the engineer asks the computer to display the desired cross-section of the fuselage and

to subtract the skin thickness to arrive at the exterior shape of the bulkhead. He then works out the machined shape—webs, flanges, lightening holes—using the light pen and the keyboards.

In addition to its graphics capabilities, CADD serves as the core component of a related set of computer programs supporting all aspects of structural design of an aircraft. These subsystems are linked to one another by the CADD data base, in which all details of the aircraft are accumulated as design progresses. One subsystem generates loft lines; others perform structural analysis and calculate the weight and structural dynamics as the detailed components of the craft take shape. A third calculates the operational performance of the hypothetical aircraft.

"We've eliminated much that is time-consuming and repetitive in engineering," says LaFavor. "Our major thrust has been to improve the flow of data from engineering to manufacturing, saving downstream dollars."

DP Dialogue is designed to provide you with useful information about data processing applications, concepts and techniques. For more information about IBM products or services, contact your local IBM branch office, or write Editor, DP Dialogue, IBM Data Processing Division, White Plains, N.Y. 10604.

IBM®

Data Processing Division

Liquid crystals, lasers and μ Ps reflected in tomorrow's displays

"Innovative" is the key word to describe a host of new displays at the recent Society of Information Display's International Symposium in Boston. Prototype systems discussed incorporate the latest technological developments—lasers, liquid crystals, magnetic and electrical particles, microprocessors and so on. Key developments include

- A 2000-character thermally addressed liquid-crystal projection display, which avoids the use of bulky, liquid-cooled lasers and inefficient transmission-type cells by substituting a room-temperature gallium arsenide laser and an efficient reflective-type liquid-crystal cell.

- Rotating-particle panels, which have an inherent memory and require low operating power, and are appearing as either electrostatically or electromagnetically operated devices.

- Multiple displays on a terminal, an emerging design trend that reflects the increasing processing power being incorporated in terminals through powerful microprocessor architecture.

Experimental liquid-crystal displays have been developed that have cooled solid-state lasers that scan patterns on transmissive liquid-crystal screens. But an experimental 2000-character, laser-driven display developed by IBM incorporates two improvements: a room-temperature, gallium-arsenide laser and a reflective liquid-crystal cell. The room-temperature laser simplifies system design. And scanning the liquid-crystal cell's aluminum reflective layer provides maximum absorption of laser power.

The IBM system can display 20 characters per second. Cell data can be bulk-erased by applying a 200-V, pk-pk ac field, and selectively erased by combining a 50-V, pk-pk ac field with laser scanning.



Gallium arsenide laser (in tweezers) mounts on heat sink inside laser module for IBM's liquid-crystal projection display system.

The cell is constructed with smectic crystals sealed between two glass plates, with the reflecting aluminum coating deposited on the inside rear plate. The internal surfaces of the glass plates are treated with plasma-deposited silicon dioxide, according to Dr. Anthony G. Dewey, staff member at IBM, San Jose, CA. This treatment aligns the individual liquid-crystal molecules, shaped like cigars, parallel—not perpendicular—to the glass-plate surfaces.

The liquid crystal is a mixture of octyl cyanobiphenyls. To prevent changes in the laboratory ambient that would alter cell characteristics, the cell is stabilized at 60 C.

In experiments, the parallel alignment of the liquid crystals proved most sensitive to the energy in the laser beam, which was focused on the rear,

internal aluminum surface of the cell. A pair of X-Y galvanometer mirrors scan the focused beam across the cell in a top-to-bottom raster.

Fabricated at the IBM Yorktown Research Laboratory, the gallium-arsenide laser is a double-heterostructure device with a junction width of 12 μ m. The laser and its drive circuitry are contained in a vacuum inside a laser module (see photo). Heat-sink temperature is maintained at 8 C (46.5 F) by a thermoelectric cooler.

Power density in the laser-beam spot is 1.1×10^{-4} W/cm². The spot on the aluminum surface struck by the beam heats up, which scatters the crystals and changes the contrast at that point. The contrast ratio obtained from the cell itself is measured at 40:1. Because the optics used for the IBM setup were not designed for the project, only 2 to 3 mW from a 15 to 25 mW laser output can be focused into a 3×15 - μ m spot on the aluminum surface. The picture elements of the cell itself are 10 μ m square, and the field of the laser system is about 7 mm. The result is a square picture of 500×500 elements, or 40 rows of 50 characters.

With a writing rate of 20 characters/s, only 35% of the time is used for actual writing, while 65% is used for flyback to give a picture-element-area scan of 280 μ s. But since the laser is pulsed during this period for 120 μ s of "on" time, the laser is being used only 15% of the total time.

The writing rate strongly depends on the laser power. But Dewey points out that refinements to the present system can increase the rate to 100 characters per second. What's more, using multiple lasers to write separate lines at 1000 characters per second is feasible, Dewey insists.

The laser beam is applied to the rear of the cell, and light from a 500-W tungsten projection bulb is focused on the front of the cell (see Fig.). The image is produced by the on-axis system. Black characters are presented on

Jim McDermott
Eastern Editor

Announcing the first major advance in magnetic shielding in 50 years.

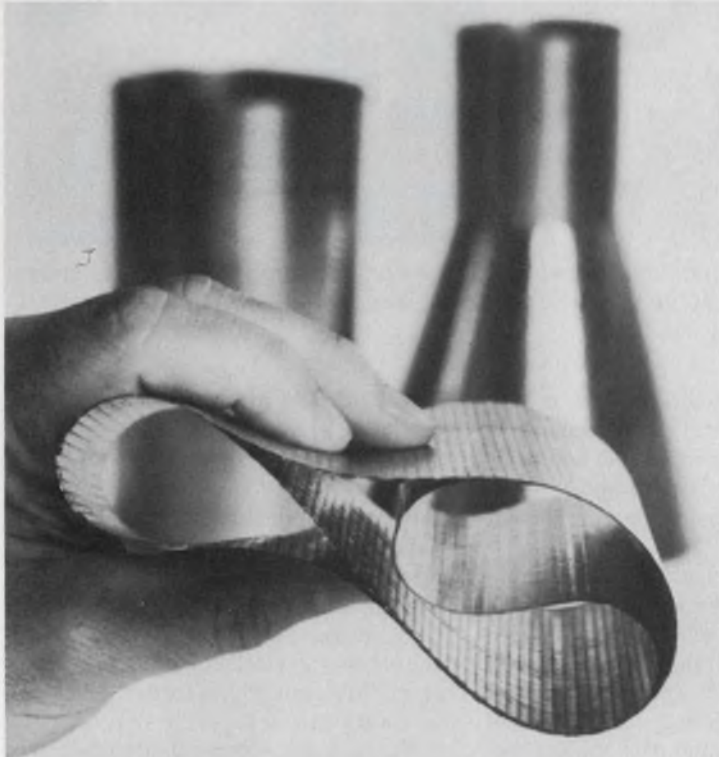

METSHIELD™ Fabric

the first magnetic shielding product made from METGLAS® alloys. METSHIELD fabric can be handled and shaped without performance degradation.

Now you have such a shielding. It's METSHIELD™ magnetic shielding fabric—a wholly new flexible product made from Allied Chemical's METGLAS® amorphous metal alloys.

Because of its exceptional strength and flexibility, METSHIELD fabric retains its full shielding effectiveness during fabrication and use.

This reliability of performance—plus the ease with which METSHIELD fabric can be handled and shaped—promises you a significant reduction in the overall cost of shielding.

You can use METSHIELD fabric for a variety of applications, including cathode ray, photomultiplier, vidicon, and image tubes.

To find out how METSHIELD fabric can help solve your shielding problems, phone John Dismukes at 201-455-4031 or Jack Thorp at 201-455-3306. Or send in the coupon.

The time is right for a revolutionary concept in magnetic shielding.

Increased sales of electronic equipment, a trend toward miniaturization, and intensified regulatory considerations have put increased emphasis on electromagnetic compatibility.

Consequently, electronics manufacturers need cost-effective magnetic shielding not plagued by fabrication problems and use limitations associated with conventional nickel alloys.

Send me information on METGLAS® alloys and METSHIELD™ fabric.

Name/Title _____

Company _____

City/State/Zip _____

Mail to Metglas Products, Allied Chemical Corporation
7 Vreeland Road, Florham Park, NJ 07932



a white background by using an off-axis telecentric Schlieren lens.

The image of the liquid crystal cell can be combined by interposing a slide in the projection system. A relay lens creates an image of the liquid-crystal cell in the plane of the overlay slide. The combined image is then projected at 25-X magnification onto a rear-projection screen. The slide image is 10-in. square and has high resolution and full color. The dynamic liquid-crystal cell information appears as a central 5-in.-square image with black characters. The 40:1 contrast ratio of the cell is reduced to 8:1 by a combination of the $f/7$ Schlieren system and scattered and reflected light reaching the screen with the present setup. Maximum screen brightness is 45 ft L.

An M6800 microprocessor modulates the laser-drive current and the selective erase field, and also drives two d/a converters to provide inputs to the galvanometer servos. Some 750 bytes of control program are stored on two EPROMs, and 1 kbyte of RAM stores the alphanumeric. ASCII code from the keyboard of a RAM controls a sampled ROM to give the correct bit sequence for any of the sixty-four 7×9 -dot characters.

Electric field drives display

Meanwhile, a number of other methods have been explored to produce ambient-light displays changing color or reflectivity. A new one, the Gyricon, developed at the Xerox Research Center, Palo Alto, CA, uses an electrical field to rotate dielectric balls encapsulated in a thin sheet of silicone elastomer. Hemispherically colored black and white balls are contained in individual, oil-filled cavities.

The Gyricon display, which promises to be both reliable and inexpensive, has a memory: Once the balls are rotated by the field, they remain in that position when the field is removed. Power consumption is limited to the capacitive displacement current associated with the switching of the display.

To fabricate the display, white glass balls are made by melting titanium dioxide—one of the whitest substances known—into the surfaces of the micron-sized glass spheres. Halves of the spheres are then coated with a proprietary black dielectric layer put on by vacuum deposition.

The spheres are then mixed with an uncured elastomer, like silicone. But organic elastomers can be used as well, points out Nicholas K. Sheridan, prin-

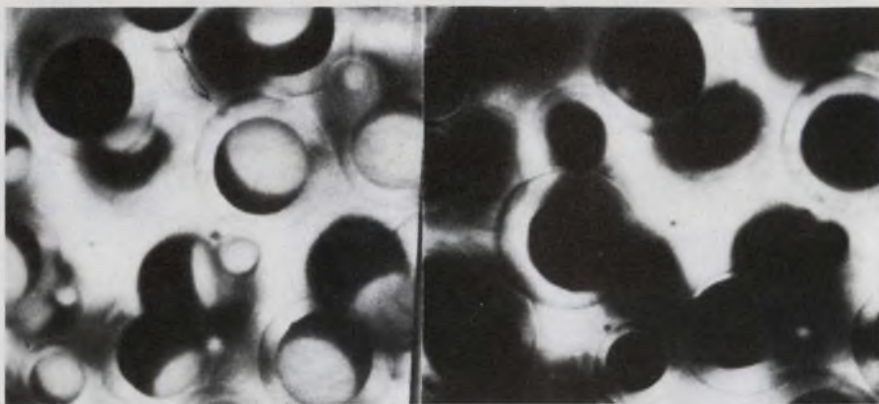

Hemispherically coated microspheres of Xerox' Gyricon system rotate under the influence of an electric field to give a black or white display. Spheres float in encapsulating liquid.

cipal scientist at the research center. The elastomer carrying the spheres is spread out into a thin sheet and heat-cured. The sheet is then immersed in a dielectric liquid—an organic solvent or an oil.

Acting as a plasticizer, the liquid swells the rubber sheet typically to more than 50% of its original cured volume. Although the elastomer swells isotropically and spherical cavities form around each ball, the cavities fill with plasticizer and the spheres become free to rotate in the liquid. When the spheres are rotated by electrical charges, the liquid also serves to dampen the oscillation of the spheres about their equilibrium positions.

The titanium dioxide and the black hemispheres have different contact potentials with respect to the dielectric plasticizer. And liquid ionic double

layers develop with different surface-charge densities and/or signs associated with the two hemispherical surfaces. Part of the charge resides in the liquid and part on the spherical particle, Sheridan explains. When an electric field is applied, the charge on the surface starts moving in one direction and the particle starts moving in the other—an electrophoretic phenomenon. Consequently, a torque develops to rotate the ball.

The torque is proportional to the sine of the angle between the pole of the ball. The direction of the electrical field orients the ball so that either the light or dark hemisphere faces an observer. Reversing the field reverses the orientation of the ball.

Both particle diameter and applied voltage influence switching time. After switching, the balls retain their orientation within the cavities for days. An X-Y grid of conductors can provide the switching medium.

Because plasticizing with a low-volatility liquid is permanent, it is not necessary to seal a display cell further. This method lends itself to low-cost manufacture.

Rotating spheres give images

Another flat-panel display that produces images by the rotation of hemispherically colored black-and-white microspheres is the Magnetic Particles Display being developed by Magnavox, Fort Wayne, IN. The magnetic display is a matrix-addressable device with free-moving magnetic spheres, each of which is a tiny permanent magnet (see photo). The amount of ambient light reflected by the particles is a function of particle orientation, which is controlled by a magnetic field.

The latest panels developed by

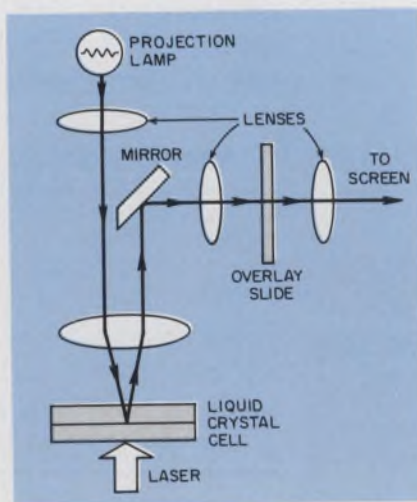

Laser beam strikes rear surface of liquid-crystal cell in IBM display. Projection lamp bounces light off front of cell, and optics project cell data onto screen.

again



New 1400 page 3rd edition Semiconductor Data Handbook from General Electric...leading supplier of transistors, unijunctions, diodes, optoelectronics, rectifiers, varistors, SCR's and triacs.

To get your copy, contact any authorized GE distributor, GE Electronic Components Sales Office, or send \$6.95 plus tax to GE Semiconductor, Electronics Park, 7-49 Syracuse, N.Y. 13201.

In Europe send £ 6 to ETC, County Louth Dundalk, Republic of Ireland.

GENERAL  ELECTRIC

giga-trim capacitors for microcircuit designers

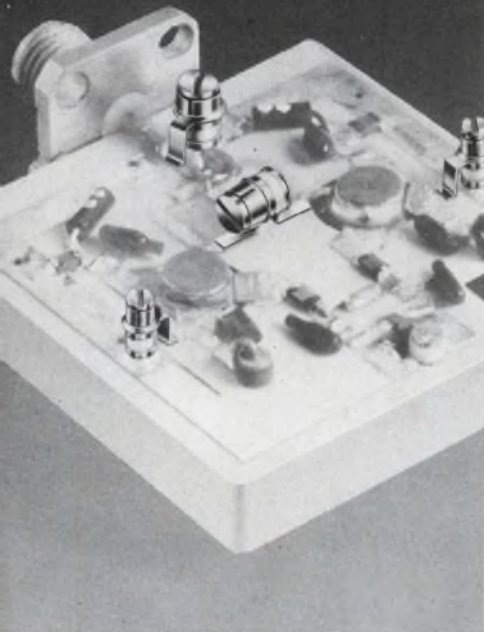

Giga-Trim® (gigahertz-trimmers) are tiny variable capacitors which provide a beautifully straight forward technique to fine tune RF hybrid circuits and MIC's into proper behavior. They replace time consuming cut-and-try adjustment techniques and trimming by interchange of fixed capacitors.

Applications include impedance matching of GHz transistor circuits, series or shunt "gap-trimming" of microstrips, external tweaking of cavities, and fine tuning of crystal oscillators.

Johanson

MANUFACTURING CORPORATION

BOONTON, NEW JERSEY 07005

201 / 334-2676

CIRCLE NUMBER 27

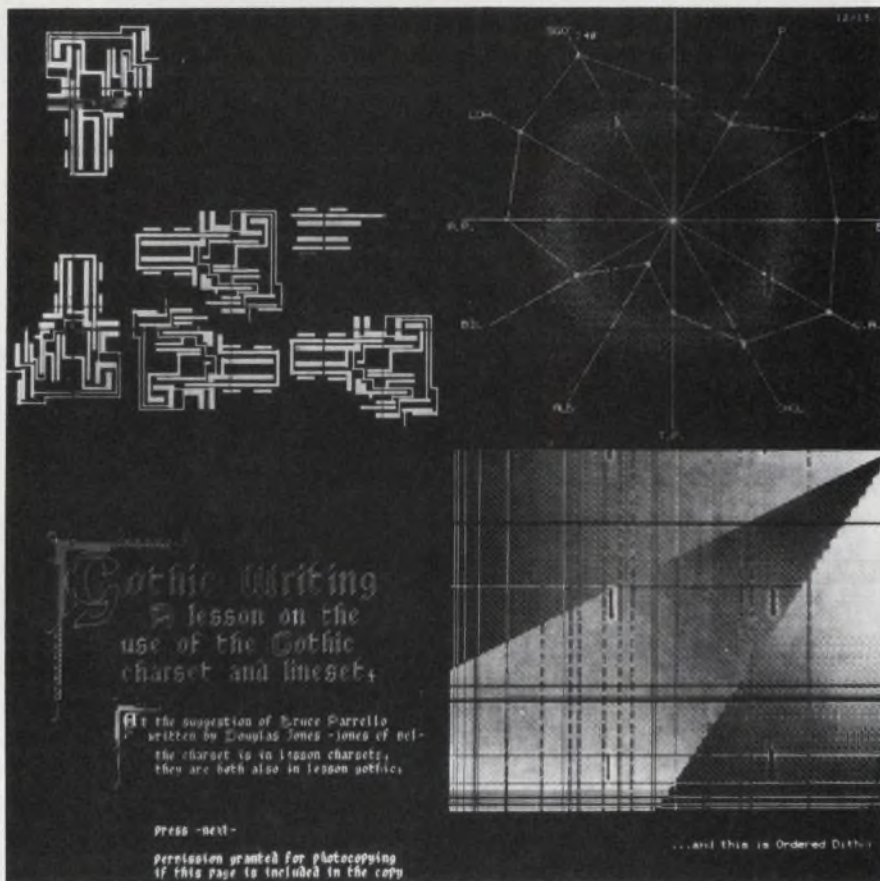

The first prototype display to use a 1024 × 1024 plasma panel, by Science Applications, can present separate graphics in each of its quadrants and can also combine all quadrants for a single display.

Magnavox require only 10 gauss to rotate the particles, reports Lawrence L. Lee. The first displays required 100 gauss to generate an image. And since the latest display uses but a single loop of No. 36 wire for addressing each row and column. It may be fabricated with photo-etching or screen-printing techniques. Previous displays required 5½ turns of No. 31 wire around each row and column.

The Magnavox panel has a 10 × 15 matrix, each element of which is formed by a group of 40 to 50-µm spheres encapsulated in liquid in a clear epoxy panel. The rotation of the particles in the individual elements is controlled by the magnetic state of a memory plane, which contains a 14 × 15 matrix of magnets.

µPs power multipanel displays

Not only are ubiquitous micro-processors putting more intelligence and computing power into shrinking display terminals, but they are also establishing a new trend: multiple screens for the terminal user. The first graphic terminal to use the Owens-

Illinois 1024 × 1024-dot ac plasma display panel has a large-screen, 12.5 × 12.5-in. display that, under the control of an LSI-11, can present independent graphic information in four 6.25 × 6.25-in. quadrants. Each quadrant is equivalent to a standard 512 × 512 plasma-panel display and has 83 picture elements per inch.

The quadra-display terminal also incorporates 32 × 32-element touch-input matrices in the quadrants, adds Patrick FitzHenry, chief engineer, system development Science Applications, Inc., Urbana, IL. As a result, the system can be accessed simply by touching that panel. Moreover, the system can simulate a Plato terminal, which is a university-education system through which a user interacts with the computer via the touch panel.

In fact, the user-programmable quadra-terminal can communicate with a variety of host systems by simulating several types of commercially available graphic terminals. Able to operate as a stand-alone computer with display, it can run commercial operating systems and higher-level languages. ■■



So what?
So OEM's are dancing in the streets, that's so what. At least the pros are.

And what makes it such a big deal is the magnitude of the cost savings—possibly 20% or more per computer system.

One reason is that interfaces are generally long on duplication and short on common sense. Most interfaces, for example, faithfully repeat half or more of the circuitry on all the other interfaces. And with multiple interfaces, that gets to be a pretty expensive proposition.

We figured a way to cut the cost of interface in half.

And once you get by its unorthodox appearance, the logic of it becomes pretty appealing. As do the cost savings.

All the basic circuitry is located on a single half-card I/O

Distributor, which can be shared by as many as eight "Intelligent Cables." Packaged into every cable is an integral PicoProcessor, which handles the functional control for each interface.

This arrangement allows much smaller computer packages, since only one I/O

board is housed inside the computer cabinet.

And along with a smaller package, comes a smaller price.

The I/O cost comparison at left shows the savings on a typical four-interface system (2 CRT's, 1 line printer and 1 card reader). And since our System handles up to eight interfaces, imagine your savings using its full capability.

Consider ComputerAutomation's Distributed I/O System. It's an uncommonly sensible solution to a commonplace problem. From the price/performance people who brought you the NAKED MINI®

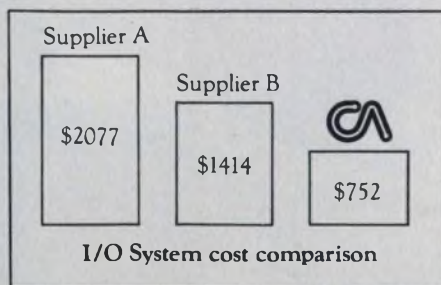

So we came up with the solution you see here: The Distributed I/O System. Designed to work specifically with our line of NAKED MINI® computers.



The Distributed I/O System



ComputerAutomation
NAKED MINI® Division
18651 Von Karman, Irvine,
California 92713, (714) 833-8830

**A lot of people depend on our
Circular Plastic Connectors.
In the air and on the ground.**





We build CPC's out of tough, durable high-grade thermoplastic. They're 50 percent lighter than comparable metal connectors. And recognized under the component program of the Underwriter's Laboratories for 250-volt service. They are also CSA certified and FAA accepted.

And in case you're not familiar with AMP technical support, you will be, because it comes with every AMP product. It's based on AMP's long-held conviction that professional engineers are entitled to expert technical support, both before and after the sale.

CPC connectors accommodate a variety of pins and socket contacts, including coax. They are part of the AMP Multimate concept. Their contacts are interchangeable with those in several other AMP connector families. And they all can be assembled with the same application tooling. For you, that means substantial production and inventory savings.

Why not try AMP CPC's in your next avionic, industrial or commercial application. For more information, just call AMP Customer Service at (717) 564-0100. Or write AMP Incorporated, Harrisburg, PA 17105.

AMP has a better way.

AMP
INCORPORATED

CIRCLE NUMBER 29

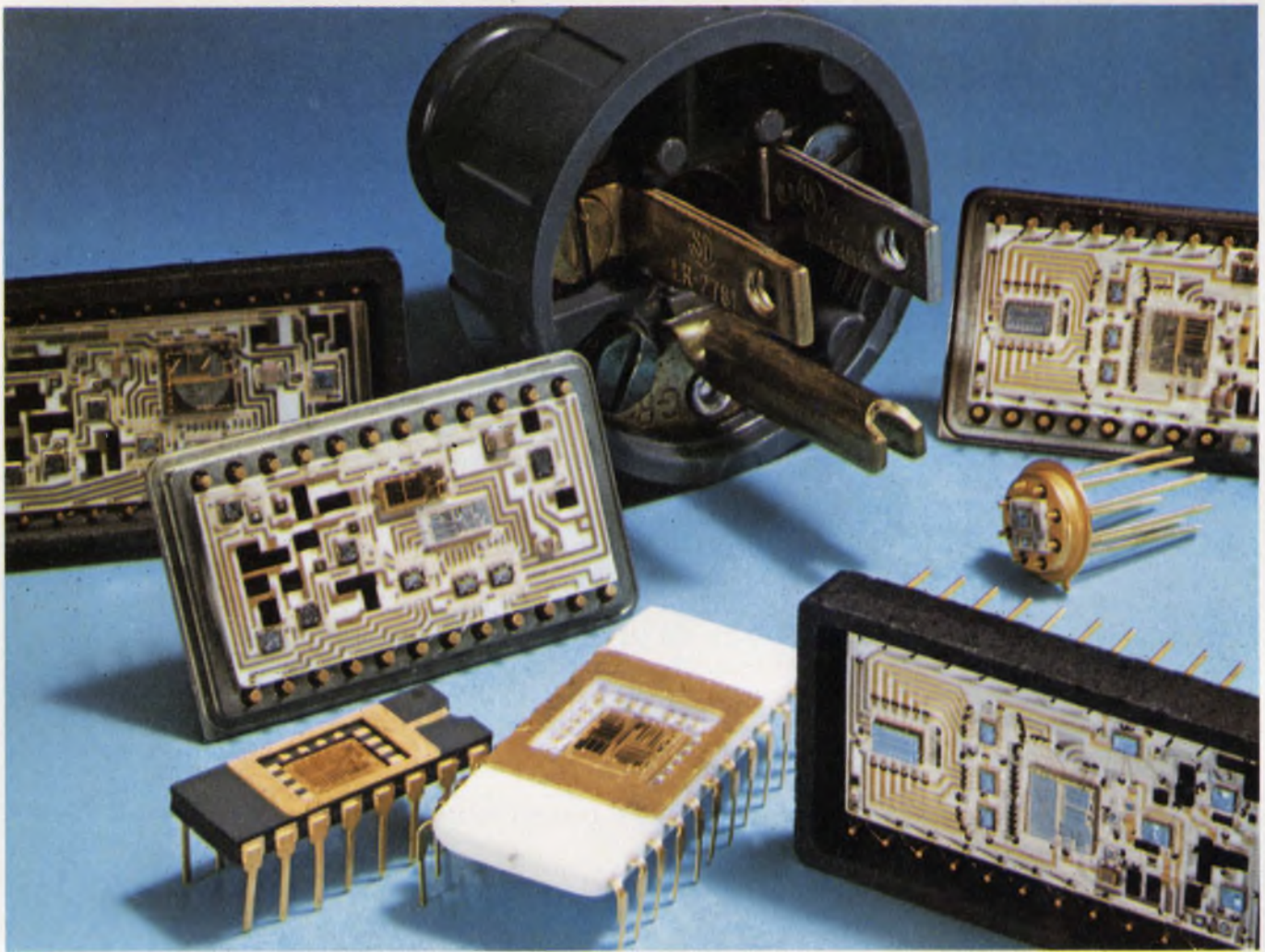

Our new low-cost industrial converter products are standard, too.

Standards, like that plug, make life less complicated.

That's why we're leading the campaign to standardize converter products.

And the group you see here is just part of a growing family that starts as low as \$19.50 in the 100-piece quantity.

They're on-the-shelf, for quick delivery. A new line of DAC's and ADC's for designers who can use standard functions. Plus thin-film ladder networks and a precision voltage reference to give exceptional design flexibility.

These competitively priced, industry-standard converter products can save you engineering, manufacturing, and inventory time and money. And you have a wide selection of package types and temperature ranges to fit your exact applications.

Learn more about Beckman-quality, Beckman-backed hybrids. They'll make your life easier, too.

For data, write or call Helipot Division, Beckman Instruments, Inc., 2500 Harbor Blvd., Fullerton, CA 92634. Phone: (714) 871-4848, Ext. 1776.

BECKMAN®

HELIPOT DIVISION

If you need hybrids, you should know about Beckman.

The unique demands of microprocessor-based systems and their increasing popularity has resulted in the development of a special breed of low-cost power supply.

INTRODUCING ACDC'S NEW LINE OF MICRO-PROCESSOR POWER SUPPLIES

- Designed to power a wide range of micros, including the popular 8080A
- 0.1% regulation on all models
- 24 month guarantee • Stock delivery
- Priced as low as \$65.00 in quantity

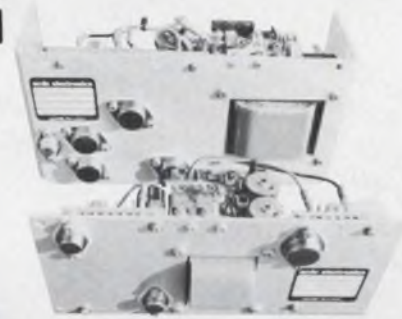

INPUT	105-125/210-250 VAC at 47-63 Hz. Derate 10% at 50 Hz.		
OUTPUT	Nominal Adj. Output Range Voltage \pm V	Ratings (Amps) Maximum Current	
		40°C	55°C 70°C
MP 301	+ 5 0.25	3.0	2.25 1.50
	+12 0.5	0.5	0.38 0.25
	- 5 0.25	0.85	0.50 0.43
MP 401	+ 5 0.25	6.00	4.50 3.00
	+12 0.5	1.00	0.75 0.50
	- 5 0.25	1.00	0.75 0.50
	All outputs are isolated from line and ground.		
REGULATION	0.1% +5mV NL-FL; \pm 0.1% \pm 5mV for a \pm 10% input change.		
RIPPLE	2mV RMS max, 20mV P-P max.		
STABILITY	Typically 10mV for eight-hour period after initial warm-up.		
TRANSIENT RESPONSE	Output voltage returns to within regulation limits within 50 microseconds in response to a 50% load step.		
OUTPUT IMPEDANCE	DC-1KHz: 0.005 ohm max. 1KHz-100KHz: 0.5 ohm max.		
TEMPERATURE COEFFICIENT	0.02%/°C max.		
REMOTE SENSING	Terminals are provided to maintain regulation at the load, compensating for up to 0.25 Volt loss in the load cable.		
AMBIENT TEMPERATURE	Operating: 0 to 70°C Storage: -55 to 85°C		
OVERLOAD PROTECTION	Inherently protected against overload and short circuit by a foldback type characteristic. Recovery is automatic.		
OVERVOLTAGE PROTECTION	The unit can be furnished with overvoltage protection on any or all of the outputs. The output will be crowbarred in the event of a rise in the voltage of between 1 to 2 Volts or 10 to 20% (whichever is larger) above maximum adjustable output voltage. This protection circuit is completely independent of the supply and is adjustable. The addition of overvoltage protection does not add to the outline dimensions of the supply.		
CONSTRUCTION	Integral aluminum chassis and heatsink. Sides are open to allow unobstructed ventilation, easy inspection and accessibility.		
DIMENSIONS (Shown as <small>inches</small>)	Wide	High	Long
MP 301	4.03	2.70	8.03
	102.36	68.58	203.96
MP 401	3.20	4.88	9.00
	81.28	123.95	228.6
PRICES			
MP301	\$ 79.00 (1-9); \$72.00 (25-49); \$71.00 (100-249); \$65.00 (250 and up)		
MP401	\$100.00 (1-9); \$95.00 (25-49); \$89.00 (100-249); \$85.00 (250 and up)		



EMERSON
ACDC ELECTRONICS
DIVISION OF
EMERSON ELECTRIC CO.

401 JONES STREET
OCEANSIDE, CA 92054
(714) 757-1880

REGIONAL SALES AND SERVICE OFFICE
524 SOUTH AVENUE EAST
CRANFORD, NEW JERSEY 07016
(201) 272-3377

acdc electronics

COMPARE THE TOP-RATED 4½-DIGIT DMMs.

Put these three 4½-digit multimeters side-by-side and you'll want the Keithley 172.

The 172 gives you superior accuracy, resolution and convenience with no compromise—at a competitive price.

If you want more evidence, send for our detailed "Comparative Guide to 4½-digit DMMs"

The Keithley 172 rates best—not on every factor, but on most.

If you want hands-on proof, put our 172 side-by-side with the Fluke 8600A, HP 3465A, or any other 4½-digit DMM. The Keithley will stand alone.

Check the chart below or make your own comparison, you'll pick the Keithley 172.

Fluke 8600A



HP 3465A



Keithley 172



	Fluke 8600A	HP 3465A	Keithley 172
Functions & Ranging:			
dcV	Auto/Manual	Manual	Auto/Manual
acV	Auto/Manual	Manual	Auto/Manual
dcA	Manual	Manual	Auto/Manual
acA	Manual	Manual	Auto/Manual
ohms	Auto/Manual	Manual	Auto/Manual
Basic Accuracy (dc volts @ 25°C ambient)	± 0.02% reading + 1 digit	± 0.02% reading + 1 digit	± 0.01% reading + 1 digit
Full Range Display (Counts)	19999	19999	29999
HI/LO Ohms	No	No	Yes
Ohms Configuration	2 terminals	2 terminals	2 or 4 terminals
Lighted Function Indicator	No	No	Yes
Price	\$549	\$510	\$525

Comparison based on manufacturers' published specifications. Prices are domestic U.S. for ac line-operated instruments.

It's easy to make your own comparison. Use coupon. Or call (216) 248-0400.

KEITHLEY INSTRUMENTS, 28775 Aurora Road, Cleveland, Ohio 44139.

In Europe: D-8000 München 70, Heighofstrasse 5, West Germany, (089) 7144065.

- Send specs on the Keithley 172. I'll make my own comparison.
- Send "Comparative Guide to 4½-digit DMMs." I need more proof.
- Bring in a Keithley 172 so I can make a side-by-side comparison.



Name _____ Title _____
 Company _____
 Address _____
 City _____ State _____ Zip _____
 Phone _____

KEITHLEY
The measurement engineers.

CIRCLE NUMBER 35

Washington report

More electronics sought for F-16 fighter

Additional electronics equipment will be installed on the Air Force's F-16 air combat fighter if the principal user of that aircraft, the Tactical Air Command, has its way.

Although the Air Force Aeronautical Systems Div., which is developing the aircraft, has specified external electronic countermeasure pods (the Westinghouse ALQ-131), TAC has requested internal ECM to improve the aircraft's aerodynamic performance and to leave space on the wings for weapons.

TAC is also asking for equipment that would enable the aircraft to use the proposed joint Tactical Information Distribution System (JMDS) secure-data link and the Navstar global positioning satellite, according to a report to Congress on the F-16 program prepared by the General Accounting Office.

The Air Force is reluctant to add any more equipment because the program unit cost of an F-16 has risen from \$9.2-million to \$9.91-million (including inflation) in the past year even though the quantity was increased from 650 to 1388 ("Washington Report," ED No. 6, March 15, 1977, p. 43). Total cost of the enhancements is expected to be at least \$1-million per aircraft.

IR warning systems planned by Air Force

In response to a growing threat from surface-to-air missiles that can home in on the infrared spectral signatures of aircraft engines, the Air Force is launching a three-year development program to outfit its slow, low-flying aircraft with a new infrared warning receiver.

The receivers, which would give a pilot enough time to take evasive action, may be installed on at least 700 helicopters and transport aircraft. Cost should run at least \$60,000 per aircraft.

Aerojet ElectroSystems, Azusa, CA, and Cincinnati Electronics were selected by the Air Force Aeronautical Systems Div. and each given \$2-million and one year to develop a prototype. One will then proceed with full-scale development. Losing bidders were Hughes Aircraft, Loral and Texas Instruments.

Navy to complete LAMPS ASW helicopter team this month

The Navy has completed its avionics subcontractor team on a new anti-submarine warfare (ASW) helicopter, the Light Airborne Multi-Purpose System Mark III, and expects to choose the airframe and engine contractors later this month.

Avionics subcontractors include Control Data, its AYK-14 standard airborne computer; Texas Instruments, with its APS-124 search radar; and Raytheon, with the ALQ-142 electronic stores management system—an airborne version of that firm's shipboard Design to Price Electronic Warfare System (DFEWS). Other avionics subs are Collins Radio, Bendix, Hazeltine, GE, Sperry Rand and Honeywell.

A prime contractor for systems integration has already been named—IBM Federal Systems Div., Bethesda, MD. For the first time in Pentagon history, the avionics supplier, rather than the airframe producer, has been designated the prime contractor.

Competing for the airframe are the Sikorsky Aircraft Div. of United Technologies Corp. and the Vertol Div. of the Boeing Co. The engine will go to General Electric or Avco Lycoming Div. The winning firms will receive 54-month development contracts to produce six prototypes, the first of which is expected to make its initial flight in December, 1978. The production phase calls for 204 helicopters at a cost of \$2.7-billion, or about \$13.4-million each (including projected inflation).

Two under-secretary defense posts proposed

The Defense Department has asked Congress to establish two new under-secretary posts—one for research and engineering, the other for policy.

In submitting the proposed legislation to both the House and the Senate, Defense Secretary Harold Brown announced that he expects to leave five or six of the assistant-secretary positions vacant. There are currently 22 assistant secretaries in the Pentagon—three for each service and 13 in Brown's office.

The under secretary for research and engineering will be former electronics executive Dr. William Perry, who has already been appointed the Pentagon's director of research and engineering ("Washington Report," ED No. 8, April 12, 1977, p. 50). As an under secretary, Perry will oversee all the Pentagon's R & D and procurement activities, and is expected to be named the department's principal acquisition executive, as required by Office of Management and Budget Circular A-109.

The under secretary for policy, as yet unnamed, will be responsible principally for international affairs.

Capital Capsules: NASA is "now at a crossroads and entering a new era in which the tremendous technological capabilities of the Space Shuttle can be used," according to Dr. Frank Press, President Carter's nominee for science advisor, at his Senate confirmation hearing. The MIT geophysics professor did not comment directly on the proposed space station ("Washington Report," ED No. 9, April 26, 1977, p. 49), but did indicate support for a space telescope, and Landsat and planetary probes. . . . The Air Force hopes to counter possible jamming of its Navstar global positioning satellite ("Washington Report," ED No. 8, April 12, 1977, p. 50) with highly directional signals in the 1 to 2-GHz frequency coupled with a pseudorandom noise-signal structure. . . . The Navy must look at satellite communications using blue-green laser light sources at optical wavelengths around 0.5 micron as an alternative to its proposed Seafarer ELF communications system for submerged submarines. The House Armed Services Committee, which issued the order, has voted \$5-million for initial studies.

If you're only measuring voltage, you're only getting half the picture

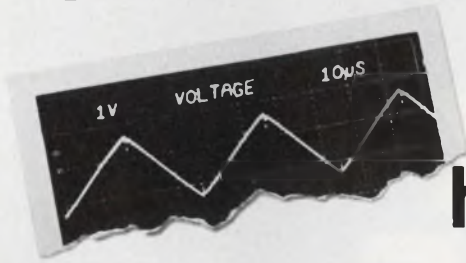

Current is the other half of the picture. And you can measure current accurately and efficiently with a TEKTRONIX Current Probe like the P6302/AM503. You'll find many uses for its 1 mA to 20 A current measurement range and its DC to 50 MHz bandwidth—such as plotting the current characteristics of a transformer, balancing an SCR circuit, or measuring the dc and ac peak current load on a power supply.

A current probe is also a helpful companion for your voltage probe when measuring signals at high impedance points in a circuit. The low circuit loading characteristic of a current probe means less signal attenuation and less rise time loss.

Tektronix offers a wide selection of general purpose and specialized probes to meet your current and voltage measurement needs. These include a number of active and passive voltage probes as well as logic probes.

The first step to an accurate, meaningful oscilloscope measurement is choosing the right probe. And your Tektronix Field Engineer can help you make the proper selection.

Once you get the whole picture, save it with a scope camera. It's still the most efficient and least expensive means of saving measurement results from your oscilloscope or waveform monitor.

With a camera you can record waveforms for publication in technical papers and journals. Prints can be kept as a permanent record in your engineering notebook, or used to support your position in a design meeting.

The low cost C-5A fits all TEKTRONIX Laboratory Oscilloscopes, 400-Series Portables and the new T900-Series. At \$250* you can afford a C-5A for your own test bench. You no longer need to share one camera with all the engineers in your group.

Other TEKTRONIX Cameras give you automatic single-shot control for transient recording, and photometer aided exposure setting for clear, no-fuss photography of even the dimmest displays.

For more information about the complete selection of TEKTRONIX Probes and Cameras, contact your local Tektronix Field Engineer or write Tektronix, Inc., P.O. Box 500, Beaverton, Oregon 97077. In Europe, write Tektronix Limited, P.O. Box 36, St. Peter Port, Guernsey, Channel Islands.

*U.S. sales prices are F.O.B. Beaverton, Oregon. For price and availability outside the United States, contact the nearest Tektronix Field Office, Distributor or Representative.

Tektronix
COMMITTED TO EXCELLENCE

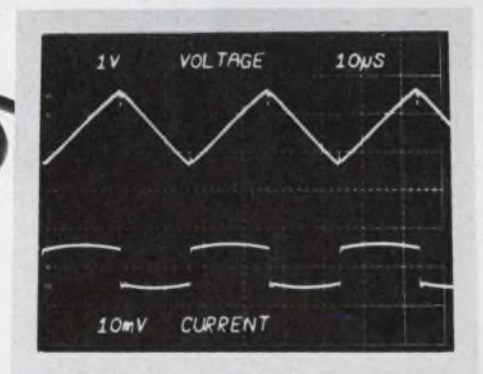

Once you get
the whole picture,
save it with
a scope camera

FOR TECHNICAL DATA CIRCLE #33
FOR DEMONSTRATION CIRCLE #34



BENDIX BRISTLE BRUSH BUNCH.

Opens new horizons for PCB design.

Free and easy are now the bywords for board and board support design with the 70% to 90% reduction in mating and unmating forces offered by the new Bristle Brush Bunch connector series from Bendix.

The need for costly board support systems is minimized.

You get extended interconnection contact counts and versatility – up to 400 contacts per connector.

You can choose from a broad product line:

- 2-, 3- and 4-row Mother Board, Daughter Board, PC receptacle and Input/Output body styles.
- Removable crimp, solderless wrap, straight or 90-degree PC stud and willowy tail termination.

For complete information, contact The Bendix Corporation, Electrical Components Division, Sidney, New York 13838.

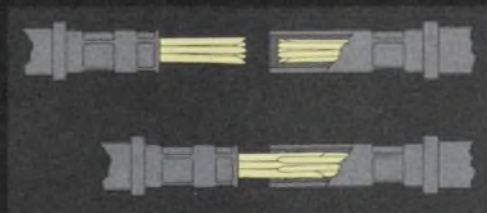

CONTACT INNOVATION

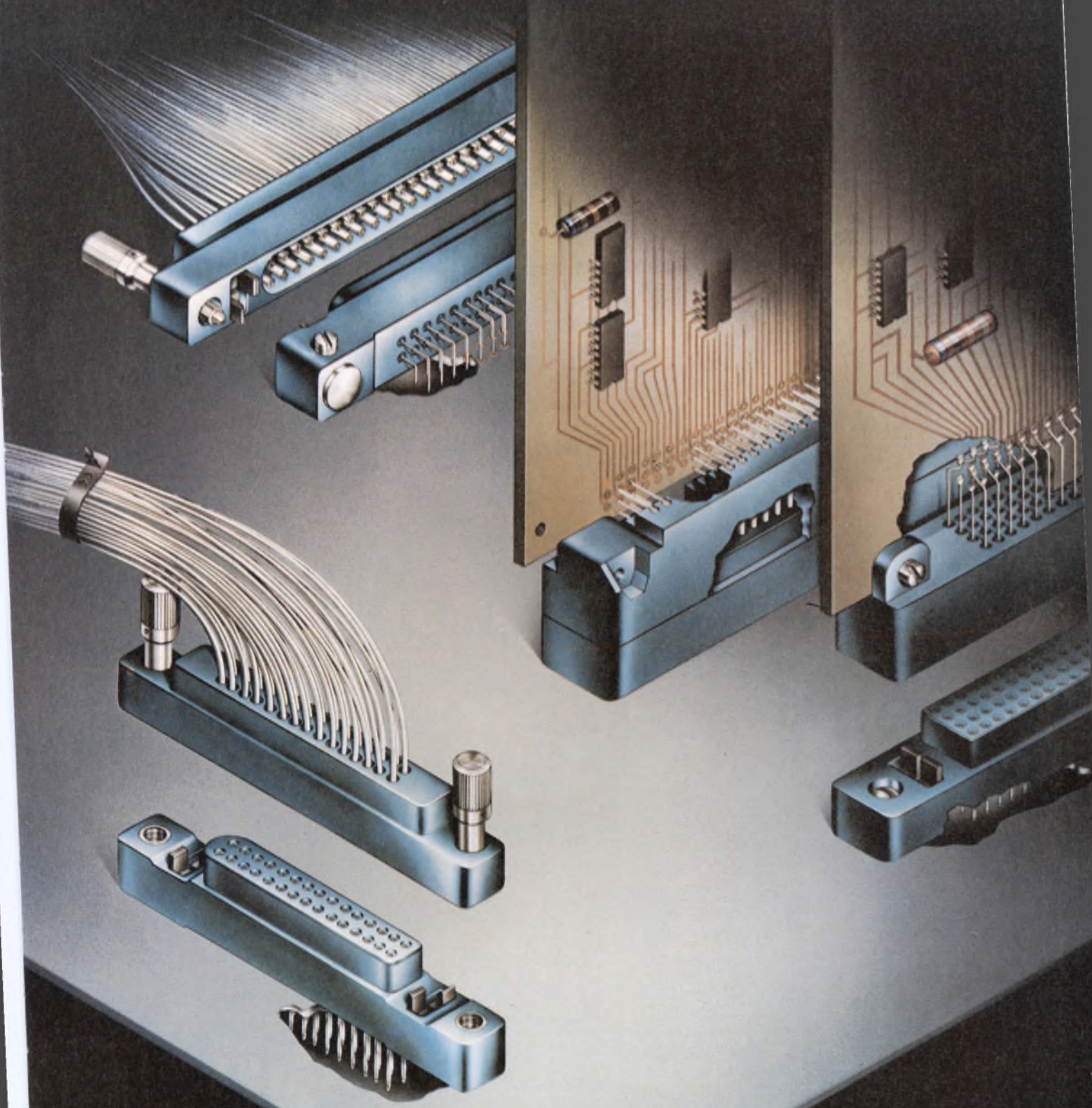

Bendix

FEATHERWEIGHT MINIATURE PANEL MOUNT THERMAL PRINTER!!



DPP-7 QUICK SPECS

Printing Rate:

3 lines per second

Inputs

Full parallel BCD

TTL logic inputs, selectable positive or negative true

Printouts:

Six digits and sign, 99±9999, ±999999 or 9±99999 (Hexadecimal optional)

Input Storage

BCD data must be valid only 1.5 microseconds during print command

Data Capacity

9000 lines on 150 foot x 1.75 inch (44.5mm x 45m) thermal paper rolls

Power Supply:

Choice of: +5VDC, +12VDC, or +28VDC, or 100, 115 or 230VAC, 47 to 440 Hz.

Size Case:

4.50" wide x 2.72" high (115mm x 69mm)

Depth:

5V Models
6.2" (158mm)
28V, 12V, or
AC Models: 8.7" (221mm)

Datel's new model DPP-7 Digital Panel Printer uses only 2 moving parts for OEM reliability. At only 2.3 Lbs, (1,1Kg) it is one of the lightest panel-mounting recording instruments available.

Includes all electronics.

The \$475* single quantity price includes everything required for full parallel BCD/TTL data inputs *plus* an input storage register for multiplexed bus applications *plus* an AC power supply! There are no extra boards to design or bulky cables and power supplies needed. The DPP-7 is ready to use.

Thermal printing means no messy inks, banging hammers or twirling print-wheels. Nothing to jam or run out of ink.

Use the miniature DPP-7 for simple data logging systems, automatic test fixtures or with a digital panel meter for accurate unattended data measurement.

The **small size** of the DPP-7 makes it ideal for panel-mounting in analytical instruments and compact data systems. Up to six digits and sign may be printed to identify channel number and data.

The DPP-7 uses +5VDC power in a very short 6.2" (158mm) deep version or 100, 115 or 230 VAC or +12V or +28VDC power in an 8.7" (221mm) deep version.



DATEL
SYSTEMS, INC.

Send for your FREE Brochure

1020 Turnpike St., Canton, MA 02021

Phone: (617) 828-8000

• Santa Ana, CA (714) 835-2751

• Santa Ana, (L.A. Exchange) (213) 933-7256

• Sunnyvale, CA (408) 733-2424

• Gaithersburg, MD (301) 840-9490

*U.S.A. domestic price only.

COVERED BY
GSA CONTRACT
NO. GS-00S-27959

CIRCLE NUMBER 36

Learning sensitivity

"Dammit, Jack, where the hell is that report I asked you for yesterday?"

"Well, sir," Jack replied to his boss, "you also asked me to find out why so many instruments were dying on the production line. It took me a long time to discover that somebody had substituted a cheap component for a better one I had specified."

"Look, Jack, when I ask for something, I want it done. Period. I don't want excuses."

"Yes, sir," Jack replied, but that's not what he really meant. He really wanted to say that he couldn't take on two simultaneous projects. He wanted to tell Charlie, too, that Charlie was the

one who had ordered cheaper components. Charlie was the one who had caused the crisis on the production line. But Jack couldn't say those things because Charlie was very sensitive. Such words might have hurt his feelings. And Jack didn't want to hurt Charlie's feelings.

In fact, most of his colleagues shared Jack's concern for Charlie's feelings. However sharply or imperiously Charlie addressed anybody, the reply was always courteous and considerate. One reason was that Charlie's feelings had a marked effect on people's paychecks and job security.

Deep down, Charlie probably sensed the difference between the way people spoke to him and the way he spoke to them. He knew he could vent his inner anger on subordinates, while they had to swallow their anger and take it home. But that's the way business runs, Charlie told himself. You mustn't let underlings talk back. You can't get things done unless you wipe out insubordination. And he did.

Unfortunately, he also wiped out a lot of people. There was staggering turnover among the people who worked for him and everybody knew it. So it was difficult for him to hire replacements—especially good ones.

As a result, the quality of his staff declined and, with it, the quality of his products. This wreaked havoc with sales and profits, which made him angrier, which made him more difficult to work for, which increased his staff turnover, which further reduced the quality of his products.

In time, he was no longer boss. With practically no experience at it, poor Charlie had to learn how to be sensitive to other people. Especially his boss.



GEORGE ROSTKY
Editor-in-Chief

Stretch your test instrument budget

Does a scope always have to be expensive to meet your needs? At B&K-PRECISION we don't think so. B&K-PRECISION offers a full line of scopes that give you the performance and features you need, at substantial cost savings... plus the advantage of immediate delivery and 10-day free trial through local distributors.

B&K-PRECISION to high-priced

B&K-PRECISION has taken a no nonsense, cost-effective, approach to oscilloscope design. All our scopes will trigger at frequencies typically 50 to 100% beyond their rated band-width. They are rugged, dependable instruments, designed to match the features and performance of far more expensive scopes, without matching their high price. An important part of our approach is that you shouldn't have to buy more scope than you need to get the features you want. Before making your next purchase, compare the features and performance you require with what we have to offer. You'll discover that your budget is a lot bigger than you first thought!

30MHz Dual-Trace 5" Triggered Scope with Signal Delay

For the engineer who requires a full-feature 30MHz scope

- Built-in signal delay line permits viewing of high-frequency pulse risetimes
- Triggers on signals up to 50MHz
- Rise time 11.7nS
- 20 calibrated sweeps—0.2 μ S/cm-0.5S/cm
- Built-in high and low-pass filters
- 5mV/cm vertical sensitivity
- Illuminated graticule
- TTL compatible intensity modulation
- X-Y capability using matched DC amplifiers
- P31 blue phosphor
- Internal .5Vp-p \pm 1% calibration source
- 5mV/cm horizontal sensitivity.

Model 1474 \$930 (Including two 10:1/direct probes)

15MHz Dual-Trace 5" Triggered Scope

Premium features and performance in a 15MHz dual-trace scope

- Ultra—flat in-band response with smooth rolloff past 15MHz
- Triggers beyond 27MHz
- 24nS risetime
- 19 calibrated sweeps—.5 μ S/cm-0.5S/cm
- 10mV/cm vertical sensitivity
- Algebraic addition and subtraction
- Illuminated graticule
- X-Y capability using matched DC amplifiers
- P31 blue phosphor
- Internal calibration source
- Built-in TV sync separator
- For fast setup, mode automatically shifts between CHOP and ALTERNATE as you change sweep times.

Model 1472C \$720 (including two 10:1/direct probes)



without stretching your standards... has an alternative oscilloscopes

10MHz Dual-Trace 5" Triggered Scope

Our lowest-cost dual-trace scope more than fills the need in applications where extended bandwidth isn't required

- Triggers beyond 15MHz
- Mode automatically shifts between CHOP and ALTERNATE as sweep time is changed
- 18 calibrated sweeps - $1 \mu\text{S}/\text{cm}$ - $0.5\text{S}/\text{cm}$
- 35nS risetime
- P31 phosphor
- X-Y capability using matched DC amplifiers
- Internal calibration source
- TTL compatible intensity modulation
- 10mV/cm vertical sensitivity

Model 1471B \$570
(including two 10:1/direct probes)

10MHz 5" Triggered-Sweep Scope

A 5" triggered scope with TTL compatible Z-axis

- 10mV/cm vertical sensitivity
- 35nS risetime
- 18 calibrated sweep ranges - $1 \mu\text{S}/\text{cm}$ - $0.5\text{S}/\text{cm}$
- 5x magnification sweeps to $.2 \mu\text{S}/\text{cm}$
- Vectorscope capability
- Internal calibration source
- Internal TV sync separator
- P31 phosphor
- 11-position vertical attenuator, calibrated in convenient 1/2/5 step sequence
- Built-in calibration source.

Model 1461 \$470
(including 10:1/direct probe)

10MHz 3" Triggered-Sweep Scope

Meets the demands for an uncompromising ultra-compact triggered-sweep scope

- 19 accurate sweep ranges
- Accurate 11-position vertical attenuator
- 10MV/div vertical sensitivity
- Front panel vectorscope capability
- Internal calibration source
- Only 5.75 x 7.9 x 12.9 - Weighs only 13 lbs
- Capable of writing speeds up to $0.1 \mu\text{S}/\text{div}$ with 5x magnification.

Model 1431 \$420
(not including probe)

5MHz 3" Compact Scope

Ideal for many dedicated applications, freeing more expensive scopes from monitoring tasks

- 10mV/div vertical sensitivity
- Direct deflection terminals for waveform display to 450MHz
- Only 6 x 7.5 x 12" - Weighs just 8.5 lbs
- 600 Vp-p maximum input voltage
- Can be externally synced.

Model 1403A \$219
(not including probe)



Save up to 50% on probes!

B&K-PRECISION has engineered a full line of cost-effective probes to meet your needs. Our probes are designed for complete interchangeability with those of leading "ultra-sophisticated" brands, giving you compatible performance at about half the price.

FOR IMMEDIATE DELIVERY,
or 10-day free trial, contact your local B&K-PRECISION distributor. Ask him for Catalog BK-77 with complete information on B&K-PRECISION oscilloscopes, probes and more than thirty other fine instruments, or contact us directly.

B&K PRECISION
PRODUCTS OF DYNASCAN

6460 W. Cortland Avenue, Chicago, IL 60635 312/889-9087

FOR PRODUCT INFORMATION CIRCLE 37
FOR PRODUCT DEMONSTRATION CIRCLE 38

Use 4-bit slices to design powerful microprogrammed processors. The 2900 family of circuits lets you build machines with cycle times of 110 ns.

Though not the first 4-bit bipolar bit-slice family, the 2900 series of processor circuits probably offers the most flexibility of any bit-slice family. What's more, with bipolar-Schottky execution speeds of 90 to 200 ns per instruction, the circuits combine to build computer systems with any word size (Fig. 1).

The basic family developed by Advanced Micro Devices consists of the 2901 4-bit arithmetic and logic unit (ALU) and the 2909 microprogram sequencer (Fig. 2). With up to 64 possible input and ALU-function combinations, the 2901 provides more than twice the capability of other ALUs. And cycle times of 120 ns for the 2901 and 90 ns for the 2901A give you a wide choice of performance levels.

Many direct-support circuits developed by AMD and other companies can be added to your design repertoire. Some of these are the 2902 look-ahead-carry generator, the 2913 interrupt expander, the 2914 vectored-interrupt controller, the 29803 16-way branch control for the 2909 and the 29811 next-address-control unit.

Some other circuits, still in development, promise to make designing a high-performance system even easier: the 2910, a sequence controller that can do the job of three 2909s; and the 2930, a program-control unit (PCU) that is sort of a cross between a 2901 and 2909—it contains the address circuitry of a 2909 and a simple ALU. (A summary of the major support circuits is shown in Table 1.)

Analyze the circuits first

Before you design a computer, though, you should understand each of the major circuit building blocks. The 2901 contains the actual processing circuits—ALU, associated scratchpad memory and control logic (Fig. 3). Control is done via nine function lines, I_0 to I_8 , which are split into groups of three.

The first group, I_0 to I_2 , controls the inputs to the ALU (Table 2)—they determine whether the ALU is fed by an external input, the on-chip scratchpad RAM or the internal Q register. Lines I_3 to I_5 determine the actual ALU function (Table 3)—from three arithmetic and five logic operations. The other three lines, I_6 to

Table 1. 2900-series support

Part number	Description	DIP size	100-up price
Am2901	Four-bit CPU slice (120 ns)	40-Pin	\$14.70
Am2901A	Four-bit CPU slice (90 ns)	40-Pin	17.85
Am2902	Carry-lookahead	16-Pin	2.65
Am2905	Bus interface (open collector)	24-Pin	6.75
Am2906	Bus interface (open collector)	24-Pin	7.45
Am2907	Bus interface (open collector)	20-Pin	5.40
Am2909	Microprogram sequencer	28-Pin	5.95
Am2910	Sequence controller	40-Pin	*
Am2911	Mini-microprogram sequencer	20-Pin	3.95
Am2913	Interrupt expander	20-Pin	2.53
Am2914	Vectored interrupt controller	40-Pin	29.95
Am2918	One-by-two port register	16-Pin	3.08
Am29LS18	Low-power one-by-two port register	16-Pin	2.60
Am2919	One-by-two port register	16-Pin	3.10
Am2920	Eight-bit register	22-Pin	2.88
Am2921	One-of-eight decoder	20-Pin	2.55
Am2922	Eight-input multiplexer	20-Pin	*
Am2930	Program control unit	28-Pin	*
Am2931	Mini program control unit	20-Pin	*
Am29700	16 × 4 RAM (open collector)	16-Pin	3.75
Am29701	16 × 4 RAM (three-state)	16-Pin	3.75

Jim Clymer, Engineering Manager, Systems and Applications, Advanced Micro Devices, 901 Thompson Pl., Sunnyvale, CA 94086.

I₈, determine whether the ALU dumps its output (Table 4) onto the Y₀-to-Y₃ output lines, or into the Q register or the scratchpad RAM. These three lines also control the RAM and Q register.

Of the 27 remaining pins on the 2901, 12 are used for the A and B word addresses and the direct-data input (four for each). So two pins are left for power, one for the clock input, one for the three-state output control, four for left or right shifts and seven for mathematical carry and overflow indicators.

The other key element of the 2901 is the two-port

scratchpad RAM. Up to 16 four-bit words can be held in the RAM and read from either the A or B ports, depending on the A and B-address inputs and lines I₆ to I₈. When the RAM is enabled, new data are always written into the location specified by the B-address lines. Three-input multiplexers are used on the RAM inputs to permit data to be shifted left or right before

Part number	Description	DIP size	100-up price
Am29704	16 × 4 two-port RAM (open collector)	28-Pin	10.50
Am29705	16 × 4 two-port RAM (three-state)	28-Pin	10.50
Am29720	256 × 1 open-collector RAM	16-Pin	3.35
Am29721	256 × 1 three-state RAM	16-Pin	3.35
Am29759	32 × 8 open-collector PROM	16-Pin	3.00
Am29760	256 × 4 open-collector PROM	16-Pin	4.50
Am29761	256 × 4 open-collector PROM	16-Pin	4.50
Am29803	16-way branch control for Am2909	16-Pin	4.95
Am29811	Next-address control unit	16-Pin	3.25
Other support			
Am2900K1	Evaluation and learning kit (containing one 2901 ALU, one 2909 and all necessary support circuits)	9 × 11 in. board	\$289
AMDASM	Mnemonic programming language available on CSC time-sharing network	Mag. tape	\$2500
Second sources Motorola, Raytheon, Signetics, Sescosem, National Semiconductor, Fairchild			

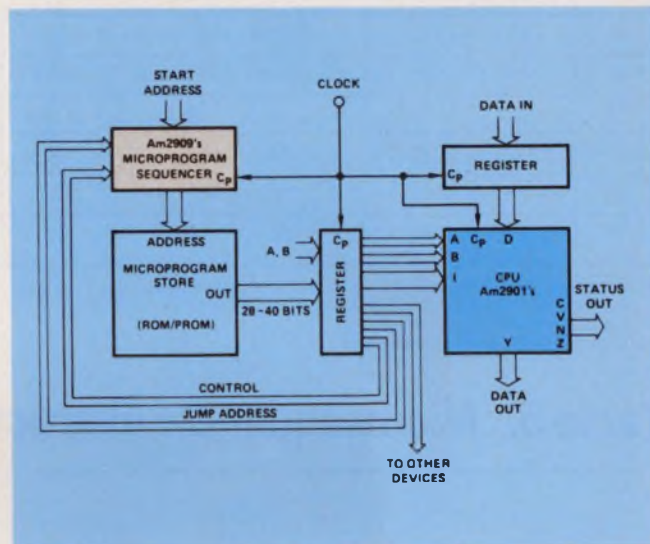

1. By combining the 4-bit 2901 ALU sections and 2909 microprogram sequencers, you can build a high-performance computer that can handle any word size.

Table 2. ALU-operand control bits

Microcode			ALU source operands	
I ₂	I ₁	I ₀	R	S
L	L	L	A	Q
L	L	H	A	B
L	H	L	O	Q
L	H	H	O	B
H	L	L	O	A
H	L	H	D	A
H	H	L	D	Q
H	H	H	D	O

Table 3. ALU-function control bits

Microcode			ALU function	Symbol
I ₅	I ₄	I ₃		
L	L	L	R plus S	R + S
L	L	H	S minus R	S - R
L	H	L	R minus S	R - S
L	H	H	R OR S	R ∨ S
H	L	L	R AND S	R ∧ S
H	L	H	R AND S	R ∧ S
H	H	L	R EX-OR S	R ⊕ S
H	H	H	R EX-NOR S	R ⊘ S

*To be announced.

Table 4. ALU-destination control bits

Microcode			RAM function		Q-reg function		Y output	RAM shifter		Q shifter	
I ₈	I ₇	I ₆	Shift	Load	Shift	Load		RAM ₀	RAM ₃	Q ₀	Q ₃
L	L	L	X	None	None	F → Q	F	X	X	X	X
L	L	H	X	None	X	None	F	X	X	X	X
L	H	L	None	F → B	X	None	A	X	X	X	X
L	H	H	None	F → B	X	None	F	X	X	X	X
H	L	L	Down	F/2 → B	Down	Q/2 → Q	F	F ₀	IN ₃	Q ₀	IN ₃
H	L	H	Down	F/2 → B	X	None	F	F ₀	IN ₃	Q ₀	X
H	H	L	Up	2F → B	Up	2Q → Q	F	IN ₀	F ₃	IN ₀	Q ₃
H	H	H	Up	2F → B	X	None	F	IN ₀	F ₃	X	Q ₃

X=Don't care. Electrically, the shift pin is a TTL input internally connected to a three-state output which is in the high impedance state.
 B=Register addressed by B inputs.
 Up is toward MSB. Down is toward LSB.

Table 5. Microsequencer instructions

Microcode				TC	Instruction	TCEN	OPREQ*	HLTRQ*	ZERO*	S ₁	S ₀	PUP	FE*
A ₄	A ₃	A ₂	A ₁										
0	0	0	0	0	RESET	0	1	1	0	X	X	X	1
0	0	0	0	1	RESET	0	1	1	0	X	X	X	1
0	0	0	1	0	EXECUTE	0	1	1	1	0	0	X	1
0	0	0	1	1	EXECUTE	0	1	1	1	0	0	X	1
0	0	1	0	0	EXECUTE	1	1	1	1	0	0	X	1
0	0	1	0	1	JUMP-THROUGH-REGISTER	1	1	1	1	0	1	X	1
0	0	1	1	0	EXECUTE	1	1	1	1	0	0	X	1
0	0	1	1	1	JUMP DIRECT	1	1	1	1	1	1	X	1
0	1	0	0	0	EXECUTE	1	1	1	1	0	0	X	1
0	1	0	0	1	JSB-THROUGH-REGISTER	1	1	1	1	0	1	1	0
0	1	0	1	0	EXECUTE	1	1	1	1	0	0	X	1
0	1	0	1	1	JSB DIRECT	1	1	1	1	1	1	1	0
0	1	1	0	0	EXECUTE	1	1	1	1	0	0	X	1
0	1	1	0	1	RETURN	1	1	1	1	1	0	0	0
0	1	1	1	0	LOOP	1	1	1	1	1	0	X	1
0	1	1	1	1	RETURN	1	1	1	1	0	0	0	0
1	0	0	0	0	PUSH	0	1	1	1	0	0	1	0
1	0	0	0	1	PUSH	0	1	1	1	0	0	1	0
1	0	0	1	0	EXECUTE	1	1	1	1	0	0	X	1
1	0	0	1	1	BRANCH AND POP	1	1	1	1	0	1	0	0
1	0	1	0	0	LOOP	0	1	1	1	1	0	X	1
1	0	1	0	1	LOOP	0	1	1	1	1	0	X	1
1	0	1	1	0	EXECUTE AND POP	1	1	1	1	0	0	0	0
1	0	1	1	1	LOOP	1	1	1	1	1	0	X	1
1	1	0	0	0	POP	0	1	1	1	0	0	0	0
1	1	0	0	1	POP	0	1	1	1	0	0	0	0
1	1	0	1	0	EXECUTE	1	1	1	1	0	0	X	1
1	1	0	1	1	HALT	1	1	0	1	0	0	X	1
1	1	1	0	0	EXECUTE ASYNC.	0	0	1	1	0	0	X	1
1	1	1	0	1	EXECUTE ASYNC.	0	0	1	1	0	0	X	1
1	1	1	1	0	EXECUTE AND FETCH	0	1	1	1	1	1	X	1
1	1	1	1	1	EXECUTE AND FETCH	0	1	1	1	1	1	X	1

they are stored in the RAM. To eliminate any possible race conditions during write operations, both the A and B RAM outputs are held in latches when the clock line goes low.

The multiplexing scheme used on the ALU inputs permits any of the A, B, D, and Q inputs, or none of them (all zeros), to be selected source operands for the ALU. When taken two at a time, these five inputs produce 10 possible combinations of source-operand pairs, of which eight are actually used in the 2901 (see Table 2 for I_0 to I_2 lines).

The D input is a 4-bit-wide direct-data input to the ALU that is used to insert all data into the working registers or modify any of the internal-data files. The Q register is a 4-bit register primarily intended for use with multiplication and division routines, but it can also be used as an accumulator or holding register.

When several 2901s are cascaded, the carry-generate and carry-propagate (\bar{G} and P) outputs can be used with such carry-look-ahead generators as the 2902 or the 74LS182 to speed up the final results. Carry-output (C_{n+4}) and carry-input (C_{in}) signals are also available to help cascade sections. The ALU has three other status outputs, the F_3 , $F=0$ and overflow (OVR) lines.

Without enabling the three-state output lines, the F_3 signal lets you determine the most-significant (sign) bit of the ALU. The $F=0$ line can be used to detect an all-zero condition. The overflow output indicates when any arithmetic operation exceeds the available 2's-complement number range.

Access instructions via a sequencer

Instructions for the 2901 bit slice come from a microprogram memory, which you can access with the 2909 microprogram sequencer (Fig. 4). Its main circuits are a cascadable 4-bit microprogram counter, a 4×4 register file with stack pointer and push/pop control for nesting, and an internal-address register.

The 2909 can select an address from four sources:

1. A set of external direct inputs (D lines).
2. External data from the address-register inputs (R lines) stored in an internal register.
3. A four-word-deep push/pop stack.
4. A program-counter register (which usually contains the last address plus one).

The address selection is controlled by two input lines, S_0 and S_1 , which determine the multiplexer output. Of the 28 pins on the 2909, four are used as direct-address inputs, four as address-register inputs, four as OR inputs for the multiplexer output, and four as the final address output. Two other lines form the multiplexer control, and two more are for power and ground. So eight lines are left for timing and control.

Of those eight remaining lines, one is used as a clock input, one enables the address-register inputs, and one enables the three-state output address. Two other lines are used for carry-in and carry-out when sequencers are cascaded, another line controls access to the stack, and another controls the direction of data flow

in the stack (push or pop). The eighth line can be used to force the address outputs to zero, which permits the 2909 to jump or branch to another address.

A second version of the 2909, called the 2911, is housed in a 20-pin DIP. Aside from the D and R lines being paralleled to squeeze down the pin connections, and no OR inputs, the 2911 is the same as the 2909.

Depending on the size of the control microprogram's memory, many of the 2909s can be cascaded in much the same way as the 2901s. A detailed arrangement for a high-performance microprogram controller is shown in Fig. 5.

Combine the controller and ALU

By combining four 2901 ALUs, several 2909s or 2911s, or a single 2910 and a microprogram memory, you can form a rudimentary 16-bit digital computer (Fig. 6). For better performance, however, add look-ahead carry with the 2902 look-ahead carry generator. A central processor built from four 2901s and three 2909s or 2911s has 16 general-purpose registers made from the paralleled 16×4 registers and up to 4096 words of microprogram memory. (For more about basic microprogramming, see "A Primer on Bit-Slice Processors," ED No. 3, February 1, 1977, p. 52.)

Each 2909 or 2911 can supply only four bits of address to the microinstruction memory. And, when n units are cascaded, the addressing range increases to 16^n words. Each word of the microprogram memory can have as many bits as necessary to perform the desired function—a 40-bit word is not uncommon.

To see how the 2909/2901 combination can be microprogrammed to function as a minicomputer, examine a design example of a 16-bit minicomputer whose architecture and operation is similar to that

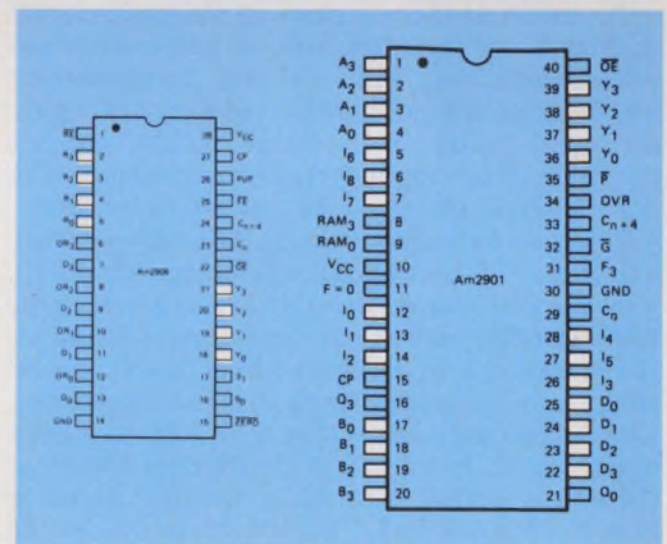

2. Housed in a 40-pin DIP, the 2901 ALU offers up to 64 different operating modes under the direction of nine control lines (right). The 2909, in a 28-pin DIP, provides the address-control logic that pulls instructions from the microprogram memory (left).

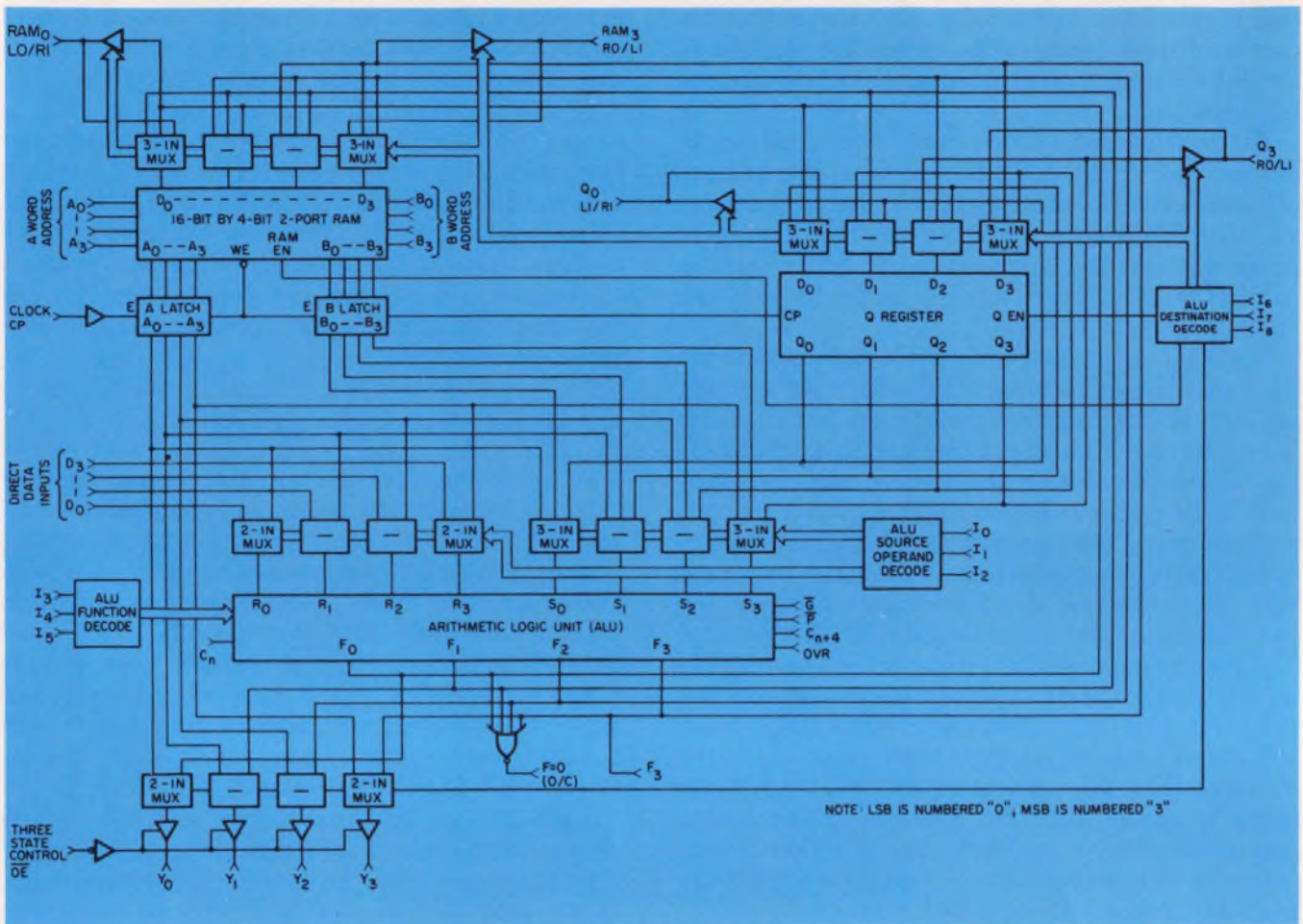

3. The eight-function ALU built into the same chip as a 16-word RAM combines forces with various registers and

multiplexers in the 2901 to make a versatile logic processor for any computer system.

shown in Fig. 7. The processor has an address bus and a data bus. Since both buses use three-state logic, expanding the system is very easy. A third bus within the processor is used only for internal control and cannot be accessed like the other two.

The mini's ALU can perform all the combinatorial arithmetic and logic functions, as well as shift and rotate operations. Also, 1's and 2's-complement mathematics, and incrementing and decrementing are performed in the ALU, which contains general-purpose registers and a Q register (scratchpad). The ALU is either the source or destination for data.

Three main elements make up the program-control unit (Fig. 6) of the computer: a program counter (PC), a memory-address register (MAR) and a subroutine stack. Once the entire computer system is turned on, the PC gets cleared to 0000 and from then on, the PC points to (contains the address of) the next instruction to be fetched and executed. The MAR holds the second operand of an instruction or the effective address of the second operand calculated in the ALU. In either case, the MAR is loaded from the data bus. At the start of any memory cycle, the contents of either the PC or the MAR are enabled onto the data bus. Either the 2930 or its mini version, the 2931 can be used to build the PCU. Addressing 65,384 words of memory requires four 2930s.

Of course, the computer system contains a memory that holds the program to be executed and the data to be operated on. The memory can be either synchronous or asynchronous.

The two other sections of the mini are the interrupt-control unit (ICU) and the computer-control unit (CCU). Handling interrupt requests from peripheral controllers, the ICU provides masking and clearing operations under program control. What's more, a minimum interrupt level can be set with an instruction. And, the highest-level interrupt wins any contention race and produces a 4-bit interrupt vector.

When an interrupt is received, the CCU grants the interrupt at a convenient point in the microprogram sequence. An interrupt-acknowledge signal is then sent back to the requesting peripheral; the current state of the processor must be saved in a stack. The 2914 is specially designed to handle interrupts.

The CCU consists of the instruction register and all the circuitry necessary to hold the microprogram for the ALU and system logic, including the clocks. The output of the instruction register feeds a PROM or programmable logic array that decodes the op code from the instruction register. The decoded output then feeds the sequencer array of 2909/11s, which in turn accesses the microprogram memory that controls the ALU and the rest of the computer.

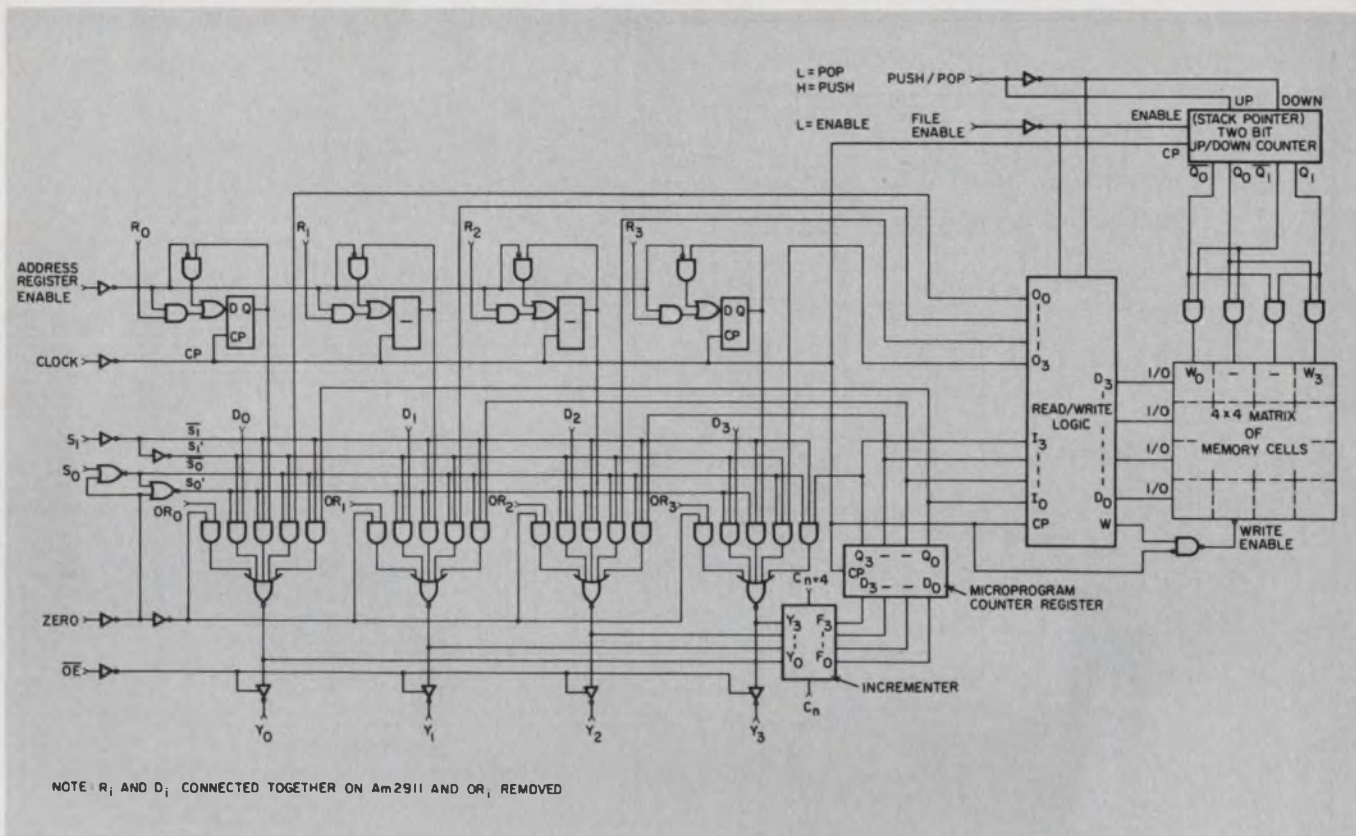

4. **Auto-incrementing logic** as well as a 4 × 4 register file are included in the 2909 microprogram sequencer. Also

included on the same chip are the stack pointer and a cascadable output bus.

The 16-bit computer operates with a main memory of 65,384 16-bit words. Data are formatted in 2's-complement integer form with the least-significant bit as bit 0 and the most-significant bit as bit 14. Bit 15 is reserved for the sign. Operations on the words held in the memory can be performed on either entire words or half-words (bytes). The lower byte is held in bit positions 0 to 7, the upper in 8 to 15.

Machine instructions consist of one or two main-memory words, which in turn are defined by sequences of microinstructions stored in the CCU memory. There are two formats for single-word instructions: register-to-register (RR) and special-function (SF). Double-word instructions also have two formats: register-indexed (RX) and register-immediate (RI).

The operation to be performed by the computer's current instruction is defined by a memory word's upper byte. The rest of the word and the next word (if it's a two-word instruction) are used as the operand. (Operands provide data, addresses or data-source and destination information.)

Machine instructions are divided into seven general function classes: arithmetic, logic, shift, data-movement, program-control (branch), input/output, and executive. The four different addressing modes already defined—RR, SF, RX and RI—must also be put into one or two-word formats (Fig. 9).

For the RR mode, the second byte of the 16-bit word defines the two registers used for the source and destination. The SF mode looks similar to the RR

mode, except that the F field uses the lowest four bits of the instruction to define any of 16 special tests.

Both the RX and RI modes require two 16-bit words. In the RX mode, the first operand is specified by the R₁ field in the first word. The second operand is specified by the sum of the second word and the contents of the general-purpose register selected by the X field of the first word. However, if the zero register is specified, the contents of the second instruction word's address field becomes the effective address of the second operand.

The RI mode is very similar to the RX mode. The second operand is contained in the second word of the instruction. To get the actual operand, the second operand must be added to the contents of the register specified by the X field in the first word.

All four of these addressing modes and the normal next-instruction addressing are performed with a program counter and push/pop stack in the PCU, and a set of program-control instructions held in the memory. Since the program-control instructions—jump, jump-to-subroutine, and return-from-subroutine—control either the PC or the stack, they all affect the next instruction address.

Define the microinstruction features

As already mentioned, the CCU controls all the operations of the computer once an instruction is pulled in from the main memory (Fig. 5). This instruc-

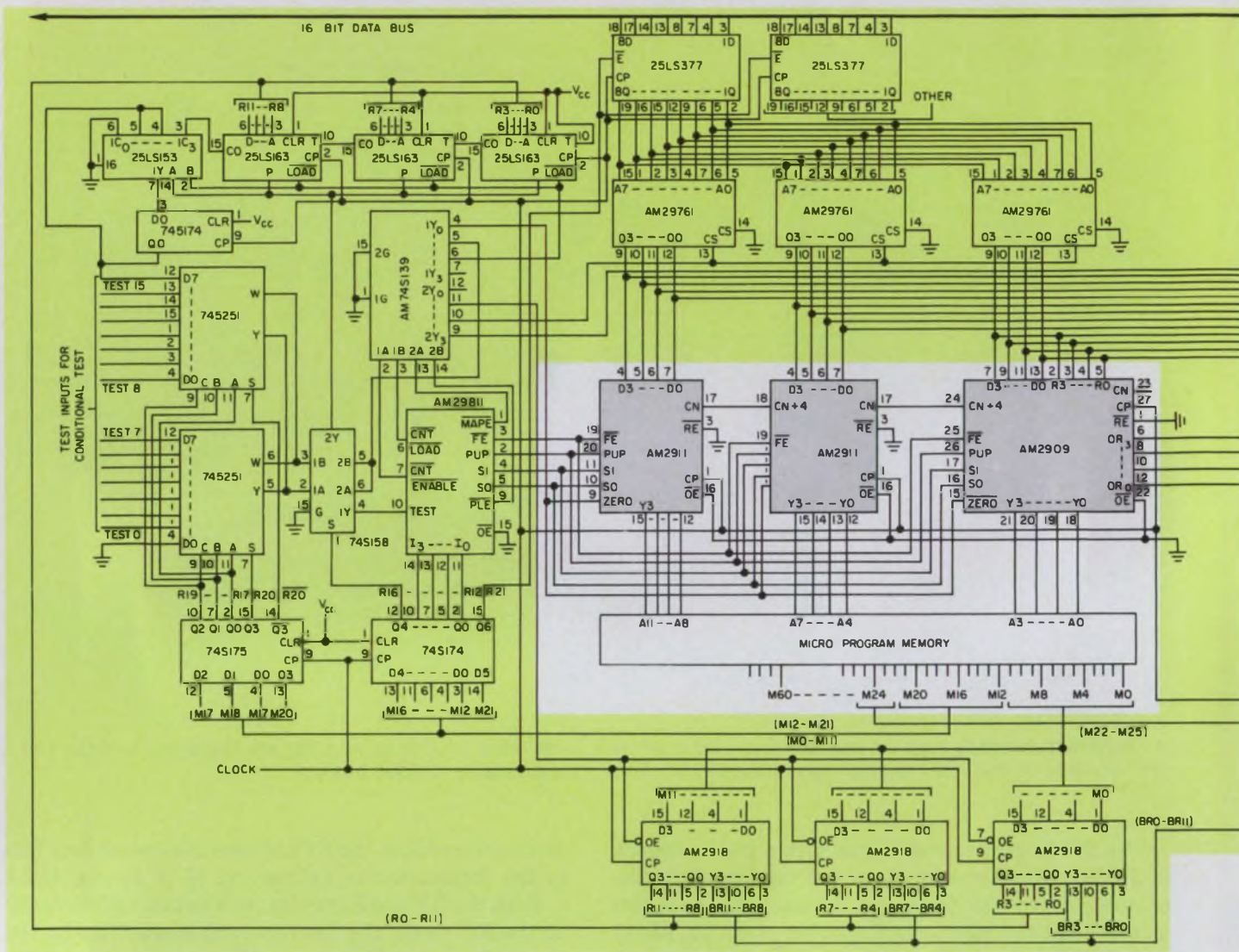

tion is routed into the CCU's instruction register. The op-code portion is fed into a mapping PROM or PLA, which in turn feeds the microsequencer.

The microsequencer determines the portion of the microprogram PROM or ROM that must be accessed to perform the operation specified by the op code. The number of bits of microprogram memory depends on the number of functions to be performed simultaneously. For the operations to be performed by the 16-bit computer under design, the microprogram memory is 64 bits wide and as many as 4096 words deep.

CCU operation is very straightforward—once the starting address reaches the microsequencer, the microprogram ROM gets addressed. A short time later, the ROM outputs the instruction code to the microinstruction register (often referred to as the pipeline register). Meanwhile, inside the microsequencer the original address is being incremented so that the next address can be rapidly accessed.

Another part of the CCU, which performs all the ancillary timing, synchronization and control must be used to coordinate all operations. The jobs performed by this logic section include initialization upon power-up, generation of the system clock, decoding of both

micro sequencer and condition instructions, and synchronizing asynchronous operations.

Operation of the PCU, which controls the computer's access to main memory, is also straightforward (see Fig. 8). Upon command, any information on the data bus can be strobed into the input register of the 2930, manipulated, then fed out of the Y bus onto the address bus.

Set up the microinstructions

Now that you know what to use, you can develop the actual microinstructions to carry out the main-program commands. Start by assigning fields to each microinstruction. The 64-bit word used in the mini-computer is split into two major sections: 26 bits determine the operation and addressing function of the CCU circuits, and the other 38 bits take care of the rest of the computer.

A flexible, high-performance CCU can be built by combining one 2909, two 2911s, a 29803, a 29811 and the necessary holding registers, multiplexers and counters (Fig. 5). To control these circuits, the 26-bit section is subdivided into five main fields:

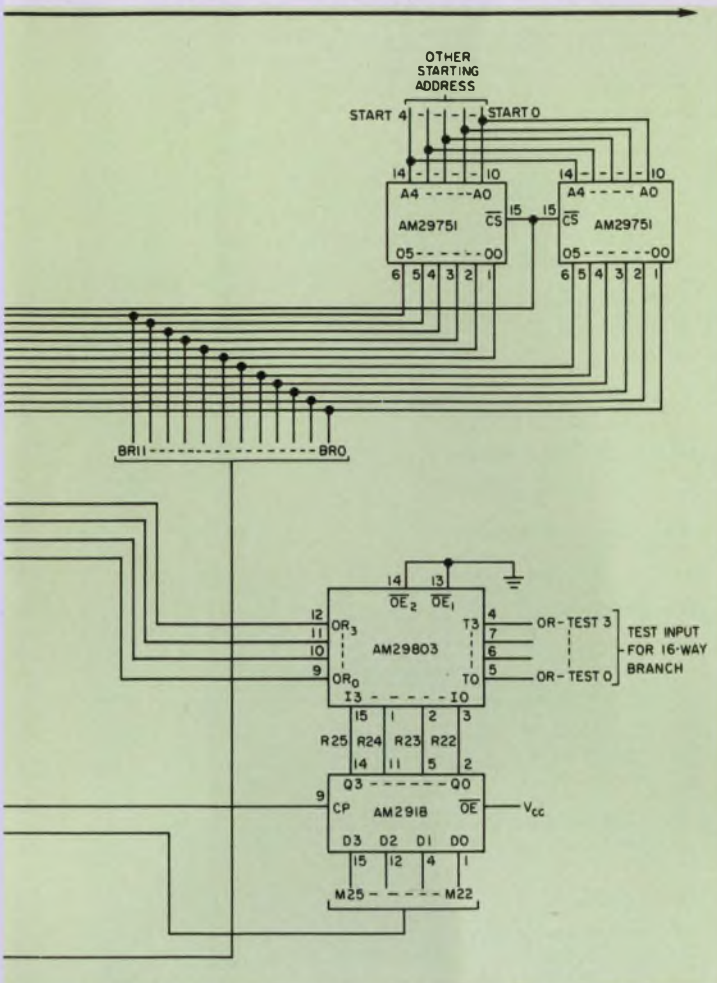

5. By cascading two 2911 sequencers and one 2909, as well as adding the necessary registers, multiplexers and memory circuits, you can build a complete high-performance computer-control unit.

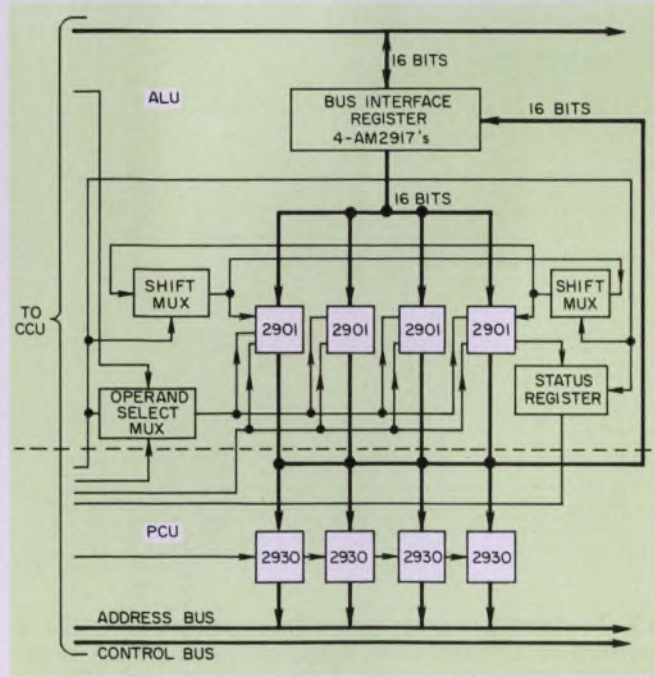

6. A basic 16-bit minicomputer can be assembled by combining four 2901s for the ALU, four 2930s for the program control unit, the CCU of Fig. 5, and appropriate memories and registers.

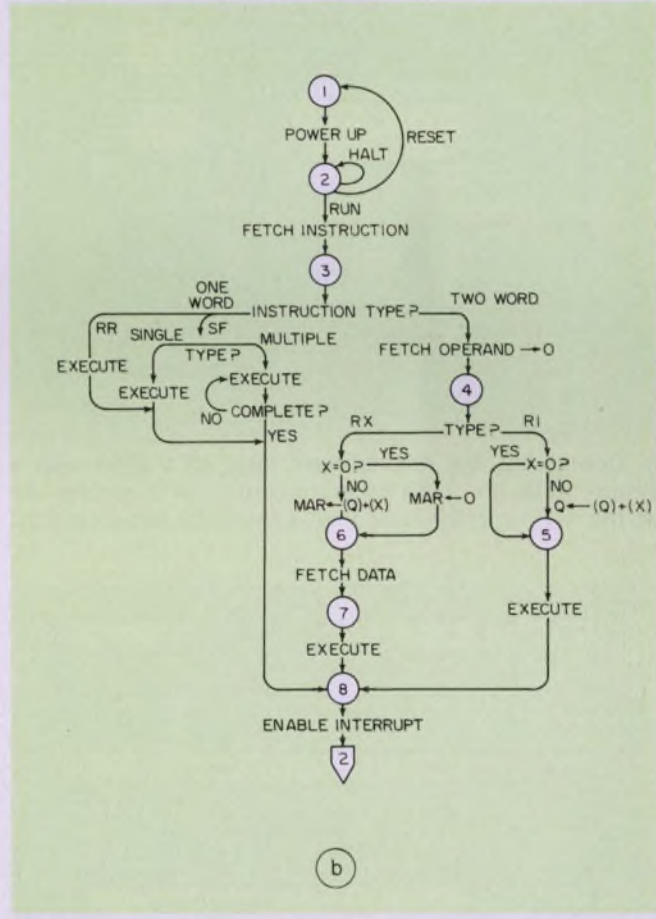
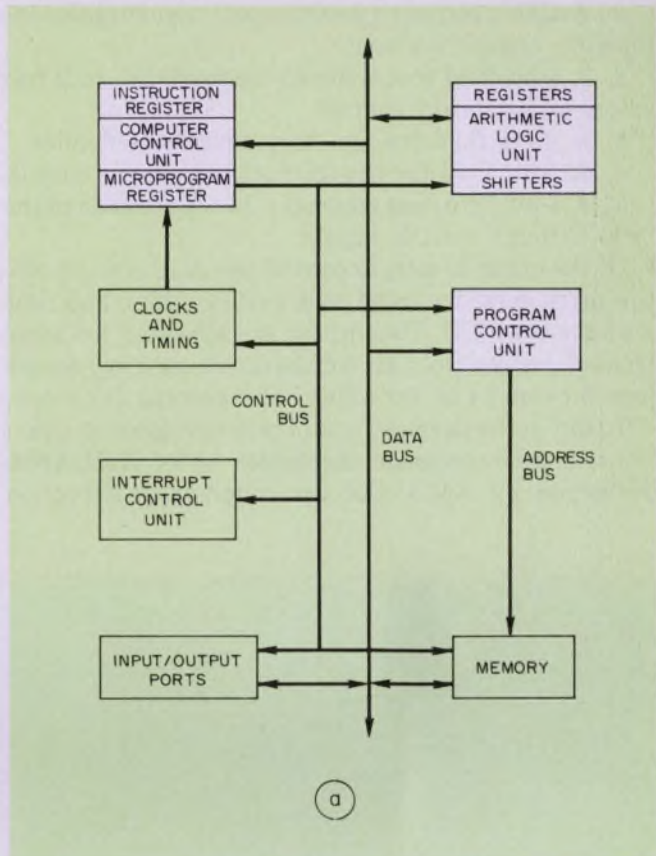

7. Breaking a 16-bit minicomputer into its various function blocks permits you to take advantage of the diverse circuits in the 2900 series (a). Computer operation can be shown very simply if a state-transition diagram is used to map the flow of an instruction.

1. A 12-bit counter (preset-input) that supplies the pipeline branch address.

2. A 5-bit field that controls the condition-code test select and polarity control.

3. A 4-bit field for the next address controller.

4. A 1-bit field for the instruction-register output.

5. A 4-bit field that controls a 16-way branch of the 2909 through its OR inputs.

Of the other 38 bits, 22 control the ALU, two handle the main memory (read and write enable), and four manage the PCU. Two others are allocated for some front-panel controls, six for the direct-memory-access interface and two for other housekeeping functions.

To aid in the development of microprogram instructions, a microprogram assembler called AMDASM, developed by AMD, can use mnemonic-instruction

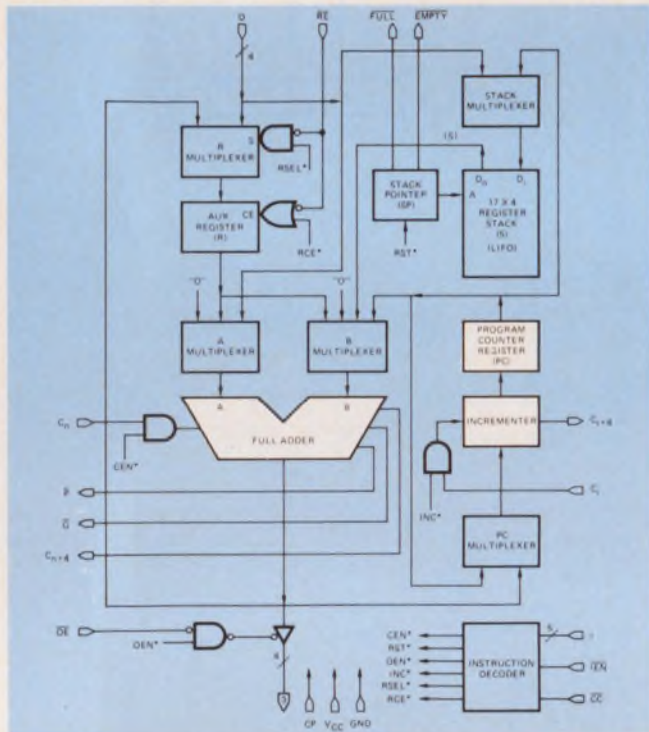

8. Combining the next-address logic of a 2909 with a simple ALU, the 2930 program-control unit can handle all the main memory's address-generation requirements.

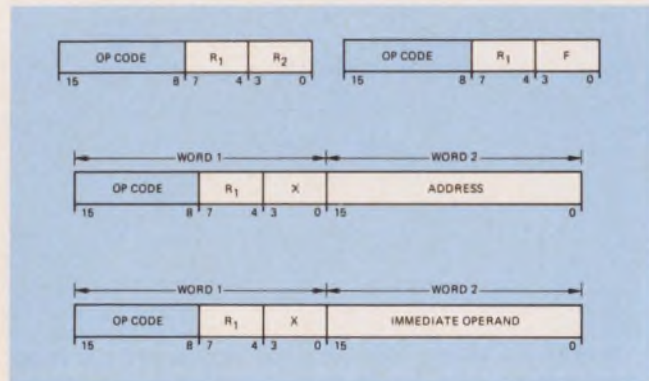

9. Different-sized instruction types—two that are one word long and two that are double-word commands—provide the computer with four addressing modes.

THIS IS AN AMDASM MICROPROGRAM ASSEMBLY EXAMPLE. AMDASM REQUIRES TWO PHASES: DEFINITION AND ASSEMBLY.

FOLLOWING IS THE DEFINITION PHASE AND THE DEFINITIONS REFER TO FIGURE 11.

WORD 64 DEFINE A 64-BIT MICROINSTRUCTION

THE FIVE MAIN CCU FIELDS ARE AS FOLLOWS

M0-M11 A 12-BIT NUMERICAL FIELD USED TO SUPPLY THE PIPELINE BRANCH ADDRESS OR COUNTER LOAD VALUE
M12-M15 THE AM29011 INSTRUCTION
M16-M20 CONDITION CODE TEST SELECT & POLARITY CONTROL
M21 INSTRUCTION REGISTER READ IN
M22-M25 THE AM29003 INSTRUCTION

DEFINE THE DEFAULT PIPELINE BRANCH FIELD. IT WILL FORCE THE MICROPROGRAM TO THE HIGHEST MICROPROGRAM MEMORY LOCATION IF LEFT IN DEFAULT FORM

NUMB DEF 52X 12V-0=1777

DEFINE THE CONDITIONAL TEST SELECT FIELD AND POLARITY CONTROL. DEFAULTS ARE NONINVERTED AND UNCONDITIONAL TESTS ARE ACTIVE LOW

TEST DEF 43X 4V% 0=0 1VB=0 16X

CNTR EDU 15 COUNTER ZERO TEST SELECT
INV EDU 8=1 POLARITY CONTROL

DEFINE THE AM29011 NEXT ADDRESS CONTROL UNIT INSTRUCTION MNEMONICS

JZ DEF 48X M=0 12X JUMP ZERO
CJS DEF 48X M=1 12X CONDITIONAL JUMP SUBROUTINE
JMAP DEF 48X M=2 12X JUMP MAP
CJP DEF 48X M=3 12X CONDITIONAL JUMP PIPELINE
PUSH DEF 48X M=4 12X PUSH CONDITIONAL LOAD COUNTER
JSRP DEF 48X M=5 12X COND JUMP SUBROUTINE REGISTER PIPELINE
CJV DEF 48X M=6 12X CONDITIONAL JUMP VECTOR
JAP DEF 48X M=7 12X CONDITIONAL JUMP REGISTER PIPELINE
RCTL DEF 48X M=8 12X REPEAT FILE LOOP ON COUNTER NE ZERO
RCTL DEF 48X M=9 12X REPEAT PIPELINE ON COUNTER NE ZERO
CRTN DEF 48X M=A 12X CONDITIONAL RETURN
CJPP DEF 48X M=B 12X CONDITIONAL JUMP PIPELINE & POP
LDCT DEF 48X M=C 12X LOAD COUNTER & CONTINUE
LOOP DEF 48X M=D 12X TEST END LOOP (CONDITIONAL LOOP ON FILE)
CONT DEF 48X M=E 12X CONTINUE
JP DEF 48X M=F 12X JUMP PIPELINE

THE DEFAULT FOR DATA BUS READ IN OF INSTRUCTION REGISTER IS DISABLE

DB DEF 42X 1VB=1 21X
IN EDU 8=0

DEFINE THE AM29003 16-WAY BRANCH CONTROL UNIT INSTRUCTION MNEMONICS

NOT DEF 38X M=0 22X
T0 DEF 38X M=1 22X
T1 DEF 38X M=2 22X
T01 DEF 38X M=3 22X
I2 DEF 38X M=4 22X
T02 DEF 38X M=5 22X
T12 DEF 38X M=6 22X
T012 DEF 38X M=7 22X
T3 DEF 38X M=8 22X
T03 DEF 38X M=9 22X
T13 DEF 38X M=A 22X
T013 DEF 38X M=B 22X
T23 DEF 38X M=C 22X
T023 DEF 38X M=D 22X
T123 DEF 38X M=E 22X
T0123 DEF 38X M=F 22X

END END OF DEFINITION PHASE

BEGIN ASSEMBLY PHASE

A DIVISION ROUTINE. ASSUME F=0 OF THE ALU IS CONNECTED TO TEST 12 (AND F3) TO TEST 13 AS BEFORE AND SIXTEEN DIVISION STEPS ARE REQUIRED IF THE FINAL REMAINDER IS NEGATIVE. IT MUST BE RESTORED BY ADDING IT TO THE DIVISOR. THE VECTOR INPUT IS SET UP FOR THE FRROR ROUTINE. NOTE USAGE OF THE AMDASM CONVENTION "S" TO DENOTE THE CURRENT PROGRAM COUNTER.

```
0001 DRG 0-1000
0002 DIVIDE: LOCT 12 TEST INV & NUMB 0-14% 1ALU OUTPUTS DIVISOR
0003 TEST 12 INV & CJV IF =0 ERROR
0004 APCT & TEST CNTR & NUMB S LOOP
0005 TEST 13 INV & NUMB S+2 & CJV IF R=0 CORRECT
0006 TEST & JMAP TEST & JMAP EXIT TO MAP
0007
0008 END
0200 XXXXXXXXXXXXXXXXXXXXXXXXXXXXXXXXXXXXXXXXXXXXXXXX 1100111111110001
0201 XXXXXXXXXXXXXXXXXXXXXXXXXXXXXXXXXXXXXXXXXXXXXXXX 0110XXXXXXXXXXXX
0202 XXXXXXXXXXXXXXXXXXXXXXXXXXXXXXXXXXXXXXXXXXXXXXXX 100100100000010
0203 XXXXXXXXXXXXXXXXXXXXXXXXXXXXXXXXXXXXXXXXXXXXXXXX 001001000000101
0204 XXXXXXXXXXXXXXXXXXXXXXXXXXXXXXXXXXXXXXXXXXXXXXXX 0010XXXXXXXXXXXX
0205 XXXXXXXXXXXXXXXXXXXXXXXXXXXXXXXXXXXXXXXXXXXXXXXX 0010XXXXXXXXXXXX
```

10. To simplify microprogram development, AMDASM, a mnemonic programming language available on time-sharing networks, lets you define instructions and constants before writing the programs (a). When actually writing a 2900-series program such as this divide routine, you can overlay microcode instructions to produce a compact microprogram (b).

equivalents for the instruction codes of the 29811 or ALU. Available on CSC time-sharing services, the program is used in two steps. Step 1 defines the microprogram word size, its fields, and the instruction mnemonics. Step 2 uses the mnemonics and permits you to write a program overlaying the different fields to arrive at the final microinstruction. A typical example of this definition stage is shown in Fig. 10a.

Once you're ready to develop the software, you should already have done most of the hardware definition and determined the microinstruction word size. The first thing you do with AMDASM is define the microword size and each of the fields that will be used (block @ of Fig. 10). Next, define some mnemonic instructions. The command NUMB, for instance, is a 64-bit microword whose first 52 bits are don't cares (52X). The next 12 bits form a variable field (12 V) with all bits substitutable—all 12 or just a few (%). If no 12-bit field is specified, the octal number 7777 is put in the NUMB field (Q#7777).

The next instruction definition follows an almost identical format. The command TEST is defined as a 64-bit microword whose first 43 bits are don't cares (43X). The next four bits are a variable field (4V), with all four bits substitutable (%). And if more than four bits are supplied, truncation will occur at four bits (:). If no variable field number is supplied, AMDASM will substitute a decimal value of 0 (D #0).

The definition continues past the comma stating that the next bit is a variable field (1V). If no number is supplied, a binary zero will be substituted (B#0). And past the comma, the last 16 bits of the word are defined as don't cares (16X).

Now the program is used to equate mnemonics CNTR and INV with numeric values 15 and binary 1, which are used to select test input 15 and set the polarity control. Next, the instruction mnemonics of the 29811 are defined. Each of the 16 instructions is represented by a microword, the first 48 bits of which are don't cares; the next four bits represent a hexadecimal number (H#0 to H#F), and the next 12 bits are don't cares (12X).

Once the mnemonics are defined, they can be put into adjacent words and ORed (overlaid) with other words to form a composite microword. A typical example of the necessary CCU instructions is shown in Fig. 10b. Here, a division example illustrates how instructions are overlaid. The & symbol indicates an overlay operation, and the * indicates an inverse function ($14^* = 85$). For example, the first instruction after the ORG command (set program counter to 1000_{octal}) combines several mnemonics into one microword: the LDCT, TEST, INV and NUMB instructions.

Should your design end up using too many bits of microword width, don't be too concerned. The extra memory won't cost very much, and will probably even keep the over-all design time down. ■■

Previous articles in this series discussed the 8080, F8, 6800, 2650, 1802, 6100, PACE, SC/MP, and Series 3000. The next article will describe the 10800 series.

CIRCLE NUMBER 39 ▶

MS-190 Removes Flux Fast



SAFELY! EFFICIENTLY! ECONOMICALLY!

MS-190 and MS-190HD (Heavy Duty) flux removers clean up flux quickly, completely, without harm to components. Used with patented Cobra Solvent Spray Brush (illustrated), the aerosol solvent is converted into an accurately directed, metered spray combined with scrubbing action of the brush for maximum cleaning with minimum waste. Risk of contamination (as in "dip" method) is eliminated. Nonflammable.

Thousands of electronics firms use these highly effective products routinely. You will too, once you've tried them.

SEND \$5 FOR TRIAL PACK

One 16 oz. can MS-190; one Cobra Solvent Spray Brush. Money back if not satisfied.



**miller-stephenson
chemical co., inc.**

Danbury, Connecticut 06810 (203) 743-4447

- Enclosed is my check for \$5. Please send Trial Pack.
 Please send me data and prices on MS-190, MS-190HD and MS-226 (Cobra Solvent Spray Brush).

Intended Use _____

Name _____ Title/Dept. _____

Company _____

Address _____

City _____ State _____ Zip _____

ED-5V

Since our products are For Industrial Use Only, government labeling regulations prevent our sending these trial units to your home address.

2901A

4-Bit Microprocessor Slice

We've got it

That's right. Raytheon now has the 2901A 4-Bit Microprocessor Slice. The 2901 became the industry standard, and now it's faster and better. The Raytheon 2901A has guaranteed lower power dissipation at elevated temperature and is a pin-for-pin replacement for the standard 2901.

There's even more good news. The drive on the "Y" output has been increased to 20mA, a whopping 30% improvement.

How fast is it? Just compare the following parameters for yourself. You'll be convinced that the Raytheon 2901A is the best bipolar microprocessor slice available.

That's only the beginning. Now you can really use the performance advantage of the

2901A with *guaranteed* min./max. parameters. For commercial/industrial as well as military applications.

Parameter	Typical 25°C 5.0V	Guaranteed -55 to +125°C 4.5 to 5.5V		Units
	2901A	2901A	2901	
Read-Modify-Write Cycle	55	80	120	ns
Minimum Clock Period	75	90	120	ns
A, B, Inputs → Y Outputs	45	90	120	ns
C _n → Y Output	20	45	60	ns
Clock → Y Output	40	90	125	ns
D Input → Y Output (Arithmetic Mode)	30	70	110	ns

For your complete data sheet, fill out the coupon. We'll do the rest. If you just can't wait, call one of our local sales offices. They can fill you in.

"The Specialists in Bipolar Microcomputer Components"

Field Sales Offices

California: Irvine (714) 833-9042, Mountain View (415) 969-3475.
 Florida: St. Petersburg (813) 576-2221. Illinois: Des Plaines (312) 297-5540. Massachusetts: Burlington (617) 272-8500.
 Minnesota: Minneapolis (612) 920-7935. New Jersey: Pennsauken (609) 663-4066. New York: Melville (516) 420-0700.



SEMICONDUCTOR DIVISION

Tell me more...

I'm interested in:

- Your full microcomputer story
 Just the new 2901A

Name _____

Company _____

Address _____

City _____ State _____ Zip _____

Send to: Raytheon Company
 Semiconductor Division
 350 Ellis Street
 Mountain View, CA 94042

No matter what your viewing pleasure, you'll find it at Digital.

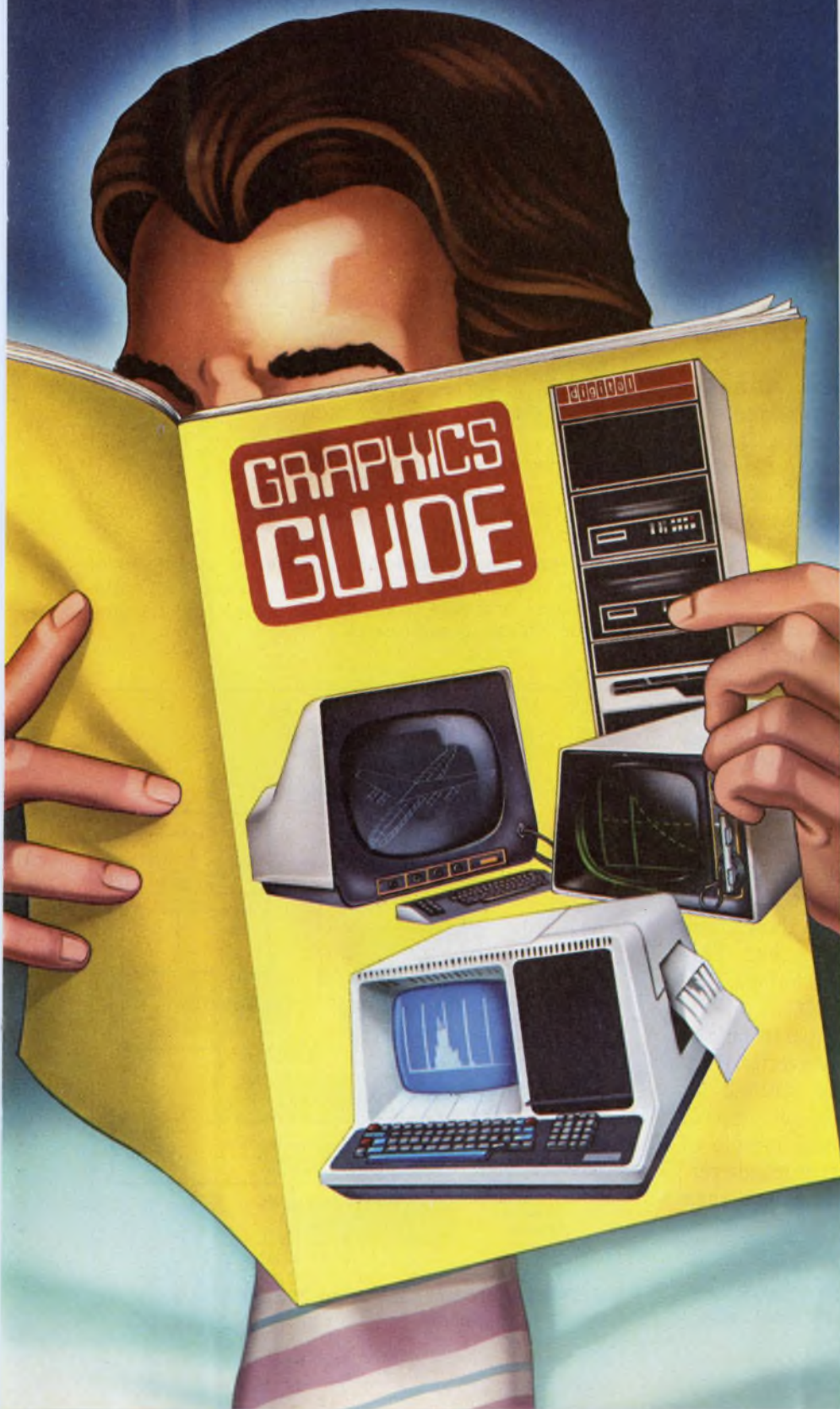

If you're looking into graphics systems, look at the company that offers you more graphics hardware, software and service than anyone else. Look at Digital.

We give you the chance to design your program first, then choose the right size graphics system to fit it. For example, you can choose our low cost VT55 graphics terminal. Or our medium performance VT11 and high performance VS60 display systems. Choose between our PDP-11/04, 11/34, 11/60 and 11/70 computers. Choose either stand-alone systems or intelligent terminals. You can even choose between our GT41, 43, 46 and GT62 processor-based systems.

And, since you're choosing Digital today, you never have to worry about adding more capability tomorrow. Because every piece of DECgraphic-11 equipment is hardware and software compatible. What's more, every system uses standard FORTRAN subroutines. So you can write your applications programs, then add on more equipment at any time. Without adding on more software.

Finally, choosing Digital means choosing the number one minicomputer manufacturer in the world. With over 4,000 sales, software and support specialists ready to lend you a hand in over 350 different cities around the world.

For all the graphic details, contact your nearest Digital sales office. Or fill out the coupon and mail to Digital Equipment Corporation, MR2-4/E14, Marlborough, MA 01752. Telephone: (617) 481-9511, ext. 6933. European headquarters: 81 route de l'Aire, 1211 Geneva 26. Tel: 42 79 50. In Canada: Digital Equipment of Canada, Ltd.

Digital Equipment Corporation,
MR2-4/E14, Marlborough, MA 01752

- I am interested. But my need is long range. Please send me graphics literature.
- I am very interested. Please have your nearest sales engineer contact me.

Name _____

Title _____

Company _____

Address _____

City _____

State _____ Zip _____

Phone _____ Ext. _____

digital ED5107

Wring out 4-bit μ P slices with algorithmic pattern generation. You will be able to pinpoint faults in both hardware and software.

Testing the 2901 and other 4-bit μ P slices demands better methods. A bit slice must be thought of as a complex, sequential logic structure, and not simply as a few gates or an LSI memory. One fairly new testing approach writes test sequences in a micro-program, or algorithm, and a generator produces the required bit patterns.

The technique contrasts with the bulk of automatic testing today, in which bit sequences are generated by a computer program held in mass memory, then transferred first to a RAM, and second, in a burst, to the device under test.

A true and meaningful test requires an understanding of the slice hardware architecture and software functionality. Hardware architecture, that is, the internal organization, consists of an ordered set of modules, such as the register stack, accumulator and arithmetic logic units (ALU). Software functionality is the arrangement of ordered micro-instructions that monitors the operation of the hardware modules.

Once both areas are mapped out, you can develop an ordered set of test sequences, written in the slice's own instruction set, to test each module one by one. Algorithmic pattern generation follows. Although the 2901 is a good example for describing the modular test approach, the technique applies to all μ P slices.

Slicing up the slice

In general, a μ P slice has two buses. One bus addresses both the external and the internal scratch-pad memory. Another bus supplies input data to the processor and processed data to the output. This second bus also links the internal functions, the scratch-pad memory, registers and ALU.

The first step in testing is to partition the device into modules, some of which may overlap (Fig. 1). Each module should be accessible through its input/output bus by the execution of micro-instructions. In other words, you should be able to apply data to the slice input either directly or indirectly with the μ P instruction set. The data should then propagate to the output.

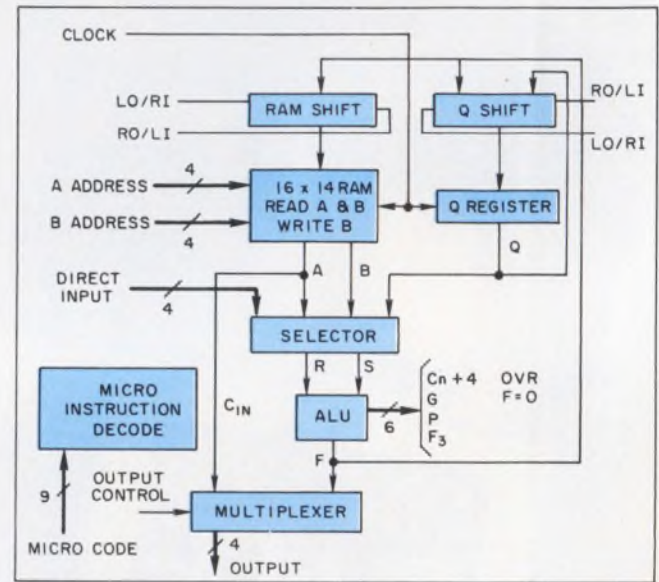

1. Microprocessor slices can be viewed as assemblies of independent functional blocks that can be tested separately. Address and data buses tie the blocks together and provide access to each block.

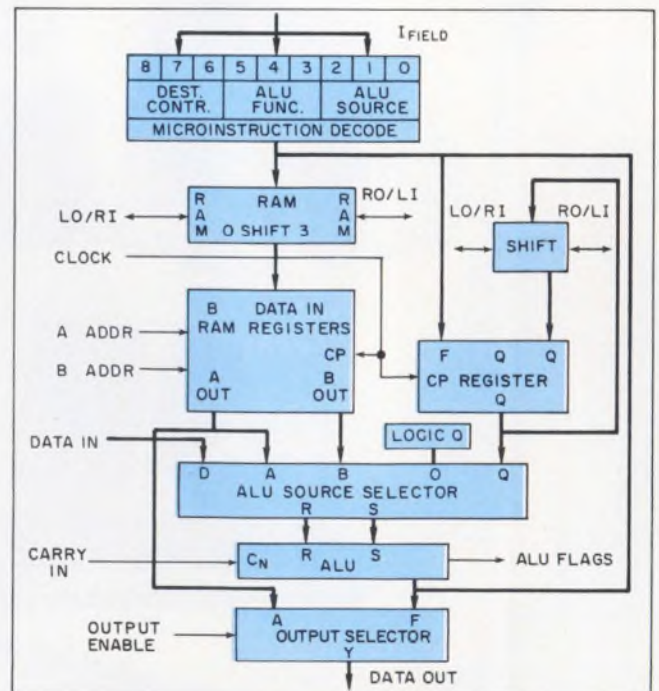

2. Architectural breakdown of the 2901: modular analysis is the most important function in developing tests.

Richard McCaskill, Manager, Application Services, Macrodata Corp., 6203 Variel Ave., Woodland Hills, CA 91364.

A test is generated for each module of the slice so that a worst-case test pattern is run on each one. Sensitivity to the pattern can be determined with yet another pattern consisting of galloping ONEs and ZEROs.

While you test the first module, a set of instructions should be executed. As you proceed towards the second module, another set of new instructions is executed. This process continues until all instructions within the set are used in testing each module.

The diagnostic information gained has dual value. First, if a failure occurs, the faulty module is pinpointed. Convenient breakpoints inherently exist in such a module-by-module approach. Second, a set of microinstructions is executed in conjunction with each module, so if a fault occurs, the specific instructions can be isolated and identified.

The 2901 lends itself to the modular test approach because of its hardware and microinstruction architecture (Fig. 2). Notice that the device can be divided into the following modules: RAM, Q register, ALU, ALU source-decode multiplexer, RAM and Q-register right/left shift logic.

Start with the ALU

Since the 2901 has an ALU section, you should first test those areas that supply data to the ALU. Start with the RAM, and then do the Q-register module. Once these have been tested, they can serve as reliable data sources for the ALU-module test.

After the RAM and Q register, a typical test flow for the 2901 proceeds to the ALU source-decode multiplexer, the ALU and flags, and ends with the RAM and Q-register right/left shift logic (Fig. 3). During the test flow, all microinstructions are used.

Once you determine the necessary bit pattern, you have to create the pattern. The most common implementation on automatic testers today, the stored-pattern method, suffers from major drawbacks: inflexible programming, a large, expensive memory, long transfer periods and lack of fault isolation. Algorithmic generation can solve these problems.

In the algorithmic method, the defined sequence of patterns is created by a high-speed pattern generator controlled by a microprogram control. A variety of distinct patterns is possible, and you can modify with ease. Each module is tested by a sequence of generated stimuli that simulates the actual μ P instruction. The device's true output response is controlled by the pattern generator.

The algorithmic technique can also solve the problem of overhead-data-transfer time. Since algorithmic generation occurs at true device speed, a substantial amount of the overhead time inherent in stored-patterns is eliminated.

Tests on the 2901 Q register and the right/left shift operation on the RAM illustrate the advantages of testing with algorithmic generation. In both cases, all operations are tested, and all number combinations

checked without having to store input or output patterns. The conventional method requires over 8000 stored patterns for the same test.

Tracking down all possible faults

To test for all number combinations, data are first sent into the Data-input port, through the ALU, and into the Q register. Then the Q register is selected and

Test flow chart	Functional-test description	Test pattern
RAM test	A galloping ONE and ZERO pattern is applied to the RAM in combinations. 1. The RAM addressed by the "A" address and tested through the Y output port directly. 2. The RAM addressed by the "A" address and tested through the ALU. ALU is held at a fixed instruction. 3. The RAM addressed by the "B" address and tested through the ALU. ALU is held at a fixed instruction.	Approx. 3000
Q register	A number 15 is loaded into the register and then read. Next, a number "0" is loaded and read. This is followed by a 14, 1, 13, 2, etc., until a "0" then a 15 is loaded.	Approx. 100
ALU source decode	The ALU source decodes are tested to see if all decodes are possible. The test is performed by loading values into the RAM and Q register and selecting all decodes while testing for any interaction between bits or sections.	Approx. 50
ALU	A series of numbers is loaded into the RAM and Q register. These numbers are then used as inputs to the ALU. At the same time, all outputs and flags from the ALU are monitored while incrementing the operations the ALU can perform.	Approx. 1000
RAM and Q register right/left shift MUX	All numbers from 0 to 15 are shifted through the RAM and Q register. While the RAM section is being tested, all locations are tested. After each shift, all possible number combinations are delivered to the output latch, without clocking the latch, to see if there is any latch sensitivity.	Approx. 8200

3. Each functional module of the 2901 slice is isolated and a test flow established for each module. All microinstructions should be used in the tests.

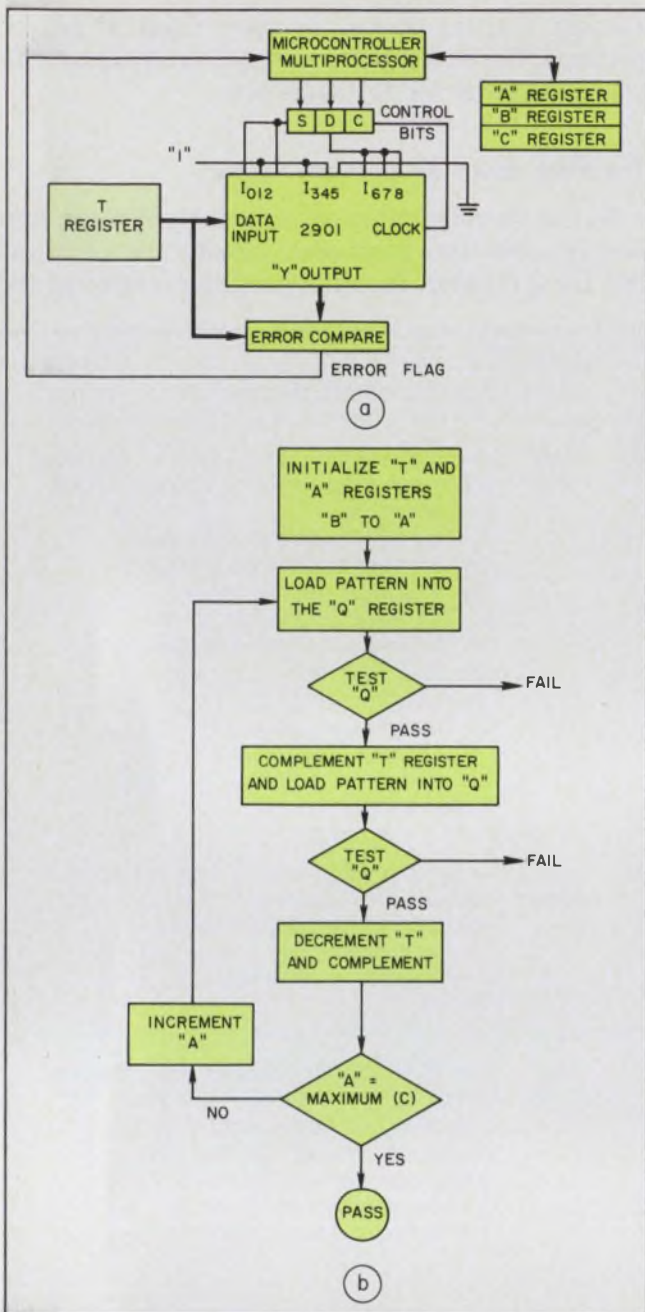

4. The Q register is tested for all numerical combinations with a register that provides inputs and compares output and input data (a). The test flow chart is shown in (b).

its contents tested (Fig. 4). All that is required is a register to keep track of the input and output data, another to keep track of the test cycles, and three bits to control the microinstructions and the μ P clock.

As shown in Fig. 4, a 4-bit test register supplies that data input and compares output and input data. The A register keeps track of the test cycles performed, the B register stores the starting count, and the C register the ending count.

The S bit selects the ALU data sources, and the D bit picks the ALU data's destination. The C bit clocks the device. Finally, a microcontroller multiprocessor controls all registers and control bits, and tests for an error in the compared data.

As illustrated in Fig. 4b, a simple test run on the

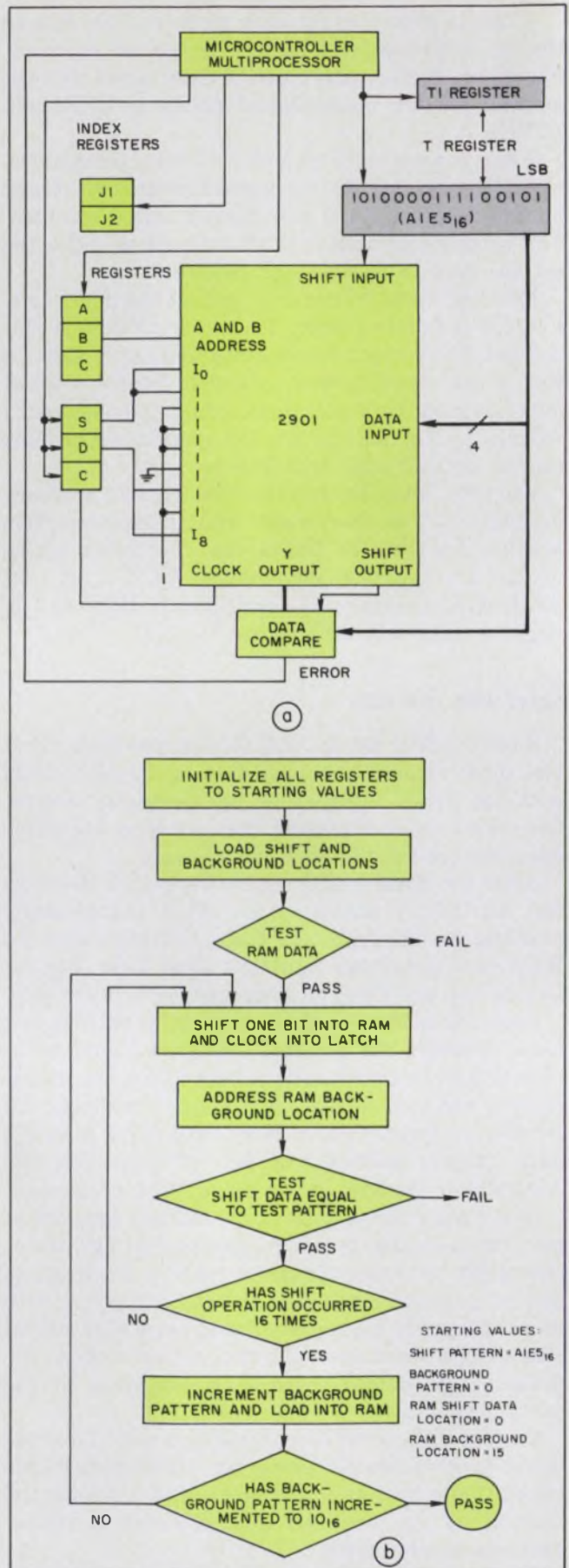

5. Testing the right/left shift operation of the 2901 RAM requires a more elaborate arrangement (a). The test flow checks the data latches as well (b). Two locations in RAM store shifted and background data.

register checks that all possible number combinations and complements are loaded. Data enter through the input port, pass through the ALU, and are clocked into the Q register. The ALU source is selected to octal-code, 7 (R=D, S=0), and the ALU function is selected to octal 3 (R or S) throughout the test.

Keeping the ALU function in R or S allows you to isolate faults easily: Only one path is used through the ALU. After the Q-register operation is loaded, the sequence selects the Q-register and tests it for the correct value. The Q-register position is selected through the ALU selector (octal-code 2) and the ALU destination set to octal-code zero to transfer the Q register to the Y output.

The test vector is then complemented and the selection operation repeated. Upon completion, the test vector is decremented and complemented, and the same test performed again until all combinations are tested: 0, 15, 1, 14, ..., 14, 1, 15, 0.

Testing the right/left shift operation of the RAM calls for a more complex test pattern. The shift test must test the right/left operation of the RAM completely, and the RAM data-output latches. Two locations in RAM are used. The first stores the shifted data, the second the background pattern delivered to the latch after the shifted data have been clocked into the data latch.

Additional hardware is required to perform the shift test (Fig. 5a). First, both the shifted and the background data values need to be stored. The shifted data are stored in the previous-test register (T), and the background data in register (T₁).

Two other features are added to the T register: a circular shift of the most-significant bit to the least-significant bit and a bidirectional 16-bit transfer path between the T and T₁ registers.

Two index registers, (J₁ and J₂), keep track of each shift operation and each incrementation of the background value. All operations are controlled by the microcontroller multiprocessor.

In the final test, checking the RAM's shift operation, the algorithm is not really as complex as it appears in the flow chart (Fig. 5b). Two locations in RAM store the test-shift background data. The test loads the two and then shifts pattern A1E5₁₆ through the RAM.

After each shift, the shifted data are checked and the background addressed. The output is again tested to see that the latch's state is unchanged. With A1E5₁₆, all number combinations will be shifted through the RAM. After all 16 bits of the pattern have shifted through, the background word is incremented and the test repeated.

The algorithm of Fig. 5b is repeated on all RAM addresses, with the complement of the background pattern acting as the test-pattern address. ■■

Bibliography

AMD-2900 Bipolar Microprocessor Family, Manual, AMD Corp., Sunnyvale, CA, June, 1976.

Chiang, Albert C. L., and McCaskill, Richard, "Two New Approaches Simplify Testing of Microprocessors," *Electronics*, January, 1976, p. 100.

power measurement made easy...



and accurate!

YEW's complete line of digital precision low frequency instrumentation for True RMS Volts/Amps and Watts to $\pm 0.01\%$ accuracy.

Model	Accuracy	Range*		Frequency Range	Approx. Price
		V	A		
APR-2	$\pm 0.01\%$	120	5	DC&60Hz	\$18,000
2885-16 1Ø, 2W	$\pm 0.03\%$	75/100/ 150/300	0.5/1/2 5/10/20	20Hz-10KHz	\$4,995
2503-11 1Ø, 2W	$\pm 0.1\%$	3/10/30/100 300/600	0.1/0.3/1 3/6/10/30	WATTS 40Hz to 1.2KHz V & A 25Hz to 2KHz	\$4,695
2503-13 3Ø, 3W	$\pm 0.1\%$	3/10/30/100 300/600	0.1/0.5/1 3/6/10/30		\$7,192
2504 1Ø, 2W	$\pm 0.25\%$	30/60/100 150/300	0.5/1/2 5/10		\$2,750
2505 3Ø, 4W	0.25%	100/150 300/600	2/5/10 20		\$7,300
2041 (analog) 1Ø, 2W	$\pm 0.5\%$	Various ranges to meet most requirements—25W to 12KW self-contained		DC and 25Hz-1KHz	\$ 332
2042 (analog) 3Ø, 3W					\$ 437

*Watt Range=VA @ unity power factor

NOTE: Above instruments useable from 0.0 P.F. to 1.0 (unity) P.F.

When it comes to low frequency AC and DC digital instrumentation, the comprehensive YEW line is the most accurate and flexible available. What's more, it's the easiest to use—even by nontechnical factory personnel. Write for complete specifications. Yokogawa Corporation of America, 5 Westchester Plaza, Elmsford, N.Y. 10523, 914-592-6767.

YEW YOKOGAWA CORPORATION OF AMERICA

Omnigraphic® Series 2000 X-Y recorders

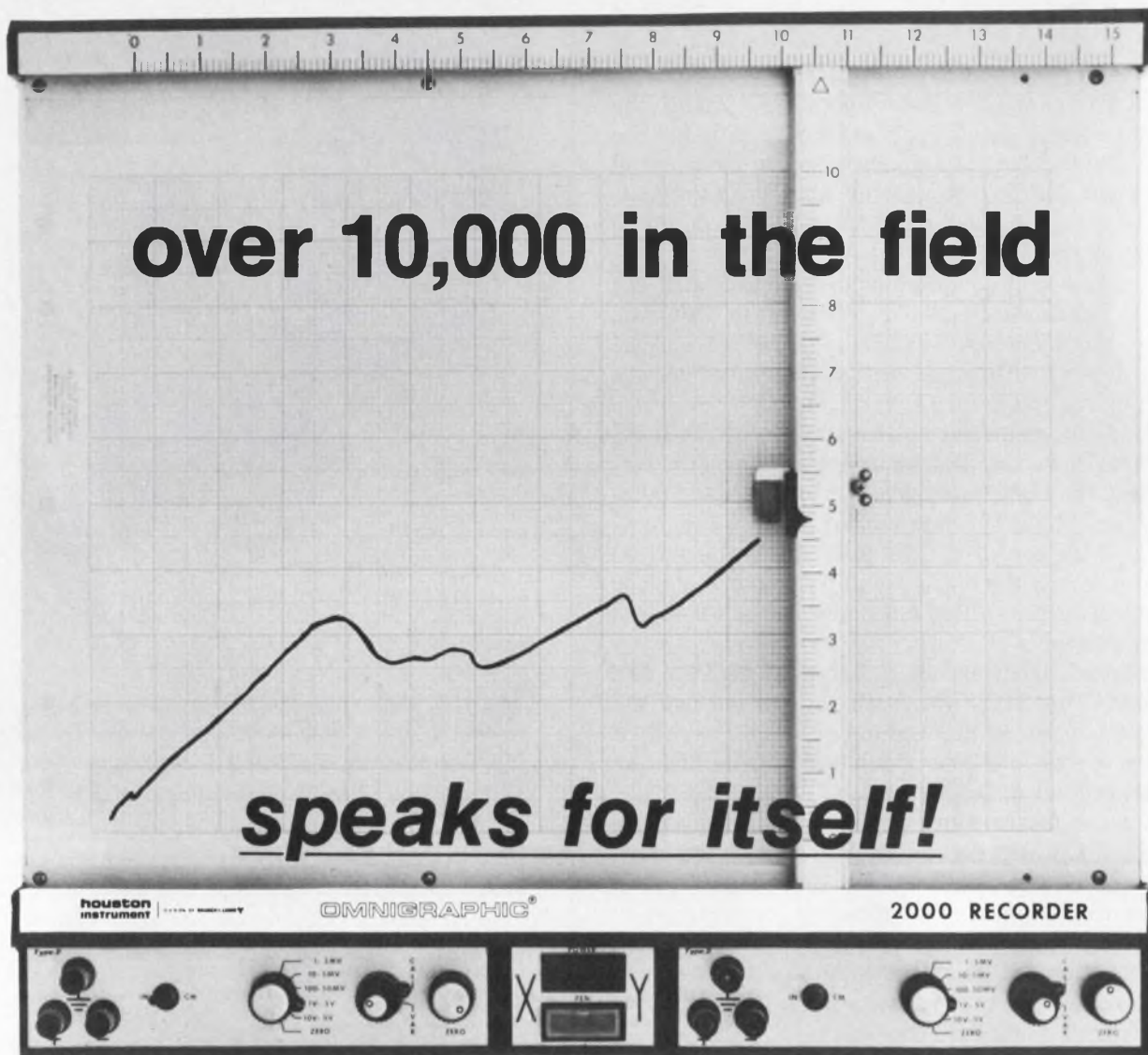

over 10,000 in the field

speaks for itself!

You get the best price/performance possible

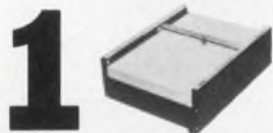

Start with the versatile main frame

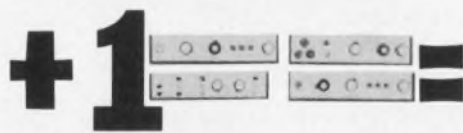

Add your "Designers Choice" from 18 input modules



You get an X-Y Recorder with the best price/performance available.

Send for FREE "Designers Choice" catalog today

® A registered trademark of Houston Instrument

houston instrument

ONE HOUSTON SQUARE
(512) 837-2820

THE RECORDER COMPANY

(at 8500 Cameron Road)
TWX 910-874-2022

DIVISION OF BAUSCH & LOMB

AUSTIN, TEXAS 78753
cable HOINCO

EUROPEAN HEADQUARTERS Phone 059/277445 Telex Bausch 81399

MICRO-DIP SWITCH

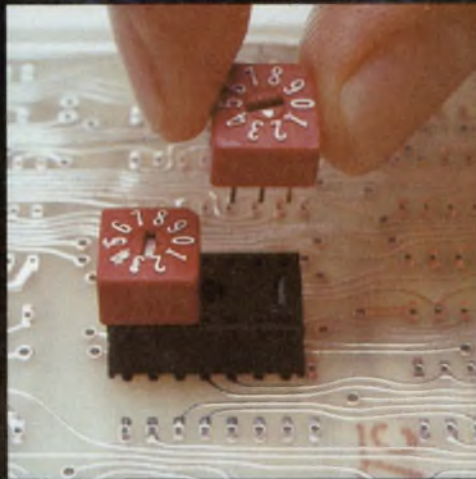

MICRO-DIP...Miniature binary-coded DIP switch designed to be mounted directly to printed circuit boards. Ideal for address encoding, pre-setting, PCB programming...every area using digital electronics.

Packaged in a glass-filled nylon housing with terminals on .100X.300 centers. Occupies only one-half of a standard 14-pin DIP socket.

Screwdriver slot is rotated in either direction to desired setting. Dust-seal concept protects gold contact surfaces. Ease of solderability and cleaning.

Positive detenting 10-position BCD code. Guaranteed life of 10,000 detent operations. Operating temperature range of -10°C to $+60^{\circ}\text{C}$ with contact resistance of 25 milliohms max. initial.

One year warranty.



E E C O

1441 East Chestnut Avenue, Santa Ana, California 92701 - Phone 714, 835-6000. Distributed in U.S. by G. S. Marshall, Hall-Mark and Schweber. In Canada by R. A. E.



Real-time systems often use interrupts to service I/O devices in order of importance. And blocks of data can be moved quickly by direct memory access.

Microcomputers are often used in dedicated control operations where inputs occur at unpredictable intervals. Process control systems that affect motor speeds, flow rates, machine operations, or process parameter variations must be sensed and controlled in real time. Program-controlled I/O (Part 5, ED No. 9, Apr. 26, 1977, p. 70) must therefore be supplemented by device-controlled interrupts.

An interrupt may occur at any time during program execution. In response to an interrupt, control is transferred to an interrupt-service routine after the current instruction is completed. When the service routine has processed the interrupt, it returns control to the main program. If all goes well, the main program continues execution without adverse effects. But only if you carefully consider, both in software and hardware, all interrupt phases: initiation, acceptance, service and return.

In its simplest form, the computer receives a single interrupt, finishes the current instruction, and calls the fixed memory location that contains the interrupt service routine (Fig. 1). The service routine performs the data transfers and returns control to the main program. Because the single-interrupt routine address is fixed by hardware, it is called a fixed (or single-level) interrupt.

Polling requires more logic

A single interrupt line can be shared by several external devices if you apply the "polling" technique. Logic must be added to the interrupt service routine to read the status of each interrupting device and determine which one requires attention. The result of the poll is used to transfer control to the proper I/O routine. If there are many interrupting devices, polling can be very slow and inflexible.

Vectored (or multiple-level) interrupts are faster and more flexible, but require more hardware. The computer then responds to an interrupt by sending out an interrupt-acknowledge signal when it has completed the current instruction or routine. The interrupting device then supplies the CPU with the

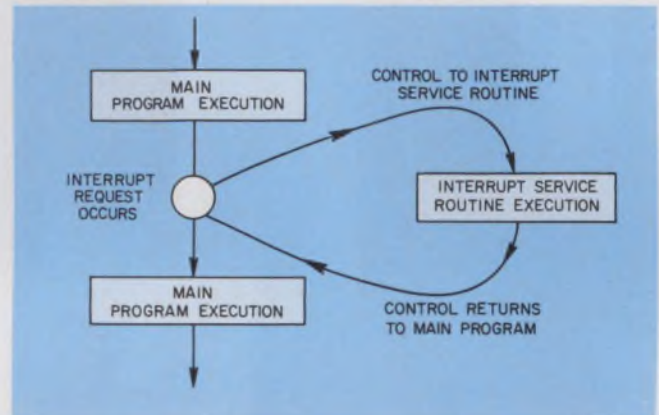

1. A single interrupt stops execution of the main program whenever it occurs. Once the interrupt service routine is executed, control returns to the main program.

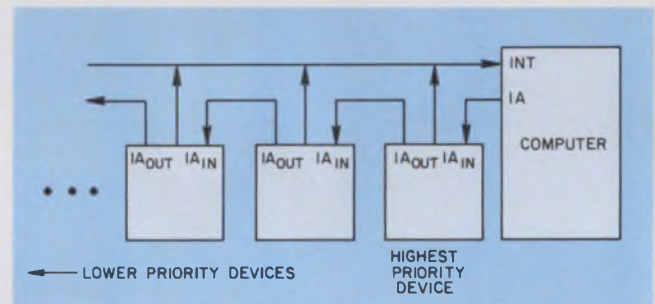

2. The daisy-chain priority interrupt system acknowledges interrupt requests only when all upstream devices have been serviced.

address of its service routine, and control is transferred directly, without polling or decoding. You may combine vectored, polled, and fixed interrupt schemes in your system architecture to obtain the desired response characteristics.

When your system contains several interrupting devices, you must establish a pecking order. The highest-priority devices may always have to be serviced on demand, while lower priority devices wait—or are ignored altogether.

A simple priority scheme for microcomputer systems is the daisy chain (Fig. 2). All interrupting devices share the common interrupt line, but the interrupt-acknowledge line is routed to the highest

priority device first, and then passed through to consecutively lower-priority devices. Until it has identified itself and been serviced—or has, in turn, been interrupted by a higher priority device—the interrupting device suppresses transmission of the acknowledge signal to lower-priority devices.

For a more sophisticated priority-interrupt scheme, LSI devices such as Intel's 8259 provide "hardware-priority" encoding, so that you can enable and disable specific devices under program control. In most systems you can completely disable interrupts during such critical program segments as timing loops. But you must be sure that only expendable data are lost when an interrupt request is disregarded.

Before enabling any interrupts, the system control program requires initialization—i.e. you must set up all data values that the interrupt-service routines will need. Normally, an interrupt-service routine is executed once each time a device interrupts. Because you don't know when the interrupt may occur, it is vital that the interrupt-service routine restore all registers and flags that it modifies during I/O processing, before it returns control to the main program. If any other interrupts are automatically disabled by the first interrupt, the service routine must re-enable them before execution continues.

How do you like your eggs?

Many microcomputer systems perform tasks for a fixed time interval—for example, cooking an egg to your preferred consistency—which requires translating elapsed time into a form that is usable by the program. Suppose you have a clock outside your system than can generate an interrupt once every second. By assigning some memory location as a counter, your system can count these interrupts and know how much time has elapsed (Fig. 3).

If you want to use this counter to time a three-minute egg, you need a 360-second delay, or 360 counts. If the counter is at, say, 600 when you start the egg timing routine, your program has only to monitor the counter until it reaches 960, then turn off the stove or ring a bell. For such simple elapsed-time tasks interrupt initialization consists of clearing the counter location and enabling interrupts. A routine that uses this timer simply reads the current value of the

counter, adds the desired number of counts to that value, saves the sum, and continues until the counter reaches the sum (Fig. 4).

To implement this routine with an 8080A system, assign the timer two memory locations labeled TIME and set up an external clock to generate an "RST5" for service (see box). Program sections for the timer routine, initialization and service routines follow:

```

;INITIALIZE TIMER
  LXI H,0      ;CLEAR TIMER
  SHLD TIME
  EI           ;ENABLE INTERRUPTS
  .
  .
  .
  LHLD TIME    ;GET INITIAL TIME
  ADD L        ;ADD COUNT TO HL

```

(continued on page 82)

The 8080A restart instructions

The 8080A provides an 8-level vectored interrupt system. When an interrupt is acknowledged, the interrupting device may place one of eight single-byte RST instructions on the data bus. The RST instructions behave as subroutine calls to a fixed block of addresses low in memory:

INSTRUCTION	ADDRESS CALLED
RST 0	0
RST 1	8
RST 2	10H
RST 3	18H
RST 4	20H
RST 5	28H
RST 6	30H
RST 7	38H

Each restart area consists of eight bytes, and if an interrupt service routine requires more, use a jump instruction to continue it elsewhere in memory.

(continued from page 81)

```

MOV L,A
MOV A,H
ACI 0
MOV H,A
XCHG ;MOVE VALUE INTO DE
TLOOP: LHL TIME ;GET CURRENT TIME
MOV A,E ;SUBTRACT FROM VALUE
SUB L
MOV A,D
SBB H
JNZ TLOOP ;WAIT UNTIL THEY MATCH

```

```

ORG 28H ;RST 5
TIMER: EI ;RE-ENABLE INTERRUPTS
PUSH H ;SAVE HL
LHLD TIME ;GET TIMER
JMP TCONT ;CONTINUE ELSEWHERE
.
.
.
TCONT: INX H ;INCREMENT TIMER
SHLD TIME ;RE-SAVE
POP H ;RESTORE
RET

```

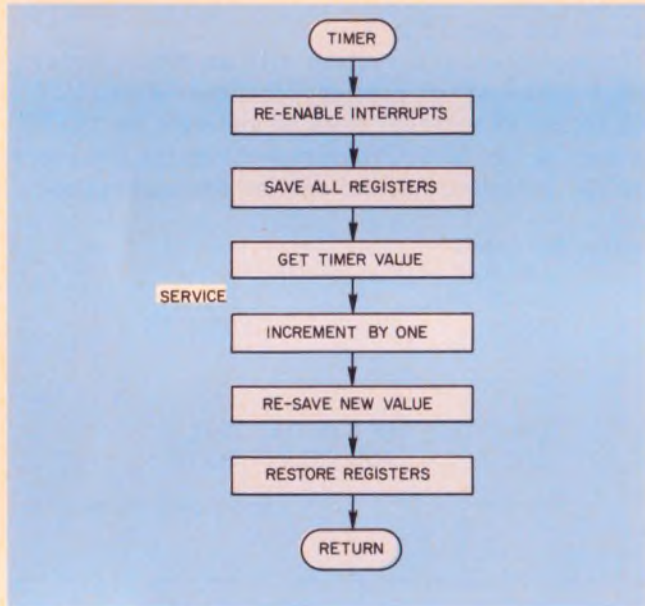

3. This timer flow chart is an example of an interrupt service routine. The time count is only correct if the interrupt is serviced promptly.

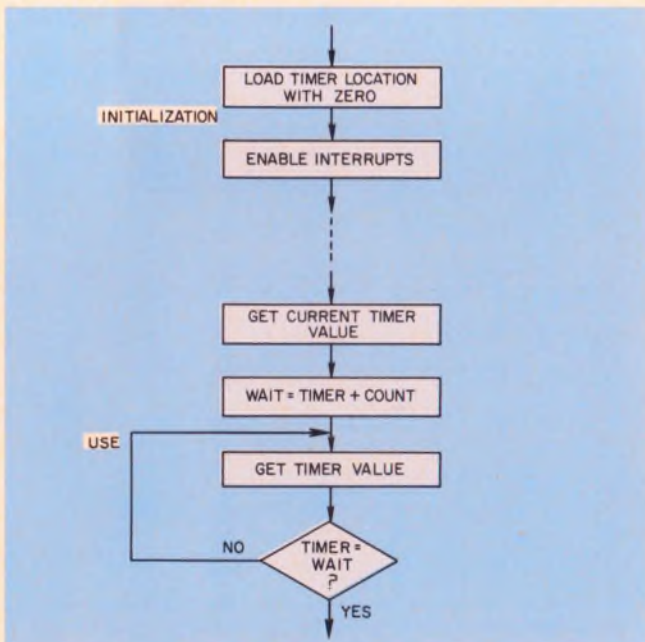

4. Interrupt service routines, like the timer routine, interface with an initialization segment and a use routine in the main program.

Note that, since the timer service routine is longer than the eight bytes provided by RST5, it is continued in another part of memory. In this case, you don't have to save and restore the program-status word (PSW), because the INX instruction does not affect any flags.

When you design software to process asynchronous interrupts, erroneous changes in the execution of the

What is a checksum?

In a commonly used method for checking data validity, a checksum is formed by keeping a running sum of all data bytes in the record. After all the data bytes have been written, the two's-complement of the sum is formed and written on the tape as the checksum. When the tape is read back, the sum of all read data is formed again, and the checksum added. If the data have been read back correctly, the result is zero. For example, consider writing six data bytes as follows:

Data: 0,1,2,3,4,5
 Sum: 0+1+2+3+4+5=0FH
 Two's-comp. checksum: 0F+1=0F0H+1+0F1H

On readback, the sum of all data on the tape is formed again, and the checksum added:

$$0+1+2+3+4+5+0F1H=100.$$

Ignoring carries, the sum is zero, which indicates that the data have been read correctly.

Checksums can be formed differently, but it is common to use the "checksum modulo w," where $w = 2^n$ and n is the number of bits in the computer's basic data word. The modulo function produces the "integer remainder" of the division of one number into another. Thus, the number 11 evaluated in modulo 5 becomes 1, because $11/5 = 2$ with an integer remainder of 1. The checksum is easily evaluated in modulo w by simply forming the sum of the data bytes and ignoring any carries. With an 8-bit micro-computer, checksums are evaluated modulo 256 ($2^8 = 256$), so that only a single-byte checksum is needed, regardless of how many data bytes are written.

main program can result, unless you pay close attention to memory and register usage. Occasionally, detailed timing analysis may be required.

Want to move data wholesale?

At times you may have to interrupt processor operation, or dedicate the processor temporarily to the transfer of a block of data between an external device and a reserved block of memory. Block transfers are used typically for interfacing magnetic tape or disc units, which have a very high data-transfer rate for blocks of data, but can't be easily started and stopped to transfer a single byte.

Memory areas reserved to store such blocks of data are called buffers. The most common type of buffer is a FIFO (first in, first out) stack. Data transferred into a FIFO are made available in the same order in which they are entered. FIFO stacks may be implemented by software in main memory, or by special-purpose hardware for very high-speed applications. In either case, the FIFO buffer matches the data-transfer rate to the rate at which the processor generates or uses the data.

To illustrate block-data transfers, suppose you have interfaced your computer to a magnetic tape unit. Now you wish to transfer blocks of data to and from tape.

A block of data on tape is called a "record." Each record contains a leading record mark, the data block itself, and a trailing record mark. The leading record mark usually contains the record length and special identifying information. The trailing record mark contains data-checking information.

Records are usually separated by gaps long enough for the tape to start and stop. The details of the record marks vary with the hardware you select. A typical record format uses a single-character record mark, a single-byte record length (which limits the record to 256 data bytes), and a single-byte "checksum" (see box), followed by a gap.

Strictly for the record

The program logic for a record-output processor shown in Fig. 5 is set up as a general purpose subroutine. The calling programs supply the record length and the memory address of the first data byte to be transferred. The processor routine then turns on the tape-write hardware and waits for the deck to reach operating speed. The time delay can be provided by control signals from the tape deck, or by software timing loops. Once the deck reaches operating speed, the routine outputs the record mark, record length, data and checksum. A zero-length record is often used to mark the end of a group of records, sometimes called a "file."

Fig. 6 shows the logic of a record-input processor. Calling programs pass-in the memory address where the data are to be loaded. The routine executes the transfer and returns with the number of bytes trans-

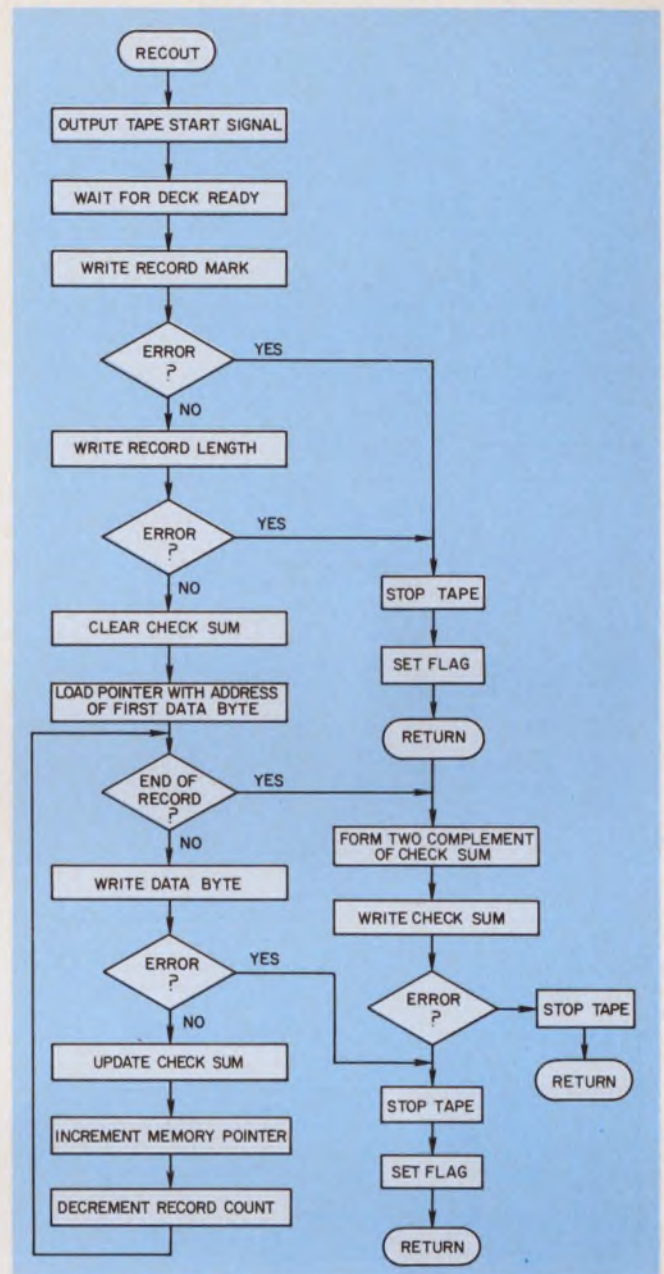

5. The program logic for record-output is set up as a subroutine. The checksum serves as an error detection device for data transfers.

ferred. Then it starts the motor, waits for the tape deck to reach operating speed, and starts reading characters from the tape. But until the record mark is detected, the routine ignores all characters.

Once the record mark is found, the record length is read in, and used to control the "end of record" loop. When the entire record is read, the checksum is tested. If no error is detected, the routine turns off the motor and returns to the calling program.

The tape reader program RI that transfers a block of data into a buffer (Fig. 7) uses a memory location as a byte counter. Whenever the byte counter is zero, a new block of data is transferred. The main program must initialize the byte count to zero before the first call to routine RI. After that, RI automatically

(continued on page 84)

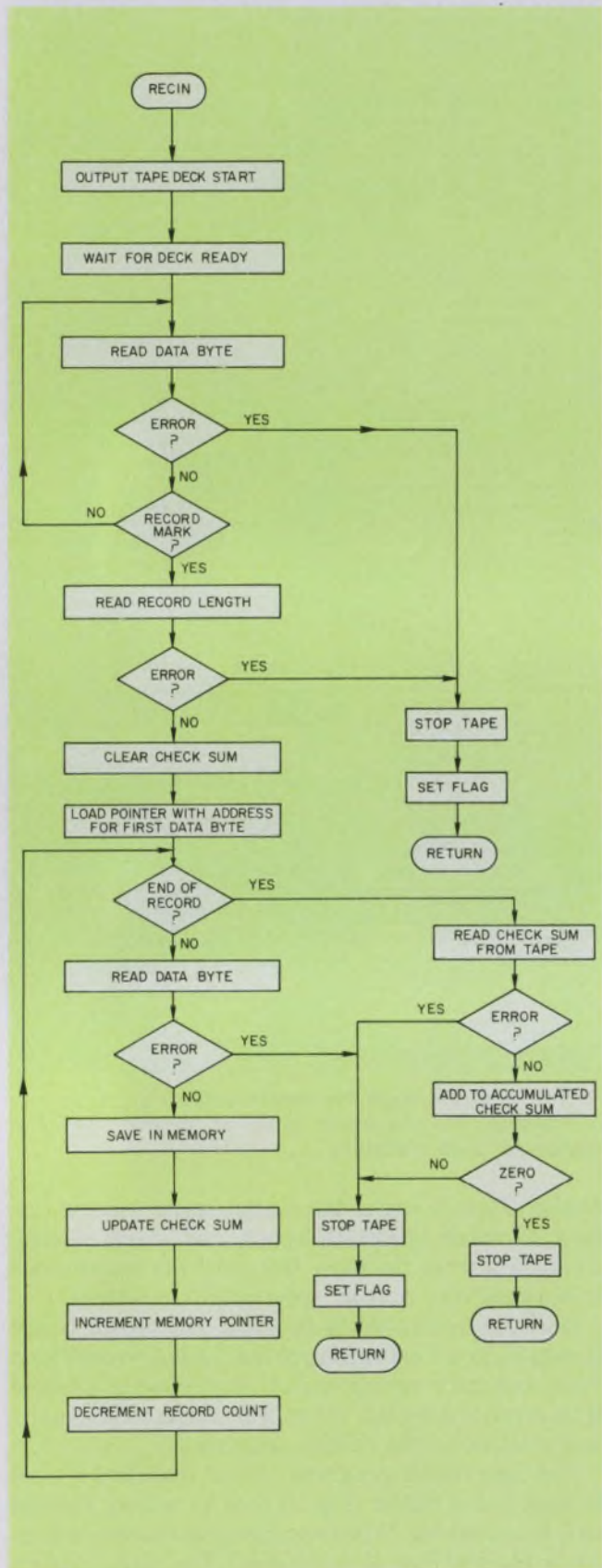

6. The record-input logic closely resembles that for record-output. But it ignores all incoming data until the record mark is found.

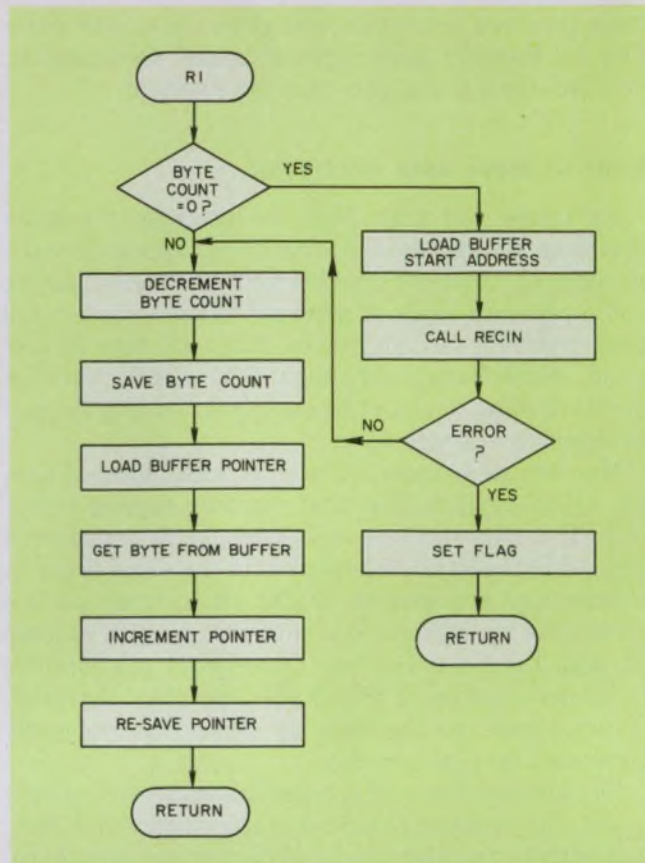

7. To transfer a block of data into the buffer, the reader-input program uses a memory location as a byte counter, which counts down to zero.

transfers data blocks from the tape whenever the byte count is zero.

The location of the next character is maintained by saving a pointer in memory and incrementing it every time a character is taken from the buffer. The byte counter and the buffer pointer form a FIFO stack.

A powerful prescription: DMA

By combining block-data transfers with a sophisticated method called "direct memory access" (DMA), data can be transferred in or out of main memory without involving the processor. "Smart" I/O devices are mandatory for DMA which treats main-memory buffers as if they belong to a processor within the accessing I/O device. In fact, they usually do. First, the main processor is put to sleep, or under local anesthesia, so that the host processor can't affect buffer-memory areas assigned to the accessing I/O device. A separate processor in the I/O device then takes control, transfers data into or out of main memory buffers, and returns control to the main processor. DMA is often used for block transfers to high-speed mass memory devices such as magnetic discs. ■■

The next article in this series will appear in the June 7 issue, and will cover the important topics of program testing, debugging, and documentation.

Meaningful ECL testing demands both:

Rep rates
to
250 MHz.

Variable
transition
times to 1 nsec.

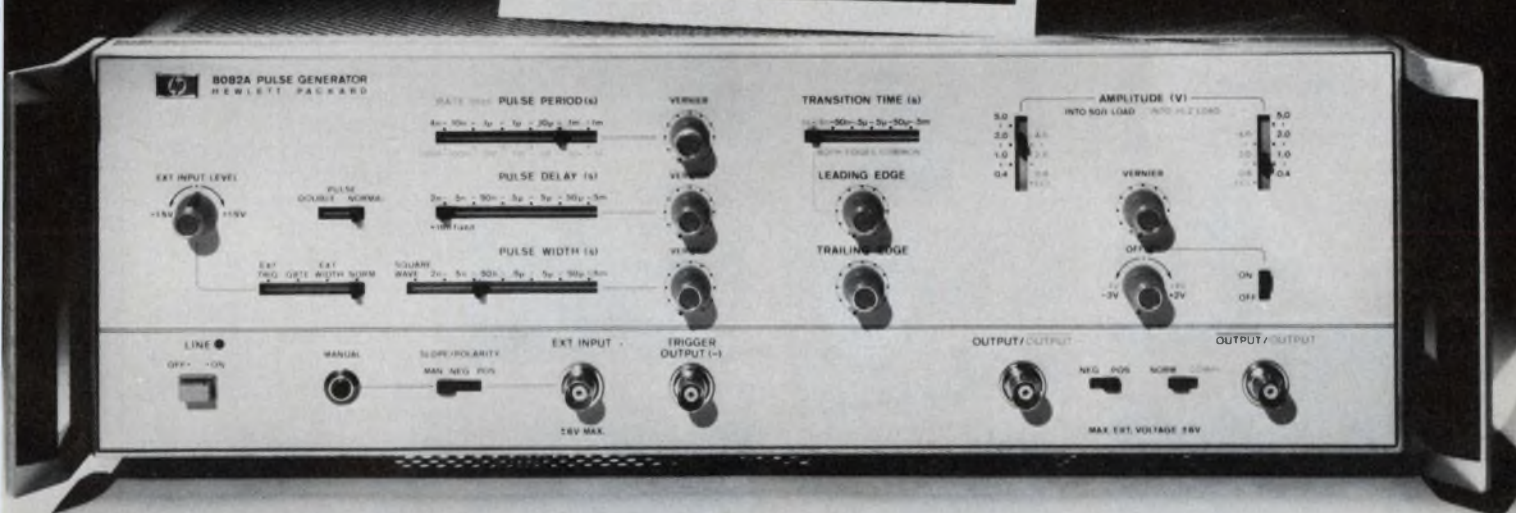
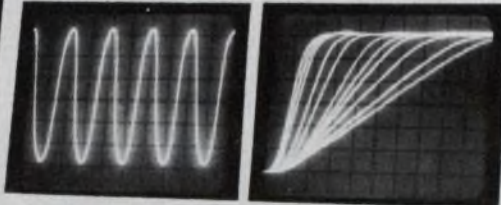

Instrument is shown with optional handles

Only HP's 8082A Pulse Generator delivers both.

In ECL testing, high rep rates and fast transitions aren't enough. You also need variable transition times to 1 nsec for meaningful results. And, HP's 8082A Pulse Generator gives you variable transition times and more.

Now you can match the manufacturer's specified conditions for propagation delay measurements. That means more accurate results for both device testing and qualification, and breadboard testing. The ability to vary transition time between 1 nsec and 0.5 msec also gives you a way to test for worst-case conditions. And it lets you use this pulser for Schottky TTL and general-purpose TTL testing too.

What's more, HP's 8082A gives you a precise 50 ohm, low-reactance source impedance for excellent pulse shape without an external termination. That means simplified setups. And, to further simplify operation, the 8082A has an ECL output switch that automatically sets amplitude and offset to specified ECL levels; complementary outputs; and switch selectable polarity.

The 8082A also provides variable pulse delay for easy scope triggering at the right instant; a double-pulse mode

with variable spacing to 2 nsec for measuring data set-up times or simulating radar pulses; and external triggering which extends the rep rate range to dc. Priced at \$3675*, the 8082A is the logical choice for both meaningful and convenient ECL testing.

And for the designer doing *state-of-the-art* logic development, HP has a new 300 MHz to 1 GHz pulse/word generator system, the 8080. This modular system can be configured either as a pulse generator or a word generator. Now, a single GHz pulser gives you dual outputs with frequency division and precise inter-channel delay for convenient and economical testing of the fastest available IC logic families.

For complete details on these versatile pulse generators, contact your local HP field engineer.

*Domestic U.S.A. price only

HEWLETT  PACKARD

1507 Page Mill Road, Palo Alto, California 94304

For assistance call: Washington (301) 948-6370, Chicago (312) 255-9800, Atlanta (404) 955-1500, Los Angeles (213) 877-1282

CIRCLE NUMBER 45

087/6

EMI/RFI shielding materials...components... sub-systems

The beginning of any answer to your EMI/RFI problems is right here.

GASKETS AND GASKET MATERIALS

- Strip Gasketing...with and without environmental seal
- Sheet Gasketing...with pressure seal
- Standard Gaskets...including connector and waveguide gaskets... environmental or pressure seal optional
- Custom Gaskets... designed and factory-fabricated to customer specifications

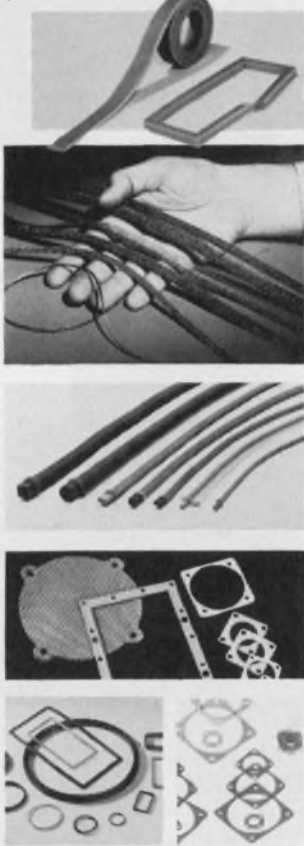

SHIELDING AND CONDUCTIVE COMPONENTS

- Static Discharge Buttons
- Grounding Components
- Cable Shielding Tapes
- Flexible Cable-Shielding Covers
- Shielded Raceways
- Shielded Conduit Fittings

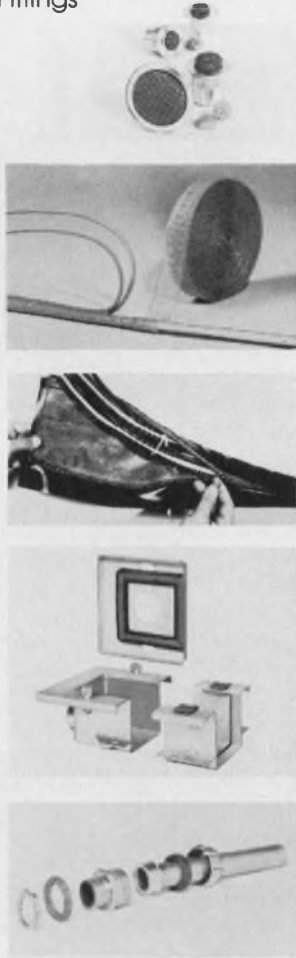

SHIELDING FRAMES AND ASSEMBLIES

- Shielded Frames... ready-to-mount... pressure or weather seal optional
- Custom-Fabricated Frame Lengths...ready for customer assembly
- Bulk Frame-Strip Gasketing
- Shielded Windows... ready to install... custom-fabricated
- Shielded Ventilating Panels
- Shielded Air Filters

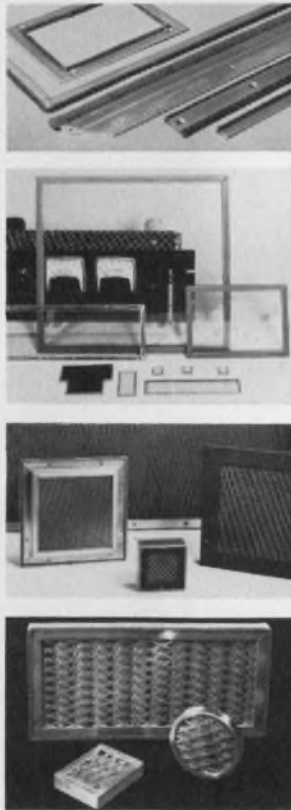

CONDUCTIVE-ELASTOMER EMI/RFI XECON® GASKETS AND COMPOUNDS*

- Composite EMI/Pressure-Seal Gasketing...7 durometer ratings... sheets, strips, custom die-cut gaskets, molded gaskets
- Armored Xecon™ High-Tensile-Strength Gasketing
- Vulcanized Xecon™ Pressure-Seal Gaskets
- O-Ring Gaskets for Waveguides
- Standard Connector Gaskets
- Conductive Adhesive
- Conductive Compounds...for EMI/RFI shield coating, caulking, cementing

*Xecon gasketing compounds are homogenous conductive elastomers consisting of high-grade silicone in which are suspended microscopic silver-coated glass particles that provide the conductive path through the gasket.

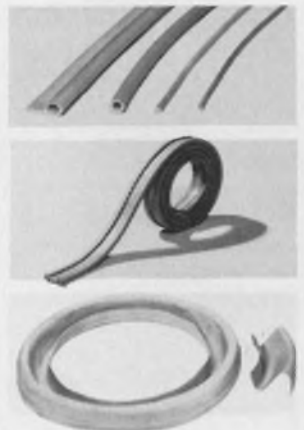

Amphenol® UHF connectors point the way. With more ways to get quality terminations.



Just what you'd expect from the standard of the industry. Whatever your assembly-line method, there's an Amphenol UHF connector that fits right in. And Amphenol hand-crimp tools and crimping machines mean more efficient small- or large-volume assemblies.

Choose any of these different Amphenol assembly types (left to right above):

83-1SP all-solder. Still the most popular way to terminate the standard RG-8, RG-58, and RG-59 cables with confidence.

83-DCP all-crimp Series. Amphenol hex crimps make strong, simple terminations.

Teamed up with our crimping machines, they give you the fastest, most economical way to terminate RG-8, RG-58, and RG-59 co-phase harnesses with Amphenol quality.

83-SP Series solder-contact/crimp-braid. Fast, reliable. Once again, the Amphenol hex-crimped braid is quicker than soldering.

83-58FCP* no-solder, no-crimp. Reduces your labor and assembly costs. Assembles with just an ordinary pair of pliers and a knife—simply package it unassembled for customer assembly. Saves you money and permits the customer to trim and customize his coax installation.

For fast solutions to your connector problems: Contact your local Amphenol sales office or Amphenol distributor. For more data call: (203) 743-9272 or write to: Amphenol North America Division, Bunker Ramo Corporation, RF Operations, Dept. C57A, 33 East Franklin Street, Danbury, Connecticut 06810.



Twin-Hex Hand-Crimp Tool.



Pneumatic Crimp Machine.

The right idea
at the
right time.

AMPHENOL



CIRCLE NUMBER 47

*Patent applied for.

Ideas for design

Crystal-controlled time-base generator measures frequency/time in low-cost scopes

Inexpensive scopes often provide only a recurring-sweep display and can't measure time intervals or frequency with any accuracy. The time-base generator (TBG) shown in the figure enables such scopes to make measurements very precisely. It can be built for about \$15.

Both frequency and time can be measured with the signal displayed on the scope, and synced in the usual manner. The TBG circuit, set at one of five frequencies, displays a series of dots along the CRT's signal trace by modulating the scope's Z axis. The number of dot intervals within the signal trace determines the timing. To facilitate the measurements, the horizontal-gain control on most of these scopes can be used to adjust the sweep length so that the dots coincide with the scope's graticule scale. The scale can then be used to establish the time or frequency measurement.

A 4-MHz crystal-controlled oscillator provides the basic timing pulses. The 4 MHz is divided by counters to produce five precise frequencies—1 MHz, 100 kHz, 10 kHz, 1 kHz and 100 Hz.

NAND gates connected to the divider-counter outputs deliver 5% duty-cycle pulses that produce sharp, well-defined dots on the CRT. A 5-k Ω pot adjusts the dot intensity.

The counter reset-line signal is derived from a negative pulse taken from the scope's blanking circuit. Each blanking pulse at the start of a new sweep resets all counters to sync the counters with the displayed signal.

CMOS ICs work well over a wide supply voltage, so 5 to 15 V may be used to power the circuit. Power consumption is only about 10 mA. Although an 18-V supply is shown for the output driver to provide maximum dot-intensity capability, 9 V may be sufficient in many cases.

The Aux-Output jack can be used as an accurate pulse source for calibrating many electronic instruments.

Rex C. Geivett, Senior Service Planner, IBM Corp., 6519 Pajaro Ct., San Jose, CA 95120.

CIRCLE No. 311

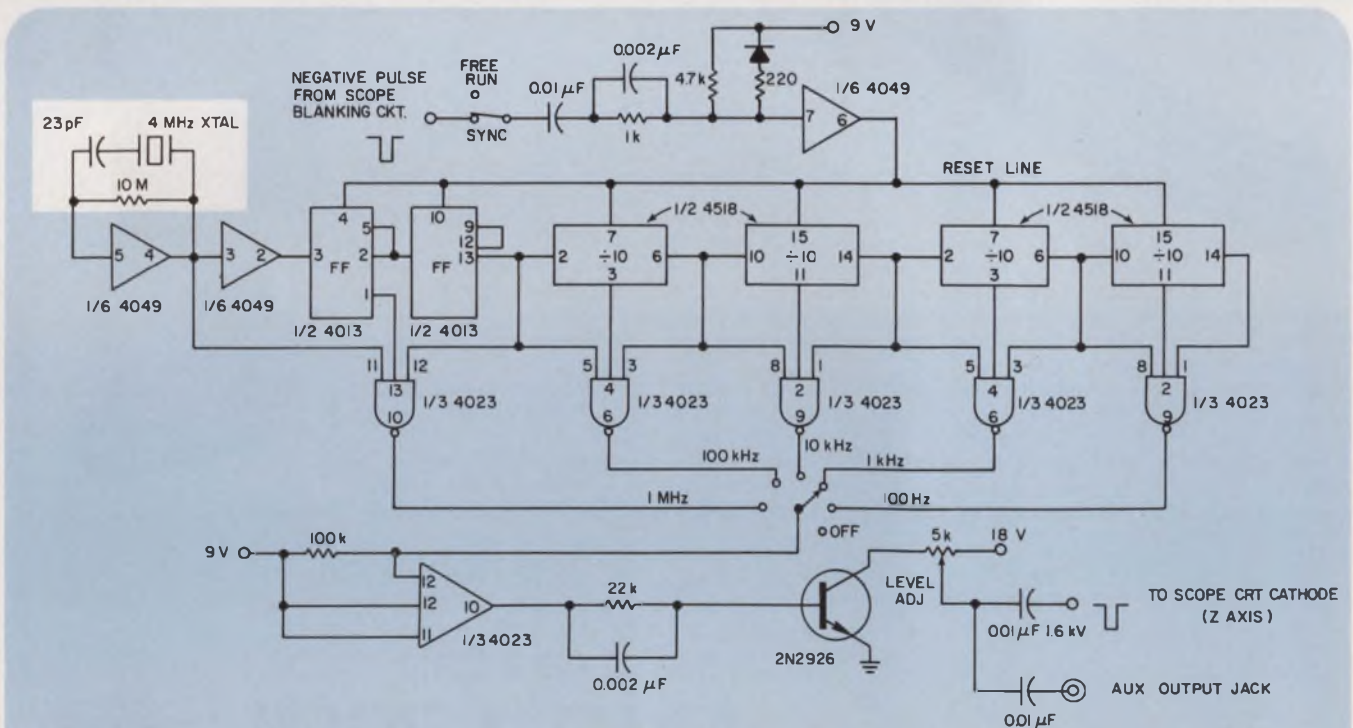

Intensified dots on the signal traces of low-cost scopes are obtained from this crystal-controlled

time-base generator. It can be used to measure time and frequency precisely.

One Mallory THF capacitor can replace up to four CSR types in a switching power supply.

These small, solid-tantalum capacitors give you a per-unit substitution factor as high as one for four and can by-pass 4.5 amp rms at 100kHz. So by using these high ripple performance capacitors you save in space, weight and cost.

Specially designed for low equivalent series resistance, at frequencies from 10kHz through 100kHz. They're ideal for high frequency power supply switching, for regulator switching, or for bypassing or filtering unwanted ripple currents.

Because ESR is low, power losses are low. With the solid electrolyte and hermetic seal, long life is inherent. Electrical characteristics are very stable over a temperature range of -80°C through 125°C . Two case sizes: .29 x .69 and .35 x .79 inches.

Mallory THF capacitors are available in a wide range of ratings: 5.6 to $330\mu\text{F}$, 6 to 50VDC.

They're the result of Mallory's engineering program that's finding ways to produce high performance type capacitors at less cost to you.

Just ask your Mallory representative. Available direct, or through authorized Mallory Distributors in U.S. or overseas. Or call Help-Force Headquarters at (317) 856-3731. Mallory Capacitor Company, a division of P. R. Mallory & Co. Inc., Box 1284, Indianapolis, Ind. 46206.

CIRCLE NUMBER 48

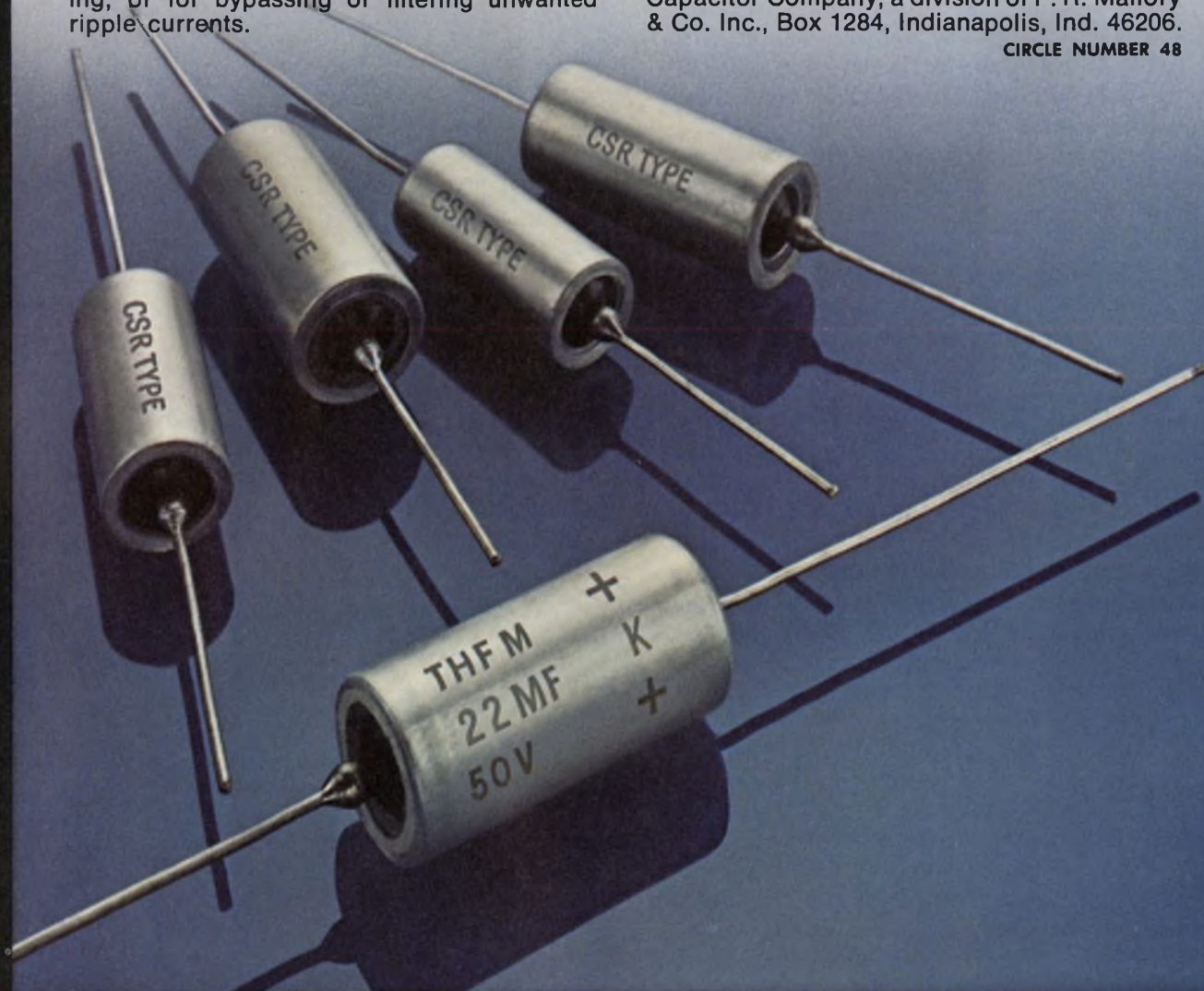

MALLORY

A 60-MHz power oscillator generates a low-noise output

The 1-W oscillator in Fig. 1 can very effectively serve as a variable-frequency oscillator (VFO) for broadband transmitters that must produce low broadband-noise outputs. Operating at 60 MHz, it produces noise as low as 145 dB below the carrier level for a 30-kHz bandwidth. Noise is lowered by the high degeneration in the emitter circuit.

The noise power, P_n , delivered to the load comes mainly from collector-current shot noise, i_c . Accordingly,

$$P_n = \overline{i_c^2} R_L = (2eI_cBS^2)R_L$$

where e is the charge on an electron, I_c is collector current, B is bandwidth and S is a space-charge reduction, or smoothing factor. For a 2N5642 transistor,¹ S^2 is 0.017. Thus, with I_c (average) = 0.2 A, $B = 30$ kHz, and $R_L = 50 \Omega$, then $P_n = -118$ dBm, close to a measured value of -115 dBm.

Oscillation is produced by feedback via the collector-base junction capacity, C_{ob} , and the small base-lead inductance, L_b . Since X_{cob} is much larger than X_{lb} for the frequencies of oscillation, the feedback current leads the collector voltage by 90 degrees. The base voltage developed by this current, in turn, leads the current by another 90 degrees and establishes the correct phase condition for oscillation. The oscillation frequency is determined by the series-tuned circuit in the emitter.

A noise measurement setup (see Fig. 2) was used to test the oscillator. Two sections of quadrature hybrid couplers with series-tuned traps produce a total notch of 60 dB for the carrier. A low-noise preamp with a 13-dB gain effectively lowers the noise floor of the spectrum analyzer. The 3-dB pad provides a proper load impedance for the oscillator, and a low-pass filter prevents the oscillator's second harmonic output, which is 30 dB below the fundamental's amplitude, from overloading the preamp.

Reference

1. Lohrmann, Dieter R., and Son, Kyung S., "Reduce the Noise Output of Linear rf Amplifiers," *Electronic Design*, Sept. 27, 1976, p. 84.

Kyung S. Son, 24 Kingsport Dr., Howell, NJ 07731.

CIRCLE NO. 312

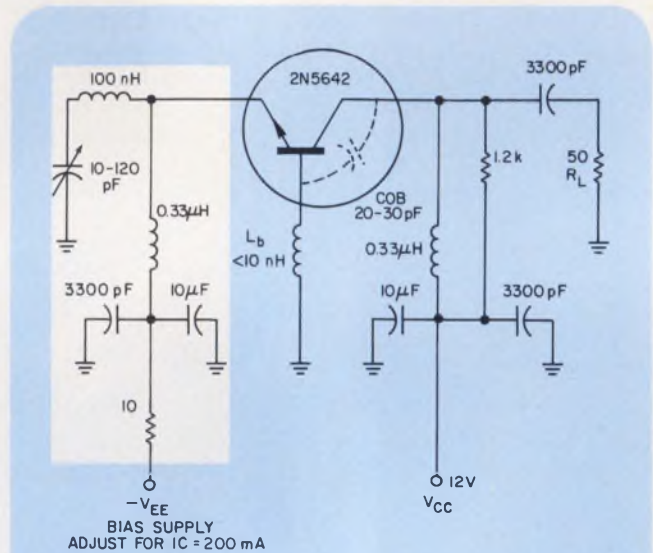

1. High negative feedback in the emitter circuit reduces the noise output of this 1-W power oscillator to very low levels.

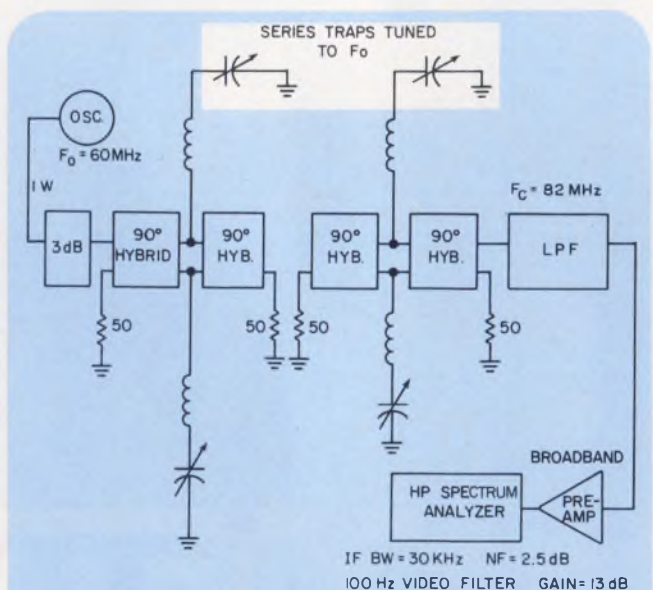

2. A noise measurement setup with carrier-suppression circuits was used to establish that the oscillator noise output is 145 dB below the carrier.



HOW DOES DATA I/O KEEP YOU ON TOP OF PROM PROGRAMMING TECHNOLOGY?

We allow you complete design flexibility.

Data I/O programmers are capable of programming all of the more than 200 PROMs currently available.

You'll always be programming to PROM manufacturers' approved specifications.

Data I/O Program Card Sets are tested and certified by the PROM manufacturers themselves before we approve them for manufacturing and distribution to our customers.

If manufacturers change specifications, we

keep our customers updated on how to make proper adjustments to the card sets.

To help you reduce programming costs and reach maximum yields and reliability, we also offer a universal calibrator so that you can conduct your own periodic calibration tests.

We're there when you need us. Data I/O is a worldwide organization. Our field sales and service offices are staffed by Data I/O personnel. Our customers have direct access to us through people who understand the products.

We'd like to tell you more.

This fact filled tabloid gives you valuable information about PROM programming technology. To get your copy, circle reader service number or contact Data I/O Corporation, P.O. Box 308, Issaquah, WA 98027. Phone 206/455-3990.

HOW TO SELECT THE RIGHT PROM PROGRAMMER FOR YOUR NEEDS.



Programmers from \$1095.00.

DATA I/O

THE PROM PROGRAMMER PEOPLE.

Complementary amplifier improved by double-ended symmetrical configuration

The principal virtue of the well known complementary amplifier of Fig. 1a is its ability to yield an output swing whose peaks nearly span the supply voltage. But the circuit has two grievous drawbacks: First, the achievable gain is limited by its dependence on supply voltage. The optimum ratio of R_4/R_3 to hold output voltage halfway between $-V_{CC}$ and $+V_{CC}$ is $R_1/2R_2$. Choosing a larger R_4/R_3 ratio to get more gain makes the operating point of Q_2 shift disproportionately with changing supply voltage. Second, the circuit is inefficient, because Q_2 is a single-ended class-A amplifier. And to drive a low-impedance load requires that collector resistors R_3 and R_4 have low values. The resultant high quiescent current then needed to establish the operating point of Q_2 results in poor efficiency.

Both disadvantages can be overcome by the symmetrical arrangement shown in Fig. 1b. Even though output transistors Q_2 and Q_4 are operating in class A, their push-pull action allows higher efficiency. Since the feedback-resistor pairs R_2, R_3 and R_6, R_7 don't carry power-output current, they can have high values with a corresponding reduction in quiescent current.

In the symmetrical amplifier, bias is supplied by voltage dividers R_1, R_4 and R_5 . Because this network is common to both inputs, the effect of varying V_{CC} on one half of the circuit cancels its effect on the other half. Hence, the output voltage tends to remain halfway between $+V_{CC}$ and $-V_{CC}$ —or at zero volts, if tracking plus and minus supplies are used. Ratios R_3/R_2 or R_7/R_6 , therefore, may be made as large as

required to obtain the desired gain. Of course, these ratios must be kept within limits dictated by the matching of complementary parts and the amount of distortion that can be tolerated.

Dale Hileman, Sphygmometrics, Inc., 6311 J De Soto Ave., Woodland Hills, CA 91367. CIRCLE NO. 313

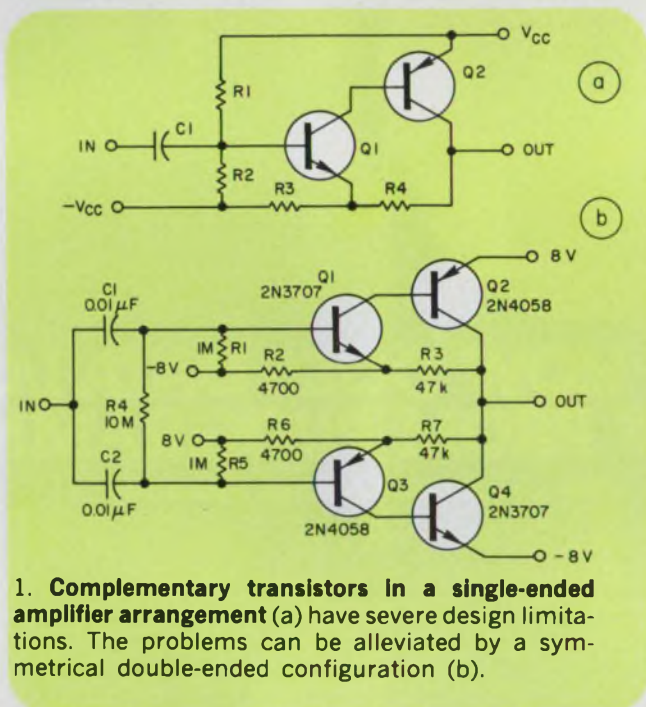

IFD Winner of January 4, 1977

Max W. Hauser, Engineering Associate, Plasma Research Laboratory, Cory Hall, University of California, Berkeley, CA 94720. His idea "Keyboard for 64-key ASCII Code Features Very Low Power Consumption" has been voted the most Valuable of Issue Award.

Vote for the Best Idea in this issue by circling the number of your selection on the Reader Service Card at the back of this issue.

SEND US YOUR IDEAS FOR DESIGN. You may win a grand total of \$1050 (cash)! Here's how. Submit your IFD describing a new or important circuit or design technique, the clever use of a new component or test equipment, packaging tips, cost-saving ideas to our Ideas for Design editor. Ideas can only be considered for publication if they are submitted exclusively to ELECTRONIC DESIGN. You will receive \$20 for each published idea. \$30 more if it is voted best of issue by our readers. The best-of-issue winners become eligible for the Idea of the Year award of \$1000.

Our KH series. Nobody satisfies your 4PDT relay needs any better.

P&B gives you more contact, terminal, socket, rating, enclosure choices than anyone else.



With all the available options, you can virtually design your own KH relay. Need bifurcated crossbar contacts for low-level switching? PC board terminals? Push-to-test button? No problem. These options and dozens more are tooled, ready for production.

KH relays are rated up to 3 amperes at 30V DC or 120V AC, resistive. Contact arrangements include DPDT and 4PDT. KHU relays are UL recognized and CSA certified. KHX relays are UL recognized for opposite polarity ratings.

This is an original Potter & Brumfield design. No wonder we've made more, with more variations for special applications, than anyone. KHU and KHS (hermetically sealed) relays are available from authorized P&B distributors.

Complete specifying information is available from your local P&B representative or call Potter & Brumfield, 200 Richland Creek Drive, Princeton, Indiana 47671. 812/386-1000.

AME
Potter & Brumfield

Potter & Brumfield

Frequency shifts keyed with SAW-based device

Based on surface acoustic waves, a novel frequency-shift keying device developed at Japan's National Defense Academy in Yokosuka uses a three-phase interdigital transducer (see figure).

A surface acoustic wave, excited by a central transducer, propagates to the left or the right, according to the polarity of a dc pulse applied to a phase-shifting and switching network. Two biphasic interdigital transducers on either side of the three-phase transducer detect the excited signals.

The detected signals are balance-modulated with a 1.6-MHz signal and then filtered. Digital coding is accomplished by assigning positive and negative pulses to the ONEs and ZEROs of binary logic.

Formed on piezoelectric ceramic, the devices are 52-mm long \times 13-mm wide \times 4-mm thick and polarized normal to

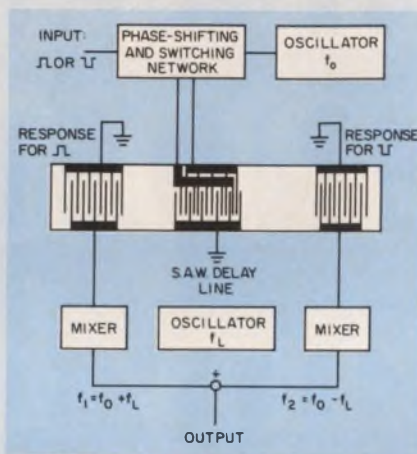

the free surface. For each of the outer transducers, there are 19 evaporated aluminum-electrode fingers, and 13 for the central transducer. The three transducers occupy about 30 mm and have a center frequency of 2.7 MHz.

Semi die, wire bonders don't need our help

Microcomputer-controlled automatic semiconductor die and wire bonders can operate continuously without human supervision. Developed by the Tokyo Shibaura Electric Co., the machines have solid-state cameras that automatically detect such errors as defective components and faulty positioning, chip mounting and wiring.

Pattern-recognition algorithms executed by the microcomputer analyze the camera outputs and discriminate between good and defective chips, and check the chip's positioning.

The die bonder's solid-state camera has 50 \times 50-bit resolution.

Because of the elaborate functions incorporated, each die bonder requires its own microcomputer. The wire bonder, however, does not require the same degree of intelligence. One microcomputer can control up to five of them.

Simple electrode paste will cut display costs

For now, both liquid-crystal and electroluminescent displays depend for their operation on an electrically conducting, transparent coating applied to a high-quality glass substrate. But with an electrode paste developed by the Electrical Research Association in Leatherhead, England, an ordinary window glass may be used for the substrate—which should reduce the manufacturing costs of both displays substantially.

What's more, says ERA, the printing and firing operations used to apply the new electrode material are much simpler than currently used methods and much more suitable to volume production.

Currently, a two-stage process is used to apply and form the conventional coating into electrodes that have the shapes of the characters to be displayed. First, a thin layer of conduc-

ing material, such as tin oxide, is deposited on the glass with sputtering or hydrolysis techniques. The electrode pattern is then obtained with photolithography.

The ERA electrode material, an organic paste containing metal compounds, is screen-printed onto the glass, which is then fired. The heat decomposes the paste, and leaves a firmly adhering oxide film. Tests have shown that the electrodes thus formed work well with field effect LCDs.

Optocouplers protected from serious degrading

The destructive effects of excessive voltage and temperature on optocoupler transistors have been overcome in a fabrication technique developed by Siemens, West Germany. The new method allows optocouplers to function at 100 C and 1000 V dc—without this technique, a voltage of 220 V dc at 80 C can damage a phototransistor irreversibly in just a few days.

Normally, the transistor is protected by silicon-dioxide or silicon-nitride layers. But these insulating layers can become positively or negatively charged due to ion migrating in the plastic at elevated temperatures. Depending on the charge and the type of doping, the ion migration can create enhancement or depletion regions, or inversion layers—all of which seriously degrade the optocoupler's characteristics.

Siemens' solution is to apply an insulating ion screen to the surface of the transistor chip. The screen thickness is matched to the LED-radiation wavelengths for negligible light absorption. The screen prevents charging effects due to ion migration and also prevents the electric field from penetrating the semiconductor crystal.

Optocouplers consist of a LED and a phototransistor mounted 0.5 to 1 mm apart and coupled by a thin plastic section that conducts the LED radiation. Internal electric fields in the devices can be considerable. For example, a 1000-V drop between LED and transistor produces a field of 10⁴ V/cm.

The big 32K ROM! Newest discovery in ROM Country

Sure it cuts your parts count and saves money — but that's only the beginning of what the big ROM offers.

Just check these seven other important advantages the EA 3200 brings the system builder:

It keeps pace with the fastest μ Ps on the market. Guaranteed access is a sizzling 350 ns.

It interfaces directly with popular μ Ps like the 8080, 6800, and Z-80.

It cuts power requirements and heat generation. Typical power per bit is 1.6 microwatts on standby and only 15 microwatts operating.

It can upgrade systems started with other popular PROMs and ROMs — because it's pin compatible with parts like the EA 2708 PROM and EA 8308/8316 ROM.

It can be shipped in prototype quantities, loaded with your program, only four weeks after data verification.

It's in stock right now already programmed as an interpreter that converts BASIC language to machine language for the 8080. We can ship you some tomorrow.

And it's made by the specialists in ROMs and PROMs, Electronic Arrays. We deliver over a billion bits every month in 19 different models.

Just contact us in ROM COUNTRY: Electronic Arrays, 550 E. Middlefield Road, Mountain View, California 94043. Phone us on our toll-free WATS line (800) 227-9962 or our regular line (415) 964-4321.

ROM COUNTRY



**electronic
arrays, inc.**

CIRCLE NUMBER 51



Can you imagine a printer like this?

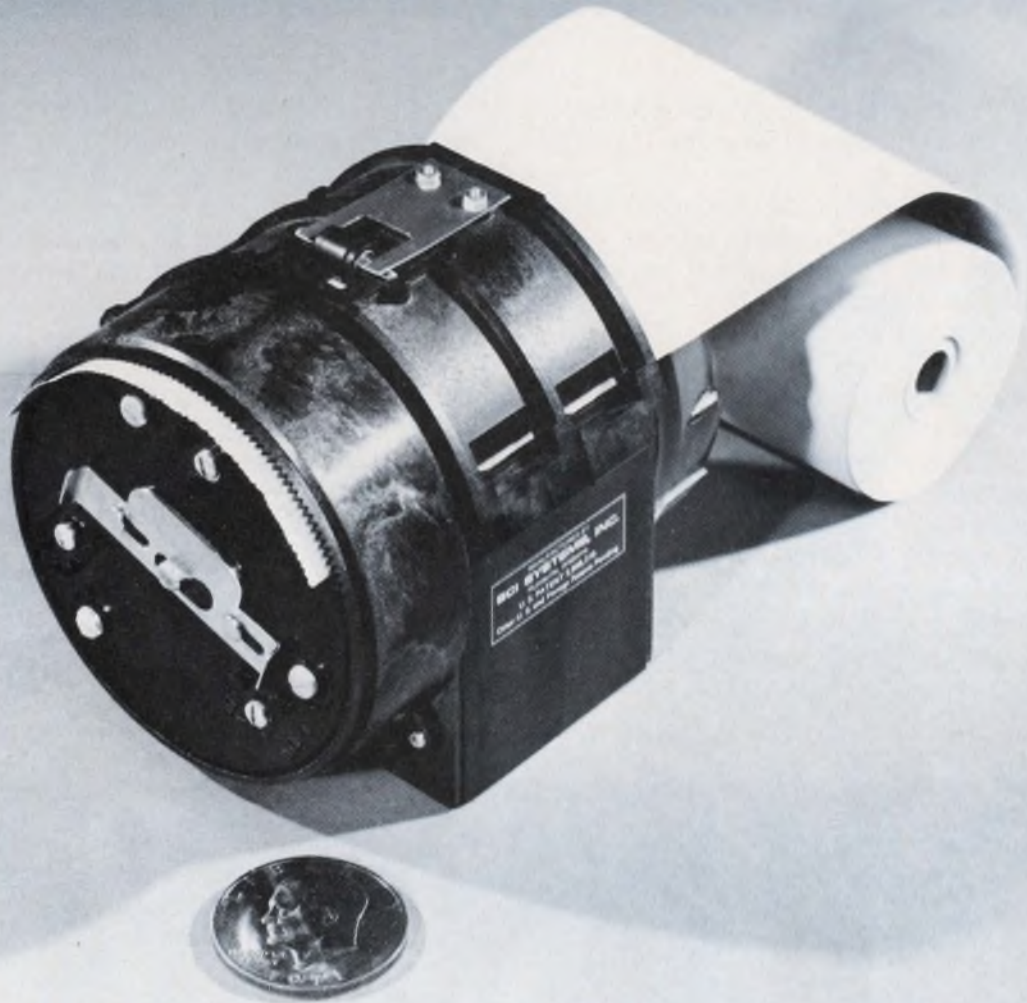

You can see it for yourself!

Can you imagine a printer like this? One that operates at 2,200 characters per second; has up to 136-column output; small enough to hold in your hand; six times quieter than the leading typewriter; rugged and low power enough for vehicular use; eight billion character drive-unit life; 25 million characters between head maintenance; no ribbons, inks, carbons or toners; no

solenoids, levers or hammers; moderately priced paper; end user cost of less than a dollar per million characters for the replaceable element; and only a few hundred dollars buys the printer complete with interface electronics.

Such a printer is no longer a dream—it's a reality! The SCI Series 1100 Rotary Printer is now available. A totally new design

concept has resulted in a true price/performance breakthrough. Its versatility suits it for a wide variety of existing applications. Its price and performance will make many new uses of printers technically and economically feasible.

You can verify the facts. Call or write to arrange a demonstration. Seeing is believing—you can see it for yourself.

SCI SYSTEMS, INC.

8600 South Memorial Parkway • P. O. Box 4000 • Huntsville, Alabama 35802 • Phone 205-881-1611

CIRCLE NUMBER 52

How fast can you measure rise time, fall time and pulse width?

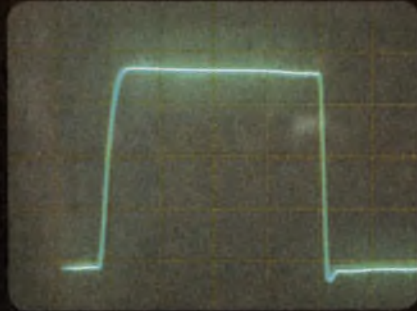

Your way.

(About 5 minutes.)

1. Connect signal to scope.
2. Adjust trace intensity.
3. Adjust focus. 4. Select VOLTS/DIV range.
5. Select TIME/DIV range. 6. Adjust vertical gain to fill screen for location of 10% & 90% points. 7. Locate 10% point. 8. Locate 90% point. 9. Determine horizontal displacement between 10% & 90% points. 10. Multiply displacement by horizontal scale factor.

That's RISE TIME. Only 9 more steps and you've got PULSE WIDTH and FALL TIME.

Our way.

(About 5 seconds.)

1. Connect signal.
2. Push button for RISE TIME. 3. Push button for PULSE WIDTH. 4. Push button for FALL TIME.

The rest is automatic.

Your move.

Give us a call and we'll tell you how the Dana 9000 Microprocessing Timer/Counter can solve your measurement problem the easy way.

DANA®

Others measure by us.

Dana Laboratories, Inc., 2401 Campus Drive, Irvine, CA 92715
Phone: 714/833-1234

Same great name. Same great color.

And now a neat new way to definitive display performance.

DOT MATRIX

Consider the new Noritake-Ise dot-matrix line-up—
9, 10, 16, 20 and 40-character line displays.
Variety aimed at giving you more design potential.
Or consider our unique 400-dot graphics display
with 17m/m depth and low 35V drive rating.
It's aimed at helping you think low voltage,
portability and economy all at the same time.

In short, consider Noritake-Ise period
for dot matrix (or segmental) displays.
Itrons always help you design more competitively.

itron[®]



DC209A2

Dimension: 41(H) × 208(W) × 10.5(D)mm Character Size: 9.0(H) × 6.3(W)mm

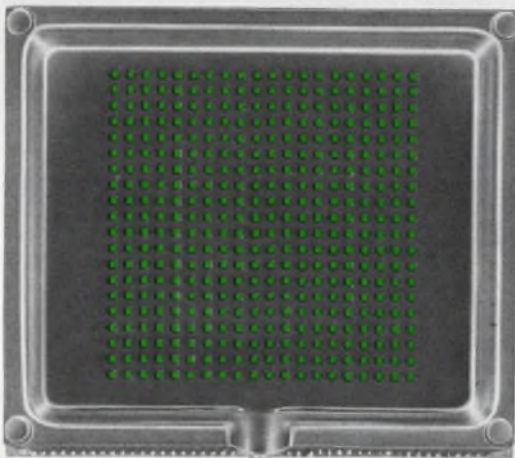

FG400DA1

Dimension: 114(H) × 130(W) × 17(D)mm



DC95A2

Dimension:
24(H) × 75(W) × 7.2(D)mm
Character Size:
5.05(H) × 3.55(W)mm



FG48D6

Dimension:
25.5(H) × 56.5(W) × 7(D)mm
Character Size:
8.0(H) × 4.2(W)mm

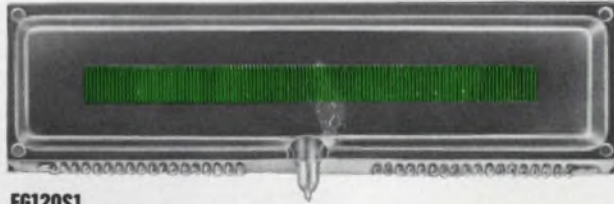

FG120S1

Dimension: 39(H) × 138(W) × 12.5(D)mm



FG209M2

Dimension: 41(H) × 208(W) × 10.5(D)mm Character Size: 9.0(H) × 5.4(W)mm

NORITAKE CO., LTD.

Electronics Division
1-1 Noritake-Shinmachi, Nishi-ku,
Nagoya-Shi, Japan
Phone: NAGOYA (052) 561-7111
Telex: J59738 NORITAKE

Electronics Office (U.S.A.)
22410 Hawthorne Blvd.
Torrance California 90505, U.S.A.
Phone: (213) 373-6704
Telex: 230674910

F.R. Germany
NEUMULLER GmbH B Muenchen 2,
Karlstrasse 55, F.R. Germany
Phone: 592.421
Telex: 522106

U.K.
ITT Component Service
Refuge House, River Front,
Enfield, Middx. England
Phone: 01-363 7459
Telex: 21637

Hong Kong
Room 1403 Shing Loan Bldg
24-26 Stanley Street Hong Kong
Phone: 5-232420 Telex: HX83151
Taipei
72-9 SEC 2, JEN AI RD, Taipei
Phone: 351-0293 Telex: 11176

Manufacturer:
ISE ELECTRONICS CORP.
P.O. Box 46, Ise-shi,
Mie-Pref., Japan
Phone: (05963) 5-2121 to 4
Telex: 4969523

MEMORY AT WORK

The First Family of 4K Static RAMs

In the semiconductor business, there are more promises than products. Not at EMM SEMI. Others promised you a family of 4K static RAMs. We delivered. In volume. Military and commercial. We've been delivering for over two years. The first 18-pin 5-volt 4K static memory components (SEMI 4801, 4804). The only 150 ns, 8080-compatible 4K static components (SEMI 4104, 4200). The only 80 ns 4K static component in production (SEMI 4200C). The only 4K static device with enough speed and power dissipation for megabyte applications. (SEMI 4402). Others talked. We delivered the First Family of 4K static RAM components. One of them will fit your need. See your local EMM SEMI distributor or call us today.

EMM SEMI

a subsidiary of

Electronic Memories & Magnetics Corporation
3883 North 28th Avenue, Phoenix, Arizona 85017
(602) 263-0202

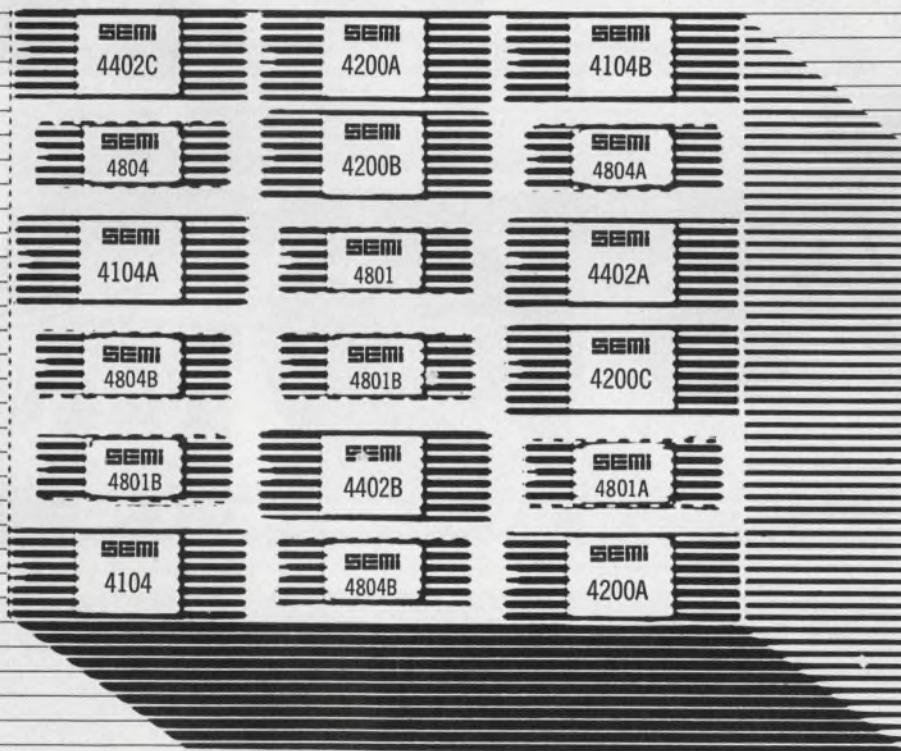

ARROW ELECTRONICS: Woburn, MA; Hamden, CT; Poughkeepsie, NY; Farmingdale, NY; Saddle Brook, NJ; Moorestown, NJ; Baltimore, MD; Fort Lauderdale, FL; Dayton, OH; Cleveland, OH; New Berlin, WI; Bloomington, MN. **CENTURY ELECTRONICS:** Denver, CO; Albuquerque, NM; Salt Lake City, UT. **SEMCOMP:** Newport Beach, CA; Sunnyvale, CA. **STERLING ELECTRONICS:** Watertown, MA; Amboy, NJ; Metairie, LA; Dallas, TX; Houston, TX; Albuquerque, NM; Phoenix, AZ; San Diego, CA; San Carlos, CA; Seattle, WA.



VISIT OUR BOOTH 319 AT THE GENEVA INTERNATIONAL MICRO MINI SHOW

VISIT US AT BOOTH 1493 AT THE NCC SHOW IN DALLAS



B 868010790
Benjamin Franklin



TEN
Ben Franklin
2

TEN

TEN

TEN

TEN

**The new DAC standard.
Analog Devices' complete
10-bit monolithic DAC.**



Less than a buck a bit.

You can pay at least twice as much for a 10-bit IC D/A converter and still not get the degree of accuracy and stability of our new AD561. Selling for less than \$10, the AD561 sets a new standard of price and performance for the other guys to shoot for.

As for accuracy, the AD561 is guaranteed to $\pm 1/2$ LSB max of 10-bits (or even $\pm 1/4$ LSB — and that's 11-bits). Monotonicity is guaranteed over the full operating temperature range. The excellent stability is made possible by a unique buried zener voltage reference and Analog Devices' proprietary thin film resistor process. And for settling time, there's nothing faster: less than 250ns for the worse case transition; that's fast enough to build a 5 μ sec ADC. Current-to-voltage conversion with an op amp is direct and simple: trimmed application resistors mean no calibration trimmers are needed.

How did we achieve this breakthrough? With the industry's most advanced monolithic processing and our pioneering technique of laser wafer trimming. The kind of advances that have quickly pushed us

to the top and made us the leading supplier of D/A and A/D converter components.

The AD561 joins another group of Analog Devices' pacesetters: a series of monolithic CMOS converters that also set new performance standards. At the same time they set a lot of microprocessor users free of analog interface problems. One is the 10-bit successive approximation AD7570 ADC. Another is the multiplying 10-bit DAC, AD7522, the only device that can be loaded in either parallel or serial modes.

And the AD561 joins the industry's 12-bit IC DAC standard, AD563.

Find out how you can cut in half the cost of your 10-bit IC D/A converters and still get true, 10-bit performance by writing for our data sheet. Contact Analog Devices, the real company in precision measurement and control.



**ANALOG
DEVICES**

The real IC converter company.

CIRCLE NUMBER 126

COMING IN



ROUND AND RACK / PANEL MULTIPIN CONNECTORS

The sixth installment of *Electronic Design's* 1977 FOCUS series will appear in the June 21 issue. The topic: Multipin Connectors.

Connectors are as crucial to a successful electronic system as the more exotic components. Associate editor Morris Grossman takes an in-depth look at round and rectangular multipin units, including rack/panel types. The report examines zero-insertion-force (ZIF) connectors, mass-termination connectors, and multiple-lead fiber-optic connectors.

As with all FOCUS reports, emphasis is placed on the significant specs readers should watch for and how to avoid pitfalls in connector selection and use. More than 61,000 *Electronic Design* subscribers specify or authorize purchase of connectors. If you're one of them... mark June 21 on your calendar. It's a report you'll want to keep for months to come.

FOCUS ON MULTIPIN CONNECTORS

**ANOTHER REASON ELECTRONIC DESIGN IS THE BEST
READ ELECTRONICS PUBLICATION IN THE WORLD!**

Want ~~4~~²-week turnaround on 16K ROMs?

Send us your debugged EPROMs.
We'll talk back to you
in the same language.
It's getting easier!

Call Synertek.

If your ROM codes—on cards or paper tape—are in one of the usual formats, we handle them the usual way. And quick. BUT GOOD NEWS! If your program is in 2708 EPROMs, we can speed things up and simplify your life. Send us your debugged 2708's; we'll read your EPROMs directly into our mask-generating computer, and then send you a couple of new EPROMs back, programmed with your code, for verification, to make sure nothing got lost in translation. Fast. Simple. And you don't have to proof-read 16,384 1's and 0's. We think you'll drink to that!

2-week turnaround for prototype

The secret is metal-mask (last mask) programming! Other ROM suppliers use



contact-mask or diffusion-mask techniques which means that a lot of wafer processing must be done after they receive your codes.

All we have to do is strip metal from wafers that are **already in inventory**. This last step programs your ROM code and also selects pinouts—the SY2316B (Intel's 2316E), the SY2316A, or the SY4600. Metal-mask programming—a great approach if you're in a hurry for ROMs.

Give a call to your local Synertek rep or distributor. Or call Bob Cushman at the factory. (408) 984-8900. TWX 910-338-0135.

S Synertek.
Solutions.
Not problems.

Sorry, we can only give 2 week turnaround on 40 codes per month (25 pieces per code). All others within the standard 4-week time frame. It's first come, first served!

Your winning hand in digital computing



1. MICROPROCESSOR BASICS

Just Published!

edited by Michael S. Elphick. A new collection of articles that appeared in *Electronic Design* magazine, providing specific "how-to" information on design for eight of the currently popular microprocessors, including the 8080, 6800, F8, PACE, and IMP. #5763-6, paper, 224 pages, \$9.95.

2. MICROPROCESSORS New Directions for Designers

edited by Edward A. Torrero. An overview of the microcomputer world. Systematically arranges all the data, information, statistics, advice, and suggestions on microprocessors that appeared in *Electronic Design* magazine. #5777-6, paper, 144 pages, \$10.95.

15-day money-back guarantee.

Please send the book(s) checked below on 15-day examination. At the end of that time, I will send payment, plus postage and handling, or return the book(s) and owe nothing. On all prepaid orders, publisher pays postage. Prices are subject to change without notice. Offer good in U.S.A. and Canada only.

- #5763-6 Microprocessor Basics \$ 9.95
- #5777-6 Microprocessors .. 10.95
- #5708-3 Digital Troubleshooting 9.95
- #5713-X Digital Experiments 8.95
- #5103-4 Game Playing With Computers .. 16.95

NAME _____
 COMPANY _____
 ADDRESS _____
 CITY _____
 STATE/ZIP _____

Send to:
Hayden Book Company, Inc.
 50 Essex Street, Rochelle Park
 New Jersey 07662  77-6

3. DIGITAL TROUBLESHOOTING

Practical Digital Theory and Troubleshooting Tips, by Richard E. Gasperini. A completely up-to-date and practical guide for servicing digital electronics. Includes the new test instruments that will replace or extend the oscilloscope in troubleshooting. #5708-3, paper, 192 pages, \$9.95. Accompanying the text: **DIGITAL EXPERIMENTS: A Workbook of IC Experiments**, by Richard E. Gasperini, #5713-X, paper, 192 pages, \$8.95.

4. GAME PLAYING WITH COMPUTERS

Revised Second Edition, by Donald D. Spencer. Sharpen your programming skills through a relaxed and radically different approach. This volume is fully illustrated and gives you over 70 games, puzzles, and mathematical recreations for your digital computer. #5103-4, cloth, 320 pages, \$16.95.

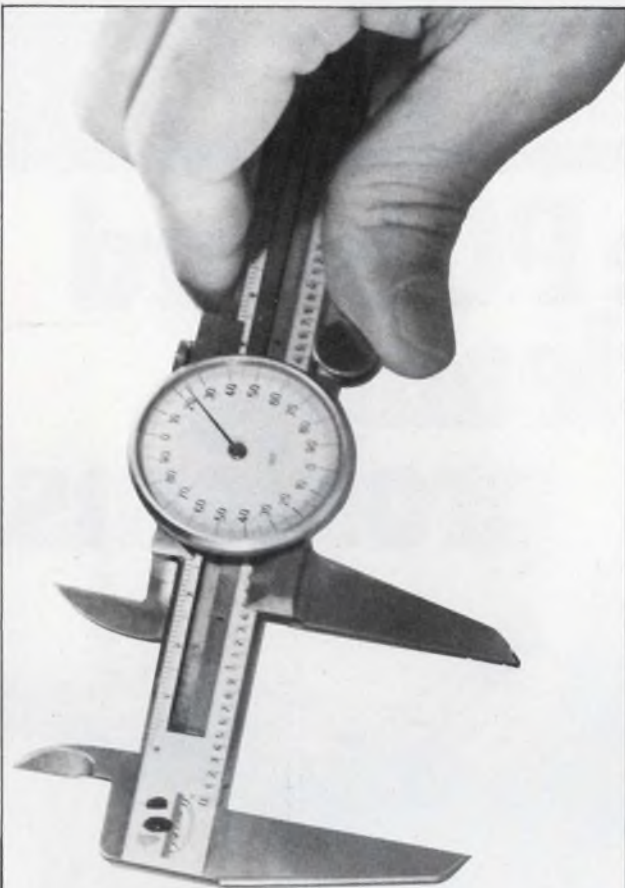

ACCURACY

Electronic Design makes every effort to be accurate. If you spot a misstatement in either editorial or advertising matter, please bring it to our attention. Corrections are made promptly and appear in "Across the Desk."

If you find that an advertiser has made promises . . . then failed to deliver . . . we'll help you. Send us the details and we'll add our pressure to yours to help rectify the situation, or if it's an honest mistake, we'll try to find out why it happened.

Electronic Design refuses to run any advertisement deemed to be misleading or fraudulent. Our accuracy statement appears in every issue. Accuracy is everybody's business. To put teeth in our policy, we need your help and support.

Send comments to:

George Rostky
Editor-in-Chief
Electronic Design
 50 Essex Street
 Rochelle Park, New Jersey 07662

Locate this remote time code reader



ANYWHERE

The Model 8371 Remote Time Code Reader accepts a serial time code input on 100, 250, or 1000 Hz carrier and displays time of day in hours, minutes, and seconds. An additional three digits displaying day of year are optionally available or may be added in the field merely by plugging in three display digits and three integrated circuits. The input code is also provided as an output to allow "daisy-chaining" of units. Brackets are provided to allow mounting of the unit from the top or bottom with an adjustable tilt of 45°.

SPECIFICATIONS

Code Input

Formats: IRIG B, IRIG E, NASA 36BIT, XR3, 2137 (specify)
Impedance: 150K ohms
Level: 0.5 to 10.0 Vpp without adjustments
Modulation Ratio: 2:1 to 6:1
Carrier Frequency: 100 Hz (IRIG E), 250 Hz (XR3), 1000 Hz (others)
Connector: BNC

Code Output

Same as input

Synchronization

Display updates within ± 5 ms of "on-time" (once per second)

Display

Type: Seven-segment LED's
Color: Red
Height: 0.5 inches
Reading distance: 30 feet
Viewing angle: 60° minimum

Power Requirements

Voltage: *110 or 220 VAC 10%
Frequency: 50 to 400 Hz
Power: 15 Watts nominal
Switch: Rear-panel On-Off power switch

PHYSICAL

Weight: 4 pounds
Height: 3.0 inches
Width: 14 inches
Depth: 5.0 inches (excluding $\frac{3}{4}$ " heat sink)

*Unit is delivered with internal jumper strapped for 110 Vac operation. This strapping may be changed in the field to convert the unit for 220 Vac operation.

Price: \$585, quantity 10. Add \$75 for days display

For further information call:
 TRAK SYSTEMS
 4722 Eisenhower Boulevard
 Tampa, Florida 33614
 Phone (813) 884-1411

TRAK
SYSTEMS
 DIVISION OF TRAK MICROWAVE CORP

CIRCLE NUMBER 53

Arrow-M Amber Relays

solve PC board cleaning problems.



Arrow-M's leak-free Amber Relays are N₂ gas-filled and sealed in plastic so they're simple to clean with most degreasers and detergent cleaners, without affecting the maximum contact reliability of the relays.

And, Arrow-M can help you substantially reduce your labor costs! Just use Arrow-M Amber Relays on your PC board in conjunction with automatic wave soldering, instead of costly hand soldering.

The total savings are even greater when you use Arrow-M Amber Relays. Arrow-M Amber

Relay prices are right in line with standard non-seal types.

Arrow-M Amber Relays. When you want maximum reliability and maximum savings. And only Arrow-M makes them.

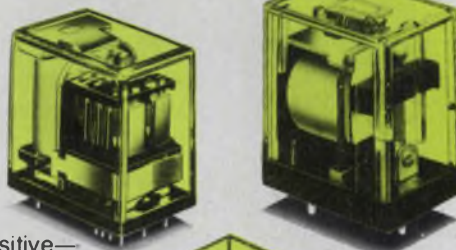

KE—Sensitive—
Long Life—10⁸ mech.

NFE—
New Low Profile—
High Sensitivity

HCE—
Miniature
Power
Type.

For more information on exact specifications, write or call your nearest Arrow-M office.

Arrow-M Corporation
250 Sheffield Street
Mountainside, N.J. 07092
(201) 232-4260

Western Office:
22010 South Wilmington Ave.
Suites 300 & 301
Carson, California 90745
(213) 775-3512



Arrow-M

Member of Matsushita Group

New products

Logic analyzer traces nested loops to 7 levels with state sequences and 'menu' control



Hewlett-Packard, 1501 Page Mill Rd., Palo Alto, CA 94304. (415) 493-1501. P&A: See text.

Just when you think you understand logic analyzers, along comes one with original features and terminology, and the most extensive troubleshooting power yet. Suddenly, you've got to start learning all over again. Getting to know HP's 1610A is well worth the effort: No other analyzer gives you as much.

With the 1610A, you can pull out and trace a given subroutine, even if the routine is buried within seven nested loops. You can require each of those loops to go through as many as 65,536 iterations. You can logically OR the capture criteria to follow μ P system operation from as many as seven different locations. And you can use as few as one or as many as 32 input bits to define the capture point.

Those capabilities put the 1610A well ahead of available analyzers. And the barely one-year-old HP 1611A dedicated unit may look like it, but the similarity ends right there. The general-purpose 1610A does much more.

Instead of the "trigger," "delay" and "map" of previous analyzers, you must

now think in terms of "trace position and selective trace," "state occurrence," and "graph." The differences aren't merely semantic.

The 1610A is HP's first menu-controlled instrument. With many modes implemented in software, the video screen, in effect, doubles as both a display and control panel. Press a button, and the screen presents one of two specification menus: a format specification, which defines the relationship between the input channels and the display, or a trace specification, which defines the conditions under which the test data will be captured. An operator-controlled cursor identifies various fields in each menu.

In the format-specification mode, which appears on power-up or at the touch of a key, you put the various inputs together in some logical manner (photo a). For instance, bits that behave as a unit can be grouped. The inputs are sensed synchronously (to 10 MHz) with 32 variable-threshold probes, fanning out of four 8-bit pods. An arbitrary label can be assigned to each group—perhaps an "A" to identify a μ P's address bus, a "D" for the data bus and so on. Six different labels, A

(continued on page 100)



(a)

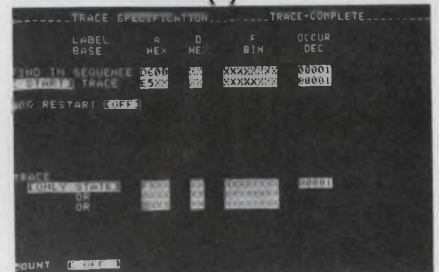

(b)

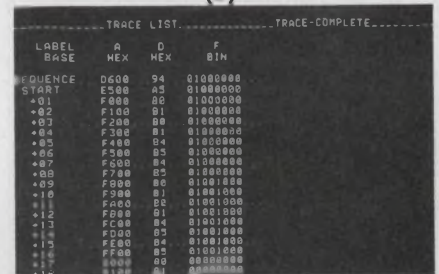

(c)



(d)

Select your format from an on-screen menu (a), and tailor the HP 1610A to almost any application. Choices include clock slope, logic polarity and radix. In this **trace-specification display** (b), the 1610A is told to find one occurrence of hex data D600 before capturing 64 words starting at E5XX. The **trace-list display** (c) shows results in a 20-line listing. You can scroll to see all 64 words. A state count or time between states can also be shown. The **trace graph** (d) gives an overview by plotting words as binary magnitudes vs time.

RF Power Amplifiers?

One unit may be all you'll ever need.



If you have the ENI Model 440LA ultra-wideband solid state power amplifier, all you need is a laboratory signal generator and you've got the ultimate in linear power for such applications as RFI/EMI testing, NMR/ENDOR, RF transmission, ultrasonics and more.

Capable of supplying more than 40 watts of RF power into any load impedance, the 440LA covers the frequency range of 150 kHz to 300 MHz.

We could mention unconditional stability, instantaneous failsafe provisions and absolute protection from overloads and transients, but that's what you expect from any ENI power amplifier, and the 440LA is no exception!

Our catalog contains complete specifications on the 440LA as well as the entire line of ENI amplifiers, and is available without obligation, of course.

For further information or a demonstration, contact ENI, 3000 Winton Road South, Rochester, New York 14623. Call 716-473-6900, or Telex 97-8283 ENI ROC.

ENI

The World's Leader
in Power Amplifiers

CIRCLE NUMBER 56

INSTRUMENTATION

(continued from page 98)

through F, are available.

After the labeling, all input data are gathered at a clock transition and treated as one parallel state. In subsequent "trace" measurements, occurring state values are collected.

While still in the format mode, you then assign a radix of 2, 8, 10 or 16 to each label. You may want to consider the address lines in octal, the data lines in hex and the status and interrupt lines in binary. Or, you can choose decimal notation. Finally, you choose either positive or negative-true logic polarities for each assigned label.

Having told the 1610A how to present a μ P's activity, you tell it which information to capture. Press a button, and the screen clears for the trace-specification menu (photo b).

The key to the 1610A's troubleshooting power lies in the trace-specification mode. Here, you define a qualifying sequence of data patterns—up to 32 bits wide and seven words deep—that must be matched by the input stream before system activity is captured.

Each of the 64 captured 32-bit words is called a "state." A reference point, called the "trace position," can be assigned as the "start," "center," or "end" of the 64 captured words.

Measurement then proceeds in two phases. First, the 1610A locates the trace position in the input data. Second, it performs a selective trace—it captures the 64 words in a specified manner. Both position and selective-trace specs are given in terms of hex, octal, decimal, binary or don't care conditions on any or all of the 32 bits.

If you select "start" for the trace position, the selective-trace states come after on the screen. Select "center," and the selective-trace states show up before and after. Select "end," and the states are displayed before.

The state sequence you have assigned—up to seven state conditions—must be found in the specified order. States that don't satisfy the sequence are ignored.

With state sequences, you can directly locate branched, looped or nested forms (or sections) of state flow. Since you can specify each state condition to "occur" up to 65,536 times, you can locate the nth pass of a loop, beginning at a given state.

In effect, both selective trace and

trace occurrence compress information flow by leaving out unnecessary states and obviating the need for a deeper, costlier, internal memory.

Count measurement, another test mode, provides even more analyzing potential. With it, you count states or measure the time between states, in either a relative (state-to-state) or absolute (referred-to-trace-position) mode. Counts can go beyond 4×10^9 , and time to 429.4 s, with a resolution of 100 ns and an accuracy of 0.01%.

To look at the captured data, take your choice of three trace presentations: "list," "graph" or "compare."

In the list display, the one you'll probably use the most, 20 traced states are presented in order of occurrence (photo c). Roll keys will let you see the remaining 44 states. Along with a line number and the captured data, which are alphabetically formatted into the assigned labels and radix, you get either the accumulated counts or timing information.

The graph display presents an overview of data in a new way: as a plot of the integer binary magnitude of each state versus time (photo d). This display mode does what the mapping displays in other analyzers do—it gives a "big picture" of over-all system activity.

With the compare mode, you get a tabular listing of the differences between a current measurement and one that's been stored. Identical bits are displayed as ZEROs, dissimilar bits as integers. For example: Octal 03, which translates to binary 000 011, indicates dissimilarity in the two right-hand bits.

The compare mode furnishes an additional capability. You can rerun a measurement continuously until current and stored data are equal. Or you can set up the analyzer to tell when the current measurement doesn't equal the stored data—handy for tracking down frustrating intermittents.

As if the 1610A's measuring capabilities weren't enough, the unit also diagnoses itself. Simply touch a self-test button, and the unit exercises and verifies the operation of internal memory, the display, the keyboard, the input pods and other portions of the circuitry. Self-test displays are presented, and an internal verification program guides you through the test via the display.

The 1610A will sell for \$9500. The first units will be available in July, 1977.

Circle No. 304

YOU'D THINK YOU DESIGNED IT YOURSELF.

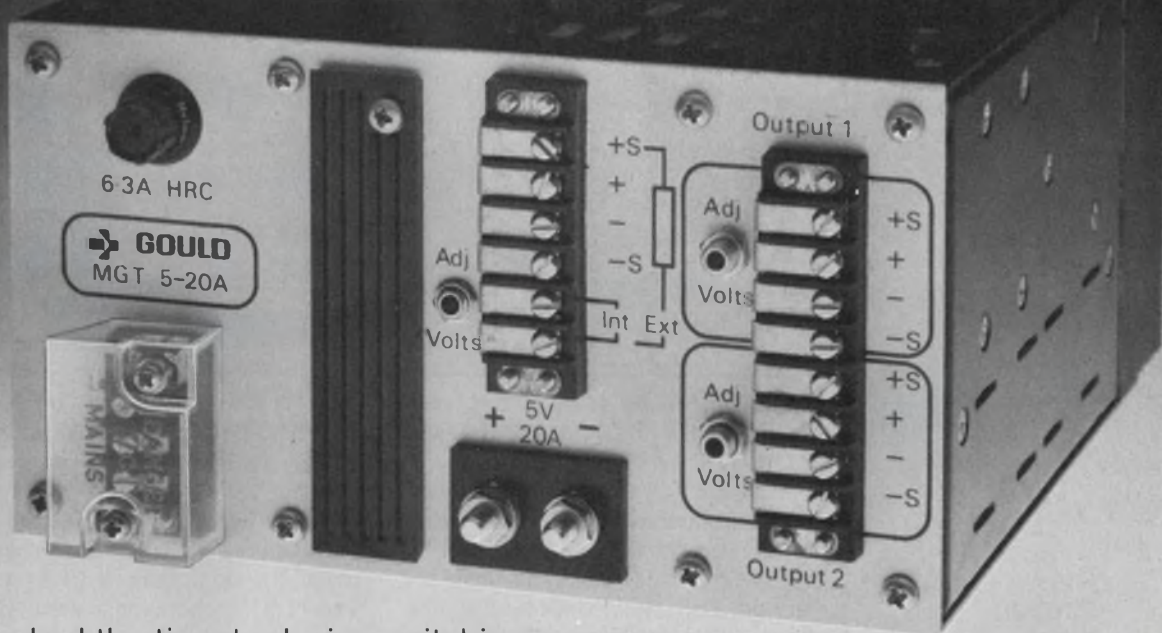

If you had the time to design switching power supplies, we think your design, like ours, would reflect this basic design precept: achieve greatest efficiency in the least amount of space at a cost comparable to linear supplies.

That's one important reason why over the past four years more than 20,000 Gould units have quietly found their way into the designs of systems engineers all over the world.

Of course there are other important reasons:

- 36,000+ hours MTBF
- Switching at 33,000Hz
- 0.1% line/load regulation
- less than 50mV peak-to-peak ripple
- full output rating at 50°C ambient
- standard remote sensing and programming

There are still more reasons, but we think you get the idea. Show a good design to a good design engineer and it'll speak for itself. So let us demonstrate to you the smallest and most efficient OEM power supplies yet designed.

For more information contact Gould Inc., Power Supply Dept., 3631 Perkins Ave., Cleveland, Ohio 44114.

**For brochure call toll free at
(800) 325-6400 Extension 77**
In Missouri: (800) 342-6600

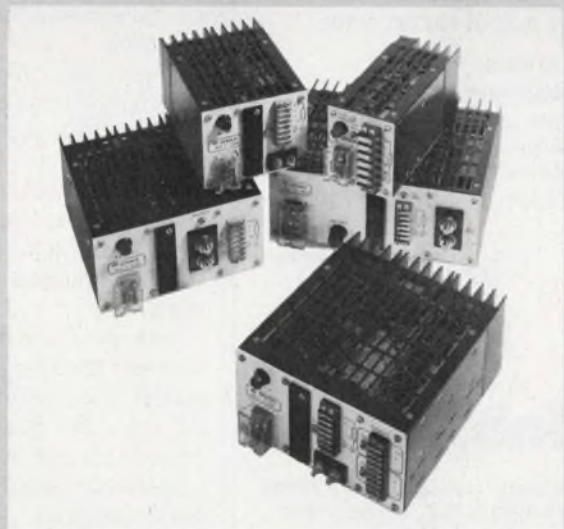

 **GOULD**
The product development company

MICRO PROCESSOR POWER SOURCES

REGULATED



For...

- MPUS
- E ROMS
- RAMS
- ROMS

**ONE WATT OUTPUT • COMPACT
DIP PACKAGE • LOW NOISE
ISOLATED • LOW PRICE**

Ultra Compact DC-DC V-PAC Power Sources* use 5v or 12v input, provide +12, -5 regulated low noise outputs. Also available with $\pm 12v$, or $\pm 15v$ output for op amps.

SPECIFICATIONS:

Output voltage tolerance $\pm 5\%$
 Output ripple _____ 30 mv, P-P max.
 Line regulation _____ 0.3%
 Load regulation _____ 0.3%
 Operating temp _____ 0° to 70°C
 Isolation _____ $10M\Omega$ @50v
 Price _____ \$20.20(100pcs)



Reliability, Inc.

5325 Glenmont/Houston, Texas 77036
 713/666-3261/TWX: 910-881-1739

International: Reliability Nederland, B.V.
 Summerhill, Nenagh, Co. Tipperary, Ireland

*Trademark, Reliability, Inc.
 Price subject to change without notice

CIRCLE NUMBER 58

INSTRUMENTATION

Function generator breaks 50-MHz output barrier



Exact Electronics, 455 S.E. 2nd Ave., Hillsboro, OR 97123. (503) 648-6661. \$1450; 30 days.

Although the 50-MHz 757 function generator by Exact Electronics doesn't exactly leave its rivals in a trail of dust, its 25% frequency advantage over the year-old Tektronix FG504 is enough to make it the world's fastest function generator. At least for now.

With frequency boosts in function generators coming ever more frequently—after Wavetek's 30-MHz 160 held the top spot for so long—a question arises: Have designers finally hurdled the barriers that can make a 30, 40 or 50-MHz waveform look more like a melted sinusoid than a square wave or triangle?

"Yes," says Jerry Foster, Exact's president. Microwave techniques in the 757 make it a true 50-MHz generator, Foster explains. Sinusoids, squares and triangles at the top frequency look like sinusoids, squares and triangles. The 757 isn't a 10-MHz unit that's been somehow pushed to 50 MHz, Foster notes.

How good are the 757's waveforms—or any function generator's, for that matter? Only your oscilloscope knows for sure. But you can get some idea from specs for sine-wave distortion, square-wave aberrations and triangle nonlinearity.

In the 757, distortion products from 100 kHz to 50 MHz are 30 dB down, aberrations stay under 5% (no frequency specified), and linearity is within 1%

of a "best" straight line—but only to 100 kHz. Beyond 100 kHz, no spec is given, at least in the preliminary sheets.

In the Tektronix FG504, the same parameters get slightly different treatment: Harmonics are 20 dB down from 1 to 40 MHz, aberrations are under 5% pk-pk plus 30 mV into a 50- Ω load, and triangular linearity is within 10% from 4 to 40 MHz, measured between the 20% and 80% points on the waveform.

Two clearer advantages of the 757 are the split arrangement of its frequency dials, and the operating versatility offered by two generators in one, each with its own set of controls. Built around a Kelvin-Varley divider, two independent dials let you set sweep-start and sweep-stop frequencies with 10-turn-type resolution.

A start or stop frequency can be dialed in either linearly or logarithmically over a 1000:1 range, from 1/100 to 10 times the frequency-range setting. LEDs peeking through the start-stop dials indicate the scales and settings and flash on and off in invalid modes.

With the 757's second built-in source not only can you sweep the output, you can step through 11 different frequency levels. LEDs indicate which level is at the output. And like the main generator, the ramp/step can not only free run but also be triggered or gated—either manually or externally.

Exact Electronics **Circle No. 301**
 Tektronix **Circle No. 302**

AIRPAX MAGNETIC CIRCUIT BREAKERS

meet U.L., C.S.A., and
military requirements.

The choice of a protective device for any application involves voltage, current, trip time delay, and short circuit ratings. Such mechanical variables as number of poles, termination, mounting, size, and type of actuation are also involved. Before final selection is made, however, be sure to consider applicable U.L., C.S.A., and military requirements. Chances are that Airpax has the magnetic breaker you need . . . qualified, recognized, or listed for your specific requirements. **Other Advantages.** Airpax magnetic circuit

breakers have accurate trip currents. They are not sensitive to ambient temperatures, can be used as ON-OFF switches, and come in single or multipole packages. Some even have a pilot light in the handle and snap-in mounting. **Full Details Available.** For further information on the full line of Airpax circuit breakers, plus U.L., C.S.A., and military listings, request Short Form Catalog 2013 from your local Airpax representative, or contact Airpax Electronics, Cambridge Division, Cambridge, Maryland 21613. Phone (301) 228-4600. Telex: 8-7715. TWX: (710) 865-9655. Other factories in Europe and Japan. European Sales Headquarters: Airpax S.A.R.L., 3 Rue de la Haise, 78370 Plaisir, France.

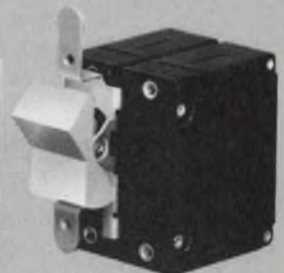
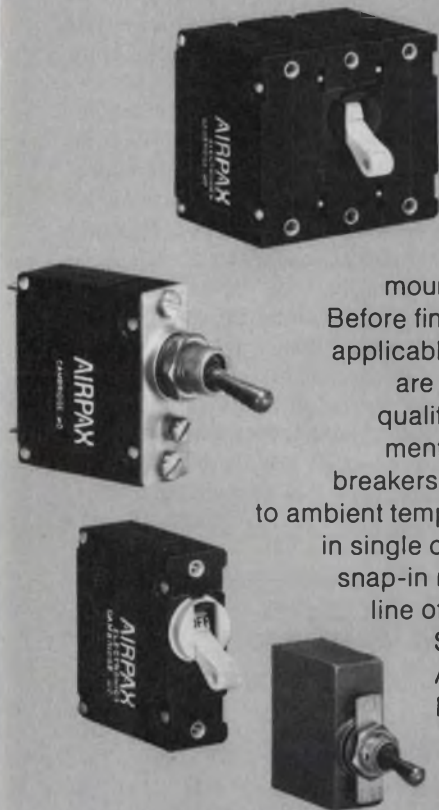

CIRCLE NUMBER 59

AIRPAX™

THE PRO IN PROTECTION

ALONE AGAIN

in low cost 1-watt
Zener Diodes

SCHAUER

"Z" SERIES ZENERS

DO-41 epoxy
molded case

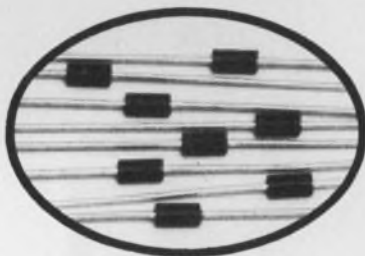

ANY VOLTAGE
2.6 to 34.0

ANY TOLERANCE
1% 2% 5% 10%

At Any Test Current

**Compare These Prices
On 1% Tolerance Diodes**

Quantity	Price each
1-99	91¢
100-499	83¢
500-999	77¢
1000 up	73¢

**LARGE STOCK
GOOD DELIVERIES**

Send for complete rating data
and other tolerance prices.

Semiconductor Division

SCHAUER

MANUFACTURING CORP.

4511 Alpine Ave., Cincinnati, OH 45242
Telephone 513-791-3030 Telex 21-4576

CIRCLE NUMBER 60

INSTRUMENTATION

Junction-to-case thermal resistance can be 'measured'



Sage Enterprises, 1080 Linda Vista Ave., Mountain View, CA 94043. Bernie Siegal (415) 969-5111. \$5750 plus test fixture; 60 to 90 days.

The Theta 210 from Sage is the first instrument to "measure" the junction-to-case thermal resistance (θ_{JC}) of transistors. The instrument completes the test in 6 s—which far surpasses home-brewed equipment that takes 15 to 30 min. per transistor and requires hand calculations.

The 210 doesn't measure junction temperature directly—it averages many pulsed-heating cycles, and extrapolates junction temperature from changes in base-emitter voltage.

A digital readout shows θ_{JC} in $^{\circ}\text{C}$ of junction temperature rise per dissipated watt. Accuracy on the 0-to-19.99 C/W scale is $\pm 6\%$ of reading ± 0.04 C/W. Accuracy on the 0-to-199.9 C/W scale is $\pm 6\%$ of reading ± 0.4 C/W. These worst-case errors include the $\pm 2\%$ tolerance in the collector voltage and current supplied by the tester. Voltage can be selected from 1 to 99 V in 1-V steps; current goes from 10 to 990 mA in 10-mA steps. Since either polarity is available, both npn and pnp transistors can be tested.

Thermal resistance is important because for every 12-C rise in junction temperature, a transistor's life expectancy is cut in half. The quality of the bond between the transistor chip and the case determines thermal resistance and, according to Sage president Bernie Siegal, "Mounting and bonding chips is still a black art."

One limitation of the 210 is that a different test fixture is required for each case type. Sage supplies some for popular cases at \$200 to \$300. Or you can build your own to Sage guidelines.

CIRCLE NO. 305

DPM reads rms, true and decibels, too



Analog Devices, Rte. 1 Industrial Park, P.O. Box 280, Norwood, MA 02062. (617) 329-4700. \$225 (100s); stock.

Model AD2033 3-1/2-digit DPM measures both the true-rms value and the decibel value of complex ac or ac+dc waveforms, and functions as a bipolar dc meter. The unit features five separate input ranges (199.9 mV, 1.999 V, 19.99 V, 199.9 V, 600 V rms full scale) and 500 mV, 5 V, 50 V, 500 V, 625 V rms for decibel readout. No external components are required. The line powered DPM features accuracy to 0.1% of reading $\pm 0.5\%$ full scale ± 1 digit.

CIRCLE NO. 309

Build your own function generator



AE Corp., 65 Wellesley Ave., Needham, MA 02194. (617) 449-3142. \$79.95, kit; \$124.95, wired.

Model 12 function generator comes as a kit or wired. Featured are external frequency-control VCO from dc to 1 MHz; remote frequency-shift keying; frequency modulation; remote tone burst and simultaneous sine, triangle and square waves. Also included are continuously adjustable amplitude and dc offset.

CIRCLE NO. 310

Spectrum analyzers get a memory, I/O interface



Polarad Electronics, Nelson-Ross Electronics Div., 5 Delaware Dr., Lake Success, NY 11040. (516) 328-1100. \$8850 to \$10,600.

A digital memory with interface capability is incorporated into the compact N-R 600 Series rf/microwave spectrum analyzers, working from 100 kHz to 40 GHz. The memory provides nonfading flicker-free display storage, and retains data for recall at will. Precise on-screen comparisons can be made between incoming signals and stored reference displays. An input/output memory interface is provided for use with data storage and signal processing accessories. The I/O is adaptable for use with an IEEE-488 format data bus.

CIRCLE NO. 421

Logic tester aimed at μ P PC boards



Fluke Trendar, P.O. Box 43210, Mountlake Terrace, WA 98043. (206) 774-2211. \$60,000 to \$95,000; 8 wks.

Model 3040A (Logictester) digital logic board tester is specifically designed to test μ P boards. The Logictester can apply user-defined test sequences at rates up to 1,500,000 input words per second. At the same time, the 3040A can also run automatic sequences at rates up to 5 MHz. The 3040 applies the technique of cyclic redundancy checks to digital board testing. Long used for error checking in data transmission applications, CRC signatures can now be used for go/no-go tests as well as nodal diagnostics.

CIRCLE NO. 422

Synthesizer resolves 1 Hz throughout range

Rockland Systems, 230 W. Nyack Rd., West Nyack, NY 10994. (914) 623-6666. \$4975. Stock-30 days.

Model 5600 frequency synthesizer works over a frequency range from 100 kHz to 160 MHz with constant 1-Hz resolution throughout the range. Model 5600 is a direct synthesizer (no phase-

locked loops) and is therefore faster than the older indirect phase-locked VCO designs; typical switching time is 20 μ s. Spurious harmonic outputs are said to be 10 to 15 dB lower than in indirect designs (> 35 dB below fundamental), and close-in phase noise is 6 to 10 dB lower (> 70 dB, typically). Output leveling is better than 2:1 (± 0.5 dB flatness).

CIRCLE NO. 423

Here's why our Model 175 is the best 3 $\frac{1}{2}$ digit portable multimeter on the market... and why you should own one!

	Data Precision Model 175	HP 3435	HP 3176B	Fluke 8000A	Fluke 8030
Digits	3 $\frac{1}{2}$	3 $\frac{1}{2}$	3 $\frac{1}{2}$	3 $\frac{1}{2}$	3 $\frac{1}{2}$
Size	34 cu. in.	395 cu. in.	123 cu. in.	212.5 cu. in.	69.8 cu. in.
Display Size	0.43" LED	0.30" LED	0.25" LED	0.25" LED	0.33" LED
Basic Accuracy for 1 Year ± 1 Digit	0.1%	0.1%	0.3%	0.1%	0.1%
DCV Sensitivity	100 μ V	100 μ V	100 μ V	100 μ V	100 μ V
AC Frequency Response	30Hz-50kHz	30Hz-100kHz	45Hz-10kHz	45Hz-20kHz	45Hz-10kHz*
Functions	6	5	5	5	6
Ranges	32	27	19	26	26
Hi/Lo Excitation	Yes	No	No	No	No
Calibration Accuracy Guaranteed	1 year	1 year	1 year	1 year	1 year
Overrange	100%	100%	10%	100%	100%
Ranging	Manual	Manual & Auto (except current)	Auto	Manual	Manual
Rechargeable	Yes	Yes	Yes	Optional (\$50.00)	Optional (\$40.00)
Recharges Batteries While Operating	Yes	Yes	No	Optional	Optional
Full Scale Voltage Drop Measuring Current	100 millivolts (EIA STANDARD)	220-400 millivolts	100 millivolts	100 millivolts	250 millivolts
Price With Batteries	\$189.00	\$400.00	\$275.00	\$349.00	\$275.00

*with true RMS

For complete information or a demonstration, contact your local Data Precision representative or Data Precision Corporation, Audubon Road, Wakefield, MA. 01880, (617) 246-1600. TELEX (0650) 949341.

The Data Precision Model 175, 3 $\frac{1}{2}$ digit miniature portable multimeter. Only \$189. The facts speak for themselves.



DATA PRECISION[®]
...years ahead

CIRCLE NUMBER 61

Single-bit μ P avoids overkill

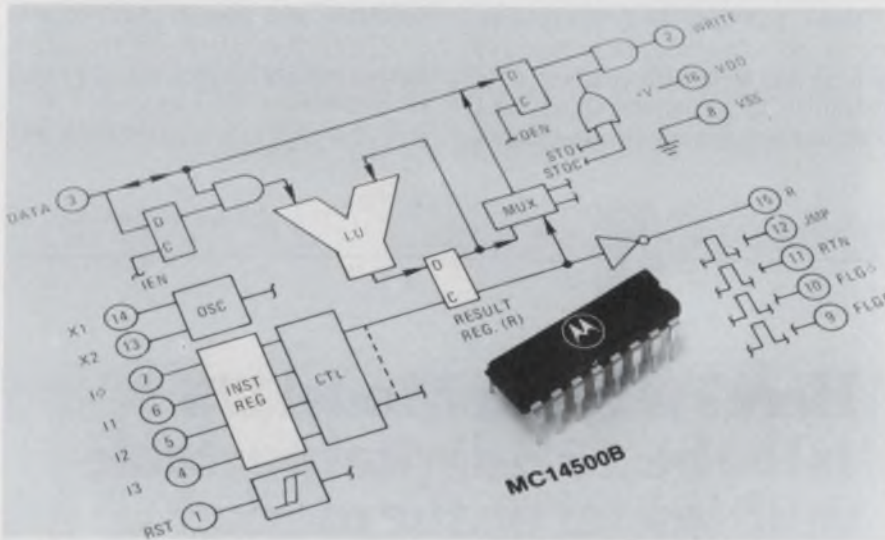

Motorola Semiconductor Products, 5005 E. McDowell Rd., Phoenix, AZ 85008. (602) 244-6900. P&A: See text.

To eliminate 4 and 8-bit processor "overkill" in many low-end applications, Motorola has developed the first commercial microprocessor with a one-bit word length. And because the

MC14500B is built with CMOS technology, its dissipation is just a few μ W.

A small, but flexible repertoire of 16 instructions includes five logic operations performed on the contents of the result register and the data held on the bus, four instructions to transfer data, five commands to manipulate pro-

grams and two commands to enable either output or input. Unlike bit-slice circuits, the μ P includes a clock oscillator, registers, ALU and power-on reset circuit.

With a crystal or resistor between the timing pins, the 14500B operates at clock frequencies up to 1 MHz with a 5-V supply. However, the unit can function over a 3 to 18-V supply range.

The circuit comes in a 16-pin DIP, with the following pin allocations: four pins for instruction inputs, two for the timing circuit, one for a reset, one for a data input, two for a data output, two for power and ground and four for program control.

External circuitry required to operate includes one-of-eight decoders (MC14512) and 8-bit latches (MC14599) to select data and perform I/O operations. A program counter is needed to provide the memory addresses; a simple ripple counter does the job.

The MC14500B can resolve decision-based questions with one instruction per logic element. Most microprocessors require three or more instructions per logic element.

Prices for the 1-bit processor are \$7.58 (100-999) and \$4.88 (1000-4999) and quantity deliveries will be available in June. **Circle No. 303**

We just brought Digital factory service one step closer to the field.

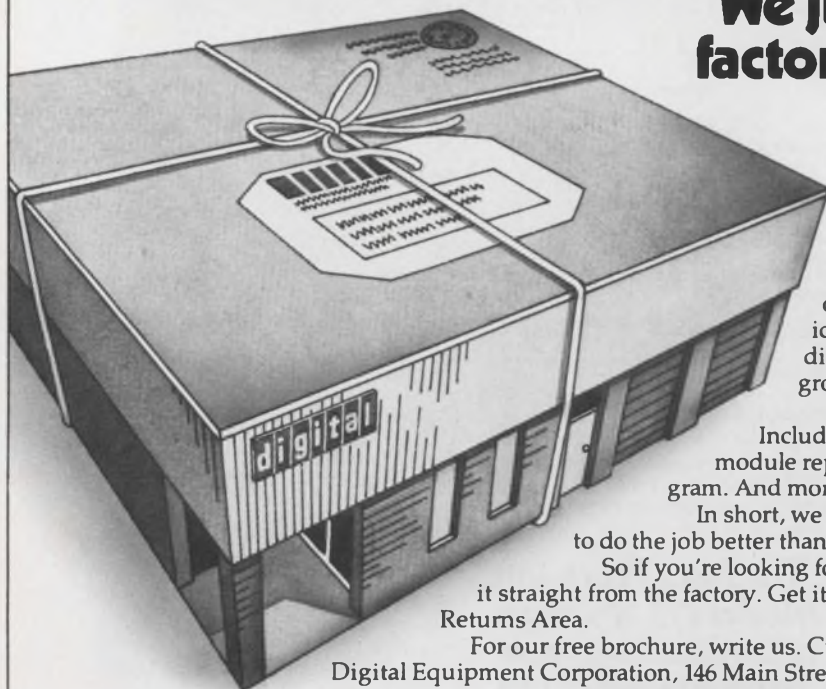

Announcing the Customer Returns Area. The major off-site repair center for Digital Equipment Corporation.

The Customer Returns Area offers all our customers direct access to factory service. We have our own parts inventory, diagnostic and test center, and engineering group.

We also have a number of service plans.

Including subassembly contracts, individual module repair, our unique Module Mailer™ program. And more.

In short, we have everything it takes to do the job better than anyone else.

So if you're looking for off-site service, get it straight from the factory. Get it from the Customer Returns Area.

For our free brochure, write us. Customer Returns Area, Digital Equipment Corporation, 146 Main Street, Maynard, MA 01754.

digital



ROM holds 32-k and accesses in 350 ns

Electronic Arrays, 550 E. Middlefield Rd., Mountain View, CA 94043. John Lipnisky (415) 964-4321. \$35.06 (100-up); 4 to 6 wks.

A 32,768 bit ROM, the 3210/20, offers a 350-ns access time and 25-mW typical standby power. There are two versions: the 3220 uses a 12-V clock for compatibility with MOS systems, and the 3210 has a TTL-level clock. Operating power is 500 mW, typical, or 15 μ W per bit. The ROMs come in 28-pin ceramic DIPs.

CIRCLE NO. 320

Rf power FETs provide 10-dB gain at 200 MHz

Siliconix, 2201 Laurelwood Rd., Santa Clara, CA 95054. Jim Graham (408) 246-8000. \$13.97 (100-up); stock.

The VMP 4, a Mospower FET, is claimed to be the first commercial rf power MOSFET. The device has no thermal runaway or secondary breakdown, withstands any VSWR, offers a 10-dB minimum gain at 200 MHz and a 35-W maximum power dissipation. It is an n-channel enhancement-mode MOSFET packaged in a 380SOE flange-mount, ceramic stripline case. The maximum voltage of the VMP 4 is 60 V in the drain-source direction and 20 V for the gate-source. Transconductance (g_m) of the VMP 4 is typically 280 millimhos. In continuous operation, the VMP 4 provides power outputs to about 14 W with inputs of less than 1 W. Saturated power outputs range up to over 20 W with power input of 1 W. The typical small-signal noise figure is 2.5 dB at 150 MHz and the two-tone, third-order intermodulation intercept point is +46 dBm.

CIRCLE NO. 321

One-chip microcomputer compatible with F8

Fairchild Camera and Instrument Corp., Micro Systems Div., 1725 Technology Dr., San Jose, CA 95110. Gordon Dagg (408) 998-0123. Under \$10 (large qty.).

A one-chip version of the F8 microprocessor, called the F8 MicroMachine, provides all the functions of the earlier two-chip F8 system consisting of the 3850 CPU and the 3851 PSU.

CIRCLE NO. 322

CCPD

WHAT IS CCPD?

It is the ultimate image sensor just introduced by RETICON. It takes advantage of the best features inherent in both CCD and RETICON's long-established photodiode array technology. It uses a CCD register for readout, providing a low capacitance, low-noise output—and diffused photodiode sensors for uniform response, high quantum efficiency, and freedom from blooming. Our CCPD™ image sensors are available with 256 to 1728 elements on 16 μ m centers.

COMPARE THESE FEATURES.

	CCD	CCPD*
● Low Noise, Low Light Level Performance (Low Output Capacitance)	Yes	Yes
● Low Dark Current (allows operation up to 40 msec integration time).	No	Yes
● Smooth Spectral Response (No Interference Pattern)	No	Yes
● Full Silicon Spectral Response (Including Blue and UV)	No	Yes
● High Resistance to Blooming	No	Yes
● High-Volume Production Process	No	Yes

*Charge Coupled PhotoDiode

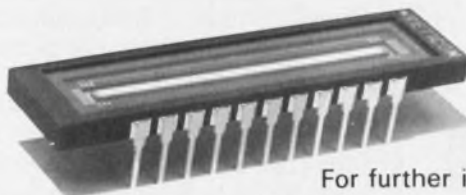

For further information, write or call:

RETICON®

AN EG&G COMPANY

910 Benicia Ave. • Sunnyvale, California 94086 • (408) 738-4266

CIRCLE NUMBER 63

NEW WIDEBAND POWER AMPLIFIER

We economized
only on the price



Model 10L

10 Watts
250 kHz to 310 MHz
\$1450

This new, all-solid-state amplifier delivers up to 20 watts of linear power or 35 watts of saturated power within the 1 to 300 MHz band. *Undamaged by open- or short-circuit loads*, the Model 10L also provides useful linear power over ten octaves of bandwidth.

The ultimate in versatility. Compatible with standard signal sources and RF test equipment, the Model 10L can be used in EMI susceptibility testing, NMR spectroscopy, laser modulation, and a wide variety of general laboratory applications. Big on performance, small on price — \$1450. For complete information, write or call;



**AMPLIFIER
RESEARCH**
Amplifier Research
160 School House Road
Souderton, PA 18964
215-723-8181

CIRCLE NUMBER 64

ICs & SEMICONDUCTORS

Magnetic bubble memory holds 92 k on one chip

Texas Instruments, P.O. Box 5012, Dallas, TX 75222. (214) 238-2011. \$200 (unit qty.); stock.

Capable of nonvolatile storage of 92,304 bits of data, the TBM0103 magnetic bubble memory chip comes housed in a 1 × 1.1 × 0.4-in. package. The bubble chip is made of a gadolinium-gallium garnet substrate upon which a magnetic epitaxial film is grown. Device architecture is a major loop/minor loop structure. Data bits are written into and read out of the major loop; data bits are transferred to minor loops for storage. Housed in a 14-pin dual-in-line module the chip is surrounded by two orthogonal coils that provide the rotating magnetic field, a permanent magnet set and a magnetic shield to protect data from external fields. Performance specifications at 100 kHz operation include an access time of 4 ms for the first bit, cycle time for the 144-bit page of 12.8 ms and an approximate power consumption of 0.5 W for continuous operation. Operating range is initially 0 to 50 C with a nonvolatile storage range of -40 to 85 C.

CIRCLE NO. 323

Premium d/a converter settles in 135 ns

Precision Monolithics, 1500 Space Park Dr., Santa Clara, CA 95050. Donn Soderquist (408) 246-9222. \$9.95 (100-up); stock.

A high-performance grade unit for the DAC-08 series 8-bit multiplying DAC, the DAC-08H, offers significantly improved performance over other converters in the series. Settling time is 135-ns max., nonlinearity is ±0.1 (±1/4) LSB max., and the output current is matched to the reference input current within ±1 LSB to eliminate the need for calibration. Complementary current outputs with a -10 to +18 V compliance allow conversion to a voltage without an external op amp. Direct interface to TTL, DTL, NMOS, CMOS, and MECL logic is accomplished using a voltage-programmed, logic threshold control pin. Specified over 0 to 70 C, the DAC-08H consumes 33 mW with ±5-V supplies and 135 mW with ±15-V supplies.

CIRCLE NO. 324

Rf transistor handles 75 W

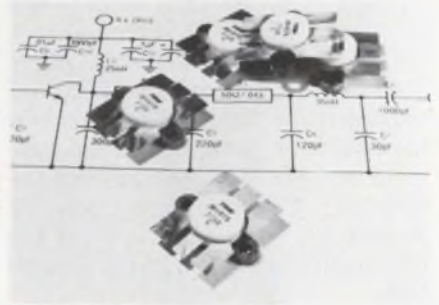

TRW RF Semiconductors, 14520 Aviation Blvd., Lawndale, CA 90260. (213) 679-4561. \$15.80 (1000 up); stock to 4 wks.

A vhf transistor, JO 4075, for land-mobile radio-transmitter applications provides 75 W of output power across the 136-to-175-MHz band at 12.5 V dc. The minimum gain at 75 W is 6.2 dB and at 70 W, 6.9 dB in Class A or AB power amplifiers. Features include a patented input-matching technique, diffused ballast resistors and a passivated-gold metalization system for greater reliability. The units are 100% tested to overstress conditions of infinite VSWR at the collector with 18 W of rf input and 15.5 V dc applied.

CIRCLE NO. 325

Electronic piano circuit senses key velocity

General Instrument, Microelectronics Div., 600 W. John St., Hicksville, NY 11802. Sol Gertzis. (516) 733-3107. \$6.25 (100-up); stock.

Developed for use in electronic pianos the AY-1-1320 circuit detects the speed of each key depression and then generates a corresponding volume signal to the sound circuitry. This produces a note that decays in amplitude in a manner similar to a keyboard instrument. And, the sound of an electronic piano can be adjusted to simulate the honky-tonk piano, the harpsichord and the clavichord by altering the character of the voicing filters. The output from each keying circuit is a square wave of the required fundamental frequency, which is then shaped by external voicing circuits. The Ay-1-1320 contains 12 separate frequency keying circuits, one for each note in an octave. Thus, a five-octave instrument would require only five 40-pin plastic devices. Each package requires 25 to 29 V at 6 mA max.

CIRCLE NO. 326

Opening new frontiers with electro optics

RCA Helium-Cadmium lasers offer long life: we ran one for more than 12,000 hours.

If you need 20 mW typical output in the blue region (441.6 nm), you get that and a lot more in RCA's Helium-Cadmium Laser System LD2186A.

You also get excellent long-term stability: $\pm 1\%$ typ. Low noise: 0.7% rms typ. (10 Hz to 10 MHz). Convection cooling: no fans or water. And — very important — long life.

As the graph shows, typical life is greater than 6,000 hours — but we operated one continuously for

more than 12,000 hours. A helium reservoir plus an innovative recirculating cadmium system are what make the LD2186A a reliable, long-life system for facsimile, COM, phototypesetting, pollution monitoring, video recording and non-impact printing. LD2186A is available from stock. For UV applications, we also offer a version with 325 nm output.

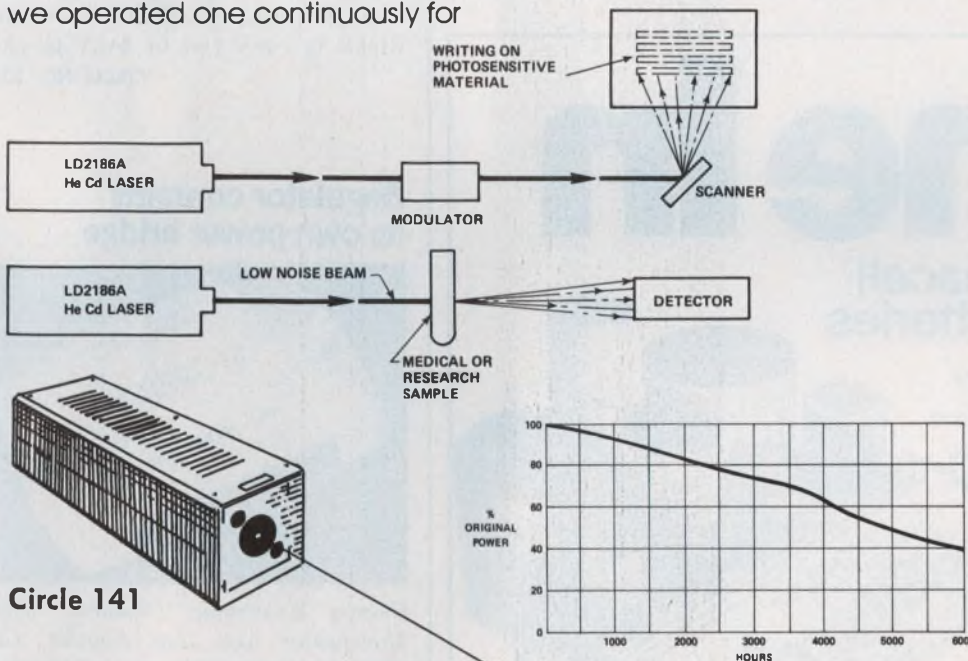

Circle 141

If electro optics can solve your problem, remember: EO and RCA are practically synonymous. No one offers a broader product spectrum. Or more success in meeting special needs. Call on us for design help or product information. RCA Electro Optics, Lancaster, PA 17604. Phone 717-397-7661. Sunbury-on-Thames, Middlesex TW16 7HW, England; Ste.-Anne-de-Bellevue, Quebec, Canada; Belo Horizonte, Brazil; Hong Kong.

Solid state laser breakthrough: CW output at room temperature!

You get at least 5 mW of continuous lasing in a solid state package. RCA's new AlGaAs CW injection lasers have a rise time of less than 1 ns — allowing modulation rates beyond 100 MHz. This plus small source size (13 x 2 μ m typical) and 820 nm wavelength make the C30130 and C30127 well suited to optical communications, facsimile, fiber-optic transmission, document reading, flying spot scanning.

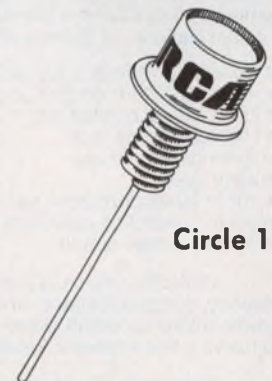
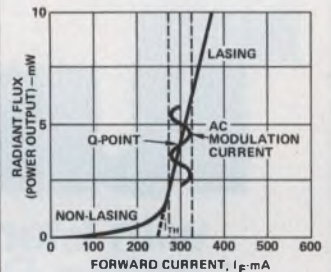

Circle 142

RCA

HOW DO YOU GET ANALOG SIGNALS INTO YOUR COMPUTER?

Using the new RAMP/Scanner, you can connect any combination of thermocouples, voltage signals or current transmitter signals directly to the input panel. Use two sets of twisted pair wires to tie the RAMP/Scanner into your computer's standard 20 ma current-loop or RS232 port. You'll now have two-way communication between the RAMP/Scanner and your computer in ASCII code. What could be simpler?



The new RAMP/Scanner features a solid-state scanning breakthrough, providing common mode voltage capability in excess of 250Vrms continuous or 600V peak • an auto-ranging dual-slope integrating DVM for high noise rejection • selectable serial transmission rates from 150 to 19,200 baud — and more!
Write or call Heinz Hoffmann at (617) 275-0300.



15 DeAngelo Drive, Bedford, Massachusetts 01730

CIRCLE NUMBER 66

POWER SOURCES

Dual outputs power μ Cs and op amps

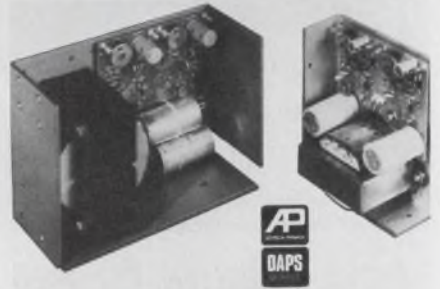

Adtech Power, 1621 S. Sinclair St., Anaheim, CA 92806. (714) 634-9211. \$35.80 to \$47.60 (100 qty).

Any two of the common voltages for μ Cs and IC op amps (± 5 , ± 12 , and ± 15 V dc) are available from the DAPS series of power supplies. The units are constructed on an open aluminum chassis with 20% more heat-sink area than competing supplies. Fasteners are available for mounting in various orientations. You can choose either separate or combined overvoltage protection for the two outputs. For reliability, the supplies use metal packaged regulators and transistors. Regulation is $\pm 0.05\%$ for line and $\pm 0.1\%$ for load. Ripple is 1-mV rms or 3-mV pk-pk.

CIRCLE NO. 327

Tune In

with Eternacell[®] Lithium Batteries

There's a new technology in primary batteries. It's called the Eternacell Lithium Battery. Or Eternacell for short.

- Operating voltage 2.8 volts per cell
- -65°F to 160°F performance
- Up to 10 years shelf life
- Highest energy and volume density of any battery system
- 1/2 to 30 ampere-hour cell sizes in production quantities
- Stable voltage output

Reliable, proven in memory standby, communications, underwater power, instrumentation, alarm systems ... to name a few. Delivery, stock to 4 weeks.

Eternacell. The highest energy, longest life battery. For information write: Power Conversion, Inc., 70 MacQuesten P'kway South, Mt. Vernon, N.Y. 10550. Or call (914) 699-7333.



Power Conversion

CIRCLE NUMBER 67

Regulator contains its own power bridge



Energy Electronic Products, 6060 Manchester Ave., Los Angeles, CA 90045. (213) 670-7880. \$6.10 (100 qty); stock.

The SI-20506, a hybrid regulator that passes 5 V at 2 A, contains its own power-rectifier bridge. The unit made by Sanken in Japan features overload and short circuit protection. The device operates from -20 to +80 C and is 2.4 x 1.6 x 0.4 in.

CIRCLE NO. 328

Overvoltage protectors span wide range

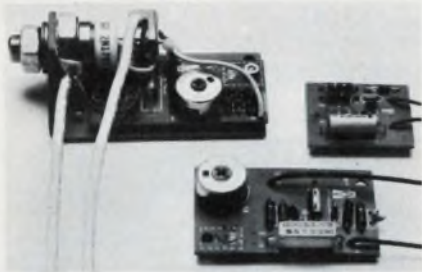

Standard Power Inc., 1400 S. Village Way, Santa Ana, CA 92705. (714) 558-8512. From \$6 to \$37 (unit qty); stock.

Overvoltage protectors of the OVP series come on a PC card with a mounting bracket and are compatible with most regulated power supplies. The 16 models of the series operate from 5 to 75-V-dc inputs at from 8 to 60-A continuous, and 25-A to 1-kA instantaneous. They are available in three voltage ranges: fixed, 5 to 32 V dc adjustable and 25 to 75 V dc adjustable. They weigh from 1 to 8 oz and range from 1.5 × 1.5 × 0.5 to 4 × 2 × 1.5 in.

CIRCLE NO. 329

Vary all three μ C supply outputs

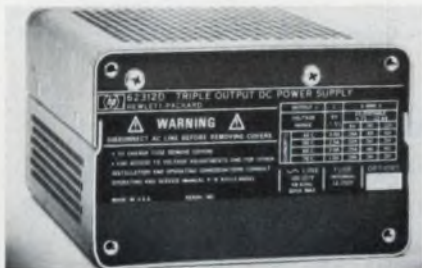

Hewlett-Packard, 1501 Page Mill Rd., Palo Alto, CA 94304. M. Fournell (415) 493-1501. \$116 (100 qty); 2 wks.

The fully enclosed HP 62312D provides three adjustable outputs that will power most μ Cs. The primary output is rated at 4.75 to 5.25 V at 3 A, while the other two each range from 4.75 V at 0.38 A to 12.6 V at 0.6 A. The supply operates fully rated up to 40 C and up to 70 C with derating. Regulation for line or load is 0.1%. PARD is 1-mV rms or 3-mV pk-pk from 20 Hz to 20 MHz. Remote programming of the 5-V output is standard. The supply operates from inputs of either 104 to 127 or 208 to 250 V ac at 48 to 63 Hz. Protection features include: fused ac; fixed, foldback, current limiting; and overvoltage limiting on the main 5-V output (optional on the other two outputs).

CIRCLE NO. 330

Dual outputs crammed into tiny module



Calex Mfg., 3305 Vincent Rd., Pleasant

Hill, CA 94523. (415) 932-3911. \$29; stock.

Supplying ± 15 V at 50 mA, the Model 22-40 regulated dc supply is just 1 × 1.75 × 2.25 in. The 6-oz unit offers line and load regulation of $\pm 0.1\%$ and noise and ripple of less than 1 mV. Along with pins, it also has a molded-in threaded insert for firm PC-board mounting. The module operates from 1.5 V ac over -25 to $+70$ C. Short-circuit protection by foldback current limiting is standard.

CIRCLE NO. 331

Anyone can make Lighted Pushbutton Switches



Unimax makes them Status Symbols.

Single lamp, dual lamp or 4-lamp lighting. Momentary or alternate switching. Ratings from dry circuit to 10 amps. Unsealed or oil-tight. Each one is a Status Symbol. To see which one is right for you, call or write: Unimax Switch Corp., Ives Rd., Wallingford, Conn. 06492. Phone (203) 269-8701.

Unimax  Switch

CIRCLE NUMBER 68

another first
from
Grayhill



16 positions in a dime-sized switch!

Now available with
PC or solder lug
terminals

- 1/4 amp, 1/2 inch switch single or double-pole with 16 positions in a single deck
- occupies only 1.1 cubic inch behind panel
- contamination-free enclosed construction, molded-in terminals

This new addition to the popular Grayhill Series 51 Rotary Switch family meets the growing number of applications calling for the maximum number of positions in the minimum amount of space. (Previously available 16 position switches had diameters of 1-1/3 inches instead of 1/2 inch!) And you'll be pleased with the performance and price of these switches too...rated for 25,000 cycles of operation, priced about \$6.00 in 100 quantities.

New Product Bulletin #257 contains complete specs and price information...free on request from the leaders in switch miniaturization, Grayhill, Inc. 561 Hillgrove Avenue, La Grange, IL 60525 (312) 354-1040.



CIRCLE NUMBER 69

MICRO/MINI COMPUTING

Single-board control computer uses 8748/8048 microprocessor

Imsai Manufacturing, 14860 Wicks Blvd., San Leandro, CA 94577. Michael Stone (415) 483-2093. From \$249 (kit form), \$299 (assembled); stock.

The first single-board microcomputer to use the 8748/8048, the 8048 control computer made by Imsai offers built-in interfaces for many applications. Included on the board with the 8748 μ P is a cassette interface, an RS-232 or current loop input, 1 kbytes of PROM, room for 1 kbytes of RAM and five relays capable of handling 2 A at 220 V or 3 A at 110 V.

Capable of operating with a 2.5- μ s instruction cycle, the 8.5 \times 10-in. board requires just a 5-V supply. Features of the board include 2 I/O lines, an internal timer/counter, on-chip oscillator and clock circuit, built-in reset and interrupt circuits and BCD arithmetic capability. Also included on the board is a 24-key keyboard and a nine-character LED display.

There are two versions of the board

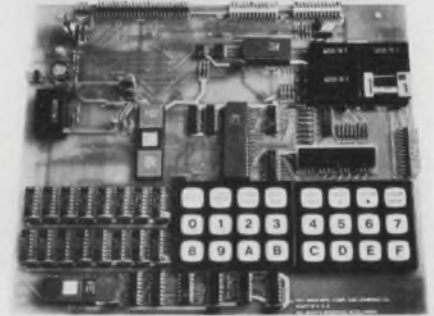

available: One version has the system monitor programmed into the μ P itself, the other version uses a separate 8716 EPROM. The monitor program permits code to be entered into program memory, data to be entered into both internal and external memory, examination of any location, execution of a program, insertion of breakpoints, and store or read from cassette tapes or paper tapes.

CIRCLE NO. 306

Packaged microcomputer based on SBC 80/20

Intel Corp., 3065 Bowers Ave., Santa Clara, CA 95051. Wayne Gartin (408) 246-7501. \$1895; stock.

The System 80/20, a completely packaged microcomputer, is tailored specifically for distributed computing and multiprocessor control. Based on the Intel SBC 80/20 single-board computer, the System 80/20 offers a dual bus architecture with multi-processor bus arbitration logic. Two programmable interval timers, eight levels of priority interrupt and programmable communications interfaces are available. The System 80/20 contains a comprehensive ROM-resident system monitor to aid in loading, executing and debugging programs. Packaged in a 3.5-in. high housing compatible with standard 19-in. RETMA rack mounting, the System 80/20 contains cardcage and backplane assembly for up to three additional boards, and includes a power supply and cooling fans.

CIRCLE NO. 332

Complete μ C system uses 8080-based CPU

Vector Graphic, 717 Lakefield Rd., Suite F, Westlake Village, CA 91361. Carole Ely (805) 497-0733. From \$349 (kit); stock.

Based on the 8080, the Vector 1 computer comes with an 18-slot motherboard with six connectors, and an 8 V at 18 A and ± 16 V at 2 A power supply. Housed in a custom cabinet, the computer has a whisper fan, card supports and guides for six cards and all hardware. The 8080-based CPU board has eight-level vector priority interrupts, current-status register, and a dual-mode, real-time clock. A PROM/RAM board with 1024 bytes of RAM and room for 2048 bytes of 1702A PROM is available. A 512-byte monitor program for use with audio cassettes and Altair, Imsai, or Polymorphic I/O boards is also available. The Vector 1 requires an I/O board and terminal or video display board, keyboard and monitor.

CIRCLE NO. 333

Cassette interface handles three drives

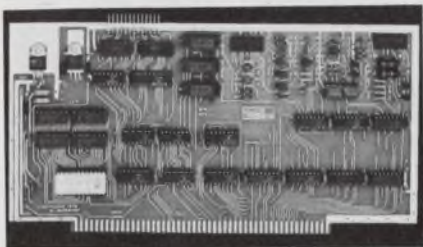

Morrows Micro-Stuff, Box 6194, Albany, CA 94706. (415) 527-7548. \$120 (kit), \$165 (assembled); stock.

Fully compatible with the Altair Microcomputer bus and the "Kansas City" standard cassette data recording format, a serial interface board developed by the company can link a computer to three inexpensive audio cassette machines for mass memory applications. Another serial port allows simultaneous communication with a teletypewriter incorporating reader control, as well as any RS-232 serial device (such as a modem or video terminal). Also on the board is an 8-bit parallel port with handshaking signals. The board has firmware in 500 bytes PROM, which contains all routines needed for cassette interfacing, UART simulation, and data transfer between the microcomputer's memory and the 500 bytes of onboard RAM. Buffers isolate internal data paths from the bus and onboard regulation simplifies power requirements.

CIRCLE NO. 334

Receive-only terminal prints at 30 cps



Texas Instruments, P.O. Box 1444, Houston, TX 77001. D. Fullerton (713) 494-5115. \$1195; 30 days.

A receive-only version of the Silent 700 thermal-printing terminal, the 743, uses a microprocessor-controlled, buffered print mechanism. It prints at 30 char/s and accepts EIA RS-232-C and TTY current loop interfaces. Only two front-panel switches are available: a paper advance switch and a baud-rate switch to change from 110 to 300 baud.

CIRCLE NO. 335

VICTOREEN WRAPS HIGH VOLTAGE PERFORMANCE IN SLIM-MOX PACKAGES.

Victoreen's SLIM-MOX is the small, flat substrate, high voltage resistor that saves you space with no sacrifice in performance.

That's because small size is only one of many SLIM-MOX features.



Designed into your high voltage circuits, SLIM-MOX will deliver better long term stability. You will appreciate its small temperature co-

efficients over a wide temperature range.

Switch to SLIM-MOX, the rugged and highly stable resistor now available in an expanded resistance range — 1 to 5,000 M. Tolerances to 1%.

Standard values are available from stock. And at any value, Victoreen quality is a built-in SLIM-MOX virtue. Find out for yourself by using SLIM-MOX wherever you need to save space in high voltage circuitry. Wherever stability and reliability are key performance characteristics.

**Victoreen Instrument Division,
Sheller-Globe Corporation,**



SHELLER-GLOBE CORPORATION

**10101
Woodland
Avenue,
Cleveland,
Ohio 44104**

RESISTOR SPECIFICATIONS

Model	SLIM-MOX 204	SLIM-MOX 208	SLIM-MOX 308
Resistance Range	1M- 5,000M	2M- 5,000M	5M- 5,000M
Critical Resistance	50M	56.25M	64.8M
Power Rating at 70°C	2W	4W	5W
Maximum Operating Volts	10,000V	15,000V	18,000V
Available Tolerance	1% 5% 15%	1% 5% 15%	1% 5% 15%
Max Surface Temp.	150°C	150°C	150°C

Applicable above critical resistance

MAXIMUM DIMENSIONS (inches)

Model	204	208	308
A	1.08	2.08	2.08
B	.59	.59	.89
C	.145	.145	.145
D	.860	1.885	1.885

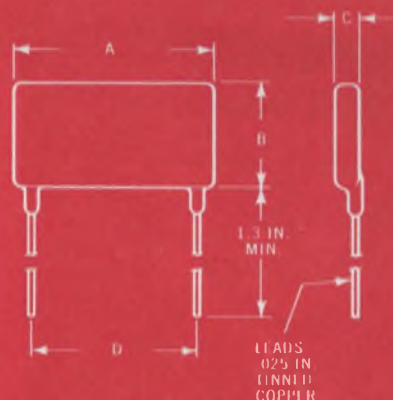

REED RELAYS

We have 5,376 varieties. Our data sheet for the 10 & 15 series lists 28 contact schematics, 6 voltages, mercury wet or dry, magnetic or electromagnetic shielding, 2 grid spaces, 2 pin locations and open frame or epoxy encapsulated.

If one of our 5,376 standard Reed Relays does not meet your requirements, we'll design one that will — or we'll build one to your print. And, this is true whether you are looking for a low-cost relay (from 70¢ in quantity), a commercial relay or a hi-rel relay. Delivery is from stock to 7 weeks.

Send the publication card or write for our 10 & 15 series data sheet.

The way to say Quality Relay. . .BABCOCK.

FREE SAMPLES

**BABCOCK
RELAYS**

Distributed nationally by Hamilton-Avnet.

Military/Aerospace/Commercial



ESTERLINE ELECTRONICS

AN ESTERLINE COMPANY

3501 Harbor Blvd., Costa Mesa, California 92626
(714) 540-1234 TWX 910-595-1517

CIRCLE NUMBER 71



MICRO/MINI COMPUTING

Flexible disc drives go four to a controller

Hewlett-Packard, 1501 Page Mill Rd., Palo Alto, CA 94304. (415) 493-1501. \$4,200 (12732A), \$2600 (12733A); stock.

Two disc drives, the 12732A and 12733A, are compatible with all systems using any of the firm's current real-time executive operating-system software. Both units, the 12732A with controller cards and the 12733A slave, have an average transfer rate of 46,000 bytes/s and an average access time of 267 ms. Recording is double-density with 67 tracks per disc, 30 sectors per track, and 256 bytes per sector. One 12732A drive with controller can handle three additional slave units. A stand-alone self-test is available at the touch of a button; any malfunction is indicated by a red light.

CIRCLE NO. 336

Microcontrollers offer designers third choice

National Semiconductor, 2900 Semiconductor Dr., Santa Clara, CA 95051. Orville Baker (408) 737-5000.

The gap between general-purpose microprocessors and dedicated custom circuits is now filled by the COPS series of four-bit microcomputers. These calculator-oriented processors, the MM5781 and 5782 chip set and the MM5799 or 57140 controllers, contain all that's necessary for most dedicated control applications—and cost under \$10. Each PMOS controller comes with clock generator, CPU, ROM, RAM, parallel inputs and programmable outputs and many different programmable single-bit I/O ports. All three microcontrollers share the same basic architecture. The MM5799 contains 1536 eight-bit instructions in its ROM, holds 96 BCD digits in its RAM, has seven-segment drive capability, and cycles through each instruction in 10 μ s. Both the 5799 and 57140 controllers have fixed-size ROMs and cannot be expanded. However, the 5782 controller uses off-chip ROM and can access 2 k (MM5781), 4 k (MM57129) or up to 16 k instructions. All controllers operate from 7.9-to-9.5-V supplies and come in 24 or 28-pin DIPs. Development time from customer definition to prototype-circuit delivery is estimated to be less than 16 weeks for most applications.

CIRCLE NO. 337

SpaceSaver: New RCA Flameproof Film Resistor Kit



Introducing RCA's convenient, preloaded and pre-labeled Flameproof Resistor Kit containing a wide range of the most-needed, standard value resistors in 1/2, 1 and 2 watt ratings. Two of each rating for a total of 330 resistors; all $\pm 2\%$ tolerance. Packed in a sturdy metal-frame cabinet for easy availability.

Service Technicians prefer RCA Flameproof Film Resistors because of their inherent safety characteristics. Design Engineers prefer them because they won't flame or short even under severe conditions. Look to RCA — your best single source for a complete line of flameproof film resistors.

Contact your authorized RCA Parts Distributor for all the details, or write to RCA Distributor and Special Products Division, 2000 Clements Bridge Road, Deptford, NJ 08096.

RCA
Flameproof
Film Resistors

CIRCLE NUMBER 72

Bipolar μ P handles MIL temps & 3-MHz clocks

Texas Instruments, P.O. Box 5012, Dallas, TX 75222. (214) 238-2011.

Able to operate over the full MIL temperature range, the SBP 9900 16-bit microprocessor developed by Texas Instruments offers all the features of the TMS 9900 and more. The SBP 9900 is an I²L circuit, and even though it requires only a single-phase clock, all operations are fully static. Clock frequencies can range now from dc to 3 MHz, but higher operating speeds should be available soon. What's more, just one dc power supply is necessary to power the TTL-compatible SBP-9900. The speed-versus-power performance is variable and, by limiting the supply current, can be adjusted over several decades. Like the TMS 9900, the SBP 9900 is supplied in a 64-pin ceramic DIP and offers separate 16-bit address and data buses. The microprocessor is also compatible with instructions in the 990 minicomputer series. For the full MIL temp version (-55 to +125 C), the SBP 9900 costs \$386 in 100-unit quantities. Delivery is from stock.

CIRCLE NO. 338

Microprogram controller handles 16 commands

Motorola, P.O. Box 20294, Phoenix, AZ 85036. (602) 244-6900.

By responding to a set of 16 instructions, the MC10801 microprogram controller can efficiently manage the microinstruction memory of 10800-series bit-slice processors. The ECL LSI circuit, a member of Motorola's 10800 MECL processor family, controls the sequence of microprogram instructions with 16 jump and branch commands. On the chip are five 4-bit I/O ports that handle memory-address information. Eight 4-bit master-slave registers in the 10801 hold the current microprogram address cycle as an index counter for repeats, store op codes and flag conditions, and reset sub-routines in a 4 x 4 last-in, first-out stack. A "next address" logic section, when used with the 16 instructions, determines the next memory address. The controller is compatible with all MECL 10,000 components and requires -5.2 and -2-V supplies. Operation is specified from -30 to +85 C. The unit is housed in a 48-pin quad-in-line package. The MC10801 costs \$50 in 100-unit quantities and is available from stock.

CIRCLE NO. 339

Microcomputer card includes its own software

Microcomputer Associates, 2589 Scott Blvd., Santa Clara, CA 95050. Manny Lemas (408) 247-8940. \$575; stock.

A "Super Jolt" microcomputer card that measures only 4.25 x 7 in. contains its own resident assembler and debug programs. The card carries a 6502 8-bit μ P, 1 kbyte of static RAM, 32 bidirectional and programmable I/O

lines, a 1-MHz crystal clock, an interval timer, four interrupts, three serial interfaces (20-mA current loop, RS-232 and TTL) and 5120 bytes of ROM. With the resident single-pass assembler, the Super Jolt can function as a single-card development system, and its programs can be debugged with the Demon debug monitor program. If a higher-level language is required, a subset of Basic, called Tiny Basic, is available on the board.

CIRCLE NO. 340

THAT AIN'T ALL!

You've read about Datanetics revolutionary new Touchboard™, the keyless keyboard with built-in reliability and prices that can't be beat. And you've probably even heard about our Model 70/75, the custom keyboard at off-the-shelf prices. Well we're not satisfied. There's a lot more to the Datanetics story we want you

to hear. So we've put out a new catalog that's yours for the asking. It covers all of our standard keyboards, keyswitches, and the Touchboard. All in one place. With all the specs you'll need to get started on your next project, even if it's custom. Send for it now.

Datanetics

Affordable reliability.

18065 EUCLID ST., FOUNTAIN VALLEY, CA. 92708
(714) 549-1191 TWX: 910-596-1301

ALL YOU NEED TO BUILD A CUSTOM POWER SUPPLY.

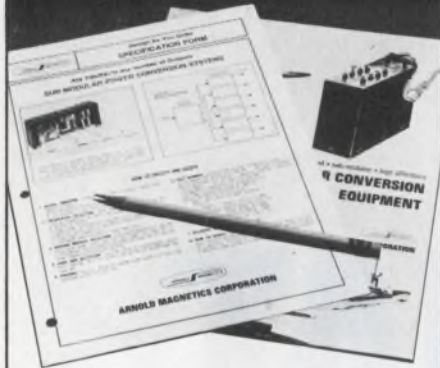

1. Catalog.

You can build your Power Supply with:

- Inputs: Single or dual; 60Hz, 400Hz, 12VDC, 28VDC, 48VDC and 115VDC.
- Regulated outputs: Single or isolated multiple; 5 to 300VDC.
- Line and load regulation to 0.1%.
- Power: 3—160 watts (up to 3.9 watts/in²).

2. Design-As-You-Order-Form.

Step-by-step instructions on how to design a custom power supply from **catalog sub-modules**. It's all there, from a simple block diagram to specs and prices . . . over 1500 possible configurations. And there are no engineering costs or long lead times.

3. A Pencil.

Fill in the "Design-As-You-Order" form—we'll do the rest. Your miniaturized, high efficiency power supply arrives encapsulated and pre-tested.

Write or call today for your
"Custom Power Supply Building Kit".



**ARNOLD MAGNETICS
CORPORATION**

11520 W. Jefferson Blvd.
Culver City, Ca. 90230 • (213) 870-7014

CIRCLE NUMBER 74

MICRO/MINI COMPUTING

Floppy/computer combo has one or two drives



GNAT Computers, 7895 Convoy Ct., Unit G, San Diego, CA 92111. Frank Adams (714) 560-0433. \$2895 (with one drive); 30 days.

Available with either a single or dual minifloppy disc drives, the System 8 microcomputer has the works in a 5.25-in.-high cabinet. Included in the unit is a 1.3- μ s 8080A processor, minifloppy disc drive with controller and interface, 16-k/64-k RAM module with 16-k RAM, serial-parallel I/O, and front panel for control and display. Software included consists of a resident PROM monitor and a complete disc operating system with file management, editor, assembler and dynamic debugger. PLM, Basic, Fortran and other high-level languages are available.

CIRCLE NO. 341

PROM programmer mates to microcomputer

MITS, 2450 Alamo S.E., Albuquerque, NM 87106, (505) 243-7821. \$4.56; stock.

Designed to work with the Altair 8800 microcomputer systems, the 88-PROM Programmer will program standard 1720A (256-byte) erasable PROMs in less than three minutes. The programmer consists of a separate chassis (10.6 \times 4.2 \times 11 in.) with a 24-pin, zero-insertion-force socket. The unit connects with the 8800 through its own interface card, which plugs into the computer bus. To function, the programmer requires an 8800 a or b computer with an 88-PMC (PROM memory card), an SIO or 2SIO serial input/output card and a terminal. The 88-PMC card is necessary because the software driver for the programmer is supplied in PROM form. All the programmer timing is controlled by the 8800 through its software driver. The PROM is programmed with a 256-byte block transfer from the 8800 memory (RAM or PROM) to the programmer.

CIRCLE NO. 342

High-level language speeds programming

RCA, Route 202, Somerville, NJ 08876. (201) 685-6423.

Developed to reduce the time necessary to write programs for the CDP1802 microprocessor, microForth executes 10 to 100 times faster than Basic and other similar microcomputer languages. The high-level language requires only 8 keywords of storage space in a microcomputer system—and that includes a 2-keyword user workspace. Since a large host computer is not needed, program-development costs should be much cheaper, say RCA officials. With microForth, the user can work on a resident or direct basis with the CDP1800 development system. The language's interactive nature is flexible enough to permit, for example, programmer-defined words to represent entire functions. MicroForth programs run on RCA's CDP1800 development system, which is equipped with a floppy-disc option. Support for microForth includes assembler, compiler, cross compiler, and inner and outer interpreter programs. The program costs about \$1000 when purchased in disc form.

CIRCLE NO. 343

RAM board holds 65 k, including refresh

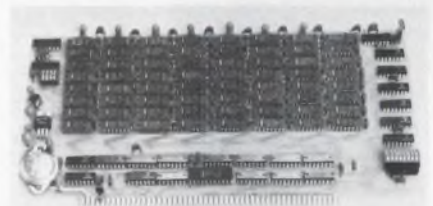

Extensys Corp., 592 Weddell Dr., Sunnyvale, CA 94086. Ed Hartnett (408) 734-1525. \$1495 (65 k), \$895 (32 k); stock.

Holding all the memory a microprocessor can directly address, a 65 kbyte RAM board developed by the company can mate with buses in Altair, Imsai and other bus-compatible microcomputers. Up to 1,048,576 bytes can be used in a bank-switching arrangement. The 5 \times 10-in. board includes the decoding hardware for bank switching and also allows memory addresses to be set in 8-k increments. A hardware write-protect capability in 16-k increments is also available. The board requires +12 V at 300 mA, +5 at 750 mA and -5 V at 1 mA, has a cycle time of 500 ns, and a 400-ns access time.

CIRCLE NO. 344

WE'RE WARNING YOU...™

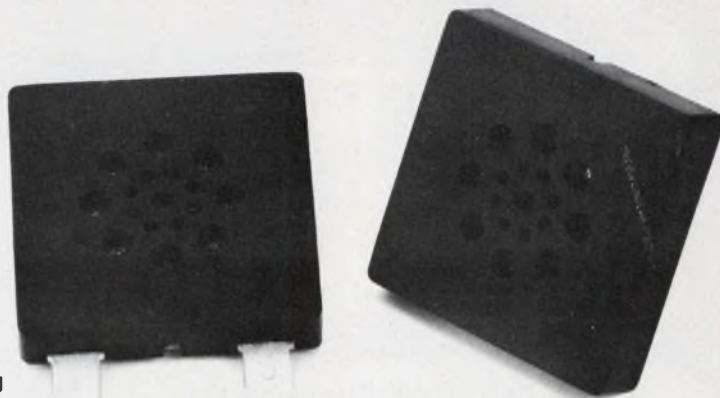

... these new audio indicators are just right for letting you know something's wrong. Ideal for computer terminals, remote control warning, fault detection and alarm devices. Six models ... featuring 35mm diameter piezo crystal ... rated to 85 dbA at 3.3 kHz ... 3 to 16 vdc, drawing just 10 mA maximum current. Supplied with .187 quick disconnect tabs, wires or PC mounting pins. Black ... 40mm square x 10mm high (X-10), or 15mm high (X-11). Life-tested for at least 1000 hours. Ask for free catalog.

Actual Size
Series X-10 Continuous
Series X-11 Pulsing

Where to buy an audio indicator for every need



3680 Wyse Road, Dayton, Ohio 45414
Tel. (513) 890-1918, TWX 810-450-2523

Distributors throughout the world.

CALIFORNIA, COSTA MESA
MarVac Electronics

CALIFORNIA, SUNNYVALE
Pyramid Electronics

COLORADO, DENVER
Waco Electronics Inc.

MASSACHUSETTS, SHARON
Adcour

MICHIGAN, FARMINGTON
CMP Distributor Co.

MISSOURI, ST. LOUIS
Olive Industrial Elec.

NEW JERSEY, WAYNE
Gordon/Horne, Inc.

NEW YORK, ROCHESTER
Ossmann Component Sales

OHIO, CINCINNATI
Hughes Peters Inc.

OHIO, CLEVELAND
CMP Distributor Co.

OHIO, COLUMBUS
Hughes Peters Inc.

OHIO, DAYTON
NASCO

TEXAS, DALLAS
GARLAND

K. A. Electronics

WASHINGTON, SEATTLE
Frank Jackson & Associates

WISCONSIN, MILWAUKEE
Taylor Electric Co.

B. C., VANCOUVER
Deskin Sales Corp.

ONTARIO, TORONTO
Deskin Sales Corp.

ONTARIO, WILLOWDALE
Electro Sonic, Inc.

QUEBEC, MONTREAL
Deskin Sales Corp.

CIRCLE NUMBER 75

NEW LOW PROFILE LSI SOCKETS FROM SMK

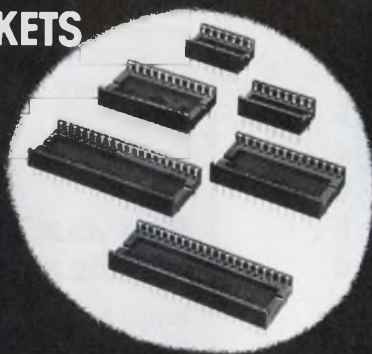

The SI-2440 Series complete line of new LSI Sockets, including 14, 16, 24, 28, 40 and 42 pin versions on 0.1" centers are designed so that they can be flush mounted end-to-end maintaining the 0.1" center-to-center pin spacing. For example, two 24 pin LSI Sockets can be mounted end-to-end to accommodate the latest 48 pin ROM.

The glass-filled Nylon bodies (66% Nylon) are designed to withstand soldering temperatures to +350°C for 3 seconds and are available with either tin plating, selective gold contact plating or gold flash.

Typical 100 piece price for the fourteen pin unit, tinned plated, is \$.311 each.



SMK Electronics Corporation
of America

118 East Savarona Way Carson, California 90746
Tel: (213) 770-8915

CIRCLE NUMBER 76

ELECTRONIC DESIGN 10, May 10, 1977

posistor® circuit protectors

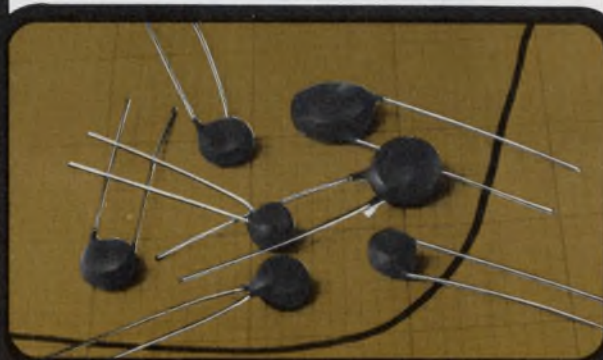

- Economical overcurrent protection • Small size
- 100 to 370 Ma protective threshold
- Self-restoring • 10-20 sec. reaction times
- 0.3 to 1.2A max. current

Designed to provide economical and compact circuit protection for a variety of electrical/electronic devices including power supplies and semiconductor circuits. Write for complete technical data.



First in ceramics

1148 Franklin Road, S.E.
Marietta, Georgia 30067
Tel: 404-422-9777
Telex: 54-2329
TWX: 810-763-4723

CIRCLE NUMBER 78

M-tron Quartz crystals



AT CUT Crystals 800 KHz to 200 MHz

COMMERCIAL

- Nation's largest capacity for commercial use crystals.
- Frequencies available for:
 - CB, Toy and Scanner Radio applications.
 - Color TV, Video Games and Clock applications.
 - Microprocessor and Mini-computer applications.
- Computer-aided Crystal Design Program assures fast delivery.
- 100% Quality Audit of Critical Parameters.

HIGH RELIABILITY

- QPL approvals to MIL-C-3098.
- Advanced hermetically sealed packaging techniques.
- Frequencies available for Avionic and Marine Radio applications.

PHONE 800-843-6842 • TWX: 910-668-3603

M-tron INDUSTRIES, INC., Box 630, Yankton, S.D. 57078
A Div. of Lynch Corp.

CIRCLE NUMBER 79

Buzzzzz.

(Write for new catalog.)

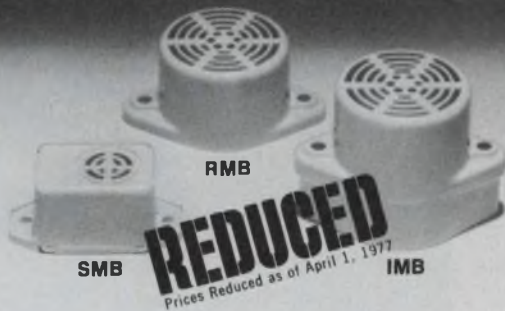

Solid state electronic MICRO-BUZZER from CITIZEN: High reliability, competitively priced with immediate delivery.

A complete range: **SMB** 1.5, 6, 12, 24, VDC
RMB 3, 6, 12, 24, VDC
IMB (Intermittent) 6, 12, VDC

CITIZEN

CITIZEN AMERICA CORPORATION
1710 - 22nd St.
Santa Monica,
CA 90404

Toll Free (800) 421-6516
In Calif. (213) 829-3541
TWX: (910) 343-6450

Name _____
Company _____
Address _____
City _____ State _____
Zip _____ Phone _____

CIRCLE NUMBER 80

MODULES & SUBASSEMBLIES

This d/a converter also multiplies

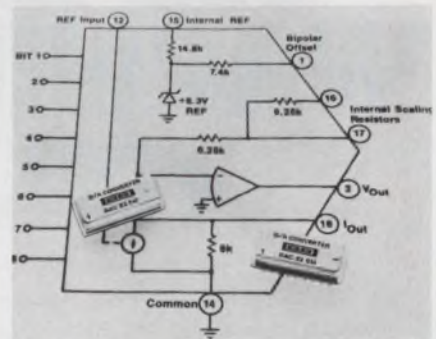

Burr-Brown, International Airport Industrial Park, P.O. Box 11400, Tucson, AZ 85734. J. Santen (602) 294-1431. From \$19.25 (100-249); stock.

DAC 82 is a multiplying d/a converter that provides ± 1 LSB accuracy at 20 C without adjustments, and $\pm 1/2$ LSB linearity over the full temperature range. The 8-bit converter can be used with either its internal reference or with an external reference for multiplying. The reference input works with any positive voltage and an appropriate input resistor. A BM version is specified from -25 to $+85$ C and an SM version covers the -55 to $+125$ C range. Features include: voltage-output settling time ($\pm 0.2\%$ of full scale) of 2 μ s; current-output settling time of 250 ns; selectable voltage-output ranges; and gain drift better than ± 50 ppm/ $^{\circ}$ C. Both versions of the device are hermetically sealed in metal packages.

CIRCLE NO. 345

Plug your Zilog Z80 into the analog world

Signal Laboratories, 202 N. State College Blvd., Orange, CA 92668. D. Flagg (714) 634-1533. From \$495 (1-9); stock.

The MAD card provides the Zilog Z80 microcomputer with analog-I/O capability. The multiplexed converter module features a commutating memory to increase system throughput by over 25%. The unit performs a/d conversion in 20 μ s. In addition to a/d and d/a converters, the system includes a programmable-gain amplifier with gains of 1, 2, 4 and 8; and an on-board Zilog interface chip. Options include 32-channel analog input capability (16 std.); dual d/a output capability; four discrete (one-bit) outputs; 5-V power operation.

CIRCLE NO. 346

12-bit a/d spans full temperature range

Beckman Instruments, 2500 Harbor Blvd., P.O. Box 3100, Fullerton, CA 92634. (714) 871-4848. \$185 (100 qty); stock.

Hermetically sealed in a 24-pin DIP, Series 873-15 offers 12-bit resolution and $\pm 1/2$ -LSB linearity from -55 to $+125$ C. Gain drift is typically less than $+10$ ppm/ $^{\circ}$ C. Gain drift and offset error are externally adjustable to provide accuracy of $\pm 0.012\%$ of full-scale $\pm 1/2$ -LSB quantizing error. Conversion speed is 30μ s. The units operate from 15 and 5-V-dc power. The successive-approximation device accepts inputs of 0 to 10, -10 to $+10$ or -5 to $+5$ V. All models offer complementary straight-binary (CSB) and complementary offset-binary (COB) codes for both parallel and serial data output.

CIRCLE NO. 347

Small fast d/a nails spikes to 2 LSB



Datel Systems, 1020 Turnpike St., Canton, MA 02021. E. Zuch (617) 828-8000. \$249 (1 to 9 qty); 4 wks.

Output glitches of the DAC-DG12B, a 12-bit d/a, are held to ± 2 LSB. Voltage \times time area for spikes in $250 \text{ mV} \times \text{ns}$, at the $4 \times 2 \times 0.4$ in. unit's output. The output can zip through a 10-V change with 1-LSB accuracy in 600 ns and to 1% in 250 ns . Changes of ± 4 LSB take 100 ns (update rate of 10 MHz). Output ranges of 0 to -10 , $+5$ to -5 or $+10$ to -10 V are pin selectable. Output current is $\pm 10 \text{ mA}$ with short-circuit protection. One model accepts complementary-binary and complementary-offset-binary coding while the other accepts complementary two's-complement coding. Gain tempo is $\pm 35 \text{ ppm}/^{\circ}\text{C}$ max from 0 to 70 C. Power requirement is $+15 \text{ V dc}$ at 50 mA , -15 V dc at 35 mA and $+5 \text{ V dc}$ at 230 mA .

CIRCLE NO. 348

Dual characters shine brightly

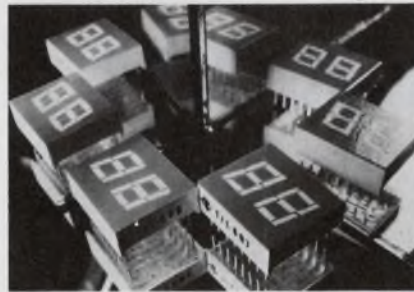

Texas Instruments, P.O. Box 5012, M/S

308, Dallas, TX 75222. B. Alexander (214) 238-3940. \$2.88 (100-999); stock.

Dual, direct-drive, seven-segment displays feature a high brightness of 500 microcandelas per segment at 20 mA . The TIL807 display has a common anode; the TIL808 has a common cathode. The 0.3 in., red, two-digit displays have a lead-frame construction with bottom pins. Pin spacing is 0.08 in., for insertion in mounting hole rows on 0.5 in. centers. The package height and width are 0.6 and 0.7 in.

CIRCLE NO. 349



CTS matches crystal specs to your microprocessor.

And no waiting. CTS Industrial Distributors supply a perfectly matched crystal at the same time you buy the microprocessor, because CTS carefully checks the crystal requirements with each semiconductor manufacturer before writing crystal specs.

CTS now has a full line of standard crystals for microprocessors and clock IC's. CTS Knights crystals feature low start-up resistance, reliable CTS mil-approved manufacturing processes and gold and silver frequency calibration for long term stability. Available in 17 standard frequencies, 1.0 to 22.1184 MHz. Other frequencies available on special order.

CTS Knights crystals are available **off the shelf** at these typical 100-piece prices: from \$5.50 each (1.0 MHz) to \$2.75 each (18.432 MHz).

See your nearest CTS distributor for full information, or write **CTS Knights, Inc.**, 400 Reimann Ave., Sandwich, IL 60548, phone: (815) 786-8411.

CTS Knights.
The frequency specialists.

CTS CORPORATION

Eikhart, Indiana



CIRCLE NUMBER 82

spill-proof power



for every stand-by emergency need



Our batteries are truly Carefree. They won't spill, never require maintenance, built with dual covers and they're completely rechargeable. We've got practically all sizes, but if you need a unique configuration that isn't on our shelf, we can probably build it for you. Call us. We're prompt and we're Carefree.

EAGLE P ICHER
SINCE 1843

EAGLE-PICHER INDUSTRIES, INC.
Commercial Products Department ED
P.O. Box 130, Seneca, Mo. 64865
Telephone (417) 776-2258

CIRCLE NUMBER 83

MODULES & SUBASSEMBLIES

Sampler peak-detects and holds forever

Hybrid Systems, Crosby Dr., Bedford Research Park, Bedford, MA 01730. W. Peacock (617) 275-1570. \$115.50 (1-9 qty); stock to 4 wks.

The SH755 peak detector stores an analog input voltage indefinitely without droop of the stored value, regardless of the duration of the holding period. The unit can be programmed by pin connections for operation as either a peak-detector or a sample-and-hold. The device has a tracking rate of 0.25 V/ μ s as a peak detector, and an acquisition time of 40 μ s, plus a sampling rate of 25 kHz as a sample-and-hold circuit. The module accepts 0 to +10-V signals.

CIRCLE NO. 350

VCO in a double DIP has crystal stability

Greenray Industries, 840 W. Church Rd., Mechanicsburg, PA 17055. (717) 766-0223. \$50 (1000 qty); 8 to 10 wks.

In just a 1.4 × 0.8 × 0.4-in. 24-pin double DIP, the Model ZN-7414, a voltage controlled crystal oscillator, offers up to $\pm 0.05\%$ frequency deviation. The hybrid unit comes with any base frequency from 50 Hz to 20 MHz with a stability of $\pm 0.004\%$ over 0 to 70 C. The base frequency can be modulated up to 15 kHz. The unit operates from +5 V dc $\pm 5\%$ and drives 10 TTL loads.

CIRCLE NO. 351

Digital transducer connects simply to μ P

Siltran Digital, P.O. Box 437, Silverado, CA 92676. M. Hordesi (714) 649-2704. \$225 (1-24 qty); 30 days.

The 8-bit output of series DPT-005 pressure transducers can be connected directly to the 8255 or 6820 interfaces for 8080 or 6800 μ Ps. To mate a μ P with the transducer you instruct the μ P to treat the interface connections as inputs. The transducer outputs are unclocked and available for sampling at any rate defined by main-program control. Power input is +5 V dc or 110 V ac and pressures up to 30,000 lb/in² are available.

CIRCLE NO. 352

Tiny ELF oscillator draws low power



Statek, 512 N. Main St., Orange, CA 92668. (714) 639-7810. \$27 (100 qty); stock.

Generating a standard 1-Hz or non-standard frequencies in the 1-Hz-to-10-kHz range, the TO-5 mounted DQXO-3 boasts 100-ppm precision and consumes only 150 μ A from a 5-V supply. Aging during the first year is 10 ppm at 25 C. The extremely low-frequency oscillators are controlled by the company's unique three-lead crystals. These laser-trimmed crystals have low capacitance, high Q (65,000 typically) and low-power consumption.

CIRCLE NO. 353

Unit converts low currents to frequency

Analog Technology, 3410 E. Foothill Blvd., Pasadena, CA 91107. (213) 449-8440. \$995 to \$1795 singles; stock to 60 days.

The 150 series of current-to-frequency converters accepts bipolar input current 3×10^{-14} to 5×10^{-6} A from low-level current sources and produces a pulse-train output whose frequency is proportional to the input current. The converter operates in three selectable sensitivity ranges, 10^{-14} , 10^{-13} and 10^{-12} AHz, and each range operates linearly in frequency up to 5 MHz. Used as an interface between a current-source device and any standard digital-data-handling equipment, the converter furnishes frequency information that varies linearly over a continuous five-million-to-one dynamic range without range switching. Pulse-position transient response is less than 1 μ s, and the transient time for 100%-frequency settleout is twice the new period. Signal-output formats of pulse train, parallel binary, parallel BCD and range-switched-analog are available.

CIRCLE NO. 354

POWER SUPPLIES



LOW COST • HIGH PERFORMANCE
FAST DELIVERY • 40 HR. BURN-IN
STD. • 1 YR. WARRANTY

AC/DC-Series W • 60 models with single, dual
and triple outputs. DC/DC-Series H • Proportional
HV supplies from 333 to 3000V outputs

Write for complete data and prices.

WALL Industries, Inc.
175 Middlesex Turnpike
Bedford, MA 01730
(617) 275-0708

CIRCLE NUMBER 84

Right on the button!



Janco

PUSH BUTTON ROTARY SWITCHES

Unique by virtue of their simplicity, Janco Push Button Rotary Switches function accurately and quickly in the most adverse environmental conditions and are "right on the button" for high density packaging.

Available in Bi-directional and Uni-directional models in 8, 10, 12 and 16 positions in all standard coded outputs with a wide variety of custom features. Qualified to MIL-S-22710.

Janco... the name for quality... since 1947.

Janco
CORPORATION

3111 WINONA AVE., BURBANK, CALIF. 91504
PHONE 213-845-7473 • TWX 910-498-2701

CIRCLE NUMBER 86

Special Relays — QUICKLY

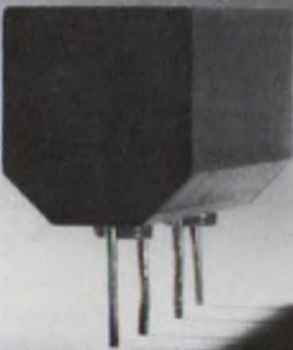

Customer Designs Own Relay

One of our customers needed a relay to switch an Amp at 50 volts, inductive. Together we filled out an EAC application questionnaire. The result? A satisfied customer, and the specs below.

1 Amp switching current, 4 Amp surge current,
5, 6, 12, 24, or 48 volt DC coil voltage
switches inductive loads with little or no arc
suppression to 50 V DC or AC
Size is 0.4 x 0.4 x 1.0 inch.

You can design your relay too — just call, write, or twx us for your copy of the EAC application questionnaire.



EAC Electronic
Applications
Company

4918 Santa Anita Avenue, El Monte, CA 91734
213 / 442-3212 Twx 910 / 587-3351

CIRCLE NUMBER 85

ELECTRONIC DESIGN 10, May 10, 1977

New Heyco[®] Nylon Cable Clamps



New from Heyman Manufacturing—nylon clamps for standard and heavy duty cable applications. Tough, lightweight nylon resists abrasion, aging and most chemicals. And provides excellent insulation. Standard clamps range from 1/8" thru 1/2" in 7 sizes. Heavy duty clamp holds 19 different diameter cables, from 1/8" thru 1 1/2". Both have standard locking holes. Both have full radiused inside edges that won't cut into wire insulation—and are open ended for easy entry. U.L. recognized. **FREE SAMPLES** on request from:

HEYMAN MANUFACTURING COMPANY

KENILWORTH, NEW JERSEY 07033
(201) 245-2345 • TWX: 710-998-5988

WAUKESHA, WISCONSIN 53188
(414) 542-7155 • TWX: 910-265-3688

Call Toll-Free (800) 558-0917 except from Wisconsin.
If calling from Wisconsin use (800) 242-0985



CIRCLE NUMBER 87

121

BUCKEYE
Variety Line

Buckeye's experienced craftsmen, design and manufacture electronic enclosures and accessories at the most economical cost. The solution to your packaging problems is at Buckeye!

Build Your Own Flex-i-pak

Write TODAY for description of each item.
the BUCKEYE stamping co.
555 Marion Rd., Columbus OH 43207 614/445-8433

CIRCLE NUMBER 88

This mark reader scans both sides at once

Chatsworth Data Corp., 20710 Lassen St., Chatsworth, CA 91311. Frank Lefkowitz (213) 341-9200. \$3500.

Model 4800 mark sense card reader, capable of reading both sides simultaneously, optically scans the card, converts the data to ASCII and stores the information in a buffer. Data from the top side are strobed out first over a standard RS232C interface, at five selectable rates from 110 to 2400 baud. Card length can vary from 5-7/8 to 14 in. Options include command-controlled card feed, code converters (EBCDIC and binary card image), and dual output ports.

CIRCLE NO. 355

Precision contact turns plated hole into socket

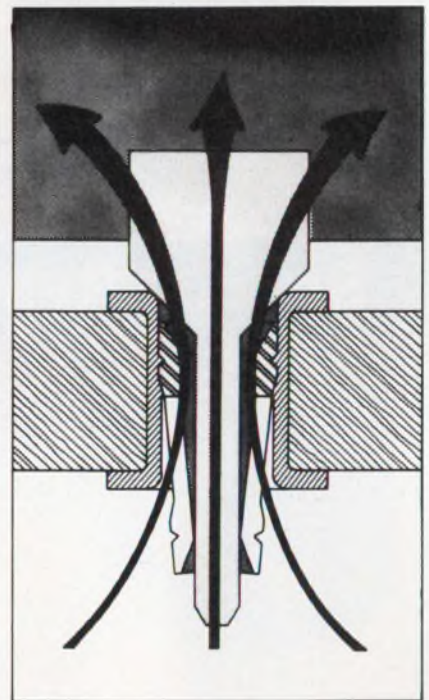

Augat Inc., 23 Perry Ave., P.O. Box 779, Attleboro, MA 02703. (617) 222-2202.

The precision-machined Holtite contact is press-fitted into plated-thru holes. It uses the existing space within the board, allowing the plated-thru hole to become the socket. The outer conical shape of the contact sizes the plated-thru hole when pressed into place, and the geometry of the contact accepts the displaced solder without damaging the hole, or affecting performance. The open contact design permits air flow through the board.

CIRCLE NO. 356

MINIATURE FREQUENCY STANDARD

UNDER \$50 (1000 UNITS)

± 3X10⁻⁷/MONTH (1.2 CUBIC INCHES)
CALL OR WRITE

Greenray Industries, Inc.
840 West Church Rd.
Mechanicsburg, PA 17055
Phone 717-766-0223

CIRCLE NUMBER 89

KEEP

Electronic Design's

GOLD BOOK

HANDY

When You Call

Save time when you contact suppliers. Check their catalog pages first in *Electronic Design's GOLD BOOK*. Maybe the information you need is right at your fingertips.



WHO SAYS ENGINEERS ARE SQUARES?

Here are the comments we received recently from *Electronic Design* reader Gottlieb Dändliker, then a project leader at SODECO-SAIA, SA (public telephone toll systems) Geneva, Switzerland:

"Being the responsible for the design of electronic equipment and the leader of several research projects, I am depending on up-to-date information regarding trends in technology and design.

"Among the multitude of publications, I consider it expedient to concentrate on a few ones, and I have chosen *Electronic Design*.

"I especially appreciate the concise articles taking into account the interest and needs of equipment designers and also the clear manner in which you regularly report on various special fields.

"I always peruse all the advertisements too.

"The photo shows me for once, not working but gliding, my favorite hobby."

TELL YOUR TOP BRASS ABOUT THE POWER OF ELECTRONIC DESIGN

Maybe your advertising and marketing people don't know about *Electronic Design's* readership in Europe. There are vast markets overseas. *Electronic Design* has the greatest coverage among engineers and engineering managers in Europe of any U.S. technical journal!

Electronic Design

BEST READ ELECTRONICS PUBLICATION IN THE WORLD!

Industry Standard A/D and D/A 12-Bit Converters

Now in
Hermetic Packages

The Micro Networks DAC 80 and ADC 80 combine low cost and high performance to make them your best buy for industrial control and instrumentation applications



DAC 80
\$24.50
ADC 80
\$77.50



Micro Networks Corporation
324 Clark Street, Worcester, MA 01606

CIRCLE NUMBER 92

PACKAGING & MATERIALS

Cool it with these stand-up heat sinks

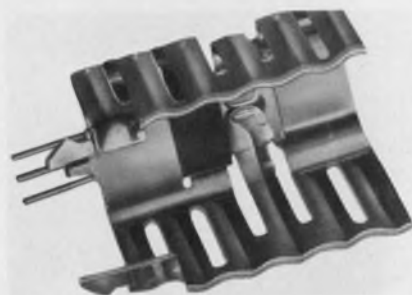

Wakefield Engineering, 77 Audubon Rd., Wakefield, MA 01880. (617) 245-5900. \$0.05 (large qty).

Stand-up heat sinks Model 297-V1-130 for cooling TO-202 and TO-220 devices provide heat transfer capability of 13 C/W. The Series 297 also features an ultrasonic tin-dip process that allows the snap-on coolers to be wave-soldered directly to PC boards. Fin lengths range from 0.8 to 1.3 in., and black, gold or plain finishes are available.

CIRCLE NO. 357

PC board damaged? Replate on the spot



Pace Inc., 9329 Fraser St., Silver Spring, MD 20910. Rhoda Deblinger (301) 587-1696. \$386.

Model PEP-230 bench-top SwaPlating system permits controlled replating of damaged or worn connectors, circuit tracks, contacts, plated-thru holes or other circuit surfaces. The system includes several plating solutions and other required materials. Gold and other noble solutions are optionally available. The power source provides pre-set dc voltages for each plating solution. A smaller system with carrying case (Model PEP-220) is also available (\$371).

CIRCLE NO. 358

Nutty screw spares thin-walled bosses

Central Screw, 999 Touhy, Suite 165, Des Plaines, IL 60018. J. Richert (312) 296-1174.

Plastite is a tri-lobular screw, developed specifically for use in ductile plastics and soft metals such as aluminum and zinc die castings. It requires less driving torque and helps eliminate bursting of thin-walled bosses. Deep-root threads create a greater shear area, increasing resistance to pull-out and vibration.

CIRCLE NO. 359

PC board headers mate boards connectors, cable

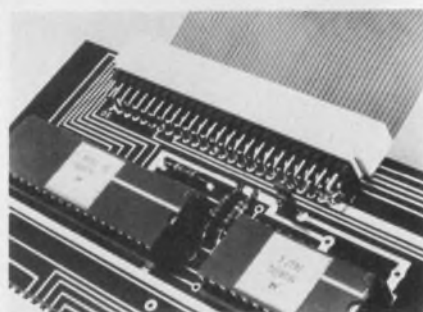

AP Products, Box 110, 72 Corwin Dr., Painesville, OH 44077. (800) 321-9668. Stock.

PC board headers come in both male and female configurations. The male headers are 0.025-in., square contact pins in a black polyester strip, spaced 0.1 in. The female headers have tuning-fork contacts, set in a black glass-filled nylon strip. Standard headers come in three configurations: 0.1 in. single-row, 0.1 x 0.1 and 0.1 x 0.2 in. Each variety comes in rows of 36 contacts, which can easily be cut to length.

CIRCLE NO. 360

Cable-tying tool fits southpaws as well

Thomas & Betts Corp., 36 Butler St., Elizabeth, NJ 07207. (201) 354-4321.

A lightweight, hand operated cable-tying tool (Cat. No. WT-1) for installing ties up to 0.19 in. wide and 0.05 in. thick is made of high impact plastic and steel, and is symmetrical to suit both left and right-handed operators. The shirt-pocket sized tool cinches up the tie when squeezed, and cuts away the excess tail with a 180° twist. A specially designed pawl prevents over-tightening which could damage the cable insulation.

CIRCLE NO. 361

CONNECTOR PROBLEM? TRY ZEBRA[®] INSTEAD!

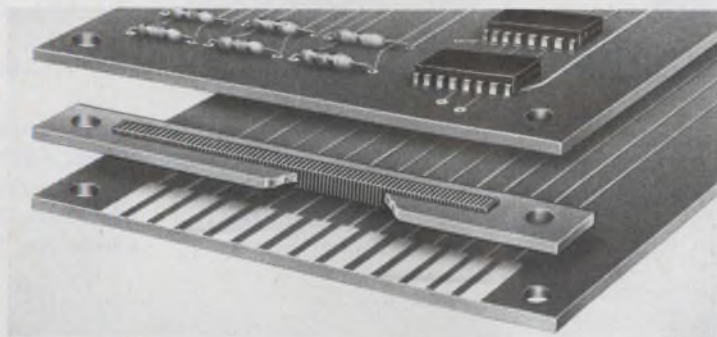

ZEBRA THE INNOVATIVE CONDUCTIVE ELASTOMERIC CONNECTOR WITH OVER 100,000,000 CONNECTIONS NOW FUNCTIONING IN THE FIELD.

LCD, BOARD-TO-BOARD, FLAT CABLE

CONTACT



TECKNIT



SEE US AT THE DESIGN ENGINEERING SHOW BOOTH NO. 1596

SEND FOR OUR NEW CONNECTOR CATALOG

EASTERN DIVISION • 129 DERMODY ST., CRANFORD, NJ 07016 (201) 272-5500

WESTERN DIVISION • 427 OLIVE ST., SANTA BARBARA, CA 93101 (805) 963-1867



SHOCK AND ENVIRONMENTAL PROTECTION



HIGH DENSITY

CIRCLE NUMBER 115

KEYBOARD SWITCHES for INSTRUMENT PANELS

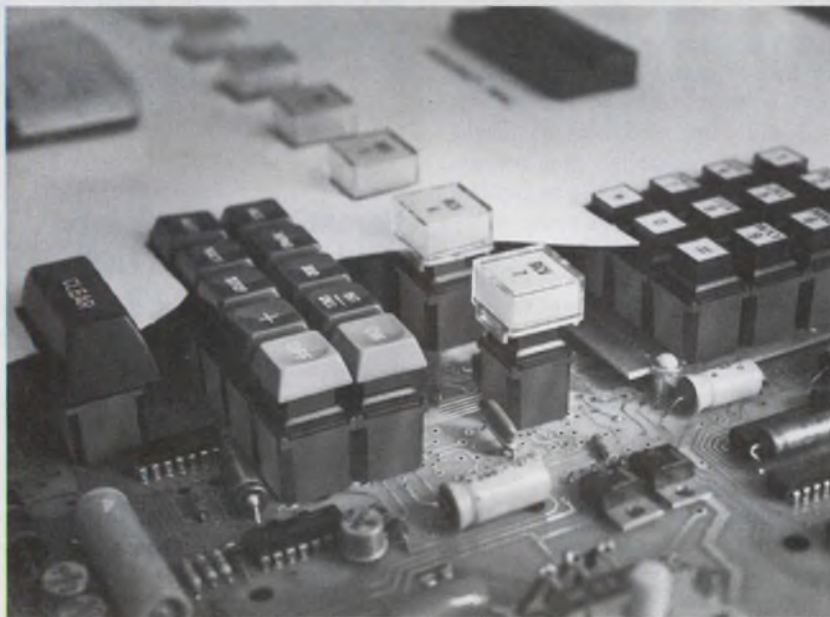

Now is the time to stop hand wiring to *expensive* panel-mounted switches.

Mechanical Enterprises' keyswitches are available at about *half-the-cost*. And, they are *self-supporting* on the PC board without the need for metal sub-plates.

Our switches feature —

- Sealed contacts or inexpensive gold bar mechanical contacts
- 3/4" or 5/8" spacing, or stand-alone
- Selection of legending systems including doubleshot keytops
- Lighted models in three lens styles, all relampable from front
- Single or double pole, NO or NC
- Momentary or alternate action
- Wave solderable
- 20 million cycle life at TTL loads with guaranteed low bounce

Please phone for a free sample with keytop.

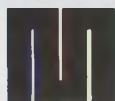

Mechanical Enterprises, Inc.

8000 Forbes Place Springfield, Virginia 22151 (703) 321-8282 TWX 710-832-0942

Germany - NEUMULLER GMBH, MUNICH / U.K. - TEKDATA Ltd., STOKE-ON-TRENT / France - TEKELEC AIRTRONIC, SEVRES / Switzerland - DIMOS, AG ZURICH

CIRCLE NUMBER 116

Fast laser system scribes —also cuts, drills and welds



Prototype of Coherent Radiation's Everlase 150S shows the system elements: Laser (in cabinet, top left) delivers beam through the black tube to the numerically controlled work table. Controller is at right.

Coherent Radiation, 3210 Porter Dr., Palo Alto, CA 94304. Don Bennett (415) 493-2111. \$68,910, plus \$3000 for loading trays; 4 mo.

The Everlase 150S ceramic laser system can scribe four times faster than its own Coherent Radiation predecessor, the 50-W 610S, and approximately twice as fast as its closest competitor, the 100-W Photon Sources 1044. Scribing speed depends on hole depth and, for the 150S, ranges from 1 in./s for 16 mil to 13 in./s for a 10 mil.

The numerically controlled, 150-W Everlase also does things neither of the other models can do—it cuts holes of any desired size, saws and contours at 20 in./min., and even welds dissimilar metals.

Lasers are taking over scribing because conventional diamond tools for working fired ceramics are expensive and slow. Instead, microelectronic circuits can be produced on big substrates—typically 2 × 2 in., scribed (perforated) by laser, then broken apart. Little material is wasted, and sizes are tightly controlled.

Ceramic substrates are used for ICs, thick-film components, hybrid circuits,

rf assemblies, and other microelectronic devices.

The 150S is set up for fast production, with quick-loading trays to handle 16 typical ceramic substrates at a time. A numerically controlled Aero-tech X-Y positioning table permits the work tray to travel 10 in. on each axis at speeds up to 13 in./s. The table is closed-loop controlled with dc torque motors by a controller that accepts either paper tape or PROMs as a source of the numerical-control data.

The laser itself, three-year-old Model 150, is an electronically pulsed CO₂ gas laser that can produce 1000-W peak power. Its fast scribing rate comes from a high ratio of peak to average power (6.6:1), which also eliminates excess melting around vaporized holes. The 610S, with mechanical shutters, has a 3:1 ratio.

In a typical scribing job, a row of holes 3 mil in diameter and 10 mil center-to-center is vaporized in alumina. But many scribing modes are possible, and many materials are absorptive enough at the 150S's 10.6- μ m wavelength to work as well—plastics, rubber, glass, beryllia, sapphire and

barium titanate.

Clean pulse-mode welding of diverse metals is also possible. The 150S can weld thin (5-mil) stainless steel—even bi-metallic strips.

For a workload that doesn't require purchasing a scribing system, CR has a job-shop scribing/machining service. Coherent Radiation **Circle No. 307**
Photon Sources **Circle No. 308**

Tiny coax switch boasts big specs, remote action

RLC Electronics, 83 Radio Circle, Mount Kisco, NY 10549. (914) 241-1334. \$99 (1-9 units).

The Model Sr-2 remote miniature SDT coax switch boasts impressive specs: a dc-to-18-GHz frequency range with 60-dB min isolation, gradually rising to 80 dB at 4 GHz; a VSWR of 1.5 max, improving to 1.2 at 4 GHz; an insertion loss of 0.3 dB max, declining to 0.1 dB at 4 GHz. By using high-density packaging techniques, the over-all volume of the 2-oz package was kept under 0.75 in³. High reliability, long life, and fail-safe operation are standard features. Latching, indicator circuitry, and make-before-break switching under power are optional.

CIRCLE NUMBER 362

Versatile rf transistors are moderately priced

Hewlett-Packard, 1501 Page Mill Rd., Palo Alto, CA 94394. (415) 493-1501. \$18 & \$40 (1-9).

Two general-purpose transistors have been added to HP's line: Model HXTR-2101 provides a tuned gain of 9 dB min at 4 GHz, with a 1-dB power compression of 70 mW. The more expensive HXTR 6105 offers a 4.2-dB max noise figure with an 8-dB min associated gain at 4 GHz (15 dB at 1.5 GHz). Its 1-dB compression power is 25 mW, and the typical noise figure is 2.2 dB.

CIRCLE NUMBER 363

now there is one... in signal processing

IF and Microwave Components From One Source.

At Merrimac we have over 750 standard catalog items from DC to 18GHz with lumped elements, stripline or ferrites. If these standard units don't meet your requirements we pride ourselves in designing and producing custom or special components. . . in fact specials are over 50% of our business.

Additionally, we can design and manufacture Sub-Systems and Integrated Packages of active and passive IF, RF and Microwave components within an IF Processing Chain, Microwave sub-system or the combination of both. NOW THERE IS ONE IN SIGNAL PROCESSING. . . MERRIMAC with over 750 standard units, Custom components and Sub-system capability.

SPORTS ILLUSTRATIONS SUITABLE FOR FRAMING.



Football, Basketball, Soccer and Hockey. Two Color reproductions FREE on request.

Circle the Reader Service Number 171

AUDIO, VHF AND UHF IN-PHASE, REACTIVE LUMPED ELEMENT POWER DIVIDERS/ COMBINERS

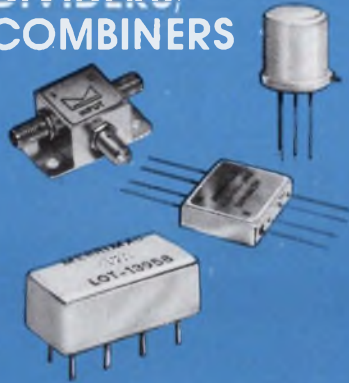

50 kHz to 2 GHz

The winning combination is 83 different standard catalog 2, 3, 4, 6, 8, 12 and 16 way Power Dividers in TO-5, FLAT PACK, RELAY HEADER, LOW PROFILE PC PLUG-IN, SMA, BNC, TNC AND "N" CONNECTOR PACKAGES. Newest models feature ultra-broadband, multi-decade frequency ranges within the range of 50 kHz to over 1 GHz, at low costs.

Following are 4 standard low cost, ultra broadband, 2-way Dividers which demonstrate Merrimac's variety of different packages available off the shelf.

Frequency range (all models) 5 (or 10) to 500 MHz

PACKAGE	MODEL NO.	PRICE	ISOLATION dB	PHASE BALANCE
TO-5 (0.3" high)	P-110	\$12.00	25 TYP. 20 MIN	2°
RELAY HEADER	113-C	\$ 9.00	30TYP. 25 MIN	1° TYP 2° MAX
FLAT PACK	PDF-2A-250	\$17.00	30TYP. 25 MIN	1°
WITH SMA CONNECTORS	PDM-20-250	\$35.00	30 MIN	1°

For complete detailed specifications on the above 4 models as well as our other 79 standard IF power dividers:

**Send for our
NEW '77 CATALOG
OF IF SIGNAL PROCESSING
COMPONENTS.**

Circle the Reader Service Number 172

MICROWAVE IN-PHASE, STRIPLINE BINARY POWER DIVIDERS/ COMBINERS

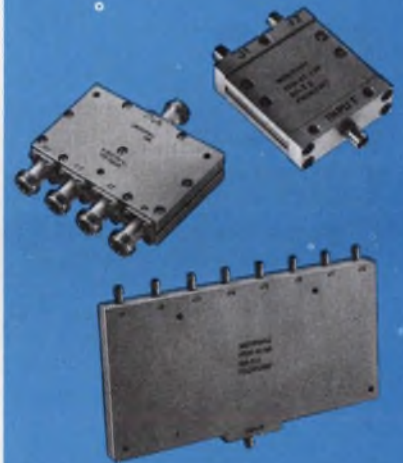

.5 to 18.0 GHz

The winning combination is 58 different standard catalog 2, 4, and 8 way Power Dividers with SMA and TYPE N, in octave, multi-octave and straddle bands from 500 MHz to 18 GHz with in-line and angled output configurations.

Following are 4 standard models which are typical of the other 54 standard items: prices from \$85.00 for 2-ways to \$265.00 for 8-ways.

MODEL No.	POWER DIVISION	FREQUENCY RANGE (GHz)	ISOLATION dB(MIN)	INSERTION LOSS dB(MAX)
PDM-22-75G	2:1	.50-1.0	20	.30
PDM-42-3.95GA	4:1	3.7-4.2	18	.50
PDM-82-6GA	8:1	4.0-8.0	17	1.0
PDM-22-15G	2:1	12.4-18	14	1.0

For complete detailed specifications on the above 4 models as well as our other 54 Standard Microwave Power Dividers:

**Send for our
NEW '77 MICROWAVE
CATALOG**

Circle the Reader Service Number 173

now there is one...in signal processing

Merrimac

INDUSTRIES, INCORPORATED
POST OFFICE BOX 986, 41 FAIRFIELD PL., W. CALDWELL, N. J. 07006
• 201 575-1300 • TWX 710-734-4314

COMPONENTS

Toggle switches lock for safety

Alco Electronic Products Inc., 1551 Osgood St., North Andover, MA 01845. (617) 685-4371. \$1.68 (500 up); stock.

Miniature locking lever switches, the MTL Series, feature a positive pull-to-unlock. The toggle locks in position to safeguard against accidental actua-

tion, especially useful where critical or dangerous switching operations are prevalent. Terminals have a molded-in heat-sink construction that prevents solder flux or other contaminants from entering the switching mechanism. All models mount in a 1/4-in. hole and contacts are solid silver rated 6 A at 125 V ac or 3 A at 250 V ac. A gold-flash finish on the terminals and contacts promotes greater soldering ease, inhibits oxidation and extends shelf life.

CIRCLE NO. 365

SS ac-current relay trips at preset current



Allen-Bradley, 1201 2nd St., Milwaukee, WI 53204. (414) 671-2000.

The Bulletin 809S solid-state relay senses ac current and operates a sealed contact when the monitored current exceeds a preset trip point. The sealed contact is rated at 600 V maximum. Three time-delay modes—start, inhibit and trip—are included in the design. In addition to adjustable trip currents, the relay also incorporates adjustable differential settings with automatic reset. Though available in two continuous current ratings—5 and 12 A—high current applications should use the 5-A relay with a current transformer. LEDs provide visual indications when the supply voltage is applied and when the load current exceeds the trip setting.

CIRCLE NO. 366

Display stick contains 12 seven-segment digits

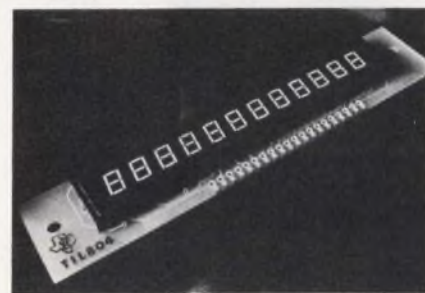

Texas Instruments, P.O. Box 5012, M/S 308, Dallas, TX 75222. B. Alexander (214) 238-3940. \$14.65 (1-99).

Multidigit visual LED display sticks with 12 digits, Model TIL804, have the largest number of digits on a single board, according to TI. Characters are seven-segment red units, 0.27-in. high with a typical brightness of 500 μ cd at 20 mA. Some features of the display stick include right-hand decimals at each digit, uniform brightness of the segments, a wide viewing angle for distances to 15 ft and a common-cathode configuration for ease in multiplex operation.

CIRCLE NO. 367

MCC builds custom ICs using I²L to provide Consumer Product Prices

With I²L designs both linear and digital functions can be combined in a single chip. This means fewer external components, lower costs and improved reliability. Also, they permit interface power output capability not available with CMOS. Micro Components Corporation is ready to discuss your requirements for custom ICs demanding high performance and consumer product pricing.

Call us at: (401) 463-6000

Successfully being used in:

- Peripheral Microprocessor ICs
- Electronics in Cameras
- Electronic Photo-Flash
- Smoke Detectors
- Ground Fault Interrupters
- Motor Speed Control
- Mobile Communications
- Dynamic Microphones
- Toys & Games
- Automotive Systems
- Opto-Electronic Interface
- Dust & Particle Detection
- Security & Intrusion Alarm Systems
- Electromagnetics
- Timers for Appliances

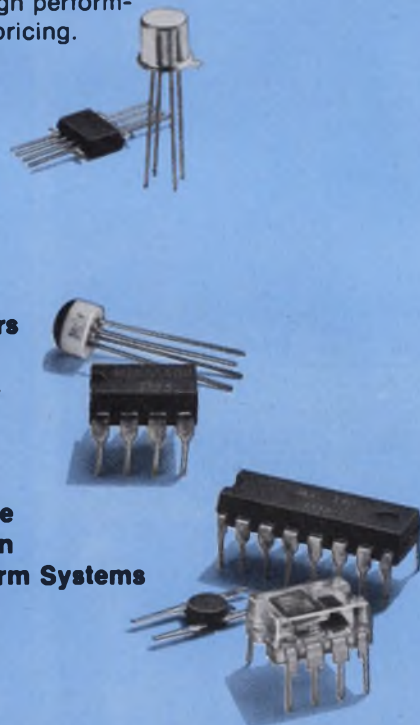

MICRO COMPONENTS CORPORATION

99 Bald Hill Road • Cranston, R.I. 02920

CIRCLE NUMBER 94

Slide-switch assembly aids ribbon-system tests

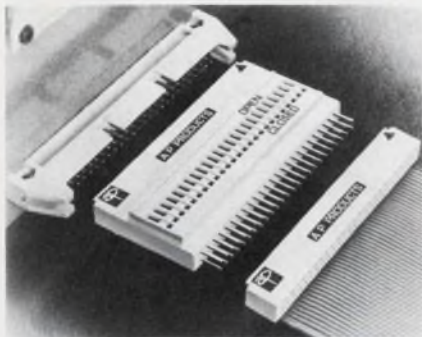

AP Products Inc., Box 110, 72 Corwin Dr., Painesville, OH 44077. (216) 354-2101.

Intra-Switch—up to 50 discrete slide switches—for interfacing between double-row flat-ribbon connectors is a testing aid. In the five widths popularly used in ribbon systems—20, 26, 34, 40 and 50 contacts—the unit has a female connector at one end, a male at the other and line-by-line discrete switching in between. A probe or pen point can set each switch open or closed for diagnostic testing, programming and selective inhibiting.

CIRCLE NO. 368

Panel-mounted breakers handle high currents

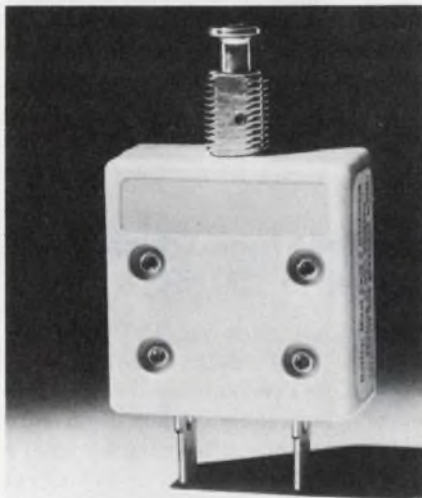

Aiken Industries, Inc., 1824 River St., Jackson, MI 49204. (517) 782-0391.

Small, thermal-trip circuit breakers feature push-pull actuation, "low unit cost" and high interruption capacity (to 5000 A). Dimensioned 1-3/8 x 1-7/16 x 11/16 in. deep, the units are trip-free with single-pole capacity. On-off marking is available on a separate metal plate. The 752 series is rated from 10 to 30 A; the 762 series, from 5 to 20 A.

CIRCLE NO. 369

Rustrak miniature DC & AC recorders

The Widest Selection of Models and Ranges. DC ranges from 10 μ V. AC up to 600V, 1000A. Choose from single, dual channel and time sharing models. In stock at your local authorized Rustrak distributor.

Attention OEM's. Custom mounting arrangements, colors, nameplates, chart paper and scales available.

New 32 Page Catalog. Provides details on DC, AC, Temperature, Servo, Multichannel, Event and a variety of special recorder types.

gulton
Measurement & Control Systems Division
Gulton Industries Inc., East Greenwich, Rhode Island 02818
401 884 6800 • TWX 710-387-1500

CIRCLE NUMBER 95

SPRAGUE GOODMAN TRIMMER CAPACITORS

Our only business!



PISTONCAP® Multi-Turn Tubular

- Low-Loss, Glass or Quartz
- High Stability/High Reliability
- Simple, Long-Life Adjust Mechanism
- Professional / Military Applications, MIL Approved

CERAMIC Single-Turn

- Compact, Conserves Board Space
- Variety of Mounting Configurations
- Low Cost for Commercial/Industrial Applications

FILMTRIM* Single-Turn Film

- PTFE, Polypropylene, Polycarbonate
- Most Stable Trimmer for Size
- Very Wide Capacitance Ranges
- Low Cost for Commercial/Industrial Applications

Tired of broken delivery promises and poor quality? Deal with the trimmer capacitor specialist, for quality products delivered on schedule! Call on us for custom designs too, we deliver!

TRIMMER CAPACITORS — OUR ONLY BUSINESS!

Sprague-Goodman Electronics, Inc.

(An Affiliate of the Sprague Electric Company)

134 FULTON AVE., GARDEN CITY PARK, N.Y. 11040 • 516-746-1385 • TLX: 14-4533

CIRCLE NUMBER 96

Senior Level Mechanical Engineer for Microwave Antenna Structures

The Engineering Division of our Radar Systems Group has an important opening for a Senior Level Mechanical Engineer who has acquired intensive experience in the design of structures for aircraft and space vehicles.

Responsibilities would include stress and vibration analysis for a broad variety of microwave antennas, some thermal analysis, and familiarity with current fabrication methods—including machine shop, metal joining, plastics layout and molding.

The position also involves the participation in many hardware development projects simultaneously, the coordination of mechanical design for a department of approximately forty RF engineers, the participation in reviews of new designs and some technical writing.

Current department projects include development of planar waveguide arrays, dipole arrays, reflectors and feeds and several types of electronically scanned antennas.

Please send resume to: Professional Employment, Hughes Aircraft Company, 11940 W. Jefferson Blvd., Culver City, CA 90230.

HUGHES

HUGHES AIRCRAFT COMPANY
AEROSPACE GROUP

U.S. CITIZENSHIP REQUIRED
EQUAL OPPORTUNITY M/F/H/C EMPLOYER



COMPONENTS

Metric rotary switches mount on PC boards

Oak Industries Inc., Switch Div., Crystal Lake, IL 60014. (815) 459-5000. For the 684: \$1.89 (1000-up); 6 to 8 wks.

Miniature metric rotary switches with 12 and 24 positions are designed for PC-board insertion. The Models 684 and 685, respectively, are each available with a bushing mount to the chassis or tab of the pin mount to the PC board. The switch sections are enclosed to prevent dust contamination. Adjustable stops on the Model 685 switch increase design flexibility. Because of its low profile, the Model 684 switch is particularly applicable where compactness is important. Contact material is phosphor bronze and brass with silver plating.

CIRCLE NO. 370

Contact protector gives EM relay SS advantages

Timeco, Inc., 1035 26th St., Huntington, WV 25705. (304) 523-5149. \$6.85: 10 A at 115 V ac (unit qty).

With the use of Timeco's Model 757 contact protector, the advantages of both solid-state and electromagnetic relay switching are obtained, and the disadvantages of both are eliminated. When the electromagnetic relay coil is switched on, the voltage developed across the relay coil switches on a triac that is connected in parallel with the relay contacts. The triac closes the circuit before the relay contacts; energizes the load through the triac; and eliminates contact bounce and EM interference. Subsequent closure of the relay contacts then carries the load for the duration of the energization, eliminating heating of the triac. When the relay is switched off, the triac is held in the on condition by means of a delay circuit, until after the relay contacts open. Both EM interference and deterioration of the contacts from arcing is eliminated. Power is removed from the load and the triac opens when the ac line voltage goes through zero.

CIRCLE NO. 371

Solenoid delivers short, powerful strokes

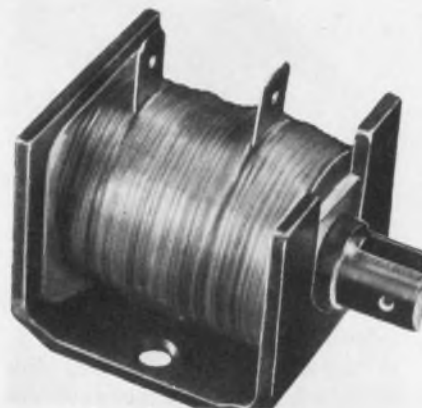

AMP Inc., Potter & Brumfield Div., 200 Richland Creek Dr., Princeton, IN 47671. (812) 386-1000. \$2.23 (1000 up); 6 to 8 wks.

A small, powerful solenoid for linear mechanical actuation, Model S9, delivers a pull-in operate force to 32 oz and holding force to 85 oz in a C-frame style of only 1.4 in³. Maximum stroke is 0.5 in. and standard voltages are 6, 12, and 24 V dc or 24 and 120 V ac, 60 Hz. Other voltages are available to 110 V dc and 240 V ac, 60 Hz. Power consumption at continuous duty is 6 W or 10 VA; and at 25% duty cycle, 10 W or 20 VA. Life expectancy at optimum conditions is over 10-million cycles.

CIRCLE NO. 372

Ceramic tone Xducers deliver to 100 dBa

Gulton Industries Inc., P.O. Box 4300, Fullerton, CA 92634. (714) 871-2150.

The CATT (ceramic audio-tone transducers) is capable of delivering variable sound intensities ranging from a quiet audible signal to over 100 dBa at 10 ft. The units are suited for electronic games, alarm clocks, intrusion alarms, keyboard signalers, industrial controls and smoke detectors. The thin construction, efficiency and rugged design of the CATT also makes it suited for solid-state alarm wristwatches and portable battery-operated equipment. Typically less than 0.03-in. thick, it has no moving coils, paper cones or electromechanical contacts and uses very low current—from 20 mA to as low as 750 μ A.

CIRCLE NO. 373

DIP reed relays handle 0.5 A and 100 V

Electronic Instrument Specialty Corp.,
42 Pleasant St., Stoneham, MA 02180.
(617) 438-5300. \$3.12 (100 up); 2 to 4
wks.

Form 2A DIP reed relays only 0.22 in. high provide a contact rating of 0.5 A and 100 V with a 10-W power limitation. Relays are capable of running directly from TTL and DTL logic. Terminals are designed for automatic insertion and feature specially constructed internal locking to eliminate damage or loosening. They are offered in 5, 6, 12, and 24-V versions, and an optional internal clamping diode is available. Specifications include: operating time, less than 0.35 ms; release time, 0.1 ms; bounce time, 0.15 ms; insulation resistance, 10^{11} Ω min; operating temperature, 0 to 65 C.

CIRCLE NO. 374

LED readouts readable from 40 ft



Dialight, 203 Harrison Pl., Brooklyn, NY 11237. (212) 497-7600. \$2.55: 6001, \$3.10: 6005/6006 (1000 up); stock.

High-brightness Diode-Lite 730 Series LED modules with 0.6-in.-high numerals are readable from 35 to 40 ft and low in cost. Made with GaP, the series includes a module with decimal point (730-6001); a plus/minus module (730-6005); and a polarity/overflow module that incorporates a plus/minus symbol, the numeral one, and a decimal point (730-6006). The series features a typical 10-mA per segment current and common-anode construction, with common-cathode an available option.

CIRCLE NO. 375

Now! Recorder modules with 2 year warranties

For medical and industrial applications . . . DC to 140 Hz . . . meet AHA specs . . . choose from low profile, extended view and wide chart AC or DC operated recorders . . . alphanumeric printing option . . . 1 through 8 channels . . . ceramic stylus with two year guarantee offered . . . custom requirements easily met. Send for new catalog.

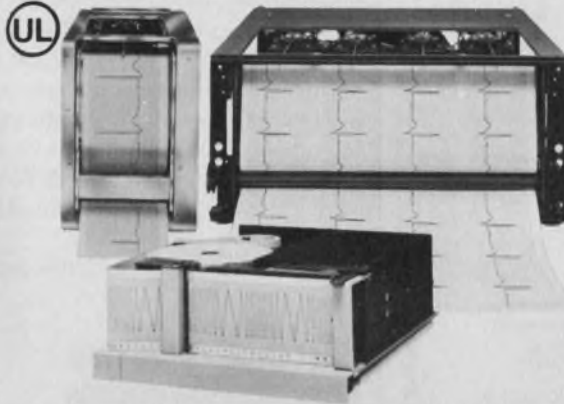

gulton[®]

Measurement & Control Systems Division
Gulton Industries Inc., East Greenwich, Rhode Island 02818
401-884-6800 • TWX 710-387-1500

CIRCLE NUMBER 98

The Complete Computer that does more than teach... only \$495.



This remarkable microcomputer is for anyone who wants to learn more about computers. The UC 1800 is a *complete* training package - - an assembled and tested CMOS computer, users manual, and software.

Everything you'll need to *learn* and *apply* a small S-100 bus expandable computer.

10 DAY TRIAL OFFER

Use UC1800 for 10 days. If it's not everything you expected, return computer and software undamaged, and your full price will be refunded (Prepaid orders, console version only).

YES, PLEASE ENTER MY ORDER:

- UC1800 (console version) at \$495.00 each
 UC1800K (kit* version) at \$389.00 each
 UC1800HK (PC boards and essential parts only) at \$129.95 each.

Add \$5.00 for shipping and handling
Florida residents add 4% sales tax.

Name _____

Address _____

City _____ State _____ Zip _____

Master Charge BankAmericard

Please send information package.

*Assembled & tested modules minus cabinet and power cord.

INFINITE
INCORPORATED

Dept. EDS
1924 Waverly Place
Melbourne, Florida 32901
(305) 724-1588

Celebrating our tenth year.

CIRCLE NUMBER 99

Available Now!



MICROPROCESSOR

BASICS, edited by Michael S. Elphick. Here's the nitty-gritty on design selected from *Electronic Design* for the eight currently popular microprocessors: 8080, 6800, F8, PACE, IMP, 2650, 1802, and 6100. Each chapter discusses one model, detailing its advantages, disadvantages, architecture, capabilities, and includes many illustrations of its applications. #5763-6 paper 224 pp., \$9.95

ORGANIZING AND DOCUMENTING DATA PROCESSING INFORMATION,

by Thomas R. Gildersleeve. Write sharp, precise DP documents that command attention. This book will show you how to... prepare a first draft... shape your sentences for reading ease... organize a document for quick study. Filled with examples of great DP writing and scores of exercises for practice. #5739-3 paper, 160 pp., \$7.95

Please send the book(s) checked on 15-day examination. At the end of that time, I will send payment, plus postage and handling, or return the book(s) and owe nothing. On all prepaid orders, publisher pays postage. Prices are subject to change without notice. Offer good in U.S.A. and Canada only.

NAME _____

COMPANY _____

ADDRESS _____

CITY _____

STATE/ZIP _____

Send to:

Hayden Book Company, Inc.
50 Essex Street, Rochelle Park
New Jersey 07662

*77-62

DATA PROCESSING

Electrostatic printers plot metric conversion

Gould Inc., 3631 Perkins Ave., Cleveland, OH 44114. (216) 361-3315.

Two models of the 5000 Series electrostatic printer-plotters are available with metric print heads. The 5005 M has 40 styli/cm, and the 5200 M 80 styli/cm, with a writing width of 26.4 cm for both models. Respective printing speeds are 8.25 and 4.19 cm/s. Direct memory access for IBM 360/370, PDP-11, Nova, and HP computers is available.

CIRCLE NO. 376

Fast tape drive has easy service access

Wangco Inc., 5404 Jandy Pl., Los Angeles, CA 90066. (213) 390-8081. \$4700 (OEM qty); Fall, 1977.

Model 14 is a 125-in/s tape drive with increased performance and reliability, but 50% reduced power consumption. Extra-length vacuum columns permit the high speed, while maintaining 19-in. rack dimensions. For fast maintenance, all subassemblies are accessible from the front. The Model 14 is format-selectable. It reads and records 1600 char/in. (dual-density PE format) or 800 char/in. (NRZI). Both formats can be implemented in the same unit. Built-in daisy-chain capability accommodates up to four units.

CIRCLE NO. 377

Brainy MUXs enhance distributed processing

Honeywell, 1100 Virginia Dr., Fort Washington, PA 19034. (215) 643-1300.

Honeywell's Total Distributed Control (TDC) family of μ P-based process controllers has new members. The TDC 7100 remote multiplexer units are interconnected by a data "highway," and perform such tasks as limit checking, sequence-of-events timekeeping, and automatic reporting of changes and alarms. The TDC 4500 processor unit is more powerful than previous Series-4000 computers, providing 256-k words of MOS memory and a cycle time of 600 ns. Its Genie I/O bus boasts a transfer rate of 1 million words/s.

CIRCLE NO. 378

Interface helps IBM 360 print bar-code mix

Information Products Systems, Inc., 6565 Rookin, Houston, TX 77074. (713) 776-0071. \$7500; 6 wks.

A hardware/software package allows IBM 360/370 computers to drive low-cost label printers. The printer controller mimics a standard IBM printer MO3/2821. The software package generates a graphics mode by converting the IBM's EBCDIC character records to coded graphics for bar-code printers (UPC, Plessey and Monarch Code-A-Bar). Lease and third-party maintenance are available.

CIRCLE NO. 379

Light pen adjusts to brightness level



HEI, Inc., Jonathan Industrial Center, Chaska, MN 55318. (612) 448-3510. \$98 (1000 up); stock.

The spot-brightness sensitivity of the Model 120-2 light pen is operator-adjustable over a 3 to 1 ratio. Mid-range is set at the factory, per customer specification. HEI offers as options a coiled cord, and a "no-touch" fingertip switch, which allows the user to activate the light pen without touching the CRT faceplate.

CIRCLE NO. 380

A farewell to the keypunch operator?

Hendrix, 645 Harvey Rd., Manchester, NH 03103. Stephen Silver (603) 669-9050. \$14,900 (unit qty).

The Typereader is designed to read data prepared on an ordinary office typewriter and transfer it to a computer. It eliminates the need to retype data for computer input, and the errors that go with it. The new peripheral reads either OCR A (IBM Element 1167170) or OCR B (IBM Element 1167210), with an accuracy of 1 error in 20,000 characters.

CIRCLE NO. 381

Application notes

Flush circuits

Designers interested in incorporating flush-circuit technology into their equipment will find specific hints in a four-page reprint, "Design Considerations for Flush Circuits." The Sibley Co., Haddam, CT

CIRCLE NO. 382

Component testing

The gathering of component test data and its reduction for product analysis by quality-control, incoming-inspection and manufacturing departments are described in an application note. GenRad, Concord, MA

CIRCLE NO. 383

A/d converters

"Using the 4130 ADC Series, 4855 Sample-Hold, and 4550 Multiplexer in High-Speed Data-Acquisition Systems" analyzes possible system configurations, and discusses design consideration. Teledyne Philbrick, Dedham, MA

CIRCLE NO. 384

Ferrite material

A four-page brochure contains equations for calculating ferrite core sizes for the most common type of inverter. Graphs illustrate Ceramag 24B's low core-loss/high-permeability characteristic. Stackpole Carbon, St. Marys, PA

CIRCLE NO. 385

Hot melt adhesives

"How to Use Hot Melts for Efficient Fastening" describes how hot melts work, applications and equipment required for their use. Du Pont, Wilmington, DE

CIRCLE NO. 386

D/a converters

"Differential and Multiplying Digital to Analog Converter Applications" contains a tutorial section on multiplying d/a converter basics. Precision Monolithics, Santa Clara, CA

CIRCLE NO. 387

New Rustrak 4" Servo Recorder



Measure temperature, dc current and dc voltage . . . choose from 47 standard plug-in range cards

If you've been frustrated by the high price of recorders with features you want, or by low priced recorders that don't have the features you need, find out about the Rustrak 500 recorder. This new series of laboratory and OEM recorders provides important features which are not available from any other single manufacturer.

They include: quick plug-in range cards, event pen, high and low solid state alarm contacts, and choice of tear-off, Z-fold, and internal rewind.

These recorders have been designed in the Rustrak tradition of high quality and reliability at a moderate price . . . they're from Rustrak, the recorder people.

New Catalog. Lists specifications of recorders and plug-in range cards.

gulton[®]

Measurement & Control Systems Division
Gulton Industries, Inc. East Greenwich, Rhode Island 02818
401 884 6800 • TWX 710-387-1500

CIRCLE NUMBER 101

Data Display: YOUR Way

Ann Arbor makes over 1000 standard RO and KSR display terminal models. Alphanumerics. Graphics. Or both.

We also thrive on *tough* CRT display applications. Unique character sets. Unusual graphics. Difficult interfacing. Custom keyboards. Special packaging. You name it.

Standard or custom, *every* terminal produced is based on a field-proven Ann Arbor engineering concept. DESIGN III desktop terminals to complement any office decor. Compact, rugged Series 200 modular terminals that defy industrial environments. Or barebones board sets for OEMs who prefer to roll their own.

Many companies sell CRT terminals. But Ann Arbor sells creative solutions to CRT display problems, as well.

Probably at lower cost than anyone else in the business.

Contact us at 6107 Jackson Road, Ann Arbor, MI 48103. Tel: 313-769-0926 or TWX: 810-223-6033. Or see our catalog in EEM, Volume One.

ANN ARBOR
TERMINALS, INC

... creating new ways to communicate

CIRCLE NUMBER 102

Better flux.

Fewer bucks.

Superior No. 30 is a different kind of flux—an organic flux. It strips joints clean of oxides. It washes off easily with water. It's non-hygroscopic, non-conductive, non-corrosive, and free of fumes or disagreeable odors. And it costs you less.

Especially now. Because we'll not only tell you all about the advantages of Superior No. 30 flux, we'll let you try it yourself. Free. Just send the coupon and you'll soon see how our better flux can cost you fewer bucks.

Superior Supersafe No. 30
Non-corrosive soft solder
liquid organic flux.

**Better flux for fewer bucks
since 1932.**



The Superior Flux
and Manufacturing
Company

95 Alpha Park
Cleveland, Ohio 44143

Free Sample!
Just send to:
Superior Flux

95 Alpha Park
Cleveland, Ohio
44143
(216) 461-3315

- Send free sample
and literature
 Send literature only

Name _____

Address _____

Company _____

City _____

State _____

Zip _____

CIRCLE NUMBER 103

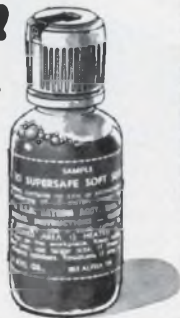

New literature

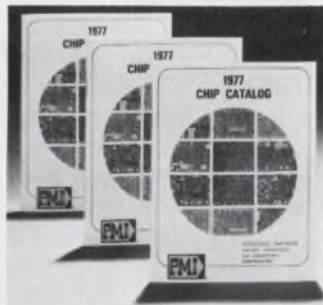

IC chips

The "1977 Chip Catalog" lists complete 25-C specifications—guaranteed min/max wafer-probe limits—for all PMI products in chip form. Precision Monolithics, Santa Clara, CA

CIRCLE NO. 388

Spectrum analyzers

Both the high-resolution 2048-line Model 4513 and the high-speed 512-line Model 4512 FFT spectrum analyzers are detailed in an eight-page catalog. Princeton Applied Research, Princeton, NJ

CIRCLE NO. 389

Limit switches

Six different types of limit switches are described in a 12-page booklet. It lists contact ratings, temperature ratings, types of actuators and enclosure classifications. Allen-Bradley, Milwaukee, WI

CIRCLE NO. 390

TTL data book

Detailed specifications on over 900 TI device types, including standard TTL and high-technology Schottky-clamped TTL are contained in a data book. It has pin-assignment drawings of all TTL types, including bipolar memories and microprocessors. The book sells for \$4.95. Texas Instruments, Inquiry Answering Service, P.O. Box 5012, M/S 84, Dallas, TX 75222.

INQUIRE DIRECT

Packaging hardware

"Electronic Packaging Round-Up," 20 pages, offers an overview of hardware—wrapped-wire boards, cards, files, drawers, frames, panels and large assemblies—as well as optional wiring and documentation services. EECO, Santa Ana, CA

CIRCLE NO. 391

UPS

An uninterruptible power system for protecting computer systems against power fluctuations, brownouts and failures is featured in an updated catalog. General Electric, Stamford, CT

CIRCLE NO. 392

Synchro converters

A 30-page catalog describes synchro converters, displays and encoders. Computer Conversions, East Northport, NY

CIRCLE NO. 393

Linear motion products

A 52-page catalog describes ball bushings, ball-bushing pillow blocks and other components for friction-free linear motion. Thomson Industries, Manhasset, NY

CIRCLE NO. 394

Switches

Engineering drawings, specifications and ordering information on miniature rotary switches are contained in an eight-page catalog. McGraw-Edison, Edison Electronics Div., Manchester, NH

CIRCLE NO. 395

Active-filter modules

A new series of active-filter modules for low-speed modem applications is featured in an eight-page bulletin. Sprague Electric, North Adams, MA

CIRCLE NO. 396

SCR dc power supplies

Specifications, features and applications of high-power SCR dc power supplies are provided in a four-page bulletin. Electronic Measurements, Neptune, NJ

CIRCLE NO. 397

Rf signal processing

A 232-page catalog features specifications and performance data on the company's rf signal processing components. An extensive applications section is included. Watkins-Johnson, Palo Alto, CA

CIRCLE NO. 398

Semiconductors

"Semiconductor Circuit Elements" is a compact survey of these devices and contains a simple classification into groups. For more information circle the reader service number. Hayden Book, Rochelle Park, NJ

CIRCLE NO. 399

Precision components

A 208-page catalog describes metric-system standardized precision-mechanical components and assemblies. Also included are working prints, technical reference-data tables, gear data, metric terms and formulas. PIC Design Div., Benrus Corp., Ridgefield, CT

CIRCLE NO. 400

A/d converters

Construction, performance, operation, PC-board layout, power-supply bypassing and external offset and gain adjustments of Series 873-78 and 873-88 a/d converters are detailed in two 6-page bulletins. Tables and diagrams provide helpful information. Beckman Instruments, Helipot Div., Fullerton, CA

CIRCLE NO. 401

Vacuum equipment

A 200-page vacuum-equipment catalog features up-to-date prices, applications data, dimensional drawings and performance specifications. Perkin-Elmer Ultek, Palo Alto, CA

CIRCLE NO. 402

RTV sealers

Properties, uses, and recommended application techniques for General Electric's 11 grades of RTV sealers have been assembled in one comprehensive data package. Commercial Plastics & Supply, Cornwells Heights, PA

CIRCLE NO. 403

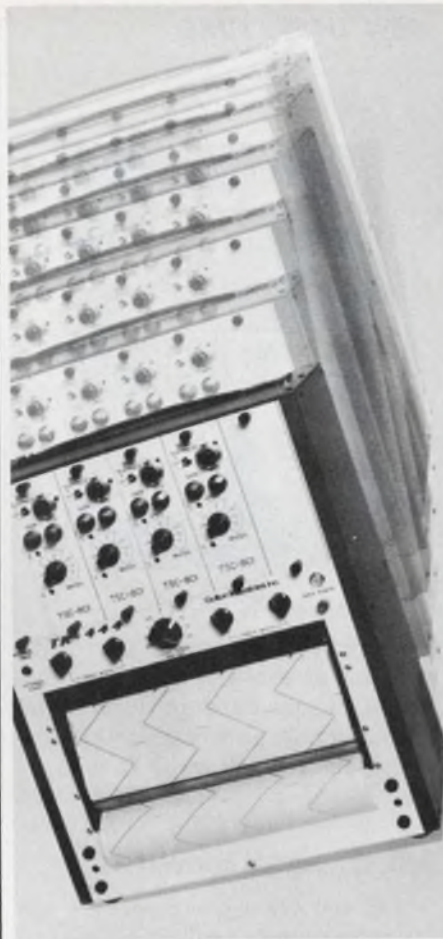

GULTON'S "unshockable" portable recorders

Rugged enough to withstand 15g for 11 msec. And without damage to stylus, electronics or performance. These rugged portable recorders give equally great results whether under grueling field conditions, or in exacting laboratory use.

They provide dependable, clear writing in any orientation. A wide selection of plug-in signal conditioners permits recording of volts, amps, pressure, temperature, strain, ac to dc, log to dc, EKG and more.

Models are available with 2, 4, 6 or 8 channels. Write or call for 12 page portables catalog.

gulton

Measurement & Control Systems Division
Gulton Industries Inc. East Greenwich Rhode Island 02818
401-884-6800 • TWX 710-387-1500

CIRCLE NUMBER 104

BYTE

The Small Systems Journal

Isn't it time you had your own personal computer?

Read BYTE, the leading consumer publication covering the fantastic new field of personal computer applications. Today, large scale integration has made it possible for the individual to enjoy the unique benefits of a general purpose computing system. Now, an entire micro industry markets microcomputer related items, products that range from computer system kits to peripherals, software and literature on the subject. But where should you go for all the details about your personal involvement in computer technology?

Read BYTE, the Small Systems Journal devoted exclusively to microcomputer systems. Every issue a monthly compendium of lively articles by professionals, computer scientists, and serious amateurs.

Fill in subscription coupon today, or phone your request directly — call 617/646-4329 and ask for your subscription. Read your first copy of BYTE, if it's everything you expected, honor our invoice. If it isn't, write 'CANCEL' across invoice and mail it back. You won't be billed and the first issue is yours.

Allow 6 to 8 weeks for processing.

BYTE BYTE Subscriptions Dept. 09E
P.O. Box 361
Arlington, Mass 02174 *Please enter my subscription to BYTE...*

\$12 One Year \$22 Two Years \$30 Three Years
 Bill me Check Enclosed
 Bill BankAmericard Bill Master Charge

Credit Card Number

Credit Card Expiration Date

Name (Please Print)

Address

City State Zip

CIRCLE NUMBER 105

POT LUCK!



What luck! You might even call it Pot Luck! Now, Bowmar can supply more different kinds of pots than ever. Precision pots with synchros, servo motors, magnetic clutches, spring return devices, commutator switches and a zillion taps ALL IN ONE PACKAGE! We've been quietly doing so for over 20 years. They're part of our extensive Vari(f)unction line and you can have just about anything and any combination you like, because Bowmar custom tailors these highly reliable packages to your specs.

MORE POT LUCK!

Besides our Vari(f)unction line our big 48 page catalog describes our whole Precision custom potentiometer line. In it you'll find:



- Precision Conductive Plastic Pots
- Precision Wirewound Pots
- Miniature Servo Pots
- Rotary Trimmer Pots
- Single and Multi-Turn Pots
- Panel Control Pots
- Unitized Mag Clutch Modules
- Commutator Switches
- Spring Return Modules

Call or write today or circle the number at the bottom of the ad for the whole story.

Bowmar

BOWMAR/TIC, INC.

850 Lawrence Drive
Newbury Park, California 91320
(805) 498-2161 · TWX 910-336-1265

CIRCLE NUMBER 106

NEW LITERATURE



Wire-wrapping tools

Many new additions to the company's line of wire-wrapping tools, machines and associated products are included in a 58-page catalog. O.K. Machine and Tool, Bronx, NY

CIRCLE NO. 404

A/d, d/a signal converters

A/d and d/a signal converters and instrumentation amplifiers are featured in a four-page catalog. CPS, Converter Products, Sunnyvale, CA

CIRCLE NO. 405

Thin-film resistors

Performance and environmental specifications, stock resistance values, and prices for thin-film resistors are tabulated in a bulletin. Included are interior wiring and power-dissipation rating diagrams plus a package outline drawing. Beckman Instruments, Helipot Div., Fullerton, CA

CIRCLE NO. 406

Linear quad/dual ICs

Detailed specifications and application information on all Raytheon Semiconductor quad and dual op amps and quad comparators are given in a 42-page guide. Distronic Ltd., Harlow, Essex, England

CIRCLE NO. 407

Thermocouples

The 1977 Omega Temperature Measurement Handbook, over 176 pages, contains thermocouple, thermistor and RTD data. Omega Engineering, Stamford, CT

CIRCLE NO. 408

Bulletin board

Signetics is second-sourcing Motorola's MC1399 color processing IC and Motorola is second-sourcing the Signetics TCA440 five-stage AM radio IC.

CIRCLE NO. 409

Intersil has reduced prices up to 65% on its on its 12-bit CMOS μ P.

CIRCLE NO. 410

Raytheon has introduced its first programmable ROMs: the industry standard 256×4 (1-k) and the 256×8 (2-k). Both bipolar products are designed with nichrome fuses and come in either open-collector or three-state versions.

CIRCLE NO. 411

Synertek has introduced a $1\text{-k} \times 4$ static RAM, the SY2114. It is a pin-compatible replacement for the Intel device of the same number. The SY2114 comes in ceramic packages and is priced at \$20 (100s).

CIRCLE NO. 412

Advanced Micro Devices' series of three high-speed, monolithic d/a converters—DAC-08, Am1508 and SSS1508A—are designed as plug-in replacements for like-numbered devices from other manufacturers. AMD's first linear-circuit entries into the data-acquisition and telecommunications markets offer nonlinearity specs to 0.1%.

CIRCLE NO. 413

Precision Monolithics' MAT-01 ultra-matched npn transistor pair second-sources National's LM114, 114A, 115, 115A; Analog Devices' AD810, 811, 812, 813 and 818, and at least 17 standard 2N numbers.

CIRCLE NO. 414

Intersil is second-sourcing National Semiconductor's LM148 quad 741 op-amp family.

CIRCLE NO. 415

Accu-Pulse ^{NEW} Low Pass Filters

D.C. to 100 Mhz Cut-off Frequency



OPT Accu-Pulse Series Constant Time Delay Low Pass Filters are a new family of filter networks that provide constant time delay through the pass band and partially into the stop band while, at the same time, providing excellent steep frequency discrimination characteristics.

The concept synthesized in this new Accu-Pulse Filter Family has resulted in a superior low pass filter for critical digital high frequency data applications.

FEATURES

- constant time delay through-out pass band, into stop band
- flat group delay
- pass band amplitude response approximates Gaussian response with steep stop band roll-off
- excellent step frequency discrimination characteristics
- superior monotonic amplitude response
- precisely balanced pass band pole frequency location and zeros of transmission

300 Red School Lane
Phillipsburg
New Jersey 08865
201/454-2600

opt
INDUSTRIES INC.
Phillipsburg, N.J. 08851

CIRCLE NUMBER 107

NOW—A FAIL-SAFE SOLID-STATE RELAY

A unique combination of dv/dt snubber, fusible-link protection in the trigger circuit, plus an oversized triac—all combine to protect against catastrophic system failure should the triac fail to turn on.

Either zero-voltage or non-zero-voltage switching, both types rated for maximum ac load currents of 5A or 10A. Any control voltage from 3 to 32V dc; all models compatible with TTL, DTL, CMOS logic. Solder-pin, quick-on, or screw terminals.

Call (609-882-4800) or write for further information. Heinemann Electric Company, Brunswick Pike, Trenton, NJ 08602.

HEINEMANN

We keep you out of trouble.

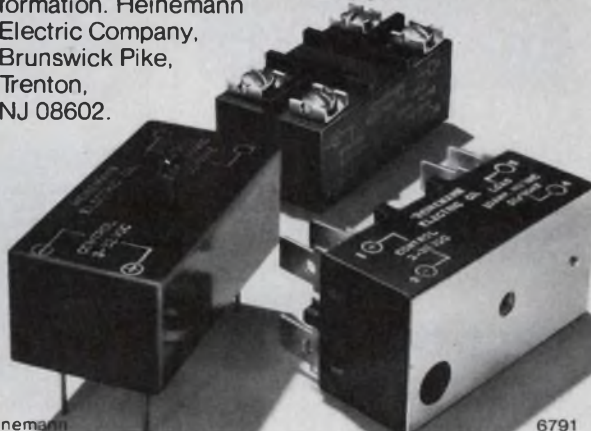

Heinemann

6791

CIRCLE NUMBER 108

COOL
COMPUTERS

ELECTRONICS

MACHINE
TOOLS

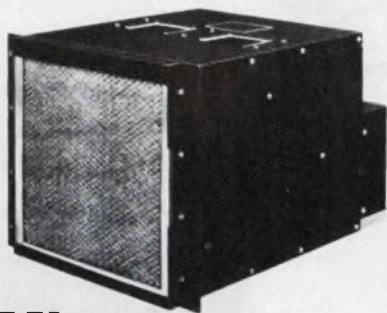

McLEAN 6000 BTU AIR CONDITIONER

This compact 19" rack-mounted "LOBOY" provides longer life, more reliability and better performance for electronic equipment. Easy to install. Operates on 115 volts, 60 Hz, draws 12 amps max., weighs only 135 lbs. Centrifugal blowers circulate cool air over entire coil/fin surface for uniform airflow. Constant clean air in contact with electronics. 20,000 hours continuous duty assured in ambients to 125°F.

SEND FOR CATALOG

McLEAN McLEAN

ENGINEERING LABORATORIES

ENGINEERING MIDWEST

Princeton Junction, NJ 08550
609-799-0100 • Telex 84-3422

9560 Eighty-Fifth Ave. N.
Maple Grove, MN 55369 • 612-425-4747

CIRCLE NUMBER 109

ELECTRONIC DESIGN 10, May 10, 1977

*Bodine has doubled
its AC horsepower*



AVAILABLE FROM STOCK

And our new 48-frame TEFC parallel shaft and right angle gearmotor designs are shorter, too. Proven gearheads with ratios from 5:1 through 60:1. Speeds from 340 through 28 Rpm. And torques through 330 Lb-in. Available in all popular AC windings and voltages. In a wide range of mounting configurations. You can get continuous duty ratings through 1/3 Hp—with gearhead or without. But get all the facts. Write for Catalog S.

ADE (After Delivery Economies)
make Bodine a better fhp buy

**BODINE
ELECTRIC
COMPANY**

Bodine Electric Company, 2500 W. Bradley Place, Chicago, IL 60618.

CIRCLE NUMBER 110

137

SERIAL/PARALLEL DATA AND TIMING GENERATORS

... Excitation sources for testing digital IC's, circuitry and memory systems

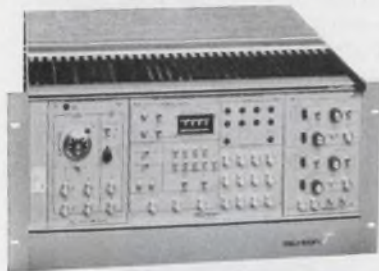

Model MG-3

User features of this line include parallel words at 100 MHz; serial data at 500 MHz. Output signal shaping; manual or computer controlled.

tau-tron INC

11 Esquire Road, North Billerica, Mass. 01862
Tel: (617) 667-3874

CIRCLE NUMBER 117

from **ovenaire**



Crystal Controlled DIP Oscillators designed especially for digital clock applications

Low-cost Models DT1-121 & DT1-221 feature...

Frequency Range: 20KHz to 25 MHz

Overall Stability: $\pm 0.010\%$ - Model DT1-121
 $\pm 0.005\%$ - Model DT1-221

Temperature Range: 0°C to $+70^{\circ}\text{C}$

Output Waveform: Squarewave 50/50 $\pm 20\%$ to drive 10TTL loads 0.4V max "0" and 2.4V min "1" level

Input Power: Voltage $+5\text{V} \pm 5\%$, Current 30 to 120MA depending on frequency

Package: 14 pin DIP, glass-filled nylon. Fits into standard 14 pin socket

Size: (WxH) Approx. $0.50" \times 0.80" \times 0.37"$

Other Ovenaire Highlights...

State of the Art High Stability Crystal Oscillators
Ovenized Crystal Oscillators • TCXO • VCXO
Crystal and Component Ovens • Thick Film Hybrid
Circuit Custom Services

for additional information contact...

ovenaire

Division of Walter Kilde & Company, Inc.
706 Forrest St. - P.O. Box 1528, Charlottesville,
Virginia 22902 • 804-977-8050 - TWX 510-587-5461

CIRCLE NUMBER 118

Electronic Design

ELECTRONIC DESIGN's function is:

- To aid progress in the electronics manufacturing industry by promoting good design.
- To give the electronic design engineer concepts and ideas that make his job easier and more productive.
- To provide a central source of timely electronics information.
- To promote communication among members of the electronics engineering community.

Want a subscription? ELECTRONIC DESIGN is sent free to qualified engineers and engineering managers doing design work, supervising design or setting standards in the United States and Western Europe. For a free subscription, use the application form bound in the magazine. If none is included, write to us direct for an application form.

If you do not qualify, paid subscription rates are as follows: \$30.00 per year (26 issues) U.S., \$40.00 per year (26 issues) all other countries. Single copies are \$2.00 U.S., \$3.00 all other countries. The Gold Book (27th issue) may be purchased for \$30.00 U.S. and \$40.00 all other countries.

If you change your address, send us an old mailing label and your new address; there is generally a postcard for this bound in the magazine. You will have to requalify to continue receiving ELECTRONIC DESIGN free.

The accuracy policy of ELECTRONIC DESIGN is:

- To make diligent efforts to ensure the accuracy of editorial matter.
- To publish prompt corrections whenever inaccuracies are brought to our attention. Corrections appear in "Across the Desk."
- To encourage our readers as responsible members of our business community to report to us misleading or fraudulent advertising.
- To refuse any advertisement deemed to be misleading or fraudulent.

Microfilm copies are available of complete volumes of ELECTRONIC DESIGN at \$19 per volume, beginning with Volume 1, 1952 through Volume 20. Reprints of individual articles may be obtained for \$3.00 each, prepaid (\$5.00 for each additional copy of the same article) no matter how long the article. For further details and to place orders, contact the Customer Services Department, University Microfilms, 300 North Zeeb Road, Ann Arbor, Michigan 48106 telephone (313) 761-4700.

Want to contact us? If you have any comments or wish to submit a manuscript or article outline, address your correspondence to:

Editor
ELECTRONIC DESIGN
50 Essex Street
Rochelle Park, N.J. 07662

AUTHOR'S GUIDE

writing
for
Electronic Design

An
Author's
Guide

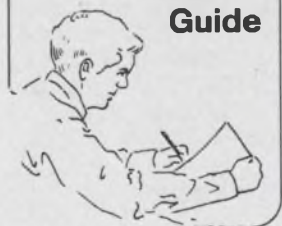

If you've solved a tricky design problem, if you have developed special expertise in a specific area, if you have information that will aid the design process... share it with your fellow engineers-readers of *Electronic Design*.

Articles you have authored not only raise your own professional status, but help build your company image as well. The readers benefit, your company benefits.

To help you prepare material that meets *Electronic Design's* high editorial standards, our editors have prepared a special author's guide entitled "Writing for *Electronic Design*." It covers criteria for acceptability, form, length, writing tips, illustrations, and payment for articles published. It's available without cost.

It's easy to write for *Electronic Design*, but it's often hard to get started. Send for your copy of our Author's Guide today.

Circle No.
250

GOOD BOOKS ARE HARD TO FIND.



WHY HIDE YOURS?

We are always looking for well-written manuscripts, or book proposals, for works on topics of interest to professional engineers that will advance their understanding of the state of their art.

What have you been working on?

What can we do for each other?

Let me know.

S. WILLIAM COOK
EDITORIAL DIRECTOR



Hayden Book Co., Inc.
50 ESSEX STREET
ROCHELLE PARK, N.J. 07662

Electronic Design

Advertising Sales Staff

Tom W. Carr, Sales Director
Jean Bunfield, Sales Coordinator

Rochelle Park, NJ 07662

Robert W. Gascoigne
Daniel J. Rowland
Thomas P. Barth
50 Essex St.
(201) 843-0550
TWX: 710-990-5071

Philadelphia

Thomas P. Barth
(201) 843-0550

Boston 02178

Gene Pritchard
P.O. Box 379
Belmont, MA 02178
(617) 489-2340

Chicago 60611

Thomas P. Kavooras
Berry Conner, Jr.
200 East Ontario
(312) 337-0588

Cleveland

Thomas P. Kavooras
(312) 337-0588

Los Angeles 90045

Stanley I. Ehrenclou
Burt Underwood
Neil Canavin
8939 Sepulveda Blvd.
(213) 641-6544

Texas

Burt Underwood
(213) 641-6544

San Francisco

Robert A. Lukas
3579 Cambridge Lane
Mountain View, CA 94040
(415) 965-2636

England

Constance McKinley
50 Essex St.
Rochelle Park, N.J. 07662
Phone: (201) 843-0550

Europe

Sanders, W. J. M.
Raadhuisstraat 24
Graft-De Ryp, Holland
Phone: 02997-1303
Telegrams: Euradteam-Amsterdam
Telex: 13039-SIPAS

G. Nebut

Promotion Presse Internationale
7 ter Cour des Petites Ecuries
75010 Paris, France
Telephone: 5231917, 1918, 1919

Dieter Wollenberg

Erikastrasse 8
D-8011 Baldham/Muenchen
Germany
Telephone: 0 8106/4541
Telex: 5215532 auri d

Tokyo

Haruki Hirayama
Electronic Media Service
5th Floor, Lila Bldg.,
4-9-8 Roppongi
Minato-ku, Tokyo, Japan
Phone: 402-4556
Cable: Electronicmedia, Tokyo



Cost Effective Data Scanning

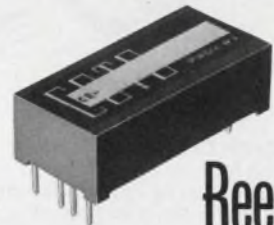

Reed Relays

**NEW GENERATION
LOW-COST, ULTRA
LOW-THERMAL EMF**

- New simpler design reduces cost, maintains performance and reliability
- Switches signals to 1 μ V resolution
- Low, stable contact resistance
- High control/signal circuit isolation
- Graded and priced to the thermal offset you need . . . pay no more.

Write or Call for Bulletin 10.4



**COTO-COIL
COMPANY, INC.**
59 Pavillon Ave.
Providence, R. I. 02905
Tel: (401) 467-4777

CIRCLE NUMBER 119

GANG INSERT 500-1200 TERMINALS PER HOUR

Easy, low cost method:

After placing pin tails in holes, press down to press in assembled pins. Ideal for wrap-posts, socket pins and solder clips.

BONUS — Press plus P-187 fixture also installs most I.D.C. plugs to flex cable.

P-186-1 Press

\$59.50

P-187 Fixture

\$29.50

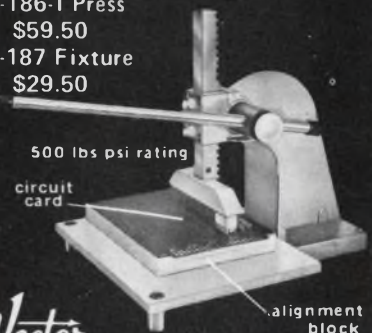

500 lbs psi rating

circuit card

alignment block

Vector

ELECTRONIC COMPANY, Inc.
12460 Gladstone Av., Sylmar, CA 91342
320177A

CIRCLE NUMBER 120

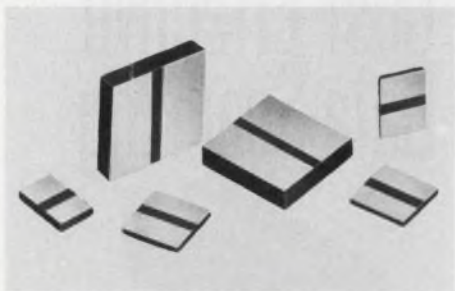

CERAMIC CHIP CAPACITORS. SPLIT-CHIP, is a new concept in ceramic chip capacitor technology. These new units have two broad electrodes on one face and eliminate conventional wrap-around end terminations. This new concept provides lower cost and easier assembly. SPLIT-CHIPS are available in five standard sizes from .040" x .030" to .130" x .090" and .015" thick and in all popular dielectrics and capacitance ranges. JOHANSON DIELECTRICS, INC., Box 6456, Burbank, Ca. 91510 213-848-4465

CERAMIC CHIP CAPACITORS 181

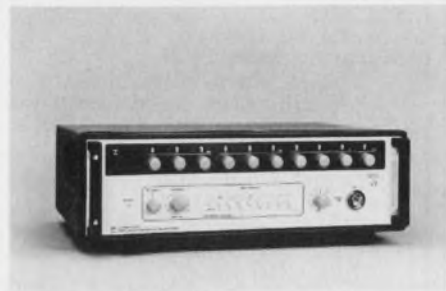

FREQUENCY SYNTHESIZERS. GenRad offers the best combination of low-phase noise, fast switching speed and price. Frequency range is dc to 500 MHz. Important features: non-harmonic spurs > 80 dB down; a-m, fm and pm capabilities; built-in search sweep; programmable (BCD parallel) frequency control; and optional resolution to 0.1 Hz. GenRad, 300 Baker Ave., Concord, MA 01742, (617) 369-8770.

FREQUENCY SYNTHESIZERS 184



Don't count down. Use SX-1 10 kHz - 300 kHz Quartz Crystals * 18 stock frequencies * 0.185" high TO-5 * 1000g shock * \$2.00 ea. in 1000 qty. (\pm 0.01% accuracy) * Details in Gold Book & EEM * STATEK CORP. * 1233 Alvarez Ave. * Orange, Calif. 92668 * (714) 639-7810 * Telex 67 8394

QUARTZ CRYSTALS 187



FREE 32 PAGE CATALOG. WINDOWS - PLATES - DISCS - OPTICS. Fused quartz, optical glasses, pyrex Ultra-low expansion materials, highly resistant to thermal shock. High UV and IR transmission. Chemically inert to most corrosive materials. Stocking center for lenses, prisms and laser accessories. Complete fabricating facilities. ESCO PRODUCTS, 181 Oak Ridge Rd., Oak Ridge, N.J. 07438. (201) 697-3700

LENSE, PRISM CATALOG 182

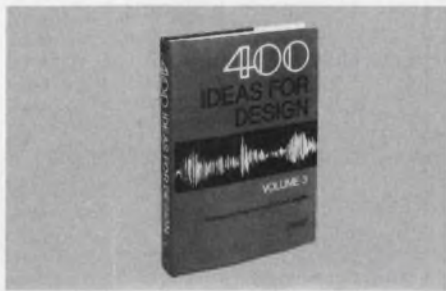

400 IDEAS FOR DESIGN, Volume 3, ed. by Morris Grossman. Brainstorm with the experts! Volume 3 of 400 IDEAS FOR DESIGN contains the best selections from *Electronic Design* that were published between 1971 and 1974. You'll find a wide range of ideas from very complicated to simple, but unique, approaches. #5111-5, 348 pp., \$13.95. Circle the Info Retrieval Number to order your 15-day exam copy. When billed, remit or return book with no obligation. Hayden Book Co., 50 Essex St., Rochelle Park, N.J. 07662.

IDEAS FOR DESIGN 185



HP-25 POCKET CALCULATORS: 26 routines compute engineering and mathematical problems elegantly. Evaluate LAPLACE polynomials of 7th-order. Do partial fraction expansion of 7 real roots; find residues. Solve ordinary differential equations. Find quickly the date of Easter. 172 pages show examples & solutions. \$8.90 includes Book/Postage/Handling. \$9.90 for overseas orders. To order: Robert W. Fowler, 12104 Arbie Rd., Silver Spring, MD 20904. After 5:30 call (301) 622-3094.

POCKET CALCULATORS BOOK 188

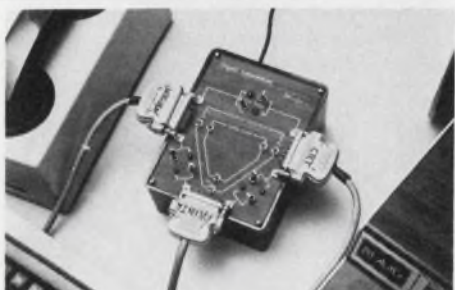

UNIVERSAL JUNCTION UNIT . . . for three devices, RS232C or current loop. . . . Six switches provide all 63 interconnects that are possible between three I-O devices. LED's indicate data flow. . . . Designed to provide circuit compatibility and easy data routing between different manufacturer's devices. . . . \$350 (1-4) from DIGITAL LABORATORIES, 600 Pleasant St., Watertown, MA 02172 (617) 924-1680

3 PORT RS232 & 20 MA LOOP 183

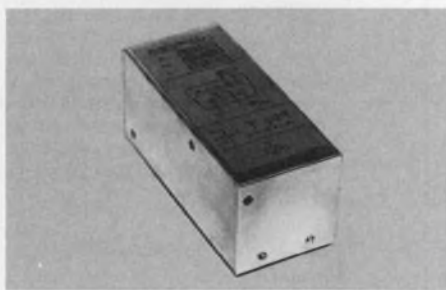

HIGH PERFORMANCE CRYSTAL OSCILLATOR This compact, highly stable, rugged oscillator operates over a wide range of temperatures and conditions and features excellent frequency stability (5x10⁻¹⁰/day), phase noise (90 db, 1 Hz from carrier), low power consumption, and low cost. The B 1325 oscillator meets performance requirements for modern instruments and systems. Frequency and Time Systems, Inc., 182 Conant Street, Danvers, MA 01923 (617) 777-1255 Telex: 94-0518

CRYSTAL OSCILLATOR 186

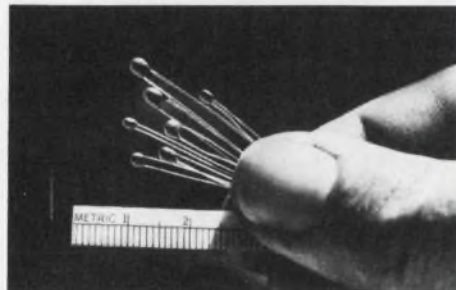

Chip Thermistors with leads and coating are highly reliable, exceptionally predictable, low cost components with small and miniature dimensions more compatible with modern circuit design. R @ 25°C 30 ohms to 3 meg ohms, tolerances \pm 10% to \pm 1%. Curved matched interchangeables \pm 1°C to \pm .3°C. Point matched interchangeables for temperature control R, to \pm 1%. WESTERN THERMISTOR Corporation, 403 Via El Centro, Oceanside, CA 92054. (714) 433-4484.

THERMISTORS 189



Synchro to Linear DC Converter: Infinite Resolution. Full ($\pm 180^\circ$) or Limited Angle DC Output ($\pm 90^\circ$), ± 6 or ± 15 minute accuracy at input rates up to $1440^\circ/\text{sec.}$, 60 or 400 Hz input. Custom Output scaling available. Module $2.6'' \times 3.1'' \times .82''$ H. Price from \$350 in quantity. Other CCC Products are Synchro to Digital, Digital or DC to Synchro, Solid State C.T.'s or CDX's, and Absolute Encoders. Send for Free Catalog & Application Notes. Computer Conversions Corp., East Northport, N.Y. 11731—(516) 261-3300.

SYNCHRO TO LINEAR DC

190

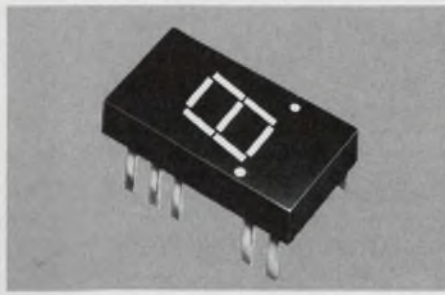

LOW COST .3" LED DISPLAYS IEE is offering three models of .3" LEDs: Model 1737 is common anode with right and left hand decimal; Model 1738 is common cathode with right hand decimal, and Model 1739 is common anode with \pm overflow indicator. All models display excellent red character appearance and uniform segments. Interchangeable with current popular models of TI, Monsanto & HP. \$1.20 each in 500 piece quantity. IEE, 7740 Lemona Ave., Van Nuys, CA 91405, (213) 787-0311, ext. 268.

ECONOMICAL .3" LEDS

193

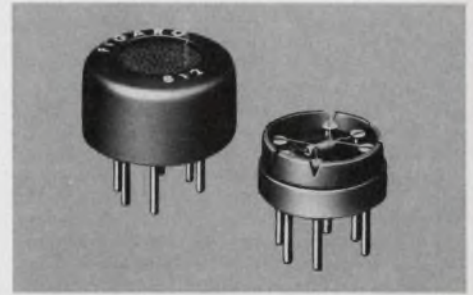

FIGARO GAS SENSOR TGS is a gas sensitive semiconductor. When combustible gas is absorbed on the sensor surface, a marked decrease of electrical resistance occurs. Major features of the sensor include high sensitivity, long term reliability and low cost. The applications are: GAS-LEAK ALARM, AUTOMATIC FAN CONTROL, FIRE ALARM, ALCOHOL DETECTOR, etc. Figaro Engineering Inc., North America Office-3303 Harbor Boulevard, Suite D-8, Costa Mesa, Calif. 92626 Tel: (714) 751-4103 Telex: 678396

GAS SENSOR

196



AVEL-LINDBERG toroidal transformer offers many electrical and mechanical advantages combined in attractive, uniform presentation in the range of standard power transformers. Toroids also have 50% less weight and volume; a lower height profile for slimline electronics and an incredible 8:1 lower radiated interference field. See Avel-Lindberg at Electro 77 Booth 2113 or circle distributor list.

VISIT OUR BOOTH #2113 AT IEE

191

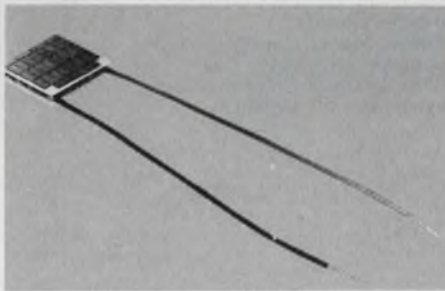

THERMOELECTRIC MODULE, a remarkable value for only \$20 (ppd.), can be used in water coolers, small refrigerators, hot and cold temperature sources, spot cooling for electronic components and other applications. Operates at 3.5 VDC, 8.5 amps, ΔT Max at Qc Zero is 60°C , T_h is 50°C , Qc Max. at ΔT Zero is 19 watts, Max. Op. temp is 100°C . Price includes Thermoelectric handbook. CAMBION, 445 Concord Avenue, Cambridge, MA 02138.

THERMOELECTRIC MODULE

194



Free New '77 catalog contains over 34,500 quality power supplies from the world's largest manufacturer, Power/Mate Corp. Power Supplies for every application including submodulars, open frame, variorated, encapsulated, laboratory & system. All units UL approved and meet most military and commercial specs for industrial and computer uses. Power/Mate Corp., 514 S. River St., Hackensack, NJ 07601 (201) 343-6294

POWER SUPPLIES

197



PRECISION ELECTRONIC INTEGRATOR Designed to measure volt-second integral of a broad range of signal levels 10^3 to $99.99 \times 10^6 \mu\text{V. sec.}$ F.S.—DC to 150 KHz. Model MI-3A analog display can be used as a bi-polar center scale instrument or as a zero left instrument for higher accuracy. (Rechargeable battery available.) the MI-3D digital display uses a bi-polar DVM with 100% overrange, and can be supplied with an isolated BCD. Write Walker Scientific, Inc./Rockdale Street, Worcester, MA 01606/(617) 852-3674.

ELECTRONIC INTEGRATOR

192



Overcurrent Protector, manual reset eliminates fuse replacement. Convenient panel mounting. 19 fractional ratings from 0.1 to 5 amp. Other models up to 400 amp. Trip-free and fool-proof, UL and CSA approved. High quality, low cost \$1.39 ea. in 1000 lots. E-T-A Products Co. of America, 7400 N. Croname Rd., Chicago, Ill. 60648. Tel: (312) 647-8303. Telex: 253780.

CIRCUIT BREAKER

195

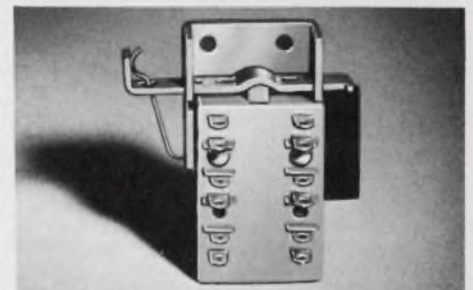

LOW COST DOOR INTERLOCK SWITCHES. Licon® Type 76 compact, sub-miniature switches protect personnel who test and service hazardous electronic equipment. Automatically interrupt current when service door or drawer is opened; allow power to continue after the door is closed. Single, double and triple-pole models, rated up to 10 amps, 125/250 VAC. Contact LICON, A Division of Illinois Tool Works Inc., 6615 West Irving Park Road, Chicago, Ill. 60634. (312) 282-4040. TWX: 910-221-0275.

DOOR INTERLOCK SWITCHES

198

Advertiser's index

Advertiser	Page	Advertiser	Page	Advertiser	Page
ACDC Electronics, Inc.	51	Fowler, Robert W.	140	*Philips Electronic Components and Materials	10, 11
AMP, Incorporated	48, 49	Frequency & Time Systems, Inc.	140	*Philips Industries, Test and Measuring Instruments Dept.	31
Acopian Corp.	31	Fujitsu Limited	12, 13	Philips Test & Measuring Instruments, Inc.	11
Advanced Micro Devices	4, 5			Potter & Brumfield, Division of AMF, Incorporated	93
Airpax Electronics, Cambridge Division	103	GenRad	140	Power Conversion, Inc.	110
Allen Bradley Co.	10	General Electric Company, Semiconductor Products Department	45	Power/Mate Corp.	141
Allied Chemical, Metglas Products	43	Gold Book, The	*8, *9, 96D, 96E, 122, 143	Precision Monolithics, Incorporated	30
Amphenol North America division, The Bunker-Ramo Corporation	87	Gould, Inc., Power Supply Dept.	101	Projects Unlimited	117
Amplifier Research Corporation	108	Grayhill, Inc.	112		
Analog Devices, Inc.	96D, 96E	Greenray Industries, Inc.	122		
Ann Arbor Terminals, Inc.	133	Gulton Industries, Inc.	129, 131, 133, 135		
Arnold Magnetics Corp.	116				
Arrow-M Corp.	98				
Avel-Lindberg	141				
		Hayden Book Company, Inc.	*18, 96H, 132, 139, 140		
B & K Products of Dynascan Corporation	60, 61	Heinemann Electric Company	137	RCA Distributor & Special Products Division, Sales Promotion Services	114
Beckman/Helipot Division	50	Hewlett-Packard	28, 85	RCA Electro Optics	109
Bendix Corporation, The, Electrical Components Division	56, 57	Heyman Manufacturing Company	121	RCA Solid State	Cover IV
Bodine Co., The	137	Houston Instruments, The Recorder Company	78	Raytheon Semiconductor	72
Bourns, Inc., Trimpot Products Division	Cover II	Hughes Aircraft Company	130	Reader Service Card	144A-B
Bowmar/TIC, Inc.	136			Reliability, Inc.	102
Buckeye Stamping Company, Inc., The	122	IBM Data Processing Division	39, 40, 41	Reticon	107
Burroughs Corporation	19	IEE	141	Rostone Corporation	16
Byte Publications, Inc.	135	Infinite, Inc.	131		
		Intel Corporation	15, 17		
CTS Corporation	119	Janco Corporation	121	SCI Systems, Inc.	96
Cambridge Thermionic Corporation	141	Johanson Dielectrics, Inc.	140	SMK Electronics Corporation of America	117
Citizen's America Corporation	118	Johanson Manufacturing Corp.	46	Schauer Manufacturing Corp.	104
Computer Automation, Inc.	47			Simpson Electric Company	27
Computer Conversions Corp.	141	Kaye Instruments	110	Sprague Electric Company	37
Computer Products, Inc.	29	Keithley Instruments, Inc.	50	Sprague-Goodman Electronics, Inc.	129
Continental Specialties Corporation	14			Statek Corp.	140
Coto Coil Company, Inc.	139	Licon, Division of Illinois Tool Works, Inc.	141	Stanford Applied Engineering, Inc.	35
				Superior Flux Company	134
		M-Tron Industries	118	Synertek	96G
Dana Laboratories, Inc.	96A	Mallory Capacitor Company	89		
Data I/O Corporation	91	McLean Engineering Laboratories	137	Tau-Tron, Inc.	138
Data Precision Corporation	105	Mechanical Enterprises, Inc.	125	Tecknit	125
Datanetics	115	Merrimac Industries, Incorporated	127	Tektronix, Inc.	Cover III, 55
Datel Systems, Inc.	58	Metex Corporation	86	Teledyne Semiconductor	20
Datum, Inc.	7	Micro Components Corporation	128	Trak Systems	97
Digital Equipment Corporation	73, 106	Micro Networks Corporation	124		
Digital Laboratories	140	Microprocessor Survey Card	128A-B		
		Miller-Stephenson Chemical Co., The	71	Unimax Switch Corporation	111
EECO	79	Mini-Circuits Laboratory, A Division of Scientific Components Corp.	2	Universal Data Systems	33
EMM Semi, A Division of Electronic Memories & Magnetics Corporation	96C	MuRata Corporation of America	117		
*EMI SE Labs	16			Vector Electronic Co., Inc.	139
ESCO Products	140	NEC America, Inc.	8, 9	Victoreen Instrument Division, Shellar-Globe Corporation	113
E-T-A Products Co. of America	141	NEC Microcomputers, Inc.	18		
Eagle-Picher Industries, Inc.	120	National Semiconductor Corporation	23, 24, 25, 26	Walker Scientific, Inc.	140
Electronic Arrays, Inc.	95	Noritake Co., Ltd.	96B	Wall Industries Inc.	121
Electronic Design	96F, 97, 123, 138, 143			Wavetek Indiana Incorporated	1
Electronic Applications Company	121			Western Thermistor Corporation	140
Electronic Measurements, Inc.	6				
Electronic Navigation Industries	100				
Esterline Electronics	114	Opt Industries Inc.	137		
		Ovenaia, A Division of Walter Kidde & Company, Inc.	138	Yokowaga Corporation of America	77
Figaro Engineering, Inc.	141				

*Advertisers in non-U.S. edition

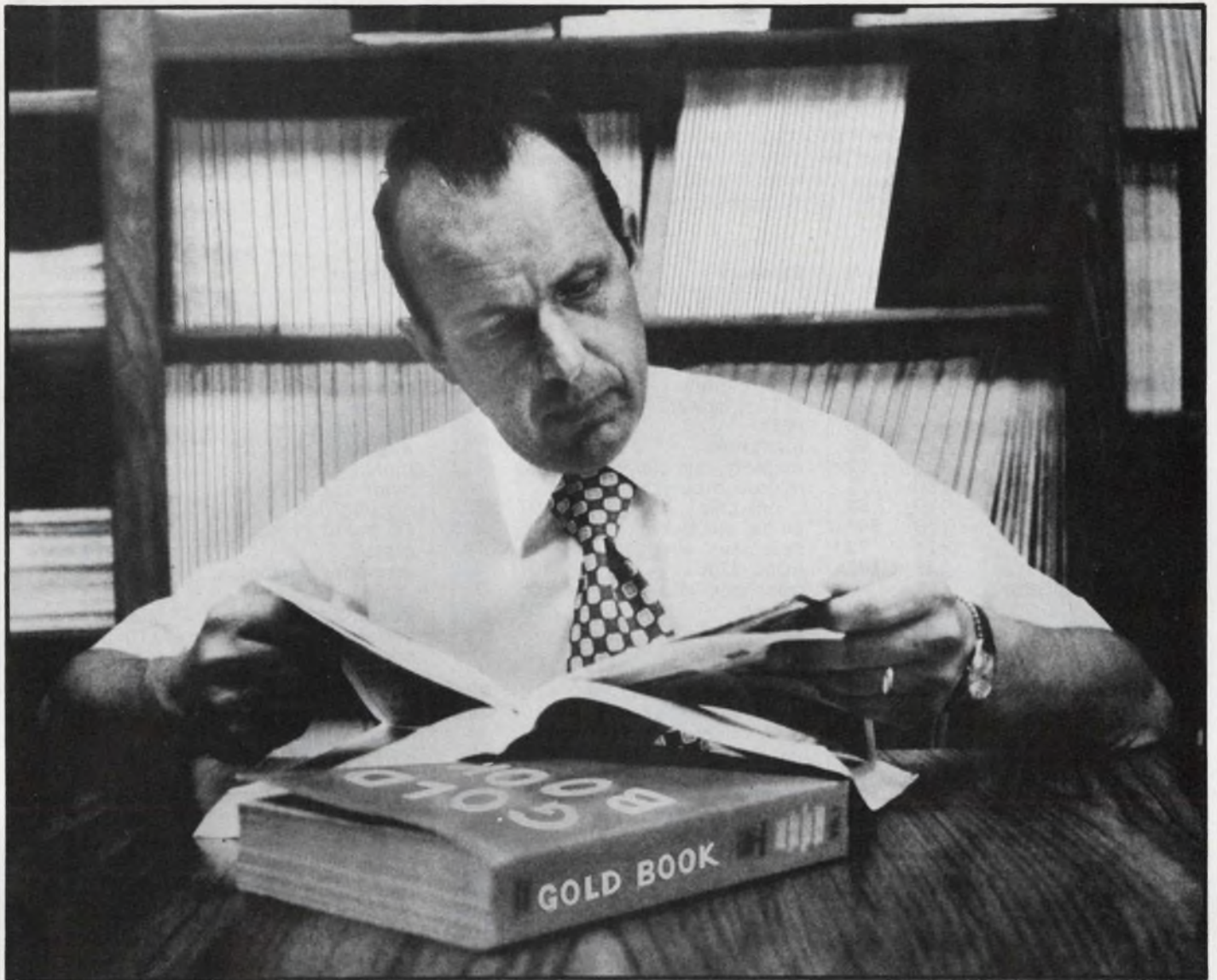

“THE GOLD BOOK HAS SAVED ME HUNDREDS OF HOURS ... I CONSIDER EEM SECOND BEST AND EBG THIRD!”

Stig Johansson is Research Engineer at the University of Maryland Clark Lake Radio Observatory, Borrego Springs, California. His job activity includes purchasing as well as the design and construction of specialized radio receiving systems, computer interfaces and control systems.

Johansson estimates that he has personally referred to the GOLD BOOK about 1200 times in the course of his work. He and his associates have purchased about \$120,000 worth of products through its use — especially computer peripherals, RF amplifiers, test equipment, IF filters, wire & cable and components.

He thinks the GOLD BOOK “is the best.”

“I think it is the most comprehensive and best arranged electronic purchasing guide available. I use it daily — often many times a day. It has saved me hundreds of hours in locating vendors and procuring electronic parts and equipment.

“I consider EEM second best and EBG third. In addition to the GOLD BOOK being the best it was also the easiest to obtain. Even after numerous phone calls, letters and a check covering the handling & mailing we were unable to obtain the last EEM. Now, we use the GOLD BOOK exclusively.”

The GOLD BOOK is working for advertisers because it's working for 90,000 engineers and engineering managers — like Mr. Johansson — throughout the U.S. and overseas. Is your company represented in its advertising pages?

IF IT'S ELECTRONIC ... IT'S IN THE GOLD BOOK

Product index

Information Retrieval Service. New Products, Evaluation Samples (ES), Design Aids (DA), Application Notes (AN), and New Literature (NL) in this issue are listed here with page and Reader Service numbers. Reader requests will be promptly processed by computer and mailed to the manufacturer within three days.

Category	Page	RSN	Category	Page	RSN	Category	Page	RSN
Components			ICs & Semiconductors			EMI/RFI shielding		
audio annunciators	130	373	converter, d/a	108	324	materials	86	46
audio indicators	117	75	custom ICs	128	94	enclosures	122	88
capacitors	37	24	electro-optics	109	65	flux remover	71	39
capacitors	46	27	FET, rf power	107	321	header strips	124	360
capacitors	89	48	FETs	20	16	LSI sockets	117	76
capacitors, trimmers	129	96	memories	105	61	magnetic shielding	43	26
circuit breakers	103	59	memory, bubble	108	323	moldings	16	13
contact protector, SS	130	371	microcomputer,			nylon cable clamps	121	87
crystals	119	82	one-chip	107	322	organic flux	134	103
displays	128	367	piano, electronic	108	326	PC board contact	122	356
film-resistor kit	114	72	processor, single-bit	106	303	press	139	120
filters, low-pass	137	107	ROM, 32-k	107	320	screw for plastics	124	359
fluorescent-indicator panels	9	6	transistor, rf	108	325			
gas-plasma displays	19	15	zeners	104	60	Power Sources		
gearmotors	136	110	μ P slice, 4-bit	72	40	batteries	110	67
micro-buzzers	125	116				power sources, μ P		
potentiometers	136	106	Micro/Mini Computing			power supplies	6	4
potentiometers	11	252	board, microcomputer	112	306	power supplies	29	19
quartz crystals	118	79	board, 65-k RAM	116	344	power supplies	31	21
readout, LED	131	375	card, microcomputer	115	340	power supplies	51	32
reed relays	114	71	catalog	106	62	power supplies	101	57
relay, ac-current, SS	128	366	combo, computer/disc	116	341	power supplies	116	74
relays	13	111	computer publication	135	105	power supplies	121	84
relays	98	55	controller, micro-			power supplies, dc	110	328
relays	121	85	program	115	338	power supply, dc	111	330
relays, reed	139	119	controllers, micro	114	337	power supply, dc	111	331
relays, reed, DIP	131	374	data modems	33	22			
relays, solid-state	136	108	display terminal	133	102	new literature		
resistors	10	7	drives, disc	114	336	a/d converters	135	401
resistors	113	70	interface, cassette	113	334	a/d, d/a signal converters	136	405
sensors	117	78	microcomputer	112	332	active filter modules	134	396
solenoids	130	372	microcomputer	131	99	IC chips	134	388
switches, DIP	79	44	microcomputer system	17	163	limit switches	134	390
switches, PB	121	86	microcomputer, 8080	112	333	linear motion products	134	394
switches, rotary	130	370	microprocessor, 16-bit	115	338	packaging hardware	134	391
switches, slide-assembly	129	368	PROM programming	91	180	precision components	135	400
switches, toggle, lock	128	365	program, development	116	343	rf signal processing	135	398
			programmer, PROM	116	342	SCR dc power supplies	134	397
			rotary printer	97	53	semiconductors	135	399
Data Processing			single-board computer	15	161	spectrum analyzers	134	389
lightpen	132	380	tape systems	7	5	switches	134	395
metric plotter	132	376	terminal, receive-only	113	335	synchro converters	134	393
process controller	132	378				thermocouples	136	408
			Microwaves & Lasers			thin-film resistors	136	406
			laser-scribe system	126	307	UPS	134	392
Instrumentation						vacuum equipment	135	402
current probe	55	33	Modules & Subassemblies			wire-wrapping tools	136	404
DMMs	27	17	converter, a/d	119	347			
DPM	104	309	converter, d/a	118	345			
digital instrumentation	77	42	converter, d/a	119	348			
function generator	102	301	converters, a/d and d/a	124	92			
generators	138	117	displays, 7-segment	119	349			
logic analyzer	99	304	frequency standard	122	89			
logic monitor	14	11	industrial converters	50	30			
portable oscilloscopes	11	8	oscillators	138	118			
power amplifier	108	64	sample and hold	120	350			
rf power amplifiers	100	56	VCO-subminiature	120	351			
recorder, 4-in. servo	133	101				application notes		
recorders	131	98	Packaging & Materials			a/d converters	133	384
recorders, ac and dc	129	95	air conditioner	137	109	component testing	133	383
recorders, X-Y	78	43	cable-tying tool	124	361	d/a converters	133	387
scanner	110	66	connector, elastomeric	125	116	ferrite material	133	385
spectrum analyzers	28	18	connectors	49	29	flush circuits	133	382
sweep-signal generator	1	2	connectors	57	35	hot-melt adhesives	133	386
therm. res. tester	104	305						

You design the system. We'll display your solutions.

Together we make each other look better than ever. Because our specialty is taking your system's output and displaying it as concepts that any user quickly understands.

Tektronix has made graphics desirable and affordable

worldwide. Our components can give your system the same universal acceptance and versatility. Our capabilities complement your needs: including graphic and alphanumeric terminals and monitors. Plotters. Hard copiers. Combined refresh and storage technology.

We'll work as your partners. We'll provide modular display components you can stake your reputation on, with prices and quantity

discounts that put it all together. You've got high standards for your OEM suppliers: we stack up to them. Give us a call soon.

Tektronix
Information Display Group
OEM Components
P.O. Box 500
Beaverton, Oregon 97077

**Tektronix
OEM components:
the perfect fit.**

CIRCLE NUMBER 253

Tektronix
COMMITTED TO EXCELLENCE

copyright © 1977, Tektronix, Inc. All rights reserved

With higher speeds and density ...

Here are three new COS/MOS ideas, good buddy.

A new 40-channel CB synthesizer and two other circuits prove: RCA COS/MOS has really got the hammer down on the rip strip of hot new applications. In these circuits and more to come, you have improved speeds and density to work with. Plus the other COS/MOS advantages. All adding up to better performance and significant cost and space savings.

1 40-Channel CB: cut costs of ownership.

Our new synthesizer IC combines receiving and transmitting oscillator functions on a single chip. Result: lower CB manufacturing cost—and more. The low power requirements and environmental ruggedness of COS/MOS help reduce power-supply and operating costs, and make it a natural for use in vehicles. Operating between 15-20 MHz with no pre-scaler, TA10336 has a transmit-receive shift, 6-bit channel code, and a 10.24 MHz reference.

Circle 241

2 FIFO Register: simplify microprocessor interfacing.

On a single chip you get 4 independent FIFO registers that can be used in parallel. CD40105B is 4 bits by 16 bits long, is expand-

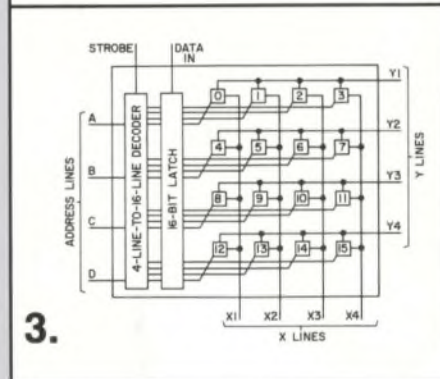
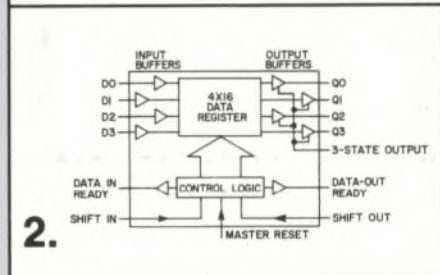
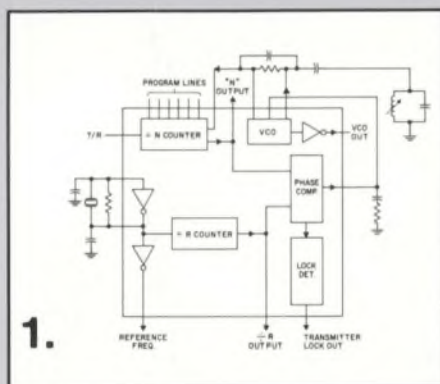

able, and features independent asynchronous inputs/outputs (outputs are 3-state). It really shines in microprocessor applications requiring input/output peripheral buffering.

Circle 242

3 4 x 4 Crosspoint Switch: lower the cost per crosspoint.

The CD22100 is 16 switches on a single chip, replacing 16 relays (at about 1/3 the cost) or 3 standard ICs. This can mean major space savings in in-house telephone and data communications systems, for example. And of course fewer connections means higher reliability. Coming soon: a 4x4x2 crosspoint switch.

Circle 243

For more information on these COS/MOS integrated circuits, contact your local RCA Solid State distributor.

Or write: RCA Solid State, Box 3200, Somerville, NJ 08876; Sunbury-on-Thames, Middlesex TW16 7HW, England; Ste.-Anne-de-Bellevue, Quebec, Canada; Fuji Bldg., Tokyo, Japan.

RCA COS/MOS experience is working for you.