

**Linear-IC amplifiers have limits.** They drift, clip, overshoot, ring and add delay and noise. Some use more power than you can spare. But often data sheets

don't tell it all. "Typicals" abound while full ranges are absent for temp, input and supply-related data. Specs are quiet on noise. For amplification, turn to p. 72.

**CONF**  
 Input Offset Current ( $I_{OS}$ )  
 Input Bias Current ( $I_B$ )  
 Resistance Diff. and Mode ( $R_{IN}$ )

(Note 3, 5),  $T_J = 25^\circ\text{C}$   
 $T_J \leq T_{HIGH}$   
 (Note 3, 5),  $T_J = 25^\circ\text{C}$   
 $T_J \leq T_{HIGH}$   
 $T_J = 25^\circ\text{C}$

**Gain vs Frequency Graph:**  
 Y-axis: GAIN (dB) from 0 to 120  
 X-axis: FREQUENCY (kHz) on a log scale from 0.01 to 10,000  
 Curves for different load resistances ( $R_L$ ):  
 1.  $R_L = 100\Omega$   
 2.  $R_L = 1k\Omega$   
 3.  $R_L = 3.3k\Omega$   
 4.  $R_L = 10k\Omega$

**Notes:**  
 Note 5: The input  $T_J$ . Due to limited temperature rises from junction to  
 Note 6: Settling voltage (the volt to the inverter. f  
 Note 7: For vol efficient of the ac value. Common

Parameter	Min.	Typ	Max
Input Offset Voltage	—	0.5	5.0
Input Offset Current	—	5.0	200
Input Bias Current	—	40	500
Input Resistance	0.3	5.0	—
Large-Signal Voltage	50,000	300,000	—

$R_L \geq 2k\Omega$   
 $V_{OUT} = \pm 10V$

	MIN.	TYP.	MAX.
10			20
0.5			20
2.0			
$10^6$			
2.0			
50,000		75	
		25	
		4.5	6
		135	180
		6.0	
		1.0	
		200	

# Swage-Bond™ ... a revolution in trimmer reliability!

## ... here today at no extra cost in every Trimpot® Potentiometer

Historically, pin-to-element termination problems have been one of the primary causes of trimmer failure ... especially during handling and PC board process operations. Bourns exclusive Swage-Bond™ process virtually eliminates pin termination failure ... truly a revolution in trimmer reliability. Furthermore, Swage-Bonding results in a marked improvement in temperature coefficient consistency.

Other trimmer manufacturers utilize a simple clip-on termination. Some solder this connection, some rely on tension pressure alone. In the Swage-Bond process, the P.C. pins are secured **through** the substrate, with a high-pressure compression swage on both top and bottom sides. The pressure of the swage locks the pin solidly into the element, and thoroughly bonds it to the thick-film termination material.

Swage-Bond™ eliminates pin termination failure, provides more reliable tempco. Microphotograph shows trimmer element magnified 20X.



### The seal that seals ... without springback

Bourns trimmers stay sealed when others fail. We know. We've tested them all. Bourns uses a chevron-type sealing technique, that seals without O-rings ... eliminating the windup and springback that frequently occurs with such seals. The result is faster and more precise adjustability ... with a seal that really works.



### Wrap-around wiper for better setting stability

Bourns multi-fingered, wrap-around wiper delivers more consistent, more reliable performance. The unique design significantly reduces CRV fluctuations and open circuit problems due to thermal and mechanical shock ... by maintaining a constant wiper pressure on the element. Compare the ruggedness of Bourns design with the common "heat-staked" wiper designs. Compare performance. Specify Bourns.

### HERE'S PROOF:

Send for a copy of our new engineering report on TRIMMER PERFORMANCE. Tell us about your application, and we'll provide qualification samples that best suit your needs.

Bourns reliability is available at ordinary prices ... off-the-shelf from nearly 100 local distributor inventories ... plus our largest-ever factory stock. TRIMMER PRODUCTS, TRIMPOT PRODUCTS DIVISION, BOURNS, INC., 1200 Columbia Avenue, Riverside, California 92507. Telephone 714 781-5320 — TWX 910 332-1252.



# The Model 186 art gallery.

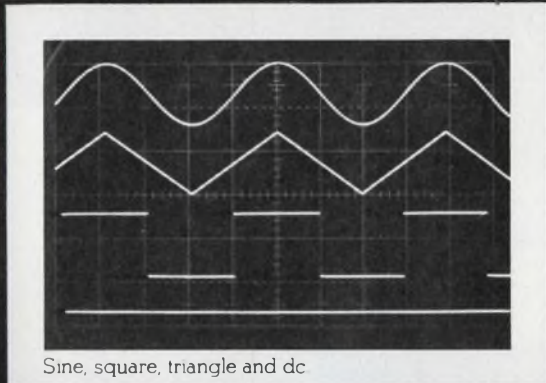

Sine, square, triangle and dc

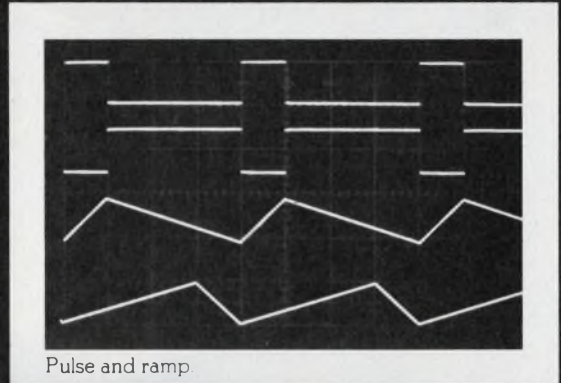

Pulse and ramp

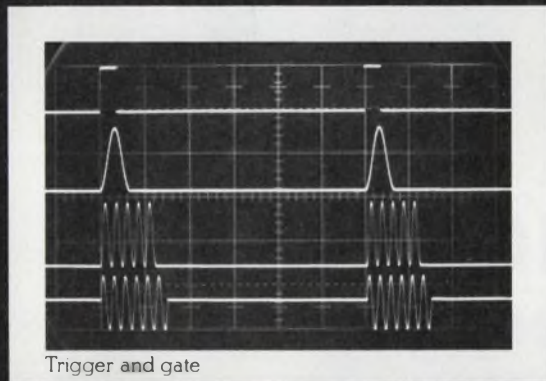

Trigger and gate

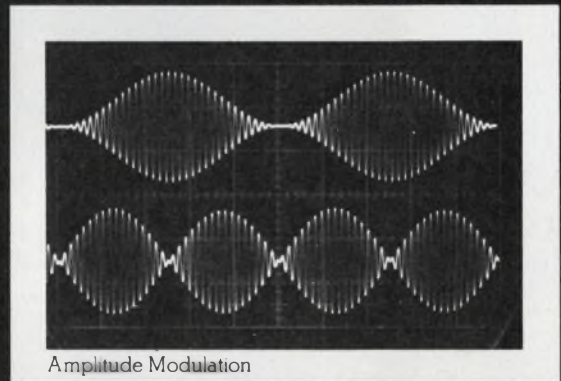

Amplitude Modulation

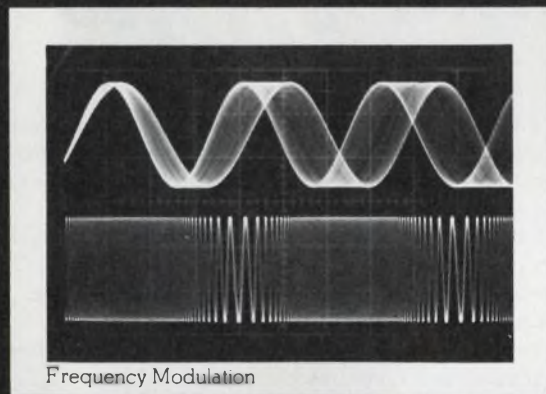

Frequency Modulation

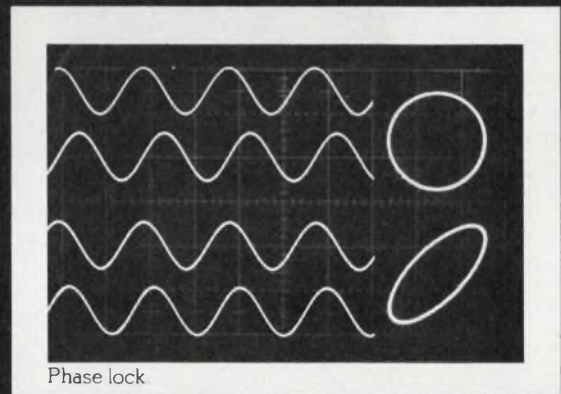

Phase lock

There's a whole lot more to the Model 186 than just pretty pictures. Like its calibrated phase lock and built-in oscillator for 1 kHz AM/FM capabilities. It also has 30 v p-p output plus continuous, triggered and gated modes. And it's the only generator that gives you the combination of AM and phase lock.

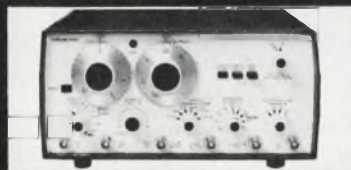

The Model 186 has a frequency range of 0.0001 Hz to 5 MHz and sells for just \$795.\* Just circle our bingo number and we'll send you the complete picture.

\*US domestic price only

**WAVETEK®**

P.O. BOX 651, SAN DIEGO, CALIFORNIA 92112  
TELEPHONE (714) 279-2200, TWX 910-335-2007

CIRCLE NUMBER 2

# Surprise!

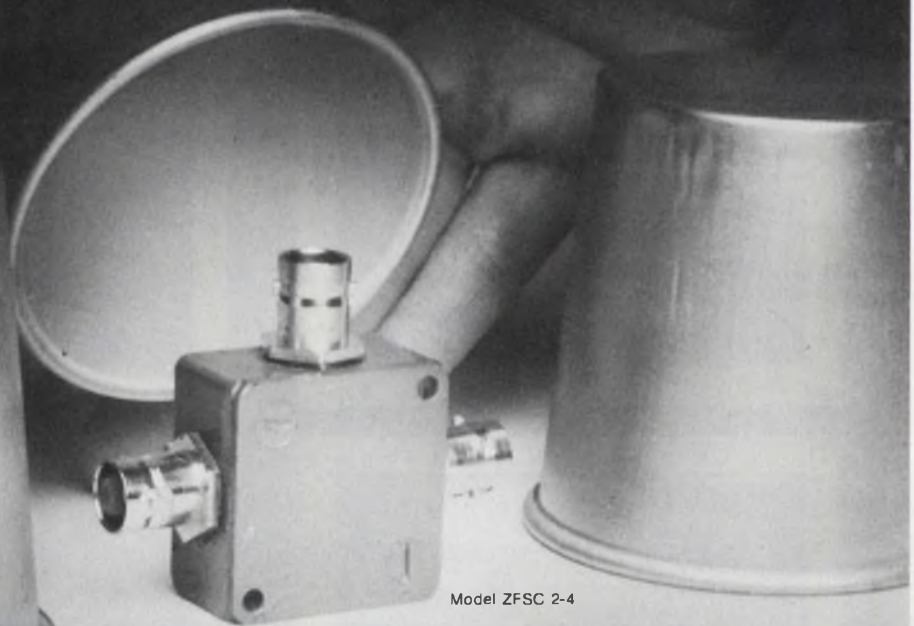

Model ZFSC 2-4

## 200 KHz-1000 MHz Power Splitter/Combiner in a single unit... **\$44.<sup>95</sup>** (4-24)

### SPECIFICATIONS FOR ZFSC-2 SERIES

Model No. (Price Qty.)	ZFSC 2-1 (\$31.95 4-24)	ZFSC 2-1W (\$35.95 4-24)	ZFSC 2-2 (\$39.95 4-24)	ZFSC 2-4 (\$44.95 4-24)
Frequency Range (MHz)	5-500	1-750	10-1000	0.2-1000
Isolation (dB)	Typ. Min.	Typ. Min.	Typ. Min.	Typ. Min.
Lower band edge to one decade higher	30 25	30 25	30 20	20 12
Mid range	28 20	28 20	25 20	25 20
Upper band edge to one octave lower	25 20	25 20	23 18	23 18
Insertion Loss (dB) above 3 dB split	Typ. Max.	Typ. Max.	Typ. Max.	Typ. Max.
Lower band edge to one decade higher	0.2 0.5	0.2 0.5	0.2 0.5	0.2 0.5
Mid range	0.3 0.6	0.4 0.8	0.5 1.0	0.5 1.0
Upper band edge to one octave lower	0.6 0.8	0.8 1.0	0.9 1.2	0.9 1.2
Phase Unbalance (dB)	Typ. Max.	Typ. Max.	Typ. Max.	Typ. Max.
Lower band edge to one octave from upper band	0.5 2	0.5 2	0.5 2	0.5 2
Upper band edge to one octave from lower band	1 4	1 4	1 4	1 4
Amplitude Unbalance (dB)	Typ. Max.	Typ. Max.	Typ. Max.	Typ. Max.
Lower band edge to one octave from upper band	0.05 0.15	0.05 0.15	0.05 0.15	0.05 0.15
Upper band edge to one octave from lower band	0.1 0.3	0.1 0.3	0.1 0.3	0.1 0.3

Common specifications: Impedance all ports — 50 ohms VSWR — 1.25 typ. Nominal phase difference — 0 Matched power rating — 1 watt max. Internal load dissipation — 1 watt (ZFSC 2-1W)

Yes . . . it's no longer necessary to order several different models of power splitters/combiners if your designs are within the 200 KHz to 1000 MHz region. If your design is relatively narrow band, you can expect tighter specs.

Order Mini Circuits new, versatile model ZFSC-2-4 offering these benefits:

- ultra wideband performance, 200 KHz to 1000 MHz
- tighter specs over narrower band range
- lower cost with single-model, high volume purchasing
- fast delivery, one week maximum

For narrower bandwidth applications models in the ZFSC series are available at low prices starting from \$31.95 (see chart)

World's largest manufacturer of Double-Balanced Mixers

## Mini-Circuits

Mini-Circuits Laboratory  
A Division Scientific Components Corp.  
837-843 Utica Avenue, Brooklyn, NY 11203  
(212) 342-2500 Int'l Telex 620156 Domestic Telex 125460

**International Representatives:**  **AUSTRALIA:** General Electronic Services, 99 Alexander Street, New South Wales, Australia 2065.  **ENGLAND:** Dale Electronics, Dale House, Wharf Road, Frimley Green, Camberley Surrey.  **FRANCE:** S. C. I. E. D. I. M. E. S. 31 Rue, Gisors, Saint 91170 Palaiseau, France.  **GERMANY, AUSTRIA, SWITZERLAND:** Industrial Electronics GMBH, Klüberstrasse 14, 6000 Frankfurt, Main, Germany.  **ISRAEL:** Veconics, Ltd., 69 Gordon Street, Tel Aviv, Israel.  **JAPAN:** Denso Kaisha Ltd., Equich Building 8-1-1 Chome Hamamatsucho Minato-ku, Tokyo.  **EASTERN CANADA:** B. D. Hummel, 2224 Maynard Avenue, Utica, NY 13502 (315) 736-7821.  **NETHERLANDS, BELGIUM, LUXEMBOURG:** Coimex, Veldweg 11, Haltem, Holland.  **NORWAY:** Datimatik AS, Ostensloveien 62, Oslo 6, Norway.

**U.S. Distributors:**  **NORTHERN CALIFORNIA:** Cain White & Co., Foothill Office Center, 105 Fremont Avenue, Los Altos, CA 94022 (415) 948-6533.  **SOUTHERN CALIFORNIA, ARIZONA:** Crown Electronics, 11440 Collins Street, No. Hollywood, CA 91601 (213) 877-3550.

For complete information and specifications see Microwaves' "Product Data Directory", Electronic Designs' "Gold Book" or Electronic Products' "EEM".

CIRCLE NUMBER 3

---

## NEWS

- 21 **News Scope**  
26 **Wage busting is continuing to plague engineers.** but legislative help may be on the way.  
34 **First monolithic 12-bit DAC design details are revealed.**  
57 **Washington Report**

---

## TECHNOLOGY

- 43 **Microprocessor Design**  
72 **FOCUS on linear IC amplifiers:** Mixed bipolar/FET processes and other advances have pushed monolithic amplifiers to new performance heights. But you'll have to push hard to get all the required performance specifications.  
86 **Driving inductive loads?** Take advantage of collector-emitter diodes in monolithic power Darlington. They can be as effective as external diodes.  
94 **Use equations to parallel transistors.** To get through the graphical morass, balance your currents with simple arithmetic and straight-line approximations.  
100 **Float your input amplifier** and you can almost laugh at ground loops or high common mode-voltages. A new design gives low drift, too.  
106 **Measure phase noise** in one of three ways, each of which has some advantages. Quadrature phase detection, for one, lets you avoid dynamic-range limits.  
112 **Measure SAW-device characteristics,** and pin down the performance of acoustic-wave filters and delay lines. Frequency response and impedance are key specs.  
120 **Build a high-frequency synthesizer** with a digital mixer in a phase-locked loop and use fewer and slower divider/counters in conventional loops.  
126 **Dick Lee of Siliconix** speaks on making your engineers bigger.  
132 **Ideas for Design:**  
Convert seven-segment numerical code to decimal with simple gates.  
Optical couplers isolate, control and monitor to allow 6-kV supply to float.  
Approximate the tangent function with a multifunction converter and op amp.  
Trace symbols on CRT screen with access to the Z axis.  
140 **International Technology**

---

## PRODUCTS

- 157 **Instrumentation:** Low-cost scope challenges more expensive rivals.  
143 **Integrated Circuits** 173 **Discrete Semiconductors**  
163 **Packaging & Materials** 175 **Power Sources**  
165 **Data Processing** 179 **Modules & Subassemblies**  
169 **Components**

---

## DEPARTMENTS

- 65 **Editorial:** The good word  
7 **Across the Desk** 191 **Vendors Report**  
181 **Application Notes** 196 **Advertisers' Index**  
183 **Evaluation Samples** 198 **Product Index**  
184 **New Literature** 198 **Information Retrieval Card**  
190 **Bulletin Board**

**Cover:** Designed by Art Director Bill Kelly, photo courtesy of National Semiconductor, Santa Clara, CA.

**Micro-  
processing  
becomes  
a buyer's  
market.**

If you're a MOS microprocessor customer, the last few years haven't been a whole lot of laughs.

One supplier had all the good stuff, made all the rules, told you what you could buy. And when. And for how much.

But something happened to change all that: Advanced Micro Devices.

We make the best microprocessor in the world, the Am9080A, and we make all the support circuits you need. They're yours now, off the shelf, at competitive prices. That's right. Competitive.

But we make more than microprocessor products. We make you a promise:

We'll sell you any part, in any quantity, bundled or unbundled. You're the customer.

So, if you suddenly find yourself having an easier time buying microprocessors, just remember why. And who.

If you're shy, and you're just not sure how to say thank you, an order would be really nice.

Write or phone Advanced Micro Devices, The Buyer's Market.

## Ours and Theirs.

(The 9080A & 8080A)

Specification	Intel	AMD
Minimum Instruction Cycle Time	1.3 microseconds	1 microsecond
Maximum Power Dissipation (at 1.3 microsec. 0-70°C)	1307 milliwatts	829 milliwatts
Output Drive	1.9mA @ 45V	3.2mA @ 4V
Minimum Input High Voltage	3.3V	3.0V
MIL-STD-883	Special	Standard

## Ours and Ours.

(Am9080A System Circuits)

AMD Part Number	Description	Availability	AMD Part Number	Description	Availability
<b>CPU</b>					
Am9080A/-2/-1/-4	0 to +70°C	Stock			
Am9080A/-2/-1	-25 to +85°C	Stock			
Am9080A/-2	-55 to +125°C	Stock			
<b>STATIC READ/WRITE RANDOM ACCESS MEMORIES</b>					
Am9101A/B/C/D	256 x 4, 22 Pin	Stock			
Am91L01A/B/C	256 x 4, 22 Pin	Stock			
Am9102A/B/C/D	1K x 1, 16 Pin	Stock			
Am91L02A/B/C	1K x 1, 16 Pin	Stock			
Am9111A/B/C/D	256 x 4, 18 Pin	Stock			
Am91L11A/B/C	256 x 4, 18 Pin	Stock			
Am9112A/B/C/D	256 x 4, 16 Pin	Stock			
Am91L12A/B/C	256 x 4, 16 Pin	Stock			
Am9131A/B/C/D/E	1K x 4, 22 Pin	Stock			
Am91L31A/B/C/D	1K x 4, 22 Pin	Stock			
Am9141A/B/C/D/E	4K x 1, 22 Pin	Stock			
Am91L41A/B/C/D	4K x 1, 22 Pin	Stock			
<b>DYNAMIC READ/WRITE RANDOM ACCESS MEMORIES</b>					
Am9050C/D/E	4K x 1, 18 Pin	Stock			
Am9060C/D/E	4K x 1, 22 Pin	Stock			
<b>MASK PROGRAMMABLE READ-ONLY MEMORIES</b>					
Am9208B/C/D	1K x 8, 250 nsec max	Stock			
Am9216B/C	2K x 8, 300 nsec max	Stock			
Am8316A	2K x 8, 850 nsec max	Stock			
Am8316E	2K x 8, 550 nsec max	Stock			
<b>ERASABLE READ-ONLY MEMORIES</b>					
Am1702A	256 x 8, 1.0 μsec	Stock			
Am2708	1K x 8, 450 nsec	1st Q 1977			
CPU: 9080A = 480 nsec -2 = 380 nsec -1 = 320 nsec -4 = 250 nsec					
MEM: A = 500 nsec B = 400 nsec C = 300 nsec D = 250 nsec E = 200 nsec					
<b>SECOND SOURCE SUPPORT</b>					
Am8212	8-bit I/O Port	Stock			
Am8216	Non-Inverting Bus Transceiver	Stock			
Am8224	Clock Generator	Stock			
Am8226	Inverting Bus Transceiver	Stock			
Am8228	System Controller	Stock			
Am8238	Extended Write System Controller	Stock			
Am8251	Prog. Communications Interface	Stock			
Am8255	Prog. Peripheral Interface	Stock			
Am8257	Direct Memory Access Controller	2nd Q 1977			
Am8259	Priority Interrupt Controller	2nd Q 1977			
<b>IMPROVED SUPPORT</b>					
<b>REPLACES</b>					
Am8238-4	High Speed System Controller	N/A	Stock		
Am9511	Arithmetic Processing Unit	N/A	2nd Q 1977		
Am9517	Multi-mode DMA Controller	8257	2nd Q 1977		
Am9519	Universal Interrupt Controller	8259	2nd Q 1977		
Am9551/-4	Prog. Communications Interface	8251	Stock		
Am9555/-4	Prog. Peripheral Interface	8255	Stock		
Am25LS138	1-of-8 Decoder	8205	Stock		
Am25LS139	Dual 1-of-4 Decoder	8205	Stock		
*Am25LS273	8-bit Common Clear Register	N/A	Stock		
*Am25LS373	8-bit Transparent Latch	8212	2nd Q 1977		
*Am25LS374	8-bit 3-State Register	8212	1st Q 1977		
*Am25LS377	8-bit Common Enable Register	8212	1st Q 1977		
*Am25LS2513	Priority Encoder	8214 & 8212	Stock		
*Am25LS2537	1-of-10 3-State Decoder	8205 (2)	1st Q 1977		
*Am25LS2538	1-of-8 3-State Decoder	N/A	1st Q 1977		
*Am25LS2539	Dual 1-of-4 3-State Decoder	N/A	1st Q 1977		

\*All combine high performance and low power in space saving 20-pin package

# Advanced Micro Devices

Bipolar LSI. N-channel, silicon gate MOS. Low-power Schottky.  
Multiple technologies. One product: excellence.



Advanced Micro Devices • 901 Thompson Place, Sunnyvale, California 94086 • Telephone (408) 732-2400 •  
Distributed nationally by Hamilton/Avnet, Cramer and Schweber Electronics.

CIRCLE NUMBER 6

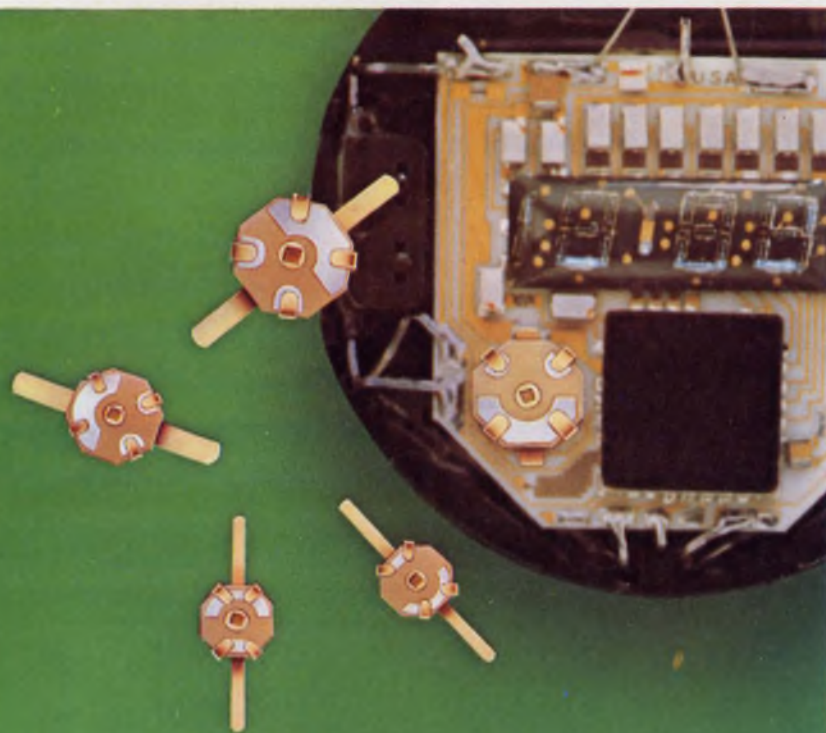

# Thin-Trim. capacitors

Tucked in the corner of this Pulsar Watch is a miniature capacitor which is used to trim the crystal. This Thin-Trim capacitor is one of our 9410 series, has an adjustable range of 7 to 45 pf., and is .200" x .200" x .050" thick.

The Thin-Trim concept provides a variable device to replace fixed tuning techniques and cut-and-try methods of adjustment. Thin-Trim capacitors are available in a variety of lead configurations making them easy to mount.

A smaller version of the 9410 is the 9402 series with a maximum capacitance value of 25 pf. These are perfect for applications in sub-miniature circuits such as ladies' electronic wrist watches and phased array MIC's.

Johanson Manufacturing Corporation  
Rockaway Valley Road  
Boonton, New Jersey 07005  
(201) 334-2676 TWX 710-987-8367

**Sr. Vice President, Publisher**  
Peter Coley

## Editors

**Editorial Offices**  
50 Essex St.  
Rochelle Park, NJ 07662  
(201) 843-0550  
TWX: 710-990-5071  
Cable: Haydenpubs Rochellepark

**Editor-in-Chief** George Rostky

**Managing Editors:**  
Ralph Dobriner  
Michael Elphick

**Senior Associate Editor**  
Stanley Runyon

**Associate Editors:**  
Sid Adlerstein  
Dave Bursky  
Morris Grossman  
John F. Mason  
Max Schindler

**Contributing Editors:**  
Peter N. Budzilovich, John Kessler  
Alberto Socolovsky, Nathan Sussman

## Editorial Field Offices

### East

Jim McDermott, Eastern Editor  
P.O. Box 272  
Easthampton, MA 01027  
(413) 527-3632

### West

Dick Hackmeister, Western Editor  
8939 S. Sepulveda Blvd., Suite 510  
Los Angeles, CA 90045  
(213) 641-6544  
TWX: 1-910-328-7240  
Dave Barnes  
844 Duncardine Way  
Sunnyvale, CA 94087  
(408) 736-6667

## Editorial Production

Marjorie A. Duffy, Production Editor  
James Keane, Copy Editor

## Art

**Art Director,** William Kelly  
Richard Luce, Anthony J. Fischetto

## Production

**Manager,** Dollie S. Viebig  
Helen De Polo, Anne Molfetas

## Circulation

**Director,** Barbara Freundlich  
Trish Edelman

## Information Retrieval

Paula Greenleaf

## Advertising Promotion

Susan G. Apolant



# Across the Desk

## Another HP-25 variation

I have received many letters from other ELECTRONIC DESIGN readers in response to my letter, and I have exchanged calculator programs with many of them. I was interested in Mr. Lewart's letter (ED No. 15, July 19, 1976, p. 11) in which the HP-25 program given for the binomial coefficient evidently has several misprints.

A program can be written in 17 steps with the same general procedure apparently used by Mr. Lewart, but with one less storage register. (This may be important because in general program use, the HP-25 has a couple of storage registers less than could be effectively used by the sizes of programs possible.) Here is a variation of that program, which is suitable for stand-alone use, but which is even shorter.

```

Σ +
↑
RCL 4
RCL 7
gx = 0
GTO 14
÷
×
1
STO - 4
STO - 7
CLx
GTO 03
↓
↓

```

To compute  $k : n k$ , fPGRAM, FREG, R/S. It is preferable to use the smaller of  $k$  and  $(n-k)$  for  $k$ . (The other program version is obtained by replacing the first two steps with STO 7; ↻; STO 4; 1; and increasing the addresses in the GTO statements by 2. Then the FREG is not needed.)

The programmable pocket calculator quickly seems to be reaching a

calculation capability that makes it competitive with computer use in many situations. The readers of ELECTRONIC DESIGN seem determined to stay in the forefront of such developments.

Henry E. Schaffer  
Professor of Genetics

North Carolina State University  
School of Agriculture  
and Life Sciences

Box 5487

Raleigh, NC 27607

*Ed. Note: A corrected version of Mr. Lewart's program appeared in the October 25 issue.*

## Get your Optical Industry Directory

The 1977 two-volume edition of The Optical Industry & Systems Directory is now available. Vol. 1 is a buyer's guide listing over 1200 categories of products and services. Vol. 2 is an encyclopedia-dictionary of optical, electro-optical and laser technology. Both volumes are available for \$32 (prepaid USA) from The Optical Industry & Systems Directory, Dept. B77, P.O. Box 1146, 59 Bartlett Ave., Pittsfield, MA 01201. Vol. 2 only sells for \$12.95 (prepaid USA). Vol. 1 is not sold separately. Add \$3 for the set and \$2 for Vol. 2 for postage and handling.

## Real world can be a rough place

Leland Langston's circuit for detecting asynchronous data edges (ED No. 22, Oct. 25, 1976, p. 192) is beautifully simple. In the real world, however, things often aren't so simple.

If the data input is truly syn-  
(continued on page 8)

## Marcoflex. The switch that turns people on.

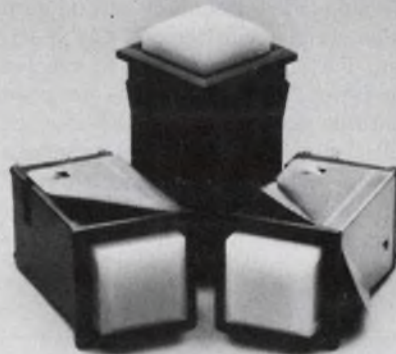

"... amazingly simple and reliable."  
"Why didn't I think of it?"

People are really getting turned on by our new Marcoflex 650 switches.

Which doesn't surprise us. After all, its patented flexing spring action is something of a *break-through*.

An incredibly simple design gives you electrical and mechanical characteristics associated with larger switches in a miniature, .625-inch package at an economical price.

Features include wiping action, multiple-point (bifurcated) contact, true snap action, high contact force, and positive tactile feel.

Plus alternate or momentary action, and excellent reliability.

Get turned on by Marcoflex yourself. Contact us today for full details.

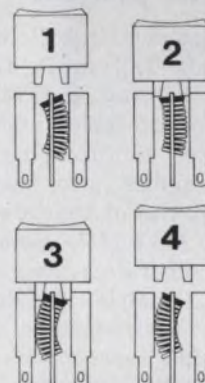

The patented Marcoflex mechanism.

### ILLUMINATED PRODUCTS INC.

A subsidiary of OAK Industries Inc.  
2620 South Susan St., P.O. Box 11930  
Santa Ana, CA 92711  
Telephone: 714/540-9471 TWX 910-595-1504

 COMPONENTS GROUP

CIRCLE NUMBER 5

Electronic Design welcomes the opinions of its readers on the issues raised in the magazine's editorial columns. Address letters to Managing Editor, Electronic Design, 50 Essex St. Rochelle Park, N.J. 07662. Try to keep letters under 200 words. Letters must be signed. Names will be withheld on request.

## ACROSS THE DESK

(continued from page 7)

chronous, its transition may violate the set-up/hold requirements of flip-flop  $FF_1$ . Behavior of the flop under such conditions is not specified.  $FF_1$  may be unable to resolve the input; it may glitch—enter an unstable state that, in the case of TTL, may last much longer than the specified propagation time of the circuit. The resultant output of gate  $G_1$  may very well look like this:

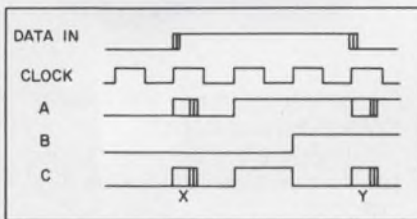

Either or both glitches, X and Y, may be present, giving a variable total of from two to four output pulses.

Therefore, the data input to  $FF_1$  must be synchronized with the clock in order for the given circuit to function reliably as intended.

Richard F. Binder  
Engineer

Modular Computer Systems, Inc.  
1650 W. McNab Rd.  
Fort Lauderdale, FL 33309

## A 'petite' protest

In "Compact High Voltage Supply Stands Tall in Performance" (ED No. 17, Aug. 2, 1976, p. 100), you make an apples and oranges comparison of three high-voltage power supplies. No mention is made that two of the three are designed to meet MIL specs, operate over a temperature range of  $-55$  to  $+71$  C, and be able to survive the MIL environments. The featured supply is commercial grade.

The article also implies that you get more for your dollar if you buy a large rather than a "petite" HV power supply. We can state from our experience that to squeeze 12 AVDC into a 6.4 in.<sup>3</sup> case, provide comparable stability and regulation as power supplies three times the volume and meet all the MIL requirements at the same time are

far more difficult and expensive. LectroLogic not only did this but we built our LP power supply with only hermetically sealed semiconductors, and used established reliability components.

Irwin B. Galter  
President

LectroLogic Inc.  
9406 N. 107th St.  
Milwaukee, WI 53224

## Misplaced Caption Dept.



Welcome to Thomson CSF.  
Our chief engineer will be right  
with you.

Sorry. That's the Boucher Room in the Frick Collection, New York City.

## Of layoffs and leadership

Layoffs, layoffs, and more layoffs—is that what today's young engineer has to look forward to? As a young engineer new to the ranks of electrical engineering, I have already witnessed the deleterious effects upon both my colleagues and classmates: Graduates can't get jobs, and engineers—often the older, over-40 crowd—are laid off much too frequently, often having to support a wife and family on unemployment.

Yet I constantly read in our newspapers that engineers are in such great demand. Who is originating these stories? Could the IEEE be behind this dastardly deed?

Now I hear the IEEE leadership is dominated by academics and company executives, men who earn their livelihood by graduating more engineers, paying them less,

and making them work uncompensated overtime. And when the interests of these men conflict with those of the working EE—as they often do—history shows who gets served first.

No other trade or professional association, union or federation would allow a member of management to be a union or association member, let alone a leader or officer! It is time we stood up to demand of the IEEE a stop to conflict-of-interest leadership. Then, and only then, will the IEEE become an organization that truly represents the engineer.

Robert Clare

Well Corp.  
54 Cottage St.  
Taunton, MA

## Leadership

A corollary to your editorial, "COMPANY POLICY," in the December 6th issue, could relate to the willingness of managers to be led by the computer. "It is a 'sophisticated' tool; we are sophisticated; ergo we will work with it. It is faster (hence better) than we are; so we will follow it."

Martyn Hodes

Spectral Dynamics Corp.  
of San Diego  
San Diego, CA 92112

## FCC 'interference' beats equipment interference

The article on EMI/RFI (ED No. 20, Sept. 27, 1976, p. 24) is definitely not up to your usual standards. Even on the cover of the magazine, you point out that EMI/RFI is "racing out of control," but then you go on to complain about the actions of the FCC to reduce these problems.

I, for one, applaud the FCC for finally getting in gear to update its regulations, and I think your magazine and our profession should offer help and solutions that provide jobs rather than allow selfish interests to whine about "interference." Better a little government interference than a lot of rf interference!

Wilson Lamb

Research Associate  
Ocean Engineering Department  
University of Rhode Island  
College of Engineering  
Kingston, RI 02881



# MEASUREMENT **COMPUTATION** **NEWS**

product advances from Hewlett-Packard

FEBRUARY 1977

## in this issue

RS-232 interface for  
9825 desktop computer

New terminal for APL\3000—  
A Programming Language

Transistor offers 1.6 dB  
max NF at 1.5 GHz

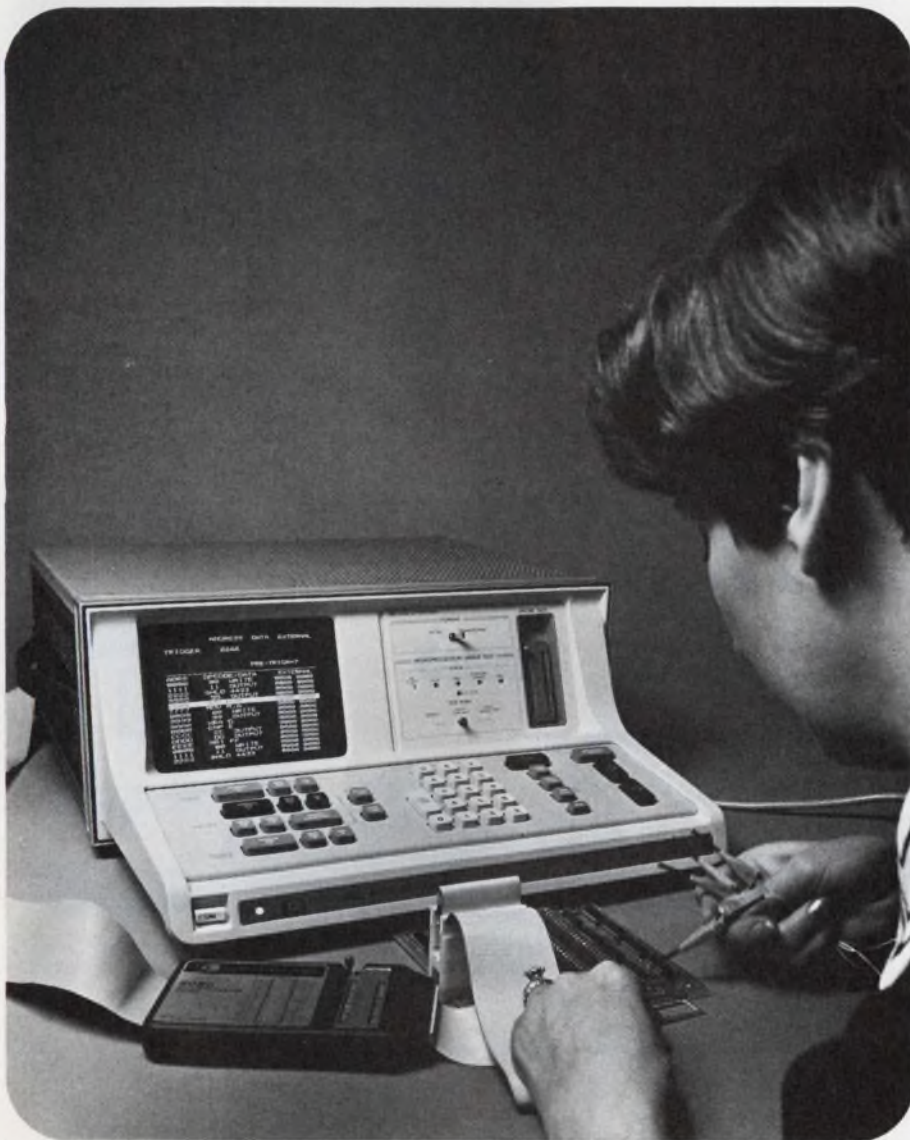

Direct connection is made to the microprocessor with the "clothespin" clip. The EXTERNAL connections are through separate leads. These may plug directly onto test pins, or they may be inserted in pincher-type miniature probes as shown. The display on the CRT is a probe test verifying internal operations of the logic analyzer.

## A new logic analyzer dedicated to debug microprocessor-based systems

As new applications for microprocessor-based systems proliferate, Hewlett-Packard recognized the need for an instrument that could handle the vast quantity and complexity of data during system debugging. This measurement need resulted in the development of the new HP 1611A logic state analyzer with powerful triggering capabilities, mnemonic display and time interval measurements, saving you a significant amount of time in debugging microprocessor-based systems.

An extremely important feature of

*(continued on third page)*

## Economical counters



The 80 MHz 5381A and 1.3 GHz 5300B/5305B are two of the choices HP gives you in economical counters. Two of the eleven 5300B modules are at the right; the D/A converter and battery pack.

Many counter problems only require a simple, economical and dependable instrument. It is for this reason that the frequency-only 5380 family and the modular 5300 system were developed.

The 5381A, 5382A, and 5383A represent an inexpensive solution to a frequency only measurement problem up to the frequency ranges of 80 MHz, 225 MHz, and 520 MHz, respectively. All these counters feature direct count-

ing capability (a resolution of 1 Hz in 1 second), as well as an optional TCXO for improved measurement accuracy.

For applications involving counter measurements other than just frequency, the modular 5300 system is an excellent and economical solution. Configurations can be changed to meet different needs by simply snapping on an appropriate module. For example, frequency extensions to 1.3 GHz, time interval measurements to

1 ns, battery operation, digital multimeter, and even "talk" capability on the H-P Interface Bus are just some of the possibilities with the expandable and economical 5300 system.

*For the whole story, check K on the HP Reply Card.*

## HP-IB programmable word generator with pulse parameter control for thorough digital testing

Hewlett-Packard's 8016A word generator is a versatile 50 MHz data source ideal for digital testing applications. Using it, you first set up your test pattern in the generator's 9-channel by 32-bit memory. By adjusting clock and inter-channel delays, pulse widths and amplitudes, you can easily simulate worst case or other conditions.

Multi-channel parametric tests such as set-up times, hold times, propagation delay, critical timing, sensitivity and noise immunity tests, are now easy with the total capability of the 8016A.

Now, you can use the 8016's multi-channel capabilities in CMOS applications as well. A new accessory, the HP 15451A TTL to CMOS translator, amplifies 4 channels of TTL information to CMOS levels with pulse amplitudes determined by the CMOS power supply.

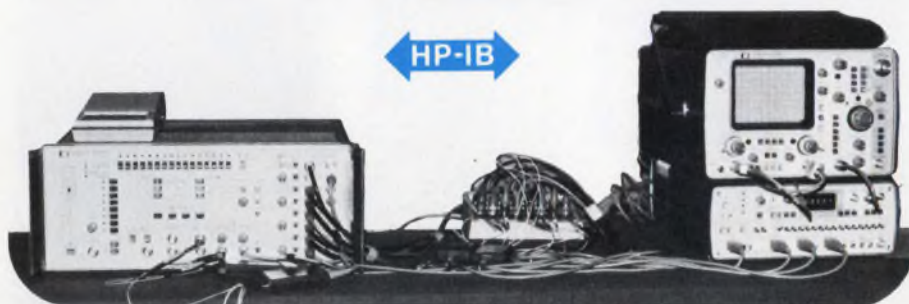

In combination with HP's 1600A logic analyzer, you have a practical stimulus-response combination for observing your logic circuits in action. Functional tests of your logic circuits, memories, microprocessors, etc. can be performed quickly with the 8016A/1600A combination.

A remote programming capability, (Option 001) allows fast loading of data to the instrument's memory with an HP Interface Bus compatible card reader, calculator, or minicomputer—a valuable option for on-line testing where speed and accuracy are important.

*For details on this powerful word generator, check M on the HP Reply Card.*

## Microwave synthesizer application note now available

A new HP Application Note 218-1, *Applications and Performance of the HP 8671A/8672A*, details applications ranging from satellite communications testing to electronic warfare and component test. The 8672A (M/C News, May 1976) has AM/FM modulation and calibrated output usually associated only with signal generators but also resolution, spectral purity, stability and programmability of a high quality synthesizer.

A typical section of the note describes a technique to obtain finer frequency resolution of 1, 2, or 3 Hz at microwave frequencies from 2 to 18 GHz. Another section covers considerations and additional equipment required for microwave coverage to 36 GHz by use of external doublers.

Other sections provide detailed information on the actual operational



For precision signal simulation from 2 to 18 GHz, the HP 8672A provides +3 to -120 dBm signals with AM and FM modulation, and all front panel functions remotely programmable.

performance of the 8672A, giving the user considerable help in getting the synthesizer applied to his job quickly. For example, specific synthesizer programming sub routines are listed and annotated to assist in writing application programs.

For your free copy, check R on the HP Reply Card.

## Dedicated logic analyzer (continued from first page)

the 1611A is its ability to display the mnemonic set used by the microprocessor in the system. If cycle-by-cycle analysis is desired, the data can be displayed in the absolute mode where the display is in hex or octal machine language. Eight additional uncommitted probes allow you to relate activity elsewhere in the system.

With new highly sophisticated triggering capabilities, the 1611A permits the framing of a real-time data window around virtually any event, or set of related events or desired sequence of

system operations. The 1611A also accurately measures execution time or counts selected events between two keyboard-selected events.

Mnemonic display has been made possible by the use of "personality" modules—consisting of special circuits and microprocessor probe—to monitor specific microprocessors. Presently, two options are available: Option 080 for the 8080 and Option 068 for the 6800. Additional optional modules will be available shortly. To reconfigure your analyzer, parts can be ordered as a kit and easily exchanged in about 15 minutes.

An internal 8-bit MOS microprocessor is used as a controller in this new keyboard controlled logic state analyzer. The CRT displays both the measurement conditions and results.

For detailed information, check B on the HP Reply Card.



## Con conversationally interactive programmable data logger also operates in unattended mode

A programmable data logger is a system to collect and analyze data, make decisions based on the data and interact with the test, process, experiment, instrument, or the system which generates the data.

The 3051A system can measure dc from 1 microvolt to 200 V with 1  $\mu$ volt resolution, ac from 10  $\mu$ volt to 200 V with 10  $\mu$ volt resolution, and ohms from 1 milliohm to 10 Megohms with 1 milliohm resolution. The system measures dc at five channels per second, ohms and ac at 4 channels per second.

System configuration includes the HP 3455A high accuracy/resolution 6½-digit DVM, a 3495A input multiplexer, a 9815A computing controller, and a 9815A HP-IB I/O card.

The user communicates with the system via an alphanumeric keyboard; the system communicates with the user by a numeric display and an alphanumeric thermal strip printer. This conversational interaction capability allows the system to be operated by personnel with no formal knowledge of programming or data logging. Auto start capability allows the system to operate unattended.

For more information, check D on the HP Reply Card.

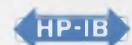

The Hewlett-Packard 3051A data logging system scans from 1 to 80 channels of analog data. A ten channel relay actuator card provides alarm and multiple switching functions.

## Easy tape duplication with expandable storage up to 1 Mbyte using new external memory unit

The HP 9877A External Tape Memory is a self-contained peripheral that can hold up to four cartridge drives to expand the capabilities of the HP 9825A desktop programmable calculator. Using the same cartridge unit, storage capacity from 250,000 to 1 Million bytes is now provided in increments of 250,000 bytes.

Each tape cartridge unit has a built-in two-track drive which provides rapid access to data and programs with automatic verification of all stored information. A 2,750 byte/second data transfer rate and a 228.6 cm/second search speed makes it a very fast and inexpensive method of storing, retrieving or duplicating data. An HP 9877A, fitted with four tape units, takes about six seconds to locate any file from any tape in the unit.

Using the duplicator program supplied with the 9877A, a full master cartridge can be copied and verified in about 16 minutes. Two copies, from the same master data tape, are sequentially copied and verified in 26 minutes and four copies in 50 minutes.

*For more information on expanding tape storage capability, check P on the HP Reply Card.*

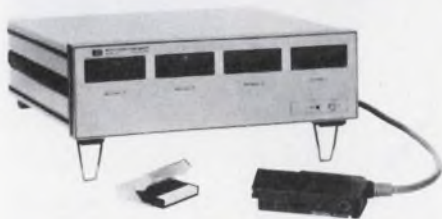

External tape memory presents an inexpensive method of storing large volumes of data plus the convenience of duplicating cartridge tapes.

## Now, interface your 9825A desktop to a teletype or a remote computer



Data can now be gathered from a remote terminal or computer, reduced and analyzed by the high speed processing of the 9825A desktop, and results returned to the remote location.

The HP 98036A bit serial interface opens new areas of application for the HP 9825A desktop computer. In addition to bit parallel, binary coded decimal, and HP-IB (Hewlett-Packard's implementation of IEEE Standard 488-1975) interface capability, the advent of the 98036A allows connection to such devices as teletypes, CRT terminals, and telephone modems.

Because of the flexibility of the 9825A desktop computer, the 98036A can be used to configure the 9825A as a timeshare terminal. This allows the keyboard of the 9825A to be used to send information to a remote computer. The 9825A display or an attached printer can be used for output information received from the remote computer eliminating the need for another terminal in a distributed system.

The vectored interrupt capability of the 9825A further enhances the usefulness of the 98036A. The desktop computer's buffered input/output scheme will allow multiple interfaces to communicate simultaneously with different remote devices while locally executing another program. Priority interrupts ensure that more important information can be dealt with quickly to maximize system throughput.

Configuration of the 98036A is ac-

complished via internal switches and by programming the 9825A. The number of bits per character, parity, internal/external data clocking, and bit rate are configured by the user. The 98036A operates in an asynchronous mode with data rates from 75 bits per second to 9600 bits per second.

*For complete information, check E on the HP Reply Card.*

## Three more spectrum analyzer application notes

Three new application notes relating to spectrum analyzers have just been published. Subjects of these brief, informative notes are:

- AN 150-9: Noise Figure Measurement
- AN 150-10: Field Strength Measurement
- AN 150-11: Distortion Measurement

In each case, the theory is reviewed, measurement procedures described, and examples of measurements presented. Advantages and tradeoffs that apply to using the spectrum analyzer are discussed.

*For free copies of these new notes, just check Q on the HP Reply Card.*

## New display station handles both APL and ASCII data

Hewlett-Packard designed the 2641A Display Station to complement the power and elegance of the APL language. Key to the secret of APL's capability is a distinctive set of characters, each one symbolizing a powerful operation.

The 2641A is a member of the 2640 family of HP terminals that pioneered internal mini-cartridge mass storage and offers features such as self-test and "soft keys". The 2641A has these family features, plus a versatile keyboard labeled with both the APL and standard ASCII characters.

The 2641A supports a full 128 APL character set, a 64 character overstrike set and a 64 character Roman set. These sets represent the special symbols used on IBM and Burroughs systems, and most symbols used by timeshare bureaus that support APL.

Overstruck characters, an APL innovation, are a combination of two existing characters and are produced by striking one key, backspacing, and striking a second key. Without the high resolution display of the 2640 family, overstrike characters would be difficult to read. The 2641A assures crisp, clear characters.

After a user inputs an overstrike character, a search and compare with the existing set in memory assures that the character is valid.

The full complement of display enhancements (inverse video, blinking, half-bright, etc.) are standard, and the optional line drawing set allows the creation of readable forms with visual prompts.

*For more information on the 2641A, or other family members, check C on the HP Reply Card.*

## Use the power of APL on a small general purpose computer

With the advent of APL\3000 in conjunction with the HP 3000 Series II computer and a new interactive terminal, the 2641A, designed especially for the language, APL is now more readily available as a new dimension in computational capability.

APL\3000 is the first APL software available on a low-cost general purpose computer. Patterned after APLSV, this enriched version from Hewlett-Packard is particularly useful for business, education, scientific and engineering applications involving the manipulation of large data arrays.

```
DVR 'HEWQUEENS'
ANS:HEWQUEENS;MEM;MUSE:P;X;J;I;K
MEM:MUSE:118,110:510
J=1 0 1-78
CYCLE:-REGRESS+RANK=1+I-(0-1)11+8*(J-1)MESCJ+R J10MUSE:1
I1J1=0 PLACQUEENS 778
-OUT:R(J)-JAP+1 0 1-1
JOIN:R(I)-MUSE10+K-(J-P)+MEM(R+(J-P)-1)-P
-CYCLE
REGRESS--NOSOL+P=0J=J-1
I=I+R(J)
-JOIN
NOSOL ANS: 'NO SOLUTION'
-8
OUT:ANS: 'SOLUTION IS ' 88
-
DCP 'PLACQUEENS'
PLACQUEENS 8;8
-818
B=K: 0:0
D=ESC: 'M' ESC: 'H'
D=8: '8'
D=ESC: '8'
```

APL, A Programming Language, has a large following of users, who embrace its use for its capacity to express complex mathematical applications in a concise manner; numerous computer operations can be compressed into just a few lines of code.

Because of its mathematical power, APL is of growing interest to those in the fields of statistics, finance, forecasting and modeling.

Hewlett-Packard's APL\3000 has the following enhancements:  
**Large workspaces.** Since work spaces are virtual, they are effectively limited only by the on-line disk storage available. As code is needed and used, it is brought from disk into main memory. APL\3000 is infinitely more useable with this close-to-infinite workspace. Microcoding the "virtual workspace" scheme results in faster execution.  
**Dynamic compiler.** APL is implemented as a dynamic, incremental compiler and not a simple interpreter; compiled code is preserved and when possible, used repeatedly without recompiling. The result is faster execution of repetitive programs.

**Powerful easy-to-use editor.** The APL\3000 editor is a full text editor as well as a function editor. Commands are given in English-like words. Anyone who has made a mistake in editing will appreciate "UNDO" which allows quick recovery from an editing error avoiding long, complex recovery edits typical of most editors today.

**Use of microcode.** The most time consuming aspects of the subsystem have been microcoded to speed operation.

The 3000 Series II computer treats APL\3000 as a standard language subsystem. When APL is executing, up to 16 terminals may be operating either in batch or interactive mode, with any of the 3000's other languages: FORTRAN, COBOL, RPG, BASIC and SPL.

*For additional details, check A on the HP Reply Card.*



**A new interactive terminal designed especially for APL, provides a clear, sharp display. APL is a terse and concise language for describing processes and algorithms.**

## Multiprogrammer expands your testing capabilities

Test engineers can now plug off-the-shelf units together and assemble their own automatic test and measurement system quickly and economically. A calculator-based HP Interface Bus (HP-IB) multiprogrammer system is designed for ease in communicating bi-directionally with your device under test.

A basic system includes the controller, (a desktop programmable calculator HP 9825 or 9830) connected via the HP-IB to a multiprogrammer interface unit, a 6940B multiprogrammer, and from 1 to 15 randomly-addressable I/O cards that plug into the 6940B mainframe.

Up to 15 extender mainframes, each holding 15 plug-in cards, can be combined permitting system expansion up to 240 I/O channels controlled by a single calculator.

Input card functions include current or voltage monitoring, digital input, counting, and event sensing. Output functions cover stimulus and control including voltage, current, resistance, relay contacts, digital bit patterns, stepping motor control, time and frequency references.

For more details, check L on the HP Reply Card.



HP-IB multiprogrammer building-block components bring the power, economy, and ease of programming of HP desktop programmable calculators to your automated testing system.

## Step attenuators now operate dc to 26.5 GHz

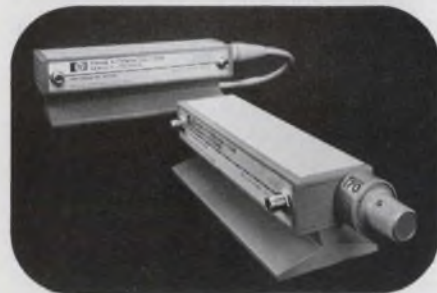

The APC-3.5 connectors used on these HP 8495D/K 70 dB step attenuators are fully compatible with the industry-standard SMA.

Considerable microwave activity is now focusing on coaxial designs above 18 GHz. Such diverse areas as satellite communications and electronic warfare require measurement components operating to 26.5 GHz and beyond.

The new HP-developed APC-3.5 coaxial connector provides a mode-free, beaded, air line for operation to 34 GHz (*Microwave Journal*, July '76). By use of this new connector, a step attenuator from the HP 8495 series is able to operate dc to 26.5 GHz.

HP 8495D manual step attenuator offers 70 dB range in 10 dB steps. HP 8495K is the programmable version with the same specifications. Solenoids operate from 20-30 volts at 110 mA. These attenuators are composed of four attenuator sections (one 10 dB card, and three 20 dB cards) connected in cascade. Each section consists of a precision thin-film attenuator card, a lossless thru line, and a ganged pair of gold plated center conductor contacts that switch the attenuation card in and out. This combination results in high accuracy and excellent repeatability (typically 0.03 dB).

For details, check N on the HP Reply Card.

## Take your instrumentation tape recorder with you

Now HP instrumentation tape recording quality is available to you in the field, where and when you need it. A dc to ac inverter, capable of operating your HP 3964A or 3968A instrumentation tape recorder, from either a 12 or 28 dc voltage source is now available as Option 021.

This new inverter option is included as part of the recorder itself and is specified as part of the original purchase. Total weight of the recorder with inverter is 31.3 kg (69 lbs).

If you have need for a rugged, portable tape recorder to be used in a variety of applications, send for data on the HP 3964A and 3968A recorders. Please check F on the HP Reply Card.

A 66-page catalog describing consumables available for HP plotters, x-y recorders, strip chart recorders, oscillographic recorders, and instrumentation tape recorders is available.

Check G on the HP Reply Card.



Analysis of vibration is possible when you transport your instrumentation tape recorder with you. Shown above is a Hewlett-Packard ITR recording data "live" on a speedway.



# HEWLETT-PACKARD COMPONENT NEWS

## Two new low-noise microwave transistors

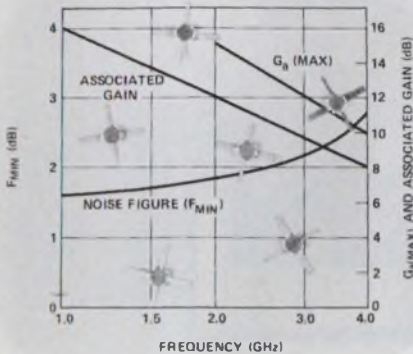

Packaged in the hermetic HPAC-100, a rugged metal/ceramic package, both devices can meet the requirements of MIL-S-19500 and the test requirements of MIL-STD-750/883.

With only 1.6 dB maximum noise figure at 1.5 GHz, the HXTR-6104 is ideal for use in low-noise amplifiers, in communications equipment and radar preamps. Associated gain at NF bias conditions is 13 dB minimum.

The HXTR-6103 with 2.2 dB maximum NF at 2 GHz and 11 dB minimum associated gain is a replacement for the Fairchild FMT 4005.

Ion implantation techniques and titanium-platinum-gold metallization are used in both devices.

For details, check J on the HP Reply Card.

## Two new technical notes

AN 967 describes the design of a single-stage state-of-the-art low noise amplifier at 4 GHz using the HXTR-6101 silicon bipolar transistor. Both the input and output matching networks are described. For a copy of AN 967, check T on the HP Reply Card.

AN 968 discusses IMPATT amplifier design. A waveguide amplifier produced 2 watts of power with 10 dB gain at 11.2 GHz. Using a coaxial structure, similar performance was obtained at 8.4 GHz. For a copy of AN 968, check U on the HP Reply Card.

## No dc bias needed with new Schottky detector diodes

These new zero bias Schottky diodes eliminate the problem of temperature compensation of the dc current required in sensitive detector circuits using conventional detector diodes. The high voltage sensitivity of these diodes makes them especially suitable for narrow-band video detectors in high-frequency receivers and measurement equipment.

The HSCH-3000 series diodes have a typical voltage sensitivity of 10 to 50 millivolts of output per microwatt of input power (depending on device type) at 10 GHz. Conventional Schottky detector diodes with dc bias applied produce 5 to 10 mV/ $\mu$ W. Both low impedance (2000 to 8000 ohms) and high impedance (80,000 to 300,000 ohms) devices are available).

For a technical data sheet, check I on the HP Reply Card.

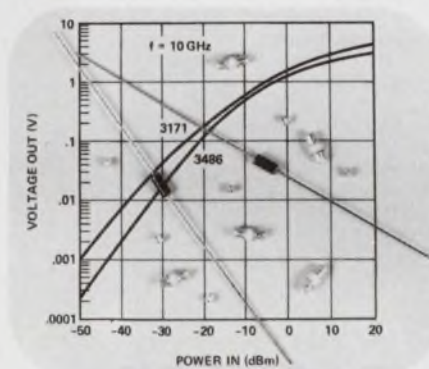

The HSCH-3000 series zero bias Schottky diodes are available in either ceramic or glass axial lead packages.

## New isolator rejects 100X more common mode noise

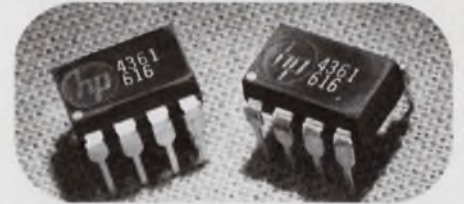

Combining a GaAsP LED and an integrated high gain photon detector, this high speed gate provides maximum dc and ac circuit isolation while achieving TTL compatibility.

A design using an internal shield for high common-mode rejection (CMR) which guarantees common-mode transient immunity of 1000 volts/ $\mu$ sec minimum is the key feature of these new optically coupled isolators.

The 5082-4361 is designed for use in high-speed, high-noise line receiver applications, logic-to-logic isolation applications and high-noise power control related applications.

For details, check H on the HP Reply Card.

## How to use optically coupled isolators in linear applications

Application Note 951-2 describes how isolators can be useful in applications where analog or DC signals need to be transferred from one module to another in the presence of a large potential difference or induced noise between the ground or common points of these modules.

Applications are those in which large transformers, expensive instrumentation amplifiers or complicated A/D conversion schemes are used.

The note covers the basics of opto-isolator operation. Specific HP devices are recommended.

For your free copy, check S on the HP Reply Card.

# High performance and precision PLUS wideband coverage—all in one RF sweeper

HP 86222B/8620C RF sweeper covering 10 MHz-2.4 GHz generates crystal markers that add frequency identification to wideband polar plots made with the HP 8410B Network Analyzer.



Hewlett-Packard's 10 MHz-2.4 GHz RF plug in (models 86222A and B) for the 8620C sweeper mainframe offers performance capabilities that make it a truly multi-purpose test signal source. It can cover the 10-2400 MHz range in one continuous sweep and deliver calibrated RF output from 0 to +13 dBm with full range flatness of  $\pm 0.25$  dB. For each of its key performance characteristics—e.g. frequency accuracy, linearity, stability, residual FM, harmonics, spurious content—the 86222 matches or ex-

ceeds other wide-range RF sweepers. For overall performance specifications, the 86222 stands alone.

This excellence of performance also commends the 86222 for narrow-band sweep testing as well. In fact, many CW test requirements can be filled with this sweeper.

The 86222B version adds precision crystal-controlled "birdie" markers (1, 10, 50 MHz) for additional precision and convenience in setting or identifying frequencies. These digitally-processed markers are uniquely com-

patible with such analysis systems as the HP 8410B (vector) Network Analyzer and the HP 8755 (scalar) Frequency Response Test Set. An applications-oriented data sheet presents many ideas on how this sweeper contributes to better RF testing.

*For all the details, check O on the HP Reply Card.*

**East**-4 Choke Cherry Road, Rockville, MD 20850,  
Ph. (301) 948-6370.

**South**-P.O. Box 10505, Atlanta, GA 30348,  
Ph. (404) 434-4000

**Midwest**-5201 Tollview Dr., Rolling Meadows, IL 60008,  
Ph. (312) 255-9800.

**West**-3939 Lankershim Blvd, North Hollywood, CA  
91604, Ph. (213) 877-1282.

**Europe**-7, rue du Bois-du-lan, P.O. Box, CH-1217, Meyrin-2,  
Geneva, Switzerland, Ph. (022) 41 54 00.

**Canada**-6877 Goreway Drive, Mississauga, Ontario,  
L4V 1M8, Ph. (416) 678-9430.

**Japan**-Yokogawa-Hewlett-Packard Ltd., Ohashi  
Bldg., 1-59-1 Yoyogi, Shibuya-ku,  
Tokyo 151, Ph. 03-370-2281/92

**HEWLETT**  **PACKARD**

Sales and service from 172 offices in 65 countries.

**MEASUREMENT** **news**  
**COMPUTATION**  
*product advances from Hewlett-Packard*

January/February 1977

New product information from

**HEWLETT-PACKARD**

Editor: Iona M. Smith

Editorial Offices:

1507 Page Mill Road  
Palo Alto, California, 94304 U.S.A.

# Mas/Ter INTERCONNECT SYSTEM INSULATION DISPLACEMENT CONNECTORS

**High-speed mass termination that lowers your total installed cost!** Here's the most exciting advancement in connector technology since Cannon introduced D Subminiatures—our new Mas/Ter-D Subminiature rectangular series of connectors and Mas/Ter-UND header series.

Designed to lower your total installed cost with a new level of reliability in mass terminating up to 50 conductors... quickly... error-free!

Look at these advantages:  25% more conductor surface contacted.  Integral strain relief on the conductor insulator.  Uniform contact force under extreme temperature, shock and vibration.  Mas/Ter-UND accommodates 26 thru 28 AWG, while Mas/Ter-D offers two ranges of 22/24 and 26/28 AWG.



With the Mas/Ter Interconnect System, the entire connector is terminated at one time with no insulation stripping, no complex tooling... using standard round conductor flat cable or individual wires, solid or stranded. The contact penetrates and displaces the insulation without severing the conductor and still provides insulation support to the wire. Integral contact spring action wipes the conductor during termination to produce a high-force, low-resistance interface.

Mas/Ter-UND connectors and pin headers are intermateable and intermountable with other similar connectors, and Mas/Ter-D pin-and-socket connectors are fully intermateable and intermountable with Cannon's D Subminiature series. These are only the first of a growing family of insulation displacement connectors coming your way from Cannon.

**Write or call today for new detailed literature!** ITT Cannon Electric, 666 East Dyer Road, Santa Ana, California 92702. Call toll-free, 24 hr. (800) 854-3573. In California (800) 432-7063.



Six decades on the leading edge of interconnect technology.

**CANNON ITT**

# You Don't Have To Beg, Borrow Or Buy...

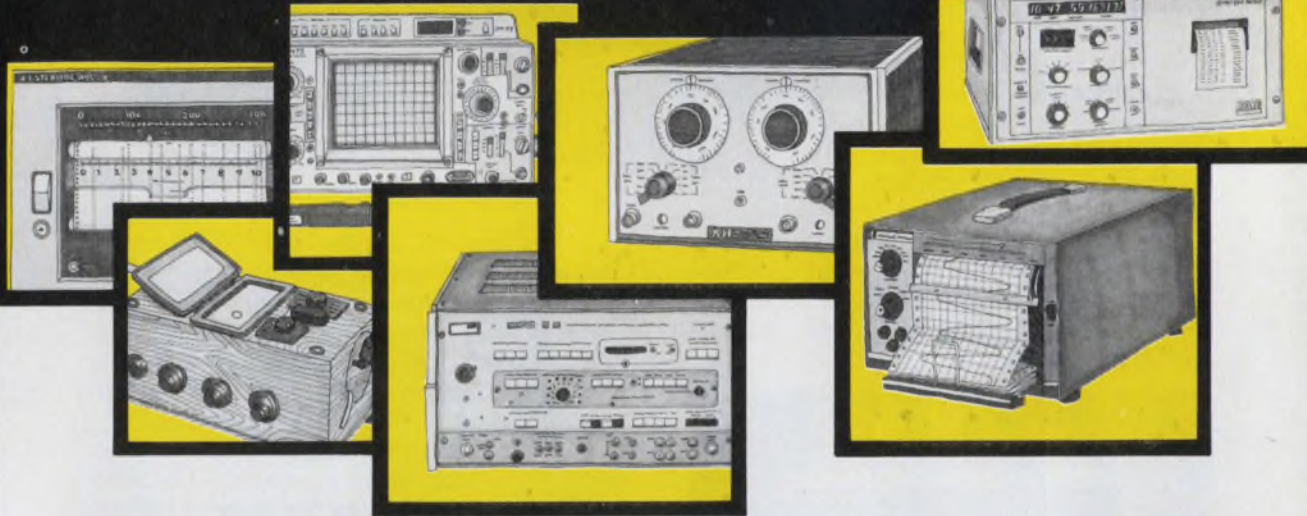
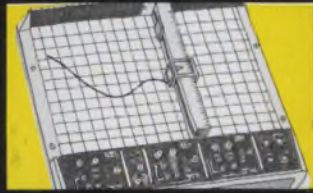

## Rent'em From GE

Short or long-term instrument rentals give you flexibility and economy.

GE has over 9,000 instruments available for immediate shipment: □ Tek Scopes □ Biddle Megger Insulation Testers □ H-P Signal Generators □ Honeywell Oscillographs □ Complete Data Systems □ Esterline Angus Recorders □ GE Chart Recorders □ Modems □ Communication Terminals ... all calibrated to the manufacturer's specs.

We have over 100 Sales/Service Centers,

and one of them is near you. In addition to maintaining our Rental Inventory, they can also repair and calibrate your own equipment.

Don't borrow someone else's GE Rental Catalog. **Call collect (518) 372-9900** or your nearest Sales/Service Center.

**Quick-rental<sup>®</sup>  
instruments**

GENERAL  ELECTRIC

ALA. BIRMINGHAM (205) 925-3101 • ARIZ. PHOENIX (602) 278-8515 or 8516, TUSCON (602) 294-3139 • CAL. LOS ANGELES (213) 674-7900, SAN FRANCISCO (415) 436-9260 • COL. DENVER (303) 371-1260 • CONN. SOUTHINGTON (203) 261-4059 • FLA. JACKSONVILLE (904) 751-0610 • GA. ATLANTA (404) 458-2231 • ILL. CHICAGO (219) 933-4500 • IND. INDIANAPOLIS (317) 639-1565 • KY. LOUISVILLE (502) 452-3311 • LA. NEW ORLEANS (504) 367-6528 • MD. BALTIMORE (301) 837-4500 • MASS. BOSTON (617) 396-9600 Ext. 160, SPRINGFIELD (413) 781-1111 • MICH. DETROIT (313) 285-6700 Ext. 212 or 209 • MINN. MINNEAPOLIS (612) 522-4396 • MO. KANSAS CITY (816) 231-4377, ST. LOUIS (314) 965-7115 • N.J. CLIFTON (201) 471-6556 • N.Y. BUFFALO (716) 876-1200, SCHENECTADY (518) 385-2195 • N.Y.C. CLIFTON, N.J. (201) 471-6556 • N.C. CHARLOTTE (704) 525-0311 • OH. CINCINNATI (513) 874-8512, CLEVELAND (216) 523-6382, TOLEDO (419) 691-3501 • OR. PORTLAND (503) 221-5101 • PA. PHILADELPHIA (609) 424-4450, PITTSBURGH (412) 462-7400 • TEX. DALLAS (214) 357-7341, HOUSTON (713) 672-3569 • VA. RICHMOND (804) 232-6733 • WASH. SEATTLE (206) 854-0211 • W.V. CHARLESTON (304) 346-9421 • WISC. MILWAUKEE (414) 744-0110 • PUERTO RICO PONCE (809) 843-4225.

FEBRUARY 15, 1977

## Chess and chance games win at electronics show

The microprocessor invasion of the home entertainment field is creating new generations of interactive video and other electronic games. Among such games highlighted at the Consumer Electronics show in Chicago were "man-against-computer" games, such as a chess game from Fidelity Electronics, and games that feature lifelike figures and objects, like General Instrument's new Black Jack and Slot Machine chip sets.

The standout of the interactive games at the show was the Chess Challenger (see photo), which can play against a Nippon Electric 8080  $\mu$ P with a 2.5-k memory. The current Challenger is programmed, according to Michael Samole, executive vice president of Fidelity Electronics, Ltd., Chicago, so that an average player can beat it from 20 to 70% of the time.

As in regular chess, pieces are placed on a game board moved by the player. Whenever the player makes a move, he enters it on the keyboard. The computer responds with its best counter move, which is programmed in accordance with the standard rules of chess.

If the computer move checkmates the player, a LED indicator is energized. If the player beats the game, another indicator says, "I lose."

Any time during the game the position of all pieces on the board can be verified by stepping the game through its moves with an Enter button through which the game moves are placed in it.

While some of the top chess experts may beat this version consistently, Samole says that the program ROM can be expanded to 5-k or 7-k for more sophisticated moves.

The trend to complex, interactive video games that feature lifelike objects and figures was heralded



Chess Challenger plays against an 8080  $\mu$ P with a 2.5-k memory.

at the Chicago show by an announcement from General Instrument's Microelectronics Div. of a series of chip sets for new games and chip-set combinations. The largest manufacturer of video-game chips demonstrated such interactive games as Black Jack, Slot Machine and Tic Tac Toe.

With GI's AY-3-8888 chip, both the Black Jack and Slot Machine games can be played against the resident microcomputer.

The Black Jack game is a single-player Las Vegas-style game that uses the equivalent of four-card decks (208 cards). The Las Vegas rules built into the game include doubling and insurance betting. The "cards," which appear on the screen with the suit symbol and a number are dealt from a virtual four-deck "shoe" stored in the  $\mu$ C memory.

The game starts after the player enters the amount in his bankroll. The game requests the player to enter a bet in \$10 increments with a \$90 limit. After a player places his bet, his hand and the computer's hand are dealt.

With GI's Slot Machine, the well-known bell, orange, cherry, dollar-sign, star and bar symbols appear on the screen in a three-box area that simulates the reels of an actual slot machine. Play begins after the game requests the player to either place a bet of \$1 to \$9 or in

a continuous mode that automatically places a \$1 bet. The mode runs repeatedly with the depression of a "0" key each time a bet is requested.

Lifelike figures and objects were also featured in Magnavox's Odyssey 500 game. Other highlights of the show included a variety of interactive third-generation video games, an interactive hand-held-calculator-sized football game from Mattel Electronics, and the demonstration of the first  $\mu$ P-controlled home pin-ball machine from Bally. Dubbed the Fireball, the machine contains diagnostic programs to enable the owner to pinpoint trouble right down to the  $\mu$ P circuit board.

## Soviet process control will go the $\mu$ P route

The Soviet Union is beginning to put microprocessors into its process-control systems, and this year will begin production of a new line of microprocessor-based controllers.

Microprocessors are being produced at five integrated-circuit facilities in Moscow, Leningrad and Siberia, according to Professor Boris Timofeev, a leading Soviet expert on process control in the metallurgy industry and a speaker at a series of process-control seminars sponsored by Control Data Corp. (CDC). Addressing newsmen at a Washington, DC, press conference prior to the seminars, Timofeev noted that for process-control applications, the microprocessors will use an 18-bit format—two 8-bit words plus two parity bits—and operate at 200,000 arithmetical functions per second. More complex functions call for microprocessors with word lengths of 30 bits or more.

The new controllers will be interchangeable with the current M6000 and M7000-series controllers, added Timofeev.

## Small PBX system has 'large' capabilities

A small (24 to 120 lines) electronic PBX with features formerly available only with much larger PBX systems is now being marketed in the United States by Nippon

Electric Co. Ltd. (NEC) of Japan.

Besides more than 50 built-in service features, including a  $\mu$ P with stored-program control and all solid-state switches, the NEAX 12 offers several options: a station-message detail system, outgoing trunk queuing, flexible routing, call back and call waiting.

"Trunk queuing" occurs when a user finds all trunks busy. He dials a special code and hangs up. The processor remembers the call being placed and, when a trunk is free, calls back to let the caller dial his call.

The "call-back" feature provides a similar service for internal calls.

With "call waiting," when an outside call comes in and the line of the intended recipient is busy, the recipient may be alerted by a beep tone audible only to him. Then, if he wishes, he can take the new call while interrupting and holding the original party.

Unlike ordinary systems of its size, NEC officials say, the NEAX 12 need not be reprogrammed after a power failure. The generic program is nonvolatile and a memory package with built-in, rechargeable batteries assures protection of station data in the event of a power outage.

Other major features include plug-in modular construction that is fully connectorized, easy expandability that can increase the number of lines in 4-line steps up to a total of 120 lines, a console that indicates call progress with lighted letters rather than blinking lights.

The company plans to start manufacturing electronic products in the United States—the NEAX 12 to be one of them—by the end of this year.

## NDRO core memory protects data from noise

A memory system for microcomputers, designed for use in heavily industrial environments, uses ferrite beads to achieve nonvolatility of its stored data. Once written, the data remain undisturbed through power outages and noise spikes and even during read operations. This feature can eliminate tape drives, floppy discs, firmware ROMs and other devices used to "bootstrap" the system into operation after a power outage or severe

noise conditions.

Controlex's CM-203 Electrically Alterable ROM doesn't actually switch its ferrite cores, but only "tickles" them to read data out. "This results in a true nondestructive readout (NDRO), and the usual 'destroy-restore' cycle common to most memory schemes is bypassed," explains Bruce Kaufman, President of the Van Nuys, CA, firm. "This is important in a severe industrial environment because noise from welders and other sources could alter the data in the critical period of time between destructive read and replication of the original data."

Eliminating the "restore" phase of the Read cycle provides the CM-203 with an access time of 350 ns and a Read or Write cycle time of 1 ms. The unit also has a switch-operated Write Enable/Disable function that allows portions of the 4-k  $\times$  8 memory to be treated as a firmware ROM, while other sections can be used as nonvolatile Read/Write Memory for real time data.

A number of NDRO core memories produced in the early 1960s soon fell into disfavor because of the critical circuitry needed to access the stored data without actually switching the ferrite cores.

"Today, however, a wide selection of integrated circuits is available with which the task of NDRO can be accomplished reliably," notes Kaufman.

Packaged on an 8.5-in.  $\times$  12-in. circuit board that needs 0.75-in. spacing along the backplane, the CM-203 takes a +5-V supply and  $\pm$ 12-V supplies and consumes about 25 W. It is mechanized to be compatible with Intel's SBC-8010 Single Board Computer. The memory is priced at \$500 each in OEM quantities.

CIRCLE NO. 318

## 16-bit bipolar $\mu$ P chip suits tough environment

The first 16-bit bipolar  $\mu$ P on a single chip operates over a temperature range of  $-55$  C to 125 C and a speed/power range of several decades. The new SBP9900 I<sup>2</sup>L (Integrated Injection Logic)  $\mu$ P from Texas Instruments of Houston, TX, uses the same memory-to-memory architecture, the same instruction set, and the same software as the NMOS TMS9900  $\mu$ P introduced by TI in 1975. Programs for the 9900  $\mu$ Ps also run on the TI 990/10 minicomputer.

The block diagrams for the two 9900 chips are identical, but the new I<sup>2</sup>L unit needs only one power supply instead of three and uses static logic that its single-phase clock to be stopped without losing data.

The variable speed-power feature, typical of I<sup>2</sup>L devices, offers savings in supply power in return for proportional cuts in speed and output current-sinking ability. At full power, 700 mW, the SBP9900 has a nominal clock speed of 3 MHz—2.5 MHz is guaranteed over the whole temperature range—and sinks 20 mA on each output, which is equivalent to 10 TTL loads. If the user chooses a lower injector-node current, operating the chip at 1/n of the 700 mW, the speed and output current are also reduced by a factor of n.

The bipolar SBP9900 has no speed advantage over the 3-MHz TMS9900. "But we see considerable potential for speeding up the SBP9900 later, perhaps in a -1 version," says Robert Bergeler, TI's Product Manager, I<sup>2</sup>L logic.

In a 64-pin Cerdip package, the TI SBP9900 sells for \$386 in quantities of 100.

CIRCLE NO. 319

## News Briefs

Shortwave broadcasts on 2.5 MHz by the National Bureau of Standards' standard time and frequency station WWV will not be discontinued after all. The bureau has discontinued, as it announced it would, broadcasts on 20 and 20 MHz from WWV and 20 MHz

from WWVH.

Sperry Univac has introduced its first small-business computer, the BC-7, priced for purchase in a range of \$28,268 to more than \$60,000. Principle competitors, Sperry says, are IBM's System 32, Burrough's B-80 and NCR's Century 8200.

# TI introduces the Face Gripper.

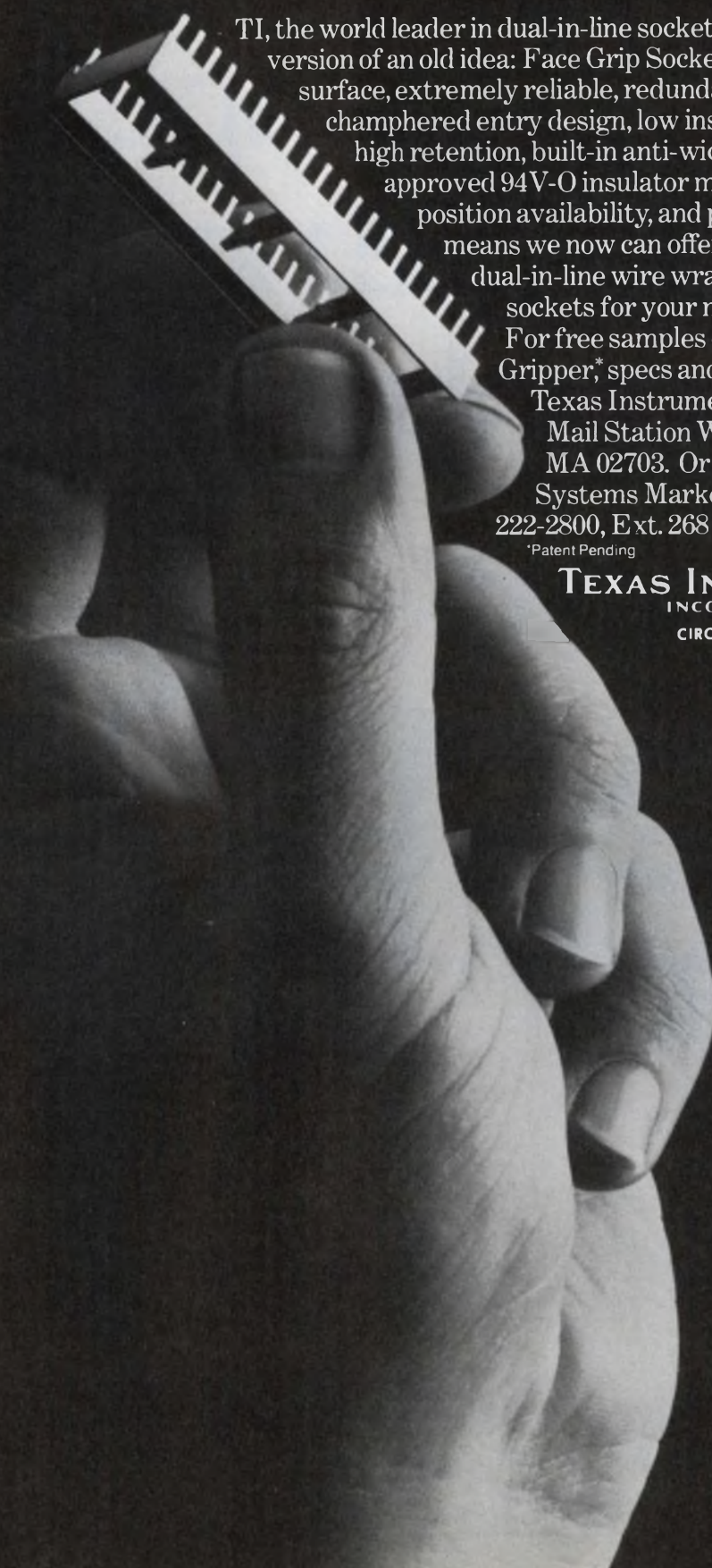

TI, the world leader in dual-in-line sockets, brings you a new version of an old idea: Face Grip Sockets. Tin or gold contact surface, extremely reliable, redundant contact points, chamfered entry design, low insertion force, high retention, built-in anti-wicking feature, U.L. approved 94V-O insulator material, 8 to 40 position availability, and priced to sell. Which

means we now can offer you a full line of dual-in-line wire wrap and solder tail sockets for your next application.

For free samples of our new Face Gripper,\* specs and literature, write to Texas Instruments Incorporated, Mail Station W-1, Attleboro, MA 02703. Or call Connector Systems Marketing, (617) 222-2800, Ext. 268 or 269.

\*Patent Pending



**TEXAS INSTRUMENTS**  
INCORPORATED

CIRCLE NUMBER 9

**Rockwell  
one-chip computers  
give you the right fit  
at the right price.**

**Right now.**





If you're designing a system or subsystem requiring as few as 10 TTL circuits, cost alone is reason enough to consider a Rockwell one-chip computer.

A wide choice of Rockwell one-chip computers is available right now. And the line-up of compatible one-chips is growing fast.

From Rockwell's PPS-4/1 family, you select the most cost-effective computer for your application.

### More on-chip I/O eliminates extra interface devices.

All of Rockwell's one-chip computers offer powerful, user-oriented I/O ports that eliminate costly interface circuitry in overall systems.

I/O features, including bidirectional ports, flexibly designed drivers and receivers, and serial input/output ports, provide you with powerful system options.

Many types of displays can be driven directly. Analog-digital conversion is easy. And serial I/O ports offer a new dimension of capability by giving you simple, "no-cost" interfacing for multi-computer systems.

### Rockwell flexibility assures cost-effective design.

Rockwell's one-chip computers give you design options you couldn't afford with other logic approaches.

During the design stage you can add or reduce functions, allocate I/O differently and make dozens of other changes by simple reprogramming or by moving to another software-compatible chip within the family.

### Powerful instruction sets increase efficiency.

Rockwell's instruction sets provide ROM efficiencies of typically 2 to 1 over other microcomputers. For example, some one-byte multi-function Rockwell instructions perform operations requiring five instructions in other systems.

More than 80% of Rockwell's instruction

types can be executed in one byte and in a single cycle. Special ROM instructions allow many subroutine calls to be handled in one byte. Table look-up instructions for MM77 and MM78 chips provide easy look up of stored data and easy keyboard decoding with minimal programming.

### The PPS 4/1 family of one-chip computers.

Model	MM76	MM77	MM78	MM75	MM76C	MM76D	MM76E
Description	Basic 76	Basic 77	Jumbo 77	Economy 76	High speed counter <sup>a</sup>	12-bit A/D converter	Expanded 76
ROM (x8)	640	1344	2048	640	640	640	1024
RAM (x4)	48	96	128	48	48	48	48
Total I/O lines	31	31	31	22	39	37	31
Cond. Interrupt	2	2	2	1	2	2	2
Parallel Input	8	8	8	4	8	8	8
Bidirectional Parallel	8	8	8	8	8	8	8
Discrete	10	10	10	9	10	10	10
Serial	3	3	3	—	3	3	3
In-line package	42 pin quad	42 pin quad	42 pin quad	28 pin dual	52 pin quad	52 pin quad	42 pin quad
Availability	Now	Now	Now	2Q 77	2Q/77	3Q 77	16 wk ARO

Power supply is 15v except low voltage version of Basic 76 available 3Q 77. Typical power dissipation is 70mw.

<sup>a</sup>Two 8-bit or one 16-bit presetable up/down counter with 8 control lines.

### Rockwell design aids also help lower your system cost.

To help control development costs, Rockwell makes available a universal Assembler that lets you assemble, edit, develop and debug programs, as well as load PROMs. Special development circuits enable prototyping.

Your Assembler can also handle incoming inspection and factory testing. And the same Assembler can be used to develop systems based on all Rockwell one-chip and multi-chip microprocessors.

For the full story on Rockwell one-chip computers, and how quickly they can be a part of your new product, write on your company letterhead to: Marketing Services, D/727-B, Microelectronic Device Division, Rockwell International, P.O. Box 3669, Anaheim, CA 92803, U.S.A. or phone (714) 632-3729.



Rockwell International

# Wage busting plagues engineers, but help may be on the way

It was 1971, and "John Smith," an electronics design engineer with Pan American World Airways at the Kennedy Space Center in Florida, was approaching his 50th birthday. He was making \$17,000 a year, which wasn't a great deal. But there were compensations: The cost of living in the Cape Canaveral area wasn't as high as it was in other places; his wife liked her secretarial job with a real estate firm; they were buying a house to which they would eventually retire; his parents who had moved down from Michigan were now installed in a small apartment three blocks away. And the weather was superb.

Within a few weeks John Smith's salary was slashed to \$9600—a cut of more than 40%.

The reason for this personal disaster? Pan Am's contract had been "recompeted"—a nasty word to some 25,000 employees of companies holding service contracts with the National Aeronautics and Space Administration, and to approximately 141,000 in a similar situation at military installations.

But *recompetition* is a common practice. When a service contract expires, or when the Government agency involved decides to renegotiate its terms, the contractor is often asked to submit a new bid along with proposals from other potential contractors that want to take over the job.

Competition is fierce, and the low bidder usually wins. The trick, naturally, is to cut costs to the bone, which in a service contract begins and ends with personnel. Whoever can be eliminated is laid off. And those who are kept on,



Neither unionized nor protected by the Service Contract Act, engineers who work under contract for NASA and the military are subject to wage busting.

stay for less pay—if such an arrangement can be made.

## His salary is 'adjusted'

In 1971, Smith was reclassified from Systems Engineer to Electrical Design Engineer and given an "adjusted" salary—\$17,000 became \$9600. He couldn't tell his employers what they could do with the new salary—the space agency's budget had depressed the whole area. And it was hard to pick up and try someplace else: He was 50 years old, he had a mortgage—the list of restraints went on and on. So he stayed.

Over the next 18 months he was able to move up to \$11,700, and finally, with another company, to \$12,480. But in 1974 his contractor had to recompute, and suddenly he was working for RCA for \$11,648.

"John Smith" was not an isolated case. Pan Am, with RCA

Service Co. as a subcontractor, recompeted its contract with the Air Force at the Kennedy Space Center in 1972—for the first time in 22 years. Hundreds of people were fired and the engineers RCA kept on took a 15% pay cut. Some Pan Am engineers lost up to 30%.

Meanwhile, the military and civil-service employees at the center and those who worked at the island stations on the Air Force Eastern Test Range received cost-of-living increases.

Salary cutting, better known as "wage busting," is handled in one of two ways—always, however, with the same goal:

- The no-frills approach—management tells the engineer that if he wants to keep his job under the new contract he'll have to work for less pay.

- The subtle approach—management informs the engineer that his regular job has been phased out but that there is an opening with a

# What this country needs is a good \$39 DPM.

And we've got it.

The AD2026 from Analog Devices. Priced at \$39 in hundreds\*, it's the first real alternative to the measurement grade analog panel meter. And the first to give you all the advantages of a DPM at a practical price. Advantages like visual appeal, accuracy, resolution, small size and reliability.

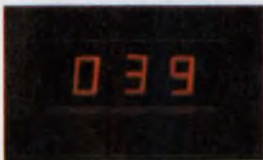

The AD2026 is a three digit, logic powered DPM that measures and displays voltages from  $-99\text{mV}$  to  $+999\text{mV}$  on 0.5" LEDs. It consumes only  $\frac{3}{4}$  Watts of 5V power. And because the AD2026 can be scaled with a simple resistive divider on its input pins, you can get direct readout in any engineering unit with equal or better resolution than APMs.

With an accuracy of 0.1% of reading  $\pm 1$  digit, the AD2026 is again far superior to conventional APMs, where their inherent inaccuracy usually limits the total performance of the instrument.

The AD2026 conserves on space, too. Its small front panel size of 3.4" x 2.0" and only 0.64" needed behind the panel makes it smaller than  $3\frac{1}{2}$ " scale APMs. But its performance outclasses  $4\frac{1}{2}$ " APMs.

When it comes to reliability, the AD2026 is unsurpassed. Its I<sup>2</sup>L technology combines most of the active analog and digital circuitry on *one* chip. The AD2026 has only 14 components and a MTBF of 250,000 hours at 25°C. In a 24-hour-a-day application, you shouldn't expect a failure for 28 years.

A new commercial tester automatically tests all AD2026's for defects such as bad components and solder shorts. It also fully tests both the LSI chip and the complete DPM. Following 168 hours of failure free burn-in, the units are again 100% tested.

The AD2026. Its low price (\$39/100s), small size, superior performance, and remarkable reliability make it the only sensible alternative to APMs. Which is just what this country needed.

Check it out. Return the coupon with your check or money order today to order an evaluation sample at the low 1-9 quantity price of \$62. And when you receive your evaluation samples you will also receive a Credit Certificate for \$23 redeemable when you place your order for the first hundred or more AD2026's.



**ANALOG DEVICES**

The real DPM company.

Box 280, Norwood, MA 02062  
Telephone: East Coast: (617) 329-4700,  
Midwest: (312) 894-3300,  
West Coast: (213) 595-1783,  
Texas: (214) 231-5094.



- Please send me \_\_\_\_\_ AD2026 for testing and evaluation at the low (1-9) price of \$62. (Enclose check or money order.)
- Enclosed is my purchase order for 100 AD2026 DPMs at the unbelievably low price of \$39 in 100s.
- I'm not ready to order my AD2026 DPM for testing and evaluation, but I would like to receive all available technical information.

P.O. # \_\_\_\_\_

Name \_\_\_\_\_

Company \_\_\_\_\_ Telephone \_\_\_\_\_

Address \_\_\_\_\_

City \_\_\_\_\_ State \_\_\_\_\_ Zip \_\_\_\_\_

\*Substantial quantity discounts available.

different job title and a smaller salary. And the same duties.

These techniques can be used by the old contractor that has rebid and won, or by the new contractor that has squeezed the old one out. It's all the same to the engineer, except that with a new employer he loses his retirement plan, accrued sick leave and vacation time.

Not all service-contract employees are subject to wage busting, however. Blue and white-collar workers are protected by the Service Contract Act of 1965 ("... if a contract succeeds a contract, under which substantially the same services are being furnished, the employee cannot be paid less in wages or fringe benefits, or equivalent, than he was formerly paid.")

lations of the Committee on Education and Labor.

Quoting a report by the Institute of Electrical and Electronics Engineers, Alexander told the Subcommittee that a survey last spring of RCA analysts (with engineering or physics backgrounds, and an average age of 44) revealed that they would have to receive a salary increase of 24% to reach the average salary for EEs in the Southeastern part of the United States.

To reach the 1975 national mean salary would require a 33% increase, Alexander added.

The engineers who suffer the worst losses of all are those who move over to a new contractor to keep their jobs. Depending on the fringe benefits provided by the for-

Huntsville in early 1972 to Teltronics for \$18,000. In 1975, he went to work for Planning Research Corp. (PRC) at \$14,500.

A senior engineer for Siemens, earning \$20,000, went with PRC in 1975 for \$16,000.

A senior EE for Martin Marietta, making \$17,000, switched to PRC in 1974 for \$8700. He couldn't live on this amount, so in 1976 he became a technical writer for another company at \$12,480.

A senior staff engineer for Martin Marietta, making \$23,000, went to PRC in 1974 for \$12,500.

An electronic design specialist was making \$18,500 with Boeing, then, in 1972, \$13,000 as a design engineer for Pan American.

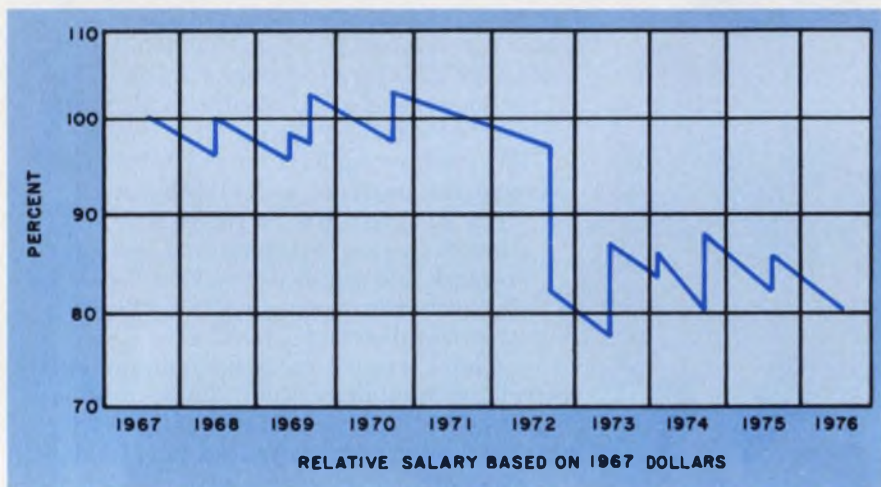

Salary of a typical Kennedy Space Center engineer, used to annual increases, dropped steadily from 1967 on—15% in 1972 alone.

But engineers, who are "professionals," have always been trimmable fat. They are not covered by the Service Contract Act, and they are not unionized.

Other professionals, such as mathematicians, physicists, scientists and computer programmers, are also without protection but since there are more engineers than other professionals, the engineers get hit the hardest.

### The problem remains

The results of wage busting are still evident, said John L. Alexander, president of the Coalition of Aerospace Professional Employees at the Kennedy Space Center, at hearings conducted in Washington last July by the House Subcommittee on Labor-Management Re-

lationships. The loss can be anywhere from \$1000 to as high as \$5000 a year.

In 1971, a PhD, who urges, "For God's sake don't reveal my name!" was surplusd by a company that had lost its contract. A few days later he got this letter:

"The Boeing Company is pleased to offer you employment as Industrial Engineer at a starting salary of \$135 per week based on a 40-hour week."

The engineer declined the offer and was out of work for two years. "Engineers whose wives didn't have jobs were in bad shape," he recalls.

There are innumerable engineers in a similar situation—none of whom wants to be identified.

One EE, age 42, went from a \$20,000 job with Electrone in

### Salaries don't fit

"Engineers who are engaged in design-support service contracts range in the lower 30% of the national average," Charles O'Neal, a PRC employee, told the Committee on Government Operations' Subcommittee on Federal Spending Practices, Efficiency, and Open Government last May at Merritt Island, FL.

O'Neal described some of the effects of wage busting:

- Fringe benefits go down by \$1000 to \$2000—hospitalization coverage is reduced and sick time paid for by working overtime.
- Payment in money for overtime is discontinued.
- Accrued vacation time is lost when contractors are changed.
- Retirement benefits are cancelled.
- Special savings plans are eliminated.

Typical of a large number of engineers who eventually leave both the Cape Canaveral and Huntsville areas—many of them giving up engineering and going into totally unrelated businesses—is "Bill Jones"—an EE, a mechanical engineer and a professional with 20 years' experience.

Bill is an engineering supervisor when his company's contract with the Marshall Space Flight Center at Huntsville expires. Luckily, he is transferred to another contract within the company, so he isn't out of a job. But he is demoted to a "senior level engineer" and given a \$1000 salary cut.

Within a year this contract is

# Our REF-02's a TWOFER.

**Free!**

**TEMP  
TRANSDUCER**

with the purchase  
of each  
PMI REF-02  
5V reference.

**FREE**

**5 VOLT REFERENCE**  
with purchase of  
each PMI REF-02  
temperature transducer.

At \$1.95 (100's), our new 5 Volt reference circuit, REF-02, is a good buy. But when you consider that we've wired up an unused pin to give you—at no additional cost—a temperature transducer, it's a steal. And it is very accurate, from super low ( $-150^{\circ}\text{C}$ ) to super high ( $+170^{\circ}\text{C}$ )!

Let your imagination explore the idea for a minute. Let's say your system design requires a **voltage reference**. What could you do with a free temperature sensor?  monitor cabinet temperature  thermal drift correction  prevent thermal runaway.

The feedback signal for a temperature control loop is right here, at the REF-02.

And if you've designed in a **temperature sensor** and could use a good voltage reference (ours is very reliable—referenced to the bandgap energy of silicon) the REF-02 offers a way to simplify your design. One part doing the work of several invariably translates into savings. **Two-fer-the-price-of-one.**

#### WANT CHIPS?

Send a P.O. We're glad to sell REF-02 Chips. And you'll find them easy to calibrate in your hybrid. How about knowing the ambient temperature **inside** your package!

For data sheet, App. Note, or name of your nearest PMI distributor, write, phone or TWX us. Ask about the Twofer.



Precision Monolithics, Incorporated  
1500 Space Park Drive, Santa Clara, CA 95050  
(408) 246-9222. TWX: 910-338-0528  
© Cable MONO.

CIRCLE NUMBER 12

lost, and Bill is offered a job by the new contractor—for \$3000 less. ("How do you think the new contractor won the contract from my old contractor to begin with?" Bill asks.)

Bill refuses and goes 10 months without work. Finally, he has to do something. He asks the contractor if the offer of 10 months before still stands. Yes, says the contractor, but for \$5000 less, not \$3000. Bill accepts.

Later that year, a new contractor comes to town and notifies Bill and several colleagues that their contractor is on the way out. "Would you like to sign with us?" the newcomer asks. "The salary won't be quite as good, of course. After all . . ." This time the cut is \$3000.

"It was flattering to be in such demand," Bill recalls, "but that would have made a \$9000 pay loss in a very short period of time. I realized that if I didn't restrain myself and start turning down offers I'd be working free."

Bill is now in the process of leaving Huntsville. He's found a job elsewhere in another field.

### Age hurts, too

Wage busting is harder on people in their 40s and 50s than on younger men, everyone agrees. Age discrimination exists. It's hard for middle-aged engineers to find work. And after 20 or 25 years with a company, they have built up equity they don't want to leave. Also, they are usually more firmly entrenched in the community, economically and otherwise—their house is almost paid for, they have bought interest in a fishing lodge nearby or they're making plans to retire.

Many engineers who have hung on through thick and thin with RCA—they accepted the 15% cut in 1972 and survived—are worried again. This time the Air Force will contract directly with Pan Am and RCA, ostensibly to prevent Pan Am from making a profit on a subcontract with RCA. "But that's not the frightening part," an RCA engineer says. "Although Pan Am's and RCA's contracts have been recompeted several times, they have always been Cost Plus awards. The new contracts will be Fixed Price.

"A fixed-price contract is far too restrictive for work as com-

plex as this—taking care of the instrumentation, including radars, here at the Cape and on the range. A lot of people are going to be hurt, as well as the calibre of the work that we, or anyone who'd come in and take our place, will be able to do."

What's the solution? "You can't really blame the contractors too much," another RCA engineer says. "They're forced to bid low to get the award. You *can* blame the Air Force and NASA a little more, but they, too, follow the law—if a company is technically competent, the award must go to the lowest bidder."

### Air Force busts less

"The Air Force has been somewhat fairer than NASA," a former



**Engineers working on the Eastern Test Range for RCA and Pan Am under Air Force contract have suffered salary cuts while civil service personnel working alongside have enjoyed steady increases.**

Kennedy Space Center engineer says. "Since 1969, contractor engineers with the Air Force have taken a \$2500 cut while those on contract with NASA have taken a \$5600 cut."

Contract companies say they don't like wage busting, but refuse to discuss it. When asked for its official position, RCA's executive group at Cherry Hill, NJ, held a meeting and came back with a firm, straightforward "no comment." "It's like when did you stop beating your wife," an RCA representative explains. "We'd just prefer not to get involved."

Pan American at Patrick Air Force Base, FL, returned no calls. Personnel at PRC headquarters in

Virginia said "the company is so departmentalized that no one would be able to speak for the different support-contract operations."

NASA stated at the Merritt Island hearings that it's aware that "it's not in the best interest of the government to select a contractor purely on a low-cost basis when there's a likelihood that he can't employ the needed talent at the wages proposed." But as of that time, "NASA management has not decided on the best way to approach recompetitions."

NASA and the Air Force are held back by the Government Accounting Office. "Specifically," says a NASA spokesman, "the GAO has ruled that a contract may not prescribe a minimum rate of wages to be paid by a contractor, in the absence of a specific statutory authority."

### Engineers aren't covered

The Service Contract Act of 1965 is such an authority. But it doesn't cover "professional" employees.

NASA's only option, according to the spokesman, is to use language in its proposal instructions that would discourage "so-called wage busting."

But so far NASA's efforts to toughen the language of its proposal instructions have disappointed Cape Kennedy engineers. The new language states, in part: ". . . Proposals which are unrealistically low or do not reflect a reasonable relationship of compensation to the job categories so as to impair the contractor's ability to recruit and retain competent personnel may be deemed reflective of failure to comprehend the complexity of the contract requirement."

"I can't believe NASA couldn't come up with stronger language than that," says an engineer who has worked on NASA contracts for 20 years.

At this point, NASA has very little way of knowing how its contractors match salary with responsibility except for a few key personnel. The agency's proposal instructions state: "Resumes for other than key personnel will not be considered, and therefore, should not be submitted."

Though surely not NASA's in-

Protection that adds value . . .

# Presto!

## You've got a better product.



Your customers (and your boss) will love you for it. And all you did was design in a Heinemann circuit breaker instead of a fuse.

Clever indeed. Because a blown fuse means downtime. If the customer can't solve the problem himself, or can't find a spare, it means more downtime. And possibly even a service call. That costs you plenty—in reputation as well as money.

How good it is that an inexpensive Heinemann breaker, doubling as a power switch for your front panel, can turn that downtime into uptime . . . just one more way our products add value to your products.

Find out more in your free Protector Selector—a handy reference chart loaded with specs, capabilities, and even dimension drawings for twelve top-selling protector lines. Including electromechanical, solid-state, and hybrid devices to protect all manner of loads against shorts, overcurrent, overvoltage, and undervoltage—singly or in combination. Get it from your nearby Heinemann representative (listed in EEM) or Heinemann Electric Company, Trenton, NJ 08602. (609) 882-4800.

**another reason  
Heinemann is  
No. 1 in OEM circuit  
protection**

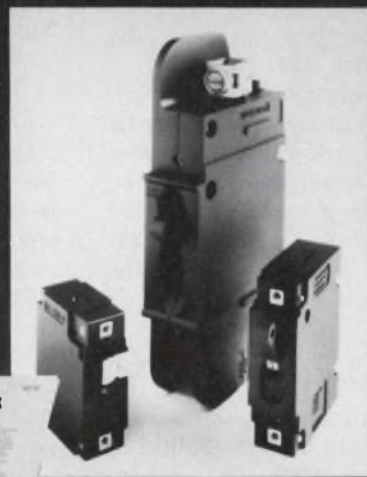

# HEINEMANN

**We keep you out of trouble.**

Factories in Trenton, Montreal, Dusseldorf,  
Johannesburg, and Melbourne.

tent, one statement in the agency's proposal instructions actually seems to encourage wage busting: "The Kennedy Space Center area, where the bulk of the effort will be performed, is an area of high unemployment. Although work-force selection is the prerogative of each proposer, recognition should be given to this high unemployment. Therefore, each offeror's recruitment plan and labor relations policies should demonstrate how they relate to the local labor situation."

"It sounds as though NASA's saying 'there are a lot of guys down there who'll work cheap—go get 'em,'" one engineer says.

"The blame belongs to the legislators who—perhaps innocently—push for fixed-price contracts and lowest-bidder-wins procedures, and who neglect to include protection for all kinds of employees in the Service Contract Act," says one long-suffering engineer at the Kennedy Space Center.

Legislation that would amend the Service Contract Act to include professionals was introduced last year by Representative Frank Thompson, Jr. (D-NJ) and Rep. James C. Corman (D-CA). The Congressmen knew it was introduced too late to get through last session, but they wanted to establish a basis for early entry in the new session.

On January 4, the first day of the new session, the bill was reintroduced, this time carrying the designation HR 314 (for  $\pi$ ).

With 314 incorporated into it, the Act would protect professionals from wage busting as it now does blue and white collar workers. An engineer's salary could not be cut when a new contract goes into effect, if he is doing essentially the same work.

### Opposition is lined up

Strongly opposed to the bill is the National Council of Technical Service Industries (NCTSI), which consists of 16 contractor members, including Avco, Boeing, Control Data, Federal Electric, Hughes Aircraft, Lockheed, Northrup, PRC, Raytheon, RCA and Systems Development Corp.

"It is our considered opinion

that Congress need take no immediate action to either amend or extend the Service Contract act beyond its present scope as interpreted by the decisions of two U.S. district courts," said Edward C. Leeson, NCTSI executive director, at the House Subcommittee hearings in Washington last July.

"We're getting a little tired of this wage busting horseshit," Leeson recently told ELECTRONIC DESIGN.

"These people represent an iso-



**Cong. Frank Thompson, Jr. (D-NJ)** (above) and Rep. James C. Corman (D-CA) have introduced legislation to include "professionals" under the protection from wage busting in the Service Contract Act.

lated microcosm of a relatively few people who feel that they'd like to be permanently guaranteed, under the protective umbrella of a socialistic government, wages that would guarantee them a style that they'd like to become accustomed to, for the rest of their lives. They're bitching about the fact that they can't seem to live in a free enterprise system. If they want to be put in the same category as the blue collar worker, to sweep the floors, that's fine; then the law is good for them. But what it means is that they're going to lose all the respect and seniority at the companies they work for."

Leeson's solution? "If we could

find some way to put into the language of the procurement regulation 'thou shalt not wage bust,' we'd be all for that. But a law would be disastrous. We don't think it can be enforced. The Labor Department has screwed up on everything else, how can they be expected to do anything with this?"

### Professional engineers opposed

Though far less vehement than the NCTSI, the National Society of Professional Engineers, headed by Paul H. Robbins, also opposes the bill.

"The problem with the Service Contract Act is that it applies to all Federal contracts, and there are many aspects of the payment in which professional people are involved which are quite different from the situation at the Cape and Huntsville. We'd like to zero in and solve the problems at the Cape and Huntsville without encompassing all the other contracts with the government that involve professional people.

"There are 350,000 engineers and scientists involved in the nation's R&D effort. We don't like the idea of setting the Labor Department or any other government agency up to establish their salaries."

The solution? "Do it by strong wording in the procurement regulations."

Both organizations are adamantly opposed to "falling into the clutches" of the Labor Department—delegating it any control of the problem. They prefer the executive branch to be in charge, which means putting clout into the procurement regulations, an approach that most engineers and many Congressmen believe is unrealistic. Both groups also fear "loss of professionalism" if salaries become fixed.

IEEE's John Guarrera believes a bill can be written so that "professionalism" will not be endangered and that all parties concerned can be appeased.

"Everyone is going to have to be willing to compromise," Guarrera says. "Everyone has got to contribute to writing the law." ■■



# Those dumb calculators are OUT!



## At last there's a talking calculator for the blind.

And Silicon Systems made it possible. We make the custom IC chip in this calculator that synthesizes the human voice. Our custom chips are also used in garage door openers, traffic control, automotive instrumentation, time code generators, computers, communications equipment, etc.

Silicon Systems **specializes** in custom LSI... it's not a sideline. We're interested when others aren't because we've lowered the volume at which custom IC's become cost effective.

Over the years we have developed the world's most advanced IC design capability. A proprietary system, created in our own computer lab, helps us solve design problems in any technology - TTL, Schottky, ECL,  $I^2L$ , Linear, PMOS, NMOS, CMOS - whatever is best for you.

So for custom IC's, write Jim Meyer or call him at  
**(714) 979-0941**

**Si Silicon Systems**  
incorporated  
16692 HALE AVENUE, IRVINE, CALIFORNIA 92714



\* Calculator Manufactured by Telesensory Systems, Inc. of Palo Alto, Calif.

CIRCLE NUMBER 14

# First monolithic 12-bit DAC uses a new zener trim technique

A digital-to-analog converter unveiled at this week's International Solid State Circuits Conference is not only the first monolithic 12-bit DAC, but also the first to avoid laser trimming. Instead, it makes use of a zener trim technique that permits precision adjustment after the DAC is hermetically sealed.

Under development by Precision Monolithics, Santa Clara, CA—and expected to be in production by mid-1977—the single-chip DAC-12, reportedly will be not only the smallest (24,000 mil<sup>2</sup> total chip area), but also the lowest-powered and fastest 12-bit DAC available.

The part is pin-compatible with Analog Devices' Model AD-562, a two-chip laser-trimmed hybrid that has led the 12-bit spec/cost race since its introduction in 1975.

The DAC-12 will have a faster settling time than the AD-562 (300 to 500 ns vs 3.5  $\mu$ s), use half the power, be compatible with more digital logic families and use inexpensive plastic and Cerdip packages. Most hybrids use side-brazed metal cases with ceramic substrates.

Although details have been sketchy, a 12-bit single-chip d/a converter, also pin-compatible with the AD-562 but 35 times faster, is under development by Harris Semiconductor, Melbourne, FL. But what makes PMI's DAC-12 doubly unique, according to its developer Don Comer, is that its design eliminates the need for time-consuming laser trimming. Instead, precision trims can be done by computer after the DAC is hermetically sealed, and burned in.

## DACs within DACs

On the production line, a computer will sense the DAC's slight bit-current errors and negate them

Dave Barnes  
Western Editor

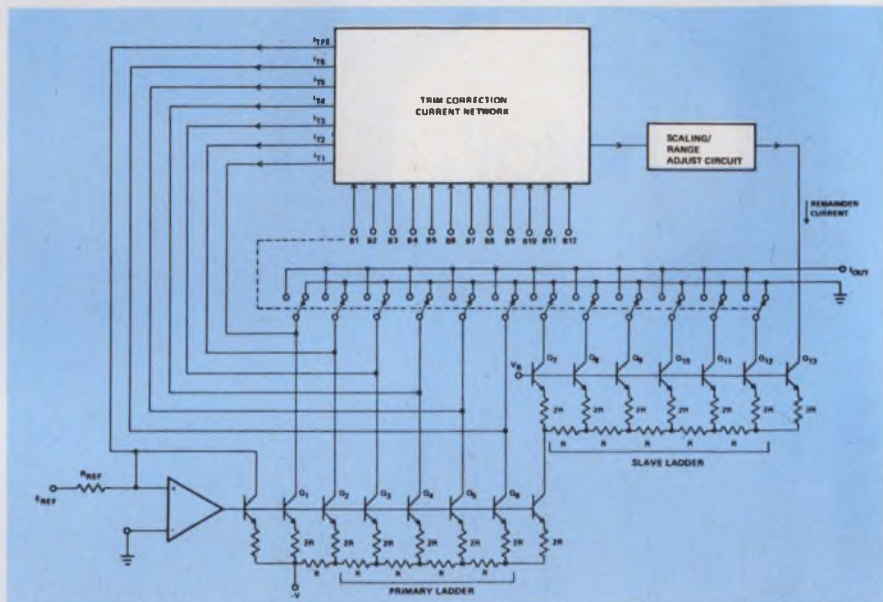

1. Laser trimming is completely avoided in the DAC-12. Precision trimming is done after the DAC is sealed and burned in.

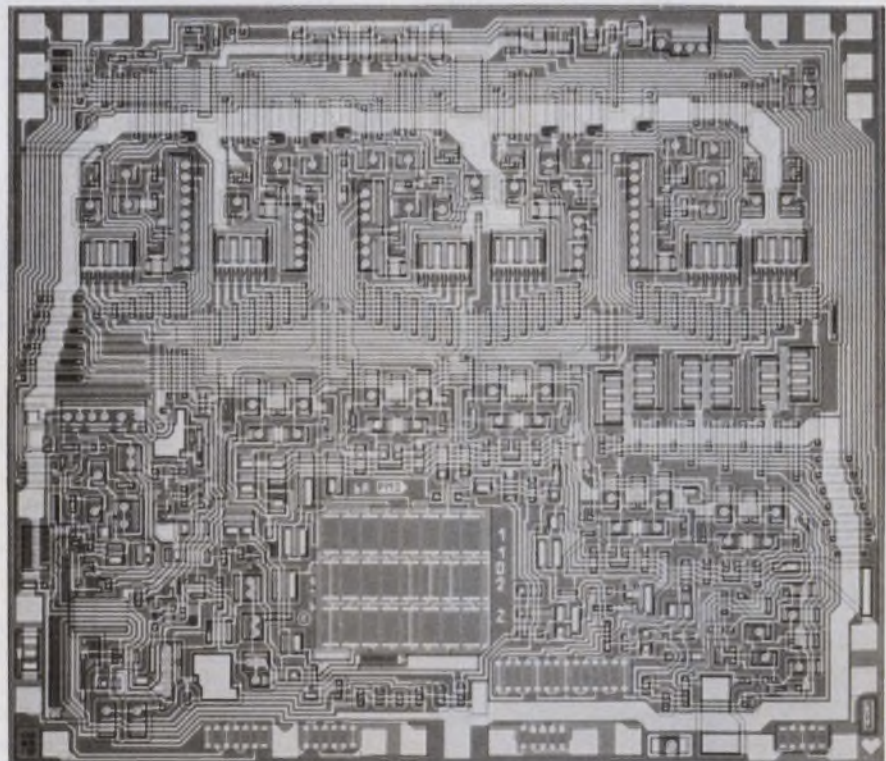

The single-chip DAC-12 will be the smallest 12-bit DAC available, measuring 145 by 166 mils. The top half of the chip is devoted exclusively to zener-zap trim circuits. It's being developed by Precision Monolithics.

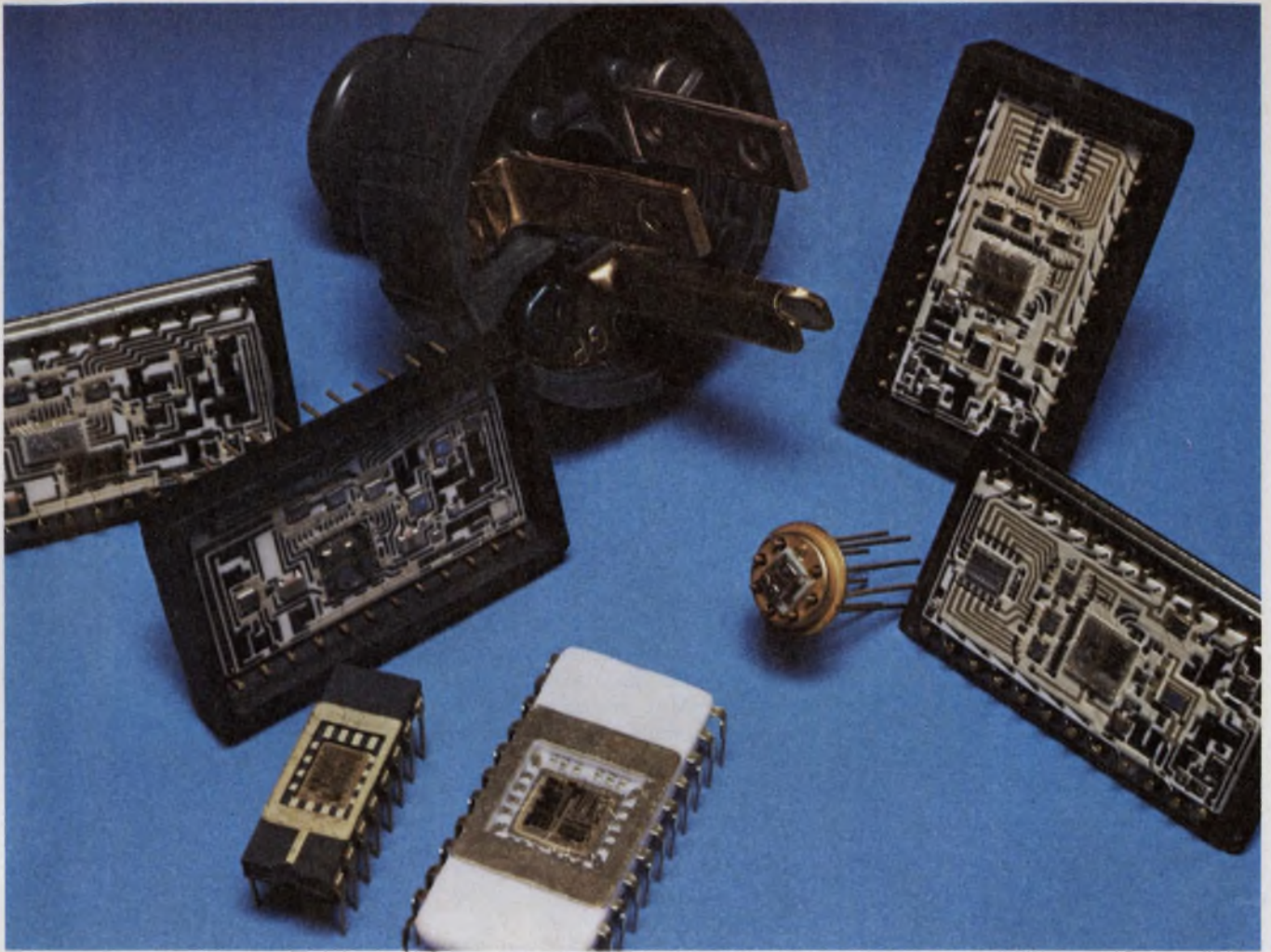

# Our new low-cost industrial converter products are standard, too.

Standards, like that plug, make life less complicated.

That's why we're leading the campaign to standardize converter products.

And the group you see here is just part of a growing family that starts as low as \$19.50 in the 100-piece quantity.

They're on-the-shelf, for quick delivery. A new line of DAC's and ADC's for designers who can use standard functions. Plus thin-film ladder networks and a precision voltage reference to give exceptional design flexibility.

These competitively priced, industry-standard converter products can save you engineering, manufacturing, and inventory time and money. And you have a wide selection of package types and temperature ranges to fit your exact applications.

Learn more about Beckman-quality, Beckman-backed hybrids. They'll make your life easier, too.

For data, write or call Helipot Division, Beckman Instruments, Inc., 2500 Harbor Blvd., Fullerton, CA 92634. Phone: (714) 871-4848, Ext. 1776.

## BECKMAN®

HELIPOT DIVISION

If you need hybrids, you should know about Beckman.

# RCL

OFFERS A  
LOW COST  
REPLACEMENT  
FOR "OBSOLETE"\*  
OPEN DECK  
WAFER SWITCHES

\*Not all, but most... ask us!



# RCL's

ENCLOSED,  
LOW PROFILE  
PC SWITCH...  
FROM  
STOCK!

Send For New '77 Catalog or Call  
our Hotline For Name Of Your  
Local Representative Or Stocking  
Distributor.

(201) 374-3311

AMF

## RCL Electronics

General Sales Office:  
700 So. 21st Street  
Irvington, N. J. 07111

CIRCLE NUMBER 148

by selectively and permanently shorting (zapping) the appropriate zener diodes on the chip. Each time a zener is shorted, one of 31 pre-trimmed selectable polarity current sources on the chip can be taken out of the circuit. The computer trims each of the six most significant bits as well as the full-scale current.

The trim circuit for each bit is itself a DAC. Fig. 2 shows that the trim circuit for the most significant bit is simply a 4-bit bipolar DAC using the zeners as hard-wired inputs.

The need for trimming makes a 12-bit DAC a formidable design problem. The state of the art in photomasking and processing, whether by diffusion, ion implant or thin film, is 9 to 10 bits without trimming, says PMI. Since a 12-bit DAC must be 10 times better, it must be trimmed. And, if it is to maintain 12-bit accuracy, the errors must remain below 0.0125%.

Conventional DAC trimming uses a laser at the wafer-sort production step to trim the ladder resistors. This laser compensates for both resistor and current-source mismatches.

There are six problems in laser trimming for 12-bit devices, PMI points out. The laser attachment to the wafer probe is expensive. The trimming takes a lot of time, about 10 times as long as zener zapping. Laser-beam resolution is limited, so large-area resistors are needed to trim to 0.01%. And because the laser actually burns away parts of the resistors, the trimmed chip's appearance is questionable for high-reliability products. But, appearance counts under MIL-STD-883.

Most important, the intense concentrated heat from the laser creates thermal stresses in the chip that may cause resistor values to change. Over the long run, these stresses may cause long-term drifts or instabilities in the DAC's accuracy, linearity or scale factor.

### The chips are down

All known laser trim methods were extensively evaluated by PMI before the decision to use zener-zap trimming, recalls Earl Rogers, PMI president.

The PMI design adds no extra pins for zeners but cleverly uses



"Eat your heart out, B.G." is the message carried by the chewed heart and initials beneath. It's PMI's answer to an industry spokesman who said last year: "There are no monolithic 12-bit DACs on the market at present, and there never will be."

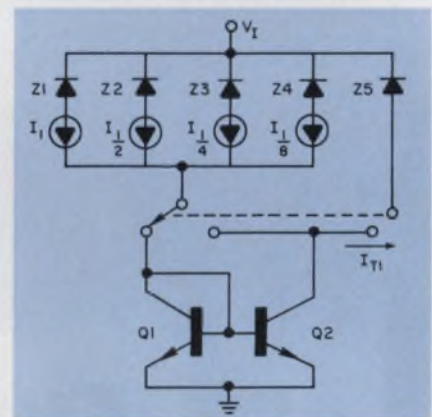

2. The converter's trim circuit makes 16 levels of current available by zapping combinations of zeners  $Z_1$  through  $Z_4$ . Zapping  $Z_5$  reverses trim polarity.

the 12-bit input pins for zapping and bit control. A thresholding circuit recognizes the zap circuit and a  $6 \times 6$  matrix decoder steers it to the right zeners.

"This pin-usage technique also lets us make the DAC-12 zappable either to binary or BCD coding," Rogers points out. "A three-digit BCD DAC requires only about 0.1% matching. Therefore, if the zapping doesn't bring in the DAC-12 to true 12-bit accuracy, it automatically zaps itself over to a three-digit BCD unit, the DAC-30, and in either case, after all trims are done, a 'fail-safe' zener is shorted to prevent any further code alterations."

The DAC-12 will be priced from \$20 to \$30 in 100 quantities. ■■

# Now, analog output is just this simple.

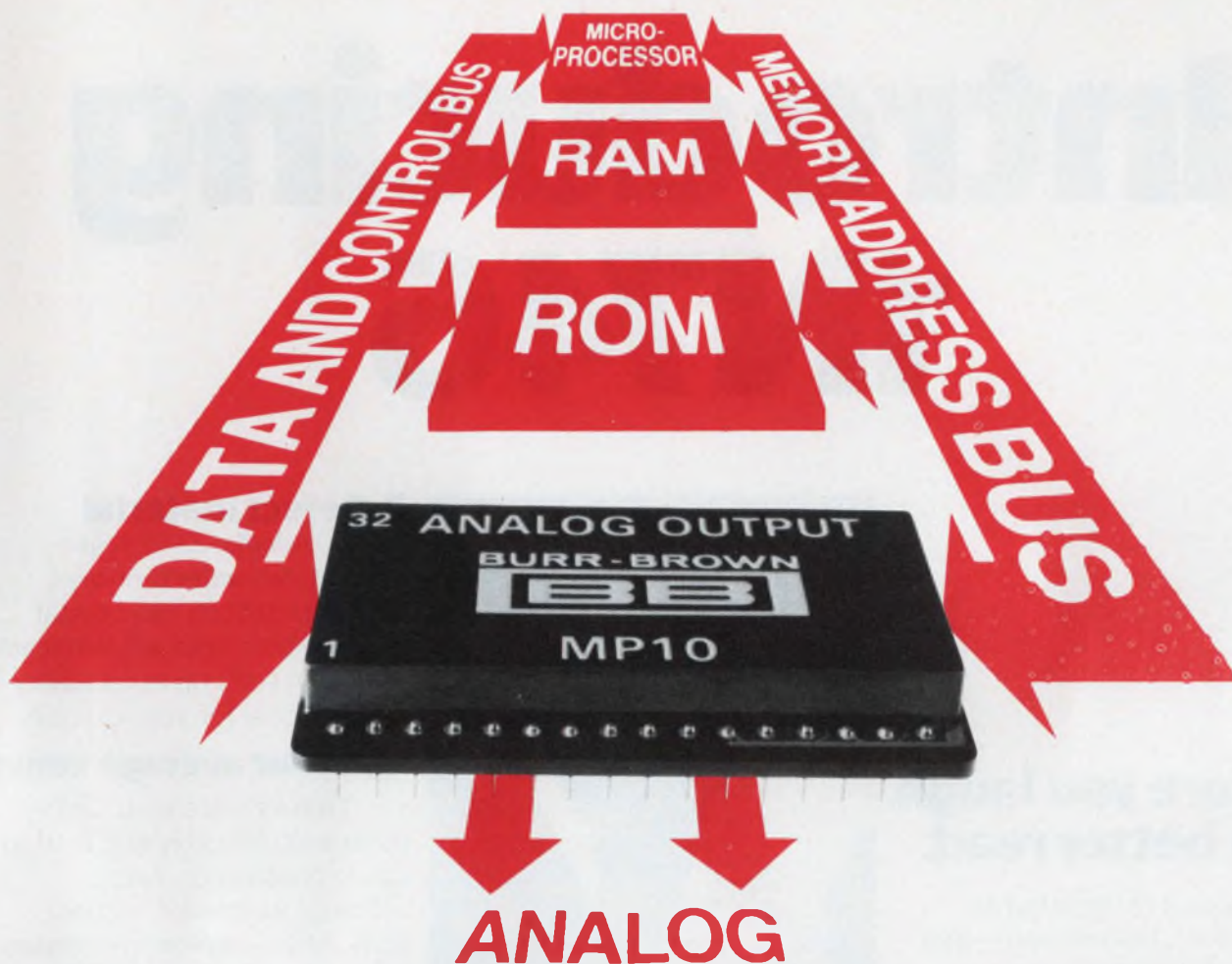

You no longer need to assemble D/A converters, address decoders and interface logic to obtain analog output from your microprocessor-based systems. Burr-Brown has solved the problem completely—for most of today's popular microprocessors—with 32-pin DIP's that provide two analog output channels each and look like memory to your CPU.

For 8080A and 8008 type  $\mu$ Ps you need our new MP10. And for 6800, 650X and 9002 types, our MP11. Both of these bus-compatible Analog Output Microperipherals are self-contained, requiring no external components for most systems. And since they're treated as memory by the CPU, just one 8-bit memory location is required per channel, and a single instruction is all you need to output data to both channels.

For analog input applications, you can combine one channel of an MP10 or MP11 with a few external components and use the microprocessor to perform the logic of a successive approximation A/D converter. The second channel continues to function as an analog output.

Both the MP10 and MP11 provide  $\pm 10V$  outputs with 8-bit resolution and throughput accuracy better than  $\pm 0.4\%$  of full scale range. With a price of just \$99 (100's), it just doesn't make sense to design your own analog I/O solutions. Send for details today. Write or call Burr-Brown, International Airport Industrial Park, Tucson, Arizona 85734. Phone (602) 294-1431.



**BURR-BROWN**  
**BB**

*Leaders in  
microcomputer I/O.*

CIRCLE NUMBER 16



# Introducing 1N746

## Before you laugh, you better read.

Taken it for granted all these years, haven't you — that old, established glass zener that's everybody's commodity and nobody's state-of-the-art? After all, one supplier's is pretty much like another's. And it's really funny how some of them knock themselves out with special deals and reduced prices just to get your biz, right?

Get serious. It's not all over in 400 mW at Motorola. Never.

## Our word is our bond

Metallurgical. Only Motorola 1N746/957 units have it down to 1.8 V.

Not a solder, but a homogeneous intermix of metal molecules between die and lead ensuring true metal continuity all the way through.



It's available across the entire range to 100 V, offering superior device structural strength, thermal conductivity and electrical integrity from end to end. Unique.

## The 30-pound package

Motorola DO-35's withstand in excess of 30 pounds lateral lead pull. Try that with a TI, Siemens, ITT, etc.

Motorola has more pull all the time, every time. Unique.

## 0-Defect material

0-Defects. Zero. None. Naught. No wafer pinholes. No degradations. No crystal faults. A mastered art. What we start with ends up in reliability and low cost for you. Unique.

## Not your average zener

There's more in it. Computerized diffusion and testing. Oxide passivation. Laser scribing. Automatic inspections. MOS-inspired processes. 100% contact tests. And the largest active area with the biggest surge current rating of any DO-35.

As usual, the only thing we offer is everything. Unique.

## Price. The secret word.

Pennies buys it all. At 25,000 pieces, unit cost is just 9¢.

Look at the quality. Look at the technology. Look at the reputation. Unique.

Maybe it's time to take a look at the leading-edge quality of Motorola DO-35 glass zeners. Even though your present source soberly tells you his are just as good.

What a laugh.



**MOTOROLA Semiconductors**

—and you thought we were just a production house

Motorola Semiconductor Products Inc. Box 20912, Phoenix, AZ 85036

## Technology Breakthrough!

# NEW! HIGH VOLTAGE MONOLITHIC CERAMIC CAPACITORS

*This breakthrough in high voltage — high temperature ceramic capacitors provides the equipment designer ways to achieve new goals in design and reliability. Semtech high voltage capacitors were initially developed to meet stringent in-house requirements utilized in the manufacture of our industrial and military type solid state high voltage assemblies and multipliers. The resulting products have exceeded our most optimistic expectations. We have now set a new standard of excellence for high voltage ceramic capacitors. As a result of the many inquiries for these devices from our rectifier customers, we have*

*established a production capability and we are now able to offer these new "state-of-the-art" capacitors for sale to the industry. These devices are now available in quantity from stock at pricing low enough for use in commercial applications.*

### "MONO" Chips



Construction: Monolithic with end terminations  
Voltage: 1, 2, 3, 4 & 5KV  
Capacitance: 18pF to .39 μFd  
Dimensions: (Body) from .23"L x .19"W x .15" to .65"L x .60"W x .25"T



### "GOLD CAP" Radials



Construction: Monolithic radial leaded and dip coated  
Voltage: 1, 2, 3, 4 & 5KV  
Capacitance: 18pF to .39 μFd  
Dimensions: From (Body) .38"L x .29"H x .25"T to .80"L x .70"H x .35"T

## Two Dielectric Types Available!

	X7R	NPO
Temperature Coefficient (T.C.)	0 ± 15% -55 to +125°C	Less than 30 ppm/°C; -55°C to +125°C
Dissipation Factor (D.F.)	2.5% max 1 KHZ 1 VAC, 25°C	Less than .0015 (.15%) at 1 KHZ, 1 VAC, 25°C
Insulation Resistance (I.R.)	100 K megΩ or 1000 megΩ microfarads, whichever is less (25°C, 500 VDC)	100K megΩ or 1000 megΩ microfarads, whichever is less (25°C, 500 VDC)
Aging	1% per decade	0
Dielectric Withstanding Voltage	1.2 Times Rated Voltage*, at 25°C	1.2 Times Rated Voltage*, at 25°C
Voltage Coefficient (V.C.)	Less than 7% at 50V per mil.	0
Dimensional Tolerance	± .010 or 5%, whichever is greater	± .010 or 5%, whichever is greater

\*Dielectric Withstanding Voltage Test on Monolithic Chips and Gold-Caps is conducted with charging current limited to 10 mA and the discharge current limited to 5A.

## Special Capacitor Requirements!

Knotty design problems? Let Semtech Capacitor Engineering personnel design the best high voltage capacitor array to meet your individual application. Special designs incorporate the proven Mono-Chip and/or single sheet discrete capacitors as building blocks to meet your voltage and capacitance needs in both NPO and X7R characteristics. Special package configurations with working voltage ratings up to 300,000 volts are available. Contact your area representative for details.

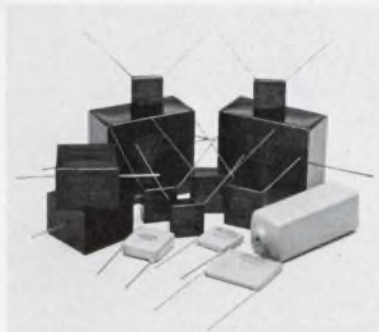

**PROTOTYPE KITS**  
also available for sale!

Contact your nearest Semtech office for our new High Voltage Capacitor Catalog.

1975 NATIONAL SBA SUBCONTRACTOR OF THE YEAR

**SEMTECH**  
CORPORATION

652 Mitchell Road, Newbury Park, California 91320  
(805) 498-2111 • (213) 628-5392 • TWX: 910-336-1264

CHICAGO: (312) 352-3227 • DALLAS: (214) 387-3551  
FLORIDA: (305) 644-5404 • MARYLAND: (301) 424-6663  
NEW JERSEY: (201) 654-4884 • SAN FRANCISCO: (415) 494-0113  
EUROPEAN SALES: Boums AG Zug, Switzerland (042) 232-242

# ***ii*incredibly low resistance!**

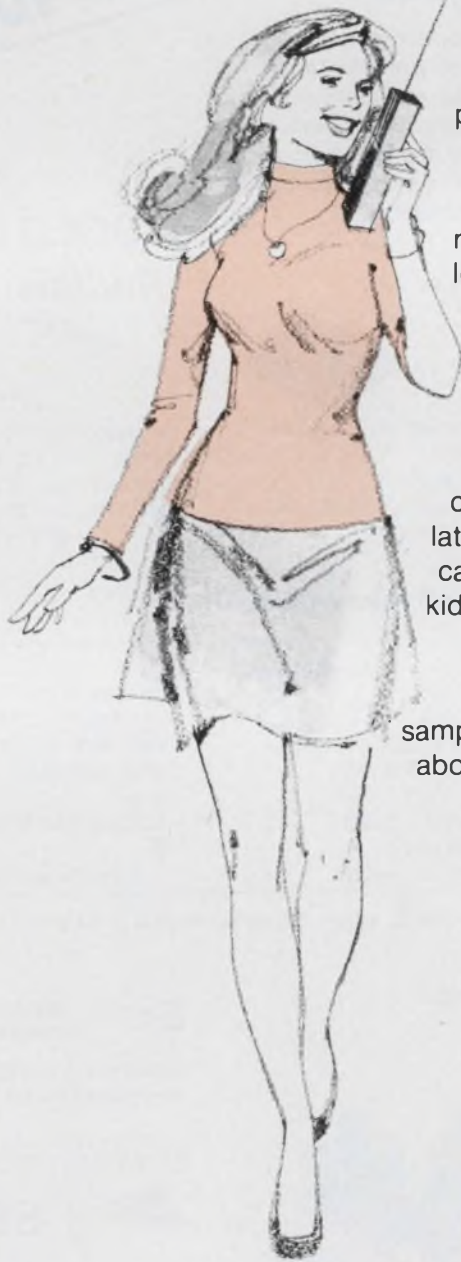

Maybe you're thinking about power conservation. So are a lot of other people.

That's one reason *iii* recommends Rubycon capacitors with low equivalent series resistance.

In most cases they offer the lowest resistance available in a good-quality, reasonably priced capacitor.

Chances are you're using our capacitors already. In that calculator on your desk. The CB in your car. The video game you gave the kids last Christmas. And dozens of other places.

Write or call Jim Ambrose for samples and literature. And let's talk about using Rubycon capacitors in your own products.

***ii*inquiries  
*ii*invited.**



2244 S. Western  
Chicago, IL 60608  
Ph. (312) 847-6363





# All our memories are worth remembering.

Everybody knows NEC Microcomputers makes the fastest and most reliable 4K MOS RAMs on the market.

But that's just the start of our state-of-the-art memories.

We've got both static and dynamic types. In NMOS, CMOS and bipolar technologies. All made with the same care and quality control we give to our more famous products.

And we can deliver them in the quantity you need, when you need them.

At prices that are very competitive.

So if you are in the market for memory components, remember everything we have.

And remember us.

NEC Microcomputers, Inc., Five Militia Drive,  
Lexington, MA 02173. 617-862-6410.

Product	Description	Organization	Access Times (Max) (ns)
2101AL	NMOS Static RAM	256 x 4	250-450
2102AL	NMOS Static RAM	1K x 1	250-450
2111AL	NMOS Static RAM	256 x 4	250-450
5101	CMOS Static RAM	256 x 4	450
2205	Bipolar TTL Static RAM	1K x 1	45
403	Bipolar PROM (A.I.M.*)	256 x 4	60
405/25	Bipolar PROM (A.I.M.)	512 x 8	70
406/26	Bipolar PROM (A.I.M.)	1K x 4	80
2308	NMOS ROM	1K x 8	450
2316A	NMOS ROM	2K x 8	450

\*Avalanche Induced Migration

## NEC microcomputers, inc.

REPS: East - C & D Sales 301-296-4306, Contact Sales 617-273-1520, Harry Nash Assoc. 215-657-2213, Tech-Mark 607-748-7473, Trionix Assoc. 516-466-2300; South - Perrott Assoc. 305-792-2211, 813-585-3327, 305-275-1132, Wolfs Sales Serv. Co. 919-781-0164; Midwest - Electronic Innovators 612-884-7471, K-MAR Eng. & Sales 816-763-5385.

R.C. Nordstrom & Co. 313-559-7373, 616-429-8560, Technology Sales 312-438-3300; West - Mike Duffy Assoc. 303-934-7392, Electronic Component Marketing 714-524-9899, 213-649-5374.

Spedden Assoc. 714-295-6122, Summit Sales 602-994-4587, Trident Assoc. 408-734-5900, Tri-Tronix 206-232-4993, 505-265-8409; Canada - R.F.Q. Ltd. 416-626-1445, 514-626-8324.

DISTRIBUTORS: Century Electronics (Albuquerque, Salt Lake City, Wheatridge CO), Diplomat (Chicopee Falls MA, Clearwater FL, Dayton Elk Grove Village IL, Farmington MI, Little Falls NJ, Minneapolis, Mt. Laurel NJ, Salt Lake City, St. Louis, Sunnyvale, Woodbury NY), Future Electronics (Montreal, Ottawa, Rexdale, Canada), Harvey Electronics (Fairfield NJ, Lexington MA, Norwalk CT, Woodbury NY), Intermark Electronics (San Diego, Santa Ana, Seattle, Sunnyvale) Liorex (Burlington MA), G.S. Marshall (Sunnyvale), Mirco Electronics (Phoenix), Resco (Raleigh).

R.M. Electronic (Kentwood MI, Madison Hgts MI), Semicomp (Newport Beach CA) Semiconductor Specialists (Burlington MA, Chicago, Dallas, Dayton, Farmington MI, Hazelwood MO, Indianapolis, Kansas City, Los Angeles, Milwaukee, Minneapolis, Pittsburgh, Malton Canada), Sterling Electronics (Albuquerque, Dallas, Houston, Los Angeles, New Orleans, Phoenix, San Diego, Seattle, Watertown MA), Technico (Columbia MD, Roanoke VA), Zeus Components (Elmsford NY).

TWO MINDS ARE MORE IMAGINATIVE THAN ONE



A regular part of our business is to assist companies in evaluating the application of plastics to their product. More and more frequently, design goals are achieved, and material and production problems successfully solved at the engineering conference table with ROSITE® thermoset plastic moldings.

Our engineers will study your design and prepare comprehensive feasibility and cost analyses. In many cases, we construct prototype molds to study the design concept and examine various ROSITE compounds to determine the optimum condition and material required for the application.

Through research we have discovered many properties and characteristics that were, at one time, thought non-existent in plas-

tics. Many of the ROSITE moldings we produce today are the result of a consistent program to expand and refine our compliment of compounds.

At our main plant in Lafayette we operate a sophisticated laboratory to test materials considered for your application, develop new formulations and run quality assurance checks on production mixes.

Mold and tool design is a major responsibility of our engineering group. Their experience is the basis of our ability to continuously improve our molding techniques. In addition, much of our manufacturing equipment is designed by us to maintain maximum control of quality and excellence in quantity production.

The net effect of using

ROSITE moldings is a superior product design produced at a favorable cost with fewer production complications. A conversation with one of our sales engineers will give you a chance to examine the applicability of ROSITE moldings to your product design. Call us.

Rostone  
Corporation

2450 Sagamore Parkway South  
Lafayette, Indiana 47902  
317/474-2421

**CUSTOM ENGINEERED  
PLASTIC MOLDINGS**

# Microprocessor Design

## Speedy arithmetic circuit unburdens busy microprocessor systems

Taking much of the calculation load off a  $\mu$ P-based system can accelerate processor speed. Up to now, however, all of the available calculator circuits haven't been fast enough to unburden the  $\mu$ P. Advanced Micro Devices plans to change that with its Am9511 arithmetic-processor unit.

The 9511 connects either to a  $\mu$ P bus or via a DMA interface to the  $\mu$ P's memory and can do floating or fixed-point arithmetic, trig functions, inverse trig functions, square roots, logarithms and exponentials. An 11-kbit ROM on the chip does calculations by using Chebyshev polynomials.

The NMOS circuit can perform 32-bit floating-point additions in 8  $\mu$ s, subtraction in 12  $\mu$ s, multiplications in 38  $\mu$ s, divisions in 41  $\mu$ s, rooting in 184  $\mu$ s, trig operations in a minimum 550  $\mu$ s and inverse trig operations in a minimum 900  $\mu$ s—all based on a 4-MHz clock rate.

Two versions of the 9511 are available: a 2-MHz unit called the 9511 and a 4-MHz model,

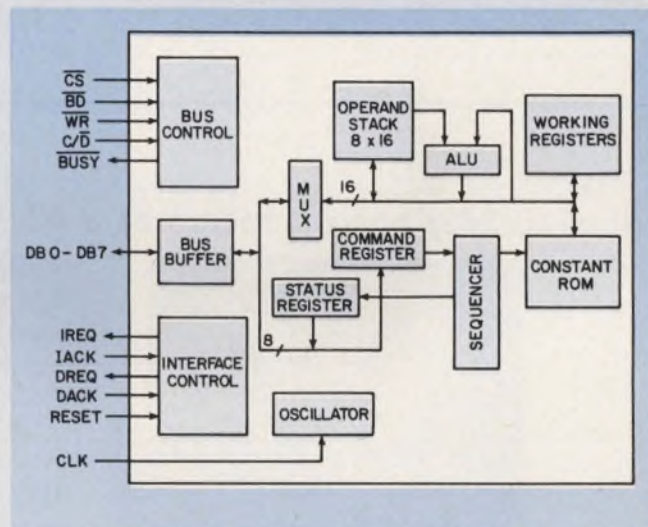

the 9511-4. Thus, typical execution time for an 8-bit floating-point multiply operation is either 76 or 38  $\mu$ s—both much faster than an

*(continued on page 44)*

## High-reliability control system uses three microprocessors



Redundant processing for high-reliability applications isn't new, but off-the-shelf systems still aren't commonly available. To solve this problem, Digital Dynamics of Sunnyvale, CA, has developed the System Q3—a triple-redundant microprocessor system for industrial-control applications that cannot be halted.

The triple system is built around three of the company's 4004-based Q-series processors. Each processor simultaneously handles the input data and compares its results with the results of the other two processors. A software "voting" procedure determines which output will be selected—if one unit disagrees with the other two, it is voted down and alarm and diagnostic signals are

generated to indicate a possible failure.

Dual-redundant power supplies with optional battery backup are diode-isolated and monitored by the processors.

The System Q3 hardware-software package has a base price of \$16,500.

## MICROPROCESSOR DESIGN

(continued from page 43)

8080 software subroutine, which requires 3 to 4 ms to perform a similar function.

All transfers, including operand, result, status and command information, take place over an 8-bit bidirectional data bus. Transfers to and from the 9511 can be handled by the associated processor using conventional programmed I/O, or by a direct-memory-access controller. Upon

completion of each command, the arithmetic chip generates an interrupt request to signal data are ready for the processor.

Two supplies, +5-V and +12-V, are required. A 24-pin DIP houses the circuit, and operation is specified for a 0-to-70-C range. Initial sample prices for the 9511 are expected to start at \$100, and units will be available around July, 1977. *Advanced Micro Devices, 901 Thompson Pl., Sunnyvale, CA 94086. Elliott Sopkin (408) 732-2400.*

CIRCLE NO. 503

---

### Video display board appears as a 4-k RAM to processor

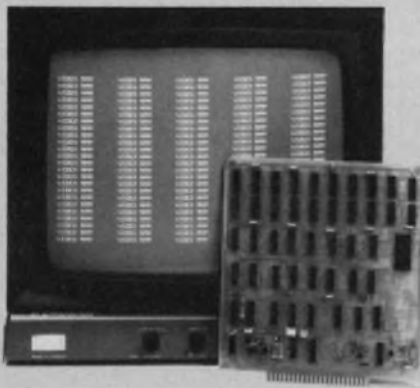

Capable of storing and displaying a 24-line  $\times$  80-column field of ASCII characters, the MTX-2480 video RAM board can connect to almost any microcomputer bus. The unit generates a video signal that can directly drive any standard video monitor (10-MHz bandwidth, min.).

Outwardly, the MTX-2480 looks like a 4-k  $\times$  9 RAM that is TTL-compatible and has an access time of less than 500 ns. Characters are normally displayed as white on a black background, but can also appear as black on white, half-intensity, or blinking. Both American (60 Hz) and European (50 Hz) operation can be configured on the board.

The 7  $\times$  7.5-in. board that holds the video RAM costs \$290 in 100-unit quantities and is available from stock.

*Matrox Electronic Systems, P.O. Box 56, Ahuntsic Stn., Montreal, Quebec, H3L 3N5, Canada. Lorne Trottier (514) 481-6838.*

CIRCLE NO. 504

---

### Two-board evaluation kit simplifies 6800-system prototyping



Prototyping and programming 6800-based systems can now be done with a combination hardware and software-development aid kit. Developed by Motorola, the MEK6800D2 kit has two printed-circuit boards with all the parts necessary to get a complete 6800 system up and running.

One board handles all the keyboard control, address and data display, and audio-cassette interfaces. The other board is the CPU, and even has a small breadboard area for custom interfacing. The cassette interface uses the "Kansas City Standard" for recording and playback levels. The transmitting rate is crystal controlled.

The CPU board contains the 6800, two PIAs, three 128  $\times$  8 RAMs and one each of the

(continued on page 46)

# NEW BURROUGHS' 480-CHARACTER GAS PLASMA DISPLAY:

**It's a space saver!**  
**It's a weight saver!**  
**It's a cost saver!**

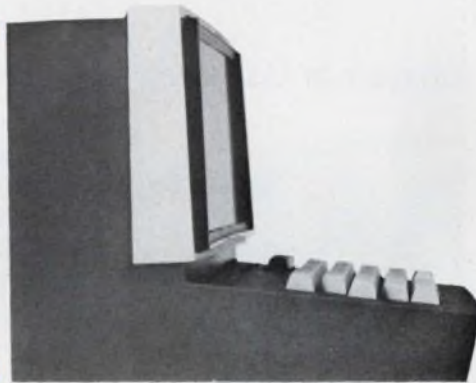

Burroughs low-cost 40, 240 and 480 character SELF-SCAN® II panel displays can help you reduce the size and weight of your data terminals by more than 50%. You'll reduce costs as well. And, at the same time, obtain excellent display readability under all operating conditions — indoors or out, day or night. Characters are uniformly bright, free of jitter and flicker with no fuzziness, distortion or loss of linearity at the display's edges. Character-to-background contrast is better than ever. And, the SELF-SCAN II panel's 40-character



line is compatible with popular software. Other significant advantages include direct digital address, easy interface to microprocessors, thin cross-section and rugged construction for long service life under all operating conditions.

Give your data terminals a bright new outlook; call or write for complete information. Burroughs Corporation, Electronic Components Division, P.O. Box 1226, Plainfield, New Jersey 07061. Telephone (201) 757-5000. SELF-SCAN® displays are available nationwide through our distributors, Hamilton/Avnet and Cramer Electronics.

You can **see** the difference

**Burroughs**



## MICROPROCESSOR DESIGN

(continued from page 44)

ACIA, clock generator and J-Bug ROM. The J-Bug ROM has a monitor program that allows the user to communicate with the 6800 via hexadecimal keyboard, trace instructions, set breakpoints and examine registers. Eight special-function keys simplify program writing and debugging.

The Evaluation kit costs \$235, and delivery is from stock.  
*Motorola, 3501 Ed Bluestein Blvd., Austin TX 78721. (512) 928-2600.*

CIRCLE NO. 505

---

### Analog I/O subsystem designed to mate with SBC-80/10 $\mu$ C

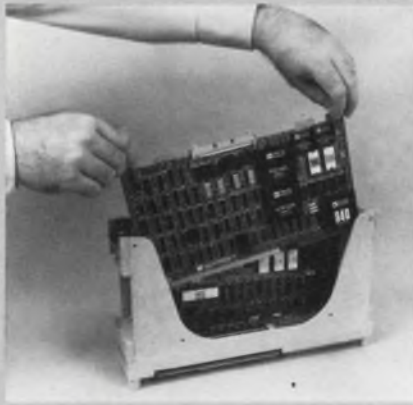

An analog input/output subsystem functionally, electrically, and mechanically compatible with Intel's SBC-80/10 single-board computer has been introduced by Analog Devices. The RTI-1200 is the first product in a series of subsystems.

The data-acquisition section includes a CMOS multiplexer, a programmable-gain amplifier, a sample-and-hold amplifier, and a 12-bit analog-to-digital converter. The basic version offers either 16 single-ended or 8 differential analog inputs, and an on-board expander option permits the number of available input channels to be doubled. Two analog-output channels that can convert 12-bit digital data into analog command signals are available optionally.

The RTI-1200 appears to the microcomputer as a block of memory locations. Software written for the subsystem can therefore make use of all memory reference instructions; hence, programming is simple.

Features of the data-acquisition subsystem include two-level overvoltage-input protection, with which input signals of up to  $\pm 28$  V can be tolerated; software-programmable amplifier, whose gain via software can be set to 1, 2, 4 or 8; a 4-to-20-mA current loop I/O, which can be set for eight of the input channels; a pacer clock system, in which two clocks are available to implement a system real-time clock or trigger evenly spaced a/d conversions; and an on-board PROM capability that allows for a 2708 1-kbyte PROM, or the equivalent.

The RTI-1200 requires +5 and  $\pm 15$ -V power. However, an optional on-board dc-to-dc power supply converts the +5 V to  $\pm 15$  V. Prices for the RTI-1200 range from approximately \$629 to \$979 each.

*Analog Devices, Inc., Route 1 Industrial Park, P.O. Box 280, Norwood, MA 02062.  
Lowell Wickersham (617) 329-4700.*

CIRCLE NO. 506

---

### Dual 8-bit I/O buffer includes 16-bit programmable timer

Housed in a 40-pin DIP, the IOB1680 does all the data-management functions necessary to support the CP1600 microprocessor. The MOS circuit from General Instrument can replace more than a dozen TTL MSI packages—and operates from a single +5-V supply.

The IOB1680 buffers data transfer between the microprocessor and all external memory and peripheral devices connected to a 16-bit wide input/output bus.

Moreover, its ability to perform three levels of priority-interrupt logic enables parity-bit  
(continued on page 48)

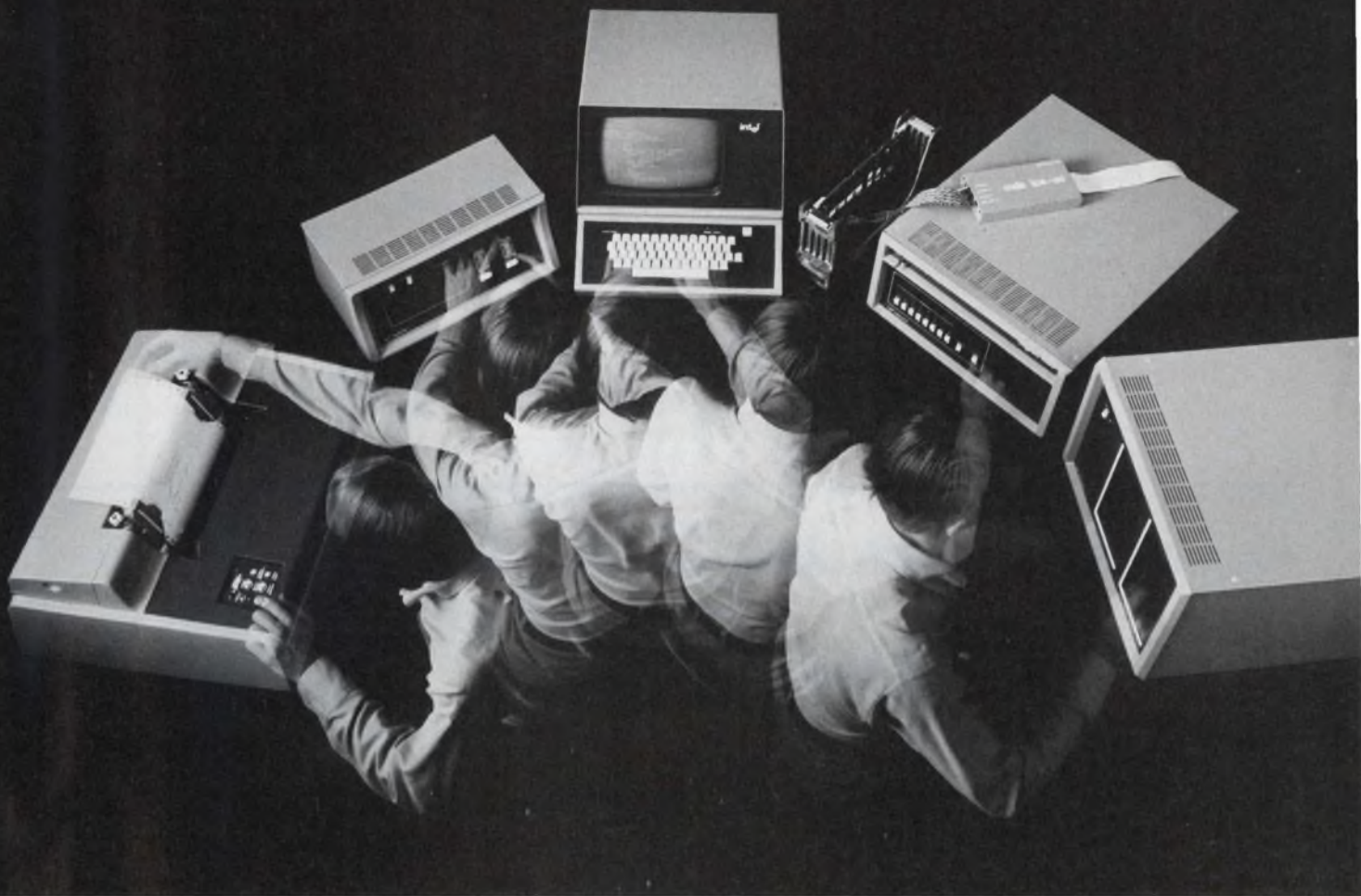

## Intel delivers resident PL/M for the Intellec<sup>®</sup> Microcomputer Development System. Say goodbye to monthly computer bills.

Now Intel has a resident PL/M compiler available with the Intellec microcomputer development system. Resident PL/M can give you a competitive edge because it can drastically cut your software development time and help you get new products to market quicker.

Having PL/M resident on the Intellec system means the end of monthly computer time sharing bills too. And eliminates delays waiting for computer availability. It makes it easier than ever to take advantage of a high level programming language.

You can lease an Intellec system for \$610\* a month with ICE-80,<sup>™</sup> dual diskette drives,

CRT terminal, line printer and resident PL/M compiler.

Or if you already own an Intellec system you can add resident PL/M for \$975\*. Once. Not monthly.

That gives you everything you'll need for fast, reliable programming of Intel<sup>®</sup> 8080 or 8085 microcomputers or our SBC-80 Single Board Computers and System 80 packaged microcomputer systems.

Under the new Intellec ISIS-II diskette operating system, PL/M provides the capability for fully modular programming. This means that programs can be developed and debugged in small, manageable modules,

and easily linked together, or linked with general purpose subroutines from a software library. And because the Intellec system supports your total development task, you save the cost and inconvenience of separate systems for hardware and software development and systems integration.

To arrange a demonstration of the Intellec system with resident PL/M contact your Intel sales office. For additional information use the reader service card or write Intel Corporation, 3065 Bowers Avenue, Santa Clara, California 95051.

**intel delivers.**

\*Domestic U.S.A. prices only.

## MICROPROCESSOR DESIGN

(continued from page 46)

errors in peripherals, data-transfer requests and event-timer operation to initiate microprocessor-interrupt requests.

The IOB1680's 16-bit programmable timer can be used to sequence peripheral events.

On the chip are also two 8-bit bidirectional input/output ports, each with parity-check logic built in. All necessary automatic handshaking logic and signals, on-chip reset logic, and a control register are included on the chip.

Available for immediate delivery in small quantities, the IOB1680 costs \$10 in 100-unit lots.

General Instrument, Microelectronics Div., 600 W. John St., Hicksville, NY 11802. (516) 733-3000.

CIRCLE NO. 507

---

### Program-development aid for 6800 systems captures cycles



Debugging can be shortened, production testing simplified and field microcomputers serviced—all with the 6800 Programmer's Panel, developed by Applied Microsystems. When connected to a 6800-based system, the unit offers such debugging features as reset, run, pause, single-step, examine/change memory and examine/change processor registers.

A memory-trace function can capture 100 processor cycles for troubleshooting, and a hardware-implemented breakpoint comparator can be set to stop program execution at any point. In addition the 16-key hexadecimal keyboard, 18 function keys permit simple operation. A six-digit hex LED display is built into the unit.

Interfacing between Panel and 6800 system is done via a 50 conductor flat cable. A separate, buffered bus

interfaces to extra memory or peripheral circuits. The price is \$1590, and delivery takes up to six weeks.

Applied Microsystems, P.O. Box 245, Bothell, WA 98011. Robin Knoke, (206) 827-9111.

CIRCLE NO. 508

---

### Hardware support for 2900 series includes 6 circuits

Six circuits have been added to the 2900 family of bipolar microprocessor components from Raytheon. One of these circuits, the Am2902 high-speed look-ahead carry generator, is pin-compatible with the 16-pin AMD unit and provides look-ahead carries across a group of four 2901 ALUs with a typical propagation delay of 6  $\mu$ s.

Three of the circuits are open-collector quad bus transceivers—the Am2905, 2906 and 2907. Each unit features a quad-D register on the driver side and a quad-output latch on the receiver side for pipeline operation. The driver outputs can sink up to 100 mA at 0.8 V, while the receiver outputs sink up to 12 mA. The 24-pin 2905 and 2906 feature dual driver inputs, while the 20-pin 2907 has only single-driver inputs. Also, the 2905 has three-state receiver capability while the 2906 has odd-parity outputs. The 2907 has both capabilities.

Another of the new units, the Am2911 microprogram sequencer, has essentially the same function as that of the 28-pin Am2909 microprogram sequencer, except that eight input

(continued on page 50)



# Multiple Output Power Systems

**Built to user requirements, shipped in just nine days.**

Avoid the complications of building power supply assemblies "in house" by having Acopian build them for you. The cost is very reasonable, even when only one is required. And, if no unusual construction or components are necessary, shipment is made within nine working days after your order is received.

Just list the dc output voltages and currents you require, determine what features and accessories (meters, controls, chassis slides, etc.) are to be included, and then call us collect at (215) 258-5441. Ask for the Power Systems Department.

During your call, we'll review your requirements with you, assign a reference number to your power system, and quote a firm price. Then, within nine days after we receive your order, we'll ship your system, completely wired and fully tested.

Additional information about Acopian power systems is contained in a full color, 16-page brochure. It also describes our standard rack mounting supplies with outputs to 50 volts and to 60 amps., as well as redundant output power systems for use where extremely high reliability is paramount. Write for your copy.

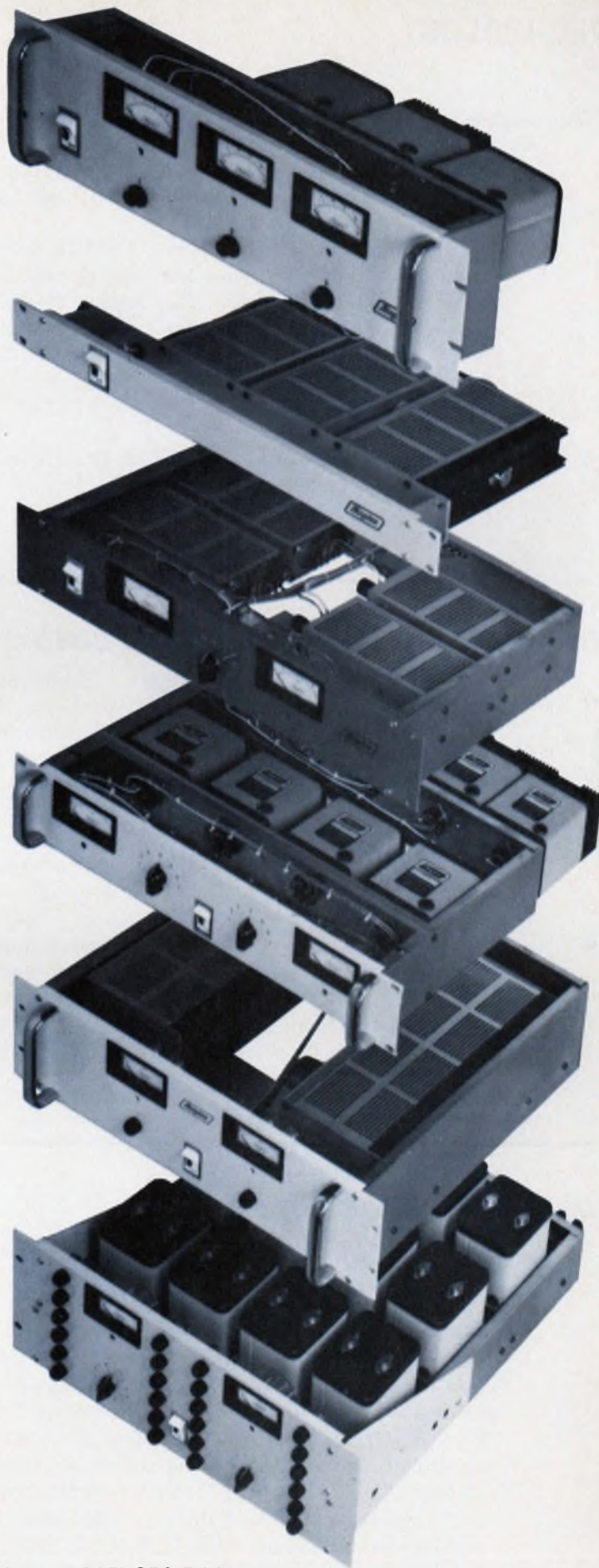

Corp., Easton, Pa. 18042. Telephone: (215) 258-5441

## TECHNOLOGY

(continued from page 48)

lines are eliminated from the 2911 to accommodate the smaller 20-pin package. In the 2911, the four direct input and register inputs are internally connected, while the 2909 has eight separate pins for these signals. Four pins are saved by eliminating the four OR inputs of the 2909.

The sixth circuit, the 16-pin Am2918 quad-D register, has two sets of outputs: four standard totem pole types and four three-state types.

With these six circuits, Raytheon's 2900 family has grown to eight. The new circuits are available from stock in both commercial and military versions. They are currently provided in hermetic DIPs, but flatpacks and plastic packages will be available soon. Prices for devices in 100-piece quantities of military/commercial quality are: \$7.28/\$3.31, \$21.84/\$7.80, \$27.93/\$9.31 and \$9.26/\$3.56 for the Am2902, 2905/6/7, 2911 and 2918, respectively.

Raytheon Semiconductor, 350 Ellis St., Mountain View, CA 94040. Dave Uimari (415) 968-9211.

CIRCLE NO. 509

---

## Intelligent breadboard speeds up 8080 circuit design



are available from stock.

IMSAI, 14860 Wicks Blvd., San Leandro, CA 94577. (415) 483-2093.

Developed to accelerate the breadboarding of micro-processor and logic circuits, the Intelligent breadboard connects directly to the company's 8080-based micro-computer. Designed by IMSAI, the breadboard communicates with the computer via the 8080 address and data bus and 48 TTL-level I/O lines.

Several thousand tie points are available for circuit connections; latched or unlatched LED indicators are available for status displays. Regulators are built onto the breadboard to regulate the  $\pm 18$  and  $+8$ -V buses tapped from the computer.

Prices start at \$435 for the breadboard in kit form and increase to \$625 for the assembled version. Both units

CIRCLE NO. 510

---

## Micro Capsules

Prices for plastic-housed 6800 family components have finally been announced by Motorola, Austin, TX. The 6800  $\mu$ P itself costs \$19.95 in quantities of 25 to 99; the 6820 PIA costs \$8; the 6850 ACIA, \$9; the 6852 SSDA, \$13; the 6826 modulator \$14, and the 6860 modem, \$12—all in quantities of 100 and up. And the price for the ceramic-cased 6800  $\mu$ P has been dropped to \$29.95 (for quantities of 25 to 99) . . . A complete personal computer system for under \$500 is the goal of a Commodore, Palo Alto, CA, design team. Based on a 6502  $\mu$ P the system will include a CRT display, full alphanumeric keyboard and resident Basic . . . Two powerful support-circuits for  $\mu$ P systems, a DMA controller and a universal-interrupt controller, are on the drawing boards at Advanced Micro Devices, Sunnyvale, CA. Expected to be available by mid-1977, these circuits are aimed by AMD to offer more capability than anything currently available. . . . Entering the microprocessor design-aids market by signing an agreement with Millennium Information Systems, Tektronix, Beaverton, OR, will build and market Millennium's Universal One  $\mu$ P development system. Tektronix expects to make first deliveries of the system in mid-1977.

# The Ultimate Instrument



## The World's First Wristwatch DMM

Now you can use two hands! Data Tech's new low cost Portable Digital Multimeter with its unique contoured hand mount frees both hands for fast, two-handed test probing. The Model 22 measures AC and DC Volts, AC and DC Current and Resistance and features basic 0.1% accuracy. The perfect DMM for field service application, it provides over 200 hours battery life on standard size disposable AA batteries and has low battery indication. The large reflective Liquid Crystal Display gives clear concise information in average or high ambient light conditions.

**DATA  
TECH**

A Division of Penril Corp.  
2700 S. Fairview · Santa Ana, CA 92704 · Phone (714) 546-7160 · TWX (910) 595-1570

# Data Tech Model 22 DMM

The Model 22 is the only low cost portable 3-1/2 Digit DMM that has all these features: Automatic polarity, complete overload protection, 200 hours minimum battery life on AA disposable cells, low battery indication, 60 hours per charge battery life on the optional Nickel Cadmium batteries, push-to-hold reading, 0.1% basic accuracy and large, crisp .5 inch high Liquid Crystal Display.

Measure DCVolts from 100 $\mu$ Volts to 1KV, ACVolts from 100 $\mu$ V to 750Vrms, DC and AC Current from 100nAmps to 20Amps, and Resistance from 0.1ohms to 20Megohms.

User convenience features make the Data Tech Model 22 the ultimate DMM in versatility and applications. The test lead terminals are on the front, where they should be, all functions except 20A range are measured in the same two terminals, and no special battery packs are required to be replaced when changing batteries.

The Model 22 is engineered and built for rough environments. It's rugged polycarbonate case and single board construction guarantee high reliability with over 35,000 hours calculated MTBF.



## Ordering Guide

The Data Tech Model 22 is available with a choice of accessories and power options. Please order by the appropriate model numbers.

Model 22-100	DMM with disposable batteries
Model 22-101	DMM only (without batteries) disposable battery model
Model 22-102	DMM only (without batteries) rechargeable battery model
Model 22-120	DMM with rechargeable batteries and 115Vac battery eliminator/charger
Model 22-121	DMM with rechargeable batteries and 230Vac battery eliminator/charger
Model 22-122	DMM with rechargeable batteries and 100Vac battery eliminator/charger

## Accessories

532176-001	115Vac Battery Eliminator/Charger
532176-002	230Vac Battery Eliminator/Charger
532176-003	100Vac Battery Eliminator/Charger
532337-100	Test Lead Set
532062-001	Deluxe Test Lead Set
532104-100	High Voltage Probe
532103-100	RF Probe
549121-101	Push to hold Probe
549734-100	Carrying Case
532312-100	Disposable Battery Set
532051-100	Rechargeable Battery Set
549735	Extra Operating Manual



	200mV	2V	20V	200V	1KV
<b>DC Volts</b>	Resolution 100 $\mu$ V	1mV	10mV	100mV	1V
	Accuracy $\pm(0.1\% \text{ Rdg} + 1 \text{ digit})$				
	Input Z 10M $\Omega$				
	Max. Input 1KV				
	NMR 50:60 Hz 60dB				
	CMR 50:60Hz 120dB				
<b>AC Volts</b>	Resolution 100 $\mu$ V	1mV	10mV	100mV	1V
	Accuracy $\pm(1\% \text{ Rdg} + 2 \text{ digit})$ 45Hz-1KHz				
	Input Z 10M $\Omega$ / <100pF				
	Max. Input 750Vrms				
<b>Resistance</b>	Resolution 1 $\Omega$	1 $\Omega$	10 $\Omega$	100 $\Omega$	10K $\Omega$
	Accuracy $\pm(0.15\% \text{ Rdg} + 1 \text{ digit})$				
	Test Current 1mA	1mA	100 $\mu$ A	10 $\mu$ A	1 $\mu$ A
	Max. Voltage In 500 Vdc or Vac rms				
<b>DC Current</b>	Resolution 100nA	1 $\mu$ A	10 $\mu$ A	100 $\mu$ A	1mA
	Voltage Drop .4V	.4V	.4V	.4V	.7V
	Max. Current 2A	2A	2A	2A	2A
	Accuracy $\pm(0.25\% \text{ Rdg} + 1 \text{ digit})$				
<b>AC Current</b>	Resolution 100nA	1 $\mu$ A	10 $\mu$ A	100 $\mu$ A	1mA
	Voltage Drop .4V	.4V	.4V	.4V	.7V
	Max. Current 2A	2A	2A	2A	2A
	Accuracy $\pm(1.0\% \text{ Rdg} + 2 \text{ digits})$ 45Hz-5KHz				

## General

Power	80mW
Display	.5" Liquid Crystal Display
Operating Temperature	0°C to +55°C
Storage Temperature	-5°C to +55°C
Operating Time	Disposable Cells (AA) 200+ Hrs NICAD (AA) 60 Hrs/Charge, 14 Hrs. Max. Recharge Time
Hold Function	Connecting Hold Jack to Low Terminal Holds Reading Indefinitely
Size	6.75" H x 3.26" W x 1.6" D (171.5 mm x 82.8 mm x 40.6 mm)
Weight	907 grams; 2 lbs with batteries
Power Options	Disposable Cells ONLY (AA Size) AC or Nickel Cadmium Cells (AA Size)

# DATA TECH

A Division of Penril Corp.

2700 S Fairview · Santa Ana, CA 92704 · Phone (714) 546-7160 · TWX (910) 595-1570

Circle Reader Service Card Number 275

# Big 0.6" double and single digits.

Our new super bright orange double- and single-digit displays are available in both common cathode and common anode configurations. These 0.6" digits (with overflow) incorporate our latest rounded-corner solid segment font to give you a display that's easy to read and easy to like.

The package is new, too. It has a colored face for optimum ON/OFF contrast. It's just under an inch in length and packs densely to provide digits on .50" centers.

The light emitting material is our new GaAsP:N on GaP, so you get all the benefits of this new high brightness technology – including direct MOS drive – plus all the inherent shock resistance and long life of solid state. Not bad.



Model Number	Description	Color	Luminous Intensity*
MAN 6610	2 Digit; Common Anode. RHDP	Orange	510 $\mu$ cd
MAN 6630	1½ Digit; Common Anode. Overflow ( $\pm 1.8$ ), RHDP	Orange	510 $\mu$ cd
MAN 6640	2 Digit; Common Cathode. RHDP	Orange	510 $\mu$ cd
MAN 6650	1½ Digit; Common Cathode. Overflow ( $\pm 1.8$ ), RHDP	Orange	510 $\mu$ cd
MAN 6660	Single Digit; Common Anode. RHDP	Orange	510 $\mu$ cd
MAN 6680	Single Digit; Common Cathode. RHDP	Orange	510 $\mu$ cd
MAN 6710	2 Digit; Common Anode. RHDP	Red	125 $\mu$ cd
MAN 6730	1½ Digit; Common Anode. Overflow ( $\pm 1.8$ ), RHDP	Red	125 $\mu$ cd
MAN 6740	2 Digit; Common Cathode. RHDP	Red	125 $\mu$ cd
MAN 6750	1½ Digit; Common Cathode. Overflow ( $\pm 1.8$ ), RHDP	Red	125 $\mu$ cd

\*Minimum digit average @ 10mA, DC per segment

So if it's bright you want, and your application calls for 0.6" displays, call your Monsanto man in and have a look at the MAN6600 and MAN6700 series. They're terrific.

**Monsanto:**  
the science  
company.

IN EUROPE CONTACT: Monsanto Europe S.A.,  
Electronics Division, Avenue de Tervuren 270-272,  
B-1150, Brussels, Belgium

Please send me a data sheet on your MAN6600 and MAN6700 series digits.

Name \_\_\_\_\_

Title \_\_\_\_\_

Company \_\_\_\_\_

Street \_\_\_\_\_

City \_\_\_\_\_

State \_\_\_\_\_ Zip \_\_\_\_\_

Mail to Monsanto Electronics Division,  
Dept. MCD, 3400 Hillview Ave., Palo Alto,  
CA 94304. Phone (415) 493-3300.

© Monsanto Company Electronics Division, 1976

CIRCLE NUMBER 25

**It's easy to inspect, test and repair  
AMP Latch multi-conductor  
connectors.**

**Even after they're in use.**



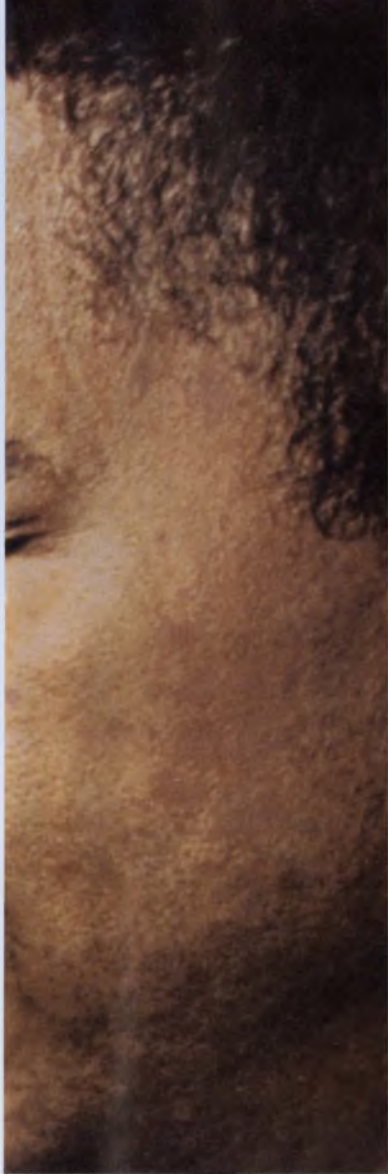

We designed them that way. Because a mass termination connector should help you save time and effort before, during and after assembly.

Their unique folded contact design, with dual camming and latching ears, assures you of four-point electrical contact and mechanical grip for each conductor. And that means superior overall reliability and protection. In addition, these fork-type contacts make it especially easy to visually inspect each termination before the cover is applied.

And even after the cover is on, each contact can still be visually checked for proper locking and latching. Because every AMP Latch cover has a built-in inspection port over each termination. This also permits electrical testing without cover removal, saving additional production time. And if repair ever is necessary, we've made that easier, too, by designing special hand and pen tools.

There are more reasons why you should choose AMP Latch connectors such as quick, easy terminating with the AMP shuttle tool, and the broad variety of pin headers and connectors. You also get AMP backup . . . expert design and production help that's yours for the asking from AMP connector engineers.

Why not contact Customer Service, at (717) 564-0100 for complete details on the AMP Latch connector line? Or write us direct. AMP Incorporated, Harrisburg, PA 17105.

# AMP

## INCORPORATED

CIRCLE NUMBER 26

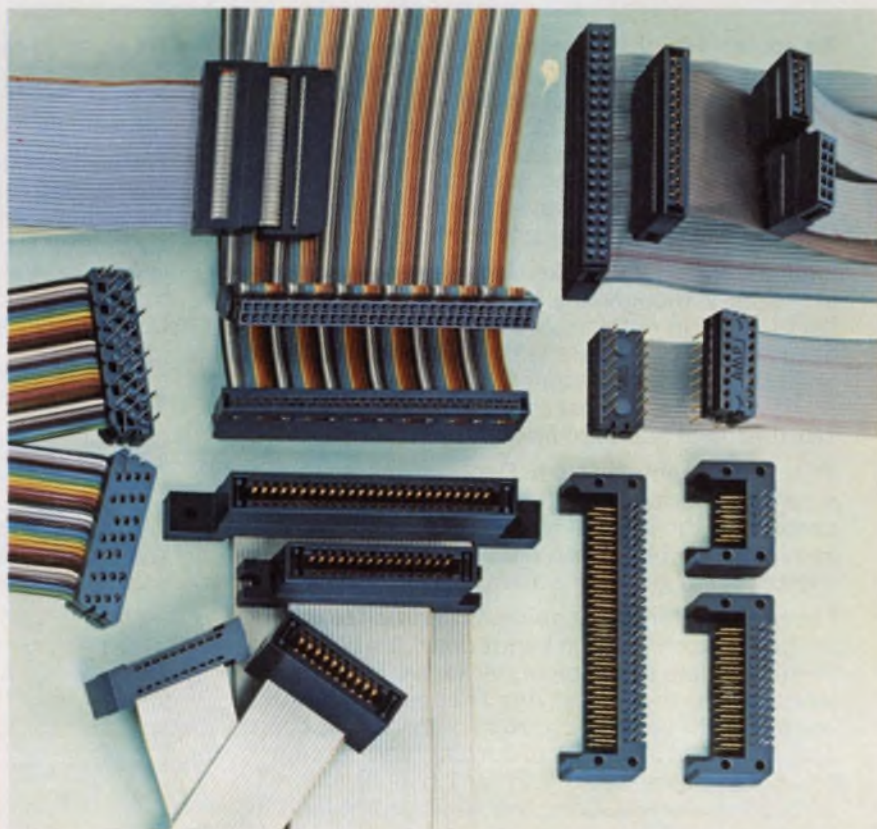
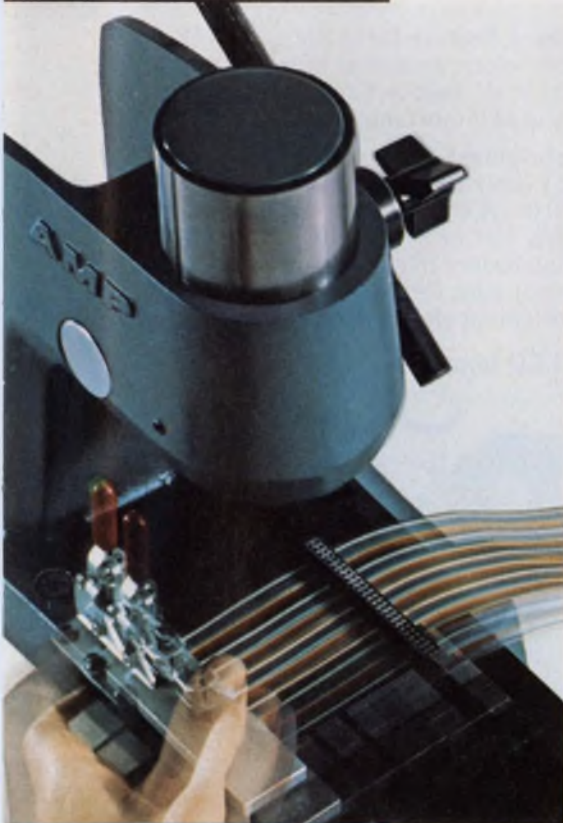

AMP is a trademark of AMP Incorporated.

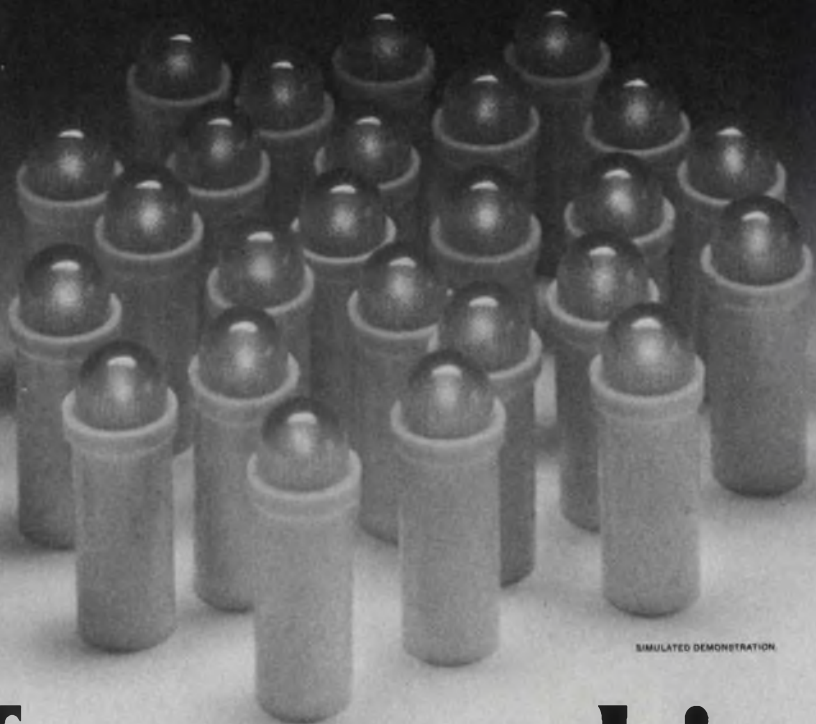

SIMULATED DEMONSTRATION

# One of ours outshines twenty-five of theirs.

We couldn't think of a better way to demonstrate our brightness story on the printed page. And although it may seem a little unbelievable at first, it's true. One of our Brite-Lite® LED lamps outshines twenty-five of most competitive LED lamps (50 mcd vs. 2 mcd). This comparison isn't just a figment of our imagination. The facts have been tested time and time again. On the bench and on the job.

**Light before bright.** We know brightness is only part of the story, though. The lamps must turn on to begin with. No problem. We offer traditional incandescent-type brightness with proven solid-state reliability. Reliability that amounts to at least 100,000 hours per lamp. In most cases, that's more than 10x the life of standard incandescent lamps.

**Brite-Lites® come through.** Our brightness story means that Brite-Lites® come shining through repeatedly in those panel and printed circuit board applications where lamp visibility is critical. In your choice of red, green or amber.

**The best combinations going.** In addition to outshining the competition lamps down, we offer the most complete selection of packages. From convenient snap-ins to space saving T<sup>2</sup> Lites, which enable you to design panel lamps right onto your PC boards. And, there are a number of current/voltage combinations you can specify. From 1.6 to 28 volts — 10 to 35 milliamps. Complete with current-limiting resistors.

**We shine on delivery.** Feature for feature, Data Display Products outperform as well as outshine the competition. Best of all, we don't keep you waiting. After all, delivery is as important as performance!

**The best and the brightest.** We don't really expect any of you to use twenty-five lamps where one will do. We do hope you'll let us shine up your project at the early design stages. Call or write, today. We'll give you a lot more than twenty-five outstanding reasons to make you look our way. Because when it comes to LED lamps, the brightest also happens to be the best.

**"The brightest LED lamps in the business!"**



5428 W. 104TH ST., LOS ANGELES, CA. 90045 (213) 641-1232



# Washington Report

## Support looks good for Defense and Space budgets

The Carter Administration is expected to make some changes in the fiscal 1978 budget submitted by the outgoing Ford Administration. But, the final budget should reflect continued growth in both defense and space R&D and hardware.

Three areas in particular will have an impact on the electronics industry: accelerated development of strategic weapons to match recent Soviet missile deployments; a five-year, \$48-billion shipbuilding program; and a series of new initiatives in space, led by the Space Shuttle program.

The Defense Department is due to receive \$123.1-billion in total obligational authority (TOA) of the total federal budget authority of \$449.1-billion—up from \$110-billion in fiscal 1977. The National Aeronautics and Space Administration TOA is projected at \$4.02-billion—up from \$3.7-billion.

Two categories in the Defense Department's budget that are extremely important to the defense-oriented electronics industry, procurement and research, development, test and evaluation (RDT&E), both exhibit strong growth in the department's proposed budget. Procurement is up from this year's level of \$27.9-billion to \$35.1-billion, and RDT&E is due to rise from \$10.6-billion to \$12.1-billion.

## The B-1 isn't the only one

The most visible Defense program, the controversial B-1 bomber, will be scrutinized by the Carter administration. The outgoing administration ordered the aircraft into production last year and requested \$2.16-billion in the fiscal 1978 budget to procure the first eight production models. The long-range plan calls for 19 more B-1s in fiscal 1979 at a cost of \$2.9-billion. Total expenditure is estimated at \$22.9-billion.

Lurking beneath the surface of the new budget figures, however, is an even more costly program: the M-X missile that outgoing Defense Secretary Donald Rumsfeld calls "the heart of the U.S. ICBM modernization plan." Designed to counter the new, heavier Soviet missiles, M-X will be more accurate and twice as heavy as the current Minuteman ICBM. The fiscal 1978 budget contains \$294-million for M-X—\$49-million for advanced development and \$245-million to begin engineering—but the long-range plan calls for \$1.5-billion in fiscal 1979. If retained by the Carter administration, M-X is expected to cost at least \$30-billion to deploy.

A new shipbuilding program for the Navy calls for 157 new ships, of which only 18 will be nuclear-powered (16 submarines and two new nuclear-strike cruisers). The aim is to bring the Navy up to 600 ships by the 1990s. In response to the National Security Council recommendation against building more large nuclear-powered aircraft carriers, two smaller

carriers using conventional power and tailored for vertical-and-short-take-off-and-landing (VSTOL) aircraft will be developed.

Another indication of the growth of the defense business is the increased procurement of aircraft. Of 548 obtained this year, 117 (mostly helicopters) went to the Army, 214 to the Navy and 217 to the Air Force. The fiscal 1978 budget calls for 697 aircraft: 139 for the Army, 181 for the Navy and 377 for the Air Force.

Tactical fighters are the major element. In fiscal 1978, 108 of the Air Force's F-15 fighter will again be acquired while procurement of the new F-16 fighter is to begin with 105 and rise to 145 in fiscal 1979. Procurement of the A-10 attack aircraft is due to rise from 100 this year to 144 in the new budget and 180 in fiscal 1979. The Navy will take 44 F-14s in fiscal 1978—8 more than in the current fiscal year—and 60 in fiscal 1979. The F-18 goes on the block in fiscal 1979.

## **Space programs will get a boost**

NASA's major program, the Space Shuttle, is budgeted for \$1.35-billion, up from this fiscal year's \$1.29-billion. The space agency's total fiscal 1978 request includes \$142-million to start acquiring three more orbiting vehicles to round out the planned fleet of five. An additional \$491-million is projected for that purpose in fiscal 1979.

Orbiter-3 should be available in the first quarter of 1982. Orbiter-4 should follow in the first quarter of 1983 and Orbiter-5 a year later. The latter two spacecraft are earmarked for the Air Force. Total cost of production is estimated at \$1.2-billion. NASA will keep Orbiter-1 and Orbiter-2, the first of which is to begin test flights in 1979.

Four new programs are slated in the NASA budget. The U.S. and Canada will put up \$15-million each for a four-year search-and-rescue satellite demonstration, which will consist of piggybacking transponders on satellites launched for other purposes—probably weather satellites—in 1979 or 1980. The goal is to locate within two hours all distress beacons from aircraft, ships or ground users in the two countries.

The other innovations are a Space Telescope, budgeted at \$36-million next year out of a total program estimated to cost upwards of \$470-million over seven years; a Jupiter Orbiter/Probe, \$20.7-million out of \$280-million for five years; and a Landsat-D earth-resources observation satellite, \$22-million out of \$182-million over six years. The probe is to be launched from the Space Shuttle with the Interim Upper Stage in 1981, the Landsat-D by a Delta vehicle the same year. A Shuttle launch in 1982 is planned for the Space Telescope.

## **Energy R&D will be a fast mover**

The Defense Dept. and NASA account for more than half of the total planned federal obligations for RDT&E in fiscal 1978, but energy R&D is the fastest growing budget sector. The federal total is projected at \$27.96-billion next year, up 8% from the current-year level of \$25.9-billion. Defense and NASA account for \$14.9-billion this year and \$16.1-billion in the new budget. Funding of the Energy Research and Development Administration (ERDA), meanwhile, is due to rise 13% from \$3.6-billion to \$4.06-billion in the new budget.

Nuclear research will lead the way: Fusion-work expenditures will rise 34%, from \$322-million this year to \$433-million in the new budget, and fission 23% from \$717-million to \$879-million. The biggest percentage gain will go to geothermal research—39%, from \$49-million to \$68-million.

# Compare our SOA and $E_{S/b}$ to theirs and you'll understand why our high current/voltage transistors work.

**High voltage and high current specs aren't enough.**

If you've ever specified transistors above 50 amps, only to find they fail on the job, you know how high-current specs may actually be misleading.

The truth is, unless you see the SOA and  $E_{S/b}$  specs, there's no way of knowing whether a high-current device has the guts to withstand a surge, and not blow out.

That's why we publish both our Safe Operating Area and  $E_{S/b}$  specs.

We want you to see precisely the kind of super-ruggedness you can expect from PowerTech—and only PowerTech—high-current transistors. Compare our  $E_{S/b}$  ratings, from 1.5 to 6 joules, against the millijoules or unpublished ratings of other high-voltage/current devices.

**Copper makes the difference.**

We use extra-heavy copper-metalizing on our bigger, beefier chip—thereby assuring maximum thermal

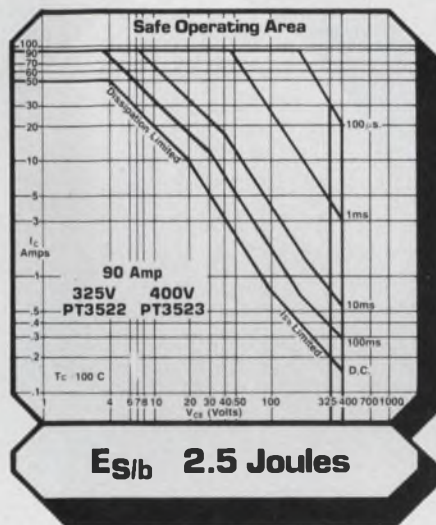
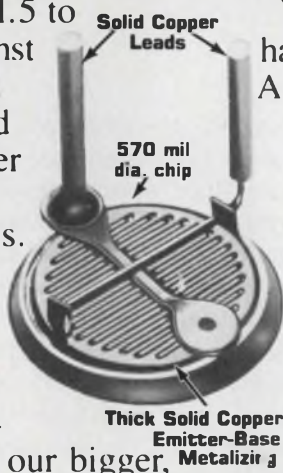

and electrical conductivity and yielding the highest resistance to second breakdown with the lowest  $V_{CE(sat)}$ . Their smaller chips use thin aluminum-metalizing with fragile, current-limiting wires (ours have solid copper posts).

Which would you rather have your circuit depend on? And we don't stop there. To guarantee rapid delivery, we pre-mount our chip on an integral moly-copper heat sink so we can categorize and pre-test the module at high currents to insure maximum reliability prior to mounting in the package of your choice (again 100% tested to the most stringent MIL/AERO specs).

They, on the other hand, must first mount their chip on the package, then test to determine if it's shippable.

**Delivery and prices.**

Our catalogs come complete with prices...we don't believe in secrets.

While our initial device cost may be slightly higher, in the long run we believe you'll find that it's less expensive to use transistors that keep on working.

We rely on direct factory-to-customer contact to ensure 100% responsiveness, backed up by the flexibility of chips already built, pre-tested and ready for whatever electrical/packaging requirements you may have.

But see for yourself: call for further information and applications assistance: Sales Engineering, PowerTech, Inc., 0-02 Fair Lawn Avenue, Fair Lawn, New Jersey 07410; Tel. (201) 791-5050.

TYPICAL PRODUCTS			
$I_c$	$V_{CE}$	$E_{S/b}$	Part No.
1200A	80V	6.0J	MT-5007
400A	120V	6.0J	PT-9503
150A	200V	1.5J	PT-4500
90A	400V	2.5J	PT-3523
40A	600V	2.5J	PT-3522

JAN-TX Types Also Available  
Guaranteed SOA

**PowerTech, Inc.**

"BIG IDEAS IN BIG POWER"

CIRCLE NUMBER 28

# Someone has developed a more efficient resistor.



**T**HE new Dale resistors are more efficient to buy. A network of computer terminals throughout our three resistor plants gives you more useful production information than you've ever been able to get—from anyone.



Place an order and in seconds we can tell you whether it can be shipped from stock. Inquire about an existing order and we can tell you its exact production status equally as fast. Discover a need for earlier delivery and we can instantly mark your order for expediting. That's

resistor efficiency you can use. It's part of an expansion program that has seen our floor space devoted to resistors grow from 300,000 square feet in 1970 to more than 400,000 square feet today. And much of this expansion has been devoted to automated facilities. Multi-station winders let you specify the stability and power of wirewounds at a lower cost than ever...and batteries of laser spiralling machines turn out RN-style metal film parts at machine-gun speed. We're making the most efficient resistors you can buy—and we're ready to prove it.

The new Dale resistors are made from more efficient materials than ever. Sophisticated equipment, like this scanning electron microscope, gives us state of the art capability for analyzing, identifying and specifying component materials. It's part of an integrated materials improvement, performance testing and quality control program we initiated 15 years ago in the early days of the Minuteman High Reliability Development Program. Today, one out of every 10 Dale employees is directly involved with Quality Control. Tangible results include: More than 100 separate QPL listings for wirewound and metal film resistors; the world's most reliable wirewound resistor (proven failure rate .000021%/1000 hours). The new Dale resistors will give you less trouble—before and after purchase—than any others you can buy—and that's efficiency! Call 402-564-3131 for wirewound and 402-371-0080 for metal film.

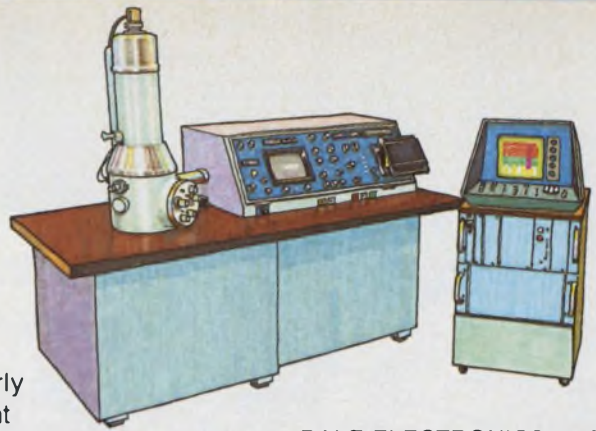

**DALE ELECTRONICS, INC.**  
1300 28th Avenue, Columbus, Nebraska 68601  
*A subsidiary of The Lionel Corporation*  
In Canada: Dale Electronics Canada Ltd.  
In Europe: Dale Electronics GmbH,  
8 München 60, Falkweg 51, West Germany



*Our complete product line can be found in Electronic Design's GOLD BOOK.*

CIRCLE NUMBER 30

# Dale!

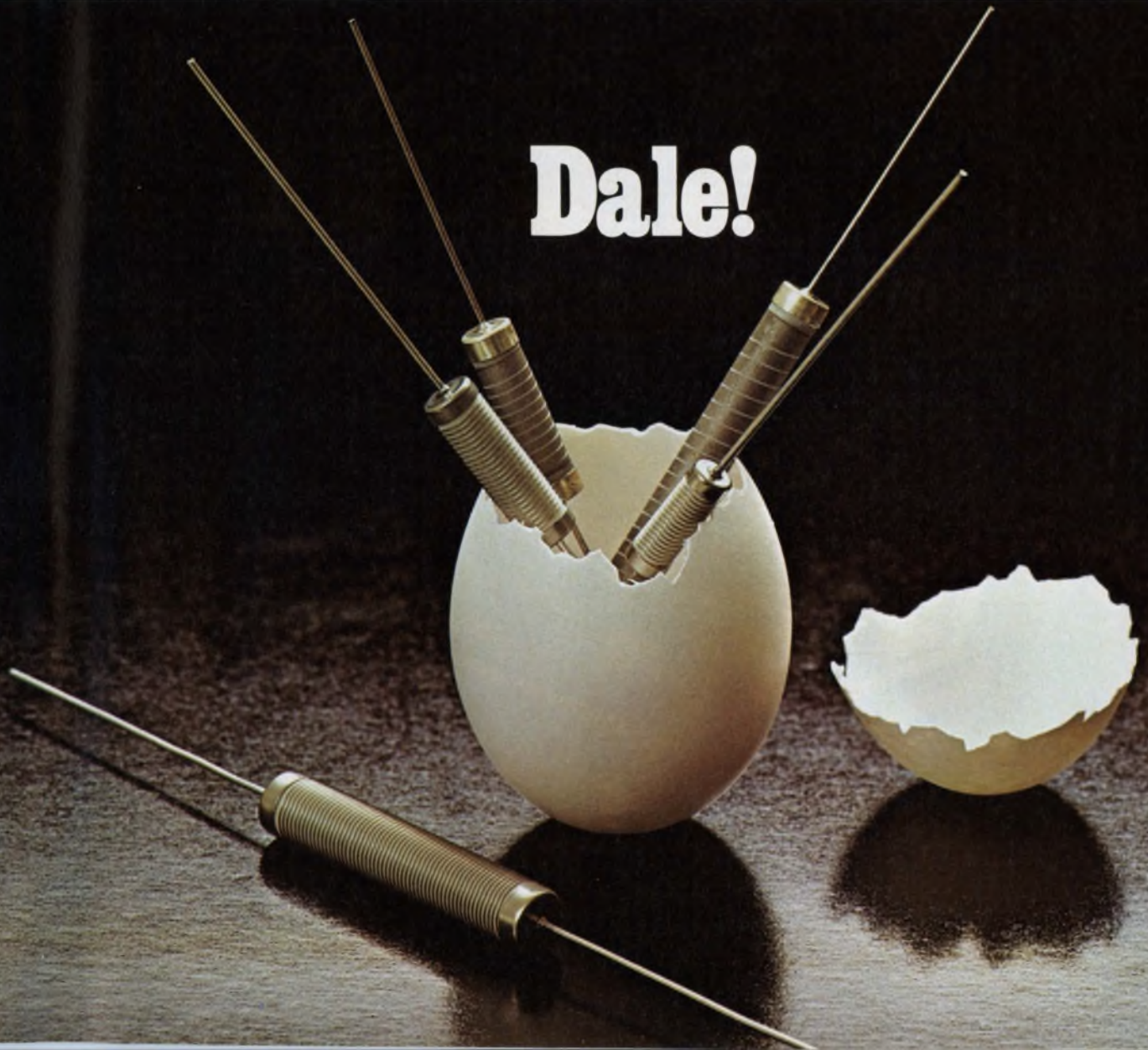

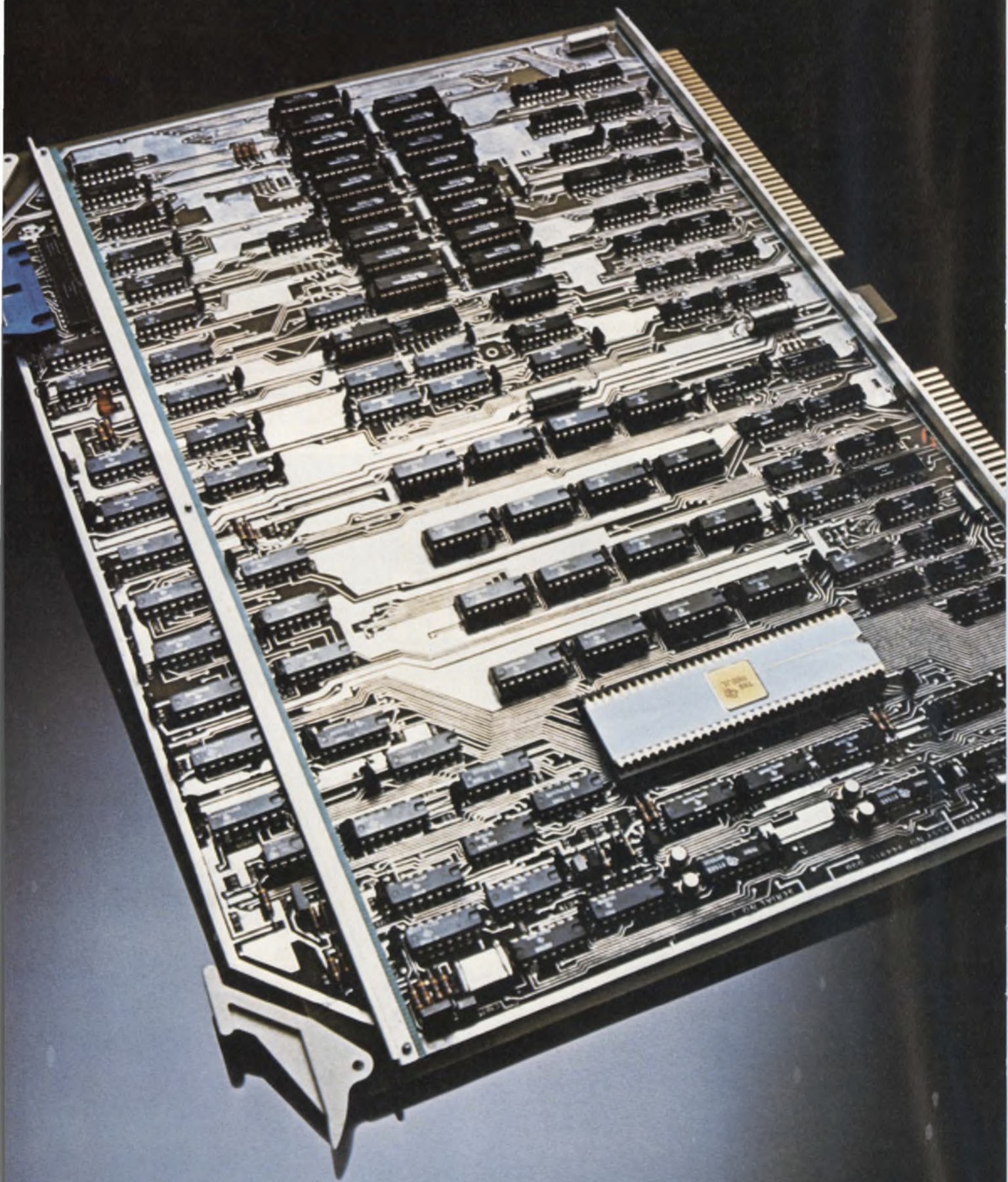

**When you're  
designing microprocessors  
into your products...  
our 990 computer products  
can give you a head start.**

# TEXAS INSTRUMENTS.

Start with the TMS 9900 microprocessor.

It delivers surprising power, speed and flexibility in a low-cost, single-chip 16-bit package. Its repertoire of versatile instructions and high-speed interrupt capabilities provide computing power usually associated with a 16-bit TTL minicomputer.

Hardware multiply and divide is standard and the software you develop for the TMS 9900 is upward compatible with any other member of the 990 computer family.

When your application calls for a microcomputer—start with the 990/4 microcomputer on a board.

It offers all the advantages of the TMS 9900, plus flexible memory and CPU options ideally suited to manufacturers' applications: up to 8K bytes of dynamic RAM memory, up to 2K bytes of RAM and/or PROM, real-time clock input, eight vectored interrupts, expansion interface and optional ROM utilities. It's our off-the-shelf answer for many production needs.

The 990/4 microcomputer is also available in a low-cost three-slot OEM chassis... or housed in a 6- or 13-slot rack-mount chassis with programmer's panel... or in a 6-slot



tabletop chassis. And, the 990/4 is available as a complete computer system supported by your choice of performance options and peripherals.

For applications requiring greater speed, we offer the most powerful member of the 990 computer family... the 990/10 minicomputer. It uses a TTL implementation of the 990 architecture and features TILINE\*, an asynchronous, high-speed 16-bit parallel I/O data bus which links the CPU, memory, and high-speed peripheral devices.



Rack-Mount 990 Computer

And to help you get on line faster and surer, there's a prototyping system using 990 computer hardware and software packages.

In addition, the 990 family is well supported by a substantial library of software development packages.

Whatever your needs... the TMS 9900 microprocessor, the 990/4 microcomputer, or the 990/10 minicomputer... you'll be working with some of the most attractive



990/9900 Prototyping System

computer component values on the OEM market. Price/performance leadership you expect from Texas Instruments.

You can start today by getting more information on the entire 990 computer family. Contact your nearest TI sales office, or phone (512) 258-5121, Computer Equipment Marketing, for your local distributor. Write Texas Instruments Incorporated, P.O. Box 1444, M/S 784, Houston, Texas 77001.

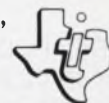

\*Trademark of Texas Instruments Incorporated

© Copyright 1977, Texas Instruments Incorporated

**TEXAS INSTRUMENTS**  
INCORPORATED

CIRCLE NUMBER 32

# Dial-A-Voltage



SHOWN ACTUAL SIZE

## 0.005% Calibrator only \$295 (SINGLES)

Datel's Digital Voltage Calibrator, DVC-8500 comes in a mini-benchtop package, at a mini-price (\$295 in singles\*), but provides very big performance. DVC-8500 offers 4½-digit resolution and a ±19.999 volt full scale output range with ±1 millivolt accuracy (±0.005% of full scale.)

Use your DVC-8500 to calibrate A/D and D/A converters, DPM's, DVM's, Op Amps, V/F converters, and Data Acquisition Systems. A short-proof, buffered output gives up to ±25mA output current with an LED overload warning signal. The ±1.5 millivolt front panel vernier allows fine tuning of A/D and D/A bit steps.

Included are rear PC sense terminals and a choice of 100, 115, or 230 VAC inputs. A panel mounting kit is optional.

Contact Datel, or your nearest Datel Representative listed in Gold Book or EEM.

\* U.S.A. Domestic Price only.

**D** **DATEL**  
**SYSTEMS, INC.**

1020 Turnpike St., Canton, Mass. 02021  
Phone (617) 828-8000

- Santa Ana, Calif. (714) 835-2751
- Santa Ana (L.A. Exchange) (213) 933-7256
- Sunnyvale, Calif. (408) 733-2424
- Gaithersburg, Md. (301) 840-9490

CIRCLE NUMBER 33



## The good word

I've always been madly in love with Lotte Lehmann. But I never told her. Though I've been to California dozens of times, I never went to Santa Barbara to give her a bunch of flowers and tell her how much she meant to me. For this glorious soprano could breathe more excitement, more passion, more fire and more sheer beauty into marvelous music than anybody I've ever heard. But I never told her.

Now it's too late. Back in September, Lotte Lehmann died in her sleep at the age of 88. I know that Lehmann, who was adored by millions, didn't need and never missed my words of esteem. But I feel smaller for not having given them. I missed my chance.

What's terrible is the fact that I'll probably miss countless future opportunities to tell people I like them or something they did. Most of us, I guess, are too shy to express our admiration openly. That's unfortunate because we all work better and are better with a word of praise now and then.

Recognizing this fact, several companies keep printed "You done good," "Attaboy" or other such awards to help shy people pat deserving colleagues on the back. That's a step in the right direction. But it would be a lot better if we could all train ourselves to lay praise where praise belongs, freely and without condescension.

Giving ourselves the excuse that we *expect* good things of our colleagues and are not surprised at their achievements, we too rarely can bring ourselves to say, "Joe, that was an elegant design," "Jack, that was a nifty idea," or "Sam, you're a fine human being." How sad. For praise enriches us all. And it costs nothing.



A handwritten signature in dark ink, which appears to read "George Rostky". The signature is written in a cursive, flowing style.

GEORGE ROSTKY  
Editor-in-Chief

# Designers'

## Toggle Switches

Bat, lever lock, Designer Line, sealed. Big, broad choice.



## Rocker Switches

Singles and multiples. Wide, colorful selection range. Legends, too.



Cutler-Hammer, of course! The broadest line. Styled to meet today's and tomorrow's requirements. They're solid quality, look great, work long and hard. Carried in stock for local availability by Switch Distributors.

Backed by Cutler-Hammer sales engineers who can deliver innovative design help for

## Pushbutton Switches

Choice of sizes, colors, circuits, ratings. Styled to "turn you on".



## Tool Handle & Slide Switches

Variable speed, reversing. Double insulated.



 **Switch to No.1**

# Choice.

the exact switch or relay you need—  
when you need it.

It's no wonder so many designers specify  
Cutler-Hammer. For quality, reliability,  
availability, and style. For commercial,  
industrial, and military applications.

We simply offer more—of everything!

## Snap Switches

Lever, roller, leaf, and  
pushbutton actuators.  
Four terminal styles.



## Rotary Switches

Precision and general  
purpose. Single and  
multiple wafer.



## Switch Accessories

Guards. Boots. Seals.  
Caps. Decorator  
facenuts. And much  
more to protect, code  
or customize.



## Illuminated Switches

Rockers, paddles,  
pushbuttons, indicators.  
Snap-in and bushing.



## Relays

Hermetics, non-sealed,  
potted. Power, latching,  
and timing functions.



**CUTLER-HAMMER**

SPECIALTY PRODUCTS DIVISION, Milwaukee, Wis. 53201



# Want mass terminations for I/O interconnecting? We have the widest choice.

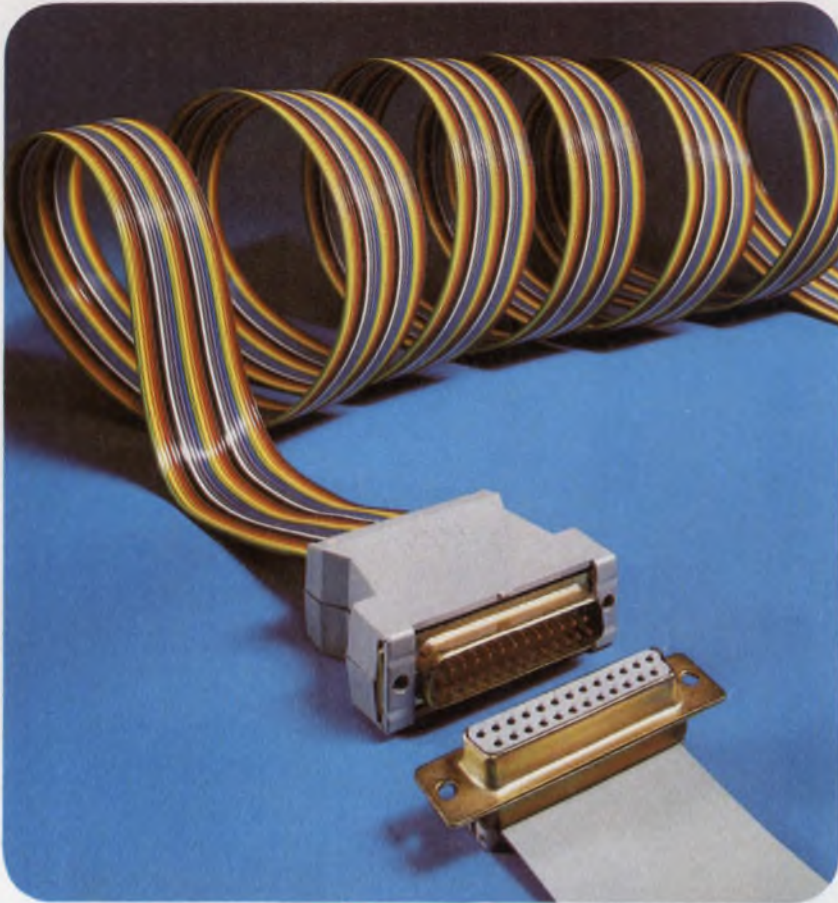

Now Scotchflex brand DELTA Connectors bring the proved labor-savings of 3M's mass termination system to subminiature connections. DELTA series components include pin and socket connectors, junction shells, 25-conductor flat cable and strain relief clips. These system assemblies interface directly with all other industry standard "D" series subminiature connectors. They're also compatible with all connectors in our complete Scotchflex line.



A family of Scotchflex male plug connectors is now available in sizes from 10 to 50 contacts to mate with Scotchflex socket connectors for T-tap or mid-span connections or rack and panel applications.

"Scotchflex" is a registered trademark of 3M Co.



Our broad line of Scotchflex socket connectors includes a variety of 12 different sizes and center spacings to fit standard wrap panels and custom configurations. Also offered are Scotchflex card-edge connectors in sizes for 20 to 50 conductors.

Only 3M offers you so wide a choice of mass terminating flat cable and system components for fast, economical assembly of I/O interconnections between modules or sub-assemblies in your equipment designs. Plus off-the-shelf availability from experienced distributors, and the unmatched experience of the people who pioneered electronic mass terminations.

For more information on Scotchflex products call 612-733-3350.

Scotchflex<sup>®</sup>  
systems  
from 3M.  
The source.



See our  
catalog in EEM,  
page 1056

# Coming through...



with wire, cable and cord  
that delivers quality,  
performance, economy...

Belden has it: a total service capability. Extensive design and application know-how. What it takes to deliver complex cable configurations, special harnesses, cords, lead wires, and even special packages to fit your requirements.

Our specialists and engineers will meet with your people at your plant to discuss problems in processing, assembly, installation, ordering, human engineering, color coordination, physical and electrical parameters, opportunities for cost reduction. And when we can't help you using standard products, we'll innovate a solution to your problem.

Talk to a Belden specialist about your new applications, product ideas, processing problems—all your wire, cable and cord needs. He has thousands of standard items to draw from. And standard or special, he'll come through with the best wire buy around. For answers right now, phone:

317-966-6661 Electronic Div. or mark No. 400 on reader service card  
312-986-1600 Electrical Div. or mark No. 401 on reader service card  
312-887-1800 Transportation Div. or mark No. 402 on reader service card,  
or write Belden Corporation, 2000 S. Batavia Ave., Geneva, IL 60134.



**Coming through...**

*with new ideas for moving electrical energy*

# FOCUS

## on Linear-IC Amplifiers

You can design reliable, low-cost linear systems with IC amplifiers—if you can find out just how well the ICs perform. For a dependable design, you need dependable specs. But data sheets often lead off with shaky claims. Among the more blatant examples: the micropower op amp that actually draws milliwatts, the two-chip “monolithic,” and the so-called premium 741 that is so “good,” it doesn’t have current or voltage noise specs. There is even a chopper-stabilized op amp with no published long-term, offset drift characteristic.

So-called “design” minimums and maximums are often untested claims that can be mistaken for guaranteed values. A particularly insidious practice is a declaration that a device operates over a broad range of either temperature, supply level or input level—but when you read further, you find only spot values for crucial parameters.

For example, you’ve got to look carefully at a data sheet to determine which parameters are specified over 0 to 70 or –55 to 125 C rather than merely at 25 C. Or temperature specs may be given relative to a 25-C junction temperature. Why? Because input currents, at least for FET devices, can look five times worse if stated at 25-C ambient.

You may rightly wonder—after going through the ambient-to-junction computation recommended in the footnote—if you indeed did arrive at the correct junction temperature. After all, it’s not as if there is only one transistor on the chip or the chip didn’t have thermal gradients.

### Heavy reading ahead

Then there’s the other kind of data “sheet” to contend with—one with so many pages as to rival

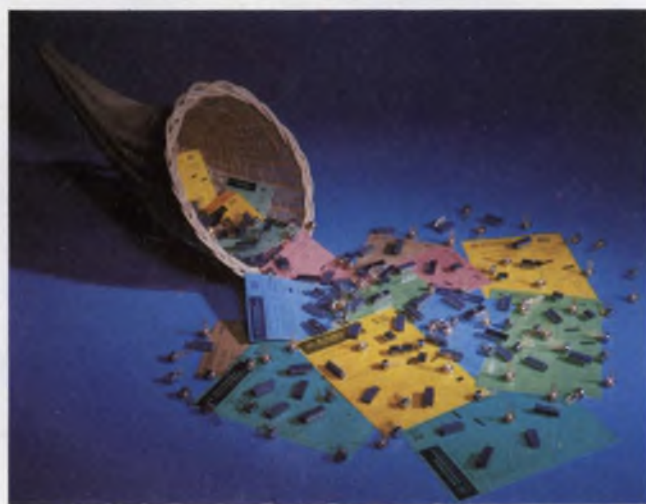

An AQL of 0.25% leads to 0.1 to 0.2% catastrophic failures/1000 h for Motorola plastic linears. The low figure applies to use in automotive applications.

Tolstoy’s *War and Peace*. Such IC epics usually categorize several devices together to add to the confusion. By the time you dig useful information out of the abundance, your head is swimming. Yet the accompanying application notes somehow don’t add to your knowledge of how the device behaves with, say, reduced power-supply voltages. You can sometimes get a clue about how good an IC is if it isn’t second-sourced. In the main, there are three reasons that a device is available from only one company:

- There is an insufficient demand, so additional suppliers don’t want to get on board.
- The process by which the device is made is unique to one manufacturer.
- The device exists only on a spec sheet that originates at the marketing end of the company. An example is the 108A, which some manufactur-

ers admit had to be redesigned to meet the published values for input offset-voltage temperature coefficient.

Not all bad specs are deliberate. A particularly bizarre example is the composite spec sheet for an op amp on which long columns of values are printed in an all but illegible gold on white.

### Jelly beans can be unhealthy

One of the more popular of the general-purpose linear devices is the 741 op amp, a device sold in such large quantities, it's sometimes referred to as a "jelly bean." The operating temperature range of the device is stated as  $-55$  to  $125$  C. But what does it do in this range? Don't expect to find out all from some 741 spec sheets. True,

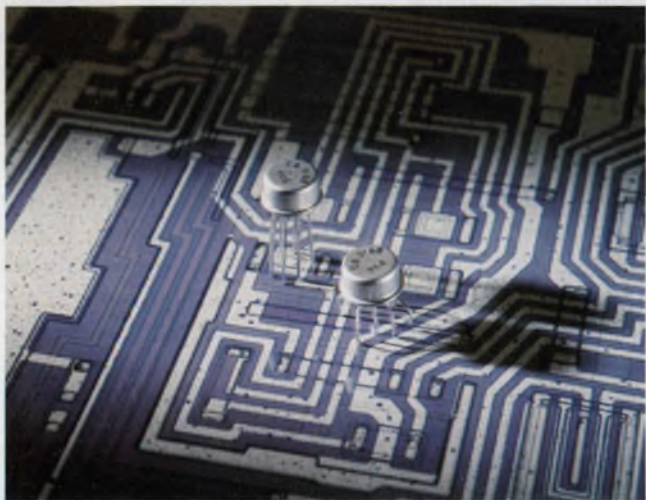

The newest RCA BiMOS op amp, the CA3160, offers frequency compensation. Like former units, the common-mode range includes the negative-supply rail.

maximum values are listed over the full temperature range, at least for input offset voltage and current, bias current and power consumption. Also given are the minimum values for input voltage range, large-signal voltage gain, output-voltage swing, common-mode rejection ratio (but with only  $\pm 12$  V, not the full  $\pm 15$  V) and supply-voltage rejection ratio.

But if you want the drift for offset voltage or current, you may draw a blank. For the offset-voltage adjustment range you get a typical value at 25 C. All you can find for minimum input resistance is the 25 C value, and for output short-circuit current a "typical" at 25 C.

When it comes to the 741's ac characteristics, you're often really on your own. Typical unity-gain rise time is given at the spot value of 25 C. Overshoot and slew rate are also typical values

at 25 C. Is bandwidth of interest to you? If so, don't be concerned about either the 3-dB or unity-gain points—neither one is even mentioned.

### 'Listen' for silent popcorn specs

In other 741 spec sheets, there isn't even a blank to remind you that this device is often known for popcorn, or burst, noise—sporadic output spikes that blast their way from rail to rail. Like bursts, other noise characteristics are also conspicuously absent.

The consensus among IC manufacturers is that the popcorn effect results from imperfect semiconductor-surface conditions incurred during wafer processing. So popcorn is a function of the cleanliness and tightness of process control. Most



Rf amplifiers span 1 MHz to 2.3 GHz, with guaranteed frequency ranges, in Avantek's thin-film GPD and UTO families, which both consist of 41 units.

also agree that burst-noise stems from a momentary change in input bias-current offset. The frequency of occurrence usually stays below 100 Hz. What is an acceptable value for burst noise? It depends on whom you talk to. Some vendors say  $1.5\text{-}\mu\text{V}$  pk. Others go as far as  $30\text{-}\mu\text{V}$  pk.

This kind of noise varies widely from lot to lot. Manufacturers, therefore, must accumulate sufficient data over long intervals before they can say with assurance that popcorn noise is no longer a problem with a particular IC amplifier.

Included in a noise spec should be the following:

- Input noise voltage from 0.1 to 10 Hz.
- Input noise voltage density at 10, 100 and 1000 Hz.
- Input noise current from 0.1 to 10 Hz.
- Input noise current density at the spot fre-

quencies of 10, 100 and 1000 Hz.

▪ Burst-noise peak voltage referred to the input for at least a 30-s sampling period.

Noise values must be given as maximums or minimums. Otherwise you can't adequately compute your amplifier's noise figure. Keep in mind that the input noise depends on the input resistor. Most vendors use 100 k $\Omega$  to specify the input noise—if you find a lower value, watch out.

Measurement of popcorn-noise levels requires

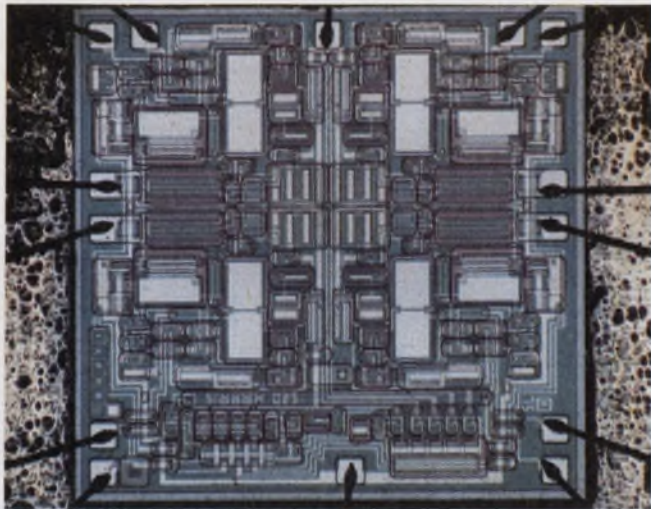

The quad 4206 is eight times faster than the 741, yet uses 40% less power per section. Harris' dielectric isolation also yields better-than-741 input specs.

that the unit under test be retained in a test fixture for about one minute. Some manufacturers feel that such a long period imposes an unacceptable cost penalty on their products, so they either sample test on an acceptance-quality-level (AQL) basis—or they don't test at all. Other IC producers claim to test 100%, but the test data are nowhere to be found on the spec sheets. Still others use automatic test equipment to provide guaranteed values for popcorn noise.

One test set-up, developed by RCA, is dedicated to popcorn noise. The details are provided in an application note published by the company for those who would like to "roll their own."

Besides adding noise, amplifiers always distort the signals to be amplified. The specifications don't always say how much.

#### Ac specs can be tricky

At least half (and perhaps as many as 80 to 90%) of the linear amplifiers sold today are used in equipment for which ac characteristics are extremely important. For instance, audio equipment, telecommunications systems and data

modems are filled with active filters designed with quad op amps.

Often the ac specs of quads are skimpy. Many manufacturers provide only typical values for such key parameters as slew rate, full-power response and gain bandwidth. You must be particularly careful to check the gain levels at which the guaranteed values are specified. Unity gain is the most meaningful, but the temptation to get better looking specs—like bandwidth—often leads to specifying at gains of 4, 5 or even 10.

Some quads are now partially decompensated. That is, the internal compensation capacitor has been reduced to the extent that the devices aren't stable at unity gain. Although these so-called "broadband" devices slew faster and exhibit higher bandwidths than the original 741 circuit from which they're derived, it's up to the user to make them stable.

Instability is by no means limited to quads. The 538 is a decompensated version of the 535, which itself is a 741 with an improved slew rate. Although the 538 is pin-compatible with the 741, before you drop it into an updated design, you had better check to see if external components are necessary. If you want to use the 538 as a follower, it's not quite clear how to relate its stated slew rate to its performance as a follower.

You can add a resistor from the 538's input to ground to get both unity-gain stability and the stated slew rate. The resistor, in effect, fools the amplifier by giving it a gain of  $-4$ —for stability—while to the external circuitry the gain is  $-1$ .

While data sheets don't usually tell you that you can do this, some application notes do. Since there's always a danger of oscillation even when you add components, be wary of this.

The slew rate itself is sometimes published in a less than candid manner. If you use an op amp whose slew rate is given for less than the full common-mode input voltage, you're in for an unpleasant surprise: the slew rate will be substantially slower over the full range.

There are two widespread ways to measure slew rates. In the first, a step much faster than the device can follow is applied to the input. The output response is the slew rate. In the second, a sine wave is impressed on the device's input, and the wave's frequency is increased until the output is a triangle. The slew rate is then measured on the triangle.

Opinions differ as to how closely related these tests are. Whatever the method, check the gain at which the device is operated, and that the output slews from the 10% to 90% points, not the 50% point. Be careful that the device slews



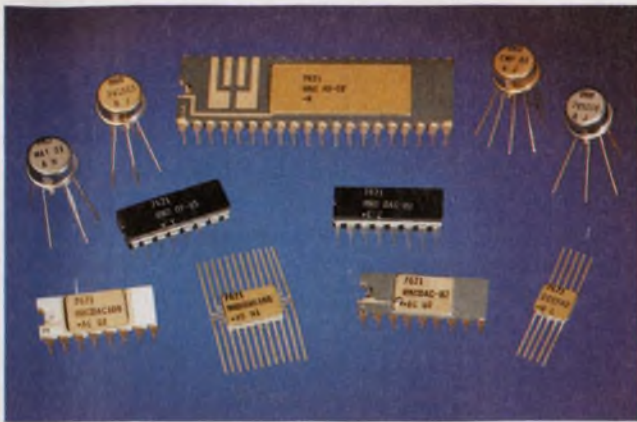

Look for internal frequency compensation plus better TC  $I_{os}$  and gain in Precision Monolithics' next op amp. It will be an update of the low TC  $V_{os}$  OP-08.

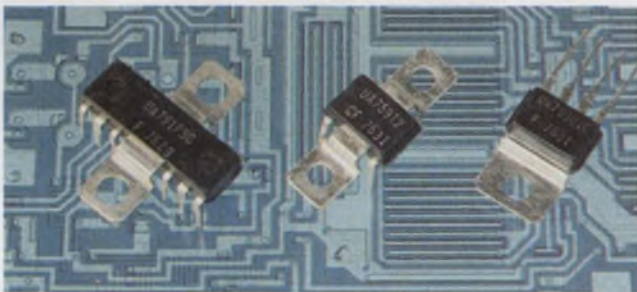

New plastic packaging shares the honors with semiconductor advances in Fairchild's  $\mu A$  759 op amp. The P5C plastic version delivers 1 A for \$2.50 (in 100s).

smoothly—not like a saw tooth, as some feed-forward amps do.

In general, you can associate slew rate with the more conservative specifications for full-power bandwidth. As a rule of thumb, then, 100 kHz of full-power bandwidth equals 6 V/ $\mu$ s of slew rate. But this isn't binding. For example, the HA2700 op amp doesn't follow this rule.

### Tune in to audio

Aware of the increasing use of linear ICs in ac-coupled applications, manufacturers are beginning to test for previously ignored characteristics like hiss, distortion and 20-Hz-to-20-kHz noise.

An interesting specification is the one for total harmonic distortion (THD). It is generally accepted that the full clipping point corresponds to 10% THD. But various suppliers evaluate devices at the 1%, 2%, and 5% THD points as well.

A major problem with audio amplifiers is that they tend to oscillate. Some vendors address this problem by supplying low-parasitic PC-board layouts with their devices. Others leave you on your own. If you can use one of the recommended lay-



Chip-to-package testing gives audio designers guaranteed ac performance and limits on input-noise voltage for Raytheon's RC 4156 quad op amp.

outs, so much the better. But if you can't, be extremely careful with your layout.

With audio active filters, look for a guaranteed values for such important parameters as full-power response, distortion and input noise over the 20-Hz-to-20-kHz band. They are now available from some manufacturers at no extra charge. More suppliers are planning to broaden their ac specifications.

Two solutions to the muting problem in i-f amplifiers are currently available in commercial ICs. The 3089, for example, reduces its gain to mute the output when the signal amplitude gets too low. Thus, in the absence of an acceptable signal level, the ever-present noise isn't amplified. Other i-f strips use deviation muting, in which the output is reduced as the circuit goes off tune. You may whistle a rather different tune when you find out what other problems await.

### And the list goes on

When you drive devices at the maximum common-mode input voltage, take care that there's enough driving-point impedance to keep input current below the maximum value. Remember,

input-current limits aren't always placed near the input-voltage values on data sheets.

Some devices are promoted for use with either single or dual-supply voltages. But when you look for the device's single-supply characteristics, you find nothing. Suspect the worst—that the operation of the circuit is degraded for all key parameters. Bear in mind that although devices can operate over a range of supply voltages, the data are usually given for only one or two fixed supply voltages.

For dc-coupled applications, an important concern is output drive capability. Can the device sink, as well as source, current? Some output stages don't have equal bidirectional current capability. If you need a fast amplifier that can

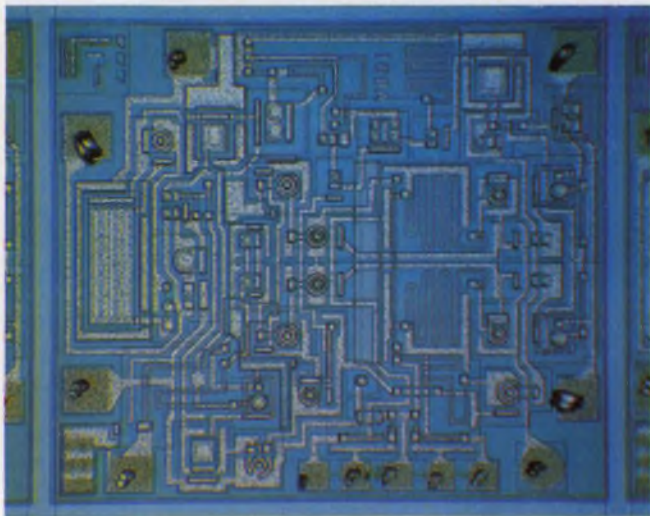

Typical offset voltages below 0.5 mV result from vaporizing metal links on SG 108A dies. Silicon General computer controls this trimming.

drive a capacitive load (say, over 100 pF), look carefully at the drive specs. Some amplifiers will drive 5 mA into a 2-k $\Omega$  load (10-V supply), but will not drive 5 mA into 200  $\Omega$ . (In some devices the output current is a function of supply voltage.)

For FET-input ICs, where bias current doubles for every 10-C increase, check that the values given are for a warmed-up device. In many amplifiers, both drift and gain specs degrade after the device is nulled. Gain and drifts should therefore be specified at null.

Everyone agrees that thermal feedback is an important and potentially serious effect in monolithic ICs. In audio work, excessive heat transfer from output to input can result in motorboating. Or because of temporary thermal imbalances, op amps drift excessively or microwave devices act up. Across the spectrum of linear applications,

temperature-induced noise can degrade circuit performance.

All IC manufacturers have addressed the thermal feedback problem in the IC-die design stage. But it seems that no one wants to test for thermal feedback. Some claim that the effect is negligible in low-power devices, others insist that feedback effects will be uncovered by other tests. But almost no one runs direct tests. This lack can be a bit unsettling. But not as unsettling as some settling-time specs.

### Make sure it settles

Whenever you expect to handle fast steps, look out for settling time. No matter how fast an am-



Slewing at 1000 V/ $\mu$ s with low typical bias current (1 nA) and input-offset drift (1  $\mu$ V/ $^{\circ}$ C), the AM-500 feed-forward hybrid from Datal only inverts.

plifier is, if it keeps on ringing, it can be useless. Although some manufacturers specify a typical value for settling time, others decline to assign any value. And they may have a point. Settling time is determined by a combination of at least three effects:

- The bandwidth of the amplifier—a linear effect.
- The slew rate of the amplifier—a nonlinear effect.
- The recovery from limiting—both a nonlinear effect and a function of power-supply voltage.

Because settling time is made up of such linear and nonlinear effects, you often can't relate the settling time given by a test circuit to the settling time of your own circuit.

Moreover, settling time—for a nonringing amplifier—can be determined in many cases by components external to the amplifier. For example,

in one test circuit, the settling time of a 10-MHz 118 op amp is 1 to 1.5  $\mu$ s.

But in a d/a converter with a 20-k $\Omega$  feedback resistor and a bunch of current switches on the input, that same amplifier sees about 20 additional picofarads. This capacitance breaks with the feedback resistor at a frequency lower than 1 MHz. The converter will then ring through five cycles before it settles to within 0.1%—the settling time of this "1-1/2- $\mu$ s settler" is now 15  $\mu$ s.

Since even the difference between a 25 and a 100-pF scope probe sometimes matters, you must make sure that testing for settling time corresponds to your application.

### Some rf specs are vague

In rf devices, the ever-present problem of intermodulation distortion is quantified by intercept points. For most rf and microwave amplifiers, the second-order products are greater than the third-order. The points for third-order intermodulation products are also usually specified, since these products can fall into an amplifier's passband. Some spec sheets, however, give the second-order point only. What happens? The user finds in practice that the third-order products are much greater than he expected.

Another prime concern, at microwave frequencies, is the power output in the linear-amplification region. The usual specification gives the power at a 1-dB gain compression. Some enterprising producers drive their devices farther into saturation and so get inflated ratings for this crucial parameter.

Still another bit of information seldom detailed for rf devices is the power-supply requirement. Often the appropriate bias voltage can come from the main system's power bus through a dropping resistor. This works out well only when the amplifier acts as a constant-current sink. But for amplifiers whose bias current varies, the resistor spoils the effective power-supply regulation. Then the amplifier usually displays quirks.

Furthermore, while some IC manufacturers still specify noise figures for rf devices at only 25 C, most vendors commendably now guarantee noise values over 0 to 50, 0 to 75 and -55 to +125 C ranges.

Finally, microwave-device parameters haven't kept pace with such sophisticated applications as direction finding, wherein the designer wants phase and gain-match data for several channels. Superheterodyne receivers have progressed from merely specifying an amplifier just to set the noise figure at the system's front end. Ampli-

fiers are becoming more crucial to total system performance—they do much more than only overcome the loss in a cable. Simply put, more parameters are needed. The need for new devices, on the other hand, is being more than satisfied by linear integrated circuit producers.

### Devices keep coming

One reason that specifications for linear ICs are so varied and confusing is the proliferation of devices and producers. Various technologies, processing methods and testing techniques provide the linear systems designer with a wide choice of performance and pricing.

For example, National and RCA have championed different approaches to mixing bipolar

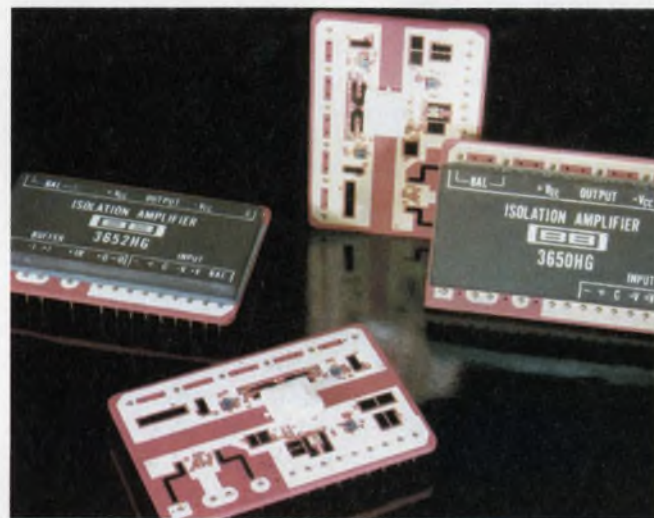

With optical coupling, unique in IC-isolation amplifiers, the hybrid 3650 and 3652 offer maximum gain nonlinearities of  $\pm 0.3\%$  (H-grade) and  $\pm 1\%$  (J-grade).

and FET technology on the same chip. Both producers ion-implant their FETs, but RCA uses PMOS transistors while National's front-ends are JFETs. Speeds are roughly the same for the LF 155, 156, 157 family, National's BI-FET devices, and RCA's BiMOS—the CA 3130 and CA 3140. Typical gain bandwidths are on the order of 4.5 MHz, and typical slew rates fall in the 10-V/ $\mu$ s area, with a slight edge to the BiMOS. Both BiMOS and BI-FET have ultrahigh input resistances: in the neighborhood of  $10^{12} \Omega$ .

Not surprisingly, the noise performance of the BI-FET is superior to that of the BiMOS. The CA 3140 series has a typical equivalent-input noise of 40 nV/ $\sqrt{\text{Hz}}$  at 1 kHz, while the LF 156 A has 15 nV/ $\sqrt{\text{Hz}}$ . Typically, the equivalent input noise current is 0.01 pA/ $\sqrt{\text{Hz}}$  at the usual spot frequencies of 100 and 1000 Hz for the 155 family. But the parameter is unspecified for the

BiMOS operational amplifiers.

Because of the PMOS input transistors, you can drive BiMOS devices as much as 0.5 V below the negative-supply rail without losing the signal's phase sense. The inputs can be driven indefinitely past the negative supply voltage without harming the unit if you limit the input current to 1 mA (a resistor will do).

The BiMOS amplifiers use a COS/MOS output pair, so that the output can swing to within 10 mV of either supply voltage, but only for very high values of load impedance. The soon to be announced CA 3160 BiMOS types will offer internal frequency compensation.

Another proprietary chip—the OP-08 from Precision Monolithics (PMI)—is a 108 redesigned with ion implantation and zener zapping. PMI still second-sources the 108/108A, and the yields are now reasonable. The problem has been a too high temperature coefficient of offset voltage ( $5 \mu\text{V}/^\circ\text{C}$ ) max. The new OP-08 boasts a TC  $V_{os}$  of  $3 \mu\text{V}/^\circ\text{C}$  max as well as the ability to drive a 2-k $\Omega$  load. The 108A drives only a 10-k $\Omega$  load.

Still another proprietary device based on the OP-08 is on the way. It will provide the internal frequency compensation that chip users want as well as improved TC  $I_{os}$ . Also, improved gain will result in a better common-mode and power-supply rejection ratio.

At Advanced Micro Devices (AMD), a three-level glassivation process produces extremely stable semiconductor surfaces. AMD's devices are marked by high radiation resistance and tend to be low on popcorn noise. All new linear IC products at AMD make heavy use of ion implantation, and several ion implants, not just one, are used to get both active and passive components in the same device.

In addition to second-sourcing the LF 155, 156 and 157, AMD has developed a PMOS front-end process—the company expects to market PMOS-bipolar devices later this year.

With dielectric-isolation separating semiconductors, Harris is constantly pushing monolithic ICs into performance usually found only in hybrid country. The HA 2530 op amp, which boasts a 330 V/ $\mu\text{s}$  slew rate and 5-MHz full power bandwidth, has just been joined by the HA 2660, a 100-MHz bipolar-FET device. At present, Harris doesn't offer an instrumentation amp, but the company is looking in that direction.

Data sheets at Harris are being expanded to show maximum values for slew rates and to give settling times for several gain values and configurations. In the wideband, high-slew-rate 2500 series, the updated specs will cover negative inputs as well as positive. In the audio area, Harris intends to specify distortion and other audio parameters for its 911 low-noise op amp and the 4741 and 4605 quad op amps.

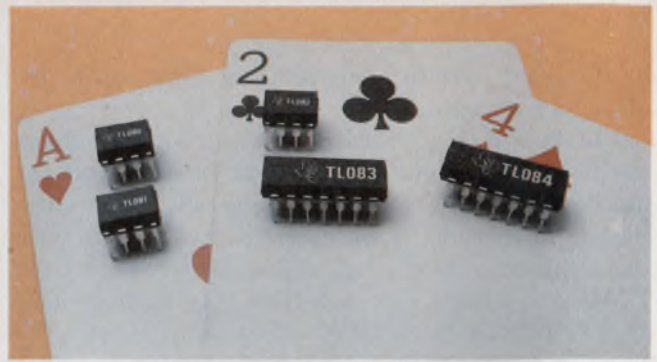

Internally compensated bipolar-FET op amps, TI's 080 series, consist of single, dual and quad versions. The ICs claim 7 V/ $\mu\text{s}$  slew rates and  $10^9\text{-}\Omega$  input resistances.

In a few months you can expect improved noise performance from the HA-2900, 2904 and 2905 chopper-stabilized op amps. Designers at Harris are seriously looking into replacing MOSFET inputs with JFETs.

A standout in the Analog Devices line of monolithic amplifiers is the AD521—an instrumentation amplifier with programmable gains from 0.1 to 1000, floating differential inputs, a minimum common-mode rejection ratio of 110-dB and maximum noise from 0.1 to 10 Hz of 0.5- $\mu\text{V}$  pk-pk. This internally compensated device also features complete input protection and a gain-bandwidth product of 40 MHz—all for \$8.50 in quantities of 100 (for the 0 to 70 C Model J).

### Hybrids still shine

Like Analog Devices, Datal is another module house that has ventured into monolithics. Datal's monolithic AM-464-2 op amp boasts a  $\pm 35\text{-V}$  output swing. The unit also offers a 4-MHz gain bandwidth product and a 5-V/ $\mu\text{s}$  slew rate. The hybrid AM-500 blazes with a 1000-V/ $\mu\text{s}$  slew rate, 100-MHz gain-bandwidth product at only 100 ns of settling time.

The only optically coupled IC isolation amplifier on the market comes from Burr-Brown. The hybrid 3560/52 is tested at a stratospheric 4000-V peak. Leakage is held to 0.5 mA at 240 V and 60 Hz for 120 dB of isolation. With a rocket-like 2000 V/ $\mu\text{s}$  of slewing, Burr-Brown's 3553 buffer amplifier is yet another example of what hybrid technology can do.

At microwave frequencies up to 18 GHz, thin-film hybrid technology takes over. Monolithics haven't arrived at these frequencies yet. Watkins-Johnson offers a line of low-noise hybrids for every octave bandwidth from 1 to 18 GHz. With each unit, the customer gets a printout of gain, VSWR, power output and noise figure.

The company has ready a 6.5-dB noise-figure FET amplifier that can cover 12 to 18 GHz. Previously, the only solid-state amplifiers in this band were tunnel diode-based devices. The FET

devices have one-fifth the weight of the tunnel-diode devices and 20% more dynamic range. Also, they don't require isolators. Tunnel-diode amplifiers in the 12-to-18-GHz region are noted for their erratic behavior.

At Avantek, 41 different units in the precision UTO series and the lower-cost GPD series of thin-film hybrid rf amplifiers have guaranteed frequency coverages ranging from 1 MHz to 2.3 GHz.

Monolithics are, however, moving to the higher frequencies. Plessey Semiconductor has the distinction of producing the highest-frequency monolithics available today. The company's wide-band limiting amplifiers operate over 30 to 350 MHz. Plessey's shallow-diffusion processes yield devices with  $f_s$  up to 2.5 GHz. The SL 1521 limiting rf amplifiers offer minimum bandwidth of 315 MHz.

High frequencies aren't the only areas that monolithics are getting better at. Power—higher outputs and lower consumptions—are now monolithic features.

#### Monolithics are power conscious

Silicon General's SG 1250/2250/3250 op amps feature adjustable power consumption down to less than 20  $\mu$ W. These internally compensated devices operate from supplies of  $\pm 0.75$  to  $\pm 18$  V, draw less than 15-nA bias current and are short-circuit protected.

Micropower linear devices are the specialty at Siliconix. The L144 is a triple op amp that draws a maximum source current of 350  $\mu$ A at 25 C when all its inputs are at zero. Another unit, the T100, is a micropower impedance buffer.

And, of course, there's the other side of the coin—higher power output. At Fairchild, new plastic-package technology shares the limelight with the company's semiconductor developments in power op amps. For example, the 1-A plastic  $\mu$ A 791-P5C is electrically identical to the tin-lead TO-3  $\mu$ A 791-KC. But in quantities of 100, the former costs \$2.50, the latter \$12.50.

Company engineers look to the  $\mu$ A 759 as the next generation's workhorse op amp. Boasting internal frequency compensation the 759 delivers up to 350 mA and is almost indestructible. It features short-circuit, safe-area and thermal-overload protection (all of which are borrowed from the company's IC regulators). The plastic  $\mu$ A 759-UIC sells for \$2 in quantities of 100.

Talking about power-output, an 8-W monolithic audio power amp aimed at automobiles is a feature product at volume-oriented SGS-ATES. Called the TDA-2002, the unit has a thermal resistance of only 4°C/W maximum. A recommended PC-card layout is included in the device's data sheets. Other features include thermal shutdown

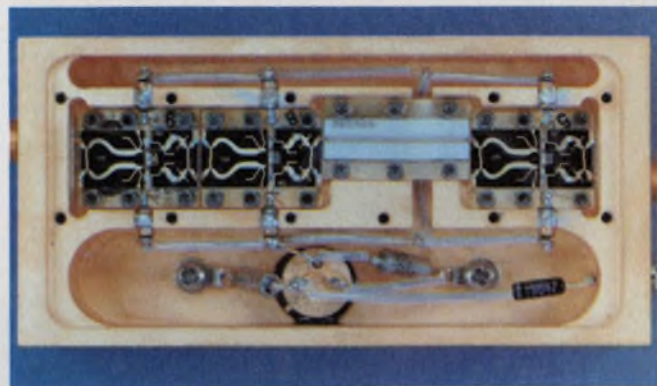
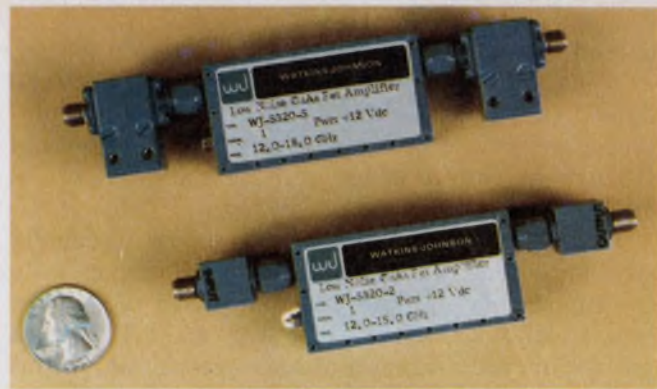

Hybrid microwave amplifiers now cover the 12-to-18-GHz Ku band (top). The Watkins-Johnson WJ-5320 series uses FETs and comes with guaranteed specifications for noise figure, small-signal gain, gain flatness, VSWR and power output (bottom).

and load-dump voltage-surge protection. Motorola is preparing to second-source the TDA-2002.

#### Quality goes up

The big news at Motorola isn't any one device in its vast line of linear ICs. The horns now blow at its automotive division, where reliability has reached an all-time high. That production facility boasts an AQL of 0.25%. Plastic devices now have fewer than 0.2%/1000 hr catastrophic failures in rugged automotive use. And the division is looking toward 0.01%.

Special test fixtures and processes have been developed by Raytheon specifically for the company's RC 4156 quad op amp. With this device, you get the general characteristics of the 741, but with guaranteed ac performance and clearly specified limits on input-noise voltage. These internally compensated op amps feature a minimum unity-gain bandwidth of 2.8 MHz, a minimum slew rate of 1.3 V/ $\mu$ s and an input noise of 2.0  $\mu$ V. In addition, active-filter designers will welcome the 4156's output stage because it produces no crossover distortion.

The Raytheon monolithic XR-2211 is a phase-locked system especially designed for data communications. Intended particularly for FSK modems, it operates over 0.01 Hz to 300 kHz as a

demodulator and tone decoder.

Teledyne Semiconductor produces the 835/836 quad "741-type" op amps. These internally compensated devices have no crossover distortion and feature an input common-mode range that includes the negative supply voltage.

Three op amps from Sprague are unusually well specified: The 2139 has typical values only for input noise, output resistance and unity-gain bandwidth; all parameters for the 2151 have maximum or minimum values except for output resistance; and the 2171 shows typical values for only input noise and output resistance.

Looking primarily at the high-volume market, Texas Instruments intends its 084 to be the beginning of an extensive family of bipolar-FET op amps. In time, this family is expected to replace all the company's linear bipolars.

At Signetics, the 535, a pin replacement for the

741, is in production. It features a slew rate (15 V/ $\mu$ s) 20 times that of the 741. Using super-beta transistors, the unit's class-AB input keeps the bias currents down. The current noise is lower than the 741's.

Signetics is also producing the 538, a broadband version of the 535, with higher slewing capability than its predecessor. The 538, however, isn't unity-gain stable. A low-noise op amp—the 5534—is imminent: input noise voltage is 4 nV/ $\sqrt{\text{Hz}}$ .

Exar is one of the sources for quad 741-type op amps that can keep your cost per op amp below 15 cents. In Exar's broad line of op amps, one standout is the XR-4202, a programmable quad. A control pin allows you to trade speed for power consumption in the 4202. Thus the IC can be operated either as a high-speed or a micropower op amp. ■■

## Need more information?

The products cited in this report don't represent the manufacturers' full lines. For additional details, circle the appropriate number on the Reader Service Card. For data sheets and more vendors, consult ELECTRONIC DESIGN's GOLD BOOK.

Advanced Micro Devices, 901 Thompson Pl., Sunnyvale, CA 94086. (408) 732-2400. (S. Thompson). **Circle No. 451**  
AEG Telefunken, 570 Sylvan Ave., Englewood Cliffs, NJ 07632. (201) 568-8570. (J. Szafranski). **Circle No. 452**  
American Microsystems Inc., 3800 E. Homestead Rd., Santa Clara, CA 95051. (408) 246-0330. (H. R. Morris). **Circle No. 453**  
Amperex Electronic Corp., Providence Pike, Slatersville, RI 02876. (401) 762-9000. (M. Smoller). **Circle No. 454**  
Analog Devices Inc., P.O. Box 280, Norwood, MA 02062. (617) 329-4700. (J. Codispoti). **Circle No. 455**  
Analogic Corp., 1 Audubon Rd., Wakefield, MA 01880. (617) 246-0300. (R. Schaffer). **Circle No. 456**  
Avantek Inc., 3175 Bowers Ave., Santa Clara, CA 95051. (408) 249-0700. (W. Briggs). **Circle No. 457**  
Burr-Brown Research Corp., 6730 S. Tucson Blvd., Tucson, AZ 85734. (602) 294-1431. (G. Tobey). **Circle No. 458**  
Collins Radio Group of Rockwell International, 4311 Jambooree Rd., Newport Beach, CA 92663. (714) 833-4600. (D. Gibson). **Circle No. 459**  
Datal Systems Inc., 1020 Turnpike St., Canton, MA 02021. (617) 828-8000. (E. Zuch). **Circle No. 460**  
Exar Integrated Sys. Inc., 750 Palomar Ave., Sunnyvale, CA 94086. (408) 733-7700. (A. Grebene). **Circle No. 461**  
Fairchild Semiconductor, 464 Ellis St., Mountain View, CA 94042. (415) 962-5011. (B. Callahan). **Circle No. 462**  
Ferranti Electric Inc., E. Bethpage Rd., Plainview, NY 11803. (516) 293-8383. (B. Kutny). **Circle No. 463**  
General Instrument Corp., Microelectronics, 600 W. John St., Hicksville, NY 11802. (516) 733-3107. (J. Wunner). **Circle No. 464**  
Harris Semiconductor, P.O. Box 883, Melbourne, FL 32901. (305) 724-7407. (R. Pittenger). **Circle No. 465**  
Hitachi Ltd., 5-1 1-chome Marunouchi Chiyoda-ku Tokyo 100, Japan. 03212-1111. (T. Takahashi). **Circle No. 466**  
Hughes Aircraft Co., Centinela & Teale St., Culver City, CA 90230. (213) 391-0711. (J. Winkel). **Circle No. 467**  
Hybrid Systems Corp., Crosby Dr., Bedford Research Pk., Bedford, MA 01730. (617) 275-1570. (C. Kramer). **Circle No. 468**  
Hycorn Inc., 16841 Armstrong Ave., Irvine, CA 92714. (714) 557-5252. (N. Goldman). **Circle No. 469**  
ILC Data Device Corp., 105 Wilbur Pl., Bohemia, NY 11716. (516) 567-5600. (J. Sheahan). **Circle No. 470**  
Interdesign Inc., 1255 Reamwood Ave., Sunnyvale, CA 94086. (408) 734-8666. (H. Camenzind). **Circle No. 471**  
Intersil Inc., 10900 Tantau Ave., Santa Clara, CA 95014. (408) 996-5000. (J. Corser). **Circle No. 472**

ITT Semiconductors, 74 Commerce Way, Woburn, MA 01801. (617) 935-7910. (P. Piedra). **Circle No. 473**  
Micro Networks Corp., 324 Clark St., Worcester, MA 01606. (617) 852-5400. (B. Smith). **Circle No. 474**  
Microwave Associates Inc., South Ave. NW Indl. Pk., Burlington, MA 01803. (617) 272-3000. (R. Conway). **Circle No. 475**  
Motorola Semiconductor Prod. Inc., P.O. Box 20912, Phoenix, AZ 85036. (602) 244-6900. (T. Mazur). **Circle No. 476**  
National Semiconductor Corp., 2900 Semiconductor Dr., Santa Clara, CA 95051. (408) 732-5000. (R. Dobkin). **Circle No. 477**  
NEC America Inc., 505 W. Olive Ave., Suite 310, Sunnyvale, CA 94086. (408) 738-2180. (J. Stewart). **Circle No. 478**  
Philips, Elcoma Div., Eindhoven, the Netherlands. (M. Hull). **Circle No. 479**  
Photain Controls Ltd., Unit 18 Hangar No 3 Aerodrome, West Sussex, UK. Little Hampton 21531. (S. Mountain). **Circle No. 480**  
Plessey Semiconductors, 1674 McGaw Ave., Santa Ana, CA 92714. (714) 540-9945. (D. Chant). **Circle No. 481**  
Power Hybrids Inc., 1742 Crenshaw Blvd., Torrance, CA 90501. (213) 320-6160. (W. Schaub). **Circle No. 482**  
Precision Monolithics Inc., 1500 Space Park Dr., Santa Clara, CA 95050. (408) 246-9222. (E. Rogers). **Circle No. 483**  
Raytheon Co., Semiconductor Div., 350 Ellis St., Mountain View, CA 94042. (415) 968-9211. (R. Andersen). **Circle No. 484**  
RCA Solid State Div., Box 3200, Somerville, NJ 08876. (201) 685-6000. (W. Dennen). **Circle No. 485**  
SGS-ATES Semiconductor Corp., 435 Newtonville Ave., Newtonville, MA 02160. (617) 969-1610. (A. Santoni). **Circle No. 486**  
Siemens Corp., 186 Wood Ave. S., Iselin, NJ 08830. (201) 494-1000. (J. Herz). **Circle No. 489**  
Signetics, U.S. Philips Corp., 811 E. Arques Ave., Sunnyvale, CA 94086. (408) 739-7700. (L. Grede). **Circle No. 487**  
Silec-Semi-Conducteurs, 69 Rue De Monceau, 75008 Paris, France. 522-6050 (G. Dumas). **Circle No. 488**  
Silicon General Inc., 7382 Bolsa Ave., Westminster, CA 92683. (714) 892-5531. (E. Bentgen). **Circle No. 490**  
Siliconix Inc., 2201 Laurelwood Rd., Santa Clara, CA 95054. (408) 246-8000. (J. Graham). **Circle No. 491**  
Solitron Devices Inc., 8808 Balboa Ave., San Diego, CA 92123. (714) 278-8780. (J. Goldman). **Circle No. 492**  
Sprague Electric Co., 645 Marshall St., North Adams, MA 01247. (413) 664-4411. (S. Chertok). **Circle No. 493**  
Teledyne Philbrick, Allied Dr. at Rte. 128, Dedham, MA 02026. (617) 329-1600. (J. Story). **Circle No. 494**  
Teledyne Semiconductor, 1300 Terra Bella Ave., Mountain View, CA 94043. (415) 968-9241. (H. Gebhardt). **Circle No. 495**  
Texas Instruments Inc., P.O. Box 5012, Mail Station 84, Dallas, TX 75222. (214) 238-2011. (D. Pippenger). **Circle No. 496**  
Thomson-CSF, Sescosem Div., 101 Boulevard Murat, 75781 Paris Cedex, 16, France. 525 7575. (E. Codechevre). **Circle No. 497**  
Watkins-Johnson Co., 3333 Hillview Ave., Palo Alto, CA 94304. (415) 493-4141. (K. Kennedy). **Circle No. 498**

# MOLDED TANTALUMS:

KEMET Precision-Molded, Solid Tantalum Capacitors with axial leads are tailor-made for your high-speed, automatic insertion operations.

Their self-insulating epoxy cases are distinctively shaped for positive polarity identification, and provide unexcelled dimensional stability and lead concentricity.

You get extremely high capacitance-to-volume ratio, excellent performance characteristics from  $-55^{\circ}\text{C}$  to  $+85^{\circ}\text{C}$ , and solid KEMET quality throughout. At a surprisingly low in-place cost.

Specify the T320 Series for sub-miniature, extended-range units in three tubular case sizes, and CV range from 0.1 to 68  $\mu\text{F}$ , 6 to 50 volts. Or the KEMET "Bullet" T310 Series in four standard cases, and CV range from 0.1 to 330  $\mu\text{F}$ , 6 to 50 volts. Write for complete data.

Components Department, Union Carbide Corporation, P.O. Box 5928, Greenville, SC 29606; phone: (803) 963-6300; TWX: 810-287-2536; Telex: 57-0496.

Or see your local KEMET Capacitors Distributor.

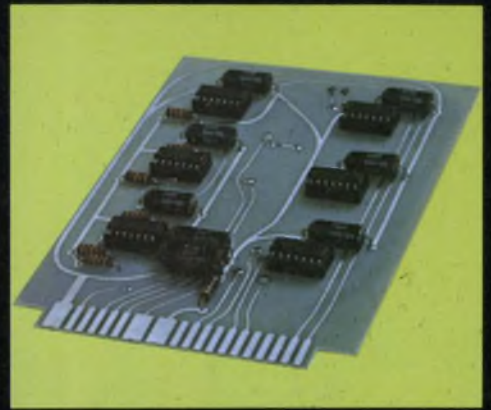

## KEMET® OFFERS YOU MORE.

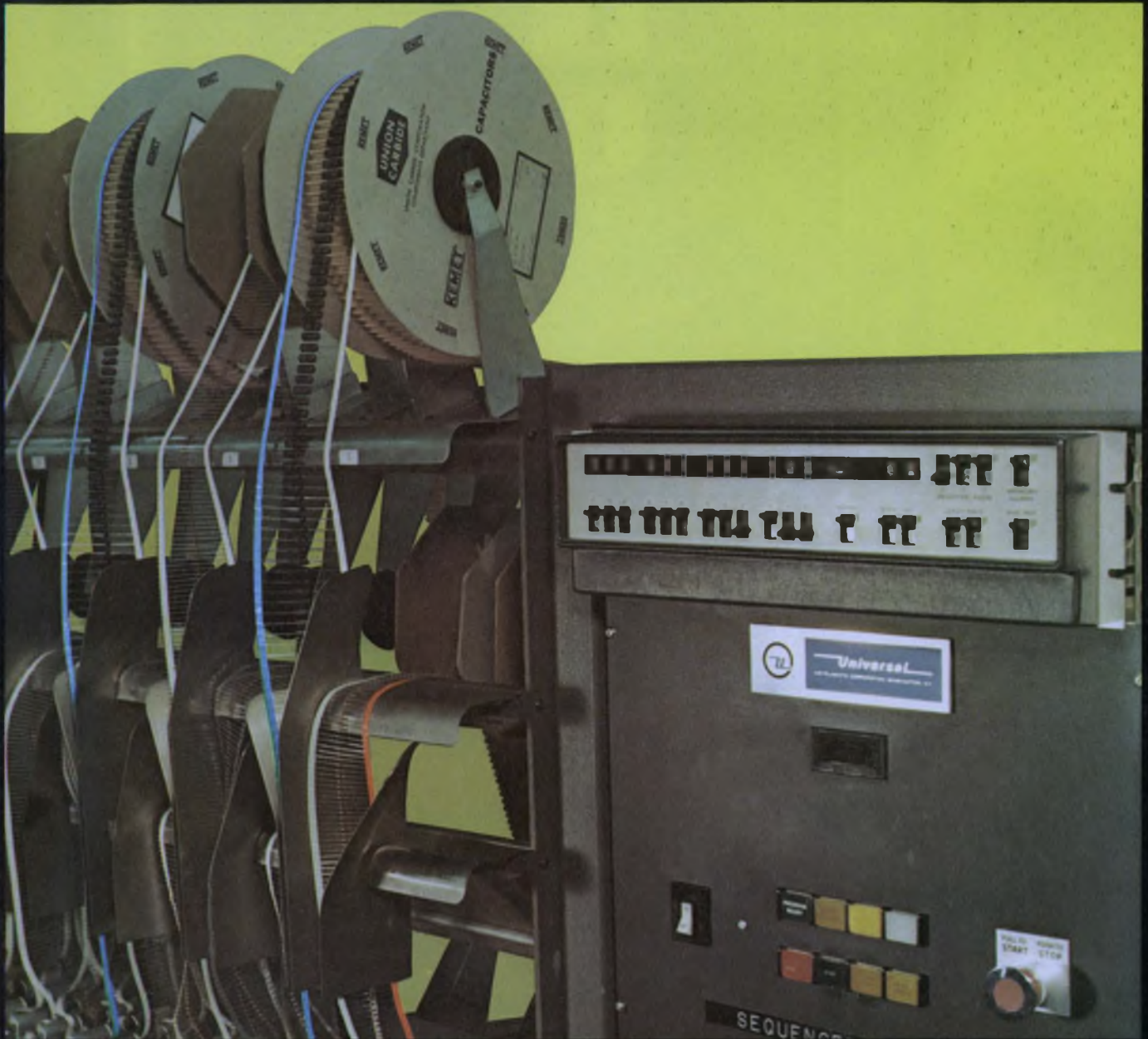

**UNION CARBIDE** COMPONENTS DEPARTMENT

CIRCLE NUMBER 38

In Europe: Union Carbide Europe, S.A. 5, Rue Pedro-Meylan, Geneva 17, Switzerland Phone: 022/47 4411 Telex: 845-22253

KEMET is a registered trademark of Union Carbide Corporation

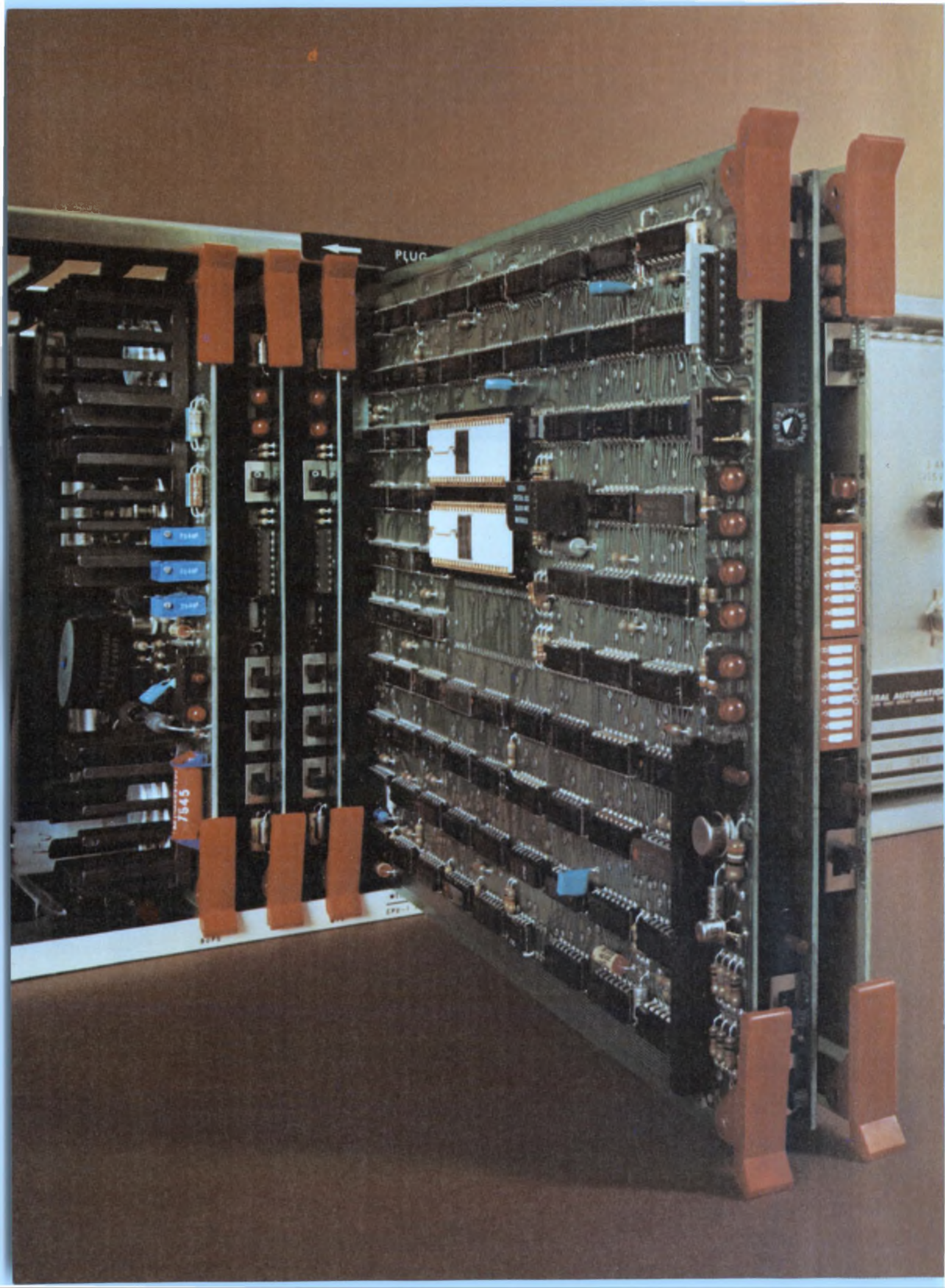



# GA counts in microcomputing.

There's not a machine that can touch GA's 220. Not from DEC, Data General, or anywhere else.

- 1. The only  $\mu$ C with COBOL, FORTRAN and in-depth software support.**
- 2. The only  $\mu$ C with a full file management system.**
- 3. The only  $\mu$ C to offer OEMs a wide choice of operating systems:** like FSOS, DBOS, RTX, RTOS.
- 4. The broadest  $\mu$ C instruction repertoire:** speeds program development, conserves memory, accelerates execution.
- 5. The only  $\mu$ C that can handle big disks:** I/O rate is 2.0 mB/second.
- 6. The fastest  $\mu$ C:** LDR/STR (indexed) 2.6  $\mu$ s.
- 7. The only  $\mu$ C with parity built-in:** hardware test, verification, fault isolation, plus write protect.
- 8. The only  $\mu$ C with a back-up power supply built-in:** protects semiconductor memory from power failures.
- 9. The only  $\mu$ C with board-level operator controls, switches and displays:** in a microconsole.
- 10. The only  $\mu$ C with over 100 field-proven I/O controllers.**

## GENERAL AUTOMATION

A big break for OEMs: family compatibility, throughout General Automation's extensive micro/mini line, gives GA-16/220 instant access to multiple batch and real-time operating systems, and to software off-the-shelf.

- Rush me full details on GA-16/220  $\mu$ C capabilities.
- Contact me for immediate requirements.

Name \_\_\_\_\_

Title \_\_\_\_\_

Phone \_\_\_\_\_ Ext \_\_\_\_\_

Clip coupon to company letterhead and send to General Automation, 1055 South East Street, Anaheim, CA 92803. Or call (714) 778-4800.

CD

See us at the Computer Caravan.

CIRCLE NUMBER 40

# Think 'IR' for hybrid circuits.

# Nobody makes as many standard types and ratings.



**Low Cost**  
**7.5 to 35 Amp**  
**Rectifier Bridges**  
 Voltages thru 800V.  
 Surge up to 300 Amps.  
 Case Temperature: 75°C



**SCR, Triac and Transistor Packages**  
 SCR's: 25-65A; thru 1200V  
 Triacs: 40-100A; thru 1200V  
 Darlington Transistors:  
 10-25 A; thru 400V.

**35 to 100 Amp Rectifier Bridges**  
 Case Temperature: 75°C  
 Voltages thru 1000V  
 Surge up to 1000 Amps.



We've been the industry leader in power hybrid modules for years, originating many of today's industry standards. But there are more important reasons to make IR your source.

First, we make our own chips using advanced technologies such as our hard-glass passivation and laser scribing to increase voltage stability and component reliability. We are not dependent on other suppliers for uniform chip quality or delivery.

Second, since we have been a major power semiconductor house for over 30 years, we have the know-how for proper bonding and heat transfer that assures long life.

Contact your IR Salesman or Distributor or write for data on the types you need. You can't do better! International Rectifier, 233 Kansas St., El Segundo, California 90245. Telephone: (213) 322-3331.

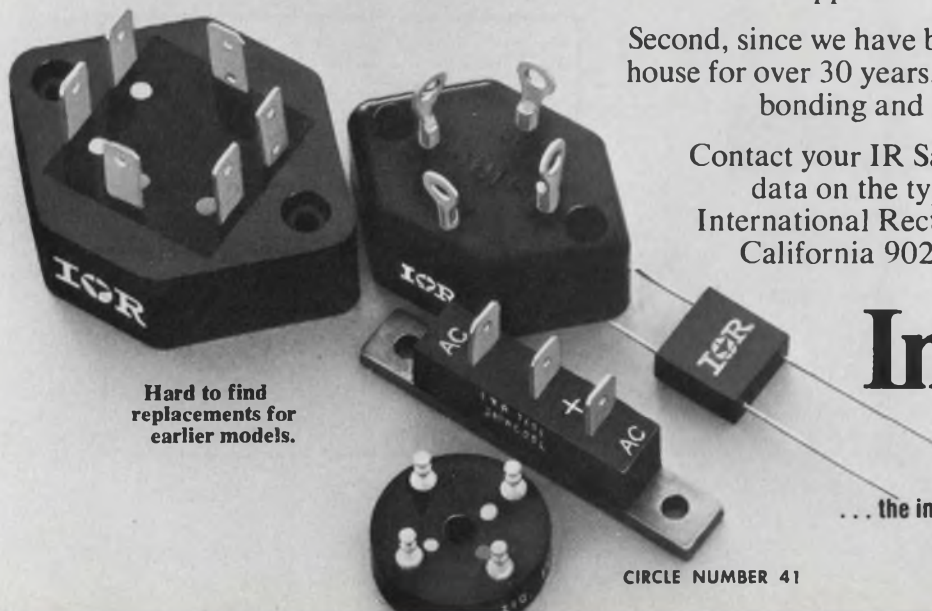

Hard to find replacements for earlier models.

# International Rectifier

... the innovative semiconductor people



What would you get if you crossed  
a rotary switch with a coded thumbwheel switch?

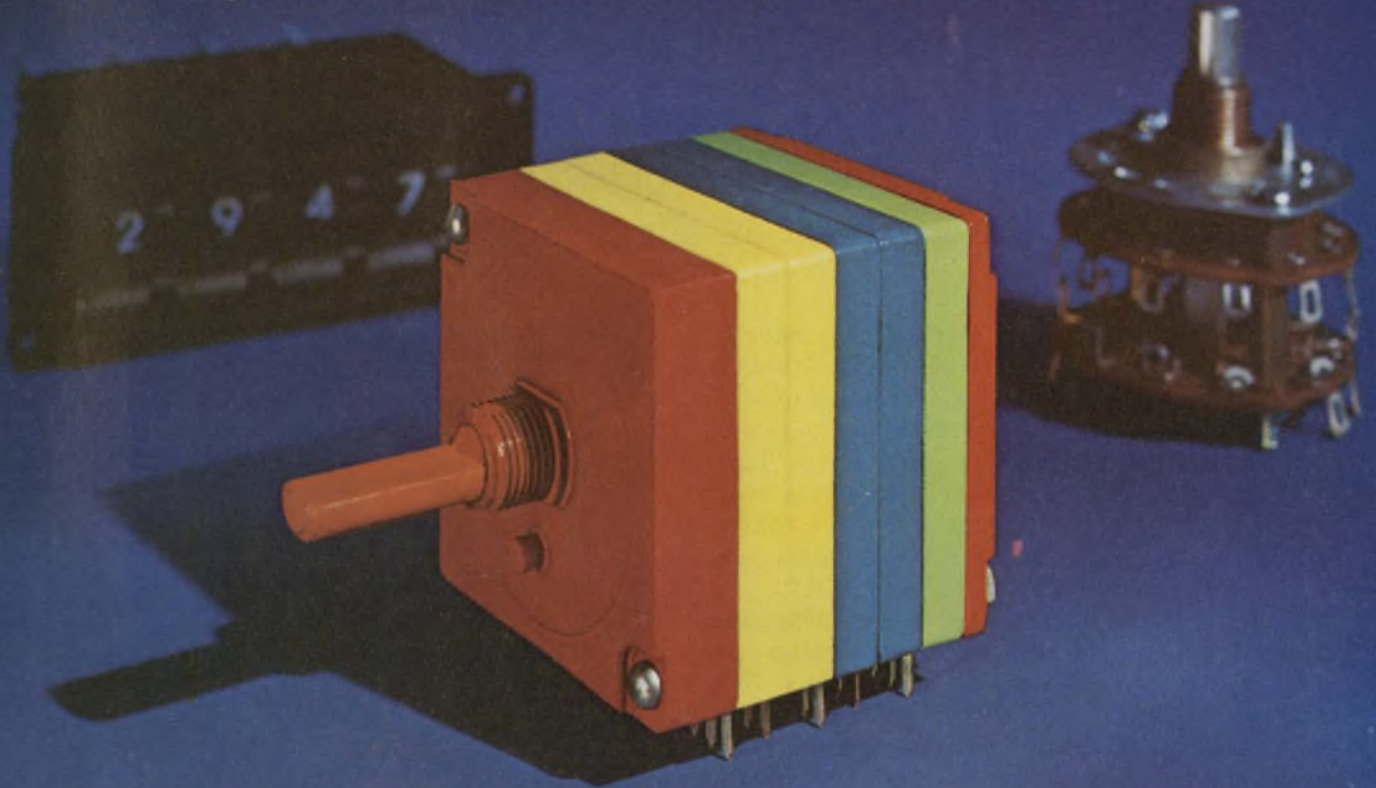

# ROTOCODE® A NEW KIND OF ANIMAL ALTOGETHER!

The shaft actuation of a **rotary switch** . . . with the coded electrical output of a **thumbwheel switch**. We call it Rotocode. You'll call it revolutionary! Ideal as a channel selector in CB, aircraft or marine radios and TV's. **Perfect** for item and price changing in vending machines. **Great** for quantity control in photocopier machines. **Versatile** enough to be modified and expanded to precisely the number of positions required . . . whether 1 or 23 or 40 or **more**. **Modular** design permits assembly of as many decks as needed for specific function. **Superb** for programming virtually any electronic instrumentation or equipment in place of conventional thumbwheel switches or multi-deck rotary switches.

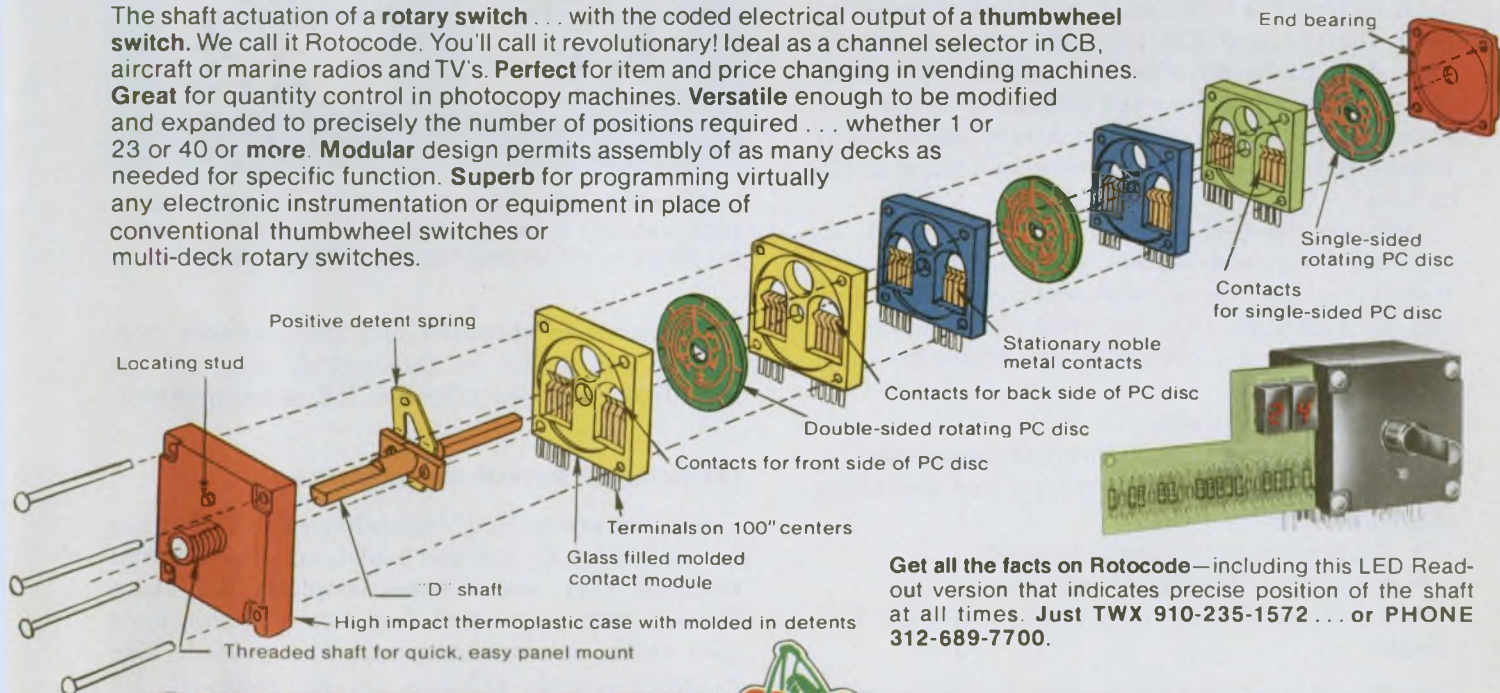

Get all the facts on Rotocode—including this LED Read-out version that indicates precise position of the shaft at all times. Just TWX 910-235-1572 . . . or PHONE 312-689-7700.



**CHERRY ELECTRICAL PRODUCTS CORP.**  
3609 Sunset Avenue, Waukegan, Illinois 60085

**SWITCHES and KEYBOARDS — Available locally from authorized distributors.**

CIRCLE NUMBER 42

## Driving inductive loads? Take advantage of collector-emitter diodes in monolithic power Darlington transistors. They can dissipate kickback as effectively as external diodes.

Most monolithic-power Darlington transistors have a built-in collector-emitter (C-E) diode that is usually ignored. But this diode is quite capable of serving as a surge suppressor for inductive loads to dissipate potentially destructive "kickback" voltages. However, the Darlington transistors must be used in such multiple transistor drive configurations as complementary push-pull, totem-pole, half-bridge and full-bridge circuits (Fig. 1).

Inductive loads presented by relays, solenoids, motors, transformers and even wiring cause special problems for switching transistors.<sup>1</sup> If a transistor is suddenly switched off, and the circuit doesn't provide an alternate path for the load current, the kickback voltage can destroy the transistor.

Placing a suppressor diode to carry the load current when the transistor turns off dissipates, or snubs, this inductive kick. In multiple-transistor drive circuits, as one transistor turns off, the inductive current can travel through the Darlington C-E diode of the second transistor.

Of course, the diode must be able to handle the peak current and dissipate the resulting power loss. And to be an effective snubber, the diode should have a low forward-voltage drop for both transient and steady-state conditions, particularly when used in high-speed power-switching applications.

Because the C-E diode is usually ignored, its characteristics are seldom given in spec sheets. However, tests on a representative Darlington can fill this data gap. To properly evaluate the diode's snubbing capabilities, the following must be determined:

- Thermal properties.
- Static forward-conduction characteristics.
- Dynamic forward-conduction and switching characteristics.
- Reverse-recovery characteristics.
- Behavior with inductive loads.
- Ability to operate in parallel with other C-E diodes.

Al Pshaenich, Applications Engineer, Motorola Semiconductor Products, Inc., 5005 E. McDowell Rd., Phoenix, AZ 85008.

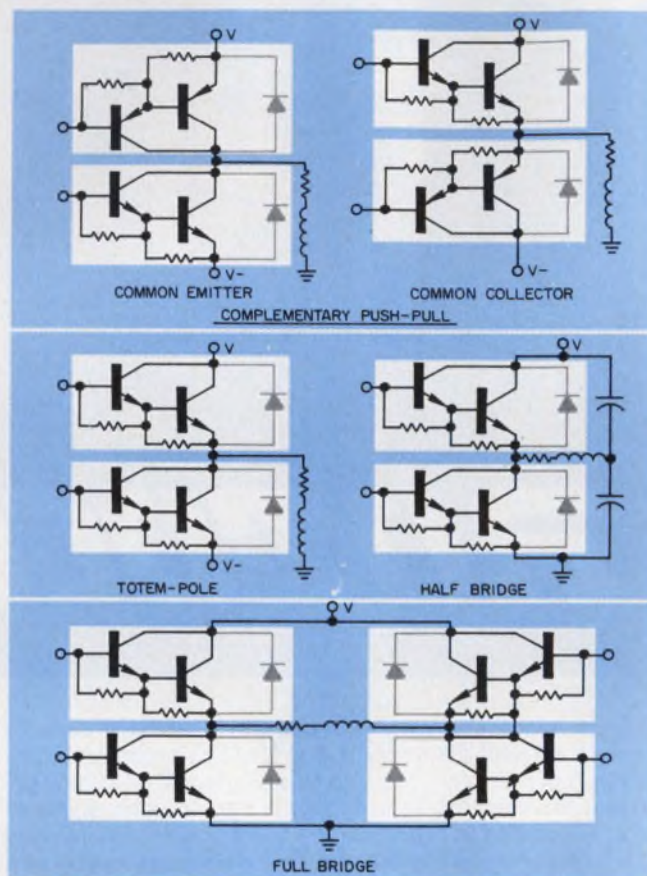

1. Monolithic Darlington power drivers, when used in pairs, can take advantage of their built-in collector-emitter diodes to act as snubbers for inductive loads.

Compared to standard and fast-recovery rectifiers, C-E diodes in Darlington transistors such as the MJ-10001 do a very effective job as suppressors.

### Evaluating the thermal characteristics

The power-handling capability of a C-E diode is dictated by its thermal resistance,  $R_{\theta}$ , thermal response,  $r(t)$ , and thermal coupling,  $K_{\theta}$ . These thermal properties aren't found on a Darlington's spec sheet, so measurements are needed. The MJ10001's diode exhibits an  $R_{\theta}$  value of  $1.1^{\circ}\text{C}/\text{W}$ . With a conservative derating factor of about 60%  $R_{\theta}$  becomes  $1.75^{\circ}\text{C}/\text{W}$ . So, for an allowed junction temperature,  $T_j$ , of  $200^{\circ}\text{C}$ , dis-

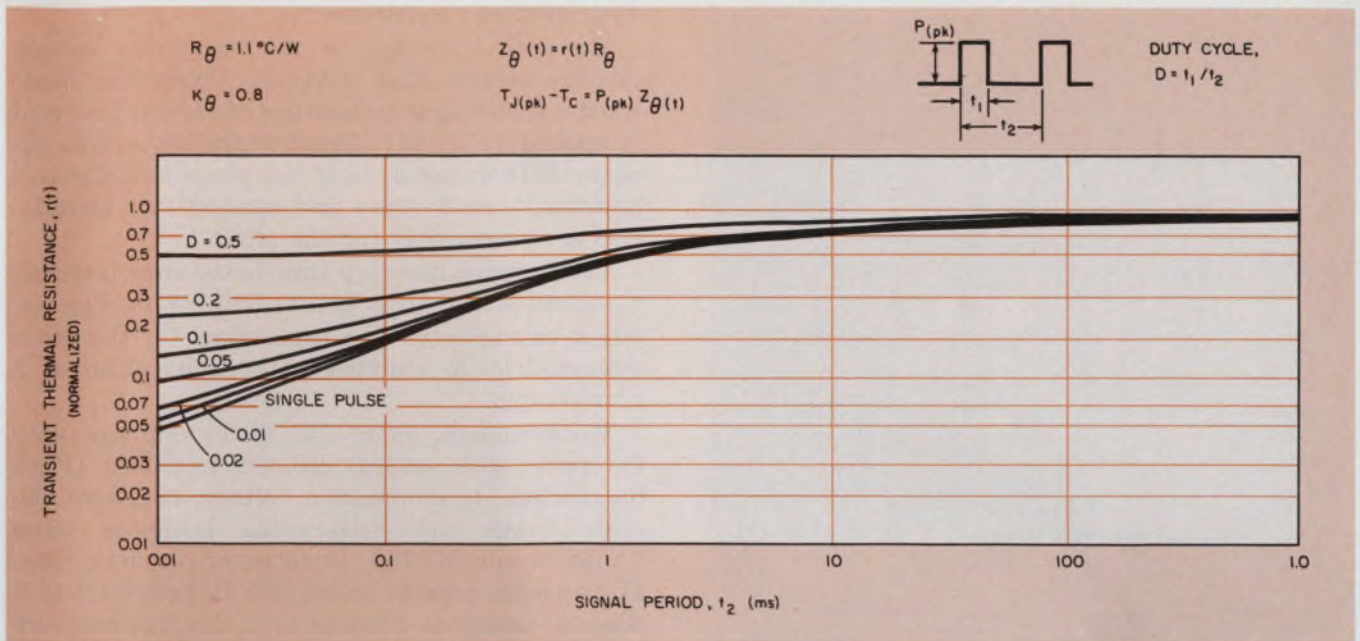

2. The thermal characteristics of C-E diodes in monolithic Darlington drivers are ample to allow dissipation

of the energy of most inductive loads. Effective thermal resistance drops with signal period and duty cycle.

sipation of 100 W will produce a case temperature,  $T_C$ , of 25 C.

But this calculation is correct only if the transistors aren't powered. When the transistors, as well as the C-E diode, are powered, the thermal coupling of the junctions reduces the effective dissipation capability of each, as follows:

$$T_J - T_C = R_{\theta J_1} \cdot P_{D_1} + R_{\theta J_2} \cdot K_{\theta} \cdot P_{D_2}$$

where  $P_{D_1}$  is the diode power and  $P_{D_2}$ , the transistor power.

The thermal coupling,  $K_{\theta}$ , between diode and transistor junctions in the MJ10001 is about 0.8 (at 25-C case temperature). Dynamic thermal-response curves for these Darlington units are shown in Fig. 2.

### Measuring the static and dynamic properties

A plot of the static forward voltages ( $V_F$ ) at currents to 90 A shows that C-E diodes compare favorably with several discrete diodes (Fig. 3). To generate these data, the diodes must be subjected to peak currents well above rated values. However, in actual applications allowed peak-current ratings shouldn't be exceeded. The MJ-10001 limit is 30 A, determined by the unit's nominal bond-wire rating.

The circuits of Fig. 4a and 4b measure the C-E diode's dynamic forward and reverse characteristics to determine if the Darlington output transistor is adequately protected. The forward-switching properties of the C-E diode are characterized by a so-called modulation voltage,  $V_{FM(\text{DYN})}$ , and forward-recovery time,  $t_{tr}$ , which determine the efficiency and effectiveness of a

(continued on page 88)

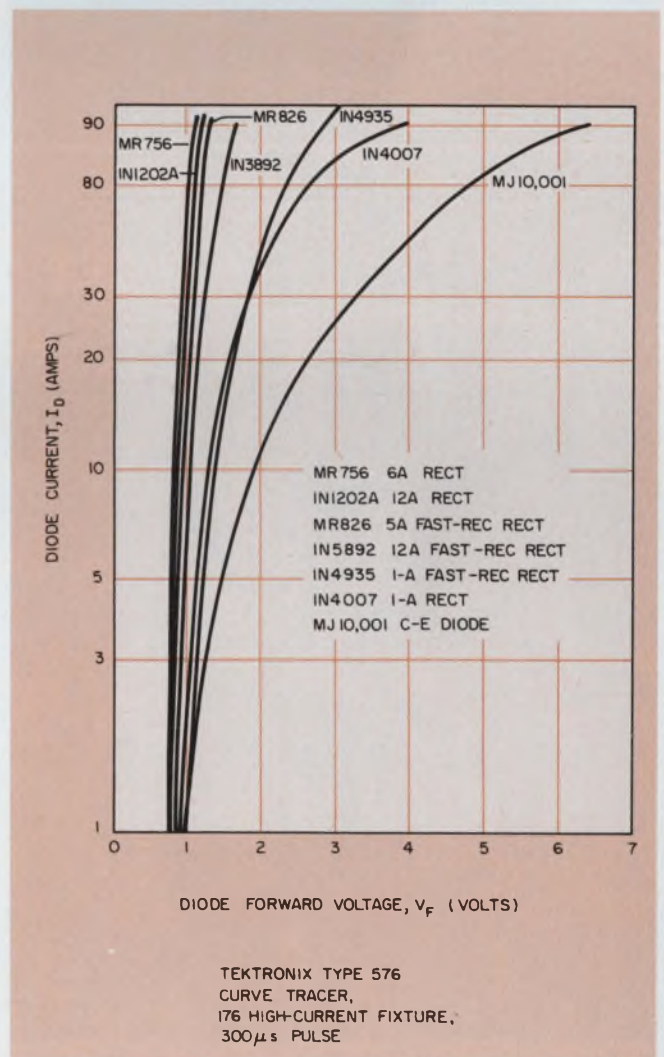

3. The forward-voltage characteristics of C-E diodes compare favorably with discrete diodes that are often used as load clamps.

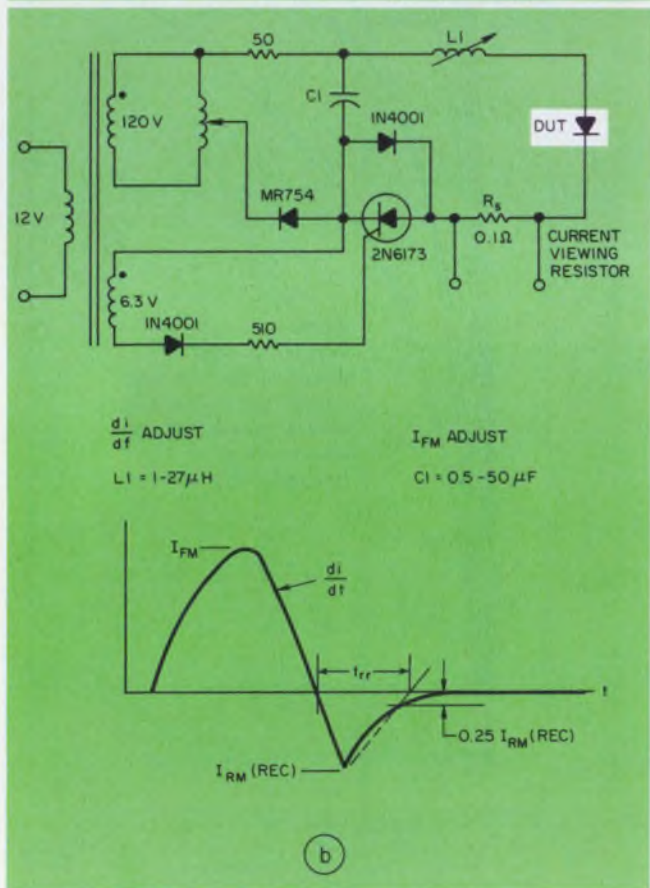
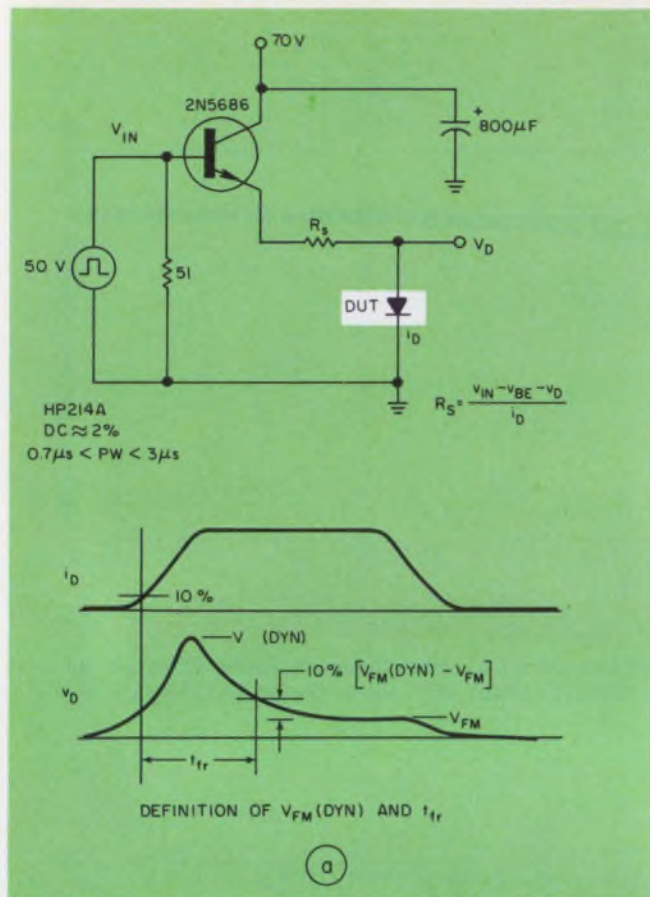

4. Test circuits must be built to measure the C-E diode properties—forward switching (a) and reverse recovery (b)—because these properties are not usually published by Darlington manufacturers.

diode used as a suppressor.

Modulation voltage is the maximum instantaneous voltage that develops across the diode when a specified step function of forward current is applied (Fig. 4a). The voltage waveform appears differentiated, as if the diode is inductive; however, transit times and conductivity modulation are responsible for the effect.

The forward-recovery time is the time interval,  $t_{fr}$ , between the 10% points defined in Fig. 4a, which characterizes the time taken for the diode voltage drop to stabilize after application of a current step.

Measurements on a C-E diode compare very favorably with several discrete rectifiers (Figs. 5a and 5b). In modulation voltage, only two discrete diodes are better—the large-die units 1N1202A and MR756. In forward-recovery time, at moderate current levels, the Darlington's C-E diode is nearly as good as even the fast-recovery rectifiers.

#### Fast-recovery diodes erroneously specified

Fast-recovery rectifiers are characterized by low reverse-recovery times: They aren't particularly fast on forward recovery. Nevertheless, fast-recovery units are often specified by circuit designers, when it's the forward-recovery characteristics that should be fast for snubbing applications. And although only the forward characteristics are important, reverse-recovery time,  $t_{rr}$ , and peak reverse-recovery current,  $I_{RM(REC)}$  also should be measured to complete the comparison of C-E and discrete diodes (Fig. 6).

Reverse-recovery time is a measure of the commutation capability of a device to switch from an ON state to OFF: Charge stored in a forward-biased diode must be depleted when the diode is suddenly reverse-biased. Interval  $t_{rr}$  is the time taken by the reverse current to fall to a specified value ( $0.25 I_{RM}$ ) after the driving source is switched from a forward to a reverse-voltage condition (Fig. 4b).

As expected, the  $t_{rr}$  of fast-recovery rectifiers is superior to both standard rectifiers and the C-E diode. And although  $I_{RM(REC)}$  values for the C-E diode and standard rectifiers are comparable, the values for the fast-recovery rectifiers are much lower.

#### Testing with an inductive load

To stress the C-E diode, a high-current inductive load (high-Q air-core of about  $75 \mu H$ ) with currents from 1 to 30 A peak is applied to a Darlington (Fig. 7). When the test circuit's drive transistor,  $Q_1$ , turns off, inductor current discharges through the Darlington's C-E diode.

(continued on page 90)

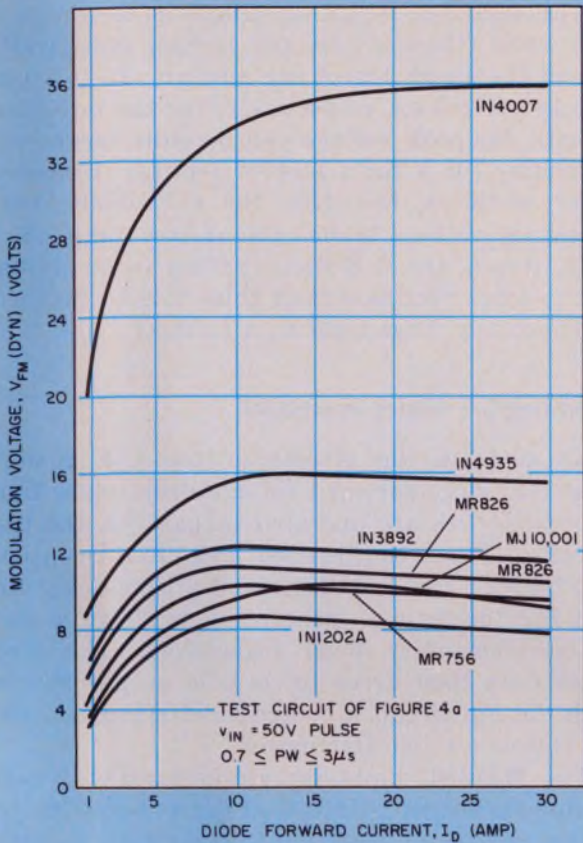

(a)

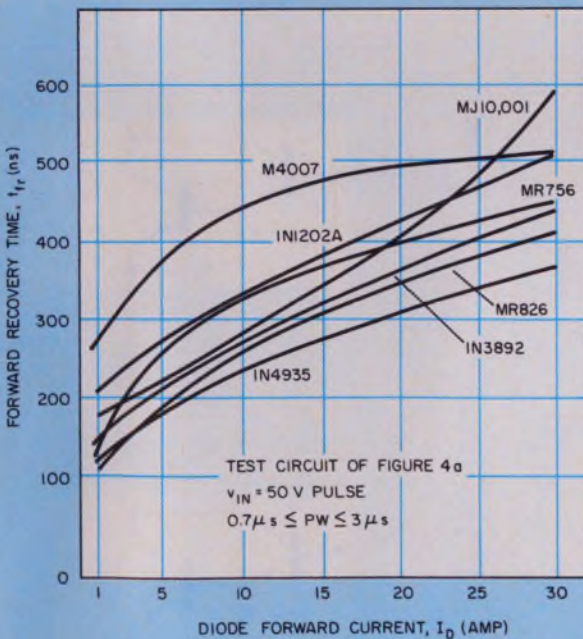

(b)

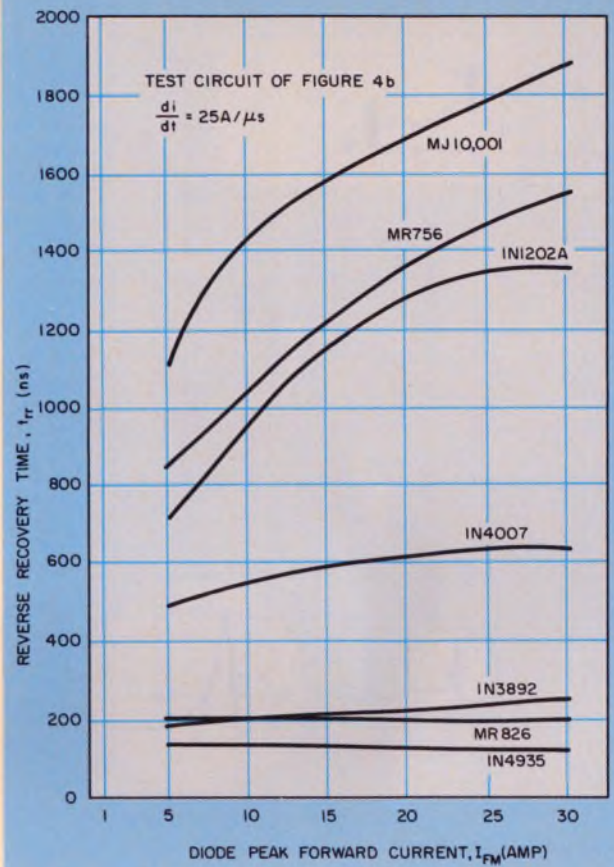

(a)

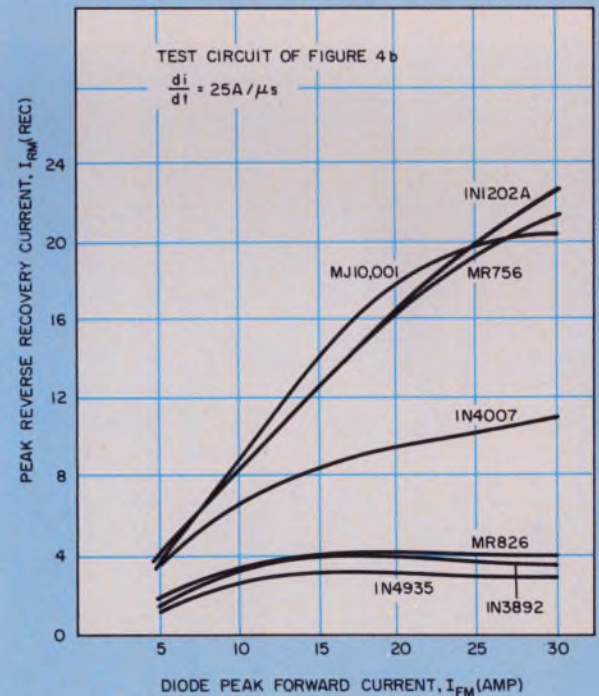

(b)

5. Forward-switching modulation voltage (a) and forward-recovery time (b)—the two most important characteristics of diodes used for snubbing—compare very favorably with the discrete diodes.

6. Reverse-recovery characteristics of C-E diodes—both reverse-recovery time (a) and peak reverse-recovery current (b)—although reasonably good, are generally not important for diodes used in load snubbing.

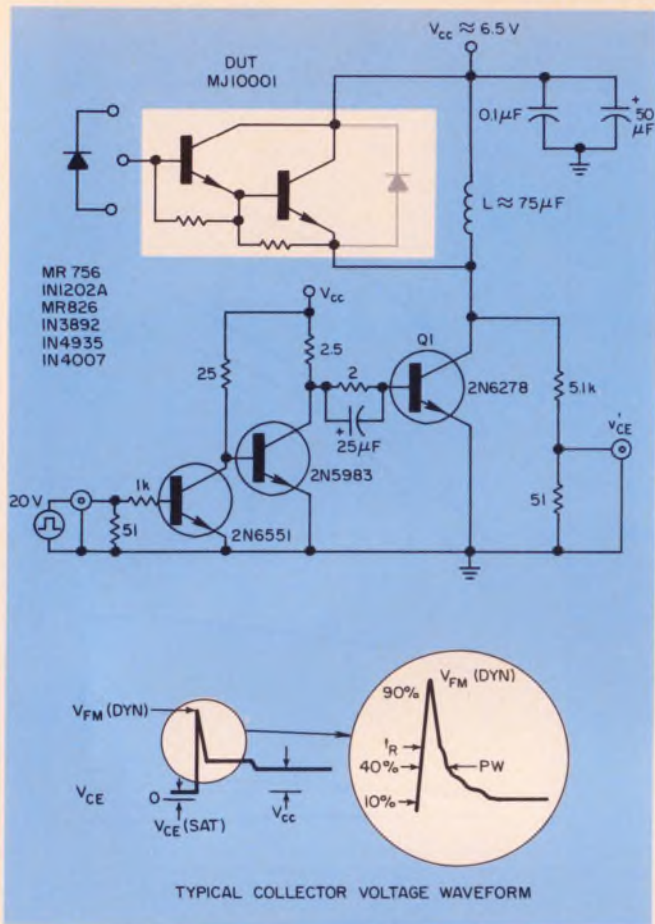

7. A test circuit to simulate actual inductive load conditions stresses the Darlington with loads of 1-to-30-A peak current. Again, the C-E diode does a good job.

The current step function from the inductor flows through the forward-biased clamp diode to produce a narrow-spike modulation voltage,  $V_{FM(DYN)}$ .

Although the energy contained in the spike is very small (the rise time and average pulse width for all the diodes tested are similar—25 to 70 ns and 100 to 250 ns, respectively, for the 5-to-20-A range), the peak voltage can be quite large—approaching 105 V for a 1N4007 rectifier. However, other rectifiers, including the C-E diode, have overshoot voltage transients of less than 45 V peak. Again, the C-E diode proves to be similar to the other rectifiers, and thus able to perform as effectively when used as a snubber.

### Operating C-E diodes in parallel

To evaluate the effects of the C-E diode's relatively large forward-voltage drop when Darlington devices are operated in parallel, the test circuit of Fig. 8 can be used. The circuit consists of a 6-kHz CMOS oscillator and a time-delay circuit for "dead-time" generation to drive a pair of complementary level translators. The level translators then drive totem-pole output stages, with the top circuit a compound Darlington, and the bottom a triple Darlington.

Two MJ10001 units operate in parallel in each totem-pole output with 0.15- $\Omega$  current-sharing resistors placed in each emitter circuit. A wire-wound load resistor simulates a typical 800-W peak inductive load (approximately 1.4  $\Omega$ , 10

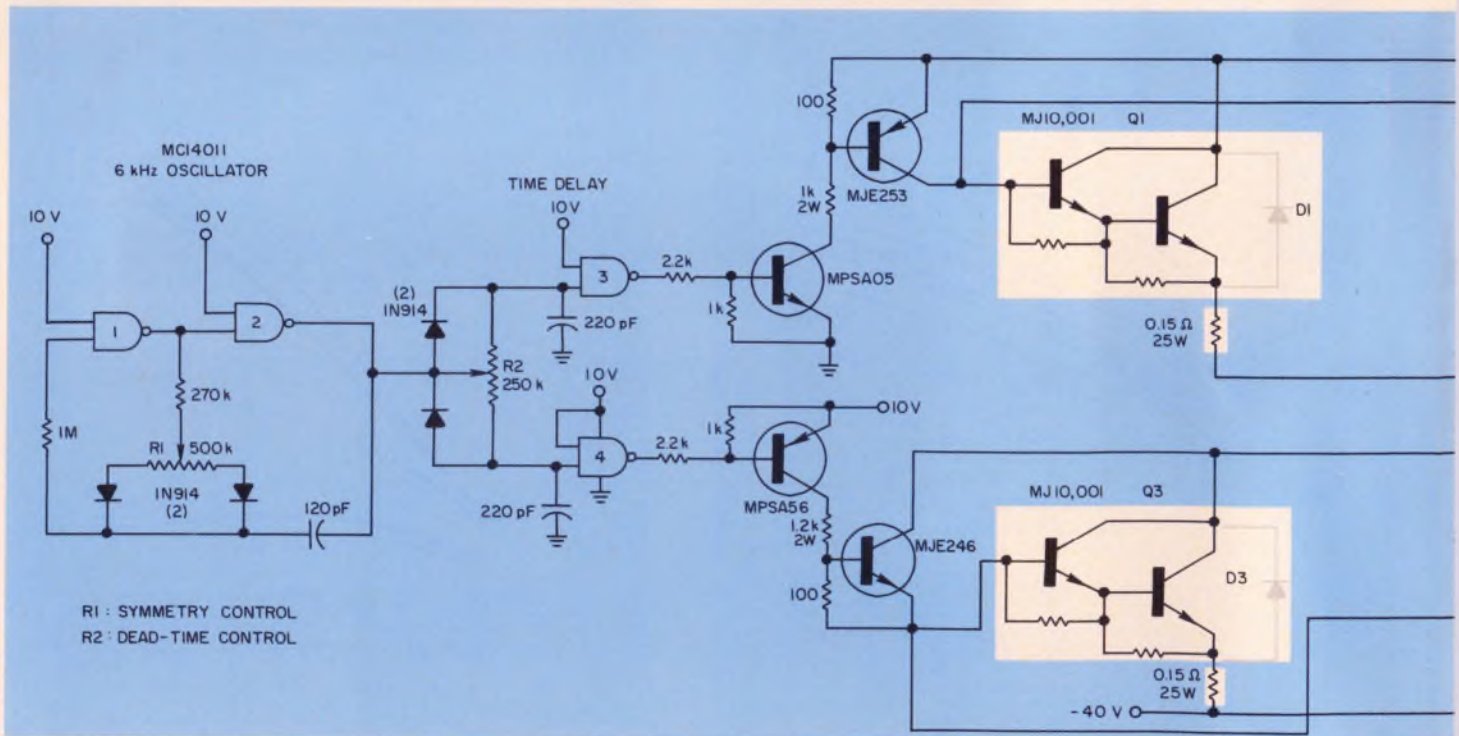

8. In a test for the paralleling effects of C-E diodes, this special circuit, when applied to random selections of Darlington shows that currents among the C-E diodes

match within  $\pm 15\%$ . The 0.15- $\Omega$  emitter resistor provides most of the control over the clamping current, even though diode voltage drops vary widely.



$\mu\text{H}$ ). With  $\pm 40\text{-V}$  supplies, each of the output transistors supplies about 12 A peak.

Whether only the internal C-E diodes of the MJ10001 are depended upon for snubbing, or whether the various discrete rectifiers,  $D_1$  and  $D_2$  (shown dotted) are used, output waveforms for all devices are virtually identical—no major differences in transient responses can be noted between the C-E diode and the other rectifiers.

To determine the sharing capability of the C-E diode snubbing currents, the power stage can be operated single-ended by reducing the  $+40\text{-V}$  supply to zero. Although the top transistors of the totem pole become inoperative, the C-E diodes still act as snubbers for the inductive load. And the current is only snubber current, not masked by the collector current of the normally functioning totem pole.

Randomly selected sets of C-E diodes match currents within  $\pm 15\%$ , even though forward-voltage drops vary widely—from about 1.7 to 2.1 V, at 10 A. Clearly, then, there is no correlation between  $V_F$  and the current shared by a diode. Current sharing for both emitter and C-E diode is controlled mostly by the  $0.15\text{-}\Omega$  emitter resistor. Moreover, when compared to standard or even fast-recovery diodes, no major difference in circuit operation can be detected for C-E diodes as a result of variations in reverse-recovery time. ■■

#### Reference

1. Pshaenich, A., "Use Pulse-Width Modulation to Control dc Motors," *Electronic Design*, Feb. 1, 1974, pp. 68-70.

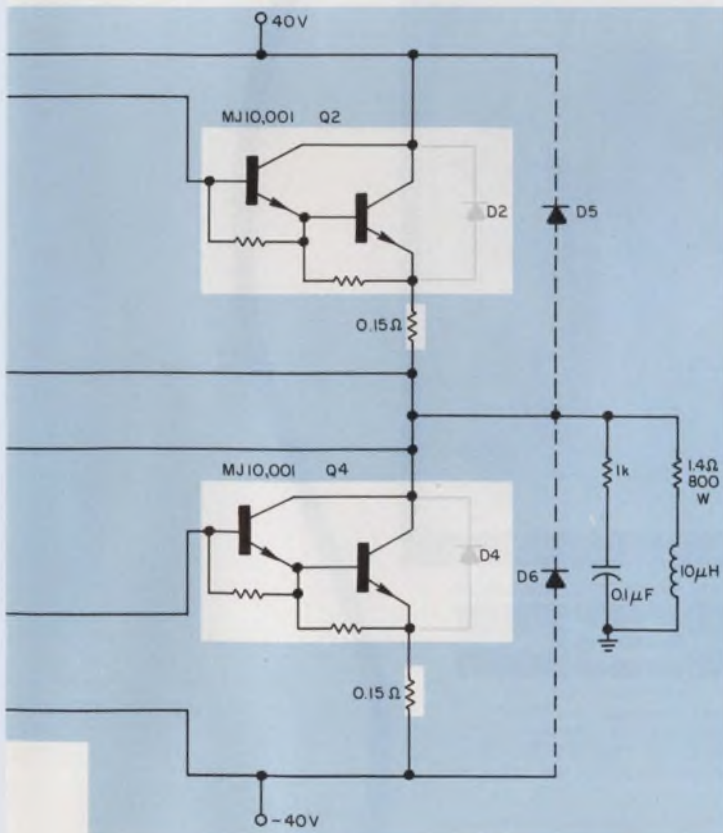

# Dialight LEDs

The widest choice for your every application.



Now available in green, yellow and red. Mini-sized for maximum front panel density and easy panel mounting. High luminous intensity, low cost. Vibration/shock resistant. Solid state for long life. Wide viewing angles. Ideal for applications like panel lighting, film annotation and alpha-numeric displays.

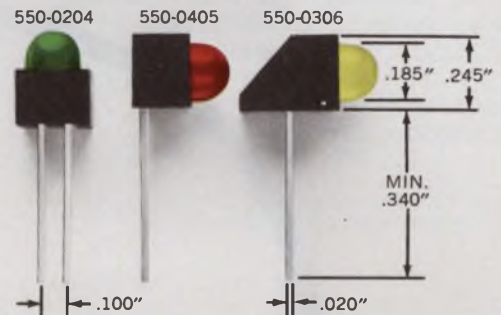

Mix 'em or match 'em. LED logic state fault indicators are available in red, yellow and green, in a variety of shapes, some with a built-in integral resistor. Can be driven from DTL and TTL logic. Designed for easy alignment on PC boards so that multiple functions can be displayed.



Dialight, the company with the widest choice in switches, LEDs, indicator lights and readouts, looks for needs . . . your needs . . . and then they develop solutions for your every application. No other company offers you one-stop shopping in all these product areas. And no other company has more experience in the visual display field. Dialight helps you do more with these products than any other company in the business, because we are specialists that have done more with them. Talk to the specialists at Dialight first. You won't have to talk to anyone else. Send for your free new copy of Dialight's current catalog.

## DIALIGHT

Dialight, A North American Philips Company  
203 Harrison Place, Brooklyn, N. Y. 11237  
(212) 497-7600

# See Dialight.

CIRCLE NUMBER 43

# YOU WERE HIRED FOR YOUR BRAINS, NOT YOUR BODY.

It's not as silly as it sounds. Because many bright engineers and technicians are still spending their time soldering, desoldering and resoldering. Instead of designing.

Which is pretty silly, considering the waste of talent. Especially when there's a better alternative.

With CSC Proto-Board<sup>®</sup> solderless breadboards, assembling a circuit is practically as fast as designing one. No special jumpers or patch cords required—all types of components—from complex microprocessors to resistors, capacitors and LED's—connect and interconnect as simply as pushing in a lead... or short lengths of #22-30 solid hookup wire. And circuit changes are done with the same

\*Manufacturer's suggested list  
Prices and specifications subject  
to change without notice

MODEL	NO. OF TIE-POINTS	14-PIN DIP CAPACITY	MFR'S SUGGEST LIST *	OTHER FEATURES
PB-6	630	6	\$15.95	Kit—10-minute assembly
PB-100	760	10	19.95	Kit—with larger capacity
PB-101	940	10	29.95	8 distribution buses higher capacity
PB-102	1240	12	39.95	Large capacity, moderate price
PB-103	2250	24	59.95	Even larger capacity, only 2.7¢ per tie-point
PB-104	3060	32	79.95	Largest capacity, lowest price per tie-point
PB-203	2250	24	75.00	Built-in 1% regulated 5V, 1A low-ripple power supply
PB-203A	2250	24	120.00	As above plus separate 1.5-amp +15V and -15V internally adjustable regulated outputs

plug-out, plug-in ease. All thanks to rugged, nickel-silver contacts and CSC's superior use-tested design.

Proto-Board breadboards are available in a variety of sizes, from 630 to 3060 solderless tie-points (six to thirty-two 14-pin DIP capacity), at prices from \$15.95\* (kit) to \$79.95. And if you'd like built-in regulated supplies, they're available too, in models priced at \$75 and \$120.

Before you start your next project, put down your soldering iron and call 203-624-3103 (East Coast) or 415-421-8872 (West Coast) for full specifications and ordering information. Once you do, you'll find yourself soldering less... and more than likely, earning more.

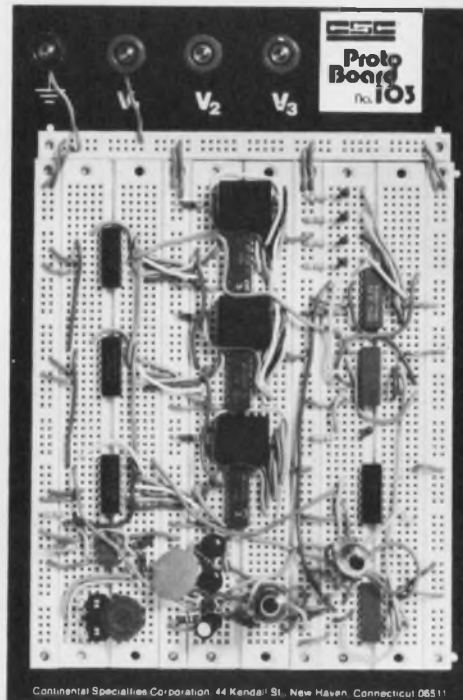

Continental Specialties Corporation, 44 Kendall St., New Haven, Connecticut 06511

CONTINENTAL SPECIALTIES CORPORATION







44 Kendall Street  
Box 1942 New Haven, CT 06509  
203-624-3103 TWX 710-465-1227  
West Coast office Box 7809 San Francisco, CA  
94119 • 415-421-8872 TWX 910-372-7992

© 1976, Continental Specialties Corporation

CIRCLE NUMBER 44

# THE HIGH VOLTAGE SUPER GROUP.

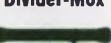

Type	Resistance Range	Power Rating At 70 C	Max Operating Volts	Temp. Coef. Rating (-55 C to +125 C)	Maximum Dimensions (Inches)
<b>Slim-Mox</b> 	1 MΩ to 5000 MΩ	5W	18,000 V	±250 ppm	Length 2.08 Height .84 Thickness .860
<b>Mini-Mox</b> 	100 kΩ to 10,000 MΩ	.25 W to 1.4 W	1000 V to 5000 V	±100 ppm to ±1000 ppm	Length .470 to 1.310 Dia. .140 or .165
<b>Divider-Mox</b> 	4.5 MΩ to 2000 MΩ	1.5 W to 6.0 W	7.5 kV to 30kV	±100 ppm to ±1000 ppm overall TCR Tracking ±25 ppm	Length 2.2 to 5.2 Dia. .345
<b>Maxi-Mox</b> 	10 kΩ to 5000 MΩ	1.5 W to 12.5 W	7.5 kV to 37.5 kV	±100 ppm to ±500 ppm	Length 1.122 to 5.2 Dia. .310 or .345
<b>Power-Mox</b> 	20 kΩ to 7000 MΩ	22.5 W to 45 W	20 kV to 45 kV	±100 ppm to ±300 ppm	Length 3.96 to 6.96 Dia. .89

## MOX resistors from Victoreen. The high voltage experts.

What's your problem? Space? Economy? Stability? Better tolerance? Here's one solution to all of the above. The Victoreen MOX high voltage resistor line.

From Mini-MOX to Power-MOX, you'll find that the people at Victoreen know how to make you happy. We know how to give you resistor performance that allows more design flexibility. And product reliability.

MOX resistors are the high voltage designer's solution to problems caused by other resistors.

The tougher your high voltage resistor requirements, the more you need our advanced, reliable MOX magic.

Send for complete technical data. Write: Victoreen Instrument Division



10101  
Woodland  
Avenue,  
Cleveland,  
Ohio 44104

 SELLER-GLOBE CORPORATION

## Use equations to parallel transistors.

To get through the graphical morass, balance your currents with simple arithmetic and straight-line approximations.

When you parallel transistors for increased power, watch out for current hogging. When a current-greedy transistor consumes more of the load than it can handle, you've got trouble. And there's no curing the sick transistor—it's gone forever. Then the full load falls onto the remaining paralleled transistors, which, in turn, topple like dominoes.

Balancing the parallel currents with emitter resistors is the answer for low-frequency circuits. But selecting these resistors by using all-graphical methods is cumbersome, at best. Practical equations can help you control the current mismatch and ease this once tedious job.

The basic problem is that current division is unequal between the circuit's parallel legs. In the simple parallel connection shown in Fig. 1a, the differences in the transfer characteristics of  $Q_1$  and  $Q_2$  (shown in Fig. 1b) indicate that  $Q_1$  handles the bulk of the current. Consequently,  $Q_1$  dissipates more power than  $Q_2$ .

One way to compensate for this unequal power dissipation is to select components for their  $V_{BE}$ - $I_C$  characteristics. But this solution causes transistor stocking and replacement problems.

A better solution, emitter-sharing resistors (see Fig. 2), reduces collector-current differences between transistors by making the drop across these resistors large compared to the  $V_{BE}$  differences for their respective transistors.

### Graphically speaking . . .

When you employ all-graphic methods<sup>1,2</sup> to determine mismatch, you assume that  $I_c$  is approximately equal to  $I_E$ . You follow with a load-line approach. For worst-case analysis (Fig. 3), you assume one transistor has maximum transconductance with maximum current and power dissipation and the other transistors have minimum transconductance.

Resistor tolerance is accommodated by drawing two load lines and assigning the minimum-

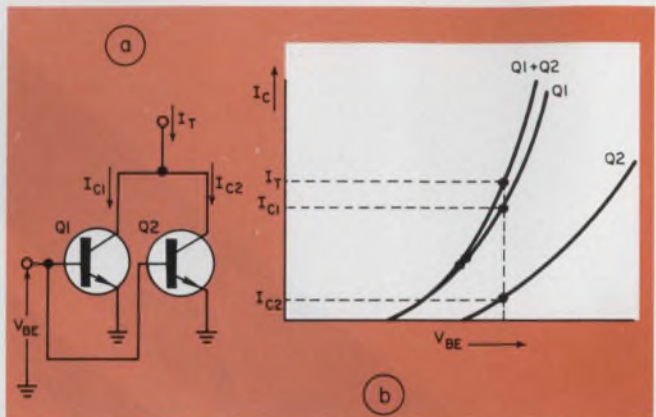

1. Current balance in parallel-connected transistors (a) depends on matching the transistors' characteristics (b). The total current usually divides unequally.

value resistor to the maximum-transconductance transistor. Conversely, the maximum-value resistor is assigned to the minimum-transconductance transistors.

If the  $I_C = I_E$  approximation is not appropriate, you can correct for  $h_{FE}$  by multiplying the  $V_{BB}/R_E$  intercept by  $(1 + 1/h_{FE})$ . The maximum  $h_{FE}$  corresponds to maximum transconductance, and the minimum  $h_{FE}$  to minimum transconductance.

While this graphic solution does yield accurate results, it is cumbersome, particularly when you

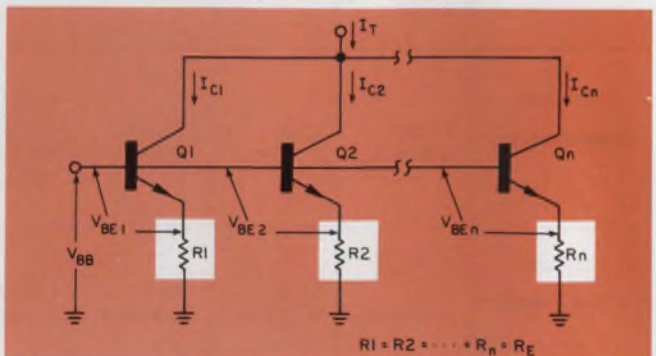

2. Emitter-sharing resistors limit current imbalances among parallel circuit legs. The penalty is lowered circuit efficiency, but the emitter resistors keep parallel transistors below their maximum power level. A resistor's voltage drop swamps its transistors'  $V_{BE}$ .

Otto R. Buhler, Senior Associate Engineer, IBM, Boulder, CO 80302.

have to analyze parameter variation or design for a fixed mismatch ratio. But the graphic method can be modified to give you a simplified design procedure that includes equations.

### Analytically speaking . . .

A technique more practical than the all-graphic uses linear approximations for the transistors'  $V_{BE} - I_C$  transfer characteristics. With these estimations you compute values for the critical parameters from equations. The emitter resistors ( $R_E$ ), the matching constant for the transistors' power dissipations ( $K$ ), and the maximum supply voltage ( $V_{BB}$ ) are so specified.

Assume that  $h_{FE}$  is much greater than 1; then  $I_E$  is approximately equal to  $I_C$ . For maximum mismatch,  $Q_1$  in Fig. 2 has maximum dissipation (implying maximum transconductance for  $Q_1$  and minimum resistance for  $R_1$ ). And transistors  $Q_2$  through  $Q_n$  have minimum dissipation (implying minimum transconductance for  $Q_1$  through  $Q_n$  and maximum resistance for  $R_2 = R_3 = \dots = R_n$ ). You then figure in the transfer characteristics to obtain critical parameters (Fig. 4).

Using the circuit of Fig. 2 and assuming that  $I_C \cong I_E$  produces this relationship:

$$I_{C1} R_1 + V_{BE1} = I_{C2} R_2 + V_{BE2} = \dots = I_{Cn} R_n + V_{BE_n} = V_{BB} \quad (1)$$

$$I_{C1} R_1 - I_{C2} R_2 = V_{BE2} - V_{BE1} \quad (1a)$$

From Fig. 4:

$$V_{BE1} = V_{T1} + I_{C1}/m_1, \quad (2)$$

$$V_{BE2} = V_{T2} + I_{C2}/m_2, \quad (2a)$$

Plugging Eq. 2 into Eq. 1 gives:

$$I_{C1} (R_1 + 1/m_1) - I_{C2} (R_2 + 1/m_2) = \Delta V_T \quad (3)$$

where  $\Delta V_T = V_{T2} - V_{T1}$  (from Fig. 4).

The total current is:

$$I_T = I_{C1} + I_{C2} + \dots + I_{Cn} \quad (4)$$

For the worst case:

$$I_{C2} = I_{C3} = \dots = I_{Cn},$$

and Eq. 4 becomes:

$$I_T = I_{C1} + (n - 1) I_{C2} \quad (5)$$

Using Eq. 3 and Eq. 5 to solve for  $I_{C1}$  and  $I_{C2}$  yields:

$$I_{C1} = \frac{I_T (R_2 + 1/m_2) + (n - 1) \Delta V_T}{(n - 1) (R_1 + 1/m_1) + (R_2 + 1/m_2)} \quad (6)$$

$$I_{C2} = \frac{I_T (R_1 + 1/m_1) - \Delta V_T}{(n - 1) (R_1 + 1/m_1) + (R_2 + 1/m_2)} \quad (7)$$

Dividing Eq. 6 by Eq. 7 gives you the matching constant,  $K$ , the power dissipation multiplier of  $Q_1$  compared to  $Q_2$ . It is expressed by:

$$K = \frac{I_{C1}}{I_{C2}} = \frac{I_T (R_2 + 1/m_2) + (n - 1) \Delta V_T}{I_T (R_1 + 1/m_1) - \Delta V_T} \quad (8)$$

Rewriting Eq. 8 in terms of a nominal emitter resistor,  $R_E$ , and appropriate tolerance multipliers, you get:

$$K = \frac{I_T (PR_E + 1/m_2) + (n - 1) \Delta V_T}{I_T (NR_E + 1/m_1) - \Delta V_T} \quad (9)$$

$P$  and  $N$  are tolerance multipliers; for example, for a  $\pm 5\%$  resistor,  $P = 1.05$  and  $N = 0.95$ . Usually,  $K$  is a known desired value, and the value of  $R_E$  to get the desired  $K$  is unknown. Rearranging Eq. 9 yields:

$$R_E = \frac{(K + n - 1) \Delta V_T + I_T \left( \frac{1}{m_2} - \frac{K}{m_1} \right)}{I_T (KN - P)} \quad (10)$$

Increasing  $R_E$  beyond the value given by Eq. 10 decreases  $K$ . But this improvement in  $K$  is not free—increasing  $R_E$  requires increasing  $V_{BB}$ . Note, of course, that negative values of  $R_E$  cannot be realized.

$I_{C2}$  is given in terms of the total current by:

$$I_{C2} = I_T / (K + n - 1) \quad (11)$$

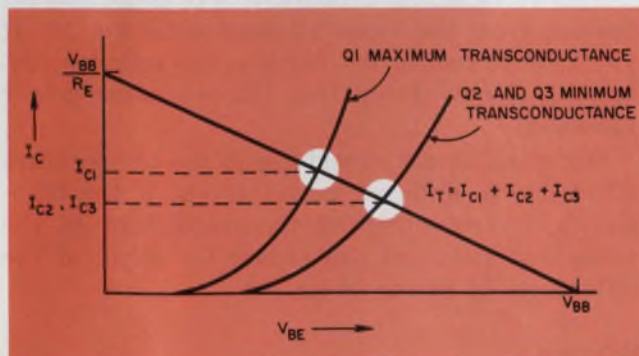

3. Graphical analysis of worst-case conditions for three paralleled transistors assumes maximum transconductance for one and minimum for the other two. The maximum-transconductance transistor hogs current and dissipates more power than the other two devices.

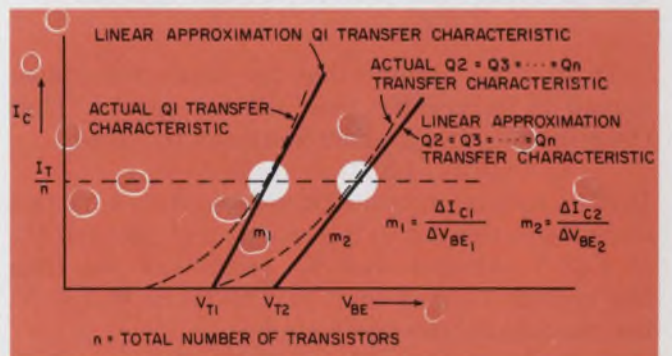

4. Linear approximations of actual curves are the basis of a simplified specification technique for emitter resistors. The two line-determining points are the intersection between an actual curve and the nominal average current line and the base-to-emitter voltage intercept.

and the maximum supply voltage is:

$$V_{BB} = I_{C2} \left( PR_E + \frac{1}{m_2} \right) + V_{T2} \quad (12)$$

When using Eq. 12 remember that  $R_E$  increases as  $K$  decreases.

For practical applications, the most useful equations are 5, 8, 9, 10, 11 and 12.

### Specifically speaking . . .

Consider sharing 15 A among three 2N3773s that use emitter-sharing resistors with  $\pm 5\%$  tolerances. Assume that the currents must match within 20%.

As in Fig. 5, you draw a linear approximation for a typical 2N3773 around the 5-A operating point. A typical transistor has a transconductance of 20.7 A/V and a  $V_T$  of 0.64 V. From the specification sheet, the  $h_{FE}$  spread is 15 to 60 at 8 A, and the maximum  $V_{BE}$  is 2.2 V at 8 A. The typical  $h_{FE}$  is 20 at 8 A. So at 8 A, the minimum  $h_{FE}$  is 0.75 times the typical  $h_{FE}$ , and the maximum  $h_{FE}$  is 3 times the typical  $h_{FE}$ .

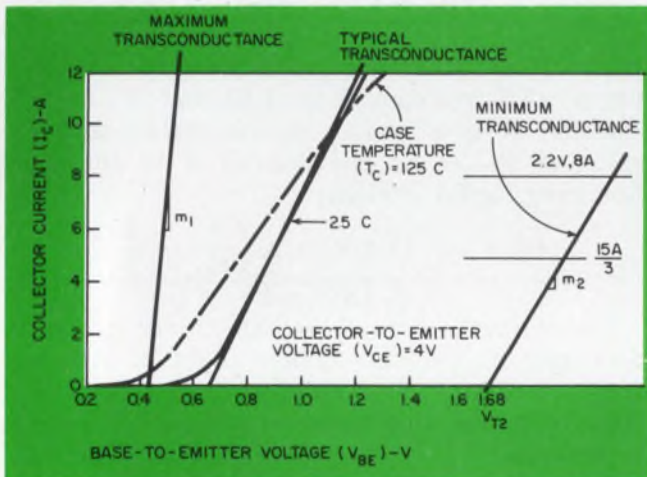

5. Linear approximation for a 2N3773, drawn through the nominal 5-A operating point and 0.64 base-to-emitter voltage intercept, shows a typical transconductance of 20.7 A/V. Max., min. bracket the typical  $g_m$  line.

To find  $V_T$ , assume that the transconductance spread is no greater than the  $h_{FE}$  spread. Then the minimum transconductance can be found:

$$(0.75) (20.7) = 15.53 \text{ A/V.}$$

Draw a minimum transconductance line with this slope from the 2.2-V, 8-A point, and you get  $V_{T2} = 1.68$  V. Assume that  $V_{T1}$  is 200 mV less than the typical  $V_T$  and that  $(3) (20.7) = 62.1$  A/V, the maximum transconductance.

Now you can draw the maximum transconductance line with:

$$\Delta V_T = 1.68 - 0.44 = 1.24 \text{ V.}$$

For 20% matching,  $K = 1.2$ . Emitter-sharing resistors with 5% tolerance imply values of 1.05

and 0.95 for P and N. Applying Eq. 10 yields:

$$R_E = \frac{(1.2+3-1)(1.24) + 15 \left[ \frac{1}{15.3} - \frac{(1.2)(1)}{62.1} \right]}{15 [(1.2)(0.95) - 1.05]} = 3.88 \Omega$$

The nearest commercial value greater than 3.88  $\Omega$  is 4.0  $\Omega$ . Now use Eq. 9 to find the  $K$  value for this value of emitter resistance:

$$K = \frac{(15) \left[ (1.05)(4) + \frac{1}{15.3} \right] + (3-1)(1.24)}{15 \left[ (0.95)(4) + \frac{1}{62.1} \right] - 1.24} = 1.19$$

Note that the increased  $R_E$  of 4.0  $\Omega$  results in a slightly better match ratio.

Next, calculate  $I_{C2}$  from Eq. 11:

$$I_{C2} = 15 \text{ A} / (1.19 + 3 - 1) = 4.70 \text{ A}$$

Then, from Eq. 8:

$$I_{C1} = K I_{C2} = (1.19) (4.69) = 5.60 \text{ A}$$

Applying Eq. 12 gives:

$$V_{BB} = (4.7) \left[ (1.05)(4.0) + \frac{1}{15.3} \right] + 1.68 = 21.73 \text{ V}$$

For most applications, this voltage results in too much dissipation for matching. If  $Q_1$  can handle higher dissipation,  $K$  can be increased. For example, with the given supply voltage, if  $Q_1$  can handle 6.0 A, Eq. 5 gives:

$$I_{C2} = (15 - 6.0) / (3 - 1) = 4.5 \text{ A,}$$

and then Eq. 8 gives:

$$K = I_{C1} / I_{C2} = 6.0 / 4.5 = 1.33.$$

Next, Eq. 10 yields:

$$R_E = \frac{(1.33 + 3 - 1)(1.24) + 15 \left[ \frac{1}{15.3} - \frac{1.33}{62.1} \right]}{15 [(1.33)(0.95) - 1.05]} = 1.50 \Omega$$

and, finally, from Eq. 12:

$$V_{BB} = (4.5) \left[ (1.05)(1.5) + \frac{1}{15.3} \right] + 1.68 = 7.38 \text{ V}$$

This value of  $V_{BB}$  represents a considerable reduction from the value attained with Eq. 12. If you want to reduce  $V_{BB}$  further, use four transistors.  $Q_1$  is now dissipating the maximum power allowable.

One variable not considered is the temperature effect due to different power levels of the transistors. By mounting all the transistors on the same heat sink, you can reduce the effect of the differences of power levels. ■■

### References

- Greenburg, R., Editor, *Motorola Power Transistor Handbook*, Motorola Semiconductor Products Div., Phoenix, AZ, 1961, pp. 141-142.
- "Parallel Operation of Power Transistors in the Linear Region," Application Note 12-A, Delco Radio Div., Kokomo, IN, March, 1964.

# Situation Wanted:

**Name — Amphenol® 97 Series connector.** For consumer, industrial, business equipment. And more. Here's the old pro of standard circular power connectors. It's for service from 250 to 4200 VDC (200 to 3000 VAC, RMS) and wire gauges from 4 to 16. So 97 Series connectors are ideal for all kinds of equipment — TV, computers, machine tools, communications, you-name-it.

**And still more qualifications.** Including MIL-C-5015. And our pre-aligned non-rotating contacts that mean quick, easy soldering. The 97 Series is also built strong to work hard. With diallyl phthalate insert material (it's highly stable at high temperatures). Molded barriers between contacts for higher voltage ratings. And a few more features you'll want to find out about.

**Literally hundreds of configurations.** Take your pick of inserts — for a number of wires, all of the same gauge. Or for lots of wire, all of different gauges. And choose the receptacle you want: wall, cable, or box. And the plug you want: straight, quick-disconnect, angle, or panel-mount.

**Availability: Whenever you're ready.** Amphenol 97 Series connectors are available now for off-the-shelf delivery from your Amphenol Industrial Distributor. Call him soon. Or to find out how Amphenol 97 Series connectors can be tailor-made to match your specific application, just write or call: Bob Ashley, Amphenol Connector Systems, Bunker Ramo Corporation, 900 Commerce Drive, Oak Brook, Illinois 60521. (312) 986-3763.



**HEAVY EXPERIENCE  
SEEKS CHALLENGE  
REASONABLY PRICED**

The right idea  
at the  
right time.

**AMPHENOL** Connector Systems **BUNKER RAMO®**

"DO IT YOURSELF" — no stripping or soldering with the innovative **NEW**  
**Vector Ribbon Cable and Connector System**

Tools are FAR LESS costly yet more versatile than others.

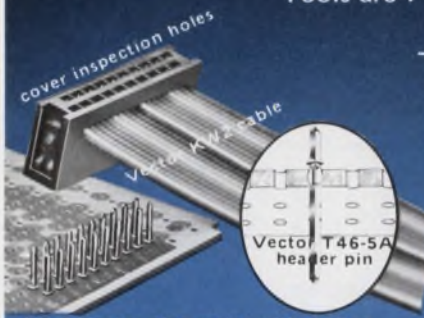

KS-2 Vector plug mates with .025 sq. or rd. pins

Vector P196 Gang Insertion Tool on T46-5A header pins. \$12.50

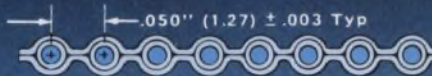
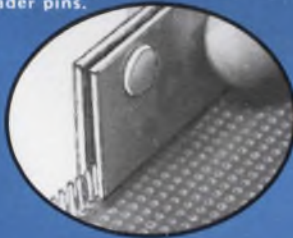

Color coded Vector KW2 cables. 20 to 40 No. 28 tinned copper, PVC insulated. 10' rolls.

**SIMPLE ASSEMBLY METHOD**

1. Insert cable in plug.
2. Place in P187 fixture.
3. Press halves together with arbor, drill press or vise.

**NO OTHER FIXTURE TERMINATES MOST TYPES OF PLUGS**

Vector, Alpha, AMP, Ansley, Berg, C.W., 3M & S.A.E. plugs all work by use of unique step design.

**MOUNT T46-5A HEADER PINS**

1. Drop pin tails in card holes with alignment block under.
2. Slide P196 tool on pins.
3. Push in with 186-1 press. (Can also gang insert other types of pins.)

Vector P187 fixture positions and terminates cable to plug \$29.50



Vector P186-1 Press drives plug into cable. Also gang inserts pins. \$59.50

"Daisy chain" also feasible with plugs mid-span



Vector pre-assembled DIP plug interconnect cables 14-pin \$3.65, 16-pin \$3.79, 24-pin \$7.30 (parts also available to make your own)

VECTOR ELECTRONIC COMPANY, Inc., 12460 Gladstone Avenue, Sylmar, CA 91342 Phone (213) 365-9661 TWX 910-496-1539 501276

CIRCLE NUMBER 145



**THE HOT NEW S-D MICROPROCESSOR ANALYZER**

**ONLY \$865** but Model 50 does more than a 32-channel logic analyzer costing 3 times as much.

**First Universal Analyzer:** Useable with all microprocessor families that have accessible bus structure.

**Display:** 16 bits of data and 16 bits of address.

**Unique Search Modes:** Identify the first and last instruction in a program loop, then step forward or backward through programs.

**Passive or Interactive:** Use as a passive real time monitor.

Find out more about the time-saving (to put it mildly) Model 50 features such as delay by loops, single step, dual clock, N - 1/N + 1strobe, multiple unit capability, etc. Contact:



10 Syston Drive • Concord, CA 94518 • Phone (415) 676-5000

CIRCLE NUMBER 146



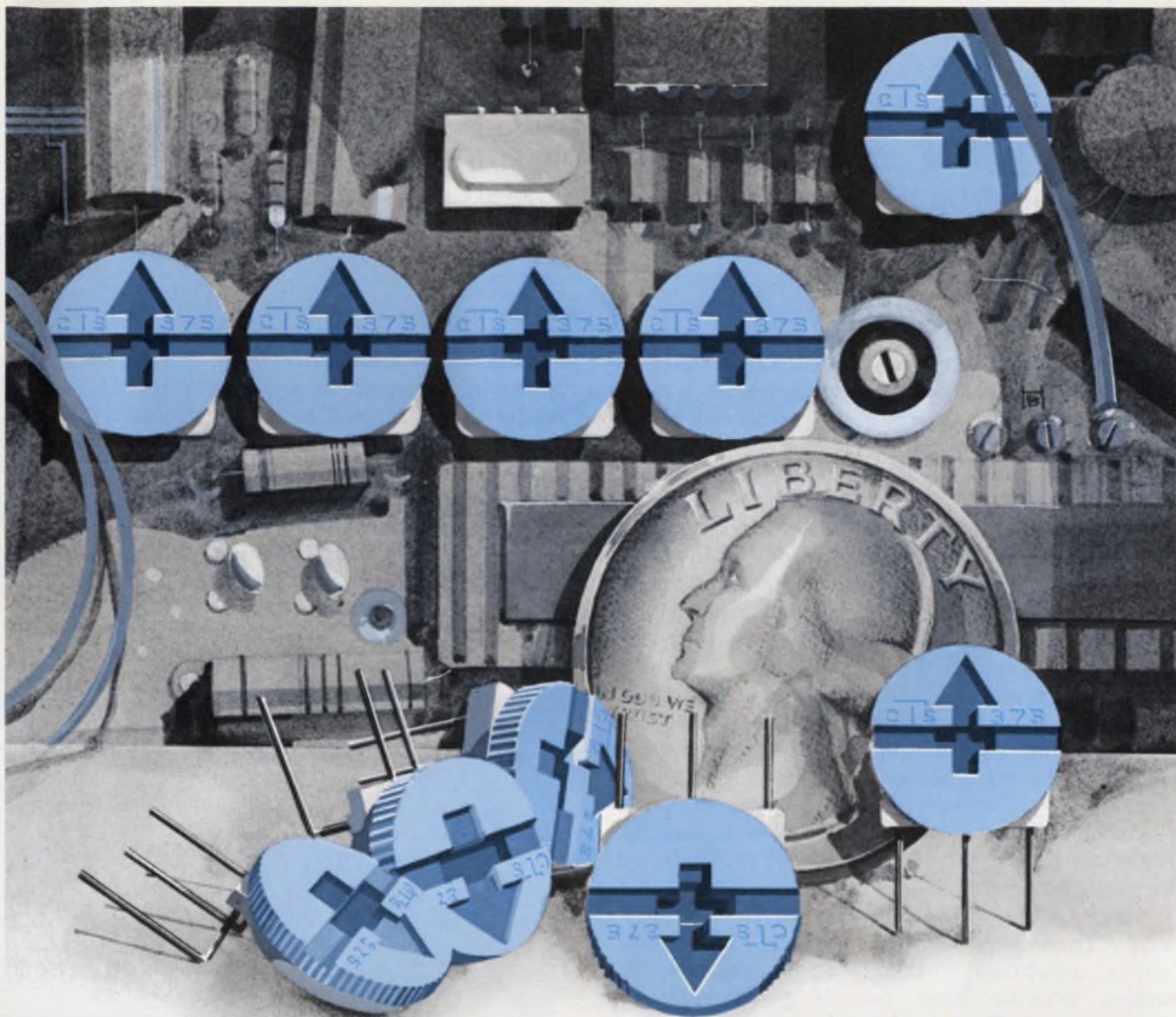

## CTS mini cermet trimmers... low in price, high in performance.

Fantastic! Small  $\frac{3}{8}$ " dia. (10mm), great performance and CTS reliability are only three reasons you should use our NEW series 375 single turn cermet trimmers. The low 25¢ price tag is still another.

CTS 375's, in six popular terminal styles, feature a low  $\pm 100$  ppm/ $^{\circ}$ C standard temperature coefficient—throughout the resistance range. Power rating, 1 watt at  $40^{\circ}$ C;  $\frac{1}{2}$  watt at

$70^{\circ}$ C. CRV of 2%. Settability of .03%.

And the serrated adjustment knob doubles as a dust cover to protect the element from dirt, oil and other contaminants. It's a lot for so little. But you expect that from a company that's put millions into electronics for industry. For complete information, write **CTS OF WEST LIBERTY, INC.**, 6800 County Road 189, West Liberty, Ohio 43357 or phone (513) 465-3030.

**CTS CORPORATION**  
ELKHART, INDIANA



A world leader in cermet and variable resistor technology.

CIRCLE NUMBER 147

# Float your input amplifier and you can almost laugh at ground loops or high common-mode voltages. A new design gives low drift, too.

Systems designers, take heart. The answer to your ground-loop headaches may lie in a novel isolation amplifier. Intended for high-accuracy dc applications, the amplifier has no trouble handling common-mode voltages as high at 600 V. And it drifts a wee 2 ppm/°C. All the amplifier asks in return is a scanty 200 nA of input bias.

Grounding is a paramount problem in many data-acquisition and process-control systems. Since transducers are often located hundreds of feet from an electronics console or computer, ground loops are hard to avoid.

For example, if a minicomputer is interfaced to a nuclear reactor located 1000 feet away, it is likely that the two equipments' grounds will not be at the same potential. Simply tying all the grounds together with heavy cable may not solve the problem. One possible solution is to float the computer or reactor off ground, but this may not be practical or safe.

Special types of amplifiers address this problem, with varying degrees of success. "Instrumentation" amplifiers, with committed feedback networks, provide high common-mode rejection ratios and excellent dc characteristics. These amplifiers achieve good results at moderate common-mode voltages. High common-mode voltages, however, call for an isolation amplifier with fully floated inputs.

## The basic principle

The design presented here achieves a precise unity-gain, input-output relationship for a 0-to-9-V input. Although there's no dc connection between input and output, the output follows the input to an absolute accuracy of 0.01% over a 0-to-50-C temperature range.

Commercially available isolation amplifiers, such as the Analog Devices 285L, can equal or surpass these specs, but do not approach the 2-ppm/°C drift performance.

Conceptually, the design is simple (Fig. 1). The input voltage is converted to a pulse whose

width ranges from 0 to 90  $\mu$ s. For isolation, the pulse is driven across a transformer whose secondary is referenced to output ground. The data pulse out of the secondary is demodulated by a pulse-width-to-voltage converter to form the amplifier output.

To convert the input voltage to a pulse width, the circuit compares the input with a precision linear-reference ramp that repeats at a rate of

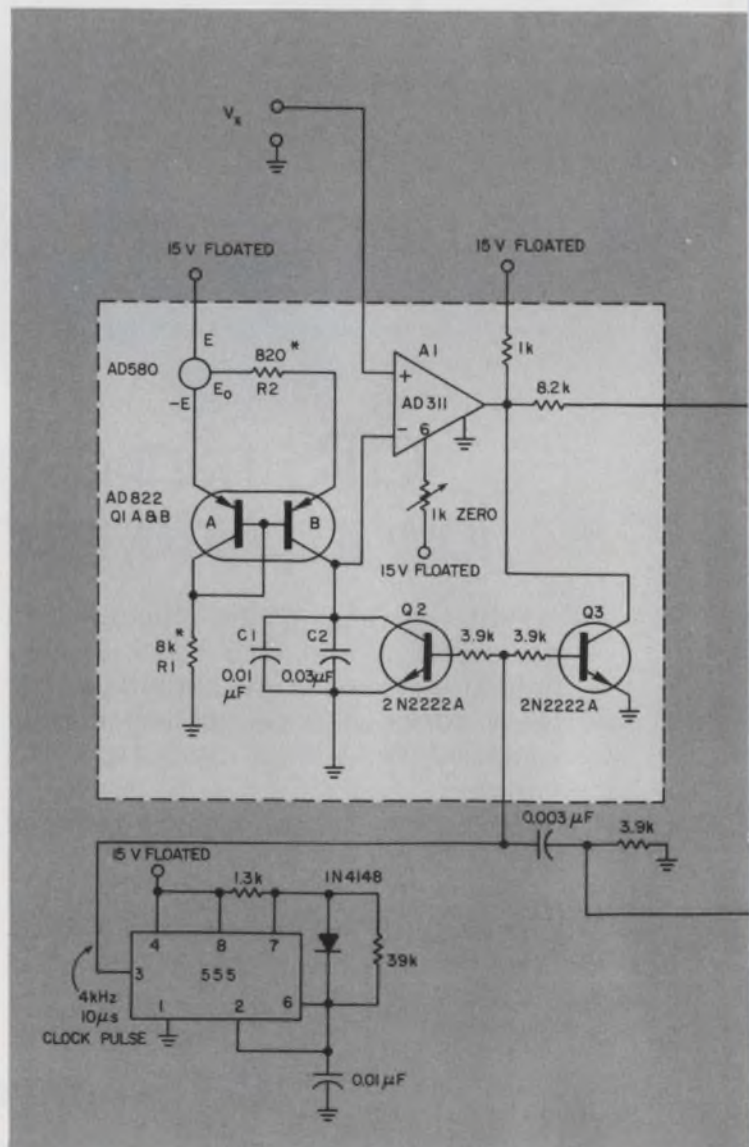

James M. Williams, Senior Engineer, MIT, Dept. of Nutrition and Food Science, Cambridge, MA 02139.

4 kHz. The ramp runs from 0 to 10 V, then is reset to zero by a 4-kHz clock pulse. The output pulse width of the comparator depends on the time the reference ramp takes to slew from zero to the value of the input voltage,  $V_x$ .

The secondary of the transformer reproduces the data pulse and uses the pulse to turn on a switchable ramp generator. The ramp starts at 0 V and goes toward 10 V until the data pulse goes low. At that point, the current source stops charging the ramp capacitor, and the voltage across the capacitor equals  $V_x$ , which is sampled and stored in another capacitor. The clock pulse resets the system, and the entire cycle repeats.

### The detailed amplifier

In Fig. 1, transistor pair  $Q_1$ , comparator  $A_1$ , and associated components form the voltage-to-pulse converter. The AD580 (from Analog Devices) in the emitter of  $Q_1$  is a band-gap voltage refer-

ence that stabilizes the differential pair in a current-source configuration. The "B" side of the pair functions as a current source, while the "A" side is diode-connected to compensate for the drift of  $V_{be}$ .

Resistors  $R_1$  (8 k $\Omega$ ) and  $R_2$  (820  $\Omega$ ) bias the current source to provide 6 mA into the  $C_{1,2}$  combination. Because the tempcos of silver mica and polystyrene-type dielectrics are opposite,  $C_1$  and  $C_2$  form a capacitor with a zero-temperature coefficient and low soakage. The composite capacitor resets when the clock pulse from the 555 timer resets  $Q_2$ . The pulse is 10  $\mu$ s long and repeats at a 4-kHz rate (Fig. 2a).

When the clock goes high,  $Q_2$  turns on and  $C_{1,2}$  resets to zero volts. When the clock goes low,  $Q_2$  goes off and  $C_{1,2}$  is charged up (Fig. 2b). The resulting repetitive, linear reference ramp forms the input to the AD311 comparator. The 6-mA charging current ensures that the comparator's input-bias current doesn't affect the linearity of

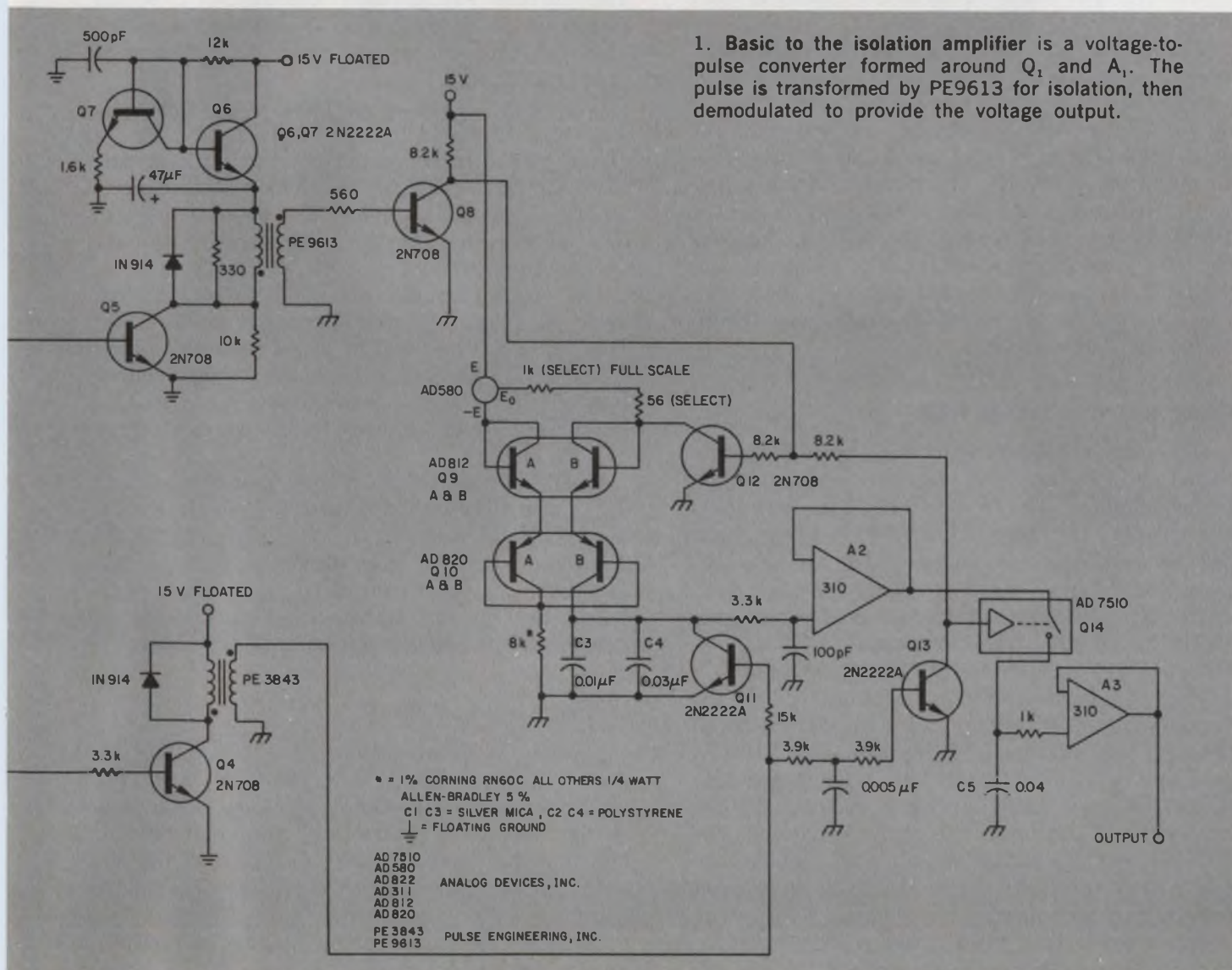

1. Basic to the isolation amplifier is a voltage-to-pulse converter formed around  $Q_1$  and  $A_1$ . The pulse is transformed by PE9613 for isolation, then demodulated to provide the voltage output.

the reference ramp.

Voltage  $V_x$  serves as the other input to the AD311. Like the rest of the circuitry in the front end of the amplifier,  $V_x$  is referenced to floating ground. The pulse width at the output of the AD311, which is directly proportional to  $V_x$ , drives  $Q_5$  into conduction (Fig. 2c). The collector of  $Q_5$  conducts current out of  $Q_5$ 's emitter, and the current passes through the PE9613 transformer primary to ground (Fig. 2d).

To keep the transformer out of saturation, the  $Q_6$ ,  $Q_7$  combination drives the transformer from a 1.2-V potential. Transistors  $Q_6$  and  $Q_7$  function as a temperature-compensated emitter follower, biased by the 12-k $\Omega$  and 1.6-k $\Omega$  resistors to provide about 1.2 V at  $Q_6$ 's emitter.

The 500-pF capacitor ensures dynamic stability, and the 47- $\mu$ F solid tantalum capacitor helps maintain a low impedance at  $Q_6$ 's emitter when  $Q_6$  is loaded (when  $Q_5$  turns on). The 1N914 diode, 300- $\Omega$  and 10-k $\Omega$  resistors provide proper damping of the transformer primary. Transistor  $Q_5$ , a 2N708, has a low storage charge and provides very fast edges—even in the relatively slow common-emitter configuration.

Transistor  $Q_3$  is biased by the clock pulse and prevents the AD311 output from going high during the period that the clock pulse resets  $C_{1,2}$ . To do so,  $Q_3$  pulls the AD311 output down when the clock pulse is high. The clock pulse biases  $Q_4$  through the 0.003- $\mu$ F/3.9-k $\Omega$  differentiator network. Because of the differentiator,  $Q_4$  drives the PE3843 pulse transformer for only 3  $\mu$ s whenever the 10- $\mu$ s clock pulse occurs. The pulse appears across the transformer secondary and performs resetting and timing functions in the pulse-width-to-voltage demodulator.

### Going back to a voltage level

Once the voltage-proportional pulse is established and driven across the transformer, it must be demodulated. The transformer secondary feeds current into  $Q_8$  (Fig. 2e), which, in turn, shifts the level of the 1-V pulse and maintains the pulse's fast edges (Fig. 2f). Transistor  $Q_8$ 's output drives  $Q_{12}$ , a switch that turns on a current source (AD812, AD820 transistor pairs) in 10 ns. Another AD580 reference stabilizes the source.

The "A" portion of the 820 functions as the current-source transistor, and the "B" portion provides temperature compensation. The AD812B pair prevents the AD820B pair from conducting in the reverse direction whenever the voltage across the  $C_3$ ,  $C_4$  composite capacitor exceeds the AD820B emitter potential (when  $Q_{12}$  is on). The 1-k $\Omega$ , 56- $\Omega$  and 8-k $\Omega$  resistors set the bias point for the current source.

Whenever a data pulse exists across the transformer,  $Q_8$ 's collector is low and  $Q_{12}$  is cut off.

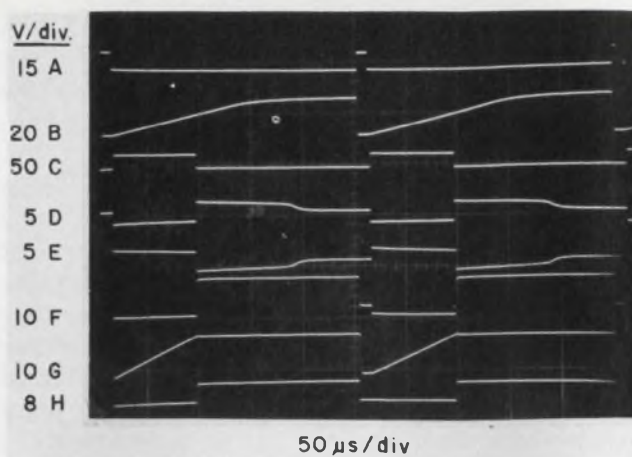

2. Scope traces show the various circuit waveforms: the 555 output—a 4-kHz, 10- $\mu$ s pulse (A); the reference ramp at the comparator's negative input (B); the comparator output for  $V_x = 8$  V (C); the transformer drive and secondary waveshapes (D and E); and the waveshape at  $Q_8$ 's collector (F). The hop is caused by current sharing between  $Q_{12}$  and  $Q_{13}$ . Traces G and H show the voltage across  $C_{3,4}$  and at the collector of  $Q_{13}$ , respectively. Note that the  $C_{3,4}$  ramp starts when "F" is at 0 V.

The current source then charges  $C_{3,4}$ , which ramps up in voltage until  $Q_8$  goes off and  $Q_{12}$  turns on. Thus, the current source is cut off very quickly (Fig. 2g).

Capacitor  $C_{3,4}$  sits at the maximum ramp voltage until  $Q_{11}$  resets it to zero. Transistor  $Q_{11}$  is driven by the reset pulse from the transformer. Since the reset pulse for the demodulator capacitor,  $C_{3,4}$ , is only 3  $\mu$ s long—as opposed to 10  $\mu$ s for  $C_{1,2}$ — $C_{3,4}$  will be reset and ready to start another ramp when  $C_{1,2}$  starts its ramp.

The voltage on  $C_{3,4}$  after its current source turns off equals the amplifier-input voltage,  $V_x$ . This voltage is buffered by  $A_2$ , a follower, which drives FET switch  $Q_{14}$ . When the current source goes off,  $Q_8$ 's collector is high and turns on  $Q_{11}$ . Capacitor  $C_5$  then charges to the voltage across  $C_{3,4}$ .

When the clock pulse arrives,  $Q_{11}$  turns on, and  $C_{3,4}$  immediately starts to reset to zero. However, the clock pulse biases on  $Q_{13}$ . This action turns off  $Q_{14}$ , and prevents  $C_5$  from discharging (Fig. 2h). To ensure that  $Q_{11}$  is off during the entire reset period of  $C_{3,4}$ , the transformer reset pulse is stretched by the RC combination in  $Q_{13}$ 's base.

### Keeping the output pure

Another RC combination—in  $A_2$ 's input—provides a delay to compensate for  $Q_{14}$ 's slow 1- $\mu$ s switching speed. Follower  $A_2$ 's response is slowed by the 3- $\mu$ s time constant of the combination. This slowing down further ensures that the resetting of  $C_{3,4}$  doesn't affect  $C_5$ , despite  $Q_{11}$ 's slow speed.

Capacitor  $C_5$  is buffered by  $A_3$ , the final output stage of the amplifier. The 1-k $\Omega$  resistor in series

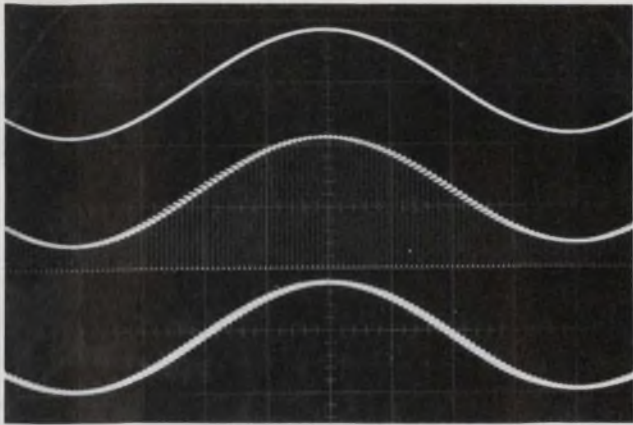

3. The amplifier's response to a 20-Hz sinusoid biased on a 2-V level (top). The center trace is the output of  $A_2$ , the bottom the output of  $A_3$  (5 ms/div, 5 V/div).

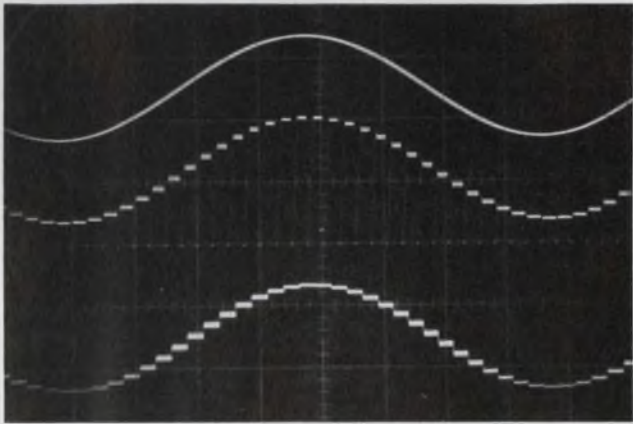

4. Response to a 200-Hz sinusoid: The input is at the top, and the outputs of  $A_2$  and  $A_3$  are at center and bottom, respectively (625  $\mu$ s, 10 V/div).

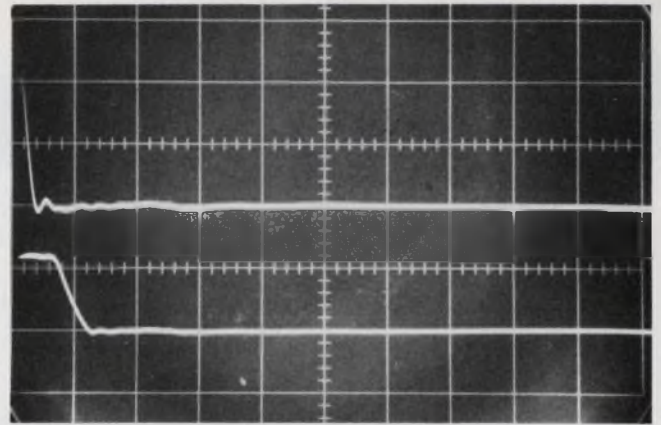

5. The fall-time delay through transistor  $Q_5$ , transformer PE9613, and  $Q_4$  and  $Q_{12}$  is measured at the AD311 output (top) and collector of  $Q_{12}$  (bottom).

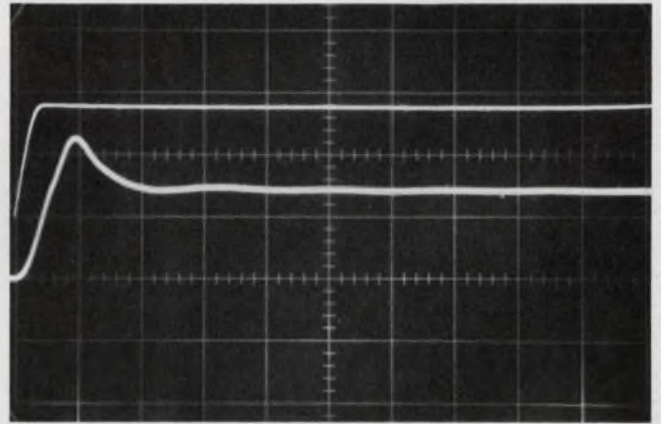

6. Rise-time delay is shown at the AD311's output (top) and at the collector of  $Q_{12}$  (bottom). The scope calibration here and in Fig. 5 is 500 ns and 5 V/div.

with  $A_3$ 's input ensures dynamic stability.

All the provisions discussed ensure that only dc will appear at the amplifier's output for a dc input. Switching spikes and noise are below 1 mV. The amplifier's response is shown in Figs. 3 and 4, and the delays encountered through the circuit in Figs. 5 and 6.

To calibrate the circuit, apply 9.000 V at the input with respect to floating ground. Adjust the 1-k $\Omega$  in the AD812B collector line for 9.000 V at the amplifier output. Next, apply 10 mV at the input and adjust the 1-k $\Omega$  potentiometer at pin 6 of the AD311 for 10 mV at the amplifier output. Repeat this procedure until the adjustments do not interact.

Note that the offset adjustment (the 1-k $\Omega$  pot at  $A_1$ ) is rather unorthodox—the method achieves a zero setting for the circuit by deliberately generating a large offset in the AD311 comparator. The adjustment is needed since  $V_{ce}$  saturation prevents  $Q_2$  and  $Q_{11}$  from resetting their associated capacitors to zero. This "bending up" of the AD311's inputs increases bias current and  $E_{os}$  drift, but not enough to cause worry.

The 56- $\Omega$  carbon resistor in the AD812B collector line trims the entire circuit functionally to achieve the 2-ppm/ $^{\circ}$ C drift. For example, the temperature drift of a standard Allen-Bradley 1/2-W resistor almost exactly compensates the residual-drift characteristics of the circuit from 0 to 50 C. Compensation results after slight changes in the charging current are delivered by the AD820-822 source to  $C_{3,4}$ .

The floating front end of the amplifier should be enclosed in a shielded metal box. If the circuit is exposed to moving air or sudden temperature transients, you can obtain optimum isothermal characteristics by putting the amplifier in epoxy resin.

Some typical applications of the isolation amplifier include interfacing a remote computer to an instrument—without grounding problems; building a 500-V floating power supply with 0.01% regulation; and using the isolation amplifier after a chopper-stabilized preamp to obtain a composite amplifier with 100-nV/ $^{\circ}$ C drift, a floating input and 0.01% absolute accuracy from 0 to 50 C. ■■

High-Frequency Transistor Reliability:

# Cool logic and cold facts

1. In high-frequency power switching, heat is a prime factor in transistor failure.
2. Turn-off time is the dominant cause of destructive temperature rise.
3. The faster the turn-off, the cooler the transistor, the greater the reliability.

Take a look at competitive transistors in an actual 20 KHz bridge converter circuit:

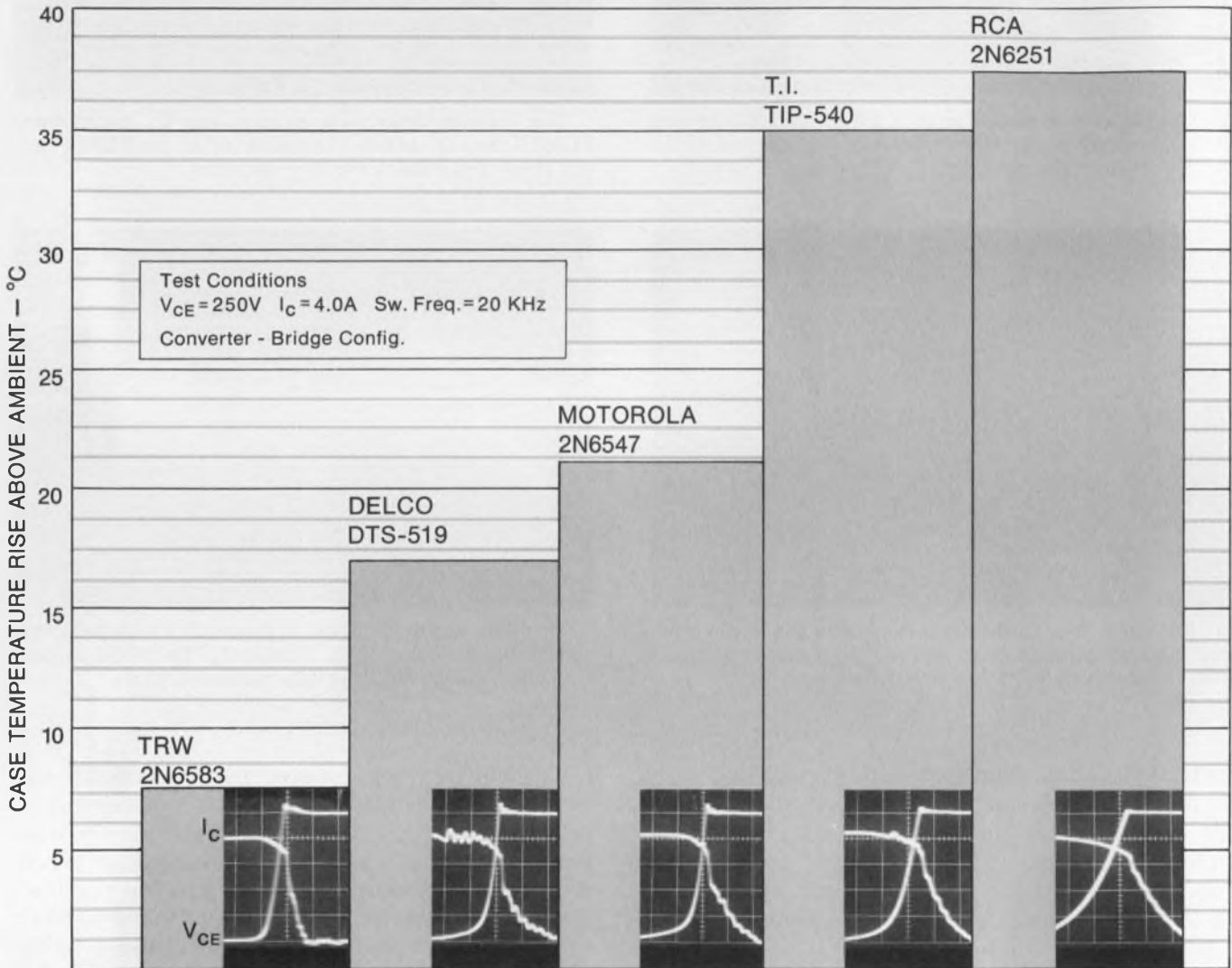

**TRW delivers the lowest operating temperatures and the greatest reliability in high-frequency off-line switching regulators.**

And that's no small thing. When you need superior performance at high frequencies, the best combination of switchtime and energy capability add up to greater efficiency and longer life. And what circuit are you about to design that doesn't deserve the best?

Particularly when TRW discretes are not only competitively priced, but are also immediately available in any quantity.

But get all the facts on TRW's high-frequency discrete transistors. Use the coupon or telephone John Power at (213) 679-4561.

**TRW Power Semiconductors**  
An Electronic Components Division of TRW, Inc.,  
14520 Aviation Boulevard, Lawndale, California 90260

Please send me data sheets on TRW's switching power transistors.

Have an applications engineer contact me. (Phone Number)

Name \_\_\_\_\_  
Company Name \_\_\_\_\_  
Position \_\_\_\_\_  
Address \_\_\_\_\_  
City \_\_\_\_\_ State \_\_\_\_\_ Zip \_\_\_\_\_

ED

## TRW POWER SEMICONDUCTORS

ANOTHER PRODUCT OF A COMPANY CALLED TRW  
CIRCLE NUMBER 48

# We'll flip you over your ceramic capacitor specs... **heads you win** **tails you win**

Heads are our standard line of MONO-KAPS™. Radial-leaded, epoxy-coated monolithic ceramic capacitors with noble-metal electrodes whose proven formulation has not been modified or compromised. They meet MIL requirements, and are available off-the-shelf in a broad range of capacitances and voltage ratings to meet your specific needs.

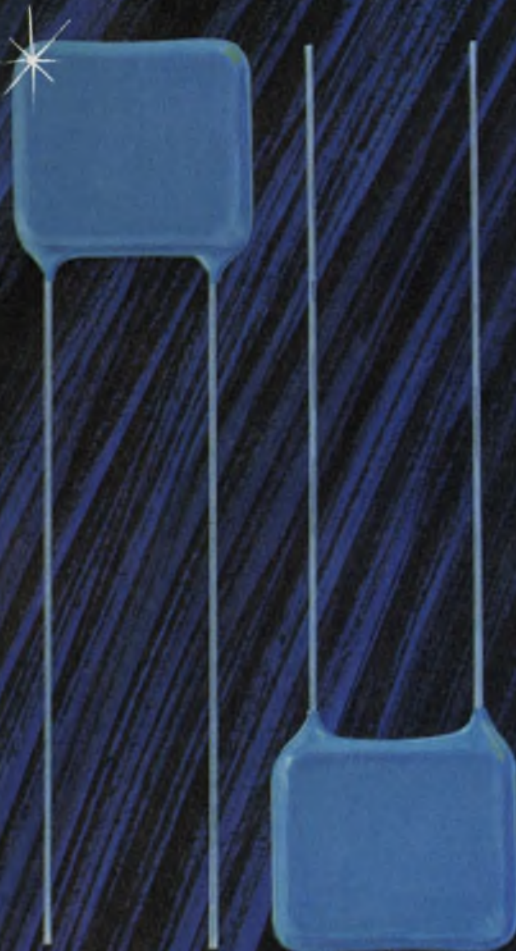

Tails are our BME-Radials™. They protect you from the noble metal cost spiral, and save you money right up front. They are the product of our unique BME capacitor technology which eliminates noble metal entirely from electrodes and terminations. But they'll meet most of the same circuit requirements with no sacrifice.

So you see, it's up to you — MONO-KAPS or BME-Radials. Both are immediately available in quantity from the only people who give you the choice. Either will do the job without compromise. Call or write for all the details today.



**CENTRALAB/USCC** 4561 Colorado Blvd. • Los Angeles, CA 90039 • (213) 240-4880

Electronics • GLOBE-UNION INC

SEE OUR COMPLETE CATALOG IN EEM: PAGES 317 TO 335, AND GOLD BOOK PAGES 103 TO 121; OR contact us directly.

CIRCLE NUMBER 49

# Measure phase noise

in one of three ways, each of which has some advantages. Quadrature phase detection, for one, lets you avoid dynamic-range limits.

Measuring phase-noise sidebands would be simple if frequency analyzers had dynamic ranges of 160 dB and 1-Hz bandwidths in the gigahertz region. All measurements could then be made around the fundamental frequency of the source. However, since equipment with this performance doesn't exist, you must use other techniques. Three good alternatives are rf-spectrum measurement, frequency discrimination and quadrature-phase detection.

The sidebands of a signal may represent both amplitude and phase modulation; asymmetry in the sidebands is an indication that both are present. However, in many cases, PM sidebands dominate. For example, if a reasonably clean synthesized signal is multiplied up, for use as a high-frequency reference, the phase-noise sidebands are also multiplied by the same factor—but the AM sidebands are either unchanged or limited.

In such a case, direct rf-spectrum measurements at the multiplied frequency are a good approximation of the phase-noise sidebands. The sidebands are usually corrected and normalized to the carrier to give the relative powers in the sideband phase fluctuations with respect to the carrier level. This ratio is termed  $\mathcal{L}(f)$ .

## Improving resolution

One way to achieve better resolution is to translate the signal down in frequency to the range of an analyzer with the desired i-f bandwidth. Fig. 1 shows a typical setup that uses a doubly balanced mixer and a low-pass filter. One of the advantages of this technique is that AM sidebands on the measured signal are stripped off.

Two potential problems must be considered. First, the difference frequency will contain sidebands that are folded up from below zero frequency. Whether the sidebands are significant or not depends on the nature of the source being measured. Second, phase-noise sidebands from

the reference will be translated down at the mixer. You can avoid this problem by using a source with better phase-noise specifications than the unit under test.

The only way to measure sidebands beyond the dynamic range of the analyzer is to eliminate the carrier frequency. You can do this with a frequency discriminator, as shown in Fig. 2. To ensure that the calibration factor is constant, you must check the linearity of the discriminator over the frequency range of interest. For microwave frequencies, the cavity discriminator is particularly useful.

Perhaps the most versatile setup is a doubly

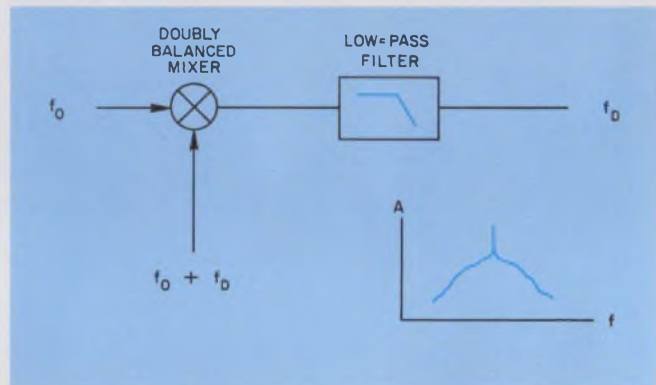

1. To improve resolution in a phase-noise measurement, a mixer and low-pass filter shift signal frequencies down.

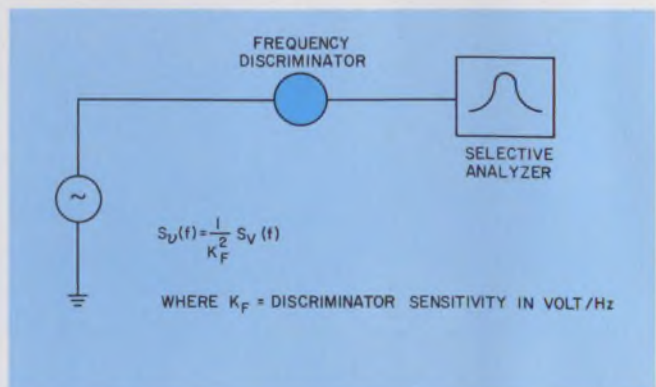

2. When sidebands are outside an analyzer's dynamic range, a frequency discriminator eliminates the carrier.

Chuck Reynolds, Product Engineer, Hewlett-Packard, Loveland, CO 80537.



balanced mixer with the unknown and the reference sources set in phase quadrature, 90°, at the input (Fig. 3). At quadrature, the difference frequency is zero hertz, and the average voltage output is zero. For phase fluctuations much less than one radian, the voltage fluctuations at the mixer output are related to the phase fluctuations by the following equation:

$$\phi = \frac{V}{K},$$

where  $K$  = calibration factor in volts/radian.

### The calibration process

The system is easily calibrated. Offset one of the sources and observe the resultant beat signal on an oscilloscope. The slope at the zero crossing in volts/radian is  $K$ , and for sinusoidal beat signals  $K$  equals the peak voltage of the signal.

The beat signal, as viewed on an analyzer, is the rms value, or 3 dB less than the peak. In terms of the ratio of the sideband voltage to the beat-signal voltage, the power-spectral density,  $S_\phi(f)$ , and the sideband power,  $\mathcal{L}(f)$ , are given by the following equations:

$$S_\phi(f) = V_s - V_B - 3 \text{ dB},$$

$$\mathcal{L}(f) = V_s - V_B - 6 \text{ dB}; \phi(f) \ll 1,$$

where  $V_s$  is the sideband voltage in dB corrected for bandwidth and analyzer characteristics, and  $V_B$  is the beat-signal rms level in dB.

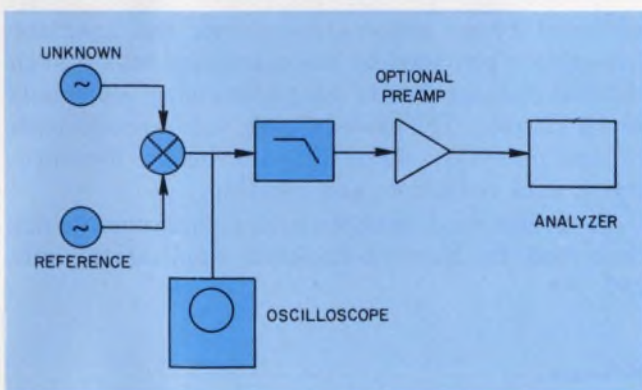

3. Phase detection at quadrature also eliminates the carrier. The mixer output is proportional to the noise.

The underlying assumption so far is that the reference source has a much lower phase noise than the unknown source. For state-of-the-art sources, you can compare two "identical" sources and assume that the phase noise of either one is 3 dB less than the measured values. Measuring various combinations of pairs of "identical" sources should test this assumption.

Often, sources don't remain stable long enough for a quadrature-phase relationship to be held during the measurement period. In this case, one of the sources must be adjusted periodically. A phase-locked loop can be used if either source—or both—has a voltage control with which to make small-frequency adjustments (Fig. 4).

To retain a constant relationship between phase and voltage fluctuations, the low-frequency cutoff of the phase-locked loop must be below the lowest frequency to be analyzed. If the breakpoint is moved out—by adding gain in the loop—the voltage fluctuations at frequencies below the breakpoint will represent frequency fluctuations. To calibrate with the phase-locked setup, disconnect the feedback voltage and observe the beat signal as before.

### Getting around frequency limits

In practice, phase-noise analysis often covers a frequency range greater than that of a single

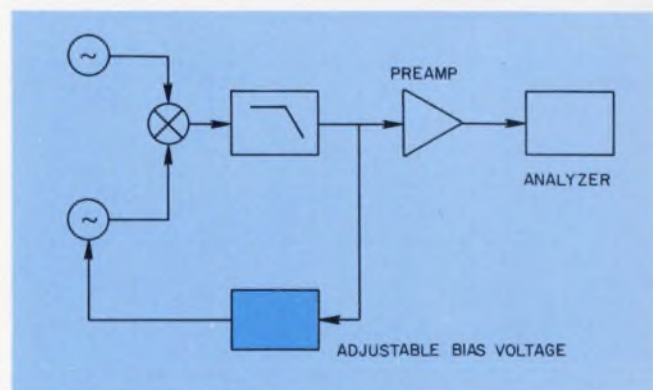

4. When source stability is a problem, a phase-locked loop permits automatic adjustment of either source.

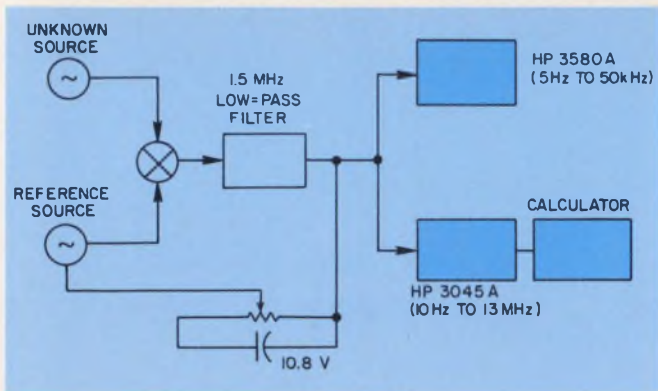

5. Two spectrum analyzers provide increased frequency coverage when phase noise spans a wide range. Adding a programmable calculator gives automatic measurements.

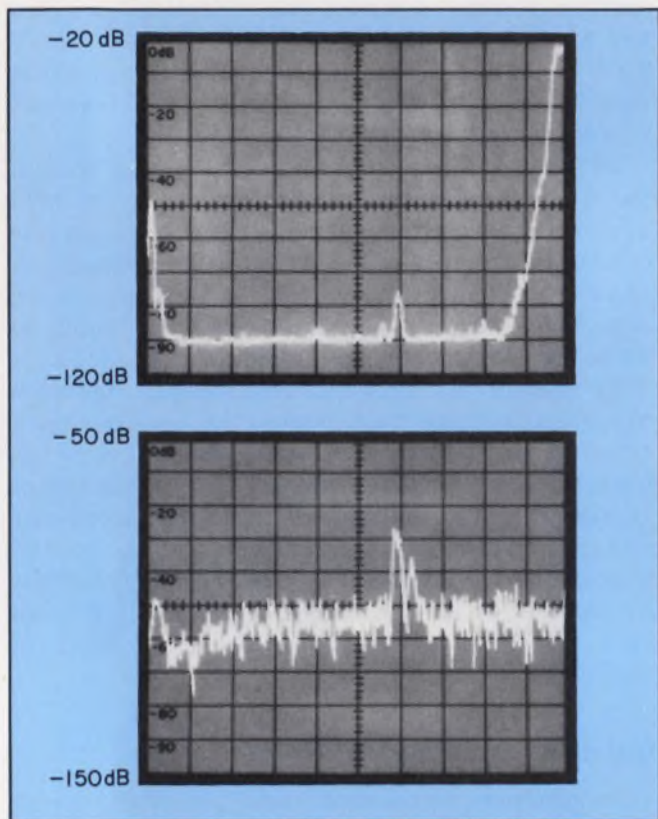

6. The beat signal (top) and the 0-to-100-Hz sidebands (bottom) produced by the setup in Fig. 5.

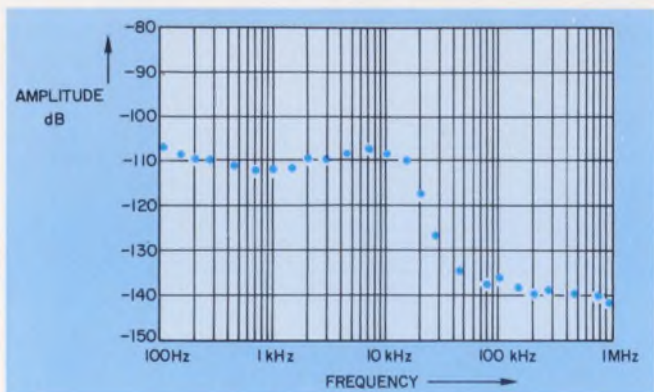

7. Automatically plotted phase-noise sidebands: Each point is the average of many readings.

selective analyzer: So two analyzers can be used. Two units covering the range of 5 Hz to 13 MHz, for example, can test a 10-MHz synthesized source. The setup is a phase-locked system as illustrated in Fig. 5. The 50-kHz analyzer shown, the HP 3580A, has a 1-Hz i-f bandwidth, which provides high resolution with minimal correction factors.

The two scope photographs in Fig. 6 show the beat signal referenced 0.5 dB below the top of the screen (+2.5 dB for correction, -3 dB for peak) and the resulting phase-noise sidebands from 0 to 100 Hz. Notice that the scale is different on the sideband photograph because the input sensitivity is increased after calibration. The discrete 60-Hz modulation signal clearly appears above the phase-noise sidebands.

### Making automatic measurements

To improve noise measurements, you can opt for an automatic system. For instance, an automatic spectrum analyzer with a calculator controller can cover the range from 100 Hz to 1 MHz. The programmable power of such a system allows the user to select points that avoid discrete signals and thus quickly determine a phase-noise-sideband envelope over a wide frequency range. The key to this capability is a programmable synthesizer combined with a tracking analyzer that features digital readout and output, rather than a built-in CRT.

The automatic analyzer's internal structure is similar to most spectrum analyzers. The programmable calculator, through software written by the operator, controls both analyzer and synthesizer over a bidirectional interface. And the calculator manipulates data received from the analyzer and plots the normalized, corrected results on an optional digital plotter.

Figure 7 shows the continuation of the phase-noise sidebands analyzed with the 3580A. Numerical averaging of many readings in software enables you to plot a single point at each frequency with a high degree of confidence.

In addition to the improved measurement achieved by an automatic system, the operator interaction provided by the calculator makes such difficult measurements as phase-noise sidebands much simpler. The system leads you through each of the necessary steps of calibration, measurement, data reduction, and plotting.

Programs used to make such measurements are described in Hewlett-Packard application note 207.<sup>1</sup> ■■

### Reference

1. "Understanding and Measuring Phase Noise in the Frequency Domain," Hewlett-Packard Application Note, 1501 Page Mill Rd., Palo Alto, CA

# AN IMPORTANT ANNOUNCEMENT FOR USERS OF RESISTORS:

## A NEW CONCEPT... including new lower prices... and stock delivery to boot.

Current design practice has been to overspecify resistors to allow for expected tolerance degradation in service.

Now, Vishay offers a new approach, with lower prices and short deliveries to bring Vishay S102 resistors within reach of designers whose end tolerance is  $\pm 1\%$ .

In the past, you had to compromise, buying some other resistor that had to start with  $\pm 0.05\%$  tolerance to assure you  $\pm 1\%$  at end of life.

**You needn't overspecify any longer.** Now, for just \$1.90, you can buy a standard  $\pm 0.5\%$  Vishay S102 resistor with the stability your designs demand, assuring a far better  $\pm 1\%$  end-of-life tolerance maintainability than is available anywhere else. And, in the bargain, you get improved system performance, reliability, and quality with the resistor you really want. It's a step-up which is now well worth taking. Specify your resistance values from the Mil-R-55182 standard value table, and get delivery from stock—ten days maximum.

**How come we can drop our price so drastically?**

Our production has always been

geared to turning out **special** orders to any crazy resistance value you might come up with. But now our computer tells us that most of you specify standard values from the E192 list of Table 4 on Mil-R-55182, and that our unique ability to create any resistance value to 7-digit accuracy is utilized by only a small percentage of our customers.

So what could be more natural than for us to build an inventory of our renowned S102 resistors in all the standard  $\pm 0.5\%$  resistance values of Mil-R-55182, and to pass our production savings on to you?

Our new \$1.90 price in 100-piece quantities (even lower in larger quantities) covers all the standard resistance values from 10 ohms to 49.9k. From 50.5k to 100k, the price is only pennies higher. So buy  $\pm 0.5\%$  Vishay resistors by this plan, and save all the headaches you may now be having with the temperature, frequency, stability, and noise characteristics of your present  $\pm 0.05\%$  resistors.

Of course, if you really need that special resistance value, or a tolerance down to  $\pm 0.001\%$ , remember we're still Vishay, the only resistor

manufacturer that can give you all six of the top performance specs.

**Purchased tolerance vs. design tolerance.**

Our new booklet on design tolerance clearly explains the differences between purchased tolerance and the actual performance of resistors after even a few hours' service. It may be an eye-opener for you. Ask for a copy.

Meanwhile, for full information on our new price plan and stocking facilities, **call us collect at (215) 644-1300.**

Vishay Resistive Systems Group, 63 Lincoln Highway, Malvern, PA 19355.



### Only Vishay resistors give you all six top performance specs.

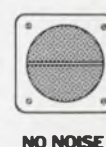
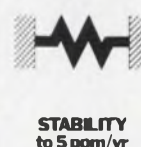
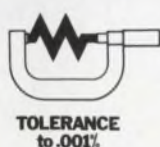
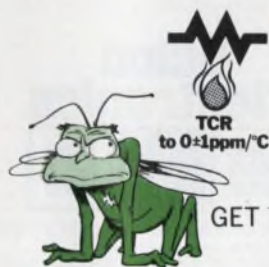

GET THAT BUG OUT OF YOUR EQUIPMENT.

# DELCO'S NEW 25-AMPERE HIGH VOLTAGE DARLINGTONS WITH THE SPEED AND ENERGY CAPABILITY YOU ASKED FOR.

Good news for motor speed control designers who have expressed a need to upgrade horsepower ratings. The 25-ampere gain of these new Darlington permits increased horsepower ratings of existing AC motor speed control systems and a reduction in paralleling in new designs. However, grouping of  $t_{off}$  is available for current sharing in designs with parallel Darlington. A speed-up diode is built into the DTS-4074 and DTS-4075 permitting data sheet  $t_f$  typicals of  $1.0\mu s$ . Drive circuit techniques involving  $1_{B2} \geq 2A$  and a Baker clamp produce  $t_f$  typicals in the  $0.4-0.6\mu s$  range for the DTS-4066, DTS-4067, DTS-4074, and DTS-4075.

Our experience with tolerances, faults, transients, and start-

stall conditions in most systems convinces us that these Darlington have the right trade-off between speed and peak power handling capability: Note the greater than  $10kVA$  region of the reverse bias safe operating graph. All this, and you still get Delco's traditional solid copper TO-3 hermetic package that has a conservative  $0.75^\circ C/W$  thermal resistance.

These Darlington are already in high volume production and are available on distributor shelves. For prices, applications literature and data sheets, visit your nearest Delco sales office or Delco distributor, or mail in the coupon on the right.



## MAJOR PARAMETER LIMITS

Type	$h_{FE}$ @ 25A	$h_{FE}$ @ 10A	$V_{CEO}$ (sus)	$V_{CE}$ (sat) @ 20A	$I_{CEO}$ @ 600V
DTS-4066	5	75	350V	3.5V	0.25mA
DTS-4067	10	150	350V	2.0V	0.25mA
DTS-4074	5	75	350V	3.5V	0.25mA
DTS-4075	10	150	350V	2.0V	0.25mA

## TYPICAL SWITCHING

	DTS-4066 DTS-4067	DTS-4074 DTS-4075
$t_r$	0.5 $\mu s$	0.5 $\mu s$
$t_s$	5.0 $\mu s$	3.2 $\mu s$
$t_f$	4.5 $\mu s$	1.0 $\mu s$

NPN triple diffused silicon Darlington are packaged in solid copper cases conforming to JEDEC TO-3 outline dimensions.

## SAFE OPERATING CURVES

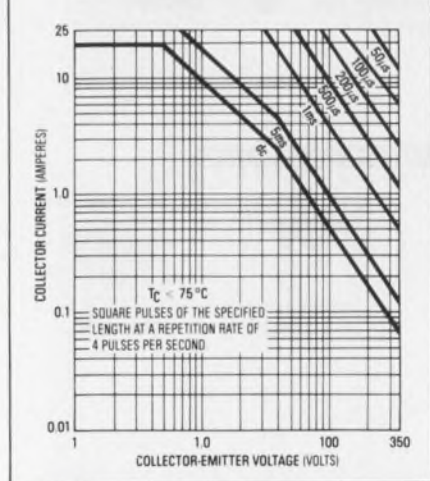

## CLAMPED INDUCTIVE SWITCHING PERFORMANCE

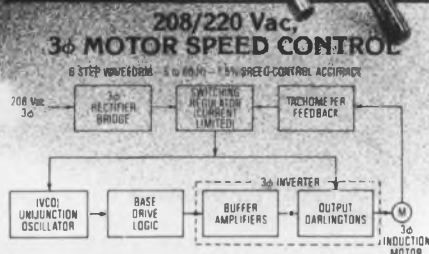
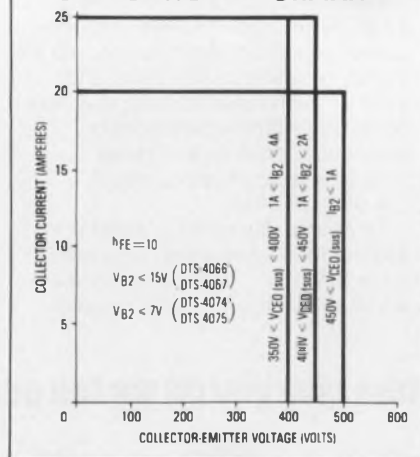

FOR MORE INFORMATION ABOUT DELCO'S NEW 25-AMPERE HIGH VOLTAGE DARLINGTONS, MAIL THIS COUPON TO:

Delco Electronics Division  
General Motors Corporation  
Marketing Services MS A-213  
700 E. Firmin Street  
Kokomo, Indiana 46901

NAME \_\_\_\_\_ TITLE \_\_\_\_\_

COMPANY \_\_\_\_\_

ADDRESS \_\_\_\_\_

CITY \_\_\_\_\_ STATE \_\_\_\_\_ ZIP \_\_\_\_\_

PHONE \_\_\_\_\_

**Delco  
Electronics**



DELCO ELECTRONICS SALES OFFICES

Kokomo, Indiana (317) 459-2175  
Charlotte, North Carolina (704) 527-4444  
Van Nuys, California (213) 988-7550



# An automatic RLC tester for \$ 995? you've got to be kidding!

There's more to the new GR 1657 RLC DigiBridge™ than its low \$995\* price. It's designed with features to lower your R, L, and C component testing cost. That's what it's all about — isn't it?

**Measures R, L, C, D and Q.**

A **microprocessor** performs a combination of measurement and control functions in addition to lowering the GR 1657 unit cost.

**Fast testing time** of three measurements per second, unqualified.

**0.2% Accuracy** for R, L, and C.

**Five full-digit LED display** for R, L and C and four full digits are displayed for D and Q. All numbers go to 9.

**Wide measurement ranges** allow you to test a greater number of component values. Test R from 00.001  $\Omega$  to 99.999 M $\Omega$ , L from 0.0001 mH to 9999.9 H, C from 0.0001 nF to 99999.  $\mu$ F, D from .0001 to 9.999, and Q from 00.01 to 999.9.

**Microprocessor-directed ranging** takes the guesswork out of setting the correct range. Lighted arrows on the front panel indicate which range

button is to be depressed and the correct range is identified automatically.

**Three range positions** provide measurements in multiples of 100, since each range has two full decades of measurement capability, a feature made possible by automatic decimal point positioning.

**Automatic decimal point positioning** causes the measurement to be made on the lowest possible range, so maximum resolution is always achieved.

**Selectable test frequencies** of 1 kHz or 120 Hz (100 Hz) are switched by the operator.

**Selectable series or parallel measurement modes** are operator specified across the full measurement range of every test parameter.

**Hi-Rel Kelvin test fixture** accommodates axial and radial lead components.

Now you know there's more to the GR 1657 RLC DigiBridge than its low price. We're not kidding!

*\*U.S.A. domestic price only.*

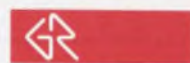

## GenRad

## Measure SAW-device characteristics, and pin down the performance of acoustic-wave filters and delay lines. Frequency response and impedance are the key parameters.

If you're working with surface-acoustic-wave (SAW) devices, you'll have to make frequency-domain measurements to determine the device impedance, amplitude and phase characteristics. One way you can find a SAW transducer's impedance requires three steps:

- Measure the interelectrode capacitance,  $C_T$ , with a special probe station and a sensitive capacitance meter.
- Determine the electrode resistance,  $R_e$ , by a  $Q$  measurement with the same equipment.
- Measure the radiation resistance,  $R_r$ , with a vector impedance meter or a network analyzer.

Device amplitude and phase characteristics can be measured most efficiently with a network analyzer. If extraneous signals are troublesome, use a gating technique to take care of them. Note that a network analyzer can measure the time delay of both dispersive and nondispersive devices.

The bandwidth and dynamic range of the test system are particularly important to your measurements. In swept frequency-domain measurements, the sweep rate must be kept well below the bandwidth of the system under test so that you don't lose valuable amplitude and phase information.

Since a SAW device is relatively lossy, you need high-gain amplifiers to provide adequate signal levels at both the input and output ports. The preamplifier should provide at least +20 dBm of

---

Phil Snow, Design Engineer, Tektronix Inc., P.O. Box 500, Beaverton, OR 97005.

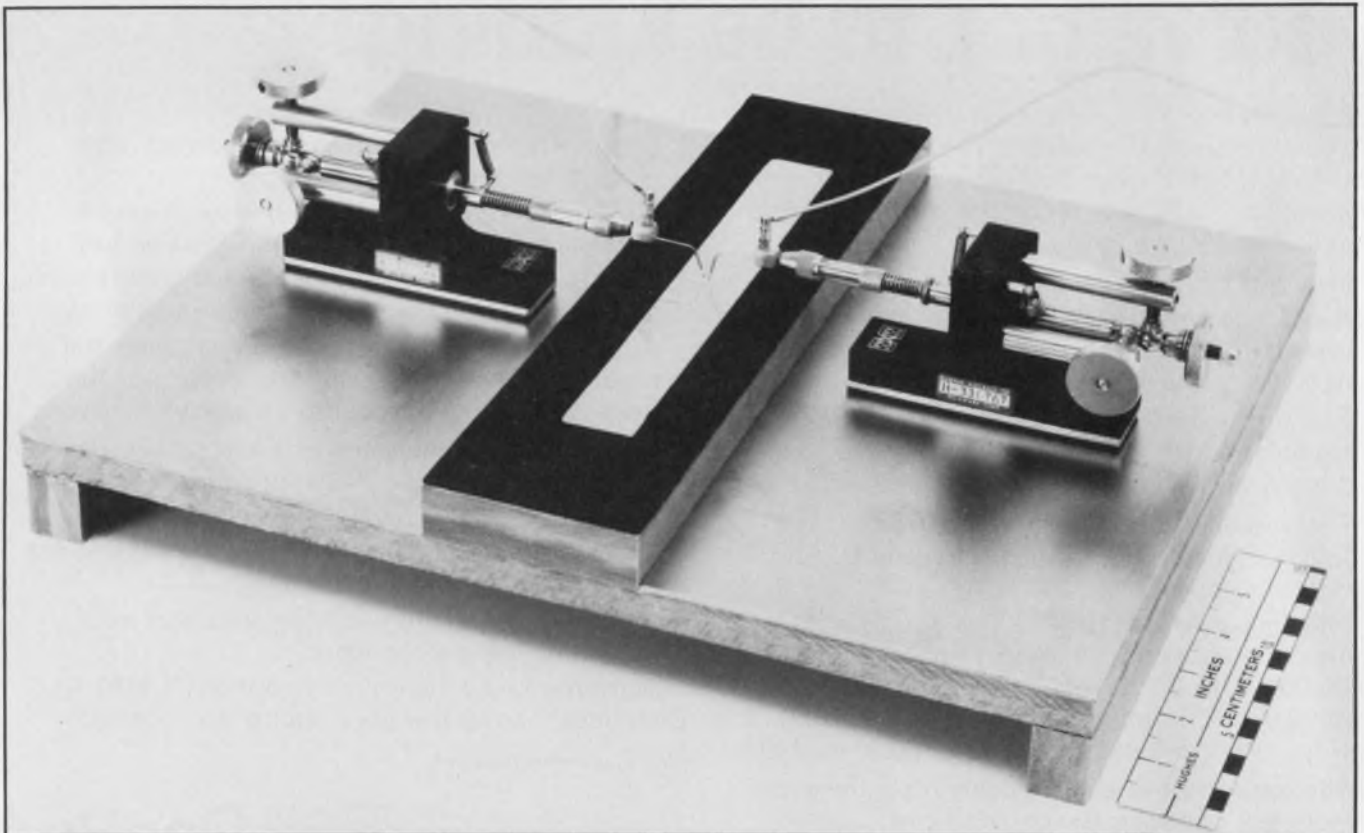

1. When measuring device parameters, a probing station makes contact with the electrode pads of an acoustic-

wave device without introducing extraneous capacitance. (Courtesy of Hughes Aircraft.)

output, and the output amplifier a relatively low-noise signal (less than 10 dB). Moreover, the amplifiers' bandwidth should be wide enough to avoid adding distortion to the amplitude and phase-response measurements.

### The dos and don'ts of measuring impedance

Knowing the SAW device's input and output impedance is important when you want to match the device to other components or design an appropriate test-equipment interface. The impedances are a function of the physical geometry of the transducers at the device input and output. The transducers, patterns of interleaved (interdigital) electrodes, translate electromagnetic signals, or vice versa.

To measure  $C_T$  without introducing stray or parasitic capacitance, you must set up a special probe station (Fig. 1). The probes should have rounded tips to prevent the transducer metal from being scratched and to make good contact with the transducer's electrode pads (called sum bars). The capacitance meter should be capable of measuring at frequencies of about 1 kHz to 1 MHz.

The frequency is kept low so that radiation reactance—which becomes a factor at frequencies within the device passband—will not be included inadvertently in the measurement. An accurate, sensitive capacitance meter is required for this measurement (for example, the Tektronix 130 L/C meter, which measures capacity from a fraction of a picofarad to 300 pF).

If the capacitance meter can also measure  $Q$ , you can determine electrode resistance  $R_e$  at the same time. Keep the measurement frequency low enough and well outside the passband of the transducer, and  $R_e$  will be the only resistance associated with the  $Q$  measurement.

Because the metal thickness of most interdigital transducers is much less than one skin depth—even at frequencies in excess of several gigahertz (thickness typically ranges from about 500 Å to 5000 Å)— $R_e$  is essentially constant for all practical frequencies of operation. Thus, you can assume that  $R_e$  equals its dc value.

### Reactance can mask results

Since the series-radiation resistance,  $R_{s,r}$ , varies with frequency, you should measure  $R_e$  over the device passband. Obtaining an accurate, direct reading with an impedance meter is difficult because the resistance tends to be masked by the relatively large circuit reactance. Even a Smith-chart plot from a direct, swept network analyzer is unsatisfactory because of the generally high reactance-to-resistance ratio.

*(continued on page 114)*

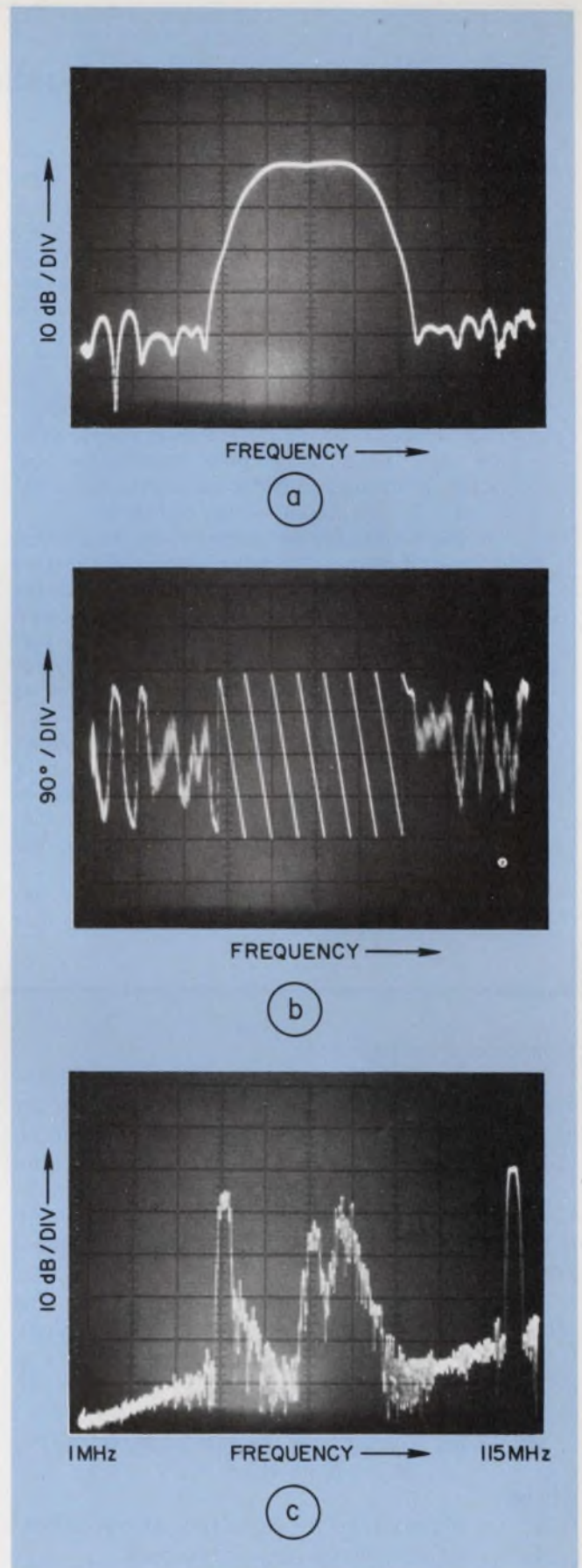

2. With a network analyzer, you can produce a SAW device's frequency-response characteristics, both amplitude (a) and phase (b). Both the fundamental and third-harmonic operation are shown in c.

## Revisiting the surface-acoustic-wave device

Surface-acoustic-wave (SAW) devices consist of piezoelectric crystal substrates, with metalized interdigital transducers applied to a highly polished surface (see figure). A SAW's physical size is largely a function of the frequency of operation, bandwidth or delay requirements. (See ED No. 16, August 2, 1975, p. 74 and ED No. 16, August 2, 1973, p. 35.)

The device is gaining in popularity in circuits like bandpass filters, delay lines and compression filters because of its high reproducibility—inherent through relatively simple thin-film and photolithographic techniques. On quartz or lithium niobate, an approximate delay of 1  $\mu$ s per 3 mm can be achieved.

In the figure, electromagnetic energy applied to the injection transducer is transformed to acoustic energy. The acoustic signal propagates primarily along the surface of the crystal and is transformed back to an electromagnetic signal at the detection transducer. An electromagnetic wave travels about 100,000 times as fast as an acoustic wave.

Since the conventional interdigital transducer radiates acoustic energy equally well in either direction along the axis of propagation, end absorbers are required to suppress acoustic signals that don't travel directly from the input to output transducer.

The frequency of operation of a SAW device is a function of the electrode spacing, and

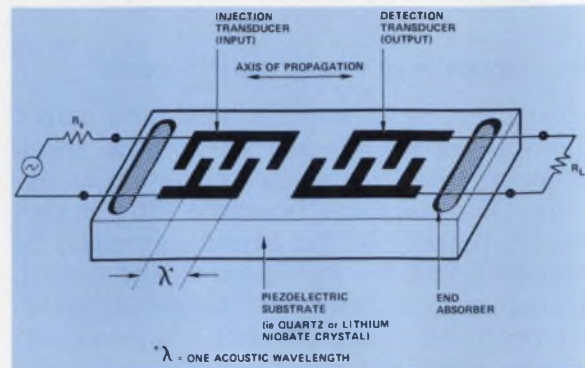

the bandwidth is inversely related to the overall length of the transducers. The acoustic nature of the crystal and the ease of amplitude and time weighting of the transducers make the SAW device suitable for delay lines and filter applications.

Which electrical tests to perform on a SAW device depends to some extent on the device function, that is, whether it is a bandpass-filter or dispersive-delay line. Also, a device mass-produced for the television industry naturally will be tested differently from a state-of-the-art component undergoing evaluation in a research laboratory. In any case, since surface-wave devices can be specified in the time as well as the frequency domain, testing in both domains is necessary.

(continued from page 113)

To circumvent the masking, eliminate reactance  $X_C$  from the measurement by connecting an appropriate variable series inductor from one of the transducer's sum bars to ground. This connection will minimize undesirable shunt capacitance effects that can invalidate the measurement if the inductor is inserted in series with the non-grounded sum bar.

The inductor is resonated with  $C_T$  and the series resistance measured at each measurement frequency. Either a vector-impedance meter or a network analyzer can indicate the series resistance at resonance.

The series resistance is the sum of three parts:

$$R_{in} = R_a + R_e + R_i, \quad (1)$$

where

$R_{in}$  = measured series resistance at resonance,

$R_e$  = series electrode resistance, and

$R_i = L_T/Q_i =$  series inductor resistance (where  $Q_i$  is the  $Q$  of the inductor  $L_T$  at the resonant frequency).

Since you have measured  $R_e$  already and since

you can determine  $R_i$  simply by measuring  $L_T$  and  $Q_i$ , you can calculate the series radiation resistance from Eq. 1.

### Impedance points to problems

Transducer resistance and capacitance can also indicate the quality of device fabrication. Opens in the transducer metallization show up as a  $C_T$  less than the design value. One or more shorted electrodes result in zero capacitance. Compare the measured value of  $R_e$  with either a calculated value (obtained from knowledge of the physical design) or an averaged  $R_e$  determined from a number of devices having the same pattern and metallization. Wide variations in  $R_e$  indicate irregularities in electrode width or metal thickness.

A typical bandpass-filter frequency response, produced by an HP 8410A network analyzer, is shown in Fig. 2a. The filter's 1-dB bandwidth is 2.5 MHz, centered at 110 MHz. The phase response of the same filter is shown in Fig. 2b. You can take a closer look at the phase response with-



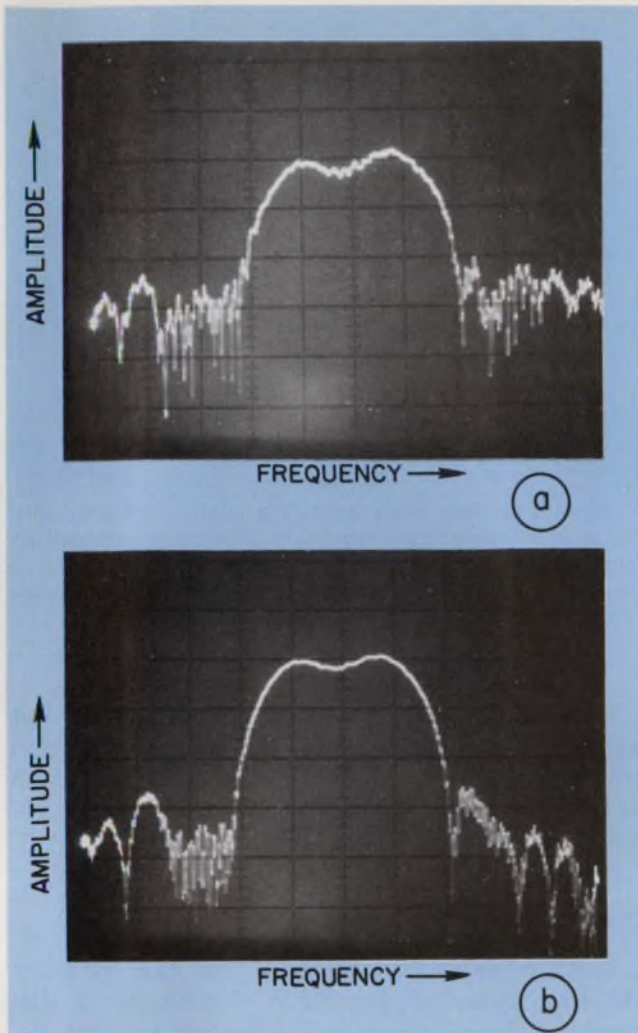

3. Spurious signals can mask true SAW-device swept response (a). You can clean up the response with a sampling technique (b).

in the filter passband by narrowing the analyzer's swept-frequency band to expand each two-pi segment of the phase-response waveform.

Since the bandpass filter of Fig. 2 has double (split) electrodes, it operates with equal efficiency at the third harmonic (110 MHz) and the fundamental (Fig. 2c). The hash near the fundamental stems from electromagnetic feedthrough of the signal, and the extraneous response at twice the fundamental can be traced to bulk-acoustic waves. Note that the filter is not connected to matching networks; only two broadband baluns suppress electromagnetic feedthrough. With matching networks, both the fundamental and bulk-wave interference are considerably reduced.

#### Avoiding interference problems

The true amplitude-response characteristics of a SAW device can be masked by high spurious signal levels. Typical interference phenomena include triple-transit echo, crystal-end reflections,

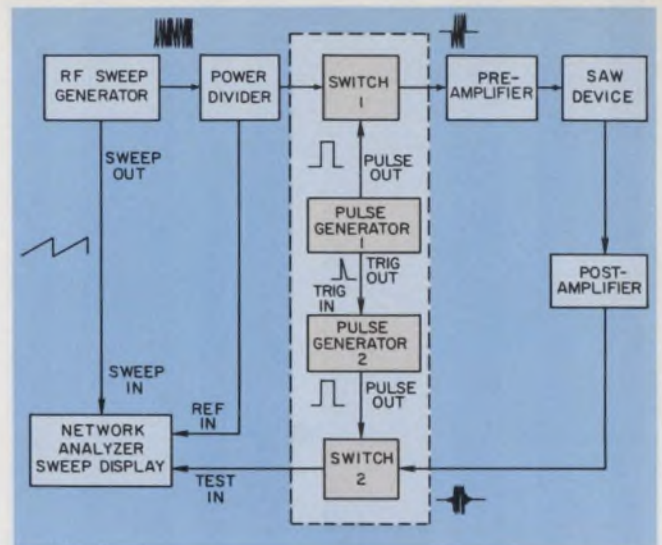

4. Test set-up selectively gates and samples the SAW-device input and output to minimize interference. Pulse generator No. 2 closes the sampling switch only when a signal is present at the device output.

bulk waves and electromagnetic feedthrough (Fig. 3a). Observe the ripple in the passband and the general filling-in of the side-lobe structure, which characterizes bulk-wave and electromagnetic-feedthrough interference.

With sampling techniques, you can sort out and eliminate interference signals from the measurement. The cleaner frequency response in Fig. 3b is the result of selective gating and sampling (Fig. 4).

The action of the test setup in Fig. 4 is as follows: Pulse generator No. 1 gates switch No. 1 to pass an rf "burst" from the sweep generator. The burst is amplified and fed to the SAW device. The pulse width is set approximately equal to the reciprocal of the device's acoustic bandwidth. This setting provides maximum amplitude for minimum pulse width.

Pulse generator No. 2 is triggered by pulse generator No. 1 to produce a delayed pulse. The delay interval is adjusted to equal the minimum time spacing between the input and output transducers of the SAW device. The delayed pulse then gates switch No. 2, which passes a signal to the network analyzer only during the brief period that the desired rf pulse is present at the output of the SAW device.

To obtain enough samples to reproduce an accurate amplitude response, the pulse-repetition rate—set by generator No. 1—should be much greater than the sweep rate of the rf sweep generator. The upper limit of the repetition rate is set by the maximum time spacing between input and output transducers. Actual pulse rate is best determined empirically, within the limits just defined, for each type of device tested.

(continued on page 116)

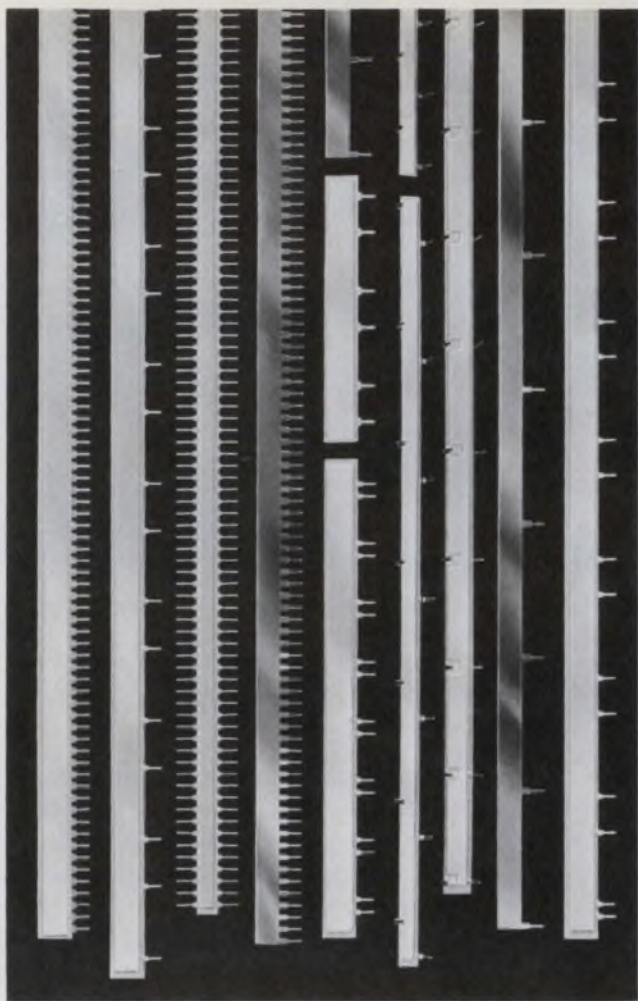

# MINI/BUS<sup>®</sup> Printed Circuit Board Bus Bars STANDARDS IN STOCK

Low-cost, noise-reducing voltage distribution comes in a wide variety of ready-to-ship designs.

Call or write Product Specialist for a listing of Rogers' Mini/Bus standards.

Prototype kits also available from stock — \$25.00

## ROGERS

**ROGERS CORPORATION**

Chandler, AZ 85224 (602) 963-4584

EUROPE: Mektron NV, Gent, Belgium. JAPAN: Nippon Mektron, Tokyo

CIRCLE NUMBER 53

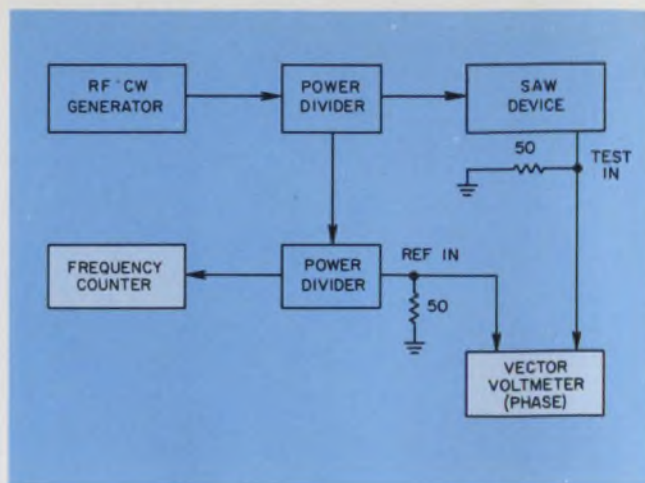

5. When a network analyzer isn't available, a vector voltmeter and counter can substitute. The counter monitors frequency changes, and the voltmeter reads changes in the phase angle. A formula then calculates the device time delay.

When phase information is not important, but amplitude dynamic range is, a combination tracking generator and spectrum analyzer (such as the Tektronix TR 502/7L13) can readily replace the rf sweep generator/network analyzer.

### Other test configurations

With a network analyzer, you can measure the time delay of any SAW device, be it dispersive or nondispersive. To determine time delay  $t_d$  at a frequency, measure the slope of the phase-vs-frequency response. A small increment ( $\Delta\phi/\Delta f$ ) near the frequency in question is sufficient. Delay is then found from the following formula:

$$t_d \text{ (in sec)} = \frac{1}{360} \times \frac{\Delta\phi \text{ (in degrees)}}{\Delta f \text{ (in hertz)}} \quad (2)$$

By definition, the time delay of a nondispersive SAW device is a constant for all frequencies in the passband. Thus a linear phase response indicates that the device under test is nondispersive.

The next best method is offered by the test setup shown in Fig. 5. A vector (phase) voltmeter measures the phase-angle change for a given frequency change. In the figure, frequency changes are monitored by the counter, and you calculate the time delay from Eq. 2.

Although highly accurate, the frequency-change method can be rather tedious, especially if the bandwidth is large or the time delay long. You'll need much time to determine the delay across the entire passband of a surface-wave device. ■■

*A subsequent article will cover time-domain measurements of SAW devices.*



# subminiature EMI filters excel in IR@125°C

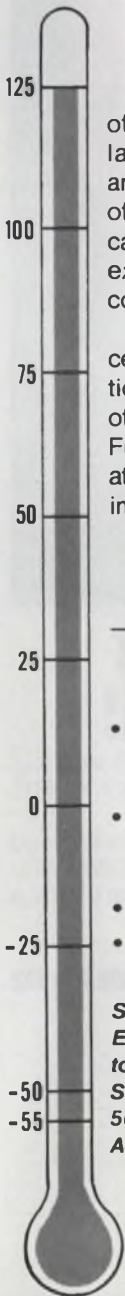

Astute users and specifiers of EMI Filters know that insulation resistance at high ambient temperatures is one of the most significant indicators of the quality and life expectancy of this type of component.

By utilizing Monolythic<sup>®</sup> ceramic layer-built construction in the capacitor elements of Sprague Subminiature EMI Filters, insulation resistance at 125°C is substantially improved.

Industry Standard (at 125°C)	Sprague Standard (at 125°C)
5-50 megohms	50-500 megohms

- **JX2000 SERIES**  
Up to 15 amperes and 200 VDC @ 125°C
- **JX3000 SERIES**  
Up to 15 amperes @ 125 VAC/400 Hz/125°C
- **M15733/23 QUALIFIED**
- **M15733/26 QUALIFIED**

For complete information on Sprague EMI Filters, write for Engineering Bulletin Series 8132 to: Technical Literature Service, Sprague Electric Company, 509 Marshall Street, North Adams, Mass. 01247.

4SF 6141

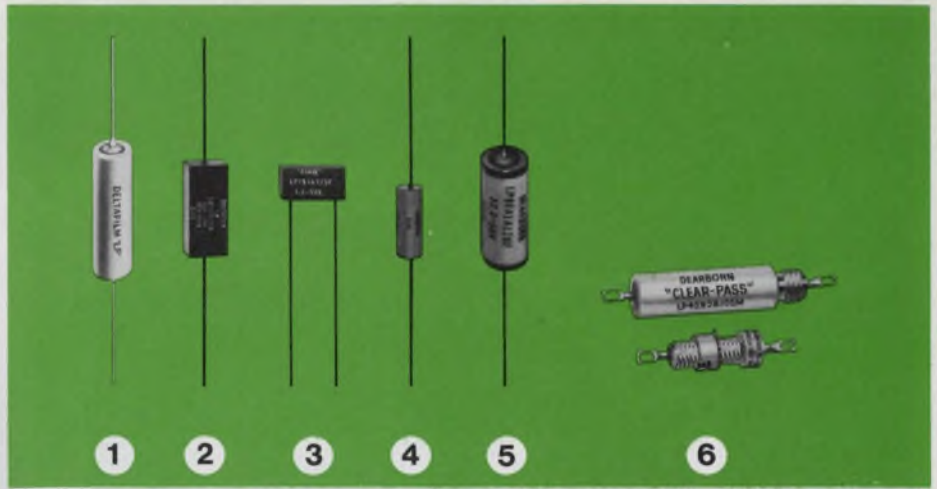

## The Dearborn family of metallized polycarbonate film capacitors gives you excellent capacitance stability, low temperature coefficient, high insulation resistance...plus a choice of construction and styles.

1. **STYLES LP8, LP9** Hermetically-sealed metal-case tubular capacitors • LP8, bare case. LP9, insulating sleeve • Capacitance values from .01 to 100.0  $\mu$ F, voltage range from 50 to 400 WVDC • Also available as Styles CHR01 and CHR10 to MIL-C-39022.
2. **STYLE LP7A** Epoxy-case rectangular capacitors with axial leads • Capacitance values from .01 to 6.8  $\mu$ F, voltage range from 50 to 400 WVDC.
3. **STYLE LP7S** Epoxy-case rectangular capacitors with radial leads • Capacitance values from .01 to 18.0  $\mu$ F, voltage range from 50 to 400 WVDC.
4. **STYLE LP66** Wrap-and-fill miniature tubular capacitors • Capacitance values from .01 to 56.0  $\mu$ F, voltage range from 50 to 400 WVDC.
5. **STYLE LP88 FUZ-ION\* SEALED** tubular capacitors . . . epoxy end-seals fused to heat shrinkable plastic case • Capacitance values from .01 to 50.0  $\mu$ F, voltage range from 50 to 200 WVDC.
6. **STYLES LP42, LP44 CLEAR-PASS<sup>®</sup>** feed-thru metal case capacitors for radio interference reduction • LP42, threaded neck . . . 10 and 15 amps. LP44, threaded case . . . 10 amps • Capacitance values from .01 to 27.0  $\mu$ F, voltage range from 50 to 400 WVDC.

\*Trademark

Write for Engineering Bulletins on the Styles that meet your needs.

SPRAGUE ELECTRIC COMPANY  
*Dearborn* electronics division LONGWOOD, FLA.



SALES OFFICES: 479 MARSHALL STREET, NORTH ADAMS, MASS. 01247

# TYPICAL "SWAP" ADVANTAGES

Up to 100  
SSI's and MSI's



Savings to the customer of 50% or more in IC direct material costs

Significant reduction in IC's required per system... one SWAP circuit replaces 5 to 100 standard devices

Reduced manufacturing costs per customer system... fewer IC insertions... simplified system check-out and repair

Small physical size

into

one SWAP chip

Less expensive PC boards and hardware

Improved reliability

Smaller and less expensive system power supplies

Reduced inventory control, procurement activity, and simplified documentation

Fully compatible with DTL, TTL, and CMOS IC's and discrete transistors

for maximum cost savings!

## SWAP.. Custom-Designed Logic Systems Now Available at Mass Production Prices!

Wouldn't you like your own custom LSI chip that can consolidate up to 50 or 100 of the standard SSI's and MSI's you are using into one circuit? Well, now it's yours with "SWAP" - Stewart-Warner Array Programming - and it will save you lots of money, too!

SWAP is a major *price breakthrough* in custom logic circuits. Forget about the usual custom-chip penalties, the large tooling costs, the huge entry fees, and the gigantic production order requirements. For as low as \$1800 you can have delivery of your first custom I<sup>2</sup>L SWAP prototypes in

just 4 weeks, and you will also cut your gate prices by as much as 50% on production orders.

SWAP is ready if you are. Send the coupon now for your SWAP Design Kit (or the "bingo card" for a brochure).

The SWAP Design Kit consists of:

1. the SWAP Design Manual (complete with vellum work sheets);
2. fifteen (15) sample devices illustrating some of the functional blocks that can be used in a SWAP design.

Okay, here's my \$25.00 (or P.O. No. \_\_\_\_\_) Rush me your I<sup>2</sup>L SWAP Design Kit.

I need more information, Please have a representative call me.

Tell me about your standard DTL, TTL, and CMOS circuits. (We have products now.)



STEWART-WARNER MICROCIRCUITS DIVISION  
**STEWART-WARNER CORPORATION**  
730 E. Evelyn Ave. • Sunnyvale Ca 94086 • (408) 245-9200

Name \_\_\_\_\_

Company \_\_\_\_\_

Phone \_\_\_\_\_

Address \_\_\_\_\_

City \_\_\_\_\_ State \_\_\_\_\_ Zip \_\_\_\_\_

CIRCLE NUMBER 55

# SORENSEN IS THE SOURCE:

## FOR THE LARGEST SELECTION OF HIGH-POWER, HIGH-EFFICIENCY POWER SUPPLIES.



The Sorensen DCR series for component burn-in, aging racks, test equipment, and general laboratory use.

- 12 package sizes in 8 voltage ranges, from 0-10 to 0-600V
- 60 current levels from 0.75 to 1000 amps
- Remote voltage, current, or resistance programming
- Constant current operation with automatic crossover
- No overshoot with turn-on, turn-off, or power failure
- Stocked for immediate delivery
- 5-year warranty, backed by a worldwide service organization

Call us and we'll give you the details: (603) 668-4500.  
Sorensen, a Raytheon Company, 676 Island Pond Road,  
Manchester, N.H. 03103.

**SORENSEN**  
POWER SUPPLIES

A Raytheon Company

CIRCLE NUMBER 176

# It pays to look into Metal Glaze™ from all angles.

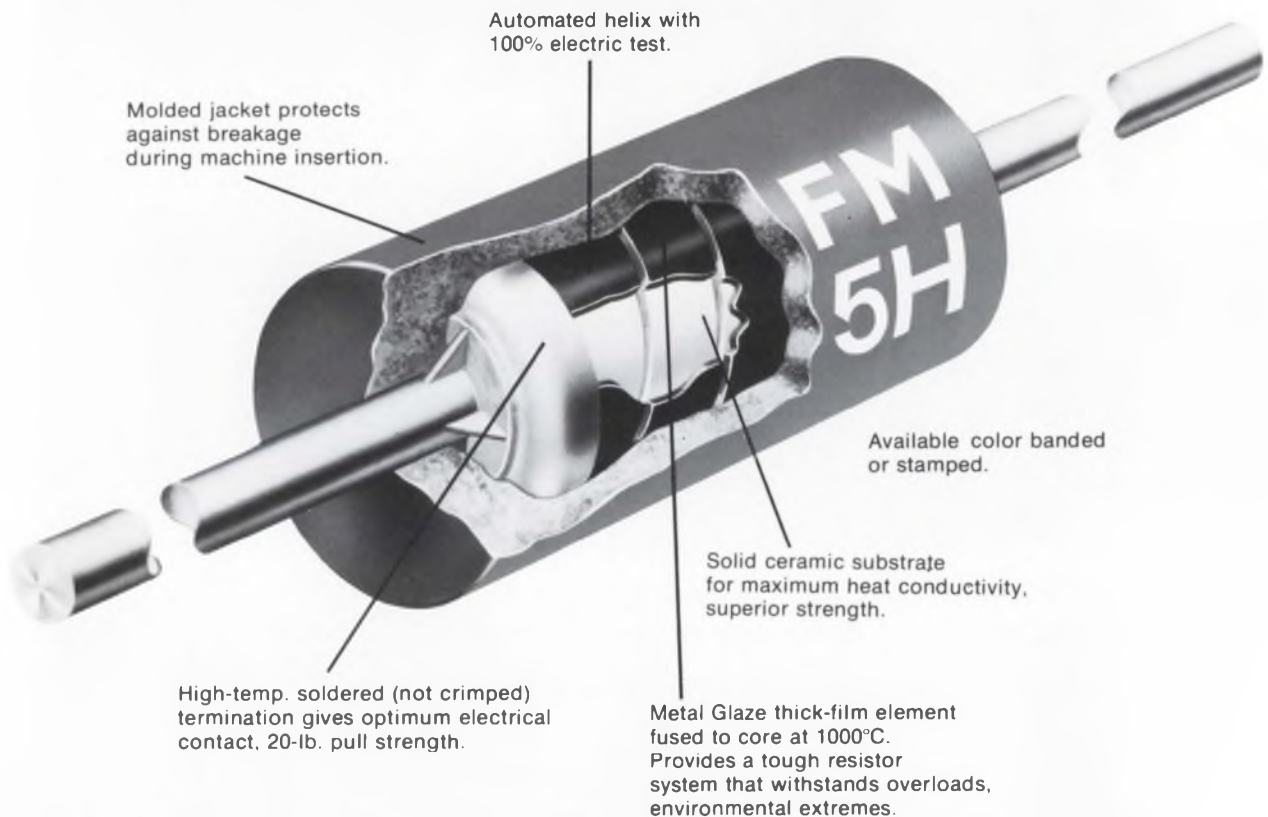

\*\*\*Metal Glaze is TRW trademark for its thick-film resistors.

We have designs on you. Especially if you're designing any type of low-power circuitry and need resistors with excellent load life stability and cost effectiveness.

TRW/IRC Metal Glaze resistors can take the heat. For instance, their thermal characteristics are outstanding, resulting in lower operating temperatures, greater reliability.

Another advantage, you can often double-rate our Metal Glaze resistors so you can use smaller resistors, saving board space.

The ability and toughness of Metal Glaze to withstand heat with minimum drift has been proven billions of times in all types of electronic equipment, worldwide. And they're available in ratings  $\leq 3$  watts,  $\geq 1\%$  tolerance, with ranges as low as 1 ohm.

For complete resistor choice including Metal Glaze, carbon comp., thin-film, wirewound and networks, contact your local TRW authorized distributor or sales representative. Or TRW/IRC Resistors, an Electronic Components Division of TRW, Inc., 410 N. Broad St., Philadelphia, Pa. 19108, (215) 922-8900.

**RG PULSE OR SURGE POWER RATING:  
MAXIMUM APPLIED POWER/PULSE ON TIME**

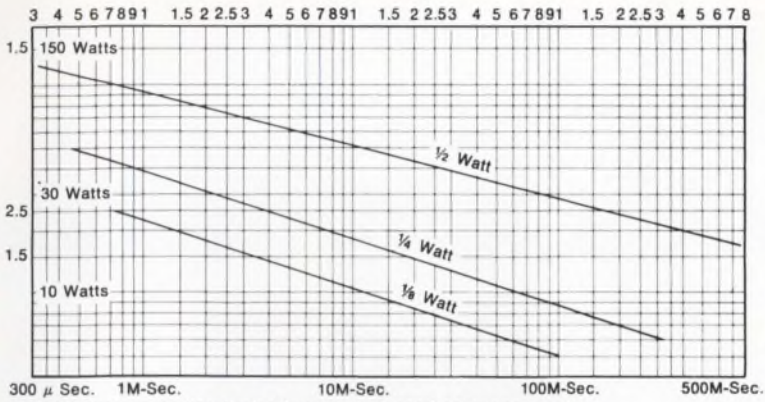

**Overload Protection**

Rugged Metal Glaze construction provides excellent power surge capability. A 1/4w unit will conservatively operate within specifications when exposed to 18w, 10msec pulses, provided average power, and max voltage ratings are not exceeded. Ask us about your applications, including those requiring steady state conditions exceeding mil rated power.

**TYPICAL TO-55 DESIGN TOLERANCE**

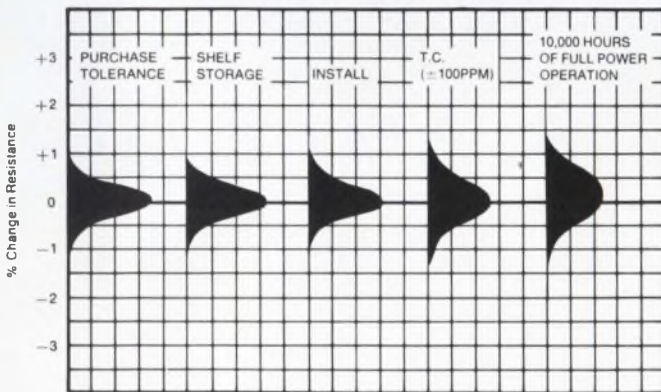

**Minimum Design Tolerance**

(Design tolerance = a statistical summation of various parameters including load life, TCR, installation, and moisture resistance) All the features of Metal Glaze Resistors result in tight, predictable design tolerances which can be as low as ±1.5%, depending upon your application.

**TYPICAL DISTRIBUTION OF TEMPERATURE COEFFICIENT OF RESISTANCE**

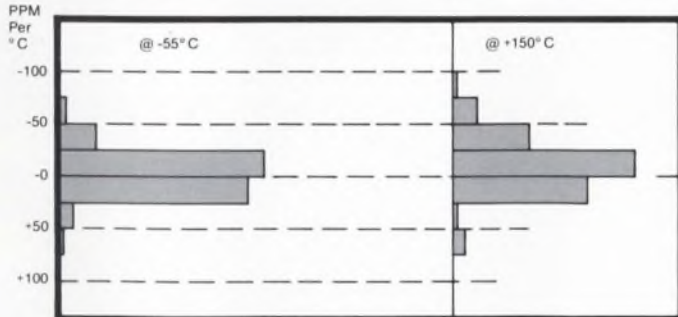

**Absolute, Linear TCR**

T.C.'s of 50, 100, or 200ppm are specified across the entire resistance range from 1Ω to 1MΩ. Our TC characteristic is essentially linear with temperature, and is a normal distribution centered near zero.

**AVERAGE RESISTOR TEMPERATURE RISE VS. APPLIED POWER**

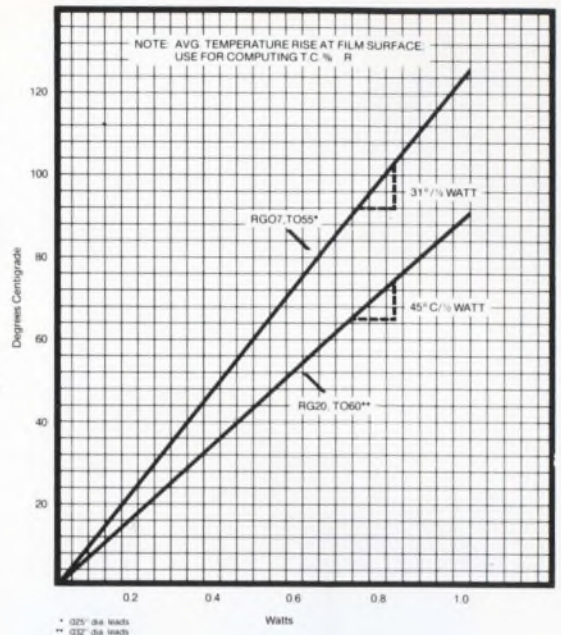

**High Thermal Conductivity**

A solid alumina substrate and other design features efficiently transfer heat from the resistor element. As an example, a 1/4w unit at full load has a hot spot temp rise of only 30°C, half the rise experienced in some other types. Cooler operation means stability and reliability are optimized.



**Capless Terminations**

All Metal Glaze resistors have our exclusive high temperature soldered terminations. This capless construction means excellent pull strength and prevents substrate damage during assembly. With the additional protection of a molded jacket, 1/4w Metal Glaze resistors withstand a 20lb pull test.

**TRW IRC RESISTORS**  
ANOTHER PRODUCT OF A COMPANY CALLED TRW  
CIRCLE NUMBER 172

# The finishing touch... Rogan knobs and dials.



Prospective customers will evaluate your product carefully . . . from the outside in. Finish-off your new design with the best looking knobs and dials that are on the market . . . Rogan's.

The sizes, the shapes, the colors, and the general styling of these components should be carefully considered. Match the knob to the job, but do it in a way that will complement the overall appearance of the unit. Larger-size knobs or bar-type shapes for heavy-detent switches. Smaller-size knobs and the more graceful shapes for low-torque potentiometers.

Colors . . . we offer 16 in addition to the ubiquitous black. As an option, you can have the matte finish, which imparts a dull-anodized appearance to the knob. The decorative inlays may be color-coded for visual identification of the controls.

The application of special nomenclature is a specialty of ours. The plastics are either hot-stamped or silk-screened. Aluminum dials and decorative inlays are either etched or silk-screened. All that we need is a sketch or a drawing.

Your phone call places our catalog in the evening mail. Evaluation samples are readily available for legitimate prototype requirements.

**If it's knobs and dials, it's Rogan.**

 **ROGAN  
CORPORATION**

3455 WOODHEAD DRIVE  
NORTHBROOK, ILLINOIS 60062  
TELEPHONE (312) 498-2300



# The GOULD/Brush 2000 Series.

## The most significant advance in direct writing recorders in the past decade.

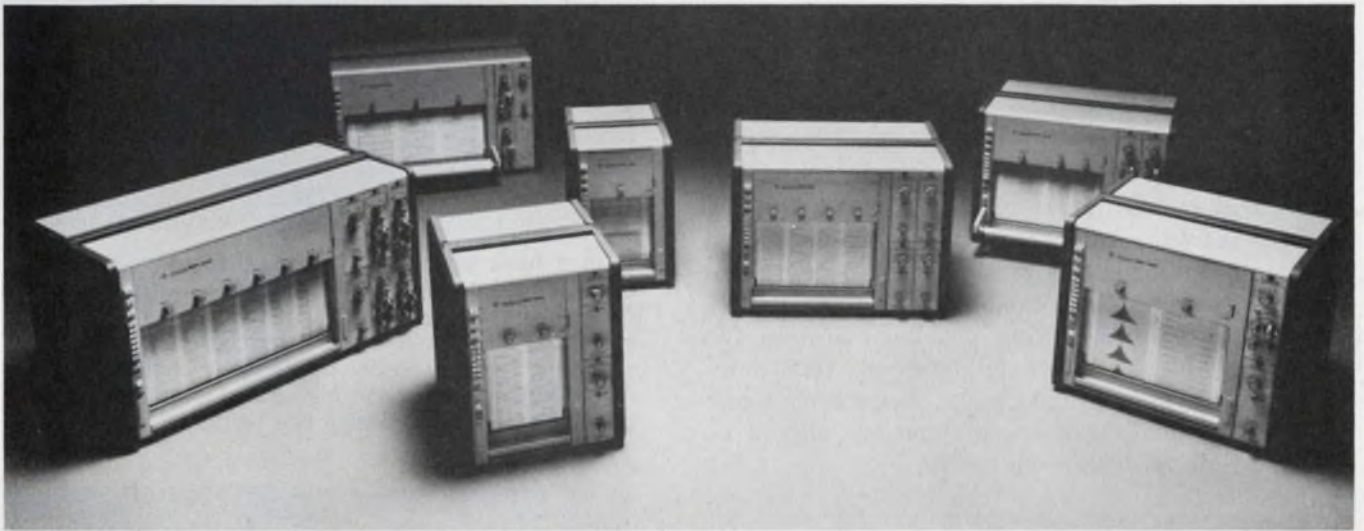

The new GOULD/Brush 2000. We can modestly say it's the best in performance, versatility and reliability. And if you take a look at all it has to offer, we know you'll agree.

Let's start with frequency response that's unexcelled in performance. An exceptional 30 Hz at 100mm, 50 Hz at 50mm, and up to 125 Hz at reduced amplitude.

Superior resolution is assured through a high-stiffness servo penmotor that enforces 99.65% linearity over the entire channel width.

Traces are uniform in width at all writing speeds. And

they're clear and crisp, with no smudges, smears or puddles. The pressurized fluid writing system is completely closed, allowing the recorder to be operated in any position—even upside down.

Then take flexibility. Our plug-in signal conditioners fit every model in the 2000 Series, and record virtually any function you could possibly want.

Thanks to its modular design, it's as versatile as your needs. Channel choices range from 1 to 8. In combinations of 100mm or 50mm channels.

There's a lot more the GOULD/Brush 2000 Series can

give you ranging from easy use and easy servicing to a cost that's downright economical. For details on the oscillographic recorders you should be using, write Gould Inc., Instrument Systems Division, 3631 Perkins Ave., Cleveland, Ohio 44114. Or Gould Allco S.A., 57 rue St. Sauveur, 91160 Ballainvilliers, France. Or call the number below.

**FOR BROCHURE CALL  
TOLL FREE AT (800) 325-6400.  
EXTENSION 77.**

In Missouri: (800) 342-6600.

 **GOULD**  
The product development company

# Build a high-frequency synthesizer with a digital mixer in a phase-locked loop and use fewer and slower divider/counters than in conventional loops.

Frequency synthesis with a phase-locked loop is an effective and inexpensive approach to most synthesis problems (Fig. 1). However, to generate signals in the vhf or uhf range with high resolution, a straightforward loop approach requires many decades of a synchronous-counter chain. And the counter must be capable of operating with frequencies in the 150-to-300-MHz range.

An improved loop that includes a digital-mixing circuit (Fig. 2) can do the same job with many fewer high-speed counter stages. Moreover, the synchronous-counter chain runs at a greatly reduced speed, and both the reference-signal frequency and resolution remain the same as in a conventional phase-locked loop.

Although digital mixing has been around for some time, it isn't widely understood; thus a review of the theory and design equations, along with an application of these equations should be useful to many design engineers.

## The mixer is a D flip-flop

The mixing operation takes place in a D flip-flop, whose clock input receives a frequency,  $f_c$ , that is lower than its D-input frequency,  $f_D$ . The relationship of the mixer's output frequency,  $f_Q$ , to  $f_c$  and  $f_D$  is defined in Fig. 3. Since only the frequency of  $f_Q$ 's zero crossings is important,  $f_Q$  requires no analog filtering when fed to the divider counter.

When input signal  $f_D$  from a VCO and a sampling signal  $f_c$  from a mixer oscillator are mixed in this manner, each signal can be considered quantized into one bit—ON or OFF. The sampling rate,  $f_c$ , is too low for accurate reproduction of  $f_D$ , and  $f_D$  is aliased, or "folded," about the value,  $1.5 f_c$ , plus all higher-order frequencies,  $(N+1/2) f_c$ , where  $N = 1,2,3 \dots$ . The mixer output  $f_Q$  never exceeds  $1/2 f_c$  (Fig. 3a).

The mixer action provides the flip-flop outputs:

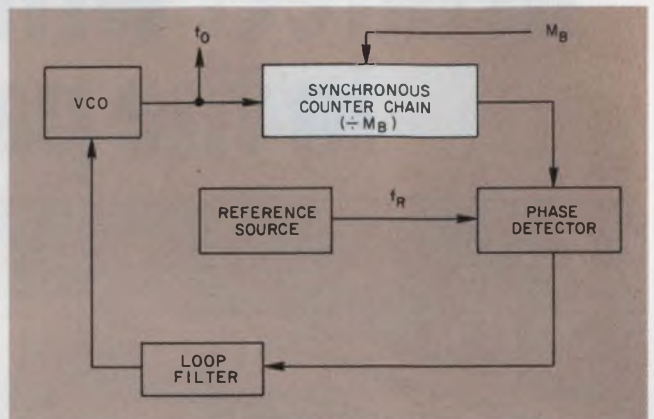

1. In a basic phase-locked loop, the output frequency,  $f_o$ , is counted down and phase-compared with a reference frequency,  $f_R$ . If  $f_o$  is a high frequency and  $f_R$  must be made low to obtain closely spaced output-frequency steps, the counter/divider needs many stages and must run at high speeds. Such high-speed counters are difficult and expensive to design and build.

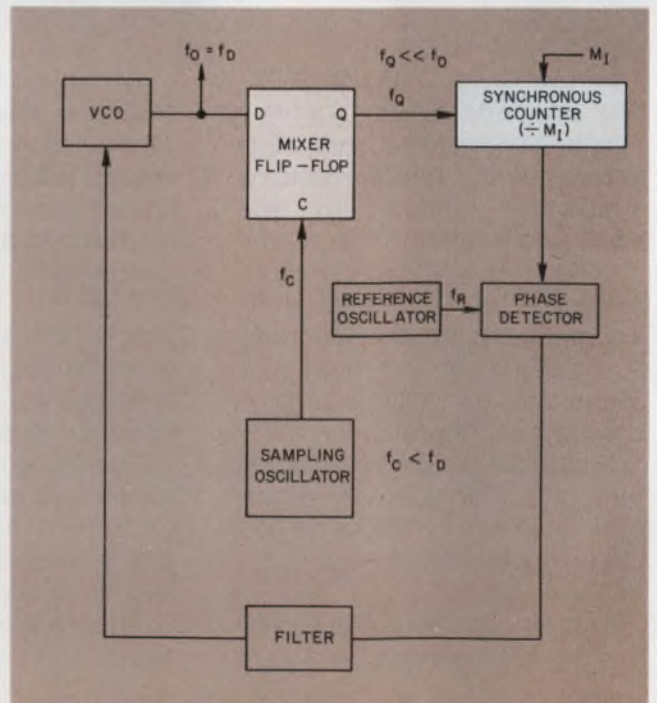

2. The introduction of a digital-mixer circuit into the loop allows fewer and slower counters to be used in the divider chain than in the basic circuit of Fig. 1. It is far easier to design a mixer than a high-speed counter.

Dr. John Nemeec, Bipolar Microprocessor Product Planning Manager, Signetics Corp., 811 E. Arques Ave., Sunnyvale, CA 94086.

$$f_o = f_D - Nf_c$$

$$\text{for } Nf_c < f_D < (N+1/2) f_c \quad (1)$$

and

$$f_o = (N+1) f_c - f_D$$

$$\text{for } (N+1/2) f_c < f_D < (N+1) f_c. \quad (2)$$

Frequency  $f_D$ , the voltage-controlled oscillator (VCO) frequency, becomes equal to the output frequency,  $f_o$ , and the mixer output drives the counter. The synthesizer counter in the improved-loop version (Fig. 2) operates with a relatively low-frequency input,  $f_Q$ , whereas in the basic phase-locked loop of Fig. 1, the counter receives the high-frequency,  $f_o$ , directly from the VCO.

Thus, where in Fig. 1

$$f_o = M_B f_R, \quad (3a)$$

in Fig. 2, the improved version,

$$f_o = Nf_c + M_I f_R, \quad (3b)$$

and  $M_B \gg M_I$ .

In both cases, the reference frequency,  $f_R$ , is the same and determined by the desired resolution of the synthesized frequencies. Since  $M_I$  (or  $M_B$ ) is a whole number with minimum increments of one,  $f_R$  must equal the resolution frequency.

At first glance, the factor  $Nf_c$  in Eq. 3b should be simply maximized to minimize  $M_I$ . However, a detailed analysis (Fig. 3a) shows that  $N$  and  $f_c$  can't be arbitrarily chosen.

### Establishing the design criteria

Suppose the circuit operates in the  $N$ th "cycle"—between  $Nf_c$  and  $(N+1/2) f_c$ —and the mixer-input signal,  $f_D$ , happens to fall somewhat above a desired frequency,  $f_H$  (Fig. 4). The mixer output with a high  $f_D$ , also is larger than a value of  $f_{QH}$ , which would correspond to an input  $f_H$ . Clearly, from Fig. 3b, if  $f_D$  falls within the  $f_H$  to  $f_{DH}$  range, the mixer-output frequency is always higher than  $f_{QH}$ . Anywhere in this range, then, the error-signal polarity and the negative-feedback configuration pull the VCO frequency back to make the system's  $f_D$  (and  $f_o$ ) equal to the desired value,  $f_H$ . Similarly, should  $f_D$  fall somewhat below  $f_H$ , the error signal in the loop acts to increase  $f_D$  to  $f_H$ .

However, if  $f_D$  exceeds the value  $f_{DH}$ , the circuit can no longer return the VCO to  $f_H$ . Although  $f_D$  exceeds  $f_H$ , the mixer output,  $f_o$  is now less than  $f_{QH}$ . Therefore, when the circuit tries to correct, the frequency of the VCO moves in the wrong direction—completely away from  $f_H$  until a new lock point is reached that is far outside of the desired  $f_L$  to  $f_H$  range.

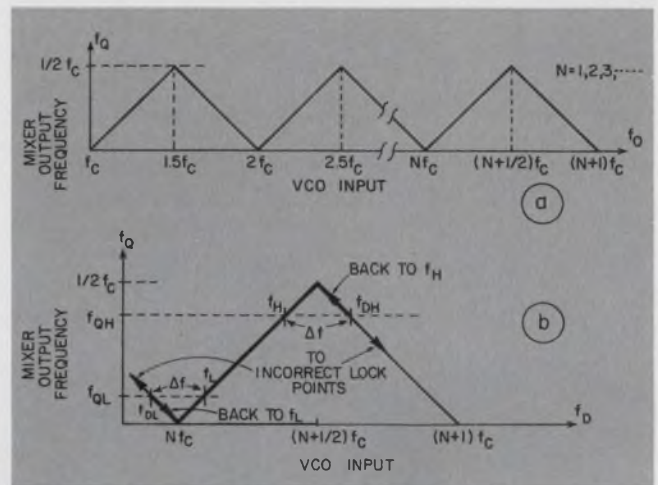

3. With a D-type flip-flop acting as the mixer, the output spectrum,  $f_o$ , is folded about a value of  $f_D$  equal to  $(N+1/2) f_c$  (a). A range of desired output frequencies,  $f_L$  to  $f_H$ , must have guard bands,  $\Delta f$ , as limits for the VCO to ensure that the loop operates correctly (b) and pulls frequency deviations back to the desired value.

A similar analysis applies to a desired frequency,  $f_L$ , near the lower end of the  $Nf_c$  to  $(N+1/2) f_c$  slope, where  $f_Q$  must remain lower than  $f_{QL}$ .

### The VCO range must be restricted

For reliable circuit operation, therefore, the VCO must be restricted to operate within the  $f_{DL}$  to  $f_{DH}$  range, so that the error signal will have the proper sense of direction. And from Fig. 3b, the range of desired output frequencies,  $f_H$  to  $f_L$ , should be comfortably less than the total range of the  $Nf_c$  to  $(N+1/2) f_c$  slope:

$$f_H - f_L < (N+1/2) f_c - Nf_c.$$

Therefore, the sampling-oscillator frequency relationship,

$$f_c > 2(f_H - f_L), \quad (4)$$

becomes a criterion for determining the minimum value of  $f_c$ .

If the operating range,  $f_L$  to  $f_H$  is centrally positioned on the  $Nf_c$  to  $(N+1/2) f_c$  slope, then

$$Nf_c + (N+1/2) f_c = f_H + f_L,$$

and

$$f_c = \frac{f_H + f_L}{2(N+1/4)} \quad (5)$$

Noting that  $f_L$  and  $f_{DL}$  appear symmetrically about  $(N+1/2) f_c$ ,

$$Nf_c = (f_{DL} + f_L)/2,$$

and

$$(N+1/2) f_c = (f_{DH} + f_H)/2,$$

then

$$f_{DL} = 2Nf_c - f_L \quad (6)$$

and

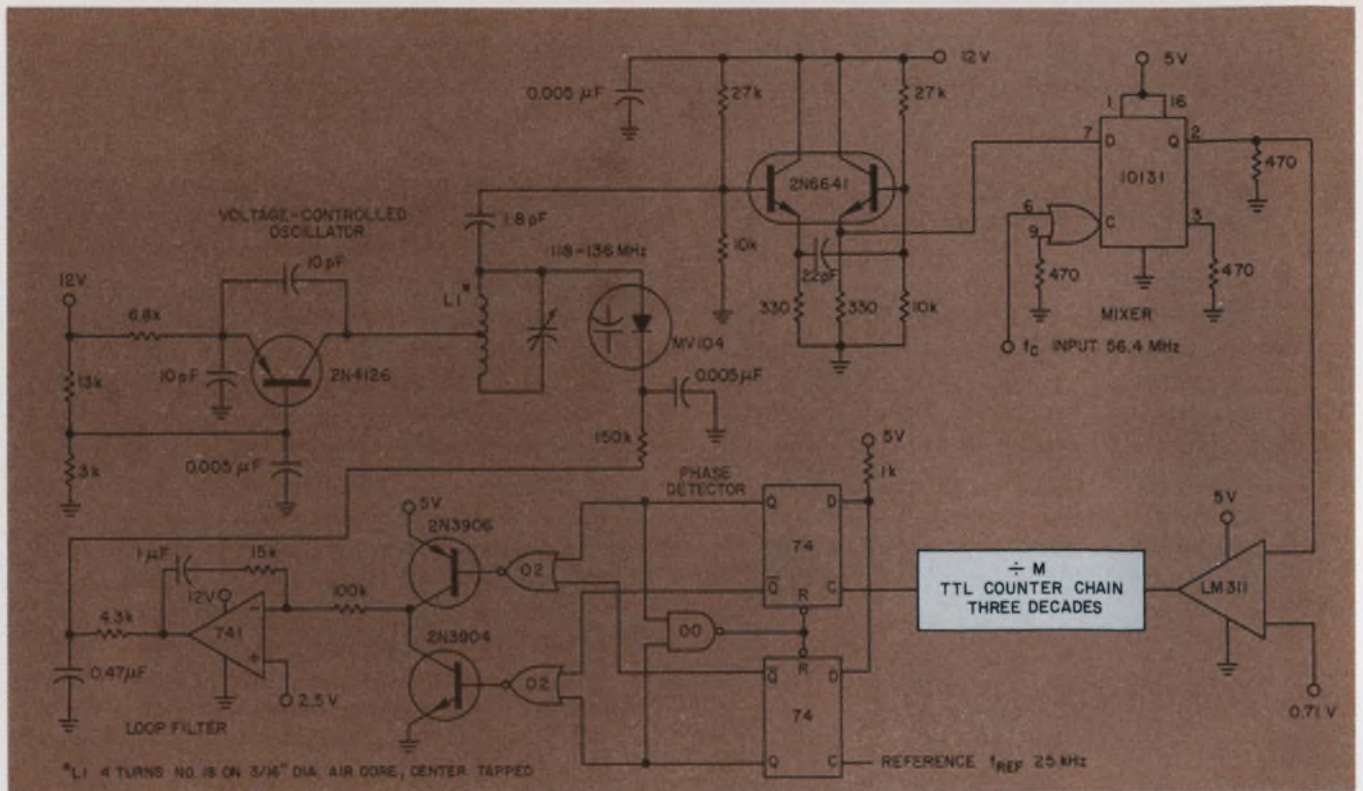

4. A vhf aircraft-radio of 118 to 136 MHz with 25-kHz resolution is synthesized with only three decades of

counters that count from 208 to 928. The 56.4-MHz mixer oscillator should be crystal controlled.

$$f_{IH} = (2N + 1) f_c - f_{IL} \quad (7)$$

Eqs. 6 and 7 represent the range within which the VCO must be restricted for the system to work properly and provide a safety margin on either side of  $f_{IL}$  and  $f_{IH}$ .

Eliminating the  $f_c$  term between Eqs. 6 and 7 and introducing the relationships

$$f_{IL} = f_L - \Delta f$$

$$f_{IH} = f_H + \Delta f,$$

where  $\Delta f$  is the safety range for operation of the VCO below  $f_L$  and above  $f_{IH}$ , we get

$$N = 1 / \left[ 2 \left( \frac{f_{IH} + \Delta f / 2}{f_L - \Delta f / 2} - 1 \right) \right]. \quad (8)$$

(Since  $N$  must be an integer, any fractional part obtained with Eq. 8 is dropped.)

As a result, given the desired frequency range—from a high of  $f_{IH}$  to a low of  $f_L$ —and safety margins,  $\Delta f$ , for the operating of VCO at both ends of the range limit,  $N$  can be determined.

#### Detailing a design example

As an example, consider a frequency-synthesis system for carrier frequencies in the vhf aircraft-radio band of 118.0 to 136.0 MHz, with the aircraft band channelized in 25-kHz increments.

As a first step, assume a safety margin for  $\Delta f$  equal to, say, 10 MHz. Then from Eq. 8

$$N = 1 / \left[ 2 \left( \frac{136 + 5}{118 - 5} - 1 \right) \right]$$

$$\approx 2$$

Then, from Eq. 5,

$$f_c = \frac{136 + 118}{2 \times 2.25} = 56.444 \text{ MHz}$$

Note, however, that 56.444 MHz is a value for  $f_c$  based only upon a safety-margin criterion. The exact value must be chosen to provide the desired channel frequencies for integral values of  $M_1$ —in this case 56.400 MHz.

And from Eq. 3b

$$f_o = 2 \times 56.4 + 0.025 M_1,$$

$$M_{1(\min)} = \frac{118 - 112.8}{0.025} = 208$$

and

$$M_{1(\max)} = \frac{136 - 112.8}{0.025} = 928$$

The final synthesizer design is shown in Fig. 4. The value of  $M_1$  to be loaded into the counter ranges from 208 to synthesize 118.0 MHz to 928 to synthesize 136.0 MHz.

All of the essential circuit details are shown except for the  $\div M$  counter chain and the 56.4-MHz oscillator for the mixer input. The  $\div M$  counter design is straightforward. The 56.4-MHz oscillator should be a crystal-controlled oscillator for stability.

With the 10131 flip-flop mixer (see Fig. 4), the VCO can run at frequencies to 250 MHz. Uhf operation requires a faster flip-flop. However, compared with the task of constructing a multi-stage counter at these high frequencies, achieving such speeds with a flip-flop is easy. ■■

# Opening new frontiers with electro optics

## PMT with big new "teacup" dynode gives scintillation counters better PHR.

We expect quite a tempest over this teacup. It's a radically different RCA approach to large-diameter PMT's: The teacup is a large, cup-shaped first dynode that is an improvement over conventional venetian-blind types. It has better spatial uniformity and better off-axis uniformity. As a result, PHR (Pulse Height Resolution) is improved by 0.3% for  $Cs^{137}$  [Nal (TI)] and 0.7% for  $Co^{57}$  [Nal (TI)].

RCA 4900 is the first in a whole new family of 2" to 5" circular and hexagonal face PMT's with teacup first dynodes. It has a 3" diameter, 10 stages, and "blue" cathode responsivity of  $10 \mu A/blue \text{ lm}$  minimum,  $10.5 \mu A/blue \text{ lm}$  typical. Available with voltage divider network.

### High performance in exacting applications

Besides scintillation counting, the teacup PMT can also be useful in gamma ray spectroscopy

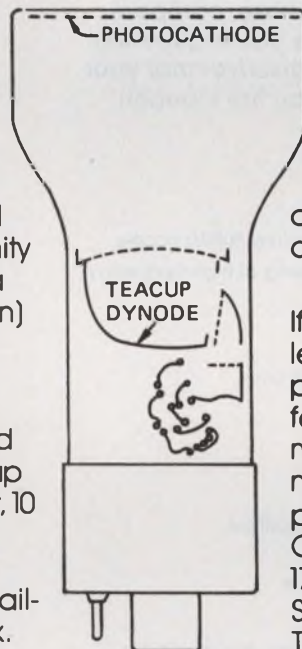

for medical applications. Several leading manufacturers of medical diagnostic equipment recently conducted their own tests on these gamma-camera type tubes, and pronounced them a giant step forward in improving camera performance.

If electro optics can solve your problem, remember: EO and RCA are practically synonymous. No one offers a broader product spectrum. Or more success in meeting special needs. Call on us for design help or product information. RCA Electro Optics, Lancaster, Pennsylvania 17604. Telephone 717-397-7661. Sunbury-on-Thames, Middlesex TW16 7HW, England; Ste.-Anne-de-Bellevue, Quebec, Canada; Belo Horizonte, Brazil; Hong Kong.

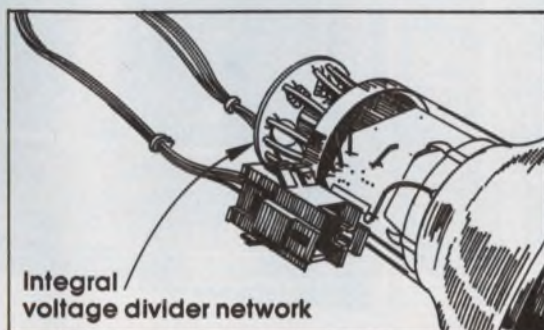
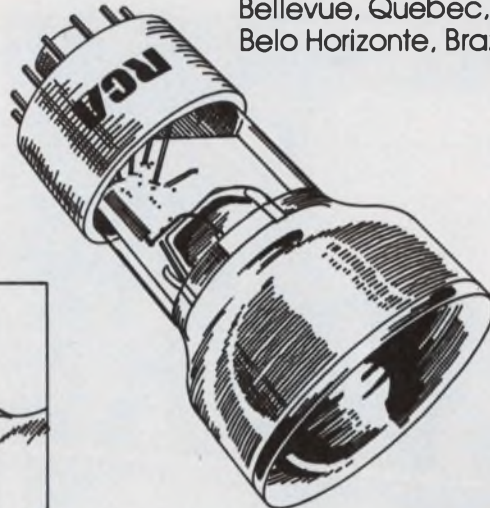

# RCA

# Stretch your test instrument budget

Does a scope always have to be expensive to meet your needs? At B&K-PRECISION we don't think so. B&K-PRECISION offers a full line of scopes that give you the performance and features you need, at substantial cost savings...plus the advantage of immediate delivery and 10-day free trial through local distributors.

## B&K-PRECISION to high-priced

B&K-PRECISION has taken a no nonsense, cost-effective, approach to oscilloscope design. All our scopes will trigger at frequencies typically 50 to 100% beyond their rated band-width. They are rugged, dependable instruments, designed to match the features and performance of far more expensive scopes, without matching their high price. An important part of our approach is that you shouldn't have to buy more scope than you need to get the features you want. Before making your next purchase, compare the features and performance you require with what we have to offer. You'll discover that your budget is a lot bigger than you first thought!

### 30MHz Dual-Trace 5" Triggered Scope with Signal Delay

For the engineer who requires a full-feature 30MHz scope

- Built-in signal delay line permits viewing of high-frequency pulse risetimes
- Triggers on signals up to 50MHz
- Rise time 11.7nS
- 20 calibrated sweeps— $0.2 \mu\text{S}/\text{cm}$ - $0.5\text{S}/\text{cm}$
- Built-in high and low-pass filters
- $5\text{mV}/\text{cm}$  vertical sensitivity
- Illuminated graticule
- TTL compatible intensity modulation
- X-Y capability using matched DC amplifiers
- P31 blue phosphor
- Internal  $.5\text{Vp-p} \pm 1\%$  calibration source
- $5\text{mV}/\text{cm}$  horizontal sensitivity.

**Model 1474 \$930** (including two 10:1/direct probes)

### 15MHz Dual-Trace 5" Triggered Scope

Premium features and performance in a 15MHz dual-trace scope

- Ultra—flat in-band response with smooth rolloff past 15MHz
- Triggers beyond 27MHz
- 24nS risetime
- 19 calibrated sweeps— $.5 \mu\text{S}/\text{cm}$ - $0.5\text{S}/\text{cm}$
- $10\text{mV}/\text{cm}$  vertical sensitivity
- Algebraic addition and subtraction
- Illuminated graticule
- X-Y capability using matched DC amplifiers
- P31 blue phosphor
- Internal calibration source
- Built-in TV sync separator
- For fast setup, mode automatically shifts between CHOP and ALTERNATE as you change sweep times.

**Model 1472C \$720** (including two 10:1/direct probes)

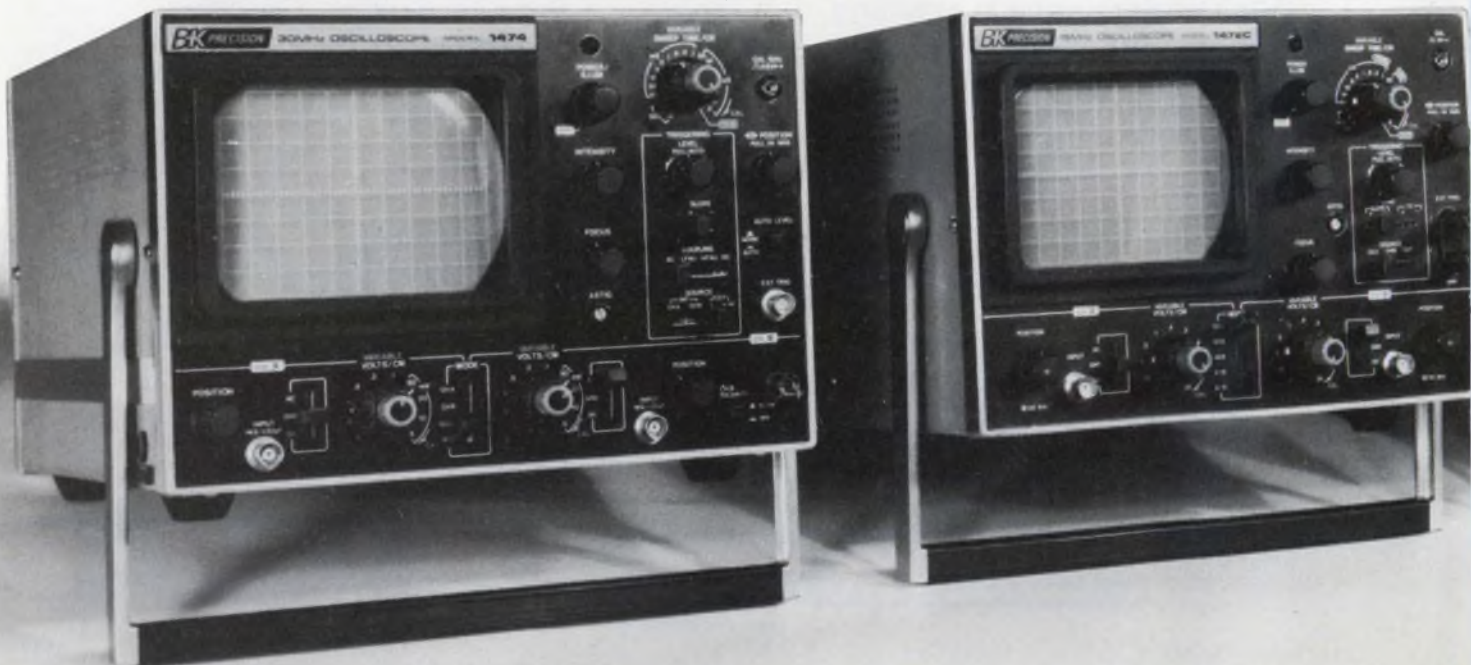

# without stretching your standards... has an alternative oscilloscopes

## 10MHz Dual-Trace 5" Triggered Scope

Our lowest-cost dual-trace scope more than fills the need in applications where extended bandwidth isn't required

- Triggers beyond 15MHz
- Mode automatically shifts between CHOP and ALTERNATE as sweep time is changed
- 18 calibrated sweeps— $1 \mu\text{S}/\text{cm}$ - $0.5\text{S}/\text{cm}$
- 35nS risetime
- P31 phosphor
- X-Y capability using matched DC amplifiers
- Internal calibration source
- TTL compatible Intensity modulation
- 10mV/cm vertical sensitivity

**Model 1471B \$570**  
(Including two 10:1/direct probes)

## 10MHz 5" Triggered-Sweep Scope

A 5" triggered scope with TTL compatible Z-axis

- 10mV/cm vertical sensitivity
- 35nS risetime
- 18 calibrated sweep ranges— $1 \mu\text{S}/\text{cm}$ - $0.5\text{S}/\text{cm}$
- 5x magnification sweeps to  $.2 \mu\text{S}/\text{cm}$
- Vectorscope capability
- Internal calibration source
- Internal TV sync separator
- P31 phosphor
- 11-position vertical attenuator, calibrated in convenient 1/2/5 step sequence
- Built-in calibration source.

**Model 1461 \$470**  
(Including 10:1/direct probe)

## 10MHz 3" Triggered-Sweep Scope

Meets the demands for an uncompromising ultra-compact triggered-sweep scope

- 19 accurate sweep ranges
- Accurate 11-position vertical attenuator
- 10MV/div vertical sensitivity
- Front panel vectorscope capability
- Internal calibration source
- Only 5.75 x 7.9 x 12.9 • Weighs only 13 lbs
- Capable of writing speeds up to  $0.1 \mu\text{S}/\text{div}$  with 5x magnification.

**Model 1431 \$420**  
(not including probe)

## 5MHz 3" Compact Scope

Ideal for many dedicated applications, freeing more expensive scopes from monitoring tasks

- 10mV/div vertical sensitivity
- Direct deflection terminals for waveform display to 450MHz
- Only 6 x 7.5 x 12" • Weighs just 8.5 lbs
- 600 Vp-p maximum input voltage
- Can be externally synced.

**Model 1403A \$219**  
(not including probe)



### Save up to 50% on probes!

B&K-PRECISION has engineered a full line of cost-effective probes to meet your needs. Our probes are designed for complete interchangeability with those of leading "ultra-sophisticated" brands, giving you compatible performance at about half the price.

**FOR IMMEDIATE DELIVERY,**  
or 10-day free trial, contact your local B&K-PRECISION distributor. Ask him for Catalog BK-77 with complete information on B&K-PRECISION oscilloscopes, probes and more than thirty other fine instruments, or contact us directly.

**B+K PRECISION**

**PRODUCTS OF DYNASCAN**

6460 W. Cortland Avenue, Chicago, IL 60635 312/889-9087

FOR PRODUCT INFORMATION CIRCLE 58

FOR PRODUCT DEMONSTRATION CIRCLE 59

## Dick Lee of Siliconix Speaks On Making Your Engineers Bigger

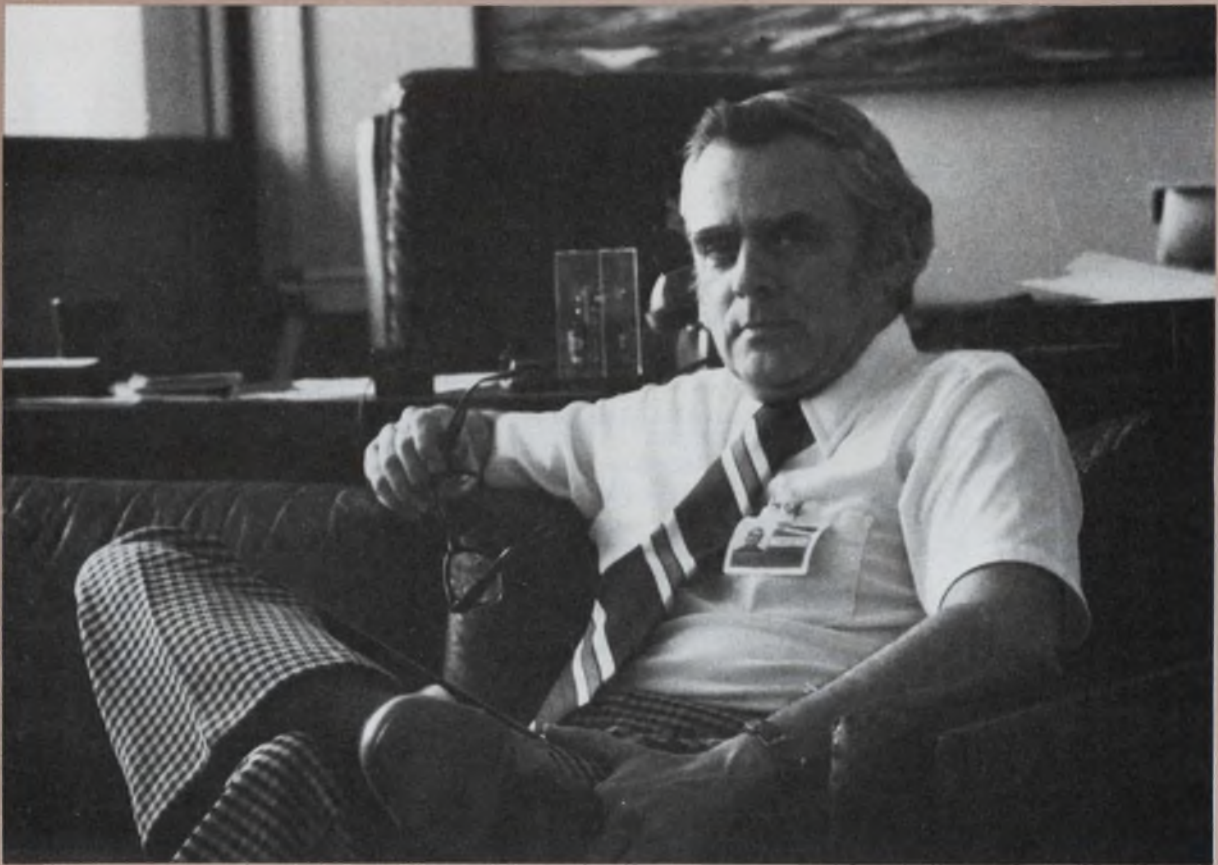

Today's engineer is not like the engineer of 30 years ago. In those days he was the introverted slide-rule pusher who was kept in the back room, dealing with formulas, figures and breadboards. That man is gone.

Today, at least in high-technology businesses, he's involved in a wide range of disciplines. He works with chemistry, physics, metallurgy, mathematics, computer science, mechanical engineering and industrial engineering.

Our universities produce young engineers with rounded personalities. We find engineers today, right out of school, who know something about behavioral sciences, transactional analysis, time management—things like that. These people

can't be locked in a back room. They are goal-oriented. They have plans about their personal careers. And they want to grow.

**If you want to succeed in a technical business, you have to help your engineers grow. But you must guide their growth so they'll be useful to themselves and to the company.**

The first lesson in growth is selectivity. You must teach your engineers that it makes sense to be selective—with people, products, markets, customers, pricing, planning—everything. They must learn that everything is a matter of choice.



Second, since all men are not created equal—or, at least, they're not equal in the business world—it's necessary to seek, recognize and reward creativity.

Third, it's wise to encourage a controlled overlap. This expands your engineers' horizons and it helps them work more effectively as it gives them a reason for what they're doing. At Siliconix we overlap functionally between all the classical elements in any organization. We overlap between engineering and manufacturing, between engineering and sales, between sales and manufacturing, and so on.

Fourth, it's necessary to focus on maximizing the congruence of goals. If some of your people are aiming at one goal and others are going in a different direction, you won't be very effective.

Fifth, I think you always have to think about raising the level of effectiveness. It's more important to do the right things than it is to do things right. The distinction is not a mere quibble. It's important to think about effectiveness rather than efficiency. I want my people to be more effective and to worry less about being more efficient.

**Finally, I think the age-old communications problem is still a major challenge to engineering managers.**

I think an unbelievable number of basic tasks of management all come down to: "How do we communicate among human beings?" We have to worry about all lines of communications involved in proposing, approving and reviewing every project. We have to know if we're dealing with facts or with the rumor mill. It's not always easy.

Now, as you go through these things, you will inevitably face pitfalls. One obvious pitfall is that you may bring in new engineers who have bad habits. There are many engineers around who lack technical excellence. They're not disciplined to seek thoroughness in their work. And in an LSI product today, a design mistake is extremely costly.

Another pitfall you face, especially if you're in a semiconductor company in the Bay Area, is the never-ending problem that the grass always looks greener somewhere else. The competitive pressures for good people here are very high.

A third pitfall is the whole collection of normal human frailties—things like jealousy, greed and the NIH and NIBM syndromes. Most of us are familiar with the Not-Invented-Here problem. But the Not-Invented-By-Me reaction can be even more destructive. A manager has to recognize and

cope with these general traits and, if he's in the semiconductor industry, with another factor that comes about because so many people have worked for other semiconductor companies.

If you check through our plant, you'll find one or more of our engineers have come from some two dozen other semiconductor companies. So you find people saying, "We should do it this way because that's the way Company X did it." Or, "We shouldn't do it this way because that's what they did at Company Y—and they were stupid."

A fourth pitfall lies in failing to recognize the individual who might make a great manager. Unfortunately, he doesn't wear a sign. So it's hard to see which fellow should be groomed for management and which should stay in engineering.

**All of these challenges and pitfalls are based on dealing with people. And that's the most complex and demanding of management skills.**

You have to remember that the key word in the electronics industry is change, and change is often painful. People resent it. Yet they must respond to it if they are to grow and if your company is to grow. But you can't change everybody. People who are unwilling to change over a reasonable period of time must be replaced, or, at least, replaced in a particular responsibility.

You may find that some peoples' management styles and operating styles may be incompatible with the company's direction. You can't have a hip-shooter managing large portions of a 50- or 100-million dollar corporation.

But it may not be easy to see the problem. In one case it may be painfully obvious that some action should be taken. In another case it may not be quite clear.

If you eliminate structures and levels between your top management and the people doing the engineering, that helps make people pretty visible quickly—but not necessarily. It's often possible to find that some of your engineers are working on a pet project that you don't know anything about.

I think that, at Siliconix, we have succeeded a great deal in eliminating that problem by making our junior engineers more conscious of the cost of their time, of techniques for managing their time and of the importance of delegating jobs they don't need to do themselves.

**We try to teach our engineers how to do the jobs that need to be done and the jobs that only they can do.**

(continued from page 127)

Now some of these problems don't have a simple, neat solution. But let me tell you how I respond to one of the trickiest of them—the problem that the grass always looks greener on the other side. Our approach is simple: We never try to make the highest salary offer to a man we want to hire.

We spend lots of time interviewing and one of the questions that comes up is always: "What do you think you're worth?" Other questions: "Whom else are you interviewing? How are you going to make the choice among the companies

you're considering? How important is the absolute dollar figure?"

Sometimes we lose somebody because another company offers him \$20 a month more than we've offered. My people often criticize me and say we should have increased our offer by that piddling amount. But I think they're wrong.

If money is that important to a man, he would jump to another company after we trained him if it offered him another few dollars. I think our philosophy really helps us separate the guy who job-hops for money from the fellow looking for an opportunity to grow. ■■

## Who is Dick Lee?



He got his bachelor's, master's and then in December 1950, at the age of 22, his degree of engineer from Stanford University. "Degree of Engineer"? A strange degree. It was recommended in those days instead of a PhD, except for people who wanted to teach or go into research.

But Dick Lee got tired of all the puzzled queries, so, after five years in industry, "I went back to Stanford and bought a PhD."

He moved to Washington, DC to join Emerson Radio and Phonograph Corp., which was

almost entirely a military house. But that was during the Eisenhower administration when there were very few military contracts. In his last major proposal, Lee turned out 900 pages of paper, but the contract went to another bidder. That was just too much frustration.

So he wrote to Mark Shepherd (who later became president of Texas Instruments), and said: "If that job offer you made in 1951 still exists, I accept." And in January 1958 he joined TI in Dallas and organized its applications engineering force, helped develop the first integrated circuit with Jack Kilby and one technician and, in time, became marketing manager for the transistor division.

He left in December 1961 when D. H. Baldwin (the piano company) invited him to become general manager of the company that, three months later, emerged as Siliconix, with Lee as president.

Lee and his wife Pauline have two daughters, 17 and 19, and lots of cars. He loves to tinker with foreign cars and now owns a Mercedes, an Alfa-Romeo and a Capri.

When he's not running Siliconix, a company with more than 730 employees in the U.S., including more than 200 professionals, and when he's not running his automobiles, Lee finds time for his substantial library of recorded music—from opera to rock—and for what he calls a modest art collection.

He frequently hangs work from his own collection at Siliconix, and allows employees to buy them, practically at cost.

He's amused by employee reactions, which range from, "That's the most beautiful painting in the world" to "Please don't make me sit in front of that monstrosity." The paintings, Lee feels, are just one part of the overall beauty of the Siliconix plant and its surroundings that helps make a pleasant and creative atmosphere.

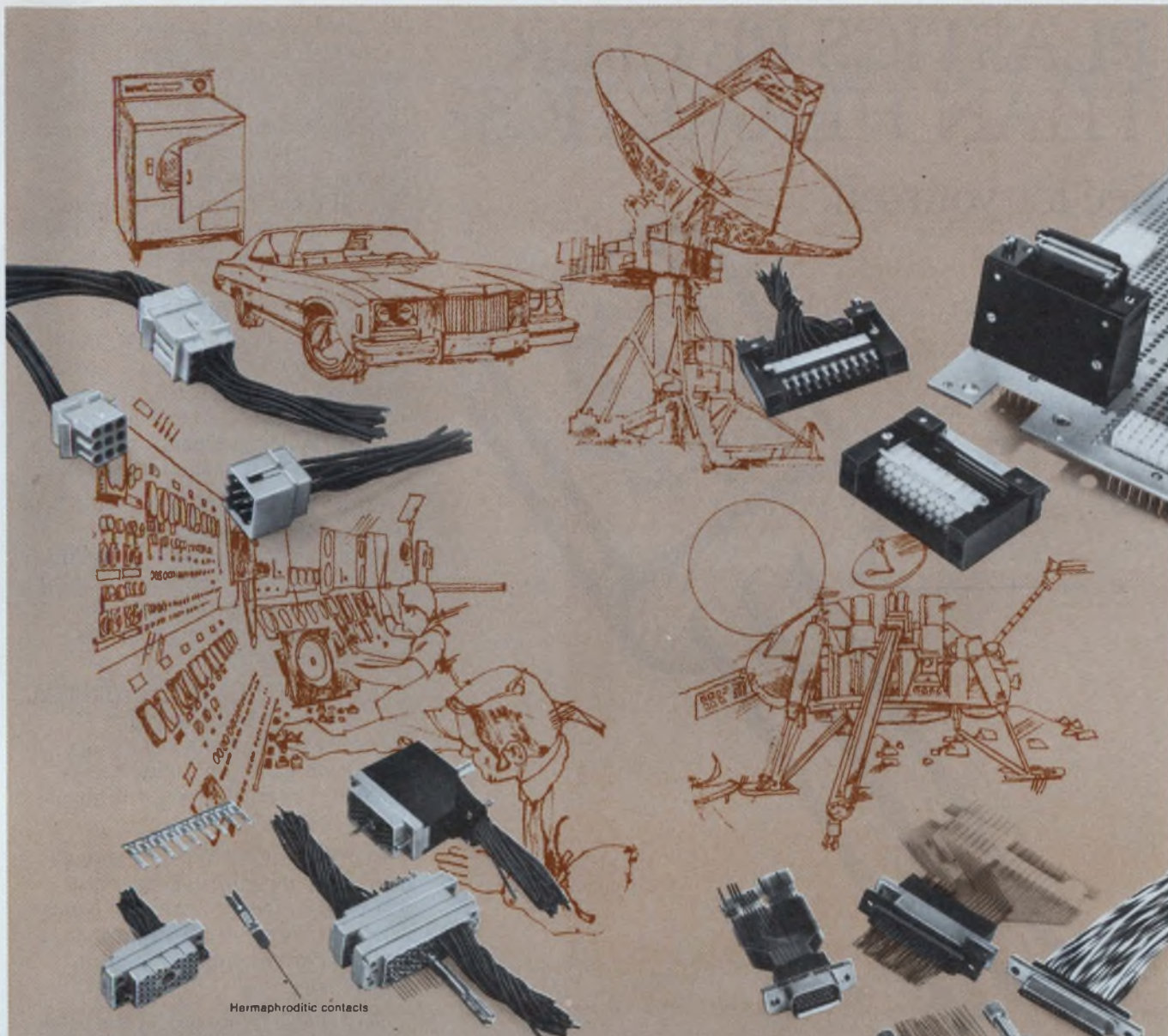

Rack and panel connectors  
for unlimited applications...

## only from Malco

You can get some of these connectors from other manufacturers, but *only* Malco offers a complete line of rack and panel connectors for any design situation. It's the broadest line of rack and panel connectors in the industry. Everything from high density spacing of .050 to our Thrift-Mate™ with spacings of .200 and .250. All with the dependability and quality you demand for superior performance. Whether your application is commercial, military or industrial, Malco has rack and panel connectors for you. Whether

your designs call for pin and socket, blade and tuning fork or hermaphroditic, Malco has it. Only Malco has it all. Write for prices and information. Malco, 12 Progress Drive, Montgomeryville, PA 18936. Phone: (215) 628-9800

 **MALCO**  
A Microdot Company

# PLASTICS BETTER THAN HERMETICS?

See for yourself.

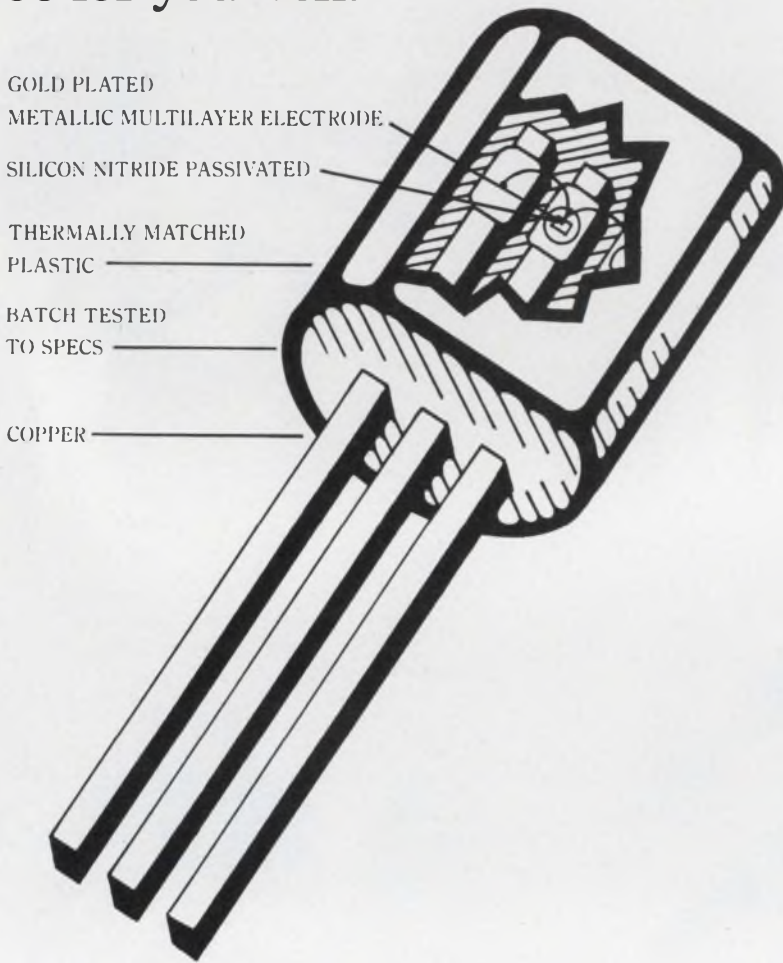

GOLD PLATED  
METALLIC MULTILAYER ELECTRODE  
SILICON NITRIDE PASSIVATED  
THERMALLY MATCHED  
PLASTIC  
BATCH TESTED  
TO SPECS  
COPPER

○ High Reliability TO-92 Transistor (Pc MAX.=300 mW)  
● TO-18 Metal Case Transistor (Pc MAX.=300 mW)  
--X-- Conventional Mold Transistor (Pc MAX.=250 mW)

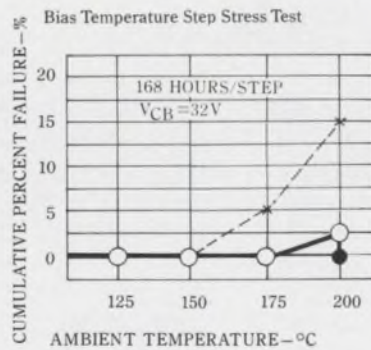
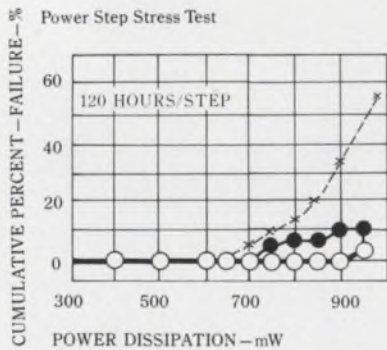

"Standard practice" can now change for the better—and cheaper. Up to now, industrial transistors have been specified in cans, to get reliability under heat and humidity. Consumer products have been able to tolerate the less expensive but less stable plastics. Now NEC has incorporated 5 technical advances that make these TO-92 plastics the equal of any hermetic metal case for most applications—and you get the lower price to boot!

- 1. GOLD-PLATED, MULTILAYER METALLIZATION.** Because gold is electrically noncorrosive and inert to acids and alkalis. And moisture resistance and bonding strength are greatly improved over aluminum construction.
- 2. SILICON NITRIDE PASSIVATION.** Increases moisture resistance, while protecting against unreliability due to impurities. And, the operating characteristics improve, such as higher dc amplification factor and better noise figure.
- 3. A UNIQUE PLASTIC MATERIAL.** Developed especially to match thermally the lead wires and other component parts. This minimizes or eliminates internal stress on the bonding wires.
- 4. COPPER LEAD WIRE.** Thermally matched to the plastic, copper also resists corrosion. A significant bonus is the much greater power dissipation stemming from copper's high heat conductivity.
- 5. RIGID QC.** Every production batch is thoroughly tested, and quality certification tests of the production process are run monthly. This stringent, continuous monitoring insures the best quality in the world, bar none.

**THEY ADD UP TO SUPER SPECS.** The two charts shown are only a sampling—NEC's 8-page brochure of TO-92 specifications is the real convincer. Write or call for your copy if you're seriously interested—our line of small-signal transistors for telecommunications, instrumentation, etc. is so broad we can provide almost any device you may require in TO-92. And if you're into hybrids, ask for data on our MINI MOLD transistors—plastics uniquely configured for reliability with big savings in assembly time and cost.

NEC America, Inc., Electron Devices Division, 3070 Lawrence Expressway, Santa Clara, CA 95051.  
Tel: (408) 738-2180. TLX: 35-7475.

**NEC**  
**NEC America, Inc.**

CIRCLE NUMBER 61

**Need standard High Q Inductors  
that meet or exceed MIL spec?  
TRW/UTC has a stock answer.**

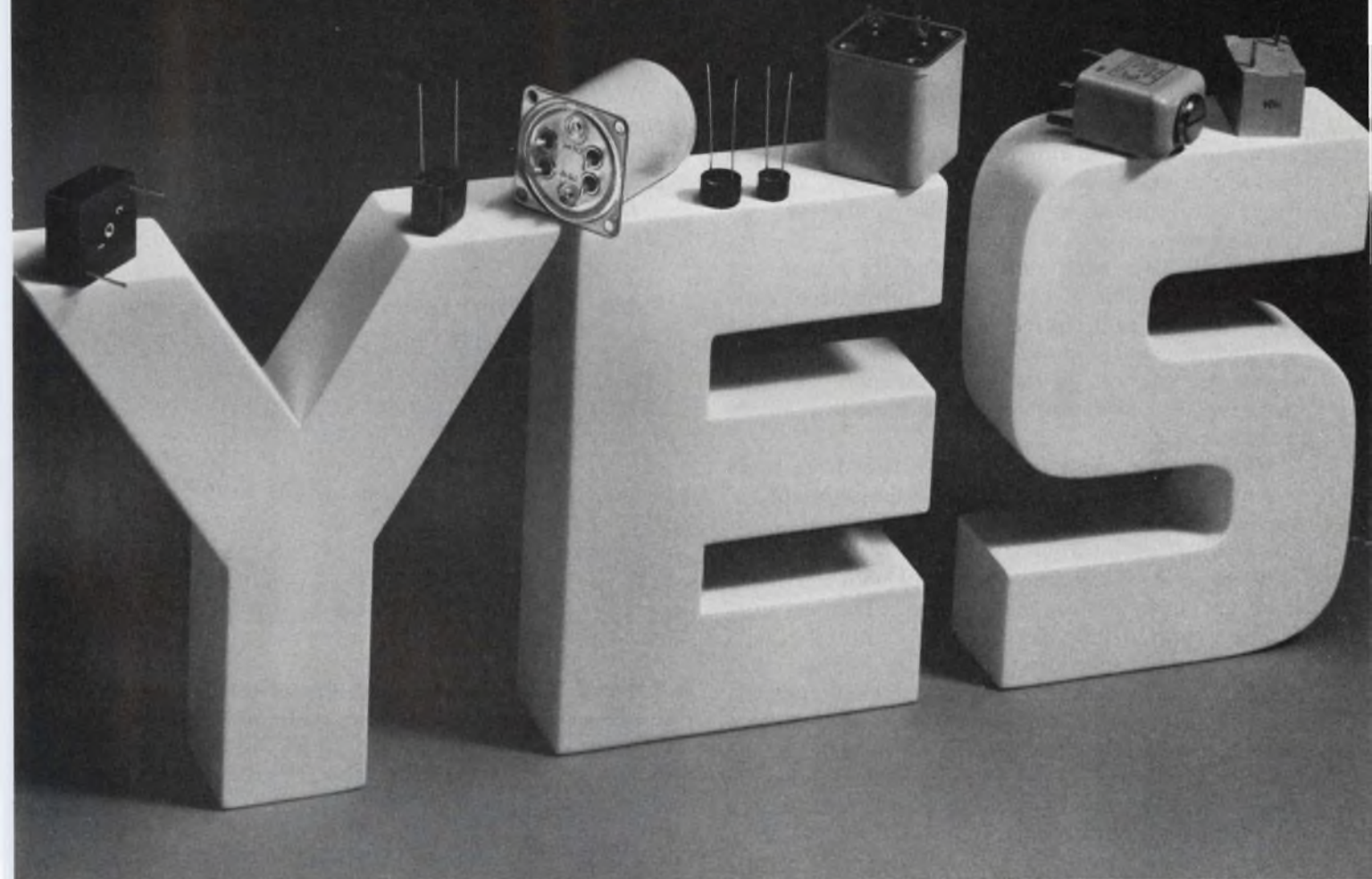

TRW/UTC has something special in standards. And they're available from stock. Now.

You name it, we'll recommend the stock inductor that meets your spec. We have standard inductances as low as .6 MHy, as high as 2500 Hy. Standard tolerances as low as 1%.

Need weight from 1.3 grams to one pound? We have it. QPL listings? We have them. Fixed or variable, we have that, too. Plus our standard High Q Inductors have maximum Q in ultra-miniature size and work at frequencies from DC to as high as 100 KHz. There's also

minimum inductance change over a temperature range of  $-55^{\circ}\text{C}$  to  $105^{\circ}\text{C}$  with excellent retrace characteristics.

For immediate off-the-shelf delivery check your authorized TRW/UTC local distributor. He'll recommend the High Q Inductor that will meet your requirements from stock that includes just about every standard available in the world.

Or for more information on standards that are something special, contact TRW/UTC Transformers, an Operation of TRW Electronic Components, 150 Varick Street, New York, N.Y. 10013. Area Code: 212 255-3500.

**TRW UTC TRANSFORMERS**

ANOTHER PRODUCT OF A COMPANY CALLED TRW

CIRCLE NUMBER 62

# Ideas for Design

## Convert seven-segment numerical code to decimal with simple gates

Any number in seven-segment code can be converted easily to decimal form with, at most, a four-input gate. Indeed, in many cases, a two-input gate with no more than three inverters can do the job.

Table 1 lists each number and its seven segment code. Table 2 provides a minimized logic equation for each number, where the variables a through g correspond to the numerical-display segments. Any one of the ORed terms in the logic equation for each number can be used to identify that number.

For example, Fig. 1 illustrates the three ways the number 0 can be detected. If the segment information comes from a scanned source (a calculator chip), an additional input (Fig. 1c) detects only the desired digit position. But note that with most calculator chips, the display is blanked during the computation period.

Another precaution: Calculator chips that drive LED segments without external current-limiting resistors have either internal resistors or internal current sources (FETs) to limit the current. Therefore, the voltage-output change is the voltage swing across the LED—typically only 2 V. Such a small change can't switch a CMOS gate reliably. But an emitter follower with a current-limiting resistor and LED segment in the

emitter can provide the required logic swing. Alternately, a resistor could be used in series with the LED, but this would dim the display.

*Raymond G. Kostanty, Consultant, 4185 Del Mar Ave., Long Beach, CA 90807. CIRCLE NO. 311*

**Table 1. Convert seven segment to decimal**

	Display	Segments						
		a	b	c	d	e	f	g
	0	1	1	1	1	1	1	0
	1	0	1	1	0	0	0	0
	2	1	1	0	1	1	0	1
	3	1	1	1	1	0	0	1
	4	0	1	1	0	0	1	1
	5	1	0	1	1	0	1	1
	6	1,0	0	1	1	1	1	1
	7	1	1	1	0	0	0	0
	8	1	1	1	1	1	1	1
	9	1	1	1	1,0	0	1	1
Minus	0	0	0	0	0	0	1	
Blank	0	0	0	0	0	0	0	

**Table 2. Code conversion equations**

0	= $\overline{gd} + \overline{ge} + \overline{gf}$
1	= $\overline{af}^1 + \overline{ag}^1 + \overline{abf} + \overline{acf} + \overline{abg} + \overline{acg}$
2	= $\overline{ca} + \overline{cb} + \overline{cd} + \overline{ce} + \overline{cg}^2 + \overline{ef}$
3	= $\overline{def} + \overline{cfg} + \overline{efg}^2$
4	= $\overline{af}^1 + \overline{aef} + \overline{abf} + \overline{def}^1$
5	= $\overline{be}^1 + \overline{ab}^2 + \overline{abe} + \overline{cbe} + \overline{dbe} + \overline{fbe}$
6	= $\overline{be} + \overline{ae}^2$
7	= $\overline{ad}^1 + \overline{afg} + \overline{aeg} + \overline{adg} + \overline{adf}$
8	= $\overline{befg} + \overline{bceg}$
9	= $\overline{abef}$
Minus	= $\overline{ac}^1 + \overline{bc}^1 + \overline{bd}^1 + \overline{bf}^1 + \overline{cd}^1 + \overline{ce}^1 + \overline{gac}$ $+ \overline{gaf} + \overline{gbc} + \overline{gbd} + \overline{gbf} + \overline{gcd} + \overline{gce}$ $\overline{gdf}$
Any Number	= $(c + g)^2 + (c + a) + (c + b) + (c + d)$ $+ (c + e) + (b + d) + (b + f) + (b + g)^2$
Blank (Minus allowed)	= $\overline{gac} + \overline{gbc} + \overline{gbd} + \overline{gbf} + \overline{gcd} + \overline{gce} + \overline{bg}$
Blank (Minus not allowed)	= $\overline{ab}^1 + \overline{ac} + \overline{bc} + \overline{bd} + \overline{bf} + \overline{cd} + \overline{ce}$ $+ \overline{cg} + \overline{bg}$
Superscripts:	
1—	This term cannot be used if display can ever be blank.
2—	This term cannot be used if display can show a minus.
3—	This term can be used only if number 9 includes segment d.
4—	This term can be used only if number 6 includes segment a.
5—	This term cannot be used if number 6 includes segment a.

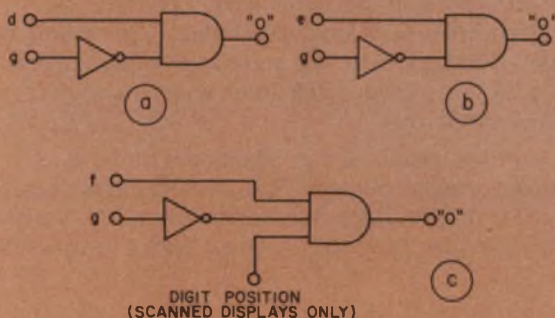

To detect the number 0, you can use any of these three configurations, when the number comes from a seven-segment readout. Circuit (c) includes an extra input for multiplexed displays.

# WANTED

**3MHz to 2350MHz**



## The VS90 SWEEP GENERATOR

### DESCRIPTION

- Wide Frequency Range-3MHz to 2350MHz**
- High Output Level-0.7v RMS into 50 ohm**
- Wide Sweep Width-100kHz to 1100 MHz**
- High Stability-Less than 20kHz residual fm**
- Flat Output-Leveling Int Ext. 0.5dB**

Price \$ **2695<sup>00</sup>** Delivery Stock

**Texscan**

Texscan Corporation 2446 North Shadeland Ave. • Indianapolis, In. 46219 (317)357-8781

# Optical couplers isolate, control and monitor to allow 6-kV supply to float

Optical couplers can be used to operate and monitor a floating high-voltage power supply and provide both electrical and mechanical isolation between the control section and the power supply (Fig. 1).

The application is in an image converter with a 6-kV power supply used for a sounding-rocket experiment. Design constraints dictate that the device float at 6 kV. To prevent possible corona problems, it is necessary to have a fully isolated method of switching the power supply on and off, operating the electronic shutter and monitoring the current drain.

Four Monsanto MCT 81 optical couplers provide the necessary isolation. Couplers  $OC_1$  and  $OC_2$  operate as on/off switches to control the main power via  $Q_1$  and the electronic shutter via  $Q_3$ , respectively.

Linear-current monitoring is provided by op-

amp  $A_2$  and two matched couplers,  $OC_3$  and  $OC_4$ . Coupler  $OC_3$  isolates the output signal and  $OC_4$  is part of the feedback circuit of  $A_2$ . Even though these couplers are nonlinear, this combination results in a monitoring circuit that has good linearity, little distortion and low gain drift.

The monitor circuit operates as follows: A 1- $\Omega$  current-sampling resistor provides the noninverting input of  $A_2$  with a signal voltage proportional to  $I_{RL}$ . Resistor  $R_7$  establishes the circuit's gain and current range. Set-point resistor  $R_2$  is adjusted to make nominal current read about half scale on the monitor-channel output and provide typically about 2.5 V (Fig. 2).

Since resistors  $R_1$  and  $R_3$  are equal,  $OC_3$  and  $OC_4$  both receive equal input currents. Also,  $R_4$  is chosen so that  $I_{RS}$  is equal to  $I_{RL}$ , thus, the phototransistors of both these couplers operate

(continued on page 136)

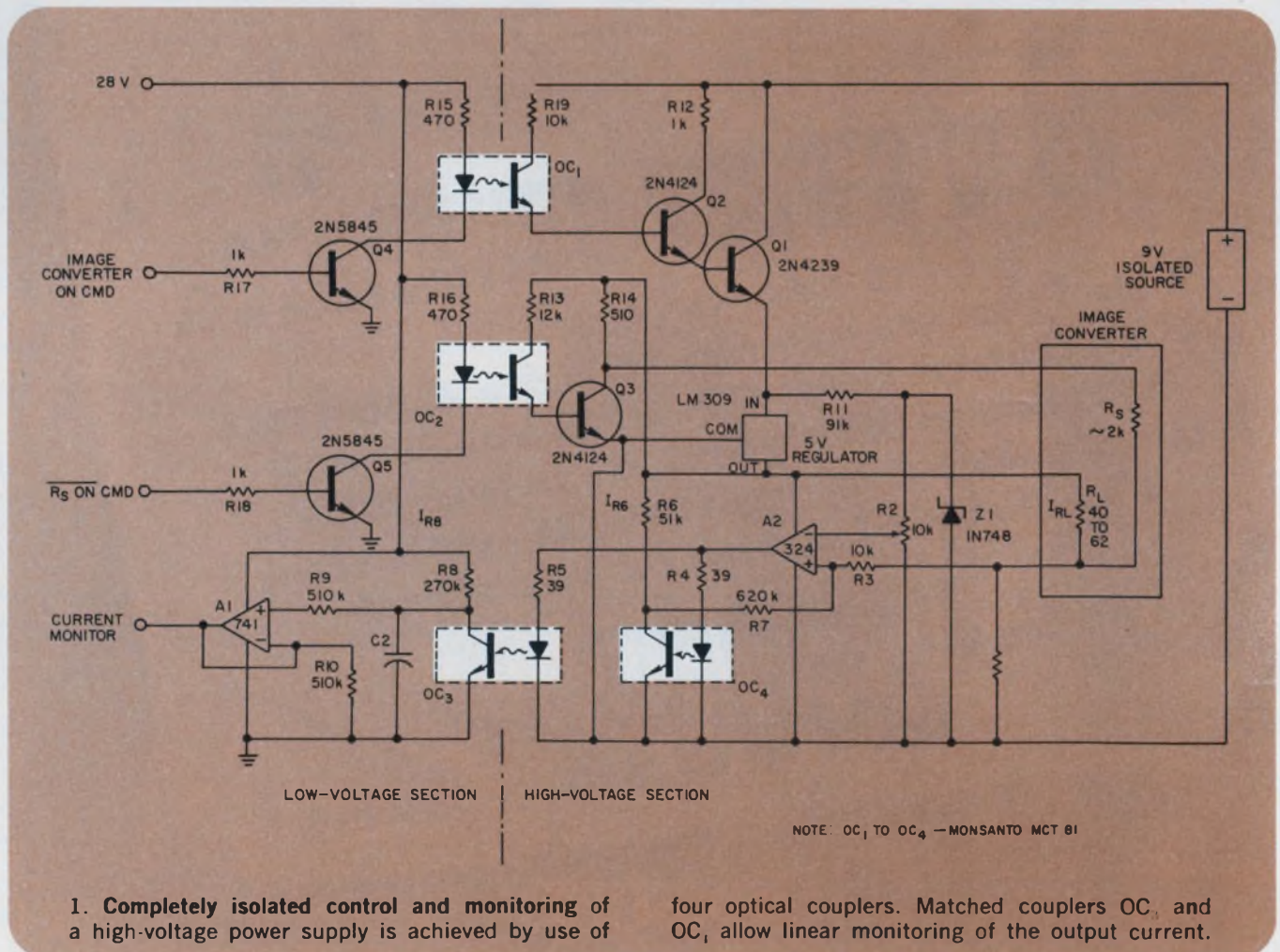

1. Completely isolated control and monitoring of a high-voltage power supply is achieved by use of

four optical couplers. Matched couplers  $OC_3$  and  $OC_4$  allow linear monitoring of the output current.



# "Should you make or buy control assemblies?"

We can simplify the decision.

It all boils down to dollars and cents. And the best way to make a business decision is to compare our quotation for making your next customized control assembly against your true cost of making it in-house.

Keep in mind the sizable capital outlay involved to turn out that first assembly if you do the job internally. Specialized production equipment. Assembly tools. Test equipment. People. Floor space. Additional inventory. You could tie up as much as \$100,000 just to set up.

On the other hand, if we make your control assembly you have none of the initial

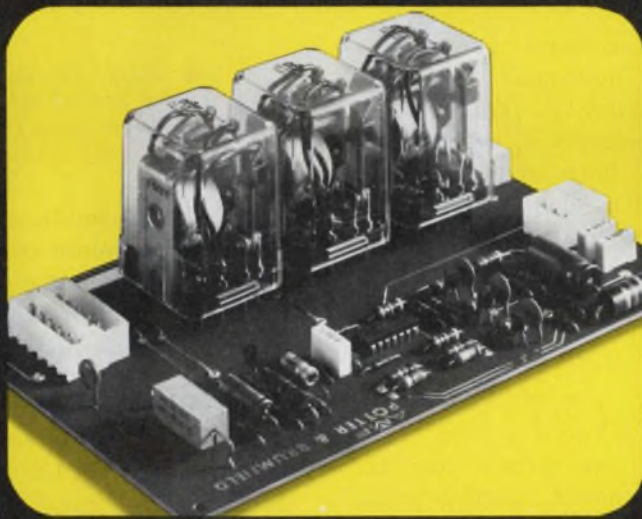

costs. You take advantage of our experience and purchasing discounts. We produce thousands of control assemblies every month. We have the people, the production and testing equipment. We can deliver any number of assemblies to any schedule you require. All 100% functionally tested. Before you decide to do it yourself see your local P&B sales

representative or contact Potter & Brumfield Division of AMF Incorporated, 200 Richland Creek Drive, Princeton, Indiana 47671. 812/386-1000.

**AMF**  
Potter & Brumfield

# Potter & Brumfield

(continued from page 134)

at the same point. If the couplers are reasonably well matched, care taken to equalize the conditions for both couplers results in a linear output.

Amplifier A<sub>1</sub> serves merely as a unity-gain output buffer whose dc-output voltage varies linearly with the current through R<sub>1</sub>.

Since the currents through R<sub>1</sub> and R<sub>s</sub> combine in R<sub>1</sub>, the circuit provides not only quantitative information on the image-converter's quiescent load current but also on the effect of the electronic shutter.

John Glaab, *Electronics Engineer, Observational Astronomy Branch, National Aeronautics & Space Administration, Goddard Space Flight Center, Greenbelt, MD 20771.* CIRCLE NO. 312

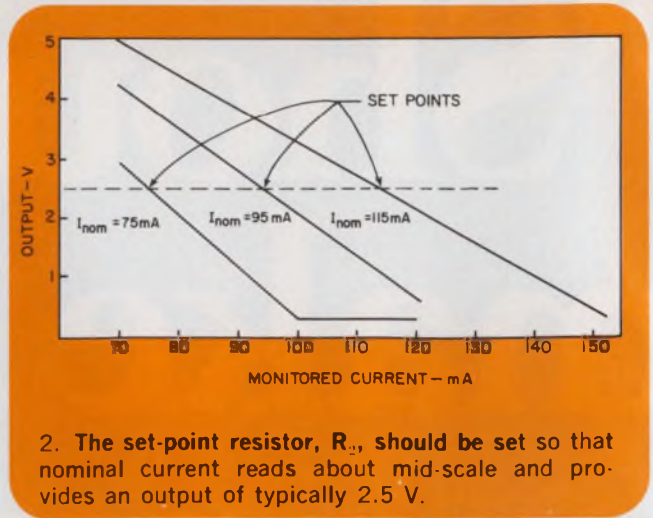

2. The set-point resistor, R<sub>s</sub>, should be set so that nominal current reads about mid-scale and provides an output of typically 2.5 V.

## Approximate the tangent function with a multifunction converter and op amp

You can mathematically approximate the tangent function to within 1.2% by using only a multifunction converter and an op amp.

Electronic computation of such nonlinear functions has frequently been performed by linear-segment approximations. Since a great number of such segments is required to make the actual response fit the desired function, the circuit can become very unwieldy.

However, a multifunction converter can simplify the approximation of nonlinear functions where only moderate accuracy is required.<sup>1</sup> A multifunction converter is simply a logarithmic multiplier/divider<sup>2,3</sup> that has been adapted to provide powers and roots. With the multifunction unit set for the noninteger power, 3.7, the tangent function can be approximated when the multifunction converter is combined with a summing amplifier (Fig. 1). The response for this combination is described by

$$e_o = -\frac{R_2}{R_1} \left[ \frac{e_i}{0.55} + E_{R1} \left( \frac{e_i}{E_{R1}} \right)^{3.7} \right]$$

Over the  $e_i/E_{R1}$  range of one radian, this expression approximates the tangent function within 1.2% as follows:

$$e_o \cong -\frac{R_2}{0.55R_1} E_{R1} \tan \frac{e_i}{E_{R1}}, \text{ for } 0 \leq \frac{e_i}{E_{R1}} \leq 1$$

The reference voltage,  $E_{R1}$ , determines the angular scaling of this expression; the resistance ratio,  $R_2/R_1$ , determines the amplitude scaling. With the values shown, the circuit is scaled for a 0-to-10-V output in response to the same input-signal range.

The mathematical approximation dominates the deviations from the true tangent function, except at low signal levels where circuit errors are sig-

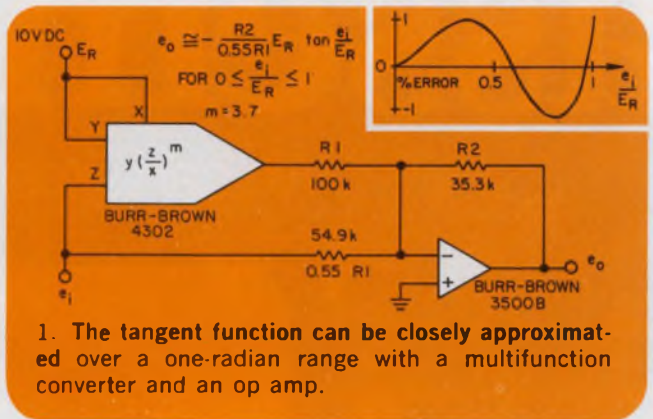

1. The tangent function can be closely approximated over a one-radian range with a multifunction converter and an op amp.

nificant. Mathematical deviation from the tangent is 1.2% maximum over a one-radian range. Beyond one radian, the deviation increases rapidly. Of course, additional deviations result from tolerances of the multifunction exponent, the summing amplifier and resistor ratio error.

The circuit tolerances introduce an error of about 0.1% of full scale, so the net maximum response error is 1.2% of amplitude plus 0.1% of full scale.

### References

1. Sheingold, D., "Approximate Analog Functions with a Low-Cost Multiplier Divider," *EDN*, Feb. 5, 1973.
2. Graeme, J., *Applications of Operational Amplifiers-Third Generation Techniques*, McGraw-Hill Book Co., New York, 1973.
3. Tobey, G., Graeme, J., Huelsman, L., *Operational Amplifiers; Design and Applications*, McGraw-Hill Book Co., New York, 1971.

Jerald Graeme, *Manager, Monolithic Engineering, Burr-Brown Research Corp., International Airport Industrial Park, Tucson, AZ 85734.*

CIRCLE NO. 313

# There's a Simpson DPM that's right for your application

## All Simpson DPM's feature:

- 0.1% accuracy
- 3-1/2 digit readout
- Automatic zero and polarity
- Dependable LSI circuitry
- Choice of 120/240 V AC or 5 V DC operation
- Panel cutout 1.682" x 3.622". Adaptors available for IEC/DIN and other domestic cutouts
- Input/output edge connector included
- Full 200 hour burn-in
- Backed by the Simpson one-year warranty



Model 2860

## The Dedicated DPM

New Series 2860—high performance at a low price

from **\$46\***

- 9 stock ranges available
- Bright 0.43" LED readout

## The Systems DPM

Deluxe Series 2850—printer/computer interfacing capability and options for custom applications

**\$92\***

- 9 stock ranges
- Specials available including AC ranges
- Choice of 0.43" LED or 0.55" planar gas discharge display
- BCD output standard

\*100-lot OEM prices

Available From  
Electronic Distributors  
Everywhere

Write for Bulletin P612  
containing complete  
technical specifications.



Model 2850



Model 2852



### SIMPSON ELECTRIC COMPANY

853 Dundee Avenue, Elgin, Illinois 60120

(312) 697-2260 • Cable SIMELCO • Telex 72-2416

IN CANADA: Bach-Simpson, Ltd., London, Ontario

IN ENGLAND: Bach-Simpson (U.K.) Ltd., Wadebridge, Cornwall

IN INDIA: Ruttonsha-Simpson Private, Ltd., Vikhroli, Bombay

KATY INDUSTRIES



INDUSTRIAL  
EQUIPMENT  
GROUP

# Trace symbols on CRT screen without access to the Z axis

Use a digital PROM instead of a special analog ROM, as is done by some makers of expensive scopes, and generate your own symbols on an ordinary oscilloscope. To get the X and Y analog waveforms that trace out the symbols on the CRT, convert the digital outputs of the PROM to analog voltages.

All the hexadecimal characters (Fig. 1) can be generated with high legibility by a  $5 \times 3$  matrix. An 8-bit PROM delivers 16 coordinate points that are scanned into a specific symbol. With the first and last points arranged to be adjacent, each character can be traced several times before the beam moves to the next character.

Outputs  $Q_0$  through  $Q_3$  of a 12-bit counter connected to lower-address inputs  $A_0$  through  $A_3$  of the PROM produce sequential tracing of the coordinates (Fig. 2). The upper four address inputs,  $A_4$  through  $A_7$ , select a specific character. To smooth the waveforms, a high scanning rate

(clock input of 250 kHz or higher) uses the limited frequency response of the two 741 op amps.

To generate horizontal and vertical spaces between the characters, add two staircase signals to the X and Y waveforms. The staircase signals can be derived from simple d/a converters driven by the  $Q_7$ -through- $Q_{11}$  outputs of the coordinate counter.

The display is not limited to alphanumeric, and the symbols need not be restricted only to a  $5 \times 3$  matrix.

Marco Barnig, Swiss Federal Institute of Technology, Department of Electronics, Zurich, Switzerland.

CIRCLE NO. 314

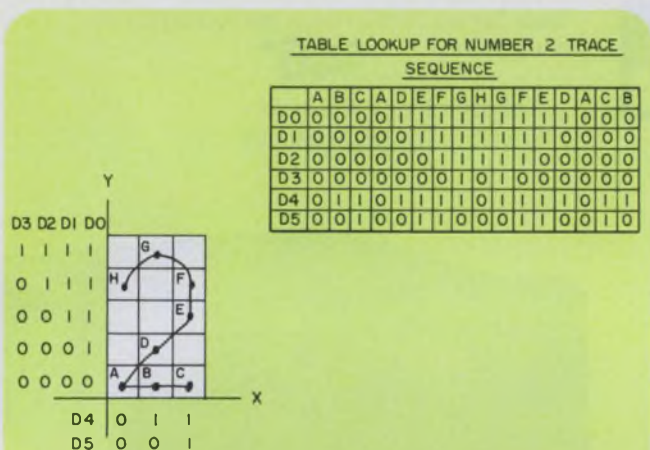

1. Each symbol is defined by 16 points derived from the output of a PROM.

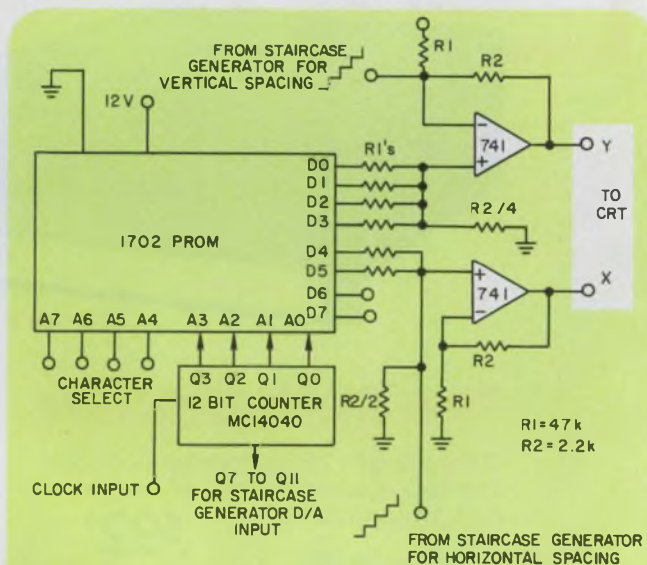

2. The characters are traced by analog signals X and Y. Two op amps convert the digital signals of the PROM and staircase generators (not shown) into the analog voltages.

## IFD Winner of October 11, 1976

Walter G. Jung, Pleasantville Labs, 1946 Pleasantville Rd., Forest Hill, MD 21050. His idea "Precision Voltage-to-Frequency Converter Uses Only Single Supply Voltage," has been voted the Most Valuable of Issue Award.

Vote for the Best Idea in this issue by circling the number of your selection on the Reader Service Card at the back of this issue.

**SEND US YOUR IDEAS FOR DESIGN.** You may win a grand total of \$1050 (cash)! Here's how. Submit your IFD describing a new or important circuit or design technique, the clever use of a new component or test equipment, packaging tips, cost-saving ideas to our Ideas for Design editor. Ideas can only be considered for publication if they are submitted exclusively to ELECTRONIC DESIGN. You will receive \$20 for each published idea, \$30 more if it is voted best of issue by our readers. The best-of-issue winners become eligible for the Idea of the Year award of \$1000.

ELECTRONIC DESIGN cannot assume responsibility for circuits shown nor represent freedom from patent infringement.



# FLAT SPRINGS

from Instrument Specialties  
cut your product's cost  
and improve performance!

Beryllium copper springs from Instrument Specialties can cut your installed costs several ways. I/S springs are more uniform, speeding assembly, because we heat-treat them *after* forming, in special fixtures. They can be delivered on strips, saving time at incoming inspection. They can be detached singly, without burrs, along precise score lines, eliminating tangling. Or, the strips can be designed for automatic assembly, virtually eliminating hand work.

What's more, Instrument Specialties springs improve your product's performance... ensure longer life... and protect *your* reputation—because they're precision-made of beryllium copper, with its inherently superior endurance life, conductivity and reliability.

We can stamp them with proprietary dies made and held exclusively for you, or, in some cases, adapt our standard tools. Or, photo-etch them, when short runs make expensive tools uneconomical.

Our catalog gives you complete information. It's free for the asking. Write today to Dept. ED-83.

**INSTRUMENT SPECIALTIES CO., INC.**

Little Falls, New Jersey 07424

telephone: 201-256-3500 twx: 710-988-5732

*Specialists in beryllium copper since 1938*



## Fast semi switch handles large surge currents

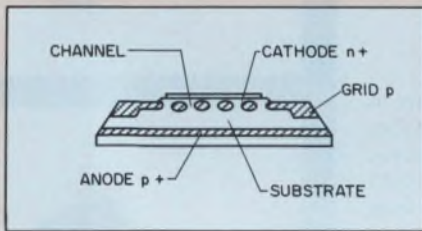

A high-power semiconductor switch can match the thyristor in its surge-current capability and high blocking voltage, yet has turn-off times nearly as fast as those for transistors. Moreover, the energy required to turn off the device, called a gridistor, is several orders of magnitude lower than that needed to turn off an equivalent thyristor.

Developed by Alsthom-Dre, in Massey, France, the gridistor, is a field-effect device with a p-i-n diode structure that uses a p-type low-resistivity grid in the I region to define a number of channels (see Fig.). The channels can all be blocked simultaneously by the field effect.

High turn-off current capability, with switching in microseconds, is achieved by a high degree of cathode-grid interdigitation. Conse-

quently, the grid's series resistance is reduced considerably.

An experimental gridistor has a 49-mm<sup>2</sup> metalized cathode area. Each grid finger is about 500  $\mu\text{m}$  long and 40  $\mu\text{m}$  wide. The I channel, less than 10  $\mu\text{m}$  wide, can be blocked by only 10 to 20 V between grid and cathode.

The grids are formed by masked-boron diffusion. An epitaxial n-type layer is then grown, followed by an n<sup>+</sup> diffusion for the cathode. Grooves are etched in the n layer to permit aluminum-grid contacts to be made.

When the grid is not connected, the device works as a p-i-n diode. When the grid is negatively biased, current is blocked. Typical forward-breakdown voltages of 700 V have been achieved with a  $V_G$  equal to 18 V.

Unlike the thyristor, no regenerative action occurs in the conducting state. This lack of regenerative action leads to more uniform dynamic characteristics. Also, the gridistor is not hampered by the thyristor's limitations of di/dt and dv/dt.

Prototype devices have been able to switch currents up to 200 A.

an accuracy of  $\pm 33$  ns within a 750- $\mu\text{s}$  cycle time, during which the satellite receiver effectively scans through the signals coming from each of the earth stations. The signals must arrive at the satellite in the right sequence and take into account not only the different and changing path lengths between earth stations and the satellite but also unpredictable atmospheric conditions.

With TDMA, the timing information is relayed via a global beam that is transmitted from the satellite as a series of sine-wave, frequency-modulated carriers. Each ground station has its own carrier frequency within the global-beam transponder. Thus, a spectrum of FM signals is transmitted and received at the satellite, each signal corresponding to one ground station.

At one of the ground stations, a master synchronizer transmits the essential timing information from which all other ground stations derive their standard. Each ground station receives not only the master signal, but also its own looped-back timing signal. Synchronization is achieved by comparing the looped-back signal with the master signal.

Several problems are involved, the chief one being the poor quality of the global timing signal. Cleaning up the signal demands that averaging be performed within the synchronizer equipment.

The averaging, which can take up to one second, is done partly by digital means because the error contributed by strictly analog averaging components would be too high. The averaging system itself is basically a hybrid with analog filtering down to 300 Hz combined with repetitive phase-error measurement to attain the goal of 30-ns accuracy.

Inaccuracy introduced by the equipment itself is eliminated by measuring errors and subtracting them from the signals.

## Earth-to-satellite beams can now be synchronized

Processing digital signals from several sources, which is being investigated by the British Post Office for use in satellite communications, will make it possible to satisfy the changing demands of various earth stations. But the method, known as time-division multiple access (TDMA), requires a continuously variable synchro-

nization system that is extremely accurate. Such a system has been developed by Cambridge Consultants of Cambridge, England.

Spot-beam transmissions of a worldwide digital satellite-communications system must be accurately timed to arrive at the satellite at the correct instant and in the right order. This timing requires

# The Solid State Memory

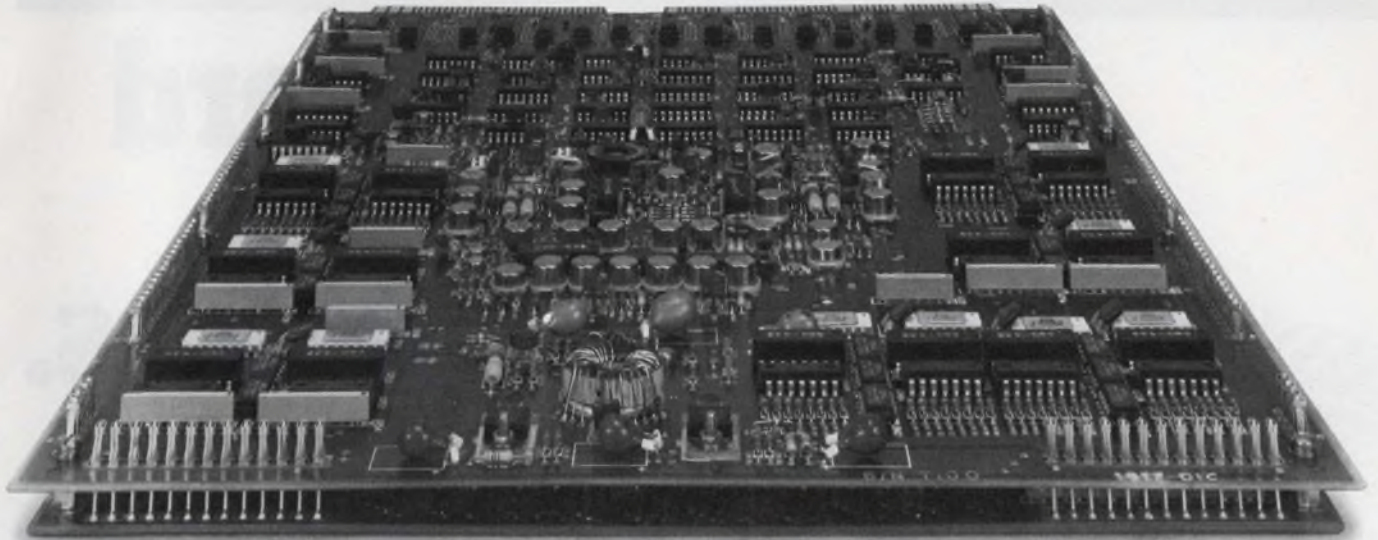

## That Works

Here's a new solid state memory that works wherever a reliable, non-volatile, high capacity, fast access digital memory is needed.

Ampex 3220 Series core memories are modular. Individual modules store 32K words of up to 20 bits each, and you can combine as many as 16 modules for a total memory capacity of 512,000 words.

New 3220 Series memories are fast, too. Data access within 275 nanoseconds and full cycle in 650 nanoseconds. And power supply options offer a choice of +5/+15 volts or +5/+15/-15 volts.

Size is no problem. Ampex 3220 Series memory modules measure *less* than 1 by 12 by 16 inches. And you can get a complete system from Ampex, too, complete with cage space for 4, 8 or 16 modules plus power supply, blowers and logic interface.

Versatility is another advantage of Ampex 3220 Series memories. They're physically and electrically compatible with Ampex 1600 Series and with Micro 3000 Series products. And you'll get far wider operating margins, thanks to temperature independent core formulation.

Solid design. Solid performance. Solid reliability. Solid value. Ampex Core. The solid state memory that works.

**AMPEX**

Ampex Memory Products Division  
200 N. Nash Street, El Segundo, California 90245  
(213) 640-0150

# Arrow-M Amber Relays

## solve PC board cleaning problems.



Arrow-M's leak-free Amber Relays are N<sub>2</sub> gas-filled and sealed in plastic so they're simple to clean with most degreasers and detergent cleaners, without affecting the maximum contact reliability of the relays.

And, Arrow-M can help you substantially reduce your labor costs! Just use Arrow-M Amber Relays on your PC board in conjunction with automatic wave soldering, instead of costly hand soldering.

The total savings are even greater when you use Arrow-M Amber Relays. Arrow-M Amber

Relay prices are right in line with standard non-seal types.

Arrow-M Amber Relays. When you want maximum reliability and maximum savings. And only Arrow-M makes them.

For more information on exact specifications, write or call your nearest Arrow-M office.

**Arrow-M Corporation**  
250 Sheffield Street  
Mountainside, N.J. 07092  
(201) 232-4260

*Western Office:*  
22010 South Wilmington Ave.  
Suites 300 & 301  
Carson, California 90745  
(213) 775-3512

### Relays for advanced technology.

**KE**—Sensitive—  
Long Life—10<sup>8</sup> mech.

**NFE**—  
New Low Profile—  
High Sensitivity

**HCE**—  
Miniature  
Power  
Type.

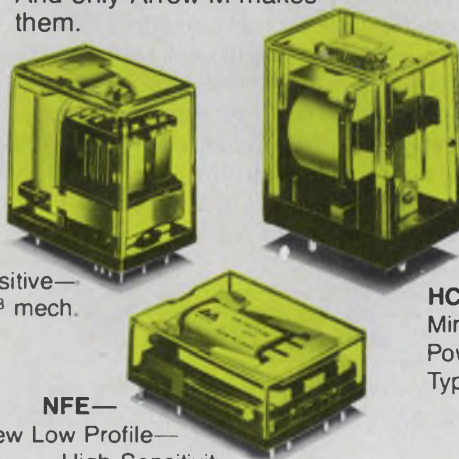

**Arrow-M**  
Member of Matsushita Group



# New Products

## Four-quadrant multiplier replaces MC1495s

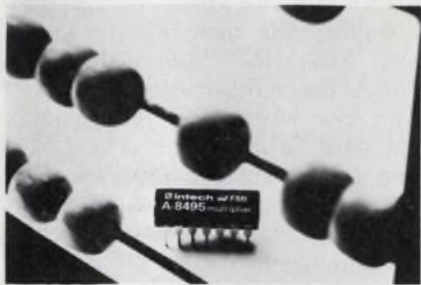

Intech/FMI, 282 Brokaw Rd., Santa Clara, CA 95050. (408) 244-0500. \$5.25 (1 to 24); stock.

The A-8495 four-quadrant multiplier is a direct pin-for-pin replacement for the MC1495L. The monolithic circuit offers a linearity of  $E_{RX} = 1.5\%$  maximum. Other features include guaranteed feed-through performance of  $Y_{fi} (X_{fi}) = 65 \text{ mV} (120 \text{ mV})$  max for a 20-V pk-pk, 1-kHz signal on the X (Y) input. The A-8495 can multiply, divide, and square root when used with an op amp. It operates over the 0-to-70-C range and versions are available for the military temperature range. The multiplier comes in a 14-pin ceramic DIP.

CIRCLE NO. 306

## Analog switches offered in four configurations

Texas Instruments, P. O. Box 5012, Dallas, TX 75222. John Spencer (214) 238-2011. From \$1.45 (100-up); stock.

A series of monolithic analog switches, the TL182, TL185, TL188 and TL191, built from BIFET technology, contains ion-implanted JFETs, p-channel MOSFETs, plus bipolar components—all on the same chip. The TL182 is a twin SPST switch, the TL185 is a twin DPST unit, the TL188 is a dual complementary SPST switch and the TL191 consists of two dual complementary SPST analog switches. Both the TL182 and TL188 come in 14-pin plastic DIPs or 10-pin metal-can packages, and the TL185 and TL191 come only in 16-pin plastic DIPs.

CIRCLE NO. 307

## 1-k CMOS RAMs access data in only 250 ns

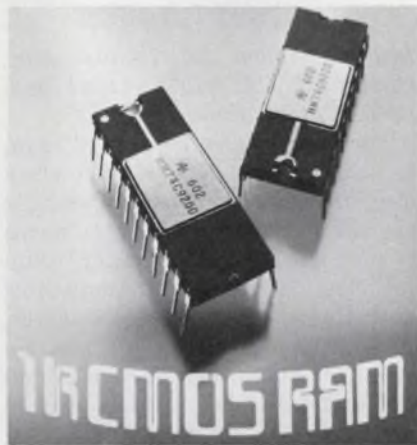

National Semiconductor, 2900 Semiconductor Dr., Santa Clara, CA 95051. Ron Livingston (408) 737-5000. From \$12.15 (100-up); stock.

Two 1024-bit CMOS RAMs are available with  $256 \times 4$  organizations. The RAMs, known as the MM54/74C920 and the MM54/74C921, come in 22 and 18-pin DIPs, respectively. The 920 has separate data-in and data-out lines, while the 921 has common I/O lines. Both RAMs have an access time of 250 ns (for the commercial version). The 74C920 has the same pin arrangement as the 2101 1-k RAM, with a strobe input to reduce power to about 3 mW. In the standby power-down mode, power consumption is only a few microwatts. Data output and data input are the same polarity in both the 920 and 921. The RAMs operate from standard TTL power supplies, and all inputs and outputs can be interfaced directly with TTL. Complete address decoding, along with two functions ( $\overline{CEL}$  and  $\overline{CES}$ ) for selecting chips plus three-state outputs permit easy expansion.

CIRCLE NO. 308

### Filler

We learn from HP's Bob Frohwerk, who feels that counting in binary is passé, that there's a nefarious relationship between Halloween and Christmas:

$$31_{Oct} = 25_{Dec}$$

## 5-V reference doubles as linear thermometer

Precision Monolithics, 1500 Space Park Dr., Santa Clara, CA 95050. Donn Soderquist (408) 246-9222. See text.

Developed as a single-chip 5-V reference, the REF-02 provides both a stable 5.00-V output and a temperature-dependent voltage output of +630 mV at 25 C. The temp output has a typical temperature coefficient of +2.1 mV/°C, which can be used to provide temperature readout. Supplies from 8 to 40 V can be used and the unit requires only 1 mA of standby current. The reference voltage tempco is 8.5 ppm/°C (maximum) and is not affected by adjusting the output voltage over a 6% range. Typical specifications include turn-on settling time to  $\pm 0.1\%$  of 5  $\mu\text{s}$ , line regulation of 0.007%/V, and load regulation of 0.006%/mA over a 0-to-10-mA range of output current. Output current can be boosted to 4 A with the addition of a 2N6053 pnp Darlington power transistor. The unit comes in a TO-99 package and is available in seven models, ranging in cost from \$1.90 to \$26.40 in 100-unit quantities.

CIRCLE NO. 309

## Low-power Schottky ALU comes in 20-pin DIP

Advanced Micro Devices, 901 Thompson Pl., Sunnyvale, CA 94086. Elliot Sopkin (408) 732-2400. From \$2.94 (100-up); stock.

Two low-power Schottky circuits combine the key functions of the Am54/74LS181 4-bit ALU with the convenience of the 300-mil wide 20-pin package. The Am25LS381 performs three arithmetic functions (A minus B, B minus A, and A plus B) and three logic functions (A  $\oplus$  B, A + B and A  $\cdot$  B) on two 4-bit words.  $\overline{G}$  and P outputs are provided for full carry-look-ahead operations. The Am25LS2517 is similar to the Am25LS381 except that  $C_n + 4$  and overflow (OVR) outputs are provided for use in cascaded applications. Both devices are available in molded and hermetic DIPs and ceramic flat packages.

CIRCLE NO. 310

## INTEGRATED CIRCUITS

### Monolithic d/a includes built-in reference

Analog Devices, Route 1 Industrial Park, P.O. Box 280, Norwood, MA 02062. Lowell Wickersham (617) 329-4700. From \$9.95 (100-up); stock.

The AD561, a monolithic, 10-bit, d/a converter, contains its own internal reference. It is accurate to  $\pm 1/4$  LSB, and its monotonicity is guaranteed over the 0-to-70-C operating range. The bipolar converter comes in four versions: The AD561J and AD561K operate over 0-to-70-C temperature range and are accurate to  $\pm 1/2$  to  $\pm 1/4$  LSB, respectively. The AD561S and AD561T are specified to the same respective accuracies over the -55 to +125 C range. Converter settling time is 250 ns to 1/2 LSB, and full-scale tempo is 30 ppm/ $^{\circ}$ C max for the K and T versions, 60 ppm/ $^{\circ}$ C for the S and 80 ppm/ $^{\circ}$ C for the J model.

CIRCLE NO. 320

### Timebase circuit eases counter design

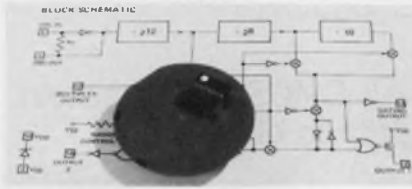

Intersil, 10900 N. Tantau Ave., Cupertino, CA 95014. (408) 996-5000. \$4.40 (100-up); stock.

Developed as a frequency counter timebase, the ICM7207A when used together with a 5.24288-MHz crystal and a 7-digit counter forms a complete timer/frequency counter. The 7207A is pin compatible with the company's 7207; however, it additionally has a 0.1 and 1-s count enable window output. Crystals cut for 1 to 10 MHz can be used, and the circuit provides outputs at the crystal frequency, and at  $\div 2^{12}$ ,  $\div 2^{20}$  or  $\div (2^{20} \times 10)$ . The CMOS circuit dissipates less than 5 mW when operating at 5 V, and is available in a 14-pin DIP or as unpackaged chips.

CIRCLE NO. 321

### 4-bit counters come in four technology versions

Raytheon, 350 Ellis St., Mountain View, CA 94040. Ray Solis (415) 968-9211. \$1.50 (100-up); stock.

Eight low-power Schottky 4-bit synchronous counters are available across the full range of LS technologies: the new military-standard 9LS, the high-performance 25LS, the military-standard 54LS and the industrial/commercial-standard 74LS devices. The LS161 and LS163 are synchronous, 4-bit binary counters that feature internal look-ahead counting, synchronous or asynchronous clear, and a carry output for n-bit cascading. The LS160 and LS162 are BCD-decade versions of the 161 and 163. The LS191 and LS193 are synchronous 4-bit, binary, up/down counters that have up/down count-mode control, asynchronous parallel-load and individual preset inputs, and are fully cascadable. The LS190 and LS192 are presettable, synchronous, BCD-decade versions of the 191 and 193.

CIRCLE NO. 322

## Problem:

You need positive alignment.

## Solution:

See Bud's new modular packaging system. When you insert a circuit board it slips into the edge connector every time.

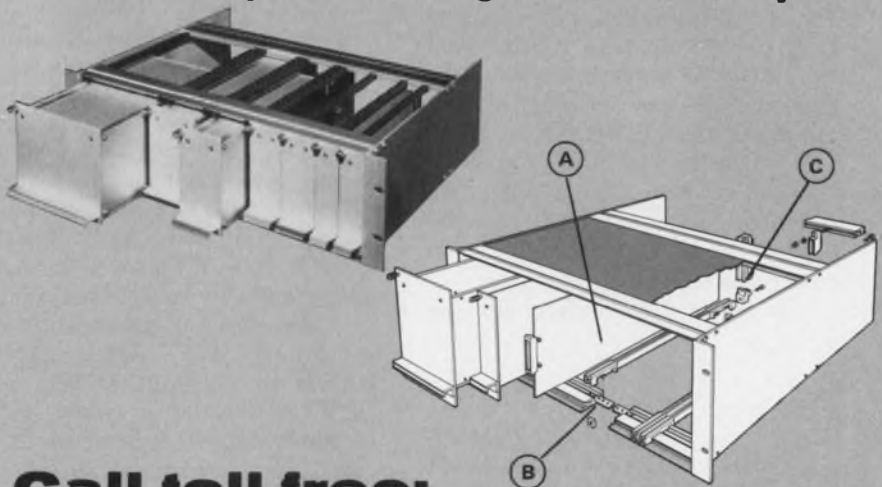

One-piece, full-length guides (a) provide accurate alignment of circuit boards and edge connectors. You can vary guide spacing (b) on any pitch that is a multiple of 0.200" up to a maximum of 42 stations on 0.400" pitch. End foot (c) provides lead-in for board and allows edge connector to be full height of board — no profiling necessary. Use any one of 44 different size modules: 30 sub-unit kits, eight sub-rack kits, six printed board kits. **YOUR PROBLEM IS SOLVED!**

Call toll free:

(800) 321-1764 for more facts. In Ohio, (800) 362-2265.

# BUD

BUD RADIO, INC.  
Willoughby, Ohio 44094

# MINI POWER

# MICRO PRICE \$868

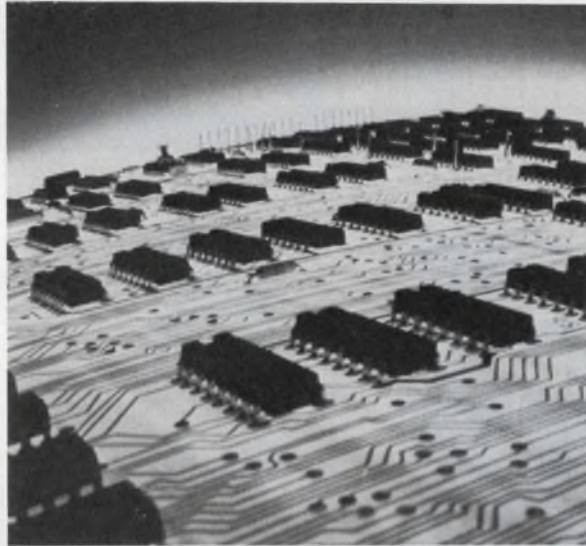

## OEMs Get Both With The 5/16

Interdata's 5/16 offers full scale mini-computer performance coupled with the economy of a microprocessor system.

By allowing OEMs to interface with I/O devices for the 8080 and 6800, the 5/16's unique Micro Bus substantially cuts total system cost. And, its Multi-plexor Bus makes the 5/16 compatible with higher performance Interdata processors for simple upgrading.

Housed on a single board, the 5/16 is a full 16-bit processor with 16 general purpose registers and 114 instructions. Up to 64KB of 600 nanosecond NMOS memory. And field proven software, such as batch and multi-tasking operating systems, FORTRAN and BASIC.

The 5/16 delivers top power at a bottom price... \$868 in quantity. Standard benefits of Interdata's OEM minicomputer family.

CLIP AND MAIL TODAY:

Tell me more about your 5/16 mini capabilities.

NAME \_\_\_\_\_

TITLE \_\_\_\_\_

COMPANY \_\_\_\_\_

ADDRESS \_\_\_\_\_

CITY \_\_\_\_\_ STATE \_\_\_\_\_ ZIP \_\_\_\_\_

**INTERDATA**<sup>®</sup>

A UNIT OF PERKIN ELMER DATA SYSTEMS  
Oceanport, N.J. 07757 (201) 229-4040

EN-F

CIRCLE NUMBER 70

# Data collection made easy with reliable low cost optical badge and card reader.

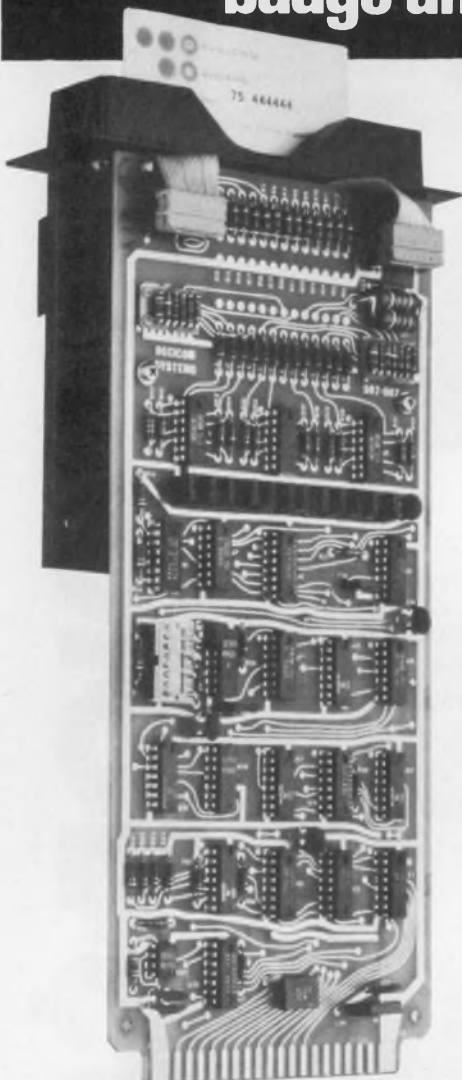

**ALPHA-NUMERIC Model P-12**

**The only reader that interchanges plastic & paper cards.**

Hollerith-punched paper or plastic cards read instantly. At any insertion speed. No adjustments necessary.

**A complete package.** No code converters to add. Plugs into standard printed circuit connector.

Internal or external clocking capability. All information and controls in one unit.

**No moving parts.** Won't damage cards, badges. Advanced optical sensing and electronic logic circuitry for high reliability, long life.

**Transmit at any speed.** Independent data clocking and storage enables reader to transmit at desired rate without adjustments.

**Self-checking! Can't make a mistake.** Integrated monitor signals any defect in a sensor, light source, card, number of characters or position of card. Transmits only good messages.

**NUMERIC Model D-57**

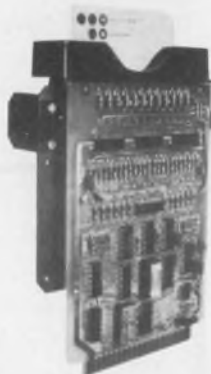

**Adapts to most card data collection needs.**

Decicom units speed production and inventory control, cost accounting, time and attendance monitoring, library systems, etc.

*Ask us how optical reliability can improve your data collection.*

# Decicom

DECICOM SYSTEMS, INC. 250 Adams Blvd., Farmingdale, N.Y. 11735 • 516/293-9270

CIRCLE NUMBER 71

## INTEGRATED CIRCUITS

### Series of 16-k RAMs gives choice of access

Texas Instruments, P. O. Box 5012, Dallas, TX 75222. (214) 238-2011. From \$61 (100-up); stock.

A 16-k NMOS dynamic RAM, the TMS 4070, is available with a choice of three access times: 350, 300 or 250 ns. All inputs and outputs are fully TTL compatible including clocks, Row Address Strobe, and Column Address Strobe signals. The address and data inputs are latched to simplify system design, while the data output is unlatched for greater flexibility. Typical power dissipation is less than 600 mW, active, and 10 mW, standby. Operation in common I/O systems is simplified by the early write feature of the TMS 4070 and faster access and cycle times are possible if the "page-mode" feature is used. Page-mode address times of 255, 210 and 165 ns are available. The TMS 4070 is supplied in a 16-pin, 300-mil wide ceramic DIP and is rated for operation over 0 to 70 C.

CIRCLE NO. 323

### Instrumentation amps have input Zs of 2 GΩ

National Semiconductor, 2900 Semiconductor Dr., Santa Clara, CA 95051. (408) 737-5000. 100-up price: \$5.50 (LF152); stock.

Known as the LF152 series, the monolithic JFET-input instrumentation amplifiers offer the combined advantages of high-input impedance and high common-mode rejection. The amplifiers have an input impedance of  $2 \times 10^{12} \Omega$  at a bias current of only 3 pA. At a gain of 100 the minimum dc common-mode rejection (referred to the input) is 100 dB for the LF252/352 models and 110 dB for the premium LF152 unit. A single resistor sets the gain at any value between 1 and 1000. The small-signal gain bandwidth at a gain of 1 is 50 kHz and the full power bandwidth is 25 kHz, both typical. The amplifier models are housed in 16-pin DIPs and require  $\pm 15$ -V supplies from which they draw only 1.8 mA, max. The LF152 is rated for -25 to +125-C operation, the LF252 for -25 to +85 C and the LF352 for 0-to-70-C operation.

CIRCLE NO. 324

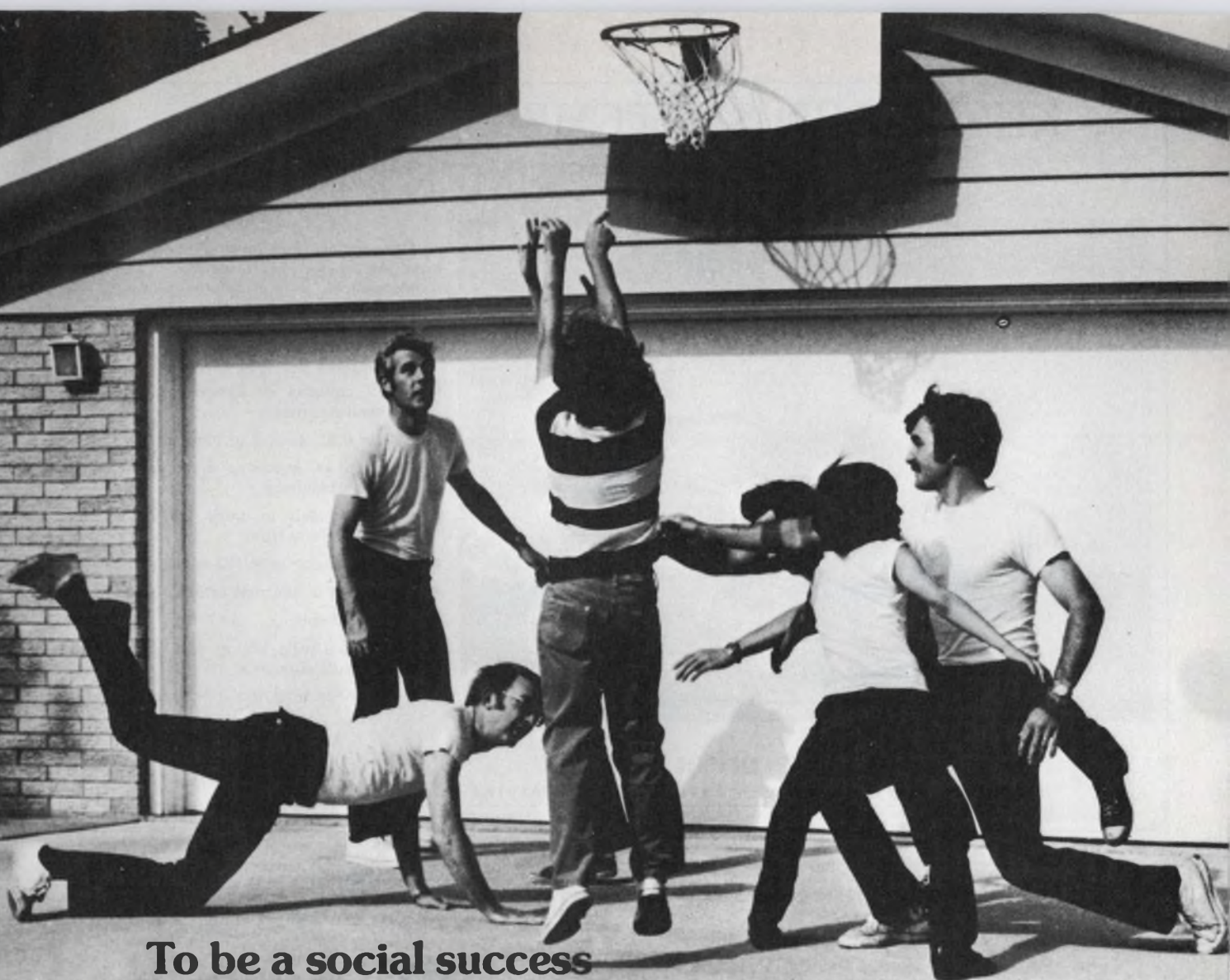

**To be a social success  
in Wabash, Indiana it helps to be  
good at playing basketball and designing coils.  
Some of us are still working on the basketball.**

If you're from these parts, people expect you to be good at one or the other. Our engineers are 'bout the best there is when it comes to designing coils. In fact, that's the reason why Wabash coils are famous and why Wabash makes the most molded coils in the United States, including epoxy, nylon, and engineered thermoplastic and thermoset materials.

But their basketball game...is awful. So on Saturday afternoons you can expect to find them over at Don Fisher's trying to pick up a few pointers from the kids. But it really doesn't bother them as much as they'd let you think. As Dick Kosiarek, our Coil Engineering Vice President put it, "George McGinnis never designed a coil in his life".



Shown: custom engineered thermoplastic and thermoset molded coils for automotive applications.

*Coils, Relays & Transformers*

**wabash**  
of  
**Wabash, Indiana**

and Huntington, Indiana; Farmington, Missouri;  
Tipton, Iowa and South Boston, Virginia

For information and quotes write or call:  
Wabash, Inc., Dept. CA-6, 810 N. Cass St., Wabash, Ind. 46992 Tel: 219/563-3111 TWX 810-290-2724

CIRCLE NUMBER 72

# KEYBOARD SWITCHES for INSTRUMENT PANELS

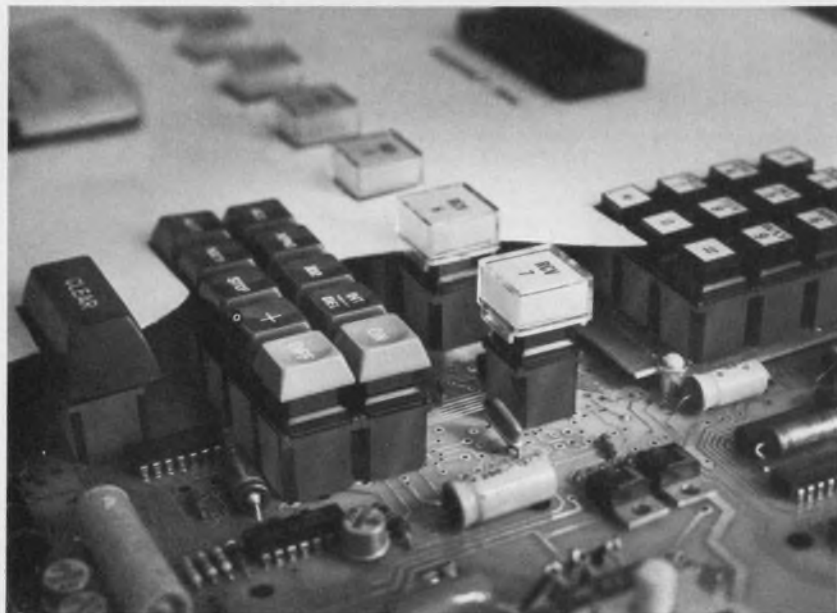

Now is the time to stop hand wiring to expensive panel-mounted switches.

Mechanical Enterprises' keyswitches are available at about *half-the-cost*. And, they are *self-supporting* on the PC board without the need for metal sub-plates.

Our switches feature —

- Sealed contacts or inexpensive gold bar mechanical contacts
- 3/4" or 5/8" spacing, or stand-alone
- Selection of legending systems including doubleshot keytops
- Lighted models in three lens styles, all relampable from front
- Single or double pole, NO or NC
- Momentary or alternate action
- Wave solderable
- 20 million cycle life at TTL loads with guaranteed low bounce

Please phone for a free sample with keytop.



**Mechanical Enterprises, Inc.**

8000 Forbes Place Springfield, Virginia 22151 (703) 321-8282 TWX 710-832-0942

Germany - NEUMULLER GMBH, MUNICH / U.K. - TEKDATA Ltd., STOKE-ON-TRENT / France - TEKELEC AIRTRONIC, SEVRES / Switzerland - DIMOS, AG ZURICH

CIRCLE NUMBER 114

All-new Phi-Deck,<sup>®</sup>  
precision remote controlled  
cassette transports starting at  
under \$100!



Featuring:

- Re-engineered precision parts
- New cast frames
- 4 motor reliability
- Remotely controlled
- Precise, fast head engage/disengage
- Quick braking
- Various speed ranges

Electronic packages for control or read/write

For application in:

- |                                   |                                       |
|-----------------------------------|---------------------------------------|
| 1. Micro processing               | 6. Data duplicating                   |
| 2. Data recording/logging/storage | 7. Security/automatic warning systems |
| 3. Programming                    | 8. Test applications                  |
| 4. Instrumentation                | 9. Audio visual/education             |
| 5. Industrial Control             | 10. Hi-Fi                             |
|                                   | 11. Others                            |



**Triple I** A Division of The Economy Co.

1901 North Walnut P.O. Box 25308  
Oklahoma City, Oklahoma 73125 (405) 521-9000

- I am interested in application no. \_\_\_\_\_  
 Have Representative call  Send application notes

Name \_\_\_\_\_ Title \_\_\_\_\_  
Company Name \_\_\_\_\_  
Address \_\_\_\_\_  
City \_\_\_\_\_ State \_\_\_\_\_ Zip \_\_\_\_\_  
Phone Number \_\_\_\_\_

CIRCLE NUMBER 115

## AC POWER PROBLEMS? voltage } frequency } OK? phase }



**LOGITEK Power Monitors** are used where electrical systems must be de-energized, loads shed or alarm devices activated when any power line characteristic varies above or below normal pre-specified limits.

**SPECIFICATIONS:**

**ACCURACY:** ± 0.1%, 1%, 5%  
**TEMPERATURE:** -55°C to +125°C  
-10° to +70°C  
**INPUT VOLTAGE:** 115/220/440 VAC  
50/60/400 Hz  
Delta/WYE

**CONTACTS:** 2 Amps, 10 Amps.

516-694-3080

**LOGITEK INC.**

42 CENTRAL AVE. • FARMINGDALE, N.Y. 11735

CIRCLE NUMBER 116

## Quad op amp comes with guaranteed minimums

Raytheon Semiconductor, 350 Ellis St., Mountain View, CA 94040. Dan Anderson (415) 968-9211. From \$1.88 (100-up); stock.

The RC/RM4156, a quad op amp, features guaranteed minimums on slew rate and unity-gain bandwidth. In addition, maximum input voltage noise is specified over the audio range of 20 Hz to 20 kHz. The circuit design retains the general-purpose capabilities of 741-type op amps but provides improved ac response over the audio range. Power supply drain for the 4156 is a maximum of  $\pm 7$  mA for the commercial unit (RC) and  $\pm 5$  mA for the military unit (RM). The minimum slew rate is 1.3 V  $\mu$ s, which provides a full-power response of 20 kHz. Minimum unity-gain bandwidth is 2.8 MHz and the input noise voltage is less than 2  $\mu$ V rms over 20 Hz to 20 kHz. Short-circuit output current is limited to approximately 25 mA and indefinite short-circuits to ground can be handled. The 4156 comes in a 14-pin plastic or ceramic DIP and is available in three temperature versions: 0 to 70, -40 to +85 and -55 to +125 C. Probed wafers or chips are also available.

CIRCLE NO. 325

## Priority encoders handle eight input lines

Advanced Micro Devices, 901 Thompson Pl., Sunnyvale, CA 94086. Elliot Sopkin (408) 732-2400. From \$1.94 (100-up); stock.

Two eight-line-to-three-line priority encoders, the Am25LS148 and Am25LS2513, are made with low-power Schottky processing. The 148 does priority decoding from eight inputs and provides a binary weighted code of the priority order of the inputs. It is available in a 16-pin package and offers standard totem-pole outputs. The Am25LS-2513 is a gated three-state output version of the Am25LS148 and comes in a 20-pin package. Both devices are available in molded and hermetic DIPs and ceramic flat packages.

CIRCLE NO. 326

# A NEW GENERATION OF IMAGE SENSORS

## SIMPLICITY OF USE

Requiring less than a dollars worth of circuitry to drive—and barely more than that for video processing—is just one of the key features of our new “G” series image sensors. Compare the non-critical single TTL clock needed for the “G” device to the complex multi-phase clocks prescribed by others.

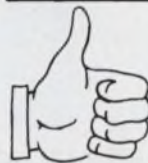
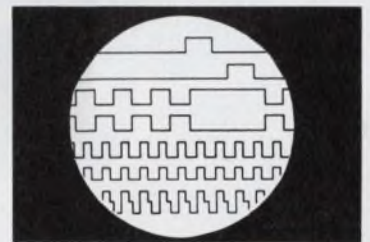
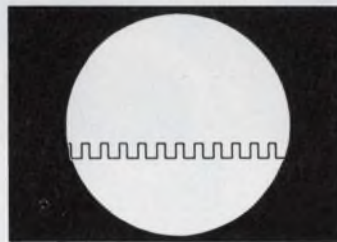

You need only this for Reticon



You need all these for others

## HALF THE PRICE

Or even less will bring you 256, 512, 768, or 1024 sensor elements on 25 $\mu$  centers or up to 1728 elements on 15 $\mu$  centers in our “H” series.

## SUPERIOR PERFORMANCE

Low dark current allowing low light level operation, on-chip noise cancellation, and smooth spectral response from visible through infrared makes this new generation the unquestionable choice.

## APPLICATIONS

Page readers, facsimile, OCR, point of sale readers, non-contact measurements and inspection and many others.

# RETICON®

910 Benicia Avenue, Sunnyvale, California 94086  
PHONE: (408) 738-4266 TWX: 910-339-9343

CIRCLE NUMBER 75

# Still chained to wire?



## Break the wire habit with Repco's modular RF links and discover new design freedom.

Repco's modular RF links are used in hundreds of applications including remote and supervisory control, voice communications, alarm and reporting systems... all become more versatile and effective through the use of Repco's rugged, reliable RF transmitters and receivers.

Repco's RF links are packed with performance features: *multiple transmission modes designed to carry tone, voice or low-speed digital data; a wide VHF/UHF frequency range; all units meet FCC and DOC requirements.*

Best of all, Repco's RF links are *economical*. They beat hard wire system costs over the long haul, thus affording you maximum performance at minimum expense. Now is the time for you to link up... with Repco's versatile RF links! Write or call today for free specs brochure, application booklet and special evaluation offer.



TX

# Repco Inc.

A subsidiary of Scope, Inc.  
1940 Lockwood Way  
Orlando, FL 32804  
(305) 843-8498



RX

World's leading manufacturer of modular communication products.

CIRCLE NUMBER 76

## INTEGRATED CIRCUITS

### 16-k RAM zips along with 150 ns access time



Mostek, 1215 W. Crosby Rd., Carrollton, TX 75006. (214) 242-0444. 100-up prices: \$100 (4116P-2); \$50 (4116P-3); stock.

Claimed to be the fastest 16-k RAM, the MK 4116P-2 offers a 150-ns access time and a 375-ns cycle time. The chip area is also the industry's smallest—it measures 122 × 227 mils. The dynamic RAM is housed in a 16-pin DIP. Additional system oriented features of the 4116 include a low power of 462 mW, active, and 20 mW, standby (max); a ±10% tolerance on all power supplies (+12, ±5 V); 128 refresh cycles; on-chip address and data registers; and two chip-select methods. In addition to the usual read, write, and read-modify-write cycles, the unit is capable of delayed-write cycles, page-mode operation and RAS-only refresh. The page-mode feature permits successive memory operations at multiple column locations of the same row address with increased speed without an increase in power. Access time during page mode is 100 ns for the MK 4116P-2 and 135 ns for the MK 4116P-3.

CIRCLE NO. 327

### Audio power amplifier delivers 5.8 W

NEC America, 3070 Lawrence Expressway, Santa Clara, CA 95051. (408) 738-2180. \$1.67 (small qty); stock.

Able to deliver 5.8 W of audio power, the  $\mu$ PC1156H monolithic audio amplifier features short-circuit protection. The circuit is designed to operate from a 13.2-V supply and feed a 4- $\Omega$  load. A 10-pin single-in-line package houses the circuit and an integral metal tab mounts to the heat sink. Overall total harmonic distortion is 0.2%, typical and noise is typically less than 1.4 mV rms.

CIRCLE NO. 328



**Monolithic capacitors have been  
our business for nearly three decades.**

**We build them better.**



## **Our CDR Chips extend our long military tradition**

Our new series of CDR Ceramic Chip Capacitors is approved to MIL-C-55681.

Like our other Vitramon, Incorporated capacitors, they have a long military tradition — dating back to MIL-C-5.

In fact, our initial order back in 1949 — for the first monolithic capacitor ever produced — went into a military system application. Even before the military created hi-reliability capacitor specifications, we wrote our own.

Military capacitors must be reliable — and that's the way we've always built them. The CDR Chips are no exception.

These monolithic ceramic chips are offered in five body sizes, with both BP (NPO) and BX dielectrics, and with values from 10 to 470,000 pF.

As important, they're built from the technology backing our 46 styles of "VEE JEM" and "VEE CAL" Chip Capacitors — components that are used in commercial products as precise as heart pacemakers, digital watches, telecommunications circuits and microwave devices.

"Want more information on our high quality chip capacitors? Call us at (203) 268-6261.



**Vitramon<sup>®</sup>**

**Vitramon North America  
Division of Vitramon, Incorporated  
Box 544, Bridgeport, Conn. 06601**

**Subsidiaries:** Vitramon Limited (London) • Vitramon GmbH (Stuttgart) • Vitramon France S.A.R.L. (Paris) • Vitramon Pty. Limited (Sydney) • Vitramon Japan Limited (Tokyo)

# Selection Guide for Ending Surge & Lightning Troublespots

APPLICATIONS	TII-317 (and TII-352)	TII-710-025	TII-410 (and TII-411)	TII-425
Key Systems				Yes
Carrier Communications		Yes	Yes	Yes
PBX		Yes	Yes	
AC Power Input Lines			Yes	Yes
Test Equipment	Yes			Yes
Computers		Yes		Yes
Control Lines	Yes	Yes		
Security Systems	Yes			Yes
Base Station & Radio	317 only	Yes		Yes
Antenna (Microwave & RF)	Yes	Yes		

Also TII-300 Failsafe Protector for Telephone Station applications.

TII 3-Electrode Heavy-Duty Gas Tube Surge Arresters reduce maintenance, protect equipment and personnel. The packages shown are most often used for retro-fit applications in existing equipment. New equipment manufacturers can choose from more than 60 standard TII packages, all designed for 20-year service life. Call or write for new booklet entitled "Surge Protection for Sensitive Electronic Equipment."

TII-317 & TII-352 Heavy-Duty & Standard Duty spade-ended primary arresters are simple to install.

TII-710-025 handles up to 10 balanced line pairs in a single unit.



TII-425 offers direct plug-in convenience plus the additional protection of a circuit breaker.

TII-410 & TII-411 Powerline Surge Protectors complete with covers, with line cord (TII-411) and without (TII-410) for 115 VAC application.



TII CORPORATION  
TELECOMMUNICATIONS DIVISION

100 North Strong Avenue, Lindenhurst, New York 11757  
(516) 842-5000 • Telex: 144631

Licensed by Western Electric Co. and M-O Valve Co., Ltd.

CIRCLE NUMBER 78

## INTEGRATED CIRCUITS

### Memory support circuits connect to 4-k RAMs

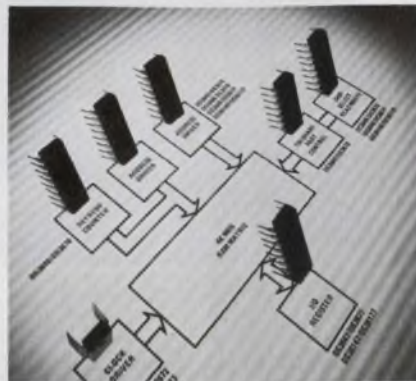

National Semiconductor, 2900 Semiconductor Dr., Santa Clara, CA 95051. (408) 737-5000. From \$1.35 (100-up).

A complete family of memory interface circuits enables designers to optimize performance of 4-k RAM systems. The circuits perform various timing, control and data transfer functions. Included are the DS3671, 3642, 3672, 3643, 3644, 3673 and 3674 clock drivers, the DC3646, 3676 refresh counter/drivers, the DS3645, 3675 latch drivers, the DS3649, 3679, 36149 and 36179 hex drivers, the DS3648 and 3678 multiplexer/drivers, the DS3640 and 3670 quad tri-share port driver and the DS3647 and 36177 quad I/O registers.

CIRCLE NO. 329

### Single chip drivers handle up to 225 V

Dionics, 65 Rushmore St., Westbury, NY 11590. (516) 997-7474. 1000-up prices: \$1.41 (210), \$2.06 (220); stock.

Two series of high-voltage driver circuits, the DI-210 and 220, are designed to interface between MOS or TTL and gas-discharge displays. The DI-210, an eight-line segment driver, can handle 150 V dc. It is a switched constant-current sink and can be current programmed by a single external resistor. The DI-220 handles a maximum voltage of 225 V dc. Otherwise it is essentially identical with the DI-210. Both drivers are housed in 18-pin DIPs. The DI-210 and DI-220 replace the company's earlier part numbers, DI-298N and DI-258N, respectively.

CIRCLE NO. 330

# Don't blow it.

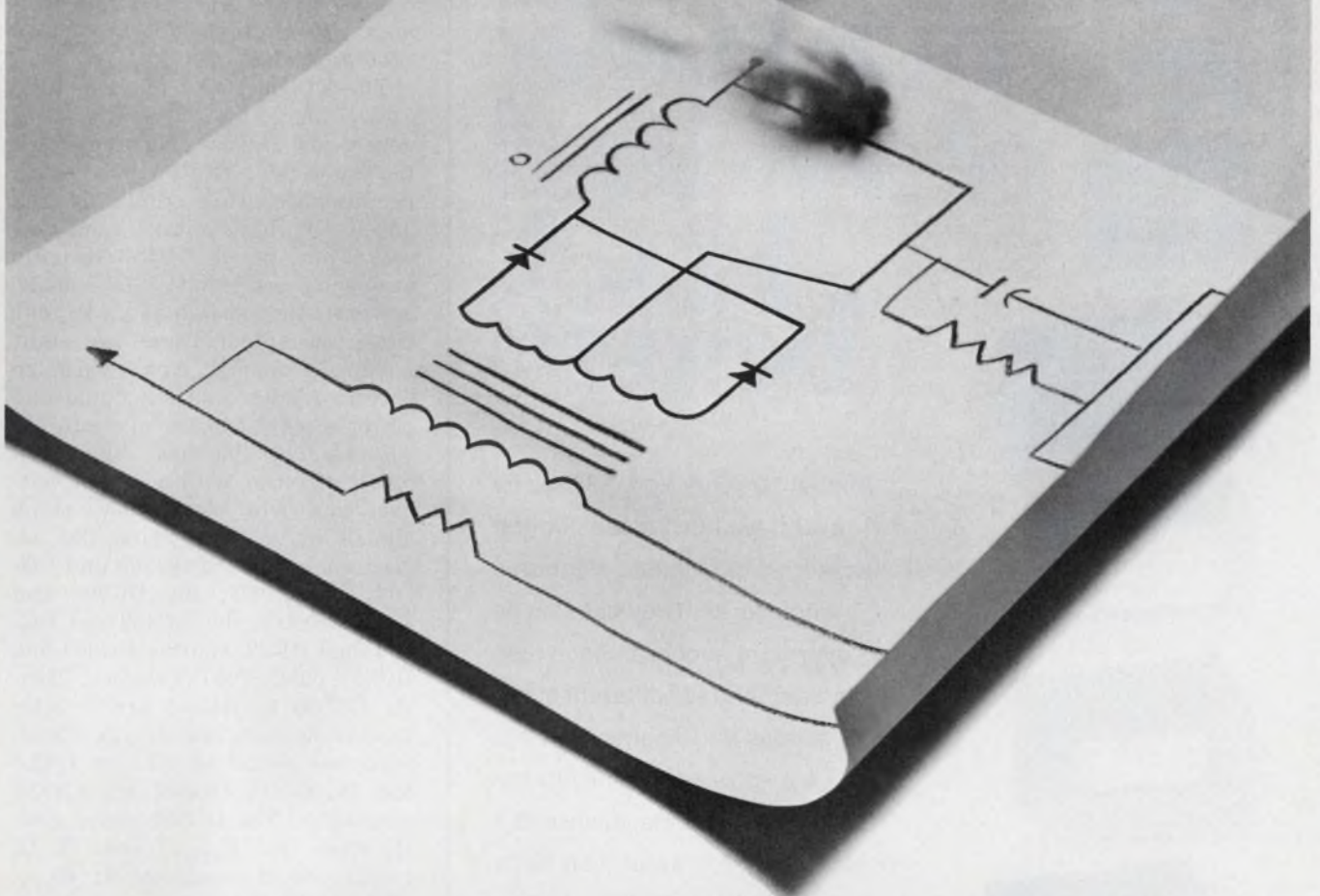

## TRW's new Transient Voltage Suppressors are low-cost insurance in 8.2 to 200V circuits

Our new solid state Transient Voltage Suppressors rapidly lower their shunt impedance to limit voltage until the fuse or circuit breaker shuts down the system. An extension of TRW Zener technology, they are capable of almost instantaneously changing impedance from a very high standby value to a very low conducting value when they are subjected to high energy surges. In operation, they effectively shunt damaging effects by clamping voltage at predetermined levels, and have proved effective against secondary lightning effects, load switching and human errors.

TRW's Transient Voltage Suppressors (TVP's) are 100% surge-tested before shipment, have a very fast response time, lower leakage currents, tighter tolerances and can be customized to your design by computer analysis. They are currently available in .5 Joule, 1.0 Joule and 1.5 Joules power-energy packages.

The potential for these relatively inexpensive TVP's is enormous. Fill in the coupon below for detailed specifications and samples as required.

<b>TRW Capacitors Solid State Operation</b>	ED
An Electronic Components Division of TRW, Inc. 301 W. "O" Street Ogallala, Nebraska 69153 • (308) 284-3611	
<input type="checkbox"/> Please send me specifications on your new Transient Voltage Suppressors.	
<input type="checkbox"/> I would also like samples. My application is _____ for _____ voltage _____ Joules.	
NAME _____	
FIRM NAME _____	
ADDRESS _____	
CITY _____	STATE _____ ZIP _____

## TRW CAPACITORS

SOLID STATE OPERATION

ANOTHER PRODUCT OF A COMPANY CALLED TRW

CIRCLE NUMBER 79



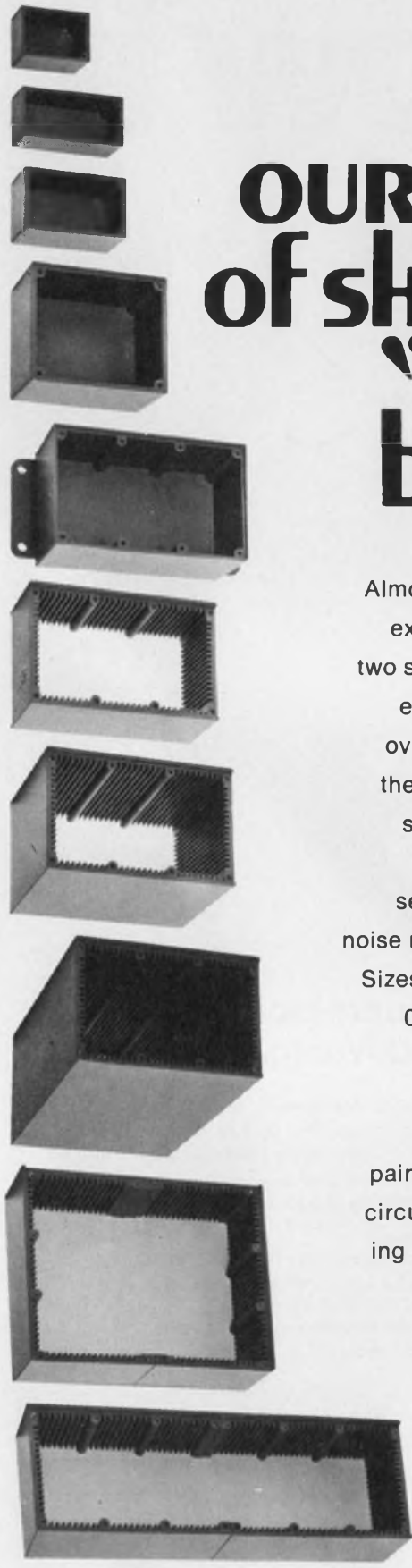

# MEET OUR family of shielded "black BOXES"

Almost 10 years ago (1966 to be exact) we introduced our first two series of shielded electronic enclosures. They became an overnight success. Since then the demand for different sizes, shapes and applications has increased our family to ten series of models, each with a noise rejection greater than 70db. Sizes range from 1.50" x 1.13" x 0.88" to 4.13" x 2.68" x 6.0"; in blank versions or with a complete choice of coaxial connectors; painted or unpainted; with or without printed circuit card guides; with mounting flanges or bottom mounting plates. All models supplied with aluminum covers and mounting screws.

AVAILABLE THROUGH YOUR  
FAVORITE ELECTRONIC  
PARTS DISTRIBUTOR

## ITT POMONA ELECTRONICS

1500 East Ninth St., Pomona, Calif. 91766  
Telephone (714) 623-3463, TWX: 910-581-3822



CIRCLE NUMBER 80

## INTEGRATED CIRCUITS

### CMOS analog switches perform like JFET units

*Siliconix, 2201 Laurelwood Rd., Santa Clara, CA 95054. Jim Graham, (408) 246-8006. From \$3.50 (100-up); stock.*

The DG300 series of monolithic CMOS analog switches are third-generation designs. They approach the multichip JFET switches in performance while retaining the low-power, high-voltage and low-cost advantages of CMOS. The units can switch and isolate 30-V signals, however, they switch at up to four times the speed. There are eight latchproof models from which to choose. All have analog-signal and power-supply ranges of  $\pm 15$  V. The switches conduct signals in either direction with no offset voltage, and will block 30-V pk-pk signals in the OFF state. The series consists of the DG300 and DG304 dual SPST, the DG301 and DG305 SPDT, the DG302 and DG306 dual DPST and the DG303 and DG307 dual SPDT switches. Models DG300 to DG303 are directly compatible with low-voltage CMOS logic, open-collector TTL or DTL; the DG304 to DG307 are CMOS compatible. The DG300 series specifications for  $R_{ps(on)}$  are: 30  $\Omega$ , typical, 50  $\Omega$  maximum at 25 C, while leakage currents are 1 nA max at 25 C. Maximum switching times are 150 ns for turn off and 250 ns for turn on at 25 C for the DG304 to 307.

CIRCLE NO. 331

### 8-bit shift registers offer 35-MHz clock

*Advanced Micro Devices, 901 Thompson Pl., Sunnyvale, CA 94086. Elliot Sopkin (408) 732-2400. From \$1.42 (100-up); stock.*

Two low-power-Schottky shift registers with gated serial inputs, the Am25LS164 and Am54/LS164 are 8-bit serial-in/parallel-out units. They offer guaranteed maximum clock frequencies of 35 MHz and 25 MHz, respectively. The Am25LS164 offers an improved noise margin and twice the fan-out over the military temperature range compared with the Am54/74LS164. Both registers come in 14-pin DIPs and ceramic flat packages.

CIRCLE NO. 332

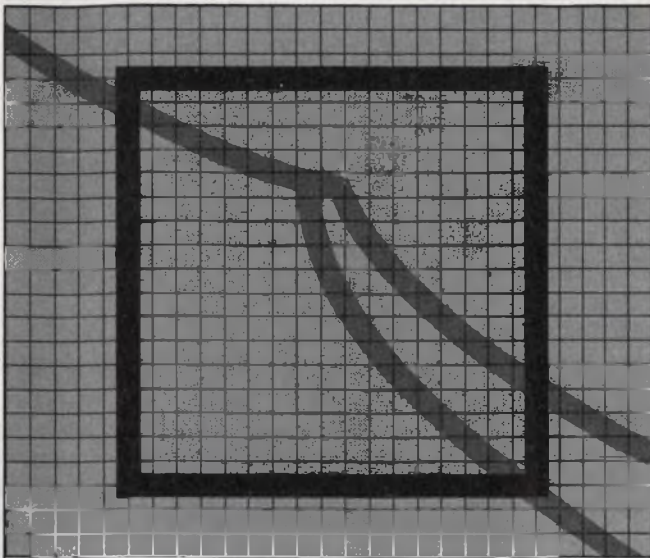

## New From Micro Devices A Unique Slow-Blow Current Limiter.

It's the new MICROTEMP 5P Series MultiProtector. A versatile, yet extremely accurate slow-blow current limiter that lets you design-in protection for a specific current requirement within a precise time and current window.

No other commercially available slow-blow fuse even comes close to matching the 5P's ability to handle high current surges without being derated.

5P's unique opening mechanism design guarantees life time rating stability and excellent surge absorption. Conventional slow-blow fuses operate through a metallic, current carrying element making them extremely susceptible to surging and derating. Thanks to its patented non-current carrying temperature sensitive opening mechanism, the MICROTEMP® thermal cutoff reacts only when current put through the heater element generates temperatures capable of

triggering the exclusive pellet-type opening mechanism.

When properly applied, 5P will not nuisance trip reducing costly and annoying "in warranty" service calls.

### Here's more:

- current values—500 milliamps to 3.5 amps
- ambient temperature range—25° to 65°C. (77° to 146°F.)
- can be designed to withstand surges up to 100 amps for 10 milliseconds
- operates within 130% of rated current

Recognized under the Component Program of Underwriters' Laboratories, Inc. UL File #E59187.

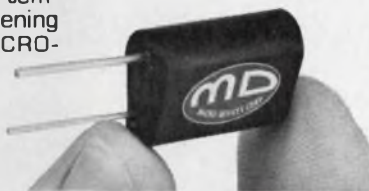

## MICRO DEVICES



DIVISION OF EMERSON ELECTRIC CO.  
1881 SOUTHTOWN BLVD.  
DAYTON OH 45439 513-294-0581

# it's so simple

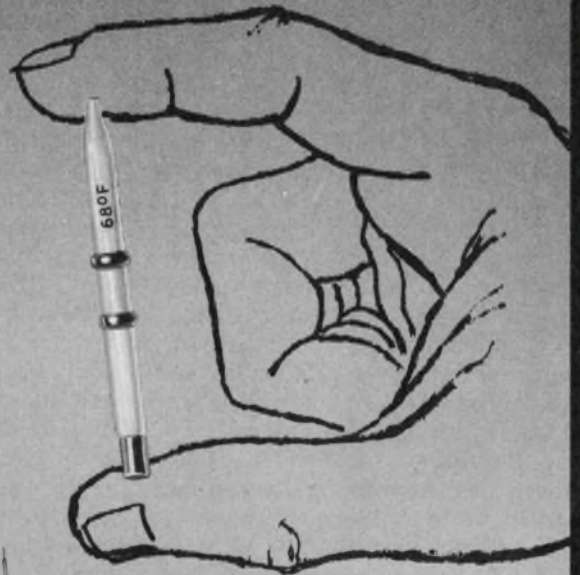

## why didn't I think of this thermostat?

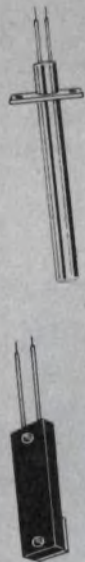

More and more engineers are asking themselves that question when they see and learn of the advantages of using P.S.G.'s Mercury and Solid State Thermostats.

ACCURACY	± .05° C to 2° C
DIFFERENTIAL	.05° C to 10° C
SHOCK	100 G
VIBRATION	20G at 2000 cycles per second
LOAD	5 M.A. to 5 amps
SIZE	length 5/16 and up - diameter 3/32 and larger

All types of mountings. Simple, no moving parts and they are low cost, ranging from \$2.10 each up (depending on model and quantity).

*We find it simple to solve temperature control problems. Let us have yours.*



*P.S.G. Industries, Inc.*  
MANUFACTURER OF PRECISION THERMO AND ELECTRONIC CONTROLS  
1225 Tunnel Road, Perkasie, Pa. 18944



CIRCLE NUMBER 81

ELECTRONIC DESIGN 4, February 15, 1977

CIRCLE NUMBER 82

155

## INTEGRATED CIRCUITS

### S/h circuit acquires signals to 0.01%

Datel, 1020 Turnpike St., Canton, MA 02021. Eugene Zuch (617) 828-8000. \$7.95 (1 to 9); stock.

A sample-and-hold amplifier, the SHM-LM-2, requires only a user-selected external holding capacitor. It is internally configured as a unity-gain follower. Acquisition time for a 10-V change to 0.01% is 6  $\mu$ s when a 1000-pF capacitor is used and 25  $\mu$ s for a 0.01- $\mu$ F capacitor. Other specifications include an aperture time of 100 ns, a bandwidth of 1 MHz and an input impedance of  $10^{10}$   $\Omega$ . Hold-mode feedthrough is less than 0.005% and hold-mode droop is 200- $\mu$ V/ms maximum (with a 1000-pF holding capacitor). The SHM-LM-2 requires  $\pm 5$  to  $\pm 18$ -V supplies and draws a quiescent current of 6 mA. It is housed in a hermetically sealed TO-99 metal can.

CIRCLE NO. 333

### Oscillator/timebase provides four outputs

Intersil, 10900 N. Tantau Ave., Cupertino, CA 95014. (408) 996-5000. \$4.40 (100-up); stock.

The ICM7213, a fully integrated micropower oscillator and frequency divider, has four buffered outputs suitable for interfacing with most logic families. The outputs deliver one pulse per second, one pulse per minute, 16 Hz, and a composite signal of 1024+16+2 Hz. All outputs of the CMOS circuit are TTL compatible. Power may be either a two battery stack or a regular power supply greater than 2 V. Current drain is 100  $\mu$ A, typical, at 3 V. Included on the chip is the oscillator and its feedback resistor. For operation only three external components are needed: a fixed capacitor, a trim capacitor and a 4.194304-MHz crystal. A test speed-up feature provides other frequency outputs including 2048, 1024, 34,133, 16, 1, and 1/6 Hz. Devices are packaged in 14-pin plastic DIPs.

CIRCLE NO. 334

### CMOS timing circuits drive liquid crystals

RCA, Route 202, Somerville, NJ 08876. (201) 685-6423. See text.

Three CMOS timing circuits, designed to drive liquid-crystal displays, operate from a single battery cell. The CD22001H, CD22002H and CD22003H are two-button-controlled devices for five-function (CD22001H and CD22002H) and six-function (CD22003H) timekeeping. The CD22003H also includes a 15-minute, 1-second stopwatch with 1-second resolution. All devices contain an inverter-amplifier for a 32-kHz crystal oscillator, a countdown chain, and counters for seconds, minutes, hours, date, and months. The display section contains seven-segment decoders plus level translators and drivers to provide high-voltage ac drive for each display segment. These devices are supplied in chip form only and are available from stock in unit packs of five chips at \$33.25 per pack.

CIRCLE NO. 335

BIPOLAR MICROPROCESSING #1

**INCREASE YOUR PERFORMANCE WITH OUR 8080 EMULATOR.**



Upgrade existing designs. New 8080 Emulator delivers 5 times increased performance. Reduces micro-code writing time, too.

Order Part #3000KT8080SK.

Clip coupon to letterhead for details on how it makes designing easy.

Name	Title
Tel.	M.S.
811 E. ARQUES, SUNNYVALE, CA. 94086	

**THINK signetics**

a subsidiary of U.S. Philips Corporation

© 1976.

CIRCLE NUMBER 83

### Bodine's PM drive family grows-

New 32D permanent magnet Control Motors and 32D-5F right angle gearmotors, perfectly matched with Bodine speed/torque controls. Continuous duty ratings of 1/12, 1/10 and 1/8 Hp at 2500 Rpm. See your Bodine Distributor or write for Cat. CDC-PM.

## New 32-frame PM motors and gearmotors!



ADE (After Delivery Economies) make Bodine a better hhp buy

Bodine Electric Company, 2500 W. Bradley Place, Chicago, IL 60618.

CIRCLE NUMBER 84

# Low-cost scope challenges more expensive rivals



Philips Test & Measuring Instruments, 400 Crossways Park Dr., Woodbury, NY 11797. (516) 921-8880. See text.

To get many of the features found in the Philips PM 3214 25-MHz scope, ordinarily you'd have to get a unit with twice the bandwidth and pay double the price. The lineup of features includes:

- Auto triggering to 40 MHz, with the trigger level derived from the signal's peak-to-peak amplitude.

- Simultaneous display of main and delayed time bases in the alter-

nate mode.

- Alternate time-base displays on both channels so that four traces can be viewed.

- Composite triggering to display two signals unrelated in time, frequency or phase.

- Dc-coupled triggering on both the main and delayed time bases, an important feature for work with digital pulses or variable-duty-cycle waveforms.

Another triggering facility is a TV display with frame (TVF) or line (TVL) triggering at the touch of either of two buttons. If you'd like to trigger at an exact point on a signal, simply push the level control instead of "auto." Furthermore, you can trigger both channels and both time bases from any of several sources: internal, external, channel A, channel B, composite or the 60-Hz line.

Horizontal deflection can be formed not only by the time bases but by any of the sources as well. Use this feature for X versus Y or

X versus  $Y_A/Y_B$  displays.

Of course, the Philips unit also offers the usual capabilities of mixed sweep: separate display of main or delayed time base, intensification of the main by the delayed, and so on.

The main sweep runs from 0.5 s/div to 200 ns/div, while the delayed spans 1 ms to 200 ns/div. Ten-times magnifiers extend both sweeps. The delay is continuously variable with a 10-turn pot between about 0 and 10 times the coefficient of the main time base. Since the main and delayed bases occupy separate sections of the unit's front panel, adjustments are easy, and you can see at a glance what the settings are. Also, since channel B can be inverted, you can subtract dc levels from, say, a 60-Hz ripple.

Sensitivity is 2 mV over the full 25-MHz bandwidth. Screen size covers  $8 \times 10$  cm, and the accelerating potential is 10 kV. The unit weighs just 18.5 lb and can operate from almost any line voltage and frequency. For \$245 more, you can get a battery-operated version. Delivery takes four weeks.

CIRCLE NO. 301

## LOW NOISE MODULAR DESIGN Switching Power Supplies!



A new line of compact, modular-design switchers that simplify design for 300-600 watt applications and sell for less than 90¢ per watt! End users benefit from low EMI noise levels and highly reliable operation plus easy add-on and maintenance features. Get everything you need to know to evaluate this high quality, money-saving line from:

**Jim Daly**  
phone (612) 830-5800  
TWX 910 576 2978  
or write: 7801  
Computer Ave. So.  
Minneapolis, MN 55435.

**CD CONTROL DATA CORPORATION**

CIRCLE NUMBER 85

ELECTRONIC DESIGN 4, February 15, 1977

## BIPOLAR MICROPROCESSING #2 SEND FOR THE BOOK ON MICROPROCESSING.



Details bipolar microprocessors' memory and interface functions. Includes useful application notes. A complete microprocessor book. All products detailed.

It's free. No obligation. Simply clip coupon to letterhead only.

Name	Title
Tel.	M.S.
811 E. ARQUES, SUNNYVALE, CA. 94086	

**THINK Signetics**

a subsidiary of U.S. Philips Corporation

© 1976.

CIRCLE NUMBER 86

157

## INSTRUMENTATION

### Signal generator covers 40 CB channels

Hickok, 10514 Dupont Ave., Cleveland, OH 44108. (216) 541-8060. \$199; stock.

Model 256 rf generator is designed for 40-channel CB transceiver service. Five-band frequency tuning covers channels 1 through 40 on an expanded tuning range. Fre-

quencies of 100 kHz through 16 MHz and any other, current or bands to provide all i-f requirements including: 455 kHz, 10.7 MHz and any other, current or future. Precision frequency selection is accomplished by connecting the output jack to a frequency counter for continuous monitoring. A calibrated/attenuated output control provides rf signal output of 100,000  $\mu$ V down to less than 1  $\mu$ V for receiver sensitivity checks.

CIRCLE NO. 336

### EIA interface monitor slips into pocket



International Data Sciences, 100 Nashau St., Providence, RI 02904. (401) 274-5100. \$185; stock.

Model 60 EIA interface monitor and breakout panel is a portable, pocket-sized test set providing access to all 25 conductors of the EIA RS232 interface. Twelve LEDs monitor the status at the source of 12 primary signals, and two additional LEDs sense either positive or negative voltage levels greater than  $\pm 3$  V. Model 60 is powered by two penlite batteries capable of over 100 h of continuous operation. No power is consumed when not in use.

CIRCLE NO. 337

# STOP

## WAITING ON OUTPUT FROM YOUR $\mu$ P DEVELOPMENT SYSTEMS

You Are Wasting More In Program Development Costs Than This LINE PRINTER Sells For

2400 LPM - 80 COL.      1400 LPM - 132 COL.  
MODEL 8210 - \$3000\*      MODEL 8230 - \$3785\*



FOR ORDERING INFORMATION CALL OR WRITE:

**houston instrument** | DIVISION OF BAUSCH & LOMB

ONE HOUSTON SQUARE (at 8500 Cameron Road) AUSTIN, TEXAS 78763  
(512) 837-2820      TWX 910-874-2022      cable HOINCO

TELECOPIER      EUROPEAN OFFICE      ROCHTERLEEN 8 8240 Gistel Belgium  
Phone 099/217449      Telex Bausch 18098

"the recorder company"

\* Domestic USA Prices, Qty 1, End User

CIRCLE NUMBER 87

### X-Y recorders come in three versions



Philips Test & Measuring Instruments, 400 Crossways Park Dr., Woodbury, NY 11797. (516) 921-8880. \$1500 to \$3465.

Three new X-Y recorders include an economical standard A-4 model, a multipurpose A-4 recorder, and a two-pen A-3 format instrument. The two-pen A-3 model complements an existing single-pen A-3 version. The standard A-4 recorder, PM 8041, has sensitivities from 2 mV/cm to 1 V/cm in nine switched ranges, while the multipurpose PM 8141 has a maximum sensitivity of 50  $\mu$ V/cm. Both offer a writing speed of 75 cm/s and acceleration of 3800 cm/s<sup>2</sup>. The PM 8132 is a two-pen model with 15 input ranges.

CIRCLE NO. 338



**INSTRUMENTATION**

**Count savings with low-cost 10-MHz counter**



Systron-Donner, Ten Systron Dr., Concord, CA 94518. (415) 676-5000; \$295; 30 days.

Model 6202B frequency counter measures from 20 Hz to 10 MHz. An outstanding feature of this solid-state counter is a complete set of adjustable input controls, including a three-position ( $\times 1$ ,  $\times 10$ ,  $\times 100$ ) attenuator switch and an offset control. This makes it possible for the Model 6202B to make accurate measurements of complex, nonsinusoidal waveforms. The variable offset control has a fixed preset trigger position. Four selectable gate times range from 0.1 Hz to 100 Hz. Minimum sensitivity is 25 mV rms for inputs to 1 MHz; 50 mV rms for inputs from 1 to 5 MHz; and 100 mV rms for all inputs above 5 MHz.

CIRCLE NO. 339

**Spectrum analyzer gives narrow bandwidth**

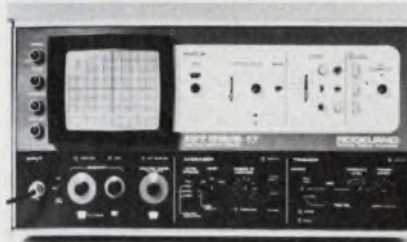

Rockland Systems, 230 W. Nyack Rd., West Nyack, NY 10994. (914) 623-6666. \$9875; 60 days.

Model FFT 512/S-17 real-time spectrum analyzer offers a narrow-band power readout that permits power measurements over the full analysis range of 0 to 100 kHz or any portion of it. Measurements may be displayed in V rms, (V rms)<sup>2</sup>, or dBV (0 dBV = 1 [V rms]<sup>2</sup>). The only limits to the bandwidth and frequency range over which measurements may be made is the 400-line resolution and the frequency range of the instrument. Optionally, the FFT 512/S-17 can be equipped to make power measurements in the millihertz region.

CIRCLE NO. 340

**Programmable source wears many hats**



Interstate Electronics, 707 E. Vermont Ave., P.O. Box 3117, Anaheim, CA 92803. (714) 772-2811. \$3195 base price; 30 days.

Model SPG-800 programmable generator is specifically designed as a multiple signal-source building block for automatic test equipment. With field installable plug-in circuits, the SPG-800 can provide a true pulse generator, a frequency synthesizer or a function generator in one package, all controlled by one IEEE-499-compatible software set, with two levels of built-in test feedback to the controller. The SPG-800 operates over 0.1 Hz to 13 MHz, with 4-1/2-digit resolution and provides amplitudes up to 15 V pk-pk into 50  $\Omega$ .

CIRCLE NO. 341

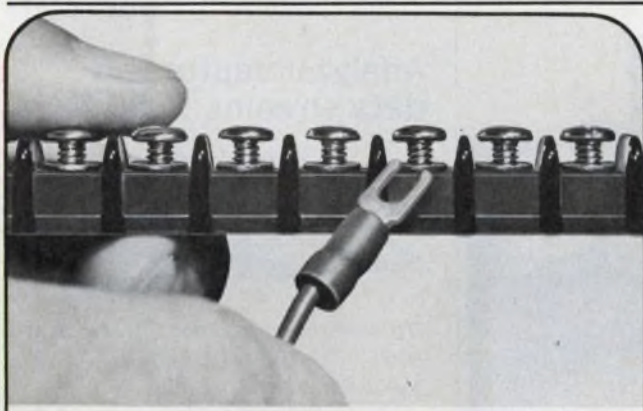

**WIRE REDDY™**

Cut wiring time in half with Kulka's new Wire Reddy™ terminal boards. Either brass or cost-saving steel screws are in place and ready to receive wire ends or terminals. Other time-saving hardware in the line are Kliptites™ and wire wraps. All are in Kulka's catalog.

**Kulka**®  
A NORTH AMERICAN PHILIPS COMPANY

520 S. Fulton Ave., Mt. Vernon, NY 10551 Tel: 914 644 4024

CIRCLE NUMBER 88

ELECTRONIC DESIGN 4, February 15, 1977

BIPOLAR MICROPROCESSING #3

**THE INDUSTRY'S LEADING FAMILY OF BIPOLAR MEMORIES TO PICK FROM.**

Widest selection of RAM's, ROM's, PROM's, FPLA's from one source... Signetics. The right memory fit saves time, optimizes system performance.

Select from over 101 memories in stock. Clip coupon to your letterhead for full list.

Name	Title
Tel.	M.S.

811 E. ARQUES, SUNNYVALE, CA. 94086

**THINK signetics**

a subsidiary of U.S. Philips Corporation © 1976

CIRCLE NUMBER 89

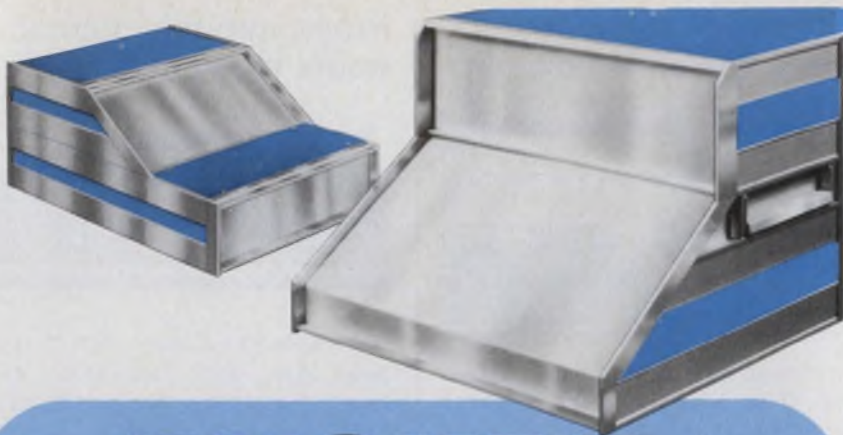

## BUCKEYE slant-front CASES

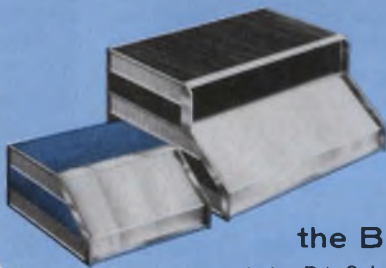

New, sloped-front aluminum cases have the modern, crisp lines of custom design at off-the-shelf costs. Stocked in a range of widths, heights and depths. Write today for detailed literature.



the BUCKEYE stamping co.

555 Marion Rd., Columbus OH 43207 Phone: 614/445-8433

CIRCLE NUMBER 90

# CRITICAL CRYSTALS

come from M-tron

M-Tron specializes in providing quality crystals and design assistance with maximum economy. Complete facilities for production of AT Cut crystals for commercial and military applications from 800 KHz to 200 MHz. Computer-aided design program speeds sample delivery for all types of precision, industrial and commercial applications.

Phone 800-843-6842 or write

# M-tron INDUSTRIES, INC.

Box 630, Yankton, South Dakota 57078 A Div. of Lynch Corp.



CIRCLE NUMBER 69

## INSTRUMENTATION

### Portable generator offers VCF input



Exact Electronics, 455 S.E. 2nd Ave., Hillsboro, OR 97123. (503) 648-6661. \$295.

Model 119P portable VCF function generator offers a dynamic frequency range from 0.02 Hz to 2.2 MHz with sine, square, triangle and variable time symmetry of all waveforms for ramp and pulse operation. A VCF input allows the generator to be varied either up or down over a range of 1000:1. Minus 10 V dc will increase the frequency three decades from a minimum multiplier setting and 10 V dc will decrease the frequency three decades from a maximum multiplier setting.

CIRCLE NO. 342

### Analyzer captures 8 data streams to 50 MHz



BP Instruments, 10691 S. De Anza Blvd., Cupertino, CA 95014. (408) 446-4322. \$3375; 6 wks.

Model 50D portable logic analyzer can simultaneously capture eight digital data streams at sample rates to 50 MHz. Like its 20-MHz predecessor (Model 20D), the 50D works with virtually any externally triggered scope or X-Y display to present multiple-trace timing diagrams. A true-sample mode allows the user to exclude all glitches that endure for a sample period or less. A dual-memory feature provides two  $8 \times 512$ -bit semiconductor memories, each of which can simultaneously capture up to eight data streams. All 16 data streams can then be viewed on a two-channel scope.

CIRCLE NO. 343

**INSTRUMENTATION**

**Pulse generators offer IEEE Bus option**



*E-H Research Laboratories, 515 11th St., Box 1289, Oakland, CA 94604. (415) 834-3030. \$1050; stock.*

All pulse generators in the company's 1500 series are now compatible with the IEEE Standard 488-1975 digital interface and can be connected directly into any programmable test system using this program bus. The 488 Bus complements the other standard digital interface options available for the 1500 series, including parallel programming, serial by ASCII character and serial 16-bit word.

CIRCLE NO. 344

**Low-pass filter rolls off at 120 dB/octave**

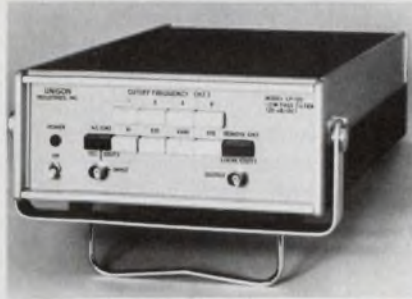

*Unigon Industries, 1 Park Ave., Mount Vernon, NY 10550. (914) 699-7545. \$850/channel; stock-45 days.*

Model LP-120 is a 120-dB/octave-rolloff, variable-frequency, low-pass filter. Cutoff frequencies are selected by front-panel pushbuttons or by a remote TTL computer-compatible I/O bus. Nominal cutoff frequencies can be set from 1 Hz to 15 kHz in decimal sequence. Solid-state switching ensures frequency selection in less than 10  $\mu$ s.

CIRCLE NO. 345

**'Carry on' with British hand-held DMM**



*Kane-May Ltd./Atkins Technical Inc., 3401 S.W. 40th Blvd., Gainesville, FL 32608. (904) 372-3517.*

A hand-held, five-function multi-meter locates all the circuitry, switching and the digital display in the probe handle. Digimeter measures dc voltage, ac voltage, dc current, ac current and resistance. It selects voltage ranges automatically and can be operated from four nickel-cadmium batteries or from a plug-in power supply. The unit measures  $8.3 \times 2 \times 1.8$  in.

CIRCLE NO. 346

**This counter is different.**



What makes Systron-Donner's new 6202B different from other low cost counters? The fact that it can accurately measure most of the signals encountered in low frequency applications. Here's why:

- Three-position attenuator: x1, x10, x100. (avoids false counting)
- Offset control allows measurement of non-sinusoidal waveforms
- Four selectable gate times from 0.1 Hz to 100 Hz
- 25 mV rms sensitivity
- Advanced input circuitry to assure error-free measurements
- 10 MHz frequency range
- Rugged and reliable
- Only \$295 (U.S. price).

In short, it's a super workhorse counter. It's the one low cost counter you can depend on. Find out more.



10 Systron Drive  
Concord, CA 94518. Phone (415) 676-5000

CIRCLE NUMBER 91

ELECTRONIC DESIGN 4, February 15, 1977

BIPOLAR MICROPROCESSING #4  
**DREAM UP YOUR OWN CONTROLLERS WITH THE 8X300 DESIGNER'S KIT.**

You do the programming, we supply all the parts—one 4K PROM half programmed, half available for you to program with diagnostic and demo program, even P.C. board. Order Part #8X300KT-100SK



Clip coupon to letterhead. Kit lets you build your own controller easier, faster, and more efficiently.

Name	Title
Tel.	M.S.
811 E. ARQUES, SUNNYVALE, CA. 94086	

**THINK**  
**Signetics**

a subsidiary of U.S. Philips Corporation

© 1976.

CIRCLE NUMBER 92

## INSTRUMENTATION

### Four-digit DMM carries low price tag

Non Linear Systems, P.O. Box N, Del Mar, CA 92014. (714) 755-1134. \$190; stock.

At \$190, the LM-40 4-digit DMM (10,000 counts full scale) is an alternative to 3-1/2-digit DMMs (2000 counts full scale) that cost as much or more. Dc voltage ac-

curacy is 0.1%. Sensitivity for dc and ac V is as low as 100  $\mu$ V. For resistance, sensitivity is 100 m $\Omega$ . Ac and dc voltage ranges of 1, 10, 100 and 1000 V are provided. Resistance ranges include 1, 10, 100, 1000 and 10,000 k $\Omega$ . The LM-40 comes complete with test leads, rechargeable batteries and a charger unit. Package size is 1.9  $\times$  2.7  $\times$  4.0 in. and power consumption is less than 3 W.

CIRCLE NO. 347

### Data-comm tester diagnoses, shows errors



Spectron Corp., Church Rd. and Roland Ave., Mount Laurel, NJ 08057. (609) 234-5700. \$7500; 45 days.

Datascope D-601B portable data-communications test instrument pinpoints problems in systems hardware and software by monitoring data-communications channels and showing exactly what was sent and received over the data link—using ASCII, EBCDIC or hexadecimal displays. Errors caused by software bugs, equipment malfunctions or line troubles are immediately visible in full detail, thus reducing time spent tracing problems. The D-601B provides both a CRT display and a magnetic tape recording of all traffic at the business-machine interface of any standard modem at speeds to 9600 bps for recording and 80,000 bps for display.

CIRCLE NO. 348

# A keyboard is only as strong as its weakest switch.

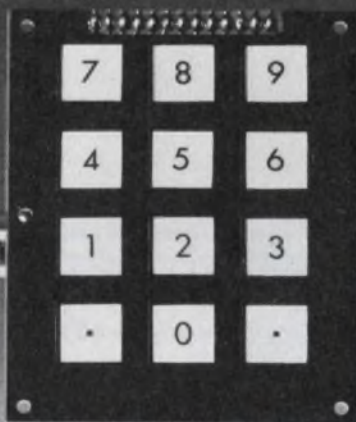

That's why we build Wild Rover® keyboards with a switch designed for over 10,000,000 cycles. Multiple contact points distribute circuit energy, provide more positive switching action and reduce contact wear. Our PCK switch has excellent noise characteristics, too. Less than 5 milliseconds bounce on leading and trailing edge.

REFAC offers standard 12 and 16 key keyboards. We'll also build custom keyboards to your specification with special legends or encoding. Or, if you prefer, we can supply our PCK switch as a component for your own keyboard assembly operations.

For more information on our keyboards and PCK switches, give us a call. We can have literature in the mail today.



**REFAC** electronics corporation

P.O. BOX 809 • WINSTED, CONN. 06098 • 203-379-2731

CIRCLE NUMBER 93

### Board testers handle analog/digital circuits

Computer Automation, 18651 Von Karman, Irvine, CA 92713. (714) 833-8830. \$17,450 w/o instrumentation.

Model 4707 adds the capability of automatic analog and hybrid circuit-board testing to the company's Capable 4000 series of computer-controlled test systems. The 4707 is a general-purpose combination of hardware and software options in one add-on package. The package consists of an IEEE-compatible bus for interfacing analog instrumentation; a four or five-bus by 32-pin switching-matrix module; an instrumentation matrix (connecting up to 10 instruments to the analog bus); and a complete control software package. Also included is programmed guided fault isolation.

CIRCLE NO. 349

**Cordless solder gun lends you a 'third hand'**



Wahl Clipper Corp., 2902 Locust St., Sterling, IL 61081. Noel Wal-len (815) 625-6525.

Did you ever wish you had a third hand when soldering? The Model 7900 kit supplies it in the form of a cordless solder gun, solder magazine, plug-in recharger, beveled and chisel-point plug-in tip, and instruction book. It works like any other solder gun, except that you can advance the solder by squeezing the trigger all the way back. The 16 available tips heat in 5 to 10 seconds.

CIRCLE NO. 350

**Plastic pouch packs premeasured portions**



Allied Resin Corp., Weymouth Industrial Park, East Weymouth, MA 02189. (617) 337-6070. 25-gm pouch: \$1.40 (25-up)

A line of flexible, transparent plastic pouches holds premeasured amounts of epoxies, urethanes or RTV silicones. Called Acu-Pak, the packages hold 7, 25, 50 or 100 grams. The pouches can be separated into compartments by removable dividers to hold two-part resins. The components mix when you remove the dividers and knead the pouch. Snip off one corner of the punch to dispense the resin.

CIRCLE NO. 351

**Wrapped-wire tool has built-in bit and sleeve**



OK Machine & Tool Corp., 3455 Conner St., Bronx, NY 10475. (212) 994-6600. \$34.95; stock.

The BW-630 wraps 30 AWG wire onto square terminals measuring 0.025 in. The tool comes complete with a built-in bit and sleeve, and a holder for C-sized batteries. The BW-630 also prevents overwrapping. It weighs 11 oz.

CIRCLE NO. 352

**FREE...WALL CHART  
POWER  
ROTARY SWITCHES**

SELECTOR GUIDE - ROTARY SWITCHES

Model	Rating	Poles	Options	Notes
RS-100	10A-240V	10	Standard	
RS-200	20A-240V	20	Standard	
RS-300	30A-240V	30	Standard	
RS-400	40A-240V	40	Standard	
RS-500	50A-240V	50	Standard	
RS-600	60A-240V	60	Standard	
RS-700	70A-240V	70	Standard	
RS-800	80A-240V	80	Standard	
RS-900	90A-240V	90	Standard	
RS-1000	100A-240V	100	Standard	
RS-1100	110A-240V	110	Standard	
RS-1200	120A-240V	120	Standard	
RS-1300	130A-240V	130	Standard	
RS-1400	140A-240V	140	Standard	
RS-1500	150A-240V	150	Standard	
RS-1600	160A-240V	160	Standard	
RS-1700	170A-240V	170	Standard	
RS-1800	180A-240V	180	Standard	
RS-1900	190A-240V	190	Standard	
RS-2000	200A-240V	200	Standard	
RS-2100	210A-240V	210	Standard	
RS-2200	220A-240V	220	Standard	
RS-2300	230A-240V	230	Standard	
RS-2400	240A-240V	240	Standard	
RS-2500	250A-240V	250	Standard	
RS-2600	260A-240V	260	Standard	
RS-2700	270A-240V	270	Standard	
RS-2800	280A-240V	280	Standard	
RS-2900	290A-240V	290	Standard	
RS-3000	300A-240V	300	Standard	

- Snap-action . . . detent . . . and cam switches
- Ratings from 10A-240V to 200A-600V
- Up to 75 poles
- Many standard & custom options
- Fast deliveries

**ELECTRO SWITCH**  
Weymouth, Massachusetts 02188

Telephone: 617/335/5200 • TWX: 710/388/0377

CIRCLE NUMBER 94

BIPOLAR MICROPROCESSING #5  
**ONE-STOP SHOPPING  
FOR BIPOLAR AND  
ANALOG MICROPROCESSING  
INTERFACE PRODUCTS.**



All at Signetics. Dozens of bipolar microprocessing interface products. Easy to select and obtain functionally correct interface every time.

We'll send you our total list, if you clip the coupon to your letterhead and mail.

Name \_\_\_\_\_ Title \_\_\_\_\_  
Tel. \_\_\_\_\_ M.S. \_\_\_\_\_  
811 E. ARQUES, SUNNYVALE, CA. 94086

THINK  
**Signetics**

a subsidiary of U.S. Philips Corporation

© 1976

CIRCLE NUMBER 95



salon international des  
**composants  
electroniques 77**

**International Electronic Components Show**

March 31 to April 6, 1977, Paris

The world's first electronic event in 1977



- Electronic Components
- Measuring Instruments
- Materials and Products
- Equipment and Methods
- Press and Publications

The electronic meeting point of the world  
An ever increasing number of visitors:

1974 :	57000	} permanent cards
1975 :	61000	
1976 :	72000	

Concurrently:

THE INTERNATIONAL SYMPOSIUM "ELECTRONIC + 5"  
from March 28 to April 1.

Yes, I would like to receive more information on:

- The International Electronic Components Show
- The Special travel arrangements to these events
- The Symposium "Electronic + 5"

Name \_\_\_\_\_

Company \_\_\_\_\_

Address \_\_\_\_\_

City \_\_\_\_\_ State \_\_\_\_\_ Zip \_\_\_\_\_

"INTERNATIONAL TRADE SHOWS IN FRANCE"  
1350 Avenue of the Americas New York, N.Y. 10019  
☎ (212) 582-4960 - ☐ 237 757 Fren Ur

CIRCLE NUMBER 96

**PACKAGING & MATERIALS**

**Wrapped-terminal posts are diverse, inexpensive**

*Auto-Swage Products, 726 River Rd., Shelton, CT 06484. Robert Mikulski (203) 929-1401. From \$1.41/1000; stock.*

Swaged from a range of materials, wrapped-terminal pins of the Wrapost series are available in a wide range of standard and custom configurations. The pins have precise, burr-free, conical ends, and come with precious or base-metal plating. Evaluation samples are available on request.

CIRCLE NO. 353

**Heat-pipe system keeps equipment cool & clean**

*McLean Engineering Laboratories, 70 Washington Rd., Princeton Junction, NJ 08550. Pete Stewart (201) 799-0100. From \$477 (1-9); 8 wks.*

Did you ever have to fix a piece of equipment, then find everything inside the cabinet was buried under a layer of grime? The Model HP1 heat exchanger now makes it possible to seal off the cabinet hermetically. A blower draws the hot cabinet air through the bottom section of the HP1 heat pipe bank, while a second blower circulates room air through the top section of the heat pipes. For power dissipation up to 2 kW, the HP1 maintains an interior temperature of 16 F above ambient.

CIRCLE NO. 354

**Dielectric foam offers low weight, loss and K**

*Emerson & Cuming, Inc., Canton, MA 02021. Jeanne B. O'Brien (617) 828-3300. \$65 per sheet; stock.*

Eccostock GT-22 is a syntactic foam with outstanding dielectric properties: K is 1.46 and the loss tangent is 0.006. In spite of the low weight of 22 lb per cubic foot (density 0.35), the foam absorbs less than 1% of water after 16 h immersion at 1500 psi (105 kg/cm<sup>2</sup>). It is available in rod and sheet form (12 × 12 × 1 in.).

CIRCLE NO. 355

## DATA PROCESSING

### 'Personal' mini needs no peripherals



Olivetti Corp. of America, 500 Park Ave., New York, NY 10022. Bruce E. Lerner (212) 371-5500. From \$7950, 4-8 wks.

One box does it all—input via extended keyboard (95 keys), 32 character visual display, 80-column thermal printer that outputs 80 character/s, up to 80 kbytes of RAM, and floppy disc. The P5050 is programmable in extended Basic, and although self-sufficient, supports a large variety of peripherals.

CIRCLE NO. 356

### CRT terminal thinks small and cheaply



Research Inc., P.O. Box 24064, Minneapolis, MN 55424. Jerry Medley (612) 941-3300. \$1450.

With a size of only 13.5 × 15.5 × 21-in. an X-Y cursor-addressable terminal can be leased for \$65 per month. The Model 3841 features wide/narrow character display, RS-232 and current-loop interface, and a choice of 15 speeds from 50 to 9600 baud. The standard model with 12-in. screen weighs 43 lb.

CIRCLE NO. 357

### Transfer your data with a light beam

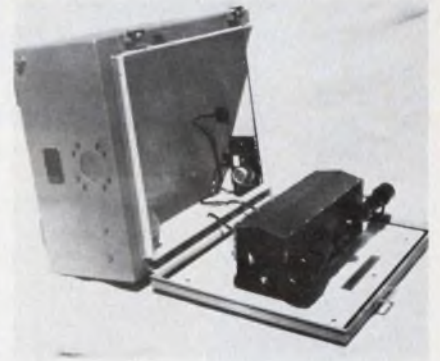

Automatic Control Systems, Inc., 8515 Freeway Dr., Macedonia, OH 44056. (216) 467-2186. From \$5000, 16 wks.

To transfer your data securely, unaffected by rf and other noise, over a distance of 2000 ft, all you need is the Model 1010 laser system. It does not require FCC licensing, and because the laser beam is harmless, the system has HEW approval. Voice or video can also be transmitted.

CIRCLE NO. 358

## Design better equipment

### OEM servo recorder

Esterline Angus original equipment Miniservo® recorder gives more design freedom. The basic unit lists at just \$320, with generous quantity discounts available. Your customers benefit from reliable simplicity, easy use, and state-of-the-art. Nationwide repair network backs every unit.

*Short specifications:* 100 mm-wide Z-fold or rolled servo chart recorder with 100 MVDC (10 MV optional) and 4 chart drive choices, 0.5 sec. response, ±0.5% accuracy, disposable ink/pen cartridge. Request Bulletin F612. Esterline Angus Instrument Corp., P.O. Box 24000, Indianapolis, IN 46224, Tel. 317-244-7611.

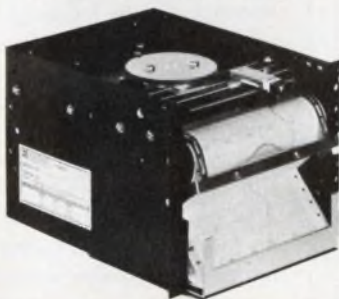

CIRCLE NUMBER 97

ELECTRONIC DESIGN 4, February 15, 1977

BIPOLAR MICROPROCESSING #6

**INTRODUCTORY  
BIPOLAR  
MICROPROCESSING  
DESIGNER'S KIT**

~~\$230.00~~  
**\$100.00**

Kit introduces you to the fastest microprocessor in the industry with 100 ns cycle time. \$100 buys you 1 MCU and 4 CPE's at the heart. Plus, 1 Lookahead Carry Generator, 3 Proms, 2 Quad bus Driver/Receivers and much more.

Attach coupon to Purchase Order to save during introductory offer.

Name	Title
Tel.	M.S.

811 E. ARQUES, SUNNYVALE, CA. 94086

**THINK  
Signetics**

a subsidiary of U.S. Philips Corporation

© 1976.

CIRCLE NUMBER 98

# Clairex optical switches



- Hermetically sealed emitter and sensor
  - Glass lenses
  - Standard designs
  - Custom designs
  - Potted for rugged environmental use
- Call (914) 664-6602

**CLAIREX ELECTRONICS**  
A Division of Clairex Corporation

CIRCLE NUMBER 99

# Inside Anzac Amplifiers

are the patented designs which make ANZAC the leader in high technology/high reliability RF components... plus the quality of workmanship you can expect from our MIL-Q-9858A approved facility.

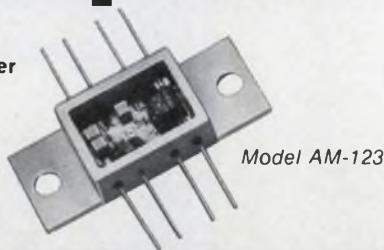

Model AM-123

## 10 dB Gain, Wide Dynamic Range 5 - 500 MHz

Noise Figure	4 dB typical
Power Output	+22 dBm (1 dB compression)
3rd Order Intercept	+40 dBm
Bias Power	1 watt typical

Call or write for the latest ANZAC Full Line Catalog.

**All Amplifiers Available from Stock**



39 Green Street • Waltham, MA 02154 • Tel. (617) 899-1900 • TWX 710 324-6484

CIRCLE NUMBER 100

## DATA PROCESSING

### This APL compiler runs on any PDP-11

Digital Equipment Corp., Maynard, MA 01754. Stephen A. Kallis, Jr. (617) 897-5111. \$1575.

The APL-11 compiler operates with all PDP-11 processors (RT-11, RSTS/E), provided you have a terminal with the APL character set, such as the new DECwriter II (Model LA37). APL is a sophisticated language, used in financial, educational, and scientific applications. Deliveries for the new compiler are scheduled for late spring 1977.

CIRCLE NO. 359

### Versatile modem can be serviced world-wide

Tektronix, Inc., P.O. Box 500, Beaverton, OR 97077. Carl A. Plog (503) 644-0161. \$350-\$800; 2 wks.

The Model 4931 modem is specifically designed for Tektronix terminals of the 4010 family. It offers 300 bit/s for full duplex systems and 1200 bit/s as well as 1200 bit/s with 5 bit/s reverse channel for half duplex systems. The modem works on unconditional voice grade lines with DAA, such as Bell CDT 1000A. World-wide service is available.

CIRCLE NO. 360

### Interactive program stops system crashes

On-Line Software International, 411 Hackensack Ave., Hackensack, NJ 07601. Thomas J. Pagano (201) 489-0400. \$6500.

InterTest, an interactive test controller program, was developed primarily for IBM's CICS and CICS/VS systems. The program makes debugging faster and easier for the user. InterTest diagnostics alert the user interactively (before the system crashes) to potential problems such as main storage destruction or errors in applications programs. Other features include: multithread testing from one terminal, dynamic error correction and retry, diagnostic message routing and status display, and on-line viewing and correction of memory or file storage. Leasing and rental arrangements are available.

CIRCLE NO. 361



## Million-point display takes the 'stairs' out

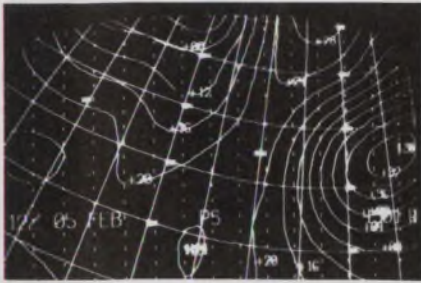

Genisco Computers, 17805-D Sky Park Circle, Irvine, CA 92714. William Huber (714) 556-4916. \$20,000 (20 up).

If the "stairs" in a typical 512-by-512-point graphic display are bothersome in your application, the Model GCT-1024 display could be your salvation. The 1024 x 1024 raster is generated by a proprietary logic circuit that provides instruction times as fast as 150 ns, and 51 mnemonic instructions. Accessories include graphic tablets and cursors, a joystick assembly, and special keyboards. Units with up to 16 gray scales are available as options.

CIRCLE NO. 362

## Half-million bytes in the palm of your hand

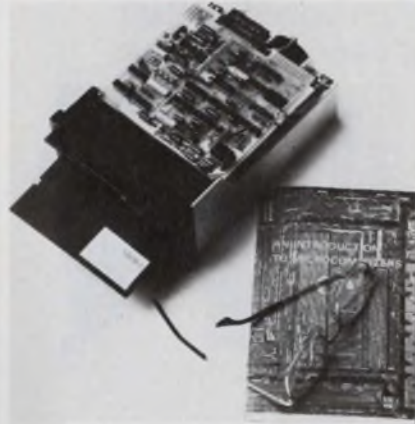

Wango Inc., 5404 Jandy Pl., Los Angeles, CA 90066. (213) 390-8081. \$300 (OEM qty.).

A little 5-1/2 in. diskette, called Micro-Floppy, holds up to 498.6 kbytes, and plays on the Model 82 drive. Unformatted capacity is 109.4 kbytes on 35 tracks, and average random seek time is 370 ms. The Model 82 has an MTBF of 8500 power-on hours, with no routine maintenance. It measures 3.25 x 5.75 x 7.95 in.

CIRCLE NO. 363

## HP minis now talk fast to IBM maxis



Hewlett-Packard, 1501 Page Mill Rd., Palo Alto, CA 94304. (415) 493-1501. \$4500; 2 wks.

With the remote job entry subsystem (RJE), the HP 1000, and (after modifications) HP-2100 or HP-21MX systems can communicate with IBM 360 and 370 series batch-oriented computers, much as an IBM 2780 terminal does. Using the IBM Bisync protocol, the RJE/1000 transfers data (e.g. from real-time data acquisition, control, or automatic testing) at up to 9500 baud. The RJE/1000 operates directly with HASP in IBM's operating system, and offers a choice of EBCDIC and ASCII code.

CIRCLE NO. 364

**VECTRON CRYSTAL OSCILLATOR OF THE MONTH**

**Screen Tested Clock Oscillator**

Model 238A-2S-2  
Output: TTL  
Input: 5V  
-55/+125°C: ±50 ppm  
Frequency: 4-100 MHz  
Vibration: 20g to 2 KHz  
Screened: 100% burned-in, temperature cycled and seal tested per MIL-STD-202

636A-2S-2  
CMOS  
5-15V  
±50 ppm  
4-10 MHz  
(other models as low as 1 Hz)

**CLOCK OSCILLATORS**

TTL: 1Hz to 100MHz  
CMOS: 1Hz to 10MHz  
ECL: 5 to 200MHz  
Stab: ±.01 to ±.0003%

**TCXOs**

0/+50°C: to ±1 x 10<sup>-7</sup>  
-55/+85°C: to ±1 x 10<sup>-6</sup>  
Aging: 1 x 10<sup>-6</sup>/year  
Frequency: 60 Hz-140 MHz

**VCXOs**

Dev: ±.003 to ±1%  
Lin: to ±1%  
For both low distortion and phase lock applications

**OVEN TYPE**

Aging: to 1 x 10<sup>-10</sup>/day  
Freq: to 400 MHz  
Stab: to ±2 x 10<sup>-12</sup>/°C

**VECTRON**

**VECTRON LABORATORIES, INC.**  
121 Water Street  
Norwalk, CT 06854  
Telephone: 203/853-4433

Send for your free product catalog and applications bulletin: "How to Specify Crystal Oscillators."



CIRCLE NUMBER 101

ELECTRONIC DESIGN 4, February 15, 1977

BIPOLAR MICROPROCESSING #7

**OUR BOOK DESCRIBES SMS McSIM AND OTHER DESIGN SUPPORT SYSTEMS.**

In addition to SMS McSim, the prototyping system, there are details on ROM Simulator, Micro-assembler, SMS McCAP Assembler and more.

Open the door to easier designing. Clip coupon to letterhead.

Name	Title
Tel.	M.S.
811 E. ARQUES, SUNNYVALE, CA. 94086	

THINK  
Signoties

a subsidiary of U.S. Philips Corporation

© 1976

CIRCLE NUMBER 102

PERMANENT MAGNET  
**MOTORS**  
BY CLIFTON PRECISION

SERVO MOTORS  
MOTOR TACHOMETERS  
MOTOR ENCODERS



● wide selection of models

● custom designs

● high reliability

● cartridge brushes

● ceramic, alnico or rare earth

**IDEAL**

for tape reels,  
carriage drives,  
recorders,

lab equipment,  
disc drives . . .



Why not  
take advantage  
of Clifton's  
servo  
technology?



for further  
information call (or write)

John Staiber  
(215) 622-1000



**CLIFTON  
PRECISION**

MARPLE & BROADWAY  
CLIFTON HEIGHTS  
PENNSYLVANIA 19018

CIRCLE NUMBER 103

DATA PROCESSING

**High-speed plotter  
is user-expandable**



Zeta Research Inc., 1043 Stuart St., Lafayette, CA 94549. Ralph Manildi (415) 284-5200. \$27,400; 6 wks.

The Model 5036 plotter combines the speed of the earlier Model 3600 plotter (up to 7.5 in./s) with the flexibility of a PDP-11 mini-computer. The user-expandable system can be used on-line as well as off-line. When connected to a remote-batch terminal, input transmission rates can be as high as 19,200 bits/s. The built-in PDP-11 transforms the input data into vectors so that the plotter can operate near maximum speed most of the time. A 12-in. model (5012) is also available, at a cost of \$16,950.

CIRCLE NO. 365

**High-capacity discs  
boast fast transfer**

Data General Corp., Southboro, MA 01772. Bob Palmer (617) 485-9100. From \$24,900; 12 wks.

With a transfer rate of 806,000 characters per second, the Model-6060 disc drive can move a lot of data into large Eclipse and Nova systems. The Model 6060's moving-head disc pack really packs it in; the density of 4040 bits per inch achieves a capacity of 96 megabytes. As an option, for \$5000 more, the Model 6061 stores 192 megabytes. Dual-access capability, error detection and correction, and the separation of command channels from read/write channels enhance the system's versatility. Discs can be shared by two Data General computers, under software control.

CIRCLE NO. 366



The  
**Accuracy Policy  
of  
Electronic Design  
Is:**

- To make diligent efforts to ensure the accuracy of editorial matter.
- To publish prompt corrections whenever inaccuracies are brought to our attention. Corrections appear in "Across the Desk."
- To encourage our readers as responsible members of our business community to report to us misleading or fraudulent advertising.
- To refuse any advertisement deemed to be misleading or fraudulent.

This statement of accuracy appears in every issue of *Electronic Design*. Staff members are imbued with it, from their very first day.

**Electronic Design**

50 Essex Street  
Rochelle Park, New Jersey 07662  
(201) 843-0550

COMPONENTS

**Low-profile SS relay is hermetically sealed**

*Teledyne Relays, 3155 W. El Segundo Blvd., Hawthorne, CA 90250. (213) 973-4545. \$16.50 (1000 up).*

Model 683-1 low profile dc solid-state relays packaged in a hermetically sealed metal DIP enclosure withstand military and aerospace environments. Using hybrid IC construction, the relay employs a proprietary constant-current micro-circuit for a TTL and HiNIL-compatible input control range of 3 to 15 V dc. A dual photovoltaic optocoupler provides high output current combined with low OFF-state leakage. Positive feedback provides snap-action to prevent damage from slowly ramped inputs. Designed to meet the requirements of MIL-R-28750, the new DIP relay operates over a temperature range of -55 to 115 C with 50  $\mu$ s ON and 150  $\mu$ s OFF maximum response time and no self-generated EMI.

CIRCLE NO. 367

**Indicator displays fault until manually reset**



*Minelco, 136 S. Main St., Thomaston, CT 06787. (203) 283-8261. Under \$10 (OEM qty); stock.*

Bite indicators, Model BHGD24, for high-density stacking on PC boards of instrument panels have dual coils and meet or exceed military specifications (which?). The indicators operate on a pulse of 20 ms or greater. A "fault" display continues until the "no-fault" color is manually reset. Single-coil units (BHGD24) are also available. The indicators operate without filaments, springs, hinges or bearings. Standard voltages of 1.5 through 28 V dc are available. Standard colors are red, white, black, green, yellow, orange and blue. Units are threaded for either front or rear panel mounting, or can be obtained with press-fit sleeves.

CIRCLE NO. 368

**Panel-light holder snaps into place**



*Freund Precision Inc., 223 E. Helena St., Dayton, OH 45404. (513) 228-8269. \$1 (OEM qty).*

The new Pop-It panel-light holder cuts assembly labor to the bone. It eliminates the need for the old-style threaded body and nut used to assemble parts on a panel. This easy snap-in collet arrangement allows assembly of the light base into any kind of panel up to 0.080-in. thick. The assembly is locked into the panel by four keys in the molded chrome-plated lens part. The unit comes assembled with the bulb installed in a separate lens assembly. Various colored lenses are available.

CIRCLE NO. 369

**Noise sensitivity problems go away—we guarantee it!**

Topaz Ultra-Isolation Transformers provide an inexpensive and reliable way to supply clean, noise-free AC power to sensitive equipment such as computers, instrumentation, communication and process control equipment.

Ultra-Isolation Transformers offer the industry's best noise attenuation:

- Common-mode noise rejection greater than 145 dB.
- Transverse-mode noise rejection greater than 125 dB at 1 kHz.
- Standard models 125 VA to 130 kVA.
- Priced from \$64.



**Our guarantee:** A Topaz Ultra-Isolation Transformer will solve your noise sensitivity problems to your complete satisfaction or we'll take it back—no questions asked.

**TOPAZ** SOLUTIONS TO POWER PROBLEMS  
ELECTRONICS

3855 RUFFIN ROAD, SAN DIEGO, CA. 92123 • (714)279-0831 • TWX (910)335-1526

CIRCLE NUMBER 104

ELECTRONIC DESIGN 4, February 15, 1977

BIPOLAR MICROPROCESSING #8

**OUR MICROPROCESSING ANSWERMEN KNOW ALL.**

Signetics' field application engineers know bipolar microprocessing—products, benefits, support systems, software, testware, all. Experts help you do it easiest, fastest, cheapest.

Send coupon with letterhead for microprocessing application help.

Name	Title
Tel.	M.S.

811 E. ARQUES, SUNNYVALE, CA. 94086

**THINK signetics**

a subsidiary of U.S. Philips Corporation ©1976

CIRCLE NUMBER 105

# When Signetics claims our bipolar microprocessors make your design resources go further

How can you switch to bipolar from MOS microprocessing without obsoleting your existing designs? How can you reduce hardware design time, reduce programming time, reduce debugging time? How can you try it before you buy it?

Signetics has put it all together in bipolar microprocessors featuring the industry's most complete product family, fastest 2-bit  $\mu$ PA (3001), first 8-bit fixed instruction processor (8X300), the 8080 emulator, several designers' kits, interface elements, bipolar memories and all using Signetics superior low power Schottky LSI technology.

**1** **8080 Emulator upgrades performance of existing system.** Delivers 5 times more performance, reduces micro-code writing time, operates from existing software, makes designing easy. (Available now.)

**2** **A free microprocessing book.** It's filled with memory, logic, interface info and application notes. All

Signetics' high performance bipolar products are listed in detail.

**3** **The industry's leading selection of RAM's, ROM's, PROM's, FPLA's, you name it.** Signetics has more configurations and performance levels available from stock. You get the right fit and absolute maximum efficiency in minimum time.

**4** **8X300 Designer's Kit.** We supply all the parts you need to build your own general purpose controller—you do the PROM programming, checkout prototype system, order production quantities from Signetics. It's just another example of Signetics total support.

**5** **Long list of interface products to pick from.** Signetics has the interface products you'll need to make your bipolar microprocessing shopping easier and more convenient. Now you get everything on your list from one source.

**6** **Introductory Designer's Kit. A \$230.00 value, for \$100.00.** You get 12 parts and 1 manual to let you work with bipolar, design with bipolar, program

# ...we support it.

- 1 Increase performance with the 8080 Emulator.



- 2 We have the book on microprocessing.



- 3 The industry's leading family of bipolar memories.

- 4 Dream up controllers with the 8X300 Designer's Kit.



- 5 One-stop shopping for interface products.



- 6 Introductory Designer's Kit \$100.



- 7 Microprocessor book describes design support systems available.



- 8 Our microprocessor answermen know all.



with bipolar, and prove out all the advantages for yourself. The parts you need to actually try out Signetics' 3000 Total System.

**7 A description of all design support systems.**

Read all about 'em. SMS ROM Simulator, SMS McSim Prototyping System, Microassembler, SMS McCAP Assembler and more, all in the microprocessor book.

**8 Field Applications Engineers that know bipolar microprocessing.** They have the industry's best support systems at hand to help you solve your design problems. They will show you exactly how Signetics' total bipolar microprocessor capabilities will make your design resources go further.

Now you know when Signetics claims to reduce your hardware design time, to reduce your programming time, and to reduce your debugging time... Signetics supports it. Start saving time in the future by mailing the coupon today.

Attach this to your letterhead for fast response.

- Send me information on the 3000 Introductory Designer's Kit.
- Send me information on the 8X300 Designer's Kit — to dream up my own controllers.
- I want to read the book on bipolar microprocessing. Send it ASAP. FREE.
- Send me info now on an emulator that delivers 5 times more performance, the 8080.
- Have a Bipolar Microprocessing Answerman call me for an appointment.

My application is \_\_\_\_\_

Name \_\_\_\_\_ Title \_\_\_\_\_

Telephone \_\_\_\_\_ Mail Stop \_\_\_\_\_

THINK **Signetics**

811 E. Arques Ave., Sunnyvale, Ca. 94086

© 1976.

a subsidiary of U.S. Philips Corporation

## COMPONENTS

### Solid-state relays in a military package

*Teledyne Relays, 3155 W. El Segundo Blvd., Hawthorne, CA 90250. (213) 973-4545. \$38.10 (1000 up).*

A line of military solid-state ac power relays packaged in rugged hermetically sealed aluminum cases withstands military and aerospace environments. The new 652 Series uses inverse/parallel SCRs for output switching over the frequency range of 45 to 440 Hz. Input drive circuitry is logic compatible with input control ranges of 3.8 to 9 V dc for the Model 652-1 and 9 to 32 V dc for the Model 652-2. The relays feature optical isolation and zero-voltage turn-on, and are designed to meet the requirements of MIL-R-28750. Other features include a temperature range of -55 to 110 C, a dv/dt rating of 200 V/ $\mu$ s, a transient peak-voltage rating of 600 V and a peak surge current rating of 10 times the steady-state for 16 ms.

CIRCLE NO. 370

### Miniature toggle-switch kit contains 286 parts



*Oak Industries, Inc., Crystal Lake, IL 60014. (815) 459-5000. \$87.50 (unit qty); stock.*

A 286-piece kit of miniature toggle and pushbutton switches with complementary caps, dress nuts, and wrench gives engineers a complete selection for use in designing circuits and systems. The kit includes single through four-pole switches with a variety of toggle and pushbutton actuators.

CIRCLE NO. 371

### PB switch mounts on PC boards



*Switchcraft Inc., 5555 N. Elston Ave., Chicago, IL 60630. (312) 792-2700. \$1.45 (1000 up).*

A miniaturized momentary-action pushbutton switch with molded-box construction and PC terminals allows high-density mounting on PCs or flat, flexible cable. The new Hi-D switch can be specified with 1-A, 1-B or 1-C contacts and the switch body has a one-piece construction of molded nylon. Contact springs are precision formed of a special nickel-silver alloy; integral contacts have silver or gold plating. A choice of red or black pushbutton is available.

CIRCLE NO. 372

# When it's time to swit

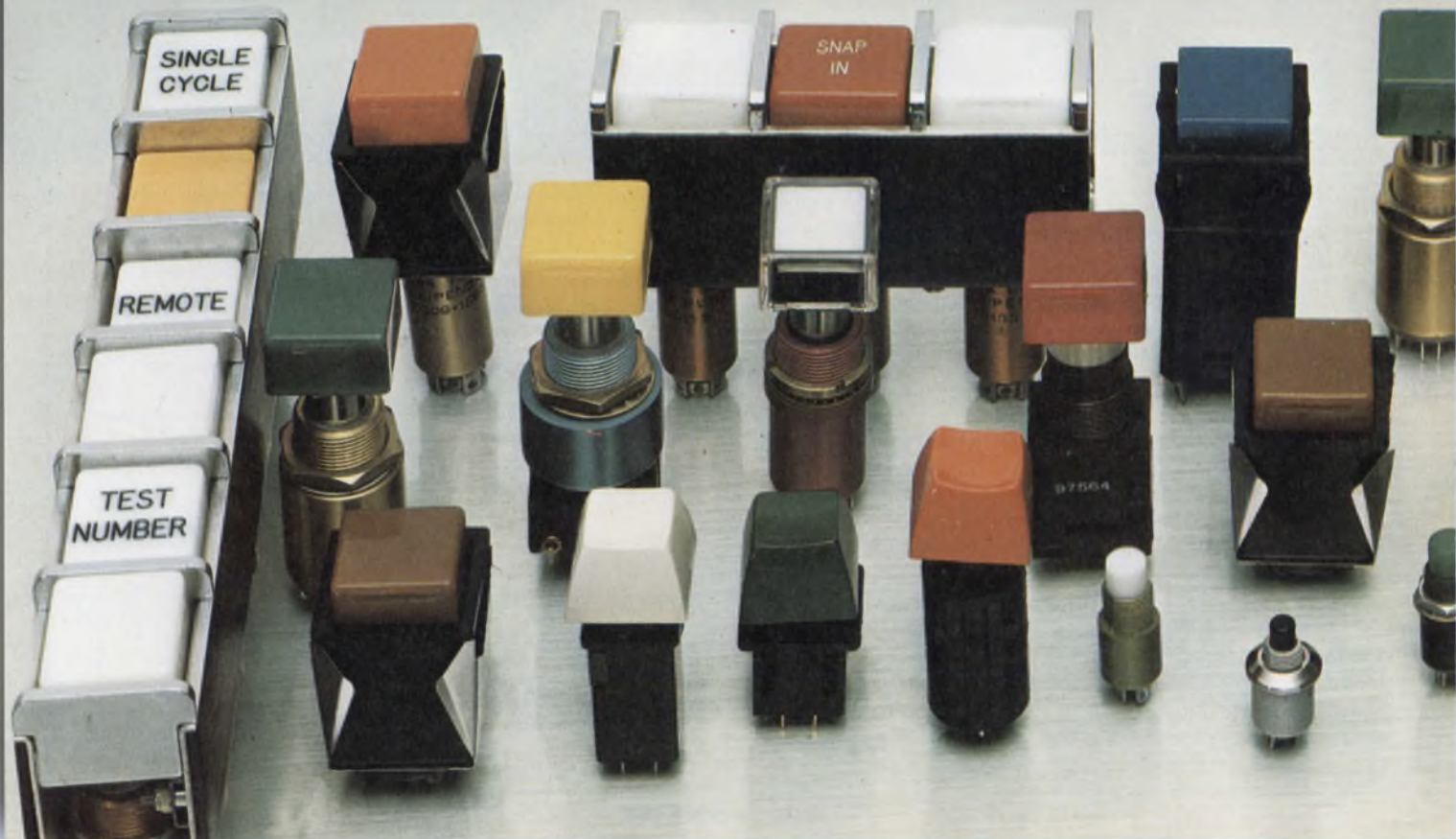

## Photodetector for lasers offers 150-ps rise time

*Lasermetrics, Inc., 111 Galway Pl., Teaneck, NJ 07666. (201) 837-9090. \$575 (unit qty); stock to 60 days.*

High-speed photodetectors, series 3117, detect the optical pulse outputs of lasers operating between 0.4 and 1.2  $\mu\text{m}$ . Ultrafast silicon photodiodes mounted in tuned coaxial-stripline assemblies can accommodate optical signals ranging from mode-locked picosecond and Q-switched nanosecond pulses to slow dc light-level variations. A selectable dual-voltage power supply provides normal or high-sensitivity outputs. The higher-voltage setting improves output signal linearity. The unit matches a 50- $\Omega$  load.

CIRCLE NO. 373

## Power Darlingtons switch fast with L loads

*Motorola Semiconductor Products, Inc., P.O. Box 20294, Phoenix, AZ 85036. (602) 244-4284. \$4.50 to \$9.50 (100-999); stock.*

High-speed MJ10004 through MJ10007 npn power Darlingtons (400 to 450 V at 1 to 2 A, sustained) are characterized for real-world, inductive-load applications. Fall and storage times are 100 and 850 ns, respectively, for the MJ-10004/5 and 90 and 780 ns, respectively, for the MJ10006/7. These time intervals are typical when switching an inductive load of 180  $\mu\text{H}$  with the devices clamped at their rated  $V_{\text{CEX}}$  and at case temperatures of 100 C. To reduce turn-off times, reversed diodes parallel the input base-emitter junctions. Due to the nature of their construction, the devices also contain reverse collector-emitter diodes.

CIRCLE NO. 374

## Seven-segment displays come in three colors

*Hewlett-Packard, 1501 Page Mill Rd., Palo Alto, CA 94304. (415) 493-1501. \$2.70 (1000 up).*

A group of 0.3-in. seven-segment displays provides high-efficiency red (5082-7610 series), yellow (5082-7620 series) and green (5082-7530 series). Each series is available with a common anode and left-hand decimal, common anode and right-hand decimal, common cathode and right-hand decimal, and  $\pm 1$  universal overflow and right-hand decimal. The units are designed for low-current multiplex operation—as low as 3 mA per segment for the high-efficiency red devices. At an average forward current per segment of 20 mA, typical luminous intensity 1430  $\mu\text{cd}$  for the high-efficiency red, 1200  $\mu\text{cd}$  for the yellow and 765  $\mu\text{cd}$  for the green. Typical forward voltage for all colors is 2.2 V.

CIRCLE NO. 375

# ch...switch to CLARE.

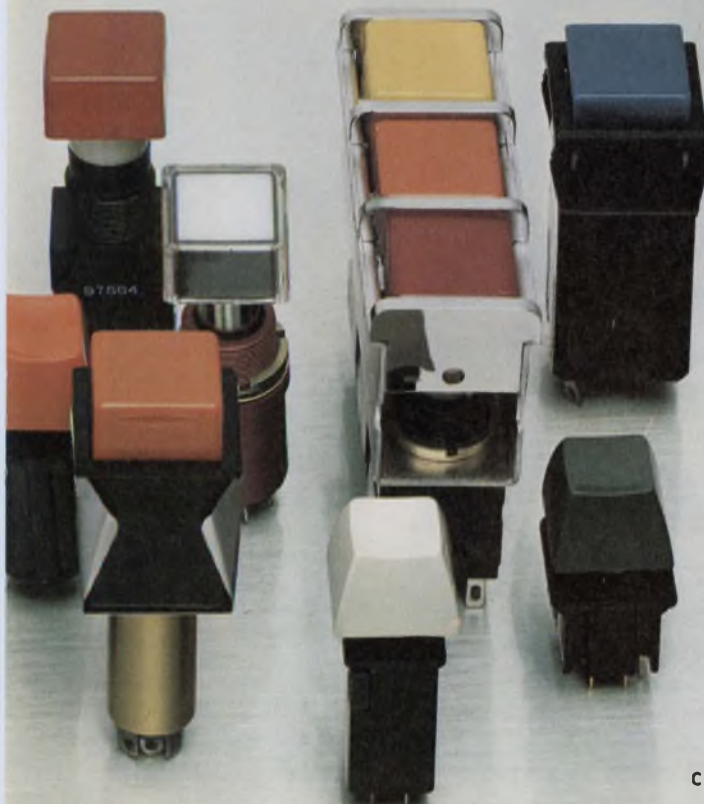

**There's an outstanding CLARE SWITCHING DEVICE waiting for your application.**

From switchlights to indicators. Interlocked gangswitch assemblies to advanced key switch designs. All backed by a quarter century of Clare-Pendar quality and reliability . . . combined with the proven service capabilities of C. P. Clare.

Ready for a switch? Contact your local distributor. Or, C. P. Clare & Company, 3101 W. Pratt Avenue, Chicago, Illinois 60645. Phone (312) 262-7700.

**C. P. CLARE & COMPANY  
GENERAL INSTRUMENT CORPORATION**



CIRCLE NUMBER 107

## DISCRETE SEMICONDUCTORS

### Npn transistors handle 50 W at 900 V

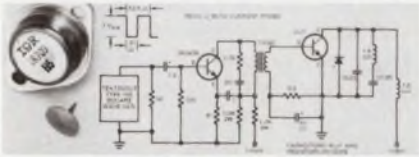

International Rectifier, 233 Kansas St., El Segundo, CA 90245. (213) 322-3331. \$2.25; IR708 (100 up).

A new series of 900-V power transistors with power-dissipation ratings to 50 W, designated IR708 and IR709, has a continuous collector current rating of 3 A. Collector-emitter saturation voltage for the IR708 is 2 V at a collector current of 1 A, and for the IR709, 1 V at 2 A. Fall time for each unit is 1.5  $\mu$ s. The IR708 and IR709 transistors are suited for applications in video horizontal deflection circuits, high-voltage switching power supplies and switching regulators.

CIRCLE NO. 376

### 3 $\phi$ bridges stand-off voltages to 5000 V

Solid-State Devices Inc., 14830 Valley View Ave., La Mirada, CA 90638. (213) 921-9660. \$7.50 to \$40 (100 up); stock.

Two new series of miniature three-phase bridge-rectifier assemblies, SDA 113 and SDA 168, provide an average output current of 3 A with 50 to 5000 V piv per leg. The SDA 113 medium-voltage series consists of seven 3-A models with piv per leg from 50 to 1000 V. Allowable peak one-cycle forward-surge is 50 A; allowable peak recurrent forward-surges are 10 A. Maximum reverse-current is 5  $\mu$ A at 25 C. The SDA 168 high-voltage series consists of seven models with piv per leg from 1000 to 5000 V. They are rated at 3 A at 25 C ambient with no heat sink and 5 A when used with a heat sink that maintains the case temperature below 55 C. Peak one-cycle forward surge-current is 150 A and peak recurrent forward-current is 75 A.

CIRCLE NO. 377

### Pellet transistors cover 2 to 6 GHz



Microwave Semiconductor Corp., 100 School House Rd., Somerset, NJ 08873. (201) 469-3311. \$37 to \$65 (100 up); 30 to 60 days.

Emitter-site ballasted power transistors, series MSC 85000, in pellet form offer the circuit designer flexibility of choice of the frequency range, power output, supply voltage and circuit topology. Miniature coaxial or stripline packages feature low loss, low parasitics and rugged metal/ceramic hermetic enclosures. The coaxial devices are available in common-base or common-emitter configurations. The stripline devices in addition, come in a common-collector arrangement. Four basic families in the series can handle from 0.6 to 1.3 W between 2 to 6 GHz.

CIRCLE NO. 378

# When "Real Estate" is important measure our Capacitors against their capacitors.

If your circuit boards are victims of the capacitor population explosion, Siemens can help solve your problem. We produce over 5 million capacitors a day and know how to put the most c-v value into the smallest package.

Our stacked film capacitors, for instance, can reduce your circuit board real-estate by 60% compared to competitive units. But this is only one alternative available. And that's our strength. Being able to offer a wider range of capacitor types than others - to guarantee you the right capacitor for your application.

To learn the full story on our tantalum, film, metallized film, stacked film, aluminum electrolytic and ceramic capacitors, contact:

Siemens Corporation, Components Group  
186 Wood Ave. South, Iselin, N.J. 08830 (201) 494-1000

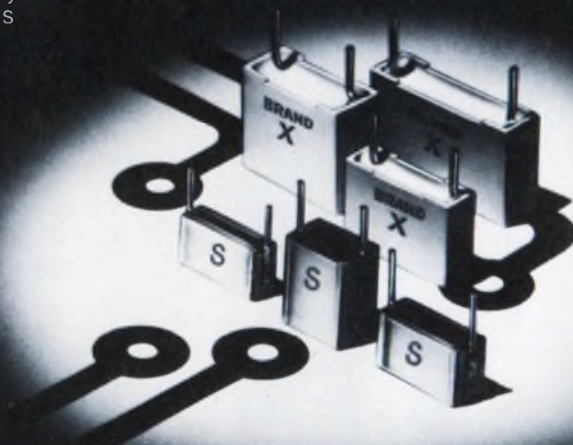

# SIEMENS

CIRCLE NUMBER 108



## POWER SOURCES

### Full open-frame line gives you OVP

Alpha Power, 9020 Eton Ave., Canoga Park, CA 91304. Thomas Ingman (213) 998-9873. \$24.95-\$82.00 (100 qty); stock to 2 wks.

Unlike other open-frame power supply families, all 40 of the OEM-111 series boast nonadjustable overvoltage protection as a standard feature. Also, instead of the usual TO-3 power transistors mounted through the chassis, these supplies use plastic versions of the 2N3055, derated to 3 A and mounted between frame and circuit board for servicing ease. All units operate from 105 to 125 or 210 to 250 V, 47 to 63 Hz, but you must derate the output by 10% for 50 Hz. These units give you 5, 6, 12, 15, 20 or 24 V dc. Additional features include:  $\pm 5\%$  output adjustment and  $\pm 0.15\%$  regulation for rated-line or 100%-load change.

CIRCLE NO. 379

### Supply stays cool, so does your board

Semiconductor Circuits, 306 River St., Haverhill, MA 01830. (617) 373-9104. Under \$80; stock.

Two models of ES and EA PC-board supplies, whose only difference is their input-ac pin spacing, provide full-rated output of 12 V at 1.2 A from  $-25$  to  $+71$  C. The units feature a typical case-temperature rise of 15 C under high-line and full-load and a smooth, well-damped response to input-power switching and abrupt load changes. Regulation is 0.15% for line and load. Output ripple and noise are 7-mV rms. The module's regulator is claimed to dissipate four times less power than series-pass types and gives more than 60-dB line-transient immunity. The modules have MTBFs in excess of 150 kh at 25 C and outputs protected via foldback limiting. They operate from 105 to 125 V ac at 50 to 440 Hz and measure  $2.4 \times 3.5 \times 2$  in.

CIRCLE NO. 380

### Units deliver 800-Hz avionics test power

Aiken Industries, 5150 Convoy St., San Diego, CA 92111, Walt Hanford, (714) 279-8620. \$770 to \$48,500; 30 days.

Invertron power sources provide 800-Hz line power. They are primarily intended for testing military avionics equipment using the new higher-frequency line power. The series includes single, two and three-phase models with output ratings from 100 VA (single-phase) to 30 kVA (three-phase). A plug-in oscillator, driving a high-power linear amplifier, determines the output frequency. All units feature distortion of less than 0.9%, line regulation of 0.25%, amplitude stability of 0.25%, load regulation of 1% (settable to 0.01%), ac noise of 80 dB below full output, operating range of 0 to 55 C and overload protection. A single unit gives you several output-voltage combinations when you stack its output-voltage taps.

CIRCLE NO. 381

# Thank you for the Vendor Excellence Award, Raytheon...our Zeners worked hard for it.



Hi-Rel Zener Diodes are one of our most important product lines. And when Raytheon commended Siemens for our excellence in this area we were understandably proud. (We were one of 30 vendors so honored, out of an evaluation group of 4000.)

The award cited Siemens for its quality, reliability and on-time delivery, plus an attitude of cooperation.

What we did for Raytheon at Andover, Mass., we can do for you. Our Hi-Rel Manufacturing facilities in Scottsdale, Arizona, produces JAN, JANTX, JANTXV, SiN Zener Diodes and specially processed devices for the Hi-Rel market.

To learn more about making our Zeners work for you... send for our new free Zener Diode wall chart.

Siemens Corporation, Components Group  
145 Wood Ave. South, Iselin, N.J. 08830 (201) 494-1000

# SIEMENS

CIRCLE NUMBER 109

# FORGET EVERYTHING YOU EVER KNEW ABOUT IMAGE PROCESSING & DISPLAY

"You want to process electronic information.  
You need an image display.  
You're thinking of using digital scan converters,  
direct view storage displays,  
or computer memories..."  
"Don't."



A revolutionary new instrument will help you solve virtually all of the problems associated with processing electronic information for image displays. From ultrasound scanners. Computers. Nuclear gamma cameras. Telephone lines. X-ray sources. Or outer space.

## The **PEP 500** Lithocon® Solid State Image Memory/Scan Converter

Pull it out of the carton. Plug it in. Knock it around. Heat it. This is a field-tested workhorse. Not a laboratory device.

It's the first beam-addressed, solid-state image memory and scan converter that has been designed for industrial and commercial use. In the field. Under extreme operating environments. In tropical heat. In sub-zero temperatures. Anywhere. Everywhere. A new dimension in electronic imaging. It's a revolution.

Call: 201-297-4448.

**PRINCETON ELECTRONIC PRODUCTS, Inc.**  
Box 101, North Brunswick, New Jersey 08902

CIRCLE NUMBER 110

## POWER SOURCES

### Small dual-switcher delivers 750 W

*LH Research, 1821 Langley Ave.,  
Irvine, CA 92714. (714) 546-5279.  
From \$750; 8 wk.*

Switching-regulated power supply Model MM-520 gives you two outputs, each up to 375 W, in a package that is 5.1 × 6.5 × 13.5 in. You have a choice of any combination of 2 V at 75 A, 5 V at 75 A, 127 V at 31 A, 15 V at 25 A, 18 V at 21 A and 24 V at 15 A. This switcher features up to 80% efficiency and 1% or 50-mV pk-pk output ripple and noise, and 0.4% line and no-load to full-load regulation. The unit operates with full rating to 40 C and derated to 60% at 70 C. For cooling, an integral fan is provided. Response time is 200 μs to 1% after a 25% load change.

CIRCLE NO. 382

### Unfloppy supplies handle disc loads

*Standard Power, 1400 S. Village  
Way, Santa Ana, CA 92705. (714)  
558-8512. From \$109; stock.*

SMS series of six multiple-output regulated-dc supplies is intended for floppy-disc and peripheral memory systems with similar input-output requirements. These multiple-output units provide combinations of 5, 12, 15 and 24 V dc, regulated to within plus or minus 0.1% for line and load, with a typical ripple of 50 mV. All models have adjustable outputs of ±5% for fine-tuning key voltages. The modules feature short-circuit and current-limiting protection for both the memory system and the power supply itself. The 24 V dc output handles surge currents of 200% of rated output for up to 500 ms to accommodate start-up and end-drive functions. The units operate from inputs of 115/230 V ac (±10%), 47 to 440 Hz. Over-voltage protection circuits are standard on all +5 V dc outputs, and optional for other voltages. Logic-inhibit and remote-programming circuits that keep critical voltages on in desired sequences during turn-off modes are optionally available.

CIRCLE NO. 383

## MONOLITHIC CRYSTAL FILTERS



### TAKE A MONOLITHIC TO LUNCH

Every day, thousands of people, in countries around the world, take our monolithic filters to lunch, or maybe home to dinner (in paging receivers which can call them to a fire, an emergency operation, or a poker game). Size, ruggedness, and low cost are important in this application. Our standard 10.7 and 21.4 MHz monolithics offer all three. Many paging receivers operate in urban, dense signal areas, and there our VHF monolithic filters can simplify front-end design and reduce intermodulation. If you're thinking about paging, or any other production application of monolithic filters, call for PTI — the standard in monolithic crystal filters.

### STRAIGHT STORY...

... about linear phase (constant group delay) monolithic filters. Three new four-pole models in our low-priced Comline® series offer a delay variation of 10 μs. max. over the specified 3 dB. bandwidth (±6 kHz.) for land mobile radio applications requiring data transmission or improved impulse response. Center frequency is 10.7 MHz. Spec sheet available. Just ask for models 5182, 5261, and 5262.

What's your application? Whether it's one of the above or something brand-new we'll be glad to work with you. Just give us a call, or a brief note outlining your requirements. We'll take it from there.

# Pi

**Piezo Technology Inc.**

2525 Shader Road Orlando, FL 32804  
(305) 298-2000

The Standard in monolithic crystal filters.

CIRCLE NUMBER 111

ELECTRONIC DESIGN 4, February 15, 1977

## High-power dc/dc units fit on PC boards



Datel Systems, 1020 Turnpike St., Canton, MA 02021. Eugene Zuch, (617) 828-8000. From \$69; 4 wk.

The 2 × 2 × 0.75-in. (5-W) UPM and the 3.5 × 2.5 × 0.875-in. (10-W) BPM series of dc/dc converters are intended for PC-card use. Together, the two series have a total of 34 models with either single or dual outputs. Operating from 5, 12 or 28-V inputs they deliver single outputs of 5, 12, 24 and 28 V and dual outputs of ±12, ±15 and ±18 V. They feature accuracy of ±1%, tempco of 0.02% and isolation of 100 MΩ. Additional characteristics include: max output noise and ripple, 20-mV pk-pk (2-mV rms); max back-ripple current, 1% of input; max capacitive coupling, 50 pF; min breakdown, 300 V dc; and transient recovery time, 50 ms. All units provide output current limiting. They operate from -25 to +71 C and you can store these converters from -55 to +85 C.

CIRCLE NO. 384

## 60-Hz switchers have low ripple

Calex Manufacturing, 3305 Vincent Rd., Pleasant Hills, CA 94523. (415) 932-3911. \$119-\$129; stock to 2 wks.

Unique in that they retain 60-Hz magnetics, Series-100 switching supplies eliminate the usual 20-kHz switching problems of spikes on the output, high-ripple content, radiation into associated equipment, and power-line feedback. These dc supplies feature pk-pk ripple of less than 2 mV and max no-load to full-load regulation of less than 3 mV. Additional features include: continuous overload and short-circuit protection, thermal protection and a max tempco of 0.03%/°C. Outputs of 5 V at 5 A, ±15 V at 75 A, or just about any combination of single and dual outputs in the 25-W range are available.

CIRCLE NO. 385



## EDGEBOARD CONNECTORS



CIRCLE NUMBER 112

## Circuits happen Faster and Easier with Super-Strip™

As little as  
**\$17**

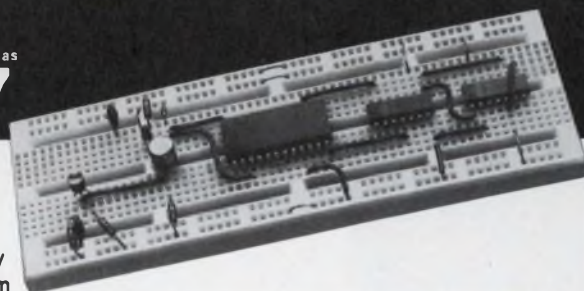

Now, whenever you'd like to give a circuit a try, you can build it up nearly as fast as you can dream it up with Super-Strips™, the faster, easier and less expensive solderless breadboards from A P Products. When you build your circuit on a Super-Strip, everything stays as good as new. Once you're through, you can use everything again and again. Instantly. Put a Super-Strip to work for you. Eight distribution lines handle signal and power, and 128 five-tie-point terminals can handle 9 ICs and then some. It's a whole lot easier than printing a circuit and a whole lot handier than haywire.

Part Number	Model Number	Terminal Type	Price Each
923252	SS-2	nickel-silver	\$17.00
923748	SS-1	gold-plated	\$18.90

Order from your A P distributor today.

Our distributor list is growing daily. For the name of the distributor nearest you call Toll-Free 800-321-9668.

Send for our complete A P catalog, The Faster and Easier Book.



**A P PRODUCTS INCORPORATED**

Box 110-F Painesville, OH 44077 (216) 354-2101 TWX: 810-425-2250

CIRCLE NUMBER 113

# SIEMENS

## To test linear IC's you can spend \$6,000 or \$100,000. Which makes sense?



It makes good sense to use an inexpensive Computest Model 735 at incoming inspection to identify bad devices. For under \$6,000, the 735 identifies defective linear IC's as rapidly as a \$100,000 "everything" machine.

The Computest 735 tests op-amps, regulators, sense amplifiers, comparators and custom linear

circuits. It sequences through 14 tests automatically, provides simple go-no/go analysis and data logging output to record why the device failed, the failed limit and the failed value.

The Computest 735 makes a lot of sense in your incoming inspection application. We will be happy to tell you why. Contact Cliff Small.

**Siemens Corporation**  
**Measurement Systems Division**  
3 Computer Drive, Cherry Hill, N.J. 08034 (609) 424-2400

## MODULES & SUBASSEMBLIES

### DIP active filter is accurate and stable

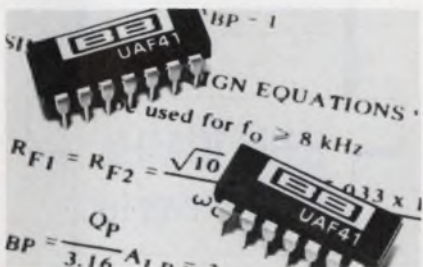

Burr-Brown, International Airport Industrial Park, Tucson, AZ 85734. (602) 294-1431. \$8-\$12.50; stock.

The UAF41, a hybrid active filter in a 14-pin DIP, gives you 0.002%/°C frequency tempco, better than ±1% frequency accuracy, and ±0.01%/°C Q tempco. This filter provides simultaneous low-pass, bandpass and high-pass transfer functions. An uncommitted op amp in the package lets you sum the high-pass and low-pass outputs to get the band-reject or notch function. You compute three or four resistor values to establish the natural frequency and Q. Typical specs include: Q range of 0.5 to 500; dc-to-50-kHz noise of 200-μV rms at Q = 50 and 20-V pk-pk output swing with ±18-V supplies. Power supply range is ±5 to ±18 V. Specification temperature range is -25 to +85 C.

CIRCLE NO. 386

### 70-MHz amplifiers claim low noise

TRW RF Semiconductors, 14520 Aviation Blvd., Laundale, CA 90260. Warren Gould (213) 679-4561. \$31.51 (100 qty); 4 wks.

Boasting a typ noise figure of 4 dB the CA2875 and 2875R hybrid rf gain blocks are intended for i-f amplification in microwave radio-relay systems. Both amplifiers have third-order intercepts of +42 dBm. The CA2875 operates from +15 to +24 V while the R version uses a negative supply. Other features include a return loss of better than 30 dB at both the input and output ports, phase linearity from 30 to 110 MHz and a wide dynamic range. These units operate at center frequencies of 70 MHz and provide nominal gains of 17.5 dB from -40 to +100 C.

CIRCLE NO. 387

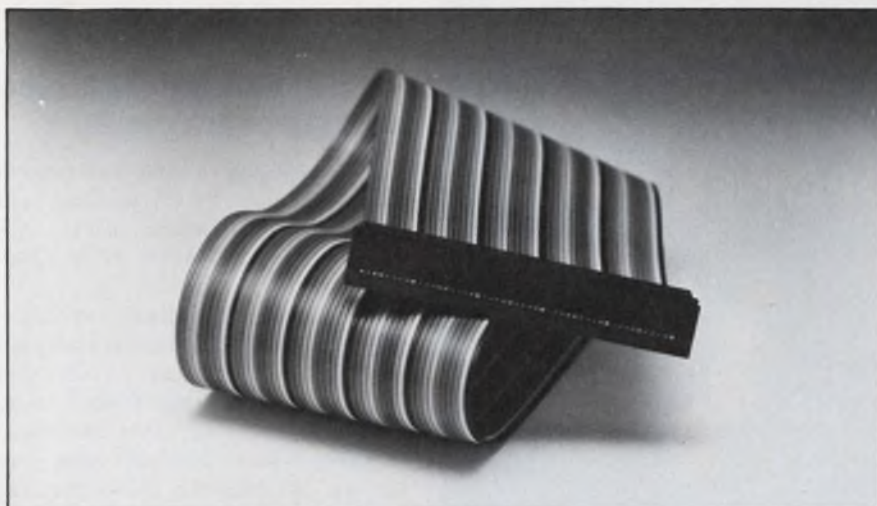

## FLAT FLEX CABLE CONNECTION SYSTEMS



CIRCLE NUMBER 117

This simple equation solves all your RF power amplifier needs:

$$5X = AR$$

Here's how! Don't consider five different sources when AR can satisfy all your RF power requirements. It's basic. Of the five major manufacturers of broadband amplifiers in the United States today, only Amplifier Research offers a full line of RF power amplifiers — from DC to 1000 MHz and up to 5000 watts. With these capabilities, our amplifiers are ideally suited for a wide variety of applications, including general laboratory use, EMI susceptibility testing, laser modulation, NMR spectroscopy and ultrasonics.

Write now for free short form catalog. Your basic formula for RF power.



Amplifier Research  
160 School House Road  
Souderton, PA 18964  
215-723-8181

YOUR BEST SOURCE FOR RF POWER AMPLIFIERS

CIRCLE NUMBER 118

# BUILDING YOUR OWN POWER SUPPLY?

## Think Twice!



### Think "DESIGN-AS-YOU- ORDER"

Think of the expense and time involved in designing and building your own power supply, and how those resources can be applied to designing and building other components.

Now think about the exclusive Arnold Magnetics "Design-As-You-Order" system. You simply order your custom power supply from proven "off-the-shelf" sub-modules . . . no engineering charges, no lost design time. Just fill in our "easy-to-use" specification form, we'll do the rest. Your miniaturized, high efficiency power supply arrives encapsulated and pre-tested.

See if these parameters meet your needs:

- Inputs: Single or dual; 60Hz, 400Hz, 12VDC, 28VDC, 48VDC and 115VDC.
- Regulated Outputs: single or isolated multiple; 5 to 300VDC.
- Line and load regulation to 0.1%.
- Power: 3—160 watts (up to 3.9 watts/in<sup>3</sup>).
- Other catalog power supplies with outputs to 5000VDC and power to 200 watts.
- Capability to design and build to your special needs.

Send for a free "Design-As-You-Order" Power Supply Kit today!



## ARNOLD MAGNETICS CORPORATION

11520 W. Jefferson Blvd.  
Culver City, Ca. 90230 • (213) 870-7014

CIRCLE NUMBER 119

### MODULES & SUBASSEMBLIES

#### Hybrid voltage regulator adjusts over 5 to 20 V

*Fairchild Camera and Instrument Corp., Analog Products Div., 464 Ellis St., Mountain View, CA 94042. (415) 962-3816. \$7.50 (100-up); stock.*

An adjustable voltage regulator, the 78 HGKC, can handle load currents of 5 A and can be adjusted for an output voltage from 5 to 20 V. The hybrid regulator has built-in short circuit and safe area protection. A four-pin TO-3 package houses the circuit. The desired voltage rating can be set by two external resistors or by a single external potentiometer.

CIRCLE NO. 388

#### Low-profile s/d boasts internal r/s

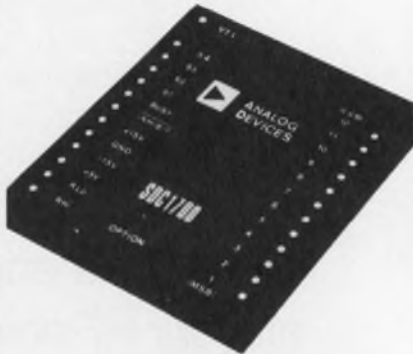

*Analog Devices, Route 1 Industrial Park, P. O. Box 280, Norwood, MA 02062. Joseph Codispoti (617) 329-4700. From \$365; stock.*

Not only does the SDC-1700 s/d converter shave the height of existing units by half, but the 12-bit device also eliminates the need for external Scott-T transformers—even at 60-Hz operation. The low-profile 3.125 × 2.625 × 0.4 in. module converts three-or-four wire synchro or resolver inputs into 12-bit binary. The device boasts ±8.5 arc-minutes of guaranteed accuracy at min-tracking rates of from 5 rps at 60 Hz to 75 rps at 2.6 kHz. Models of these tracking converters are available for frequencies from 50 Hz to 2.6 kHz and for inputs from both high-level and lower-level synchros. The 521 version operates from 50 to 1200 Hz and, with external resistors, accepts inputs from high-level as well as low-level synchros.

CIRCLE NO. 389

Compress a  
1969, \$8750...

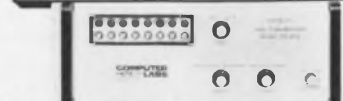

8-Bit, 10MHz  
A/D Converter

and get a...

1977, \$1150  
8-Bit, 11MHz

A/D  
Converter

## HIGH-SPEED A/D CONVERTER MATV-0811

8-Bit • 11 MHz • 20 Cu. in.

# \$1150

COMPUTER  
LABS

COMPUTER LABS, INCORPORATED  
505 EDWARDIA DRIVE • GREENSBORO, N. C. 27409  
(919) 292-6427

CIRCLE NUMBER 120

ELECTRONIC DESIGN 4, February 15, 1977

# Application Notes

## Electronic thermometers

Electronic thermometer applications of the REF-02, a 5-V reference, is described in an application note. Complete theory of operation and design schematics are provided including a discussion of bandgap-voltage-reference design. Precision Monolithics, Santa Clara, CA

CIRCLE NO. 390

## A/d converter interface

Interfacing the 8700 A/D Converter with the 8080A  $\mu$ P System describes the basic techniques for interfacing, and the advantages in size and cost. Included are specific block diagrams, hook-up circuits and interrupt routines. Teledyne Semiconductors, Mountain View, CA

CIRCLE NO. 391

## Alphanumeric displays

A 12-page design and application guide is intended to help the user of the HP HDSP-2000 display. A complete electrical description is given with detailed diagrams, followed by the theory of device design and operation. Hewlett-Packard, Palo Alto, CA

CIRCLE NO. 392

## Plastic parts

A Look at Problem Solving with "Vespel" Parts describes the properties of custom-made plastic parts, provides comparisons of "Vespel" parts' base resins with other plastics and offers typical solutions to design problems. Du Pont, Wilmington, DE

CIRCLE NO. 393

## Thermal-stress analysis

A 16-page manual describes thermal-stress analysis for contraction voids in polyethylene cable. Stress-strain relationships are discussed and correlations of computer data with outputs are shown. Union Carbide, Wire and Cable, New York, NY

CIRCLE NO. 394

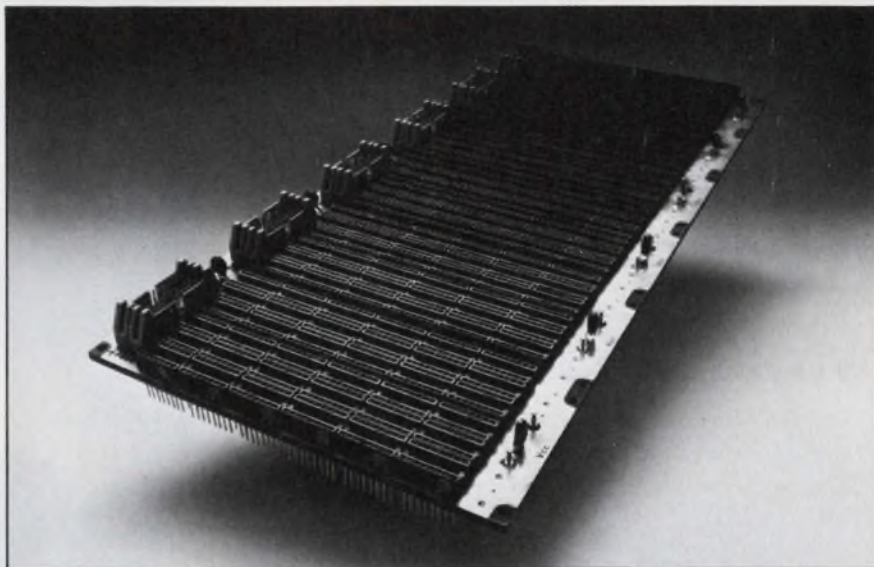

# LOGIC PANELS

CIRCLE NUMBER 121

## TAKE YOUR PICK!!

NLS' DPMs fill every need and the prices are pleasing.

NLS' Silver Jubilee Year

PM SERIES DC OR AC VOLTS

Features include:

- Operates from a +5-volt separate power supply.
- MOS/LSI construction. • Smallest package available anywhere - 1" H x 2.5" W x 3.25" D. • Automatic zeroing. • Programmable decimal. • Overload indication. • Protected input. • Low power consumption. • Large 0.3" LED display.



PM-4 PANEL METER

MODEL	RANGES	ACCURACY	AUTO POLARITY	MUX BCD OUTPUT	RATIO OPERATION	DIGITS	PRICE
PM-3	VDC	$\pm 0.1\%$ F. S.	No	Optional	Optional	3	\$ 85
PM-3/OL	1V, 10V, 100V, or 1000V	$\pm 0.1\%$ F. S.	Standard	Optional	Optional	3	\$ 89
PM-3.5	(PM-3.5 has 100% over-range - 1200V maximum)	$\pm 0.05\%$ F. S.	Standard	Standard	Standard	3-1/2	\$ 99
PM-4		$\pm 0.02\%$ F. S.	Standard	Optional	Optional	4	\$170
PM-3.5AC	VAC - 2V, 20V, 200V or 1000V	$\pm 0.5\%$ F. S.	N/A	Standard	Standard	3-1/2	\$136



**Non-Linear Systems, Inc.**

Originator of the digital voltmeter.

Box N, Del Mar, California 92014 Telephone (714) 755-1134

See your local distributor!

Distributor inquiries invited.

CIRCLE NUMBER 122

AVAILABLE  
FROM STOCK

**40V PIV**

# SCHOTTKY BARRIER RECTIFIERS

WITH  $T_J = 150^\circ\text{C}$

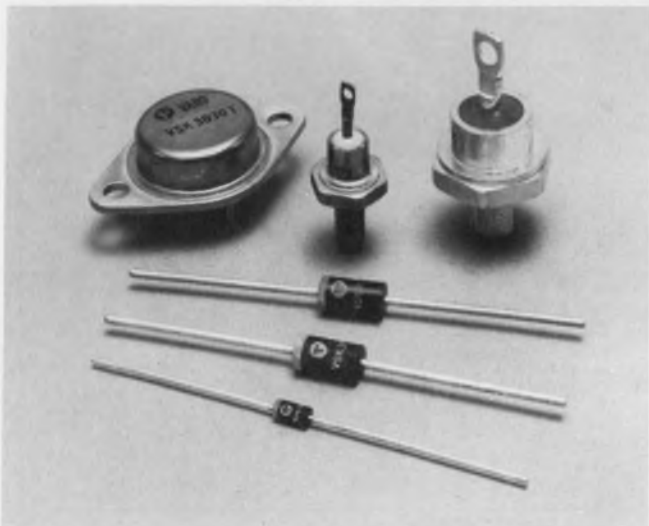

#### VERY LOW FORWARD VOLTAGE DROP ( $V_F$ )

Because of the large metal-barrier-to-silicon junction,  $V_F$  ranges are from 550 mV,  $I_F = 1$  A, to 620 mV,  $I_F = 40$  A. This results in less heat dissipation, low power loss, and greatly improved efficiency.

#### EXTREMELY FAST RECOVERY TIMES ( $t_{rr}$ )

Typically  $\leq 10$  nsec. Schottkys are ideally suited for low-voltage power supplies, free-wheeling diode and flyback diode applications, and polarity protection in high-speed switching circuits.

#### MAJORITY CARRIER CONDUCTION

In addition to fast recovery, Schottky barrier construction results in high surge capacity and low stored charge. Schottkys are not subject to conventional P-N diode forward and reverse recovery transients caused by minority carriers.

#### OTHER VARO SCHOTTKY FEATURES ARE:

- $-65$  to  $+150^\circ\text{C}$  junction operating temperatures
- 1 A, 3A, 5A, 15A, 30A and 40A ( $I_O$ ) ratings
- 20V, 30V, and 40V ( $V_{RRM}$ ) ratings
- Low reverse leakage
- Epoxy axial lead, DO-4, DO-5, and TO-3 package configurations
- Competitive pricing

Try one in your circuit; you will see for yourself these advantages and more.

For more information and data sheets on all Varo Schottky Barrier Rectifiers call Mike Hawkins, 214/272-4551



Design us in . . . we'll stay there

**VARO SEMICONDUCTOR, INC.**

P.O. BOX 676, 1000 N. SHILOH, GARLAND, TEX. 75040  
(214) 272-4551 TWX 910-860-5178

EUROPEAN OFFICE: UK: VARO SEMICONDUCTOR INTERNATIONAL, INC.  
Deepdene House, Bellegrave Road, Welling, Kent, England DA163PY, 01-304-6519/0

CIRCLE NUMBER 123

# LOW COST MAGNETIC SENSORS



## . . . for your speed/position input requirements!

Electro has developed a new competitively priced line of molded plastic magnetic sensors for use in producing input signals for the control of speed and position.

Consider the reliability and economy offered by Electro magnetic sensors proven in these applications:

- Engine timing (position and synchronization)
- Closed-loop motor speed control
- Mixer/blender speed sensing
- Conveyor speed monitoring
- Anti-skid control sensing systems
- Turbine RPM monitoring and control.

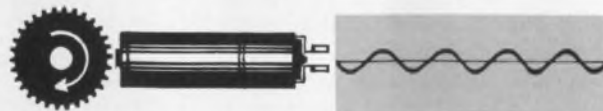

Electro magnetic sensors provide many advantages including: non-contact sensing of any ferrous metal object; trouble-free operation under all conditions such as dust, dirt, oil and other adverse environments;  $-65^\circ\text{F}$  to  $+300^\circ\text{F}$  operating range.

Send us your system input sensing specifications. We will provide you with the most economical solution!



**ELECTRO  
CORPORATION**

1845 57TH STREET

P.O. BOX 3049, SARASOTA, FLORIDA 33578  
AREA CODE (813) 355-8411 • TELEX 5-2683

CIRCLE NUMBER 124

ELECTRONIC DESIGN 4, February 15, 1977



## Evaluation Samples

### Wirewound resistors

RW series resistors come in MIL-R-26 styles; namely, the 1-W RW70, 2.5-W RW69, 3-W RW79, 5-W RW74, 7.5-W RW67 and the 10-W RW78. RCD Corp.

CIRCLE NO. 395

### Drafting aids

Multicolor PC drafting aids save drafting time and allow the designer greater flexibility in creating more accurate master artwork. Samples are available along with a four-page bulletin describing these products. Bishop Graphics.

CIRCLE NO. 396

### Rectifier bridges

The Model PKF quick-disconnect rectifier bridge operates at 12 A and joins existing 6, 8 and 10-A models. All are available for 50, 100, 200, 400, 600, 800 and 1000 peak reverse-voltage operation. Surge current is 150 A. Dielectric strength is 1500 V rms. Size is 0.89-in. max diameter. The design can be chassis or heat-sink mounted. Electronic Devices.

CIRCLE NO. 397

### Toggle switches

Miniature toggle switches in SPDT (GT-124) and DPDT (GT-126) feature a tease-resistant detent mechanism. Housing is moisture-resistant; size is 0.4 × 0.712 × 0.369 in. over-all height. CW Industries.

CIRCLE NO. 398

### Coding forms

Coding forms for those who work in assembly or machine language are bound together in pads of 50 sheets. The pads are formatted to accept code of any  $\mu$ Ps. Columns include address, code, label, instruction and notes. Codes can be written in either octal or hex form. The pads sell for \$1.95 each postpaid. Walton Electronics, Box 503, Bethany, OK 73008.

INQUIRE DIRECT

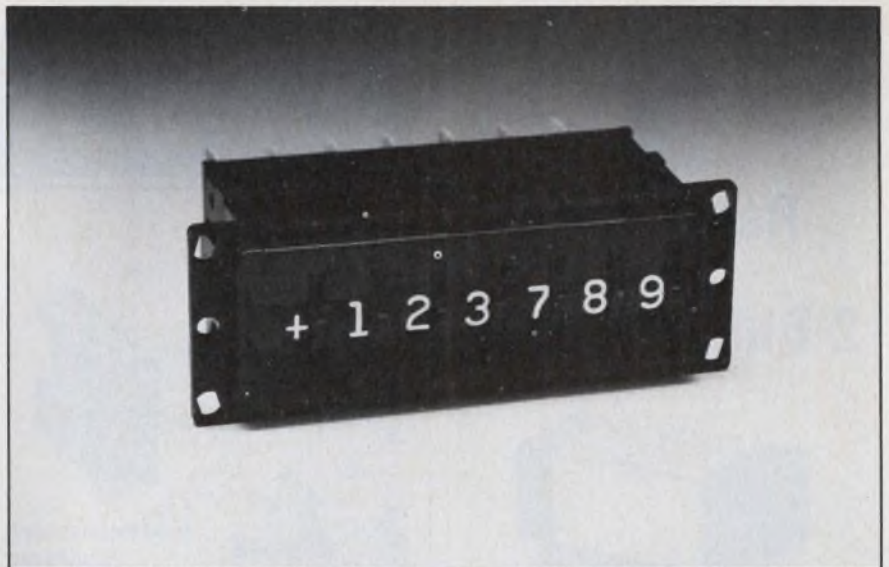

## SWITCHES



CIRCLE NUMBER 125



electrocube solutions...

## POLYSULFONE



## WHEN THINGS GET HOT



When your application specifies 150°C, specify Electrocube's new Polysulfone capacitors. You have a wide choice of extremely stable units in six case styles ... capacitances from 0.0010 to 50 mfd, and standard ratings to 600 VDC. Get more information today on this miniature series from Electrocube, 1710 So. Del Mar Ave., San Gabriel, California 91776; Tel. (213) 573-3300; TWX: 910-589-1609

CIRCLE NUMBER 126

# 1

## Relay Miss every 2-Billion Cycles



Series E Relay (actual size)

We tested 129 of our new Series E Relays at loads from dry circuits to 3 Amps. After 35-billion operations, only 10 single-cycle misses were monitored.

### Series E Relays offer:

- Indefinite life
- No contact bounce
- Operation in all positions
- Contacts stable to  $\pm 0.015$  ohms over life
- Reliability at dry circuit or power loads
- Self-healing contacts
- Hermetically sealed contacts
- 1250V rms contact breakdown
- Low cost

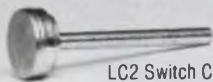

LC2 Switch Capsule (actual size)

Series E Relay uses a rugged LC2 welded capsule rather than a fragile glass reed switch. This patented design holds a film of mercury securely to the metal walls of the capsule. With every operation, the mercury film renews the switch contacts. You get the reliability of mercury relays, but with complete freedom of mounting orientation. LC2 welded capsule reliability is proven by hundreds-of-thousands of units in the field, as well as billions of cycles under stringent laboratory conditions.

Send for a FREE SAMPLE of the LC2 welded capsule on your letterhead. Circle the reader service card number for Series E Relay information.



**Fifth Dimension, Inc.**

P.O. Box 483  
Princeton, N.J. 08540  
Tel: (609) 452-1200

CIRCLE NUMBER 127

## New Literature



### Power supplies

Ac-dc and dc-dc miniaturized, submodular, high-efficiency power supplies are described in a 12-page catalog. Electrical and mechanical specifications are included. Arnold Magnetics, Culver City, CA

CIRCLE NO. 403

### DIP switches

Dimensional drawings, electrical and mechanical specifications and materials and finishes of DIP switches are shown in an eight-page catalog. Grayhill, La Grange, IL

CIRCLE NO. 404

### Portable carrying cases

Deep-drawn aluminum portable carrying cases are featured in a 12-page catalog. Zero Manufacturing, Burbank, CA

CIRCLE NO. 405

### RFI/EMI shielded cases

Low-cost RFI/EMI shielded cases are described in a 20-page catalog. Circuit boards, feedthroughs and rf connectors along with a comprehensive group of gaskets to solve shielding problems are noted. Compac, Smithtown, NY

CIRCLE NO. 406

# GOOD BOOKS ARE HARD TO FIND.



## WHY HIDE YOURS?

We are always looking for well-written manuscripts, or book proposals, for works on topics of interest to professional engineers that will advance their understanding of the state of their art.

What have you been working on?

What can we do for each other?

Let me know.

**S. WILLIAM COOK**  
EDITORIAL DIRECTOR



**Hayden Book Co., Inc.**

50 ESSEX STREET  
ROCHELLE PARK, N.J. 07662

## Film capacitors

A 20-page catalog describes film capacitors for instrumentation, data processing, telecommunications, industrial controls and special applications. The Potter Co., Wesson, MS

CIRCLE NO. 407

## Relays

Electromechanical, dry-reed, mercury-wetted-reed, time delay, interval-timer, hybrid and solid-state relays, and precision snap-action switches are covered in a catalog. Potter & Brumfield, Princeton, IN

CIRCLE NO. 408

## Product digest

Products developed, manufactured and marketed by Beckman are illustrated and described in a 28-page catalog. Beckman Instruments, Fullerton, CA

CIRCLE NO. 409

## Conductor cables

Dimensions, descriptions and other engineering data on conductor cables from 2 conductor to 51 pair types are given in a four-page catalog. Atlas Wire and Cable Co., Yonkers, NY

CIRCLE NO. 410

## Semiconductor etchants

An 18-page catalog covers etchants used on silicon, gallium, phosphide, dielectrics and metalization. Transene, Rowley, MA

CIRCLE NO. 411

## Motor-actuator controller

An electric-step controller with PI action is described and illustrated in a four-page bulletin. The bulletin includes functional and switching diagrams, specifications and ordering data. Siemens, Iselin, NJ

CIRCLE NO. 412

## Interconnections

A 36-page catalog lists all of the company's interconnection products. Elco Corp., El Segundo, CA

CIRCLE NO. 413

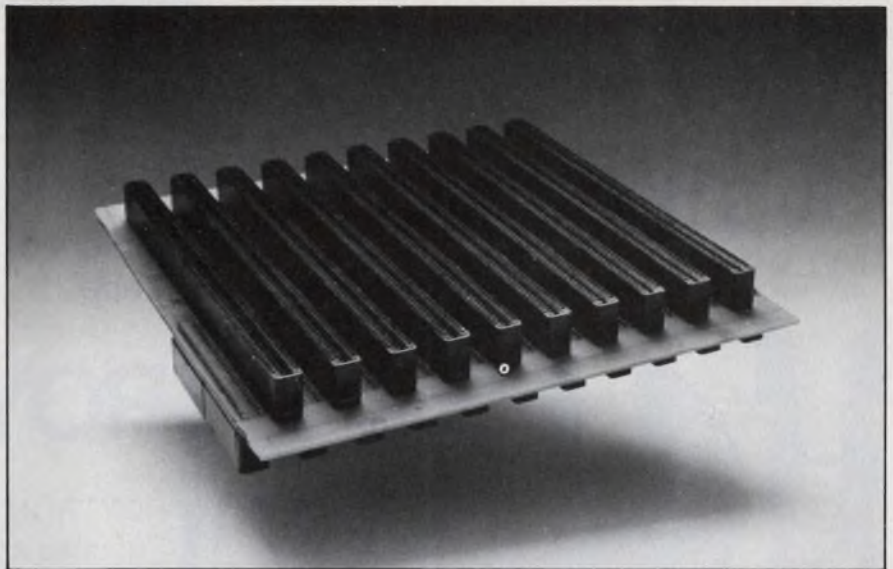

# BACKPLANES



CIRCLE NUMBER 129

## 98% EFFICIENT AC LINE REGULATORS

**TOPAZ AC Line Regulators** solve brownout problems once and for all. Whether your application is a large computer system or a small instrument, TOPAZ regulators are the best solution.

Here's why:

- **98% EFFICIENCY** reduces heat losses and feeder costs.
- **FAST RESPONSE** (less than one cycle) prevents problems caused by short term voltage changes.
- **NO DISTORTION** is added to the output wave form.
- **SMALL SIZE AND WEIGHT** ease handling and reduce space requirements.
- **SILENT OPERATION** permits use in office areas without the annoying noise common to constant voltage transformers.
- **OUTPUT VOLTAGE** is unaffected by input frequency variations.



600 VA to 100 kVA  
Priced from \$265.

All this plus TOPAZ noise suppression and quality at prices lower than you'd pay for regulators without these features. Put an end to brownout problems. Send for our brochure or give us a call today.

**TOPAZ**  
ELECTRONICS  
SOLUTIONS TO  
POWER PROBLEMS

3855 Ruffin Road, San Diego, California 92123—(714) 279-0831—TWX (910) 335-1526

CIRCLE NUMBER 130

# VIBRATION!

## IC's Backing Out?

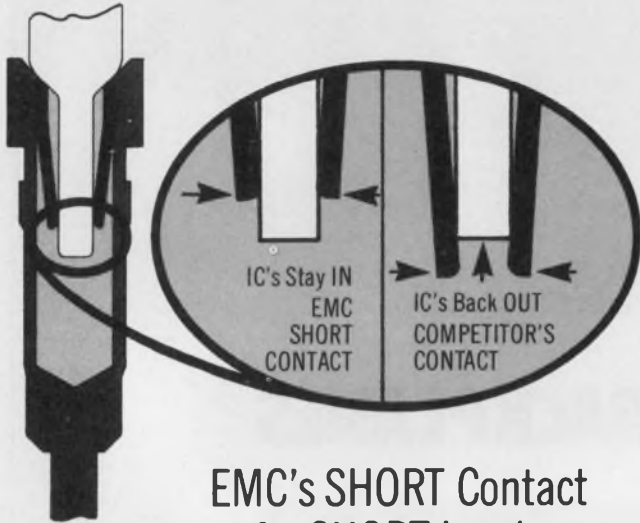

### EMC's SHORT Contact for SHORT Leads

Many newer IC's have shorter or highly tapered leads. If plugged into longer standard terminal contacts, lateral pressure caused by the angle of the contacts vector into a constant potential ejection force. Add a little vibration from nearby equipment, and out they come. EMC's new four-finger Short Contacts move the lateral pressure well up onto the body of the lead . . . grab and hold leads even .095 inches long. Specify Short Contacts in EMC's full line of sockets and packaging panels . . . field-proven for over a full year in actual usage. Phone or write Electronic Molding Corp., 96 Mill St., Woonsocket, R.I. 02895. (401) 769-3800.



Interconnection Specialists

CIRCLE NUMBER 131

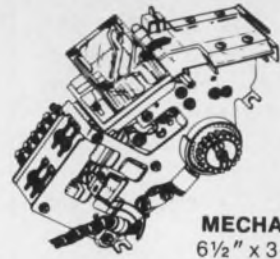

**MECHANISM ONLY**  
6 1/2" x 3-3/16" x 4 1/2"

Punched  
Tape

# ROYTRON™

ROYTRON Readers, Punches and Combination Reader/Punches are offered in over 20 standard configurations.

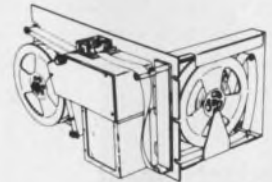

**RACK MOUNTED**  
12" x 19" x 10 1/2"

**Paper Tape/  
Edge Punch Card**  
Punches (50-60 cps)

**Paper Tape/  
Edge Punch Card**  
Readers (50 cps)

**Combination Paper Tape  
Reader/Punch**  
Reader (50/150/250 cps)  
Punch (60 cps)

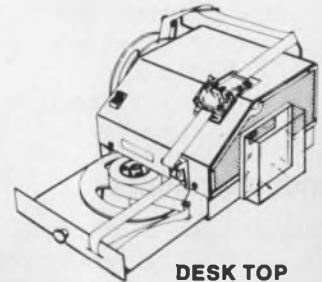

**DESK TOP**  
14 1/2" x 15" x 9 1/2"

ROYTRON is manufactured in the U.S.A.  
Parts Availability  
Interface Documentation  
Servicing Documentation  
In-Plant Service  
High Reliability  
Cost/Performance

PUNCH COVER  
(Punch Mechanism  
and  
Tape Fault Switch  
Located Below)

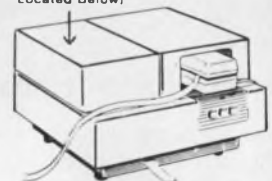

**PHOTOELECTRIC  
READER/PUNCH**  
16" x 16" x 10 1/2"

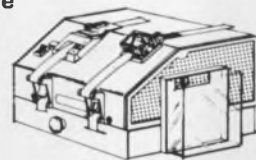

**COMBINATION  
READER/PUNCH**  
16" x 16" x 10"



for full details, write or call

**SWEDA INTERNATIONAL**  
Litton OEM Products

34 Maple Avenue, Pine Brook, N.J. 07058/(201) 575-8100

IN U.K. — ADLER BUS. SYSTEMS/OEM PRODS., Airport House, Purley Way, Croyden, Surrey, England

IN FRANCE — SWEDA INTERNATIONAL/OEM, 103-107 Rue de Tocqueville, 75017 Paris, France

CIRCLE NUMBER 132

ELECTRONIC DESIGN 4, February 15, 1977

## NEW LITERATURE

### Screws and studs

A catalog features screws and studs. Specifications are given in both inches and millimeters. Illinois Tool Works, Shakeproof Div., Elgin, IL

CIRCLE NO. 414

### Card packaging system

The Customatic custom card packaging system is described in a 10-page brochure. Scanbe, El Monte, CA

CIRCLE NO. 415

### CATV coaxial cable

Physical and electrical characteristics for more than 60 CATV coaxial cables are specified in a 20-page guide. Belden, Geneva, IL

CIRCLE NO. 416

### Insulating material

Specifications and illustrations of insulating materials can be found in a 44-page catalog. Sizes, colors and shrinkage ratios are featured in easy-to-read coded charts. Cole-Flex, West Babylon, NY

CIRCLE NO. 417

### $\mu$ P-based products

Microprocessor-based products—from the LSI-11 microcomputer through the PDP-11V03 computer system—are described in an eight-page bulletin. The bulletin details the elements of LSI-11 hardware and firmware, software and both mechanical and environmental specifications. Digital Equipment, Marlborough, MA

CIRCLE NO. 418

### Personal calculator digest

*The Hewlett-Packard Personal Calculator Digest*, 32 pages, includes sections on thermal printing, testing, servicing, CMOS, PMOS and NMOS circuits and RPN language. Hewlett-Packard, Corvallis, OR

CIRCLE NO. 419

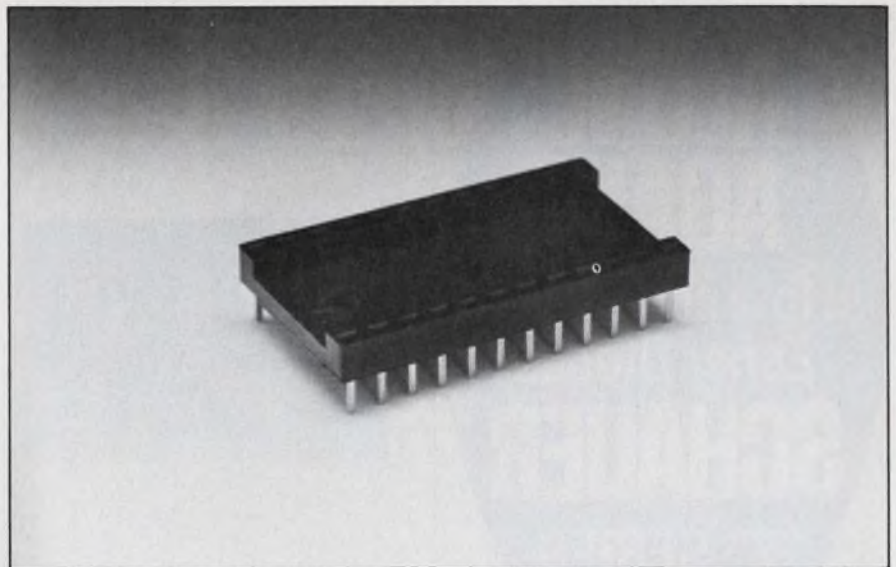

## IC SOCKETS

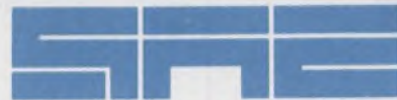

CIRCLE NUMBER 133

# ETERNACELL<sup>®</sup>

## The only complete line of Lithium Primary Batteries

There's a new technology in primary batteries. It's called the Eternacell Lithium Battery. Or Eternacell for short.

- Operating voltage 2.8 volts per cell
- -65°F to 160°F performance
- Up to 10 years shelf life
- Highest energy and volume density of any battery system
- 1/2 to 30 ampere-hour cell sizes in production quantities
- Stable voltage output

Reliable, proven in memory standby, communications, underwater power, instrumentation, alarm systems ... to name a few. Delivery, stock to 4 weeks.

Eternacell. The highest energy, longest life battery. For information write: Power Conversion, Inc., 70 MacQuesten P'kway South, Mt. Vernon, N.Y. 10550. Or call (914) 699-7333.



# Power Conversion

CIRCLE NUMBER 134

# ALONE AGAIN

in low cost 1-watt  
Zener Diodes

# SCHAUER

## "Z" SERIES ZENERS

DO-41 epoxy  
molded case

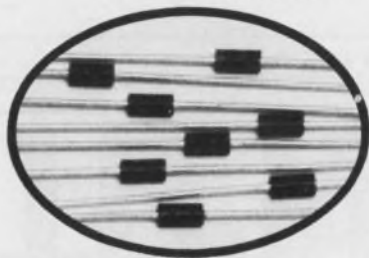

**ANY VOLTAGE**  
2.6 to 34.0

**ANY TOLERANCE**  
1% 2% 5% 10%

**At Any Test Current**

**Compare These Prices  
On 1% Tolerance Diodes**

Quantity	Price each
1-99	91¢
100-499	83¢
500-999	77¢
1000 up	73¢

**LARGE STOCK  
GOOD DELIVERIES**

Send for complete rating data  
and other tolerance prices.

Semiconductor Division

# SCHAUER

MANUFACTURING CORP.

4511 Alpine Ave., Cincinnati, OH 45242  
Telephone 513-791-3030 Telex 21-4576

CIRCLE NUMBER 135

## NEW LITERATURE



### Motor controls

Features of motor controls are explained in an eight-page brochure. Allen-Bradley, Milwaukee, WI

CIRCLE NO. 420

### Power supplies

Over 1000 models of standard power supplies are covered in a catalog. The catalog contains specifications, photographs, outline drawings and voltage/current rating charts for every unit available. Power/Mate, Hackensack, NJ

CIRCLE NO. 421

### Numeric printer

Specifications, features and details on the NP-7 thermal numeric printer are included in a four-page catalog. Included are photos of the printer and printout, instructions and illustrations. Gulton Industries, Measurement & Control Systems Div., East Greenwich, RI

CIRCLE NO. 422

### Fixed resistors

Comprehensive technical specifications on more than 20 different resistor configurations, ranging from 0.05 W, at 0.01%-tolerance, noninductive thin-film resistors to 250-W high-power wirewounds, are contained in a 28-page booklet. TRW/IRC Resistors, Philadelphia, PA

CIRCLE NO. 423

## Solid-state relays

Ac and dc solid-state relays are covered in a six-page catalog. Theta-J Relays, Reading, MA

CIRCLE NO. 424

## Servo-system components

Performance and application information for industrial servo system components, which include motor pots, amplifiers, power supplies, command pots and dials, are presented in a 12-page brochure. Beckman Instruments, Helipot Div., Fullerton, CA

CIRCLE NO. 425

## Connectors

Solutions to connector problems are presented in a 12-page brochure entitled *Special Electrical Connector Products & Cable Assemblies*. Viking Industries, Chatsworth, CA

CIRCLE NO. 426

## Rental instruments

A 74-page electronic test equipment rental catalog features over 140 photos of instruments and new indexing and prices. Special sections cover the general-purpose interface bus (IEEE 488) and video-training tapes. U.S. Instrument Rentals, San Carlos, CA

CIRCLE NO. 427

## Scientific Encyclopedia

The fifth edition of Van Nostrand's Scientific Encyclopedia is mammoth. In one 12.6-lb, \$67.50 volume, it covers more than two dozen fields of science and technology, with more than 2.2 million words in 7200 entries covering 2382 pages. As might be expected in a work of this breadth, there can be regrettable omissions—like micro-processor. One might feel, too, that an entry like "Integrated Circuit" might deserve more than 19 lines and an illustration of diode-transistor logic, even if it were necessary to sacrifice some of the 370 lines devoted to "Electronic Tube." Van Nostrand Reinhold Co., 450 W. 33 St., New York, NY 10001.

INQUIRE DIRECT

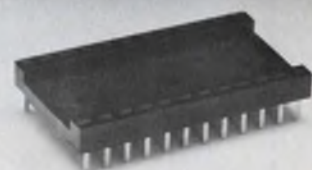
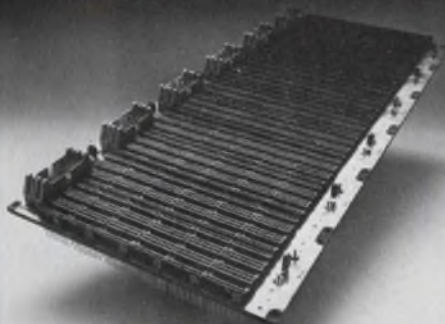
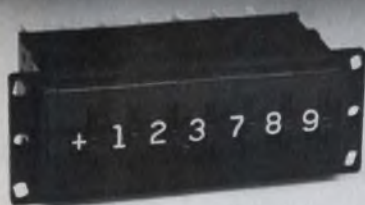
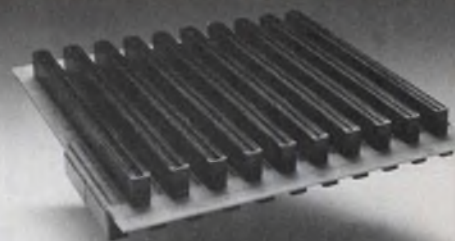
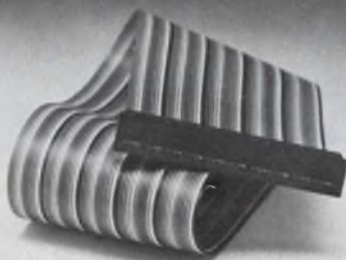

# THE OEM CONNECTION

When you do business with SAE, you're well connected. We make edgeboard connectors, flat flex cable interconnection systems, switches, logic panels, backplanes and IC sockets. And that's just the beginning.

We also supply complete wiring and sub-assembly services, printed circuits, card files, MIL-C-5015 and other extreme environment connectors, transformers, chokes, delay lines and RF filters.

We're a growing, broad-line supplier of elec-

tronic OEM hardware, ready to quote and deliver anything from a wide selection of individual components to a completely assembled interconnection system.

Component specs are in our catalog, and guidance on ways to save time and money is as close as an SAE sales rep. If you haven't yet made The OEM Connection, do it now. Write Stanford Applied Engineering, 340 Martin Avenue, Santa Clara, California 95050. Phone (408) 243-9200. TWX 910-338-0132.



Plants at Santa Clara and Costa Mesa, California, West Babylon, New York and Boulder, Colorado.

CIRCLE NUMBER 136

# UL-Listed\* Switcher!



Priced at only \$595\*\* and now UL-listed (to save you time and money), our supercompact, 80% efficient, 5V, 120-amp LH 700 switcher gives you all the advantages you want in a switcher:

- Compact size — 8"W. x 10"L. x 5"H.
- Multiple outputs — 1, 2 or 3 outputs.
- Primary output 5V DC, 120 amps; other outputs  $\pm 12V$  or  $\pm 15V$  DC, 8 amps.
- Forced air cooling.
- 80% efficiency primary output, 75% average on others.
- Fully regulated outputs.
- Over-temperature protection; RFI line filtering.
- Over-voltage protection standard on primary, optional on secondaries.
- Externally selectable AC inputs 115/230V, 47 to 63 Hz.

\*File No. E52634  
\*\*10 to 24 pieces



**World's largest switcher manufacturer!**

The LH 700 typifies the high-reliability, easy-to-maintain switchers LH Research offers. Nobody packs more power in smaller packages or offers a broader line of switchers than LH Research. 1 through 6 outputs. Up to 2.45 watts/in<sup>2</sup>. Up to 65 watts/lb. Up to 80% efficiency. At less than 65¢/watt in quantity.



LH RESEARCH, INC.  
1821 Langley Avenue, Irvine, CA 92714  
(714) 546-5279

CIRCLE NUMBER 137

## Bulletin Board

Motorola's 2N6306 and 2N6308 power transistors for high-speed switching applications are now available in JAN, JANTX and JANTXV MIL-S-19500/498 versions.

CIRCLE NO. 428

Nicolet Scientific has reduced the price of its Model UA-500A-1 500-line, dual-memory, real-time analyzer to \$9850 from \$12,500.

CIRCLE NO. 429

The Westinghouse 1N3289 series of high-power rectifiers has received JAN qualification.

CIRCLE NO. 430

Technical enhancements in Honeywell's Series 60/Level 66 large-scale systems involve major performance upgrades, multiple processor configurations and expanded memory capabilities.

CIRCLE NO. 431

Signetics is second-sourcing Intel's and Texas Instruments' 4-k dynamic RAMs. The 4-k  $\times$  1 device, designated 2680, is fabricated using N-channel silicon gate MOS technology.

CIRCLE NO. 432

Exar Integrated Systems has slashed prices 30 to 40% off the XR-2240 CN and CP programmable timing circuits. The new prices are \$2.75 for the CN in 100 quantity, down from \$4.68, and \$2.58 for the CP, down from \$3.60.

CIRCLE NO. 433

Texas Instruments is offering two dual op amps, the LM358 and LM-2904. Both are second source for the National devices with the same designations.

CIRCLE NO. 434

## Data Acquisition in a Nutshell

Industry's First DAS in a DIP

- 8-channel, 8-bit
- Complete. Includes: Multiplexer Sample-and-hold Addressing logic A/D converter
- Adjustment free
- High performance  $\pm 1/2$  LSB linear from 0° to 70°C or -55° to +125°C
- Expandable to 256 channels
- Hermetic 32-pin DIP
- Low cost
- 90-kHz throughput rate

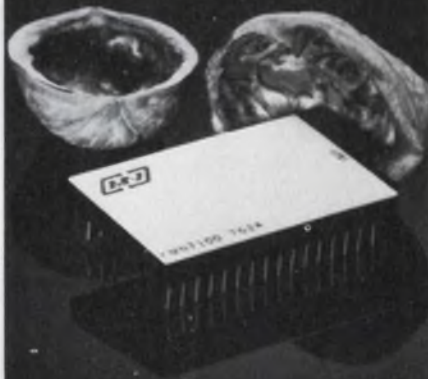

**MN 7100**

**\$140.00\***

\* in 100 quantity



Micro Networks Corporation  
324 Clark Street, Worcester, MA 01606  
(617) 852-5400 TWX 710-340-0067

CIRCLE NUMBER 138

ELECTRONIC DESIGN 4, February 15, 1977



## Engineers: Imagine Southern California

**Hughes/Missile Systems is looking for a lot of good engineers. With imagination.**

Hughes Aircraft Company/Missile Systems Group, Canoga Park, California, is a highly respected, prestigious firm, noted for leadership in technology and for a long-term record of stability and growth. Creative engineering is our business, and we do it in a campus-like facility. You'll have a real chance to apply your skills to major missile programs:

### \*Circuits Engineers

Experience in design, development of RF/IF, digital, analog circuits for missile-guidance systems. Must know applicable state-of-the-art components.

### \*Systems Analysts

Tasks involve system function design, solving systems-engineering problems. Experience in signal processing, controls, assembly language, performance analysis, weapon-system integration.

### \*Electronic Product Engineers

Develop conceptual product designs for state-of-the-art electronic systems, and mechanize designs in low-cost hardware.

### \*RF Systems Engineers

Experience must include microwave-systems design and test, with emphasis on digital signal processing.

Degree from an accredited institution required. Send resume to: Engineering Employment, Hughes Aircraft, Fallbrook at Roscoe, Canoga Park, CA 91304.



HUGHES AIRCRAFT COMPANY  
MISSILE SYSTEMS GROUP

US citizenship required  
Equal opportunity M/F/H/C employer

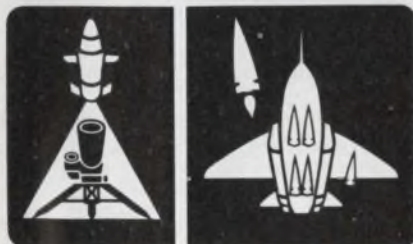

CIRCLE NUMBER 139

ELECTRONIC DESIGN 4, February 15, 1977

## Vendors Report

Annual and interim reports can provide much more than financial position information. They often include the first public disclosure of new products, new techniques and new directions of our vendors and customers. Further, they often contain superb analyses of segments of industry that a company serves.

Selected companies with recent reports are listed here with their main electronic products or services. For a copy, circle the indicated number.

**Park Electrochemical.** Adhesive bonding films; metal and plastic nameplates; diecast and plated parts; aluminum and plastic sheet decorative trim and copper-clad materials.

CIRCLE NO. 435

**Astrosystems.** Electronic and electromechanical devices for the control, measurement and display of physical parameters involving motion.

CIRCLE NO. 436

**Coherent Radiation.** Advanced laser modulation systems.

CIRCLE NO. 437

**Datum.** Minicomputers; minicomputer-directed data-acquisition and control systems; computer-peripheral controllers and systems; timing instrumentation; digital cassette recorders and rotating drum memories.

CIRCLE NO. 438

**Incoterm.** Intelligent computer display terminals and software and peripheral equipment.

CIRCLE NO. 439

**Nashua.** Image-forming, adhesive or magnetic recording materials.

CIRCLE NO. 440

**Scan-Data.** Computer data entry.

CIRCLE NO. 441

**Data Disc.** Disc memory, tape memory, graphic display and video.

CIRCLE NO. 442

## MICRO PROCESSOR POWER SOURCES

REGULATED

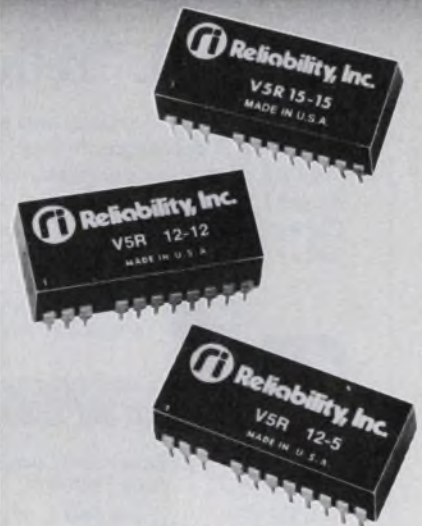

For . . .

- MPUS
- E ROMS
- RAMS
- ROMS

**ONE WATT OUTPUT • COMPACT DIP PACKAGE • LOW NOISE ISOLATED • LOW PRICE**

Ultra Compact DC-DC V-PAC Power Sources\* use 5v or 12v input, provide +12, -5 regulated low noise outputs. Also available with  $\pm 12v$ , or  $\pm 15v$  output for op amps.

### SPECIFICATIONS:

Output voltage tolerance  $\pm 5\%$   
Output ripple \_\_\_\_\_ 30 mv, P-P max.  
Line regulation \_\_\_\_\_ 0.3%  
Load regulation \_\_\_\_\_ 0.3%  
Operating temp \_\_\_\_\_  $0^\circ$  to  $70^\circ\text{C}$   
Isolation \_\_\_\_\_  $10M\Omega$  @50v  
Price \_\_\_\_\_ \$20.20(100pcs)



## Reliability, Inc.

5325 Glenmont/Houston, Texas 77036  
713/666-3261/TWX: 910-881-1739

International: Reliability Nederland, B.V.  
Summerhill, Nenagh, Co. Tipperary, Ireland

\*Trademark, Reliability, Inc.  
Price subject to change without notice

CIRCLE NUMBER 140

# OPTICAL ISOLATORS

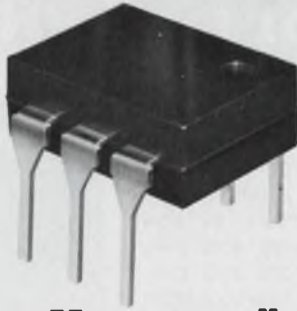

## 5KV, UL "Yellow Tag" Approved

The same advanced technology used to develop the innovative Spectronics fiber optic product line is incorporated in these 5KV, UL "yellow tag" approved optical isolators. They are directly interchangeable with standard industrial 6-pin isolators. UL approval number E58979.

Coming soon: medium and high-speed isolators in 8-pin DIPs! For more information, contact our corporate office or call the number in your area listed below.

*We make optoelectronics work for you with superior quality, competitive pricing, fast deliveries!*



**Spectronics**  
INCORPORATED

830 E. Arapaho Rd., Richardson, Texas 75080  
(214) 234-4271 Telex 73-0890

(213) 398-6239 (612) 698-3841 (713) 772-0730  
(415) 369-4671 (617) 944-8484 Canada: (416) 438-6393

The  
Quality  
Leader

CIRCLE NUMBER 141

# MINIATURE FREQUENCY STANDARD

UNDER \$50  
(1000 UNITS)



$\pm 3 \times 10^{-7}$ /MONTH  
(1.2 CUBIC INCHES)  
CALL OR WRITE



**Greenray  
Industries, Inc.**

840 West Church Rd.  
Mechanicsburg, PA 17055  
Phone 717-766-0223

## Signal Processing Is Our Bag

Princeton Applied Research, a leading manufacturer of sophisticated signal processing instruments, invites you to write or call for information on:

- low noise preamplifiers
- real time spectrum analyzers
- light measuring instrumentation
- signal averagers
- capacitance-voltage (CV) plotters
- lock-in amplifiers

Send for your free copy of our new catalog.



Princeton Applied  
Research Corporation  
P.O. Box 2565  
Princeton, N.J. 08540  
Phone: 609/452-2111

CIRCLE NUMBER 143

# Electronic Design

ELECTRONIC DESIGN's function is:

- To aid progress in the electronics manufacturing industry by promoting good design.
- To give the electronic design engineer concepts and ideas that make his job easier and more productive.
- To provide a central source of timely electronics information.
- To promote communication among members of the electronics engineering community.

Want a subscription? ELECTRONIC DESIGN is sent free to qualified engineers and engineering managers doing design work, supervising design or setting standards in the United States and Western Europe. For a free subscription, use the application form bound in the magazine. If none is included, write to us direct for an application form.

If you do not qualify, paid subscription rates are as follows: \$30.00 per year (26 issues) U.S., \$40.00 per year (26 issues) all other countries. Single copies are \$2.00 U.S., \$3.00 all other countries. The Gold Book (27th issue) may be purchased for \$30.00 U.S. and \$40.00 all other countries.

If you change your address, send us an old mailing label and your new address; there is generally a postcard for this bound in the magazine. You will have to requalify to continue receiving ELECTRONIC DESIGN free.

The accuracy policy of ELECTRONIC DESIGN is:

- To make diligent efforts to ensure the accuracy of editorial matter.
- To publish prompt corrections whenever inaccuracies are brought to our attention. Corrections appear in "Across the Desk."
- To encourage our readers as responsible members of our business community to report to us misleading or fraudulent advertising.
- To refuse any advertisement deemed to be misleading or fraudulent.

Microfilm copies are available of complete volumes of ELECTRONIC DESIGN at \$19 per volume, beginning with Volume 1, 1952 through Volume 20. Reprints of individual articles may be obtained for \$3.00 each, prepaid (\$.50 for each additional copy of the same article) no matter how long the article. For further details and to place orders, contact the Customer Services Department, University Microfilms, 300 North Zeeb Road, Ann Arbor, Michigan 48106 telephone (313) 761-4760.

Want to contact us? If you have any comments or wish to submit a manuscript or article outline, address your correspondence to:

Editor  
ELECTRONIC DESIGN  
50 Essex Street

Rochelle Park, N.J. 07662

ELECTRONIC DESIGN 4, February 15, 1977

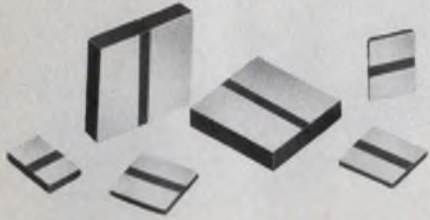

**CERAMIC CHIP CAPACITORS.** SPLIT-CHIP, is a new concept in ceramic chip capacitor technology. These new units have two broad electrodes on one face and eliminate conventional wrap-around end terminations. This new concept provides lower cost and easier assembly. SPLIT-CHIPS are available in five standard sizes from .040" x .030" to .130" x .090" and .015" thick and in all popular dielectrics and capacitance ranges. JOHANSON DIELECTRICS, INC., Box 6456, Burbank, Ca. 91510 213-848-4465

CERAMIC CHIP CAPACITORS 181



**MEMODYNE INCREMENTAL LOW POWER DATA LOGGER Model 2221**, is ideal for remote or unattended collection of sporadic measurements. Features 16 channels, 0 to +10 volt analog input, 12 bit resolution, over 2 megabit capacity per 300 foot cassette. Standby current is less than 50 microamps. Available for line or battery operation. Unit price is \$1670.00. Memodyne Corporation, 385 Elliott Street, Newton Upper Falls, Massachusetts, 02164. (617) 527-6600.

LOW POWER DATA LOGGER 184

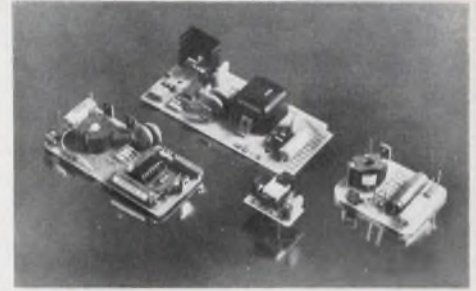

**Activate gas discharge readouts!** Custom designed and produced DC-to-DC power supplies to activate gas discharge displays, or for other applications. Regulation I/O options, packaging (encapsulated, aluminum shell or open frame), size and configuration, heat dissipation, mounting (PC board pins, edge connectors), etc., can be tailored to meet individual specifications. Price and delivery discussed after specifications are submitted. Endicott Coil Co., Inc., 31 Charlotte Street, Binghamton, N.Y. 13905 (607) 797-1263.

CUSTOM DESIGNED POWER SUPPLIES 187



**Low-cost tape reader is fast—up to 300 cps—and quality-built.** Dual sprocket drive, a state-of-the-art fiber optic light source and photo transistor read head. Simplicity of design makes it easy to adapt to specific OEM requirements. Decitek, 250 Chandler Street, Worcester, MA 01602 (617) 798-8731

SAM<sup>®</sup> TAPE READER 182



**GAME PLAYING WITH COMPUTERS, Revised Second Edition**, by Donald D. Spencer. This volume presents over 70 games, puzzles, and mathematical recreations for a digital computer. The reader will also find brand-new "how to" information for applying mathematical concepts to game playing with a computer. #5103-4, 320 pp., \$16.95. Circle the Info Retrieval Number to order your 15-day exam copy. When billed, remit or return book with no obligation. **Hayden Book Co., 50 Essex St., Rochelle Park, N.J. 07662.**

GAMES-PLAYING GUIDE 185

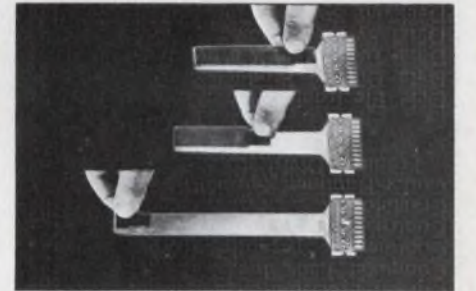

**When you want a flexible circuit that doesn't just sit there, but really flexes—millions of times with complete reliability—then you want an R/flex flexible circuit from Rogers.** Rogers has the know-how to make *flexible* flexible circuits to do your job. For help, write or call Rogers Corporation, Chandler, AZ 85224. Telephone: (602) 963-4584. (EUROPE: Mektron NV, Ghent, Belgium; JAPAN: Nippon Mektron, Tokyo)

FLEXIBLE FLEXIBLE CIRCUITS 188

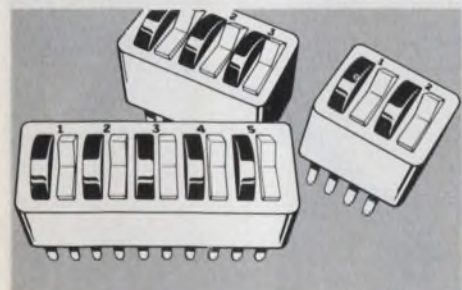

**Dependable LED DIP switch from AMP** combines the capabilities of the LED with the reliability of AMP low profile, miniature DIP switches. Available in SPST "on" or "off" and momentary contact types, they are ideal for many visual applications. For more information, call AMP Customer Service at (717) 564-0100. Or write AMP Incorporated, Harrisburg, PA 17105.

LED DIP SWITCH 183

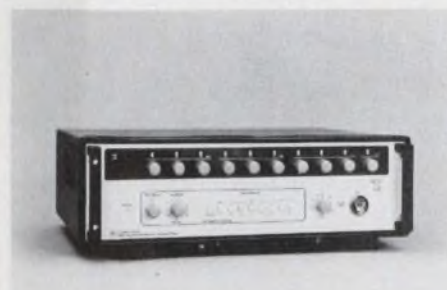

**FREQUENCY SYNTHESIZERS.** GenRad offers the best combination of low-phase noise, fast switching speed and price. Frequency range is dc to 500 MHz. Important features: non-harmonic spurs > 80 dB down; a-m, fm and pm capabilities; built-in search sweep; programmable (BCD parallel) frequency control; and optional resolution to 0.1 Hz. GenRad, 300 Baker Ave., Concord, MA 01742, (617) 369-8770.

FREQUENCY SYNTHESIZERS 186

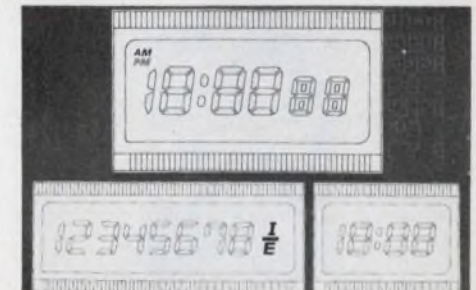

**SHARP LIQUID CRYSTAL DISPLAY.** We have a wide range of standard displays and can special design for a low design cost. Quick delivery on all displays. Contact:—Sharp Corporation, Semi Conductor Division, Overseas Marketing, 2613-3, Ichinomoto Tenri, Nara, Japan. Tel: (07436) 5-1321 Telex: 5522364 SHAPEL J

STANDARD/SPECIAL DISPLAYS 189

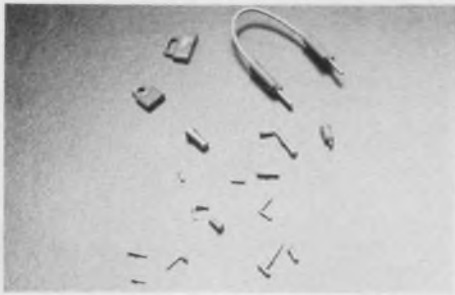

Versatile tiny jumpers and spring-loaded receptors are widely used today as low-cost trouble-free circuit switches because of their dependability (insertion tests proved reliability over more than 50,000 cycles), color coding and positive indication features. Part of extensive Cambion connector line, all detailed in separate catalog. Write: Cambridge Ihermionic Corp., 445 Concord Avenue, Cambridge, MA. 02138. In California, 2733 Pacific Coast Highway, Torrance 90505.

JUMPERS

190

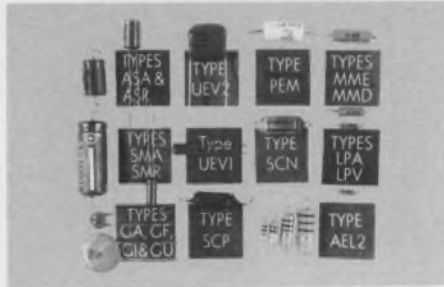

**R-C COMPONENTS. 100% TESTED. CAPACITORS** - Ceramic Disc to 0.47 $\mu$ F & to 1KV; 0.1 $\mu$ F/30V - 4.1 $\phi$ . Electrolytic to 3300 $\mu$ F & to 100V; 100 $\mu$ F/25V - 6.7 $\phi$ . Polyester to 1 $\mu$ F & to 400V; 0:01 $\mu$ F/100V - 2.4 $\phi$ . Polystyrene to 0.47 $\mu$ F & to 630V; 1000pf/100V - 2 $\phi$ . **RESISTORS** - Carbon Film, Type LPA - 1/8W & 1/4W, 5% to 1%. \$6.65/K to \$19/K; Type AEL2 - 1/4W 1W, 5% - \$21/K; 2W, 5% - \$32/K. Prices - 10K lots. Electronents Inc., Box 625, Eatontown, NJ 07724. (201) 542-8464.

R-C COMPONENTS

193



**QUIK/STRIP BY ROGERS.** Fast, low-cost system for connecting in-line pins on DIP socket boards and connector arrays. Shock and vibration resistant. 18 gauge current capacity. Can be used on pin densities as high as .100" x .100" and be stacked two or more high. Write or call for details. Rogers Corporation, Chandler, AZ 85224. Phone: (602) 963-4584. (EUROPE: Mektron NV, Gent, Belgium; JAPAN: Nippon Mektron, Tokyo.)

QUIK/STRIP

196

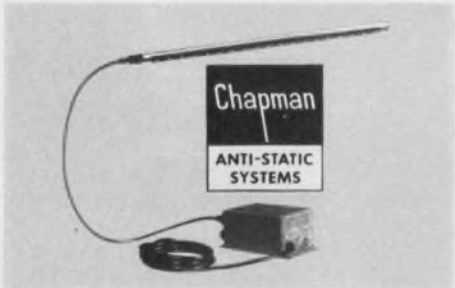

**ANTI-STATIC SYSTEMS FOR PRINTERS, OCR COM and other machines.** Static causes rapidly moving paper and film to jam. . . cause arc tracks on undeveloped film. . . attract and hold dust to photographic negatives causing imperfections on printed circuit boards. Numerous products, of interest to both OEM and user, are detailed in new 32 page catalog to solve these problems quickly, reliably and economically. Chapman Anti-Static Div., Portland Co., 58 Fore St., Bx 427, Portland, ME 04112. (207) 773-4726

ANTI-STATIC SYSTEMS

191



**MINICOMPUTERS: Structure and Programming,** by T. G. Lewis and J. W. Doerr. An introduction to computer science using small computers, this book thoroughly covers all the essentials needed to understand and use minicomputers: assembly language, machine architecture, and small machine algorithms. #5642-7, 288 pp., \$12.95. Circle the Info Retrieval Number to order your 15-day exam copy. When billed, remit or return book with no obligation. Hayden Book Co., 50 Essex St., Rochelle Park, N.J. 07662.

MINICOMPUTERS TEXT

194



**The Cost-Effective Solution to Linear-IC Testing.** GenRad's 1730 Linear Circuit Tester tests op amps, comparators, voltage followers and regulators, and other common linear IC's. Up to 18 parameters can be automatically tested in a GO/NO-GO or measurement mode at the push of a button in under 2 seconds. Easily reset memory panel sets test conditions and limits. Broad selection of device-adaptor modules. GenRad, 300 Baker Ave., Concord, MA 01742, (617) 369-8770.

LINEAR IC TESTER

197



Free New '77 catalog contains over 34,500 quality power supplies from the world's largest manufacturer, Power/Mate Corp. Power Supplies for every application including submodulars, open frame, varigated, encapsulated, laboratory & system. All units UL approved and meet most military and commercial specs for industrial and computer uses. Power/Mate Corp., 514 S. River St., Hackensack, NJ 07601 (201) 343-6294

POWER SUPPLIES

192

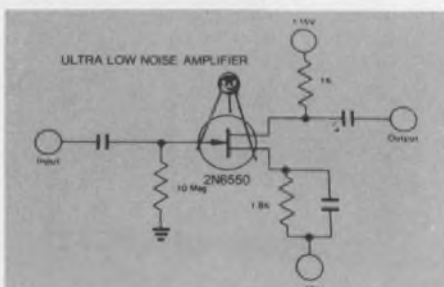

**ULTRA LOW NOISE FET, ULTRA LOW PRICE.** Now at 1/2 price, Crystalonics 2N6550 silicon N-Channel Junction FET provides an ultra low noise figure of 2nV/ $\sqrt$ Hz at 1 kHz and the highest  $G_m$  available. This low cost device features improved  $A_v$ , high  $I_{DSS}$  within a 10-250mA range and low output impedance. Samples. Priced at 1/2 off: 1-99 \$7.50; 100-999 \$5.00. Teledyne Crystalonics, 147 Sherman St., Cambridge, MA 02140 (617) 491-1670

LOW NOISE FET

195

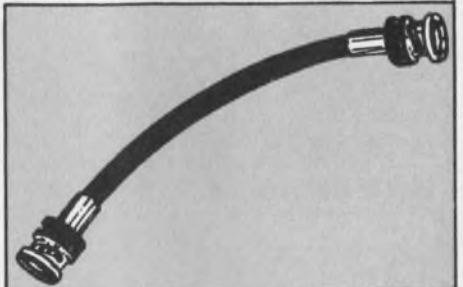

**\$2.99 each. BNC COAXIAL CABLE ASSEMBLIES.** 75 Ohm RG-59. Model No. PE3075-12, 12"; PE3075-24, 24"; PE3075-36, 36"; PE3075-48, 48"; PE3075-60, 60". 15 pieces, \$3.99; 25 pieces, \$3.49; 50 pieces, \$3.39; 100 pieces, \$3.29; 250 pieces, \$3.19; 500 pieces, \$3.09; 1000 pieces, \$2.99. Shipped same day order received. Custom made cable assemblies at competitive prices. Assorted sizes OK. Offer expires 3/31/77. Net: 10 days. FOB: Pasternack Ent., 8538 Hamilton, Huntington Beach, CA 92646 (714) 536-7511. COAXIAL CABLE ASSEMBLIES

198

# Electronic Design

ELECTRONIC DESIGN's function is:

## Advertising Sales Staff

Tom W. Carr, Sales Director  
Jean Bunfield, Sales Coordinator

## Rochelle Park, NJ 07662

Robert W. Gascoigne  
Daniel J. Rowland  
Thomas P. Barth  
50 Essex St.  
(201) 843-0550  
TWX: 710-990-5071

## Philadelphia

Thomas P. Barth  
(201) 843-0550

## Boston 02178

Gene Pritchard  
P.O. Box 379  
Belmont, MA 02178  
(617) 489-2340

## Chicago 60611

Thomas P. Kavooras  
Berry Conner, Jr.  
200 East Ontario  
(312) 337-0588

## Cleveland

Thomas P. Kavooras  
(312) 337-0588

## Los Angeles 90045

Stanley I. Ehrenclou  
Burt Underwood  
Neil Canavin  
8939 Sepulveda Blvd.  
(213) 641-6544

## Texas

Burt Underwood  
(213) 641-6544

## San Francisco

Robert A. Lukas  
3579 Cambridge Lane  
Mountain View, CA 94040  
(415) 965-2636

## England

Constance McKinley  
50 Essex St.  
Rochelle Park, N.J. 07662  
Phone: (201) 843-0550

## Europe

Sanders, W. J. M.  
Raadhuisstraat 24  
Graft-De Ryp, Holland  
Phone: 02997-1303  
Telegrams: Euradteam-Amsterdam  
Telex: 13039-SIPAS  
G. Nebut  
Promotion Presse Internationale  
7 ter Cour des Petites Ecuries  
75010 Paris, France  
Telephone: 5231917, 1918, 1919  
Dieter Wollenberg  
8111 Baldham/Muenchen  
Erikastrabe 8  
Germany  
Telephone: 0 8106/4541  
Telex: 5215532 auri d

## Tokyo

Haruki Hirayama  
Electronic Media Service  
5th Floor, Lila Bldg.,  
4-9-8 Roppongi  
Minato-ku, Tokyo, Japan  
Phone: 402-4556  
Cable: Electronicmedia, Tokyo

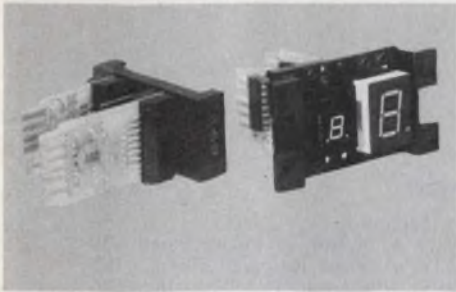

**LED DISPLAY DECODER/DRIVER** IEE's new Series 1760, with inherent memory, accepts either four line BCD or serial, pulse count inputs and performs the decode/drive functions for most mfr's LED display devices. The package is uniquely designed to plug-on directly (without tools) to IEE-ATLAS Series 1750/51/52 hardware. The hardware accommodates up to 8 decoders and LED displays with character heights of 0.3 to 1.1 inch. Available off shelf. IEE, 7740 Leona Ave., Van Nuys, CA 91405 (213) 787-0311, X. 268.

DECODER/DRIVER

199

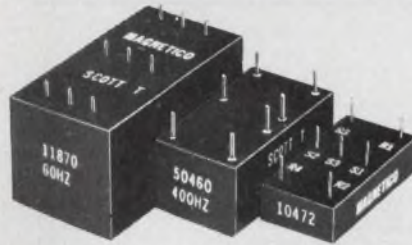

**Scott T Transformer.** 11870: 60HZ, 90v, L-L in. 1.1x2.1x1.1. 50460: 400 HZ, 90v, L-L in. 7/8x1.5/8x11/16. 50642: 400HZ, 11.8v, L-L in. 7/8x5/8-11/16. 10472: 400-HZ, 11.8v, L-L in. 3/4x1-1/2x3/8. All with 6v RMS sine & cosine output. MAGNETICO, INC., 182 Morris Ave., Holtsville, N.Y. 11742 516-654-1166.

TRANSFORMER

202

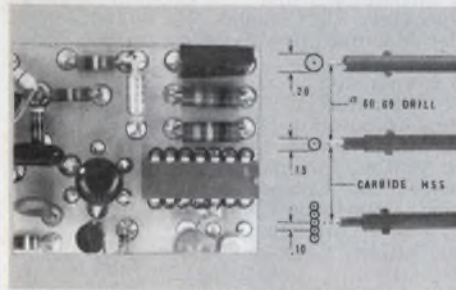

**NO ETCH BREADBOARDS** . . . WIRE-WRAP BREADBOARDS with isolated pad drill-mill construction. Quickly duplicate any etched board; build circuits from full-size artwork. Add components to and/or change circuitry of previously etched boards. Complete freedom in wire-wrap design/layout. Ideal for high frequency ground plane construction. A kit of three IP6003C with #60 carbide drills, \$27.50. A.F.Stahler Company, P.O. 354, Cupertino, CA 95014 (408) 252-4219.

NO ETCH BREADBOARDS

200

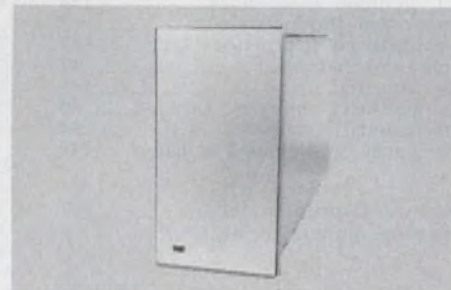

**New M100 custom blank plug in kit** with on-card regulated power supplies fits the Tektronix TM-500 system. Kit containing hardware and universal circuit board simplifies development of custom plug-ins. Provides a positive and a negative adjustable supply, 10 to 20 volts, and a +5 volt logic supply. Provision for additional positive or negative 3 terminal regulators. Universal circuit board has 0.1 inch hole array for mounting IC's, components, or function modules. MetroTek, Inc., P. O. Box 101, Richland, WA 99352 (509) 946-4778

M100 CUSTOM KIT

203



**SOLID STATE ANGULAR RATE SENSORS.** Single axis, two axis, and three axis models, operate on less than 3.0 watts per axis, offer unlimited altitude, 10,000 hour life, accuracies of 1.0 percent. Instant startup, withstand 100 G shock, 10 G vibration. Rate ranges available from 50°/sec to 3000°/sec. Bandwidth .002 Hz to 10-50 Hz depending on rate range. Humphrey, Inc., Dept. ED277, 9212 Balboa Ave., San Diego, CA 92123. Phone (714) 565-6631.

SOLID STATE RATE SENSORS

201



**Overcurrent Protector**, manual reset eliminates fuse replacement. Convenient panel mounting. 19 fractional ratings from 0.1 to 5 amp. Other models up to 400 amp. Trip-free and fool-proof, UL and CSA approved. High quality, low cost \$1.39 ea. in 1000 lots. E-T-A Products Co. of America, 7400 N. Croname Rd., Chicago, Ill. 60648. Tel: (312) 647-8303. Telex: 253780.

CIRCUIT BREAKER

204

★ABP

BPA

# Advertiser's Index

Advertiser	Page	Advertiser	Page	Advertiser	Page
A P Products Incorporated.....	177	Gould Inc., Instrument Systems Division .....	119	Power Tech, Inc.....	59
AMP, Incorporated .....	54, 55, 193	Greenray Industries, Inc.....	192	Precision Monolithics, Incorporated..	29
Acopian Corp. ....	49			Princeton Applied Research Corp.....	192
Advanced Micro Devices.....	4, 5	Heinemann Electric Company .....	31	Princeton Electronic Products, Inc..	176
Ampex Memory Products Division.....	141	Hayden Book Company Inc. ....	*40, 184, 193, 194		
Amplifier Research Corporation.....	179	Hewlett-Packard .....	9 thru 18	RCA Electro Optics.....	123
Analog Devices, Inc.....	27	Houston Instruments, A Division of Bausch & Lomb.....	158	RCA Solid State.....	Cover IV
Anzac Electronics .....	166	Hughes Aircraft Company.....	191	RCL Electronics, Inc.....	36
Arnold Magnetics Corp.....	180	Humphrey, Inc. ....	195	Refac Electronics Corporation.....	162
Arrow-M Corp. ....	142			Reliability, Inc. ....	191
		IEE .....	195	RepcO, Incorporated .....	150
B & K Products of Dynascan Corporation .....	124, 125	ITT Cannon, A Division of International Telephone and Telegraph Corporation .....	19	Reticon .....	149
Beckman Instruments, Inc. Helipot Division .....	35	ITT Pomona Electronics.....	154	Rockwell International .....	24, 25
Belden Corporation .....	71	Illuminated Products Co.....	7	Rogan Corporation .....	118D
Bodine Co., The.....	156	Individualized Instructions Inc.....	148	Rogers Corporation .....	116, 193, 194
Bourns, Inc., Trimpot Products Division .....	Cover II	Intel Corporation .....	47	Rostone Corp. ....	42
Buckeye Stamping Company, Inc., The .....	160	Interdata, Inc. ....	145		
Bud Radio, Inc. ....	144	International Importers, Inc.....	40	Salon International des Composants Electroniques 77.....	164
Bunker Ramo Connector Division.....	97	International Rectifier .....	84	Schauer Manufacturing Corp.....	188
Burr-Brown .....	37	Instrument Specialties Company.....	139	Semtech Corporation .....	39
Burroughs Corporation .....	45			Sharp Corporation .....	193
		Johanson Dielectrics, Inc.....	193	Siemens Corporation .....	174, 175, 178
CTS Corporation .....	99	Johanson Manufacturing Corp.....	6	Signetics Corporation .....	156, 157, 159, 161, 163, 165, 167, 169, 170, 171
Cambion .....	194	*Kienzle Apparate .....	172, 173	Silicon Systems, Incorporated.....	33
Centralab/USCC .....	105	Kulka Electric Corp.....	159	Simpson Electric Company.....	137
Cherry Electrical Products Corp.....	85			Sorensen, a Raytheon Company.....	118A
Clairex Electronics, A Division of Clairex Corporation .....	166	LH Research, Inc.....	190	Spectronics, Incorporated .....	192
Clare & Co., C. P. ....	172, 173	Logitek, Inc. ....	148	Sprague Electric Company.....	117
Clifton Precision .....	168			Stahler, A.F. ....	195
Computer Labs, Inc.....	180	3M Company .....	68	Stanford Applied Engineering, Inc. ....	177, 179, 181, 183, 185, 187, 189
Continental Specialties Corporation.....	92	M-tron Industries Inc.....	160	Stewart-Warner Corporation .....	118
Control Data Corporation.....	157	Magneto, Inc. ....	195	Sweda International OEM Products.....	186
Crystalonics .....	194	Malco, A Microdot Company.....	129	Systron-Donner .....	98, 161
Cutler-Hammer, Specialty Products Division .....	66, 67	Mechanical Enterprises, Inc.....	148		
		Memodyne Corporation .....	193	TII Corporation .....	152
Dale Electronics, Inc.....	60, 61	MetroTek, Inc. ....	195	TRW Capacitors, Solid State Operation .....	153
Data Display Products .....	56	Micro Devices Corp. ....	155	TRW/IRC Resistors .....	118B-C
Data Technology Corporation.....	51, 52	Micro Networks Corporation.....	190	TRW Power Semiconductors .....	104
Datel Systems, Inc.....	64	Mini-Circuits Laboratory, A Division of Scientific Components Corp. ....	2	TRW/UTC Transformers, an Electronic Components Division of TRW, Inc. ....	131
Datcom Systems, Inc.....	146	Molex, Incorporated .....	Cover III	Texas Instruments, Incorporated .....	23, 62, 63
Decitek .....	193	Monsanto Company .....	53	Texscan Corporation .....	133
Delco Electronics, Division of General Motors Corporation .....	110	Motorola Semiconductor Products, Inc. ....	38	Topaz Electronics .....	169, 185
Dialight, A North American Philips Company .....	91				
		NEC America Inc.....	130	*U.S. Department of Commerce .....	178
*EMI SE Labs.....	41	NEC Microcomputers, Inc.....	41	Union Carbide Corporation, Components Department .....	81
E-T-A Products Co. of America.....	195	Non-Linear Systems, Inc.....	181		
Electro Corporation .....	182	*Oscilloquartz SA .....	20	Varo Semiconductor, Inc.....	182
Electro Switch Corp.....	163			Vector Electronics Co., Inc. ....	98
Electrocube Corp. ....	183	PSG Industries, Inc.....	155	Vectron Laboratories Inc.....	167
Electronetics Inc. ....	194	Pasternak Enterprises .....	194	Victoreen Instrument Division, Shellar-Globe Corporation .....	93
Electronic Molding Corporation.....	186	*Philips Electronic Components and Materials .....	27, 35	Vitramon North America Division of Vitramon Incorporation.....	151
Endicott Coil Co., Inc.....	193	*Philips Industries, Test and Measuring Instruments Dept.....	174, 175	Vishay Resistive Systems Group.....	109
Esterline Angus Instrument Corporation .....	165	Piezo Technology, Inc.....	176		
		Portland Co., Inc.....	194	Wabash, Inc. ....	147
Fifth Dimension, Inc.....	184	Potter & Brumfield, Division of AMF, Incorporated .....	135	Watkins-Johnson Company .....	69, 70
		Power Conversion, Inc.....	187	Wavetek San Diego, Inc.....	1
GenRad .....	111, 193, 194	Power/Mate Corp. ....	194		
General Automation, Inc.....	82, 83				
General Electric Company, Instrument Rentals .....	20				
Gold Book, The.....	*42, 197				

\*Advertisers in non-U.S. edition

# Electronic Design's GOLD BOOK

MEANS BUSINESS FOR  
Datel Systems, Inc.

IT CAN MEAN BUSINESS FOR YOU!



*Electronic Design's* GOLD BOOK has emerged as the selling force whose time has come for today's marketing needs. Any company who wants inquiries and sales from the U.S. and the world can simply no longer ignore the GOLD BOOK.

The GOLD BOOK contains the largest, most comprehensive and most useful electronics directories ever published. As *Electronic Design's* 27th issue it goes to the world's most responsive audience of engineers, engineering managers and specifiers — 90,000 strong. It facilitates customers' first-step search for suppliers, streamlines contact, answers technical questions and enables engineers to buy directly from its pages.

The GOLD BOOK's mass catalog distribution method is within the reach of every company — large or small. Discounts for *Electronic Design's* advertisers, free layouts, free consultation, production and typesetting at cost and low, low printing costs for overruns all add up to a package price that is often less than many companies spend for catalogs alone!

Get complete details plus a personalized quote for your GOLD BOOK catalog pages without any charge or obligation. Do it now. 1977-78 edition closes...**MARCH 1 FOR COPY TO BE SET. APRIL 1 FOR FILM OR CAMERA-READY ART.**

# Electronic Design's GOLD BOOK

## HAYDEN PUBLISHING COMPANY, INC.

Peter D. Coley, Senior Vice President/Publisher  
Albert B. Stempel, Vice President/Publication & Printing Director  
50 Essex Street, Rochelle Park, New Jersey 07662. Tel: 201-843-0550

## ADVERTISING SALES OFFICES

**ROCHELLE PARK, N.J. 07662**  
David Greenberg  
Stan Tessler  
Joel Rose  
50 Essex Street  
(201) 843-0550  
TWX: 710-990-5071

**CHICAGO 60611**  
Ed Wang  
200 East Ontario  
(312) 337-0588

**LOS ANGELES 90045**  
Neil Canavin  
8939 Sepulveda Blvd.  
(213) 641-6544

## OVERSEAS OFFICES

**LONDON**  
Constance McKinley  
50 Essex St.  
Rochelle Park, N.J. 07662  
Phone: (201) 843-0550

**PARIS**  
Pierre J. Braude  
10 rue Louis Philippe  
Neuilly (Sur Seine) 92200  
France  
Tel: 747-4953

**GERMANY**  
Dieter Wollenberg  
8011 Baldham/Munchen  
Erikastrasse 8  
Tel: 08106/4541

**AMSTERDAM**  
Sanders, W. J. M.  
Raadhuisstraat 24  
Graft-De Ryp, Holland  
Phone: 02997-1303  
Telegrams: Euradteam-  
Amsterdam

**TOKYO**  
Haruki Hirayama  
Electronic Media Service  
5th Floor, Lila Bldg.,  
4-9-8 Roppongi  
Minato-ku, Tokyo, Japan  
Phone: 402-4556  
Cable: Electronicmedia, Tokyo

**SEOUL**  
Mr. O-kyu Park, President  
Dongbo Intl Corp. —  
World Marketing  
C.P.O. Box 4010  
Seoul, Korea  
Tel: 76-3910/3911  
Cable: DONGBO SEOUL  
Telex: EBKOREA K27286

# Product Index

**Information Retrieval Service.** New Products, Evaluation Samples (ES), Design Aids (DA), Application Notes (AN), and New Literature (NL) in this issue are listed here with page and Reader Service numbers. Reader requests will be promptly processed by computer and mailed to the manufacturer within three days.

Category	Page	RSN	Category	Page	RSN	Category	Page	RSN
<b>Components</b>			zener diodes	188	135	<b>Modules &amp; Subassemblies</b>		
arresters	152	78	zener, glass	38	17	amplifier, i-f	179	387
capacitors	6	4	zeners	175	109	amplifiers	166	100
capacitors	40	19	<b>Instrumentation</b>			analog-output micro-		
capacitors	81	38	analyzer, $\mu$ P	148	73	peripherals	37	16
capacitors	174	108	board tester	162	349	cassette transports	178	115
capacitors, ceramic	105	49	counter	159	339	converter products	35	15
capacitors, monolithic	39	18	DMM	161	346	counters	161	91
ceramic chip	151	77	DMM	162	347	DPMs	137	65
circuit breakers	31	13	DMM	162	348	DPMs	181	122
coils, relays & trans-			data-comm tester	162	348	data-acquisition module	190	138
formers	147	72	function generator	160	342	filter, active	179	386
contacts	186	131	logic analyzer	160	343	frequency standard	192	142
inductors	153	79	pulse generators	161	344	gas-plasma display	45	22
keyboards	162	93	rental instruments	8	20	image-memory/scan		
motors, gearmotors	156	84	scope	157	301	converter	176	110
motors, pm	168	103	spectrum analyzer	159	340	logic systems	118	55
panel, switches	148	74	sweep generator	133	63	magnetic sensors	182	124
relays	135	64	tester	111	52	oscillator, clock	167	101
relays	142	68	variable filter	161	345	regulator, voltage	180	388
relays	184	127	<b>Integrated Circuits</b>			rf power amplifiers	179	118
relays, solid-state	172	370	ALU, 4-bit	143	310	servo recorder	165	97
resistors	61	30	amplifier, instrumenta-			<b>Packaging &amp; Materials</b>		
resistors	93	45	tion	146	324	backplanes	185	129
resistors	109	50	amplifier, power	150	328	breadboard	92	44
switch, PB, miniature	172	372	amplifier, quad	149	325	breadboards	177	113
switches	7	5	bipolar memories	159	89	bus bars	116	53
switches	67	35	CMOS	IV	254	cabinets	154	80
switches	85	42	converter, d/a	144	320	cable and connector		
switches	173	107	crystal filters, mono-			system	178	114
switches	183	125	lithic	176	111	cases, slant-front	160	90
switches	190	137	displays, double & single			connection systems	189	136
switches, optical	166	99	digit	53	25	connector system	III	253
switches, PC	36	20	drivers, display	152	330	connectors	19	7
switches, rotary	163	94	electro-optics	123	57	connectors	129	60
thermostat	155	82	encoders, priority	149	326	connectors, edgeboard	177	112
toggle-switch kit	172	371	IC chips	33	14	design-support systems	167	102
transformers	131	62	op amps, bipolar FET	99	47	dielectric foam	164	355
<b>Data Processing</b>			optical isolators	192	141	flat-cable connection		
computer terminal	165	357	PROM, 4-k	161	92	systems	179	117
data xmitter, laser	165	358	RAM, 16-k	146	323	flat springs	139	66
disc storage	168	366	RAM, 16-k	150	327	heat exchanger	164	354
graphic display	167	362	RAMs, 1-k	143	308	logic panels	181	121
interface system	167	364	reference, 5-V	143	309	mass terminations	68	36
line printer	158	87	sensors	149	75	multiconductor connec-		
minicomputer	165	356	solid-state memory	141	67	tors	55	26
modem	166	360	switches, analog	143	307	plastic moldings	42	21
plotter	168	365	switches, CMOS	154	331	sockets, IC	187	133
readers and punches	186	132	temp transducer	28	12	solder gun	163	350
recorders	119	56	$\mu$ P interface	163	95	terminal, wire-wrap	164	353
supplies	157	85	<b>Microprocessor Design</b>			terminals, board	159	88
system software	166	361	bipolar microprocessor	157	86	wire, cable and cord	71	400
<b>Discrete Semiconductors</b>			bipolar $\mu$ Ps	165	98	<b>Power Sources</b>		
bridge rectifiers	174	377	bipolar $\mu$ Ps	171	106	ac-line regulators	185	130
Darlington	110	51	bipolar $\mu$ P products	169	105	batteries, lithium	187	134
Darlington, power	173	374	emulators	156	83	dc-dc converter	177	384
high-current/voltage			microcomputer	83	39	power sources	191	140
transistors	59	28	microprocessor products	5	6	power supplies	180	119
LED lamps	56	27	PL/M compiler	47	161	power supply	176	383
LEDs	91	43	<b>Microwave &amp; Lasers</b>			power supply, dc	175	379
rectifiers, Schottky			power splitter/combiner	2	3	power-supply switches	177	385
barrier	182	123	rf links	150	76	power supply, 800 Hz	175	381
transistor	130	61				power systems	49	24
transistors, power	174	376				switching regulators	104	48
transistors, $\mu$ wave	174	378				transformers	169	104



# AVOID GOLD

With MOLEX'S New, Innovative,  
High Force, Gas Tight,  
Connector System  
**PRESS-SURE-MATE™**

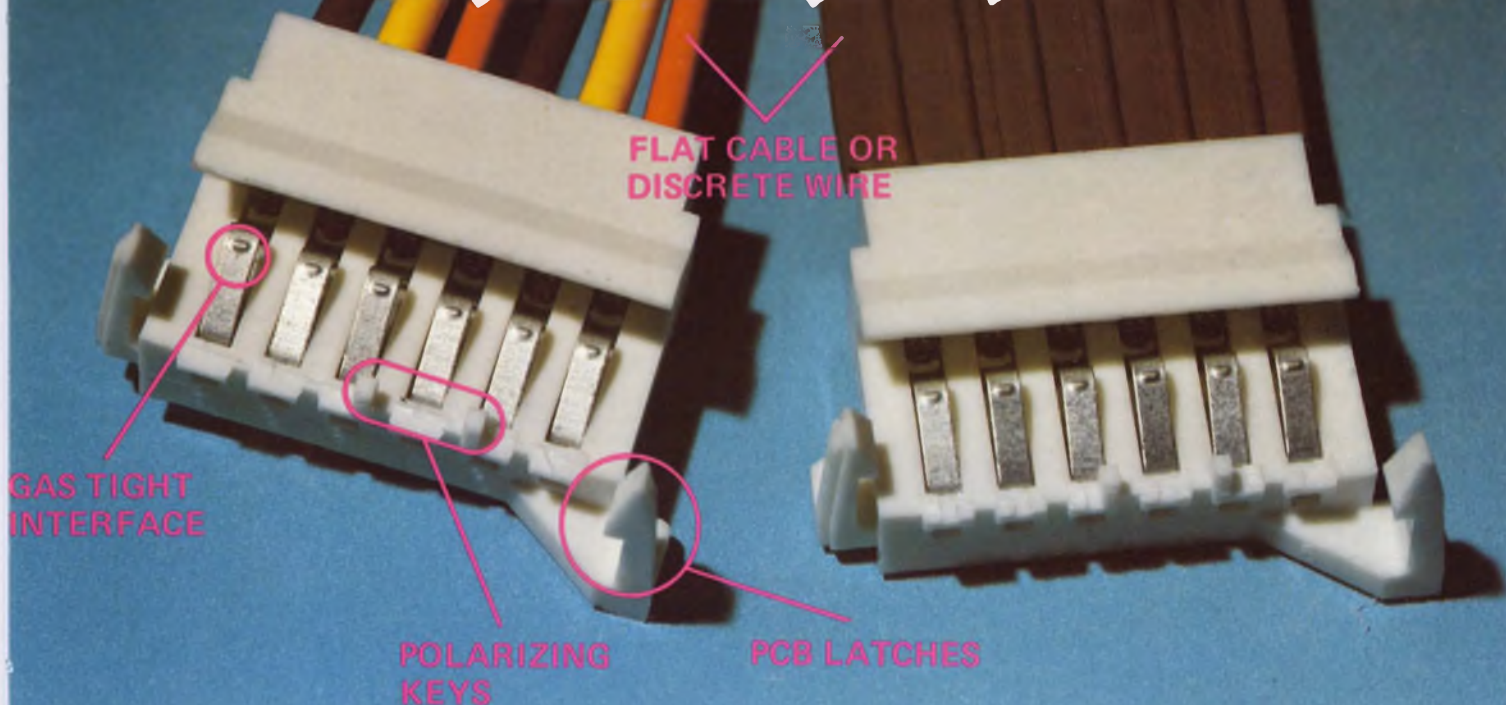

Cut your interconnection costs by eliminating gold contacts and by gang crimping with the new Molex U.L. listed Press-Sure-Mate connector 6063 series.

This unique zero insertion force connector system incorporates a high pressure point contact to achieve connection to P.C.B. solder pads creating a gas-tight interface.

The U.L. 94V-O polarized housing is designed to mate with P.C.B. pads on .156" centers. Standard contacts are tin-plated rated at 3 amps with an operating voltage of 250 V RMS.

The connector is available in 2, 4 and 6 contact configurations. The crimp contacts afford the ability to mate either discrete wires or flat cables. Contacts have

been designed, along with assembly tooling, to gang crimp as many as 6 contacts at one time. This feature will lower assembly costs, and therefore, increase production and lower installed costs. A special "inhibited motion" feature has been designed into the contact that does not allow the contact to move once it has been inserted in the connector housing.

Avoid gold . . . with the design features, reliability, ease of installation, and the low cost, you expect from Molex.

For complete details and options available call (312) 969-4550 or write Molex Incorporated, 2222 Wellington Court, Lisle, Illinois 60532.

**molex** . . . Affordable Technology

CIRCLE NUMBER 253

In high-voltage CMOS designs...

# To B or to UB? RCA COS/MOS helps with the answer.



Not all B-Series CMOS is buffered — that's why there's a UB suffix. RCA experience shows that certain designs call for a buffered gate, but in others, unbuffered is better. Only the designer is in a position to decide.

That's why we offer you both. To JEDEC specs. With COS/MOS you don't have to worry about non-interchangeability of "B" devices in applications where speed, noise immunity, output impedance and linear gain-bandwidth characteristics are critical. As the table shows, you can select the COS/MOS option that does what you want in the environment to be faced — without having to add components or compromise on system performance.

Get the RCA B-Series Product Guide from your Solid State distributor. Or RCA.

## Which COS/MOS option is best for your design?

Requirement/environment	Buffered	Unbuffered
High speed		x
Ultra-low frequency		x
High freq., moderate gain, linear amplification		x
High-noise environment, low-speed system	x	
Constant output impedance	x	
Low freq., high gain, linear amplification	x	

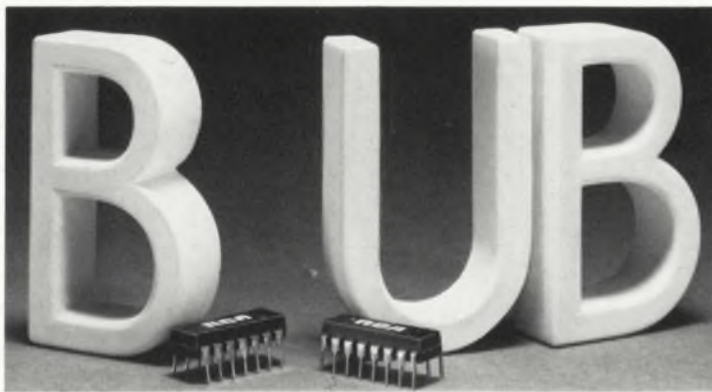

**Buffered B      Unbuffered B**

CD4000B	CD4000UB
CD4001B	CD4001UB
CD4002B	CD4002UB
CD4011B	CD4011UB
CD4012B	CD4012UB
CD4023B	CD4023UB
CD4025B	CD4025UB

Write: RCA Solid State, Box 3200, Somerville, NJ 08876; Sunbury-on-Thames, Middlesex TW16 7HW, England; Ste-Anne-de-Bellevue, Quebec, Canada; Fuji Bldg., Tokyo, Japan.

**RCA COS/MOS experience is working for you.**

# RCA