

Electronic Design 3

VOL. 25 NO.

FOR ENGINEERS AND ENGINEERING MANAGERS

FEB. 1, 1977

Logic analyzers on your mind?

The difference in displays is just part of the picture. Other things to think about: how the probe system affects the performance,

how the data are collected, how many channels you'll need. With μ P analyzers, learn the interface requirements. Above all, know your application. More on p. 40.

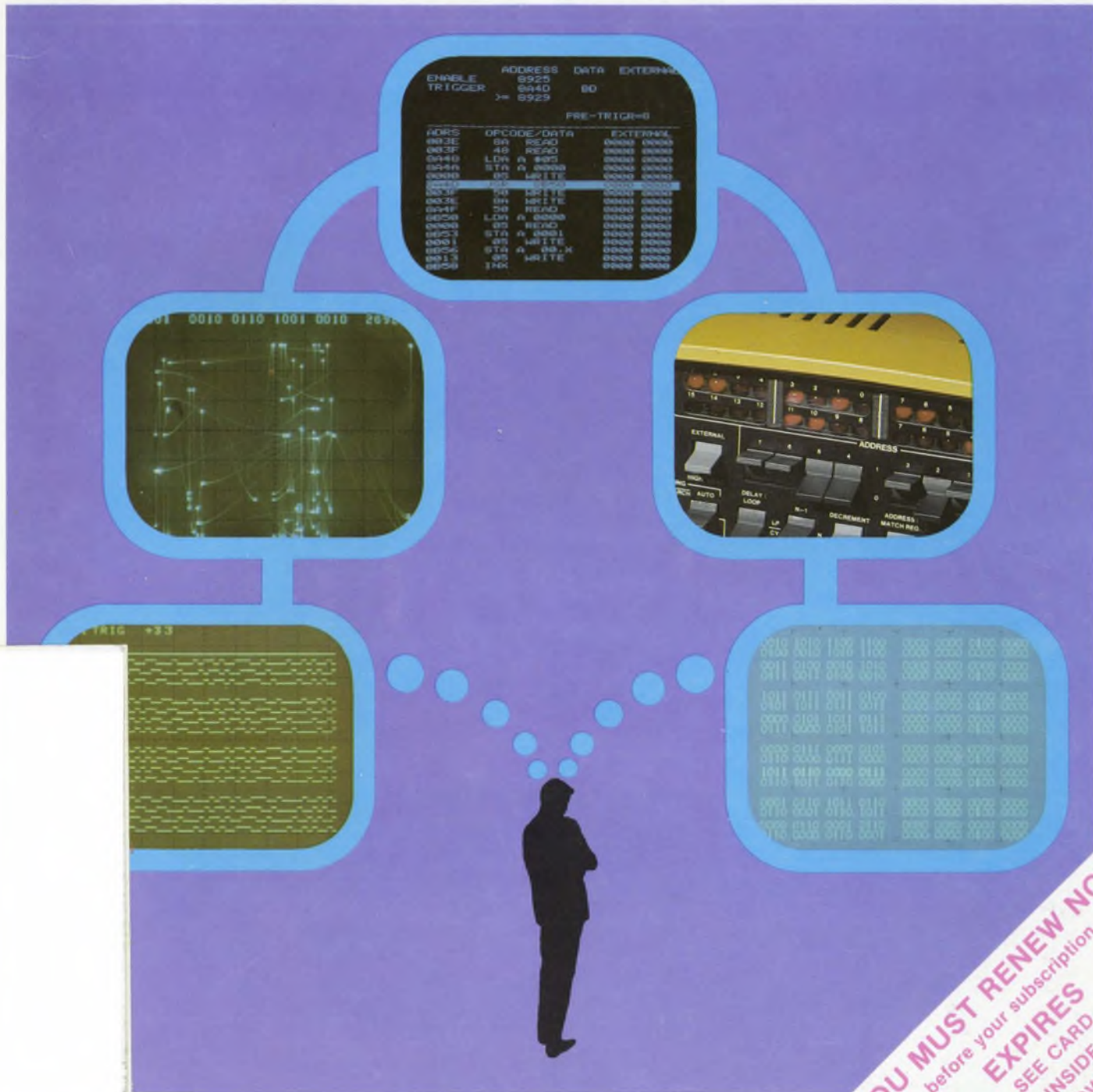

ENABLE TRIGGER	ADDRESS	DATA	EXTERNAL
	8925	80	
	>= 8929		
PRE-TRIG=0			
ADDRS	OPCODE/DATA	EXTERNAL	
892E	89	REFO	ONHOLD
892F	40	REFO	ONHOLD
8940	LDV R #075	ONHOLD	ONHOLD
8944	STA R #0000	ONHOLD	ONHOLD
8945	LDI	ONHOLD	ONHOLD
8946	LDI	ONHOLD	ONHOLD
8947	LDI	ONHOLD	ONHOLD
8948	LDI	ONHOLD	ONHOLD
8949	LDI	ONHOLD	ONHOLD
894A	LDI	ONHOLD	ONHOLD
894B	LDI	ONHOLD	ONHOLD
894C	LDI	ONHOLD	ONHOLD
894D	LDI	ONHOLD	ONHOLD
894E	LDI	ONHOLD	ONHOLD
894F	LDI	ONHOLD	ONHOLD
8950	LDI	ONHOLD	ONHOLD
8951	LDI	ONHOLD	ONHOLD
8952	LDI	ONHOLD	ONHOLD
8953	LDI	ONHOLD	ONHOLD
8954	LDI	ONHOLD	ONHOLD
8955	LDI	ONHOLD	ONHOLD
8956	LDI	ONHOLD	ONHOLD
8957	LDI	ONHOLD	ONHOLD
8958	LDI	ONHOLD	ONHOLD
8959	LDI	ONHOLD	ONHOLD

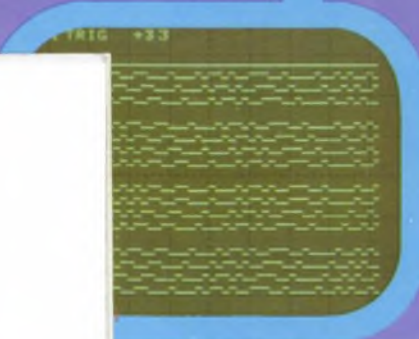
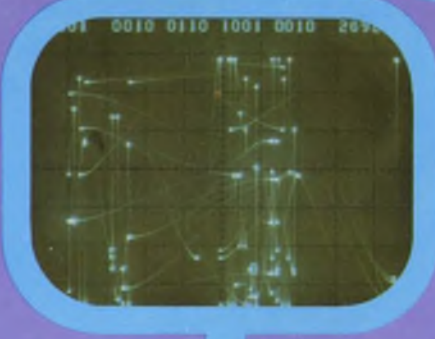

YOU MUST RENEW NOW
before your subscription
EXPIRES
SEE CARD
INSIDE
COVER

Swage-Bond™ ... a revolution in trimmer reliability!

... here today at no extra cost in every Trimpot® Potentiometer

Historically, pin-to-element termination problems have been one of the primary causes of trimmer failure ... especially during handling and PC board process operations. Bourns exclusive Swage-Bond™ process virtually eliminates pin termination failure ... truly a revolution in trimmer reliability. Furthermore, Swage-Bonding results in a marked improvement in temperature coefficient consistency.

Other trimmer manufacturers utilize a simple clip-on termination. Some solder this connection, some rely on tension pressure alone. In the Swage-Bond process, the P.C. pins are secured **through** the substrate, with a high-pressure compression swage on both top and bottom sides. The pressure of the swage locks the pin solidly into the element, and thoroughly bonds it to the thick-film termination material.

Swage-Bond™ eliminates pin termination failure, provides more reliable tempco. Microphotograph shows trimmer element magnified 20X.



The seal that seals ... without springback

Bourns trimmers stay sealed when others fail. We know. We've tested them all. Bourns uses a chevron-type sealing technique, that seals without O-rings ... eliminating the windup and springback that frequently occurs with such seals. The result is faster and more precise adjustability ... with a seal that really works.



Wrap-around wiper for better setting stability

Bourns multi-fingered, wrap-around wiper delivers more consistent, more reliable performance. The unique design significantly reduces CRV fluctuations and open circuit problems due to thermal and mechanical shock ... by maintaining a constant wiper pressure on the element. Compare the ruggedness of Bourns design with the common "heat-staked" wiper designs. Compare performance. Specify Bourns.

HERE'S PROOF:

Send for a copy of our new engineering report on TRIMMER PERFORMANCE. Tell us about your application, and we'll provide qualification samples that best suit your needs.

Bourns reliability is available at ordinary prices ... off-the-shelf from nearly 100 local distributor inventories ... plus our largest-ever factory stock. TRIMMER PRODUCTS, TRIMPOT PRODUCTS DIVISION, BOURNS, INC., 1200 Columbia Avenue, Riverside, California 92507. Telephone 714 781-5320 — TWX 910 332-1252.



International: HQ Switzerland, 042/23 22 42 • Belgium 02/218 2005 • France 01/2039633 • Germany 0711/24 29 36 • Italy 02/32 56 88 • Netherlands 070/88 93 18 • United Kingdom 01/572 6531 • Japan 075 92 1121 • Australia 86 9410 • Brazil 257-3535 • India 373 544

CIRCLE NUMBER 262

SURPRISE!



Our New Display Can Say A Lot For You

Our new HDSP-2000 Alphanumeric Display can spell it out for you in bright, crisp LED characters. The full 5x7 dot matrix can display ASCII or custom character sets including lower case and symbols.

Compact and complete with on-board electronics, the HDSP-2000 dramatically reduces display system size and complexity. Each 12 pin DIP contains 4 characters with row drivers and storage. End stackable and easy to interface, they're ideal for "smart" instruments, medical systems or business terminals, military applications, and almost any mobile, portable or hand-held device.

The price is \$47.00* per 4-character cluster in quantities of 125 clusters. They're in stock today at HP's franchised distributors. In the U.S. contact Hall-Mark, Schweber, Wilshire or the Wyle Distribution Group (Liberty/Elmar) for immediate delivery. In Canada, contact Zentronics, Ltd. *U.S. Domestic price only.

HEWLETT  PACKARD

Sales and service from 172 offices in 65 countries.
1507 Page Mill Road, Palo Alto, California 94304

TO-5 RELAY UPDATE

The Relay of Tomorrow is here today: the Centigrad.

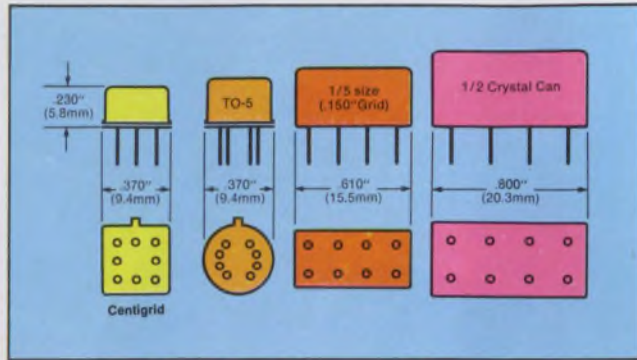

Out of Teledyne's TO-5 relay technology has evolved the Centigrad® — the ultimate subminiature relay. It combines the proven TO-5 relay design concept and internal construction into an even more compact package. Low profile height — just .230" (5.84mm) — with terminals spaced on a .100" (2.54mm) grid permitting direct pc board mounting without the need for lead spreading.

Add to this the same low coil power consumption as the TO-5 relay, with obvious thermal and power

supply advantages. And for RF switching, the Centigrad's low inter-contact capacitance and contact circuit losses provide high isolation and low insertion loss up through UHF frequencies.

To top it all off, the Centigrad is qualified to levels "L" and "M" of MIL-R-39016, including the internal diode suppressed versions.

For complete specification data on the Relay of Tomorrow, contact Teledyne Relays, the technology leader in the relay industry.

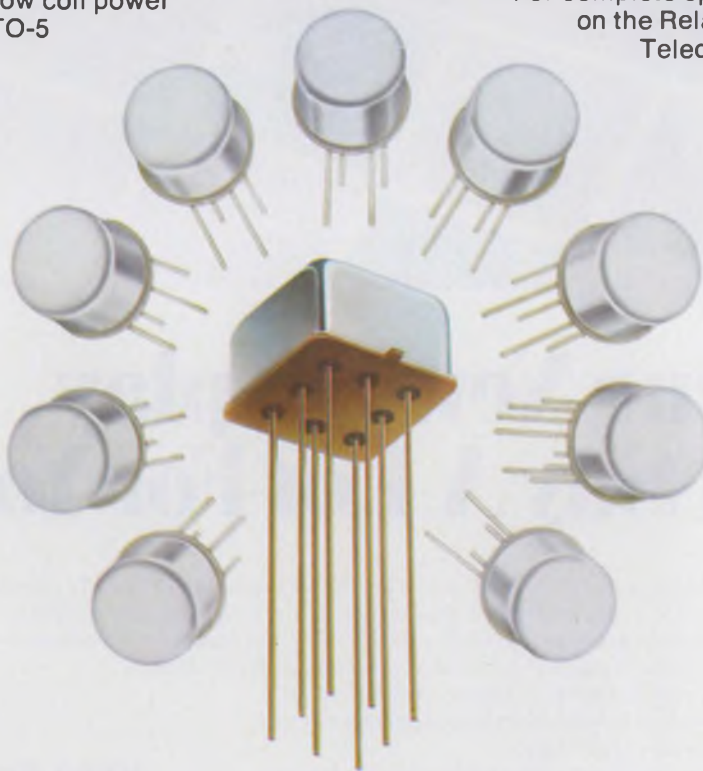

 **TELEDYNE RELAYS**

3155 West El Segundo Boulevard, Hawthorne, California 90250, Telephone (213) 973-4545

CIRCLE NUMBER 3

NEWS

- 15 **News Scope**
- 20 **Charge-coupled approach** leads to new LSI digital devices.
- 22 **SSB and vhf-FM radiotelephones** highlighted at National Boat Show.
- 24 **Bipolar processor in TV set** leads to preprogrammed channel selection.
- 31 **Washington Report**

TECHNOLOGY

- 35 **Microprocessor Design**
- 40 **FOCUS on logic and μ P analyzers:** Keeping up is a problem in this fast paced area. Breaking an analyzer into its basic parts helps.
- 52 **A primer on bit-slice processors**—basics for the uninitiated. Here are the principles of operation for these most flexible of logic processors.
- 62 **Software modules are the building blocks** of 'structured programming.' Employ this tactic, and you will be rewarded with fewer errors, come debug time.
- 68 **Ideas for Design:**
 - Implement a lab-scope data display with μ P software.
 - Expander matches ground-fault interrupt circuit to UL trip-time specifications.
 - Test probe checks power or continuity without switching or probe adjustments.
 - Output from compression amplifier is constant over an input range of 50 dB.
- 76 **International Technology**

PRODUCTS

- | | | | |
|----|-------------------------|----|-------------------------|
| 78 | Integrated Circuits | 86 | Data Processing |
| 80 | Modules & Subassemblies | 88 | Discrete Semiconductors |
| 82 | Instrumentation | 90 | Packaging & Materials |
| 84 | Components | 92 | Power Sources |

DEPARTMENTS

- | | | | |
|----|----------------------------|-----|----------------------------|
| 39 | Editorial: Feedback | 98 | Vendors Report |
| 7 | Across the Desk | 102 | Advertisers' Index |
| 93 | Application Notes | 104 | Product Index |
| 94 | New Literature | 104 | Information Retrieval Card |
| 95 | Bulletin Board | | |

Cover: Cover designed by Art Director, Bill Kelly, photos courtesy of Biomation, E-H Research Laboratories, Hewlett-Packard, Systron-Donner, Tektronix.

**The
microprogrammed
state machine:**

**Get an Am 29811
and you've
got it made.**

If you make state machines — and you're tired of gates and flops and hassles and headaches — we've just made your life a lot easier.

Get an Am29811, add some Am2911's and you get an amazingly powerful, efficient microprogram controller. Throw in a couple other 16- and 20-pin packages, and throw away your state machine problems. For good.

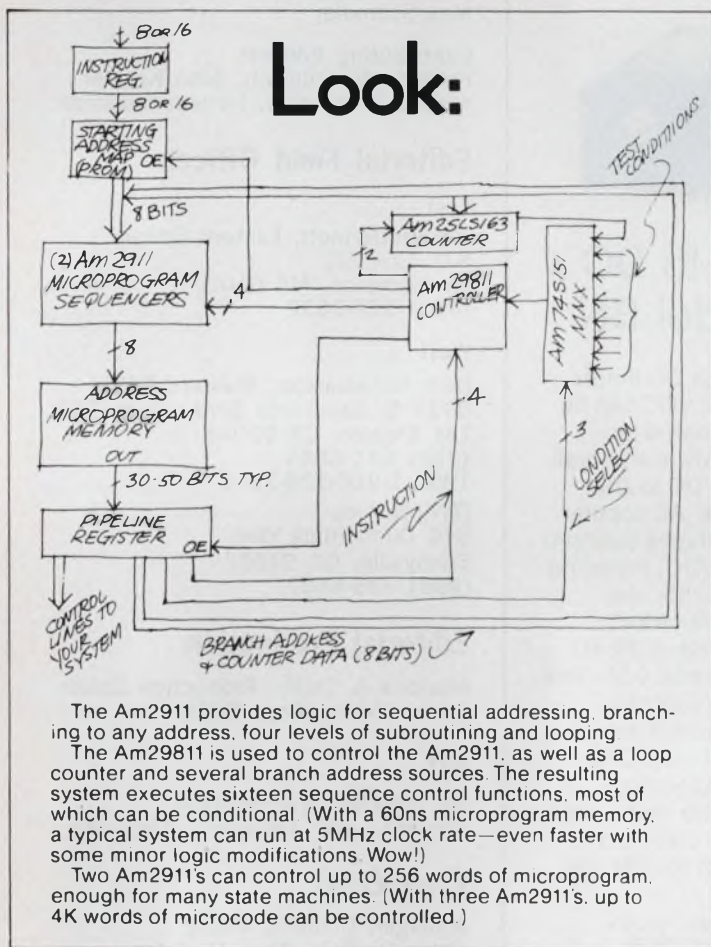

Look again:

Sequence Control Instructions

Jump to Zero

*Jump to Branch Address

Load Counter

*Repeat Jump if Counter \neq 0

*Push PC or Push PC and Load Counter

Jump to Map Address

*Loop

*Repeat Loop if Counter \neq 0

*Jump to Subroutine

*Return

*Jump to One-of-Two Subroutines

*Jump and Pop Stack

Jump to External Address

Jump to Branch Address

*Jump to One-of-Two Branch Addresses

Continue

*Conditional Instructions

Terrific. But how much?
Am2911, \$2.95 in volume.
Am29811, \$2.60 in volume.
 The entire controller shown, including 8-bits of loop counter and 8-input multiplexer is only \$11.64. That's right. \$11.64 total price.

If you want to know more about the Am2911 or the Am29811, just wire, write or phone. We'll send you a whole book about microprogrammed controllers. For free, of course.

Boy. Some guys really have it made.

Advanced Micro Devices

Bipolar LSI. N-channel, silicon gate MOS. Low-power Schottky.
 Multiple technologies. One product: excellence.



Advanced Micro Devices, 901 Thompson Place,
 Sunnyvale, California 94086 Telephone (408) 732-2400.

CIRCLE NUMBER 5

INTERESTED IN HIGH EFFICIENCY POWER SUPPLIES?

ABBOTT HAS THE ANSWER

Abbott Transistor Laboratories manufactures three complete lines of hermetically sealed, switching regulated power supplies. These rugged and dependable power modules have already found wide use in many military, aerospace and industrial applications. All units are designed to meet the EMI requirements of MIL-STD-461 and the environmental requirements of MIL-STD-810.

77%
EFFICIENT



**60 Hz to DC
model VN**

Abbott's Model VN series converts 47 to 440 Hz AC lines to any DC voltage between 4.7 and 50 VDC at output powers of 25, 50 and 100 watts. Line and load regulation are controlled to 0.4% with a peak-to-peak ripple of 100 mV. Efficiencies of 77% are achieved with power densities of greater than 1 watt per cubic inch.

70%
EFFICIENT



**400 Hz to DC
model UN**

Designed to operate from 380 to 420 Hz AC lines, Abbott's Model UN series offers output powers of 25, 50 and 100 watts at all popular voltages between 5 and 50 VDC, including ± 12 and ± 15 . The full load operating temperature range is -55°C to $+100^{\circ}\text{C}$. Peak-to-peak ripple of 100 mV and load regulation of 0.5% are just a few of the standard features of this line of 70% efficient power modules.

70%
EFFICIENT



**DC to DC
model BN**

Wide range DC inputs of 20 to 32 VDC can be accommodated by Abbott's BN line of high efficiency DC to DC converters. All popular output voltages between 5 and 50 VDC, including ± 12 and ± 15 , are available at output power levels of 25, 50 and 100 watts. 0.5% line and load regulation, 100 mV peak-to-peak ripple and -55°C to $+100^{\circ}\text{C}$ operating temperature range are a few of the standard features of the BN line.

Complete electrical specifications, size charts and prices for these units are listed in our new 60 page free catalog. Also listed are 12 additional line of power modules, including —

60 A to DC
400 A to DC
DC to DC
DC to 60 A
DC to 400 A

For immediate complete information on Abbott Modules, see pages 1037-1056 Vol. 1 of your 1975-76 EEM Catalog or pages 612-620 Vol. 2 of your 1975-76 GOLD BOOK.

abbott transistor
LABORATORIES, INCORPORATED

Send for our
new 60 page
FREE catalog —

GENERAL OFFICES
5200 W. Jefferson Blvd.
Los Angeles, CA. 90016
(213) 936-8185
Telex 69-1398

EASTERN OFFICE
1224 Anderson Ave.
Fort Lee, N.J. 07024
(201) 224-6900
Telex 13-5332

CIRCLE NUMBER 6

Sr. Vice President, Publisher
Peter Coley

Editors

Editorial Offices
50 Essex St.
Rochelle Park, NJ 07662
(201) 843-0550
TWX: 710-990-5071
Cable: Haydenpubs Rochellepark

Editor-in-Chief George Rostky

Managing Editors:
Ralph Dobriner
Michael Elphick

Senior Associate Editor
Stanley Runyon

Associate Editors:
Sid Adlerstein
Dave Bursky
Morris Grossman
John F. Mason
Max Schindler

Contributing Editors:
Peter N. Budzilovich, John Kessler
Alberto Socolovych, Nathan Sussman

Editorial Field Offices

East

Jim McDermott, Eastern Editor
P.O. Box 272
Easthampton, MA 01027
(413) 527-3632

West

Dick Hackmeister, Western Editor
8939 S. Sepulveda Blvd., Suite 510
Los Angeles, CA 90045
(213) 641-6544
TWX: 1-910-328-7240
Dave Barnes
844 Duncardine Way
Sunnyvale, CA 94087
(408) 736-6667

Editorial Production

Marjorie A. Duffy, Production Editor
James Keane, Copy Editor

Art

Art Director, William Kelly
Richard Luce, Anthony J. Fischetto

Production

Manager, Dollie S. Viebig
Helen De Polo, Anne Molfetas

Circulation

Director, Barbara Freundlich
Trish Edelmann

Information Retrieval

Paula Greenleaf

Advertising Promotion

Susan G. Apolant

Across the Desk

A 'latent' discrepancy

The diagram of IEEE-488 interface timing in the article by Holt and Shirley (ED No. 22, Oct. 25, 1976, p. 156) seems at odds with the diagram published in the standard.

The discrepancy has to do with the "latency zone," which begins with the response of the fastest listener and ends with that of the slowest.

Figure 9 of the article indicates this zone with heavy shading and attaches it to the falling edges of the RFD and DAC signals. The standard uses dotted lines to indicate latency in multiple listeners, but zones are attached to the rising edges of the RFD and DAC signals.

Obviously, there are response latencies attached to both sides of these signals in a multiple-listener configuration. Depicting only one or the other without explaining why only adds to the considerable confusion surrounding IEEE-488.

*Sam Mallicoat
Design Engineer*

Tektronix, Inc.
P.O. Box 500
Beaverton, OR 97077

The author's reply:

The IEEE-488 standard shows the timing diagram with respect to the talker, and the "latency zone" represents the time required for all listeners to respond to the control signals. Our diagram was drawn with respect to the listener and only shows the time relationship between the different control signals. Hewlett-Packard shows a similar diagram in its manual for the 3340A frequency counter.

*Oliver Holt
Frederick Shirley*

Electronic Design welcomes the opinions of its readers on the issues raised in the magazine's editorial columns. Address letters to Managing Editor, Electronic Design, 50 Essex St. Rochelle Park, N.J. 07662. Try to keep letters under 200 words. Letters must be signed. Names will be withheld on request.

Fill in the corrections

Thank you for covering our LS-7030 eight-decade counter (ED No. 24, Nov. 22, 1976, p. 228). Unfortunately, a few technical errors occurred in the release. The multiplex scan counter may be driven by an on-chip oscillator whose frequency is determined—not reduced—by an external capacitor. The maximum multiplex frequency—not the on-chip oscillator frequency—is 500 kHz. And the circuit operates from a single power supply between +5 V dc and +15 V dc—not +18 V dc.

Alvin Kaplan

LSI Computer Systems, Inc.
22 Cain Drive
Plainview, NY 11803

Misplaced Caption Dept.



If this new silicon ribbon doesn't work out for solar cells we can always use it to make skis.

Sorry. That's Domenicos Theotocopoulos (El Greco) "St. Andrew and St. Francis," which hangs in the Prado Museum in Madrid.



OPTRON REFLECTIVE TRANSDUCERS

NEW OPB 704 OFFERS
MAXIMUM RELIABILITY
IN A SINGLE
HERMETIC PACKAGE

OPTRON's new, low cost OPB 704 reflective transducer assures maximum reliability by combining a high efficiency solution grown LED with a silicon phototransistor in a single miniature hermetic package.

The hermetically sealed glass-metal-ceramic package offers extremely high reliability and stable performance at a cost competitive with that of plastic encapsulated devices. And, the OPB 704 has a usable continuous operating life of more than five years when operated at an average LED device current of 20 mA.

The OPB 704's phototransistor senses radiation from the LED only when a reflective object is within its field of view. With an LED input current of 50 mA, the output of the phototransistor is typically 0.5 mA when the unit is positioned 0.100 inch from a 90% reflective surface. With no reflective surface within the phototransistor's field of view, maximum output is 10 μ A with a LED input of 50 mA and V_{CE} of 5 volts.

Ideal applications for the OPB 704 reflective transducer include EOT/BOT sensing, mark sensing, detection of edge of paper or cards and proximity detection.

The OPB 704 and other low cost, high reliability Optron reflective transducers are immediately available. Custom designed versions for special applications are available on request.

Detailed information on the OPB 704 reflective transducer and other Optron optoelectronic products... chips, discrete components, limit switches, isolators and interrupter assemblies... is available from your nearest Optron sales representative or the factory direct.



OPTRON, INC.

1201 Tappan Circle
Carrollton, Texas 75006, U.S.A.
TWX-910-860-5958
214/242-6571

STORE



ERASE



OR
VIEW
TIME

ERASE
(PUSH)

MAX

BRIGHTNESS



MAX

WRITE



STORE



DISPLAY



1741A STORAGE

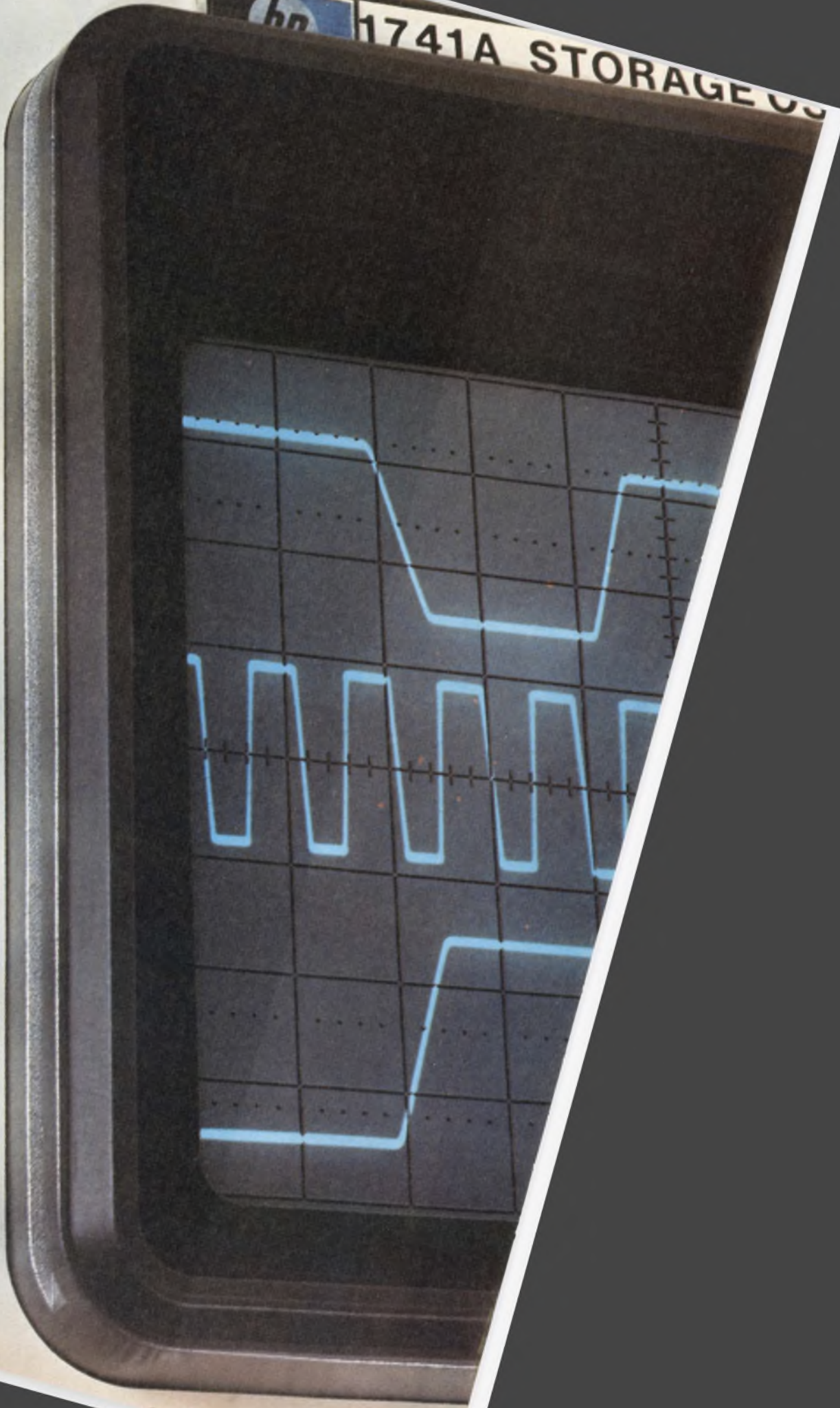

For one easy-to-use scope that: Captures single-shot events... Displays low-duty-cycle signals clearly... Provides three channels for the price of two...

HP's the Answer.

And the new 1741A is your scope. It gives you a unique combination of features for a moderately priced 100 MHz storage scope: Variable persistence for clear viewing of glitches and low-duty-cycle traces; storage for studying single-shot events; and third-channel trigger view for convenience in making simultaneous three-channel timing measurements.

Excellent variable persistence means a bright, sharp trace you'd expect only on a nonstorage scope. The result is an easy-to-read display of fast, low-duty-cycle repetitive signals. And the ability to see leading edges and glitches you'd otherwise miss.

Auto erase/Auto store. In Auto erase you adjust the display rate up to 2.5 per second. After that, it's all automatic, which means you simplify set-ups and eliminate smeared displays of digital data. It's a powerful tool for capturing those elusive glitches in data streams. In Auto store, your 1741A is armed, and as long as the instrument is fully operational and powered, will wait indefinitely, ready to store a random, single-shot event when it occurs.

Third-channel trigger view, selected at the push-of-a-button, lets you observe an external trigger signal along with channel A and B—three traces in all—so you can easily make timing measurements between all three channels. In most applications, that means three-channel capability for the cost of a two-channel variable persistence/storage scope.

For measurement convenience, the

1741A has a selectable 50 ohm input in addition to the standard 1 megohm input. A 5X magnifier permits two-channel measurements as low as 1 mV/div to 30 MHz, without cascading. You can even select a special modification (TV Sync) to tailor this scope for TV broadcast and R&D applications. Priced at \$3950*, the 1741A is an exceptional storage scope value.

Call your local HP field engineer today for all details. And for low-cost variable persistence/storage in a 15 MHz scope, ask him about HP's new 1223A.

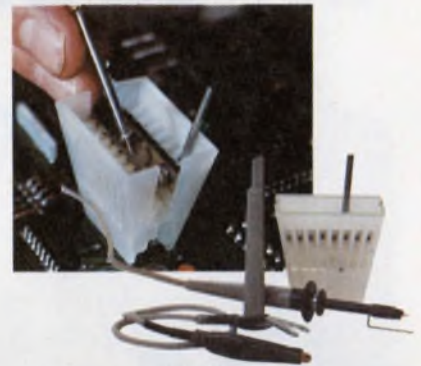

And here's something NEW for scopes. HP's EASY-IC PROBES. A new idea for probing high-density IC circuits that eliminates shorting hazards, simplifies probe connection to DIP's and generally speeds IC troubleshooting. Ask your HP field engineer about them.

*Domestic U.S.A. price only.



HEWLETT **hp** PACKARD

1507 Page Mill Road, Palo Alto, California 94304

For assistance call: Washington (301) 948-6370, Chicago (312) 255-9800, Atlanta (404) 955-1500, Los Angeles (213) 877-1282

CIRCLE NUMBER 8

Datel Systems, Inc.

RECEIVED

\$1,786,000

IN NEW BUSINESS IN 6 MONTHS



THROUGH Electronic Design's **GOLD BOOK**

AND... THE GOLD BOOK SAVED DATEL MORE THAN \$200,000 IN PRINTING, OVERRUNS, MAILING AND POSTAGE!

Datel's Vice President of Marketing, John H. Gallagher, tells the story:

"In 1975 we placed 10 pages in the GOLD BOOK and obtained phenomenal results. A flow of inquiries and orders (more than \$130,000 worth) came in from all over the world.

"So this year we placed 297 pages — an entire separate volume — the largest single paid advertisement ever carried by an electronics directory.

"In just six months, July through December 1976, we can trace over one and three-quarter million dollars in new business directly to the GOLD BOOK.

"Because of the economies we found in planning, preparation, production, printing, overruns, postage, and distribution of our catalog (115,000 copies were overrun with a special 4-color cover for our own use) we were able to achieve massive coverage and still save well over \$200,000 on the total package.

"We chose *Electronic Design's* GOLD BOOK to place this record number of catalog pages because of its buying power and influence among 90,000 engineers and engineering managers in all the major plants in the USA, Europe and throughout the world.

We know the GOLD BOOK sells for us. We're so confident of even greater success.

— John H. Gallagher, Vice President of Marketing
Datel Systems, Inc., Canton, Mass.

GOLD BOOK
IS WORKING FOR DATEL SYSTEMS, INC.
IT CAN WORK FOR YOU

1977-78 EDITION CLOSES

March 1, 1977 — For copy to be set.

April 1, 1977 — For camera-ready art or film.

Electronic Design's GOLD BOOK

Peter D. Coley, Senior Vice President & Publisher
Albert B. Stempel, Vice President, Publication & Printing Director

HAYDEN PUBLISHING COMPANY, INC.

50 ESSEX STREET, ROCHELLE PARK, NEW JERSEY 07662 • TEL: 201-843-0550 • TWX: 710-990-5071

Some answers about inlay clad metals and the new opportunities open to design engineers

What is inlay cladding?

The combination of two or more metals, metallurgically bonded under high pressure, resulting in a one-piece composite with physical and electrical properties not given to a single metal or alloy. TMI's skive inlay cladding is a special application of this process, a technique of precisely locating stripes of precious or non-precious metal only at the contact point, causing a substantial savings in precious metals.

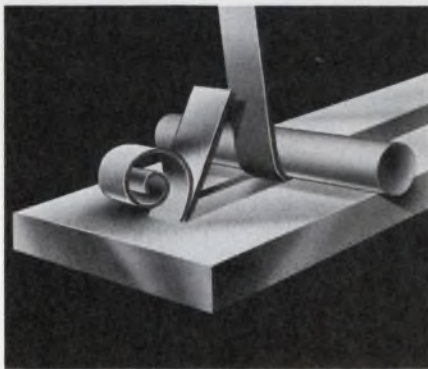

How reliable is metallurgical bonding?

High pressure and temperature causes highly attractive atomic forces to interact with increased magnitude which produces diffusion at the bond interface. Clad inlays are far more reliable than welded or plated contacts as testified by preferences in the computer and telecommunications field.

What are the possible configurations?

TMI offers a wide variety of design options which includes multiple inlays, top and bottom inlays.

All can be combined in a variety of selectively clad stripes.

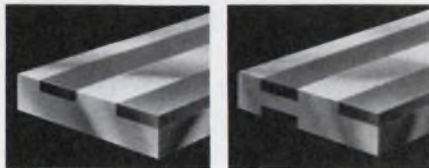

1. Inlay and Edgelay stripes. 2. Top/bottom inlay and edgelay stripes.

Why are TMI clads superior to plating?

TMI clad inlays offer many advantages not possible with alternate processes:

- Utilization of low karat and precious metals alloys.
- Precious metal is flush with base metal surface.
- Improved porosity over electroplating.
- Superior formability.
- Low contact resistance.

What are multigauge base metals?

Multigauge base metals are produced by skiving away unwanted sections of metal leaving a strip with two or more thicknesses offering a combination of rigidity and flexibility. A multigauge strip can be supplied in conjunction with an inlay.

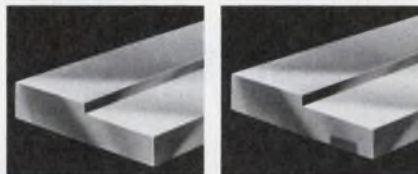

1. Multigauge skiving. 2. Multigauge with inlay stripe.

What is the TMI Thrulay?

TMI has developed a technique whereby dissimilar metals with different tempers can be welded in continuous coils. This product conserves precious metal by eliminating solid precious metal parts. Soft metal can also be welded to a harder metal such as in connector applications. Thrulays are used in both switch and connector applications.

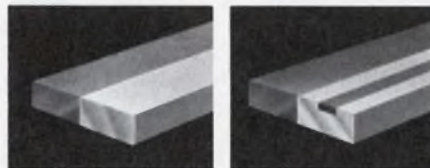

1. Thrulay welded base metals. 2. Thrulay with inlay.

What is solder striping?

A process developed by TMI provides two types of solder stripes.

- Thin Stripes: .0002"-.0005" of any solder. This stripe offers the user a readily solderable surface during fabrication and assembly.
- Thick Solders: .001"-.020" of any solder. This stripe is used to replace a preform thus permitting automation.

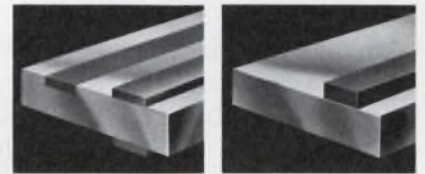

1. Over/under thin solder stripes with precious metal inlay. 2. Heavy solder stripe.

Why Precious Metal Dots?

Precious metal dots accurately welded by using the customer's specified pilot positions makes it possible for the user or job stamper to fabricate springs with the contact already in place. Each individual welded dot is automatically tested to insure 100% reliability.

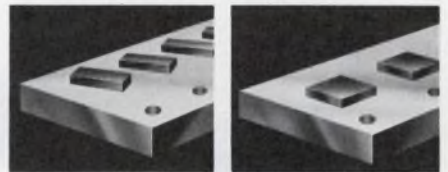

1. Typical Configurations

What are some applications for TMI clads?

TMI inlay clad and solder stripes are used in a broad range of high reliability products in the appliance, automotive, computer electronics, semiconductor and telecommunication industries. In addition, many cost-effective designs utilizing the versatility of clads are used in cameras, calculators and other consumer products.

How can I learn more about TMI clads?

Write to Craig Harlan at the address below or TWX 710 384 0600, TMI LCLN.



TECHNICAL MATERIALS, INC.

5 Wellington Rd., Lincoln, Rhode Island 02865
Telephone: (401) 333-1700

CIRCLE NUMBER 10

7 trimmers handle 95% of your applications.

Single-turn

With these industry standard cermet trimmers, you're assured design versatility, high quality, and fast delivery.

Just decide what you need regarding: (1) single- or multiturn; (2) sealed or not; (3) size; (4) resistance; (5) pin spacing; and (6) price.

Then call your local Beckman Helipot distributor for *free* evaluation samples. To get his number, or immediate technical literature, call (714) 871-4848, ext. 1776. See how fast and easily you can solve trimmer problems.



Model 91

- High quality — low price
- Unique brush contact
- Excellent setability
- Protective dust cover
- Top or side adjust
- Standoffs prevent rotor binding, permits board washing
- Small 3/8" dia. size



Model 72

- 3/8" square
- Sealed for board washing
- Available in flame-retardant SEO housing
- Top or side adjust
- Brush contact
- Excellent setability
- 2 ohms of end resistance



Model 82

- 1/4" dia. by 0.150" max. height
- Sealed for board washing
- Flame-retardant SEO materials
- 82P — top adjust; 82PA — side adjust
- Brush contact for excellent setability
- Resistance range: 10 Ω to 1 meg Ω

Multiturn



Model 64

- Miniature, sealed
- 22 turns of adjustment
- 0.25 watt at 85°C
- Resistance range: 10 Ω to 1 meg Ω
- 1/4" square for tight P.C. board packaging
- Unique brush contact
- Adjustability — voltage ratio within 0.01%



Model 68

- Low-cost
- Sealed for board washing
- 18 turns for adjustment accuracy
- 3/8" square housing
- Brush contact
- 3 pin styles for efficient packaging
- Broad resistance range: 10 Ω to 2 meg Ω
- Operates with 1/2 watt at 25°C

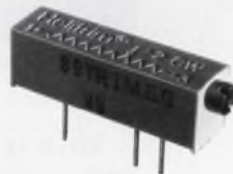

Model 89

- Our lowest cost multiturn
- Sealed for board washing
- 3/4" rectangular, 0.250" high
- 15 turns for accurate adjustment
- 7 pin styles for mounting versatility
- Panel mount available
- Resistance range: 10 Ω to 2 meg Ω

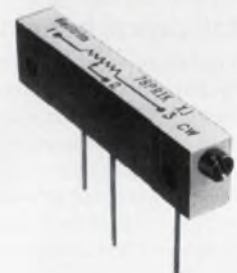

Model 78

- Military performance, industrial price
- 1 1/4" rectangular, 0.195" wide
- Sealed
- 3 terminal styles: flex leads, P.C. pins, solder lugs
- Power rating: 0.75 watt at 70°C
- 22 turns of adjustment
- Resistance range: 10 Ω to 2 meg Ω

BECKMAN®

HELIPOT DIVISION

CIRCLE NUMBER 11

FEBRUARY 1, 1977

IR-activated headphone works without a cord

Using optical diodes in place of copper wires, a recently introduced stereo headset has no need for the conventional umbilical cord, which restricts a listener's movements. Instead, this wireless stereo headset receives frequency-modulated infrared pulses that carry the audio signal.

A high-fidelity stereo signal is fed into a small IR transmitter sitting atop the listener's normal stereo equipment. An array of 12 GaAs LEDs—six for each channel—is mounted in parabolic reflectors on the front of the transmitter, which can accommodate audio frequencies ranging from 20 Hz to as high as 20 kHz.

To obtain proper channel separation, the LEDs are pulsed on and off at two different center frequencies—95 kHz for the left, 220 kHz for the right.

The receiving headphone, developed by Sennheiser Electronics Corp., New York, NY, uses a separate IR-sensitive semiconductor diode to receive each channel. The diodes are mounted behind an optical "fish eye" lens common to both channels and fitted with a black filter to reduce noise caused by ambient-light conditions. The lens provides ± 75 degree reception at close range.

Both receiving diodes are biased in the forward direction, and the impinging IR radiation modulates the bias current. Before being applied to the speakers, the received left and right-channel signals are amplified, filtered, demodulated, and re-amplified. The headset's frequency response is, like the transmitter's, 20 Hz to 20 kHz.

The stereo signals are made to frequency-modulate the LEDs' light output—frequency excursion of the pulsed IR signal is 30 kHz for a mean 1-V signal level and a maximum 50 kHz for a 1.5-V signal.

The six LEDs per channel emit a total of 60 mW of infrared energy at a wavelength of 932 nm—"enough power to saturate an average-size living room," notes Horst Ankerman, Sennheiser's Vice-president of Engineering. "And out of doors, the line-of-sight range is about 70 feet," he adds. Moreover, transmitters can be daisy-chained together to accommodate areas larger than a living room.

Individual volume controls are provided for each earpiece, as well as facilities for selecting monaural-left, monaural-right or stereo modes.

The headphone operates from a 9-V, 400 mA-hr battery. While designed primarily for high-fidelity audio, the infrared headphone is also expected to find use in telephone switchboards, airplane cockpits, military-communication networks and drive-in movies. The cordless headphone costs \$209, the transmitter \$184.

Mini systems group upgraded by Honeywell

The 6/30 group of minicomputer systems, developed by Honeywell for commercial, OEM and scientific applications, has been upgraded in terms of speed, memory-access capability and new peripherals into an upward-compatible 6/40 group.

One version of the new mini family announced by Honeywell Information Systems, Waltham, MA—the 6/43—has a processor speed some 30% faster than its 6/36 predecessor. A second version of the 6/43 incorporates what is termed "double-word-access" to make it 60% faster than the 6/36.

The double-word-access feature permits fetching 32 bits at a time, instead of the usual 16. Consequently, 32-bit minicomputer speed

is provided for the lower price of a 16-bit system.

The 6/43 systems are also capable of addressing up to 1-million 16-bit words of memory. The largest previous memory was 64-k words. The words are addressed directly, but addressing through memory management is an option.

A new scientific instruction processor added to the 6/40 group permits a Fortran mix to be run on a 6/43 three times faster than it would run on the 6/36.

New peripherals for the 6/43 include a magnetic tape and printer.

CIRCLE NO. 319

X-band radar receiver has everything but bulk

An X-band radar receiver for fighter aircraft and guided missiles weighs only 12 ounces and is about one-tenth the size of conventional radar receivers.

Developed by the Air Force Avionics Laboratory, Wright-Patterson AFB, OH, the receiver uses microwave integrated-circuit technology for its small size (3 in. \times

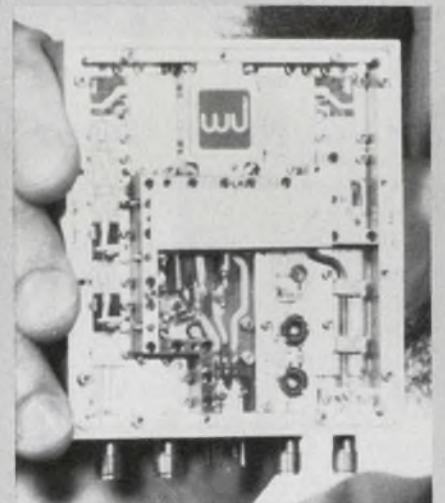

X-band radar receiver for aircraft and missiles weighs 12 ounces.

3 in. \times 3/4 in.) and gallium arsenide FETs for its good performance. The receiver boasts a noise figure of 4.5 dB, a frequency range of 9 to 10 GHz, an rf to i-f gain of 30 dB, and a gain-adjustment range of 15 dB.

Major components include a low-noise rf preamplifier, image-rejection mixer, intermediate-frequency

preamplifier, bias electronics and voltage-tuned local oscillators.

Five brassboard models now being tested by the Air Force were built by Watkins-Johnson, Palo Alto, CA.

International standards set for fiber optics

To take the uncertainties out of telecommunication systems designed with fiber-optic components, international standards for the increasingly popular, but up to now unpredictable, conduits will be established later this year. The proposal to set standards in a field where no recognized national or international standards exist (ED No. 1, Jan. 4, 1977, p. 54) comes from the U. S. National Committee of the International Electro-technical Commission (IEC).

The plan was approved by the IEC's Advisory Committee on Electronics and Telecommunications at a meeting in Geneva in late 1976. Standards are needed, the committee agreed, to cover

- Physical and electrical characteristics of fiber-optic cables, such as light and signal transmission, splicing and joining and termination;

- Connectors for fiber-optic cables;

- Light sources and other signal input means;

- Detectors and other signal receiving means;

- Electrical, mechanical and environmental test methods and procedures.

How the work will be divided up within the IEC among existing—and possibly newly formed—technical committees will be decided by April 1. The decision will be announced at a commission meeting to be held in Moscow in June.

Digital radio affected by lack of standards

Digital communication by land-mobile radio would draw even more adherents than it's now attracting if communication standards were uniform, according to John Ward, research engineer at the Massachusetts Institute of Technology's Electronic Systems Laboratory, Cambridge, MA.

While attempting to write specs for a Dial-a-Ride bus system for Rochester, NY, Ward surveyed the field of land-mobile radio equipment—with difficulty because of the lack of published data on existing devices—and found little or no consistency among bit rates, message formats, error protection or input-output. Among the seven terminals he studied, bit rates ran from 450 bits/s to 4800 and modulations included FSK, PSK and PASK. The number of display characters ranged from 16 to 256, and character height from 0.125 in. to 0.44 in. Error-detection techniques included parity, redundancy (sending each message twice) and the use of error detection codes. Radio prices ranged from \$1000 to \$3500.

"Every police or transportation organization that would like to go digital must wrestle with the same information-gathering and analysis problem that I did in determining the state-of-the-art and deciding which way to go," Ward says.

Despite the problems, however, many police departments and bus companies are equipping themselves with mobile digital terminals for direct interaction between mobile units and computerized dispatch or data-based systems. "And the trend is accelerating," Ward observes.

Atomic structures are more precise in 3-D

An electro-optical technique that produces three-dimensional pictures of single atoms may be use-

ful in developing, analyzing and fabricating semiconductor materials used for thin-film and large-scale integrated circuitry. Combining the computer generation of holograms with optical (nondigital) computing, the method produces three-dimensional models of the atomic structure of molecules that are clearer and more accurate than models produced by any current method, says Dr. George W. Stroke, creator of the technique and head of the Electro-optical Sciences Laboratory, at the State University of New York at Stony Brook.

First, data are collected from X-ray diffractometers used to obtain dimensions of intermolecular structures. Then this information is digitized and processed to provide a computer-generated hologram—an entirely new type called a "Fourier-domain projection hologram," says Stroke.

The key to the method lies in the unique algorithms used for the holograms' digital generation. The digital data are transferred to a film by means of a digitally controlled plotter. The film contains a Fourier-domain projection hologram of a cross-section of a molecule under investigation.

Finally, the 3-D atomic images are produced by a laser beam passed through the hologram and through a special optical-computing transform lens. These images are magnified to provide spots that tell the researchers of the precise position of the atoms.

Until now, Stroke points out, workers have been unable to view these three-dimensional structures directly.

News Briefs

An arithmetic processing circuit, intended to reduce μ P calculation time, is currently planned for mid-1977 introduction by Advanced Micro Devices, Sunnyvale, CA. The NMOS circuit is said to provide trig, inverse trig, logs, square roots, e^x and X^y functions as well as single and double-precision, floating-point arithmetic. **A 12-bit d/a converter, 35 times faster than its pin-compatible equivalent,** has been developed by Harris Semiconductor, Melbourne,

FL. Dubbed the HI-562A, the unit settles in 100 ns maximum and is pin-compatible with the Analog Devices AD532. It's expected to sell for under \$30 apiece in 100-unit quantities.

Combining the flexibility of CMOS with the advantages of ultraviolet erasability, Intersil is coming out with a series of low-power UV PROMs. The circuits will operate from a single supply, and be available in two configurations— $1\text{ k} \times 4$ and 512×8 .

The one variable the world can standardize on.

Our new Type M conductive plastic variable resistor is hard metric. A 10 mm cube that's tiny, flexible and rugged. The MINI-METRIC is the smallest dual pot available today. Manufactured in the United States, it's dimensioned the way the rest of the world thinks. Allen-Bradley has what you need; or, it can be ordered through our distributors. Ask for Publication 5239.

Choices

single or dual pot or pot/switch combinations

100 ohms to 1 megohm

conductive plastic resistance elements, $\pm 20\%$ tolerance, standard resistance values conform to IEC.

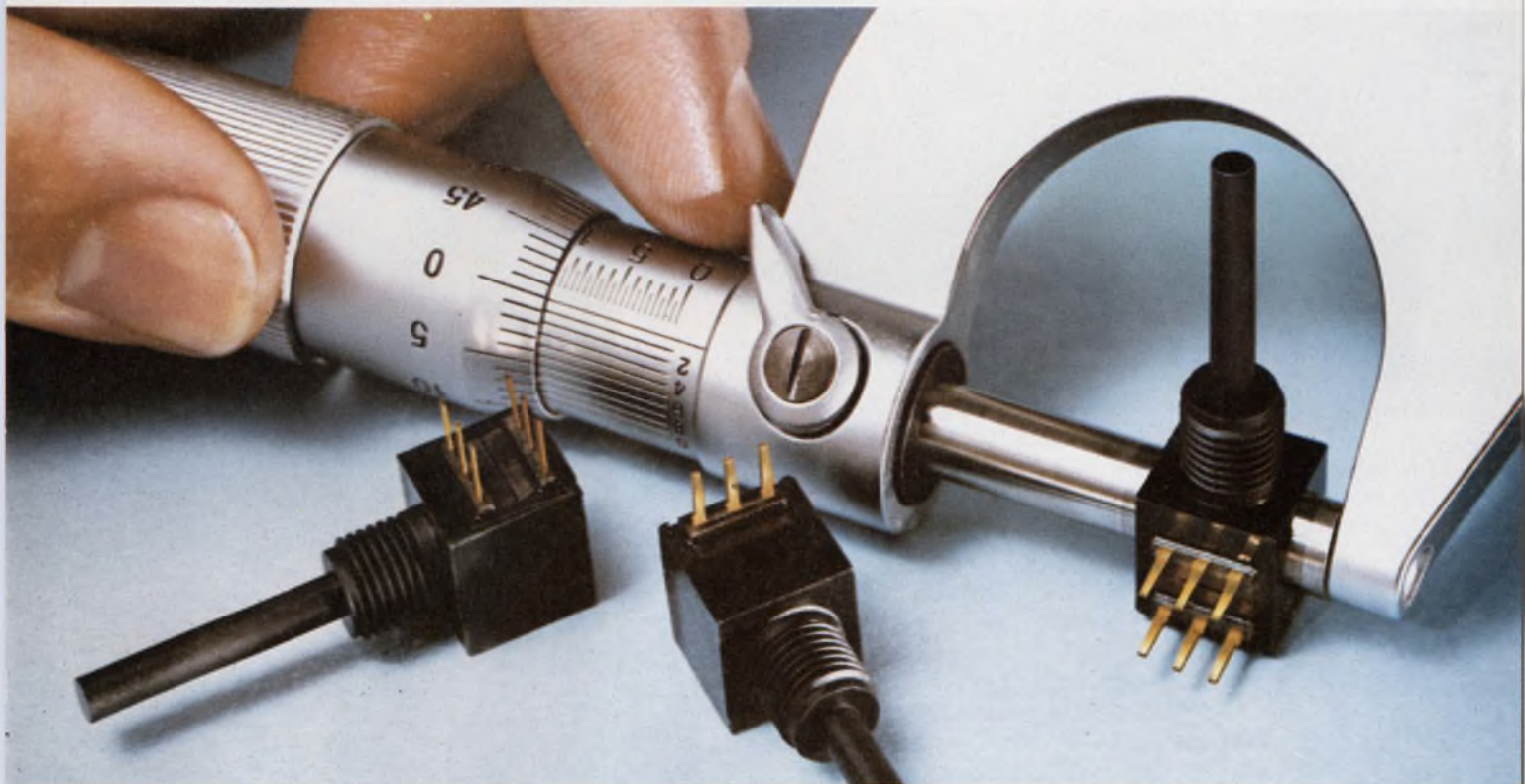
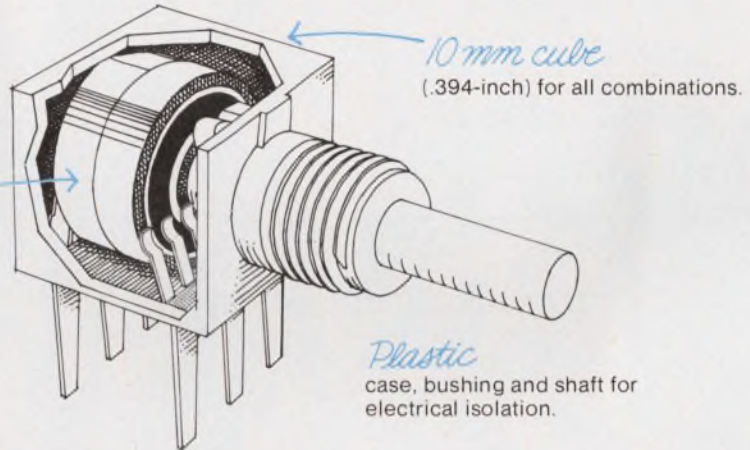

Quality in the best tradition.



ALLEN-BRADLEY
Milwaukee, Wisconsin 53204

CIRCLE NUMBER 75

EC131



0998

00.00 8774

+8688755

43

3.168

STO DEV = 23.63

HP-41C
HANDHELD CALCULATOR
1975
STOPPED BY
FBI
1975

HP computing controllers.

12 reasons why they're ready-made for interfacing.

1. Direct memory access (DMA)
2. Vectored priority interrupt
3. Buffered I/O
4. High-level language
5. Plug-in interface cards
6. High-speed tape cartridge
7. Built-in printer
8. Preprogrammed I/O drivers
9. Keyboard programming
10. 32 character display
11. Live keyboard
12. Editing keys

An HP 9825 computing controller provides minicomputer-like performance in one complete easy-to-interface, easy-to-program, easy-to-use package. I/O is built-in. Software for the operating system, which includes high-level language and I/O drivers, is built-in. Interface cards just plug in. You get a cost-effective solution to instrument interfacing.

I/O cards and simplified programming make interfacing easy. You can choose off-the-shelf interfaces for BCD, bit parallel, bit serial, or HP-IB (HP's implementation of IEEE Standard 488-1975).

For many applications, interfacing can be just this simple. You plug the correct I/O card in the back of the computing controller that fits your needs. Then connect your instrument to the other end of the card. After programming the controller with a few simple commands, your automated system is ready for work.

Vectored priority interrupt, DMA (direct memory access), and buffered I/O allow the 9825 to do multiple interfacing jobs routinely.

The HP 9815 provides low cost interfacing. For applications that don't need interrupt and DMA, the HP 9815

computing controller offers a ready-made solution for data-logging and instrument control. It, too, has a self-contained printer, tape storage, display, easy-to-use language, and integrated keyboard. Auto Start allows your program to begin executing automatically when power is turned on. It provides a lot of performance for its low price.

Improve your system and become more productive. No matter what kinds of instruments you use—scanners, counters, spectrometers, meters, converters, chromatographs, or what have you—an HP computing controller can greatly enhance their performance—now. Find out more. Send for our interfacing brochure today.

*From computers-on-a-board to general-purpose systems,
HP can meet your interfacing needs.*



P.O. Box 301, Loveland, Colorado 80537

For assistance call: Washington (301) 948-6370, Chicago (312) 255-9800, Atlanta (404) 955-1500, Los Angeles (213) 877-1282

CIRCLE NUMBER 12

FOR INFORMATION OEM APPLICATIONS CIRCLE 13

Our fast their half-

RAM vs. fast RAM.

We just can't help feeling that Intel's 1K CMOS RAM doesn't belong in the same ball-park as ours.

Ours is twice as fast as theirs (250 nsec.).

And uses only one-tenth the power (50 μ w.).

It comes in two configurations and three packages. And is being second-sourced with pin-compatible products.

It's up to you.

A fast RAM.

Or a you-know-what RAM.

National Semiconductor Corporation
2900 Semiconductor Drive, Santa Clara, CA 95051

Gentlemen,

Please send me further information fast on your fast 1K CMOS RAM. I'm interested in:

- MM54C920, MM74C920 (256 x 4, 22-pin)
- MM54C921, MM74C921 (256 x 4, 18-pin)
- MM54C929, MM74C929 (1K x 1, 16-pin)
- MM54C930, MM74C930 (1K x 1, 18-pin)

(54 series numbers are military temperature, range, 74 series are commercial.)

- Other CMOS RAMs _____
- Other Memory Components _____

NAME _____ TITLE _____

COMPANY _____

ADDRESS _____

CITY _____ STATE _____ ZIP _____

 **National Semiconductor**

Charge-coupled approach leads to new LSI digital logic devices

Major advances in charge-coupled device (CCD) technology are producing new kinds of digital devices, a new kind of memory and very high packing densities in large-scale CCD chips.

The development of LSI digital logic devices, including 16 and 32-bit adders and 8 and 16-bit multipliers, was reported at the International Electron Devices Meeting held in Washington, DC.

The digital CCD approach produces devices with very low fabrication cost, high chip density, and low power requirements, says R. A. Allen, researcher with TRW's Defense and Space Systems Group in Redondo Beach, CA.

The CCD is one of the simplest processes available to produce LSI digital logic devices, Allen points out. "Currently we're using only five masks. The first mask cuts the channel, the second and third masks are for polysilicon layers and there is a fourth mask for etching and a fifth for metal cutting."

Digital CCD technology has inherently high density because of four layers of interconnection. The first layer is formed by a silicon substrate, which acts as a ground plane. Signal flow runs along channels below the silicon surface.

Two levels of polysilicon that are insulated from each other can be used as cross-overs and to interconnect electrodes within logic cells. The fourth level, a single layer of metal, forms the bus lines from the clock phase.

It's got low power dissipation

The power dissipated in a digital CCD is due solely to the ac clock—

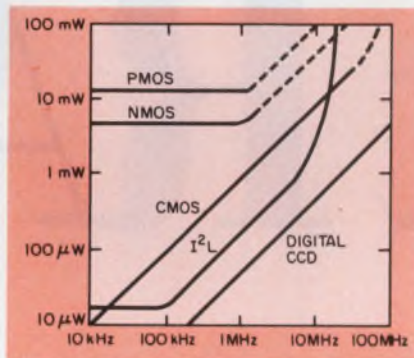

1. Digital CCDs have a lower power dissipation than other comparable full-adder technologies.

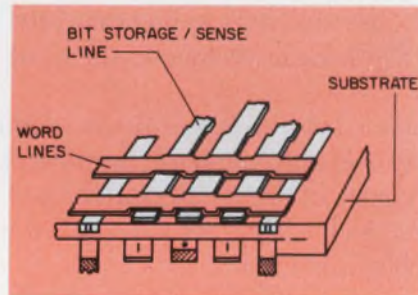

2. The merged-charge memory is fabricated with a wave of polysilicon bit lines crossed with word lines. Bit charge is stored under cross points.

the digital device itself does not require any dc current. For example, digital functions that use a floating gate, such as full adders, require up to five clock phases.

The total power dissipation of five phases for full adders used in an 8-bit \times 8-bit multiplier add up to 49.4 μ W at a clock frequency of 1 MHz. The power dissipation is linear and rises with clock frequency to about 50 mW at 10 MHz (Fig. 1).

Dissipation of the CCD full adder is substantially less than that of the CMOS, PMOS, NMOS, and I²L adders over the full range of clock frequencies. Power comparisons

that involve digital CCDs must be based on a full-adder logic cell. Comparisons made at the single-gate level, which work for comparing the other digital techniques, are meaningless for the digital CCD technique.

Furthermore, comparing the active areas of CCDs and other digital devices for multipliers and adders shows that the CCD has the smallest (see Table).

A principal application of the digital CCD circuitry is expected to be in chips organized to do the complex mathematics of fast Fourier transforms.

"It's the only technology right now with which you can put a fast Fourier transform processor on one chip," Allen says. "You can't do it with CMOS or I²L because of the problems of interconnecting the on-chip elements."

CCD structure makes new RAM

CCD memories are devices in which data must be accessed in a serial string of bits. They are totally unlike MOS random-access memories (RAMs) in which the data in a single bit-cell can be accessed. But CCD technology has now been used by IBM to fabricate a new kind of RAM—one with a simplified structure that dispenses with these "indispensable" FET-transistor memory cells in which the individual bit data are stored.

This type of memory has two major advantages, according to W. D. Pricer, senior engineer at IBM System Products Division, Essex Junction, VT. One is a potentially low cost for large-scale arrays. Another is a high tolerance for misregistration of the masks used to lay down the memory's micron-sized lines and elements.

Registration can be off substantially and still produce good memo-

The most significant price breakthrough in DOUBLE-BALANCED MIXERS!

...from Mini-Circuits of course!

\$2.95
500 pieces
\$3.95 (10-49)



Model SBL-1

For demanding industrial and commercial applications, where low cost and high performance are critical, model SBL-1 will fill your need.

Don't let the low price mislead you. As the world's number one supplier of double-balanced mixers, Mini-Circuits' has accumulated extensive experience in high-volume production and testing, a key factor in achieving a successful low cost/high performance line of products.

The tough SBL-1 covers the broad frequency range of 1-500 MHz with 6 dB conversion loss and isolation greater than 40 dB. Only well-matched, hot-carrier diodes and ruggedly constructed transmission-line transformers are used. Internally, every component is bonded to the header and metal case for excellent protection against shock, vibration and acceleration.

Here are some of the steps taken to ensure quality: Every SBL-1 is RF tested four times, every solder connection is 100 per cent inspected under a high power microscope, all transformer leads are double-wrapped, and all components are rated for more than +100 C operation. Of course, our one-year guarantee applies to these units.

Frequency Range, MHz		Typ.		Max.	
LO	RF	IF	OC	500	
Conversion Loss, dB		Typ.		Max.	
One Octave from Band Edge		5.5	7.5		
Total Range		6.5	8.5		
Isolation, dB		Typ.		Min.	
Lower Band Edge to LO-RF		50	35		
One Decade Higher LO-IF		45	30		
Mid Range LO-RF		45	30		
	LO-IF	40	25		
Upper Band Edge to LO-RF		35	25		
One Octave Lower LO-IF		30	20		
Signal, 1 dB Compression Level +1 dBm					
Impedance, All Ports 50 ohms					
Electronic Attenuation Min (20mA) 3dB					

World's largest manufacturer of Double-Balanced Mixers

Mini-Circuits

MINI-CIRCUITS LABORATORY A Division of Spangco Enterprises, Inc.

837-843 Ullica Avenue, Brooklyn, NY 11203 (212) 342-2500 Int'l Telex 620156 Domestic Telex 125460

INTERNATIONAL REPRESENTATIVES: AUSTRALIA: General Electronic Services, 99 Alexander Street, New South Wales, Australia 2063. ENGLAND: Dore Electronics, Dore House, White Road, Farnley, Gorton, Cambridge, Surrey. FRANCE: S. G. I. E., D. I. M. F. S., 31 Rue Garance, Saint 91120 Palaiseau, France. GERMANY, AUSTRIA, SWITZERLAND: Industrial Electronics GMBH, Hublerstrasse 11, 1000 Frankfurt, Main, Germany. ISRAEL: Vertronics, Ltd., 69 Gordon Street, Tel Aviv, Israel. JAPAN: Denko Kasei, Ltd., Teicho Building 8-1-1 Chomei Hamamabacho Minato-ku Tokyo. EASTERN CANADA: E. O. Bennett, 2224 Mainway Avenue, Ullica, N.Y. 11502 (315) 736-7821. NETHERLANDS, BELGIUM, LUXEMBOURG: Conitex, Wildweg 8, Hatten, Holland. NORWAY: Dalamaik AS, Ostensrommen 62, Oslo 6, Norway.

U.S. DISTRIBUTORS: NORTHERN CALIFORNIA: Carr-White & Co., Toolbill Office Center, 105 Fremont Avenue, Los Altos, CA 94022 (415) 948-0000. SOUTHERN CALIFORNIA, ARIZONA: Crown Electronics, 11440 Collins Street, No. Hollywood, CA 91601 (213) 877-3550.

ry cells, which is not possible with standard RAM fabrication. And because of this tolerance, finer lines can be used. Consequently, the chip density is higher than the RAM's.

"If you look at the structure of the merged charge memory (MEM)," says Pricer, "it looks somewhat like a fly screen, with a wave of polysilicon bit lines aligned in one direction and word lines aligned at right angles to them."

The source and the drain of the FETs have disappeared—merged into the bit lines—and all that's left is the gate and channel underneath the word lines.

The information charge is stored as minority carriers in potential wells under the cross points of the word lines and the polysilicon bit sense/storage (BSS) lines. The storage-potential wells are defined by regions of thin oxide and separated from adjacent wells along the BSS line by intervening areas of thick oxide.

To verify the merged-charge con-

Comparison of active areas, in μm^2 , for adders and multipliers

Technology	Adders		Multipliers	
	16 + 16 bit	32 + 32 bit	8 × 8 bit	16 × 16 bit
CCD	6.19	21.4	5.39	47.1
PMOS	11.3	49.2	12.2	67.7
NMOS	7.78	34.7	7.65	44.2
CMOS	16.5	70.2	19.5	104
I ² L	14.9	64.9	26.2	137

cept, an 8 × 8 array of storage cells was fabricated. In this, each of the polysilicon BSS lines is connected to a reset and a source-follower detection circuit. The array is made with an n-channel, self-aligned gate process using a 2 Ω cm-p type substrate and gate oxide 500 Å thick. The storage area is 65 μm^2 .

While there is no current idea as to how large a memory array can be, the practical limit will

probably be due to the support circuitry, Pricer points out.

"As you make the array larger, the bit signals become weaker. And at some point they will become impossible to detect reliably."

Differentially sensing the complement of the data stored in adjacent potential wells will obtain twin-cell operation that provides twice the signal level of the single-bit sensing and better common-noise rejection. ■■

SSB and vhf-FM radiotelephones highlighted at National Boat Show

Single-sideband and vhf-FM radio-telephones dominated the marine-electronics portion of the 67th National Boat Show last month at the New York Coliseum. Single-sideband types used by ships that venture out more than 25 miles from shore were of particular interest because of the Federal ban, effective since Jan. 1, on the use of AM shipboard transceivers.

"Since boaters are forced by Federal law to buy SSBs whether they want to or not, they probably don't want to spend much money," says Luis Maldonado, project engineer for radiotelephones and depth sounders at Raytheon's Marine Division, Manchester, NH. "We got the cost down by trying to simplify circuitry and by reducing the number of components."

So, functional integration has been used wherever possible. An i-f amplifier, for example, serves as both transmitter and receiver. The result: Ray-1210, which is smaller than its predecessor, the 1209, and

sells for \$750. It provides eight channels.

"The smallest single-sideband radio in the country" comes from General Aviation Electronics, Indianapolis. Built originally to fit into an aircraft panel, the GBS/1000 measures 6 by 2-1/2 by 10-1/2 in. It provides 10 channels that operate from 2 to 9 MHz.

How was it built so small?

"For one thing," says designer Lowell Atkinson, "we tune the filter with a miniature variable resistor, which supplies voltage to varactor diodes. The resistors replace bulky plug-in components."

The SSB radio provides a 50- Ω output impedance for use with 50- Ω trap antennas. A companion antenna coupler is available (for \$290) for use with other antennas.

A triple-threat transceiver

A new marine vhf-FM transceiver offered by SBE, Inc., in Watsonville, CA, provides a triple-

function metering system that can read incoming S units of received signal, actual output power and precise check of input voltage of the ship's battery.

A vhf-FM synthesized radio telephone showed by Apelco, Manchester, NH, has 56 frequencies for transmitting and 99 for receiving. A two-channel scanning circuit enables the radio (AF-40MA) to monitor automatically the distress and calling frequency, channel 16, which must be monitored by law, and a channel chosen by the operator.

In addition to a line of radio-telephones displayed by SGC in Bellevue, WA, an antenna coupler was featured that enables one technician to match SSB units to a variety of antenna systems in a matter of minutes. Called Model ASU, it also features a servo tracking system that monitors the standing wave ratio at the radio-telephone and compensates for environmental changes. ■■

You get variety, unique design, economy and more when you specify AMP's DIP sockets.

You get more performance.

And that's what all the features of AMP's DIP and microprocessor sockets add up to.

Take variety. You can choose from standard and low profile housings, a wide range of sizes, tin or gold plated contacts, in widths of .300", .400" or .600". And that's only the beginning.

There's design and economy. DIP socket contacts include a unique retention feature. It makes sure that every socket you insert into a pc board will stay there, even during the soldering process.

The design also prevents solder wicking problems. And with AMP automatic insertion equipment,

the sockets can be installed at rates to meet your production needs.

And don't forget AMP's solid backup. You can count on it with the kind of personal attention your product line deserves.

So why not get AMP quality when you need DIP and microprocessor sockets. Just call Customer Service at (717) 564-0100. Or write AMP Incorporated, Harrisburg, PA 17105.

AMP

INCORPORATED

CIRCLE NUMBER 15

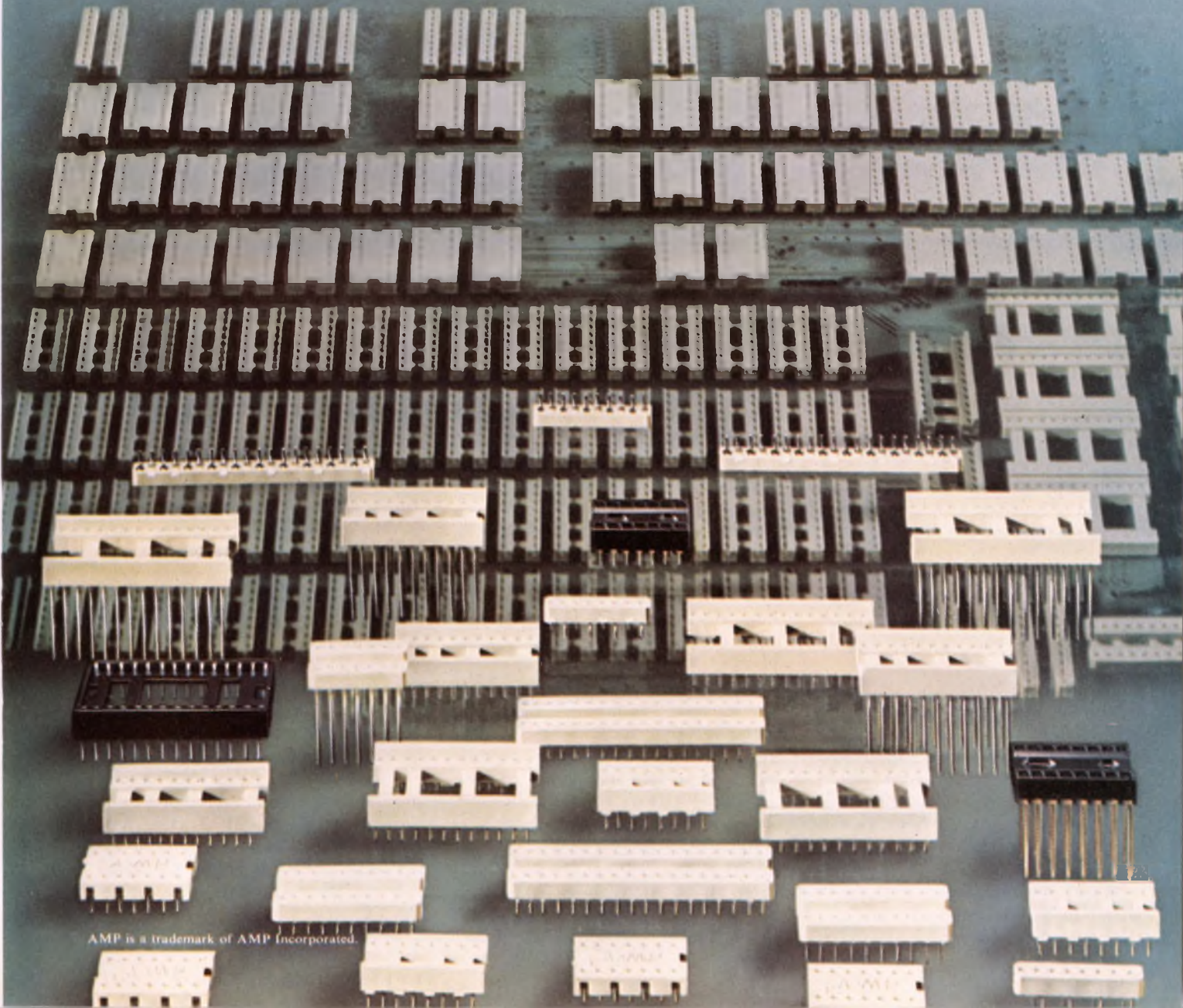

AMP is a trademark of AMP Incorporated.

Bipolar processor in TV set leads to preprogrammed channel selection

Three TV-receiver design innovations will make viewing Heathkit's new 25-in. color TV—the GR-2001—a snap. One development from the Benton Harbor, MI, company, a computerized TV programming system, can change pre-selected channels as many as 32 times automatically—within two 12 or two 24-hour periods. Another, an electronically controlled antenna-rotator system, automatically turns the antenna in the direction of a TV channel selected by the programmer or the viewer. A third innovation, a phase-locked-loop oscillator for the vertical-sweep circuits, eliminates the vertical-hold control.

The programmer is a 60-chip bipolar processor designed in-house. It interfaces with a digital clock, a digitally controlled 16-channel (optionally 24) varactor tuning system, on screen displays of time and channel numbers, and front-panel data-entry keyboards.

Bipolar best for programmer

The programmer is designed around TTL logic chips, according to Steve Barton, the engineer who created it. Most of the logic is low-power Schottky, but a few standard TTL and CMOS devices are incorporated along with a 256 × 4 bit NMOS program RAM, Barton notes.

Standard microprocessors, such as the 8080 and 6800 had been considered for use in the programmer but rejected because of their low speeds. And bit-slice μ Ps would have been too expensive. The programmer had to be designed to sell for \$170 as a TV-kit option, Barton explains.

Moreover, the system interfaces with on-screen display circuits that operate at too high a speed for

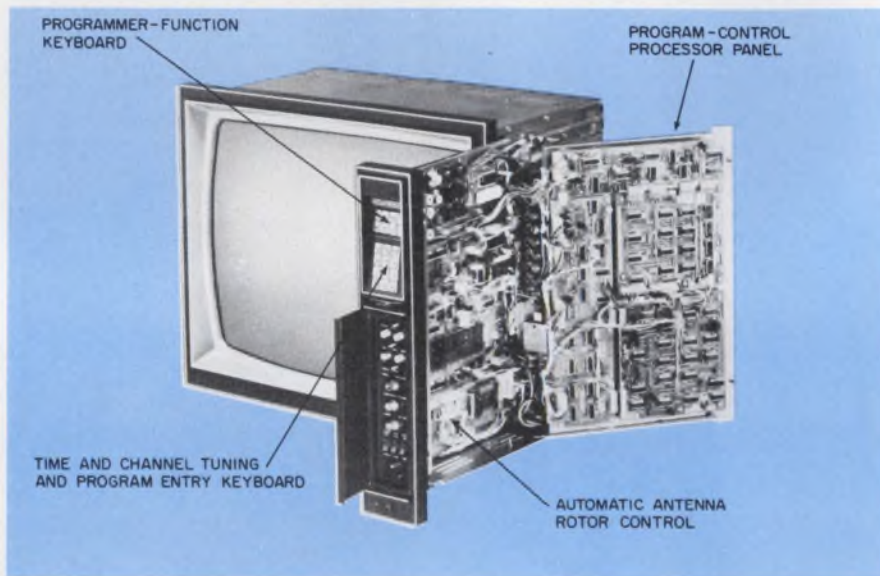

A bipolar processor in this color TV permits the viewer to program the Heathkit set for up to 32 automatic channel changes in two days of viewing. An automatic antenna rotator turns the antenna as channels switch.

the standard NMOS microprocessors. Four-bit slices would have been fast enough, Barton concedes, but the cost of the necessary support circuits makes the price prohibitive for this application.

The desired time and channel number sequences are entered into the processor through two keyboards—an eight-button programmer-function unit and a 12-button numerical keyboard used also for random-access manual tuning (see photo).

The numerical keyboard entries are converted to binary-coded decimals, and the processor stores time and channel data as eight-bit words in the RAM. Each word corresponds to two decimal digits.

One set of 256 bits stores the hours (12 or 24), a second set the minutes, and a third set the channel numbers (2 through 83).

The TV programmer operates in three modes: manual, program-

control and memory-access. In manual, a channel can be changed with the 0 to 9 numerical and channel up and down keys. In the program-control mode, automatic channel changes are dictated by the times and channels stored in the RAM. In the memory-access mode (used for programming), the times and corresponding channels are entered into the memory by means of the digit keys and the programmer-function keys. These are: MC (memory cycle), T (time), CH (channel), E/R (enter-read) and CL (clear). During memory-access, time and channel are displayed on-screen continuously.

Three shift registers—hour, minute and channel-number—temporarily store the BCD time and channel data. Time is entered by depressing the T key, and the channel number is stored by pressing the CH key.

Shift-register outputs are con-

If you're considering a LOGIC ANALYZER or DATA GENERATOR, see the one that's both



It's a DIGITESTER...3 digital test instruments in 1.

Here are 3 ways you can use a DIGITESTER to reduce your digital logic design costs

INITIAL DESIGN...
It's a DATA/WORD GENERATOR



Generate 1024 serial bits to help you develop your communication products.



Generate up to 64, 16 bit words parallel so you can test your interfaces.

The DIGITESTER Model 777 is the most valuable test instrument you can get for developing or testing digital logic products...including microprocessors.

To begin with, no other test instrument is quite like the DIGITESTER. It offers you unequalled flexibility for simultaneous or independent logic generating, logic receiving/analysis or comparison. Programs are stored in 1 of 4 internal memories, ready for transfer at variable data rates up to 20 MHz, internally or externally controlled.

TROUBLESHOOTING...
It's a LOGIC ANALYZER



Serial look forward—look back lets you see to 1023 bits on either side of Trigger Point.

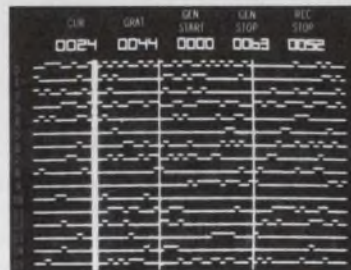

Parallel look forward—look back. Check "fault" symptoms on both sides of selected pattern.

You can generate any program with any number of "1" or "0" bits, by using the integral scratch pad keyboard...or an external source if you prefer.

Data is displayed jitter-free, on a 5" CRT. Cursor, graticule, generator start, generate stop and receive stop positions are numerically displayed on the CRT.

Of course the DIGITESTER has all front panel controls needed to make digital development and test work fast, easy and accurate.

TEST/RECEIVING INSPECTION...
It's a DATA COMPARATOR

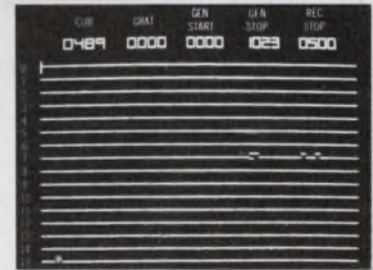

Compare serial response with known program in memory and see disagreement appear.

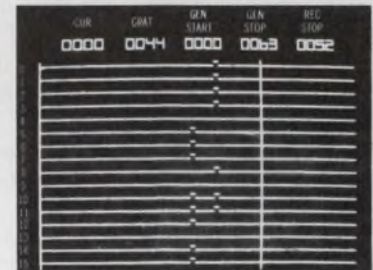

Compare input data with expected pattern in memory and see errors as difference bits.

You get 3 precision instruments in 1 with exceptional versatility for \$9495.00.

Contact the factory or your local Moxon sales engineer to find out about all the DIGITESTER'S capabilities and discover the savings you'll accrue compared to home-built pattern generators... plus you'll have the added savings of a logic scope. The DIGITESTER can pay for itself in a year. So be sure you see the DIGITESTER...it's the only one that's both a Logic Analyzer and Data Generator.



MOXON INC. • 2222 Michelson Drive • Irvine, California 92715 • Phone: (714) 833-2000 • TWX: 910-596-1362

CIRCLE NUMBER 16

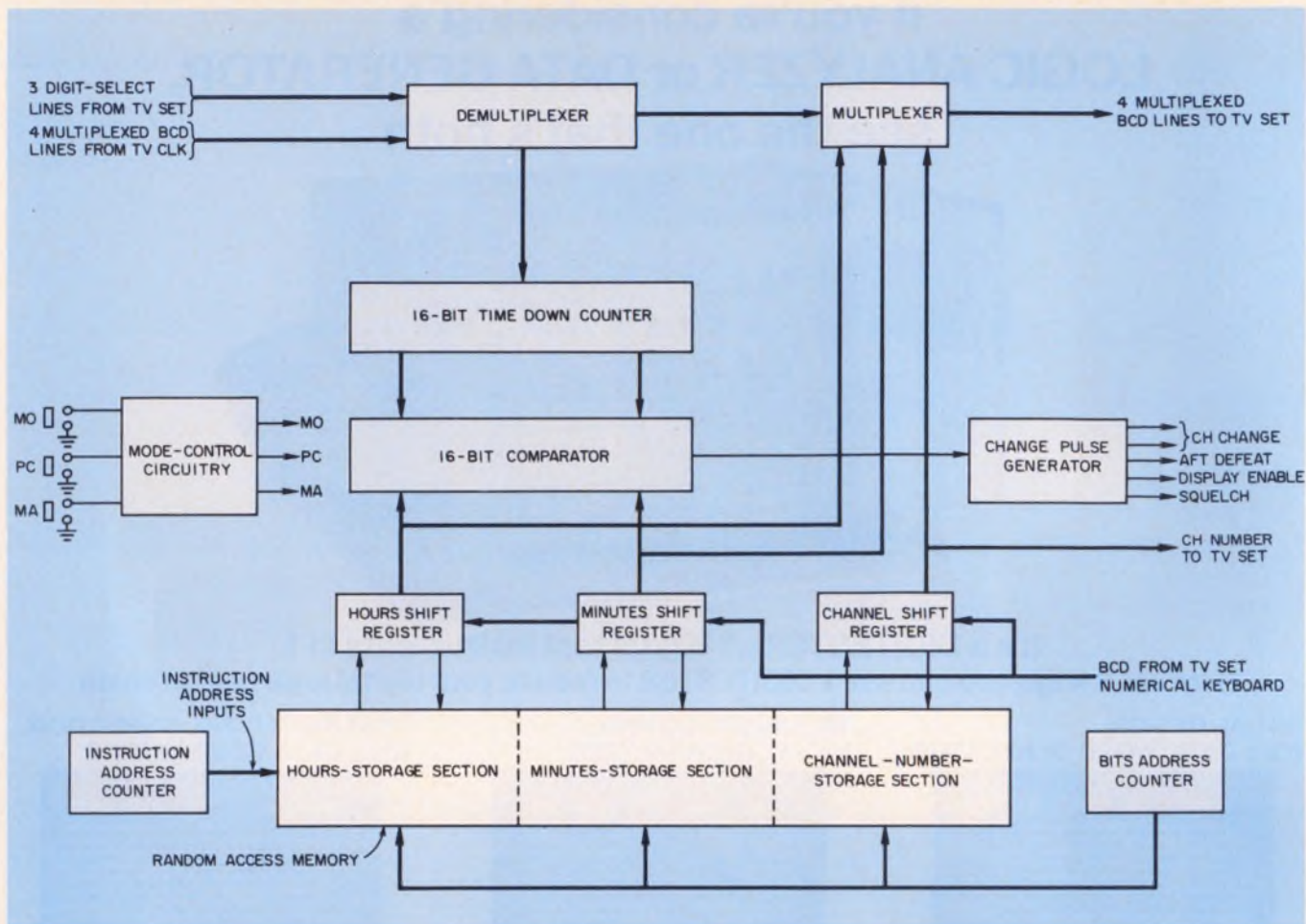

BCD inputs from manual keyboards and a digital clock are stored in a RAM for automatic TV channel changes

at the present times. The stored time is compared with the real time once each minute.

nected to a multiplex circuit with outputs that are sent to the on-screen display circuitry in the TV set. The register information is displayed instead of the actual time from the TV clock.

The hour, minute and channel data from the registers are also entered into the RAM.

In the programmer-control mode, the BCD time data from the TV clock is demultiplexed. When a change in the minutes-digit is detected, the actual time in BCD hours and minutes is loaded into a 16-bit time down counter.

The time in the down counter is compared to the programmed time and if they aren't equal the comparison is continued on a minute-by-minute basis until they are. At that instant, a channel change is signalled by the generation of a change-channel pulse and the transfer of a BCD channel number to the electronic tuning-control system.

In the tuning-control circuitry, the BCD is converted to digital

notation that directly controls the channel selection and sends the channel data to the automatic rotator-control circuitry.

Rotator directs channels

The rotator can point the antenna in up to eight preset directions—within 360°—that are controlled by direction potentiometers. Three TV channels can be connected to each of eight potentiometers.

Whenever a channel change is made, either manually or by program, one of the antenna-rotator position potentiometers is switched into the circuit through a diode network. At the same time, the TV set supplies a start pulse to apply power to the rotator.

The desired rotator position corresponds to the dc voltage from the potentiometer, which is fed to an input of a comparator IC. The other comparator input is the actual rotator-position voltage coming from the potentiometer in the rotator assembly.

The comparator output controls a relay that determines the direction of rotation. When the actual rotator-position voltage is equal to the voltage from the rotator, the comparator output changes and removes power from the rotator.

PLL controls vertical hold

Phase-locked loop control of horizontal sweep synchronization has been around for years, but not vertical control. Until now, that is. After examining other control schemes—such as digital-count-down—Heathkit designers settled on a PLL system to control vertical synchronization.

"The problem with digital count-down," notes Barton, "is that the set won't stay in vertical sync if a nonstandard signal is being received."

Sources of these nonstandard signals include locally generated signals on cable TV and signals from videotape recorders, some of which are slightly off frequency. ■■

TI introduces the Face Gripper.

A black and white photograph of a hand holding a dual-in-line socket component. The hand is positioned in the lower-left quadrant, with fingers gripping the component. The component is a long, narrow strip with two rows of pins along its length. The background is dark, making the hand and the component stand out.

TI, the world leader in dual-in-line sockets, brings you a new version of an old idea: Face Grip Sockets. Tin or gold contact surface, extremely reliable, redundant contact points, chamfered entry design, low insertion force, high retention, built-in anti-wicking feature, U.L. approved 94V-O insulator material, 8 to 40 position availability, and priced to sell. Which means we now can offer you a full line of dual-in-line wire wrap and solder tail sockets for your next application. For free samples of our new Face Gripper,* specs and literature, write to Texas Instruments Incorporated, Mail Station W-1, Attleboro, MA 02703. Or call Connector Systems Marketing, (617) 222-2800, Ext. 268 or 269.

*Patent Pending

TEXAS INSTRUMENTS
INCORPORATED
CIRCLE NUMBER 17

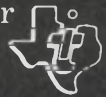

MOTOROLA OMNIBUS



Rollin' along the routes to right design.

What a dummy . . .

Whoever said all solid-state varactor-tuned AM/FM receivers weren't practical?



Must have been a competitor.

Motorola's got the smarts, the reputation, the technology and—for the first time in the industry—state-of-the-art single AM varactor diodes, the MVAM115/125!

Now you can bring to reality all those long-awaited, all-solid-state AM/FM receivers with the '115/125 plus our already existing FM varactors.

The '115/125 can be ordered in matched sets ($\pm 1.5\%$ or 1 pF, whichever is greater) over the entire tuning range allowing flexibility for optimum circuit layout and performance.

The MVAM115 features 1- to 15-V tuning range, the '125 at 1- to 25-V range. Both offer state-of-the-art minimum capacitance ratio of 15 and 500 pF typical capacitance at 1 V.

More Motorola smarts include ion implant, ensuring guaranteed matching over the entire C-V curve and the most intelligent move of all—low price. Just \$1.00 for the '115 and \$1.10 for the '125, 100-up.

Get educated on the MVAM115/125. Send for data, design 'em in and then watch what people say about you. What a genius!

MOSFET, JFET,

Motorola's got the most in FETs and here are 3 more series . . .

. . . just to prove the point. We didn't even have to come up with the 3N211, 12, 13 or the U308, 9, 10 or the J308, 9, 10 to prove the point. No, indeed.

While others lay claim to only one or two FET technologies, Motorola has four: JFETs, single-gate MOSFETs, dual-gate MOSFETs and DMOSFETs. Most are offered in plastic or metal packaging. For use in *all kinds* of industries, like communications and consumer and industrial.

The 3N211 series is a prime example of turning technology into household words in the consumer/communications field. That means popular performance at popular prices, friends.

This is a high-performance series for VHF/IF amplifiers/mixers with high Y_{fs} and characterized at 45 and 200 MHz. The '211 and '213 have high power gain of 33 dB typ @ 45 MHz and the '212 offers high 25 dB typ conversion gain.

The U- and J-series are two popular JFETs offering performance through 512 MHz and rated for communication receiver design. Both furnish high gain—11 dB typ @ 450 MHz and 16 dB typ @ 100 MHz, respectively—and low noise—3 and 1.5 dB typ at their rated frequencies.

Popular 100-up pricing for these household words is like this: 85¢ and 90¢ for the 3N-types . . . \$1.35 to \$1.55 for the U-series and 45¢ to 53¢ for the J-types.

Give us your call or your order for these or any other type of FET. We'll give you back satisfaction. For sure.



Target: One bulletproof 60-W, 470-MHz RF device

The way to shoot holes in any landmobile RF transistor is to give it 100% worst-case conditions like high line at 16 V with 50% over drive into a 20:1 VSWR.

Zap most of them and you've got zip. Not so with MRF648.

This off-the-shelf 60-W unit is rugged in the full sense of the word.

Because you get a device correctly tested under real-use conditions *exactly* like the above . . . conditions fatal to less armored types.

It's all fully verified by IR scan on our QC rifle range.

The units furnish Controlled Q* technology with computer-designed, internal matching networks maximizing bandwidth and ensuring easier circuit design.

Specs include 4.8 min dB gain and 60% efficiency with series-equivalent large-signal impedance parameters.

If you want more detailed reports we'll shoot our mouth off on the data sheet.

*Trademark of Motorola Inc.

Things that run long and hard . . .

Run better with 3N-Registered Bridges

You deserve a better bridge, right? You just found it.

For just two-bits† you can get a 3N-registered single phase, full-wave bridge that withstands MIL and Motorola quality standards others surrender to unconditionally.

Like 1,000 HTRB at 600 V, 150°C ambient with no failures. Or 5,000 cycles of power cycling at 2.2 A (10% over rated current) with a ΔT_j of 100°C and no failures. Or 1,000 hours of high-temperature storage with no failures. Or solder heat, solderability and moisture resistance to MIL-S-19500/202B and /202D with no failures.

Like 1% AQL. And on. And on. And on. With no failures.

Even UL recognizes them. And you know how *they* are.

Electrically the 3N246/253 series is a 1- and 2-A, 50- to 1,000-V family with 30-A and 60-A surge capability with the 2-A units operating to +165°C T_j .

Physically, their slimline cases save much board space.

Economically, their aggressive prices will give any bridge a run for its money.

Our volume production is running long and hard to give you what you deserve in a bridge—top quality at a low price.

And you can't beat that.

†1 A, 50 V unit, 25,000-up.

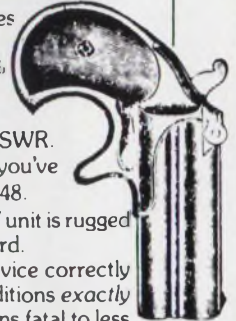

Switch bus routes with Schottky Three-State



Multiprocessor applications allow increased information throughput and greater flexibility than simpler MPU configurations.

With these systems, however, comes a requirement for switching bi-directional data to either of two or more ports. The MC6881/MC3449 switch performs bus routing.

A single 5-V supply is used and it's even possible to place all input/output nodes in high impedance state. Both driver and receiver are short-circuit protected.

You can visualize the unit as three single-pole, double-throw switches with center OFF positions. Thus, data can be transferred to either of two selected ports or neither of them. And the direction of data flow is selectable with a logic controlled input.

The Schottky Three-State logic implementation guarantees the OFF-state nodes will present minimal loading to respective bus lines and logic inputs will not significantly load the bus.

Use it for shared memory and data bus multiplexing, too. It's MOS- and 74LS-compatible.

All aboard with MC6881/MC3449.

Low-cost



mask-programmable 2708 alternatives.

EPROMs are the greatest when that's what you really need. We recommend our MCM68708, being introduced this month. However, lots of people are going the whole hog with EPROMs where less expensive mask programmable ROMs will do every bit as well. You needn't ever be caught in that bind again. Motorola supplies four mask programmable alternatives, two 8Ks with the 2708 pin-outs and two 16Ks with nearly identical pin-outs.

The MCM65308 is a low-cost metal gate ROM for systems that already require three power supplies, and an access time that's actually much faster than the 350 ns printed on the data sheet. The other 8K is the silicon-gate MCM68308, a depletion load, high-performance ROM requiring only a single 5-V supply.

Put 16K of ROM where only 8K fit before with the metal-gate MCM68317 for lowest cost in systems already designed for three supplies, or the silicon-gate MCM68316E for single supply, extended temperature range applications.

All four ROMs are available with fast turnaround from authorized Motorola distributors and Motorola sales offices.

In a pinch with globtops?

Don't get burned or something fiddling with those expensive, single-sourced, TO-105 and TO-106 globtops.

Get pennypinching Motorola TO-92s and squeeze out:

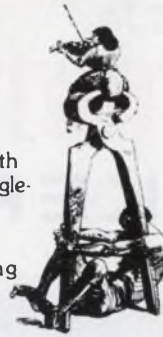

- Another source**—Motorola volume eliminates sole-source strangulation.
- More milliwatts**—Motorola TO-92s stretch out to 625 mW.
- Expanded reliability**—Motorola chips run cooler, Motorola TO-92s are more hermetic.
- Cost contractions**—Motorola is the plastic transistor price leader. See? . . .

Motorola drop-in

Motorola drop-in	Price 100-999 c
MPS3563-18	18
MPS3565-18	16
MPS3566-5	18
MPS3567-5	16
MPS3568-5	19
MPS3569-5	19
MPS3638A-5	21
MPS3640-18	19
MPS3646-18	18
MPS4248-18	16
MPS4249-18	19
MPS4250-18	22
MPS4258-18	23
MPS4275-18	18
MPS4355-5	26
MPS5133-18	13
MPS5134-18	14
MPS5135-5	13
MPS5138-18	13

Motorola knows you won't take getting pinched sitting down.

(Coupon Missing?) Send inquiries to Department LDC Motorola Semiconductor P.O. Box 20912 Phoenix, AZ 85036

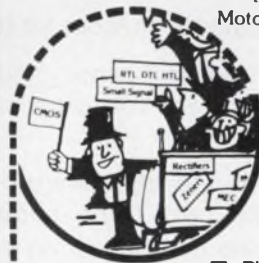

ALL ABOARD!

For complete product itineraries, fill out and send to: Motorola Semiconductor, Box 20912, Phoenix, AZ 85036

Please have salesman call () _____

Name _____ Title _____

Company _____ Address _____

City _____ State _____ Zip _____

- | | |
|---|--|
| <input type="checkbox"/> MRF648 Amplifier | <input type="checkbox"/> MVAM115/125 Tuning Diodes |
| <input type="checkbox"/> 3N246/253 Bridges | <input type="checkbox"/> MC6881/3449 Bus Switch |
| <input type="checkbox"/> MC1458/4558 Op Amps | <input type="checkbox"/> 3N211/U308/J308 FETs |
| <input type="checkbox"/> MPS - Globtop Subs | <input type="checkbox"/> MCM65308/68308/68316E/65317 PROMs |
| <input type="checkbox"/> AN-766, "A Variable Frequency Control for 3Ø Induction Motors" Application Note. | |

Strike Up A Wideband '1458!



76 trombones and one MC4558 lead the big parade to higher frequency performance in existing op amp designs!

This dual op amp plugs right into existing standard '1458 sockets with the same performance and then some: 2.5 MHz unity gain bandwidth . . . high common-mode input voltage range and the absence of latch-up . . . internal compensation . . . short-circuit protection . . . gain and phase match between amps . . . lowest power consumption—135 mW @ 125°C.

No external components are needed for frequency compensation.

Besides providing over 3 times the bandwidth of the '1458, the '4558 is characterized for operation over the full MIL temperature range, -55° to +125°C. The MC4558C will operate from 0° to +70°C.

It's also available in the 8-pin ceramic package (U suffix).

Pricing is fantastically low for this performance:

Commercial	100-up \$
MC4558CG (metal-can)	.95
MC4558CPI (mini-dip)	.80
MC4558CU (ceramic)	.90
Military	
MC4558G (metal-can)	2.20
MC4558U (mini-ceramic)	2.10

A final note. Motorola's fully orchestrated to turn out volumes . . . just give us the downbeat with an order.

introducing:

A MULTI-OUTPUT POWER SUPPLY

KEPCO MPS 620M



Price:
\$475.00

THREE STABILIZED OUTPUTS

0 to 6V d-c @ 5A	Crowbar Protected
0 to +20V d-c @ 1A 0 to -20V d-c @ 1A	Tracking

a convenient bench top power supply offering the voltage/
current combination required for IC's & microprocessors

- FEATURES:**
- 10-turn controls for high resolution control of the 0—6V output and the tracked 20V outputs.
 - Adjustable crowbar for the 0—6V output ... with indicator.
 - Remote error sensing connections on the panel to accommodate a 1 volt drop in the load wires from the 0—6V output.
 - Full range adjustment of voltages and rectangular current limits (not a "slot" supply, no "foldback" current limiting, and no derating to an ambient of +50°C).
 - All three outputs available simultaneously and at full rating.
 - Convection cooled.
 - Two large recessed meters with switch, to monitor voltage and current.
 - Rack mountable in a 5¼" rack space (¾ width).

KEPCO® For complete specifications, write Dept. FM-05

KEPCO, INC. • 131-38 SANFORD AVENUE • FLUSHING, N.Y. 11352 U.S.A. • (212) 461-7000 • TWX # 710-582-2631 • Cable: KEPCOPOWER NEWYORK

CIRCLE NUMBER 19

Washington Report

Military will seek microprocessor standards

Parallel trends toward greater integration of functions on microprocessor chips and more standardization of μ Ps for military applications are on the way, predicts W. A. Clapp of RCA.

Speaking at the Army Microcomputer Seminar held at the Army Electronics Command, Fort Monmouth, NJ, the manager of RCA's Applied Computer Systems Laboratory in Camden forecasts that in five to ten years extrapolation of current technology trends should result in complexities of 50,000 to 100,000 transistors per chip. "This further underlines the necessity for lower-power technologies to keep the chip dissipation around 1/2 watt—an average of 10 microwatts per transistor in the system," Clapp cautions.

De facto standards for microprocessors are already emerging, Clapp observes, because of the popularity of the Intel 8080, RCA 1802 and Motorola 6800. Currently, the military spends more than \$100-million annually for semiconductors, mostly for controllers and dedicated real-time data processing. Moreover, says Clapp, the military is emphasizing requirements for second and third sourcing as well as for full military specifications not only for the microprocessors, but also for memories and I/O devices.

NASA eyes upgrading antennas for Saturn mission

The National Aeronautics and Space Administration is weighing methods of upgrading its Deep Space Network to improve the data returns from the Mariner Jupiter/Saturn flybys.

The problem is getting data back from Saturn, which is farther away from earth than Jupiter, and which will be lower on the horizon when the two Mariner Spacecraft pass the planet in November, 1980 and August, 1981. And most of the scientific data will be returned to earth by X-band, which is sensitive to weather because air moisture attenuates the signal. If the weather is good, say program officials, tracking stations should collect 44.8 kbits/s of data from Saturn during nine hours of daily operation. But if the weather is fair, the stations, located at Goldstone, CA, Melbourne, Australia, and Madrid, Spain, will be operated 20 hours per day to collect 29.9 kbits/s.

Five steps recommended by Dr. Carl Sagan, professor of astronomy at Cornell University and a member of the Mariner scientific team, will increase the station antennas' gain by 5.5 dB and assure adequate data return regardless of the weather; upgrading the 64-m antennas to 70 m for a gain of 0.8 dB; resurfacing the telescopes for the larger antennas to gain another 0.7 dB; optimizing the secondary cones to gain another 0.7 dB;

using the 34-m secondary antennas in phased arrays for another 0.8 dB; and multiplexing different-sized antennas for nonreal time processing—and for another 2.5 dB.

Federal science department plan advances

The on-again, off-again drive for a new Department of Science and Technology is picking up momentum once more as the Carter administration settles into office.

A new cabinet level agency that would combine the functions of the Energy Research and Development Administration and the Federal Energy Administration and abolish the Federal Power Commission was envisioned by Carter during his campaign. Carter's plans are also believed to include folding the National Aeronautics and Space Administration and the National Science Foundation into this agency.

An even more-encompassing plan has been proposed by Rep. Mike McCormack (D-WA), chairman of the House Science and Technology subcommittee on energy and a former Atomic Energy Commission scientist. His goal is a Department of Science, Technology, Energy and Materials. In addition to the forementioned agencies, the new department would take over the Nuclear Regulatory Commission, the National Bureau of Standards, the Environmental Protection Agency, and the science-oriented functions of three existing departments: Interior, Housing and Urban Development and Transportation.

DOD to eliminate some industry paperwork

The Defense Dept. is expected to follow the recommendation of the Commission on Federal paperwork and eliminate its form for contractor requests for progress payments. A position paper adopted by the bipartisan commission last month describes the form—DD 1195—as “lengthy, complex and a costly paperwork burden.”

Government and industry agree that use of the form and a similar one required by the Dept. of Transportation and other civilian Federal agencies, should be discontinued, according to commission chairman Rep. Frank Horton (R-NY). Instead, contractors will use “their normal commercial invoice, with certain minimum information annotated thereon.

“This procedure will suffice for 85% of such invoices submitted,” he adds. “The balance requiring in-depth analysis will be supported by cost detail similar to that furnished for cost-reimbursement contracts.” The estimated savings to industry and government will be \$5 million.

The commission has also recommended that the quarterly progress payment status report—a DOD document usually about 600 pages long—be discontinued.

Capital capsules: The Defense Dept. is requiring that the metric system be used in new weapons systems, only if the use doesn't raise costs. Stipulated in directive 4120.18, the step is considered important for future joint-development programs with other NATO countries, since the U.S. is the only member that doesn't use metric standards for its weapons. . . . Dr. Albert Kelley, dean of the Boston College school of management and former head of NASA's electronics programs, is considered the frontrunner for administrator of the space agency. . . . Hughes Aircraft will study fuels for high-energy laser weapons under a classified contract managed by the Naval Surface Weapons Center. The firm was selected over McDonnell Douglas Astronautics.

Announcing a breakthrough in

FAST PULSE ANALYSIS

A storage oscilloscope that captures 1.4 ns rise time.



FOR TECHNICAL DATA CIRCLE # 101
FOR DEMONSTRATION CIRCLE # 102

Superior Performance. A stored writing speed of 2500 cm/ μ s, enabling you to capture single-shot rise times to 1.4 ns, 3.5 cm high, at full reduced scan amplitude (or 900 ps 2.25 cm high). System bandwidths from 160 to 400 MHz, depending on plug-ins selected. Four storage modes . . . bistable and variable persistence, FAST bistable and FAST variable persistence . . . to cover a wide range of storage applications. Auto-erase for automatic display updating. A save control for 30 times longer viewing. Gated readout, which prevents the blooming that tends to occur between sweeps with nongated readout. Adjustable multi-trace delay for varying the crt view time prior to storing the next sweep when using FAST transfer mode.

4-Compartment Flexibility. Perform more than one measurement at the same time without switching plug-ins. For example, store a single-shot event and simultaneously measure pulse width with a digital counter. Choose from over 30 7000-Series plug-ins for the combination your application requires. The selection includes the 7A19 for full system bandwidth, the 7D11 for digital delay, the 7L5 for spectrum analysis.

Future Expandability. The 7834 represents a breakthrough in oscilloscope technology. It follows the 7633 mainframe which introduced the then-highest stored writing speed of 1000 cm/ μ s. The 7B80 and 7B85 time bases, establishing a convenient delta delay measurement technique. The 7D01 Logic Analyzer and DF1 Formatter transforming the oscilloscope into a logic state—logic timing analyzer with a choice of 5 display modes.

The 7834. For fast pulse analysis in the laser fusion lab. For single-shot or low-rep-rate fast pulse analysis, glitch detection, or ECL logic analysis in digital design. For single-shot fast pulse analysis in destructive and nondestructive component testing. When you buy into the 7000 Series, you're assured of technological advances that help set the pace for the oscilloscope world.

The 7000-Series . . . more than an oscilloscope

For a demonstration or more information, contact your local Field Engineer. Or write Tektronix, Inc., P.O. Box 500, Beaverton, OR 97077. In Europe, write Tektronix Limited, P.O. Box 36, St. Peter Port, Guernsey, Channel Islands.

The ~~one~~ ^{three} and only...

Three Series of Amphenol® connectors are now qualified to MIL-C-26482, MIL-C-38999 and MIL-C-83723.

One company offers connectors qualified to all three specs—Amphenol Connector Systems, Bunker Ramo Corporation.

These three connector series are preferred under military standard MIL-STD-1353A. They're designed for general-purpose and high-density applications in ground-support and airborne equipment.

Polymer retention is a big plus. Each of these Amphenol connectors uses a one-piece, molded polymer retention disc. (It's an advanced design we pioneered. For a closer look at how it works, see the cross-sectional view at lower left.) Polymer retention eliminates as many as 128 troublesome metal clips. And you know the fewer parts there are, the less can go wrong.

To learn more, call or write. Ask about the wide range of shell sizes, insert arrangements and termination tooling available for the Amphenol Connector 118, 418 and 518 Series. And ask for a free catalog, too. Call Vince Pusateri, (312) 986-3761. Or write: Amphenol Connector Systems, Bunker Ramo Corporation, 900 Commerce Drive, Oak Brook, Illinois 60521.

MIL-C-83723/Series III
Amphenol Connector 518 Series

MIL-C-38999/Series I & II
Amphenol Connector 418 Series



MIL-C-26482/Series 2
Amphenol Connector 118 Series

The right idea
at the
right time.

AMPHENOL Connector Systems **BUNKER RAMO**®

Microprocessor Design

Development aids speed SC/MP system prototyping



An LCDS (low-cost development system) and a keyboard kit have been designed to support National Semiconductor's SC/MP microprocessor. The LCDS (right) costs \$499 and comes with a SC/MP CPU card, three auxiliary edge connectors, a 16-key, dual-function keypad, a six-digit LED display and seven control

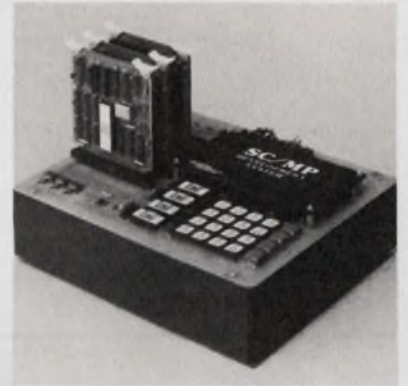

switches. Even lower in cost is the \$95 SC/MP keyboard kit (left), which consists of a hand-held calculator-like keyboard with 6-digit hex display and all components needed to modify a user-supplied SC/MP μ P kit.

The basic LCDS contains all necessary control logic, scratchpad memory and ROM-based
(continued on page 36)

Microprocessors speed driver/dispatcher communications



Lengthy communications between drivers and dispatchers can be minimized with a microprocessor-based fleet-management system developed by Speedcall Corp. of Hayward, CA. A 6800 μ P manages the master control console and decodes all incoming messages from mobile transceivers.



The Speedcall system consists of the control console (Model 916) and mobile encoder/decoders (Model 912). The mobile units use hardwired logic and generate tone-encoded signals whenever one of the panel buttons is pushed or the mike is keyed. The 6800 checks the contents of the incoming messages and displays status information on multiple-digit LED displays.

Since most of the routine communications signals are generated by hardwired logic and the transmissions are decoded at the dispatcher console, all the driver has to do is press buttons for such indications as loading, leaving-plant, arriving-location, unloading and leaving-location. Up to four master consoles can be ganged on the same transceiver frequency, and a command from the console can program the field units to tell them which of the consoles to report to.

Whenever a mobile unit transmits a coded signal and the console receives it, an acknowledgement signal is sent back to light the display corresponding to the depressed button. Each signal transmission consists of a three-digit unit-identification number and a digit code for the status report. Only half a second is needed for normal transmission and acknowledgement. Moreover, the mobile unit can be set to automatically reinitiate any unacknowledged status transmissions up to five times.

MICROPROCESSOR DESIGN

(continued from page 35)

firmware to permit the user to alter SC/MP registers. Memory locations run SC/MP programs in continuous or single-instruction modes and operate a user-supplied teletypewriter. Four prewired 72-pin edge connectors permit expansion via 2-k × 8 RAM cards (\$160) or 4-k × 8 unpopulated ROM/PROM cards.

Built-in control and monitor functions permit control to be transferred between resident firmware and application programs generated by the user. The firmware routines permit the entry of software debug commands.

The keyboard kit comes with assembly and operating manual, all required ICs, passive components and even a wrapping tool for the wire. One of the ICs is a program ROM that replaces the ROM supplied in the SC/MP CPU kit. The calculator-like keyboard and 6-digit display permit the SC/MP to execute programs, modify or examine register and memory contents, and monitor program performance.

National Semiconductor, 2900 Semiconductor Dr., Santa Clara, CA 95051. Hashmukh Patel (408) 737-5000.

CIRCLE NO. 507

Microprocessor-based system functions as μ C or terminal

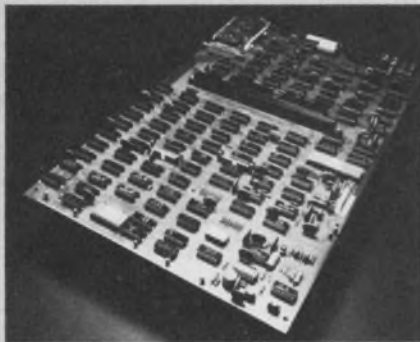

A single PC board can now combine all the circuitry for a microcomputer and/or intelligent terminal. The Sol terminal computer board contains memory, video display, keyboard interface, audio cassette interface and all basic operating software.

Sol can be used as a microcomputer with up to 2 kbytes of ROM, 2 kbytes of RAM and a 1024-point character video display generator. Options include a power supply, video monitor, ASCII keyboard, case, floppy-disc operating system, high-speed paper tape reader, PROM programmer and color-graphics interface.

Since the Sol processor is based on the 8080, memory expansion to 65 kwords is possible. The bus structure is completely compatible with Altair, Imsai and similar microcomputers. The video display signal can deliver 16 lines of 64 characters each and all 96 ASCII upper and lower-case characters as well as 32 selectable control characters. Processor-power requirements are +5 V at 2.5 A, +12 V at 150 mA, and -12 V at 200 mA.

Available as a kit, the Sol processor costs \$475. Delivery takes up to 45 days. *Processor Technology, 6200 Hollis St., Emeryville, CA 94608. (415) 652-8080.*

CIRCLE NO. 508

Microcomputer accessories include printer/plotter and a/d converter

As part of the continuing support for the Altair 8800 series of microcomputers, MITS has introduced four bus-compatible products. One is an electrostatic printer/plotter, and the other three are circuit cards that plug into the motherboard of the Altair.

The printer/plotter, Model 7000, uses 5-in.-wide sensitized paper and forms all displays with a 5 × 7 dot matrix. Vertical resolution is 65 dots/in. and horizontal resolution 128 dots/in., maximum. Up to 120 lines (80 characters each) can be printed every minute. Altair Basic supports three different sizes of character sets to produce 20, 40 or 80 characters in the 4-in.-wide printing area.

Three plug-in cards include a 12-bit analog-to-digital converter, the 88-ADC; a 24 channel multiplexer, the 88-Mux; and a synchronous memory board, the 88-S4K. A buffer amplifier,

an eight-channel multiplexer, a 50- μ s a/d and all addressing logic come on the converter card. The 88-Mux card can be used to replace the eight-channel a/d converter multiplexer and provide 24 channels of analog inputs. The memory board provides 4 kbytes of RAM and has an access time of 200 to 300 ns.

Prices start at \$155 for the kit version of the memory board and range up to \$785 for the printer/plotter. Delivery of all items is 60 days.

MIT S, 2450 Alamo S.E., Albuquerque, NM 87106. (505) 265-7552.

CIRCLE NO. 510

Microcomputer card set includes floppy controller

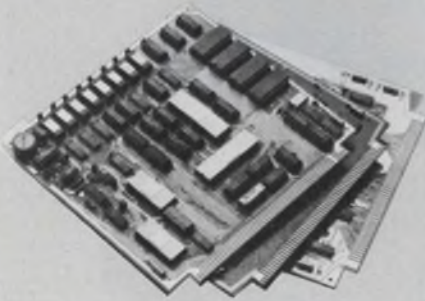

Packing a full CPU, 16 kwords of RAM and a disc controller onto three 7.7 \times 7.5 in. circuit boards, the Z80-based microcomputer card set from Zilog is one of the most powerful available. The CPU has 158 instructions, and the CPU board has enough space to hold 4 kbytes of RAM as well as up to 4 kbytes of ROM or PROM.

Called the MCB, the board also has a serial channel for use by a CRT and two channels for parallel I/O. Up to four floppy discs can be controlled by the MDC disc-controller board, which has 12 kbytes of RAM to

buffer incoming or outgoing data. The memory board, Model RMB, holds 16 k of high-speed RAM.

All boards require only +5 V and interface to the outside world via 122-pin edge connectors. Power is 10 W, maximum, for each card.

Prices for the MCB, MDC and RMB are \$475, \$745 and \$750, respectively, in single-unit quantities. Delivery is 30 to 45 days.

Zilog, 10460 Bubb Rd., Cupertino, CA 95014. (408) 446-4666.

CIRCLE NO. 509

Micro Capsules

A 15-lb attaché-case **EPROM programmer** dedicated to the Intel 2704/2708 and similar memories includes keyboard and RAM editing buffer. Price of full-function Model 1007K from Technitrol in Philadelphia is \$1185, about half the cost of units that program a wider variety of PROMs. . . . 256 \times 8 and 512 \times 8 bipolar PROMs in 20-pin packages can save one-half to two-thirds of the PC-board space needed by the popular 24-pin PROMs, since the 20-pin units are the same width as 16-pin DIPs that usually share the board. Raytheon Semiconductor has these nichrome-link devices now in the 256 \times 8 size, and expects to have the 512 \times 8 size next quarter. The Mountain View, CA, firm new in LSI last June, also makes eight 2900-family bit-slice devices, more than other second sources of the AMD-designed circuits. . . . A new **general-purpose microprogram assembler** named AMDASM (AMD Assembler) is available on the Infonet time-sharing service operated by Computer Sciences Corporation, New York. Designed by Advanced Micro Devices of Sunnyvale, CA, the program can be used easily by hardware engineers, and is flexible enough to fit any micro-coded processor. AMD will also lease AMDASM to users at a later date. It's written in Fortran for portability. . . . A three-day course on the **design of 8080 μ P systems** will be held at NEC, Lexington, MA, Feb. 7 to 9, March 7 to 9, Apr. 18 to 20, and May 2 to 4. The fee is \$295. Also, Virginia Polytechnical Institute at Blacksburg, VA, has a free 8080 workshop June 9 to 11. . . .

Borrow my coffee cup... but never my C-Meter.



The C-Meter opens up a new route to efficient designing. It's so handy that you'll find yourself measuring capacitors as a matter of course. Why? Because its pushbutton speed, high accuracy (.1%), small size and versatility (.1pf to .2 farads), make capacitors easier to measure than resistors.

With the C-Meter, you'll waste no time twiddling, and nulling, and you'll cut the need for expensive tight-tolerance capacitors or tweak pots in your circuits. You'll be a much more efficient engineer. And popular too, because people just can't keep their hands off the C-Meter.

You owe it to yourself to try one. Our reps are stocking them at **\$289.**



ECD CORP.

196 BROADWAY, CAMBRIDGE, MASS. 02139
(617) 661-4400

SALES OFFICES: AL, Huntsville (205) 533-5896; AZ, Scottsdale (602) 947-7841; CA, Costa Mesa (714) 540-7160; CA, Sunnyvale (408) 733-8690; CO, Denver (303) 750-1222; FL, Winter Haven (813) 294-5815; GA, Chamblee (404) 457-7117; IL, Elk Grove Vill (312) 593-0282; IN, Indianapolis (317) 293-9827; MD, Silver Spring (301) 622-4200; MA, Burlington (617) 273-0198; MN, Minneapolis (612) 781-1611; NJ, Camden (215) 925-8711; NM, Albuquerque (505) 299-7658; NY, Great Neck (516) 482-3500, (212) 895-7177, Syracuse (315) 446-0220; NC, Raleigh (919) 787-5818; OH, Centerville (513) 433-8171; TX, Houston (713) 688-9971; TX, Richardson (214) 231-2573.

Feedback

Jack was a smart enough manager to know that he wasn't smart enough to know everything. He had learned enough about psychology and human nature to know that each of us, himself included, forms judgments based on his own prejudices, hang-ups and limited experience. So he relied heavily on feedback from his engineers, while he naturally reserved for himself the right to make final decisions.

He was pleased with this set-up because he had great respect for his engineers, as they had for him. And they were intelligent individuals—even though they didn't always agree with him. Jack was smart enough to know that he didn't have a corner on all the world's intelligence.

Typically, when there was a problem to be solved or a business opportunity presented itself, Jack would invite several of his engineers to discuss it with him. Sometimes he'd let them know early what he wanted to discuss so they could think about it in advance or dig up pertinent material in their files. But Jack would never push his own views too hard for fear of suppressing others by weight of his own authority. He knew it was dangerously easy to prove that he was right because he was boss.

Then Jack began to learn about management techniques. He learned, for example, that such informality was unsuitable and that management decisions must rest on careful documentation. So whenever one of his engineers would offer an unusual idea during their informal meetings, Jack would ask that he prepare written support for his idea. "Give me a report," he would insist. Jack, of course, never had to write a report since he was the manager. So he never had to support his own views with documentation. His engineers, who were rather smart, quickly saw that if they offered a view contrary to Jack's, they had to write a report.

In time, Jack began to wonder if age had not bestowed on him an uncanny ability to be right all the time. Those meetings that had always been filled with the excitement of differing viewpoints had lost their zing. Jack's engineers didn't disagree with him any more. Whenever he put forth a new idea, they always greeted it with: "Gee, I guess you're right again, Chief."



A handwritten signature in dark ink, appearing to read "George Rostky". The signature is fluid and cursive, written in a professional style.

GEORGE ROSTKY
Editor-in-Chief

FOCUS

on
Logic
and
 μ P Analyzers

Logic analyzers are a moving target. In an industry known for fast product turnover, they are among the speediest and the youngest. The problem of selecting an appropriate analyzer, therefore, is essentially one of keeping up.

Stanley Runyon
Senior Associate Editor

Before you set out to track the relatively new frontier of logic and μ P analyzers, map out your applications thoroughly. Then make sure to define the destination. Not doing so is like exploring an unknown continent without a compass—in both cases, you're almost certain to get lost.



Opening the door to a new domain: In the world of logic analyzers, voltage levels give way to ONEs and ZEROs,

and digital mapping displays guide you across the bit streams of system data flow. (Hewlett-Packard)

With all the analyzer variations available, and more arriving almost weekly, your path to the right instrument will wind past state analyzers, timing analyzers, logic recorders, general-purpose logic analyzers, universal μ P analyzers and dedicated μ P analyzers. Strwn in between you'll find related equipment: development systems, programmers' panels and even software in the form of monitor, emulator and debugging programs. Which is best? Only your application can guide you.

Whatever the form, almost all analyzers can be split into four essential elements: the data-acquisition section (the front end), the memory, the data processing or interpretation section, and the display. A fifth category can include all else—convenience features, outputs, status indicators and the like.

Analyzing the analyzer

Often forgotten in a product search is the need for the analyzer to connect to the circuit under test. This is no minor concern, considering that sometimes 32 channels of data collection are necessary.

Some vendors encourage such a memory lapse



Keyboard control provides powerful relational triggering in Hewlett-Packard's 1611A logic-state analyzer. The unit is dedicated to μ P-based systems (6800 and 8080, at present) and offers mnemonic or absolute notation. Address, data and external information are shown.

by barely mentioning the probing systems, glossing over the high price of the probes or ignoring either the inconvenient method of connection or the loading effects on the circuit under test.

A little digging may reveal that an attractively low-cost analyzer isn't attractive after all. The cost of the probes, interface circuitry and cabling



Combine logic analysis with real-time troubleshooting: Two scope plug-ins, the Tektronix 7D01 and DF1, provide

timing, map, hex, octal and binary displays. Another Tek unit, the LA501W, is a portable analyzer.

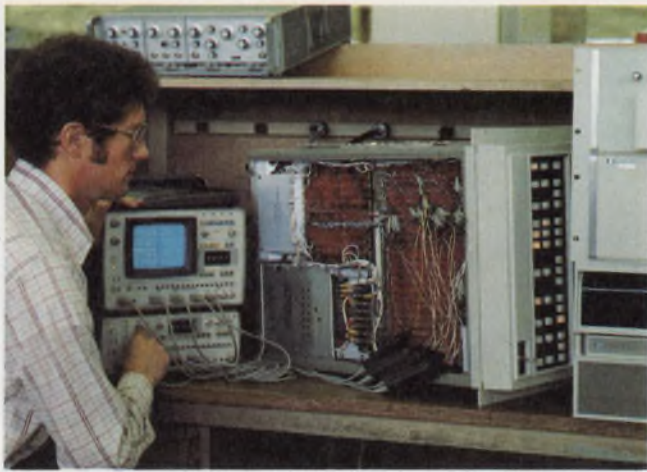

You can hook two HP analyzers together to get even more capabilities: triggering on words up to 36 bits wide, dual clocks and triggering when two sequential events occur. Unit shown is the 1600 S.

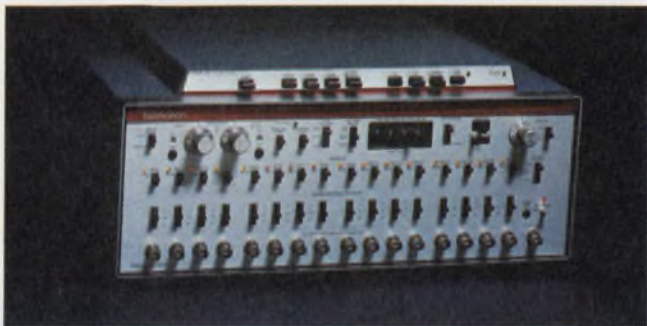

Record 16 signals at once up to 50-MHz with Biomatron's 1650-D. The unit works synchronously or asynchronously and, with an accessory, provides various display formats. The company offers one of the widest analyzer lines.



Microprocessor analyzers are an important subset of logic analyzers. This one, from Systron-Donner, monitors the μ P address and data bus and provides various troubleshooting modes. For example, a search mode lets you identify the first and last instruction in a loop.

isn't included. And more than just a little digging is needed to uncover the probe resistance and shunt capacitance. Instead of a Z_{in} , you find the liberal use of the word "transparent" to indicate that the analyzer doesn't bother the μ P or logic being monitored. Tread carefully. That word can be a "transparent" attempt to hide too many picofarads or not enough ohms.

As with oscilloscopes, the speed of an analyzer can't be divorced from its probes. Unlike scopes, however, which generally use 10:1 probes that compensate for shunt capacitance, the best connection isn't as clear cut for analyzers. And especially for a μ P analyzer, which can send out many umbilicals at once to monitor address and data buses plus control or I/O lines. A couple of vendors solve the connection problem very simply. They leave it up to you to come up with a "suitable" configuration.

Several vendors of μ P analyzers offer alternative connections: flat, flexible cable terminating in a DIP clip; a DIP socket; wire-wrapping connections; or dead-ended leads for soldering directly into a circuit. Other analyzers come with

miniature, spring-loaded probes to pick off the test points. Some offer individual, separated probes; in other designs, the probes emanate from pods located close to the circuit under test. Both passive and active probes are available.

Whatever the method, ask: Are the probes buffered? If so, at which end? Buffering at the analyzer end, instead of right at the probe, may signify either a limit to operating speed or to the length of the test cable. No buffering at all can spell noise or loading troubles. With DIP sockets, remember that the continual plugging and unplugging of a 40-pin IC can lead to mechanical or electrical damage.

Getting pointed in the right direction

Consider also the locations of the points you'd like to check. If the points are widely scattered along I/O ports, peripherals, logic boards or other spots, you'll need separated probes. With separated probes you'll need some way to keep track of the rats' nest of 8, 16 or 32 roving wires. Color coding is one way to see which probe goes to

which channel as you change test points.

If the points to be tested are closely spaced—all on one PC board, for instance—then the pod approach is probably the least confusing.

With so-called universal or general-purpose μ P analyzers, check carefully into the interface between the μ P and the tester. Is an interface available, or must you build your own? How easily is the interface changed for the various μ Ps? What's the cost of the interface? Must you alter your circuit design to accommodate the analyzer?

Don't get the answer to the last question the hard way—after you buy a unit, only to discover that certain μ P states must be disabled or wiring modifications made. Such analyzer limitations can lead to annoying limitations in your system design. Another key point: Find out how the analyzer handles μ Ps with addresses and data multiplexed on the same bus.

One question you'll want to settle quickly is how many data-input channels you'll need. Experience with oscilloscopes teaches that you always seem to need one more channel than you've got. That may be true in many instances. But there are pros and cons for both fewer and greater channels.

Is less better?

The case for a simpler two or four-channel machine goes like this: By reducing the number of channels, a vendor can put more features or capabilities into each channel. Or he can lower the price. Furthermore, while troubleshooting hardware, it's conceivable to have hundreds of points to monitor. Keeping track of four roving probes is hard enough. Imagine having 32.

Troubleshooting μ Ps or minicomputers is another story. Take 16 bits of address, add 8 data

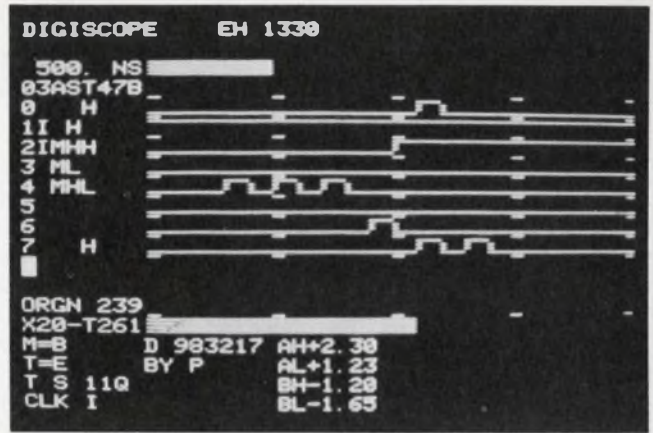

bits, throw in status lines, control lines and I/O ports—suddenly, even a need for 32 channels doesn't seem extravagant. Indeed, the trend in analyzers has been from two to eight to 16 to 32 channels in just a few years. (Remember, these are the number of inputs, which don't necessarily equal the number of display channels.) And new μ Ps may demand additional analyzer changes.

One compromise you may have to make is between the number of inputs and the maximum sampling or clock rate. That's because, to keep costs down, a vendor may choose not to place a memory behind each input. Instead, he'll multiplex a number of channels into one memory and so limit the speed—the more channels, the slower the unit.

Fortunately, the slower analyzers (about 1 to 4 MHz) can match the current needs of μ P testing, while the speedier units (to 200 MHz) can handle faster logic, which may not require more than

bits, throw in status lines, control lines and I/O ports—suddenly, even a need for 32 channels doesn't seem extravagant. Indeed, the trend in analyzers has been from two to eight to 16 to 32 channels in just a few years. (Remember, these are the number of inputs, which don't necessarily equal the number of display channels.) And new μ Ps may demand additional analyzer changes.



Dedicated analyzers, like the Pro-Log M822A, offer still another choice. The 822 is targeted towards the 8080, and serves as a control panel, program monitor and program-to-hardware integrator.



Motorola's MPA-1 analyzer works with the 8080 or 6800 and captures and displays 32 words in hex format. Status information can be ignored or captured and alternated with corresponding data.

Zeroing in on logic-analyzer displays



The ONES-and-ZEROs functional, or state, display pioneered by Hewlett-Packard is now offered by several vendors (the one shown here is from Tektronix). In this format, binary words are plotted against clocks in a matrix m bits wide by n clocks deep. Such a format lends itself to troubleshooting where word flow, or data sequencing, is of primary interest, and allows easy correlation with software, algorithms or flow charts. The side-by-side tables shown let you compare incoming data with stored information. Dissimilar bits are intensified.

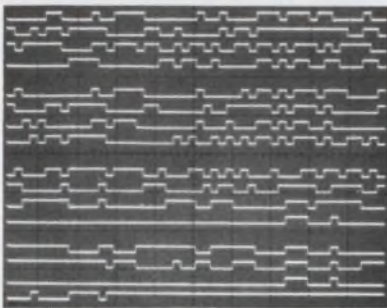

The timing-diagram presentation contrasts sharply with the ONES and ZEROs approach. In the timing format, first offered by Biomation, words are plotted against time—not clock ticks—and the vertical scale is pseudo-voltage, not an actual logic waveform. The high value of the “voltage” represents a ONE, the low value a ZERO. Thus, timing displays aim mostly at hardware or electrical problems, e.g., incorrect timing between parallel lines. The timing diagram is not to be confused with “real-time” displays, which show actual logic or μ P waveforms, usually on an external oscilloscope.



For troubleshooting μ P and mini-based systems—where looking at 32 bits of information simultaneously is not uncommon—data flow, or sequences, is of top importance. But because of the wide data stream, some form of compaction or interpretation is a must. In the display shown (the Hewlett-Packard 1611A), ONES and ZEROs consequently give way to the hexadecimal number base. Or, at the flick of a switch, the information is shown in octal. These are the two languages most often used by assemblers. Another key converts the data to mnemonic form for easy comparison with program listings.

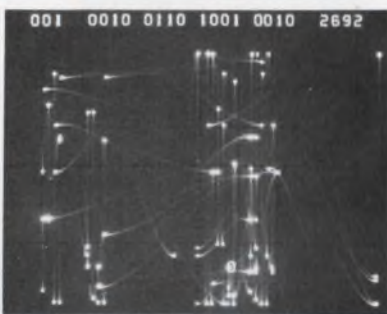

A very different data format is the mapping mode, also originated by Hewlett-Packard and now offered by others (the one shown here is from Biomation.) Here, each word is converted into a unique CRT location and represented as a single dot. To do so, the word is split in half, with the most-significant bits positioning the dot vertically (through a d/a converter), and the least-significant bits locating it horizontally. The word pattern so formed appears one way for a correctly operating system, and another way for a troubled system. Thus, knowing what a “good” pattern should look like, you can spot the problem.



Still another original format, found in the Biomation 168-D μ P analyzer, is what the company calls a page-display mode, one of four in the unit. This mode shows details of memory activity within prescribed address boundaries. The eight least-significant address bits are viewed here, and the display indicates the number of accesses at that address, the data at a certain access and other information.

about eight channels.

What about the input signals themselves? Can the analyzer handle all the levels you'll be working with—TTL, PMOS, NMOS, CMOS, ECL? What are the restrictions, if any, on transition times, levels, speeds, clocking, timing and the like?

Don't be misled by vague statements like "Our analyzer looks at ECL signals." Check the details to see just what is meant by "looks." Figures of merit that are traditional to scopes—such as bandwidth—don't necessarily apply to analyzers. Other factors come into play—data setup or hold-time specs, to name just two.

Grabbing hold time

These two specs must be known so that you can determine either the true maximum clock rate in externally clocked analyzers or the best timing resolution in asynchronous (internally clocked) analyzers. Up front, an analyzer spec sheet blasts 100 MHz loudly and clearly. Way in the back, a minuscule spec quietly bleeps out a 5-ns hold time. Your actual resolution: 15 ns, not 10—a 50% difference.

Hold time is something you're better off without, anyway. Whatever the spec, the data must remain stable for that interval after a clock edge. Otherwise, ambiguous readings may result. Can you guarantee that your logic remains stable for that long? If not, look for a unit with zero hold time.

When you evaluate a unit's sampling frequency, don't forget that the analyzer must work faster than your circuit. Sampling theory states that a ratio of no less than 2:1 is necessary. For the best results, however, the analyzer should sample at frequencies 5 to 10 times faster than your circuit speed.

Remember that probe capacitance can kill speed—the spec sheet doesn't always tell you. Other things the sheet may not say:

1. When data are gated into an analyzer by a system clock (usually on the leading edge), the delays in the data and clock paths should be closely matched.

2. The channel-to-channel timing skew of the unit may exceed the one-bit time uncertainty normal in a/d conversion.

Watch for other holes in the spec sheet. Because an analyzer "works" to 30 MHz, can you assume the unit will handle all frequencies to the maximum? Nope. The span of acceptable clock frequencies can be as full of holes as the spec sheet itself.

Another slippery area where specs are glossed over involves a unit's threshold. Threshold stability or noise uncertainty are often conspicuously absent. Of if given, the number may apply at the

analyzer's input jack, not at the probe tip. Remember: with 10:1 probes, an innocent-looking 100 mV of uncertainty at the front panel represents an unacceptable 1 V at the business end of the probe.

Crossing the threshold

When you look into thresholds, you'll no doubt run across arguments for the superiority of dual over single thresholds and vice versa. Here's how the arguments stack up:

Proponents of the dual approach point out that this method can detect four anomalies that are possible with logic signals—ringing, slow rise or fall times, low-amplitude ONEs and high-amplitude ZEROs.



Aimed at the 6800, the AQ6800 from AQ Systems, stresses interaction with the μ P system. Besides single-step and breakpoint, the unit can examine and modify the memory, registers, program counter and I/O.

A dual threshold, the argument continues, provides more sensitive glitch detection, because a glitch must cross only the lower threshold to be spotted. With a single, center-set threshold, the glitch won't be detected unless its amplitude is greater than half the logic swing. A few proponents of the dual approach say that the technique is necessary for hardware troubleshooting but not so valuable for software work.

Advocates of single-threshold instruments say that dual thresholds aren't necessary, that by moving the variable-threshold level around, you can detect many of the same anomalies. Or, better yet, you can use the analyzer's trigger output (assuming the analyzer has one) to see the real-time waveforms on a scope screen. In any case, don't confuse mixed thresholds—a different threshold on each channel—with dual thresholds, which use two comparator levels per channel.

The glitch, pulse-stretching or latch modes found on some analyzers are another source of controversy. Two things you should know: Is the

mode necessary and, in analyzers that have it, is the mode fully specified?

The pitch for glitch detection

The "glitchers" insist that the feature is a must for hardware troubleshooting. With the latch mode, random logic pulses as narrow as 5 ns can be detected. The anti-glitchers say, "Not so," for two reasons:

First, if the glitch has enough energy to mis-set a bit, the analyzer will detect the erroneous bit. Second, if the analyzer is fast enough, say 100 MHz or so in the asynchronous mode, you can resolve events within 15 ns. So a separate glitch detector isn't necessary. If the analyzer is even faster, so much the better.

Moreover, the antis continue, latch modes don't necessarily catch all glitches. The mode is fine for isolated, narrow pulses but less effective with glitches near transitions (ringing, for example).

The glitchers reply: "Higher sampling rates present only a limited picture of real time; glitch catchers display fast transitions over long real-time intervals. Thus, at a 50-MHz sampling rate, at 500 bits per channel, only 10 μ s are spread across the screen. By contrast, with at least one pulse stretcher, you can see a 25-ns pulse within a 5-s time slot. You need such capability because you usually don't know where to look or the exact place to trigger when a problem first occurs."

Another argument for glitch detection involves analyzers that don't have an integral display, but work with an external scope. With those units, glitch detection can, in effect, extend the bandwidth of older or slower scopes.

The detection of glitches and other anomalies is just one facet of a farther-reaching consideration—whether to opt for a hardware-oriented machine or one that leans mostly toward software troubleshooting. But with the recent trend to analyzers that can do both, your choices number three.

Compared with software units, hardware analyzers generally are characterized by asynchronous recording with an internal clock, higher speeds, larger memories and timing-diagram displays. And a hardware analyzer may include a glitch catcher. A "typical" software analyzer records synchronously with the system-clock input and shows information directly as binary ONEs and ZEROs (one type of state display).

Some recently introduced machines include both timing and state displays. A few add even more. Bear in mind that there are many variations of the typical, so that the words "timing," "state," "hardware," or "software" placed before the word "analyzer" aren't definitive.

Whether an analyzer is hardware or software-oriented, its triggering, or data-acquisition, capabilities take center stage. Performance in this area is a key to a unit's usefulness.

The need for trigger power

If your goal is to debug software, or both soft and hardware, look for the widest possible range of triggering capability. For hardware alone, you may need no more than simple word recognition (combination triggering). If that's not enough, other hardware-oriented units offer more—word delay, qualifiers, pre and post-triggering, among



Never has such a young field sprouted so many diverse products. (Clockwise from upper left): Davco's DM-230 reads digital data or shows real-time waveforms on an external scope. The unit captures 128 32-bit words. The Vector 1625A can trigger from a μ P address bus while all 16 data inputs keep an eye on system logic. The 12-in. display is standard. Paratronics' 100A, a new entry, comes in kit (\$189) or finished form. The 100A's truth-table display (1 byte by 16 deep) can be formatted in hex or octal. Digital Laboratories DSR-505 is a hardware-oriented unit that comes with two 512-bit input channels. Two 505s can be hooked together with an optional synchronizer.



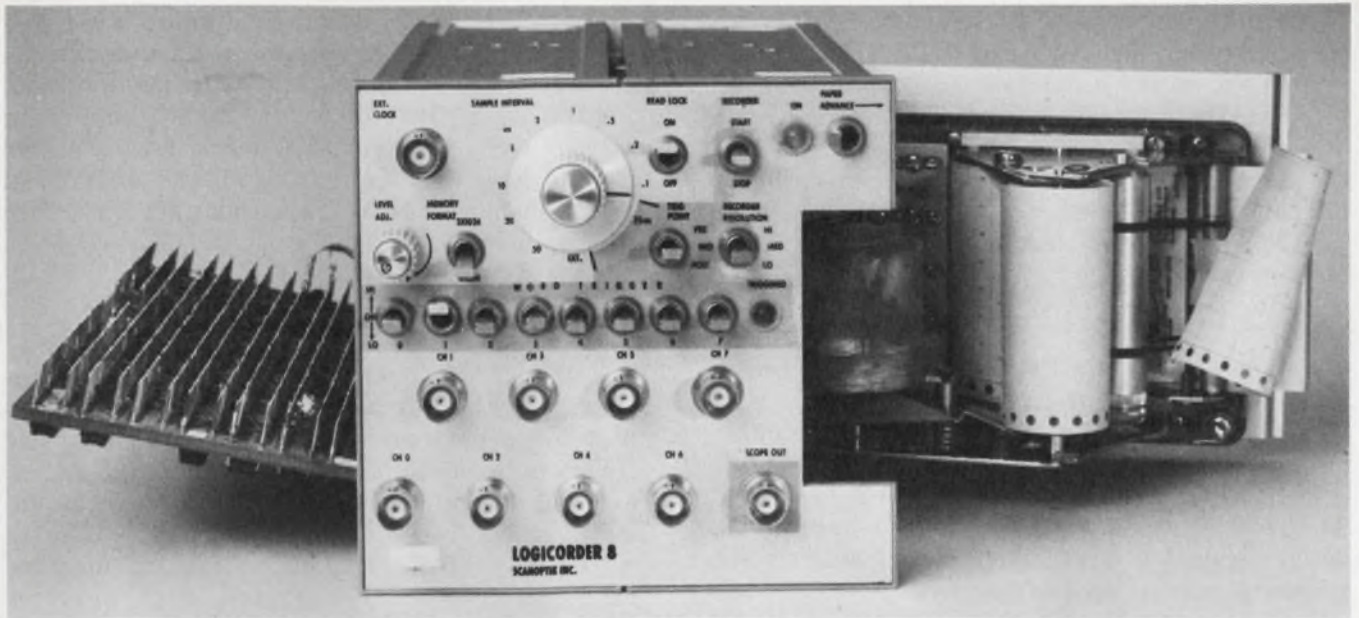

Hard-copy output from a miniature, 8-channel strip-chart recorder—that's the hallmark of the Logicorder-8 from

Scanoptik. The unit is designed to fit the Tektronix TM-500 modular instrument line.

other capabilities.

Some of the new μ P analyzers provide extensive triggering features. Be prepared: Comparing the features of competitive units is akin to riding in a steeplechase blindfolded. The unseen obstacles take the form of nonstandard terminology, substantial design differences between competing analyzers, and in the still freshness of μ P technology.

You practically have to become intimate with the μ P to be tested—understand its timing requirements, its instruction set, its peculiarities and its lingo. Once you've cleared that hurdle, the other obstacles will not be so formidable. In some cases, two instruments that look nothing like each other, and use totally different nomenclature on their respective front panels, surprisingly will turn out to have similar triggering capabilities.

The purpose behind most software debugging is to get into any point in a program, however long, to see either how you have reached that point or where you're going from that point. Since loop hangups are fairly common, you should have some means to trace the loop, find out where it starts and where it re-enters. In programs with multiple passes through a given operation (branches), you might look for some means to capture information at any given pass.

While debugging, you may want to look at selected data, perhaps only certain Reads or Writes. Or pull out certain data from a multiplexed bus. What if a peripheral and your μ P run at different speeds, and you'd like to look at both sides of I/O—how does the analyzer handle that? Perhaps the problem is missing information or an unwanted event in a regular series—how does the analyzer let you know about it?

Timing might be the culprit. Is there some way to track down the cause? In short, how does a prospective analyzer search out the trouble spots you're likely to run into?

Some kind of digital delay is practically indispensable to reach data far removed from a trigger point. Likewise for loop analyzing or paging through a program. Take note: there are several ways to delay data—by clocks, trigger words, machine cycles and more. Which are important to you?

Other questions you might ask: When does the instrument store relative to the trigger? Can the delay redefine to a new trigger? Can the majority of memory be shifted into the problem area?

In acquiring data, most analyzers—but not all—store the information, then play it back (not necessarily all at once) on a built-in CRT or external display. Because storage strongly shapes an analyzer's character, it's logical to ask: How wide is the memory? How fast? How deep? The answer you're looking for is "wide enough, fast enough and deep enough to do your job."

Don't forget the memory

Such an answer sounds a bit smug, but really isn't. That's because larger or faster memories don't necessarily make a more powerful box. Nor do smaller or slower ones always lead to a less useful instrument. It all depends on how the vendor uses the memory. In the extreme, he may use no memory at all. (So the rule-of-thumb value rating that divides an instrument's cost by its memory size in bits is only a very rough starting point.)

(continued on page 48)

After a memory is wide enough to hold the anticipated word size (address, data and status in micros or minis), and fast enough to give the machine the speed you need, the spotlight falls on depth, or length. The more illumination here, the better. The major arguments for more or less memory go as follows:

- For hardware debugging, fast, asynchronous recording is practically a must, and this calls for memories of at least 256 bits per channel.

- Word length must be long enough to record through an interrupt sequence of at least 50 instructions. A 256-bit memory meets this requirement with a good safety factor.

- In μ Ps, it's important to be able to look at 30 to 40 locations before or after a trigger. To do so requires a large memory. If, however, you trigger primarily on a certain event, you need less storage.

- No memory is long enough, because most programs run longer than 512 steps. Therefore, it is better to be selective about capturing data, and display qualification can be a better alternative than deep memory. Qualification can capture information that's spread out over thousands of clock cycles, it can examine a particular instruction, display microcode, acquire only valid address, look at RAM or I/O Reads or Writes, and more.

- The relatively small price savings for a smaller memory is offset by the inability to acquire long programs or data sequences on a single pass. When multiple acquisitions are needed to study a long data train, the result is time wasted. And viewing the effects of an infrequent transient on a long data train becomes difficult, if not impossible.

- On repeatable problems, memory has questionable value as long as the analyzer can step backwards to trace the problems. On intermittent troubles, a short memory, 16 or 32 steps deep, is frequently not enough.

And so the memory question goes.

Whatever the memory size, the stored informa-

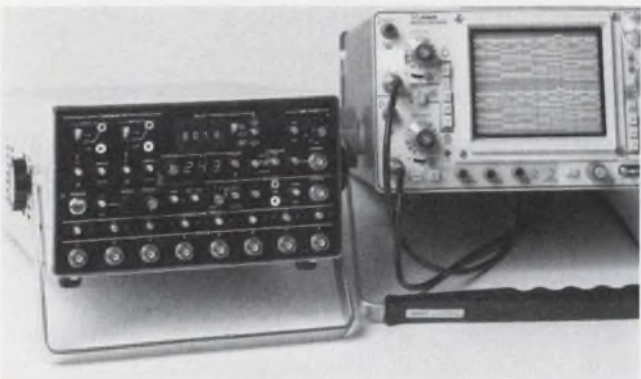

Dual memory for comparison work is offered by the BP Instrument 50D, a 50-MHz general-purpose analyzer. A mode in the 50D lets you ignore glitches.

tion, or part of it, is ultimately dumped into a display. Perhaps, no other portion of an analyzer has received more attention, and with good reason. It's the display that shows you what's happening in your logic. How much it shows, how it shows it—and how well—can make all the difference. Which display is best? That's another difference—of opinion.

Is hex good for you?

Right off, you'll have to decide between analyzers with built-in displays and those that connect to an external scope or X-Y display. The tradeoffs involved are cost, availability of an external display, size (portability), where the instrument will be used, and so on. Most analyzers work with CRT displays, but at least one machine has a built-in hard-copy unit that produces timing-diagram recordings. Another offers a printer option that copies memory words.

Where the machine will be used is no small consideration. Remember two things: μ P analyzers are not parametric testers, and incoming inspection is not the best way to use μ P analyzers.

Another class can be termed "real-time" analyzers. Those units don't sample and store logic levels for later playback. Instead, they let you see many actual logic waveforms at once (usually 8) on a conventional scope. One model works in both the time and data domains.

Other analyzers show address, data and status information on rows of binary LEDs, a method often used on minicomputer control panels or programmers' panels. One opinion holds that in debugging software, LED readouts aren't sufficient to follow program flow since each instruction (or cycle) is viewed in isolation. And when a program branches, it is important to see why by looking at a preceding step.

That opinion further states that comparison of the display with written codes should be immediate, with minimum display interpretation, and that a hexadecimal CRT display allows such direct comparison efficiently. (Instruction mnemonics, the opinion continues, represent a higher level of readout that is helpful but not essential.)

On the other hand, you find this argument: Nothing is lost by displaying information sequentially, one unit at a time, since that's the way computers operate and the way users inspect information. Being able to display more kinds of data is more important than being able to display large amounts of limited types of data on an expensive CRT.

Mapping out the data shape

Until about a year ago, the choice in formats fell basically between ONEs and ZEROs, and the

timing diagram. By and large, the former are more efficient for software debugging, the latter for hardware debugging. But each alternative can be used in the other's territory.

Today, however, several analyzers provide both formats—and even others, such as logic maps—with the choice left up to you, the operator. Of course, multiple formats cost more, and justification for the extra dollars must be either need or saved test time.

With analyzers aimed especially at μ Ps, you've got even more formats to choose from: listings in absolute codes or mnemonics, macro pictures of memory activity, page-display plots, among others.

Which do you choose? Look at your application rather than at a display that seems familiar. Do you need state flow, timing or both? Perhaps one of the other formats? Assess your problems, then address the machine.

Some formats are called by the same name (not the one you use when the box doesn't work) in different units and may even look alike. So not until you see the analyzer perform do you realize that a rose by any other name isn't. The map mode is a case in point.

The object of mapping is to provide an overview for spotting gross (or possibly subtle) problems by comparing a known good pattern with the one at hand. A correctly operating system will have one pattern, a troubled system another. Or you might spot trouble by the shifting of dots, which leads to a detectable change in the over-all "normal" pattern of dots. For instance, an error in the LSB can move a dot halfway across the CRT.

Connect the dots, complete the picture

Watch out: All dot patterns are not alike. In some, each dot is connected by a vector that shows the sequence, or "dynamic motion," from dot to dot as program data change. Brightness indicates relative word frequency—the more often the word appears, the brighter the dot.

Other maps are composed of "static" patterns of uniformly bright dots, with no vectors between them. The claim for this technique is that, with no vector effect, each data word shows up clearly.

However, as one prominent vendor points out, without vectors a dot pattern can be interpreted several ways (which lets in all possible combinations of interconnections, with multiple occurrences). Furthermore, dynamics are needed for the kinds of system activity commonly found in computers or other digital systems—the constant branching and jumping back and forth between subroutines and executive programs. Without dot intensification, of course, you can't tell if a word repeats as it should—or shouldn't.



Another unit that works in real time or with digital data is Digital Laboratories' 80M. The 8-channel unit can memorize 1024 bits per channel. The static memory is said to ease output-device interfacing.

Keep in mind that some dynamic modes require that the data be repetitive. Thus the mode can't be used to observe transients. But still another manufacturer—one who offers a vector display—says that the major purpose of maps is to reveal a problem with a static pattern, not a dynamic one. The same vendor also states that maps play a secondary role in analysis and that the other formats are far more important. Other means may be provided to capture an infrequent malfunction (comparison modes, for example, in which incoming data are compared with reference data in memory, and differences are indicated by intensified ONEs or ZEROs).

Comparison modes are features that can make life easier by speeding up analysis. Many others are offered: reformattable memories, intensified triggers, column blanking, status lights, CRT readout of control settings, to name a few. Some features are almost indispensable—like a cursor that lets you keep track of a specific word as you switch from one display mode to another.

In μ P analyzers especially, look for interactive modes: the ability to insert breakpoints, halt or interrupt the μ P, or single-step it. Some special-purpose units go so far as to let you examine and modify memory locations, internal registers, program counters and the like. General-purpose logic or μ P analyzers are usually limited in this respect. (Recognize the distinction between hardware and software breakpoints.)

Look into special-purpose analyzers—ones designed to work with just one μ P like the 6800 or 8080, or perhaps both. Theoretically, such analyzers are designed to minimize bus loading and, as mentioned, may interact with the μ P in ways missing from general-purpose machines. Moreover, special-purpose units can cost less.

Such units can be split into two categories: those that stand alone and those that either convert a development system into an analyzer of

See real time power.. to 40 MHz

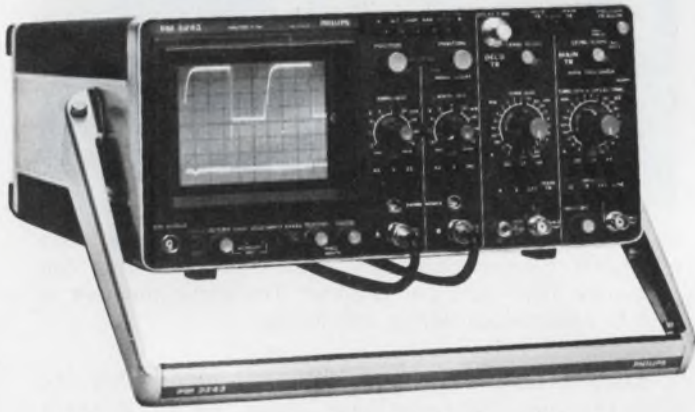

- 40 MHz multiplication
- Variable persistence and full storage

The Philips PM 3243 50 MHz dual trace storage oscilloscope has built-in multiplication capability - A x B to 40 MHz, (-3dB). Variable persistence, to 90 seconds, and full storage capability enable the inspection of switching transients for voltage, current and power.

The A x B function of the oscilloscope provides real time multiplication on screen, as well as an A x B output for instantaneous and average power measurements into other instruments.

As part of the Philips HF family of portable oscilloscopes, the PM 3243 has a switching regulated supply that enables operation from 90 to 270 V (AC or DC), cold switch controls featuring completely separate delayed timebase section, lightweight and the high reliability and level of user oriented design common to all Philips instruments.

There is also a 100 MHz multiplier available on the PM 3265 dual trace multiplier oscilloscope which has a basic bandwidth of 150 MHz.

For further up-to-the-minute technical information contact Philips Test & Measuring Instruments, Inc., or utilize our toll free HOT LINE number 800 631-7172 New Jersey residents call (201) 529-3800 collect.

In the United States
85 McKee Drive
Mahwah, New Jersey 07430
(201) 529-3800

In Canada
6 Lesney Road
Toronto, Ontario Canada M6A 1K2
(416) 789-7188



PHILIPS

FOR INFORMATION CIRCLE 24
FOR DEMONSTRATION CIRCLE 25

sorts or insert a debug program into a μ P or mini system. Whether the latter category can be called analyzers—in the sense of test and measuring instruments—is doubtful. But as long as you recognize whatever restrictions apply, those devices just might do your job.

In some cases, development systems or monitor programs can provide the same information as an analyzer. But remember: The μ P system must be up and running to use the monitor. And development systems can't address all problems.

There are many other things to look for in analyzers—hidden costs, for one. Will you need to buy options—things like digital delay or extra memory—to get the full measuring power? Will you have to hook several units together to get the promoted wide bit range or features? For that matter, if you *want* to do so, does the unit provide for such interconnection?

Because analyzers are so new, perhaps the safest approach is to discuss your problems freely with the vendor, get a demonstration, then a trial period. The extra time spent being careful will be worth it. ■■

Need more information?

The products cited in this report don't represent the manufacturers' full lines. For additional details, circle the appropriate number on the Reader Service Card. For data sheets and more vendors, consult ELECTRONIC DESIGN's GOLD BOOK.

- Applied Microsystems, P.O. Box 245, Bothell, WA 98011. (206) 827-9111. (R. Knoke) **Circle No. 469**
- AQ Systems, Inc. (marketed by E & L Instruments), 1736 Front St., Yorktown Heights, NY 10598. (914) 962-4264. (Steve Halpern) **Circle No. 451**
- BP Instruments, Inc., 10601 S. De Anza Blvd., Cupertino, CA 95014. (408) 446-4322. (Ken Pine) **Circle No. 452**
- Biomation Corp., 10411 Bubb Rd., Cupertino, CA 95014. (408) 255-9500. (Roy Tottingham) **Circle No. 453**
- Brensal Electronics Ltd., 24 Park Row, Bristol, England. (David Hunt) **Circle No. 454**
- Davco Manufacturing Co., 169 Ridgedale Ave., Morristown, NJ 07960. (James C. Lawless) **Circle No. 455**
- Digital Broadcast Systems Inc., Brentwood Lane, P.O. Box 381, Madison, AL 35758. (205) 837-2183. (Winton Churchill) **Circle No. 456**
- Digital Laboratories, 600 Pleasant St., Watertown, MA 02172. (617) 924-1680. (William M. Kahn) **Circle No. 457**
- E-H Research Laboratories, Inc., 515-11th St., Oakland, CA 94607. (415) 834-3030. (Earl Olsen) **Circle No. 458**
- E & L Instruments Inc. (markets AQ Systems' analyzer), 61 First St., Derby, CT 06418. (203) 735-8774. (R. J. Vuillequez) **Circle No. 459**
- Hewlett-Packard, 1501 Page Mill Rd., Palo Alto, CA 94304. (415) 493-1501. (Inquiries Manager) **Circle No. 460**
- Motorola Data Products, 455 E. North Ave., Carol Stream, IL 60187. (312) 690-1400. (Robert M. Bahnsen) **Circle No. 461**
- Moxon Inc., 2222 Michelson Dr., Irvine, CA 92715. (714) 833-2000. (Walter B. Larson) **Circle No. 462**
- Paratronics, Inc., 150 Tait Ave., Los Gatos, CA 95030. (408) 354-7766. (Gerald F. Meuthing) **Circle No. 463**
- Pro-Log Corp., 2411A Garden Rd., Monterey, CA 93940. (408) 372-4593. (Jim McDonald) **Circle No. 464**
- Scanoptik Inc., P.O. Box 1745, Rockville, MD 20850. (301) 977-9660. (Jerry L. Shumway) **Circle No. 465**
- Systron-Donner Corp., Ten Systron Dr., Concord, CA 94518. (415) 676-5000 (Zoltan Tarczy-Hornoch) **Circle No. 466**
- Tektronix, Inc., P.O. Box 500, Beaverton, OR 97077. (503) 644-0161. (Bob Down) **Circle No. 467**
- Vector Associates Inc., 685 Station Rd., Bellport, NY 11713. (Dick Serocki) **Circle No. 468**

Electronic Design's GOLD BOOK

MEANS BUSINESS FOR

Datel Systems, Inc.

IT CAN MEAN BUSINESS FOR YOU!



Electronic Design's GOLD BOOK has emerged as the selling force whose time has come for today's marketing needs. Any company who wants inquiries and sales from the U.S. and the world can simply no longer ignore the GOLD BOOK.

The GOLD BOOK contains the largest, most comprehensive and most useful electronics directories ever published. As *Electronic Design's* 27th issue it goes to the world's most responsive audience of engineers, engineering managers and specifiers — 90,000 strong. It facilitates customers' first-step search for suppliers, streamlines contact, answers technical questions and enables engineers to buy directly from its pages.

The GOLD BOOK's mass catalog distribution method is within the reach of every company — large or small. Discounts for *Electronic Design's* advertisers, free layouts, free consultation, production and typesetting at cost and low, low printing costs for overruns all add up to a package price that is often less than many companies spend for catalogs alone!

Get complete details plus a personalized quote for your GOLD BOOK catalog pages without any charge or obligation. Do it now. 1977-78 edition closes...MARCH 1 FOR COPY TO BE SET. APRIL 1 FOR FILM OR CAMERA-READY ART.

Electronic Design's GOLD BOOK

HAYDEN PUBLISHING COMPANY, INC.

Peter D. Coley, Senior Vice President/Publisher
Albert B. Stempel, Vice President/Publication & Printing Director
50 Essex Street, Rochelle Park, New Jersey 07662. Tel: 201-843-0550

ADVERTISING SALES OFFICES

ROCHELLE PARK, N.J. 07662
David Greenberg
Stan Tessler
Joel Rose
50 Essex Street
(201) 843-0550
TWX: 710-990-5071

CHICAGO 60611
Ed Wang
200 East Ontario
(312) 337-0588

LOS ANGELES 90045
Neil Canavin
8939 Sepulveda Blvd.
(213) 641-6544

OVERSEAS OFFICES

LONDON
Constance McKinley
50 Essex St.
Rochelle Park, N.J. 07662
Phone: (201) 843-0550

PARIS
Pierre J. Braude
10 rue Louis Philippe
Neuilly (Sur Seine) 92200
France
Tel: 747-4953

GERMANY
Dieter Wollenberg
8011 Baldham/Munchen
Erikastrasse 8
Tel: 08106/4541

AMSTERDAM
Sanders, W. J. M.
Raadhuisstraat 24
Graft-De Ryp, Holland
Phone: 02997-1303
Telegrams: Euradteam-
Amsterdam

TOKYO
Haruki Hirayama
Electronic Media Service
5th Floor, Lila Bldg.,
4-9-8 Roppongi
Minato-ku, Tokyo, Japan
Phone: 402-4556
Cable: Electronicmedia, Tokyo

SEOUL
Mr. O-kyu Park, President
Dongbo Intl Corp. —
World Marketing
C.P.O. Box 4010
Seoul, Korea
Tel: 76-3910/3911
Cable: DONGBO SEOUL
Telex: EBKOREA K27286

A primer on bit-slice processors --

basics for the uninitiated. Here are the principles of operation for these most flexible of logic processors.

Designing logic processors with bit slices is no more difficult than designing μP -based processors. However, much of the terminology is different and some design rules may change. The following is intended as a primer on what goes into bit slice processors and how they work. The only assumptions are that you have a background in logic design and are familiar with state machines and parallel data paths.

Designing with complex LSI digital circuits opens up a new world to you, the logic designer. But the overwhelming number of new terms and concepts can only confuse you if you can't relate the terminology to more familiar, basic logic concepts. So if you understand the basic logic design of a sequential-state machine, you will be shown how the machine can evolve into a sequence of logic instructions, and how that sequence of instructions can be carried out by a processor built from complex logic arrays called bit slices.

Sequential-state machines: a review

The sequential-state machine is the basis for most logic-processor designs. One possible arrangement of a four-state machine is outlined in the state diagram shown in Fig. 1. To move from one state to another (from 00 to 01, for instance), there are always conditions to determine which transition will be made.

Condition A is required to move from 00 to 01, condition B to move from 01 to 10, and so on. Functionally, of course, the purpose of the machine is to perform a specific job, such as setting a function, F, and then clearing it. But there are many ways to accomplish these tasks.

To realize the simple four-state machine, several J-K flip-flops and some logic gates can be used (Fig. 2a). The actual design, however, is done by using Karnaugh (Fig. 2b) to establish the circuit connections to the J and K inputs.

While the state machine resulting from the sequential-logic design accomplishes dedicated

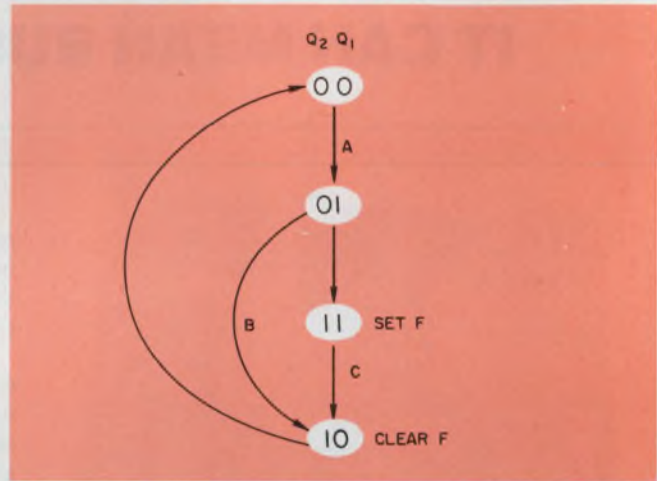

1. A simple four-state sequential machine can be represented by this state diagram.

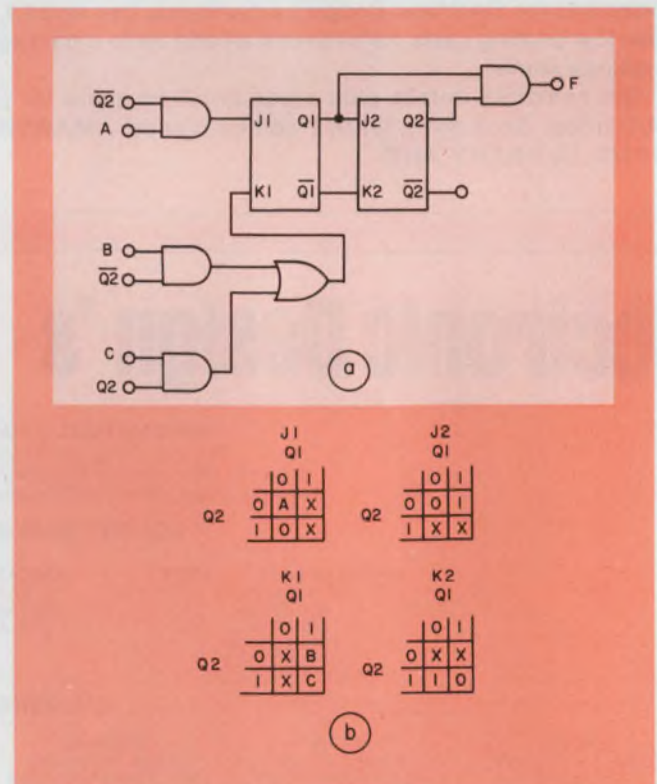

2. The equivalent circuit of the four-state machine (a), as diagrammed in Fig. 1, can be derived by use of Karnaugh maps and J-K flip-flops (b).

Dr. John Nemeec, Bipolar μP Product Planner, Gordon Sim, and Brian Willis, Senior Applications Engineers, Signetics, 811 E. Arques Ave., Sunnyvale, CA 95050.

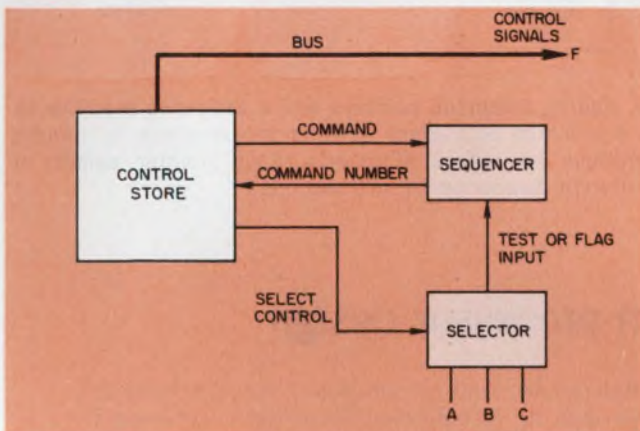

3. Building a programmed equivalent to the state machine requires a place to hold the commands (control store), a condition selector and some form of counter (sequencer) that addresses the control store.

functions, it is limited in two important ways:

1. It is inflexible, because once wired it accomplishes only its single function.
2. It is expansion-limited, because larger designs using a state-machine approach become much more difficult to implement.

If you are familiar with the state machine approach, you can easily visualize the entire machine as a set of sequential commands that are simply directions to get from one state to another. The state diagram in Fig. 1 can thus be interpreted as the command sequence of Table 1.

With the commands arranged in the correct sequence, the "programmed" machine operates just as the sequential state machine. In the example of Table 1, the first command requires that condition A be true before the program can proceed from 00 to 01. If A isn't true, the next command simply sends the machine back to the starting state until A becomes true. The command sequence has been kept simple for this example, but actually it can consist of many instructions to go from one state to another.

Putting a system together that can follow the instructions calls for some special circuits. The circuit designed to hold the sequence of commands is called the *control store*, which is actu-

Table 1. Instruction equivalents for a simple sequential machine

Command number	Equivalent machine state	Command
1	0 0	If A is true, skip next command
2		Jump back one
3	0 1	If B is true, jump to command 6; otherwise go to next command
4	1 1	If C is true, skip next command
5		Jump back one
6	1 0	Jump to command 1

ally a memory that stores the instructions in binary form.

Next, the over-all circuit needs to act on the commands by examining the external conditions (A, B, and C) and selecting the appropriate command from the control store. The *sequencer* does this with the help of an input selector circuit that feeds in the correct input.

The block diagram shown in Fig. 3 illustrates this concept. Operation begins when the control store sends command 1 to the sequencer. Since this command requires a check of condition A, the control store also sends out a signal to tell the selector to send A to the sequencer. If A is true, the sequencer notifies the control store by asking for command 3. If A is not true, the sequencer asks for command 2. In both cases, the sequencer acts on conditions specified in the original command.

Clearly, the control store specifies the progression through which the machine will sequence. It initiates the first command and then acts on the command sent back. Since it points to an instruction to be carried out, the new command can be referred to a vector. This vector controls the selector as well as the sequencer, but what is more important, it issues the value of F required as an

output for a particular state.

While the functions of the machine described in Fig. 3 are the same as the hardware machine discussed earlier, the command-sequence machine is more flexible than the hardware version: The circuit operation can be altered simply by changing the command sequence. It is no longer expansion-limited, either, since any number of commands can be entered to control operation.

The concept of the control store can be further expanded to include any number of instructions—and two special circuits must be added to help keep track of the instructions (Fig. 4). The command pointer is used to indicate which sequence the machine is to execute. A circuit called the sequence modifier receives the pointer indicator and instructs the control store to move to command 1 of the indicated sequence.

The procedure can be explained most simply

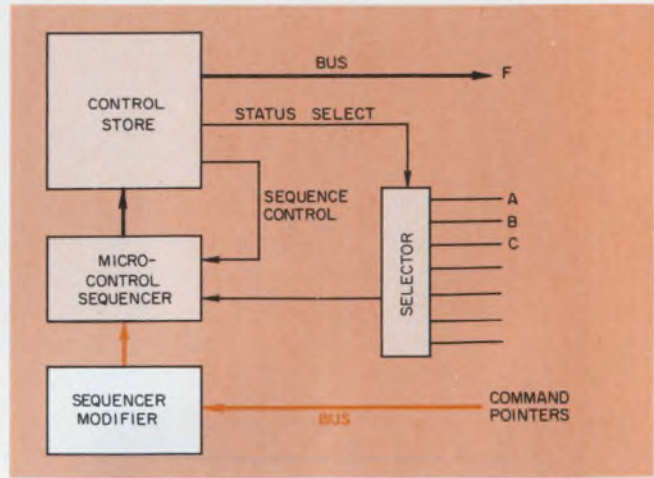

4. Adding command pointers and a sequence modifier to the machine equivalent permits the machine to handle multiple sequences of events. Each pointer selects a different sequence of instructions.

Some key terms used in processor design

Control store: a memory circuit designed to hold the sequence of commands that determines operation of the sequential-state machine (sometimes referred to as the microprogram store).

Sequencer: a circuit that pulls information from the control store memory, based upon external conditions.

Command pointer: a multiple-bit register that indicates the memory location being accessed in the control store.

Memory-address register (MAR): a multiple-bit register that keeps track of where instructions are stored in the main memory.

Instruction counter: a multiple-bit register that keeps track of the address of the current instruction and is used as the input to the MAR.

Register file: a bank of multiple-bit registers

that can be used as temporary storage locations for data or instructions (sometimes referred to as a stack).

Arithmetic and logic unit (ALU): a complex array of gates that can be used to perform binary arithmetic, logic operations, shifts and rotates and complementing.

Microprogram: a sequence of instructions held in the control store that determines what operations the processor performs for each command given to it by the main memory.

Field: a portion of a microprogram word that represents a group of bits dedicated to controlling a specific piece of hardware.

Pipelining: a hardware arrangement that permits different sections of a bit-slice processor to work simultaneously instead of sequentially, and thus speeds up processing.

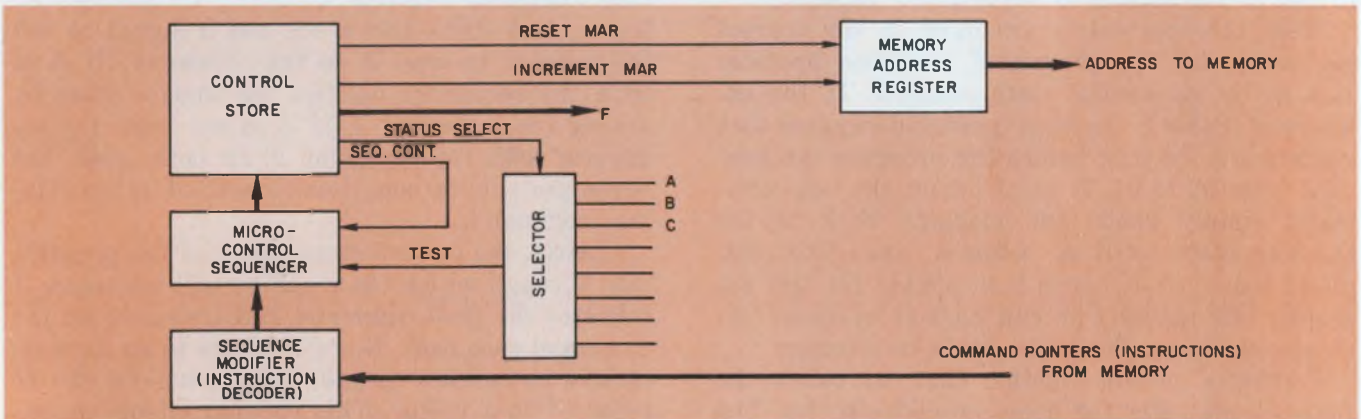

5. Accessing commands stored in a large memory becomes simple when the memory-address register is

added. The MAR outputs act as an address bus and connect to the memory address lines.

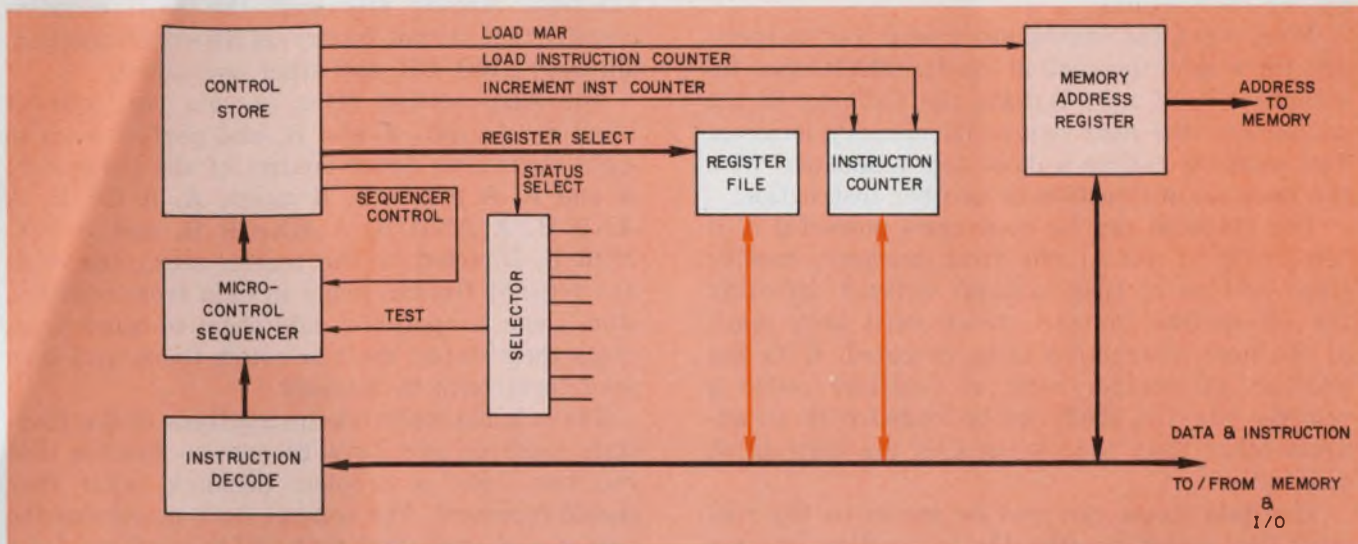

6. To store commands temporarily, add a LIFO register stack; to track them, add an instruction counter.

by likening it to a signal switch outside the machine. Assuming the control store has three predetermined sequences that can be followed (say, X, Y, and Z), the user can set a switch to X, and the machine will then perform that sequence of commands. If the switch is moved to Y or Z, the machine again will follow the selected sequence.

In reality, you have three different machines available since each switch position can instruct the machine to perform a totally different task.

Pointers expand machine capabilities

Giving the state machine the ability to respond to requests from an outside source lays the foundation concept of the digital computer.

The command pointers, which instruct the machine to perform different Fs, can be called instructions; the sequence modifier can then be more accurately described as the instruction decoder.

The instructions the machine receives from an external source can grow in complexity and numbers as the flexibility of the machine grows. The external storage section that holds all the instructions is called the memory. And a special register that keeps track of where the information is stored—the *memory address register* (MAR)—makes accessing the instructions simple.

Every time the machine has to get an instruction from the memory and use it, the machine goes through a fetch and execute cycle. The first step, of course, is for the machine to fetch an instruction from memory by telling the MAR to access the location it is pointing to, pull the information from it and load the information into the machine's instruction decoder.

Once the information is in the instruction decoder, it is interpreted. Then it tells the control store where to start for the sequence to be exe-

cuted. The sequence, in turn, fulfills the instruction. Instruction after instruction is executed in this manner until the desired result is obtained. Each time an instruction is completed, the control store modifies the MAR so that it points to the next location to be accessed.

So far, you have developed a machine that can go through a list of instructions in a sequential manner or go back to the beginning of the list from any point on the list. But the machine is still too limited. It should be able to go to any instruction from any other instruction, without incrementing or decrementing through each one in sequence.

The next step is to add another register, the *instruction counter* (often called the program counter), to the machine (Fig. 6). Then the control store, which controls the counter, can reset (clear) the register or increment it. Once the control store sets the instruction counter to its selected value, the counter's output can be used as the input to the MAR.

Jumps add freedom of movement

Now you can add a feature that allows you to modify the instruction counter in some way other than merely resetting or incrementing. You do it by adding both a load feature to the counter and a way to load the counter with the number. The information with which the counter is loaded can be stored in the memory as part of the instruction list. A new instruction must be added, of course—one that tells the machine to load the next information into the instruction counter.

Your machine now has the ability to go through a list of instructions and to any point on the list without a delay. Such information as new instruction locations is called data items since these aren't really instructions, but data acted upon

by the instructions.

Now, when the control store sends out to memory for a new instruction via the MAR, that instruction itself may initiate the fetching of the contents in the next sequential memory location. The contents can be a data item associated with the previous instruction or another instruction.

The machine can be even more powerful if it can bring in data items from memory, modify them and move them around without affecting the instruction counter, which must keep track of the next instruction to be executed. With the addition of another bank of registers called a *register file*, the MAR can be loaded with an address other than the contents of the instruction counter.

The data items can now be stored in the register file, which permits the instruction counter to carry on without modification. Once the data items are in the register file, they can be manipulated and called in any sequence, since the register file has its own special selection circuit (register select). The circuit is controlled by the control store.

Get the machine to pick the instruction

Even greater flexibility is possible if the machine can determine which instruction to fetch based on the various conditions of data items.

For your machine to be able to make its own decisions, another circuit is needed—the *arithmetic and logic unit* (ALU). When this block is added to the expanded machine (Fig. 7), the resulting circuit approximates the full computer.

The ALU actually combines two of the functional blocks discussed earlier, the instruction counter and the register file. In addition to the

functions already discussed, the ALU contains circuits that permit binary addition, subtraction, shifting, AND, OR, and other operations.

The ALU section often accepts two four-bit input words, say, A and B, and performs up to eight operations under control of the sequencer: A and B, A minus B, B minus A, A OR B, A AND B, \bar{A} AND B, A EX-OR B, and A EX-NOR B. Directed by the control store, the ALU and register file can bring in data from memory, store them temporarily, add them to other data, check their status, shift or rotate them, and even send them back to memory.

The original inflexible instructions of the four-state machine now have become so flexible that you may have a problem deciding what they should represent. The control store maintains the sequence of operations that will be performed for each instruction, the memory holds the list of instructions and related data items, and the ALU provides the means to manipulate the data in accordance with the instructions.

Basically, the machine described so far is a computer that is divided down into its most basic logic elements. Manufacturers have been able to integrate the major building blocks into complex LSI circuits, called bit slices. The ALU is actually the bit slice since it is often made to handle only two or four bits at a time. Most processing applications with minicomputers or large computers use 16 or more bits (Fig. 8).

If a central processor of a computer had to be divided into two parts, it would most naturally be split into one part that does all the manipulation—the ALU—and another part that contains the circuits that give the machine its “personality” or instruction set—the controller. The machine described thus far is a microprogrammable

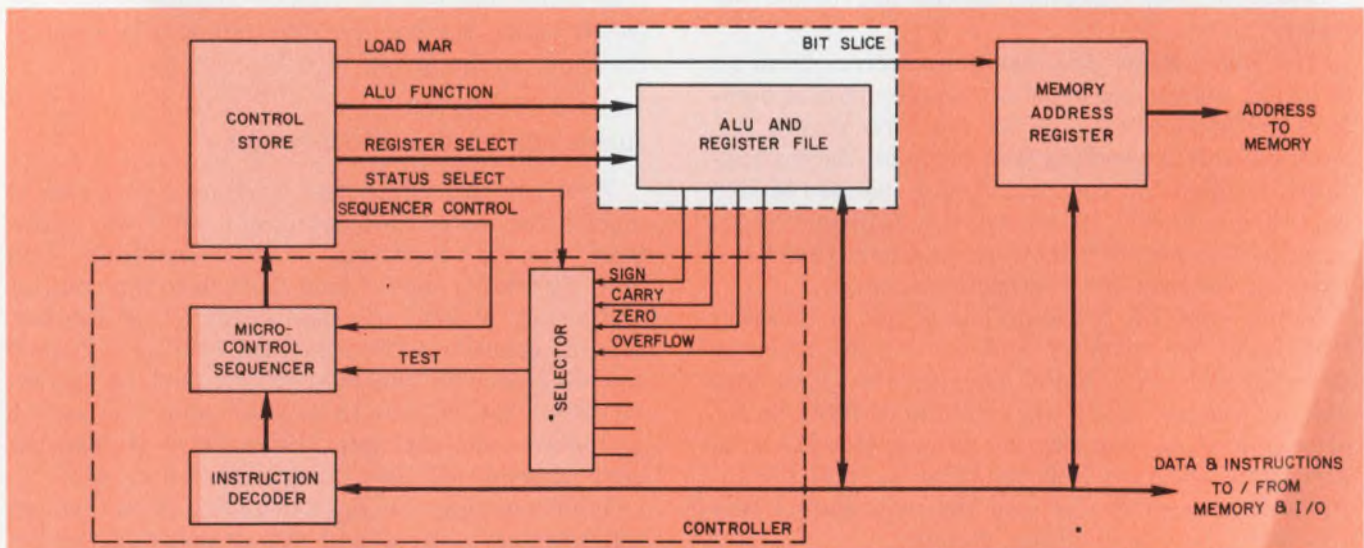

7. By combining the register stack into a larger circuit that also contains an arithmetic and logic unit, the last part of the basic logic processor falls into place. The ALU

and register stack are basically what is called a bit slice and the other circuitry, aside from the control store, is often called the controller.

Table 2. Available bit-slice processor circuits

Mfr. Device	Signetics	Intel	Texas Instruments	AMD	Raytheon	Motorola*	Monolithic Memories	Fairchild
Control store sequencer	8X02/3001	3001	74S482/	2709/2911	2909/2911	10801	6710	9408
Bit slice	2901-1/3002	3002	74S481/ SBP-0400	2901, 2901A	2901	10800	6701	9405A
Miscellaneous functions				29811 29803 2922	2902, 2905 2906, 2907	10802, 803, 804, 805, 806, 807 and 808		9404, 6, 7, 1 3, 10

*Motorola is also currently second-sourcing the 2900 series.

computer in which the definitions for each instruction held in the control store give the machine its "personality." Changing the way the ALU reacts to instructions by altering the microprogram held in the control store is called microprogramming.

There are, of course, many different ways to actually build a bit-slice processor, and even the bit slice itself. Table 2 lists the various manufacturers of available bit-slice circuits. If several bit slices and a controller are connected together with a control store memory, a complete processor can be built.

Cascade slices to make a processor

The basic architecture of a multiple bit-slice processor can be split into three major blocks—the bit slices, the controller and the control store. Many other circuits, of course, are necessary for it all to work—memories, buffers, interface circuits and clocks.

As discussed earlier, the ALU and the MAR are usually combined into a single circuit referred

to as a bit slice. Since each slice can handle four bits at the most, these circuits are designed so that they can be cascaded. Typical lines on a 4-bit slice include two four-bit data buses, two four-bit address buses, carry-in and carry-out lines, and many instruction control lines.

A cascaded arrangement would usually require that all the similar control lines from each slice be connected in parallel and the carry output of one circuit be connected to the carry input of the next. Any instruction then presented by the control store to the bit slices will be executed by all slices simultaneously.

All arithmetic and logic functions performed by the bit slice are dictated by the microcontrol store and the control sequencer. The sequencer presents an address to the microcontrol store, which, in turn, accesses the specified location and brings the microinstruction stored there to the sequencer. Next, the sequencer decodes the instruction, sends the command to the bit slice and computes the next microinstruction address. (The microcontrol store is typically a ROM or PROM that holds the binary patterns that represent

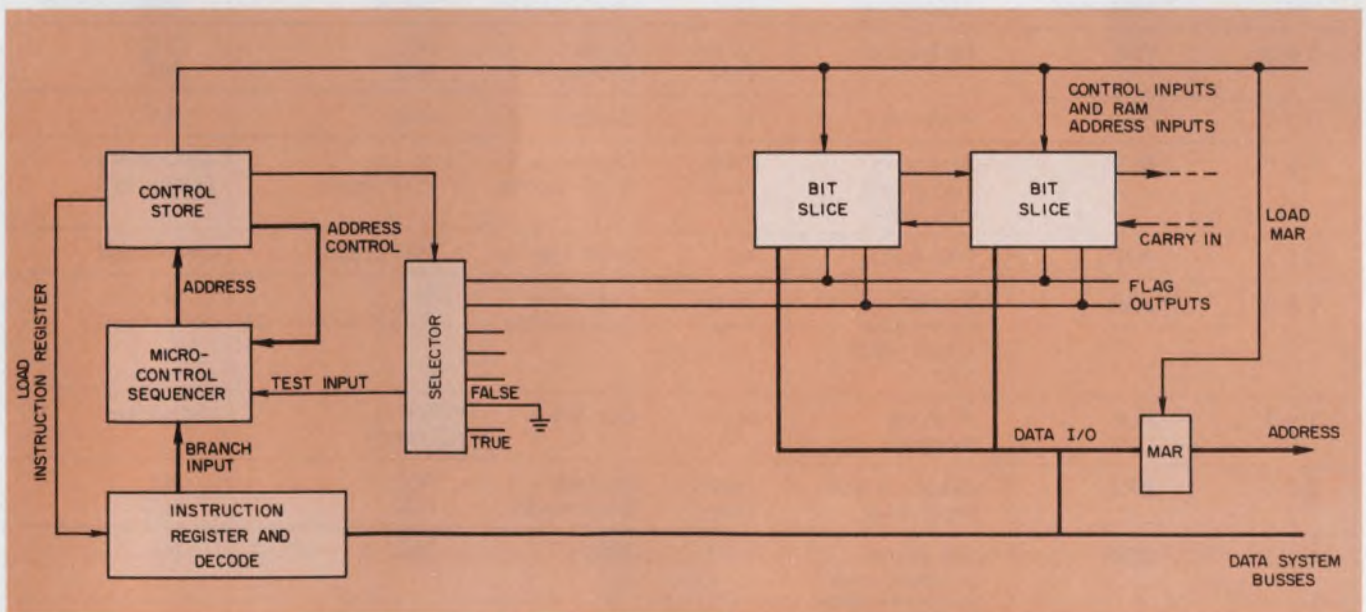

8. Multiple bit-slice sections can be combined with one controller to form an n-bit processor.

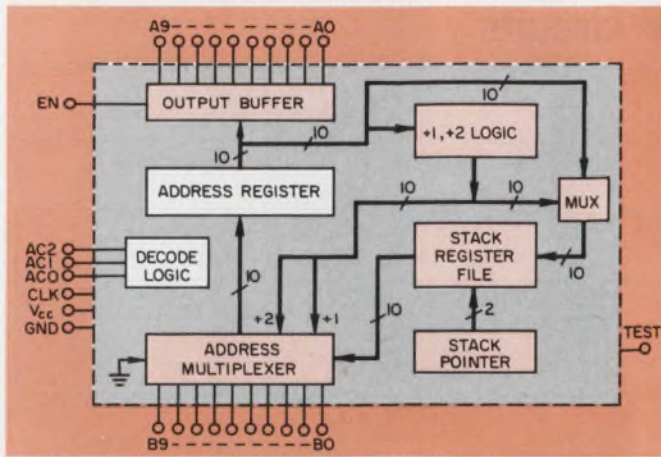

9. Inside a typical bit-slice sequencer you'll find the decode logic, address register and all other logic necessary to control the operation of the bit slice itself.

each microinstruction.)

Most bit-slice manufacturers have designed very similar circuits—each contains an ALU and can perform many of the same operations.

However, since most of the sequencer circuits vary widely in capability, a general discussion calls for a look at a simple “generic” sequencer that contains some decode logic, an address multiplexer, an address register, a stack pointer, a stack-register file and some other specialized logic (Fig. 9). Three control lines feed the decode logic and, depending upon the binary pattern fed in, any of eight different commands are possible (Table 3).

Each bit pattern can be represented by a three-

letter mnemonic that describes the function it will perform. The test-and-skip (TSK) instruction is much like the first instruction used in the four-state machine described in the beginning. To step through successive locations that can be addressed, the increment (INC) instruction provides a simple way to add one to the contents of the address register.

Special pairs of instructions that can alter the addressing sequence of the control store, such as branch-to-loop-if-test-true (BLT) and push-for-looping (PLP), can be used to establish points in a sequence of instructions where a small loop must be executed (Fig. 10).

When executed, the PLP instruction places the current microinstruction address in a temporary storage location. The next address presented to the control store is the current address plus one.

The microinstructions executed after a PLP instruction are part of a loop. When the set of microinstructions has been executed, the last instruction in the loop should be a BLT command to test a condition input. If the condition input is true, the address held in the temporary storage location is returned to the address register and the program goes back to its normal flow. If the test condition is false, the loop part of the program continues until a tested condition is true and the flow can alter again.

Register stacks provide temporary storage

More than one loop command can occur before a program reverts back to its original flow. In

Table 3. Typical sequencer commands and actions

Function AC _{2,1,0}	Mnemonic	Description	Test	Next address	Stack	Stack pointer
0 0 0	TSK	Test & skip	False True	Current + 1 Current + 2	N.C. N.C.	N.C. N.C.
0 0 1	INC	Increment	X	Current + 1	N.C.	N.C.
0 1 0	BLT	Branch to loop if test input true	False True	Current + 1 Stack reg file	X POP (read)	Decrement Decrement
0 1 1	POP	POP stack	X	Stack reg file	POP (read)	Decrement
1 0 0	BSR	Branch to subroutine if test input true	False True	Current + 1 Branch addr.	N.C. PUSH (Curr + 1)	N.C. Increment
1 0 1	PLP	Push for looping	X	Current + 1	PUSH (Current)	Increment
1 1 0	BRT	Branch if test input true	False True	Current + 1 Branch addr.	N.C. N.C.	N.C. N.C.
1 1 1	RST	Set micro-program addr. output to zero	X	All 0's	N.C.	N.C.

X—Don't care N.C.—No change

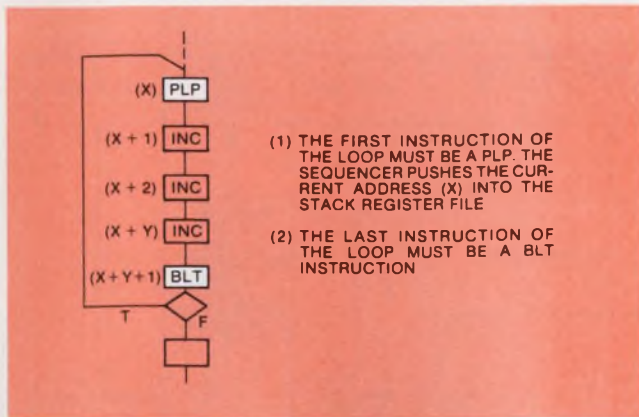

10. Program loops can be performed by the sequencer. Use a PLP instruction to initiate the loop and a BLT instruction to end the loop by testing for a condition.

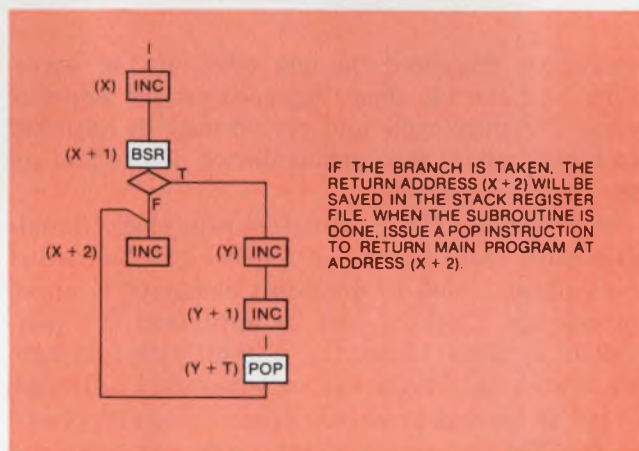

11. Branching within a program can be initiated with a BSR instruction and ended with a POP command.

this case, the temporary register must be able to hold several addresses in sequence. This temporary register is often referred to as a last-in, first-out (LIFO) stack.

A simple analogy to this register stack is the pile of unused trays in a cafeteria. When a tray (address) is placed on top of the stack, it remains there until removed (popped). However, another tray (address) can be placed on top of the stack. This tray pushes all the other trays (addresses) to inaccessible locations below the top level. When the top tray (address) is removed (popped), the one immediately below it assumes the vacant top position and all the others below move up.

Another pair of instructions that can affect the stack registers consists of the branch-to-subroutine (BSR) and "pop"-stack (POP) commands (Fig. 11). The BSR instruction pushes the current address plus one onto the stack and gets a new address from the branch input of the sequencer. When inputted to the control store this new address brings (vectors) the sequencer and control store to the first location of the subrou-

tine held in the control store.

When all steps of the subroutine have been executed, the last instruction encountered should be a POP command, which transfers the address stored in the stack back to the control-store address register. The instruction stored in that location is then fetched and executed.

The last two instructions for the sequencer are equally powerful commands. A branch-if-test-input-is-true (BRT) command provides for an unreturnable branch. The other available instruction is a reset (RST) command to the microprogram address register. When an RST instruction is given, the microprogram address register gets set to zero.

As the sequencer and control store proceed through a sequence of microinstructions, the address presented to the control store accesses a multiple-bit instruction. However, not all of the bits have to be used to control the bit slice.

The words in the control-store memory can be made any number of bits long, and can be split into different sections, called *fields*, which control various aspects of processor operation.

Suppose, for example, a system has many individual hardware elements that require several control bits each—for a total of 48 bits. ROMs can be placed end-to-end to make a 48-bit word. Each hardware element can then be controlled by a different field in the control word: 3 bits for the sequence, 3 bits for selector control, 3 bits for microprogram addressing, and so on (Fig. 12). In this illustration, bits 46 to 48 are used to control the control-store sequence and are referred to as the microinstruction field. Each bit combination in each field can be represented by a different mnemonic for easy recognition.

Once you define the physical connections and identify the mnemonics, the functions of the machine can be described by a sequence of microwords. But bear in mind that when you put together the microprogram instructions, most of your effort is toward direct control of specific hardware elements. You are bound by hardware timing restrictions, propagation delays, multiplexers and registers, decoding circuits and, most important, the bit slices.

Circuit structure determines timing

Detailed considerations of timing sequences and propagation delays are too complex and too variable to be discussed in a general article. Basically, however, every bit slice, sequencer and memory circuit can strobe the end result of any calculation into its destination with the rising edge of the clock-input signal.

Processors based on bit slices have timing cycles between the sequencer and control store. They are called microcycles. These time periods

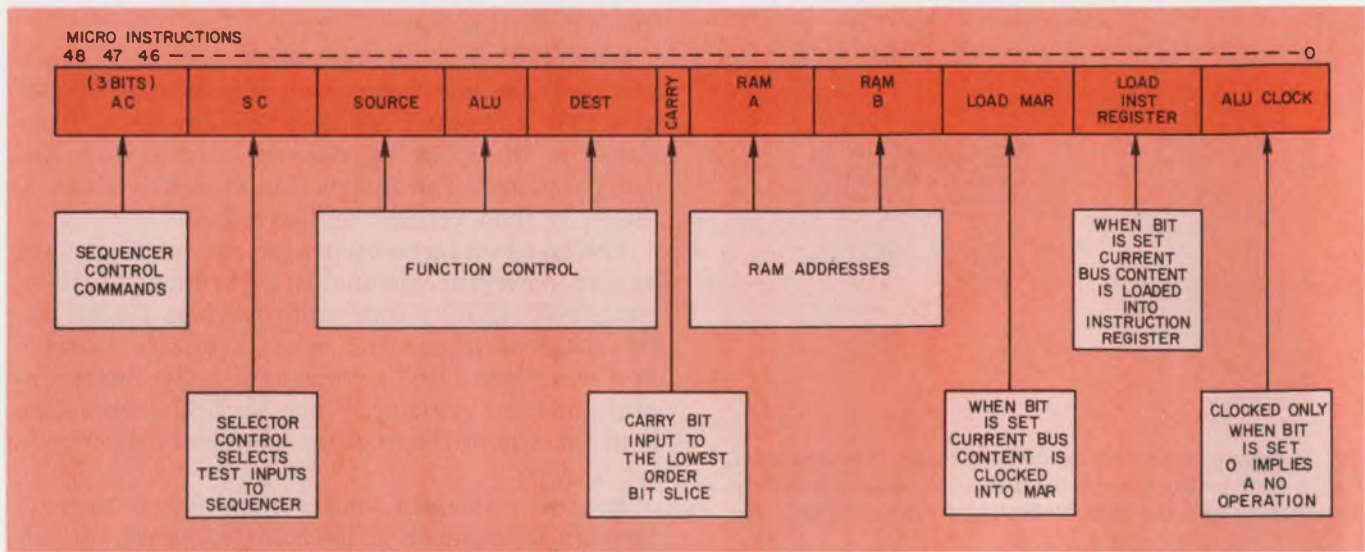

12. Each word held in the control store can be broken into many fields, with each performing a specialized function.

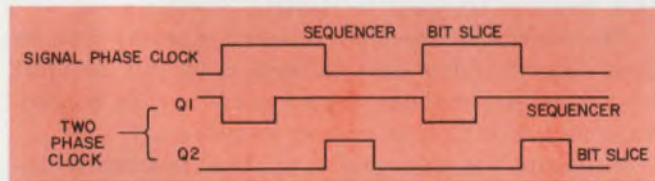

13. Single-phase or multiple-phase clocking schemes can be used to drive bit-slice processors. With nonpipelined processor designs, single-phase clocks can do the job, but for pipelined circuits, multiphase clocking can sometimes cut cycle times by 50%.

Table 4. Comparison of nonpipelined vs pipelined system cycle times

System		Cycle times	
		Nonpipelined	Pipelined
77 ns	8X02 sequencer	210 ns	130 ns
50 ns	82S115		
80 ns	2901-1 slice		

begin with the clocking of a control store address (microaddress) into the address register of the sequencer. This address must propagate out of the sequencer and reach the control store where, after a memory-access period, the microword held in the control store is brought out and presented to all elements.

After the microword appears, the bit slice requires a setup time so that the microword instructions can be followed. Once the bit slice is stabilized, it can be clocked to perform the ALU operation and either deposit the result in a selected location or put it on the system bus.

Timing for the entire process can be done in several ways, two of which are shown in Fig. 13. In a single-phase clock system, one clock and its inverse are used to drive all circuits, with the

sequencer triggered on one edge of the waveform and the bit slice triggered on the opposite edge. The duty cycle and period may be adjusted to accommodate the various device delays and set up time requirements.

A two-phase clock (two separate clock signals generated from a common source) can be used if each phase is fed to different elements to speed processing. Clocking can be optimized for individual sections better in a multiphase system since each duty cycle can be separately adjusted.

In the general processor organization discussed so far, the end result is not ready until the end of a time period equal to the sum of all the propagation delays and set-up times in the system. The delay can be shortened and the cycle time reduced by a circuit rearrangement known as *pipelining*.

The simplest form of pipelining consists of modifying the basic processor organization by adding a multiple-bit latch at the control store's output. When the output of the control store is known to be valid and the bit slice is finished with its current task this latch is clocked. Thus, the latch can hold control signals while the sequencer and control store get the next microinstruction. The system delay is no longer the aggregate, but is merely the longest delay of any one element. Table 4 shows a comparison of nonpipelined versus pipelined cycle times.

Of course, pipelining does not always speed things up. In programs requiring conditional branches, the condition that must be tested may occur long after the branch point. In this case, programming generally proceeds down the path with greatest probability of occurrence. Thus, if the path turns out to be the correct one, processing continues without any loss of time. However if the alternate path must be branched to, all levels of pipeline storage have to be cleared and new paths started from the branch point. ■■

WHETHER LOOKING FOR LIFE ON MARS...OR SUPPORTING LIFE ON EARTH...



SPRAGUE HYREL[®] COMPONENTS ARE PREFERRED.

Sprague is *the major source* of highly-reliable electronic components for *both* life-support medical electronics *and* space electronics.

For complete information on how Sprague Hyrel Components can benefit *your* high-reliability program, write or call John Moynihan of the Sprague Electric Company, 347 Marshall Street, North Adams, Mass. 01247. Telephone 413/664-4411.

'Hyrel' is a registered trademark of the Sprague Electric Co.

THE BROAD-LINE PRODUCER OF ELECTRONIC PARTS





Software modules are the building blocks of 'structured programming.'

Employ this tactic, and you will be rewarded with fewer errors, come debug time.

Software design, like hardware design, is attacked in two phases. First you look at the whole problem to be solved, state the problem objectively in the form of a functional specification and break the problem down into functional blocks. With the development of algorithms for each block you complete this first, or strategy, phase of your task. Second, you code each functional block in a suitable language, debug each block with a suitable computer and, finally, interface the programs for each block to form a complete solution to the problem.

These steps represent the tactics of programming. Fig. 1 combines the strategy and the tactics of software design in a systematic procedure called "top-down" design. It is the secret of good software engineering. The strategy of top-down design was discussed in Part 2 (ED No. 2, Jan. 18, 1977, p. 54).

Consistent software tactics (bottom part of Fig. 1) often involve the concept of structured programming. To some, structured programming is a procedure for constructing programs from a rigorous set of software modules that permit the realization of any definable algorithm. But, you can regard it simply as a consistent way of implementing programs through the use of a few basic building blocks that have proven convenient and reliable.

The key is simplicity

Structured programming is the basis for some of the higher-level languages (ALGOL, PL/1, and others). But the same basic structures can be used in assembly-language programming. All the basic elements of structured programming have one thing in common: Each valid structure has exactly one entry point and one exit point. As a result, individual program modules may be designed separately, then combined with a minimum of interface problems. Control is transfer-

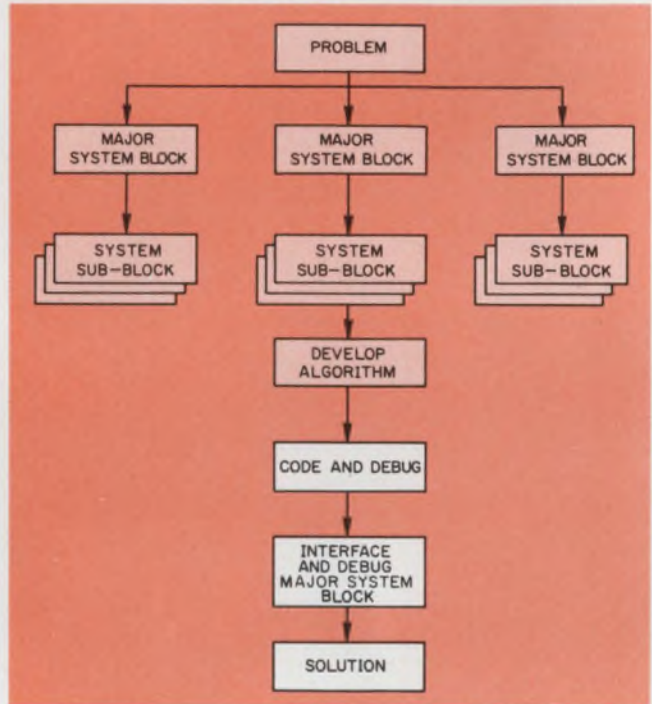

1. The final steps of "top-down" design are tactics (white). They are just as important as your strategy.

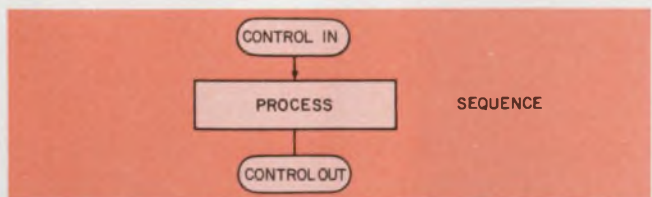

2. The sequence element is one of the basic building blocks from which software structures are assembled.

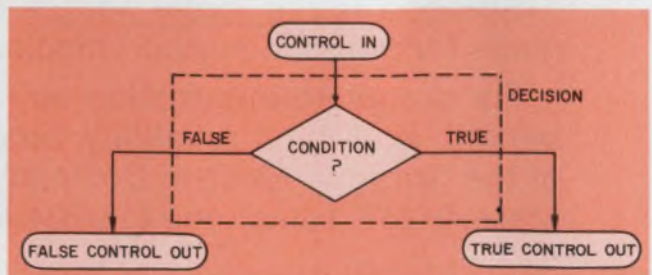

3. The decision element is the second software building block. It controls program branching.

Robert Ulrickson, President, Logical Services, Inc., 711 Stierlin Rd., Mountain View, CA 94043.

red from one structure to the next without any ambiguity.

The arch-enemy of sound programming, and the source of many errors is unrestricted use of program branching (several exits for one entry point). It is much easier to test and debug—and understand—program modules that have only one way in and one way out. Such modules are also easier to modify and maintain. Large, complex and varied programs can be formed from a few simple structures that have one entry and one exit point. Learning and using structured programming requires a certain amount of discipline and may mean unlearning some bad habits, but the resulting benefits—faster and less expensive program development—are sure to outweigh the difficulties.

All components of structured programming are composed of two building blocks, connected together in different configurations. Because both elements have well defined characteristics, the resulting structures have well defined characteristics. Hence, the programs you construct from them are reliable.

One basic building block is the sequence element (see Fig. 2), which is the simplest of the basic software structures. Control is transferred into it, a process is performed, and control is transferred out to the next program element. The process performed within the element can be as simple as a single instruction or as complex as the algorithm for an entire program. But a complex sequence element can usually be partitioned into simpler sequence elements.

The decision element (Fig. 3) is used to modify the flow of program control. When control passes into the decision element, a condition test is performed. If the condition is fulfilled, the test result is "true" and control exits in a particular direction. If the test result is "false," control exits in a different direction. Because it has more than one exit, the decision element isn't one of the

basic software structures. Therefore, the decision element must be combined with sequence elements to form single-entry, single-exit structures.

True-false decisions are made with conditional arithmetic/logic instructions, as discussed in the first part of this series. When an operation is performed by the computer, the result of that operation sets various "flags." You can use a decision element to test the state of these flags and thereby determine the next program step.

Program decisions can be passive or active. The passive decision tests the result of an operation that you perform anyway. For example, suppose you have just added a number to the accumulator and you want to know if the operation makes the accumulator overflow. You can make a passive decision without executing any other instructions by testing the carry flag.

A decision is active when you perform an arithmetic or logic operation specifically for the purpose of testing a condition. For example, suppose you have instructed the computer to input a character from a keyboard. The input operation itself doesn't usually affect any flags. To find out whether the new character is, for instance, a numeral, you must perform one or more specific tests and make an active decision.

Software starts with seven structures

The first group of basic programming structures is known as open structures. In an open structure, control passes into the structure, a process is performed, and control passes out of the structure after a single sequence is executed. Open structures provide no means to transfer control back to the entry point of the same structures. There are four open structures: sequence, if-then/else, if-then and select-operation.

A *sequence structure* is composed entirely of sequence elements, strung together as in Fig. 4. Sequence structures can be broken down into

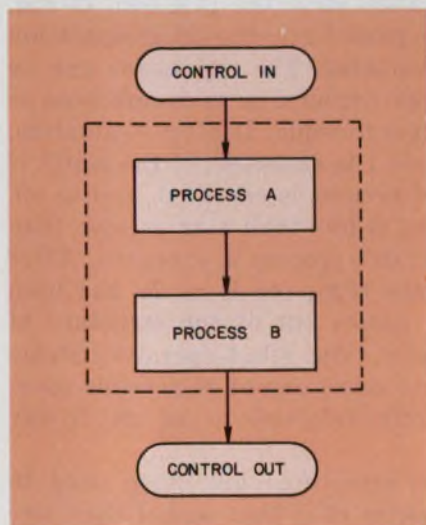

4. Sequence structures are formed exclusively from sequence elements or sequence structures.

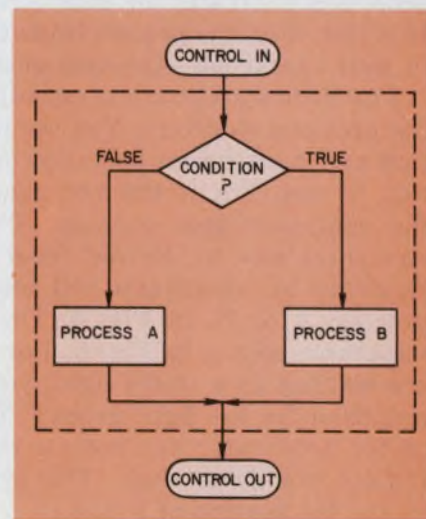

5. An if-then/else structure provides two paths for program execution, depending on the "condition."

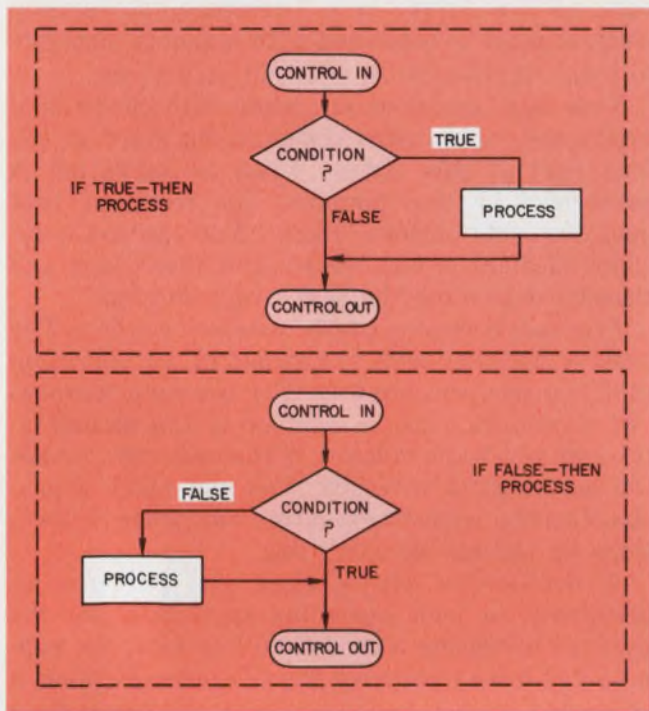

6. Two variations of the if-then structure differ only in the branching condition.

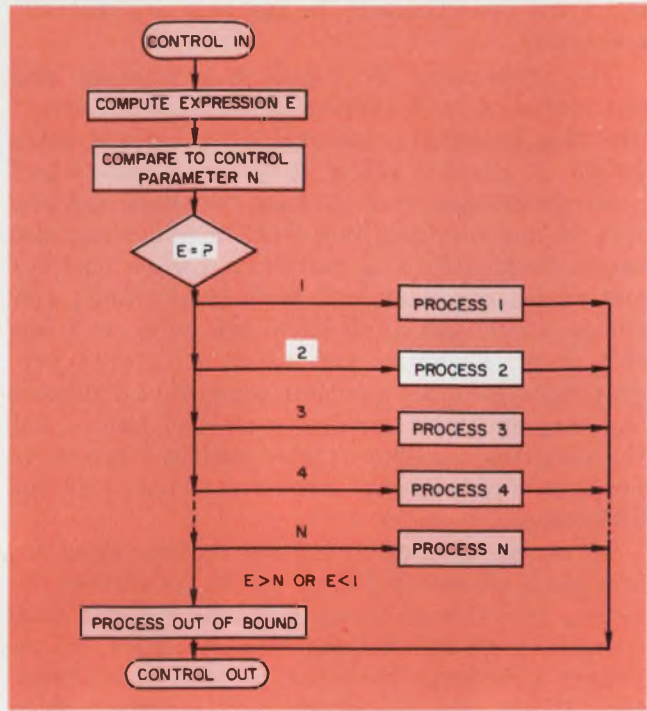

7. The select-operation structure is governed by an expression E. If $E = 2$, process 2 is performed.

simpler sequence structures, until they contain a single sequence element.

The if-then/else structure in Fig. 5 consists of a decision element and two sequence elements. In operation, control passes into the if-then/else structure and a condition is tested. If the condition is true, one process is performed. If the condition is false, the other process is performed. Regardless of the process performed, control passes out through the same exit. The structure thus conforms to the basic single-entry, single-exit rule.

Any program decisions and sequences can be used within the if-then/else structure. For example, you make an entry in your checkbook. If the entry is a deposit, process A adds the entry to your balance. If the entry is not a deposit, process B subtracts the entry from your balance. In either case, the process leads to the same place in your checkbook—the next entry.

The if-then structure is essentially a variant of the previous structure. You use it to test a condition and perform an operation if the test condition is met. But if the test condition isn't met, the computer does nothing. Two such if-then structures can be derived from the if-then/else structure by inserting a null sequence for either process, A or B, in Fig. 5. The results are the structures shown in Fig. 6. For example, if you are waiting at a traffic light, you might test the condition "is the light green?" If true, you step on the accelerator and execute the process "GO." If false, you do nothing. (This event is illustrated by the top portion of Fig. 6.)

Now assume you are approaching a traffic light. You perform the same test, "Is the light green?" If true, continue on (do nothing). If the condition is false (the light is red or yellow), you step on the brake and execute the process "STOP" (bottom part of Fig. 6). The only difference between the two structures in Fig. 6 is whether the process is executed when the condition is true, or false.

The select-operation structure is an open structure similar to the if-then/else structure, but it allows you to select one of N different operations based upon a more complex decision element. The decision element in this structure does not give a simple true or false decision as before. Instead, it evaluates an expression, E, and transfers control based on the value of E.

The select-operation structure is shown in Fig. 7. When control is passed into the select-operation structure, E is evaluated. The expression can be as simple as a single numeral or as complicated as a long mathematical formula. If after evaluation, $E = 1$, then process 1 is executed; if the result is $E = 2$, the second process is executed, and so on.

If the expression is less than 1 or greater than N, an "out-of-bounds" process is executed. After the selected process (e.g., for $E = 2$) has been executed, control passes out of the structure at the single exit point. The select-operation structure that is used to select one of N possible operations is frequently referred to as an N-way branch.

Select-operation structures are often used to replace a whole series of if-then and if-then/else

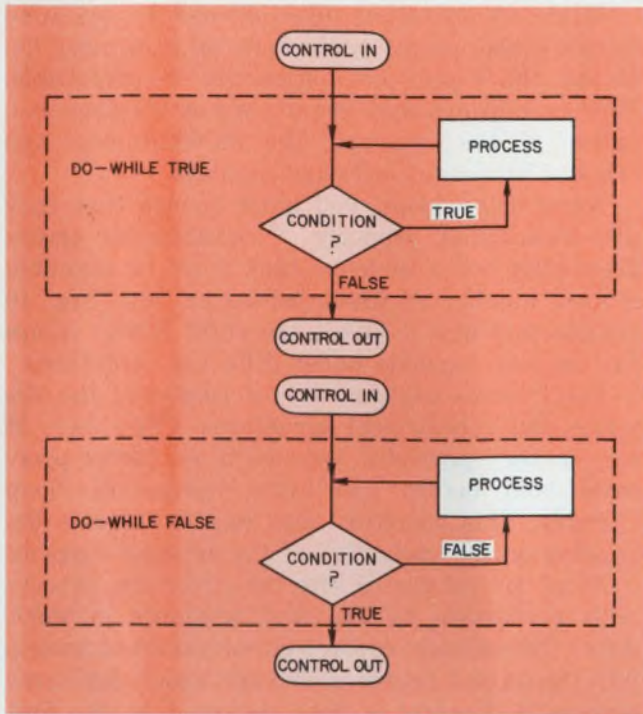

8. The variations of the do-while structure provide looping capabilities. They are closed structures.

structures. Instead of performing a series of individual tests, you can use a single variable. But you do need an algorithm for the evaluation of expression E.

Computers love to do the loop

The second group of basic programming structures provide a means for transferring control back to the entry point so that a sequence within the structure can be executed more than once. In these "closed structures," the sequence is executed repeatedly until a "terminal condition" is reached. Control passes into the structure through a single entry point and remains in the structure until the terminal condition causes control to exit through the single exit point. Often called "loops," closed software structures are found in most programs because computers excel in fast, repetitive operations. There are three fundamental loop structures: do-while, repeat-until and process-while.

The *Do-while* structure (see Fig. 8) has a decision element and a sequence structure. When control enters the do-while structure, the terminal condition is tested first. Depending upon whether the condition is met, either control passes out of the structure or the process is performed and the condition retested.

The two versions of the structure, do-while-true and do-while-false, differ only in that the loop terminates on a true or a false condition. Control passes out of the do-while structure when the terminal condition is met. Because the

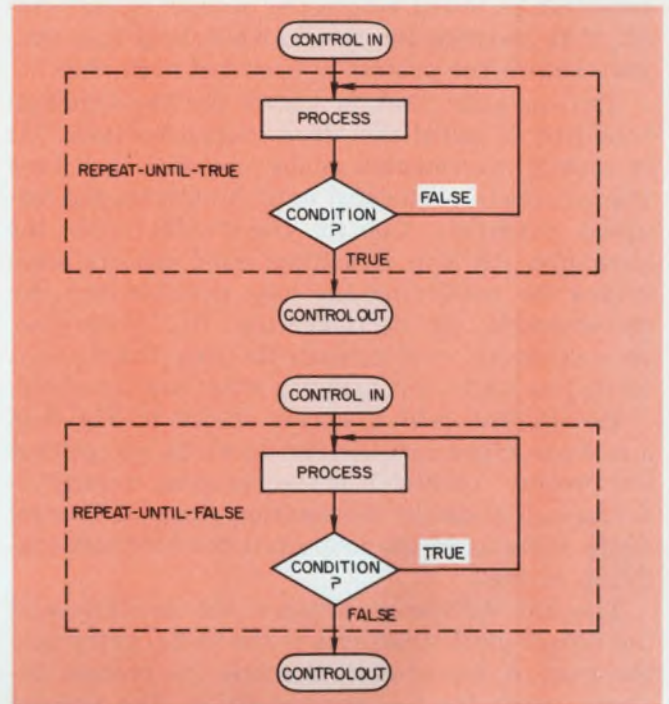

9. Repeat-until structures provide looping capability, executing the process at least once.

IF YOU DECREMENT	COUNT-DOWN LOOPS THAT	
	TERMINATE ON ZERO	TERMINATE ON NEGATIVE
BEFORE THE TEST	N + 1	N
AFTER THE TEST	N	N - 1

10. The initial condition of the loop variable, or counter, can be selected from this table.

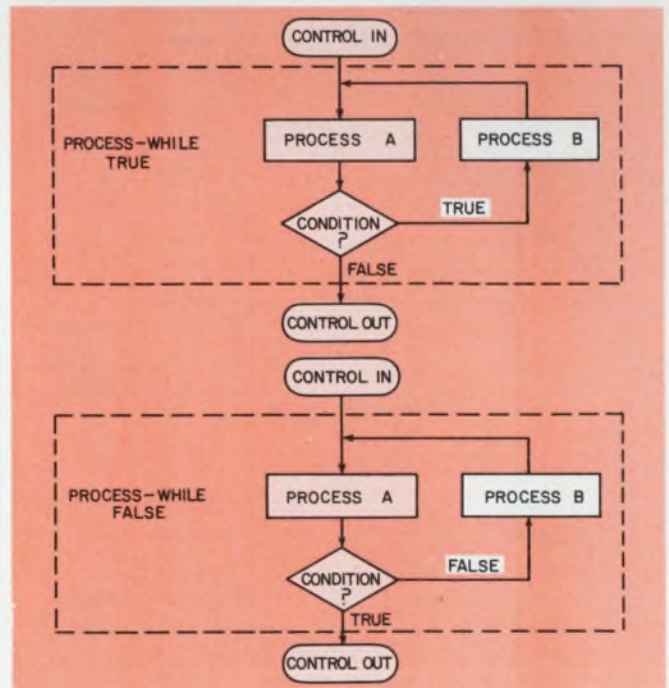

11. Process-while structures are combinations of the do-while and repeat-until modules.

condition is tested before the process is performed, it is possible for the do-while loop to terminate before the process is executed even once.

The quantity that is tested for the terminal condition is called the "loop-control variable." It is usually incremented or decremented each time the process is performed until it satisfies the terminal condition. Control then exits from the structure. All loop structures must contain some means for modifying the loop variable (e.g. by incrementing or decrementing it). Otherwise, your computer will process the loop indefinitely, while you wait—not knowing what has happened.

The Repeat-until structure shown in Fig. 9 is a loop structure just like the do-while, except that the process contained in the sequence element is performed ahead of the decision element. Control again remains in the loop until the terminal condition is met.

The key difference between the do-while and the repeat-until structures is the initial entry into the loop. A repeat-until executes its process before it tests for the exit condition. The process associated with a repeat-until structure is therefore always executed at least once before control exits from the structure. The do-while structure can be transparent.

The do-while and repeat-until loops can be used almost interchangeably in most applications. In counters and timers you can always adjust the loop variables to allow for the position of the decision element in relation to the sequence element.

When an operation must always be executed before a test can be performed, as in a pulse detector, the repeat-until structure is preferable. When conditions may require an exit before execution of the sequence, the do-while does the trick as in certain software counters.

When using loops, you must ensure that they are terminated properly. Programming errors frequently occur in loops that must be executed a fixed number of times before exiting. Fig. 10 summarizes how to select the right initial values for the loop variable under different conditions.

The Process-while structure combines the do-while and repeat-until structures (Fig. 11). It can be very powerful because it performs processes both before and after testing the loop variable. This structure also has two forms depending on the "polarity" of the decision element.

After control passes into the structure, process A is performed by the first sequence element. After the decision, control either exits or passes into the second sequence element which performs process B. Control is then returned to the first sequence element. Control remains in the loop until the terminal condition is reached.

Build a nest of looping loops

Inside the sequence structure of a do-while loop or a repeat-until loop you may well find other loops. This situation is so common that a special terminology for loops has evolved. Loops that are contained wholly within other loops are called "nested" loops. When several loops are nested (Fig. 12), their "nesting level" is numbered starting with the outermost loop (1) and proceeding to the next inner loop (2), and so on.

All nested loops must terminate in the reverse order from their initiating sequence. Failure to ensure the inner loops terminate before outer loops can lead to very interesting, but very useless results.

These seven basic structures can be used to construct programs of any complexity. You can write individual structured programs for each block in a larger program and then easily combine them into a complete system while adhering to the single entry, single exit rule. Structured program blocks can be interfaced in a straightforward way to minimize debug problems that stem from unrestricted branching, and the associated "rat's nest" of control transfers.

Future articles in this series will illustrate the use of top down design and structured programming techniques in computer arithmetic and I/O operations. ■■

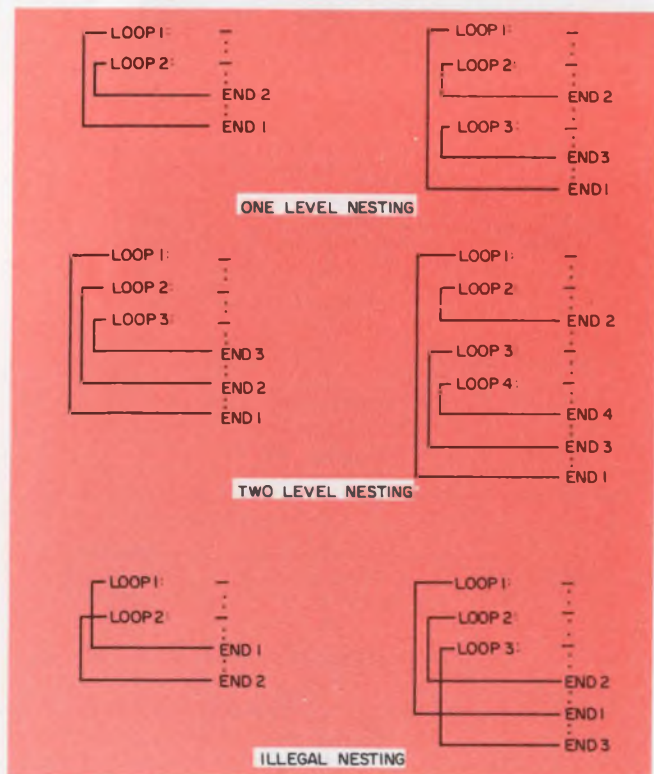

12. Loops can be nested, but you must take care that control is not transferred illegally.

Part 4 of the series will appear in the March 29 issue.

Not much, is it?

Log IF strips have never been easier or less expensive.

Thanks to the Plessey SL1521 Wideband Amplifier.

Complete in a single 8-lead TO-5 can, the SL1521 has a mid-band voltage gain of 12 dB, a video output of 1.0 mA and operates over the full MIL-temp range from -55°C to $+125^{\circ}\text{C}$.

For up to 60 dB compression from 60-240 MHz, just cascade up to five devices and you're done. No transistors, no discrete components, no interstage filters. And none of the costs and problems that go with them.

Or add another two SL1521's and a single interstage filter for more than 85 dB compression and a ± 20 MHz bandwidth at 240 MHz. It's still the simplest, least expensive way to go, so get all the details now.

At our prices, never has so little done so much.

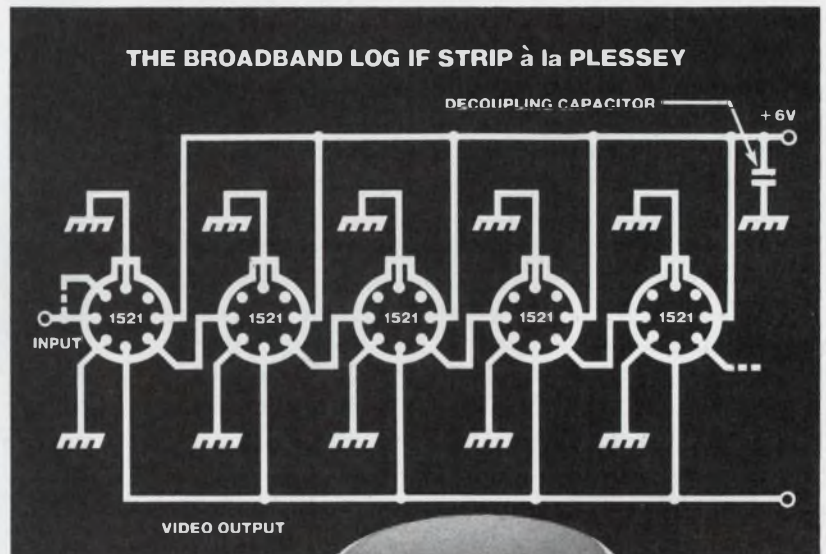

PLESSEY SEMICONDUCTORS

1674 McGaw Avenue, Irvine, CA 92714
Tel: (714) 540-9945 TWX: 910-595-1930
Represented world-wide.

State-of-the-art brought down to earth

Limiting wideband amplifiers □ TV, radio & telephone communications circuits □ High-speed dividers

Implement a lab-scope data display with μ P software

Design engineers need a flexible I/O device they can build with a minimum of interface hardware for use during the development phase of small μ P-based systems. A simple, low-cost video-display unit can be constructed with a conventional lab oscilloscope and only three discrete components. Synchronization and display refreshing are done with 49 bytes of software on an Intel 8080A μ P (Fig. 1).

The scope can display 24 characters (3 lines of 8 characters). Each character is formed with a 5×7 -dot matrix. Associated spacing increases each character to an 8×8 dot matrix, which corresponds to 1536 picture elements per frame. The 8080A can refresh sufficiently rapidly (about 50 ms per frame) to obtain a flicker-free display with a normal persistence scope.

Three bits—frame-sync, line-sync and video—control the CRT scanning. The frame-sync pulse rapidly charges an RC network through a diode. The gradually decreasing voltage as the capacitor discharges, ac-coupled to the scope's vertical (Y) input during the frame-refresh cycle, produces vertical scanning. Horizontal scanning is done with the built-in time-base generator, activated from its external trigger input by the μ P's line-sync bit. Finally, the video bit is connected to the Z-input to modulate the intensity.

A map of the display-data buffer (Fig. 2) shows that each character occupies eight bytes corresponding to eight buffer locations. If the display is to be updated from a keyboard, or other device, the device-generated interrupt switches from the video program to a new service routine. The service routine takes the ASCII-code from the input port associated with the particular device and uses it as an argument for accessing a look-up table that contains the dot matrix for each character. The table data are then distributed by a data-manipulation routine to locations in the display-data buffer that correspond to one of the characters.

Peter Ole Jensen, Applied Computer Technology, Lindevangshusene 19, DK-2630 Taastrup, Denmark.

CIRCLE No. 311

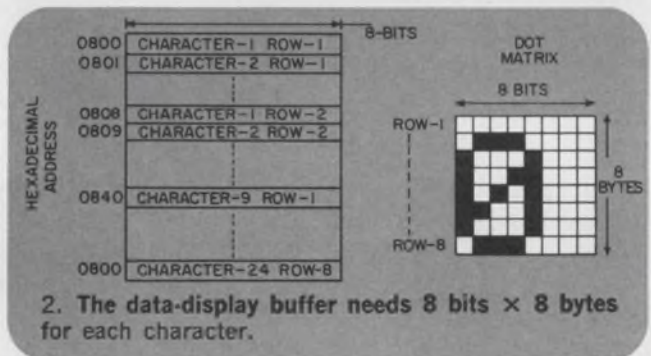
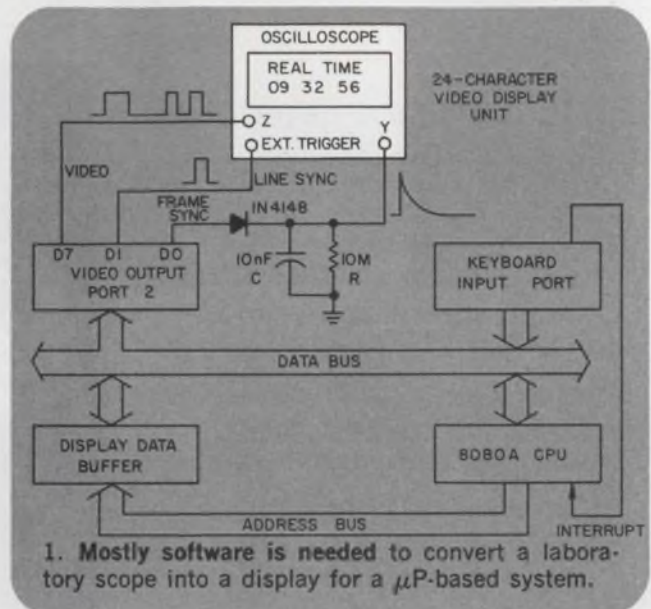

```

0100  55H      PSH  ATC 354; START VIDEOPROGRAM
0101  D3C7    CTR 2 ; OUTPUT PARALLEL
0104  1618    WRT  D,24; NUMBER OF LINES PER FRAME
0105  21000B  LDC  B,C000; DISPLAY DATA BUFFER START
0109  29C9    LDR  R,1
010B  D3C2    OUT  Z; OUTPUT LINE SYNC
010D  09C0    WRT  D,64; NUMBER OF COLUMNS PER CHARACTER
010F  7E      MOV  R,P
0110  00      NOP
0111  47      MCR  R,4
0112  7D      MOV  R,8;
0113  56DC    ANI  12H
0115  96F1    ORI  1
0117  D3C2    CTR  Z; OUTPUT VIDEO
0119  7D      MOV  R,8;
011A  17      BAL
011B  47      MOV  R,8;
011C  00      NOP
011D  C212C1  JRD  17H; NOW FINISHED
0120  5E01    WRT  A,1
0122  0A02    CTR  Z
0124  23      INR  R
0125  7D      MOV  R,4;
0126  5607    ANI  7;
0128  C2C0D1  JRD  57; LINE FINISHED
0129  15      DCR  R
012C  C2C7C1  JRD  55; FRAME FINISHED
012F  05C0C1  JOP  12;

```

3. This program for an 8080A μ P implements the use of a laboratory scope for data display.

If you need
a tester
with **special**
scales, ranges,
accessories
or any
combination...

Buy a
Triplett tester
custom-designed
for you

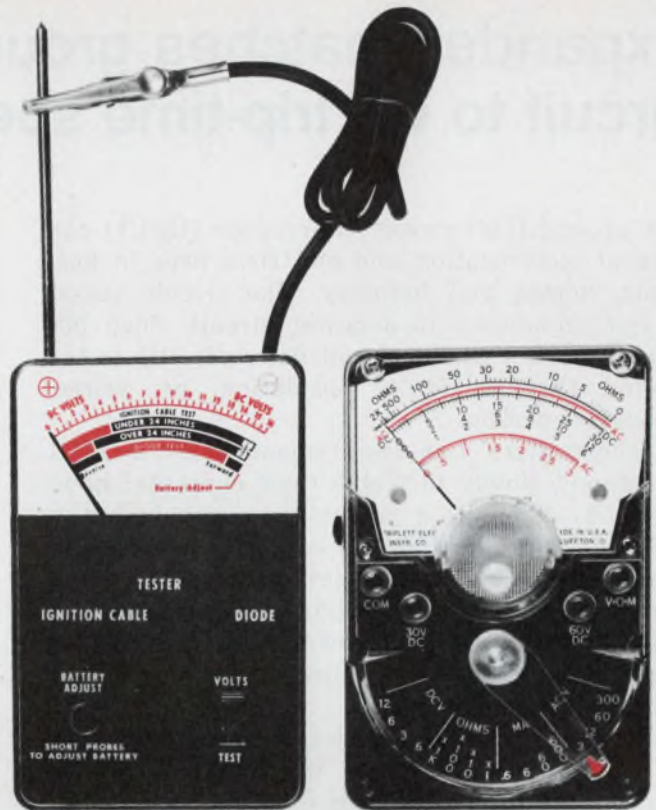

A

B



C

Triplett, manufacturer of the World's most complete line of V-O-M's, is ready, willing and able to design and manufacture special testers of virtually any size, style or type to meet your specifications.

Tester A (above) was designed to give auto mechanics a simple, rugged tester for "go/no go" tests that would otherwise be measured in electrical units unfamiliar to them.

Tester B is a modification of a

standard Triplett tester incorporating only the specific ranges needed by the field service engineers for whom it was designed.

Tester C has special ranges and special input connectors and cables to permit a single-point connection for trouble-shooting and servicing all the circuits of a complex business machine.

Several other buyers of standard Triplett test equipment request their company name on the dial to personalize their testers.

If you think a custom tester may solve some problems for you, contact your Triplett representative. He'll put you in touch with the Tester Designers and Engineers at Triplett who'll help you analyze the problem and suggest the optimum cost/result solution. Triplett Corporation, Bluffton, Ohio 45817

TRIPLETT
BLUFFTON, OHIO 45817

*Manufacturers of the World's
most complete line of V-O-M's*

CIRCLE NUMBER 29

CIRCLE 30 FOR FREE DEMONSTRATION

Expander matches ground-fault interrupt circuit to UL trip-time specifications

A ground-fault circuit interrupter (GFCI) can prevent electrocution and electrical fires in hospitals, homes and industry. The circuit senses current imbalance in a power circuit. Such imbalance occurs when current flows directly to the ground through faulty insulation, or, worse, through a person.

Underwriters' Lab requirements allow a GFCI to respond slowly to feeble fault currents; however, UL demands a prompt response to heavy faults. UL specification 914 is plotted as the solid line in Fig. 1. Acceptable devices must have current-time characteristics lying to the left and below the solid line. However, trip times much less than acceptable will cause too much nuisance tripping.

Commercially-available devices are surprisingly unsophisticated: Most trip within 25 ms, whether the fault current is 5 or 264 mA. But in the design shown in Figs. 2 and 3, the addition of a signal integrator greatly reduces the false tripping. However, a signal expander must be added to the integrator to restore fast action for large fault currents (Fig. 2).

Details of the signal expander, C, and inte-
(continued on page 72)

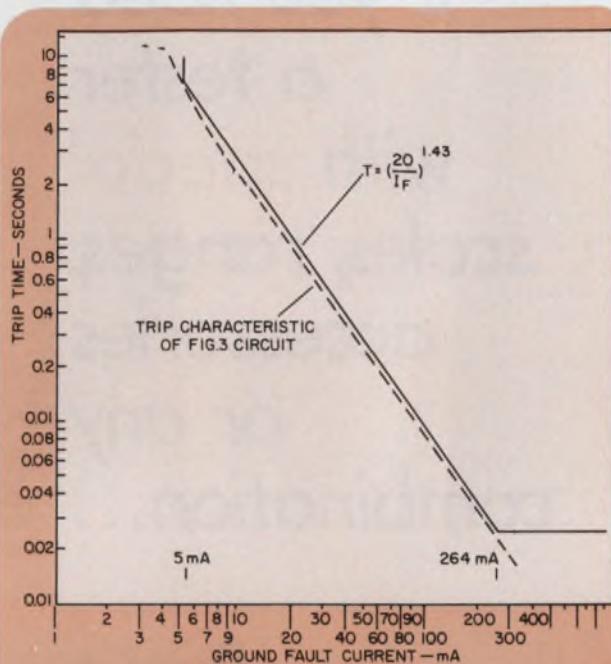

1. UL specs for GFCI systems allow slow response to small currents, but demand very rapid response when the current is substantial.

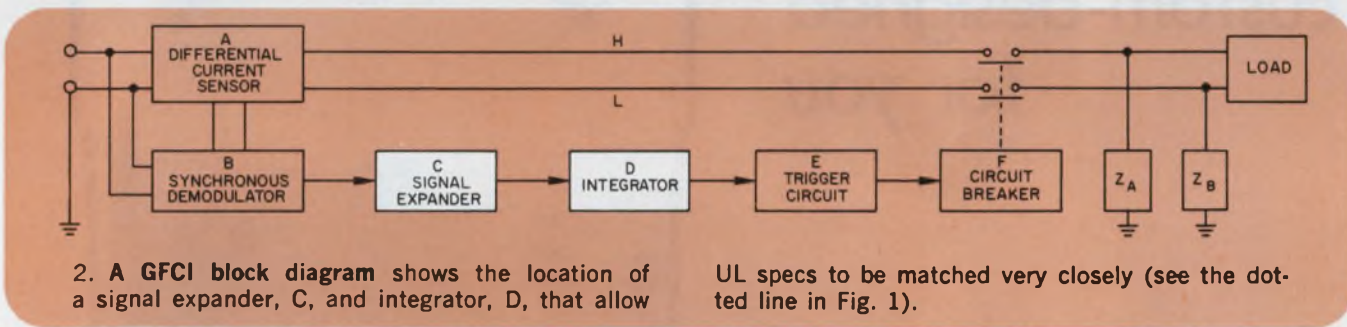

2. A GFCI block diagram shows the location of a signal expander, C, and integrator, D, that allow

UL specs to be matched very closely (see the dotted line in Fig. 1).

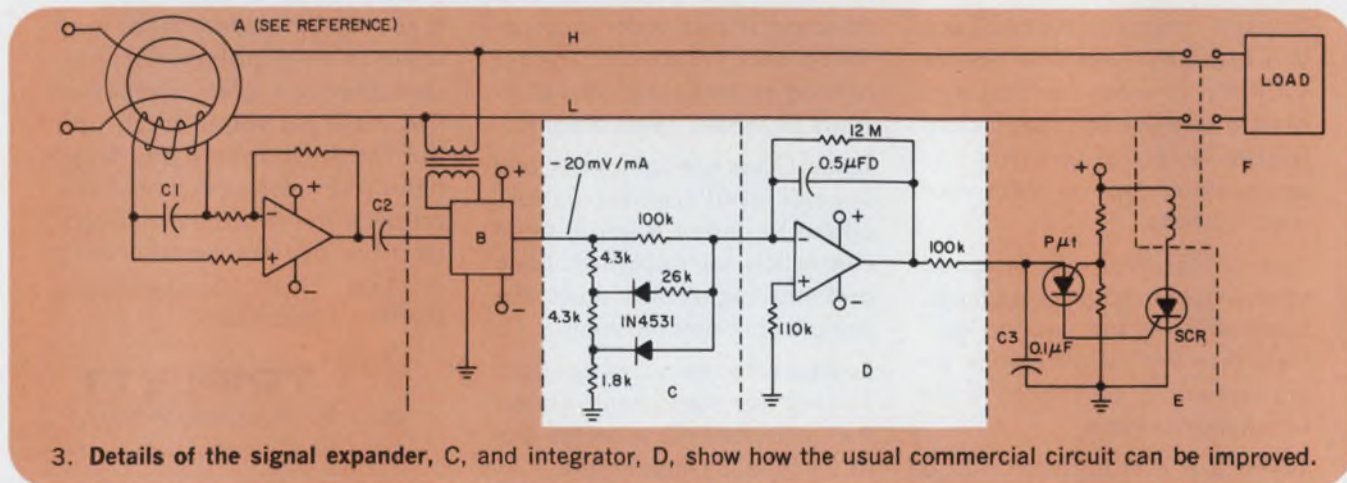

3. Details of the signal expander, C, and integrator, D, show how the usual commercial circuit can be improved.

Panasonic® Component News

Our technology is all around you

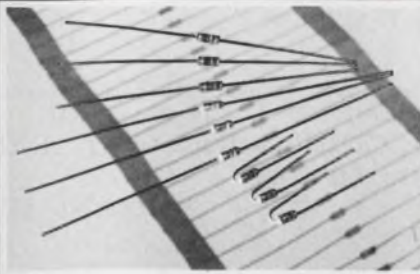

1/8W Miniature Fixed Resistors.

Both carbon film (ERD-10T: 1/8W at 70°C, 4.7 thru 220 Kohms with 2% or 5% tol.) and carbon composition (ERC-18G: 1/8W at 70°C, 10 thru 1 megohms with 5% or 10% tol.). These low cost, high performance resistors meet or exceed spec. RC05 of MIL-R-11 spec.

CIRCLE NUMBER 131

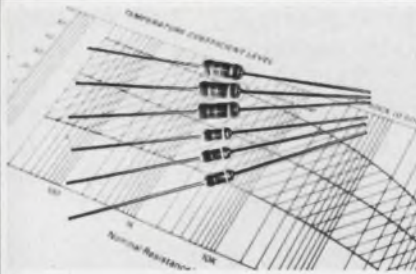

Precision Metal Film Resistors.

Commercial metal film resistor (in equal sizes with carbon composition), ERO-25C (1/4W at 70°C and 1/8W at 125°C, TCR: ± 50 or ± 100 ppm/°C, TOL: $\pm 0.5\%$ or $\pm 1\%$), ERO-50C (1/2W at 70°C and 1/4W at 125°C, TCR: ± 50 or ± 100 ppm/°C, TOL: $\pm 0.5\%$ or $\pm 1\%$) are available to meet MIL-R-10509 spec. Characteristic D.

CIRCLE NUMBER 132

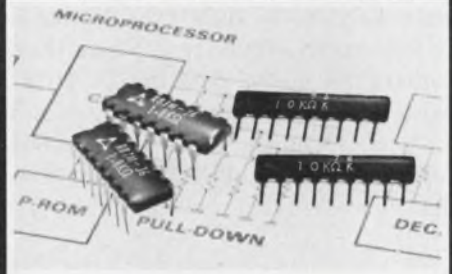

SIP/DIP Resistor Networks.

available in the popular configurations at low cost for such typical applications as pull-ups and pull-downs or line terminations.

SIP: 4 to 12 resistors, 100 Ω to 1 meg Ω with tol of 5, 10 or 20%

DIP: 7 or 13 resistors, 100 Ω to 10 K Ω with tol of 5, 10 or 20%

CIRCLE NUMBER 133



EVN-KOA and EVN-K4A series, highly reliable 8mm dia. trimming potentiometers available from large scale, completely automated production. Mounting pitch is compatible with Piher PT10h (2.5)/PT10v series and CTS X260/U260 series.

CIRCLE NUMBER 134

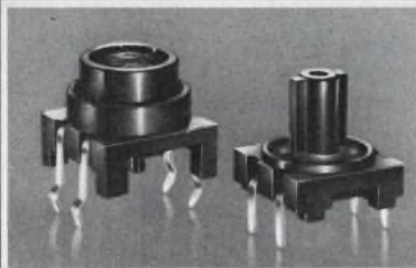

Momentary Push-On Light Touch Switch, EVQ-P series features short push stroke (0.4 \pm 0.1mm), light push force (130 \pm 40 grams) and long million time operating life. EVQ-PAR11K has snap in terminal with 13mm sq. body and EVQ-PBR12K of 12mm sq. and pc board terminal.

CIRCLE NUMBER 135

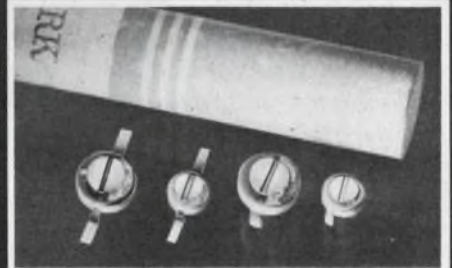

Thin Type Trimmer Capacitor ECV-1NW series, has wide variation adding SLF and high Q types. Small in size, excellent resettability, solid construction and low cost.

Dia.	Height	Cap range
.138"	.059"	3-10pF, 4.5-30pF, 5-35pF
.197"	.079"	2.5-10pF, 5-25pF, 5.5-40pF

CIRCLE NUMBER 136



Snap in terminal and safety top vent of large aluminum electrolytic "TS series", provides stable mounting on pc board and reliable performance. Capacitance Tol.: -10 to +50%, Life: 1,000 hours at 85°C, Capacitance Range: 220 to 10,000 μ F, Working Voltage: 16 to 200Vdc, Terminal Pitch: .394" common to all can size.

CIRCLE NUMBER 137

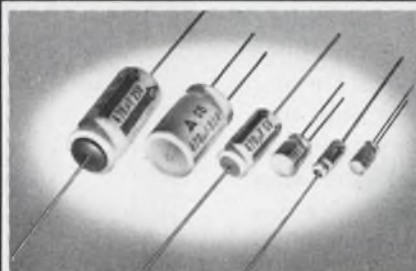

Miniature aluminum electrolytic capacitor Z series, features low impedance and leakage current. Max. Leakage Current: .002CV + 1 μ A, Life: 2,000 hours at 85°C, Capacitance Tol.: $\pm 20\%$, Capacitance Range: 0.1 to 2,200 μ F, Working Voltage: 6.3 to 50Vdc.

CIRCLE NUMBER 138

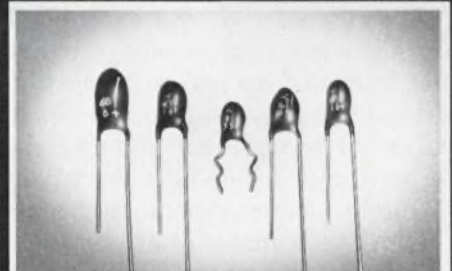

SQ series, epoxy resin dipped solid tantalum capacitor features long life of 2,000 hours at 85°C. Ideal for both consumer and industrial applications. Max. Leakage Current: 0.01CV or 0.5 μ A, whichever is greater, Capacitance Tol.: $\pm 20\%$, Capacitance Range: 0.1 to 220 μ F, Working Voltage: 3.15 to 50Vdc.

CIRCLE NUMBER 139

PANASONIC COMPANY, Division of Matsushita Electric Corporation of America.

Industrial Components Department, 1 Panasonic Way, Secaucus, New Jersey 07094 Tel: (201) 348-7000 TWX: 710-992-8920

grator, D, are shown in the schematic (Fig. 3). With -20 mV, mA of fault current driving the expander, the dotted-line characteristic of Fig. 1 is achieved.

This remarkable approximation is obtained with the use of only two diodes in the expander. Below approximately 1 V, neither diode conducts for inputs corresponding to 50 mA of fault current. The integrator averages noise signals over several seconds. With an increasing signal, the top diode conducts first, then the lower diode, to decrease the integration time constant so that

prompt response to strong faults is achieved.

If the diodes are removed from this circuit, the integration time is governed by the $100\text{-k}\Omega$ input resistor. The time to trip with a 264-mA fault would then be over 130 ms, more than enough time for someone to get hurt.

Reference

1. Gross, T. A. O., "Super Toroids with Zero External Field," *Electronic Design*, Sept. 1, 1976, pp. 110-111.

T. A. O. Gross, Consulting Engineer, T. A. O. Gross & Associates, Lincoln, MA 01773.

CIRCLE NO. 312

Test probe checks power or continuity without switching or probe adjustments

A simple probe circuit with two LED indicators not only equals, but even outperforms a VOM for troubleshooting in many applications—and costs less than \$4 to make. Small enough to fit into the housing of a penlight flashlight, the probe uses an AA-sized 9.8-V mercury battery.

Live ac or dc circuits (1.5 to 500 V) and the continuity of components—including semiconductors—can be checked without any switching, adjustments or changes in the probe unit. This feature is especially handy when testing switched-ground circuits that present continuity or voltage levels, alternately, at the same point.

When the probe circuit's test-lead tips are placed across a circuit with continuity but with no difference in potential, current from the internal battery forward biases the emitter-base junction of transistor Q_1 and turns it ON. Collector current from Q_1 illuminates the green LED; the small base current that flows through the red LED is not sufficient to light it.

The intensity of the green LED is maximum when the external-circuit resistance is low. Since this intensity decreases proportionally as the external-circuit resistance increases, not only can the relative resistance value of many components be determined, but also the functional operation of potentiometer wipers can be checked.

If the external circuit contains a semiconductor, the green LED will light only when the probe tip is connected to the n-type material.

When the probe tip is made positive by 1.5 V or more (relative to the other test lead), the emitter-base junction of Q_1 becomes forward-biased and turns Q_1 ON. The voltage of the battery in the Q_1 collector circuit adds to the external voltage, and the resulting current is enough to cause the red LED to illuminate. Since the voltage drop across the Q_1 emitter-collector circuit is low enough to keep Q_2 OFF, the green LED stays dark.

If neither LED lights—even when the leads are interchanged—the tested circuit is open or of relatively high resistance (above $5 \text{ k}\Omega$). If the red LED lights no matter which way the leads are connected, an ac voltage is present. A dc voltage lights the red LED only when the probe tip is positive.

A coiled test lead is desirable and should be removable to prevent the tips from touching and draining the battery when not in use. If installed in a metal enclosure, the housing should be insulated with heat-shrinkable tubing.

L. H. Logan, 436 Warner Circle, Norfolk, VA 23509.

CIRCLE NO. 313

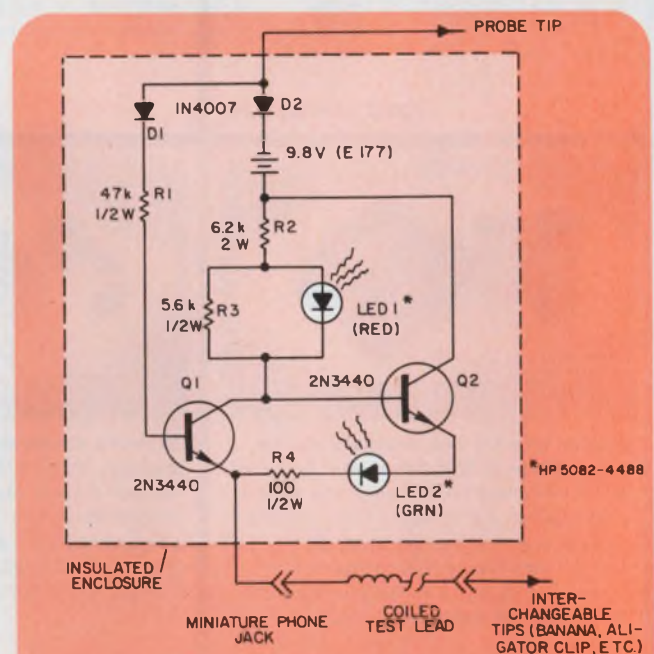

A handy testing probe can check circuit continuity, live 115-V-ac or 28-V-dc power circuits, or even transistor circuits, without changing scales or switching.

WE KNOW A LOT ABOUT A LITTLE.

Silicon-iron alloys, for instance.

Magnetics offers you fast delivery on silicon-iron alloy coils in 1- to 7-mil thicknesses, either coated or uncoated. And we're the only source for 5- and 7-mil nonoriented types. You can count on them for uniformity in magnetic properties—in fact, we make and use them for our own magnetic devices, so they have to be right. In widths to 15".

Our Magnesil catalog tells more. For a copy, write Magnetics, Metals Division, Butler PA 16001.

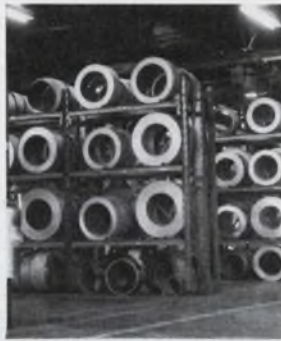

Magnesil materials provide low core losses.

Very special specialists in specialty alloys.



CIRCLE NUMBER 73

WE KNOW A LOT ABOUT A LITTLE.

High Q ferrite cores, for instance.

Our V material offers you outstanding loss and temperature characteristics in critical filter applications. With a loss factor of 1.5×10^6 @ 100 KHz and a temperature factor of $0.4 \times 1.0 \times 10^6$ from 0°C to 55°C, the cores enable you to reduce filter size and improve

both temperature and frequency stabilities. Sample pot cores are available for evaluation. For more information on our 14 different ferrite materials, write Magnetics, Components Division, Butler PA 16001.

Typical curve of a Magnetics high Q ferrite core.

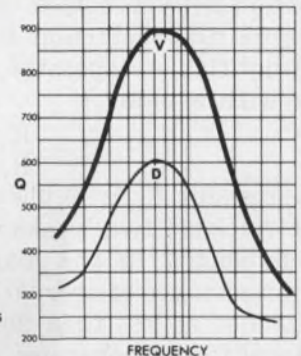

Very special specialists in ferrites.



CIRCLE NUMBER 74

new from Hayden!

“. . . well-organized, extremely well written . . . highly recommended for practicing engineers...”

IEEE Transactions

DIGITAL SIGNAL ANALYSIS

Samuel D. Stearns

This is an ideal master handbook on today's signal processing procedures and systems, containing recent advances, new design material, and a comparison between continual and digital systems that's extremely helpful to newcomers to the field. Featuring a foreword by Richard Hamming, the book contains a review of linear analysis; sample-data systems; analog-to-digital and digital-to-analog conversion; the discrete Fourier transform and the fast Fourier transform algorithm; spectral computations; non-recursive and recursive digital systems; computer simulation of continual systems; analog and digital filter designs, and more. 288 pages

“Jacobi's book is great . . . a new, original, readable, usable book on writing for business and professional people. . . .”

Jim Lufkin, Mgr. Professional Publications, Honeywell.

WRITING AT WORK: Dos, Dont's, and How Tos

Ernst Jacobi, Xerox Corporation.

This guide to better writing follows its own principles by being lively, informative, and easy to read. More than a collection of pat rules and formulas, the book is a storehouse of practical advice for business and professional people to make their writing sharper, more interesting, and more informative. It shows you how to overcome procrastination and change your entire attitude toward writing, making it easier and more enjoyable for you! 208 pages.

ELECTRONIC DESIGN 3, February 1, 1977

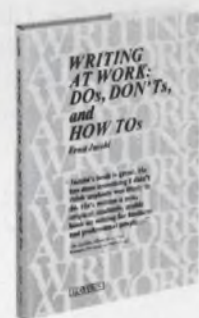
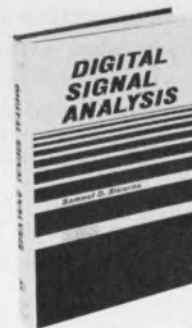

HAYDEN BOOK COMPANY, INC.
50 Essex Street, Rochelle Park, New Jersey 07662

Order today—15-day examination!

Please send me the following book(s) to read and use FREE for 15 days. At the end of that time I'll either send the amount indicated, plus postage and handling, or return the book(s) with no obligation.

- DIGITAL SIGNAL ANALYSIS, #5828-4, \$19.95
 WRITING AT WORK, #5730-X, \$10.95

Name _____

Company/Institution _____

Address _____

City/State/Zip _____

SAVE MONEY! Payment Enclosed. Publisher will pay all shipping and handling charges. Same 15-day return privilege and full refund if not satisfied.

Output from compression amplifier is constant over an input range of 50 dB

The amplifier shown in Fig. 1 can provide a fixed-amplitude output with input changes of over 55 dB; distortion is very low.

Amplifier A₁ operates as an inverting amplifier with a gain

$$E_o = \frac{R_2}{R_1} E_i.$$

The resistor R₂ is a photoconductive cell whose spectral sensitivity peaks in the red area. The cell recommended in the diagram has a measured dark resistance of over 20 MΩ; in maximum light, resistance is less than 200 Ω.

Amplifier A₂ operates as a high-input-impedance rectifier. The amplifier's dc output is proportional to its input, and it drives a LED that is optically coupled to the photoconductive cell in a negative-feedback arrangement.

With the values shown, the output, E_o, remains substantially constant at 2 V over an input range of 0.05 to 30 V. This output level can be changed by adjusting the value of R₃. For example, with R₃ = 100 Ω, E_o = 0.2 V; with R₃ open circuited, E_o = 3 V.

The housing for the LED photoconductive cell assembly must be light tight. Suggested dimensions for an adequate housing are shown in Fig. 2.

Of course, the frequency response of the circuit depends upon the op amps used.

K. F. Fehling, Engineer, RCA, AUTECH Project, Weapons Range, FPO New York, NY 09559.

CIRCLE No. 314

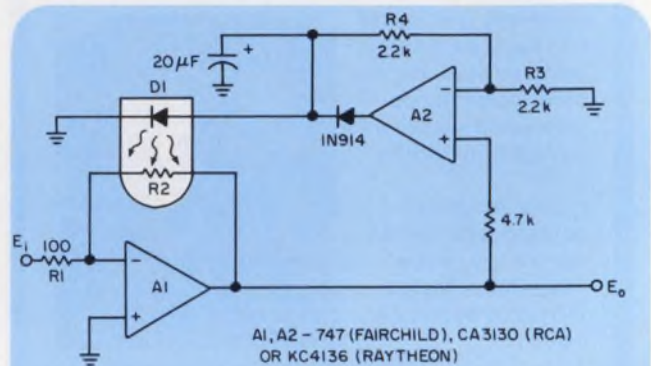

1. The output of the compression amplifier can be set from about 0.2 to 3 V by changing R₃ from 100 Ω to an open circuit.

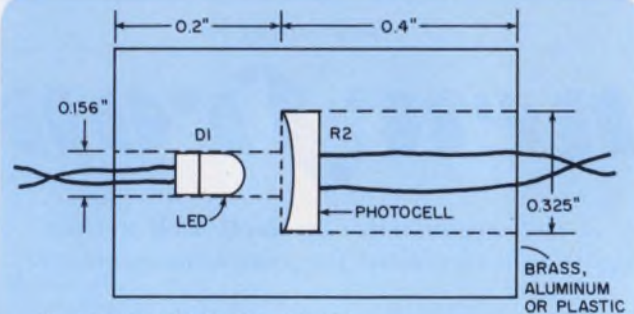

2. A housing for the LED/photocell assembly can be made from almost any material, but it must be light tight.

IFD Winner for September 27, 1976

Ivar A. Dybvik, Engineer, River & Harbour Lab., Klabuyn 153, N-7000 Tr. heim, Norway. His idea "Temperature-Measuring Bridge Uses Constant-Current FET Circuits" has been voted the most valuable of Issue Award.

Vote for the Best Idea in this issue by circling the number of your selection on the Reader Service Card at the back of this issue.

SEND US YOUR IDEAS FOR DESIGN. You may win a grand total of \$1050 (cash)! Here's how. Submit your IFD describing a new or important circuit or design technique, the clever use of a new component or test equipment, packaging tips, cost-saving ideas to our Ideas for Design editor. Ideas can only be considered for publication if they are submitted exclusively to ELECTRONIC DESIGN. You will receive \$20 for each published idea, \$30 more if it is voted best of issue by our readers. The best-of-issue winners become eligible for the Idea of the Year award of \$1000.

**This low cost
10 amp relay
conserves
PC board
space**



... and look at all the other design advantages our 28H Series relay offers.

Our 28H Series SPDT relay has so much going for it, it's hard to know where to begin. First, it's mini-sized—occupies only .92 sq. in. board area x 1.188" high. Second, it comes with a dust cover as standard and is available with a choice of enclosure styles and terminals to suit your application. It's also sensitive... 176 mw pick-up. Best of all, its low cost meets or beats competitive prices. U/L recognized. 10 amp 0.8 PF 120V 60Hz or 28V dc resistive. 3 amp models also available.

Write for information today!

NORTH AMERICAN PHILIPS CONTROLS CORP.

Frederick, Md. 21701 • (301) 663-5141

CIRCLE NUMBER 34

FREE! THE ALL-NEW NEWARK ELECTRONICS CATALOG 103

**688 PAGES!
100,000 ITEMS.
ALL PRODUCTS LISTED
ARE STOCKED.
150 TOP BRAND NAME
LINES**



FEATURING **RCA**
**SOLID STATE
DEVICES**

- Triacs
- SCRS
- Hi-Rel
- COSMOS
- Memories
- Power Transistors
- Microprocessors
- Linear I.C.'s

**WRITE
OR PHONE
TODAY
FOR YOUR
PERSONAL
COPY!**



NEWARK ELECTRONICS

500 N. PULASKI • CHICAGO, IL 60624
PHONE (312) 638-4411 • TELEX 25 3218

CIRCLE NUMBER 35

ELECTRONIC DESIGN 3, February 1, 1977

FLEX CIRCUITS MEAN SECURITY

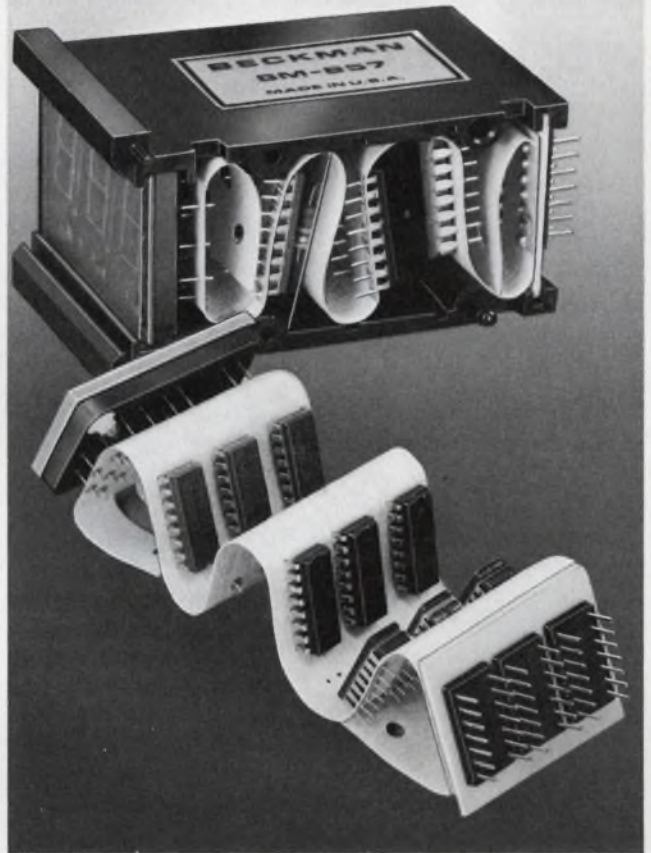

A new, exciting way to pack a lot of added security into your design.

R/flex circuits do several jobs at once and accordion fold to fit.

Heightened reliability and lowered costs assured by elimination of multiple circuit boards and jumpers. Labor savings, too, with components mounted directly on circuit—manually or automatically inserted. Stiffeners can be added where needed.

Can be made in one to six layers in a variety of shapes and sizes, with or without plated-through holes.

ROGERS CORPORATION
Chandler, AZ 85224 (602) 963-4584

EUROPE: Mektron NV, Ghent, Belgium JAPAN: Nippon Mektron, Tokyo

CIRCLE NUMBER 36

Optoelectronic switcher works in GHz range

An optoelectronic device that can switch signals in the GHz range has been developed at the Universitat Erlanger-Nurnberg in West Germany. Switching is achieved by exciting highly conductive solid-state plasmas with laser pulses.

The basic structure is a 50- Ω microstrip transmission line fabricated on a 4000- Ω silicon substrate measuring $2.54 \times 2.54 \times 0.05$ cm (see Fig. 1). The microstrip has a narrow gap that normally blocks the signal path; a grounded structure close to the microstrip is also separated by a gap (0.1 mm).

A laser pulse focused on the gap

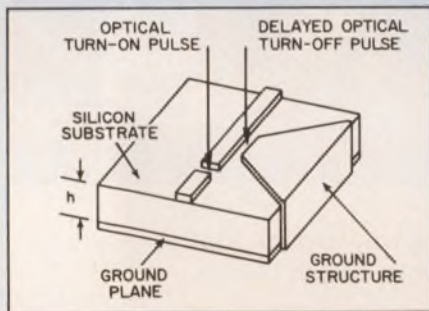

in the microstrip produces a solid-state plasma of high photoconductivity within the excited semiconductor region and allows a signal to cross the gap. The only time required to switch ON is the rise time of the optical-switching pulse.

Decay of the photoconductivity depends on carrier recombination, which normally leads to relatively long turn-off times ranging from 1 μ s to 1 ms. To reduce the turn-off times, a second delayed laser pulse is focused on the gap between the microstrip and the ground structure. The plasma generated in this gap short-circuits the microstrip to ground, and causes the signal on the strip to be reflected.

Because the turn-off time is also limited by the optical pulse's rise time, turn-off can be as short as turn-on. The switch is inoperative, however, until the optically produced carriers have been recombined or swept out. Consequently, repetition rates are confined between 0.1 and 1 MHz.

Experimental devices with 7- μ m-

thick gold structures on a 4000- Ω cm silicon substrate have been produced at the Universitat. A gap resistance of about 40 Ω and a shunt resistance of about 7 Ω have been obtained that produce a microwave power transmission of 50% in the ON state and 3% in the OFF state. Since the controlling signals are optical pulses, the isolation between the signal and the control pulses is inherently high.

German phototransistor has high current gains

A new heterojunction phototransistor with current gains as high as 2000 has been developed at the Institut fur Halbleitertechnik der RWTH in Aachen, West Germany. The transistor has an npn structure with a $\text{Ga}_{1-x}\text{Al}_x\text{As}$ wide-gap emitter, a thin (0.6 to 0.8 μ m) Ge-doped GaAs base and a Te-doped GaAs collector. The emitter layers, about 2- μ m thick, consist of Te-doped GaAs containing 30 (mole) % AlAs. The layers are grown by liquid epitaxy on (100)-oriented, n-type GaAs substrates.

The wide-gap emitter provides an exponential increase of the emitter efficiency with increasing difference voltage (ΔE_G) between the energy gaps of emitter and base. The ΔE_G is about 0.4 eV, so the deviation of the emitter efficiency from unity is only about 10^{-7} at room temperature.

The phototransistor's spectral sensitivity at 300 K extends from about 650 nm to 870 nm corresponding to the absorption edges of the $\text{Ga}_{0.7}\text{Al}_{0.3}\text{As}$ emitter window and GaAs.

Beta current gains (greater than 2000) corresponding to an integrated sensitivity of about 700 A/W, and internal cut-off frequencies of about 2 GHz have also been achieved with these phototransistors, which operate with a V_{CE} of 3 to 5 V.

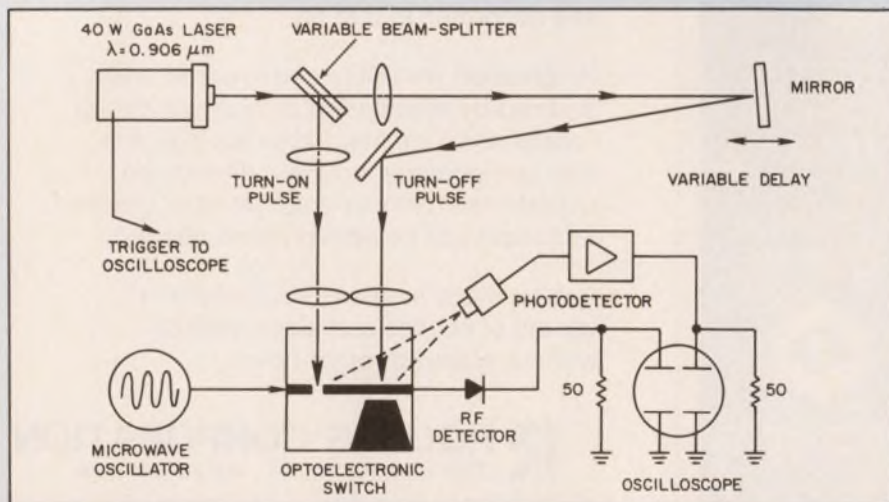

\$1,786,000 IN NEW BUSINESS IN SIX MONTHS



**DATEL SYSTEMS' 297 GOLD BOOK PAGES
SET AN INDUSTRY ADVERTISING RECORD...
SAVED \$200,000 IN PRINTING, OVERRUNS,
MAILING AND POSTAGE!**

John H. Gallagher, VP of Marketing for Datel Systems, Inc., Canton, Mass., tells the story:

"In 1975, we took 10 pages in the GOLD BOOK and got phenomenal results — more than \$130,000 in orders from engineers all over the world.

"So this year we placed 297 pages — an entire separate volume — the largest single paid advertisement ever carried by an electronics industry directory.

"The result? From July 1976 to Dec. 1976 we've booked more than one and three-quarters million dollars in new orders that have come to us directly from the GOLD BOOK.

"And because of free layouts, production at cost, and massive savings in printing, postage and distribution, we saved \$200,000 in the bargain.

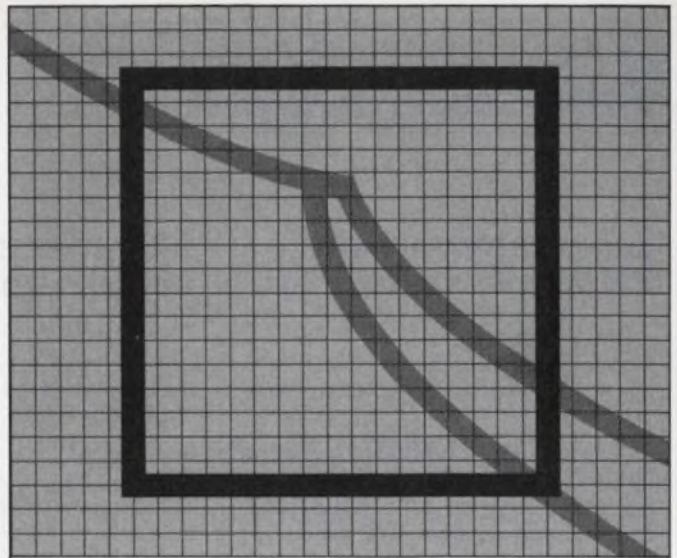

New From Micro Devices A Unique Slow-Blow Current Limiter.

It's the new MICROTEMP 5P Series MultiProtector. A versatile, yet extremely accurate slow-blow current limiter that lets you design-in protection for a specific current requirement within a precise time and current window.

triggering the exclusive pellet-type opening mechanism.

When properly applied, 5P will not nuisance trip reducing costly and annoying "in warranty" service calls.

No other commercially available slow-blow fuse even comes close to matching the 5P's ability to handle high current surges without being derated.

Here's more:

- current values—500 milliamps to 3.5 amps
- ambient temperature range—25° to 65°C. (77° to 146°F.)
- can be designed to withstand surges up to 100 amps for 10 milliseconds
- operates within 130% of rated current

5P's unique opening mechanism design guarantees life time rating stability and excellent surge absorption. Conventional slow-blow fuses operate through a metallic, current carrying element making them extremely susceptible to surging and derating. Thanks to its patented non-current carrying temperature sensitive opening mechanism, the MICROTEMP® thermal cutoff reacts only when current put through the heater element generates temperatures capable of



MICRO DEVICES



DIVISION OF EMERSON ELECTRIC CO.
1881 SOUTHTOWN BLVD.
DAYTON OH 45439 513-294-0581

CIRCLE NUMBER 38

New Products

Line receiver handles IBM levels, delivers TTL

Texas Instruments, P.O. Box 5012, Dallas, TX 75222. Dale Pippenger (214) 238-2011. From \$2.12 (100-up); stock.

The SN75125 high-speed seven-channel line receiver meets interface specifications of IBM's System/360 and System/370 products. Receiver outputs of the unit are TTL compatible. Schottky-clamped transistors are used to maintain fast switching speeds and low power dissipation. The receiver is available in both plastic and ceramic 16-pin DIPs and operates over 0 to 70 C.

CIRCLE NO. 301

Precision amplifier comes already trimmed

Burr-Brown, International Airport Industrial Park, Tucson, AZ 85734. Naresh Shah (602) 294-1431. From \$6.90 (100-up); stock to 4 wks.

A completely self-contained amplifier, the 3627, provides an accuracy to within $\pm 0.015\%$. The unit is a unity-gain differential amplifier that is mounted on a substrate that holds a resistor network and laser trimmed offset circuitry. Housed in a TO-99 package, the amplifier needs no external trimming to obtain its accuracy at 25 C. The accuracy includes the combined effects of gain error, non-linearity, offsets and common-mode rejection. Two versions are available: The 3627AM offers a CMR, dc to 60 Hz, of 80 dB min and an offset voltage drift of $40 \mu\text{V}/^\circ\text{C}$ max (RTO). The 3627BM has a CMR of 100 dB min and an offset drift of $10 \mu\text{V}/^\circ\text{C}$ max, respectively. Specifications common to both units are: offset voltage (RTO) of less than $250 \mu\text{V}$; small-signal $\pm 3\text{-dB}$ response better than 0.8 MHz; slew rate of $0.6 \text{ V}/\mu\text{s}$ min., and settling time (to 0.1%) of 20 μs . All units operate over -25 to $+85 \text{ C}$.

CIRCLE NO. 302

Character generator has built-in registers

National Semiconductor, 2900 Semiconductor Dr., Santa Clara, CA 95051. (408) 737-5000. \$14.95 (100-up); stock.

Designed for use in cathode-ray tube (CRT) displays and matrix printers, the DM8678 is a 64-character, 7×9 row scan character generator. On the chip are included the CRT system functions of parallel to serial shifting, character address latching, character spacing and character line spacing. The $124 \times 161\text{-mil}$ chip consists basically of a 6-bit series of fall-through latches for the character address; a 4032-bit ROM ($64 \times 7 \times 9$); a 7-bit parallel-in, serial-out shift register; a data-output buffer with a three-state control; a multiplexer and an edge-trigger generator. The line counter consists of a 4-bit ripple counter with an asynchronous clear input, plus an input clock that is shaped by the edge-triggered clock generator. The output can sink 16 mA at 0.45 V for a LOW signal out and will source 2 mA at 2.4 V for a HIGH signal out. Total power required for the DM8678 is 725 mW, which is about 30% less than conventional MOS-ROM character generation systems, and about 50% less than those with bipolar ROMs.

CIRCLE NO. 303

Low power reference requires only $50 \mu\text{A}$

Micro Power Systems, 3900 Alfred St., Santa Clara, CA 95050. Richard Koury (408) 247-5350. \$4.95 (100-up); stock.

The MPS-5010, a low-voltage reference IC, requires only $50\text{-}\mu\text{A}$ bias current. With a breakdown voltage of 1.22 V, the low-power reference also has a temperature stability of $0.01\%/^\circ\text{C}$, typical. Provided in a two-lead TO-52 package, the MPS-5010 can be used as a direct replacement for the LM-113 band-gap reference from other suppliers.

CIRCLE NO. 304

Low power static RAMs drain only 350 mW

Advanced Micro Devices, 901 Thompson Pl., Sunnyvale, CA 94086. (408) 732-2400. From \$12.55 (100-up); stock.

Consuming only 350 mW maximum the Am91L30 and Am91L40 4-k static RAMs keep access times to a low 250 ns. The RAMs are available in two organizations: 1024×4 and 4096×1 . Both operate from +5 V and are available for operation over the full military temperature range with guaranteed access times to 300 ns. All inputs and outputs are TTL compatible, and latched outputs with enough drive to handle two full TTL loads are built in.

CIRCLE NO. 305

Line drivers/receivers do RS-422/3 interfacing

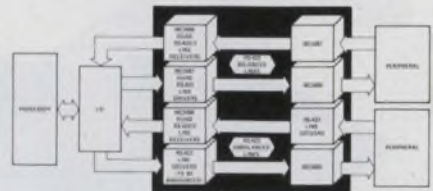

Motorola Semiconductor Products, P.O. Box 20294, Phoenix, AZ 85036. (602) 962-2294. From \$2.25 (100-up); stock.

The MC3486 quad line receiver and the MC3487 quad line driver are designed to meet RS-422 (balanced line) and RS-423 (unbalanced line) interface requirements. Both devices are Schottky TTL-compatible, have three-state outputs and operate from a single +5-V supply. The data inputs of the driver and the three-state control inputs of both devices are pnp-buffered to minimize input loading. The four receiver chains in the MC3486 and the four driver chains in the MC3487 operate independently of each other. Propagation delays are typically 25 ns through the receivers and 15 ns through the drivers. Rise and fall times at the driver outputs are less than 20 ns, typically. The differential input threshold of the receivers is $\pm 0.05 \text{ V}$, typically, and the output short-circuit current of any single driver is 40 mA, minimum. Both units are available in 16-pin plastic and ceramic DIPs.

CIRCLE NO. 306

Jumbo ROMs access in 350 ns & hold 16 kbits

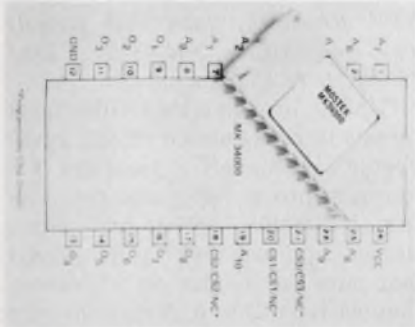

Mostek, 1215 W. Crosby Rd., Carrollton, TX 75006. (214) 242-0444. From \$14.85 (1000-up); 3 wks.

Featuring a 350-ns access time (max) and a 330-mW power dissipation (max), the MK 34000 offers a storage capacity of 16 kbits. The ROM is organized as 2048 words by 8 bits and requires a single +5-V supply. All inputs and outputs are TTL compatible. There is a wide $\pm 10\%$ tolerance for the power supply and the outputs are capable of driving 2 TTL loads and 100 pF. The MK 34000 pinout is compatible with the 2708, 1 k \times 8 EPROM. The three chip select inputs can be programmed for any desired combination of active HIGHS or LOWs or even an optional "DON'T CARE" state. To reduce the turnaround time for a custom ROM the company offers contact programming rather than conventional gate mask programming. Expected turnaround times can be as short as three weeks.

CIRCLE NO. 307

CMOS clock generator delivers 10-MHz signals

Intersil, 10900 N. Tantau Ave., Cupertino, CA 95014. (408) 996-5000. From \$2.40 (100-up); stock.

The ICM7209 CMOS clock generator is guaranteed to operate at frequencies to 10 MHz in 5-V systems. When used to drive a fanout of five TTL gates, typical rise-and-fall-times are 10 ns. The circuit's oscillator requires only a quartz crystal and two capacitors and power consumption is just 50 mW. Users have a choice of two output frequencies: oscillator or oscillator $\div 8$. Both outputs have a disable control. Operation is possible over -20 to $+70$ C. Devices are packaged as 8-lead plastic mini-DIPs.

CIRCLE NO. 308

Now, a single integrated circuit, our TAD-32 (Tapped Analog Delay), can provide filtering with passband-to-stopband ratios of 40 DB or more per device. Simple variation of the clock sampling rates over 5 decades will accordingly shift a given filter characteristic. Transversal or recursive filters can be constructed with over 60DB dynamic range and linear phase. Tapped delays up to several hundred milliseconds are possible.

Discrete time analog signal processing using charge transfer devices is a reality at RETICON.

The TAD-32 is just one device in this growing family.

We don't just talk about them, we make them.

THIS DIP DOES IT ALL.

TAPPED DELAYS
MATCHED FILTERS
CORRELATION
CONVOLUTION

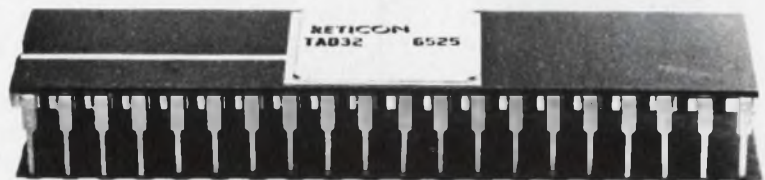

RETICON®

910 Benicia Avenue, Sunnyvale, California 94086
PHONE: (408) 738-4266 TWX: 910-339-9343

MILITARY
APPLICATIONS

AD CONVERTERS

by

MSK

Accuracy

Speed

Size

Repairability

Military

Temp. Range
-55°C to +125°C



- 4 Bit/50 nSec; Low Cost
- Ideal for Radar Scan Converters
- Holds Absolute Accuracy Over Temperatures
- Tracks a 10 MHz Analog Input



- 9 Bit/200 nSec.
- < 2 Bit Drift Over Temperature
- Insensitive to Clock Frequency

For Further Information Call or Write
M.S. Kennedy Corp.
Pickard Drive, Syracuse, New York 132
Tel. 315-455-7077

CIRCLE NUMBER 40

MODULES & SUBASSEMBLIES

Multiply over 360° to 0.05% linearity

Calex Manufacturing Co., 3305 Vincent Rd., Pleasant Hill, CA 94523. Ron Kreps (415) 932-3911. \$82 (singles); stock to 4 wks.

The 602-K four-quadrant multiplier features a nonlinearity of less than 0.05% and a full-scale error of $\pm 0.2\%$ max at 25 C. The unit's error tempco is $\pm 0.02\%/^{\circ}\text{C}$ and its power supply error coefficient is $\pm 0.02\%/ \Delta V$. The two input voltages, X and Y, can range between ± 10 V and the output is scaled for ± 10 V. The output formula is $XY/10$. This unit can also be used to square-root and divide without adding any external amplifiers. External components and trimming are not required. All you need is ± 15 V for operation. A mounting kit is available to ease wiring.

CIRCLE NO. 309

Tunable filters span wide frequency range

Frequency Devices, 25 Locust St., Haverhill, MA 01830. (617) 374-0761. \$48-\$69 (1-9); stock to 3 wks.

The 770 series of resistively tunable active filters consists of four 2-pole models and four 4-pole models—all give you a Butterworth response. A tuning range of 0.02 to 20 Hz, 0.2 to 200 Hz, 2 Hz to 2 kHz and 20 Hz to 20 kHz is available from the appropriate model for both the 2 and 4-pole models. The 2-pole models include simultaneous high-pass and low-pass outputs with a fixed, noninverting passband gain of 0 ± 0.2 dB. The 4-pole models contain a high-pass output only, but you can vary the noninverting passband gain from 0 to 10 dB. All models feature monotonic stopband-rolloff, full-power response to 100 kHz, 20 k Ω input impedance, 1 Ω output impedance, and an input offset-voltage drift of 20 $\mu\text{V}/^{\circ}\text{C}$ over the operating temperature range of 0 to +70 C. All models are designed for ± 15 -V-dc power, but they can operate from +5 to ± 18 V. The outputs are short-circuit protected.

CIRCLE NO. 310

Modulator circuit turns video signals into rf

ATV Research, 13th and Broadway, Dakota City, NE 68731. (402) 987-3771. \$8.50; stock.

Capable of converting video level signals into modulated rf, the Pixerverter can convert a standard TV receiver into a video monitor. The circuit accepts 0.25-to-5-V video signals and delivers an rf signal that puts the display on a receiver channel from 2 to 6. Available only in kit form, the circuit requires less than 3 mA at a bias of 6 V. Although the parts kit does not constitute a Class 1 TV device until assembled and connected to a video source, the final assembly must receive FCC approval before it can be used.

CIRCLE NO. 320

Multiplier-divider offers low noise

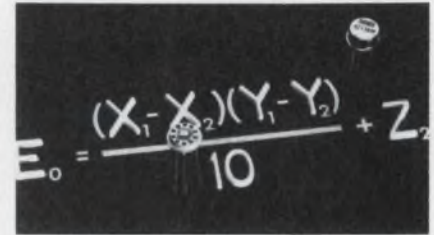

Burr-Brown, International Airport Industrial Park, P.O. Box 11400, Tucson, AZ 85734. (602) 294-1431. From \$15.50; stock to 4 wks.

The 4213 differential-input multiplier-divider offers up to 0.5% accuracy and 120- μV rms of noise from 10 Hz to 10 kHz. Other features of the TO-100 unit include four-quadrant multiplication, division and square rooting without additional amplifiers. Three versions are available: The 4213BM provides better than 0.5% accuracy, less than 25-mV output offset and less than 0.7-mV/ $^{\circ}\text{C}$ drift over -25 to +85 C. The 4213SM provides the same performance as the BM version over -55 to +125 C. The 4213AM delivers better than 1% accuracy, less than 50-mV output offset and less than 2 mV/ $^{\circ}\text{C}$ drift over -25 to +85 C. Small-signal bandwidth for ± 3 -dB flatness is 610 kHz (typ) and for $\pm 1\%$ flatness is 90 kHz (typ). Small-signal $\pm 1\%$ vector error (0 to 57 $^{\circ}$ phase-shift) is 7.5 kHz (typ).

CIRCLE NO. 321

Hybrid amp offers highest precision

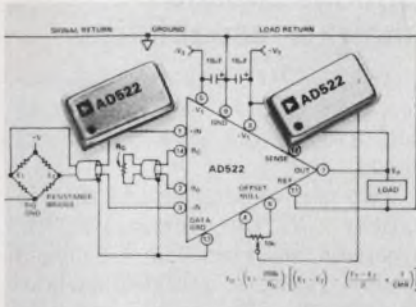

Analog Devices, Route 1 Industrial Park, P.O. Box 280, Norwood, MA 02062. (617) 329-4700. \$13 (unit qty); stock to 2 wks.

The AD 522 is the highest-precision IC instrumentation amplifier available. This hybrid unit boasts a max linearity error of below 0.001% at unity gain, a common-mode rejection of greater than 80 dB at unity gain (110 dB at 1000 gain), an input offset-voltage drift of less than 10 $\mu\text{V}/^\circ\text{C}$ at unity gain (below 0.5 $\mu\text{V}/^\circ\text{C}$ at 1000 gain) and pk-pk noise of 1.5 μV from 0.1 to 100 Hz. The device comes in four versions for different accuracy and temperature range performance, including "A," "B," and "C" models specified for -25 to $+85$ C, and an "S" version specified over -55 to $+125$ C.

CIRCLE NO. 322

TO-3 hybrid regulates 12 V at 5 A

Fairchild Camera and Instrument, 464 Ellis St., Mountain View, CA 94042. Bob Frostholt (415) 962-2043. \$7.00 (100 up); stock.

The 78H12KC hybrid voltage regulator delivers 5 A of regulated power at 12 V with built-in short-circuit and safe-area protection. It complements the company's previously announced 78H05KC 5-V regulator. The device comes in a standard TO-3 package that is pin-compatible with the 7800 series of monolithic voltage regulators. Junction temperature of the power output transistor is limited to provide alternate thermal-overload protection. If the safe operating area is ever exceeded, the device simply shuts down, rather than failing or damaging other system components.

CIRCLE NO. 323

IR scanner burns through smoke, dust

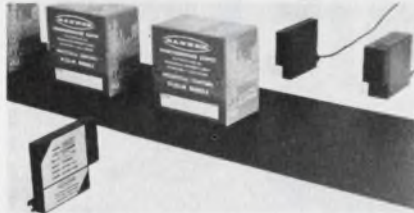

Banner Engineering Corp., 9714 10th Ave. N., Minneapolis, MN 55441. Floyd Schneider (612) 544-3164. \$110; stock.

Combining an infrared-LED emitter (Model SM51E) with a sensitive high-gain receiver scanner (Model SM51R) forms a system that "sees" objects, even in dirty factories. When used side-by-side in a "proximity" mode, both units can operate from a single 12-to-18-V-dc supply. In the receiver, complementary-npn output transistors rated at 250-mA max can drive an external relay or counter. Response time is less than 5 ms, over the 0-to-50-C operating range.

CIRCLE NO. 324

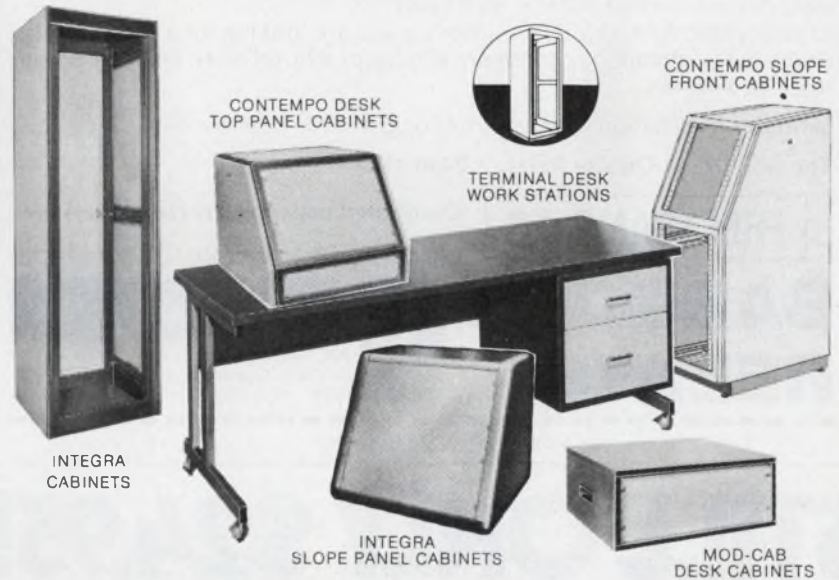

Just a few examples of Par.Metal's packaging systems...

an extensive line of modern electronic cabinets, racks, terminal desk work stations, instrument cabinets, accessories and hardware.

SEND FOR THE LATEST CATALOG...

Par.Metal
PRODUCTS, INC.

1260 Atlantic Ave., Brooklyn, N.Y. 11216
(212) 772-5800



CIRCLE NUMBER 41

5,376 VARIETIES

Our data sheet for the 10 & 15 series lists 28 contact schematics, 6 voltages, mercury wet or dry, magnetic or electromagnetic shielding, 2 grid spaces, 2 pin locations and open frame or epoxy encapsulated...that adds up to 5,376 varieties.

If one of our 5,376 standard Reed Relays does not meet your requirements, we'll design one that will—or we'll build to your print. And, this is true whether you are looking for a low cost relay (from 70¢ in quantity), a commercial relay or a hi-rel relay. Delivery is from stock to 7 weeks.

Send the publication card or write for our 10 & 15 series data sheet.

The way to say Quality Relay. . .BABCOCK.

FREE SAMPLES

Distributed nationally by Hamilton-Avnet.

Military/Aerospace/Commercial

**BABCOCK
RELAYS**



ESTERLINE ELECTRONICS

AN ESTERLINE COMPANY

3501 Harbor Blvd., Costa Mesa, California 92626
(714) 540-1234 TWX 910-595-1517

CIRCLE NUMBER 42

STILL ONLY \$24.95! 5V at 3A, with OVP...

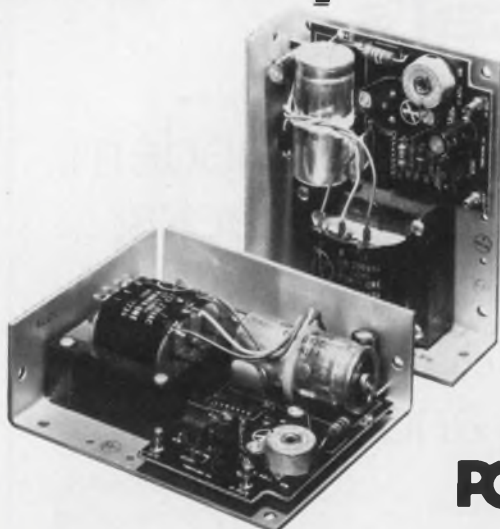

**MODEL HB5-3/OVP
\$24.95, SINGLE
QUANTITY**

- 115/230 VAC INPUT
- OVP BUILT-IN
- .05% REGULATION
- 2 YR. WARRANTY
- 2 HOUR BURN-IN
- UL RECOGNIZED



It's a Fact!

531 Dawson Dr. Camarillo, CA 93010
Phone 805 484-2806 TWX 910-336-1297

POWER-ONE, INC.

IN-STOCK FOR IMMEDIATE DELIVERY . . . NATIONWIDE

SALES OFFICES **ARIZ.** Scottsdale (602) 957-9110 **CAL.** Pasadena (213) 681-5631, San Diego (714) 565-6814, San Jose (408) 246-5860 **CANADA** Ontario (416) 742-4448 **COL.** Denver (303) 773-1218 **CONN.** Hamden (203) 281-6539 **FLA.** Orlando (305) 894-3351 **ILL.** Chicago (312) 858-8355 **IND.** Indianapolis (317) 353-9441 **MD.** Lanham (301) 552-2200 **MASS.** Waltham (617) 899-4300 **MINN.** Minneapolis (612) 925-1883 **N.J.** E. Hanover (201) 377-3220 **N.M.** Albuquerque (505) 255-2330 **N.Y.** Roslyn Hts. (516) 484-1276, Burnt Hills (518) 399-9200 **ORE.** Portland (503) 238-0001 **TEX.** Houston (713) 442-2944, Dallas (214) 361-8584 **WASH.** Seattle (206) 763-2210

SEE OUR COMPLETE PRODUCT LISTING IN EEM & GOLDBOOK

CIRCLE NUMBER 43

INSTRUMENTATION

Options expand analyzer capabilities

Tektronix, P.O. Box 500A, Beaverton, OR 97077. (503) 644-0161. LS, \$750; 7L5 with option 25, \$5600.

Two new options expand the versatility of the company's 7L5 spectrum analyzer. The L3 plug-in module features a high-impedance (1 MΩ/28 pF) probe-compatible input with input-termination selections of 50 and 600 Ω. Option 25 tracking generator provides the 7L5 with selectable 50-Ω, 75-Ω, and 600-Ω impedance source with calibrated frequency output for swept frequency tests from 10 Hz to 5 MHz. Output of the option 25 tracking generator can be adjusted so it tracks within 10 Hz of the spectrum-analyzer frequency.

CIRCLE NO. 325

Scope probes attach to DIPs, small leads



Hewlett-Packard, 1501 Page Mill Rd., Palo Alto, CA 94304. (415) 493-1501. Test clip, \$15; divider probes, \$90; 1:1 probes, \$35; 2-4 wks.

Miniature scope probes connect readily to individual pins on modern DIPs or to the small, insulated conductors used on IC circuit boards, without hazard of shorting. The unit consists of a clip that encompasses an entire DIP and an accompanying set of demountable probes, said to be the smallest yet commercially offered. The basic part of each probe can be inserted by itself into the DIP clip at any pin position; or 15 can be inserted simultaneously into a DIP clip; one position is used with a grounding pin, so any pin on the DIP can be used as probe ground. Various models are offered.

CIRCLE NO. 326

Panel meter swaps data for lower cost



Nationwide Electronic Systems, 536 Brandy Parkway, Streamwood, IL 60103. (312) 289-8820. \$79 (100s); stock-2 wks.

This unit is a limited feature version of the company's regular slimline 3-1/2-digit voltmeter. Data outputs have been dropped to lower costs. The unit offers bipolar input, autopolarity, autozero and screw terminals for inputs and outputs (no extra connectors to buy), all backed by a 5-year warranty. The case measures only 4-1/2 wide x 3-1/2 high x 5/8-in. thick; and mounts on the front of the panel.

CIRCLE NO. 327

Function generator is remotely controlled

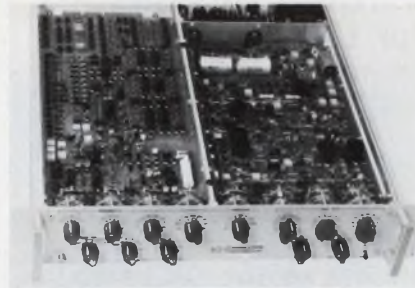

Krohn-Hite, Avon Industrial Park, Bodwell St., Avon, MA 02322. (617) 580-1660. \$1995; 8 weeks.

Model 5500AR programmable function generator provides sine, square, triangle, pulse and sawtooth waveforms over a frequency range of 0.0001 Hz to 5 MHz. The 5500AR can be triggered or gated as well as run in the continuous mode. All functions can be remotely controlled. At a main output of 30 V pk-pk (open circuit), the positive waveform duration can be programmed independently of the negative duration. FET switches provide a switching time of typically 100 μ s.

CIRCLE NO. 328

IEEE-488 Bus added to oscillator line



California Instruments, 5150 Convoy St., San Diego, CA 92111. (714) 279-8620. Start at \$2150; 30-90 days.

The addition of a microprocessor-based GPIB interface provides complete conformance to IEEE 488-1975 standards and also makes possible programmable ac power that is not limited to functions on individual command. Rather it allows predefined sequences to be initiated on a single command. This capability is now available in the Invertron® series 830T/GPIB line of programmable oscillators. In operation, the programmable oscillators—operating with one of the company's single, two or three-phase ac power sources—offer the ability to program frequency, phase angle and amplitude independently.

CIRCLE NO. 329

MULTI-POSITION SLIDE SWITCH



SL SERIES

Designed specifically for PC applications. Saves space, installation time and wiring errors. Features a ball detent for positive feel, self-cleaning contacts and sealed terminals. Choice of 5, 6 or 7 pos. with dual bridging contacts. Excellent replacement for rotary switches and many other uses.

Write or call (617) 685-4371 for complete details on these and other ALCOSWITCH products.

CIRCLE NUMBER 44

NEW LOOK BATON TOGGLE



CST SERIES

A new generation of toggle switches with the look of tomorrow. Features 2 or 4 poles; 2 or 3 positions in a compact case style for PC board mounting. Excellent tactile feel and long life expectancy in excess of 10,000 operations at rated current.

Call (617) 685-4371 for more detailed information, prices and samples.

CIRCLE NUMBER 45

ALCO ELECTRONIC PRODUCTS, INC.
1551 DEGGOOD STREET, NORTH ANDOVER, MA 01845 U.S.A.

Tel: (617) 685-4371 TWX: 710 342-0552

A SUBSIDIARY OF AUGAT INC.

ELECTRONIC DESIGN 3, February 1, 1977

THE TOTAL MEMORY SUPPLIER

WE HAVE DYNAMIC MOS RAMS. THINK ABOUT IT.



The most complete line of Dynamic MOS RAMs available. From 1024 x 1 to 4096 x 1, 16, 18 and 22 pin, 4096 x 1, 16K x 1 available 1st quarter '77.

Clip to letterhead. Rush complete list of total memories in stock.

Name _____ Title _____
Tel. _____ M.S. _____
811 E. ARQUES, SUNNYVALE, CA. 94086

THINK
signetics

a subsidiary of U.S. Philips Corporation

© 1976

CIRCLE NUMBER 46

RF Power Amplifiers?

One unit may be all you'll ever need.



If you have the ENI Model 440LA ultra-wideband solid state power amplifier, all you need is a laboratory signal generator and you've got the ultimate in linear power for such applications as RFI/EMI testing, NMR/ENDOR, RF transmission, ultrasonics and more.

Capable of supplying more than 40 watts of RF power into any load impedance, the 440LA covers the frequency range of 150 kHz to 300 MHz.

We could mention unconditional stability, instantaneous failsafe provisions and absolute protection from overloads and transients, but that's what you expect from any ENI power amplifier, and the 440LA is no exception!

Our catalog contains complete specifications on the 440LA as well as the entire line of ENI amplifiers, and is available without obligation, of course.

For further information or a demonstration, contact ENI, 3000 Winton Road South, Rochester, New York 14623. Call 716-473-6900, or Telex 97-8283 ENI ROC.

ENI

The World's Leader
In Power Amplifiers

CIRCLE NUMBER 47

COMPONENTS

Varistors suppress for 110-V applications

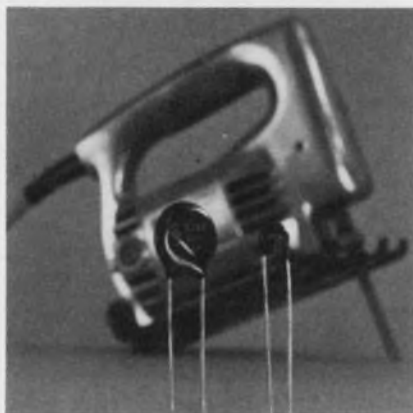

Siemens Corp., 186 Wood Ave. S., Iselin, NJ 08830. (201) 494-1000. \$0.55: S5K130-1, \$0.70: S14K130-10 (1000 up); stock to 14 wks.

SIOV metal-oxide varistors for transient suppression, designated S5K130-1 and S14K130-10, are especially suited for use on 110-V-ac power-line applications. The S5K130-1 has a maximum energy rating of 1 J and a surge-current rating of 200 A. The ratings for the S14K130-10 are 10 J and 2000 A. Both devices are rated at 130 V ac rms. The increased use of solid-state devices increases interest in transient protection, because of semiconductor sensitivity to transients.

CIRCLE NO. 330

Pendulum potentiometer measures vertical angle

Betatronix Inc., 100 Ricefield Lane, Hauppauge, NY 11787. (516) 543-8780.

A group of wire-wound and conductive-plastic pendulum potentiometers directly measures angular displacement from a vertical reference point. The voltage output is proportional (linearly or nonlinearly) to the angular displacement of the case from the vertical reference. The units are hermetically sealed in silicone oil, which acts as a damping medium. The oil viscosity may be specified to provide almost any required damping characteristics. Pendulum potentiometers are available in 2-1/2 and 3-in. diameters with accuracies to 6 minutes of arc and with angular displacements to ± 90 degrees.

CIRCLE NO. 331

Low-profile keyboard has high-priced look

Chomerics, 77 Dragon Court, Woburn, MA 01801. (617) 935-4850.

The ET keyboard is a low-cost (how low?) look-alike for applications where the appearance of a Touch Tone is desired. In use within the telephone equipment industry, the ET provides "snap-action" feel and a life expectancy of 10-million operations. Key travel is 0.015 to 0.020 in. with 10-to-12-oz operating force. The keyboard is available for single-pole encoding with a common and separate contact for each key, as well as for three Touch Tone (row/column) matrix encodings with one, two or no common contacts per key. Contact rating is 20 mA at 30 V, contact resistance is ≤ 20 ft and capacitance ≤ 20 pF. The profile can be as little as 0.12 in. above the mounting panel.

CIRCLE NO. 332

Xenon arc lamps rival older types

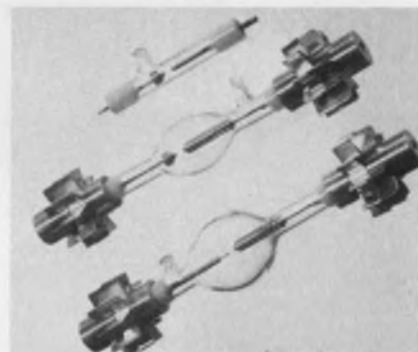

Illuminex Corp., 1200 Norman Ave., Santa Clara, CA 95050. (408) 248-6186. \$1.50 to \$30.

A completely new line of high-intensity Xenon compact arc lamps and flashtubes are priced at less than half the cost of quartz short-arc products. In addition to their price advantage, these new lamps and flashtubes are of considerably greater intensity than both Xenon long-arc flashtubes and quartz-iodine lamps. Available in 25, 75 and 150-W models, the new units provide a highly concentrated source of light, similar to a point light source that can be easily collimated with simple, low-cost reflectors and lenses.

CIRCLE NO. 333

Impact detector can be reset



Impact-O-Graph Corp., 4943 Mc-Connell Ave., Los Angeles, CA 90066. (213) 822-2332. \$25 (unit qty); stock.

Omni-G is a resettable all-directional shock indicator. The unit weighs 2 oz, is accurate to within 10% of its rated value and is available from the factory for ratings of 2 to 500 g.

CIRCLE NO. 334

Active antenna system covers 0.1 to 30 MHz

Bayshore Systems Corp., 5404B Port Royal Rd., Springfield, VA 22151. (703) 321-9625. \$9950. (GSA contract).

The UPS-191A active-antenna system provides reception capability for signals in the 100-kHz-to-30-MHz range. The system consists of a 9-in. blade antenna with integral matching amplifier and an eight-output distribution amplifier that can be located up to 100 ft from the blade. Output ports can be tailored to present selected bands or the entire frequency range. The system mounts in vehicular, ship-board or aircraft platforms. The unit is essentially immune to interfering frequencies induced by ground paths. The blade assembly is specially coated to minimize ionization and precipitation static. The interconnecting cable carries signals as well as power from and to the matching amplifier.

CIRCLE NO. 335

Servomotor accelerates to 63% in 9 ms

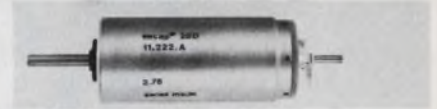

Portescap U. S., 730 Fifth Ave., New York, NY 10019. (213) 245-7716.

The Escap 28D servomotor series accelerates to 63% of final speed in only 9 ms, making it the fastest motor of its type available in production today, according to Portescap. With four models, the motor series has a voltage range from 5 to 24 V dc, stall torques from 10.4 to 14.9 oz-in and developed power output from 6.1 to 15 W. No-load speed is from 3200 to 5400 rpm with an average no-load current from 23 to 40 mA. These motors feature ironless rotors with very-low rotor inertia and precious-metal commutators and brushes. Motor diameter is 28 mm and length, 63 mm.

CIRCLE NO. 336

STANDOFFS AND SPACERS

Over 200 assorted sizes and styles cataloged for you to choose from. Available in Aluminum, Brass and Phenolic, tapped or thru-hole. Immediate delivery from stock. Free engineering service for your special requirements.

NEW FREE CATALOG ON REQUEST
FREE ENGINEERING WALL CHART 17x22

Manufacturers of Standardized Hardware for Electronics

KEYSTONE ELECTRONICS CORP.

49 BLEECKER STREET, NEW YORK N.Y. 10012 212-475-4600

CIRCLE NUMBER 48

ELECTRONIC DESIGN 3, February 1, 1977

THE TOTAL MEMORY SUPPLIER

WE HAVE BIPOLAR & STATIC MOS RAMS. REMEMBER THAT.

Total line in stock. 24 Bipolars—from 8 to 1024 bits. 14 MOS Statics—from 256 x 4 to 1024 x 1 with 1K x 4 and 4K x 1 available 1st quarter '77.

Clip to letterhead. Send me complete list of total memories in stock.

Name	Title
Tel.	M.S.

811 E. ARQUES, SUNNYVALE, CA. 94086

THINK Signetics

a subsidiary of U.S. Philips Corporation

© 1976

CIRCLE NUMBER 49

Clip & Save

Clip-on Thermalloy "Slip-Clip" heat sinks and save assembly time, board space, and heat sink costs. They require no mounting hardware, PC board drilling, or adhesives, and clamp firmly to the device for maximum heat transfer. "Slip-Clips" are available for TO-202, TO-220, TO-126, Motorola case 90 and most other popular case styles.

Number one in Semiconductor Accessories

Thermalloy, Inc.
 Post Office Box 34829
 2021 West Valley View Lane
 Dallas, TX 75234 • (214) 243-4321

Free Catalog and Sample with your response

CIRCLE NUMBER 50

DATA PROCESSING

Get MIL-computer power now at half the price



Rolm Corp., 18922 Forge Dr., Cupertino, CA 95014. (408) 257-6440. From \$9500.

By updating its Model 1603 (AN/UYSK-27), Rolm has added 16-k words of internal core memory, and more I/O interface to a fully MIL-spec core module. The new 1603A is available with 16-k words at \$9500, and with 32-k core at \$15,500—about half the price of the first version with the same capacity.

CIRCLE NO. 337

New entry in mini race is 'doped' with VMT



Hewlett-Packard, 1501 Page Mill Rd., Palo Alto, CA 94304. (415) 493-1501. From \$8500.

The well established 21MX mini-computer has sired a new family member, known as the E-series. With program execution 70 to 100% faster than the parents', the newcomers' "horsepower" can be increased at will. What makes them so powerful? Variable microcycle timing (VMT) in the 24-bit micro-programmable control processor permits variable cycle length. This speeds up the execution of most instructions to 175 ns, from the 325 ns previously required. The E-series also places an expandable control-processor address space at your disposal—enough to train 21MX-E yourself, by writing your own executive system.

CIRCLE NO. 338

How to save up to 50% on flat cable/connectors just by changing colors.

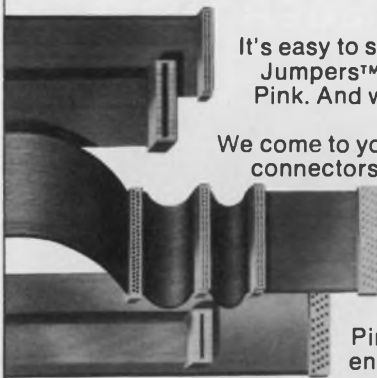

It's easy to spot new Great Jumpers™ and Great Daisy Jumpers™ from A P Products. Our ribbon is Electric Pink. And we're jumps ahead of any other flat cable/connector system.

We come to you fully factory assembled and tested. Our connectors are molded on and feature integral strain relief plus complete line-by-line probeability. Nothing could be easier to use.

And we cost less.

Just name your jump and watch us hop to it. We offer the five most popular flat cable widths, solid or stranded Electric Pink or rainbow cable, single ended, double ended or daisy chained. And Great Jumpers are directly-interchangeable replacements for the jumpers you're using now.

Connect with the A P rep nearest you.

(203) 868-7748	(216) 333-4120	(313) 356-2161	(513) 433-0966	(713) 691-3961
(205) 883-9630	(219) 743-0362	(314) 569-2660	(602) 946-4437	(714) 560-6266
(206) 822-8223	(301) 484-5400	(414) 421-2300	(602) 949-8424	(714) 833-1802
(212) 682-5844	(303) 420-4646	(415) 328-3232	(609) 429-4013	
(214) 238-0408	(305) 855-0274	(503) 223-3374	(612) 922-7011	
(215) 923-5195	(312) 298-4830	(512) 443-9687	(617) 272-8163	

Faster and easier is what we're all about.



A P PRODUCTS INCORPORATED

Box 110-F Painesville, OH 44077 (216) 354-2101 TWX: 810-425-2250

CIRCLE NUMBER 51

Rustling paper is only sound from 1-pen plotter



Houston Instrument Div., 1 Houston Square, Austin, TX 78763. (512) 837-2820. \$8400.

The Model DP-85 single-pen plotter is so quiet you hear only the rustle of paper as it moves over the 36-in. plotter drum. Even though the pen zips along at 4.5 in/s. Step sizes range from 0.00125 to 0.01 in. For A and B-size drawings, 12-in. paper can be used. Positive paper feed or take-up reel are optional.

CIRCLE NO. 339

Unit makes long words to test data links



International Data Sciences Inc., 100 Nashua St., Providence, RI 02904. (401) 274-5100. \$750 (single qty); stock.

The Model 25 full-duplex long-word converter kit generates and receives a 2047-bit test pattern. It fits into a WECO 914B or Sierra 1914B data test set to add loopback and end-to-end tests of transmission links. The kit contains two PC boards, a control panel, harnessing, a switch-marking overlay and a printer-output connector. The Model 25 has a selectable dot, 63, 511 or 2047 word length, and transfers data at 150 to 2400 baud. It can also make a precoded error when transmitting.

CIRCLE NO. 340

'Mass' switch taps up to 512 remote data lines

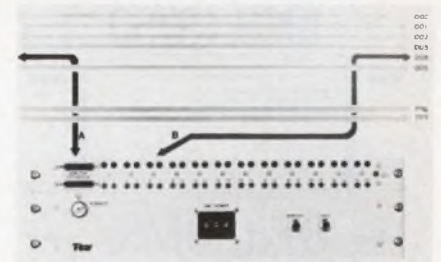

T-Bar Inc., 141 Danbury Rd., Wilton, CT 06897. Vaughn K. Darnell (203) 762-8351. From \$2350; 6-8 wks.

You can monitor, and break into, as many as 512 communications lines with the MASS multiple access switching system. And you need only run a single line to the monitor, up to several hundred ft away. To cut in, you simply set a thumbwheel switch to the desired line number. The unit becomes cost effective on as few as 30 lines. Its height is 3-1/2 in.

CIRCLE NO. 341

The original economy power supply.
Proven reliable 125,000 times.

More than 125,000 DPS supplies have been sold to OEM's and it's still a best seller. That's your assurance of quality...reliability...cost effectiveness.

Models available to supply 5 volts at 3 amps to 24 volts at 0.8 amp. Each is a U.L. listed recognized component.

Write or call for additional data.

TELE-DYNAMICS

DIVISION OF AMBAC

525 Virginia Drive, Fort Washington, Pa. 19034 • 215-643-3900

A STEP AHEAD IN QUALITY

CIRCLE NUMBER 52

ELECTRONIC DESIGN 3, February 1, 1977

THE TOTAL MEMORY SUPPLIER
WE HAVE BIPOLAR & MOS PROMS. THINK OF THAT.



Long list in stock. 17 Bipolars—from 256 to 8K bits—with 16K available soon. 4K and 8K MOS EROMS available 1st quarter '77.

Clip to letterhead. Send list of total memories in stock.

Name	Title
Tel.	M.S.
811 E. ARQUES, SUNNYVALE, CA. 94086	

THINK **Signoties**

a subsidiary of U.S. Philips Corporation

©1976

CIRCLE NUMBER 53

Compress a
1969, \$8750...



8-Bit, 10MHz
A/D Converter

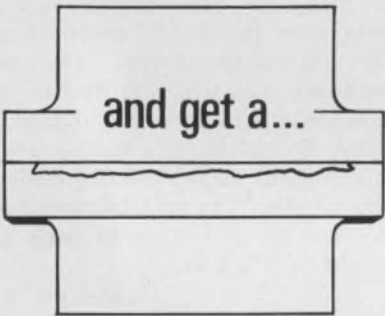

and get a...

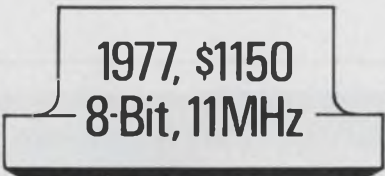

1977, \$1150
8-Bit, 11MHz

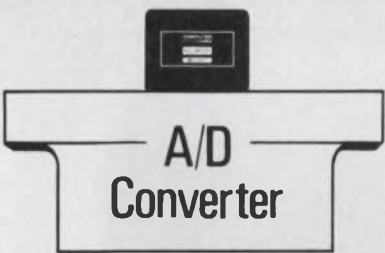

A/D
Converter

HIGH-SPEED
A/D CONVERTER
MATV-0811

8-Bit • 11MHz • 20 Cu. in.

\$1150

**COMPUTER
LABS**

COMPUTER LABS, INCORPORATED
505 EDWARDIA DRIVE • GREENSBORO, N. C. 27409
(919) 292-6427

CIRCLE NUMBER 54

DISCRETE SEMICONDUCTORS

Glass-passivated Xistors offer improvements

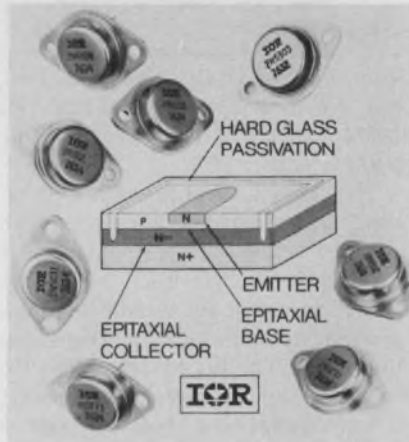

International Rectifier, 233 Kansas St., El Segundo, CA 90245. (213) 322-3331. \$1.98; IR3771, \$6.40; 2N5745 (100-999); stock.

In a second major addition to its power transistor line, IR announces 22 new epitaxial-base transistors as replacements for popular industry-standard units. Sixteen have standard 2N numbers and six are IR-numbered devices. Units in the new line are rated from 20-to-50-A continuous collector current from 40 to 150 V sustaining (collector to emitter). Both npn and pnp-type transistors are available. All incorporate IR's proprietary glass passivation of the silicon chip.

CIRCLE NO. 342

LED displays seen from 30-ft distance

Industrial Electronic Engineers, Inc., 7720-40 Lemon Ave., Van Nuys, CA 91405. (213) 787-0311. \$1.15 (10,000 up); stock.

Hercules Series 1721/41 0.6-in. LED displays have a slimline configuration with 14-pin DIP connections and provide 250 μ cd per segment intensity at 20 mA/1.6 V_F. Single plane, 150-degree construction allows 25-to-30-ft viewing and a high contrast ratio. Series 1721 (0 to 9) and 1741 (± 1) are common-anode designs, while Series 1726 (0-9) and 1746 (± 1) are common cathode. All models are designed with two dies per segment and GaAsP emitting material.

CIRCLE NO. 343

Darlington DIPs deliver 50 and 100-V outputs

Texas Instruments, Inc., P.O. Box 5012, M/S 308, Dallas, TX 75222. (214) 238-2895. \$1.13 to \$1.97 (100 up).

Two series of DIP seven-channel Darlington transistor arrays feature high-current switching (500-mA rated collector current), output clamp diodes and inputs compatible with various types of logic. One series features 50-V output and is designated ULN 2001A through 2004A. They are second-source devices for the Sprague series with the same designation. The second series of arrays has 100-V output capability and is designated SN75466 through SN75469.

CIRCLE NO. 344

Schottky detector diodes need no dc bias

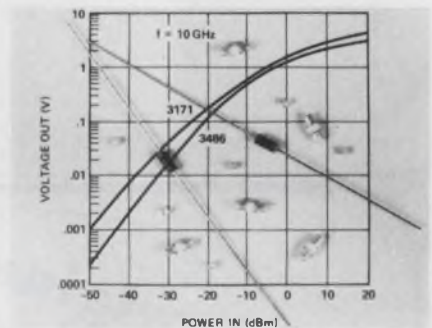

Hewlett-Packard, 1501 Page Mill Rd., Palo Alto, CA 94304. (415) 493-1501. \$10 to \$22 (10-99).

Zero-bias Schottky diodes, the HSCH-3000 Series, eliminate the problem of temperature compensation of dc currents required in sensitive circuits using conventional detector diodes. The high, zero-bias voltage sensitivity of these diodes makes them especially suitable for narrow-bandwidth video detectors, such as in high-frequency receivers and measurement equipment. The diodes have a typical voltage sensitivity of 10 to 50 mV of output per μ W of input power (depending upon device type) at 10 GHz. Conventional Schottky detector diodes with dc bias applied produce 5 to 10 mV/ μ W. Both low-impedance (2000 to 8000 Ω) and high-impedance (80,000 to 300,000 Ω) devices are available. The diodes come in either ceramic or glass packages.

CIRCLE NO. 345

Silicon diodes serve auto-ignition systems

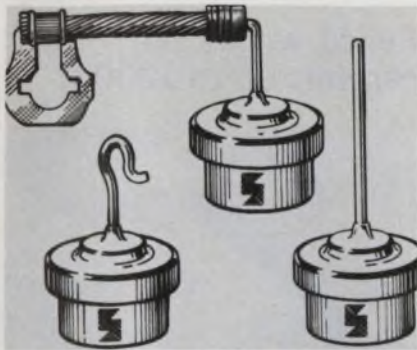

Semitronics Corp., 64 Commercial St., Freeport, NY 11520. (516) 623-9400. \$0.59 (100-999); stock.

Two silicon diodes for automotive ignition systems—the 1N3491-R and 1N3660-R series—are used in Ford, Chrysler, Delco and Motorola alternators and come in 25-to-35-A, 50-to-600-V ranges. Each diode series comes in three configurations—straight lead, hook lead or reverse polarities. All are in 1/2-in. D021 press-fit packages.

CIRCLE NO. 346

Varactor diodes vary over 5:1 cap range



MSI Electronics Inc., 34-32 57th St., Woodside, NY 11377. (212) 672-6500. \$4.50 (100 to 999); 2 wks.

The flat leads of the SL800 series of varactor tuning diodes can be soldered directly to PC-board striplines for minimum rf mismatch at vhf/uhf frequencies. The 0.005-in. thick leads present a relatively small discontinuity. The diode package capacitance is 0.2 pF and the lead inductance is 5 nH, which can be compensated so the diodes become almost ideal variable capacitances. Capacitance variation is a minimum of 5:1 from the nominal 1.8-pF value at 20-V bias. The diodes have a 30-V breakdown rating and Q of 300 at 50 MHz with a 3-V bias.

CIRCLE NO. 347

SCR series trigger on min of 100 μ A



RCA/Solid State Div., Route 202, Somerville, NJ 08876. (201) 685-6423. \$0.37 to \$1.15 (100 up); stock.

Three sensitive-gate SCRs, series S106, S107 and S108, have an rms on-state current rating of 4 A. Each series includes nine types with voltage ratings of 15 through 600 V. All the series are in standard JEDEC TO-202AB packages. For low-level logic-circuit applications with a high-degree of noise immunity, a minimum gate current of 100 μ A is specified.

CIRCLE NO. 348

New Mini-Toggle Switch Line from SMK



The JT-3000 Series complete line of UL Approved mini-toggle switches feature rugged construction with the terminals molded and secured into the housing to provide excellent shock and vibration characteristics.

Available in either SPDT or DPDT, the switches are rated at 6 amps at 125V AC or 12V DC resistive load and will operate from -10°C to $+60^{\circ}\text{C}$. Mechanical life is 100,000 cycles with no load and 20,000 cycles with rated resistance load.

Priced from \$.90 in 100 piece quantity.

 SMK Electronics Corporation of America

118 East Savarona Way Carson, California 90746
Tel: (213) 770-8915

CIRCLE NUMBER 55

ELECTRONIC DESIGN 3, February 1, 1977

THE TOTAL MEMORY SUPPLIER

WE HAVE BIPOLAR & MOS ROMS. DON'T FORGET IT.



Wide variety in stock 13 Bipolars—from 256 to 16K bits Plus 7 Static MOS including 8K and 16K Plus 4 character generators including 8K Both TS & OC

Clip to letterhead. Send Bipolar & MOS list of total memories in stock.

Name _____ Title _____
Tel. _____ M.S. _____
811 E. ARQUES, SUNNYVALE, CA. 94086

THINK **Signetics**

a subsidiary of U.S. Philips Corporation

© 1976

CIRCLE NUMBER 56

IMC FAN FACTS

Our Super Boxer Fan delivers more

New aerodynamic impeller design gives this IMC fan about $\frac{1}{3}$ more air delivery than other fans of its class*. This super airmover is a natural for efficient and economical cooling in tightly packed card racks, cabinets and other enclosures. Literature on request! For immediate service please call Fred Taylor, Sales Manager at (603) 332-5300 or write.



50/60 HZ AIRMOVER



4-11/16" square
by 1-1/2" deep.



Our 25th Anniversary

IMC MAGNETICS CORP.

NEW HAMPSHIRE DIVISION

ROUTE 16B, ROCHESTER, NEW HAMPSHIRE 03867

CIRCLE NUMBER 57

Waters Conductive Plastic Elements Can Cure Your Servo Feedback Problems

When it comes to the application of conductive plastic potentiometers or elements in servo feedback systems for recorders, controllers, and actuators, Waters wrote the book.

Waters makes rotary servo potentiometers from $\frac{1}{2}$ " to 2" diameter, and custom elements from $\frac{1}{2}$ " to 40" in length. All Waters' CP units provide infinite resolution, multi-million cycle life, and low output smoothness (.03%). Linearities can be specified to 0.1% using Waters own automated linearization technology.

Bring your servo feedback requirements to Waters for the professional solution to your individual application.

Call Waters at 617-358-2777 or circle reader service card.

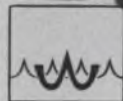

**WATERS
MANUFACTURING INC.**

LONGFELLOW CENTER,
WAYLAND, MA, 01778
(617) 358-2777

CIRCLE NUMBER 58

PACKAGING & MATERIALS

Pencil writes on ceramic up to 1200 C



Electro Materials Corp. of America, 605 Center Ave., Mamaroneck, NY 10543. (914) 698-8434. \$1.25 (24-up); stock.

The ceramic marking pencil's writing will remain visible in air or nitrogen at temperatures up to 1200 C. Markings are not affected by chlorinated hydrocarbons, alcohols or other cleaning agents. Pencils are available with either brown or white marking colors.

CIRCLE NO. 349

Enclosure takes a keyboard and display

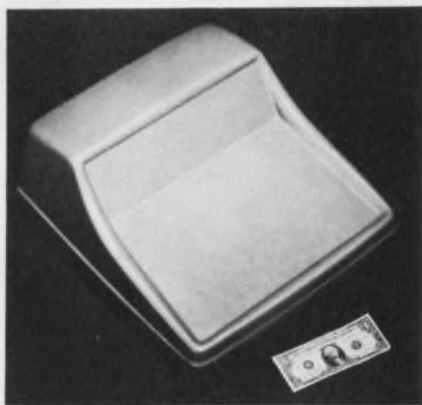

Techmar Corp., 2237 S. Cotner Ave., Los Angeles, CA 90064. (213) 478-0046. \$58.05; 3 days.

The Model MC-9H, a console-shaped enclosure, accepts a digital display and keyboard. The unit has over-all dimensions of 8.8 x 15.5 x 19.5 in. The enclosure is vacuum-formed from 0.1875-in.-thick vinyl-acrylic alloy with a fine-grain matte finish. It comes with either a beige or blue top and either a black or cocoa base. The material retards flame, to UL specifications, and resists temperatures to 170 F.

CIRCLE NO. 350

Joystick probe card has 24 good points

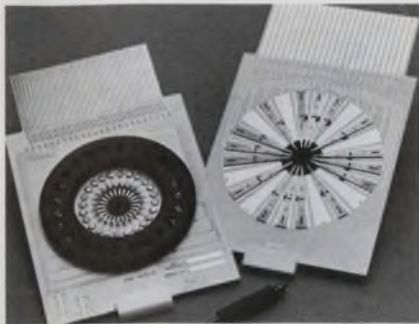

Probe-Rite, Inc., 2725 Lafayette St., Santa Clara, CA 95050. (408) 249-1255. From \$125.

With probe densities of 8, 16 and 24 points, the joystick-controlled PS series of adjustable probe cards offers versatility, quick set-up, and three-axes adjustment. Connector configurations of 48 and 70 contacts are available. Die sizes of 0-100, and 100-200 mils can be accommodated, using the AT-10 adjusting tool (\$18).

CIRCLE NO. 351

Transistor heat sinks hold without hardware

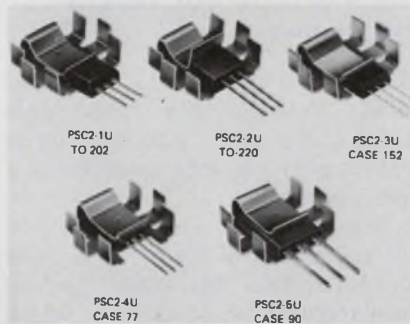

IERC, 135 W. Magnolia Blvd., Burbank, CA 91502. (213) 849-2481. 5¢ (1000-up).

A series of heat dissipators, designated the PSC2 series, has a retaining clip that fits over plastic power transistors. The retaining clip holds onto the transistor case without additional mounting hardware. The series PSC2-1U through 5U fit over TO-202, TO-220, case 152, case 77 and case 90, respectively.

CIRCLE NO. 352

DIP-socket price dips with stackable model

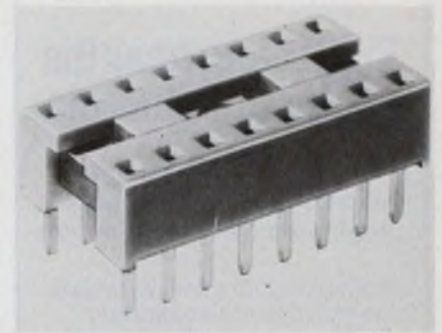

Samtec Electronic Hardware, 2652 Charlestown Rd., New Albany, IN 47150. Sam Shine (812) 944-6733.

KEL-series DIP sockets offer quality features of more expensive sockets: side-wipe contacts, side-side and end-end stacking, two-piece bodies for closed-entry plug-in, and positive no-solder wicking. UL-rated 94V-0, the glass-filled polyester sockets are available with 14 to 40 contacts.

CIRCLE NO. 353

AUTHOR'S GUIDE

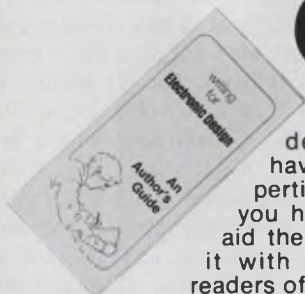

If you've solved a tricky design problem, if you have developed special expertise in a specific area, if you have information that will aid the design process... share it with your fellow engineer-readers of *Electronic Design*.

Articles you have authored not only raise your own professional status, but help build your company image as well. The readers benefit, your company benefits.

To help you prepare material that meets *Electronic Design's* high editorial standards, our editors have prepared a special author's guide entitled "Writing for *Electronic Design*." It covers criteria for acceptability, form, length, writing tips, illustrations, and payment for articles published. It's available without cost.

It's easy to write for *Electronic Design*, but it's often hard to get started. Send for your copy of our Author's Guide today.

Circle No.
250

THE TOTAL MEMORY SUPPLIER
**WE HAVE
BIPOLAR PLAS/FPLAS.
SOMETHING TO REMEMBER.**



Variety of Bipolars in stock. Field programmable input/output connections in the package for greatest flexibility. Both TS & OC available and second sourced.

Clip to letterhead. Show me how they can be programmed in-house & on-site, plus send complete list of total memories in stock.

Name _____ Title _____
Tel. _____ M.S. _____
811 E. ARQUES, SUNNYVALE, CA. 94086

THINK
Signoties

a subsidiary of U.S. Philips Corporation

© 1976

CIRCLE NUMBER 59

Engineers: Imagine Southern California

Hughes/Missile Systems is looking for a lot of good engineers. With Imagination.

Hughes Aircraft Company/Missile Systems Group, Canoga Park, California, is a highly respected, prestigious firm, noted for leadership in technology and for a long-term record of stability and growth. Creative engineering is our business, and we do it in a campus-like facility. You'll have a real chance to apply your skills to major missile programs:

*Circuits Engineers

Experience in design, development of RF/IF, digital, analog circuits for missile-guidance systems. Must know applicable state-of-the-art components.

*Systems Analysts

Tasks involve system function design, solving systems-engineering problems. Experience in signal processing, controls, assembly language, performance analysis, weapon-system integration.

*Electronic Product Engineers

Develop conceptual product designs for state-of-the-art electronic systems, and mechanize designs in low-cost hardware.

*RF Systems Engineers

Experience must include microwave-systems design and test, with emphasis on digital signal processing.

Degree from an accredited institution required. Send resume to: Engineering Employment, Hughes Aircraft, Fallbrook at Roscoe, Canoga Park, CA 91304.

HUGHES

HUGHES AIRCRAFT COMPANY
MISSILE SYSTEMS GROUP

US citizenship required
Equal opportunity M/F/H/C employer

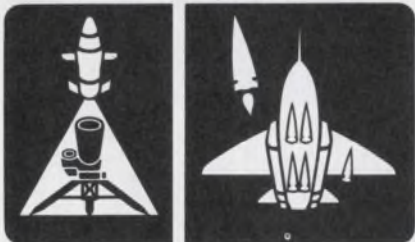

CIRCLE NUMBER 60

POWER SOURCES

New shape for Ni-Cd batteries

SAFT-America, 711 Industrial Blvd., Valdosta, GA 31601. Jack Landrieux (912) 247-2331. \$1.51 (1000 qty); 2 wks (samples); 6 wks (prod. qty).

The VEP-430 rechargeable Ni-Cd cell measures $2.5 \times 1.2 \times 0.18$ in. With this flat shape the cell packs 430 mA-h of capacity which is comparable to AA type cells. This cell can be recharged in 6 h, and it has a safety vent.

CIRCLE NO. 354

Small unit doubles as transfer standard



Datel Systems, 1020 Turnpike St., Canton, MA 02021. (617) 282-8000. \$295; 4 to 6 wk.

The $5.6 \times 2.1 \times 5.5$ in. DVC-8500 voltage calibrator generates a bipolar output of up to ± 19.999 V at 25 mA. Its 1-mV switch-selected steps are accurate to 0.005% of full-scale or ± 1 mV of setting. A front-panel continuous-vernier control with $100 \mu\text{V}$ graduations varies the output setting from 0 to ± 1.5 mV for zeroing calibration. The instrument features a 90-day drift stability of 27 ppm of full scale and a zero drift of $5 \mu\text{V}$. Over the 0 to +50 C range, the calibrator offers less than 1-mV error (1 count in a 4-1/2-digit instrument). A buffered +10 V, 5 mA reference output allows external reference tracking. Remote sensing is also provided. A LED overload lamp lights if the bipolar output exceeds 25 mA. Powered by 100, 115 or 230 V ac $\pm 10\%$, 47 to 440 Hz at 10 W, the unit offers transformer isolation of ± 300 V dc from output-common and an output impedance of less than 10 m Ω . Wideband output noise is $25 \mu\text{V}$ pk-pk max. An optional kit adapts the instrument for panel mounting.

CIRCLE NO. 355

CRT supply allows fast blanking

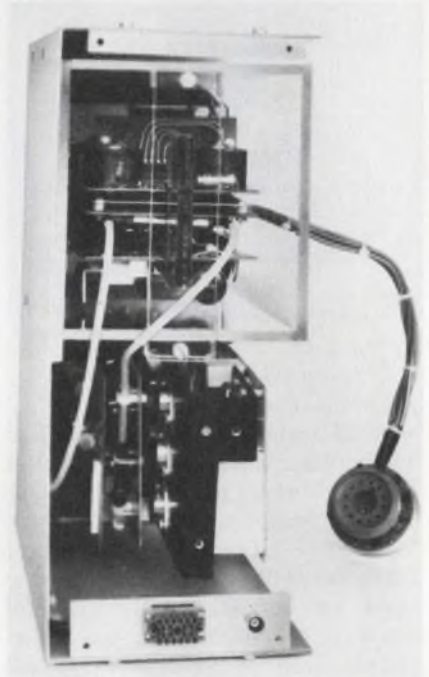

Spellman High Voltage Electronics, 1930 Adeo Ave., Bronx, NY 10469. (212) 671-0300. \$2000; 10 wks.

The FDC-15 high-voltage CRT power supply for depressed-cathode-mode operation features blanking rates up to 4 MHz with 70-ns rise-and-fall times. The unit operates from an input of ± 35 V dc at 0.75 A. Outputs are: -15 kV $\pm 2\%$ at $250 \mu\text{A}$, for the depressed cathode (Q); -10 to -140 V (referenced to the cathode) for G_1 ; $+1$ kV $\pm 2\%$ at 5 mA (referenced to the cathode) for G_2 ; 40 V more negative than G_1 for G_1 blanking; 6.2 ± 0.1 V dc at 0.8 A for the filaments. The G_1 voltage, which has a 14 mV/ $^\circ\text{C}$ tempco, is adjustable by a ground-referenced variable resistor. Regulation, for line and load extremes, is 0.1% for Q, G_1 and G_2 , while the filament voltage is maintained within $\pm 2\%$. For low ripple and low stored energy, a 30-kHz series-resonant inverter generates the regulated voltages. All voltages are short-circuit and arc-over protected with a self-restoring feature. Cutoff of G_2 is assured should the filaments drop below 5 V, or G_2 current exceed 5 mA. The supply contains four plug-in PC boards on a ground-referenced chassis and three PC boards semi-enclosed in plastic. High-voltage circuits are encapsulated in silicone.

CIRCLE NO. 356

Application Notes

Advanced calculators

What to Look for Before You Buy an Advanced Calculator is a readable, comprehensive analysis of available scientific, business and programmable calculators. Hewlett-Packard, Palo Alto, CA

CIRCLE NO. 357

Voltage regulators

The theory and practical application of IC voltage regulators are described in a 202-page handbook. The handbook contains sections on basic regulator theory, easy-to-use circuit configurations and practical design examples. The book is priced at \$2.50. Motorola Semiconductor Products, Literature Distribution Center BB100, P.O. Box 20924, Phoenix, AZ 85036

INQUIRE DIRECT

Polishing IR crystals

How to Polish Crystals, a 10-page brochure, details the techniques used to grind, polish and buff sodium-chloride, potassium-bromide and cesium-bromide crystals and cavity cells used in infrared spectrophotometers. Barnes Engineering, Stamford, CT

CIRCLE NO. 358

CDP1802 μ P

Written for engineers having only a limited familiarity with computers and computer programming, the *User Manual for the RCA CDP1802 COSMAC Microprocessor* guides the reader through the μ P architecture and introduces a set of comprehensive easy-to-use programming instructions. Copies of the 115-page guide may be obtained at \$5 a copy from RCA Solid State Div., Box 3200, Somerville, NJ 08876.

INQUIRE DIRECT

Data acquisition

"Everything from Computers to Connectors" is described in a 16-page brochure about using computers for data acquisition and control. Data General, Southboro, MA

CIRCLE NO. 359

Stress-analysis techniques

The techniques of experimental stress analysis are described in a 20-page catalog. Application photographs are shown. Vishay Inter-technology, Malvern, PA

CIRCLE NO. 360

Time-sharing

Looking at the possibility of using time-sharing for the first time? A four-page brochure, written for the new users of time-sharing or remote communications, shows how it can be done. Omnitech, Phoenix, AZ

CIRCLE NO. 361

QUICK-CONNECT BLOCKS

With Infinite Design Possibilities

There's an Underwriters Terminal Block for virtually any design requirement you have or can conceive.

No other line offers a wider selection of blocks and variations of in-block circuitry. Any number of terminations. Wide choice of configurations. Most are UL recognized and CSA certified. Blocks in kit form, too. Also special designs and hot-stamped coded blocks.

Request bulletin.

Underwriters Safety Device



an **Eltra** company

7300 W. Wilson Ave., Chicago, Ill. 60656 • 312-867-4600

CIRCLE NUMBER 61

ELECTRONIC DESIGN 3, February 1, 1977

THE TOTAL MEMORY SUPPLIER

WE HAVE 8K OR 16K N-CHANNEL ROMS. KEEP THAT IN MIND.

Easy to buy, one time mask charge per code. Easy to order 300 piece minimum. Easy to get. One hundred piece minimum delivered as fast as four weeks after receipt of order.

Clip to letterhead. Send details on 8K and 16K ROMS plus full list of total memories in stock.

Name	Title
Tel.	M.S.

811 E. ARQUES, SUNNYVALE, CA. 94086

THINK **Signetics**

a subsidiary of U.S. Philips Corporation

©1976

CIRCLE NUMBER 62

Electro-optics, Optomechanics, Infrared, Laser, Computer Hardware Development, Radar

The professionals: EEs, physicists

The tasks: advanced and conceptual design; electro-optical sensor analysis; performance analysis; advanced image and signal processing; stabilization/tracking analysis; systems design, including space-based programs; circuit design that uses MOS or bipolar; design of CCDs and microprocessor/microcomputer techniques.

The professionals: EEs, physicists, MEs

The tasks: device development; high-energy-laser alignment-control systems; servos; precision gimbals and mechanisms.

The professionals: EEs

The tasks: computer-controlled test equipment and system integration and checkout, including systems design and application.

The professionals: radar circuit designers

The tasks: analog or digital circuit design and development; radar transmitters; RF subsystems—all using RF power-amplifier components/subsystems, modulators, high-voltage power processing, and control/protection circuits and techniques.

The professionals: radar systems engineers

The tasks: systems design using Fourier analysis, pattern recognition, and radar signal processing using digital techniques.

Degree from an accredited institution required. Please send resume to: Professional Employment, Hughes Aircraft Company, 11940 West Jefferson Blvd., Culver City, CA 90230.

HUGHES

HUGHES AIRCRAFT COMPANY

AEROSPACE GROUP

US citizenship required
Equal opportunity M/F/H/C employer

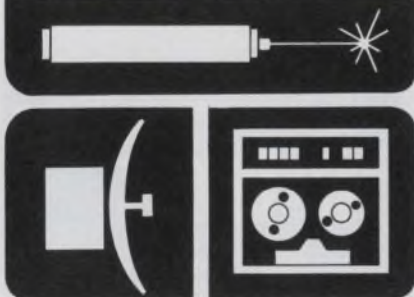

CIRCLE NUMBER 63

New Literature

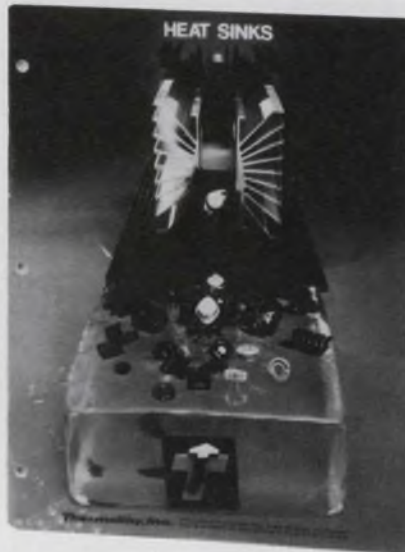

Heat sinks

A 52-page heat-sink catalog features a quick-reference index by case style, thermal performance and part number. Engineering drawings, thermal performance curves, photographs and isometrics are provided. Thermalloy, Dallas, TX

CIRCLE NO. 362

Modular products

Application and theory notes on the miniModem modular products and the use of Cermetek filters with IC modulator/demodulator products are given in a 16-page catalog. Cermetek, Mountain View, CA

CIRCLE NO. 363

EMI/RFI shielding

The 124-page *Metex EMI/RFI Shielding Handbook & Catalog* contains theory, gasket design, method of gasketing and package design for EMI shielding. It contains equations, tables, graphs and photos. The price of the book is \$10; however it is free to qualified engineers who request a complimentary copy on their company letterhead. Metex Corp., 970 New Durham Rd., Edison, NJ 08817.

INQUIRE DIRECT

Cabinets

Be your own stylist. Pick out the cabinet in your choice of color and style from a four-color 20-page catalog. Amco Engineering, Chicago, IL

CIRCLE NO. 364

Digital panel meters

Thirty-nine basic models of Ballantine's 4-1/2, 3-1/2 and 2-1/2 digital panel voltmeters and ammeters are described in a brochure. Ballantine Laboratories, Boonton, NJ

CIRCLE NO. 365

San Francisco year

A four-color calendar, suitable for framing and with a scene depicting the Golden Gate Bridge and the San Francisco bay and skyline, is available from California Microwave, Inc., Sunnyvale, CA

CIRCLE NO. 366

μ P bibliography

A bibliography entitled " μ P: Microprocessors 1970-75" covers 145 articles selected from top industry publications. Information is supplied on the author, publication, data of issue and page numbers. Newark Electronics, Semiconductor Div., Chicago, IL

CIRCLE NO. 367

Resistors, switches

Precision and power wire-wound resistors, miniature rotary switches, PIP switches, ladder networks, knobs and accessories and electromagnetic delay lines are covered in a catalog. RCL Electronics, Irvington, NJ

CIRCLE NO. 368

Solid-state memories

Memory products are described in a 16-page catalog. The brochure gives basic parameters and benefits for six CMOS memories (five static RAMs and one ROM), ranging from 4×8 to 512×8 ; static and dynamic NMOS RAMs, both 1-k and 4-k; and three static 1-k SOS RAMs. RCA Solid State Div., Somerville, NJ

CIRCLE NO. 369

Bulletin Board

Interdata has introduced software to provide line-level or device-dependent support for synchronous data link control (SDLC). The new software enables designers to develop communications systems compatible with the SDLC protocol.

CIRCLE NO. 370

The Digital Products Div. of Fairchild has added six circuits to its Isoplanar 4000 series CMOS family. They are the 4006 18-stage shift register; the 4041 quad true/complement buffer; the 4043 quad NOR R/S latch, three-state; the 4044 quad NAND R/S latch, three-state; the 4510 BCD up/down counter; and the 4516 binary up/down counter.

CIRCLE NO. 371

EMM/SEMI has entered the military memory components market with the introduction of its military-grade 4096 × 1 static RAM.

CIRCLE NO. 372

Tracor Westronics has re-issued its 510 model indicator for analog signal types and the 520 indicator for linear types. Plug-in range modules are standard and feature solid-state circuitry.

CIRCLE NO. 373

Trak Microwave has added standard and full-bandwidth waveguide isolators to its product line.

CIRCLE NO. 374

Burroughs Corp. has announced increased main memory capacities for the medium-scale B 2800 and B 3800 systems. These systems can be expanded from the current capacity of 500,000 bytes to one-million bytes of MOS IC memory.

CIRCLE NO. 375

Motorola's MC3503 quad op amp is available in flip-chip form as well as in conventional chip form and in a variety of plastic and hermetic packages. The flip-chip consists of a silicon chip with solder bumps on the geometry surface to provide easy mechanical mounting and electrical connection.

CIRCLE NO. 376

Texas Instruments is second-sourcing Fairchild's μ A78M and μ A79M series of fixed voltage regulators.

CIRCLE NO. 377

Mostek is second-sourcing the Zilog Z80 component family, which includes the Z80 CPU (Mostek MK 3880); Z80 parallel I/O controller (MK 3881), Z80 DMZ (MK 3883), Z80 serial I/O controller (MK 3884), and Z80 counter/timer circuit (MK 3882). Mostek has also unveiled a new development system designed for support of the company's Z80 microcomputer.

CIRCLE NO. 378

WHO MAKES WHAT & WHERE TO FIND IT

Volume 1 of **Electronic Design's GOLD BOOK** tells all. And, when you look up an item in its **PRODUCT DIRECTORY** you'll find each manufacturer listed **COMPLETE WITH STREET ADDRESS, CITY, STATE, ZIP AND PHONE.** Save time. There's no need to refer elsewhere to find missing information.

IT'S ALL THERE
in
Electronic Design GOLD BOOK

THE TOTAL MEMORY SUPPLIER

WE HAVE BIPOLAR MIL-SPEC MEMORIES. STORE THAT AWAY.

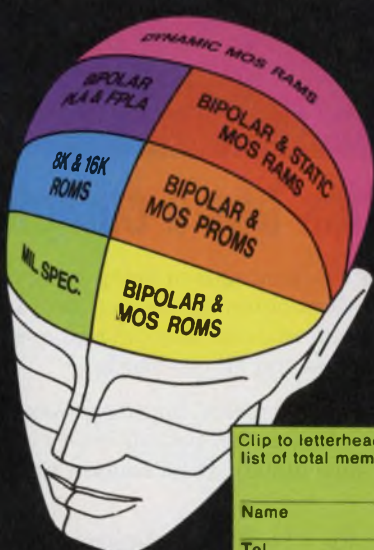

Total lineup manufactured in fully military approved plants. RAMs, ROMs, PROMs, FPLAs to 883 processing. Dual in-lines & flat packs ready to take on toughest assignments.

Clip to letterhead. Send entire list of total memories in stock.

Name	Title
Tel.	M.S.
811 E. ARQUES, SUNNYVALE, CA. 94086	

THINK signotics

a subsidiary of U.S. Philips Corporation

© 1976

We're the only total memory supplier.

Remember it.

Only Signetics has a complete line of Bipolar & MOS memories.

There are definite advantages in doing business with a total supplier. Most obvious, you get everything you need from one source without shopping all over the country. So you save time and all the hassle.

In addition, you get increased buying power. Because when you buy in volume, you naturally get the lowest price. So you save money. It all sounds simple because it is.

Signetics has made a positive commitment to stay ahead in technological leadership in Bipolar & MOS memories. No brag, just fact. With years of experience in supplying the needs of major customers and being a subsidiary of U.S. Philips Corporation, Signetics has the resources to make it happen.

Signetics has a total product line of memories — RAMs, ROMs, PROMs, FPLAs/PLAs and a long list

of Shift Registers including 12 Static and 8 Dynamic from 100 to 1024 bits.

Signetics Bipolar & Static MOS RAMs.

Signetics' total line of Bipolar & MOS devices includes all the hard-to-find and in-demand devices. 24 Bipolars — 8 to 1024 bits. 14 MOS Statics — 256 x 4 to 1024 x 1. 1K x 4 and 4K x 1 available 1st quarter '77.

Signetics Dynamic MOS RAMs. The most complete line of dynamic MOS RAMs from 1024 x 1 to 4096 x 1 (16, 18 and 22 pin). 1024 x 1 to 4096 x 1 organization. 16K x 1 available 1st quarter '77.

Signetics Bipolar & MOS ROMs. These mask-programmable chips offer easy word expansion. 13 Bipolars in stock — 256 to 16K bits. 7 MOS Statics in stock — up to 16K bits. Plus 4 character generators including 8K's. Both TS and OC available.



Signetics Bipolar & MOS PROMs.

All readily available through a vast Signetics distributor programming network. The new 18-pin devices offer small size, high PC board packing density, low complexity, very low power, and low component and system cost. 17 Bipolars in stock from 256 to 8K bits, with 16K available 1st quarter '77. 4K and 8K MOS EROMS available 1st quarter '77.

Signetics Bipolar FPLAs/PLAs. All devices deliver increased do-it-yourself flexibility and greatest system reliability with fewer parts and connections. It's easiest, fastest and simplest to modify and correct logic functions by limited editing of input/output connections within the package, and it's second sourced. Both TS and OC are available and in stock.

Signetics Bipolar MIL-SPEC Memories. Total line manufactured to 883 military standards and available in dual in-line and flat pack configurations. In addition, Signetics supplies logic and analog require-

ments from standard military circuits to proprietary high performance series—making Signetics the total military supplier, too.

Clip to letterhead for fast response.

- Send me a full list of total Bipolar & MOS memory line.
- Please have a Field Applications Engineer call me for an appointment.

My application is _____

Name _____ Title _____

Telephone _____ Mail Stop _____

THINK Signetics

811 E. Arques Ave., Sunnyvale, Ca. 94086

© 1976.

A subsidiary of U.S. Philips Corporation

ANNOUNCING

D-20 LINE-OF-20 DIGITS THERMAL PRINTHEAD

- 20-1x5 DOT MATRIX SILICON IC'S
- ALPHA-NUMERIC, 5 DOT, 0.080 INCH CHARACTER WIDTHS ON 0.105 INCH CENTERS
- BUTTABLE: 20, 40, 60, 80,....., COLUMNS
- SPEED: 100 CHARACTER LINES/MINUTE
- ENERGY: 12 MILLIJOULES/DOT ACTIVATED
- SIMPLE, STANDBY, HARDCOPY PRINTOUT FOR VISUAL DISPLAYS OR INSTRUMENTS
- PRICE: (1-9) \$100. QUANTITY DISCOUNTS
- AVAILABLE: IMMEDIATELY FROM PLANT ONLY
- D-20 PAPER TRANSPORT: AVAILABLE BY MAY

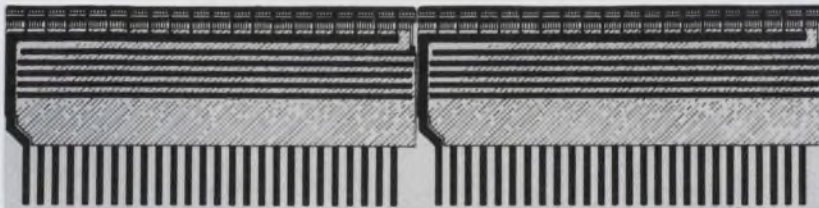

Call or write
 Cliff Ensminger, (214) 239-9193
 4124 Billy Mitchell Road P.O. Box 737
 Addison, Texas 75001
 Circle Reader Service No. 141



PS-40 THERMAL SERIAL PRINTER

- F-8 MICROPROCESSOR CONTROLLED INTERFACE TTL PARALLEL, AND TTL OR RS232C SERIAL
- RS232C: VERSION A: "UNBUFFERED"
 TYPE C -- 110 BAUD
 TYPE D -- HANDSHAKING, 300 BAUD
- RS232C: VERSION B: "BUFFERED"
 TYPE D -- HANDSHAKING, UP TO 9600 BAUD
- ADJUSTABLE 24 TO 48 COLUMNS
- MECHANISM 1-24 \$300; WITH INTERFACE \$550

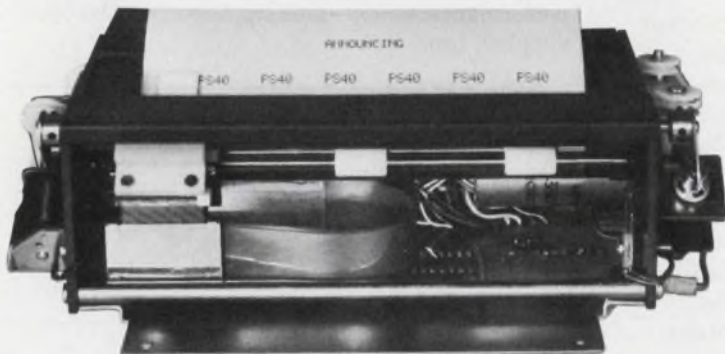

For more information contact
 Dick Hanschen, (214) 233-6631
 4132 Billy Mitchell Road P.O. Box 796
 Addison, Texas 75001
 Circle Reader Service No. 142

telpar, inc.

CIRCLE NUMBER 67

Vendors Report

Annual and interim reports can provide much more than financial position information. They often include the first public disclosure of new products, new techniques and new directions of our vendors and customers. Further, they often contain superb analyses of segments of industry that a company serves.

Selected companies with recent reports are listed here with their main electronic products or services. For a copy, circle the indicated number.

Varian. Electronic components; analytical instruments; minicomputer systems; industrial equipment and linear accelerators.

CIRCLE NO. 379

Mostek. Memory circuits; μ Ps; consumer and industrial circuits.

CIRCLE NO. 380

Joslyn. Electric power and distribution equipment.

CIRCLE NO. 381

Baird Atomic. Analytical instruments, components and systems.

CIRCLE NO. 382

Cavitron Corp. Medical electronics.

CIRCLE NO. 383

Texas Instruments. Semiconductors, memory components, μ Ps, calculators, data terminals, consumer electronics and metallurgical materials.

CIRCLE NO. 384

Analog Devices. Computer interface products; analog products and modular instruments.

CIRCLE NO. 385

National Bureau of Standards. Calibrate standards.

CIRCLE NO. 386

Recognition Equipment. OCR systems and equipment for banking and credit-card applications.

CIRCLE NO. 387

Data Access Systems. Data terminals and electromagnetic shielding.

CIRCLE NO. 388

Milgo Electronic. Data communication products, modems and terminals.

CIRCLE NO. 389

Tech/Ops. Electronic controls; industrial radiography equipment; analytical instruments and broadcasting.

CIRCLE NO. 390

John Fluke Mfg. Co. Electronic test and measurement instruments.

CIRCLE NO. 391

Data General. Digital computers and peripheral products.

CIRCLE NO. 392

Belden. Wire, cable and cord.

CIRCLE NO. 393

SRI. Research & development.

CIRCLE NO. 394

United Computing Systems. Communications networks.

CIRCLE NO. 395

Triangle Industries. Metal fabricated products, coin-operated equipment and preinsulated pipe.

CIRCLE NO. 396

Engelhard Minerals & Chemicals. Ores, minerals and metals.

CIRCLE NO. 397

Tocom. Cable TV and communications equipment.

CIRCLE NO. 398

Pertec. Tape transports; key data entry systems; digital and flexible disc drives; key disc data processing systems; CRT terminals and computer output microfilm systems.

CIRCLE NO. 399

Keene Corp. Commercial and industrial lighting products; pollution control/fluid handling products and industrial products.

CIRCLE NO. 400

Digital Computer Controls. General-purpose computers and associated software.

CIRCLE NO. 401

ARi Industries. High-precision products that sense and control temperature, generate heat and conduct electrical current.

CIRCLE NO. 402

Sola Basic. Electrical/electronic equipment for distribution and control of electric energy.

CIRCLE NO. 403

MSI Data. Electronic ordering systems.

CIRCLE NO. 404

The Ericsson Corp. International telecommunications.

CIRCLE NO. 405

Talley. Printers and data-communications systems.

CIRCLE NO. 406

Advanced Micro Devices. MOS/LSI, bipolar LSI, linear products and bipolar logic and interface.

CIRCLE NO. 407

Spar Aerospace Products. Gears and transmissions; solar arrays.

CIRCLE NO. 408

5½ DIGIT ACCURACY. 4½ DIGIT PRICE.

The 4600 is our brand new 4½ digit multimeter. It gives you the accuracy and resolution of typical 5½ digit multimeters. At half the cost.

And the 4600 stays accurate longer than other DVM's. DC accuracy stays within 0.01% ± one digit for six months at a time. We guarantee it.

80dB normal mode noise rejection produces a 10,000:1 reduction of excess noise. A full decade better than the 1,000:1 reduction of comparable instruments.

Loading errors are virtually eliminated by the 4600's 10,000M Ω input impedance on the two lowest DC voltage ranges.

There's a lot more. Send for a free catalog on our new 4½ digit 4600 multimeter. And find out how to get 5½ digit accuracy without paying for it.

Dana Laboratories, Inc.,
2401 Campus Drive, Irvine,
California 92715. 714/833-1234.



DANA

Others measure by us.

“AVAILABLE THROUGH ELECTRO-RENTS”

FOR PRODUCT DEMONSTRATION
CIRCLE #68

FOR LITERATURE ONLY
CIRCLE #125

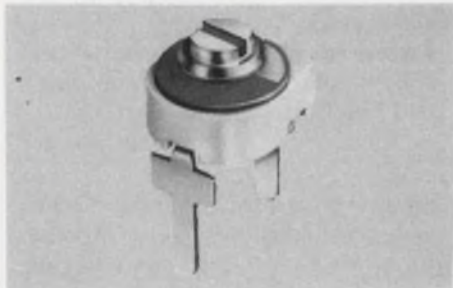

MINIATURE CERAMIC TRIMMER CAPACITORS 9371 series of ceramic trimmer capacitors are compact, economical and rugged. They are 50% smaller than other trimmers of this type yet provide high capacitance values. Available in 4 capacitance ranges, 1.5 to 4, 3.0 to 10, 3.5 to 18 and 5.0 to 25 pf with Q's > 300 at 10 MHz. They have an overall diameter of .225" with .215" above board height. **JOHANSON MANUFACTURING CORPORATION**, Rockaway Valley Road, Boonton, N.J. 07005 201-334-2676

TRIMMER CAPACITORS

181



MAGNETIC SHIELDING Take advantage of Eagle's 23-year background in shield design and production. Custom and standard models. Full service includes design, engineering, fabrication, heat treating, finishing, testing. Also wide selection of sheet and foil so you can form your own shields. For helpful design and cost data, request Bulletin E-77. **Eagle Magnetic Co., Inc.**, Box 24283, Indianapolis, IN 46224, 317-297-1030.

MAGNETIC SHIELDING

184



MULTI-TURN ABSOLUTE ENCODER ± 1 part in 100,000 system accuracy—Electro-Magnetic Transducer +5 digit LED Display + BCD, Binary, and DC output — 10, 64 or 100 turns — adjustable scale factor (0 to 999,999) — Hi noise immunity — zero offset — unambiguous cross-overs. Units less than \$995.00/axis. Send for Free Catalog & Application Notes. **Computer Conversions Corporation**, East Northport, N.Y. 11731 — (516) 261-3300

MULTI-TURN ABSOLUTE ENCODERS 187

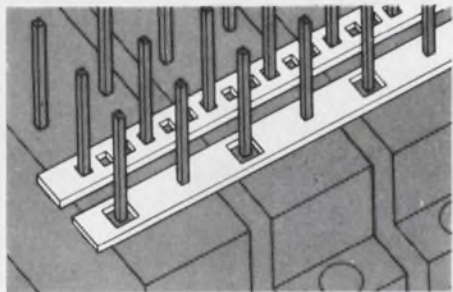

STRIP/BUS BY ROGERS. Low Cost Bussing Systems; easy installation, reliable solder joints; greater pin exposure. Write or call for details. **Rogers Corporation**, Chandler, AZ 85224. Phone (602) 963-4584. (EUROPE: Mektron NV, Ghent, Belgium; JAPAN: Nippon Mektron, Tokyo)

STRIP/BUS

182



400 IDEAS FOR DESIGN, Volume 3, ed. by Morris Grossman. Brainstorm with the experts! Volume 3 of 400 IDEAS FOR DESIGN contains the best selections from *Electronic Design* that were published between 1971 and 1974. You'll find a wide range of ideas from very complicated to simple, but unique, approaches. #5111-5, 348 pp., \$13.95. Circle the Info Retrieval Number to order your 15-day exam copy. When billed, remit or return book with no obligation. **Hayden Book Co.**, 50 Essex St., Rochelle Park, N.J. 07662.

IDEAS FOR DESIGN

185



Keypads speed up numeric entry four times or more. Attach in seconds. All characters. For TI, TTY-33, ADM-3, Memorex and... From \$200. Send terminal info for details. Also, data collection terminals, vandal-proof keypads and custom peripheral. **CASCADE RESEARCH ASSOCIATES**, POB 534, Longview, Wash. 98632 (206)425-9256

NUMERIC KEYBOARDS

188



FREE HIGH VOLTAGE CAPACITOR CATALOG. Complete source listings for over 1000 power, pulse, high voltage, and special purpose capacitors and high voltage power supplies in glass, plastic and CP72 styles. Special low inductance types for laser and high energy applications. Many "custom" designs are standard with us. High reliability, long life, moderate cost, and fast delivery assured. To get your catalog, just drop us a line. **Condenser Products Corporation**, P.O. Box 997, Brooksville, FL 33512.

HIGH VOLTAGE CAPACITOR CATALOG 183

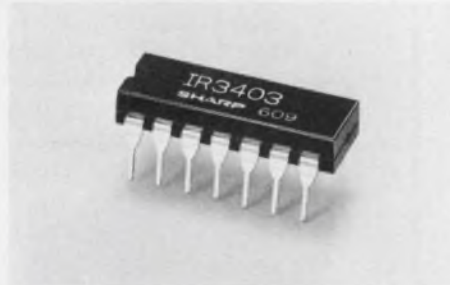

DUAL IN-LINE HIGH CURRENT DRIVER BLOCK *Special driver for Seiko 310, extra versatile. *5 Darlingtons with 350 mA output current each. *26V supply voltage. *14 pins. *Off-the-shelf sales. *45 cents each for 50K FOB Japan. Contact: **Sharp Corporation**, Semiconductor Div., 2613-1 Ichinomoto, Tenri City, Nara 632, Japan. Phone: (07436) 5-1321 Telex: 5522364 SHAPEL J

DARLINGTON ICS

186



CGH Metal Glaze Resistors from TRW operate in high ambient temperatures with excellent high voltage load stability. These thick film resistors are particularly suited for precision high voltage and high impedance applications such as voltage multipliers, X-ray equipment, and high voltage power supplies where precision tolerances and TCs are required. **TRW/IRC Resistors**, an operation of TRW Electronic Components, 401 N. Broad St., Phila., Pa. 19108. (215) 922-8900.

CGH HIGH VOLTAGE

189

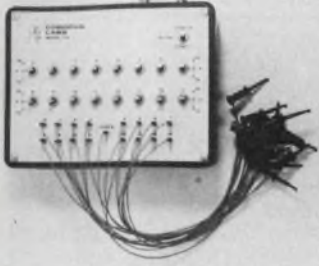

SIXTEEN BIT LOGIC TRIGGER Model 116 is an inexpensive solution to many digital circuit troubleshooting problems. It features synchronous and asynchronous modes, TTL compatible input logic levels, low input currents, miniature plug-in probes, and a 50-ohm output driver. Response time is typically better than 35ns. Compact—6.8 x 5.3 x 2.3 in. An unbeatable value at \$475. **CORDOVA LABS**, 4516 53rd St., Sacramento, CA 95820 (916) 455-8717 or 366-1292.

LOGIC TRIGGER

190



Free New '77 catalog contains over 34,500 quality power supplies from the world's largest manufacturer, Power/Mate Corp. Power Supplies for every application including submodulars, open frame, varigated, encapsulated, laboratory & system. All units UL approved and meet most military and commercial specs for industrial and computer uses. Power/Mate Corp., 514 S. River St., Hackensack, NJ 07601 (201) 343-6294

POWER SUPPLIES

193



MAY I HELP SPEED LEAD BENDING OPERATIONS? Cut costs by 50%! Fast, exact, thumbwheel control adjusts to precise measurements. Match pointers with eyelet holes in circuit boards by adjusting knurled wheel with thumb, automatically spacing bends for insertion of component into boards. All axial lead components accommodated. From 1/2" x 1 1/2" long with max. distance between inside of bends of 1.725". Harwil Co., 1548 17th Street, Santa Monica, CA. 90404. (213) 829-2310

COMPONENT LEAD BENDER

196

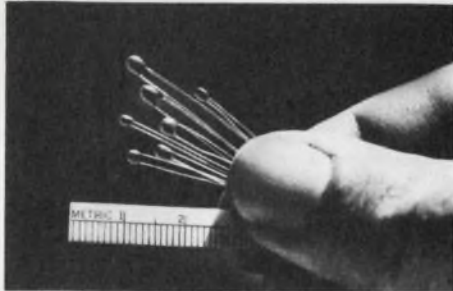

Chip Thermistors with leads and coating are highly reliable, exceptionally predictable, low cost components with small and miniature dimensions more compatible with modern circuit design. R @ 25°C 30 ohms to 3 meg ohms, tolerances ± 10% to ± 1%. Curved matched interchangeables ± 1°C to ± .3°C. Point matched interchangeables for temperature control R, to ± 1%. **WESTERN THERMISTOR Corporation**, 403 Via El Centro, Oceanside, CA 92054. (714) 433-4484.

THERMISTORS

191



LARGE-SCALE COMPUTER ARCHITECTURE: Parallel and Associative Processors, by Kenneth J. Thurber. A rare and comprehensive reference encompassing both general theory and practical coverage of the architecture of parallel and associative processors. Includes complete descriptions of ILLIAC IV, PEPE, STARAN, and OMEN. #5775-X, 352 pp., \$18.95. Circle the Info Retrieval Number to order your 15-day exam copy. When billed, remit or return book with no obligation. **Hayden Book Co.**, 50 Essex St., Rochelle PK, NJ 07662

COMPUTER ARCHITECTURE

194

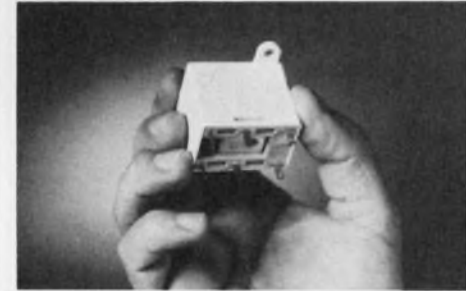

LOW COST 10 AMP MINI RELAY. 2 pole. Only 1.61" x 1.09" x 1.38" high. DPNO, DPNC OR DPDT contacts. DPNO is U/L recognized. 10 amp 0.8PF inductive 125V ac 60 Hz or 28V dc resistive. 470 mw sensitivity. 1/4" surface spacing between terminals inhibits arcing in high humidity areas. For refrigerators, TV, radio and similar equipment. A quality relay, reasonably priced. Series 39. **North American Philips Controls Corp.**, Frederick, Md. 21701. (301) 663-5141.

2 POLE GP RELAY

197

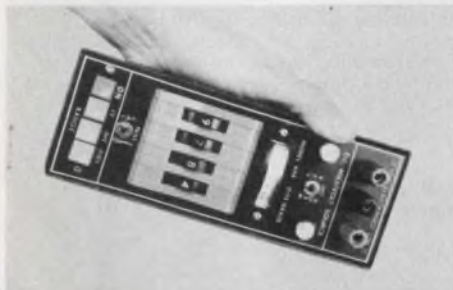

Millivolt Sources, Voltage & Current Calibrators, Potentiometers, Null Detectors. Choose from a complete range with convenient low impedance uV, mV or V outputs. Accuracies from 0.1% to 0.005%. Four, five or six digit thumb-switch display. Battery or line powered. Portable with built-in, high-stability reference. Ideal for many laboratory, industry or field uses. Prices start from \$225—available from stock. **Zi-Tech Division**, Aikenwood Corporation, 2151 Park Boulevard, Palo Alto, CA 94306.

192



NEW! Solid state digital timer: The new electronic digital timer measures time in hours, minutes and seconds. Time measurement, forward - Time measurement, backward - 24- /100 hours operation - High recycling accuracy - quartz time base - Easy reading - Incorporated powerpack - Panel mount case 72 x 72 x 160 mm. Request literature for complete details. **N. ZIVY & CIE SA.**, Box 412 C H-4104, Oberwil Switzerland Telex. NR 62254

DIGITAL TIMER

195

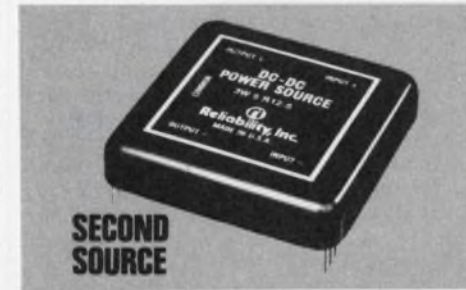

HIGH PERFORMANCE DC-DC POWER SOURCE provides highly regulated ±12-vdc and ±15vdc output. Low ripple and noise for data acquisition modules, op amps, etc. Short circuit protected. 100% burn in. Isolated outputs. Thermally protected. Input filtering. Quick delivery. Order evaluation units from stock. For pricing and a brochure, write **Reliability, Inc.**, P.O. Box 37409, Houston, Texas 77036. (713) 666-3261.

POWER SOURCE

198

Electronic Design

ELECTRONIC DESIGN's function is:

- To aid progress in the electronics manufacturing industry by promoting good design.
- To give the electronic design engineer concepts and ideas that make his job easier and more productive.
- To provide a central source of timely electronics information.
- To promote communication among members of the electronics engineering community.

Want a subscription? ELECTRONIC DESIGN is sent free to qualified engineers and engineering managers doing design work, supervising design or setting standards in the United States and Western Europe. For a free subscription, use the application form bound in the magazine. If none is included, write to us direct for an application form.

If you do not qualify, paid subscription rates are as follows: \$30.00 per year (26 issues) U.S., \$40.00 per year (26 issues) all other countries. Single copies are \$2.00 U.S., \$3.00 all other countries. The Gold Book (27th issue) may be purchased for \$30.00 U.S. and \$40.00 all other countries.

If you change your address, send us an old mailing label and your new address; there is generally a postcard for this bound in the magazine. You will have to requalify to continue receiving ELECTRONIC DESIGN free.

The accuracy policy of ELECTRONIC DESIGN is:

- To make diligent efforts to ensure the accuracy of editorial matter.
- To publish prompt corrections whenever inaccuracies are brought to our attention. Corrections appear in "Across the Desk."
- To encourage our readers as responsible members of our business community to report to us misleading or fraudulent advertising.
- To refuse any advertisement deemed to be misleading or fraudulent.

Microfilm copies are available of complete volumes of ELECTRONIC DESIGN at \$19 per volume, beginning with Volume 1, 1952 through Volume 20. Reprints of individual articles may be obtained for \$3.00 each, prepaid (\$.50 for each additional copy of the same article) no matter how long the article. For further details and to place orders, contact the Customer Services Department, University Microfilms, 300 North Zeeb Road, Ann Arbor, Michigan 48106 telephone (313) 761-4700.

Want to contact us? If you have any comments or wish to submit a manuscript or article outline, address your correspondence to:

Editor
ELECTRONIC DESIGN
50 Essex Street
Rochelle Park, N.J. 07662

Advertiser's Index

Advertiser	Page	Advertiser	Page
A P Products Incorporated	86	NEC America Inc.	Cover III
AMP, Incorporated	23	National Semiconductor Corporation	18, 19
Abbott Transistor Laboratories, Inc.	6	Newark Electronics	75
Advanced Micro Devices	4, 5	North American Philips Controls Corp.	75, 101
Aikenwood Company	101		
Alco Electronic Products, Inc.	83	Optron, Inc.	7
Allen Bradley Co.	15		
		Panasonic Company, A Division of Matsushita Electric Corporation of America	
Beckman Instruments, Inc. Helipot Division	12	Par-Metal Products Inc.	81
Bourns, Inc., Trimpot Products Division	Cover II	*Philips Electronic Components and Materials	12
Bunker Ramo Connector Division ...	34	Philips Test & Measuring Instruments, Inc.	50
		Plessey Semiconductors	67
Cascade Research Associates	100	Power/Mate Corp.	101
Computer Conversions Corp.	100	Power One, Inc.	82
Computer Labs, Inc.	88		
Condenser Products Corporation	100	RCA Solid State	Cover IV
Cordova Labs	101	Reliability, Inc.	101
		Reticon	79
Dana Laboratories, Inc.	99	Rogers Corporation	75, 100
Displaytek Corporation	98		
		*SE Labs (EMI) Limited	15
ECD Corp.	38	SMK Electronics Corporation of America	89
Eagle Magnetic Co. Inc.	100	Sharp Corporation	100
Electronic Design	91	Signetics Corporation	83, 85, 87, 89, 91, 93, 95, 96, 97
Electronic Navigation Industries	84	Sprague Electric Company	61
Esterline Electronics	82		
		TRW/IRC Resistors, an operation of TRW Electronic Components	100
Gold Book, The	10, 51, 77, 95	Technical Materials, Inc.	11
		Tektronix, Inc.	33
Harwil Co.	101	Teledyne Relays, A Teledyne Company	2
Hayden Book Company, Inc.	73, 100, 103	Tele-Dynamics, Division of Ambac	87
Hewlett-Packard	1, 8, 9, 16, 17	Telpar, Inc.	98
Hughes Aircraft Company	92, 94	Texas Instruments, Incorporated	27
		Thermalloy Company	86
IMC Magnetics Corporation	90	Triplett Corporation	69
Johanson Manufacturing Corporation	100	Underwriters' Safety Device Company	93
Kennedy Corporation, M. S.	80	Waters Manufacturing, Inc.	90
Kepeco, Inc.	30	Western Thermistor Corporation	101
Keystone Electronics Corporation	85		
		Zivy & CIE SA., N	101
Magnetics, Inc.	73		
Micro Devices Corp.	77		
Mini-Circuits Laboratory, A Division of Scientific Components Corp.	21		
Motorola Semiconductor Products, Inc.	28, 29		
Moxon, Inc.	25		

*Advertisers in non-U.S. edition

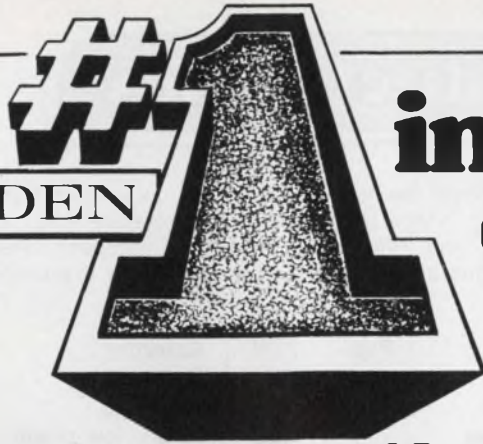

HAYDEN

in personal computing books!

See for yourself the reasons why:

- 1. MICROPROCESSORS: New Directions for Designers** by Edward A. Torrero, #5777-6, paper, 1975, 144 pp., 8½ x 11, illus., \$10.95.
- 2. GAME PLAYING WITH COMPUTERS** Rev. 2nd Ed., by Donald D. Spencer, #5103-4, cloth, 1976, 320 pp., 6 x 9, illus. \$16.95.
- 3. FUNDAMENTALS AND APPLICATIONS OF DIGITAL LOGIC CIRCUITS** by Sol Libes, #5505-6, paper, (\$6.95), #5506-4, cloth, (\$9.95), 1975, 192 pp., 6 x 9, illus.
- 4. COMPUTERS IN ACTION: How Computers Work** by Donald D. Spencer, #5861-6, paper, 1974, 160 pp., 6 x 9, illus., \$5.50.
- 5. COMPUTERS IN SOCIETY: The Wheres, Whys and Hows of Computer Use** by Donald D. Spencer, #5915-9, paper, (\$5.50), #5916-7, cloth, (\$7.50), 1974, 208 pp., 6 x 9, illus.
- 6. PROGRAMMING PROVERBS** by Henry F. Ledgard, #5522-6, paper, 1975, 144 pp., 6 x 9, illus, \$6.50.
- 7. PROGRAMMING PROVERBS FOR FORTRAN PROGRAMMERS** by Henry F. Ledgard, #5820-9, paper, 1975, 144 pp., 6 x 9, illus., \$6.50.
- 8. COBOL WITH STYLE: Programming Proverbs** by Louis J. Chmura, Jr., and Henry F. Ledgard, #5781-4, paper, 1976, 144 pp., 6 x 9, illus. \$5.45.
- 9. MINICOMPUTERS: Structure and Programming**, by T.G. Lewis and J.W. Doerr, #5642-7, cloth, 1976, 288 pp., 6 x 9, illus., \$12.95.
- 10. PATTERN RECOGNITION** by M. Bongard, #9165, cloth, 1970, 256 pp., 6 x 9 illus., \$14.90.
- 11. DIGITAL SIGNAL ANALYSIS** by Samuel D. Stearns, #5828-4, cloth, 1975, 288 pp., 6 x 9, illus., \$19.95.
- 12. BASIC BASIC: An Introduction to Computer Programming in BASIC LANGUAGE** by James S. Coan, #5872-1, paper, (\$7.95), #5873-X, cloth, (\$9.95), 1970, 256 pp., 6 x 9, illus.
- 13. ADVANCED BASIC: Applications and Problems**, by James S. Coan, #5856-X, cloth, (\$8.95), #5855-1, paper, (\$6.95), 1976, 192 pp., 6 x 9, illus.
- 14. FORTRAN FUNDAMENTALS: A Short Course** by Jack Steingraber, #5860-8, paper, 1975, 96 pp., 6 x 9, illus., \$4.95.
- 15. DIGITAL TROUBLESHOOTING: Practical Digital Theory and Troubleshooting Tips** by Richard E. Gasperini, #5708-3, paper, 1976, 180 pp., 8½ x 11, illus., \$9.95.
- 16. DIGITAL EXPERIMENTS** by Richard E. Gasperini, #5713-X, paper, 1976, 192 pp., 8½ x 11, illus., \$8.95.

Write for 15-day examination copies of any of these books!

At the end of 15 days, please remit payment plus postage and handling, or return the books and owe nothing. Prices subject to change without notice. If payment

accompanies order, we pay postage and handling. Outside USA, cash must accompany order — include \$2.00 per book for shipping and handling.



Hayden Book Company, Inc.

50 Essex Street, Rochelle Park, New Jersey 07662

phone: (201) 843-0550



Advertising Sales Staff

Tom W. Carr, Sales Director
Jean Bunfield, Sales Coordinator

Rochelle Park, NJ 07662

Robert W. Gascoigne
Daniel J. Rowland
Thomas P. Barth
50 Essex St.
(201) 843-0550
TWX: 710-990-5071

Philadelphia

Thomas P. Barth
(201) 843-0550

Boston 02178

Gene Pritchard
P.O. Box 379
Belmont, MA 02178
(617) 489-2340

Chicago 60611

Thomas P. Kavooras
Berry Conner, Jr.
200 East Ontario
(312) 337-0588

Cleveland

Thomas P. Kavooras
(312) 337-0588

Los Angeles 90045

Stanley I. Ehrenclo
Burt Underwood
Neil Canavin
8939 Sepulveda Blvd.
(213) 641-6544

Texas

Burt Underwood
(213) 641-6544

San Francisco

Robert A. Lukas
3579 Cambridge Lane
Mountain View, CA 94040
(415) 965-2636

London

Constance McKinley
50 Essex St.
Rochelle Park, N.J. 07662
Phone: (201) 843-0550

Amsterdam, Tokyo, Seoul

Sanders, W. J. M.
Raadhuisstraat 24
Graft-De Ryp, Holland
Phone: 02997-1303
Telegrams: Euradteam-Amster-
dam
Telex: 13039-SIPAS

Haruki Hirayama

Electronic Media Service
5th Floor, Lila Bldg.,
4-9-8 Roppongi
Minato-ku, Tokyo, Japan
Phone: 402-4556
Cable: Electronicmedia, Tokyo

Mr. O-kyu Park, President

Dongbo Intl Corp.—
World Marketing
C.P.O. Box 4010
Seoul, Korea
Tel. 76-3910/3911
Cable: DONGBO SEOUL
Telex: EBKOREA K27286

Information Retrieval Service. New Products, Evaluation Samples (ES), Design Aids (DA), Application Notes (AN), and New Literature (NL) in this issue are listed here with page and Information Retrieval numbers. Reader requests will be promptly processed by computer and mailed to the manufacturer within three days.

Category	Page	RSN	Category	Page	RSN
Components			MOS RAMs	83	46
antenna system	85	335	memories	97	66
arc lamps, xenon	84	333	RAMs, low power	78	305
coils	73	73	ROMs, 8-k or 16-k	93	62
current limiter	77	38	ROMs, 16-k	79	307
electronics catalog	75	35	receiver, line	78	301
fans	90	57	single chips, 24-pin DIP	III	263
ferrite cores	73	74	static & bipolar MOS		
impact detector	85	334	RAMs	85	49
keyboard, low profile	84	332			
pendulum potentiometers	83	331	Microprocessor Design		
potentiometers	II	262	accessories, μ C	36	509
relays	2	3	aids, development	35	507
relays, 10-A	75	34	card set, computer	37	510
relays, reed	82	42	terminal, microcomputer	36	508
resistor	17	12			
resistors	71	131	Microwaves & Lasers		
servomotors	85	336	mixers, double-balanced	21	14
switches, slide	83	44			
switches, toggle	83	45	Modules & Subassemblies		
switches, toggle	89	55	amp, instrumentation	81	322
varistors	84	330	converter, a/d	88	54
			converters, a/d	80	40
Data Processing			filters, tuned	80	310
computer, ruggedized	86	337	modulator, rf	80	320
minicomputer	86	338	multiplier	80	309
plotter	87	339	multiplier/divider	80	321
switching system	87	341	photoelectric	81	324
tester, data-link	87	340	regulator, voltage	81	323
			tapped analog delay	79	39
			transducers	7	7
Discrete Semiconductors					
Darlington arrays	88	344	Packaging & Materials		
diodes, auto-ignition	89	346	cabinets	81	41
diodes, Schottky	88	345	chip tester	91	351
LED display	88	343	conductive plastic		
SCR	89	348	elements	90	58
transistors	88	342	connectors	34	22
varactor diodes	89	347	DIP socket	91	353
			enclosure	90	350
Instrumentation			flat cable/connectors	86	51
C-meter	38	23	flexible circuits	75	36
DMMs	99	125	heat sinks	86	50
DPM	83	327	heat sinks, transistor	91	352
digital test instruments	25	16	inlay clad metals	11	10
function gen	83	328	pencil, ceramic marking	90	349
oscilloscope	33	101	sockets	23	15
oscilloscope	50	24	standoffs, spacers	85	48
probes	82	326	terminal blocks	93	61
programmable scope	83	329			
spectrum analyzer	82	325	Power Sources		
VOMs	69	29	battery-rechargeable	92	354
			power supply	82	43
Integrated Circuits			power supply	92	355
alphanumeric display	1	2	power supply	92	356
amplifier, precision	78	302	power supplies	6	6
amplifier, wideband	67	28	power supplies	30	19
bipolar & MOS PROMs	87	53	power supplies	87	52
bipolar & MOS ROMs	89	56			
bipolar memories	95	65	application notes		
bipolar PLAs/FPLAs	91	59	advanced calculators	93	357
CMOS	IV	264	polishing IR crystals	93	358
drivers, receivers, line	78	306			
generator, character	78	303			
generator, clock	79	308			

NOW: 1 TV SET = 1 CHROMA CHIP.

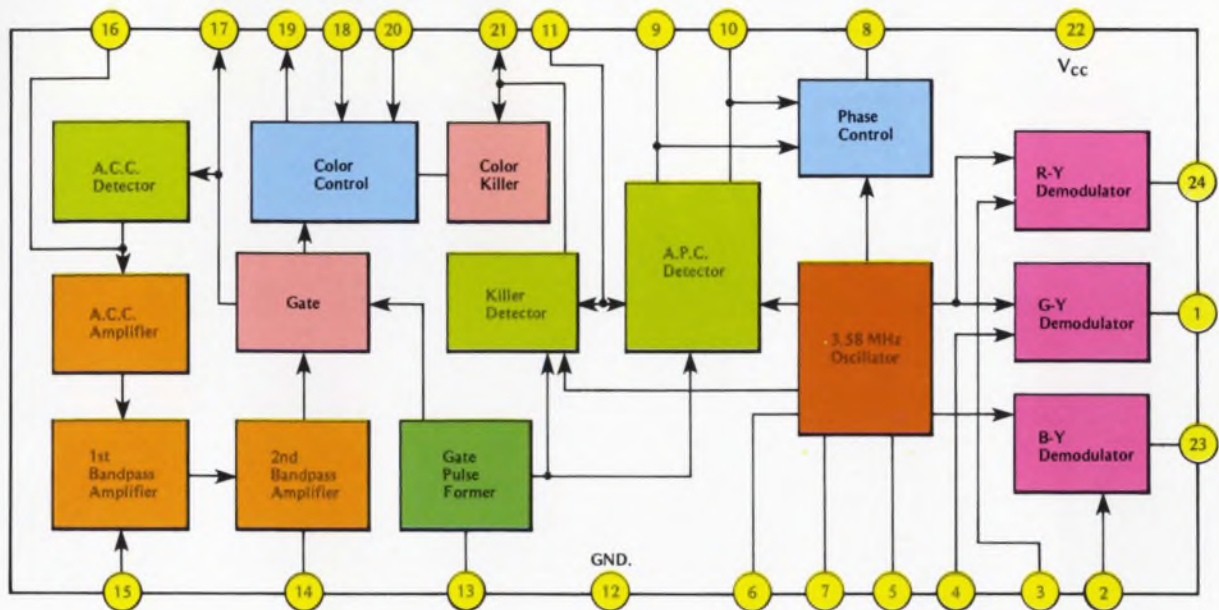

We're shipping what others are still developing.

Here's true high technology—you cut component count, assembly time, design time. And get every color processing function except video power output from one MSI device, the μ PC580C. While most other sources are still perfecting two-IC chroma, NEC's single-chip, plastic, 24-pin DIP is already user-proven in NTSC color TV. And being shipped in volume to TV manufacturers world wide.

In one chip, you get all these: ACC level and color killer setting automatically performed, eliminating variable resistors. Plus a triaxial color demodulator that lets you set the external axis. And, NEC gets rid of the tuning coils for you.

And more: The DC control system for color adjustment not only eases wiring, but greatly improves anti-interference characteristics. You get it all—ACC bandpass and color burst amps, color killer, phase-locked subcarrier regeneration, triaxial chroma demodulator, gating, detector, oscillators—everything but video output power stages. Ahead of its time? No way. You're ready, and so are we, with product in volume, high volume, and of super high quality.

The μ PC580C is just one sample of NEC's high technology, quality, and deliverability across the entire semiconductor spectrum. For more information, contact us.

This is what we're doing for TV. NOW: what can we do for you? With 60,000 employees, our 78-year old firm is shipping world-wide, high volumes of such products as:

ECL	TTL	MOS
Linear	Zeners	Discretes
Diodes	Rectifiers	Thyristors
Optoelectronics	Power transistors	

Quality? QUALITY! NEC's QC is the best in the world. Has to be, for us to have gained the customer confidence that's made us a major world source of semiconductors.

How can we help you? What do you need in semiconductors? Send a letter or give us a call about your needs. We could have some exciting answers for you. NEC America, Inc., Electron Devices Division, 3070 Lawrence Expy., Santa Clara, CA 95051, (408) 738-2180. We have representatives in major U.S. cities.

NEC
NEC America, Inc.

CIRCLE NUMBER 263

RCA announces...

COS/MOS-B. The new standard in CMOS.



COS/MOS-B is a comprehensive series of 130 high-voltage digital ICs which set new performance standards—yet conform fully to all JEDEC specs. This is what COS/MOS-B offers:

Unprecedented performance

- 20-volt rating
- 100% tested for quiescent current at 20 V
- Maximum input current (leakage) of $1 \mu\text{A}$ at 18 V over full package-temperature range; 100 nA at 18 V at 25°C
- Standardized symmetrical output characteristics
- 5, 10 and 15 V parametric ratings
- Noise margin (over full package-temperature range): 1 V at $V_{\text{DD}} = 5 \text{ V}$; 2 V at $V_{\text{DD}} = 10 \text{ V}$; 2.5 V at $V_{\text{DD}} = 15 \text{ V}$



New design options

You can either take advantage of these higher ratings—or gain some extra insurance by electing not to design to maximum limits.

Add all this performance and flexibility to the inherent advantages of COS/MOS, plus the multiple-source advantage that comes from conformance to JEDEC specs, and you have an IC product line in a class by itself.

The RCA COS/MOS-B product guide gives you all the basic information you need to move into your new high-voltage design. For your copy, contact your RCA Solid State distributor. Or RCA.

Write: RCA Solid State,
Box 3200, Somerville,
NJ 08876; Sunbury-on-
Thames, Middlesex
TW16 7HW, England;
Ste.-Anne-de-Bellevue,
Quebec, Canada; Fuji
Bldg, Tokyo, Japan.

RCA

RCA. First house in CMOS.

CIRCLE NUMBER 264